

**MOULD  
KING**®

宇 | 星 | 模 | 王

12009

1809+ Pcs/Pza

宇星世界铁路系列  
**WORLD RAILWAY**

No. 铁路信号塔  
Train signal station



mould king

# OPEN



广东宇星科技

微信扫描二维码，关注公众号。  
获取第一手的新品资讯，享受  
便捷的补件服务。

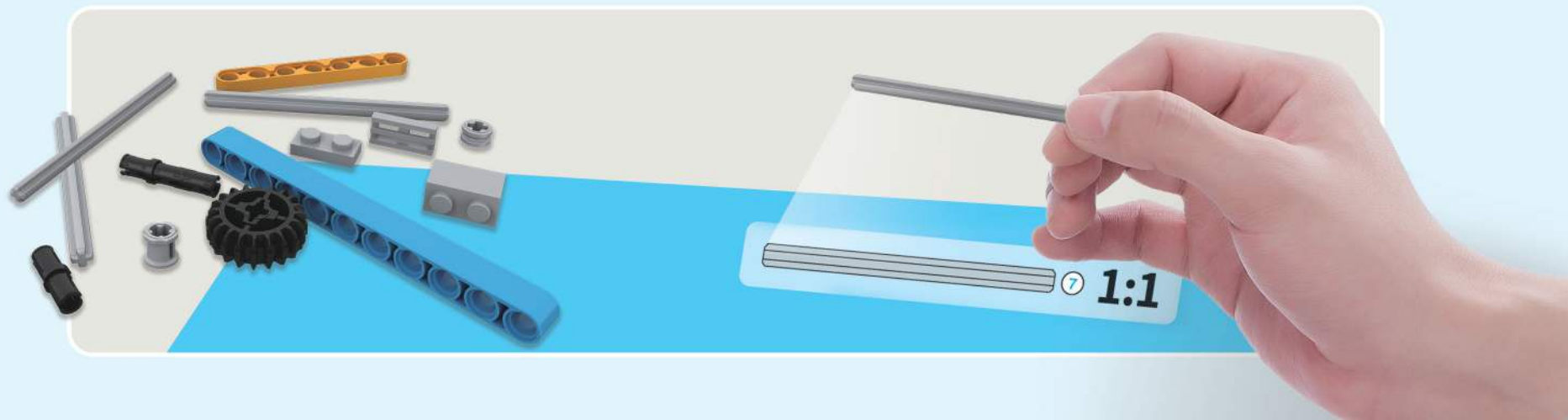

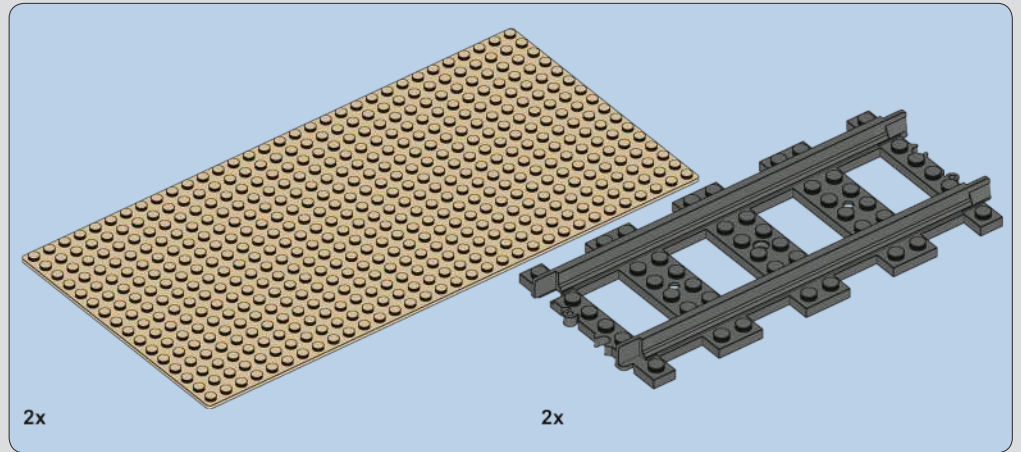
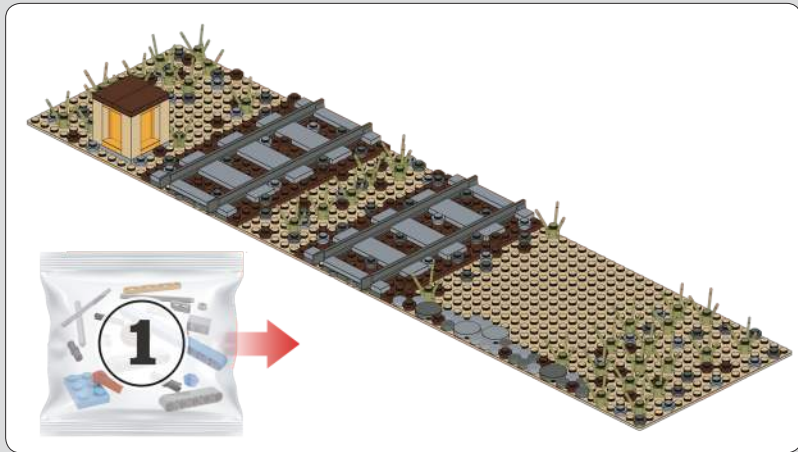

1

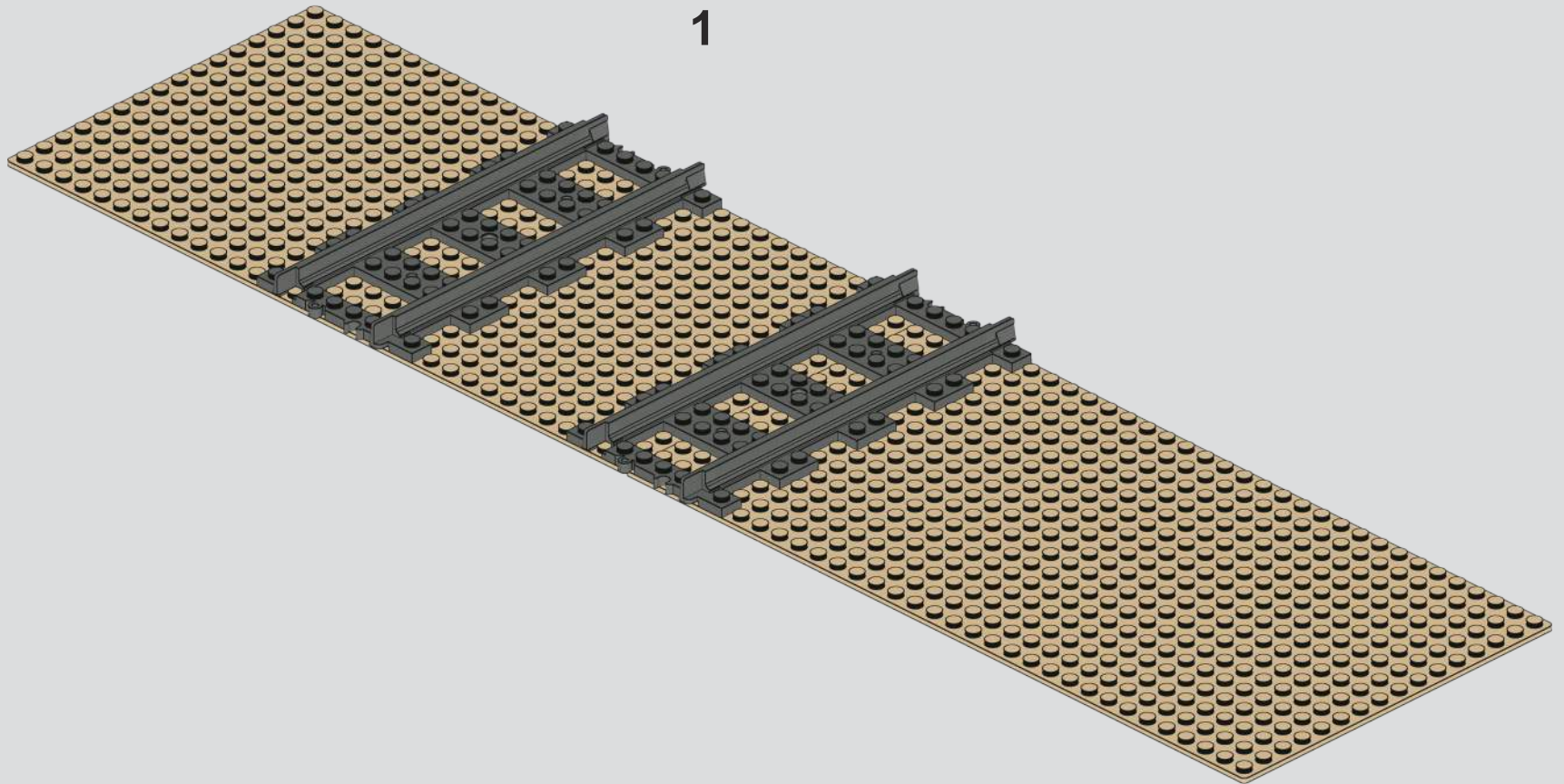

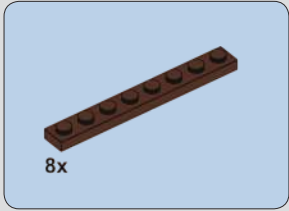

2

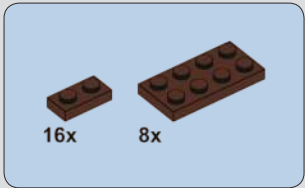
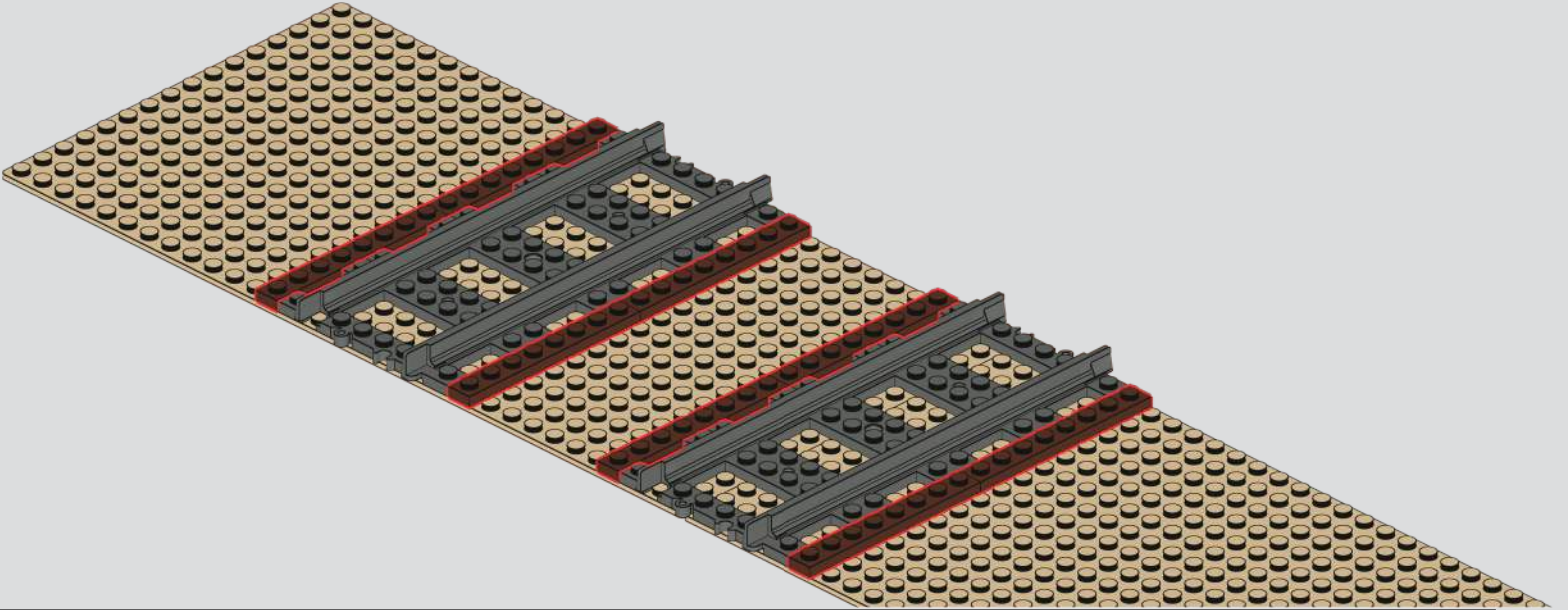

3

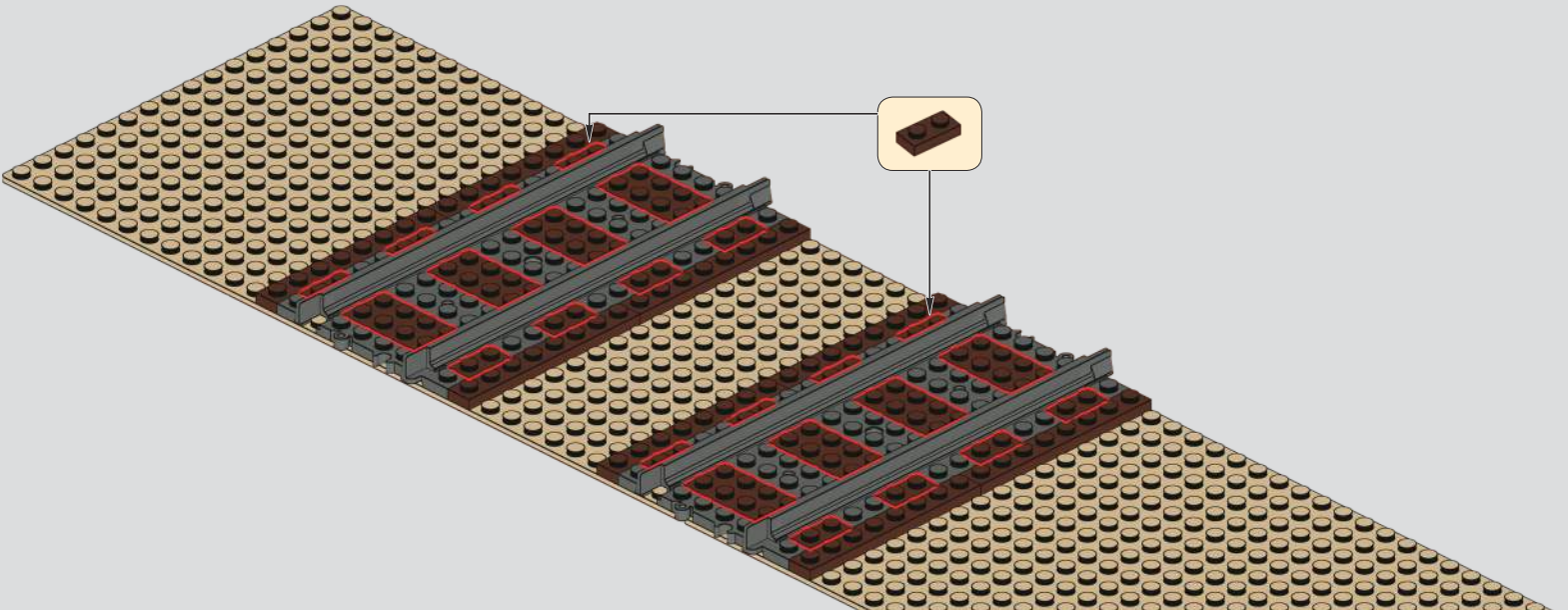

2

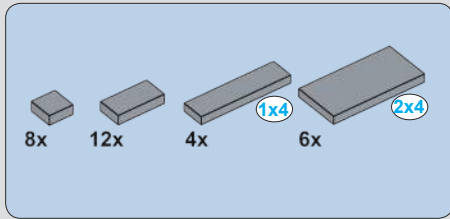

4

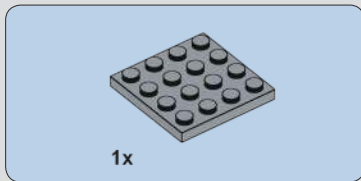
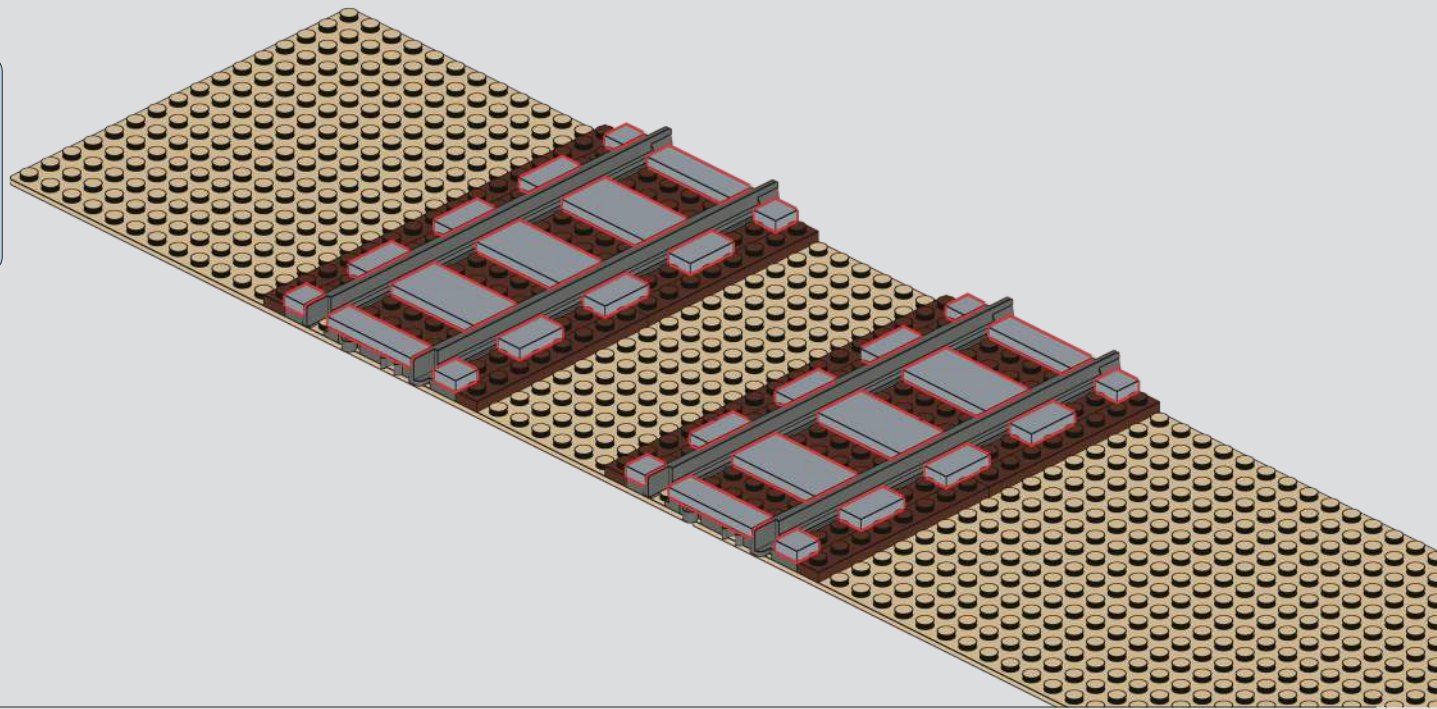

5

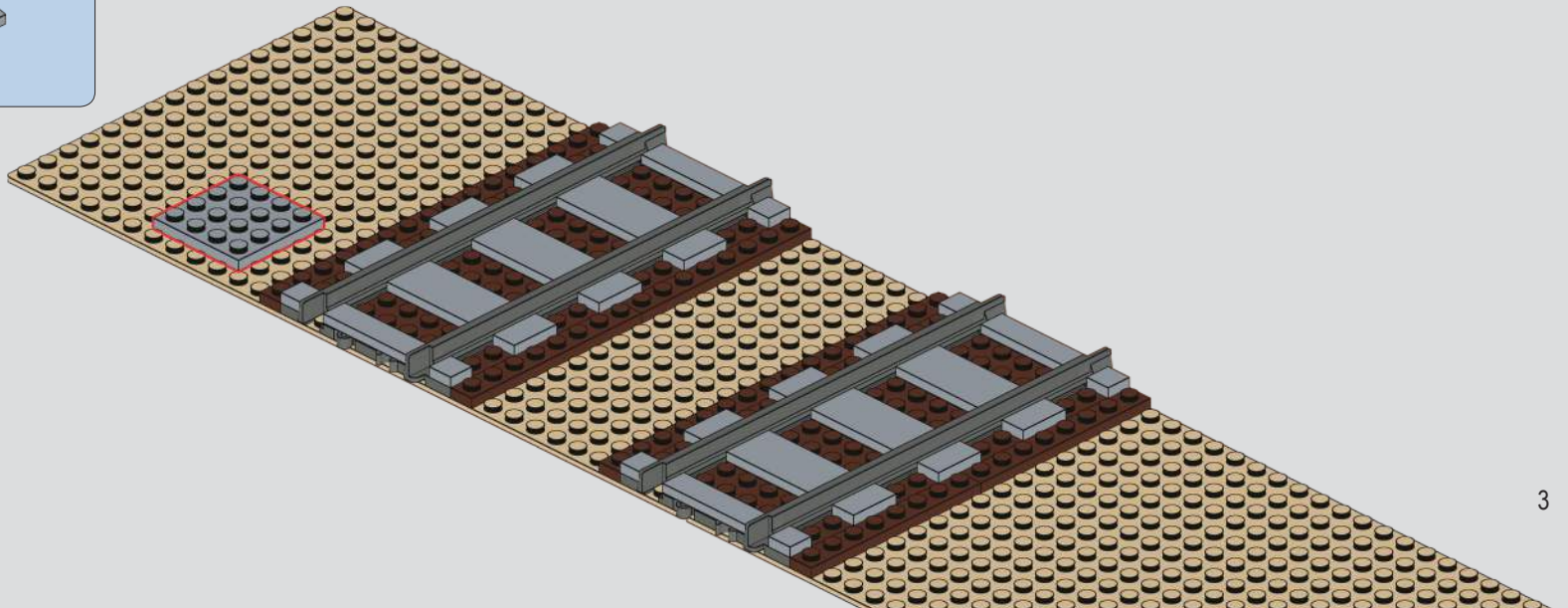

6x 6x 6x

6

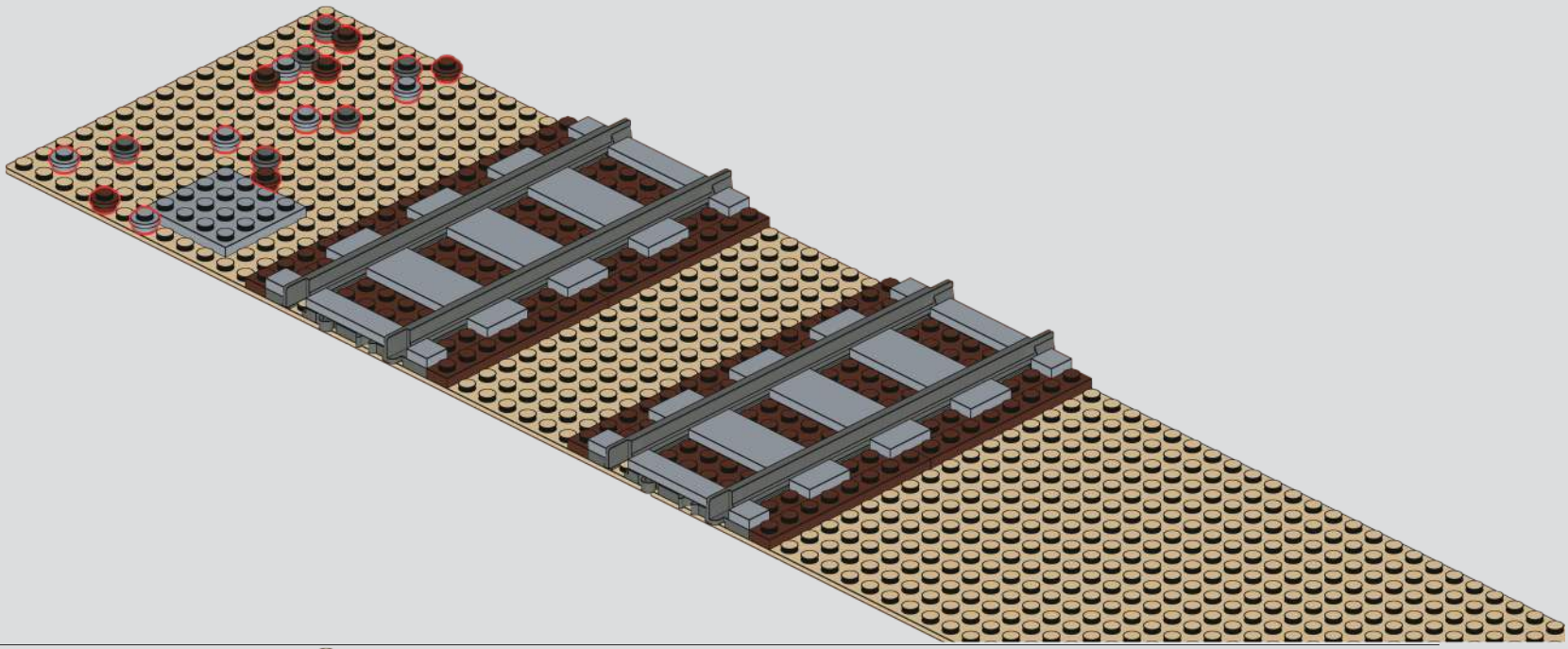

5x 3x 3x

7

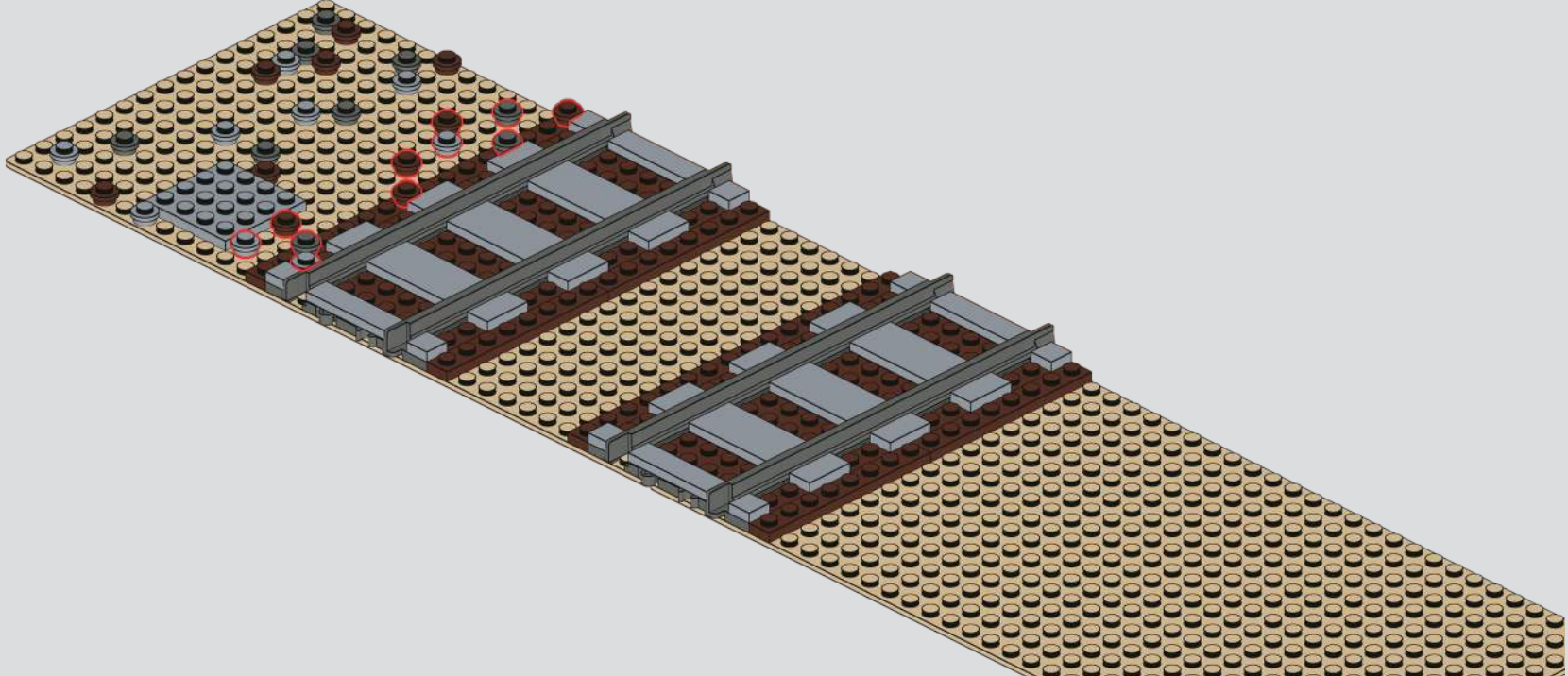

3x 3x 6x

8

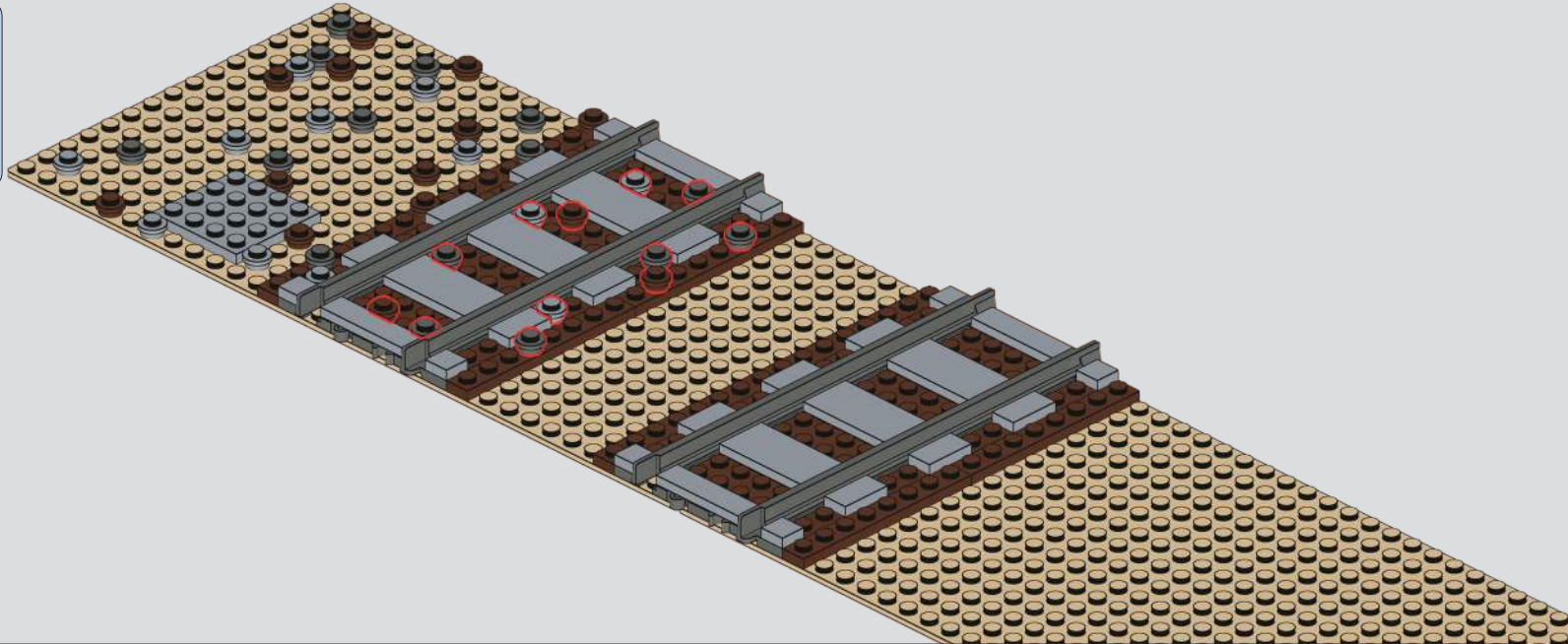

8x 4x 6x

9

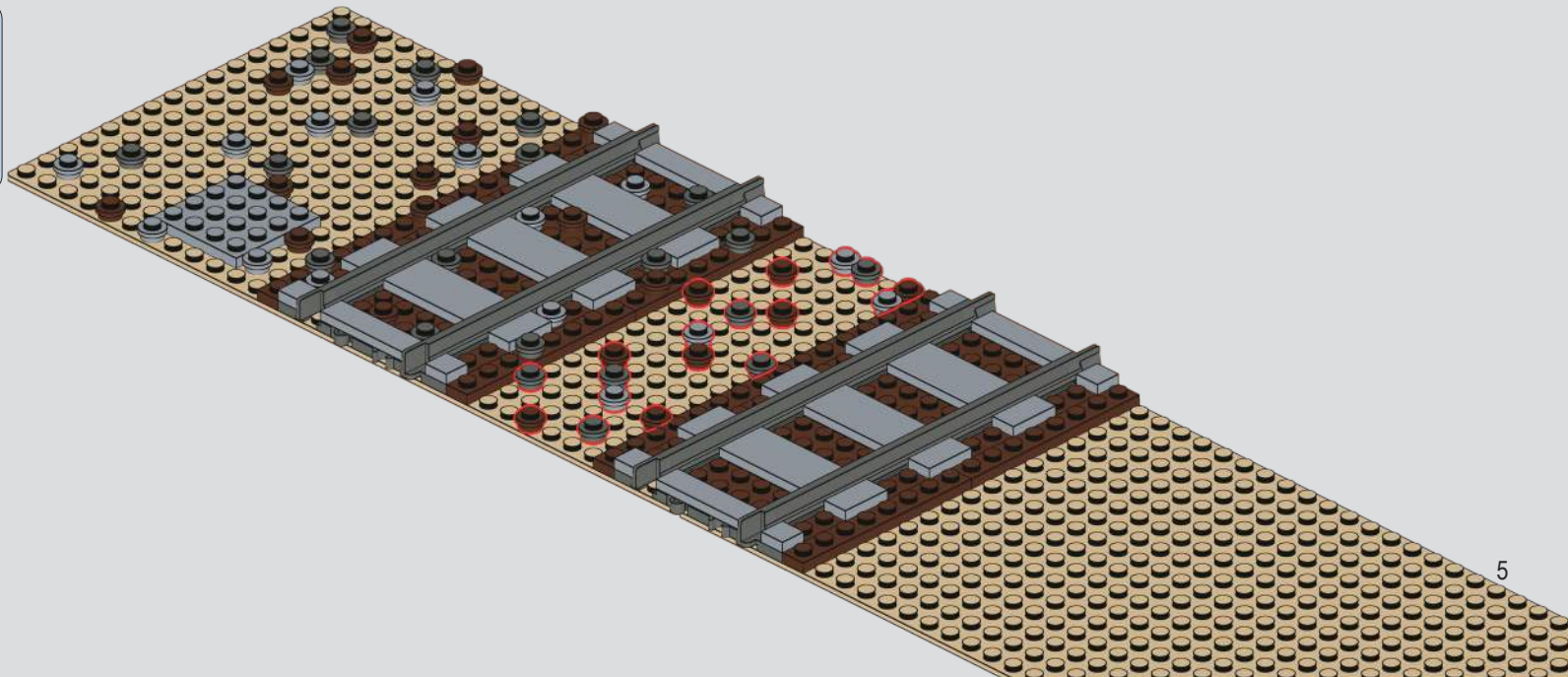

5x   4x   9x

10

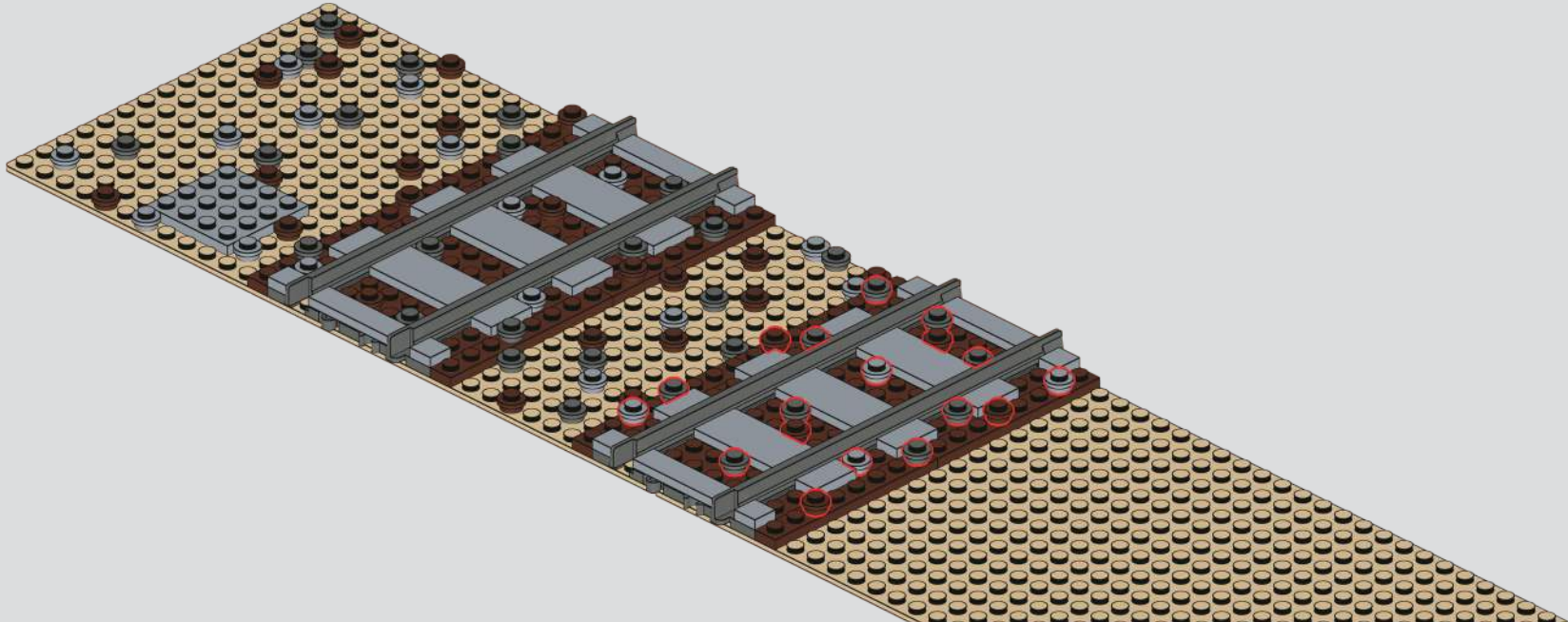

2x   5x   1x   3x

11

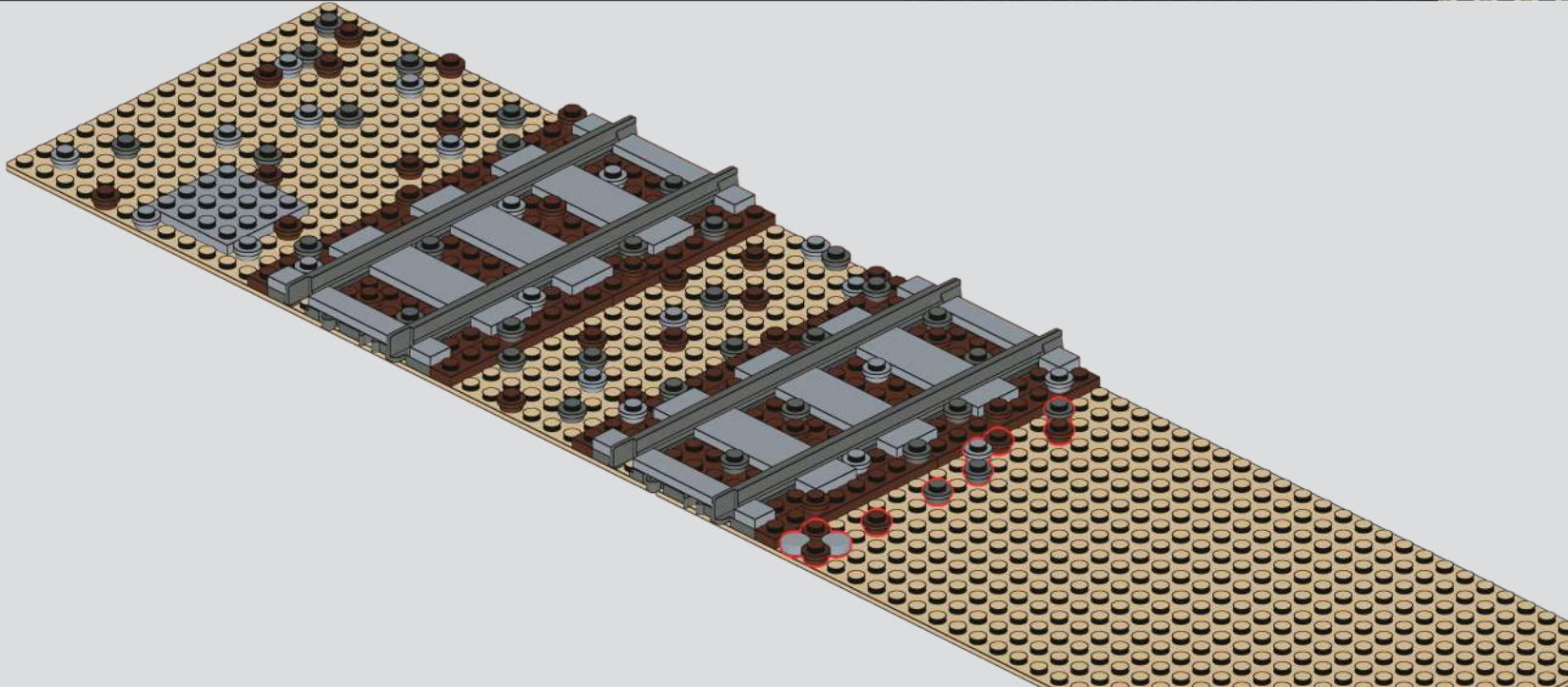

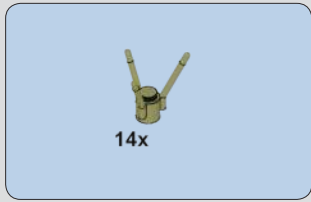

12

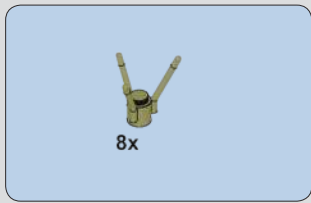
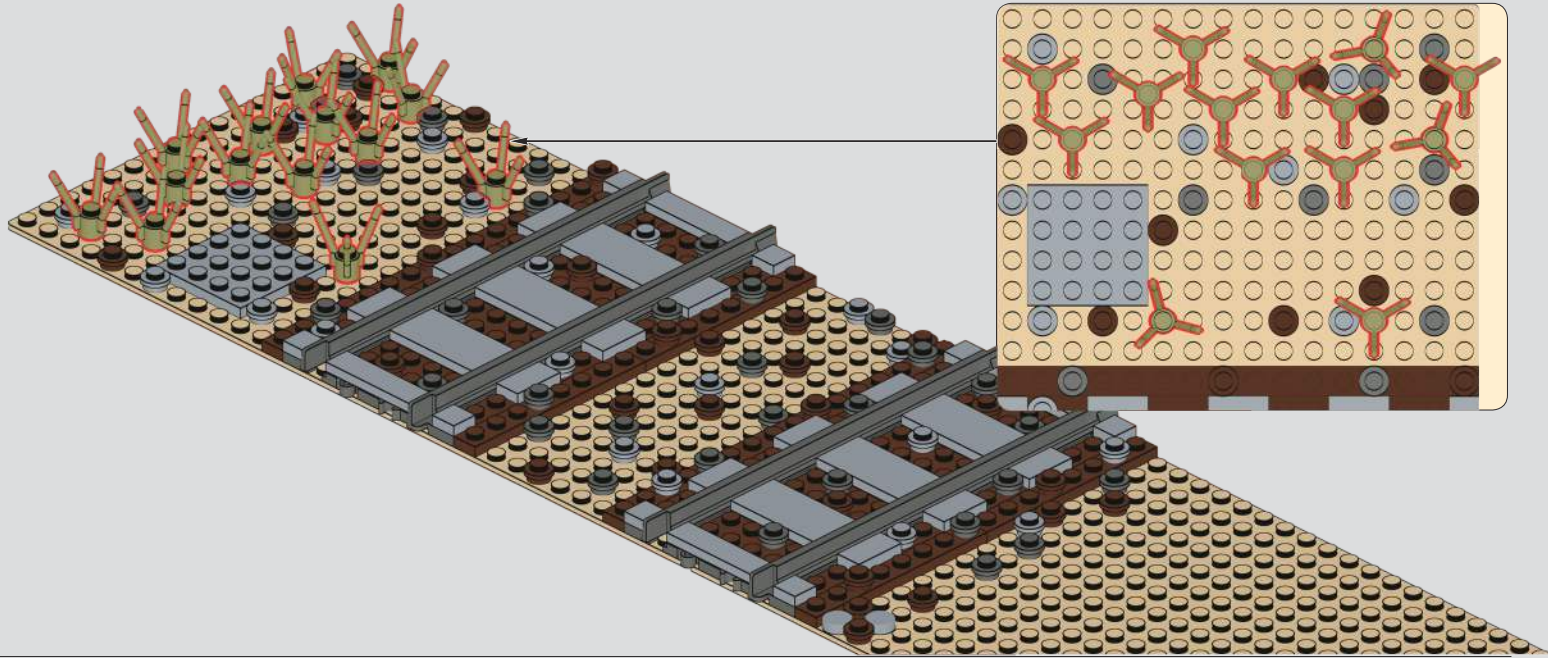

13

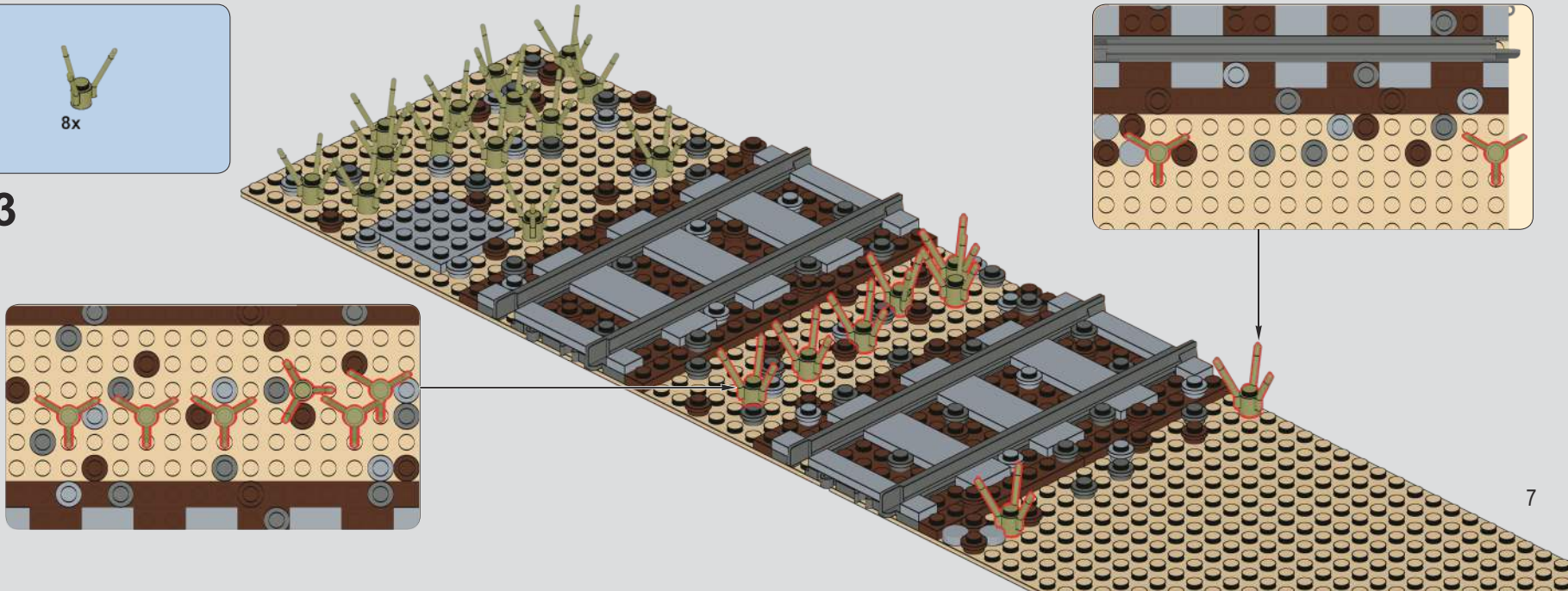

7x 2x 1x 2x 1x

14

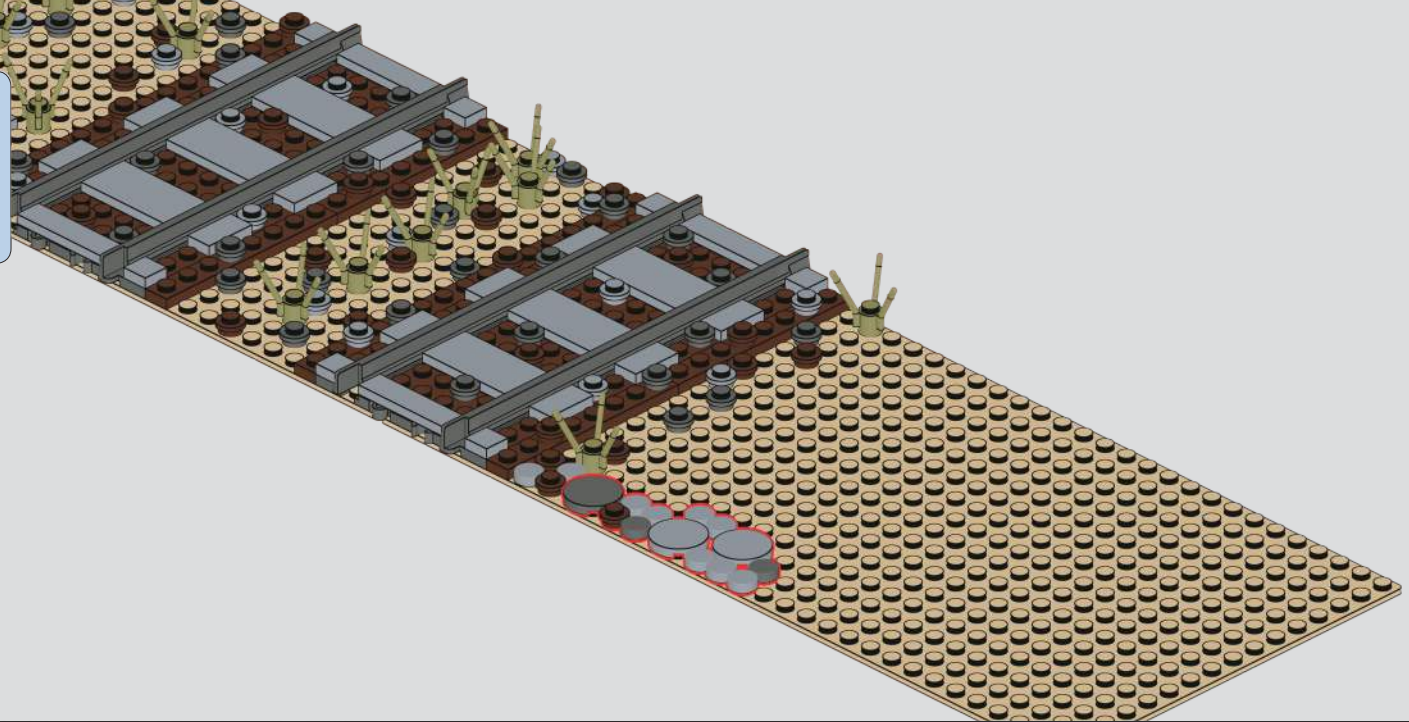

4x 6x 3x 1x

15

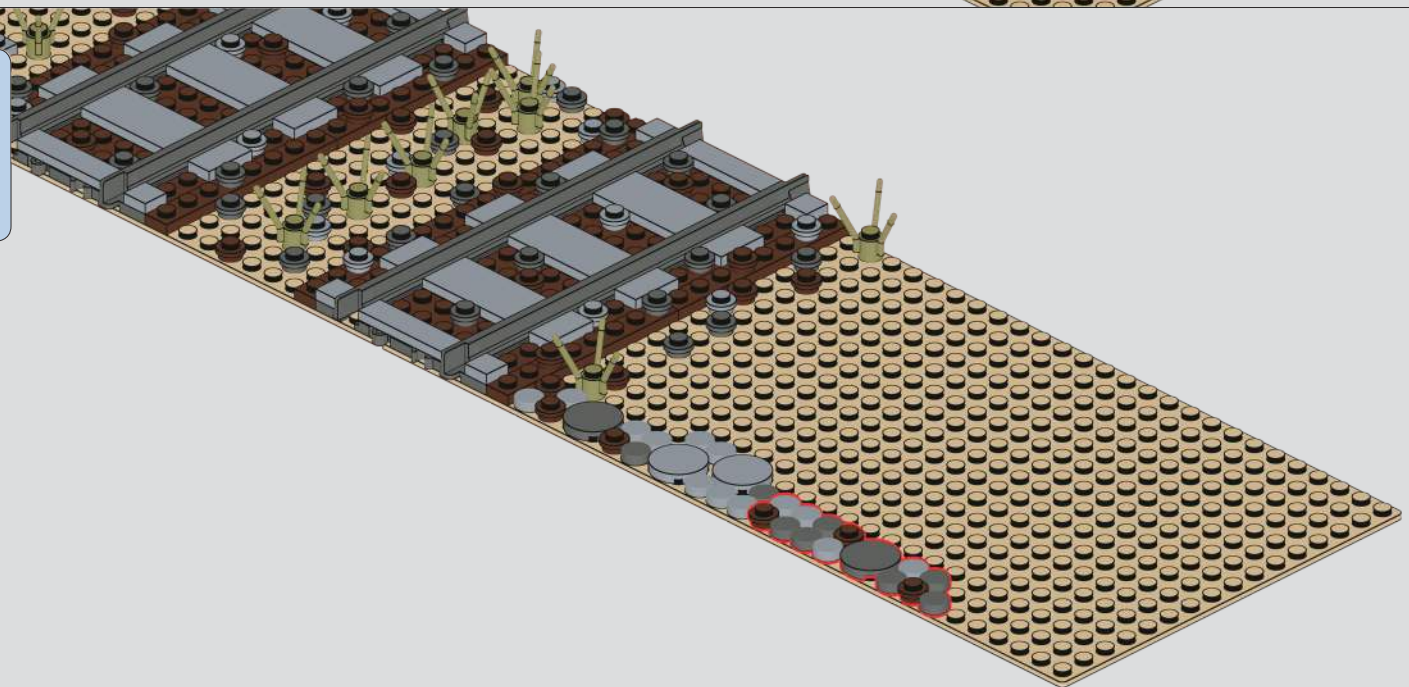

4x 4x 5x

16

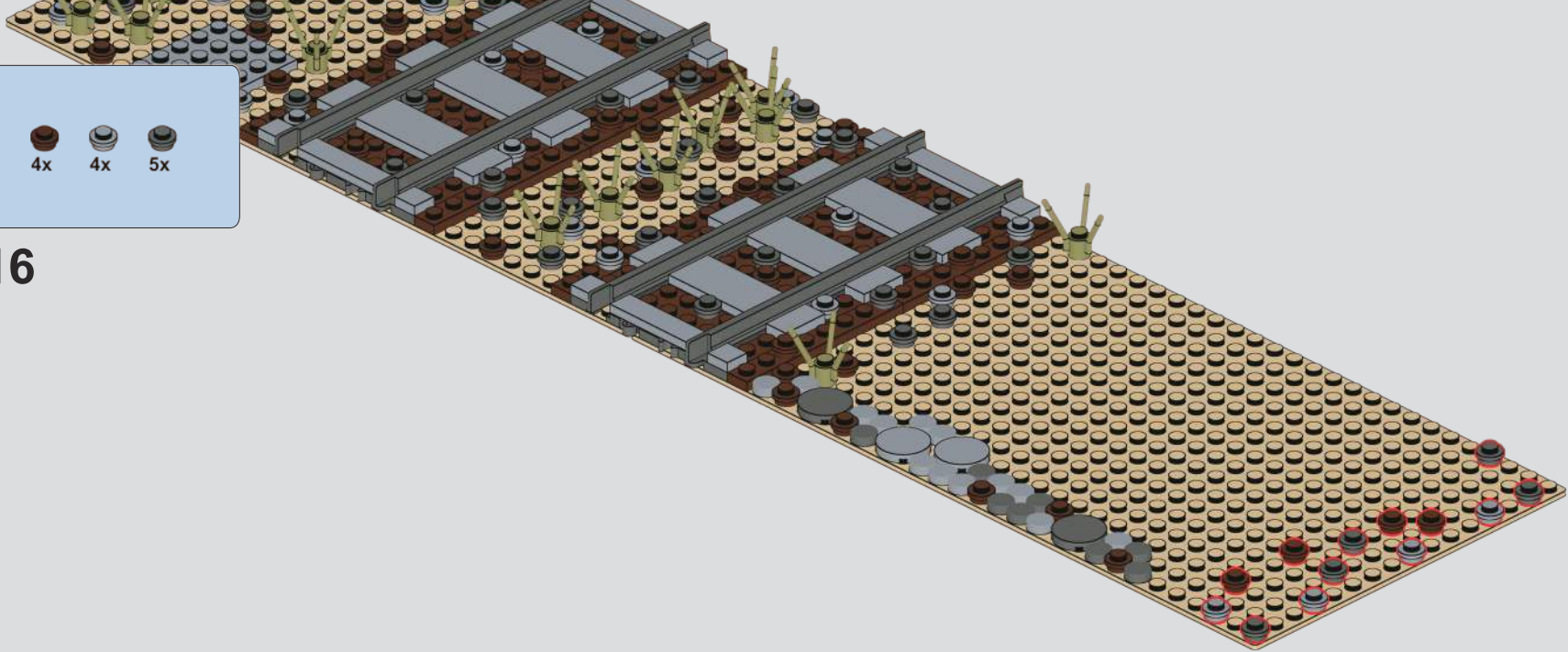

4x 4x 3x

17

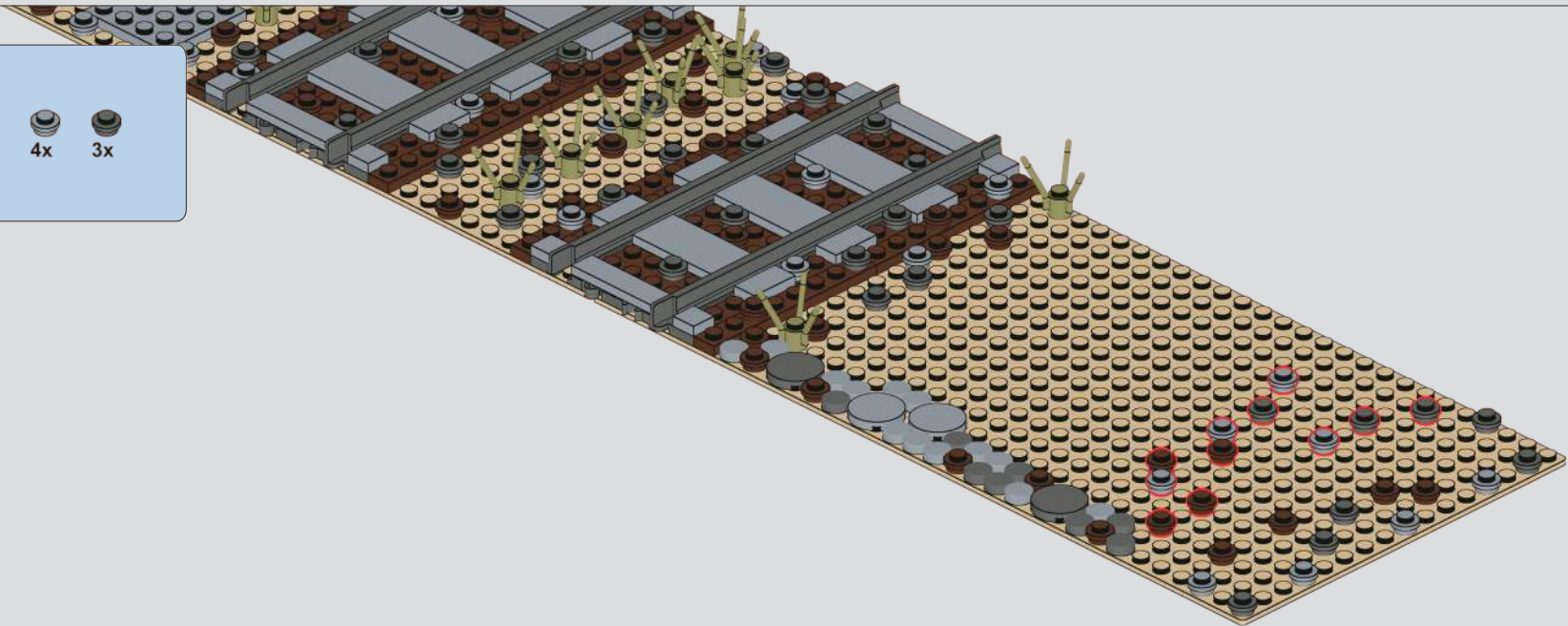

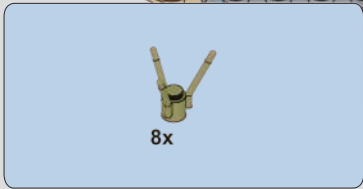

18

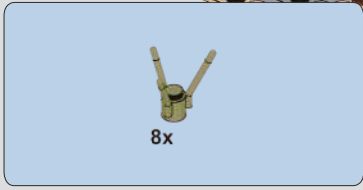
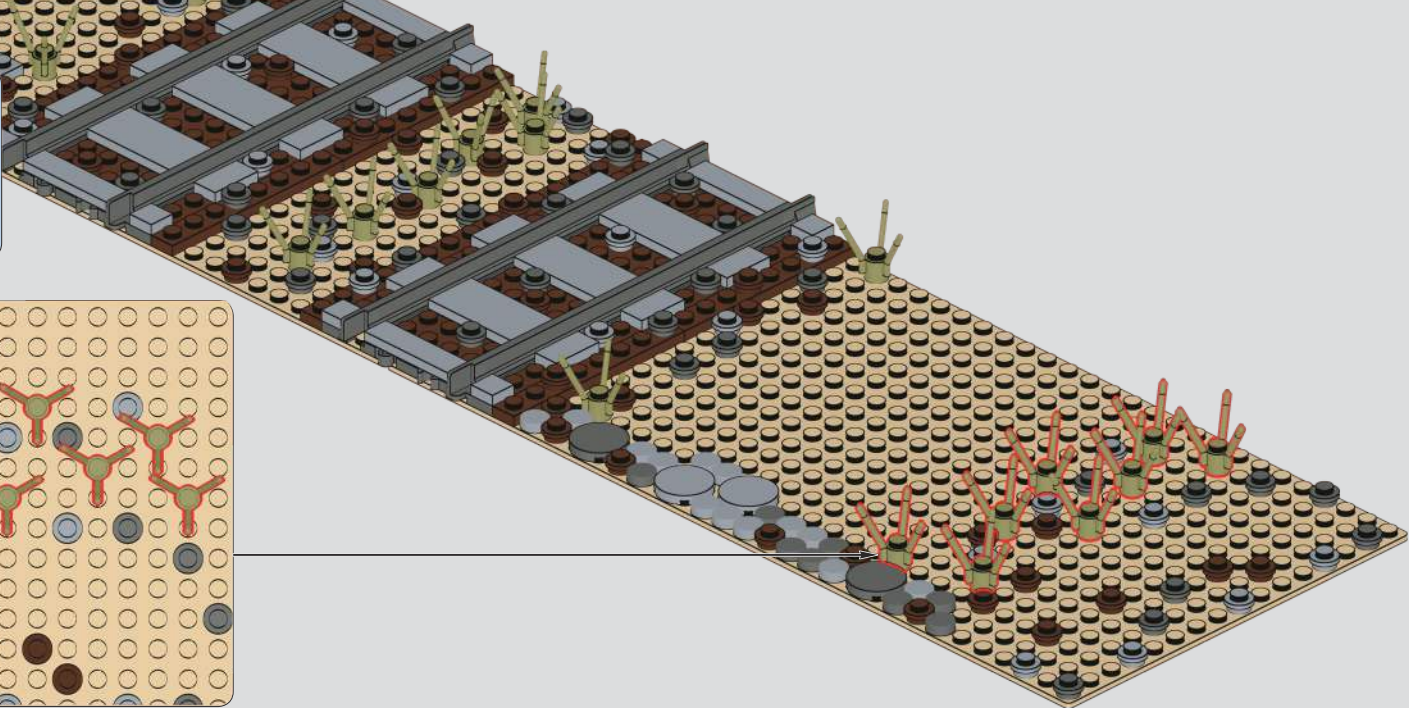
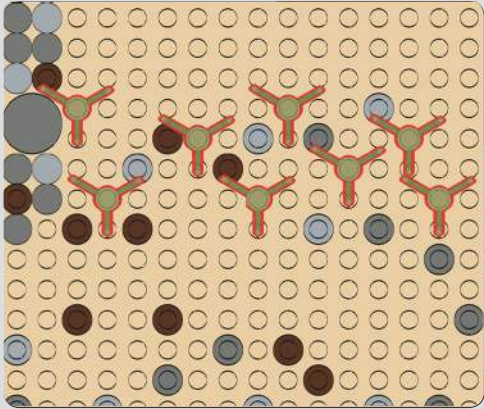

19

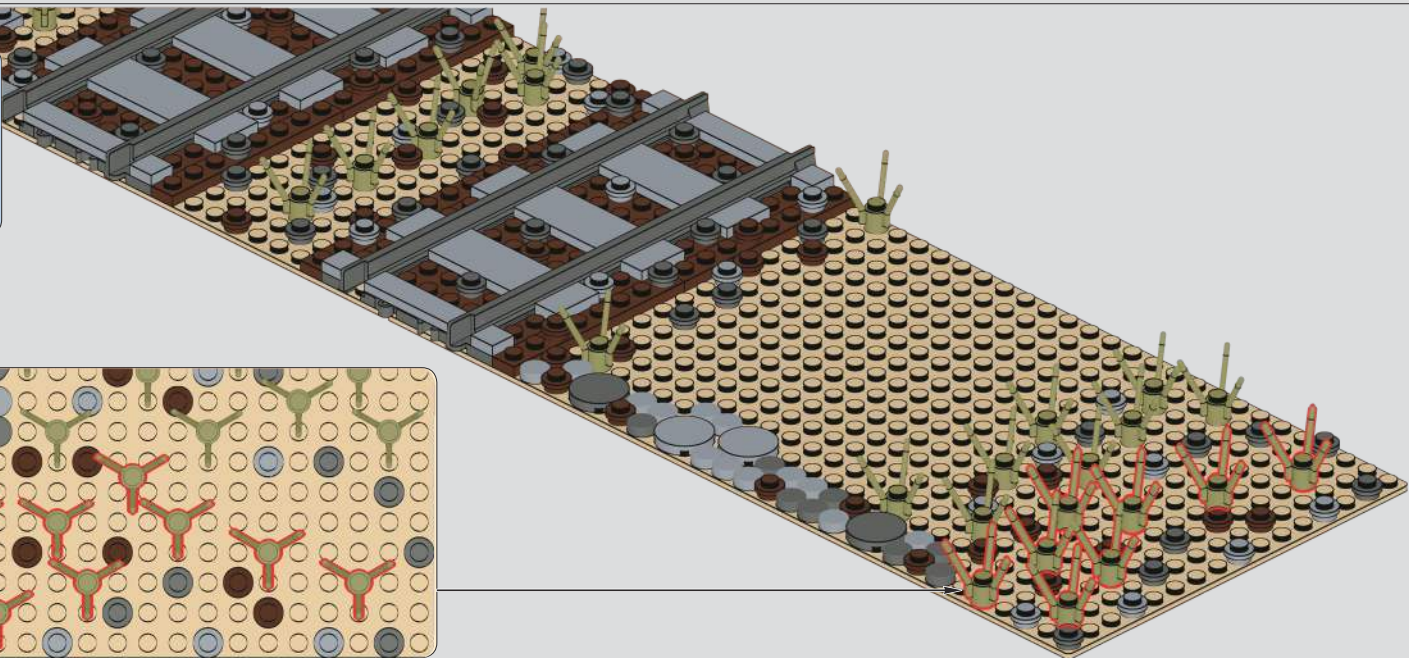
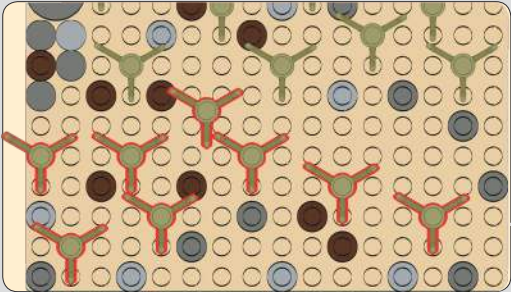

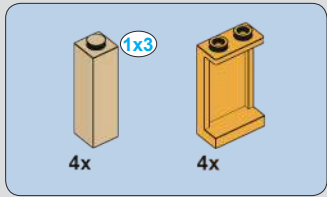

20



21

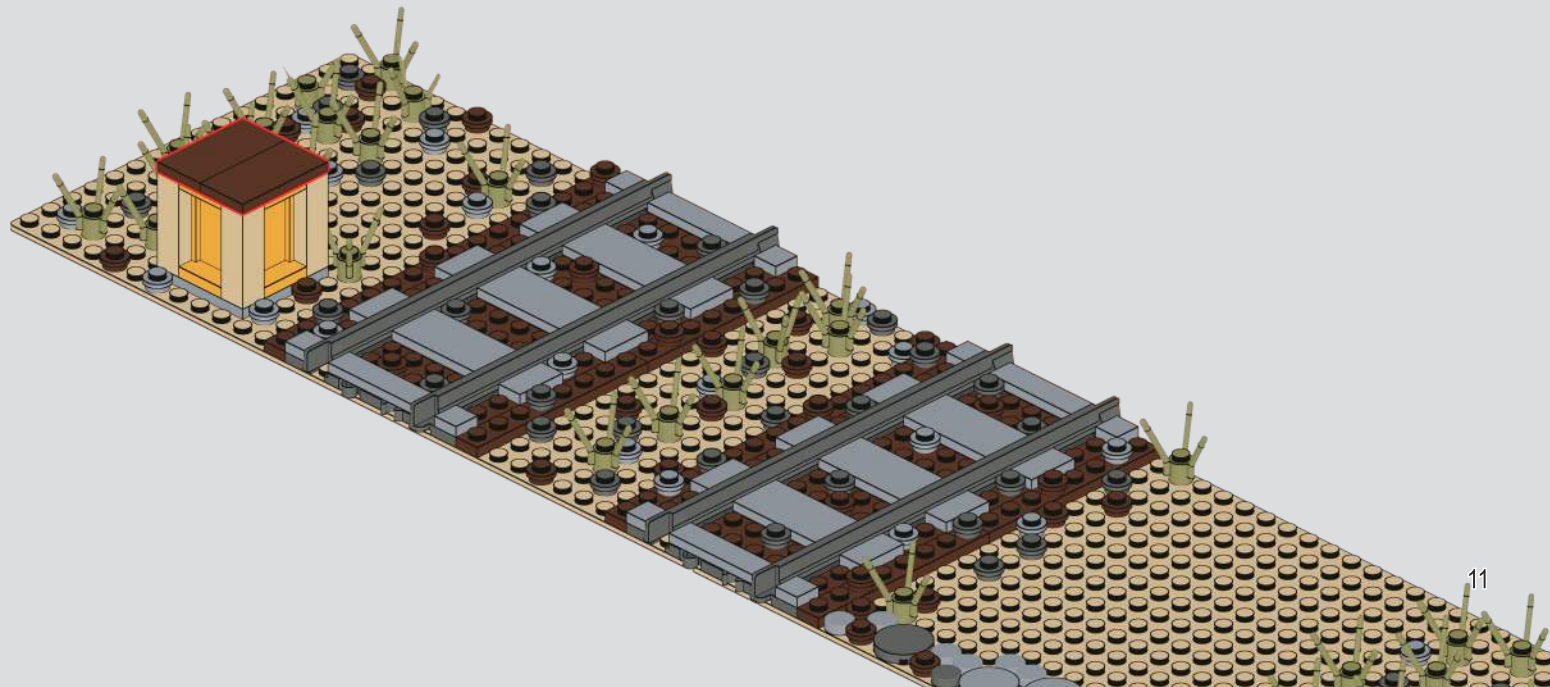

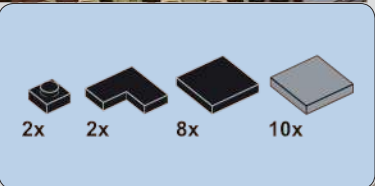
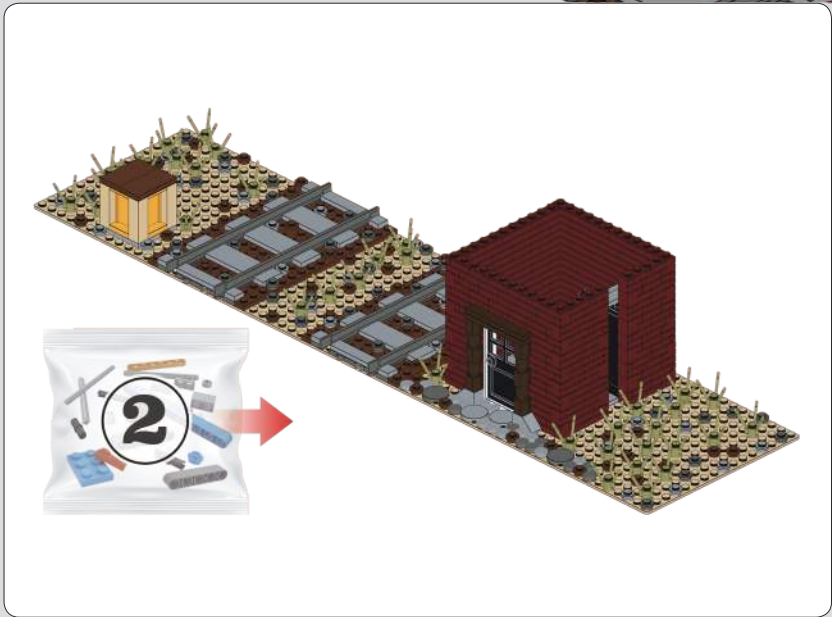

22

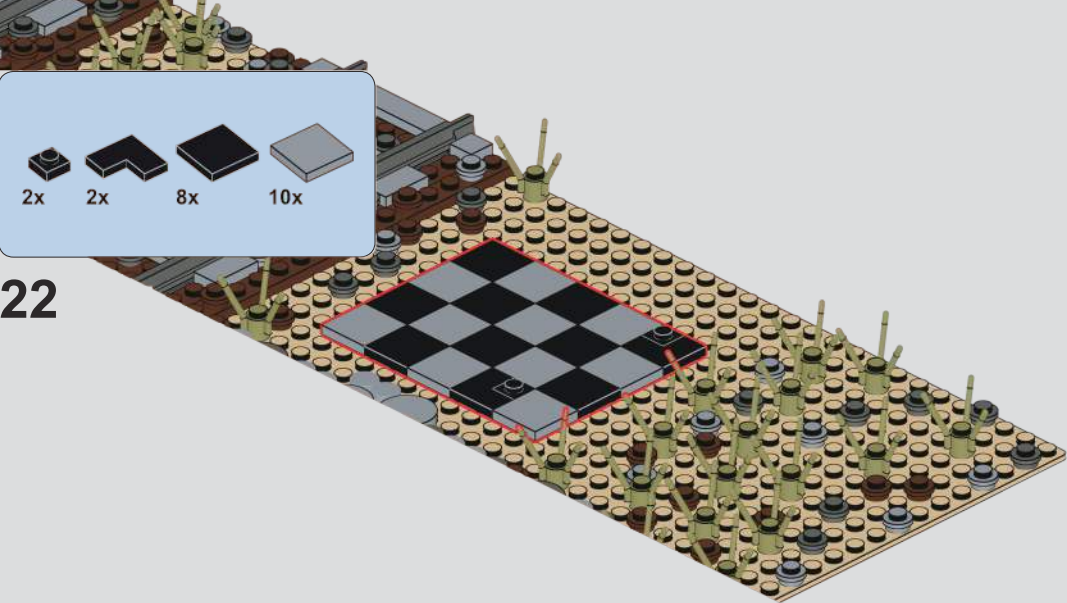

23

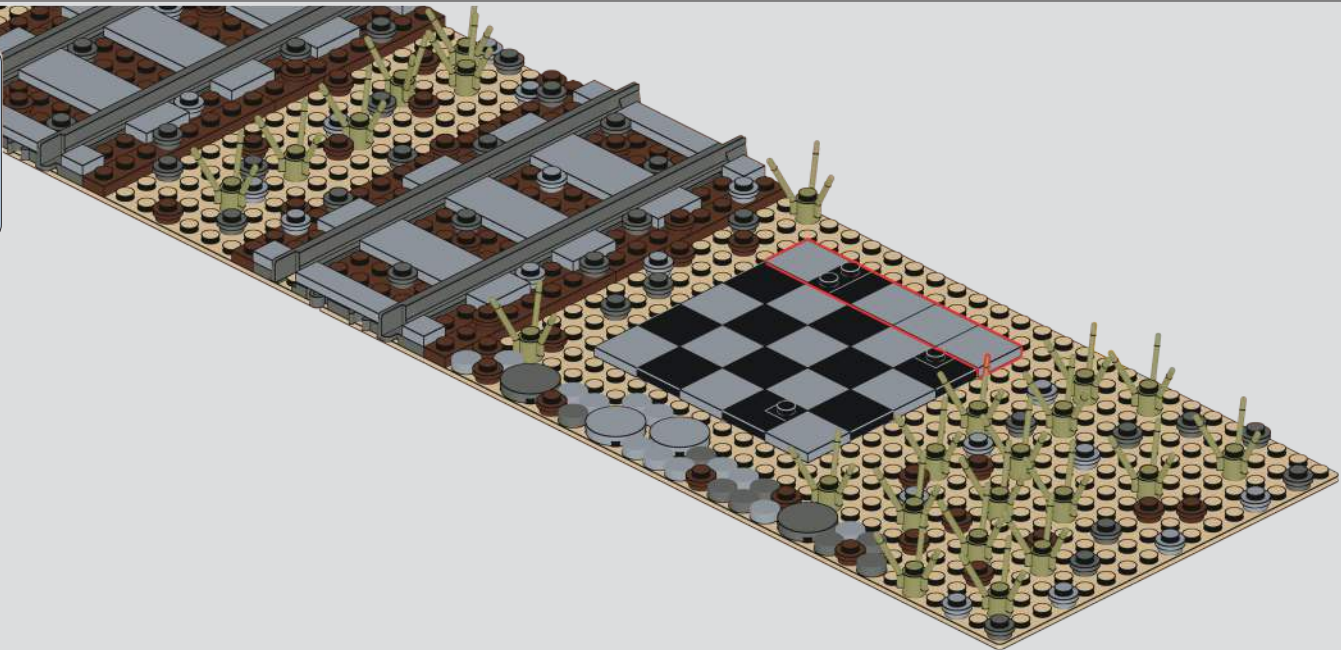



24

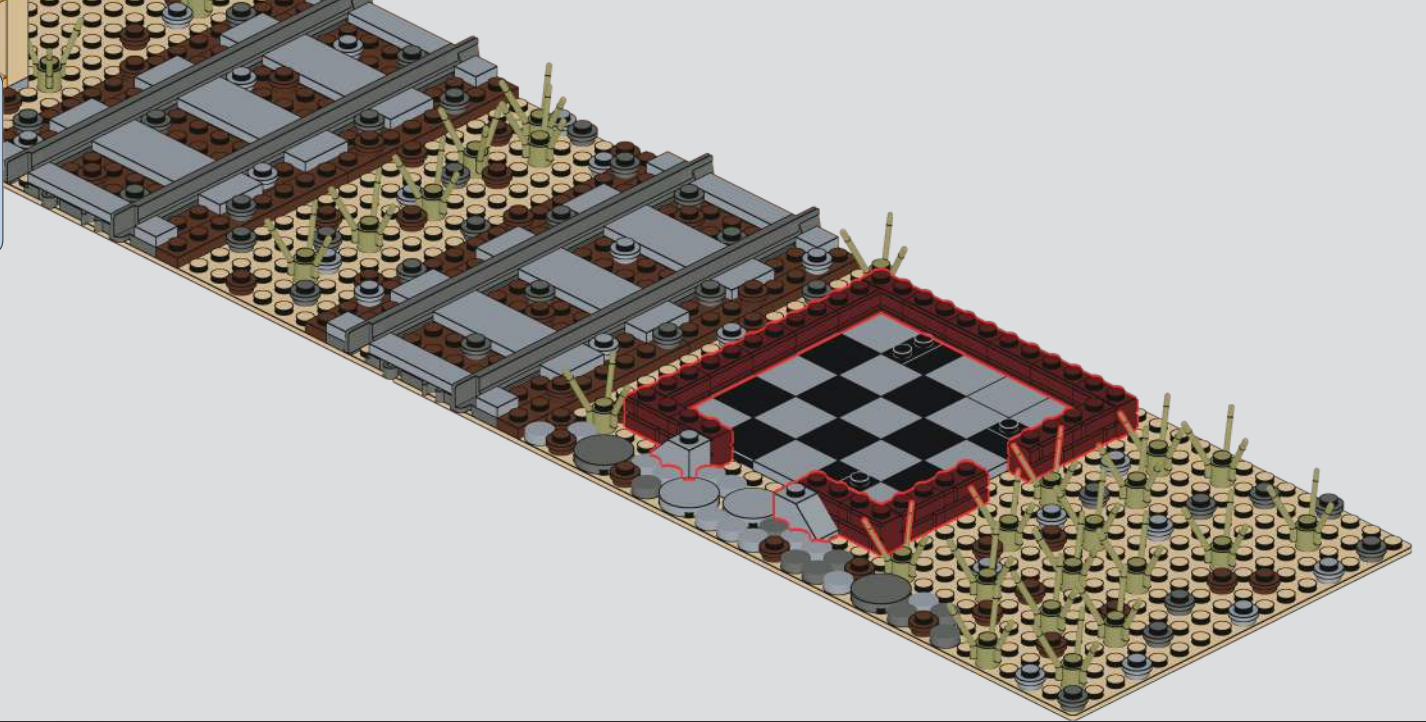

25

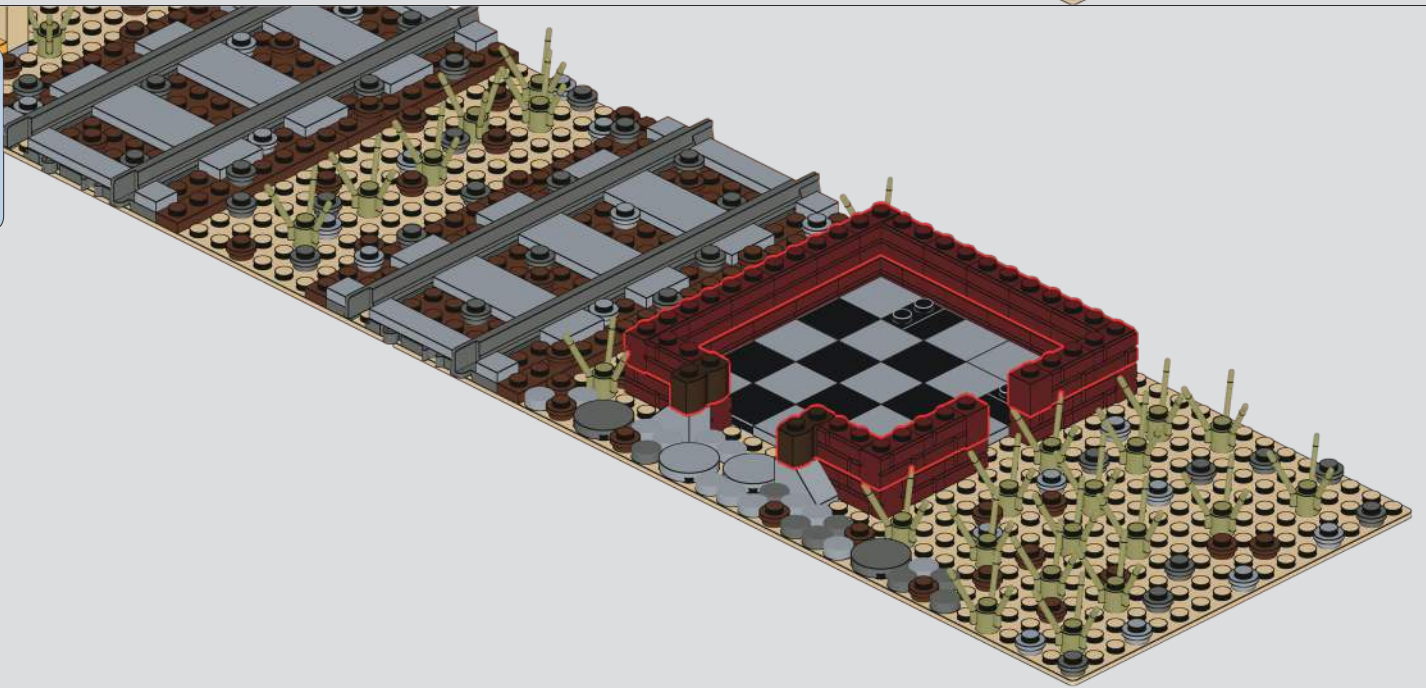

2x 19x

26

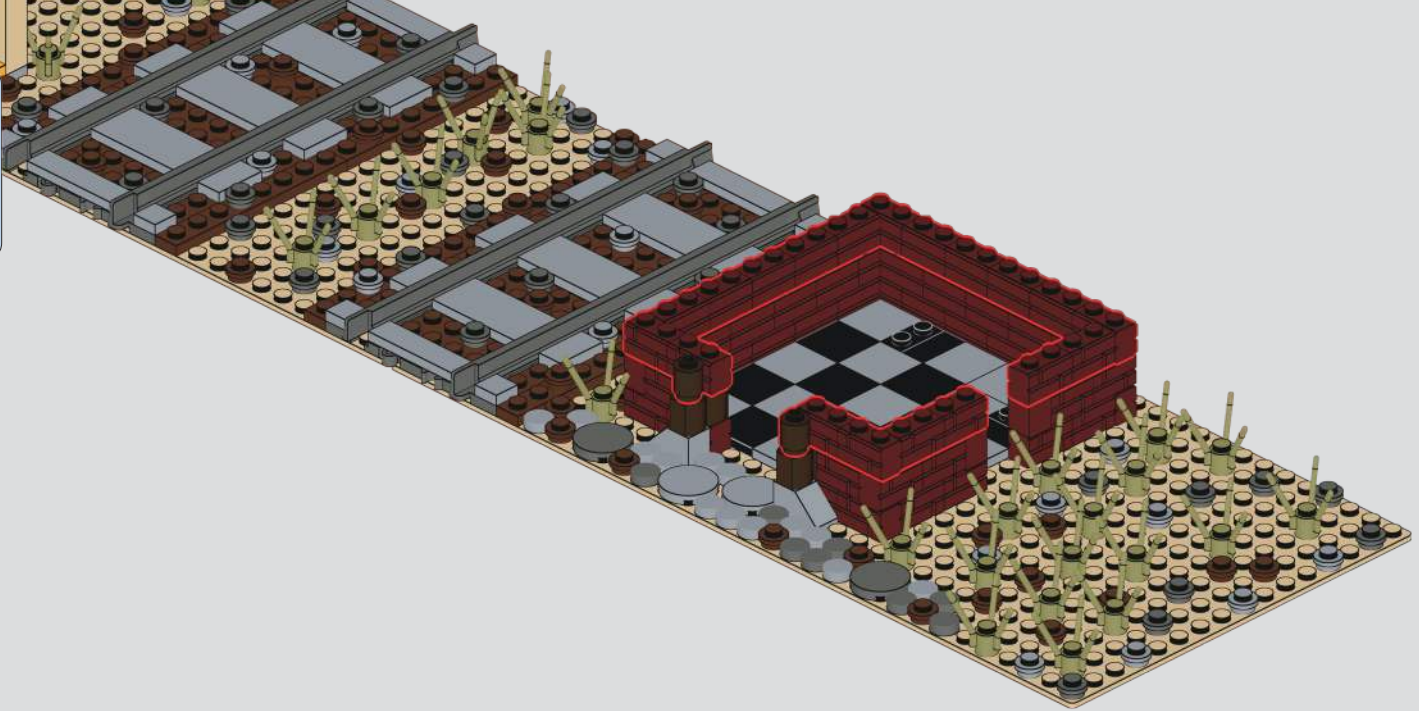

2x 17x 2x

27

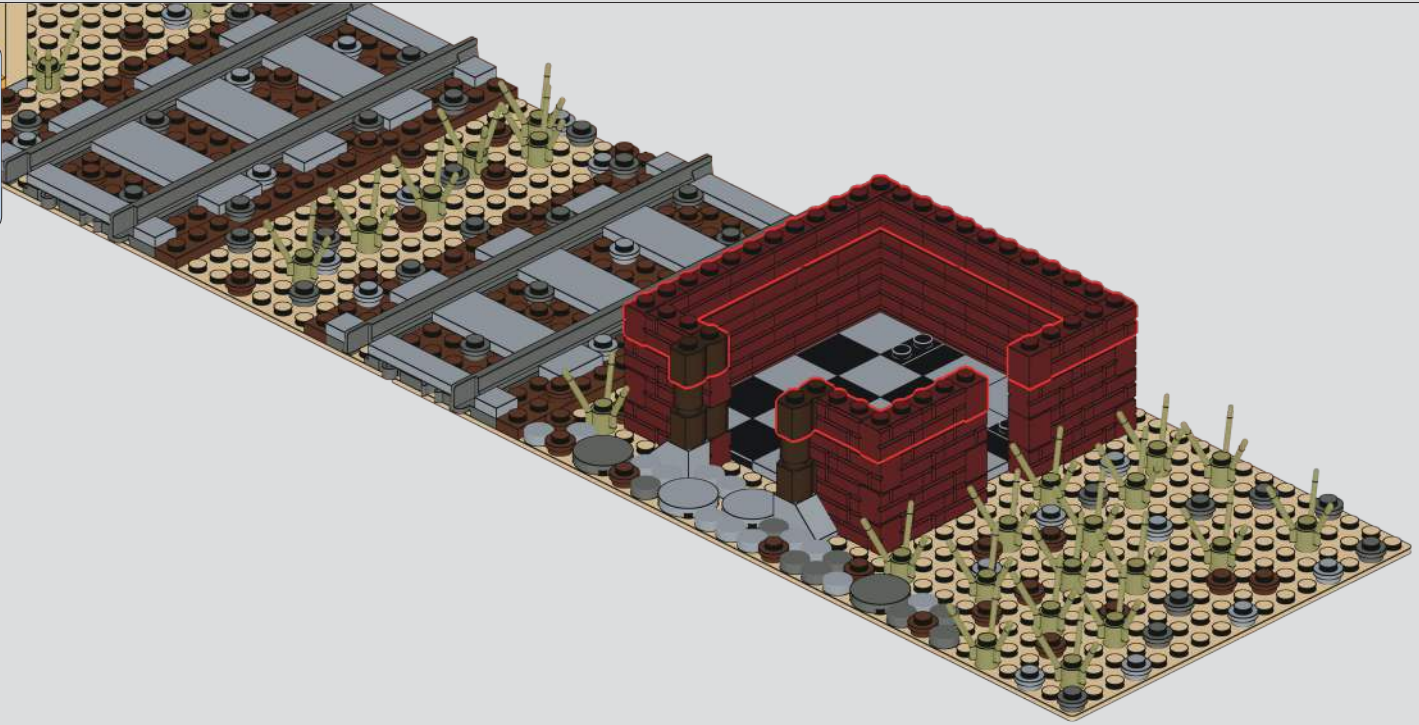

2x      19x

28



2x      17x      2x

29

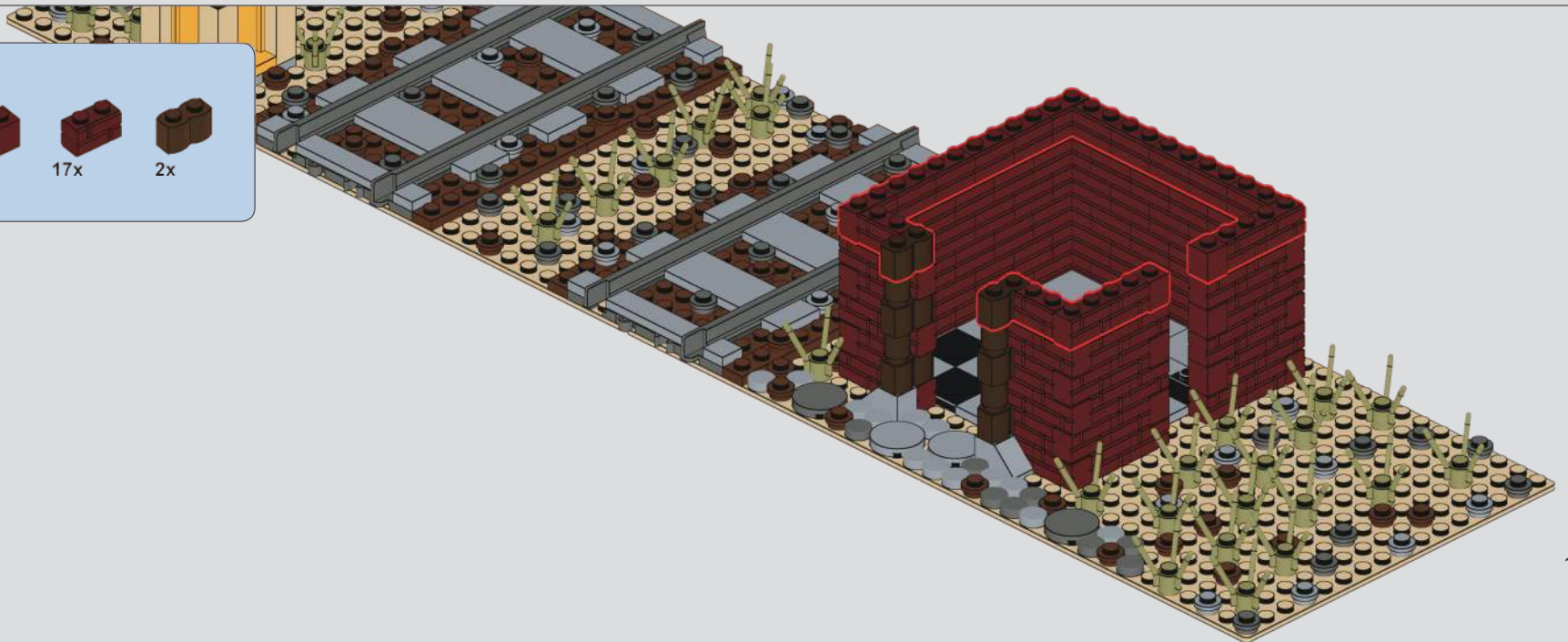

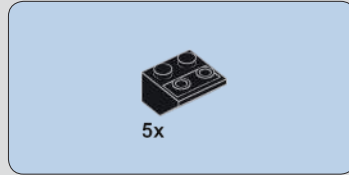
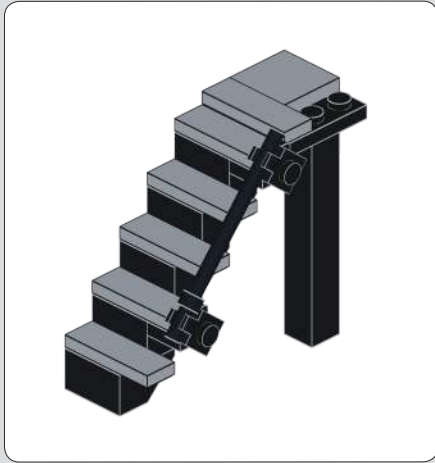

30

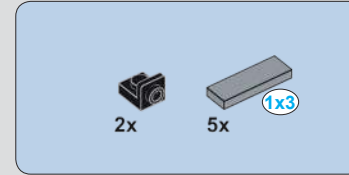
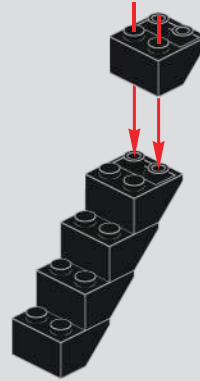

31

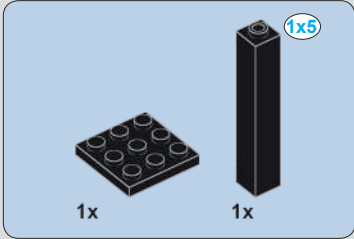
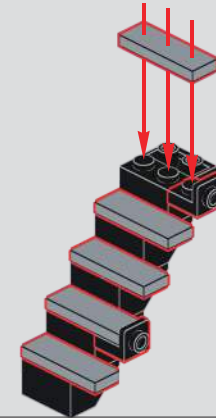

32

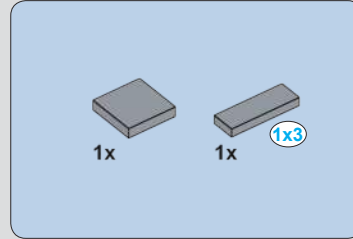
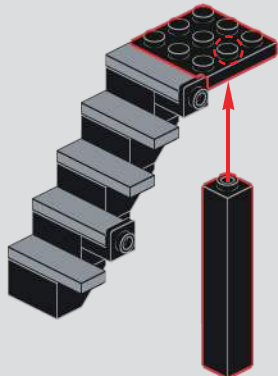

33

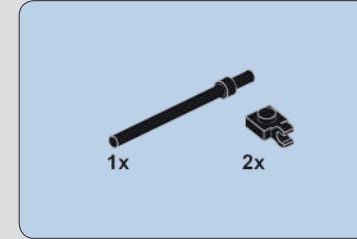
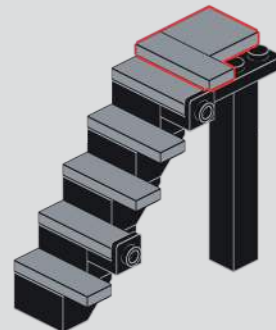

34

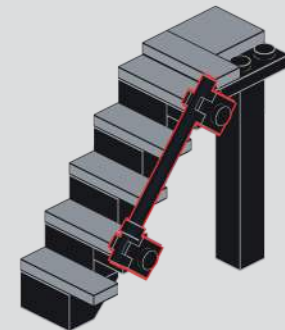

35

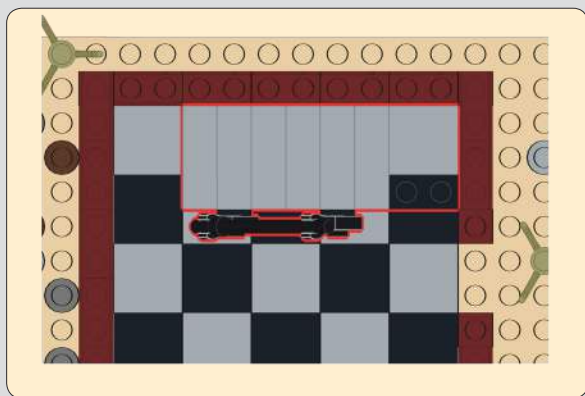

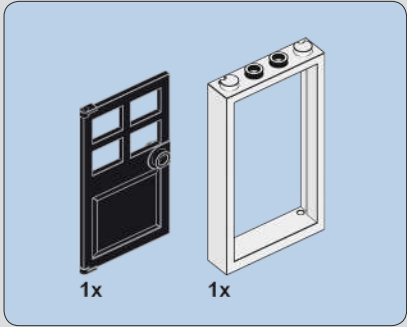

36

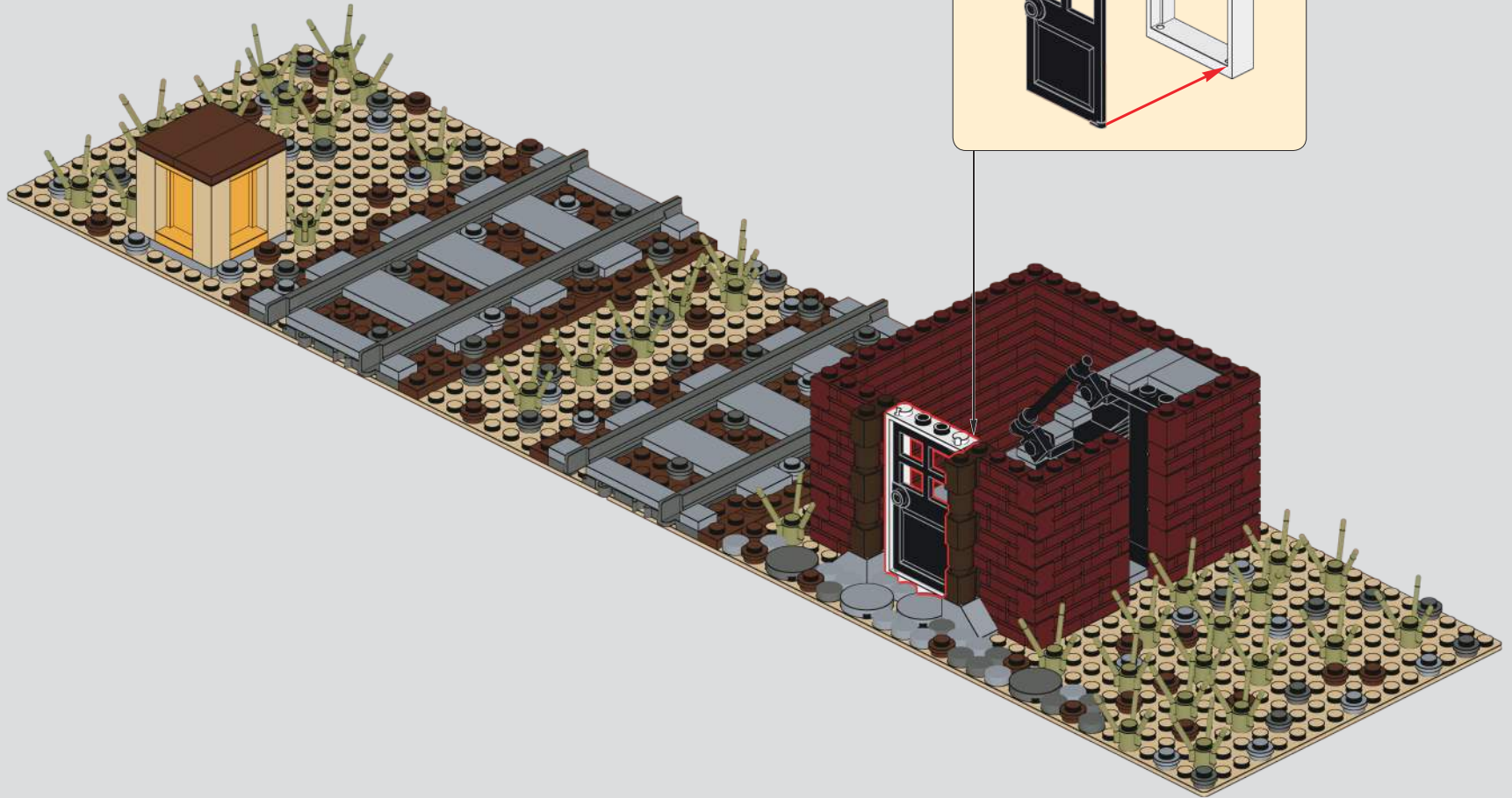
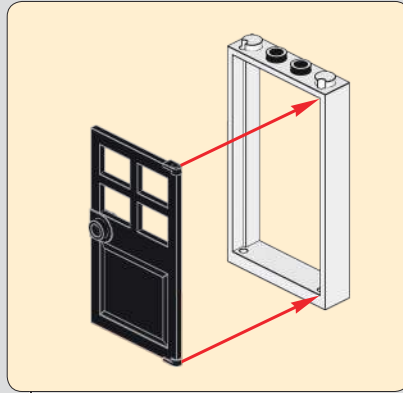



2x      20x

39

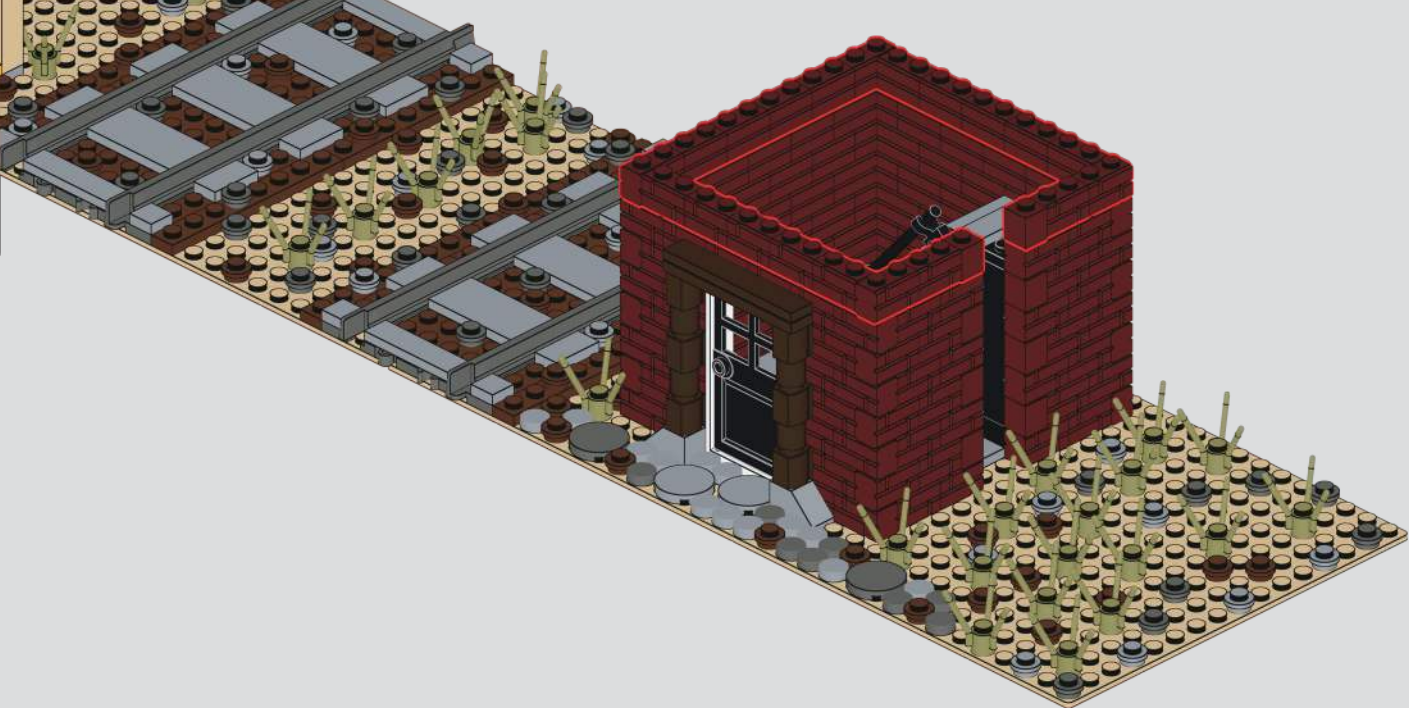

21x

40



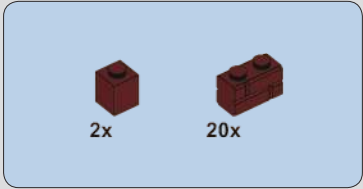
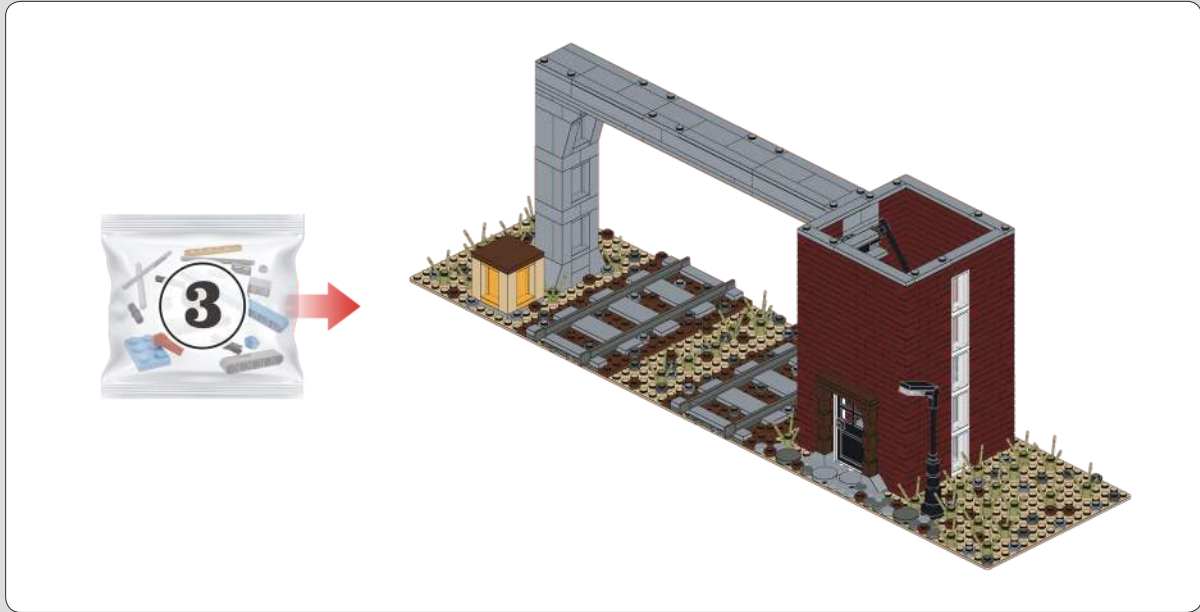

41

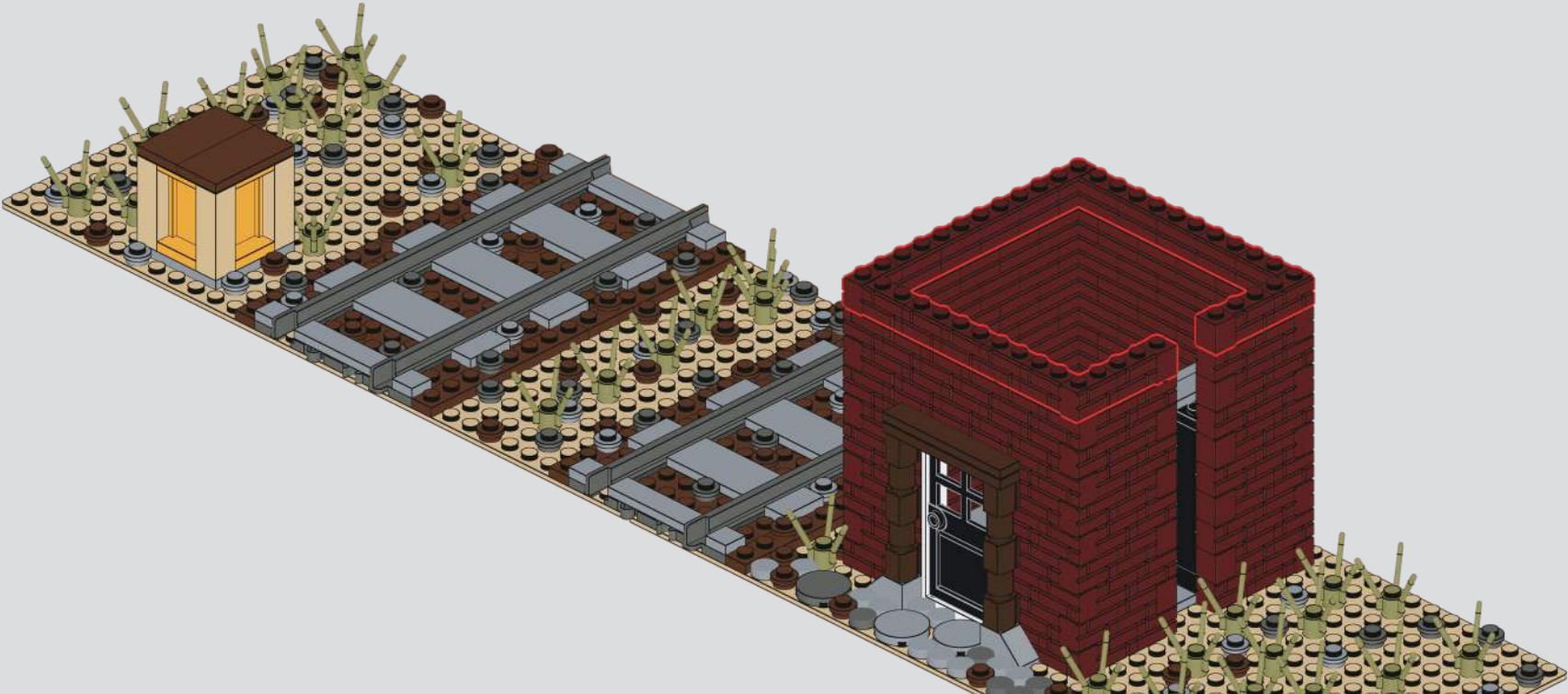

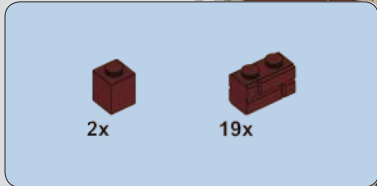

42

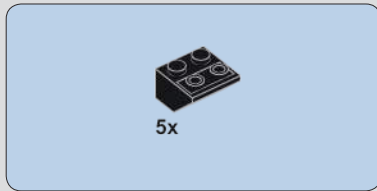

43

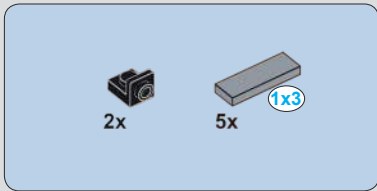
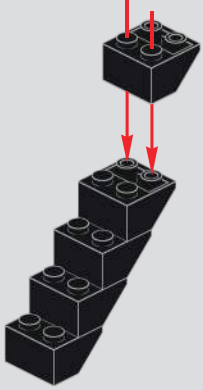

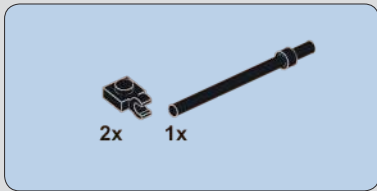
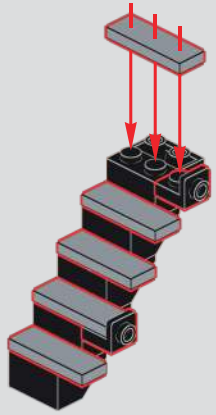

44

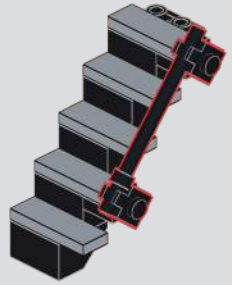

45

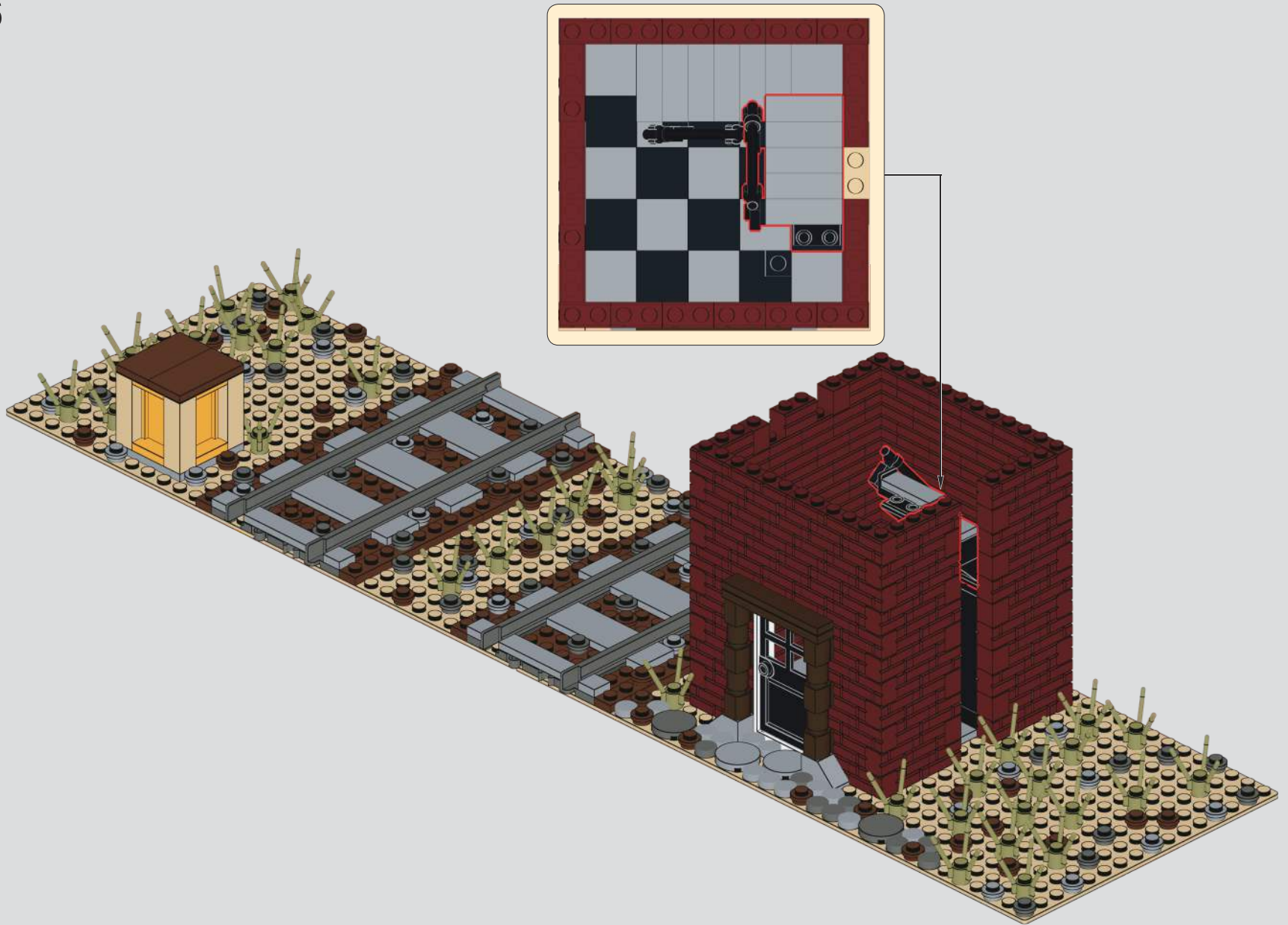



2x  19x 



47

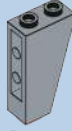

2x 



48



2x  19x 

49



2x  2x  20x 

50



1x 2x

51



2x 18x

52



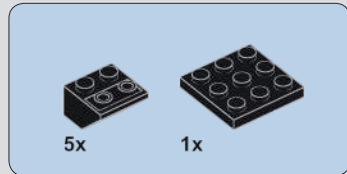
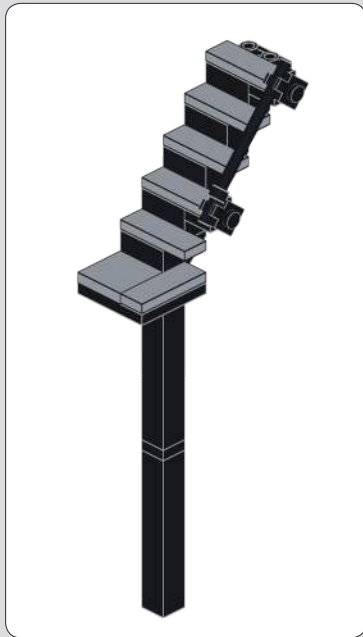

53

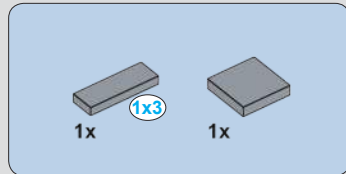
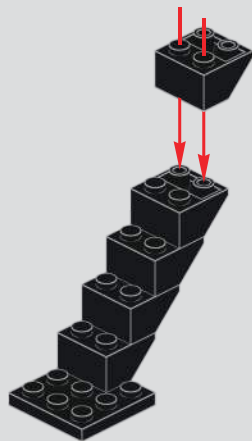

54

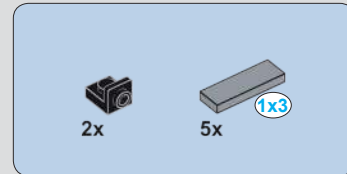
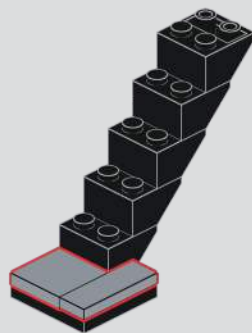

55

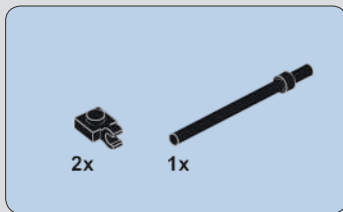
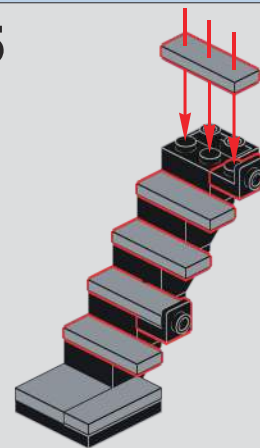

56

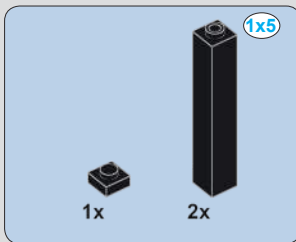
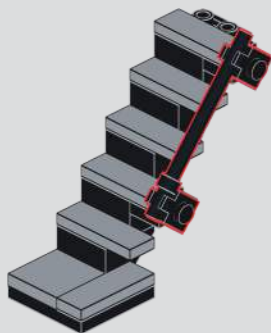

57

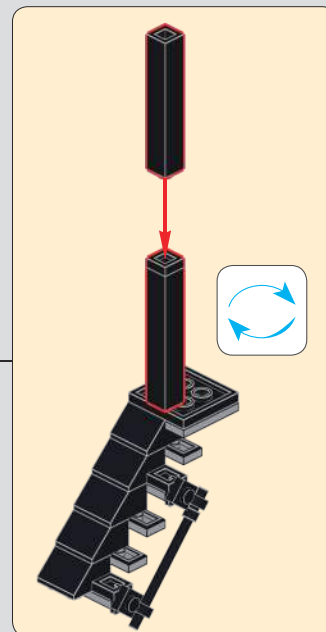
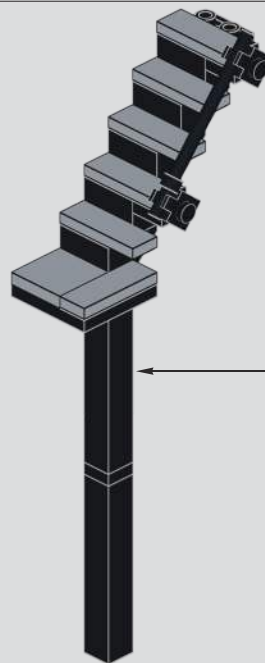

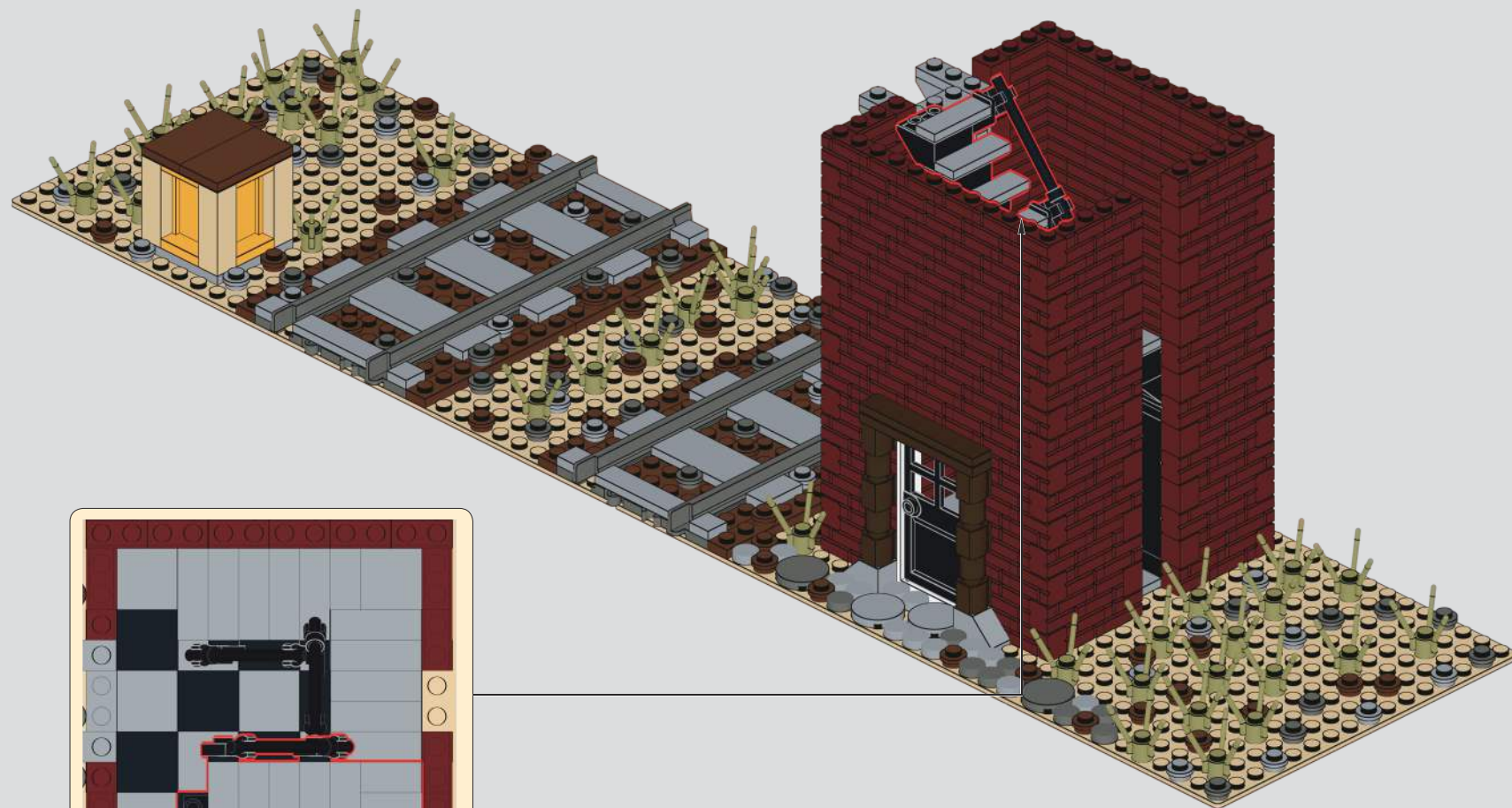

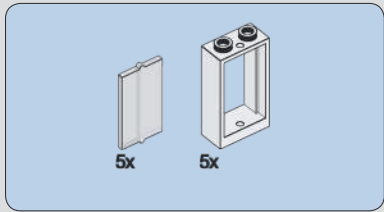

59

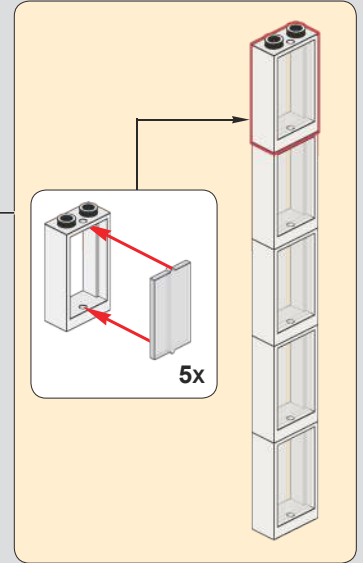

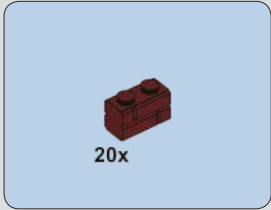

60



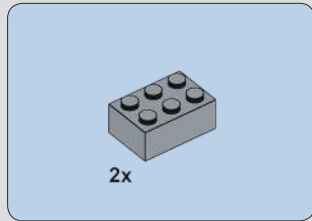
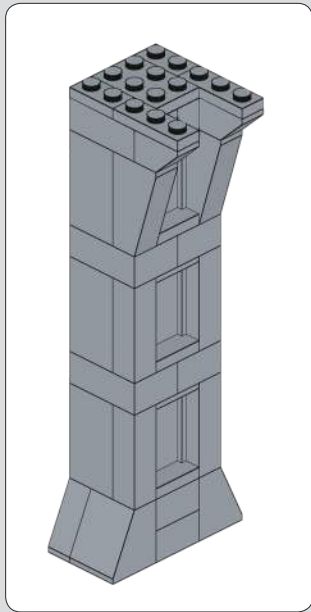

61

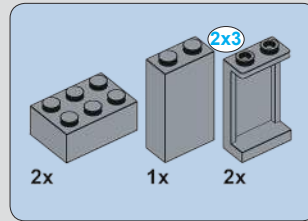
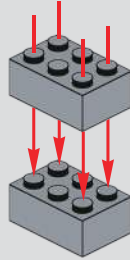

62

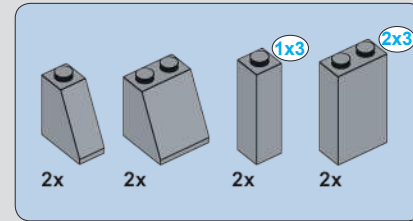
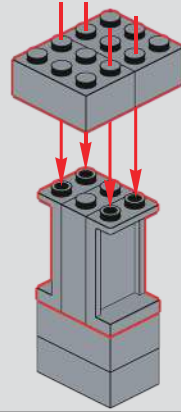

63

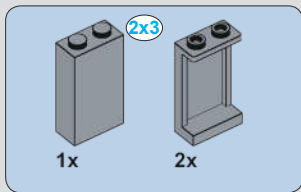
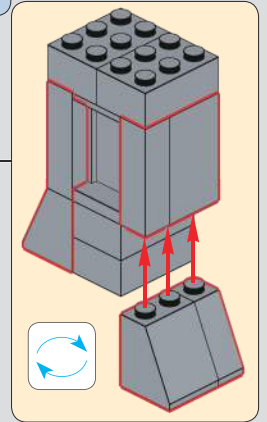
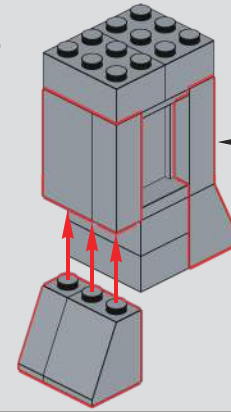

64

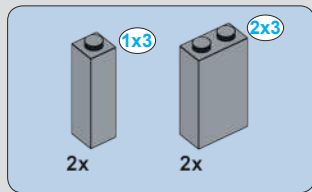
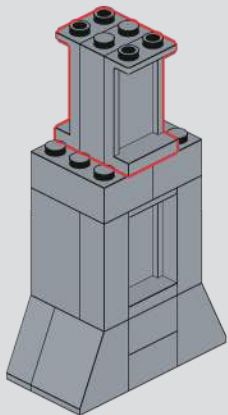

65

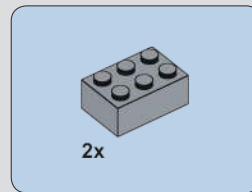
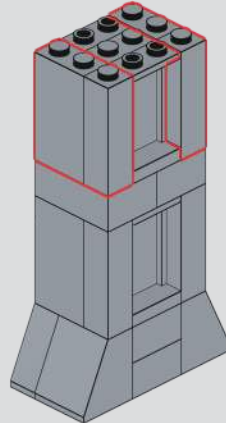

66

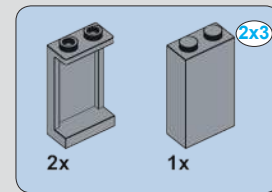
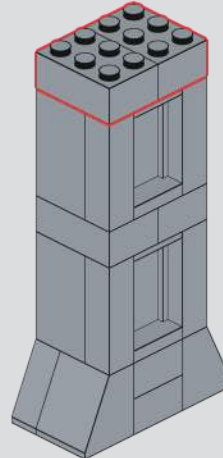

67

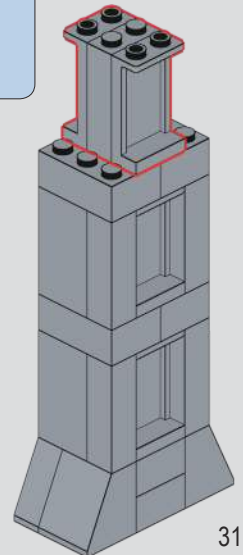

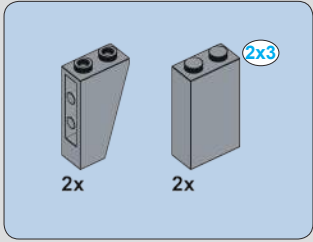

68

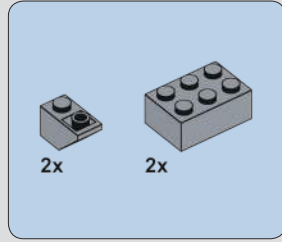
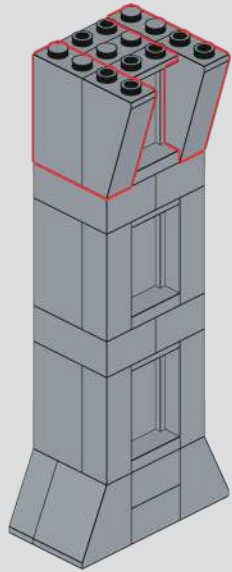

69

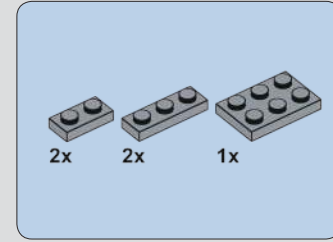
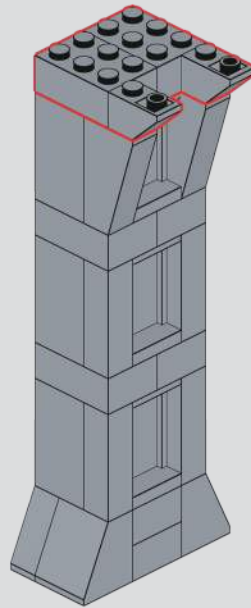

70

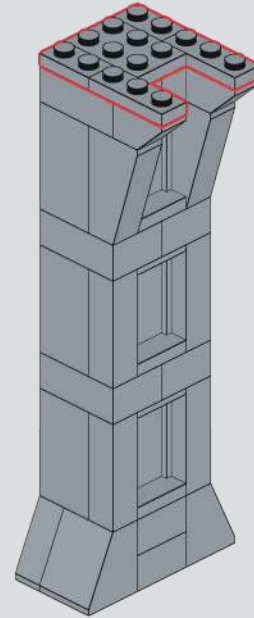

71



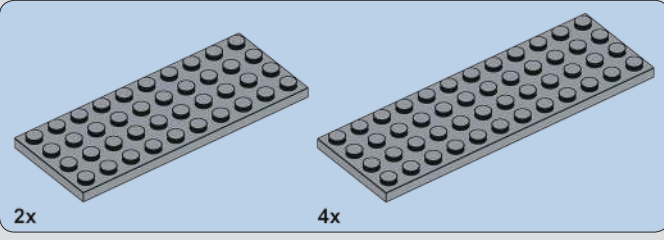
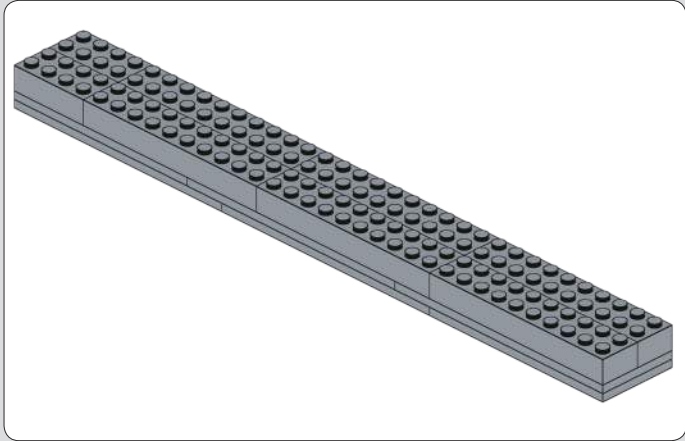

72

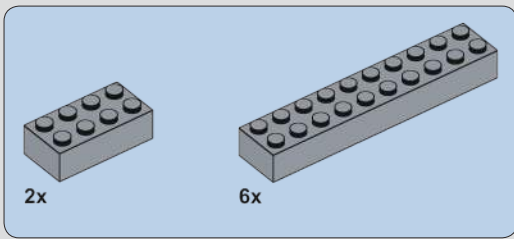
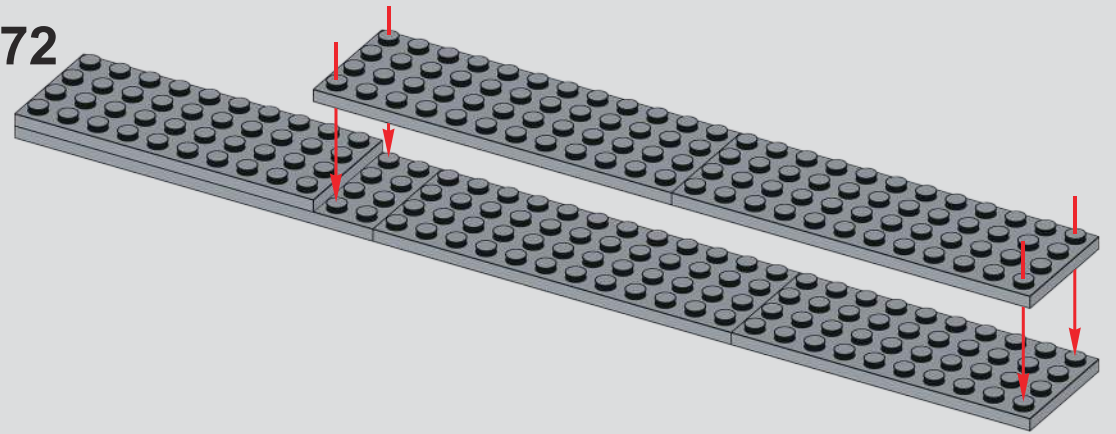

73

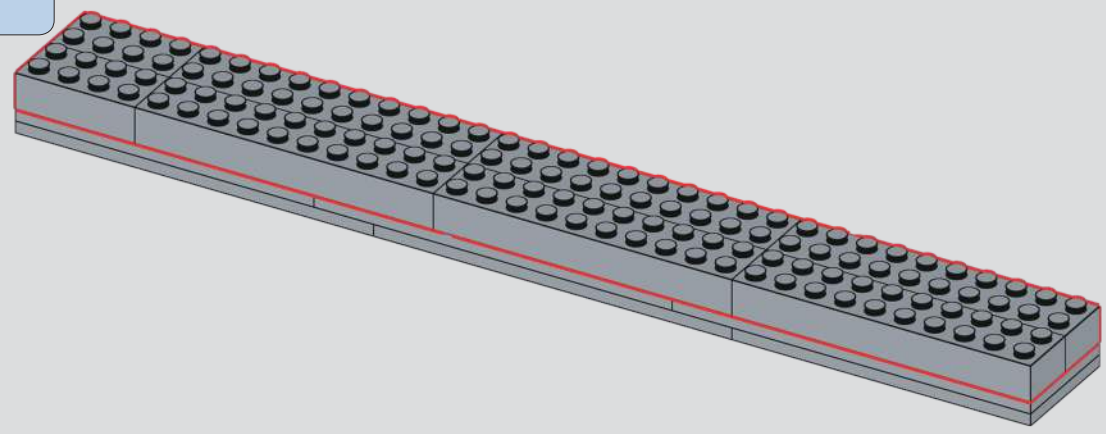



9x

8x

2x

8x

2x4

1x6

1x8

75

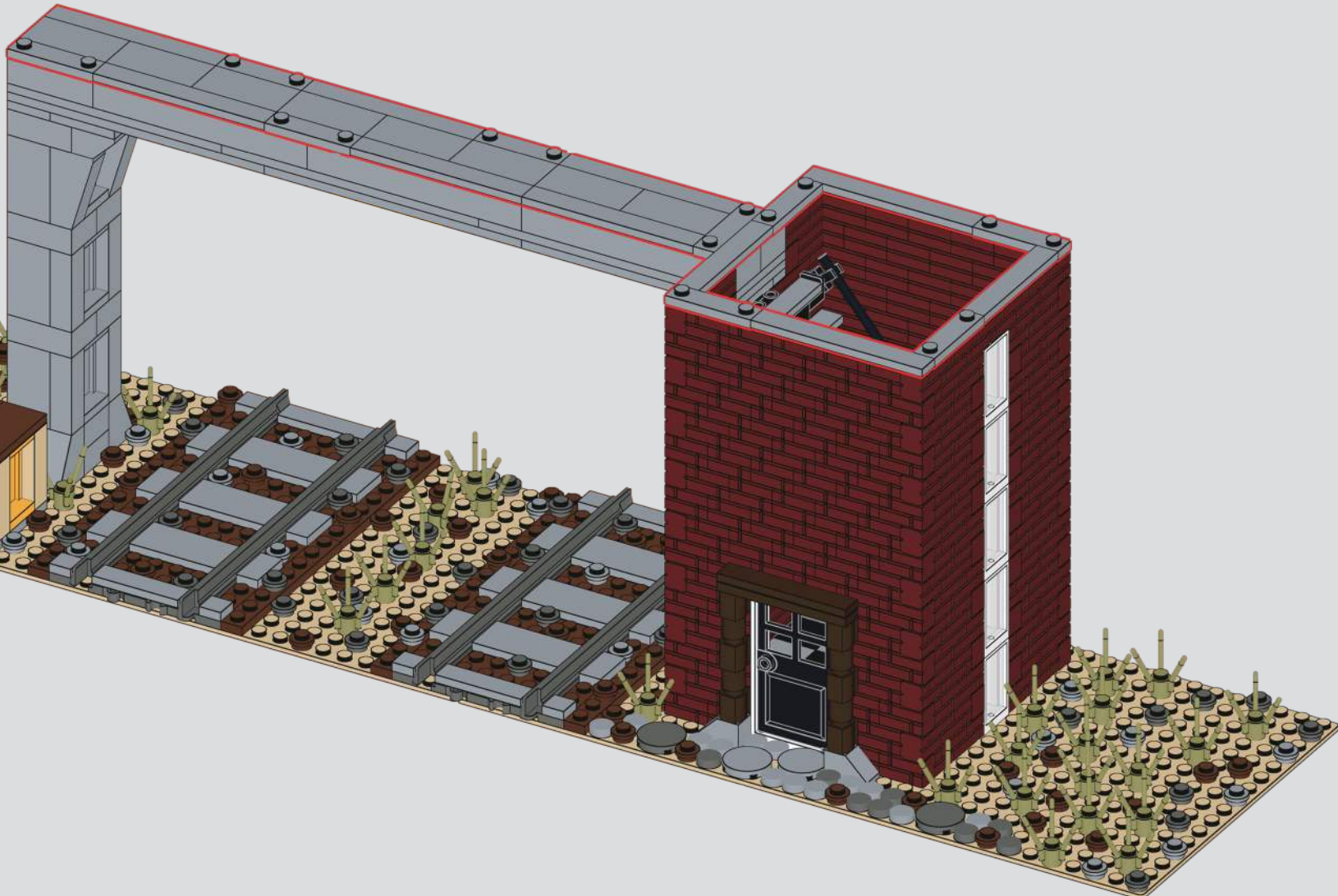

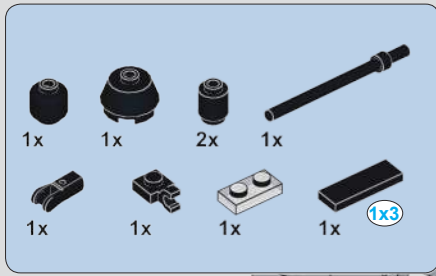

76

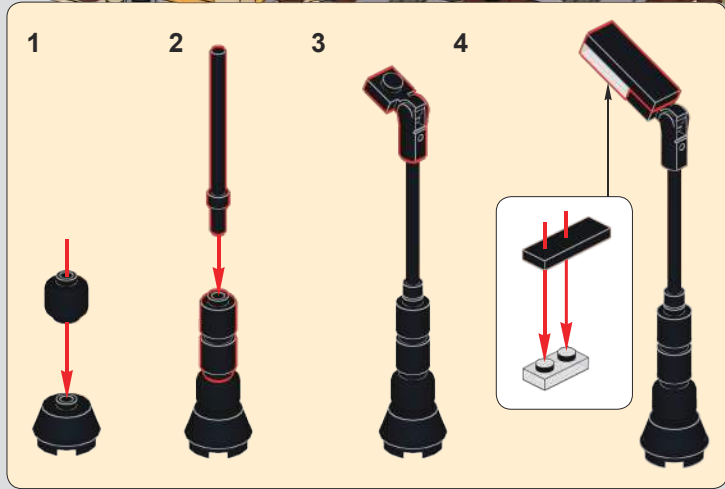
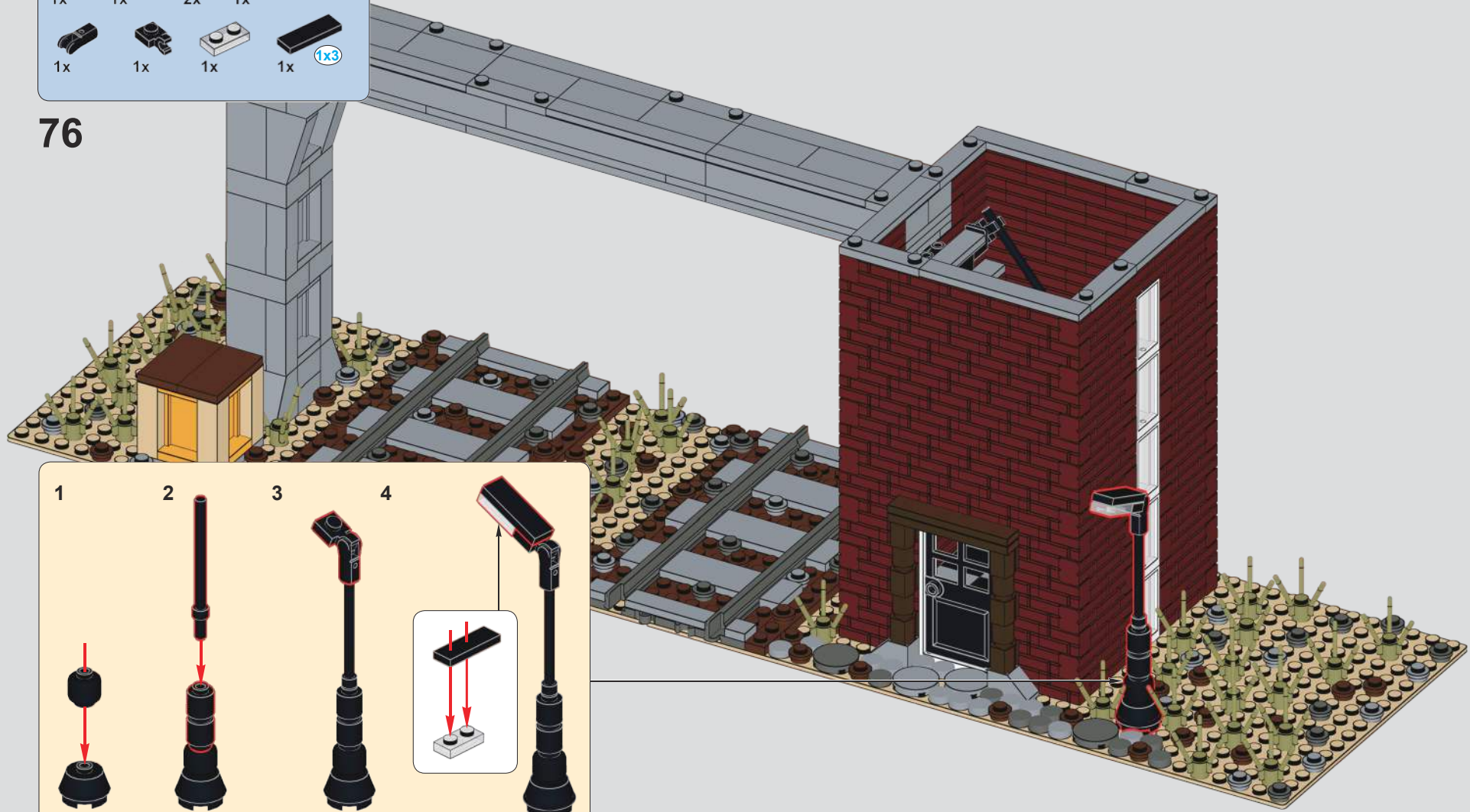

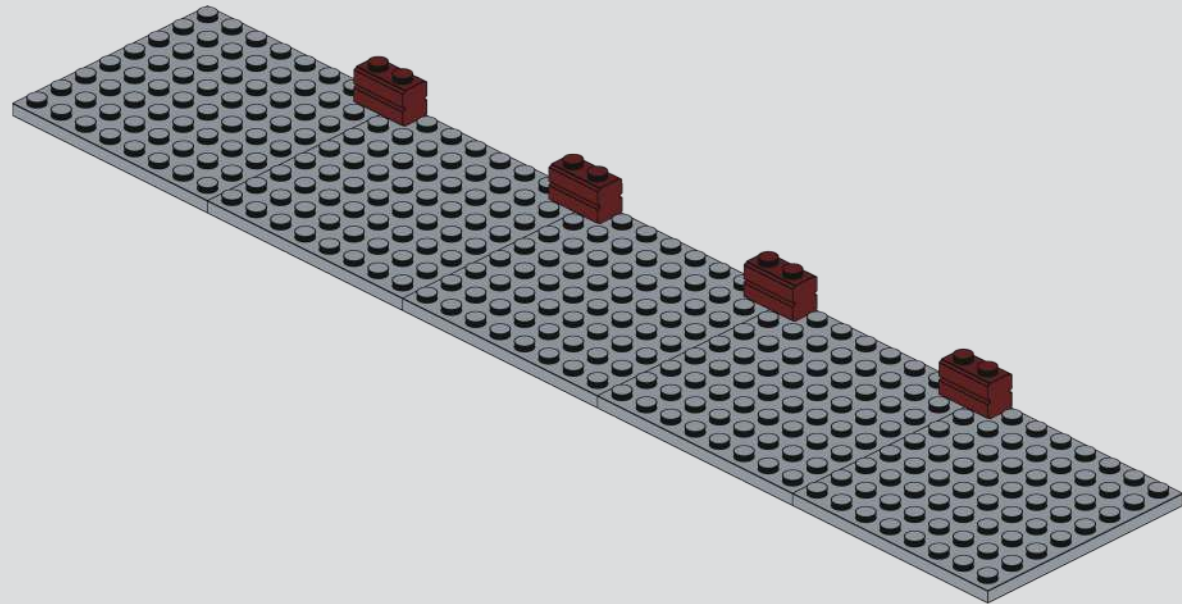
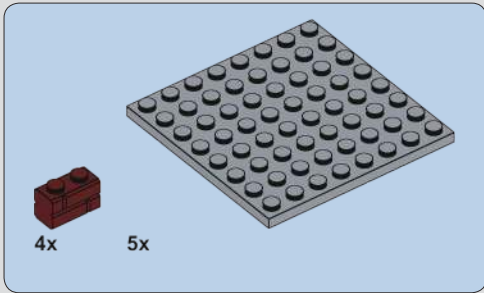
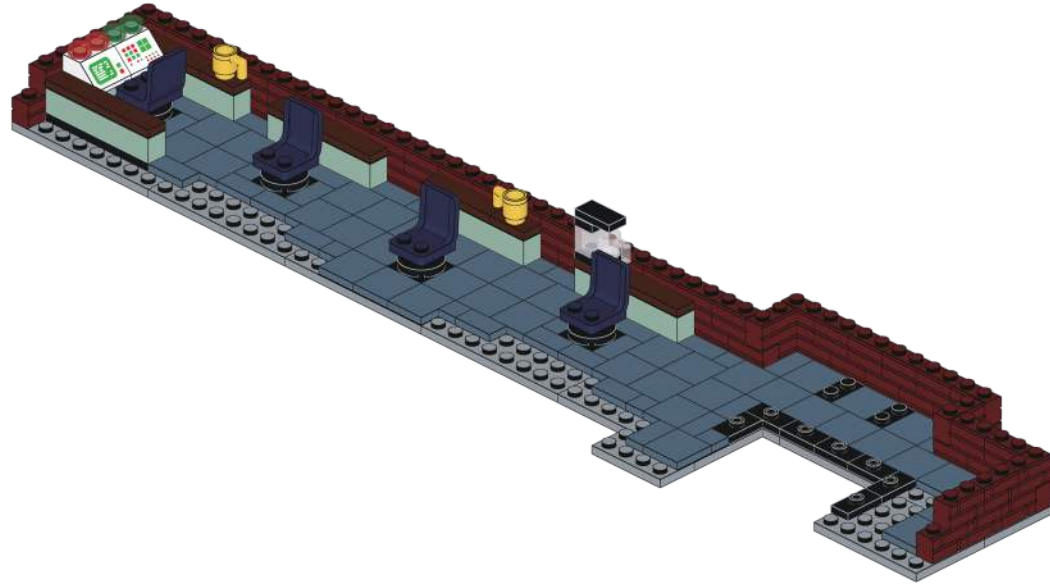

77

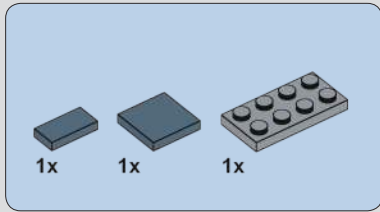

78

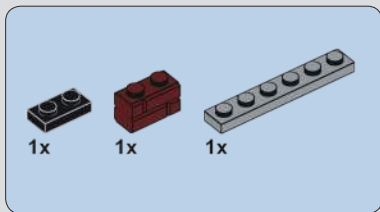
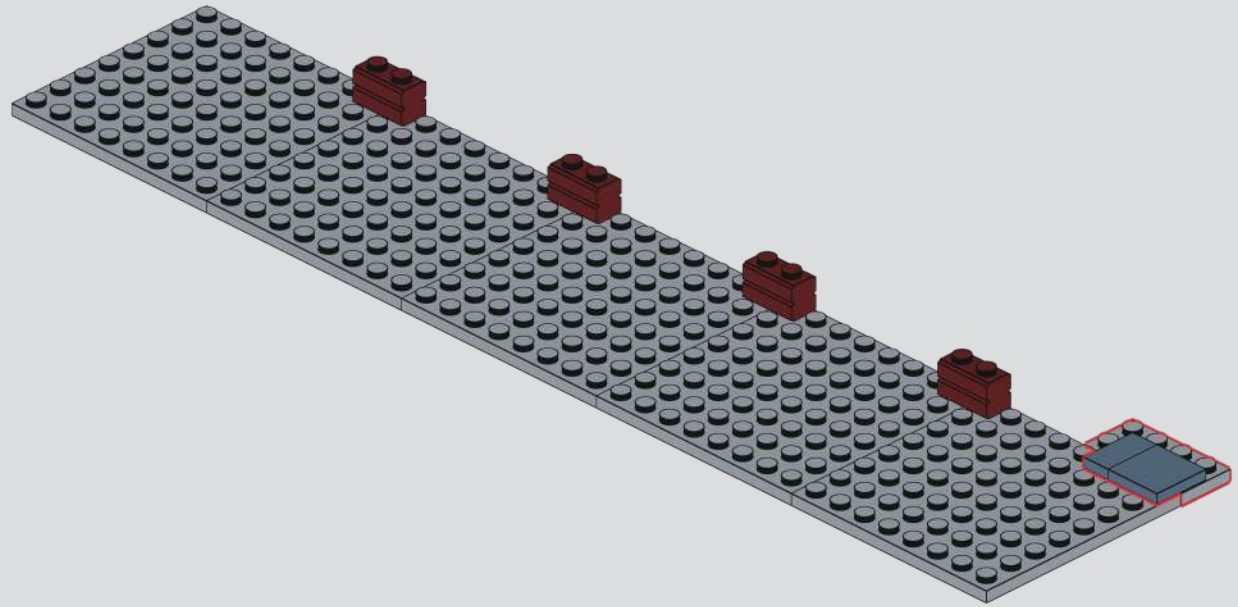

79

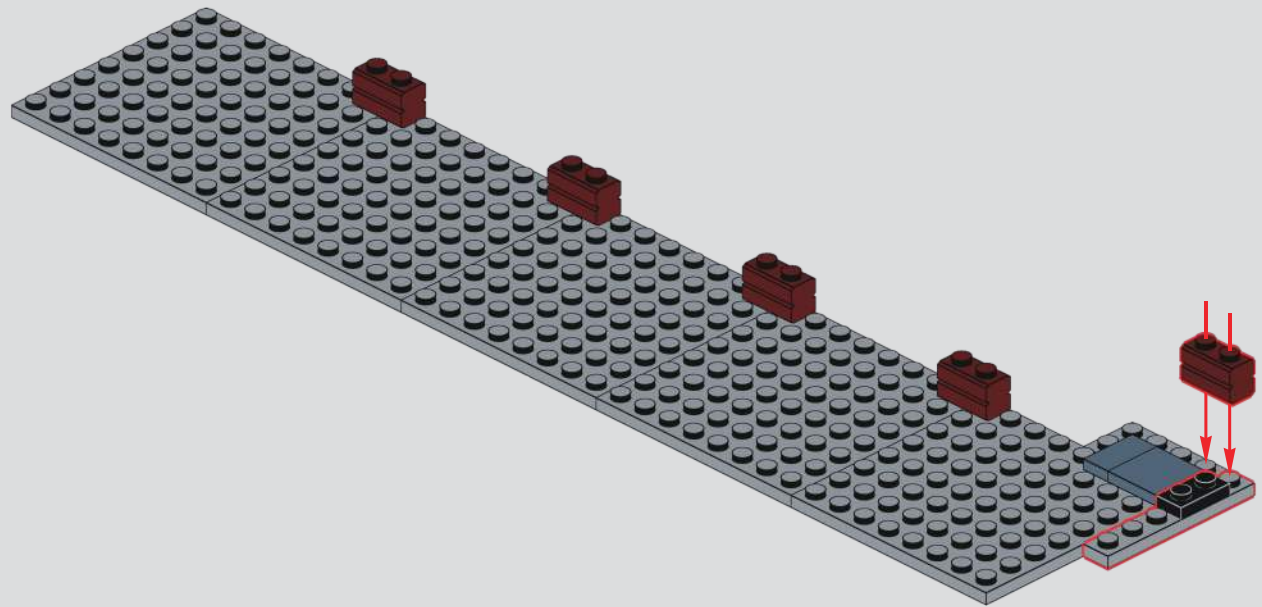

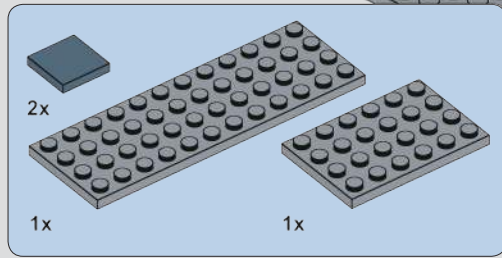

80

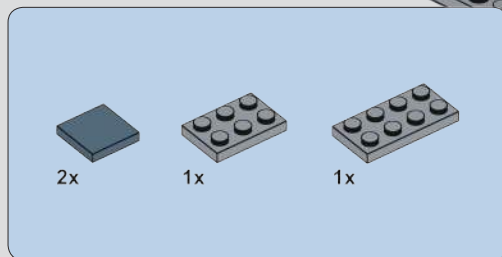
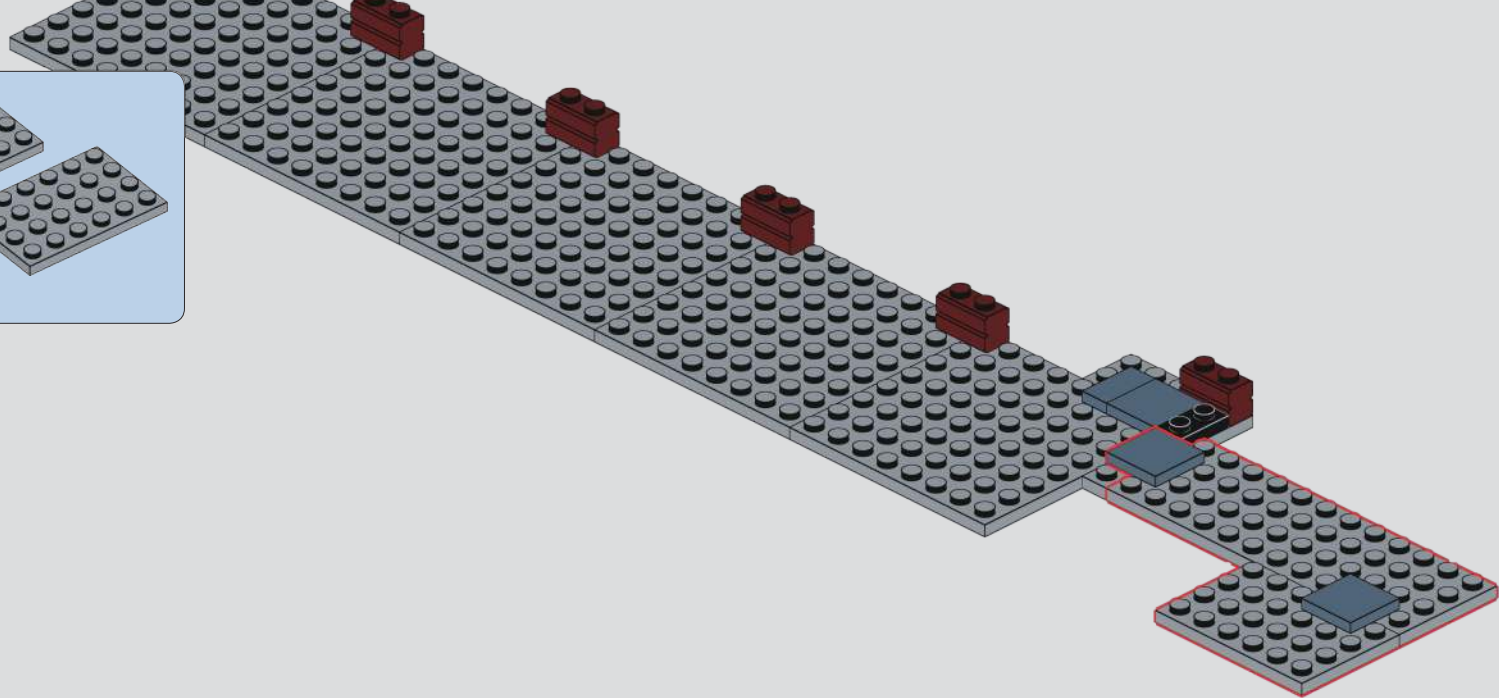

81

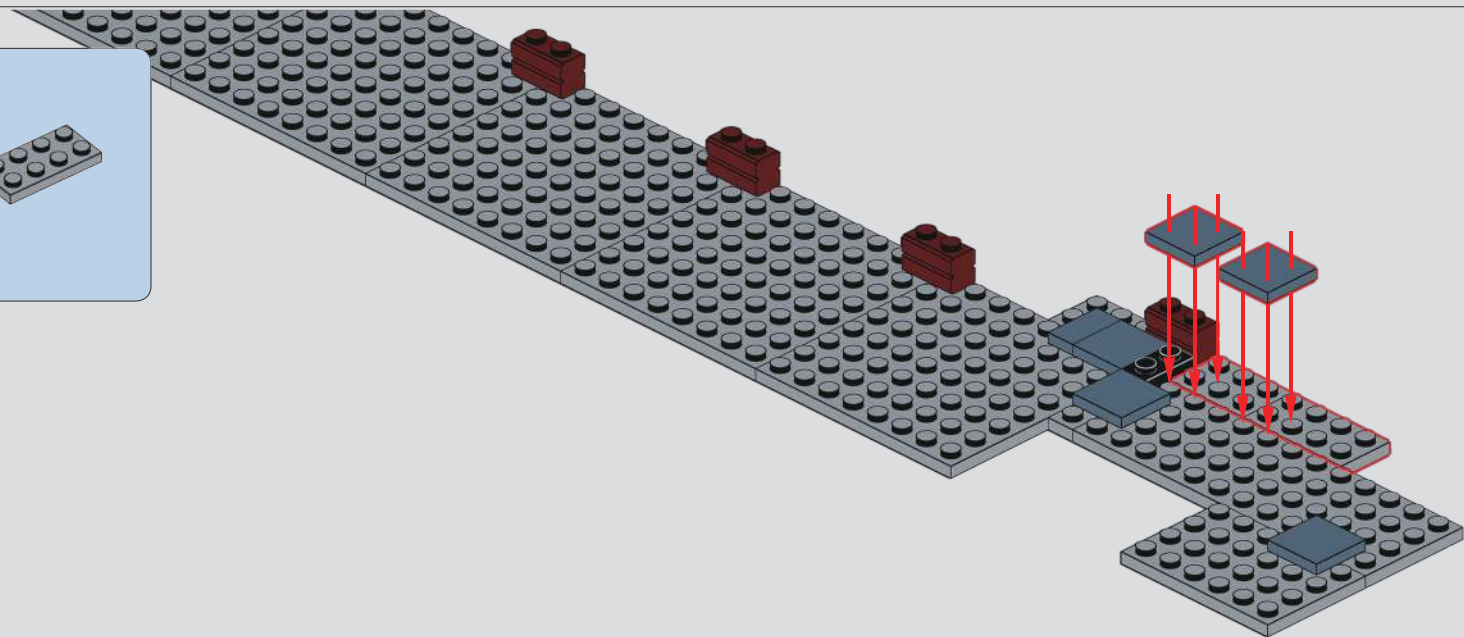

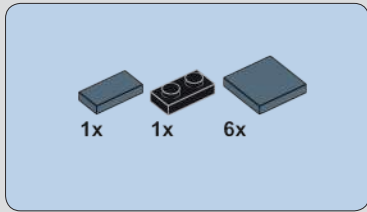

82

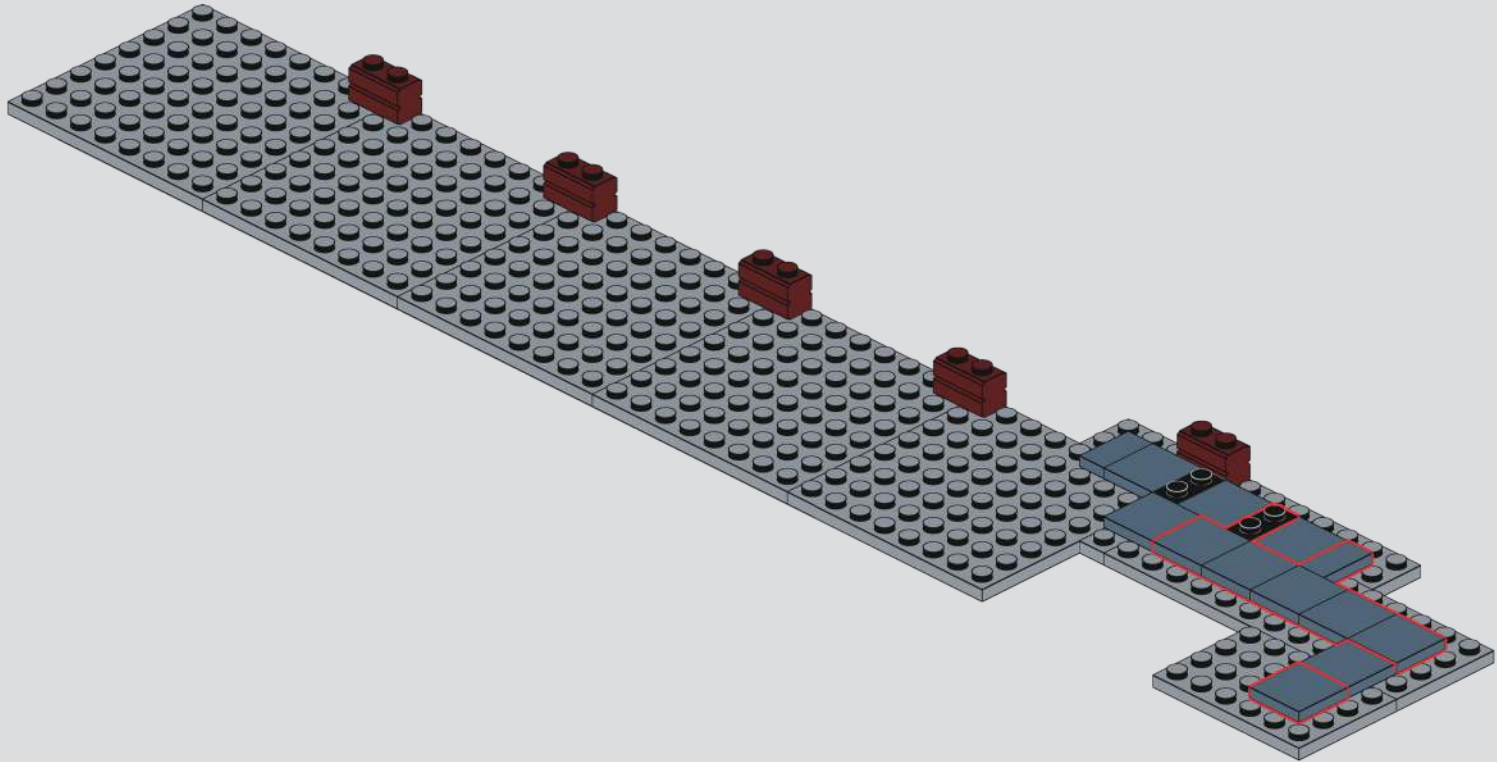

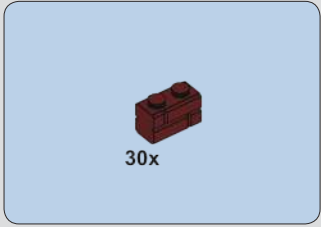

83

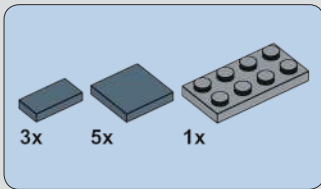
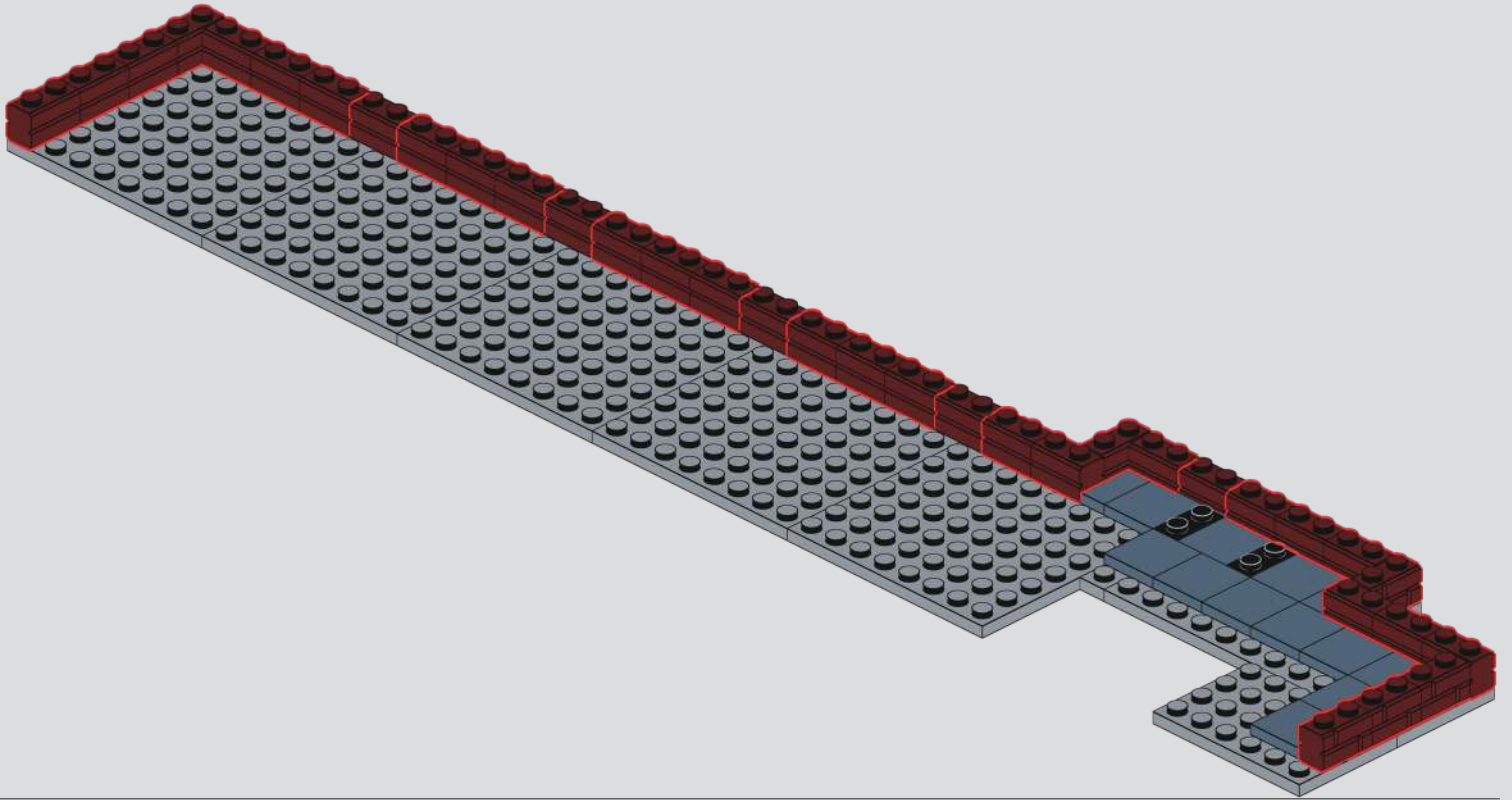

84

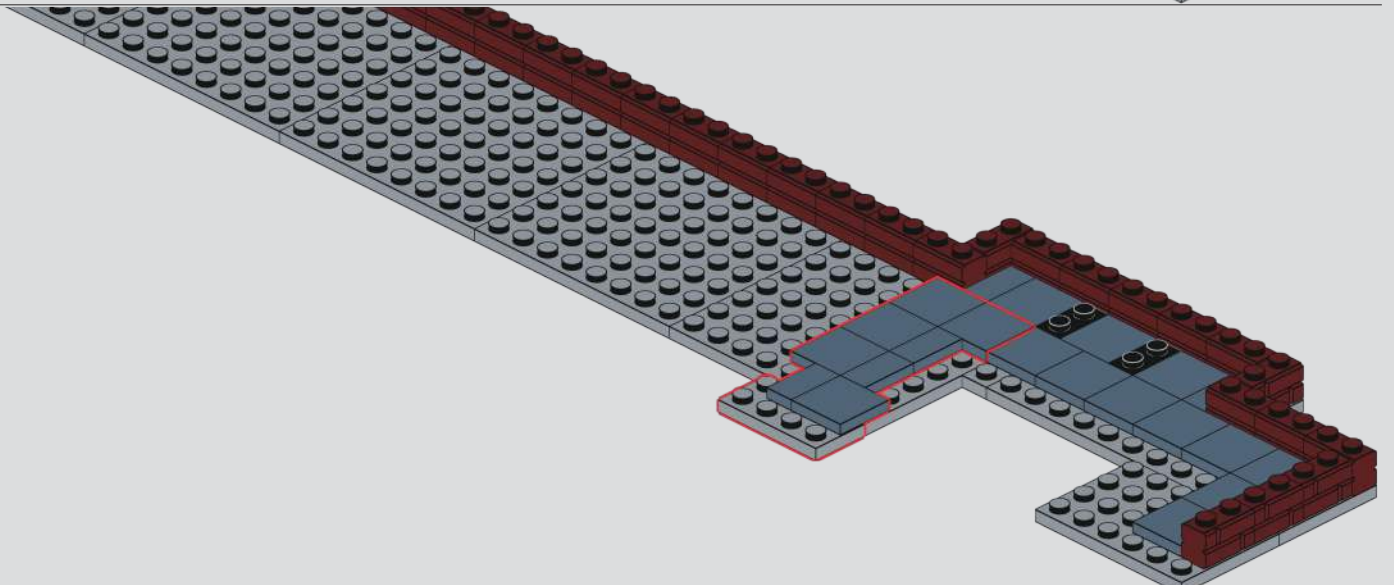

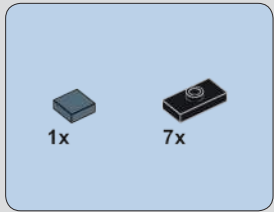

85

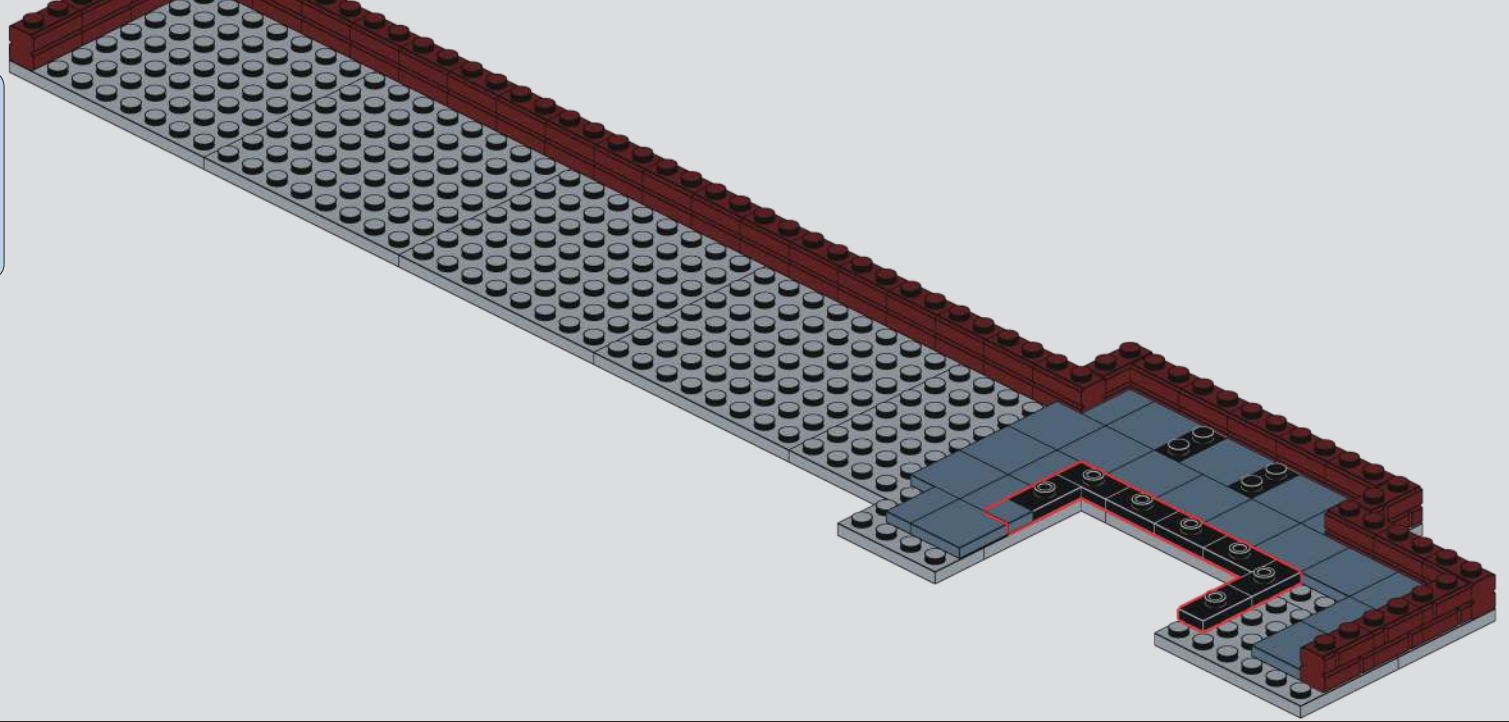

86

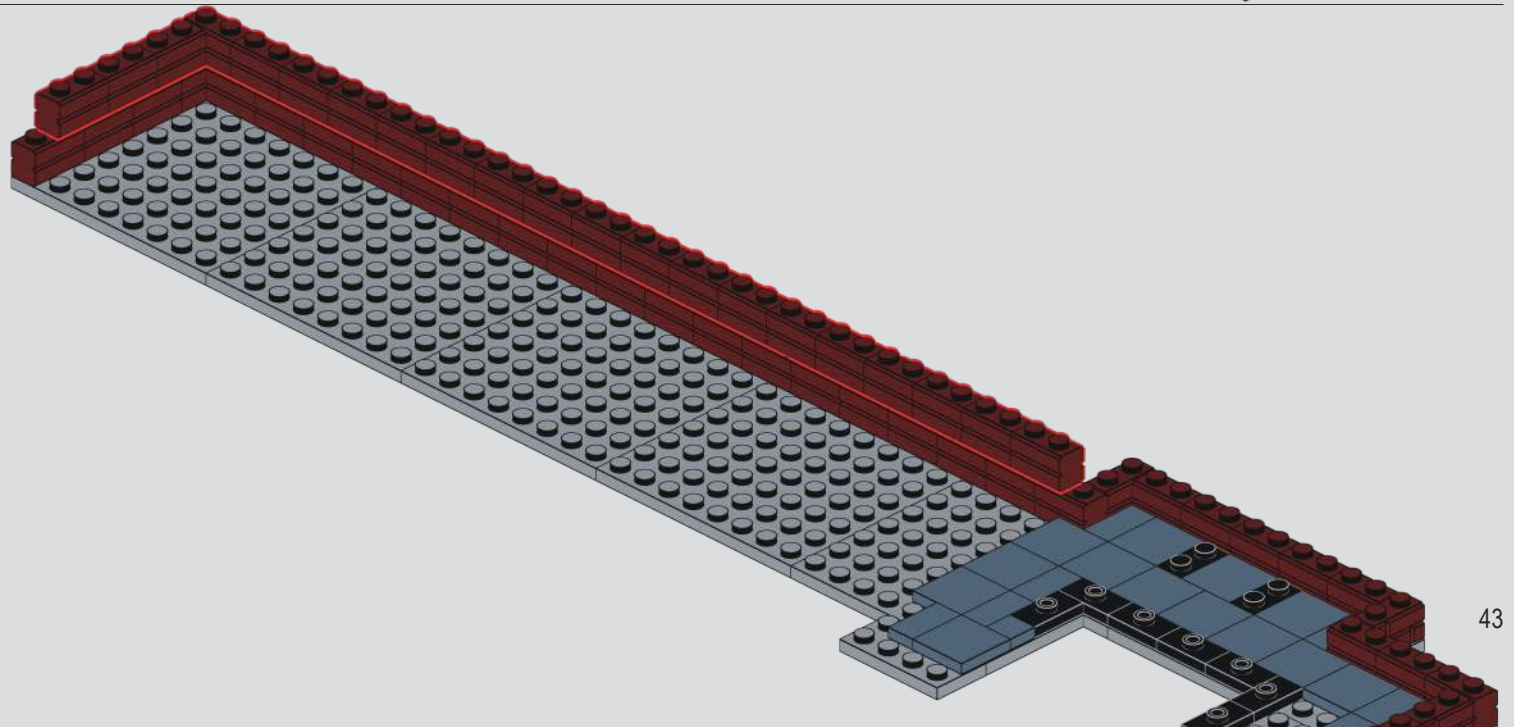

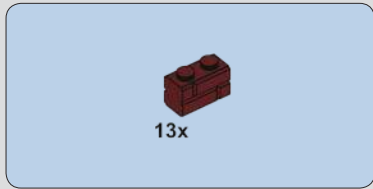

87

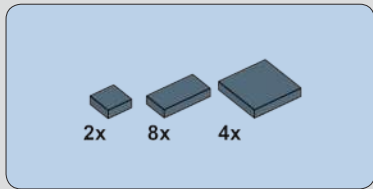
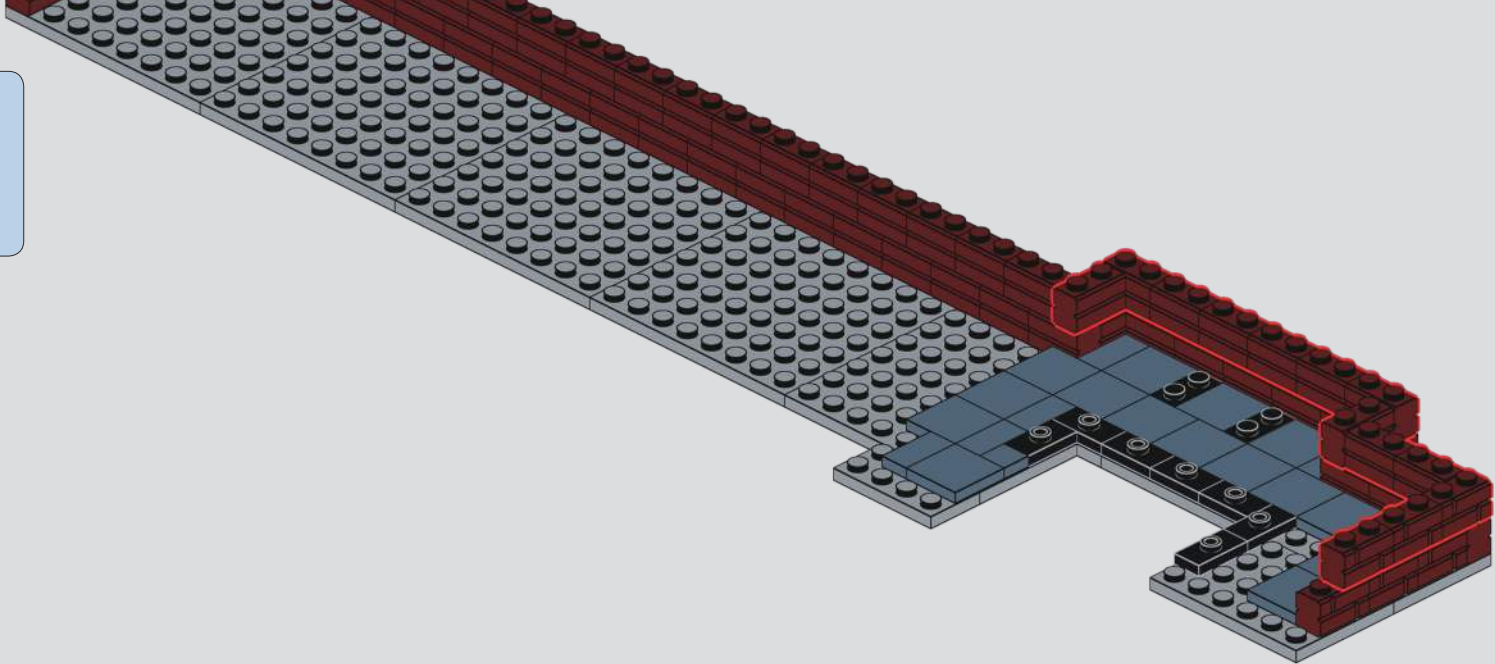

88

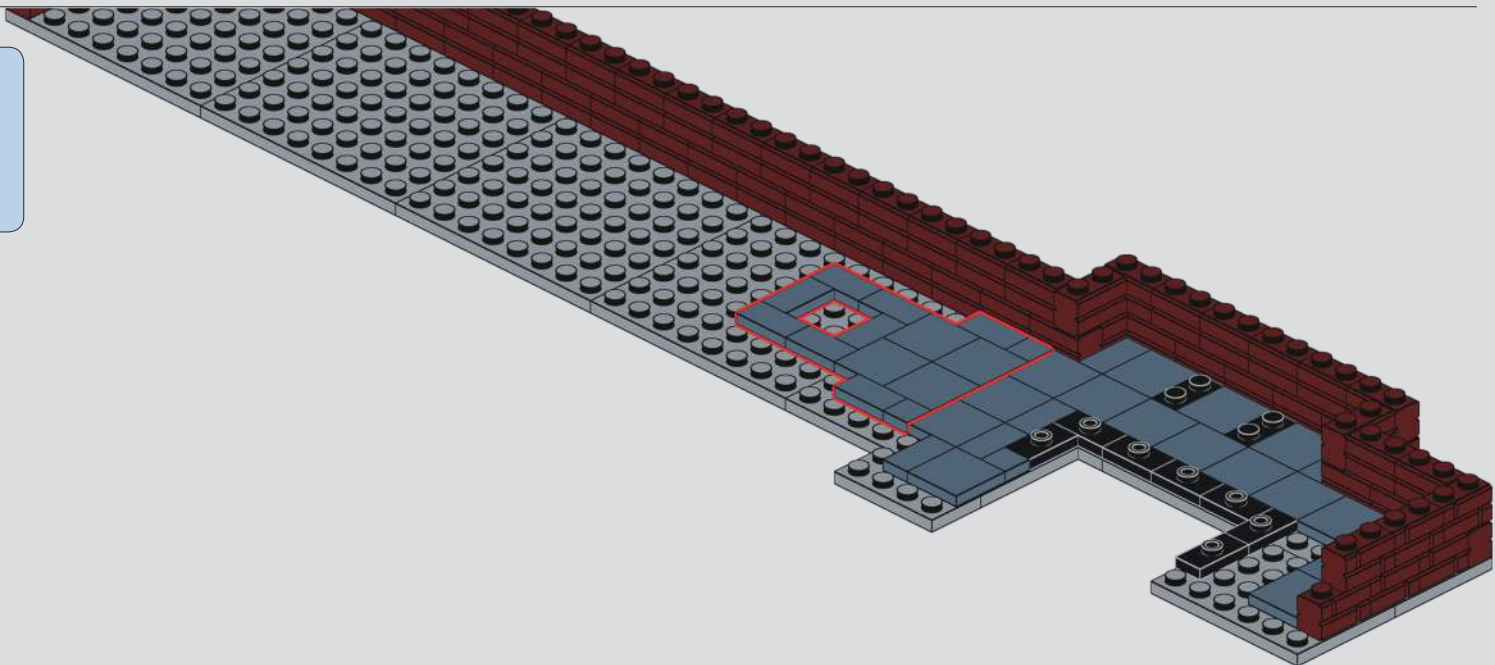

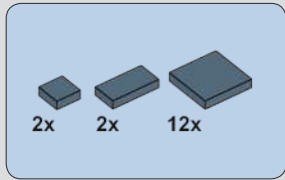

89

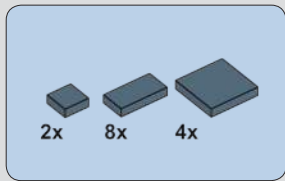
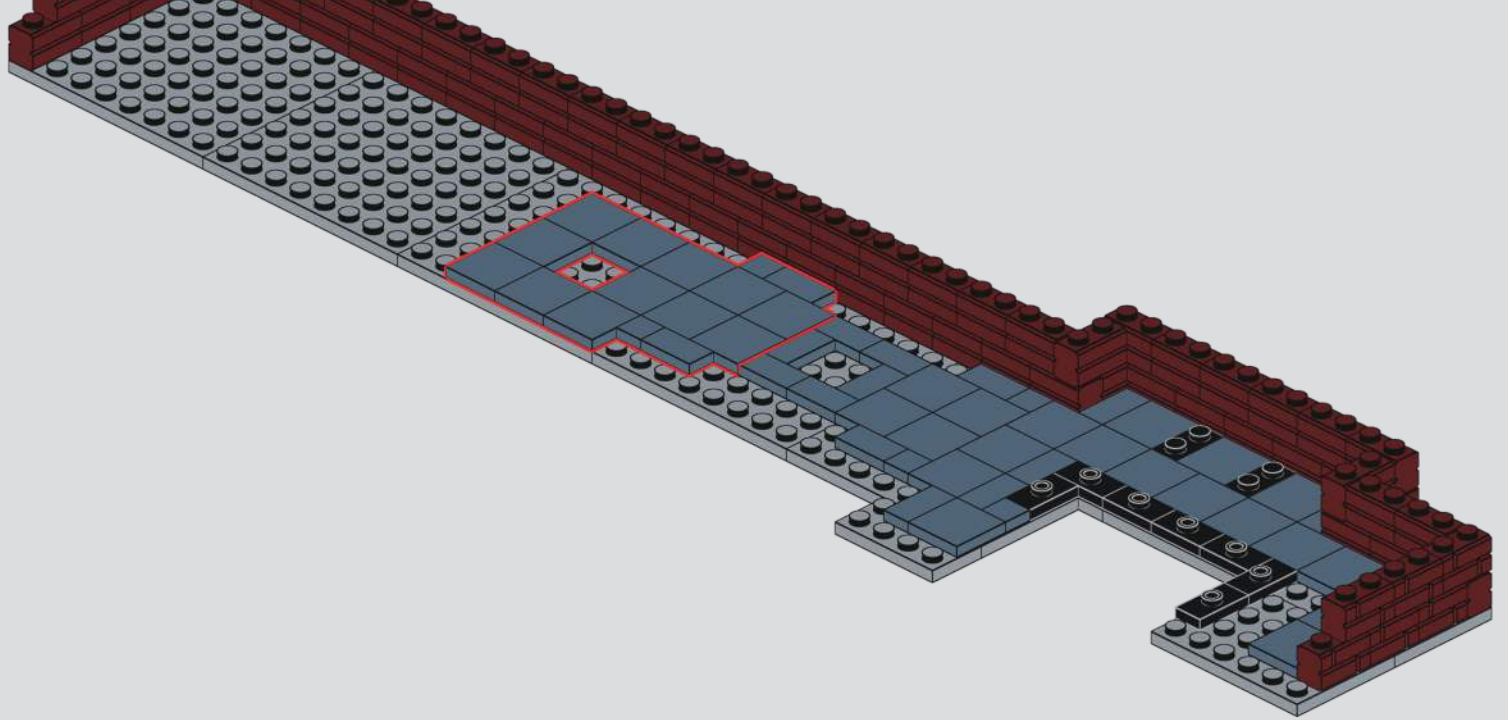

90

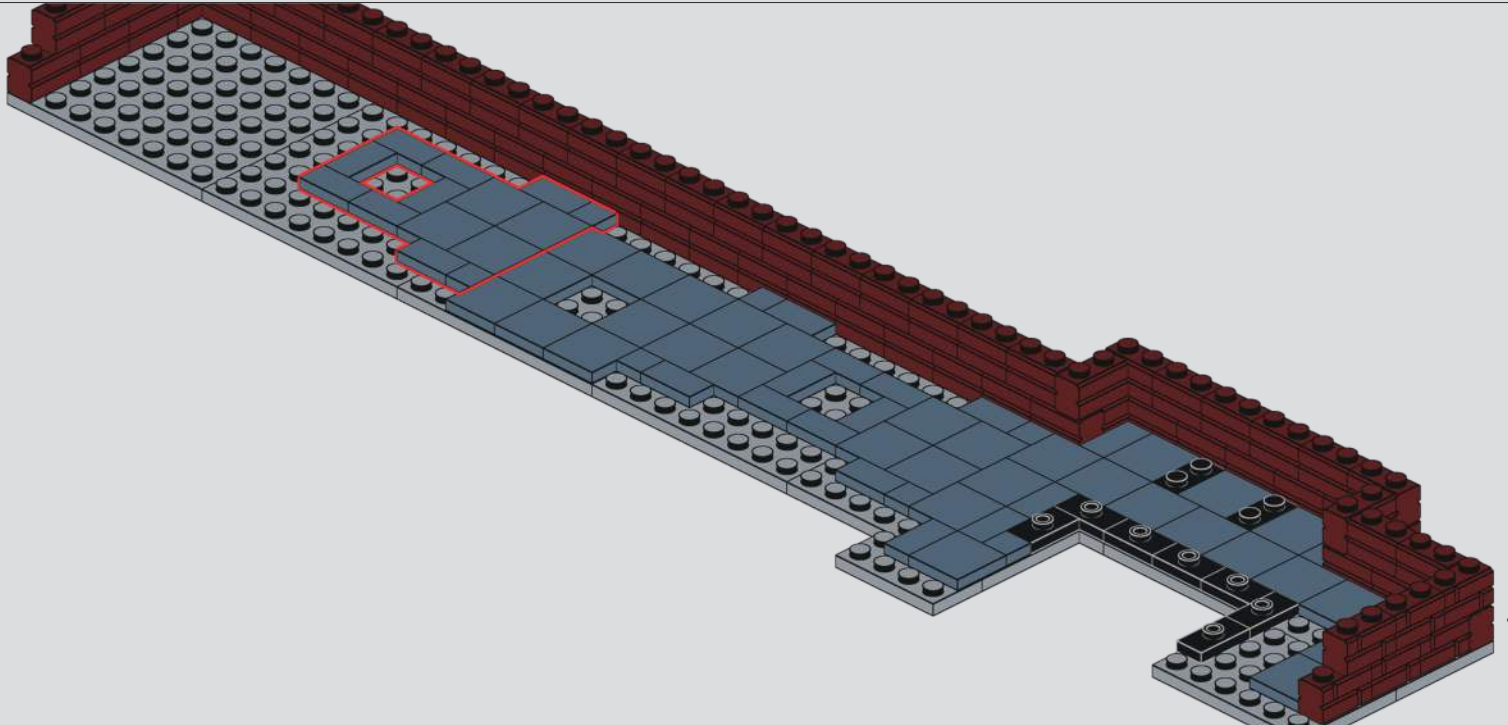

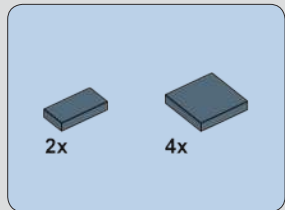

91

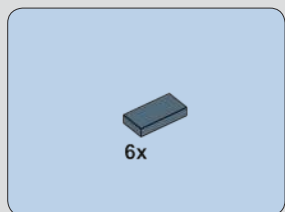
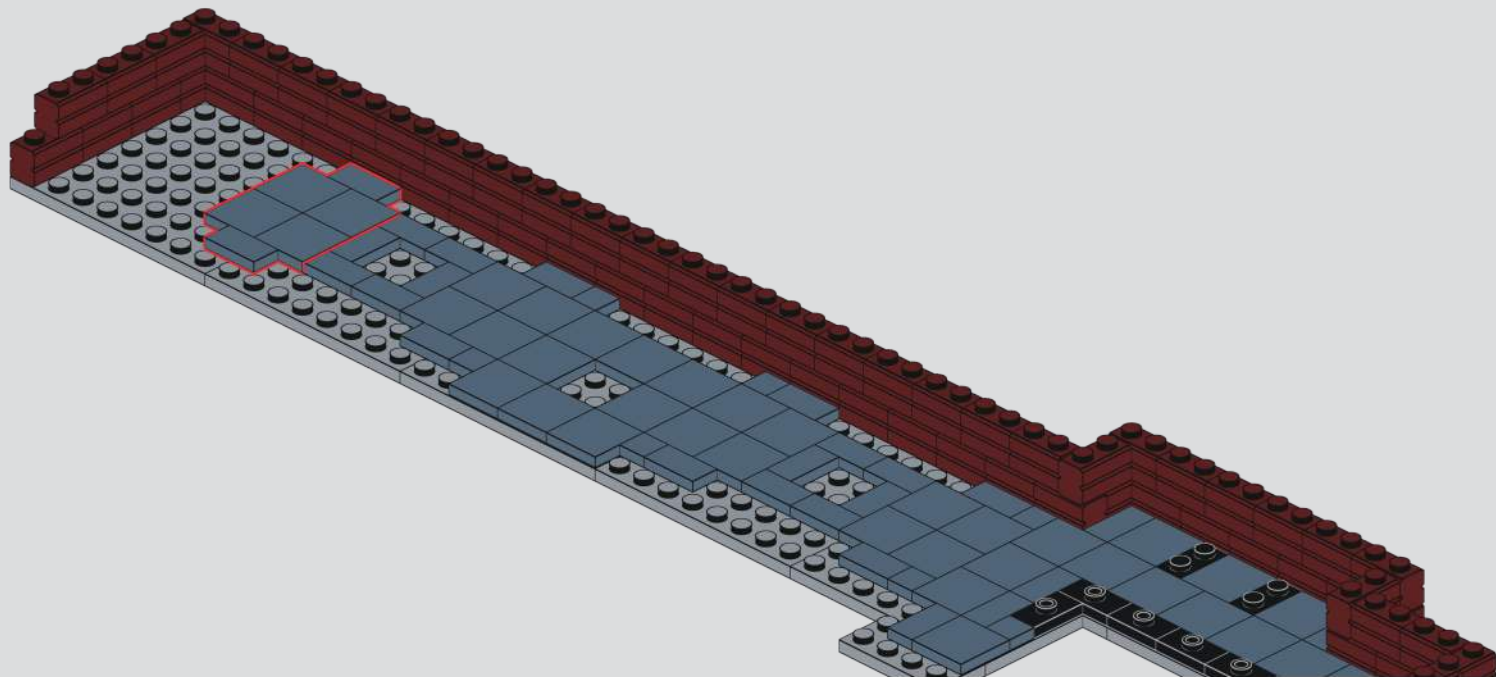

92

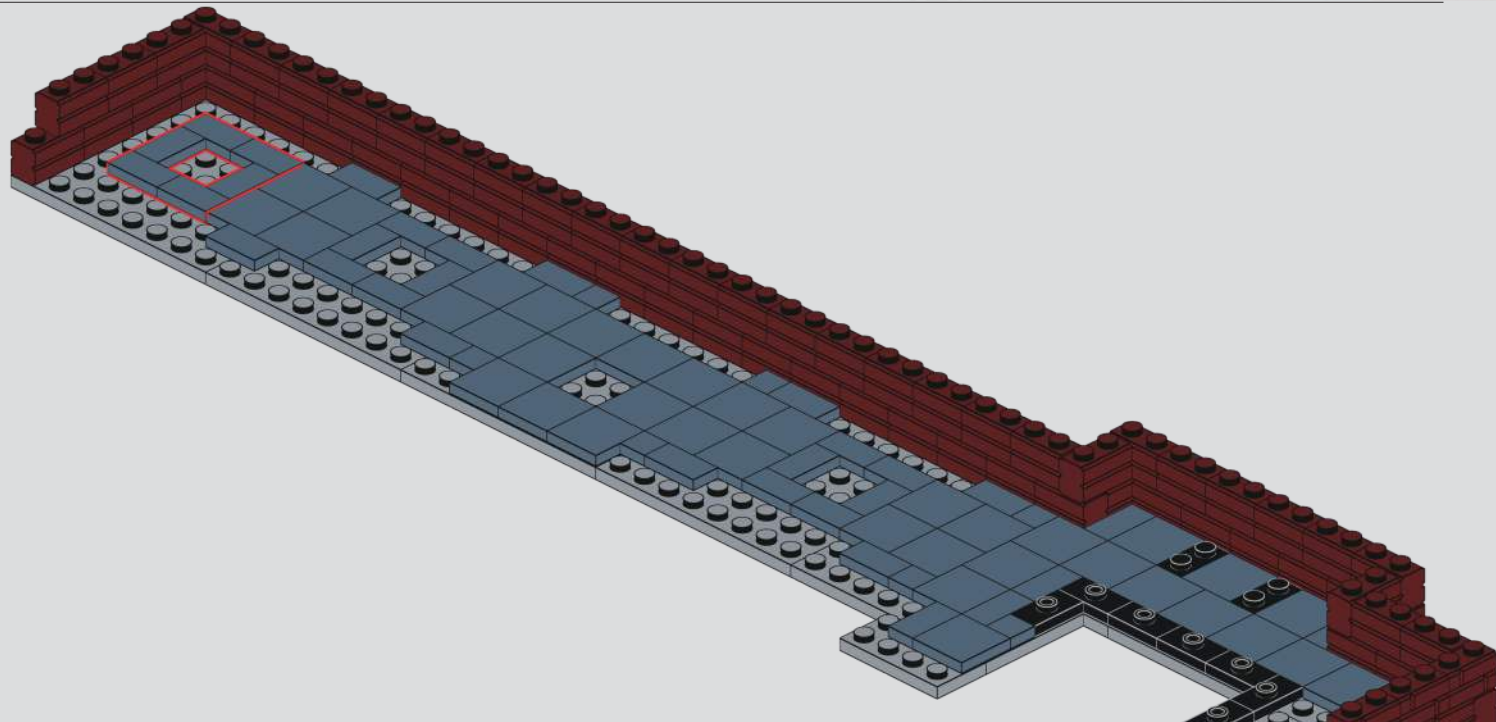

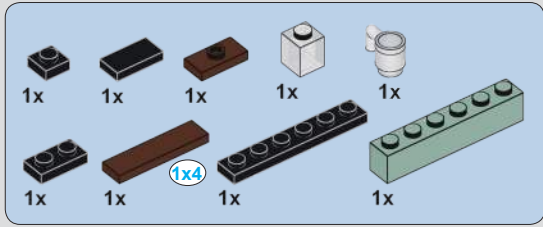

93

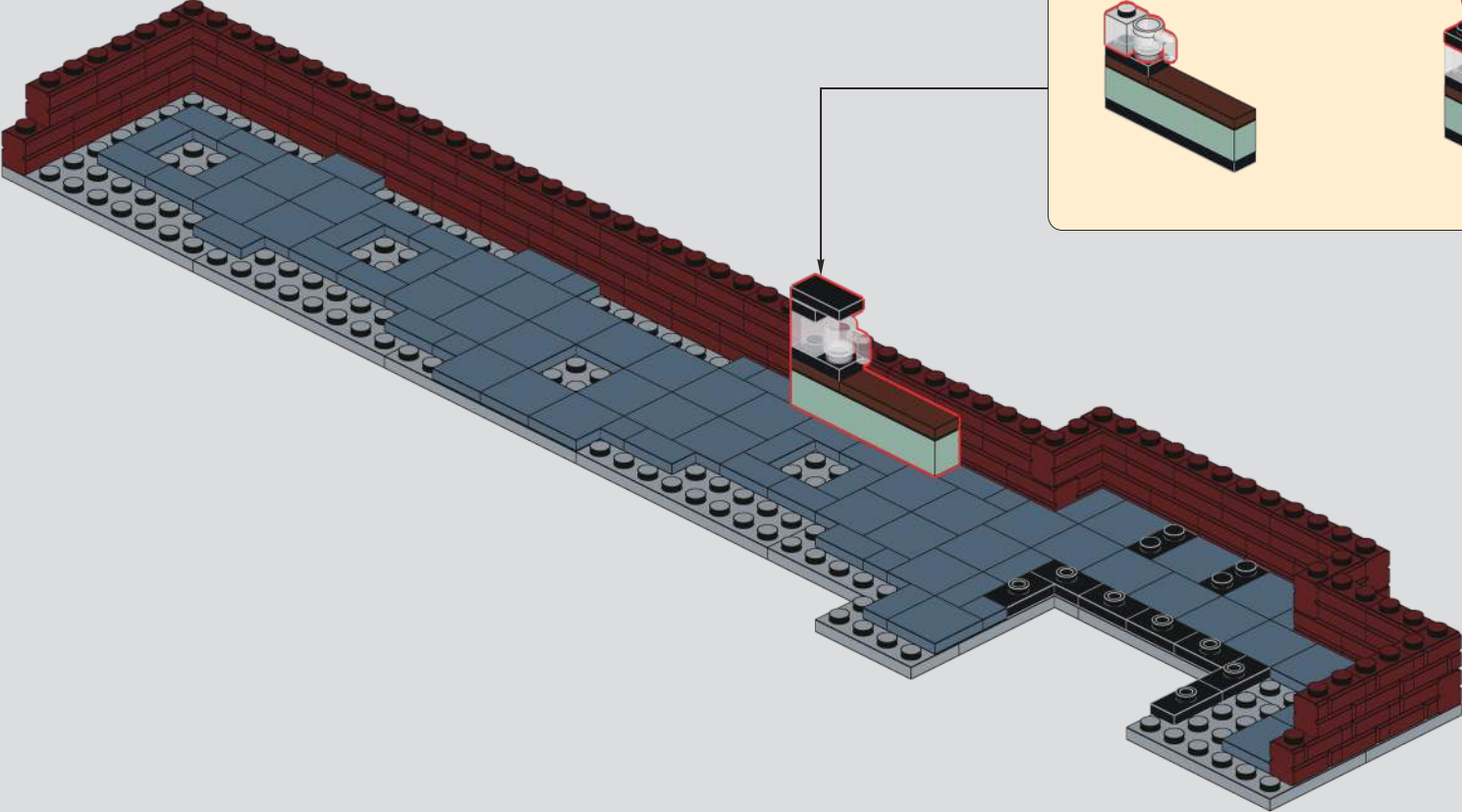
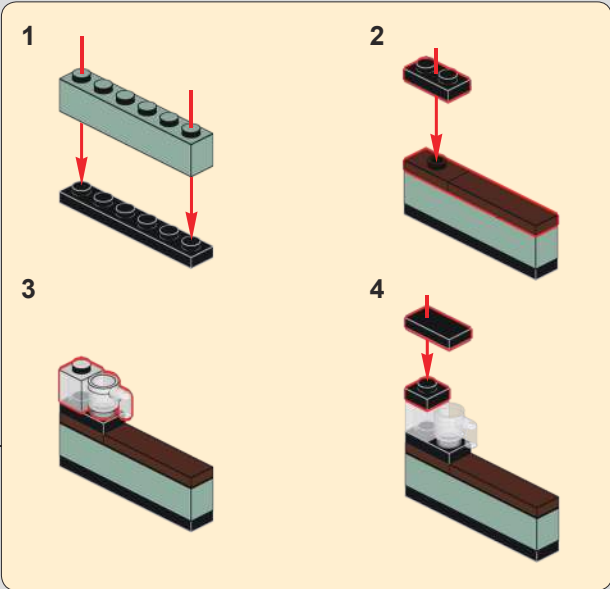

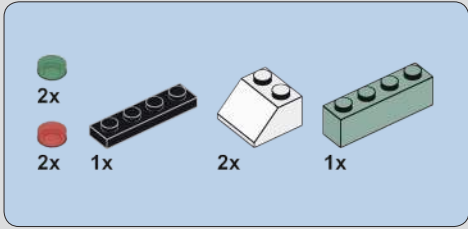

94

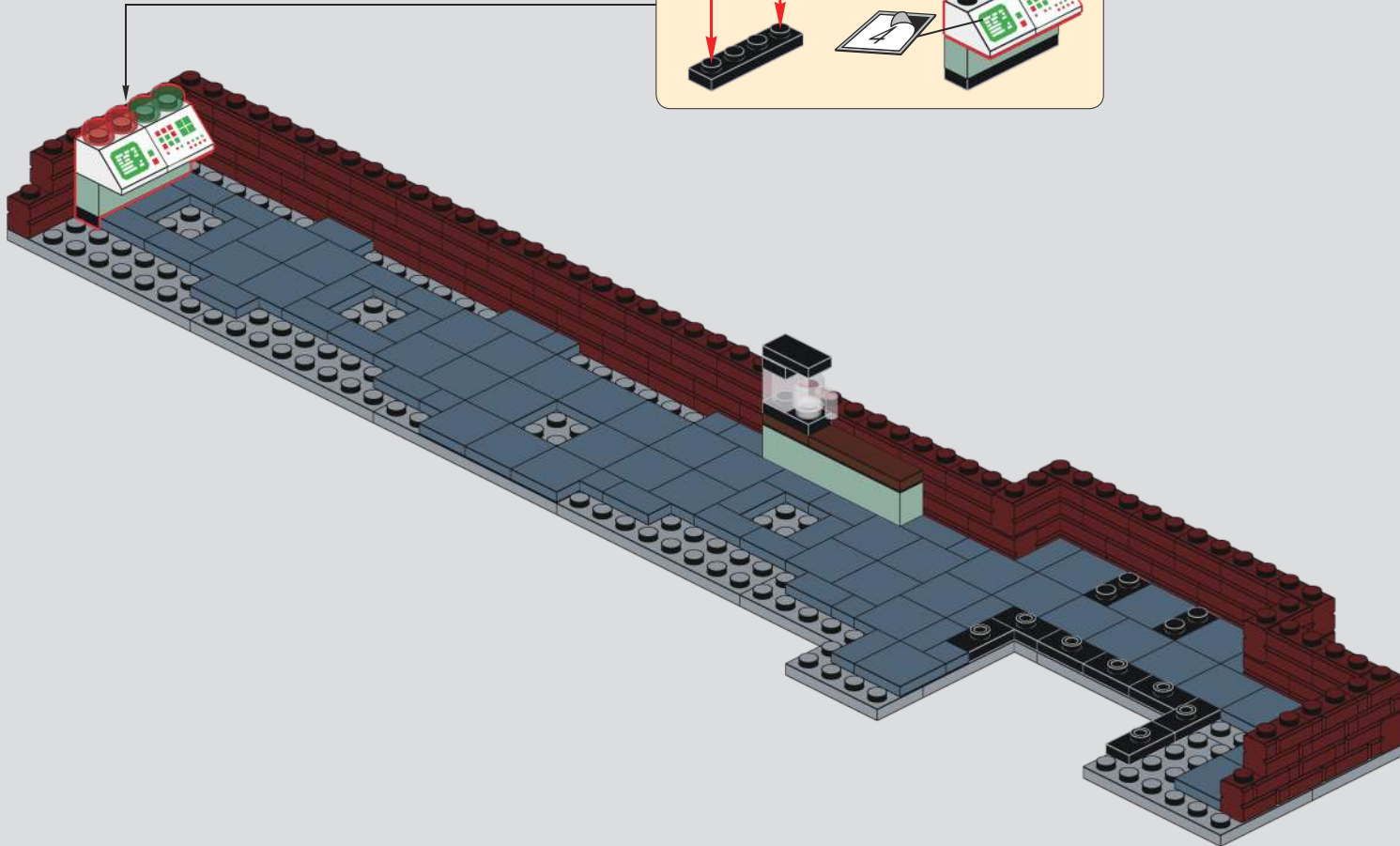
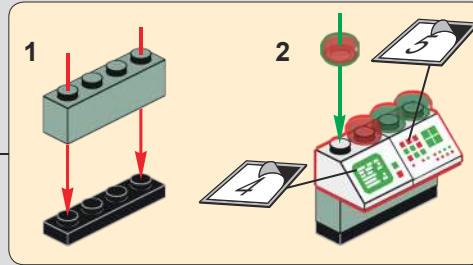

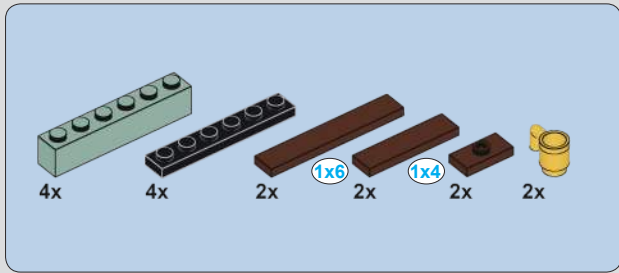

95

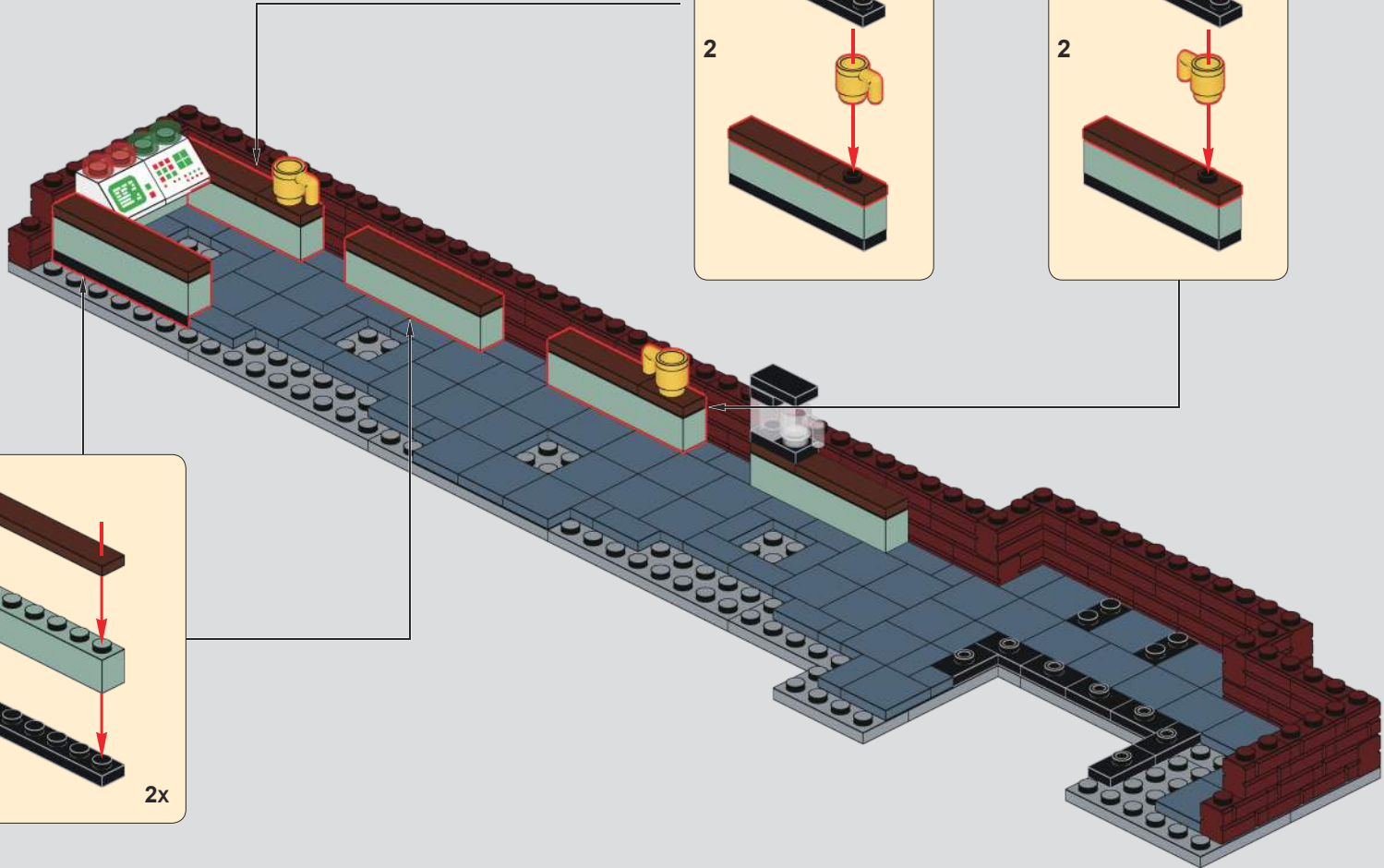
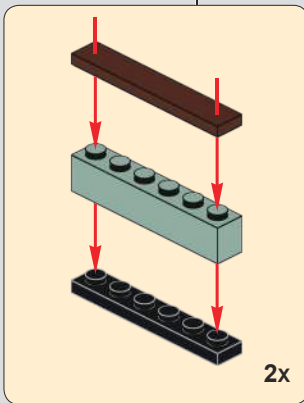
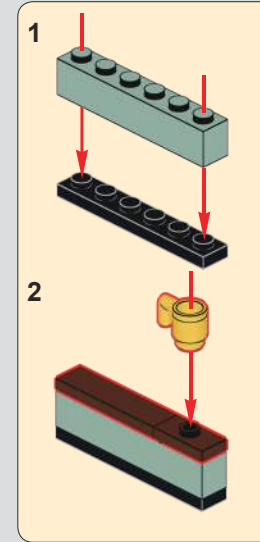
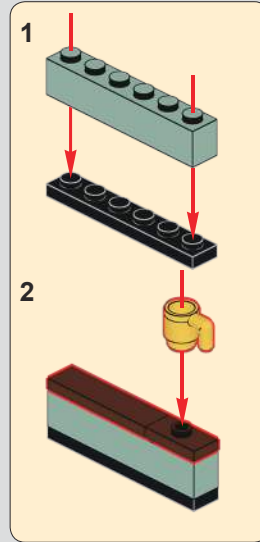

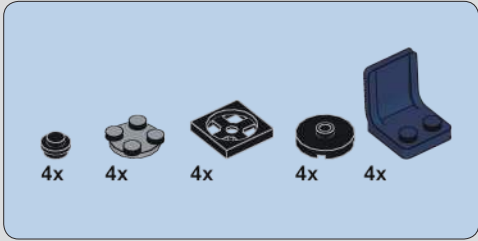

96

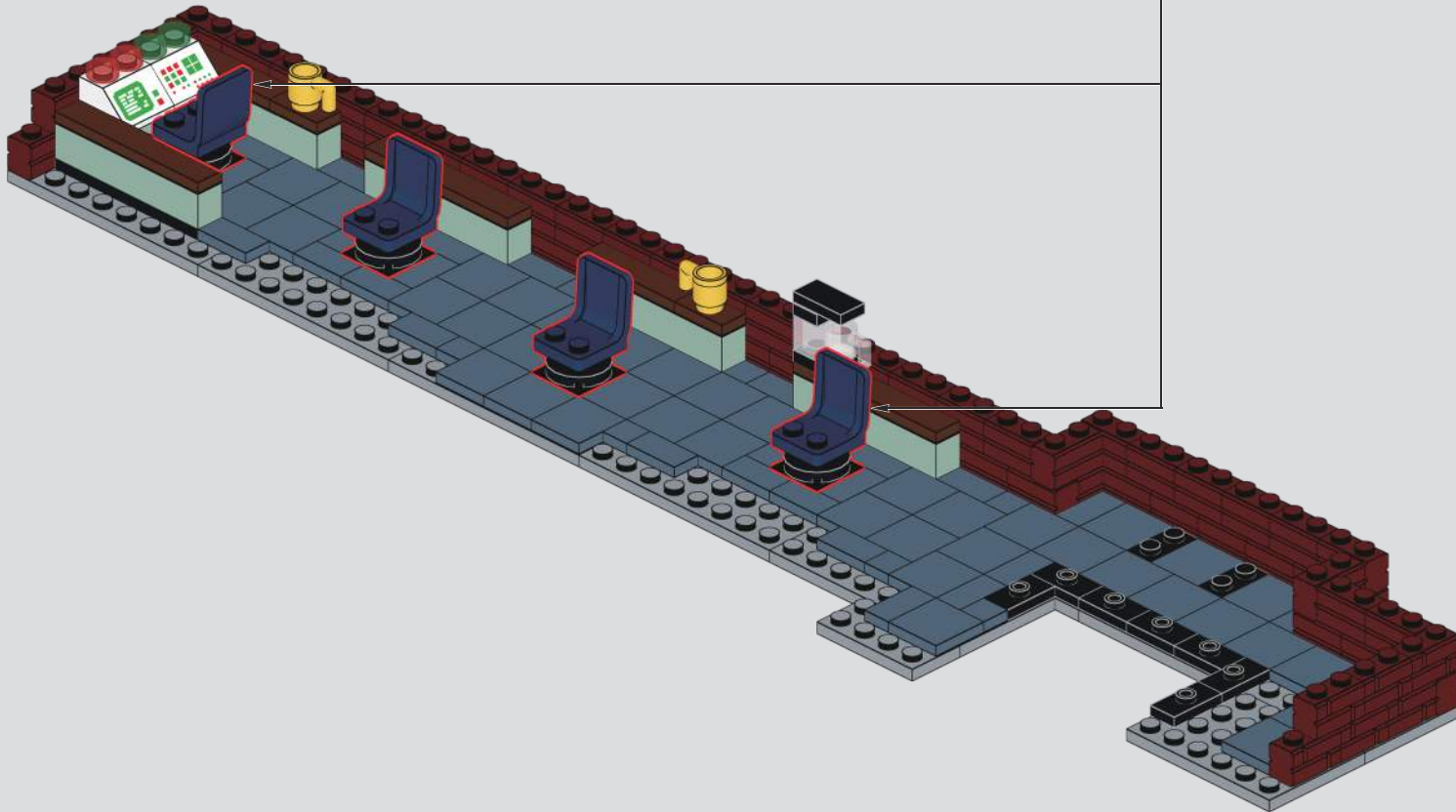
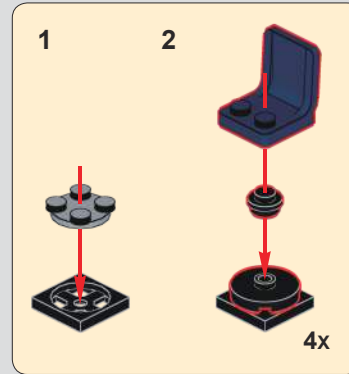

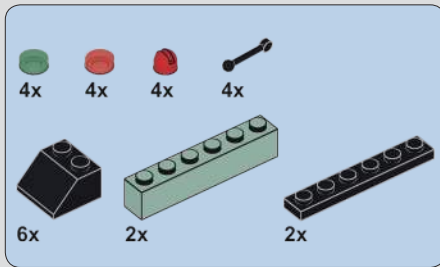
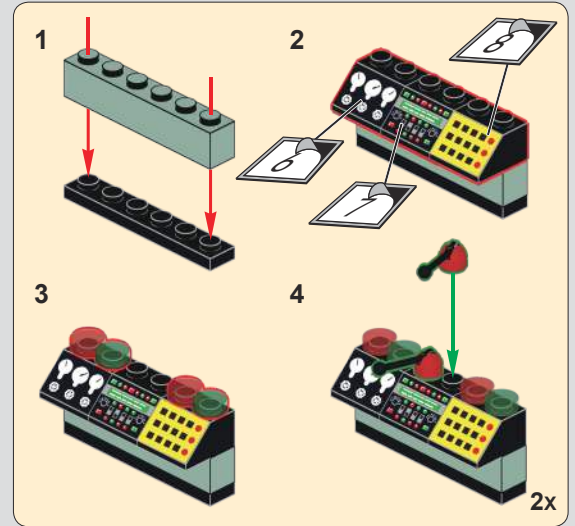
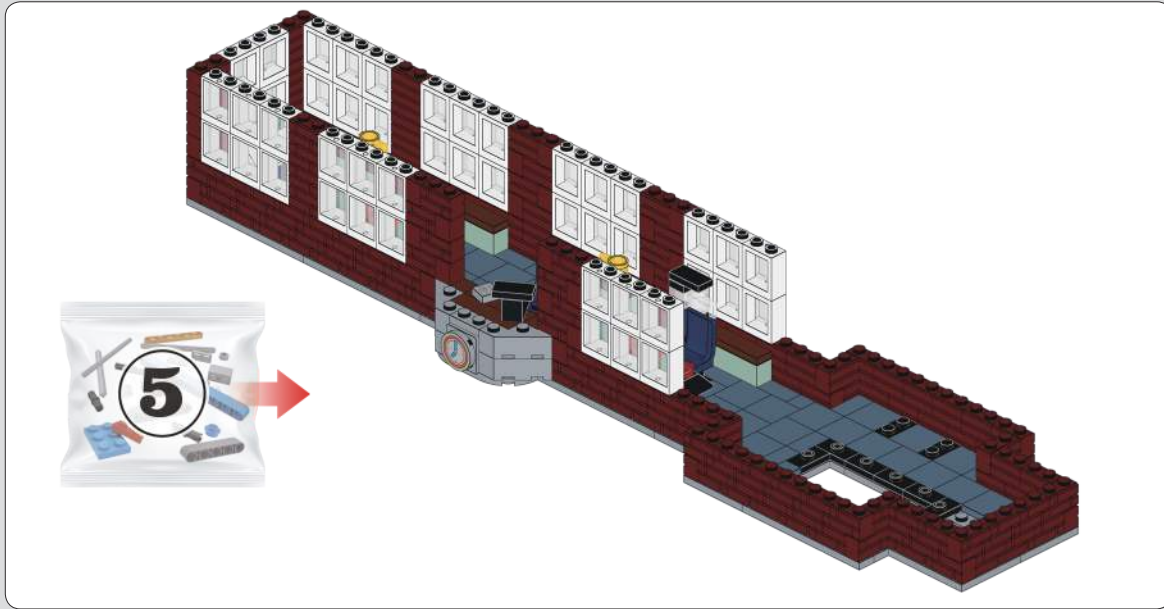

97

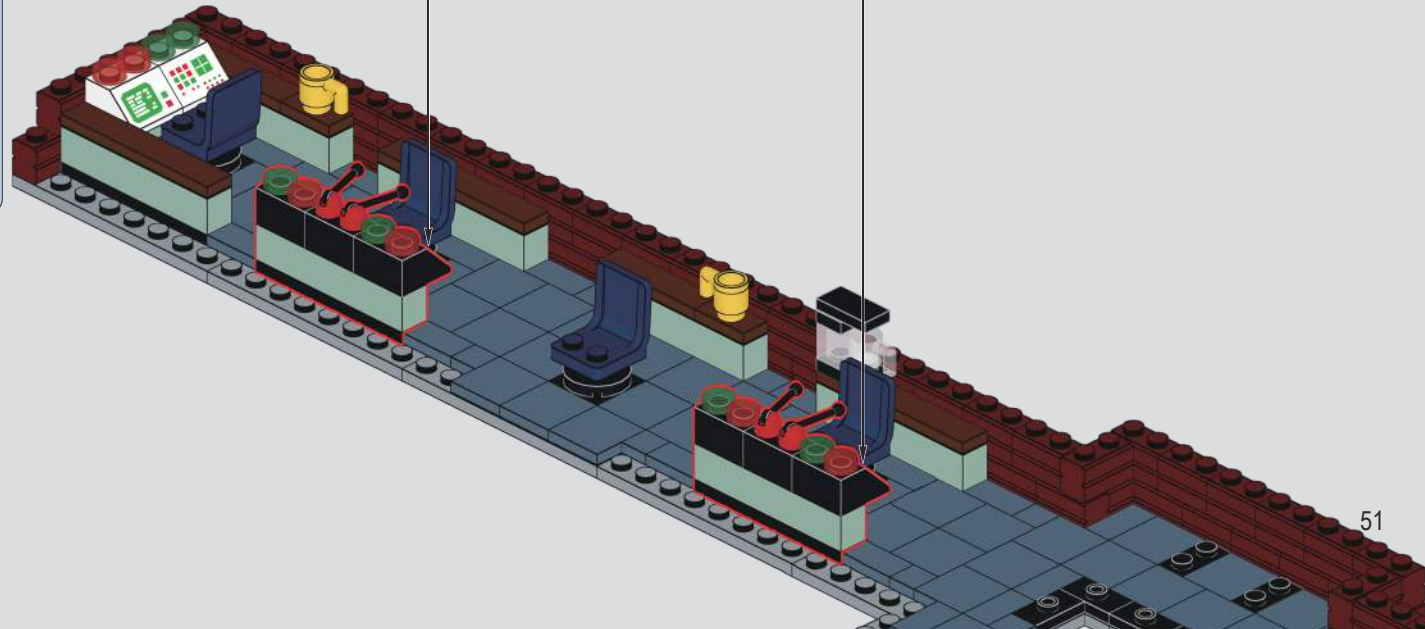

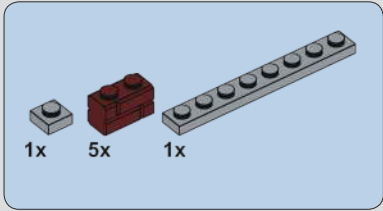

98

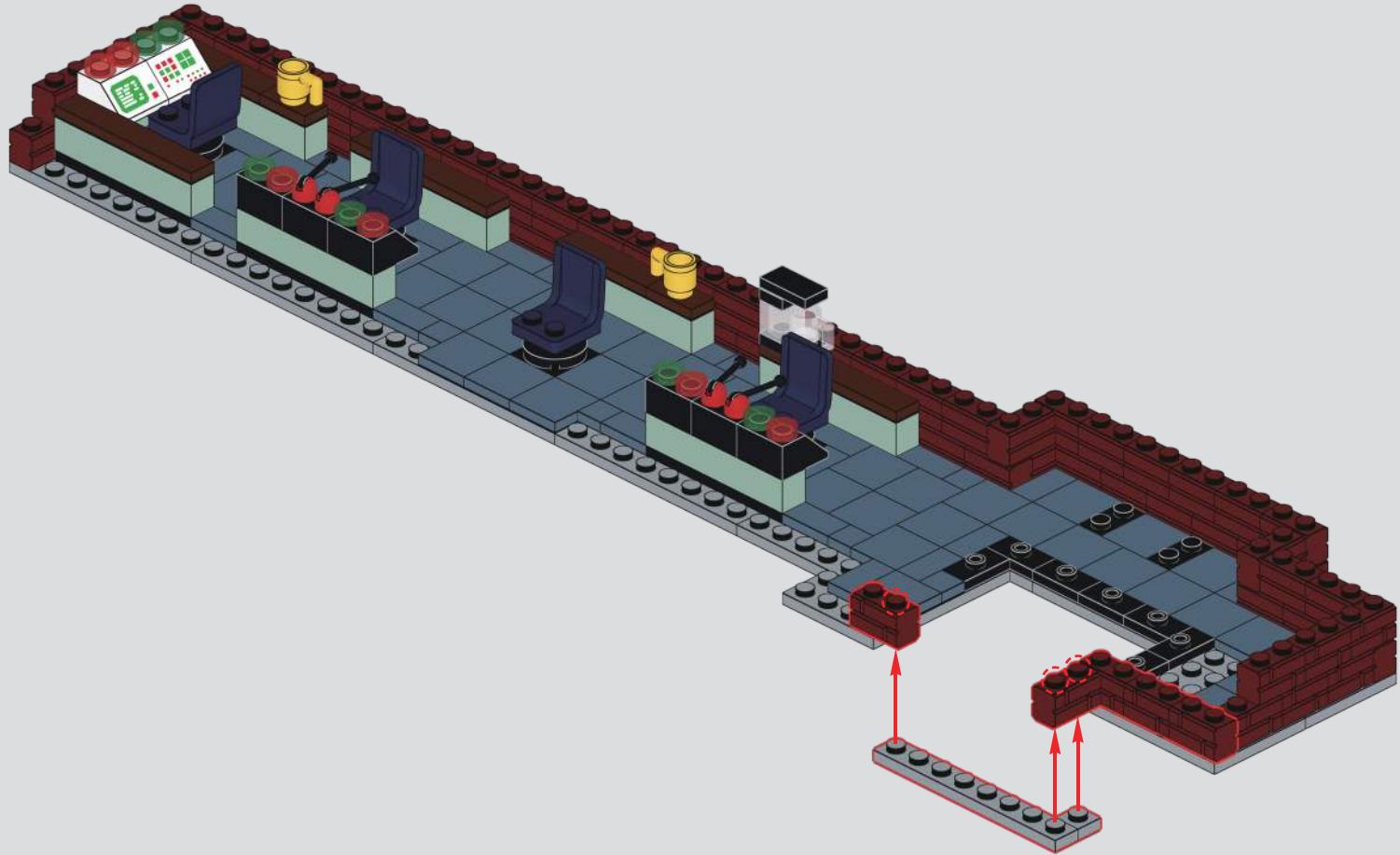

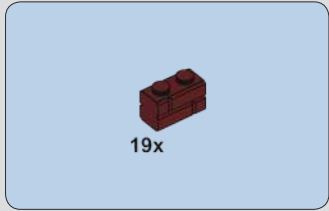

99

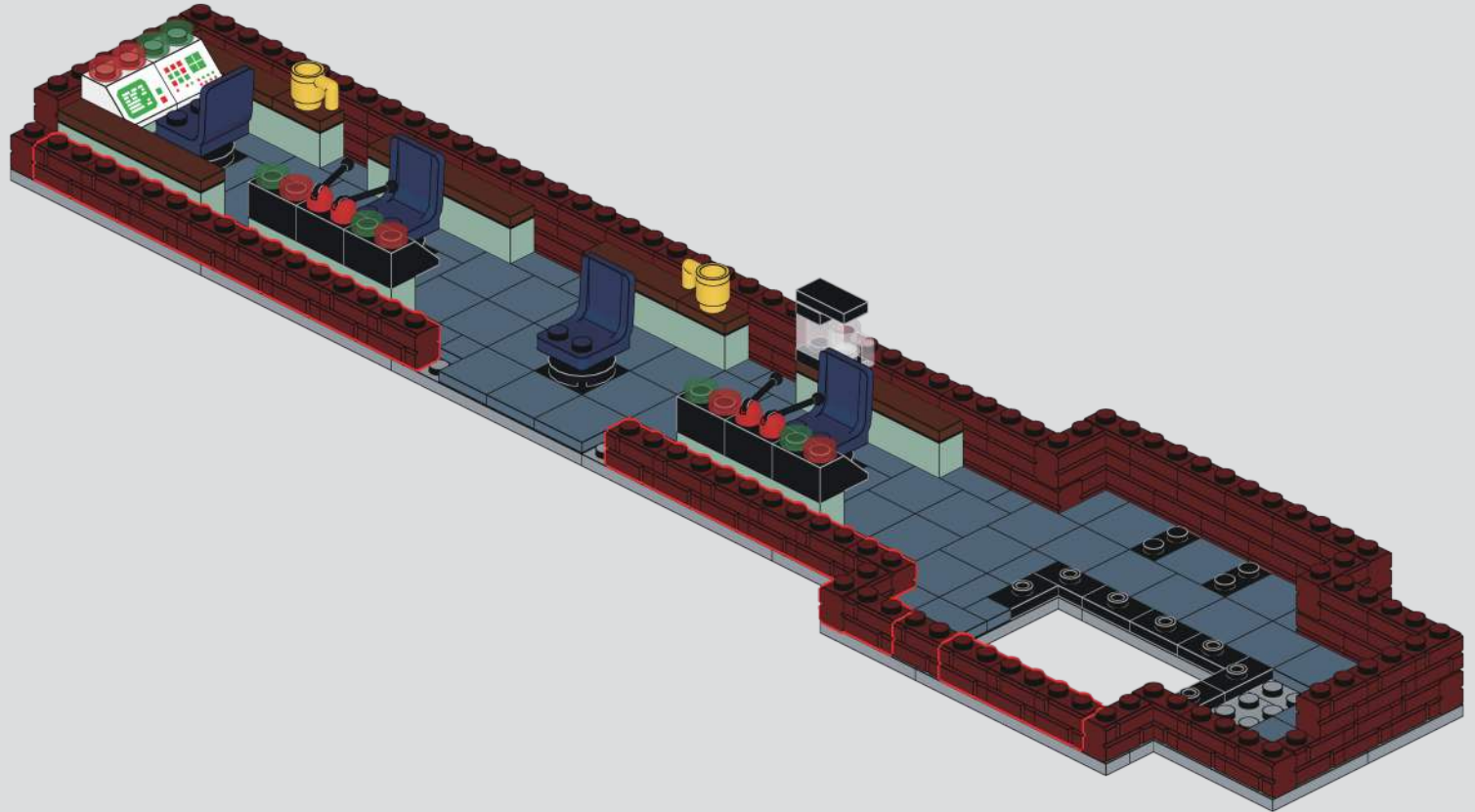

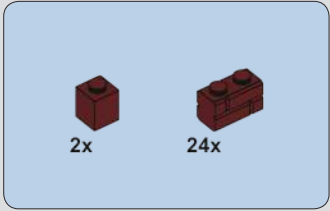

100

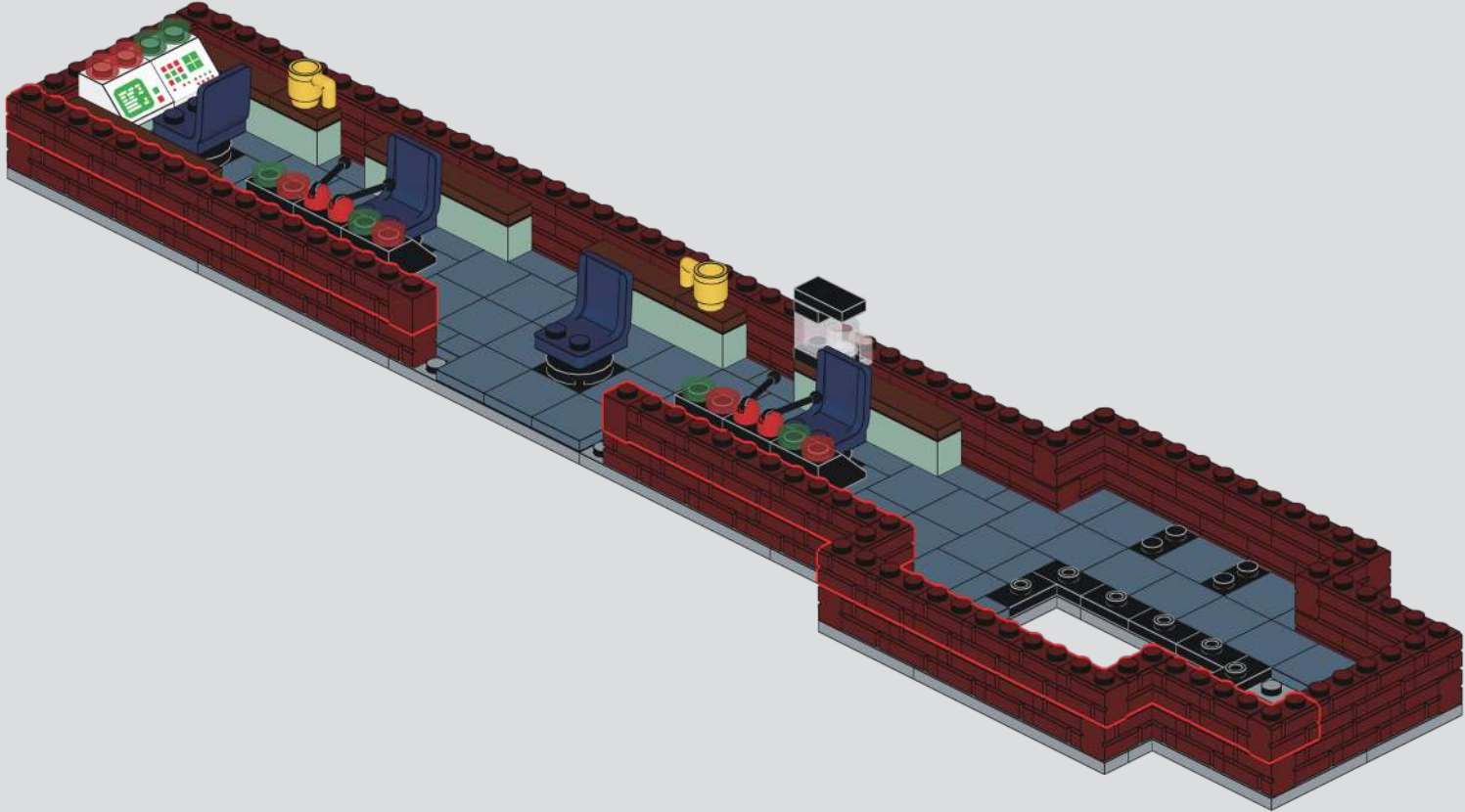

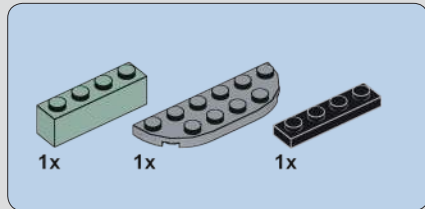
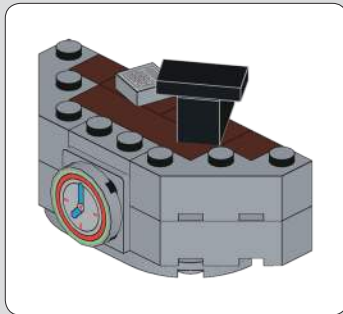

101

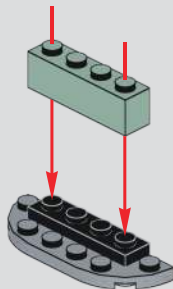

102

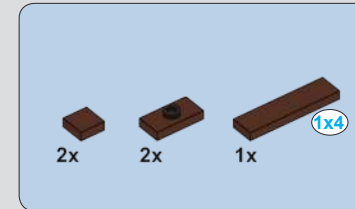
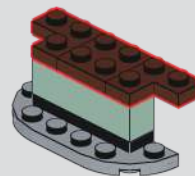

103

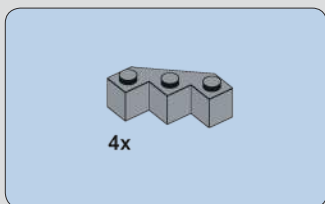
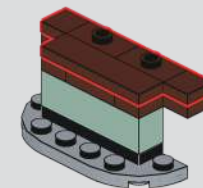

104

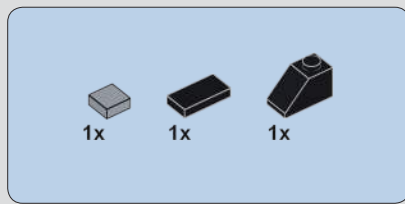
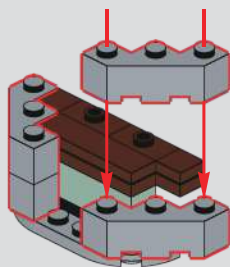

105

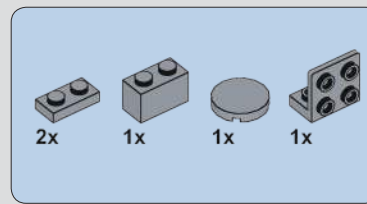
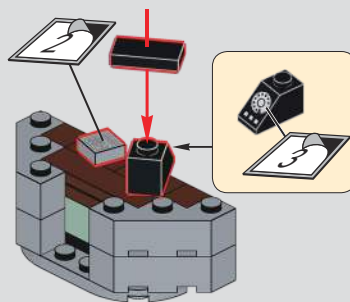

106

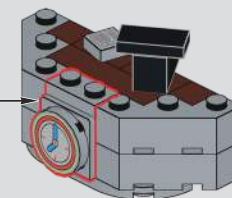
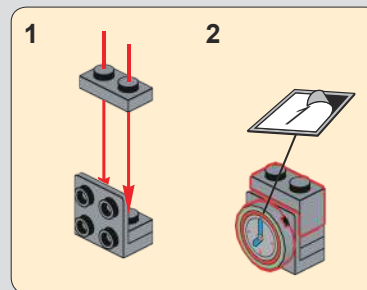

107

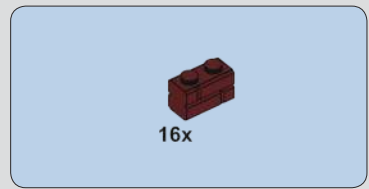
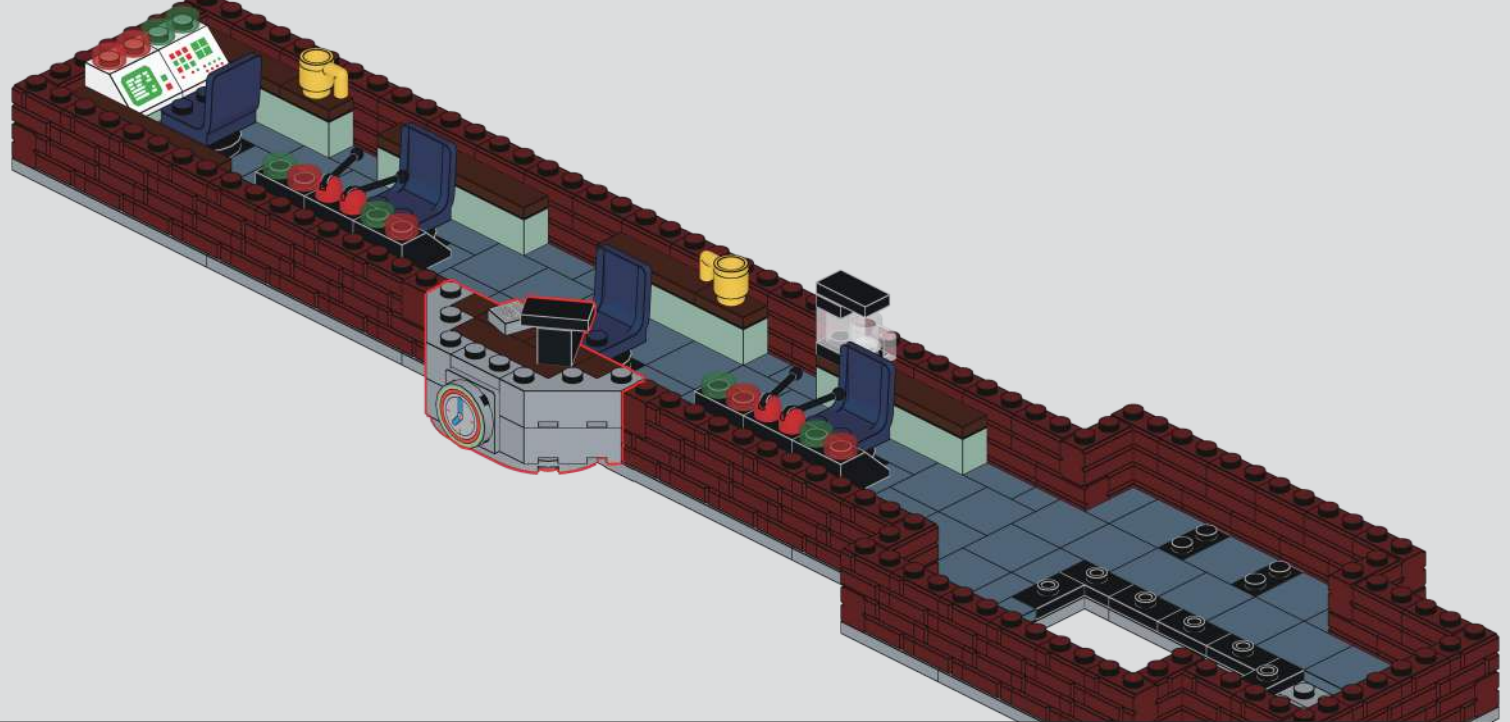

108

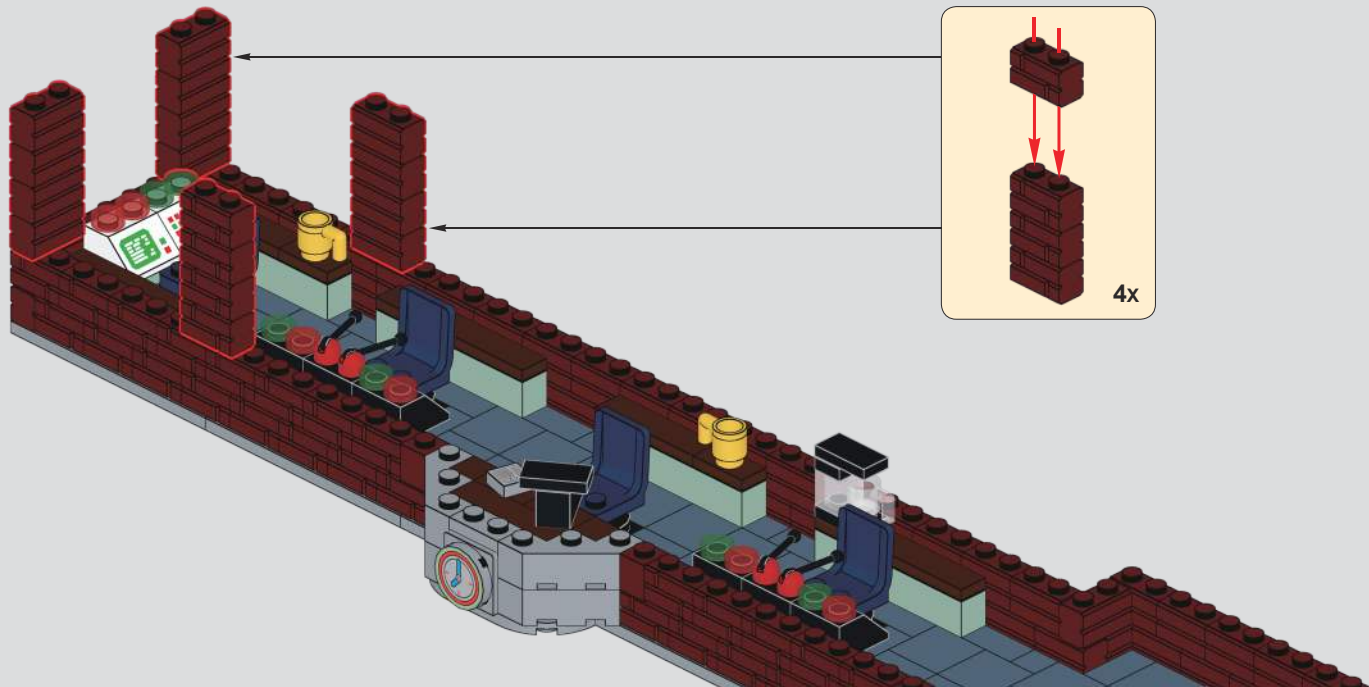

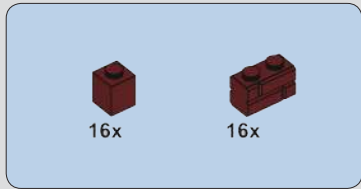

109

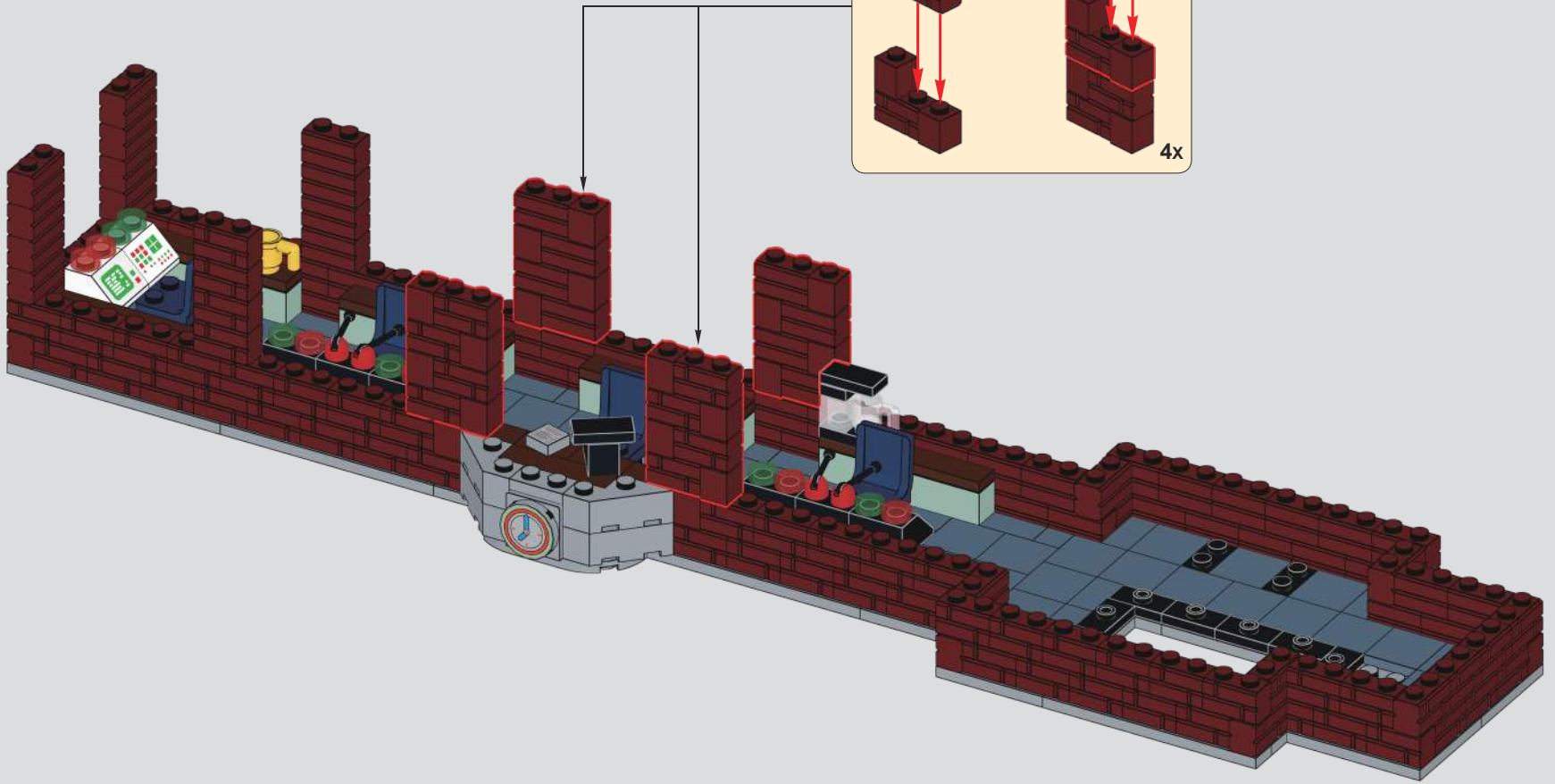
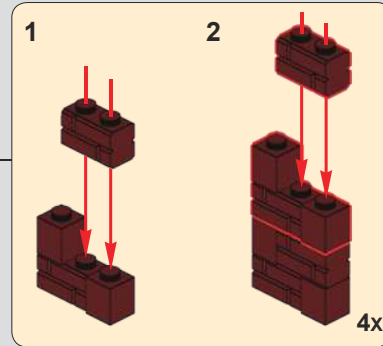

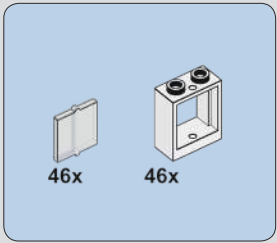

110

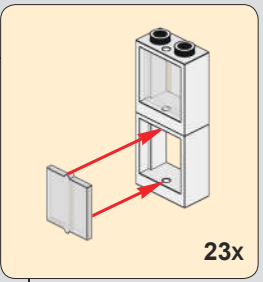
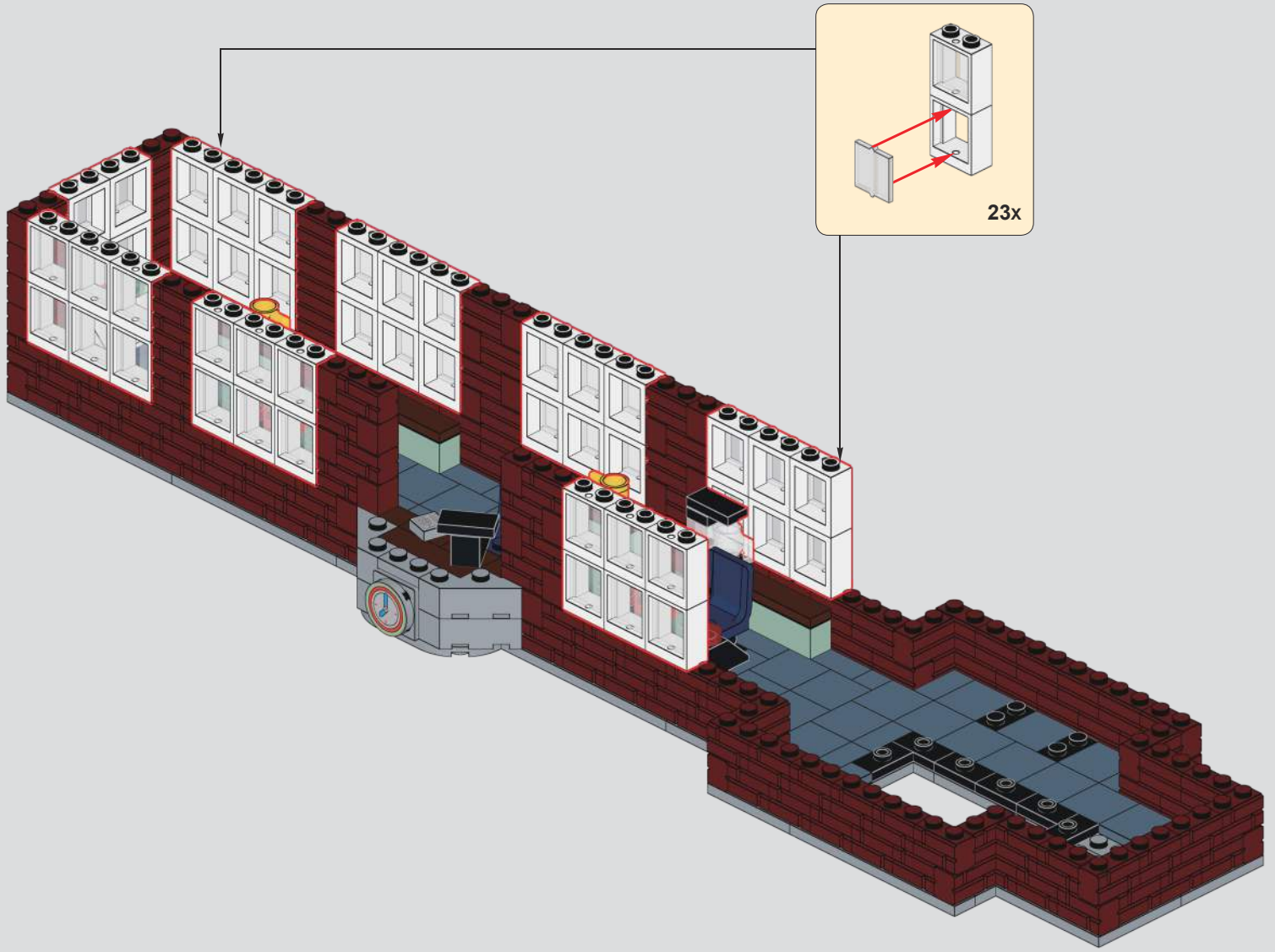



8x

111

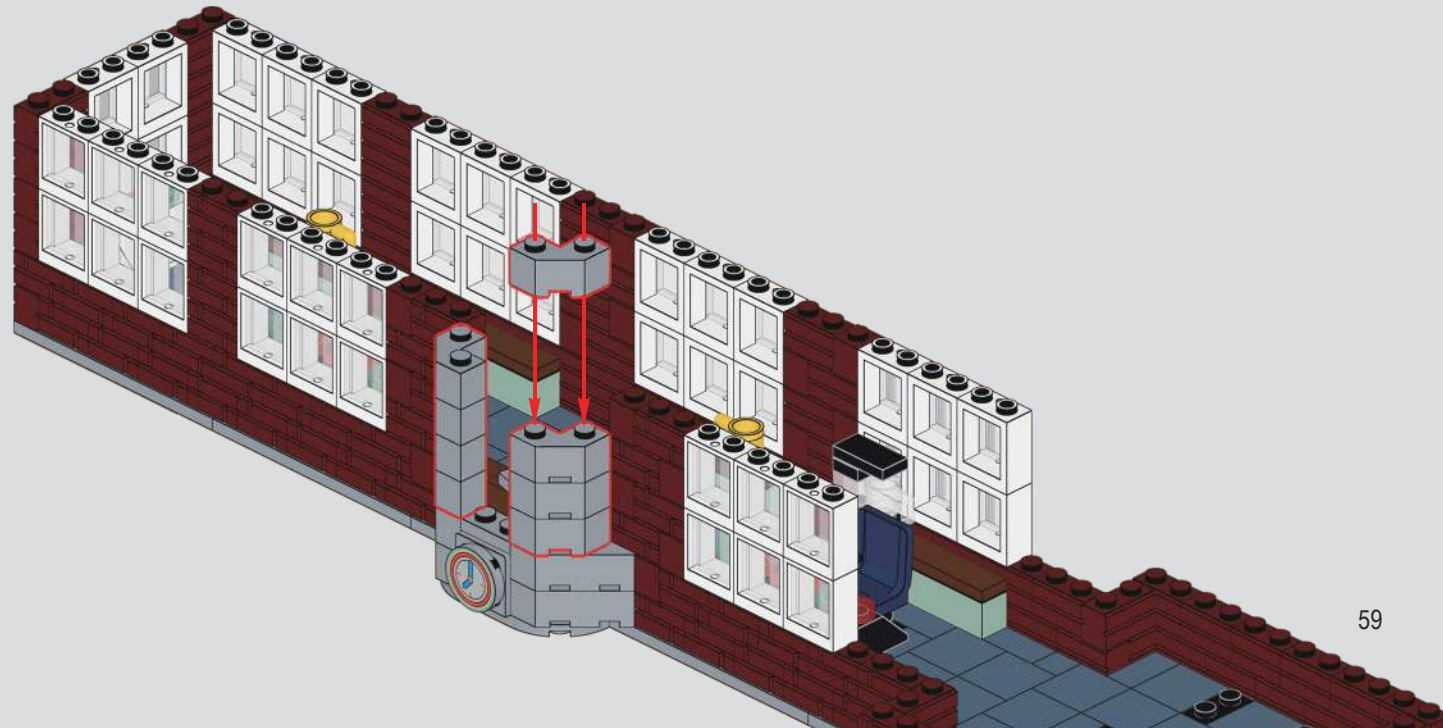

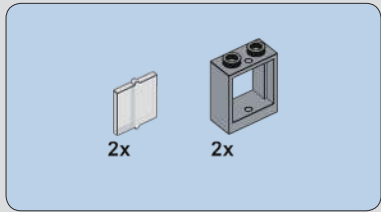

112

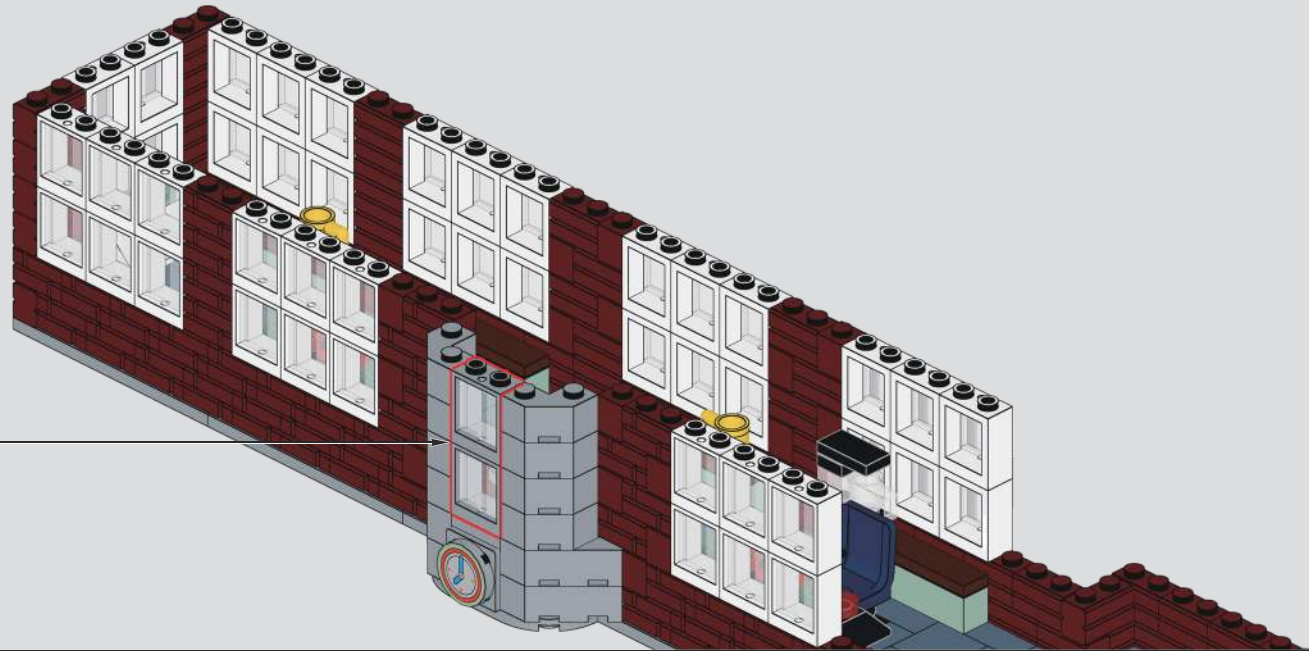
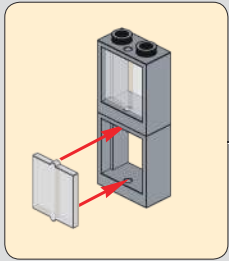

113

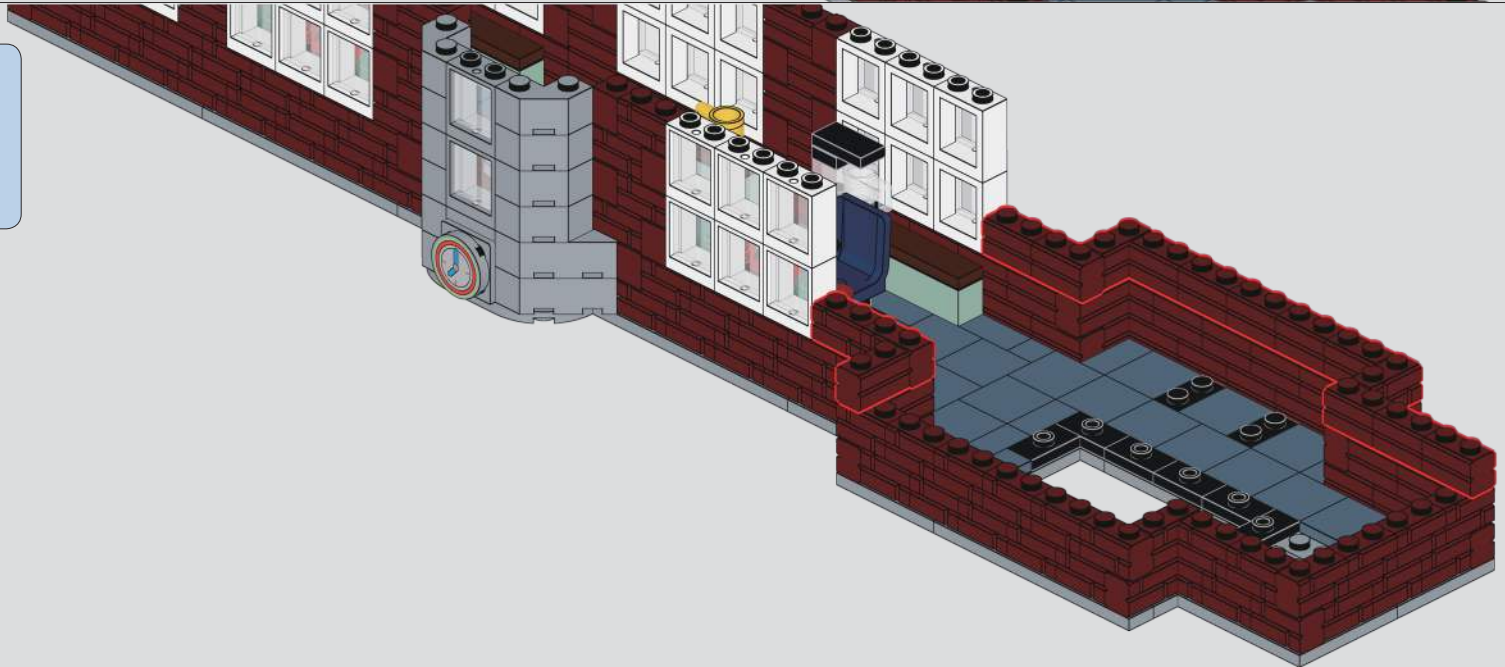

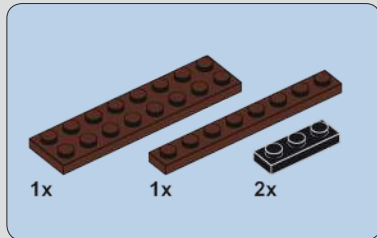
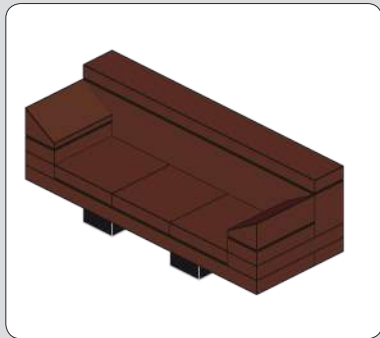

114

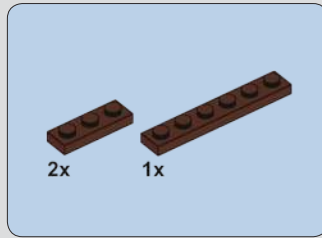
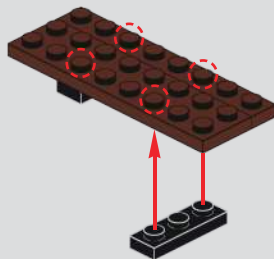

115

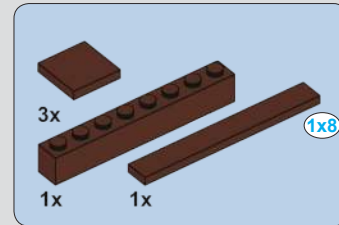
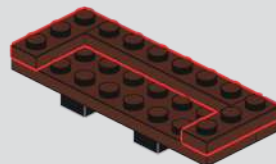

116

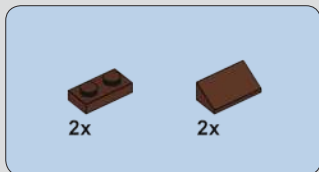
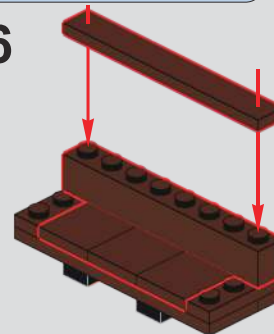

117

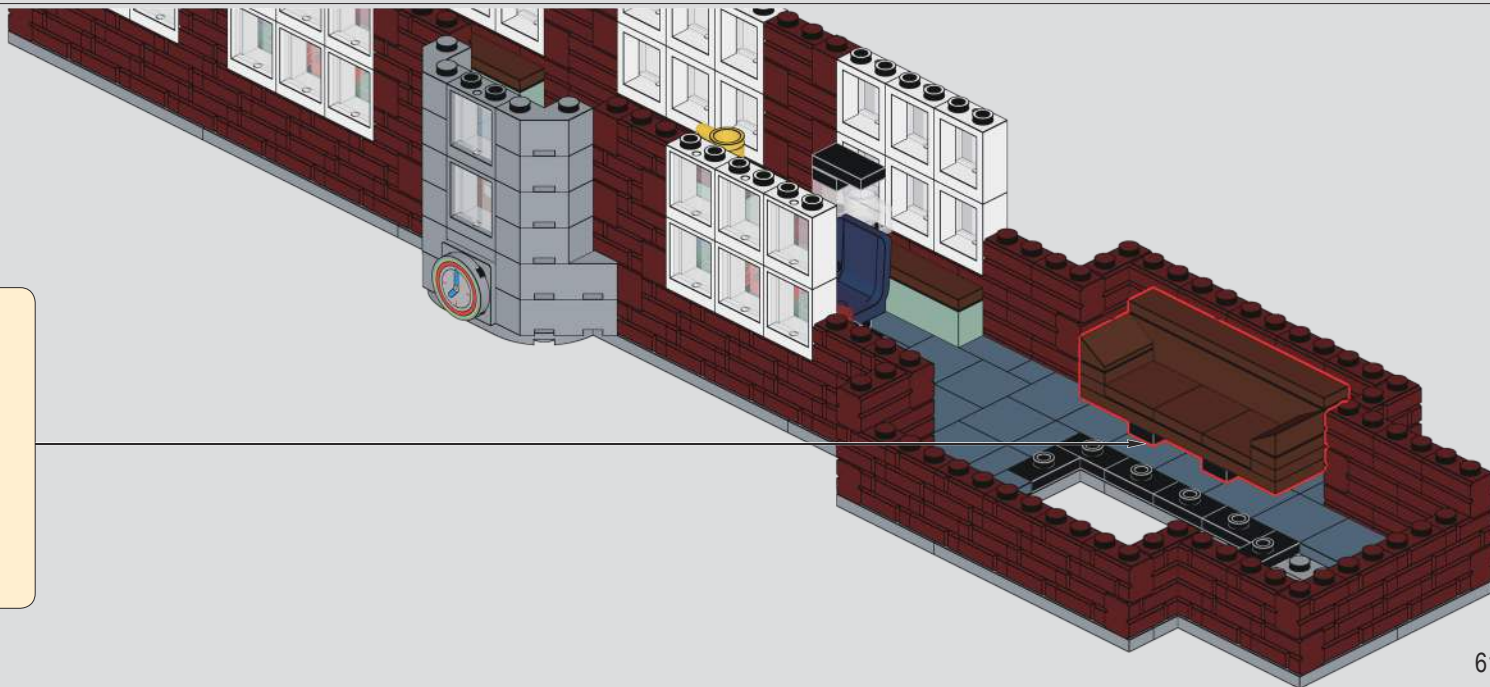
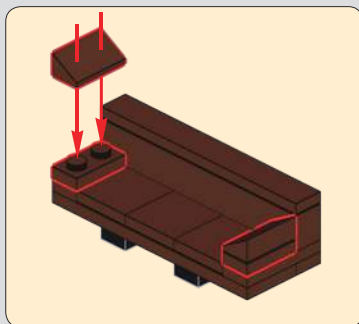

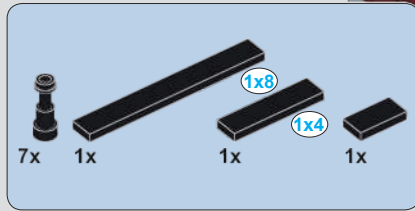

118

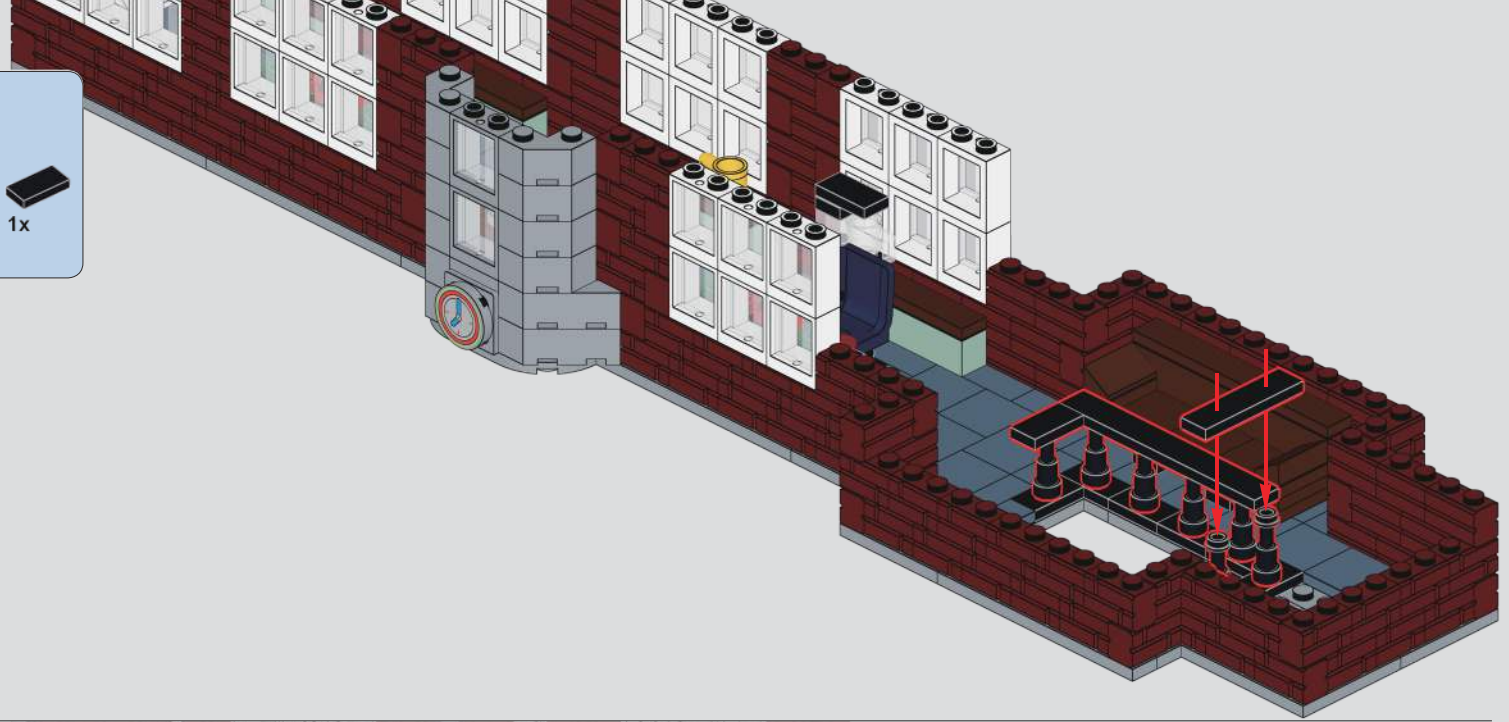

119

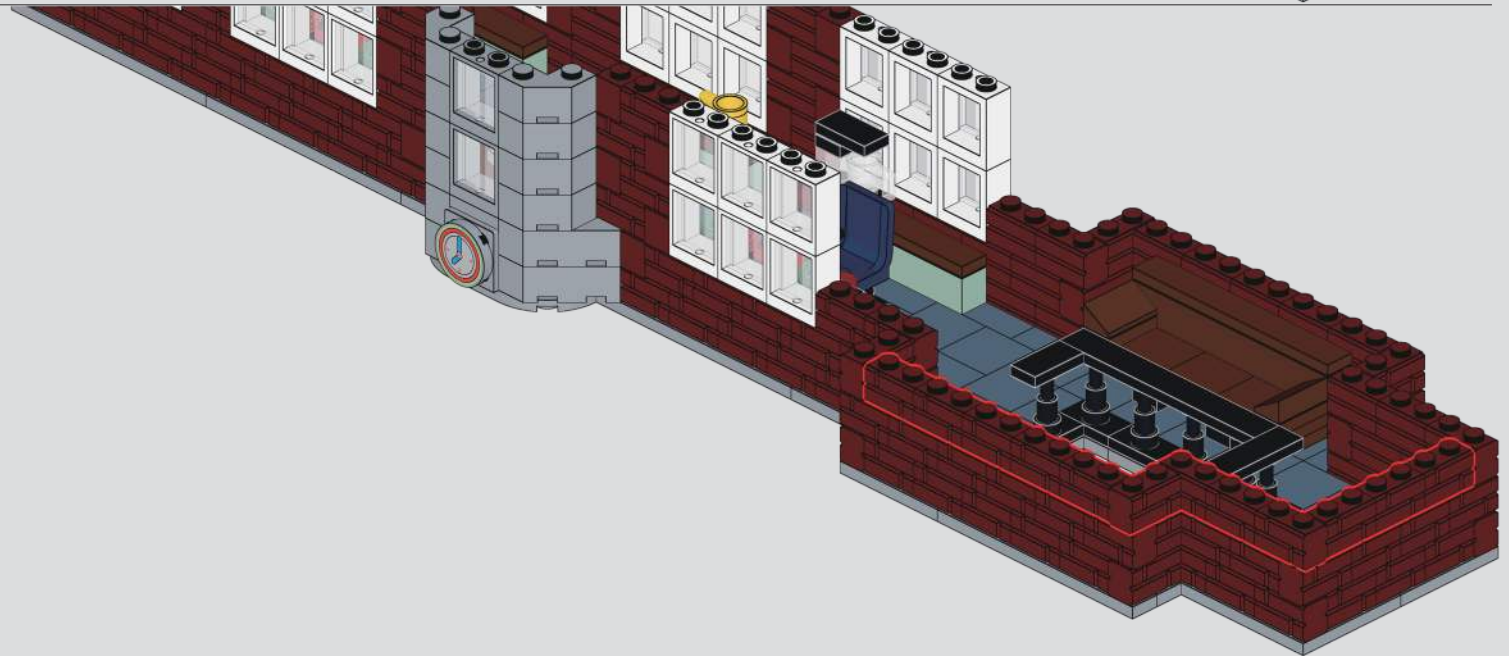

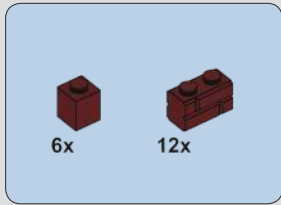

120

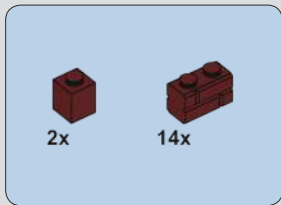
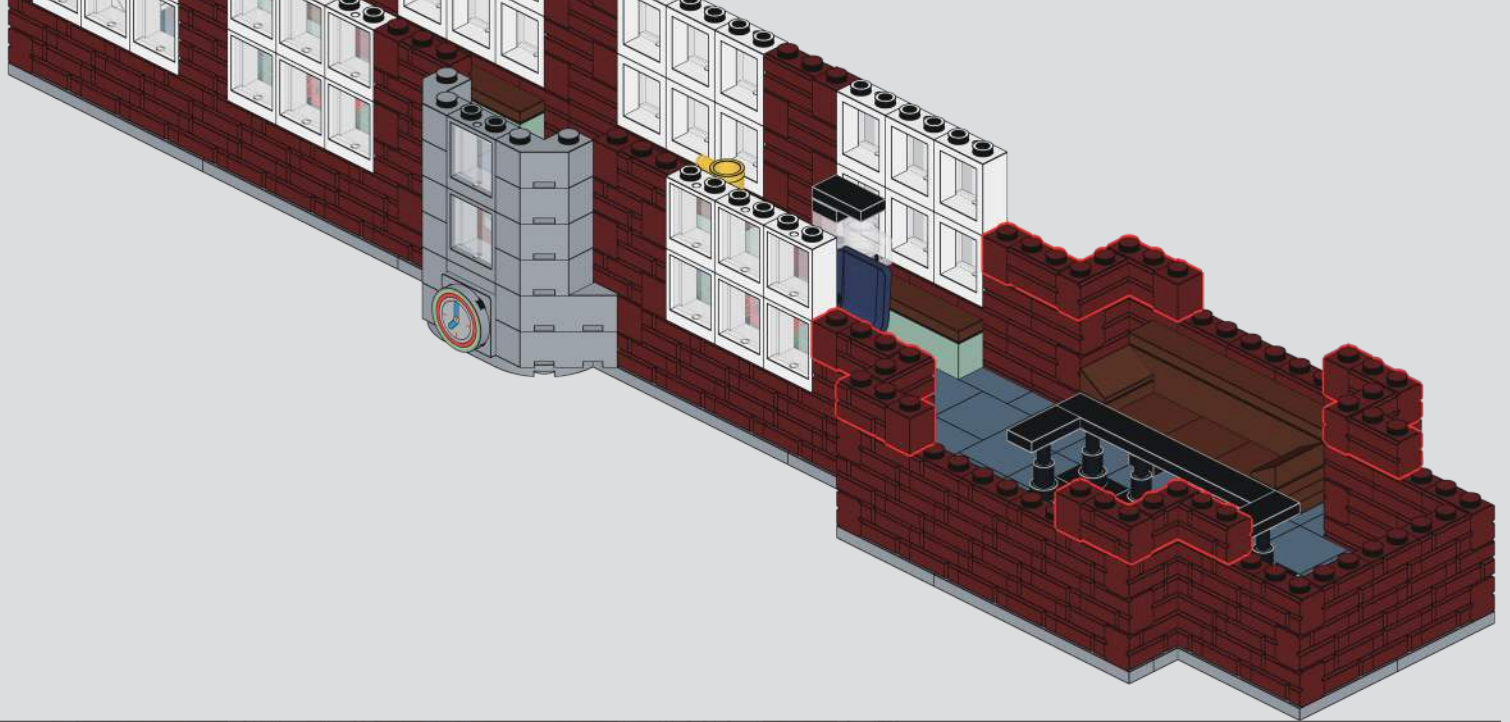

121

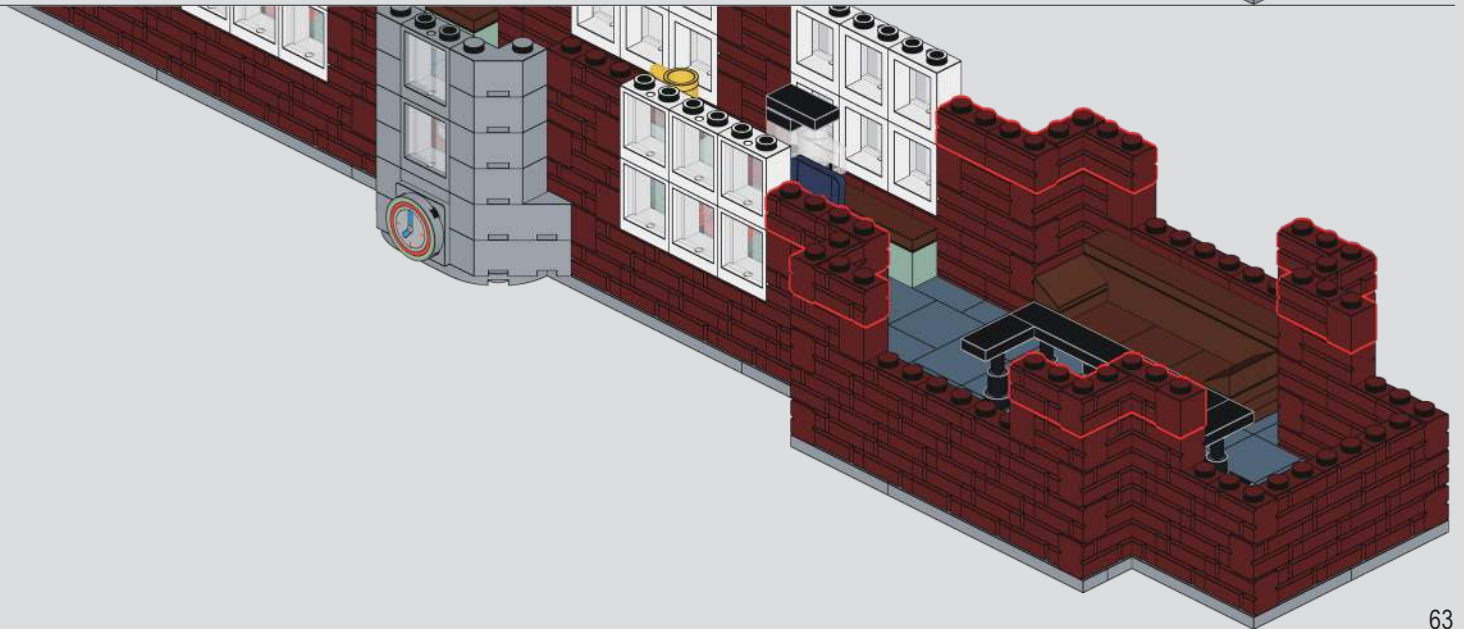

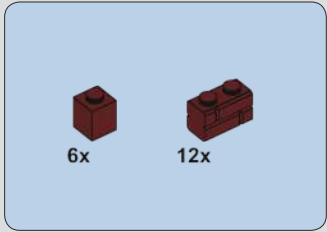

122

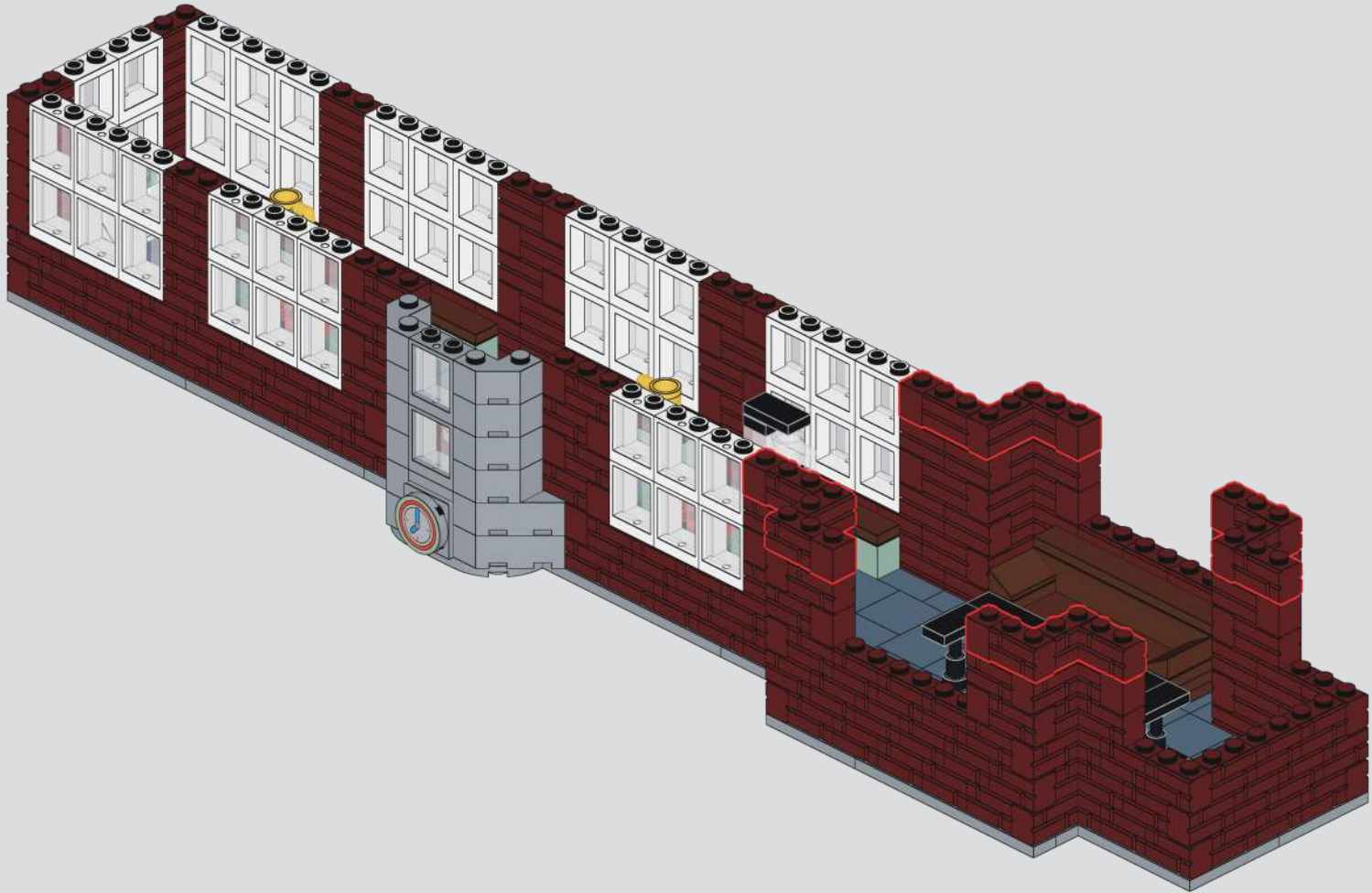

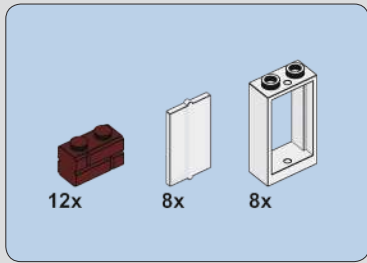

123

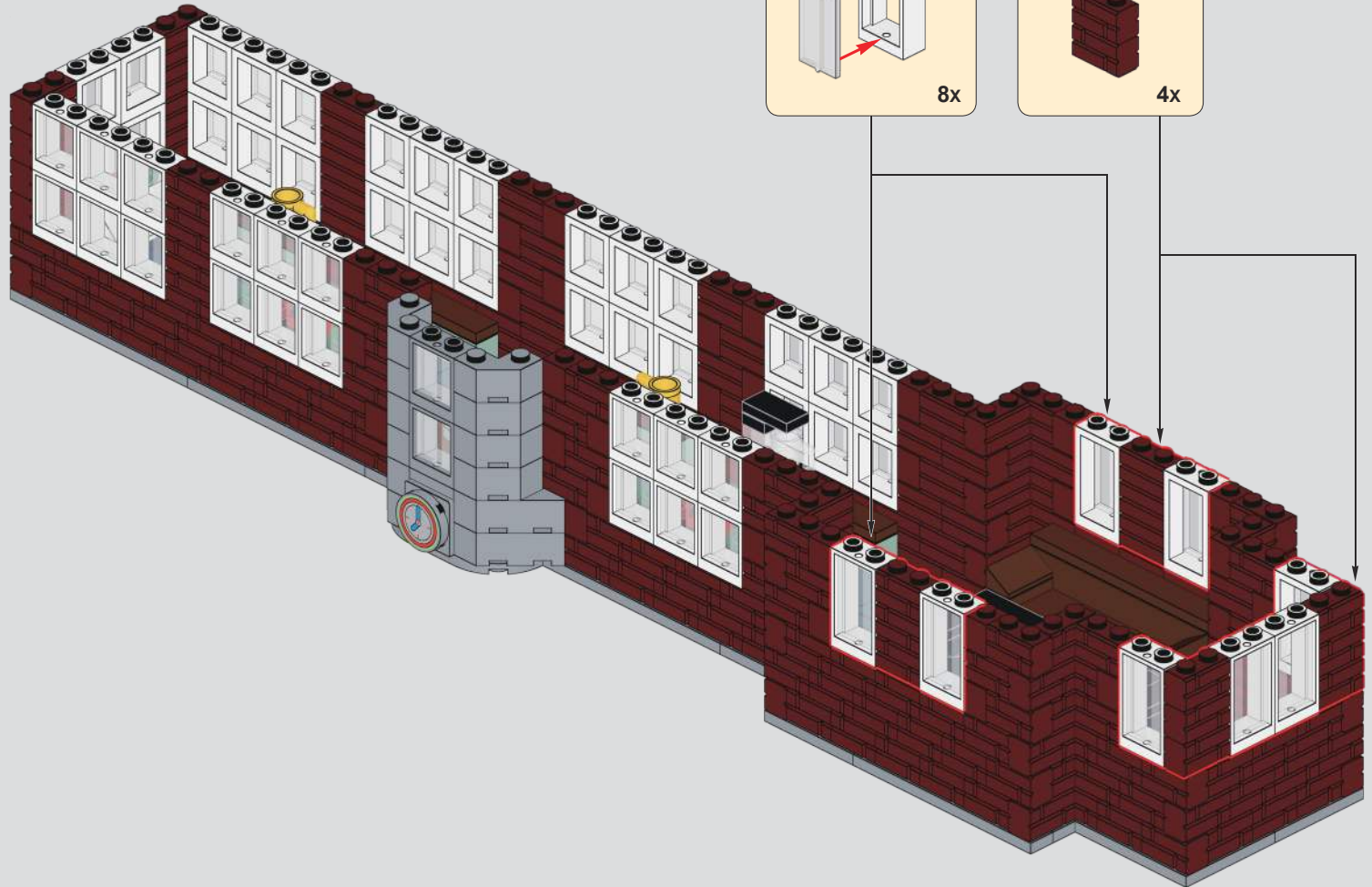

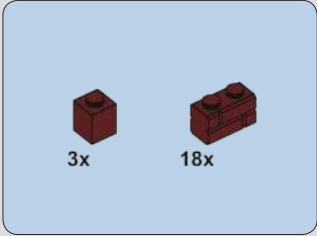

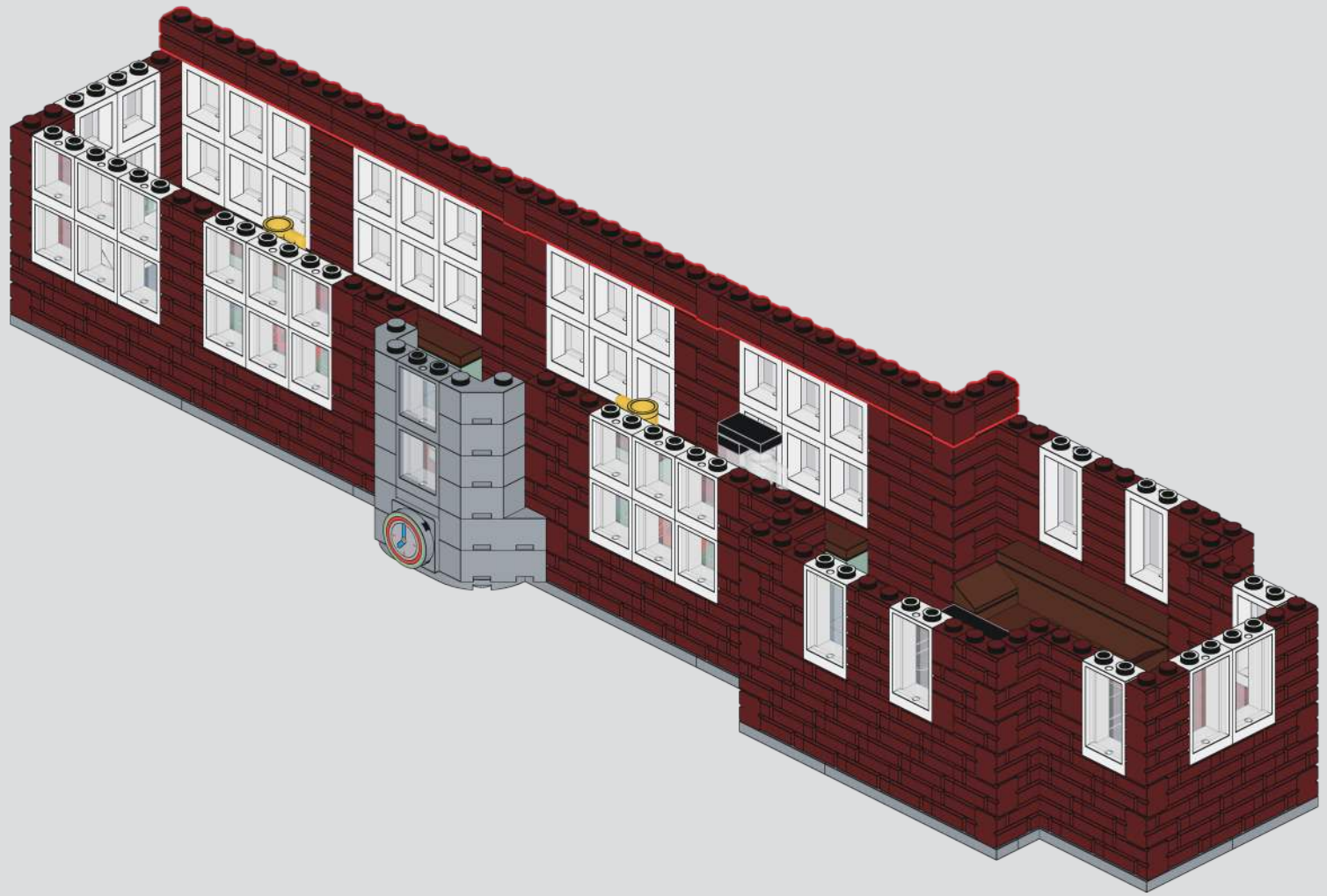

124

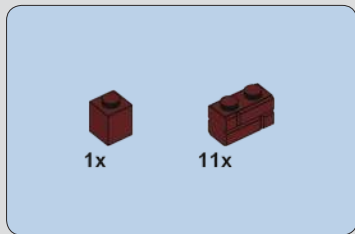

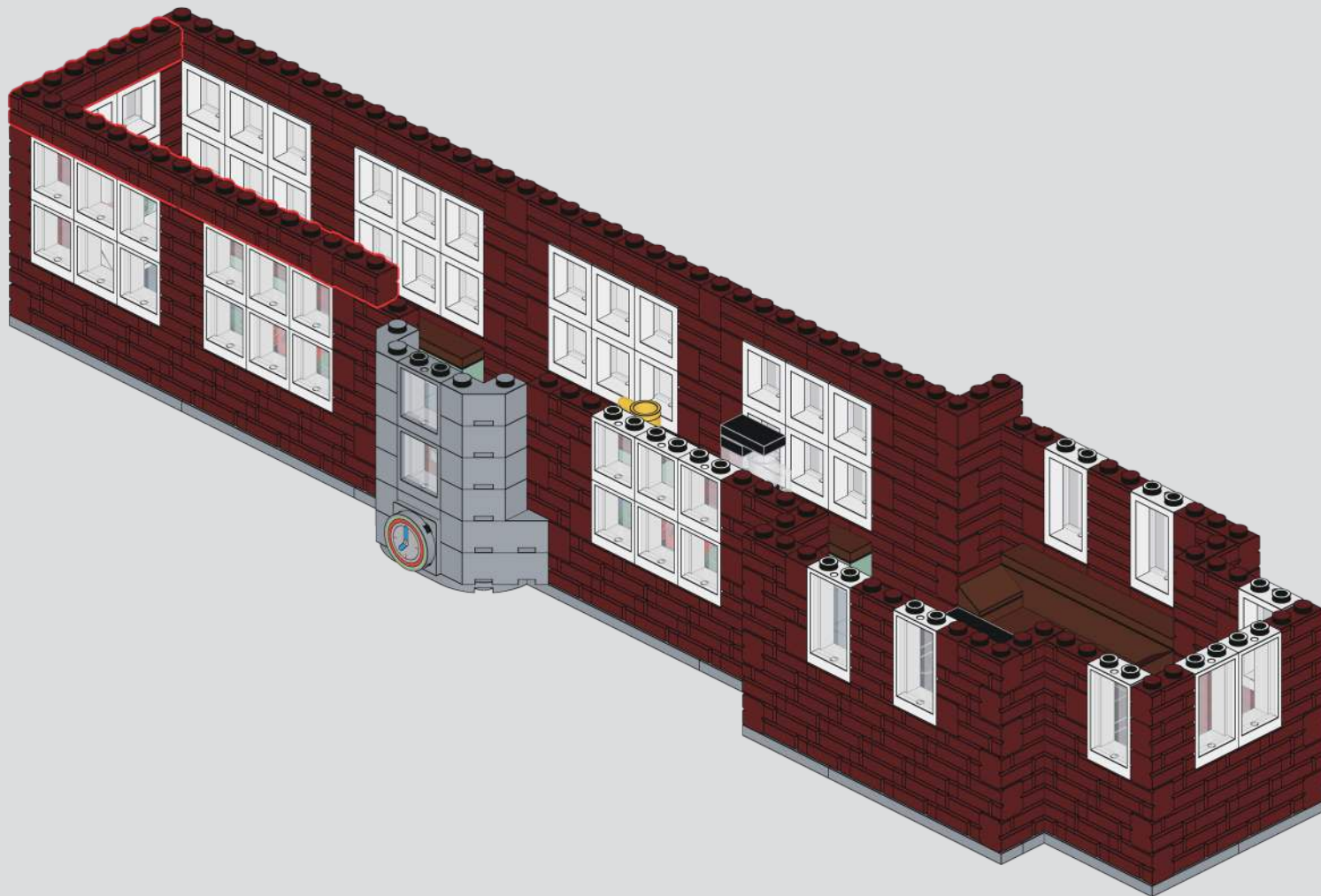

125



2x  11x 

126

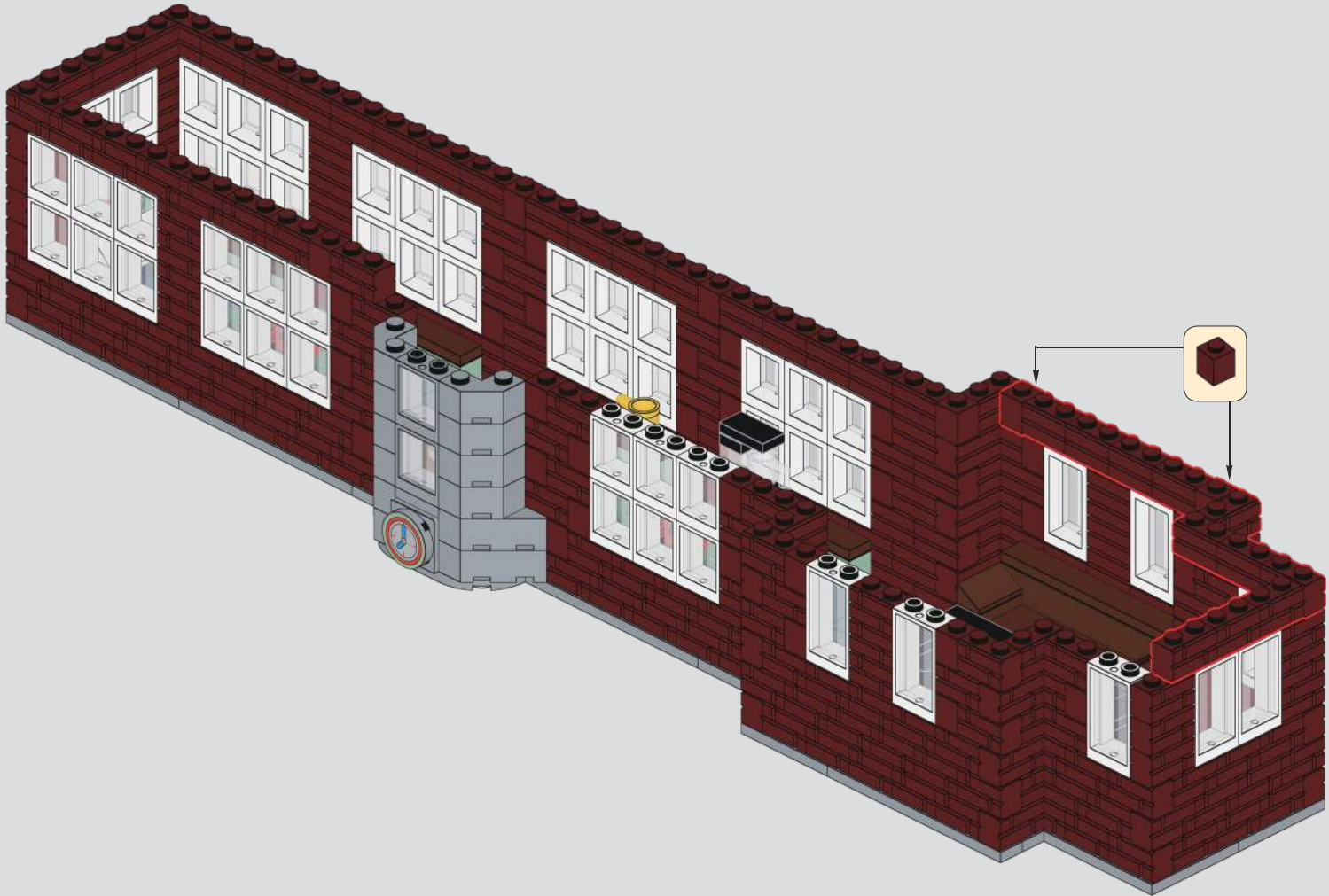

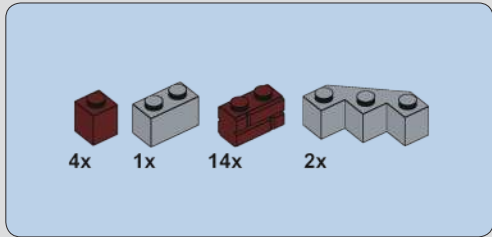

127

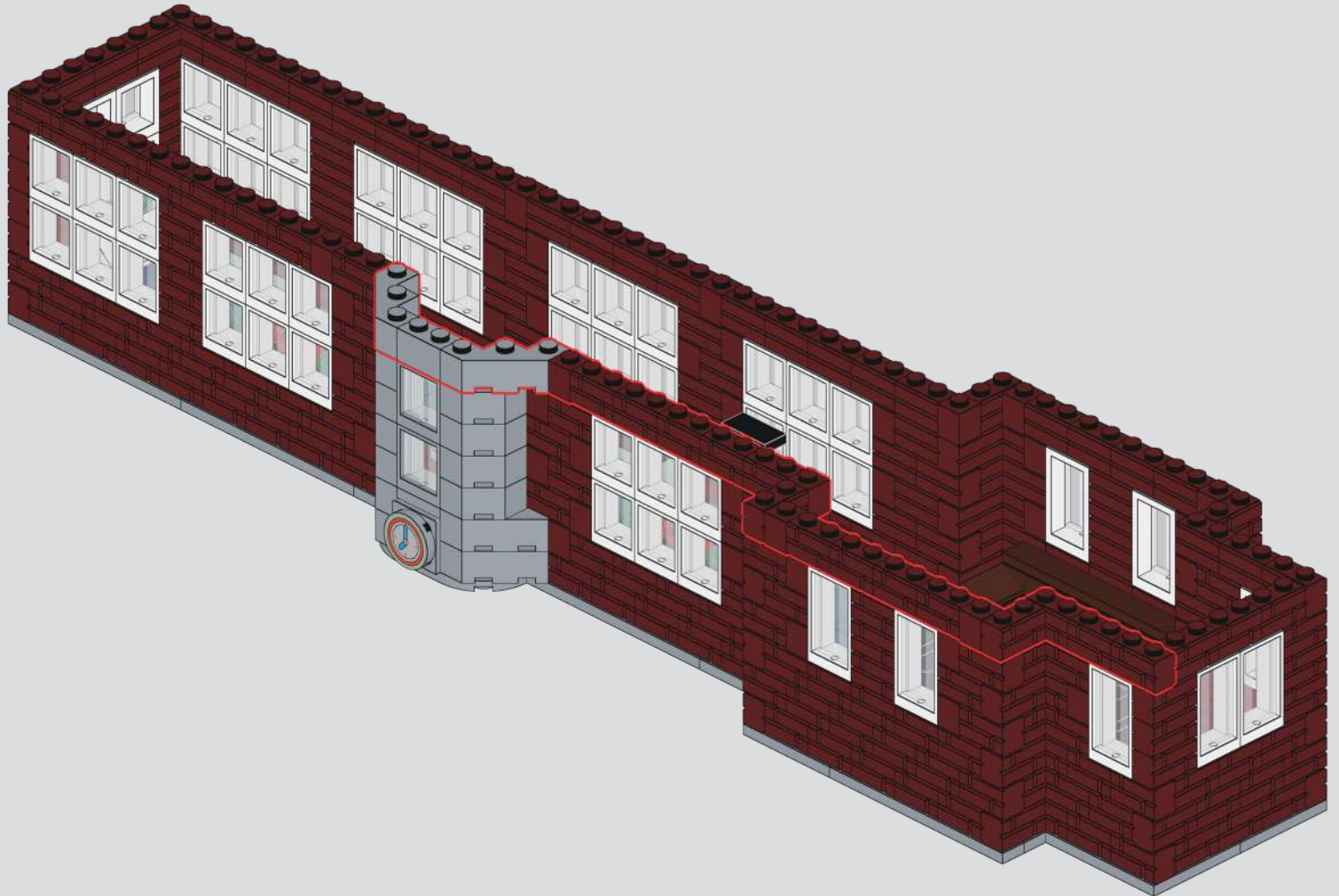

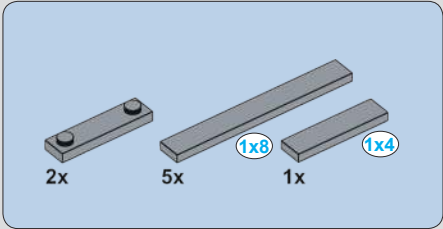

128

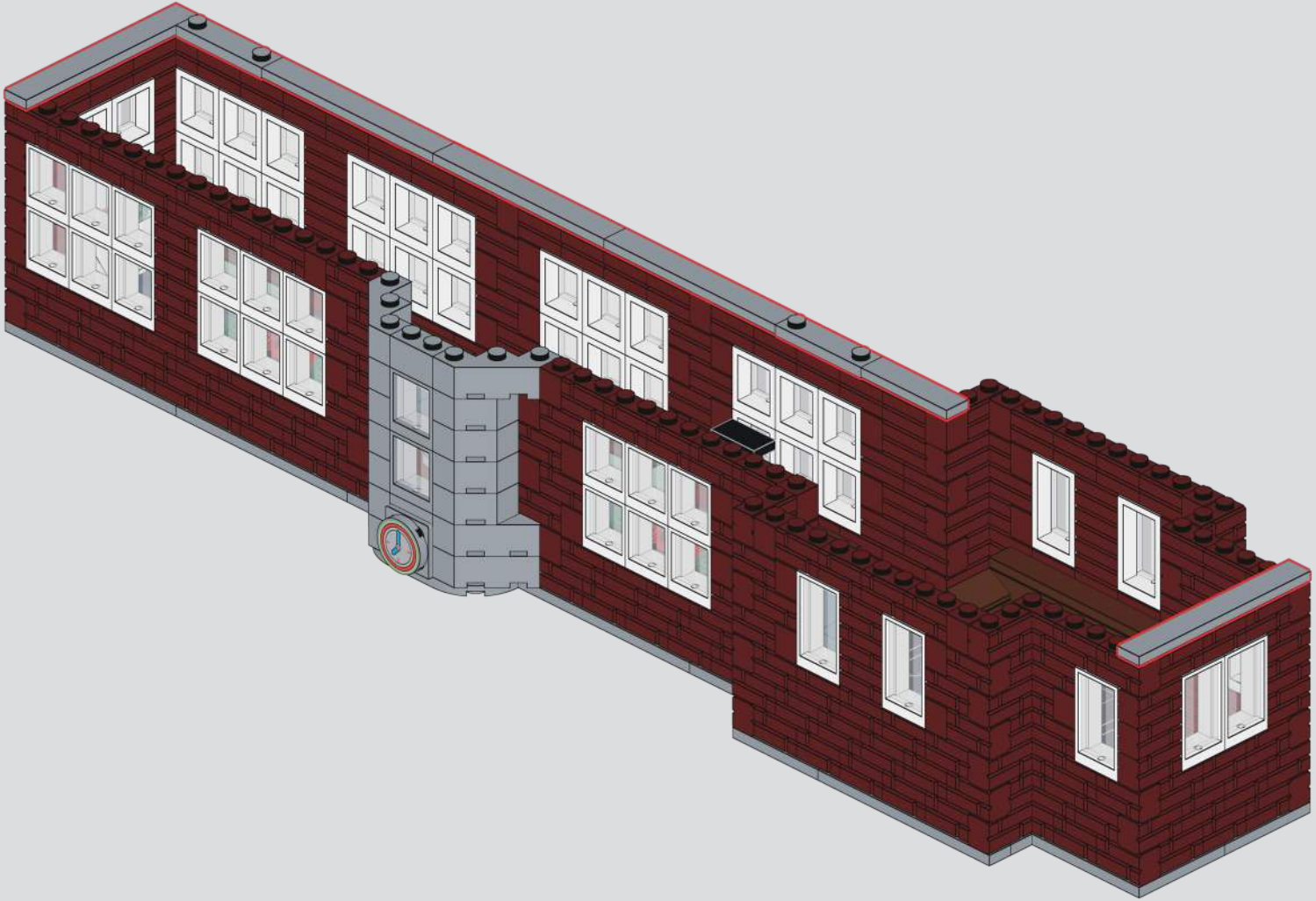

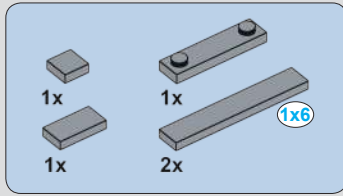

129

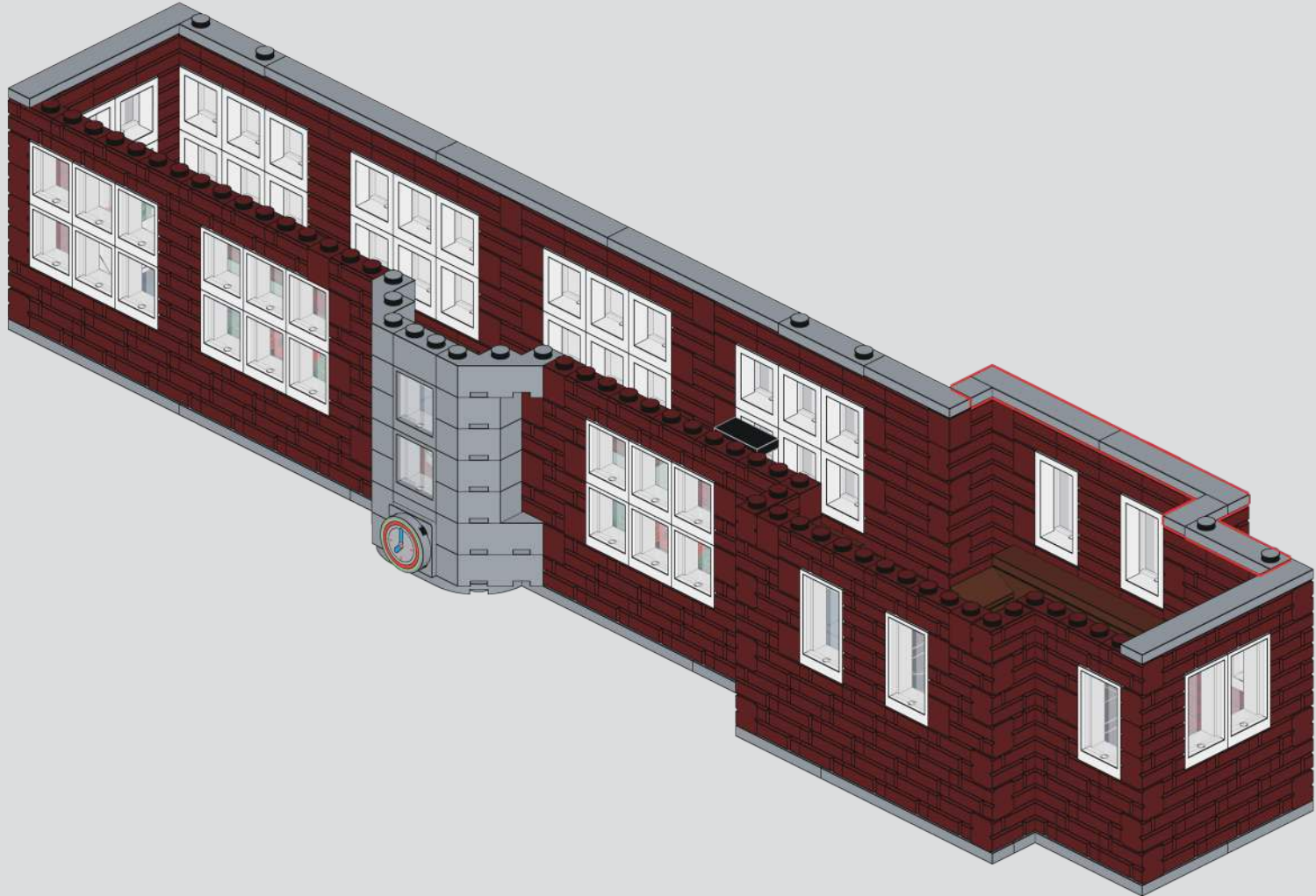

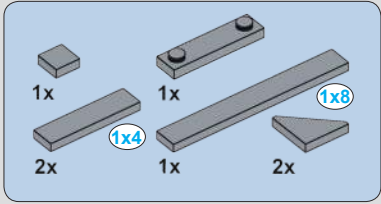

130

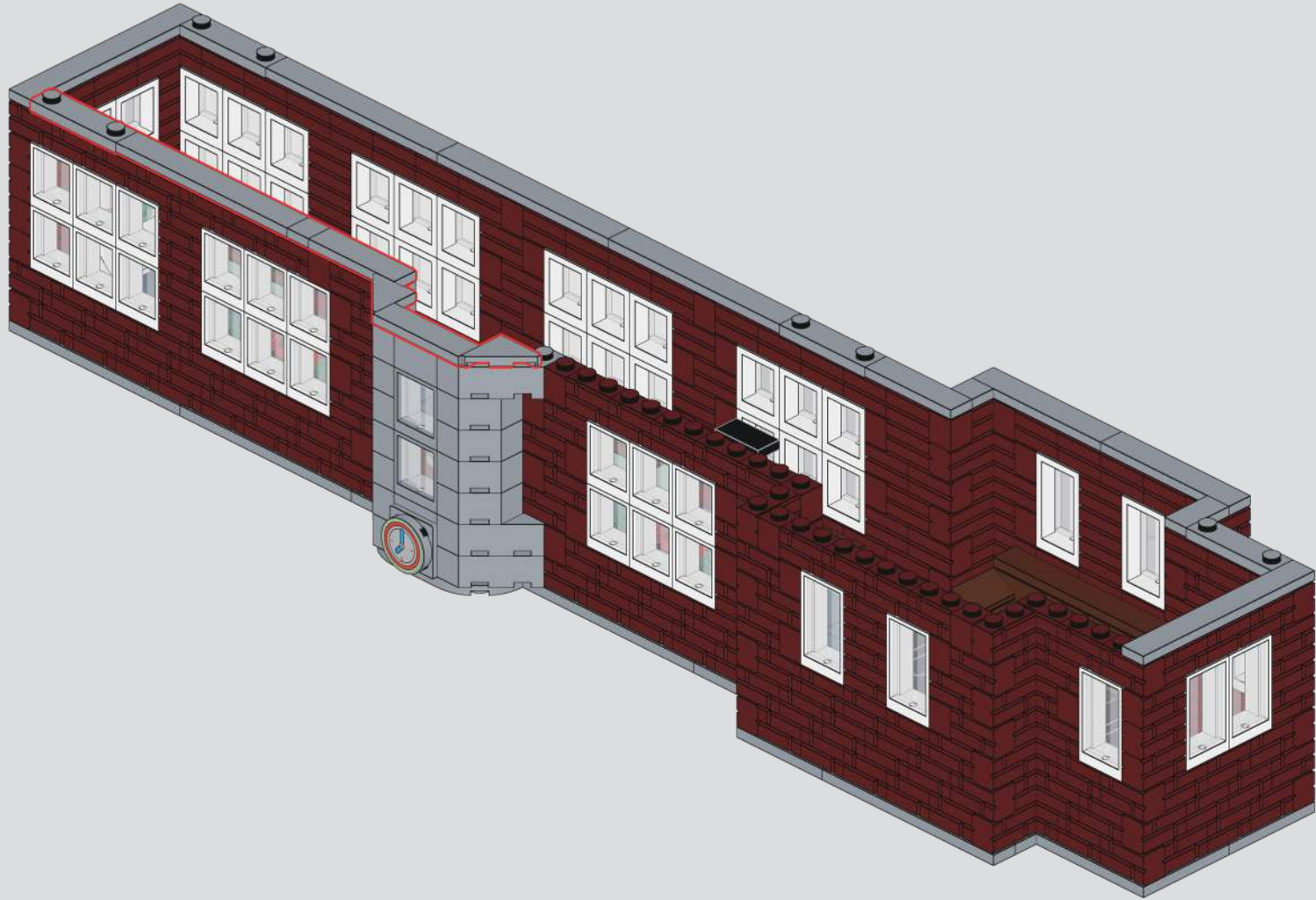

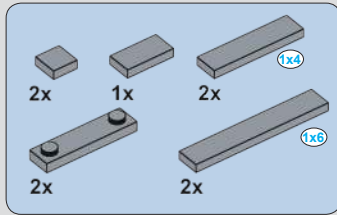

131

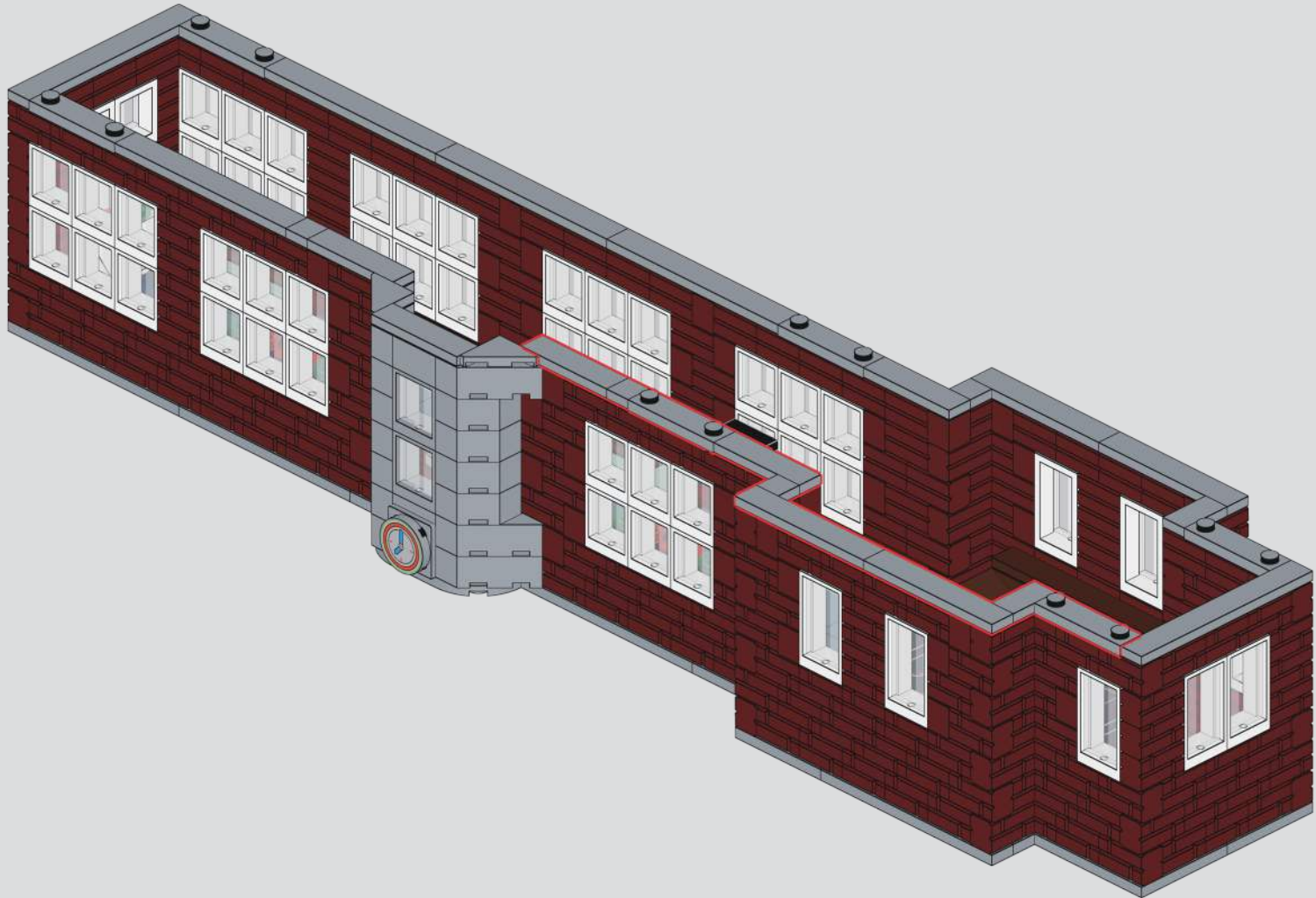

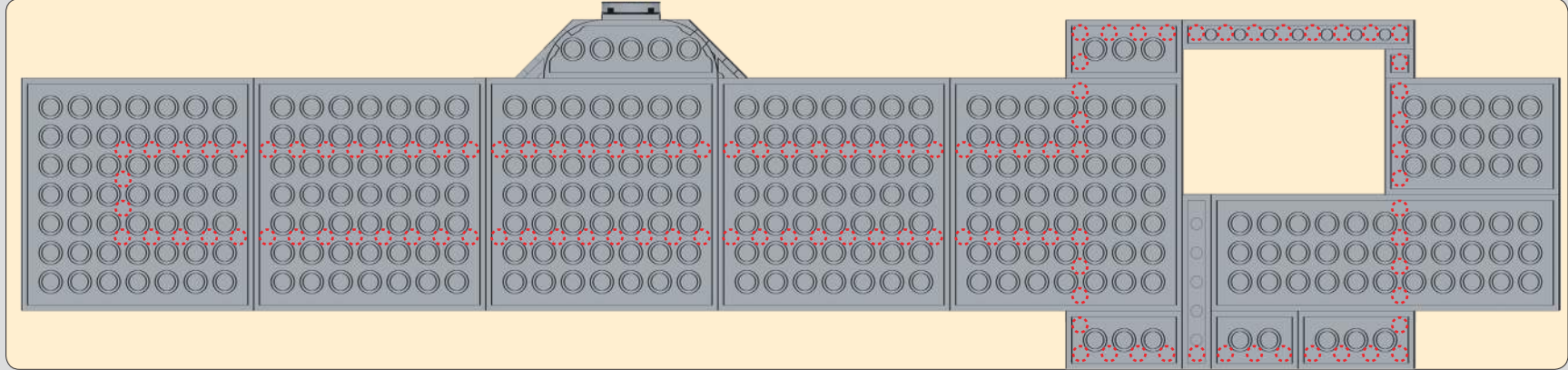
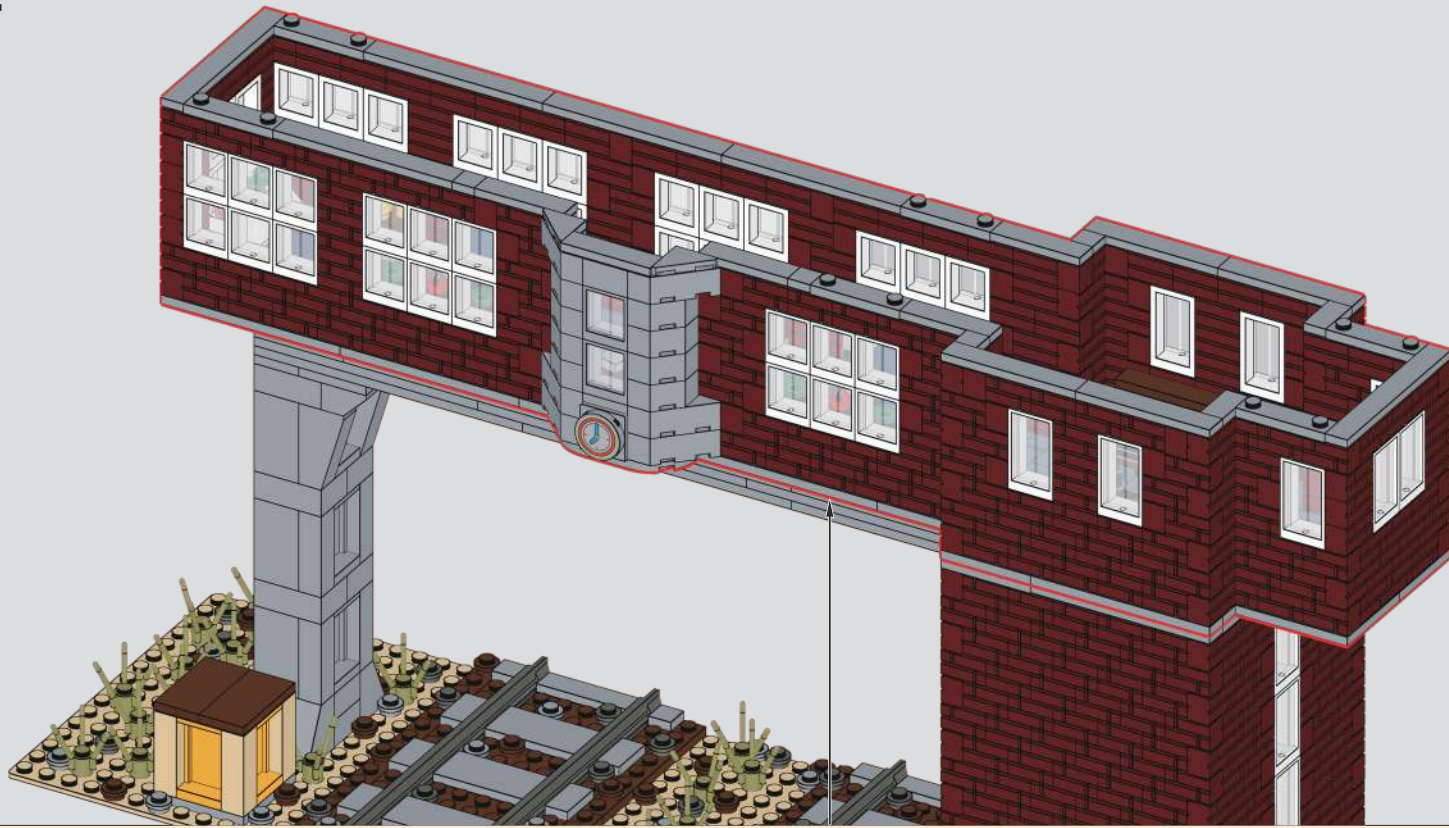

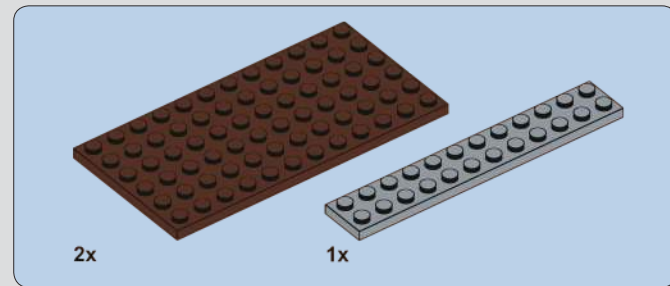
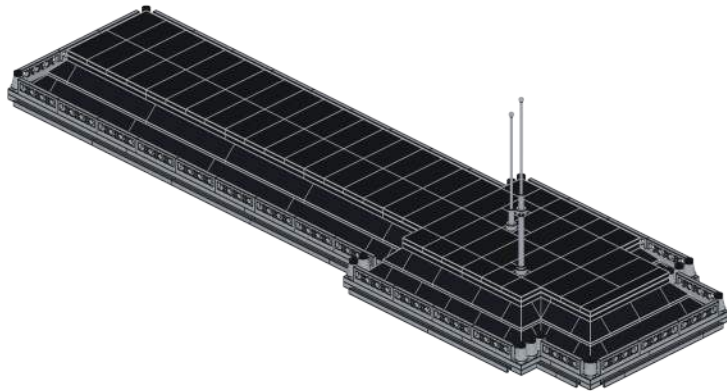

133

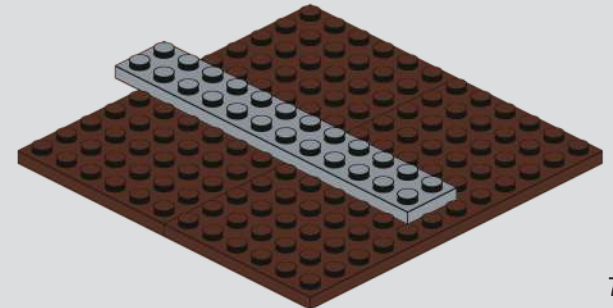

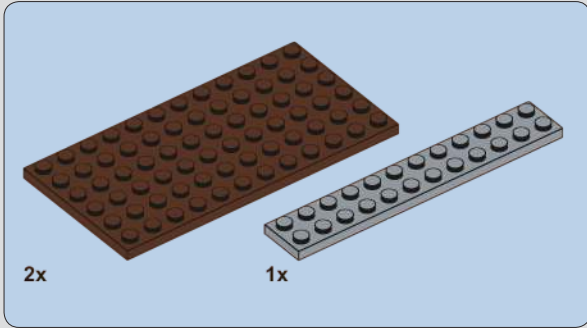

134

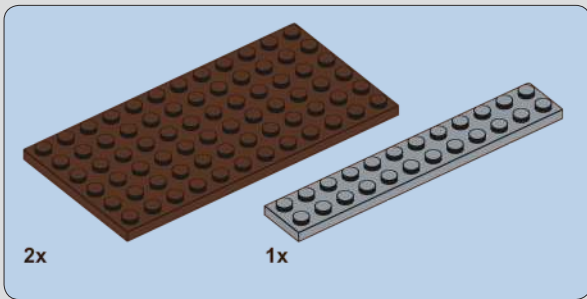
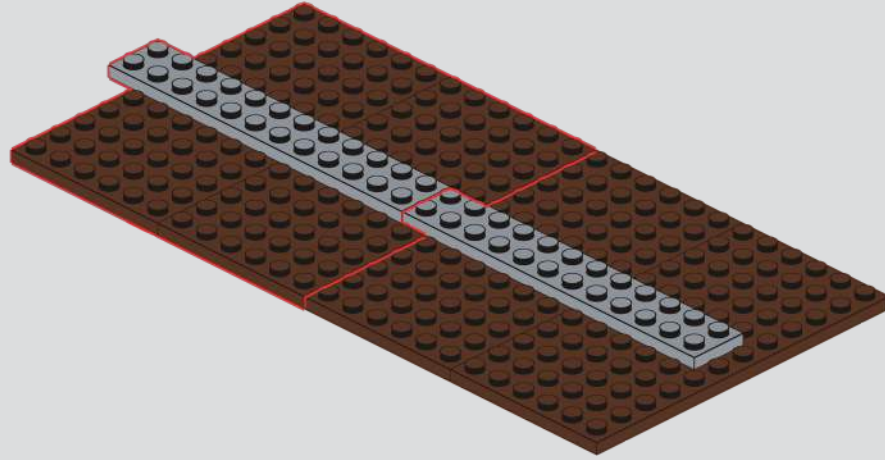

135

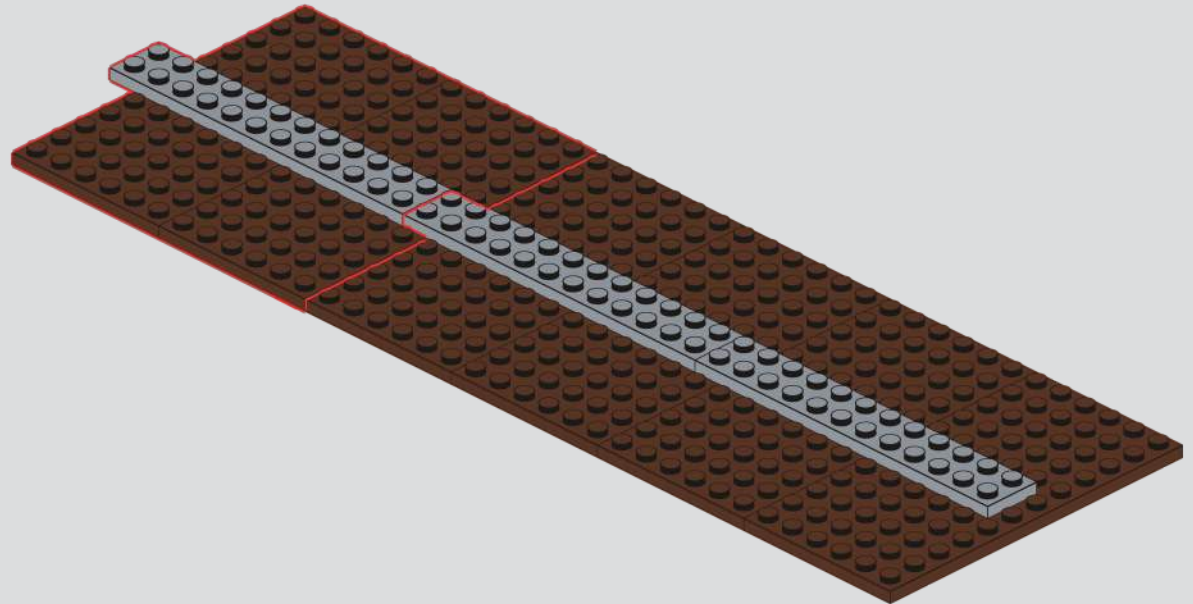

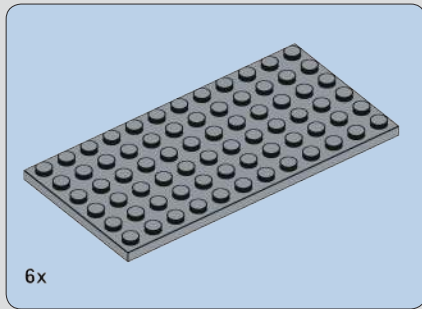

136

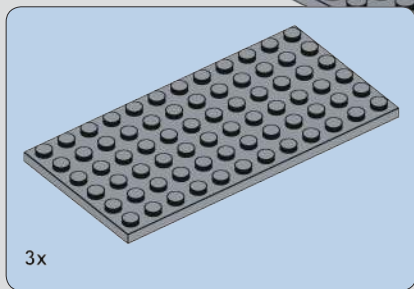
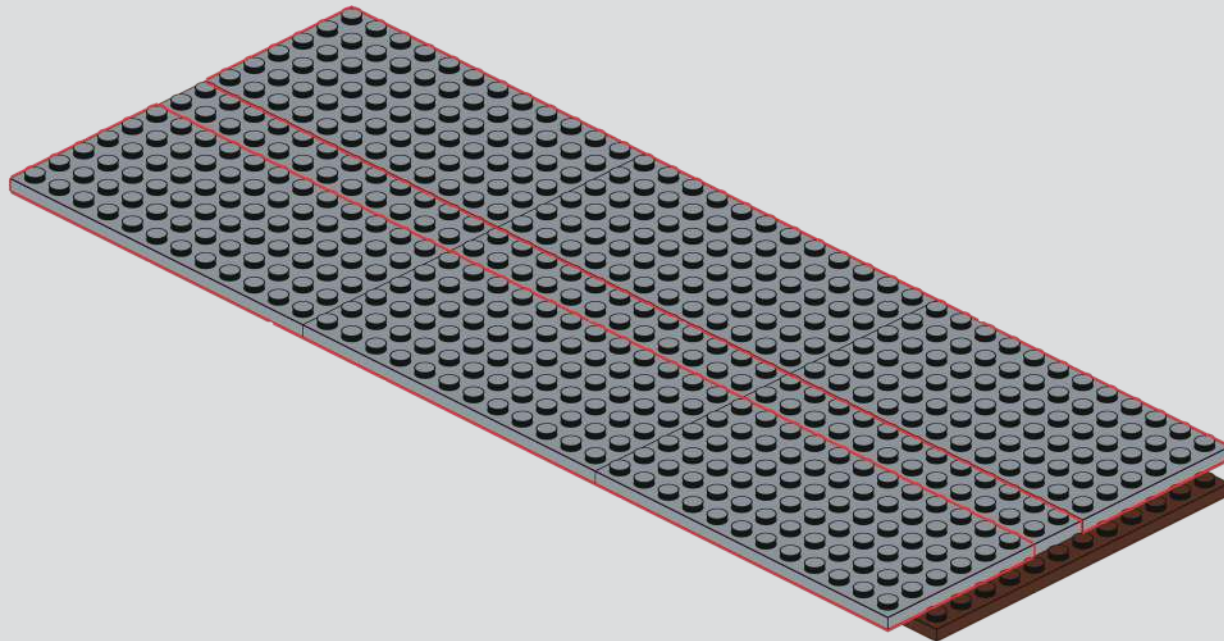

137

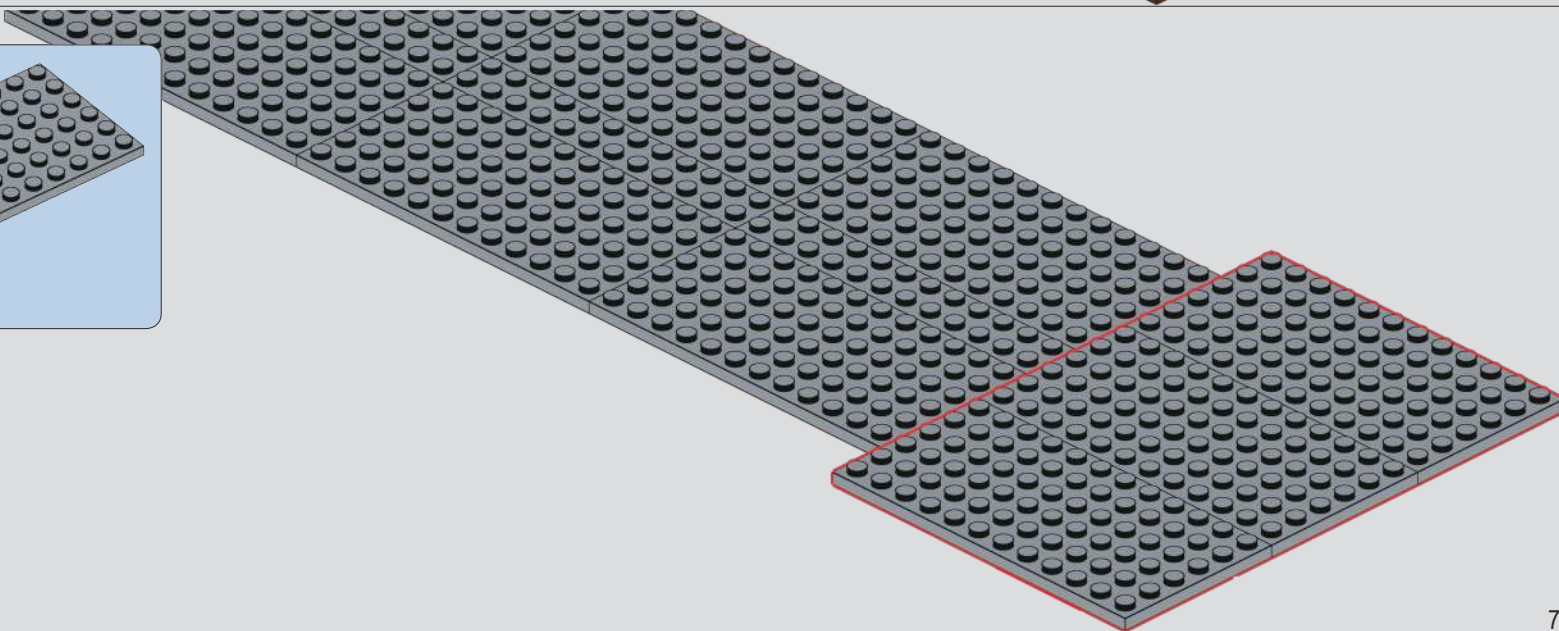

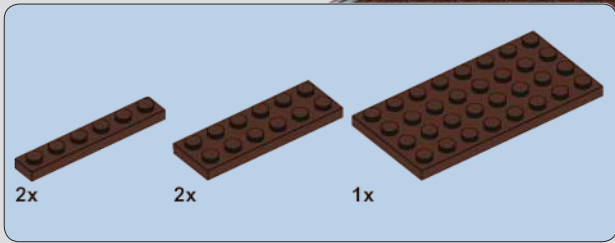

138

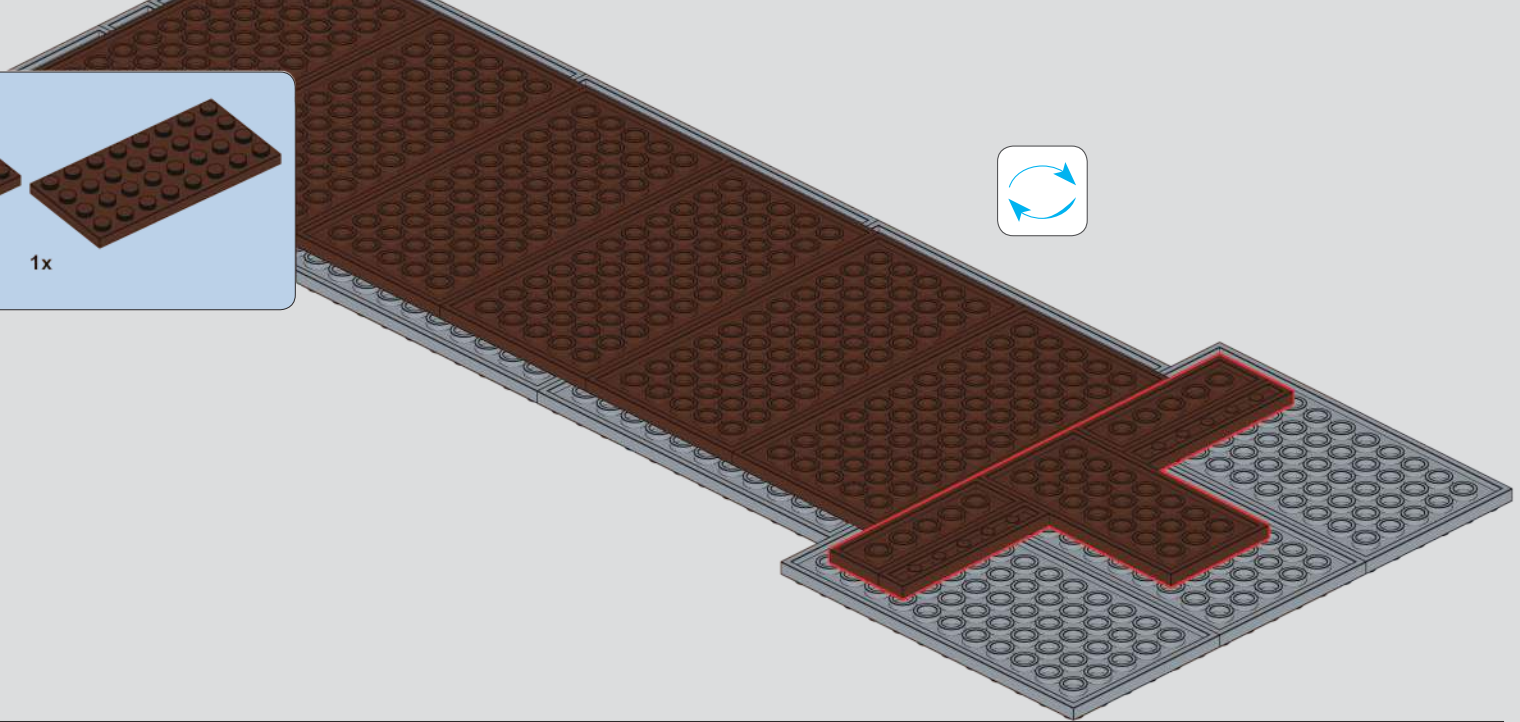

139

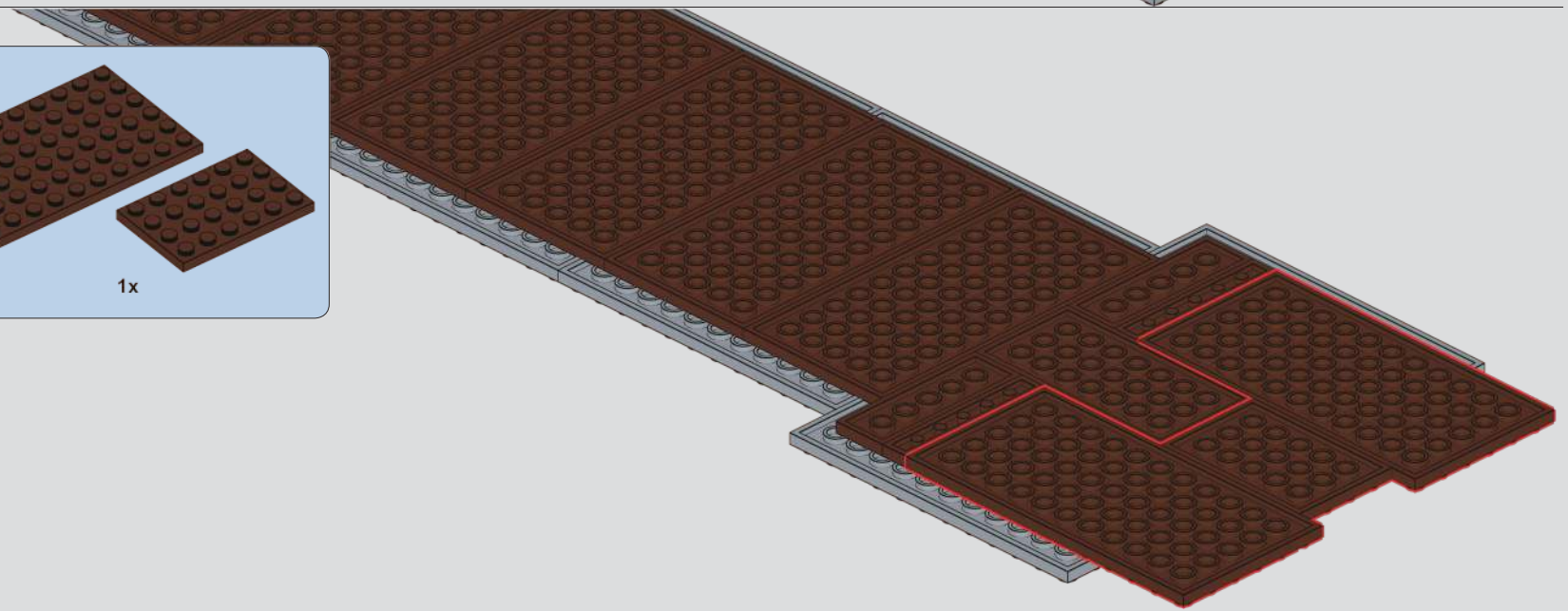

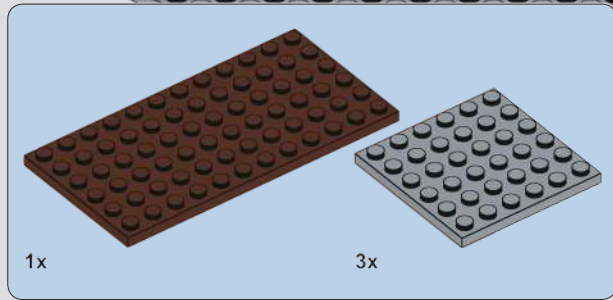

140

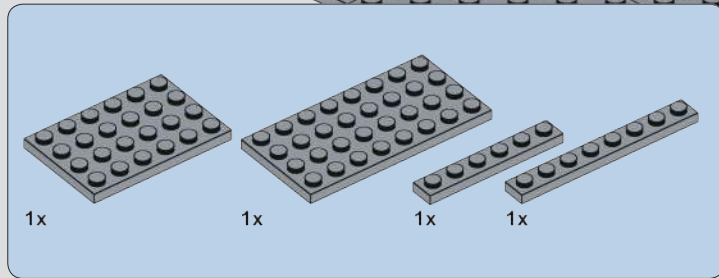
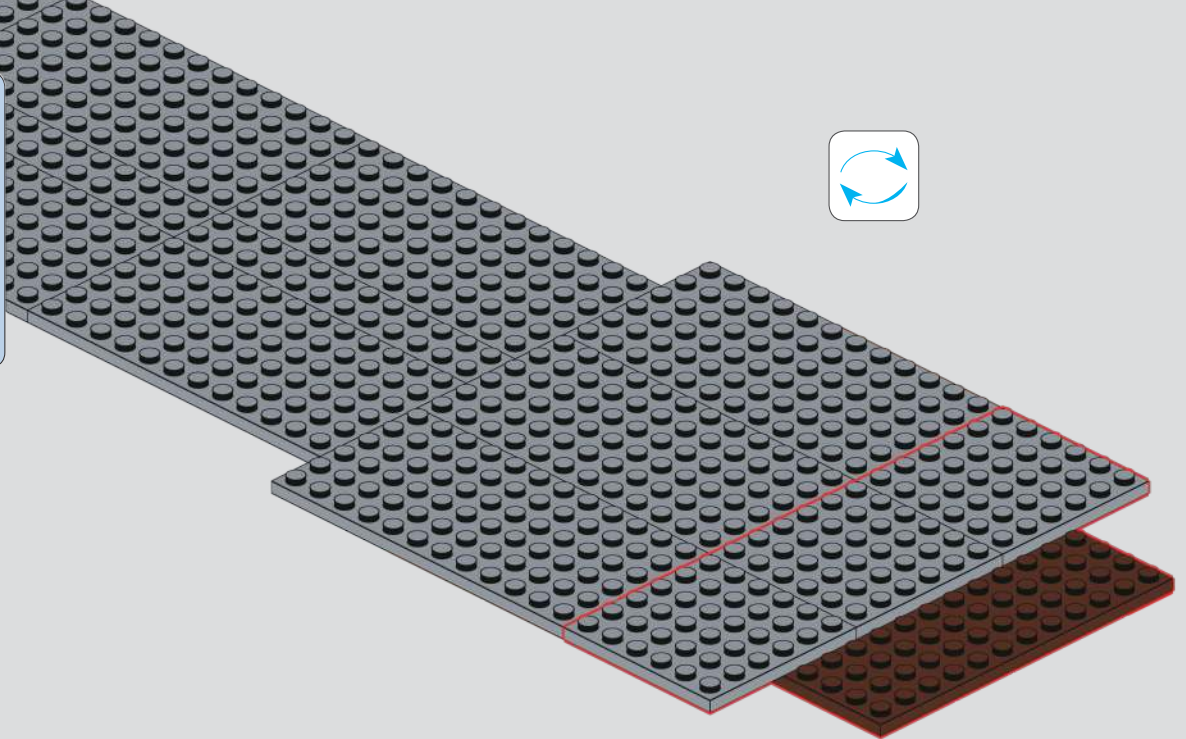

141

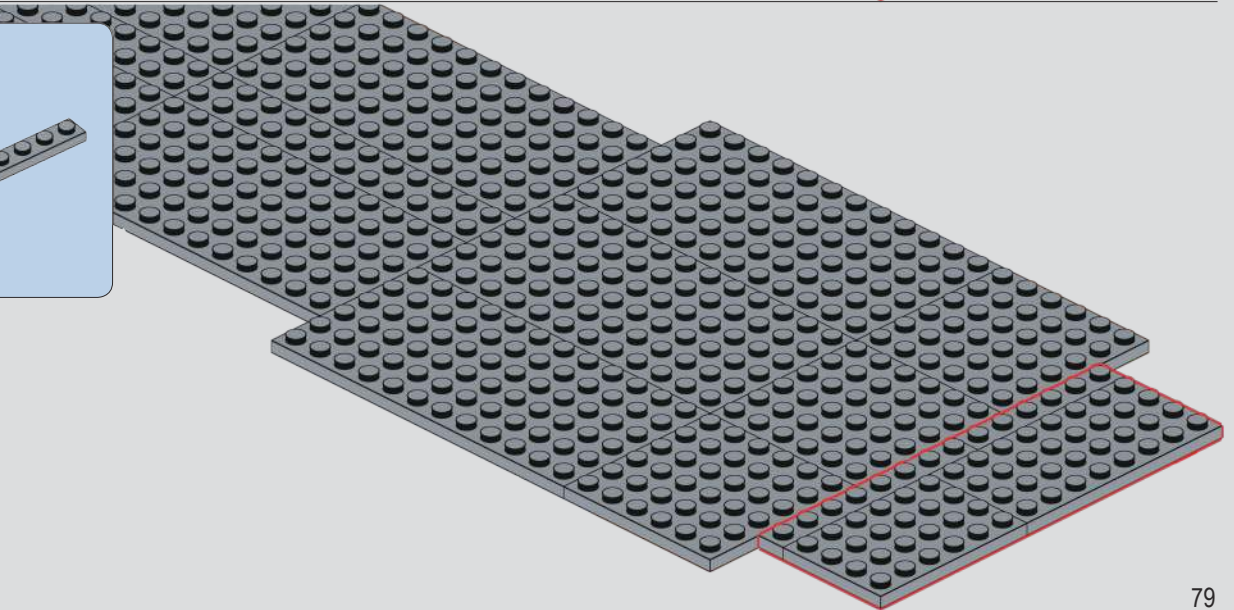

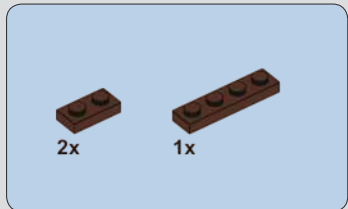

142

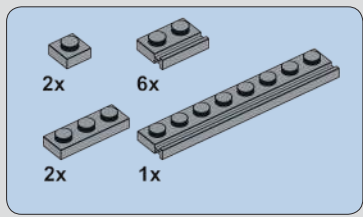
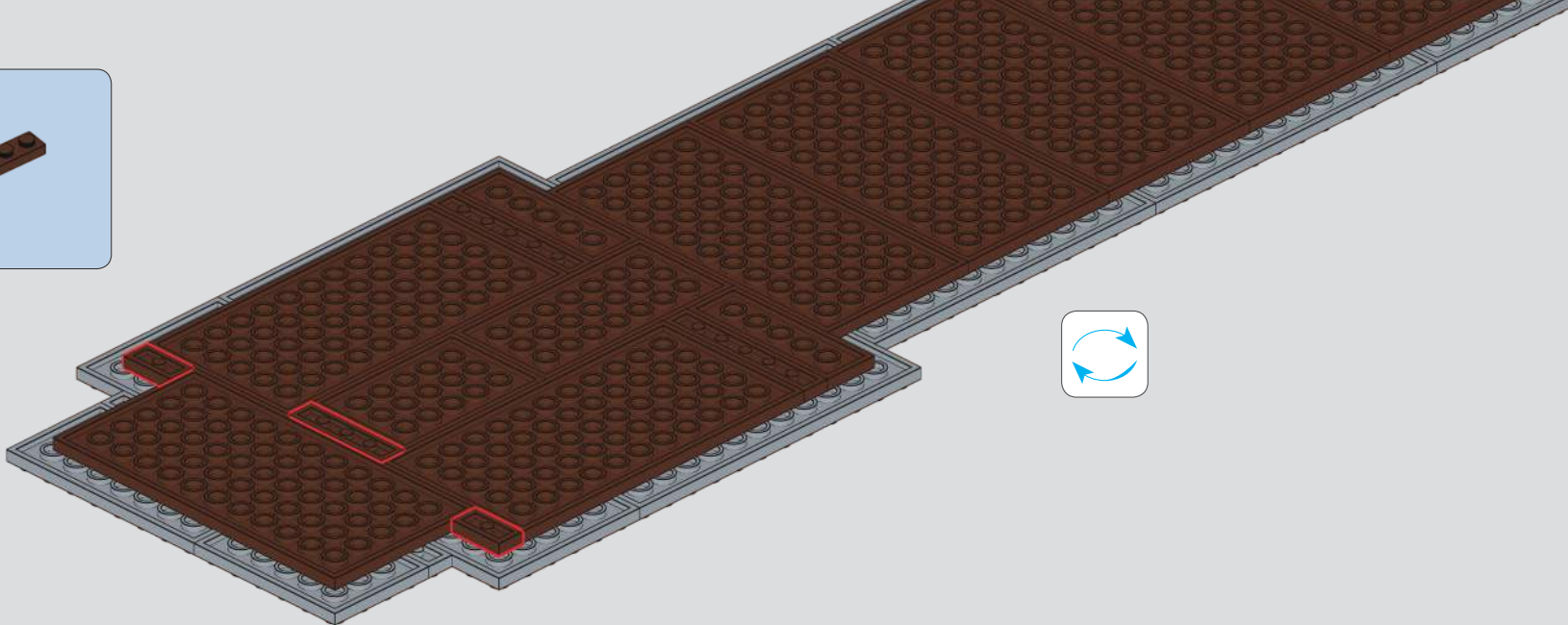

143

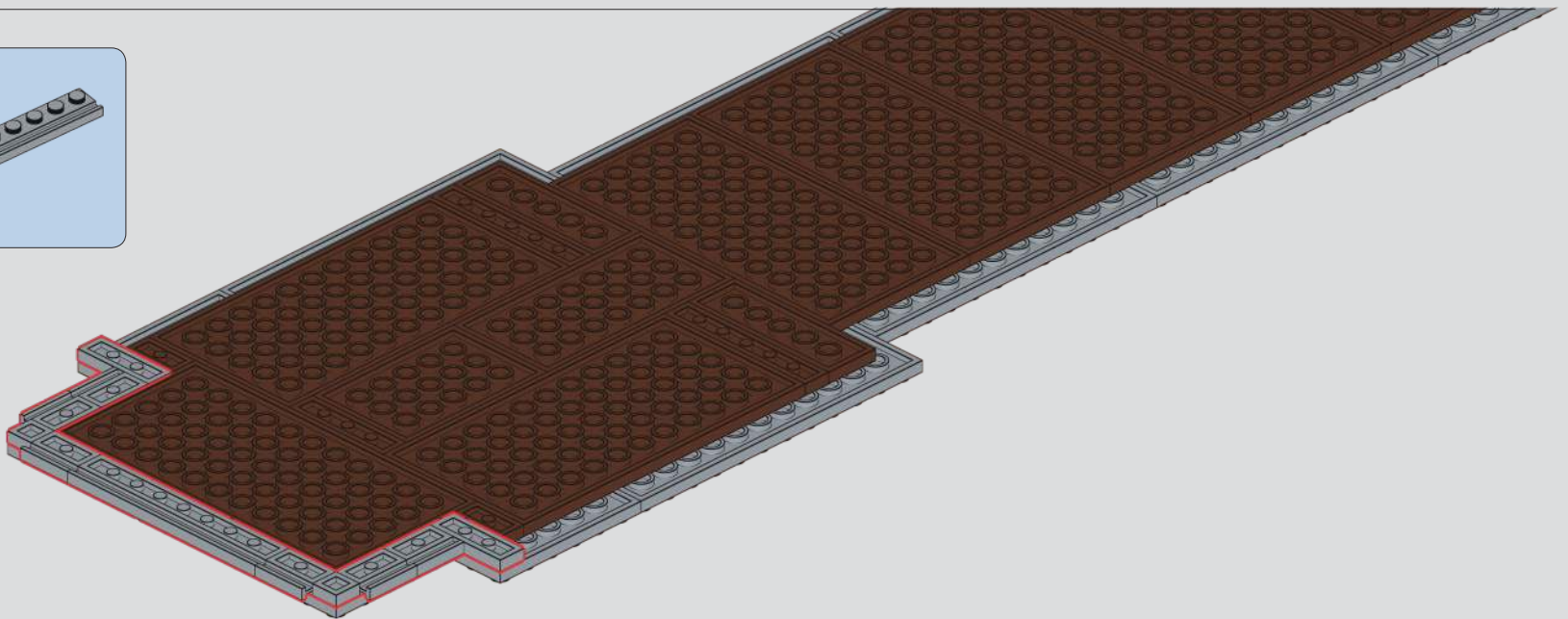

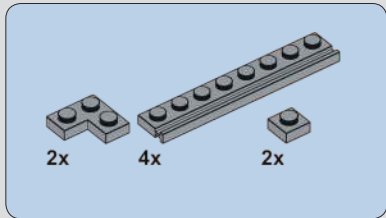

144

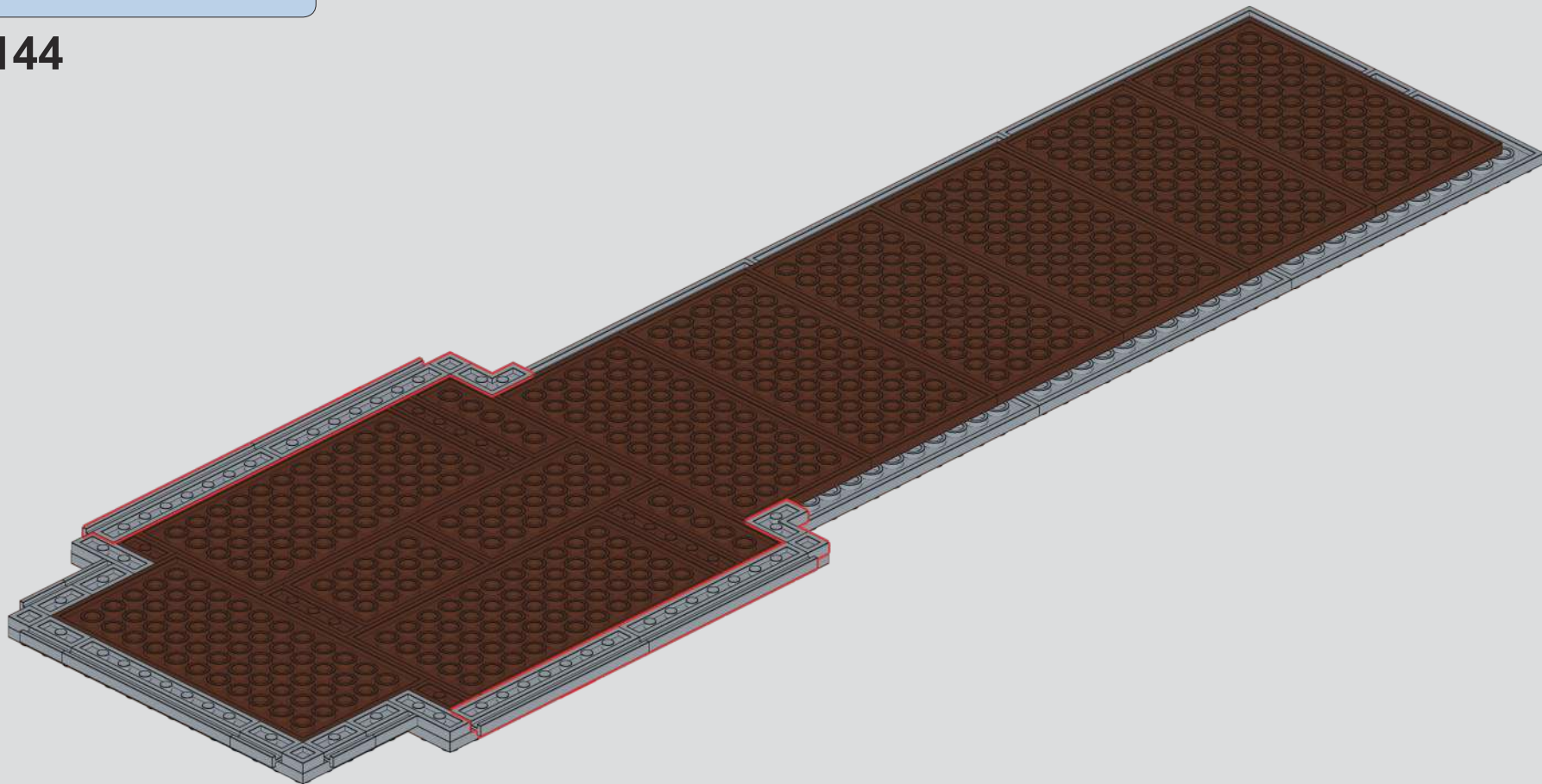

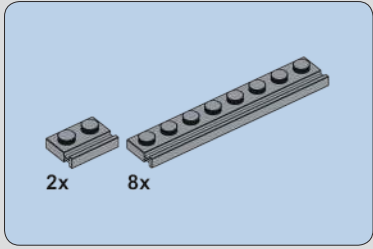

145

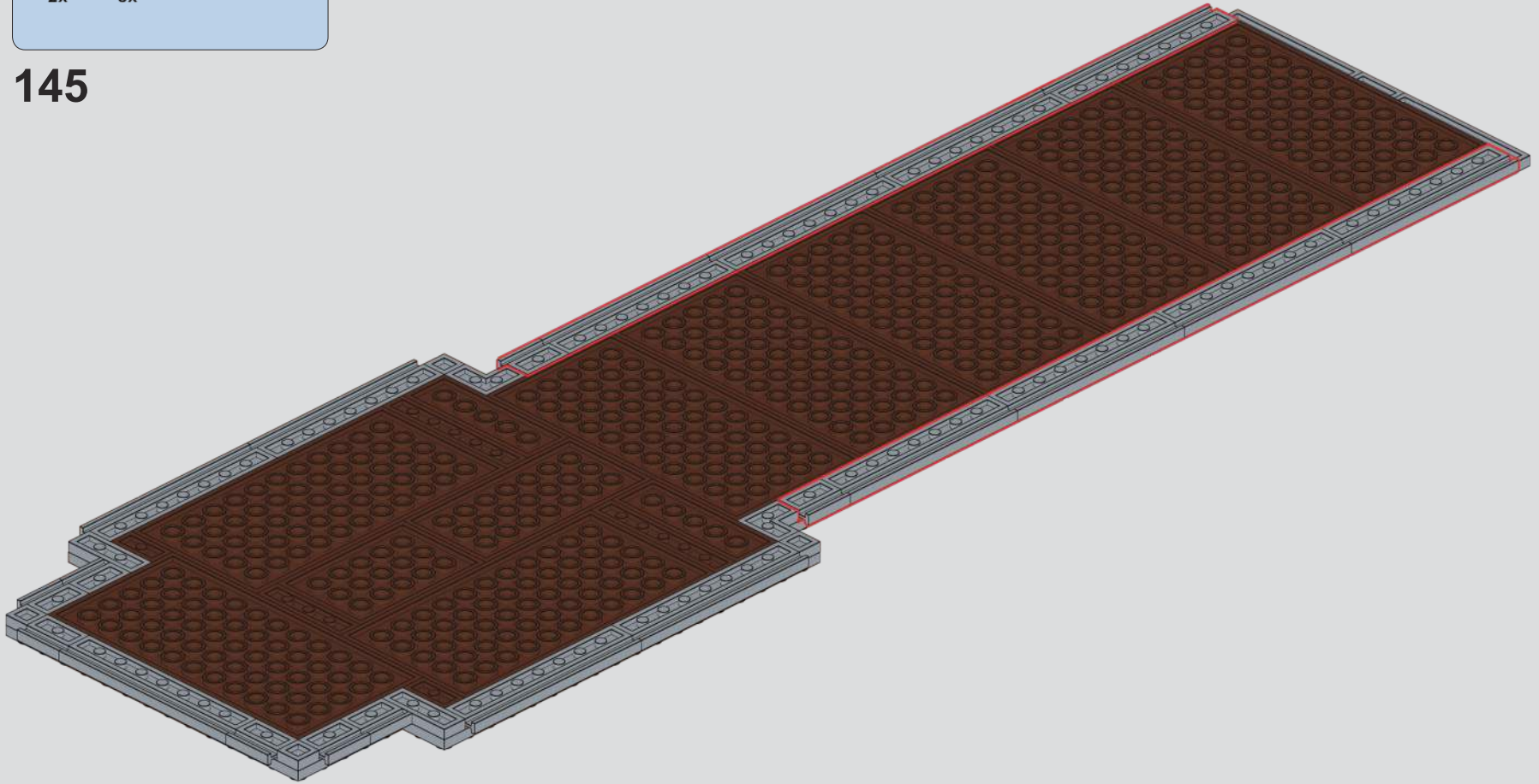

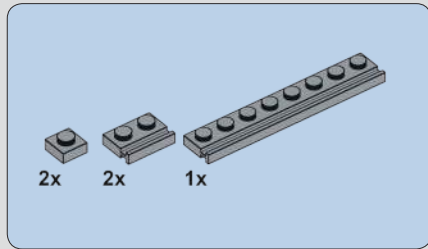

146

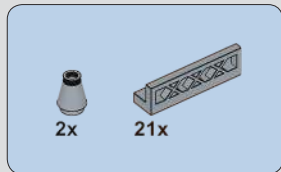
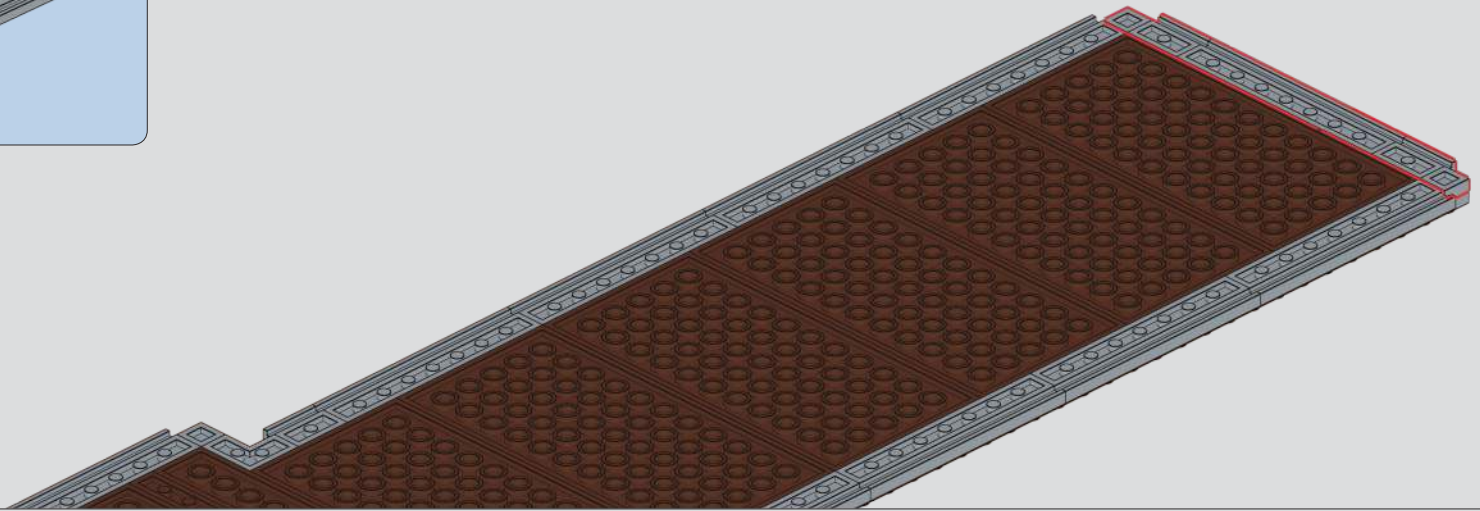

147

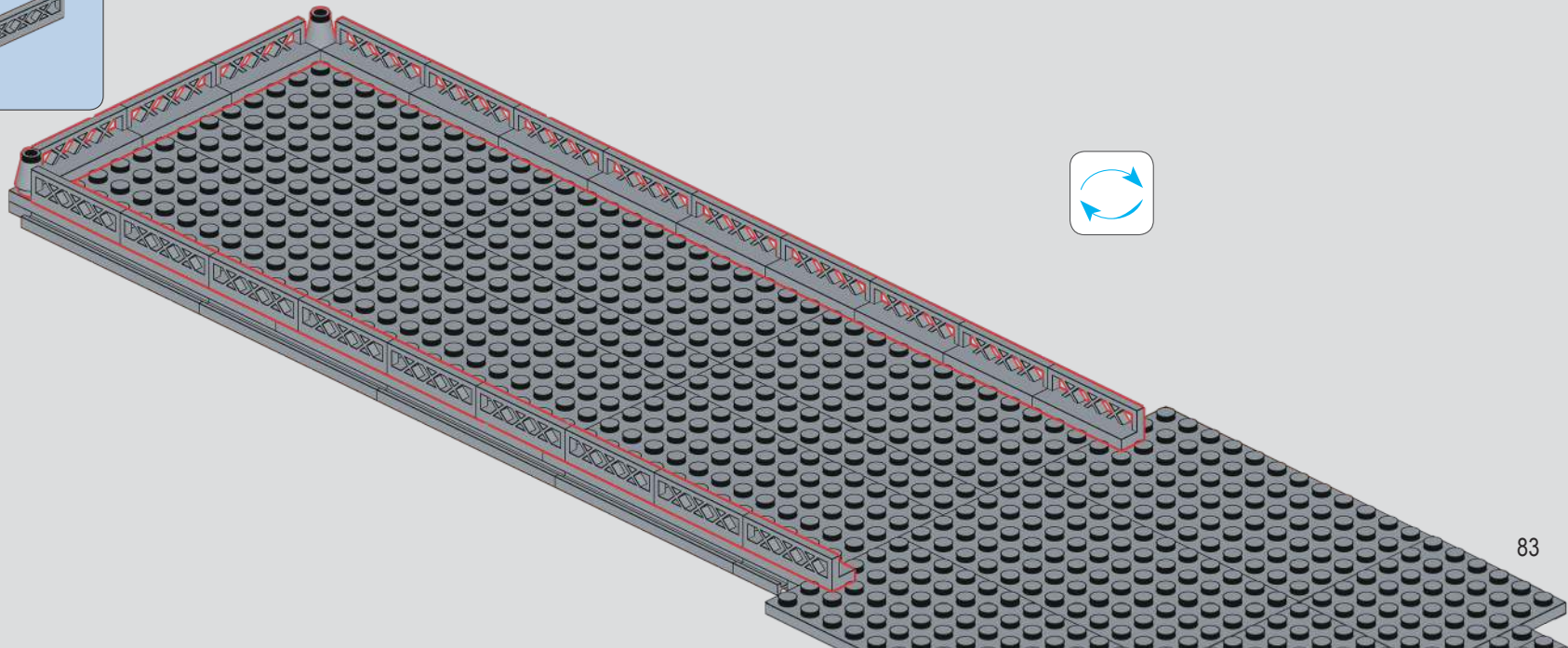

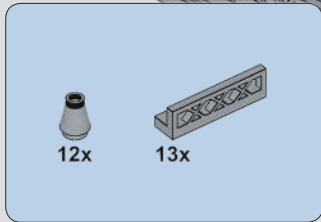

148

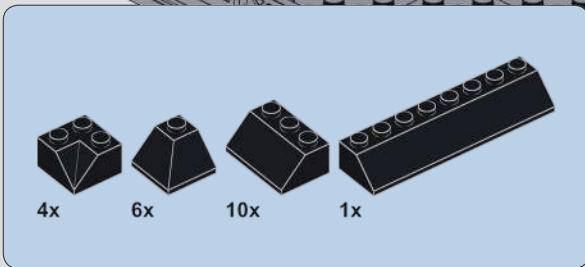
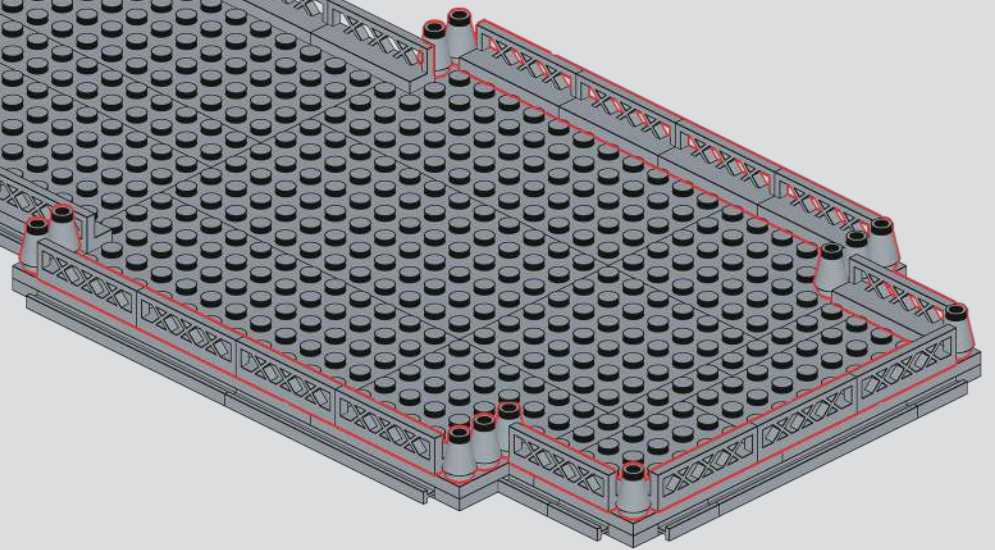

149

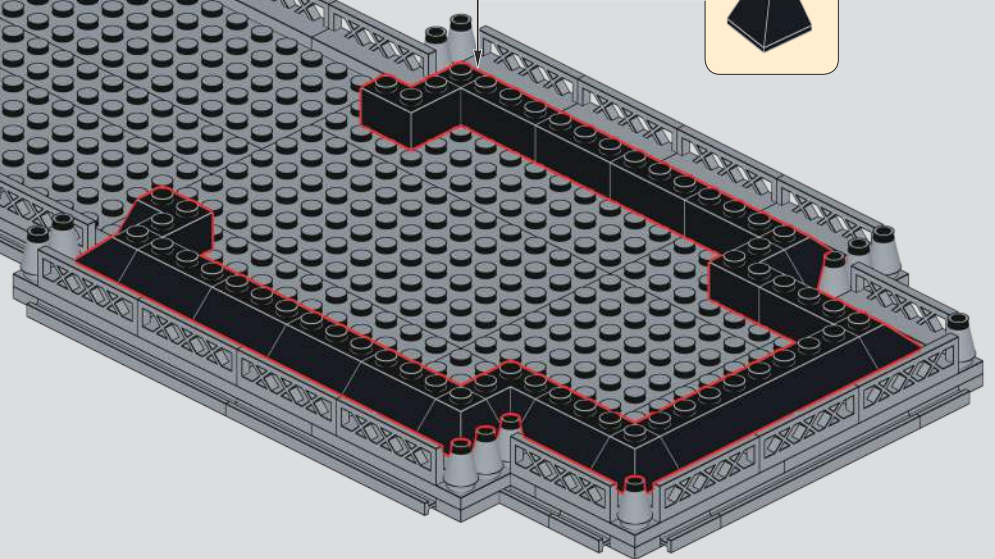

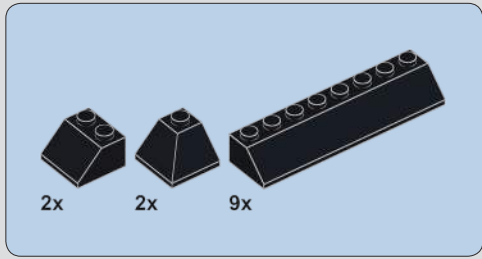

150

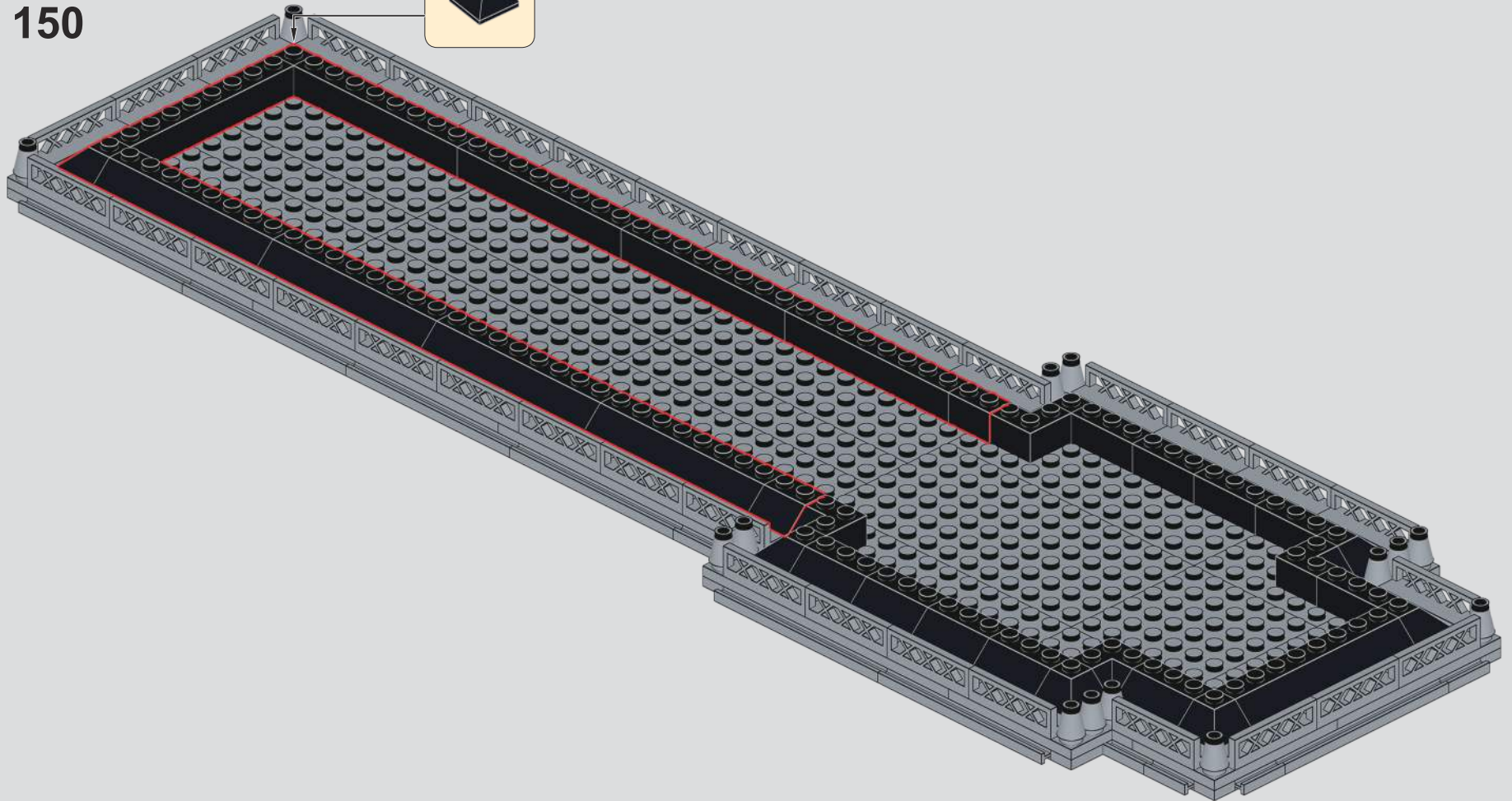

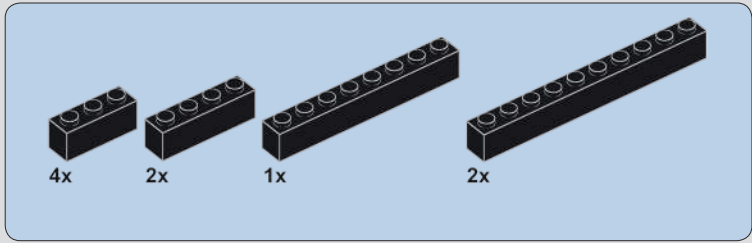

151

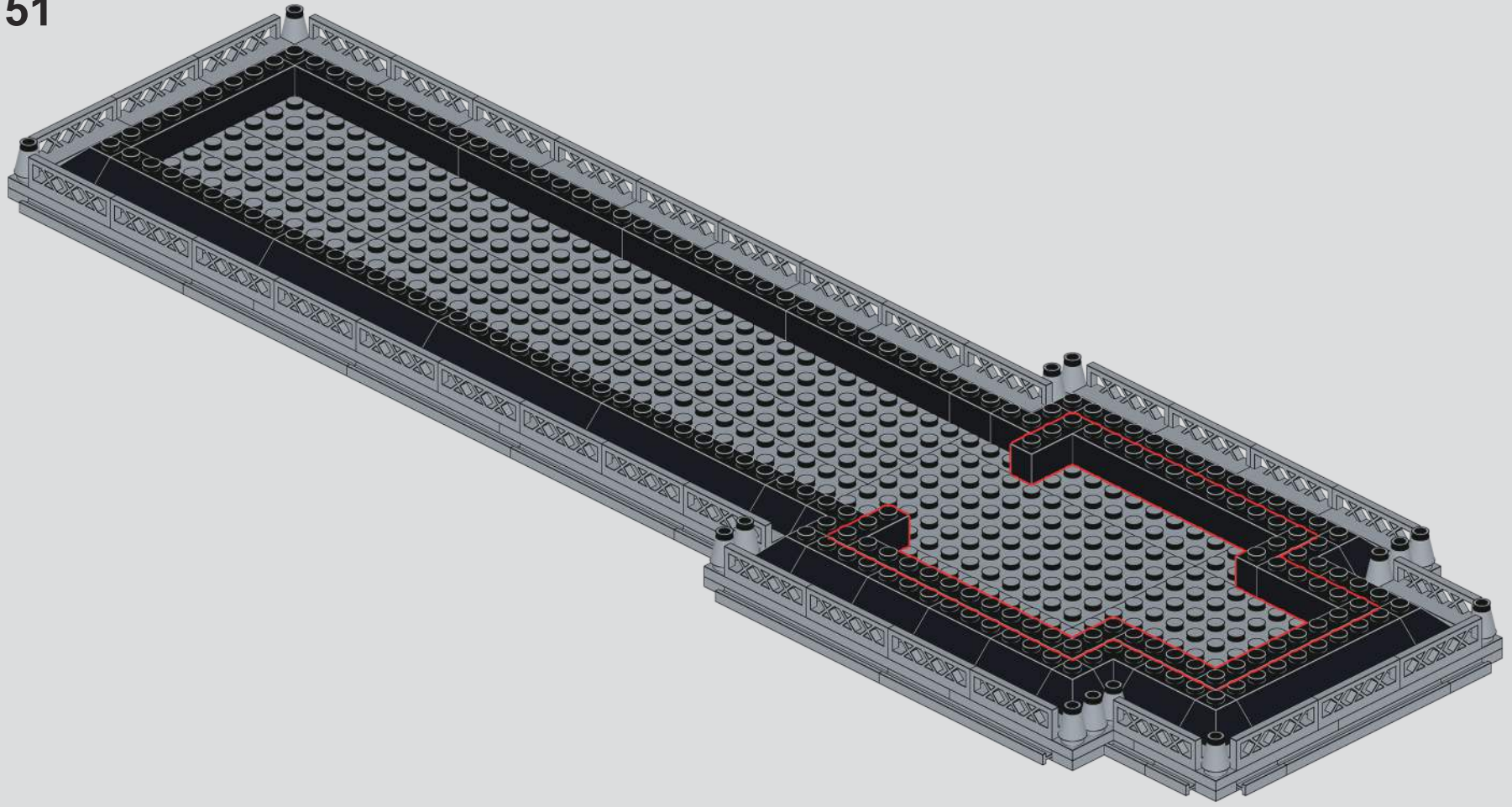

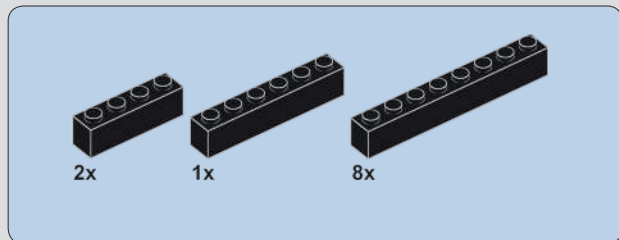

152

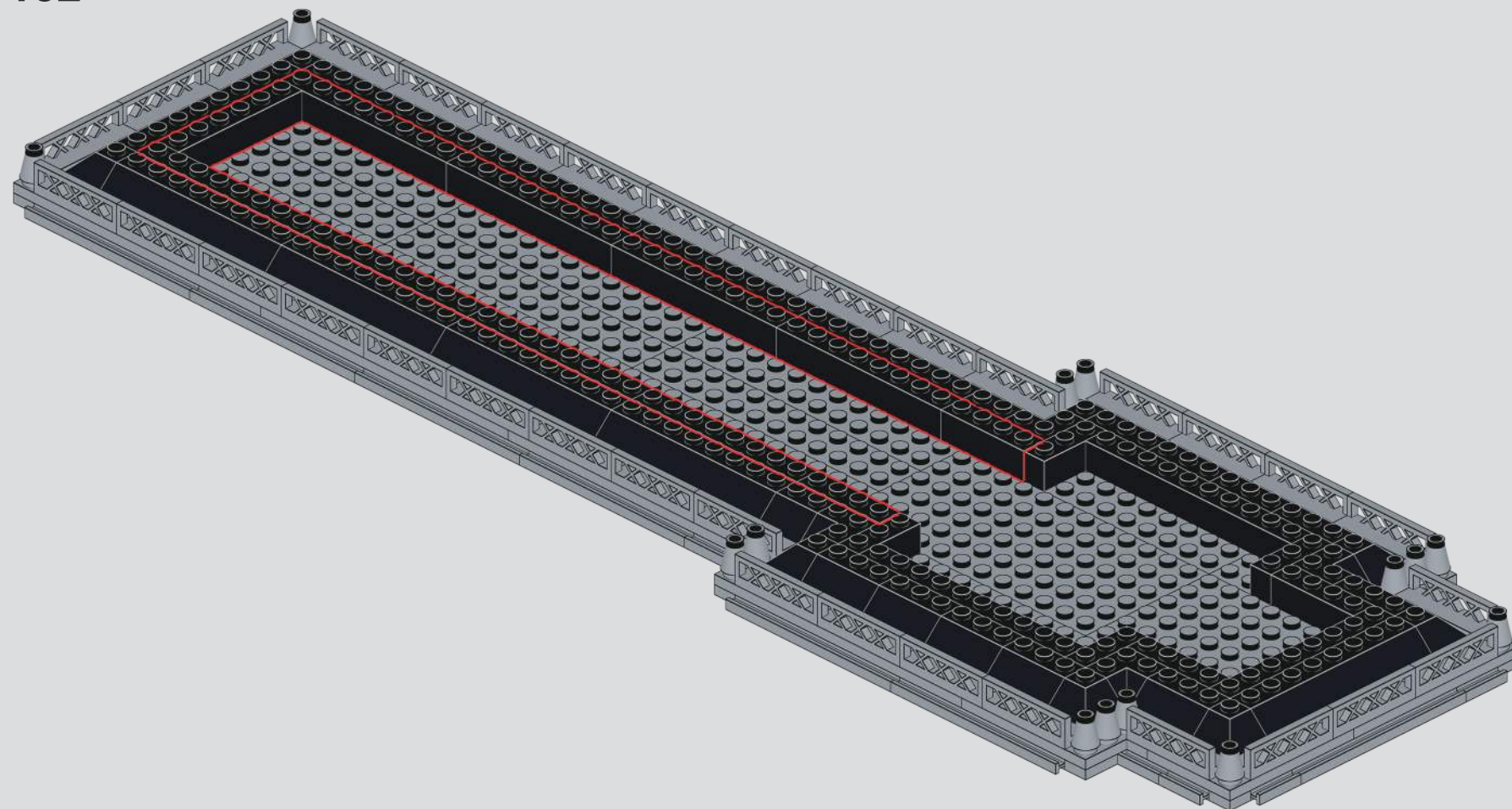

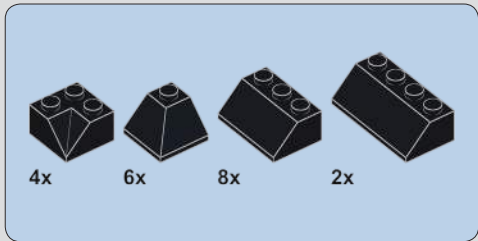

153

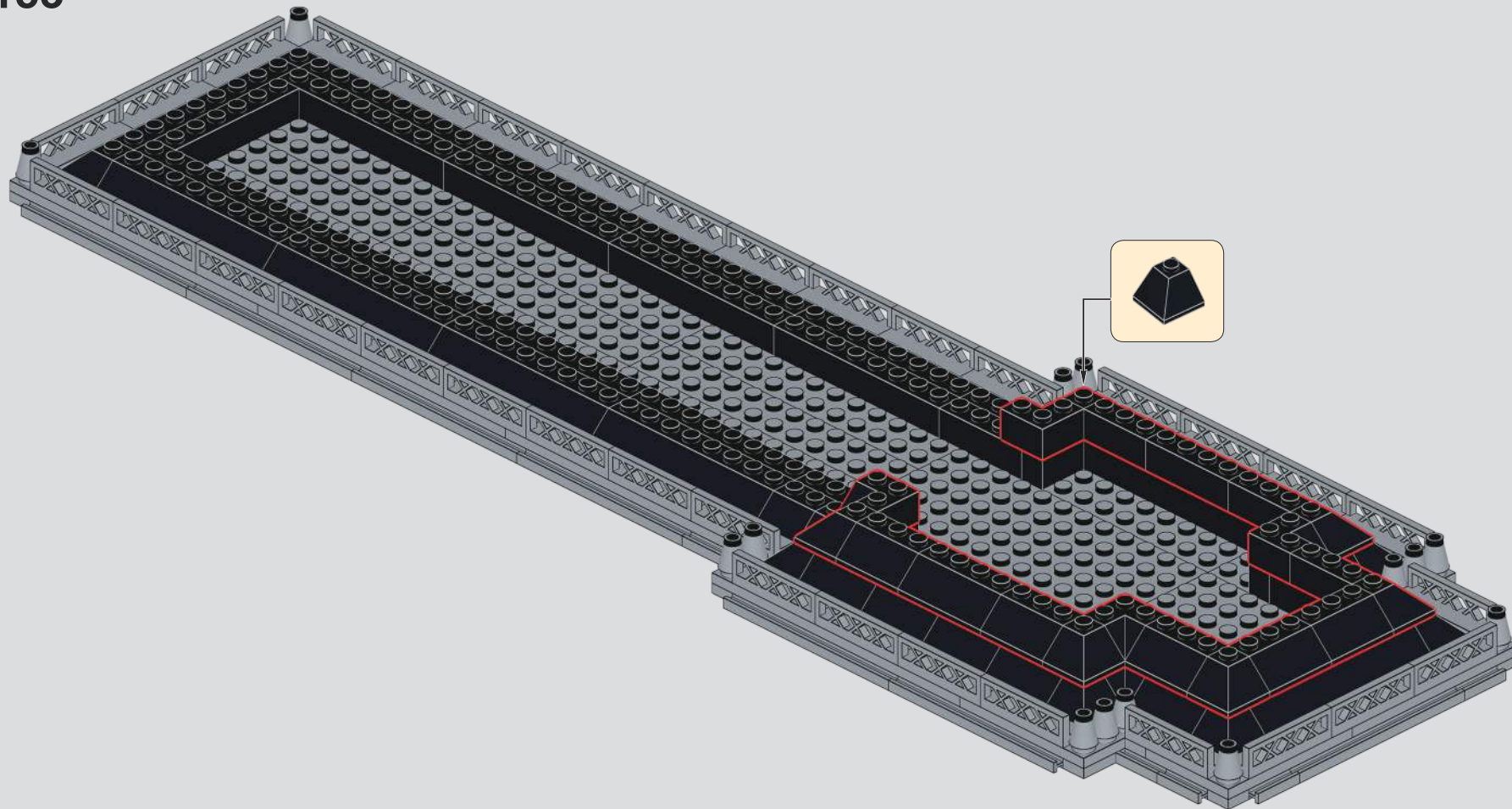

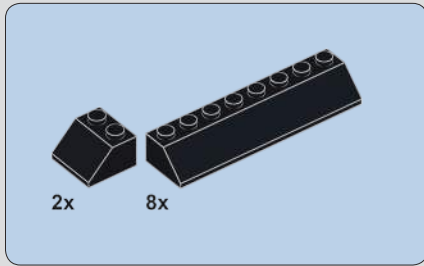

154

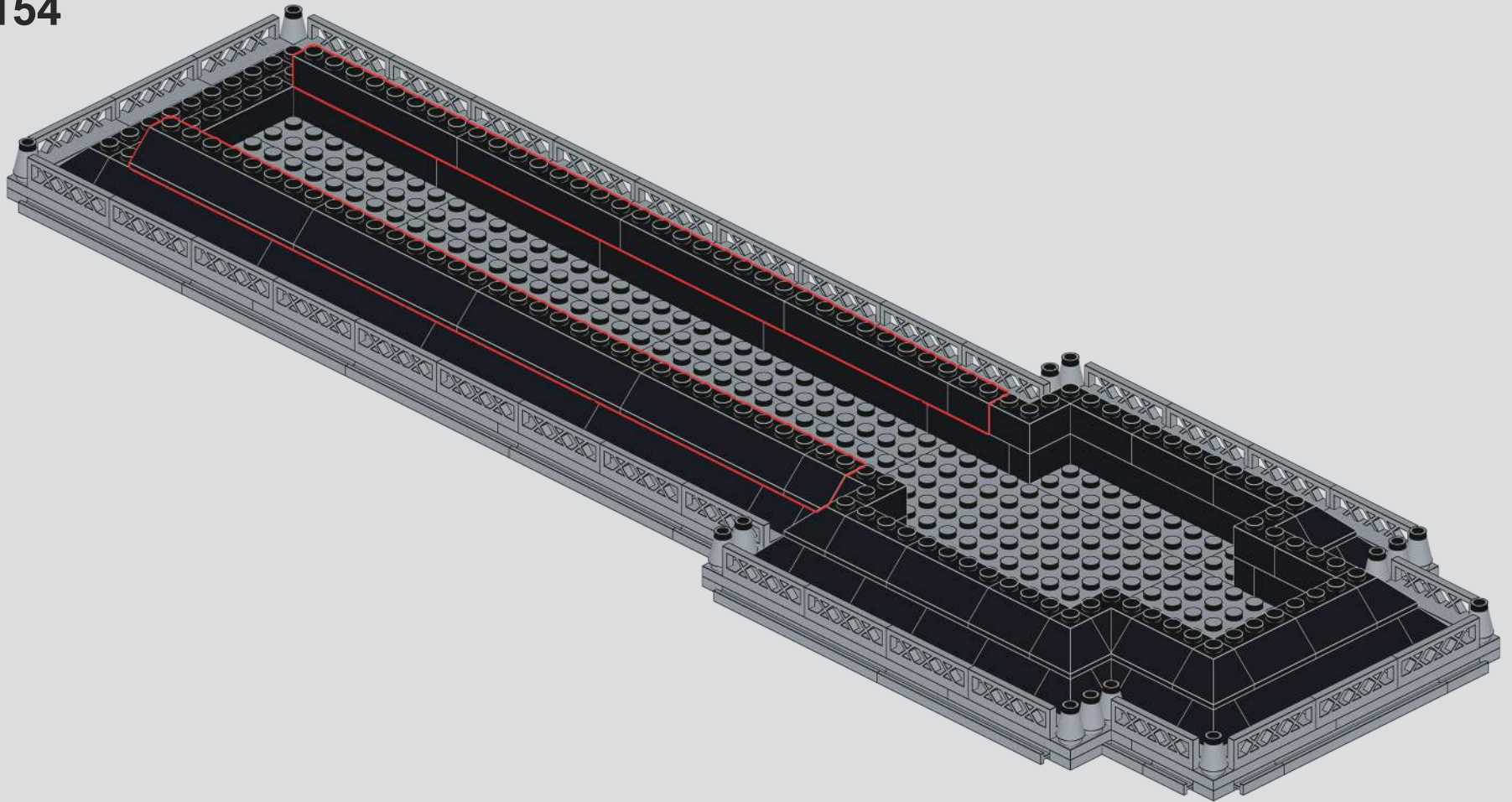

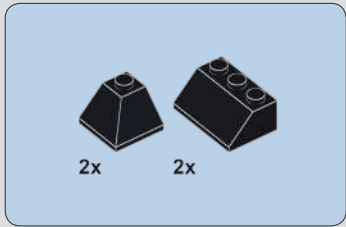

155

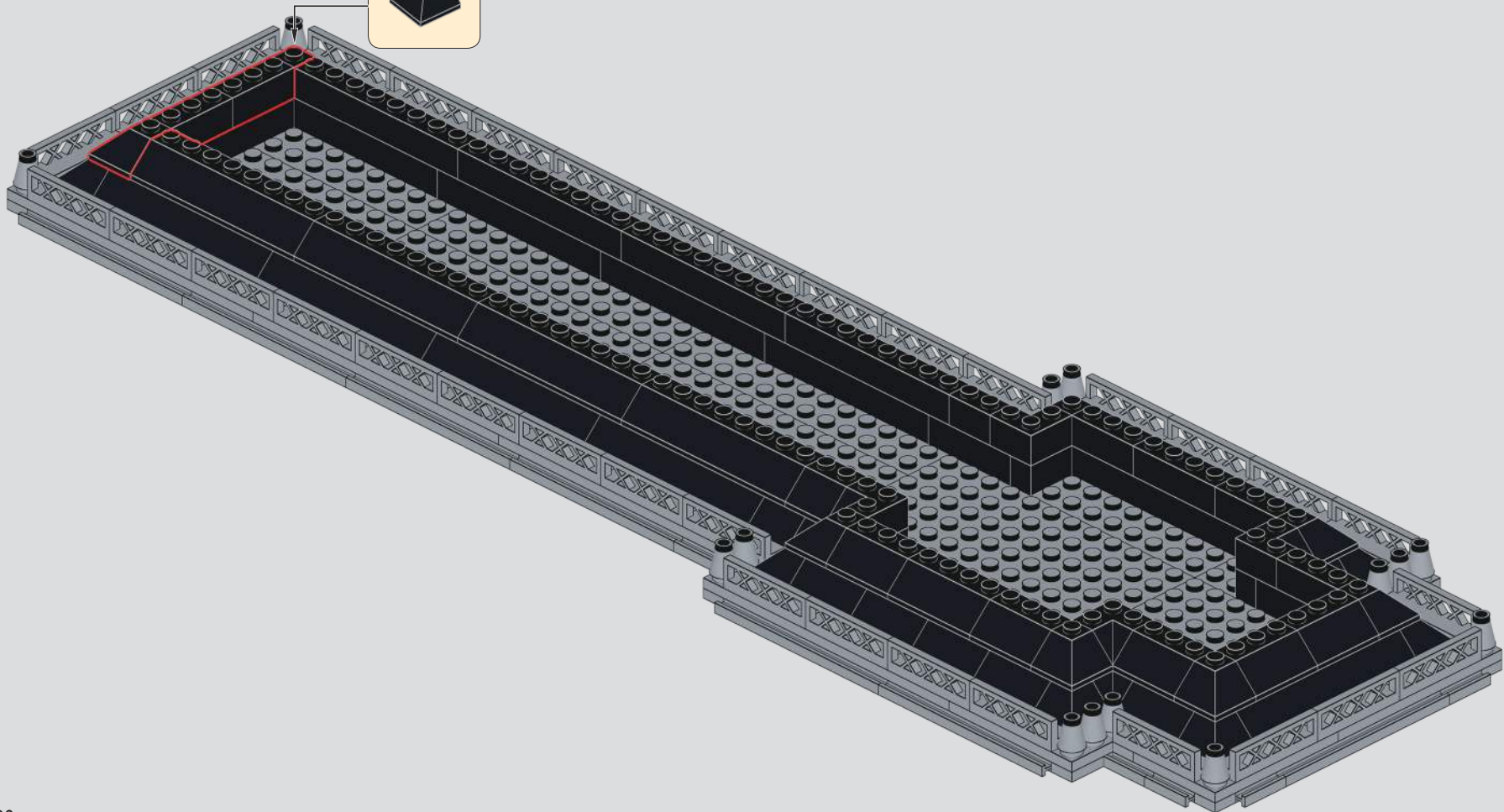

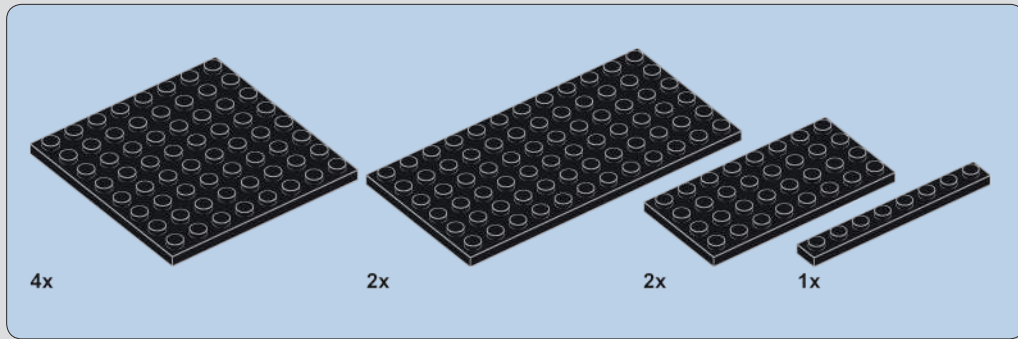

156

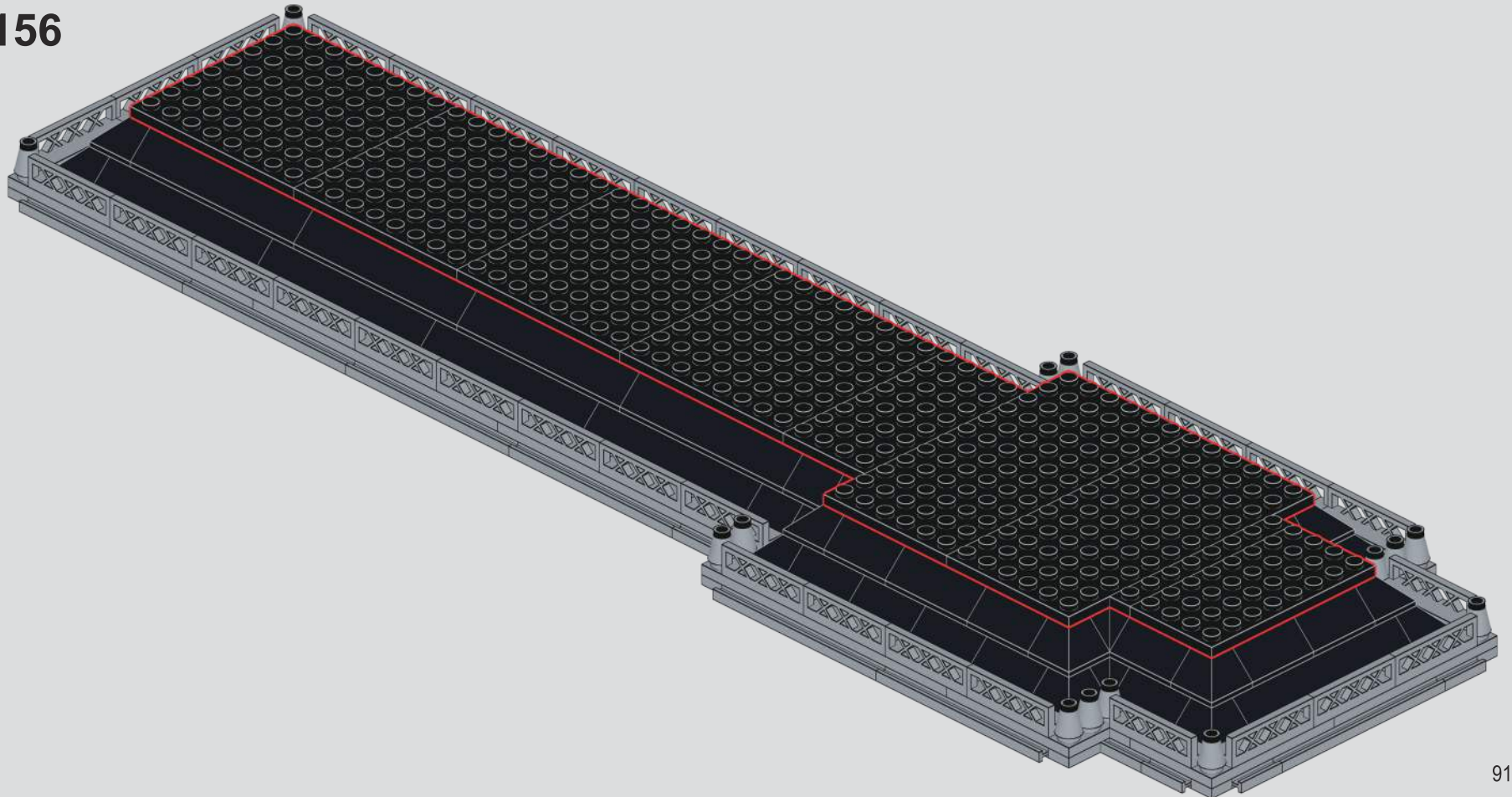

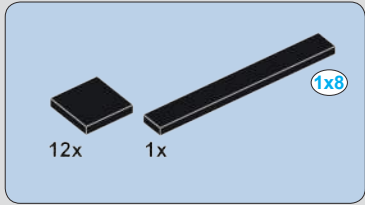

157

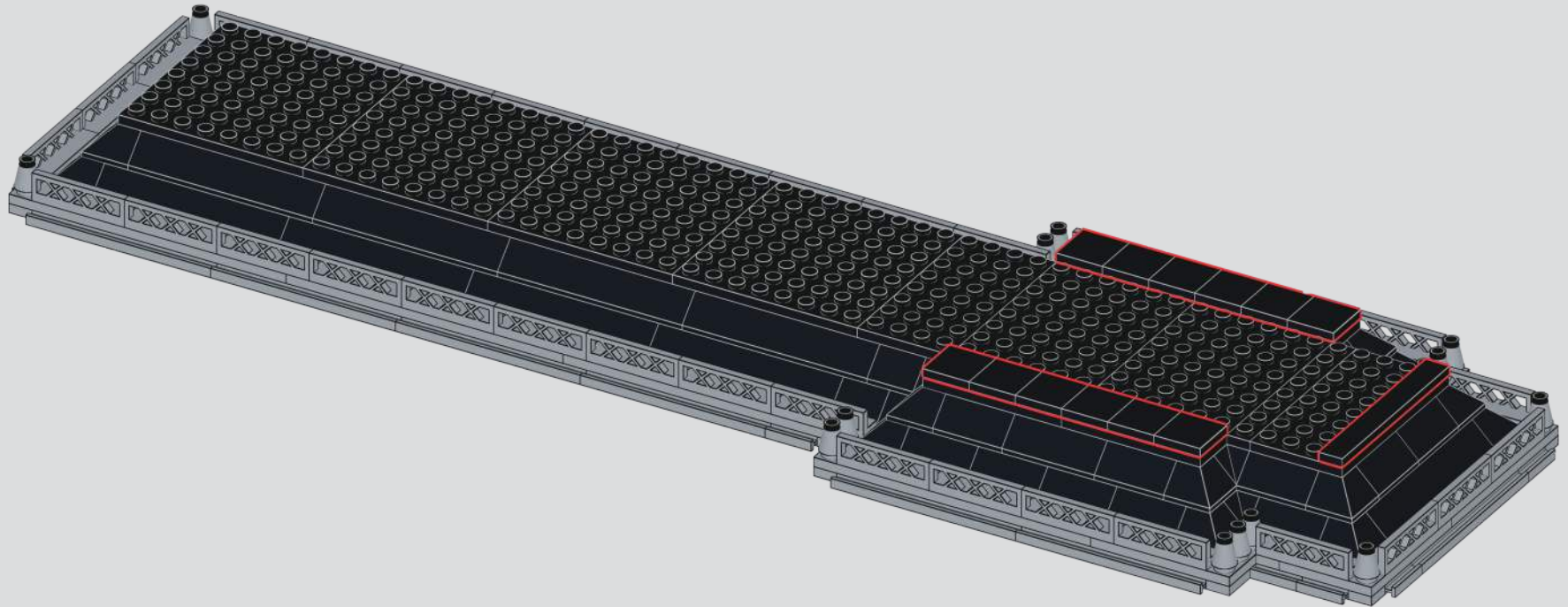

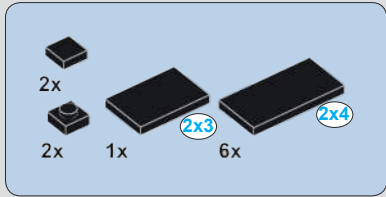

158

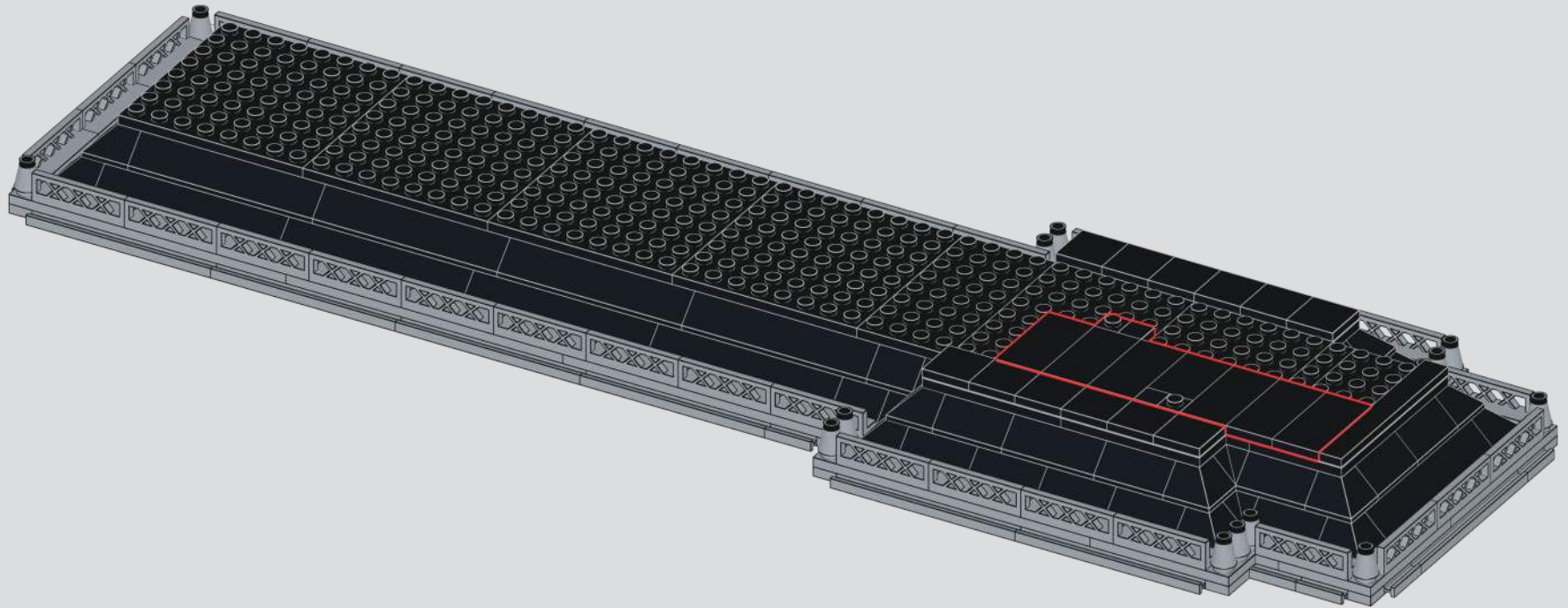

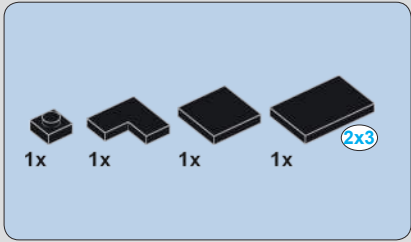

159

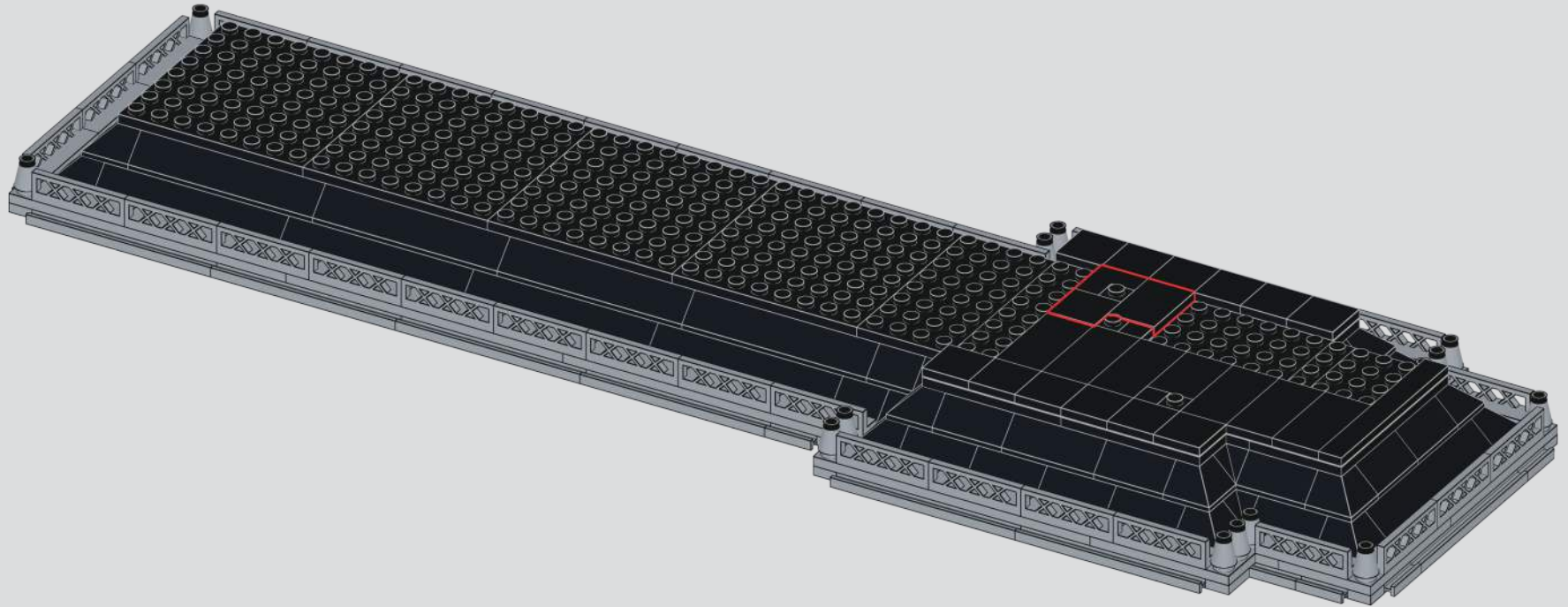

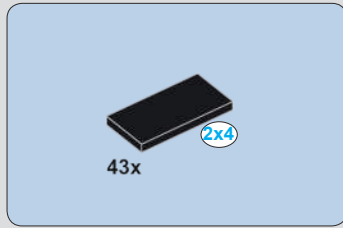

160

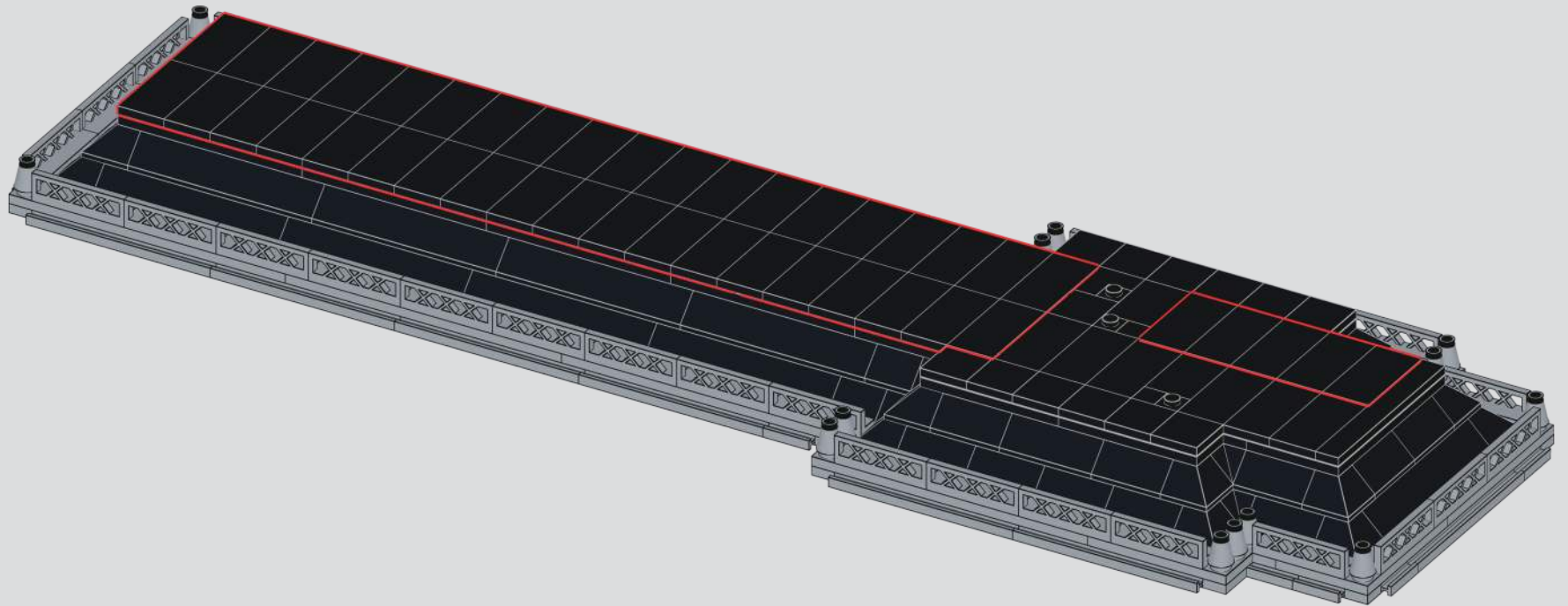

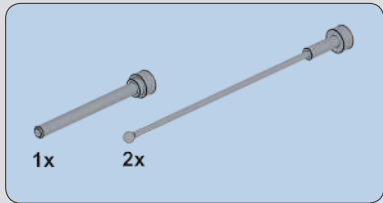

161

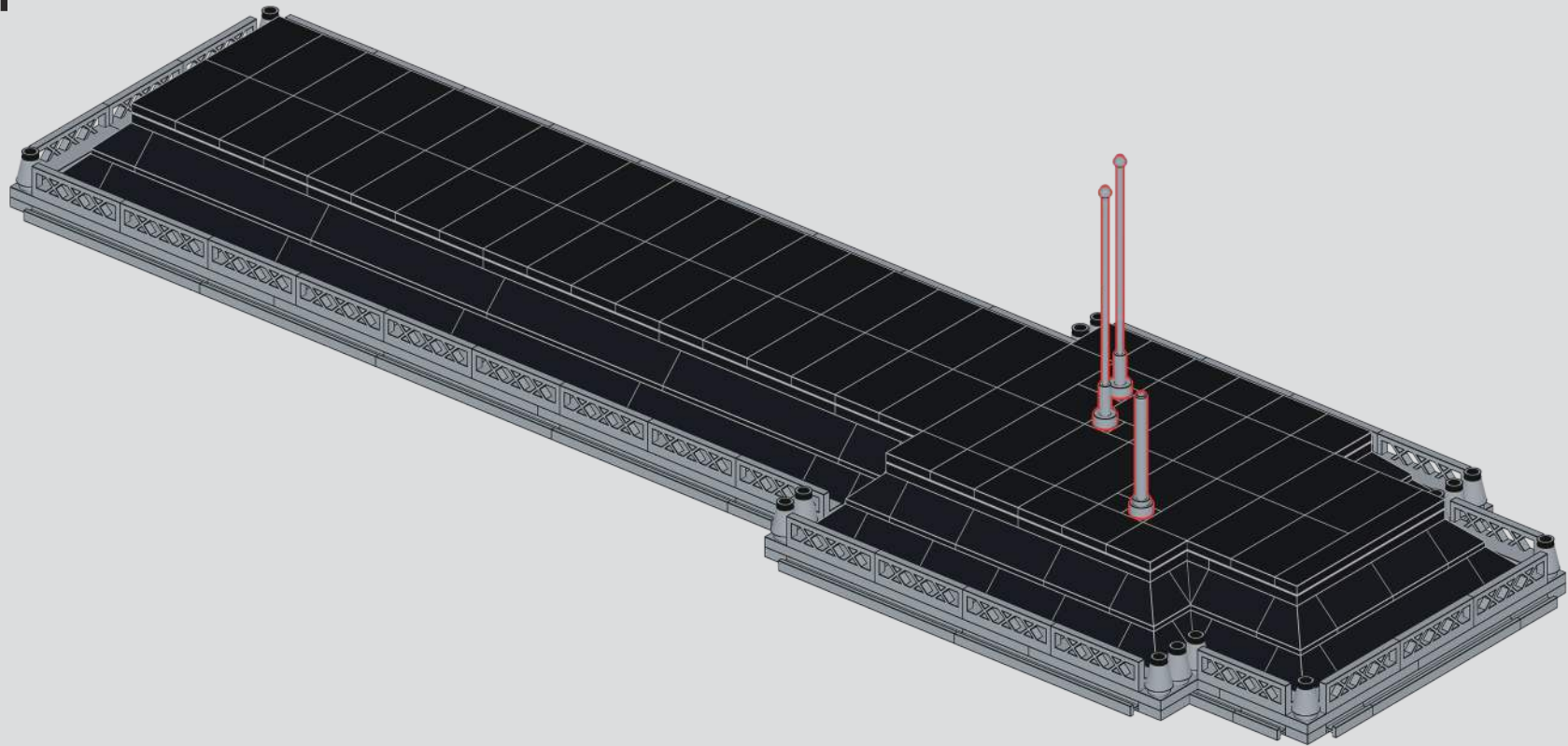

162

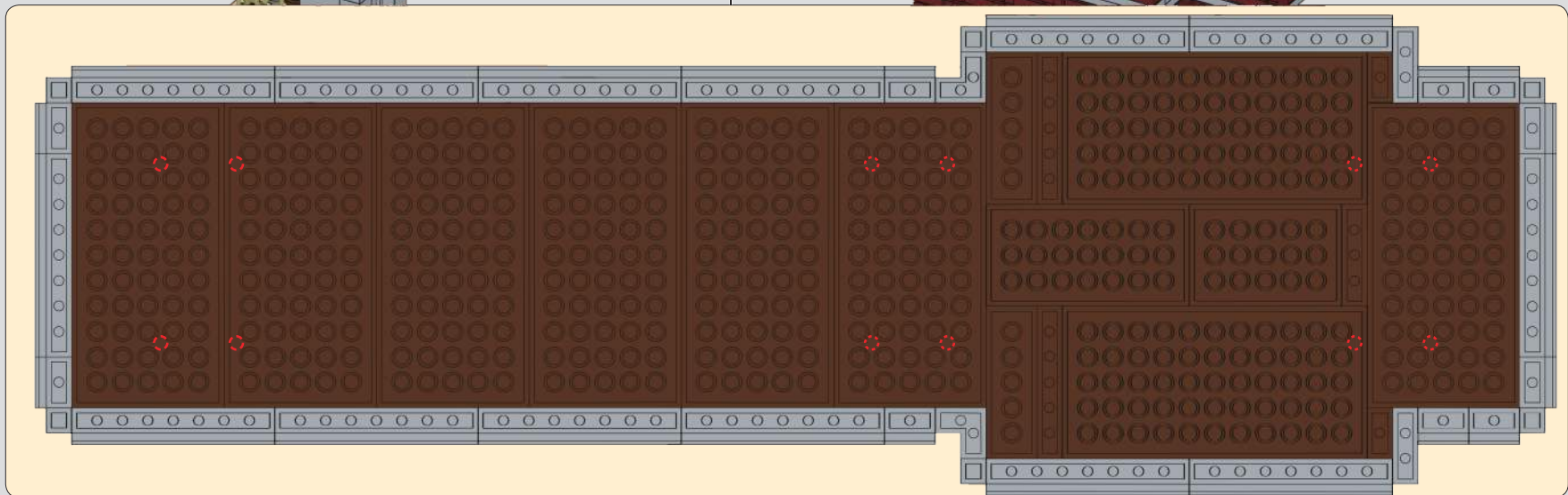
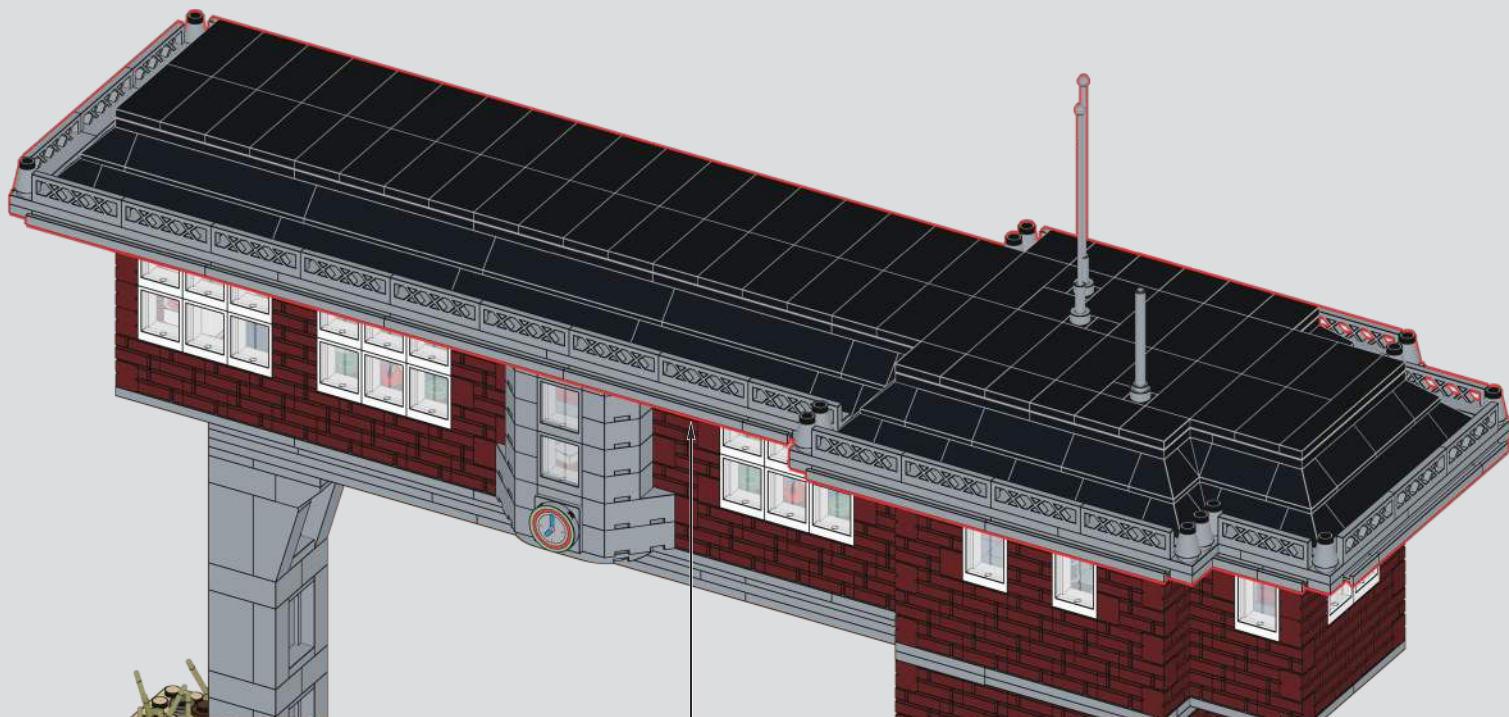



火车和轨道需另购，增加更多乐趣  
Trains and tracks are sold separately, for more fun.