

**MOULD
KING**

宇 | 星 | 模 | 王

20024

8 + 年龄
Ages/Edades

®

宇星军事系列
MILITARY

谢尔曼
NO.M4



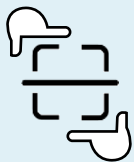

Qr code APP (APP二维码)

Need the apple version 9.0 and above,the android version 5.0 and above.

* This APP supports most of the mainstream Android models on the market, but due to the large number of Android models, different models of systems and hardware reasons, there may be some models do not support, specific according to the actual test!

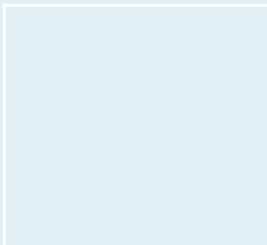

广东宇星科技
Mould King



产品资讯



积木补件



售后服务

Customer Service
客户服务



www.yx-mk.com



"酷砖家"是宇星模王设立的特殊标识，代表着产品的独特性和原创性。每一款带有"酷砖家"标志的积木套装，都由宇星的原创团队或者与宇星有密切合作的全球顶尖设计师亲自设计或授权。这个标识是我们对消费者的承诺，确保他们可以享受到独一无二且高品质的积木拼搭体验。

"Bri X pert" is a special mark established by MOULD KING, representing the uniqueness and originality of the product. Every building set with the "Bri X pert" logo is personally designed or authorized by MOULD KING's innovative team or world-class designers who work closely with MOULD KING. This logo is our commitment to consumers, ensuring that they can enjoy a unique and high-quality building experience.

OPEN

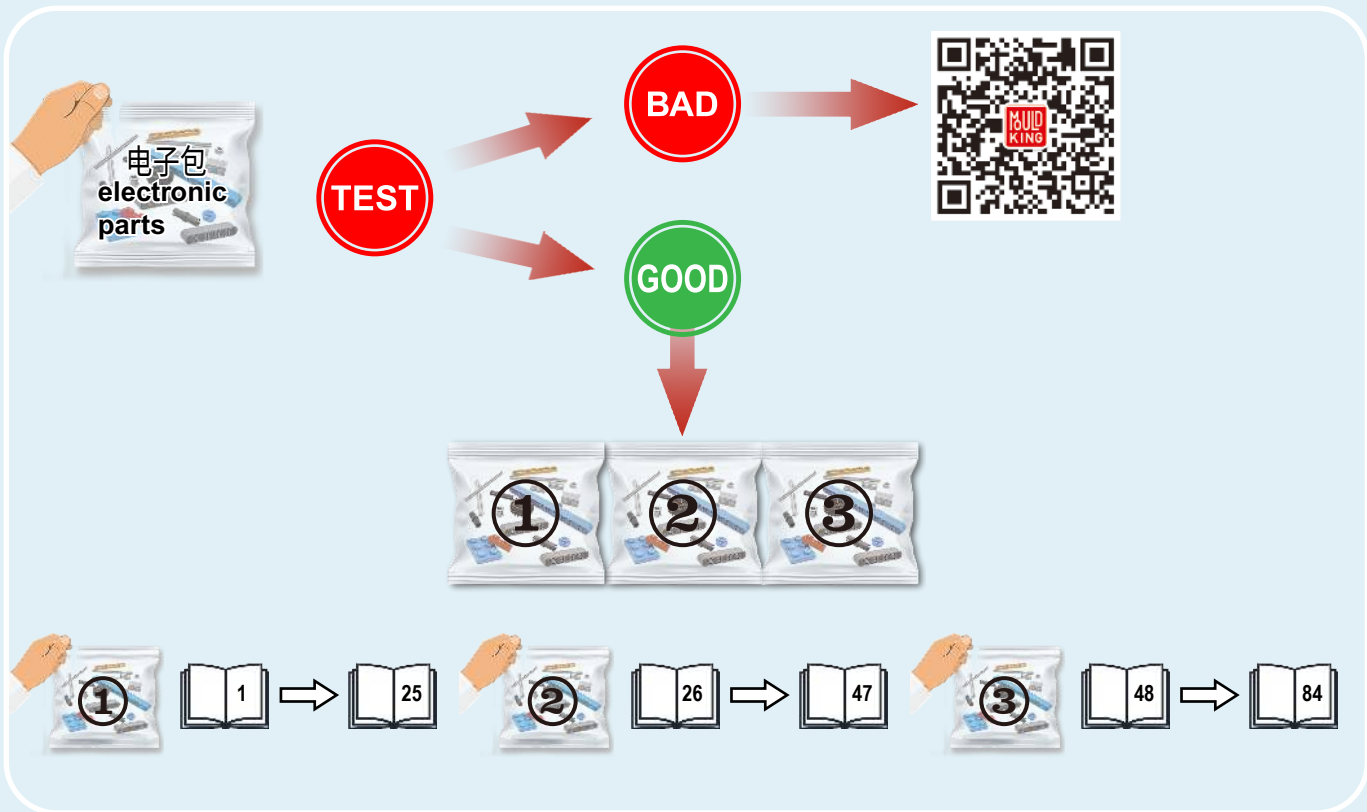

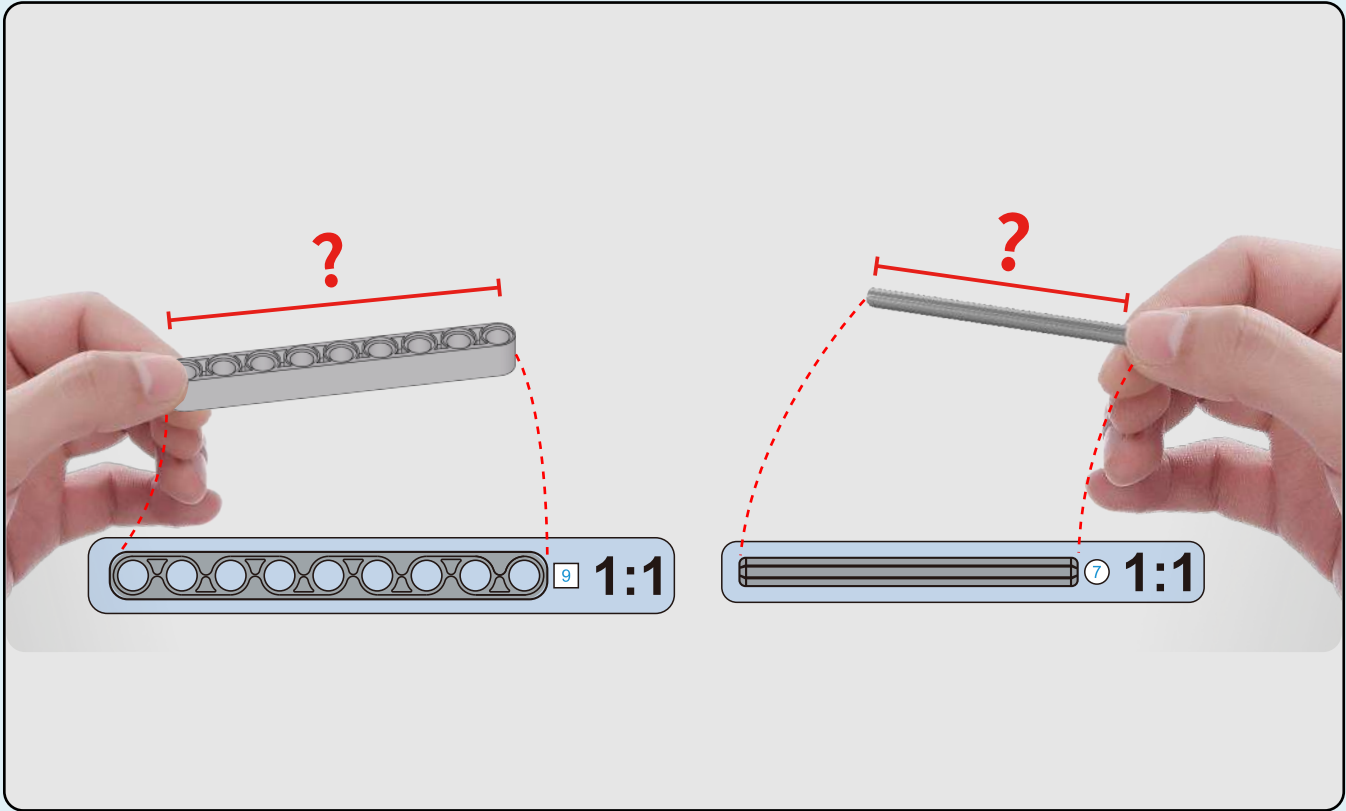

战斗全重33650千克;车高2.97米;车长7.54米;车宽3.0米;引擎FordGAA。
combat total weight 33650 kg; Vehicle height 2.97 meters, length 7.54 meters, width 3.0 meters, engine FordGAA.

最大速度公路/越野38千米/小时;21千米/小时;最大行程公路/越野178千米/90千米;标准乘员5人。

Maximum speed road/off-road 38 km / h; 21 km/h; Maximum on/off-road 178 km/90 km; Standard crew 5 people.

主炮:75毫米M3坦克炮,76毫米M1A1坦克炮,76毫米M1A2坦克炮。
Main guns: 75 mm M3 tank gun, 76 mm M1A1 tank gun, 76 mm M1A2 tank gun;

机枪:2x7.62毫米caliberMGM1919A41×12.7毫米M2HB。
Machine gun: 2x7.62 mm caliber MGM1919A41 × 12.7mm M2HB.

弹药:7.62毫米:6250发,76毫米71发;装甲:13-76.2毫米。
Ammunition: 7.62 mm: 6250 rounds, 76 mm 71 rounds; Armor: 13-76.2mm.

M4A3 (76)W

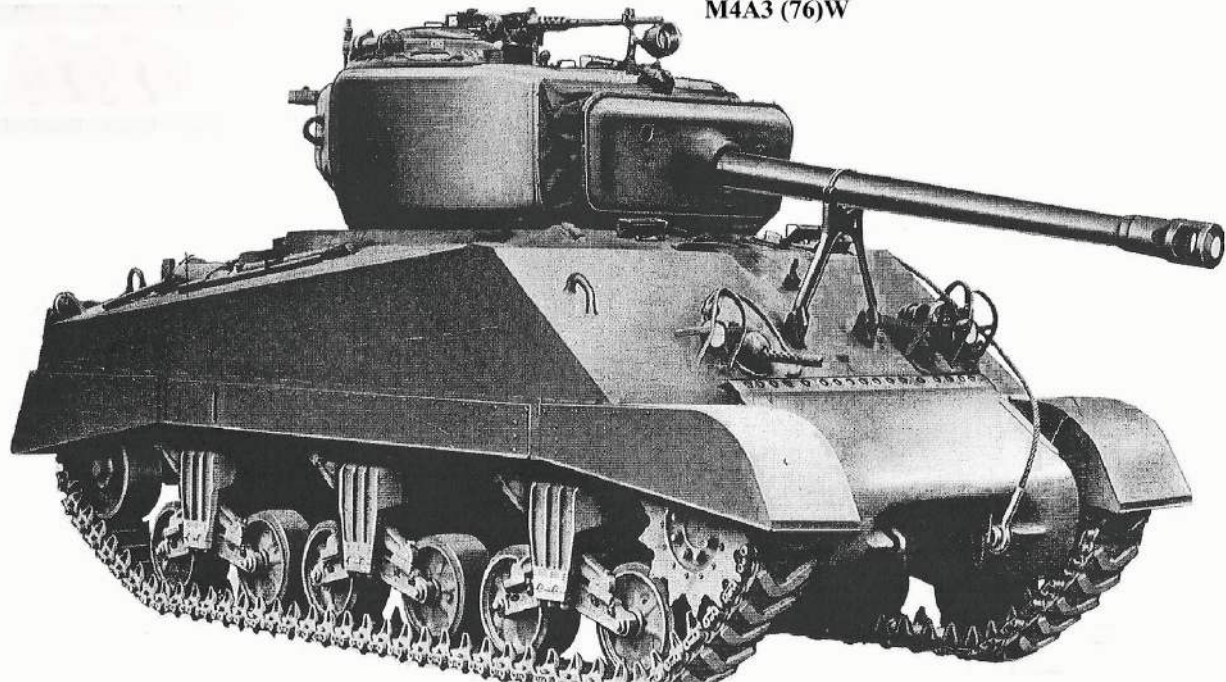

谢尔曼还是二战少数装备了火炮垂直稳定仪的坦克，能够在行进当中精确瞄准目标开炮。谢尔曼的500马力汽油发动机也是二战最优秀的坦克发动机之一，使谢尔曼坦克具有47公里的最高公路时速。这些优点都很对机动作战有帮助。

Sherman was one of the few World War II tanks equipped with an artillery vertical stabilizer, which could accurately aim at the target and fire on the move. The Sherman's 500 hp petrol engine was also one of the finest tank engines of World War II, giving the Sherman tank a top road speed of 47 kilometers per hour. These advantages are very helpful for mobile combat.





M4中型坦克还拥有几项世界领先技术。首先炮塔转动装置是二战最快的，转动一周只需要不足10秒钟，这使得谢尔曼在近距离坦克战中能够快速反应，迅速射击从而击毁对手。

The M4 medium tank also boasts several world-leading technologies. First of all, the turret rotation device was the fastest in World War II, taking less than 10 seconds to rotate in a cycle, which allowed Sherman to react quickly in close tank combat and shoot quickly to destroy opponents.

第二次世界大战中的机械化决战,因为拥有M4中型坦克是进行“钢铁较量”的入场券。

Mechanized decisive battles in World War II, because the possession of the M4 medium tank is the ticket to the "steel battle".

M4中型坦克的总产量达到49234辆, M-4谢尔曼系列中型坦克创造了西方战车生产史上的奇迹,在欧洲大陆进行的坦克战中, M4坦克发挥了重大的作用。

The total production of M4 medium tanks reached 49234 units, the M-4 Sherman series of medium tanks created a miracle in the history of Western tank production, and the M4 tank played a significant role in the tank battles fought on the European continent.



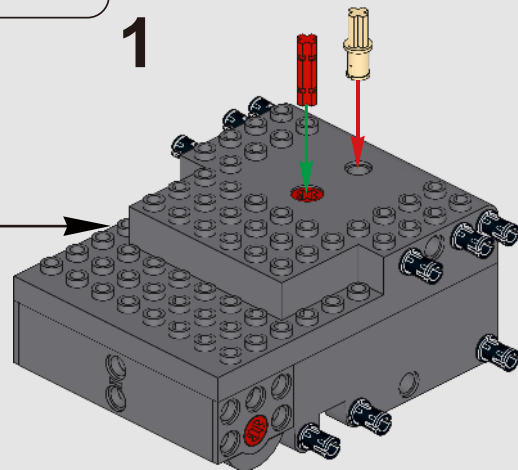
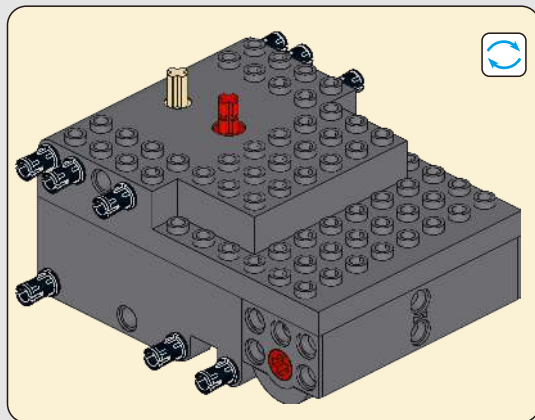
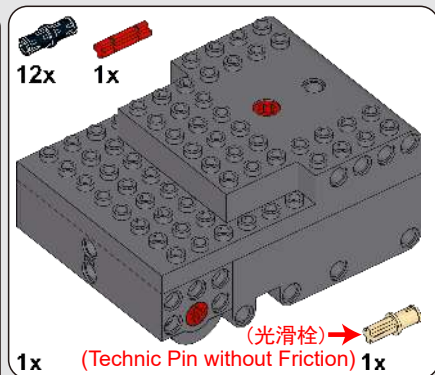
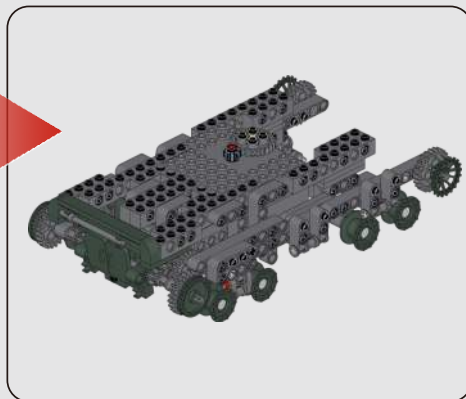
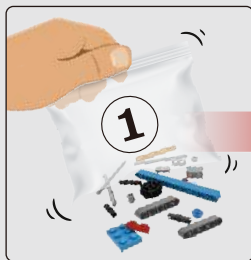

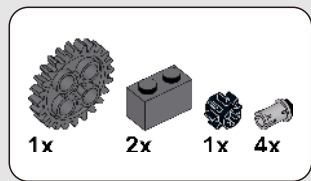

2

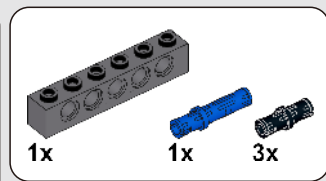
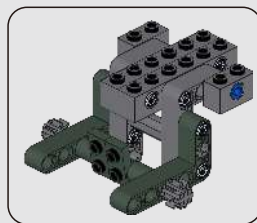
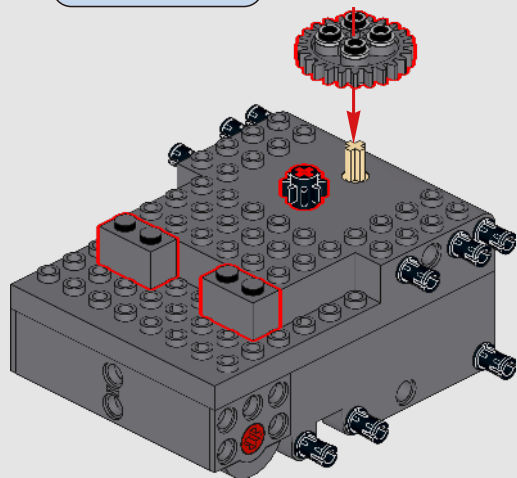
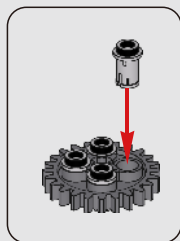

3

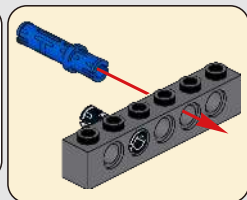
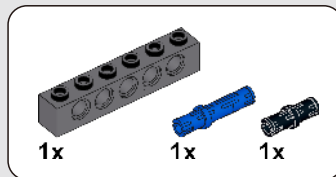
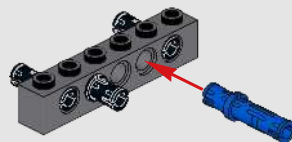

4

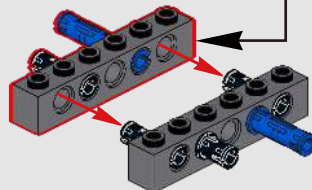

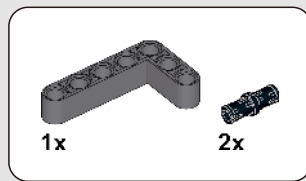

5

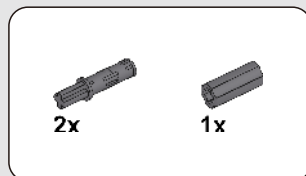
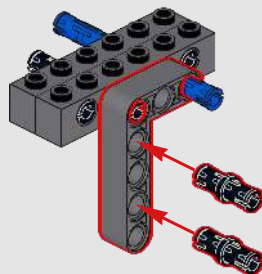

6

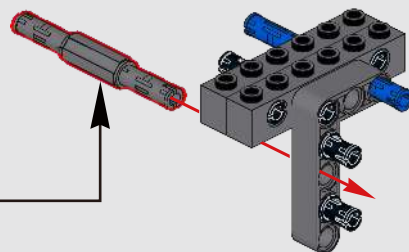
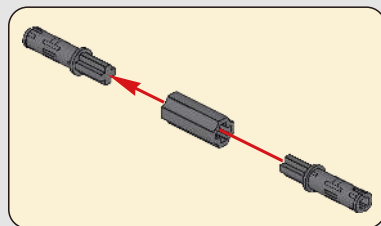

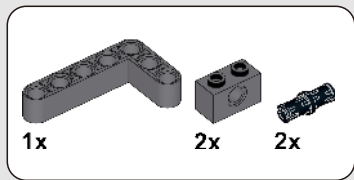

7

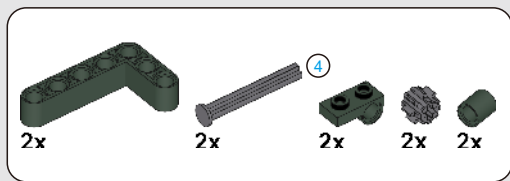
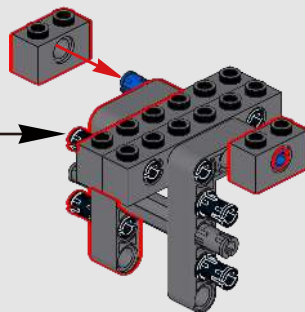
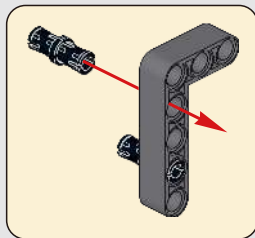

8

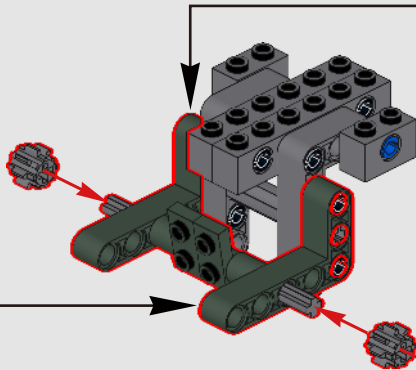
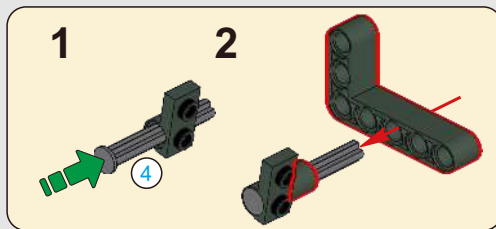
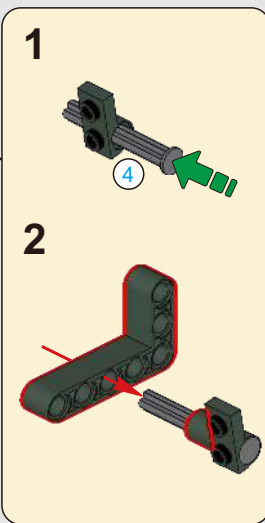
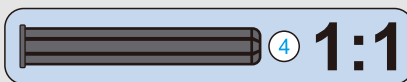

9

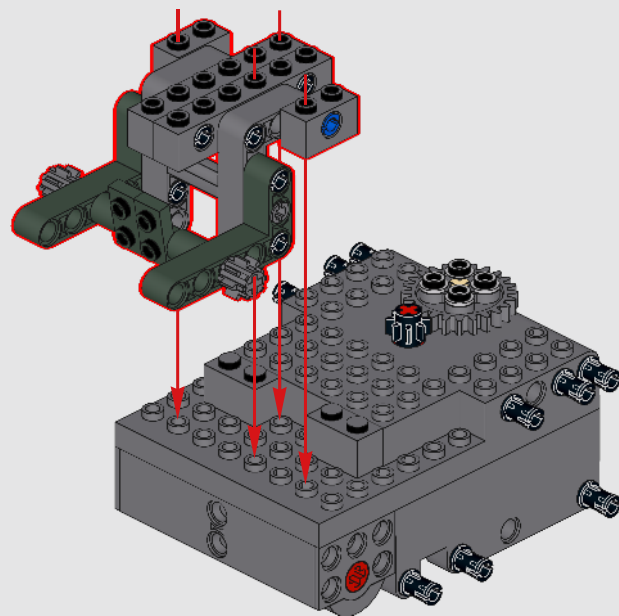

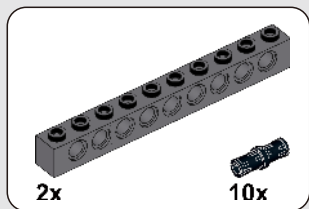

10

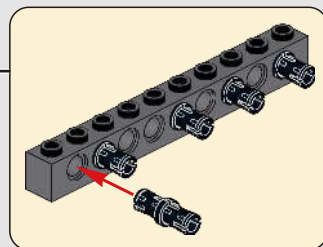
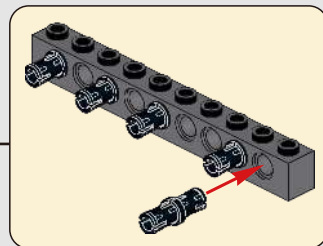
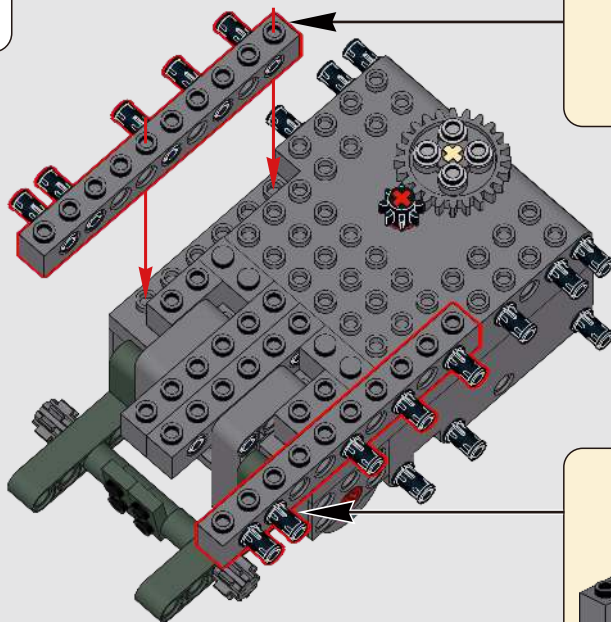

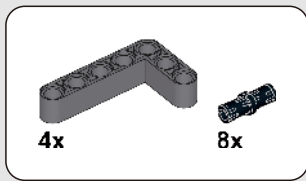

11

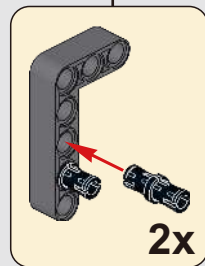
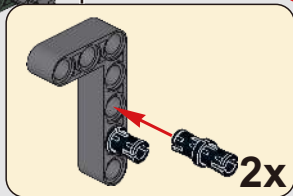
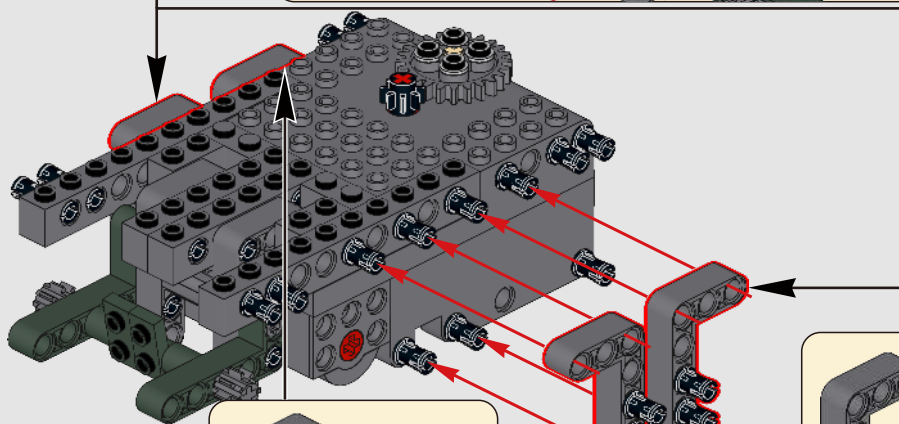
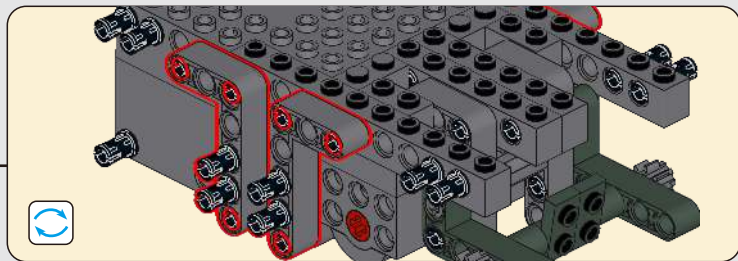

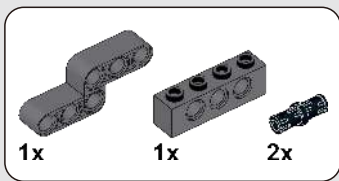
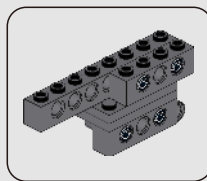

12

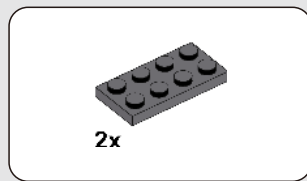

13

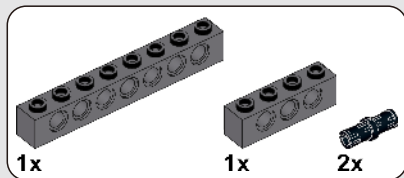
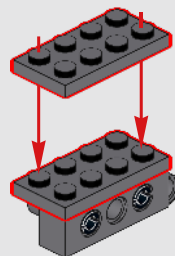
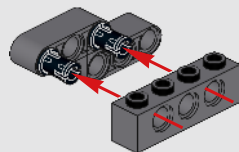

14

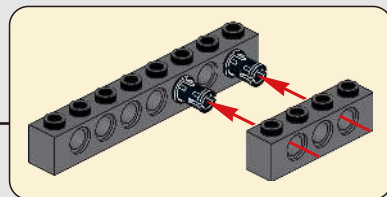
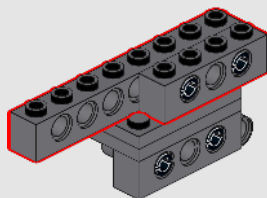

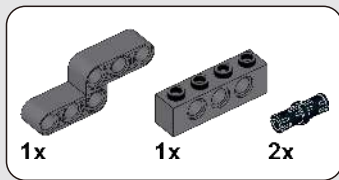
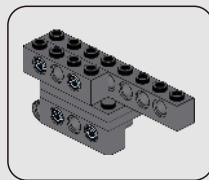

15

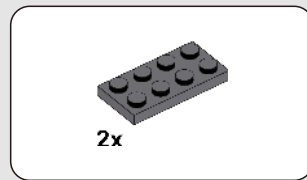
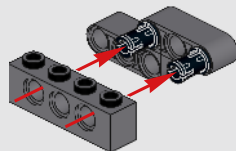

16

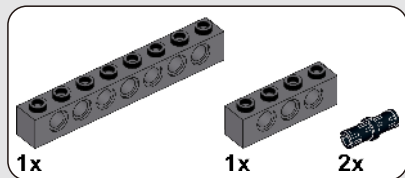
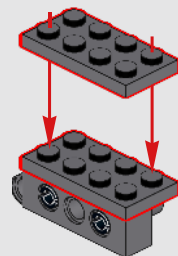

17

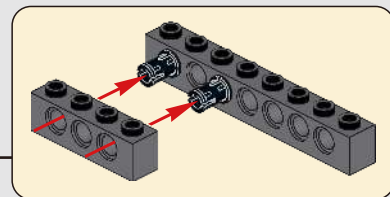
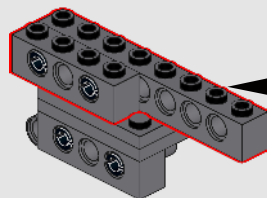

18

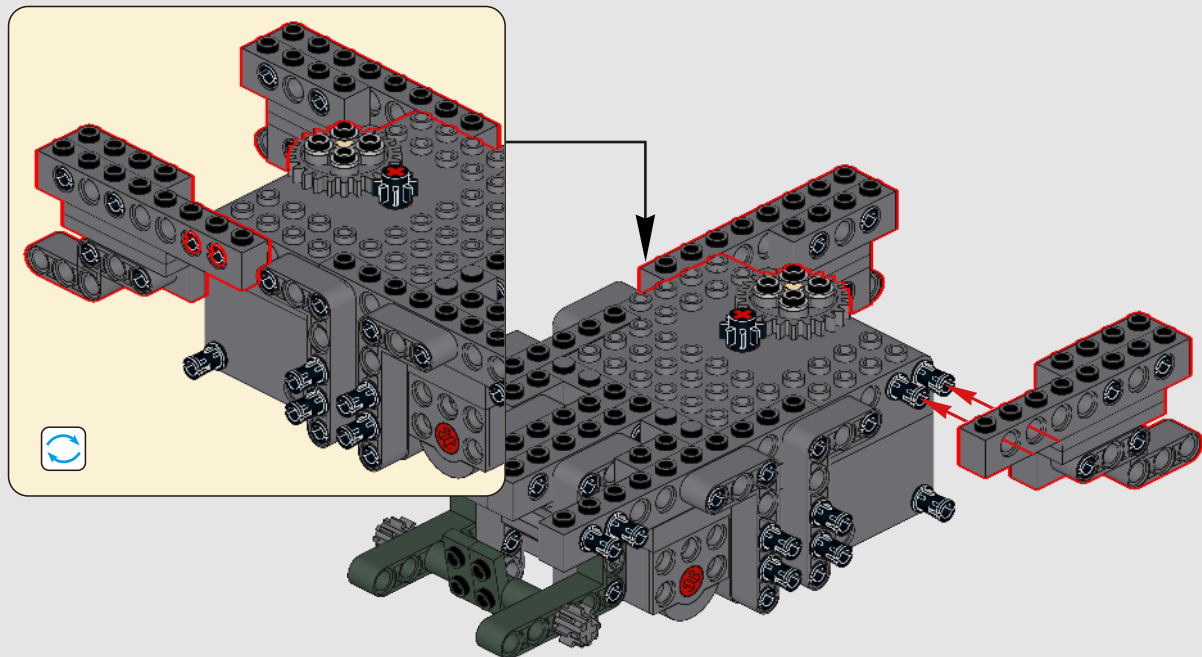

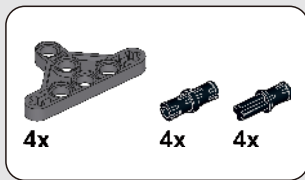

19

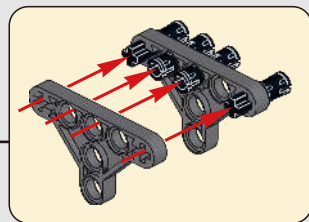
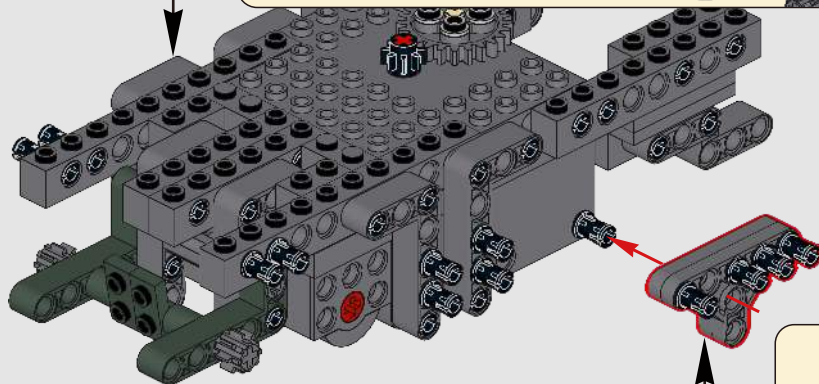
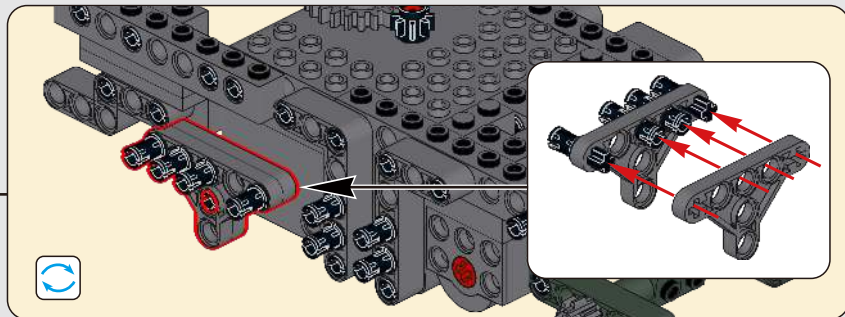

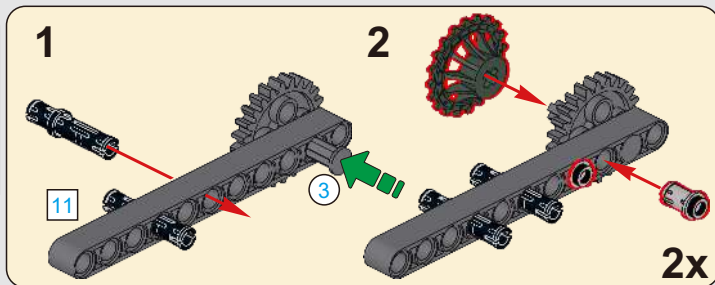
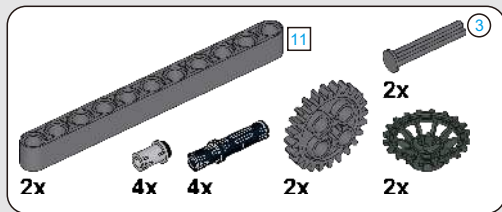

20

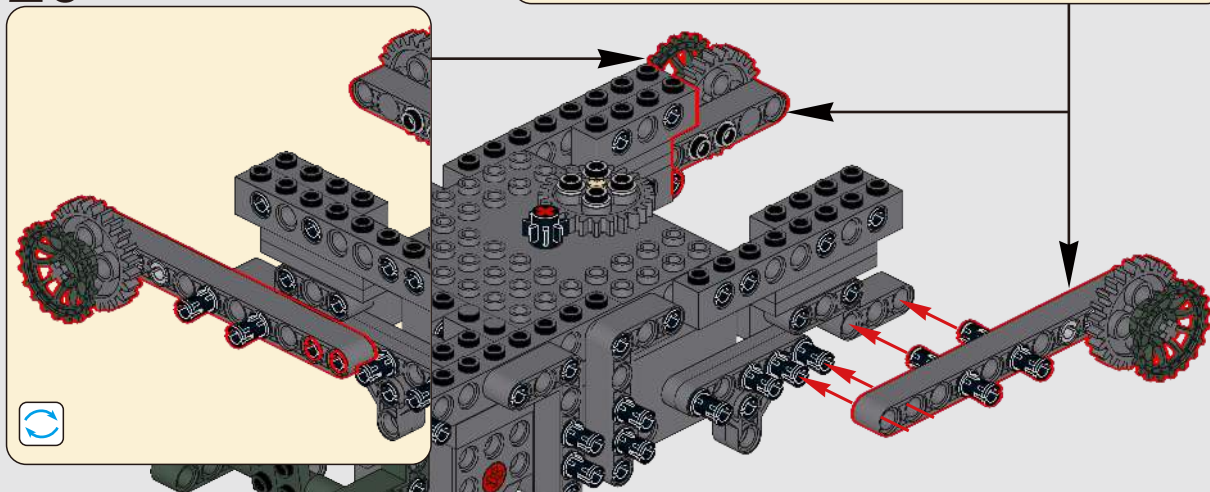

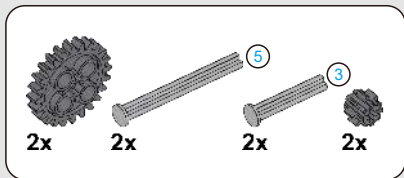
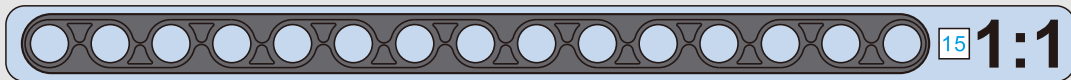
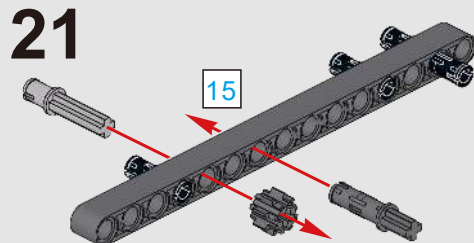
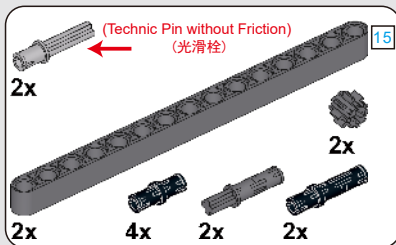
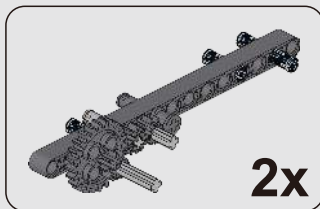

22

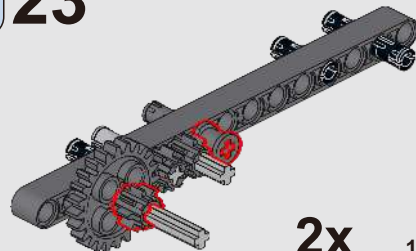
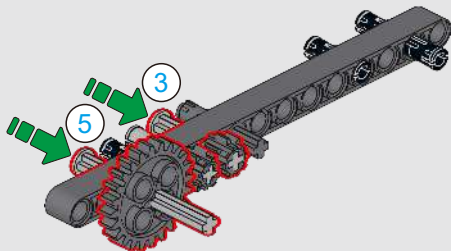
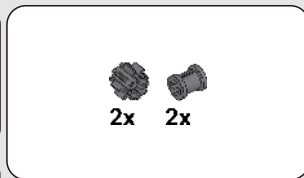
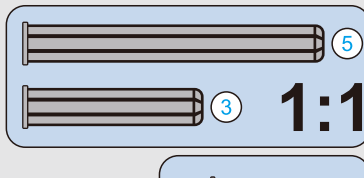



2x

24

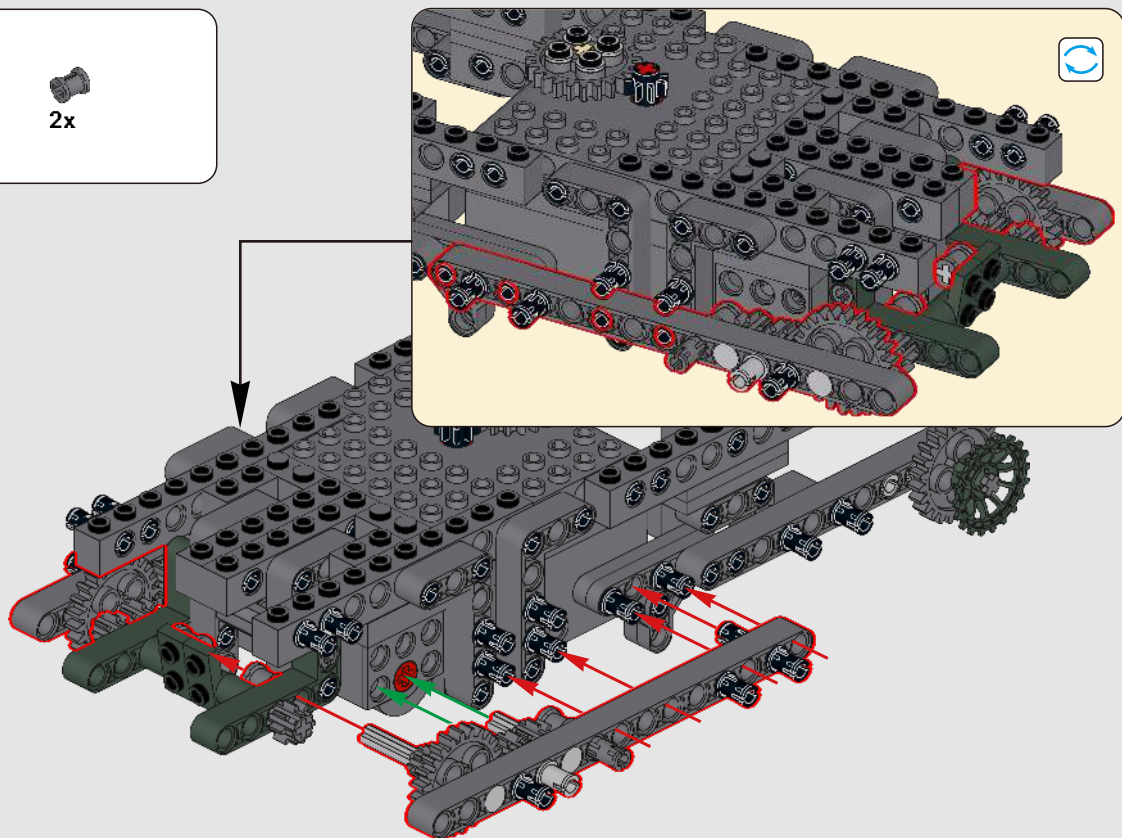

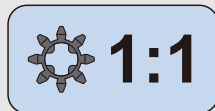
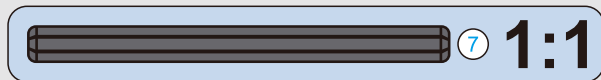
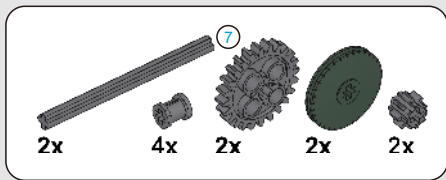

25

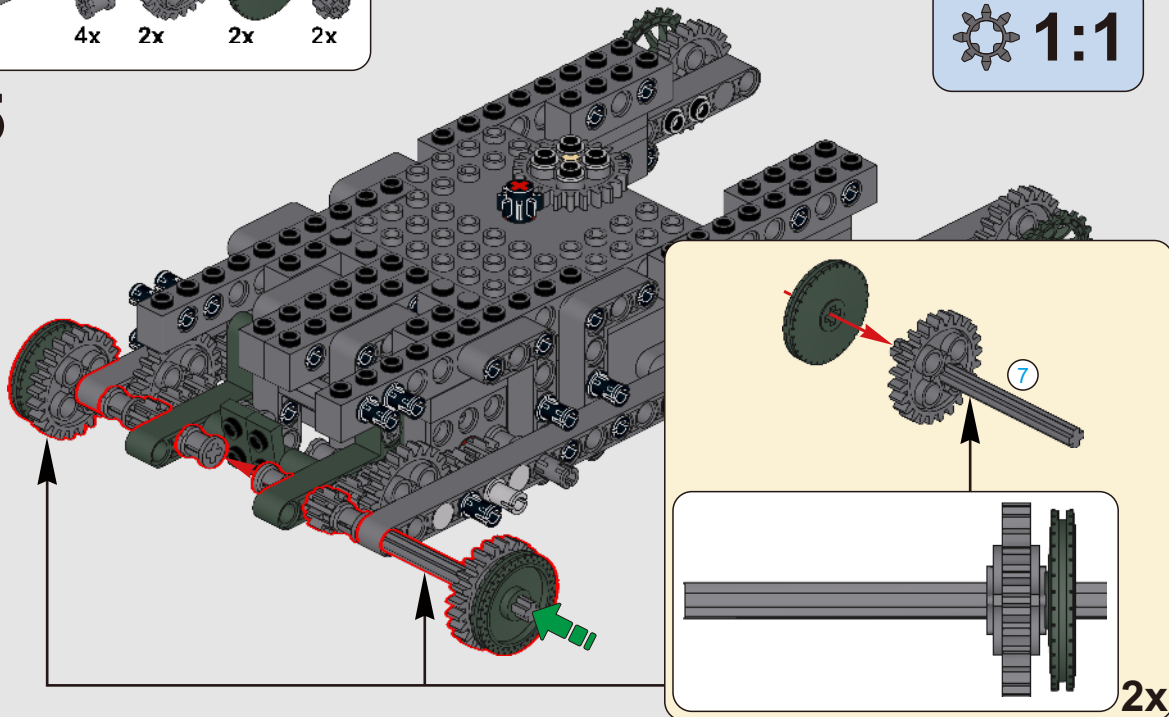

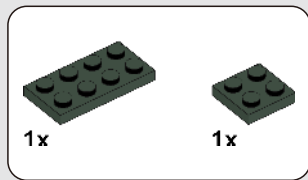
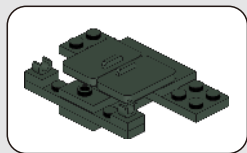

26

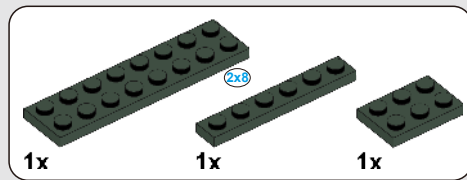
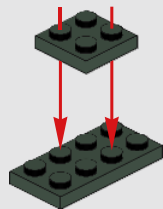

27

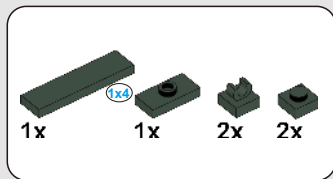
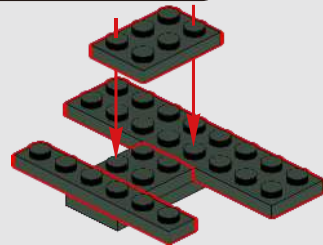

28

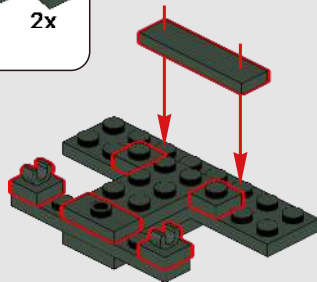

29

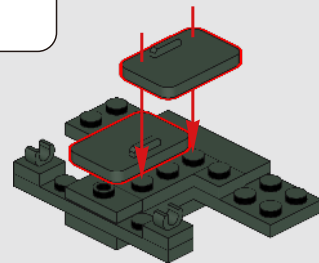

30

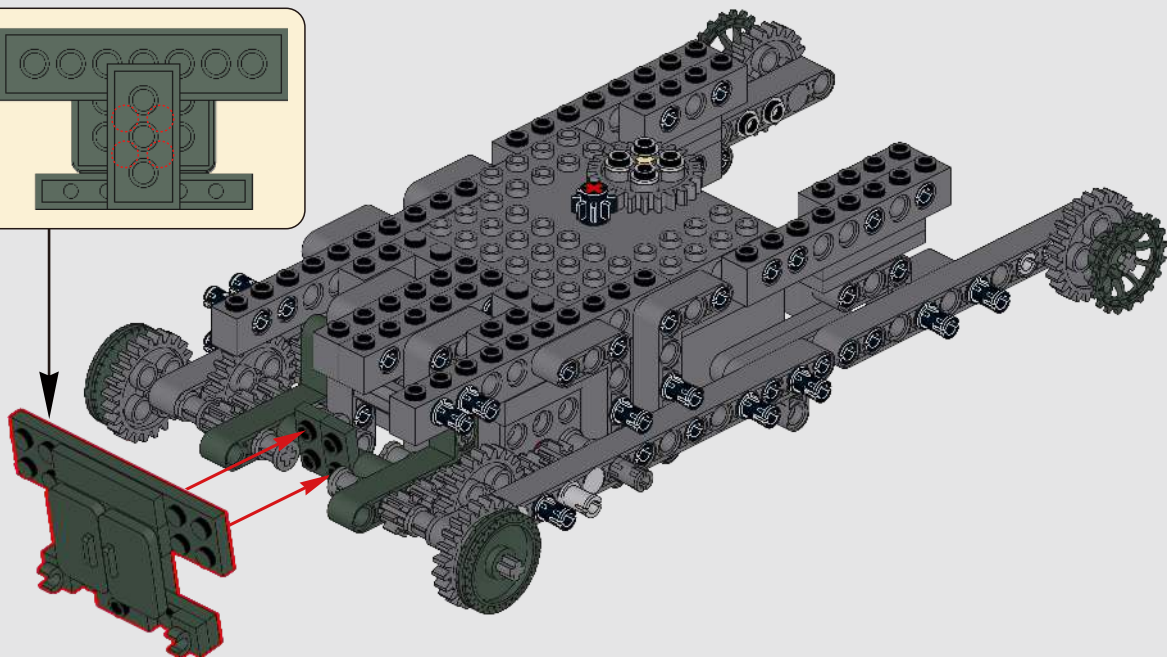
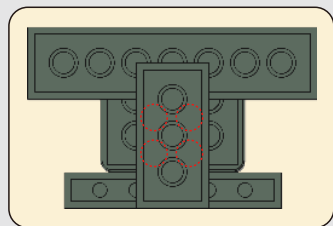

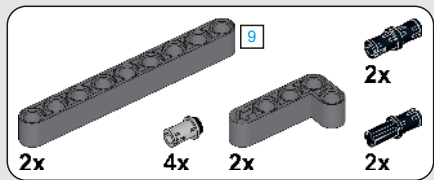

31

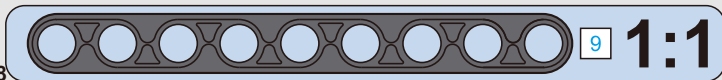
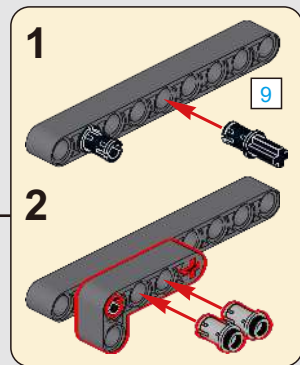
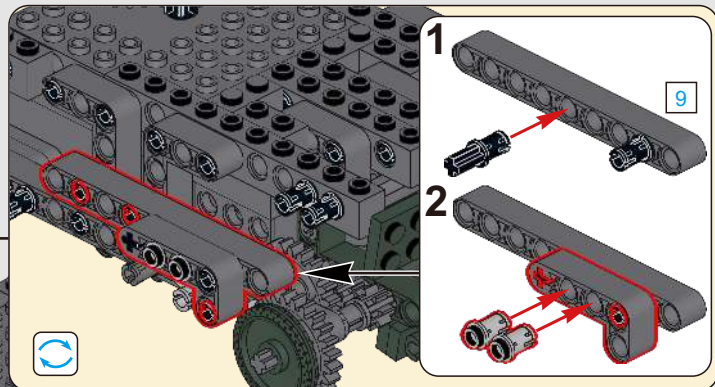
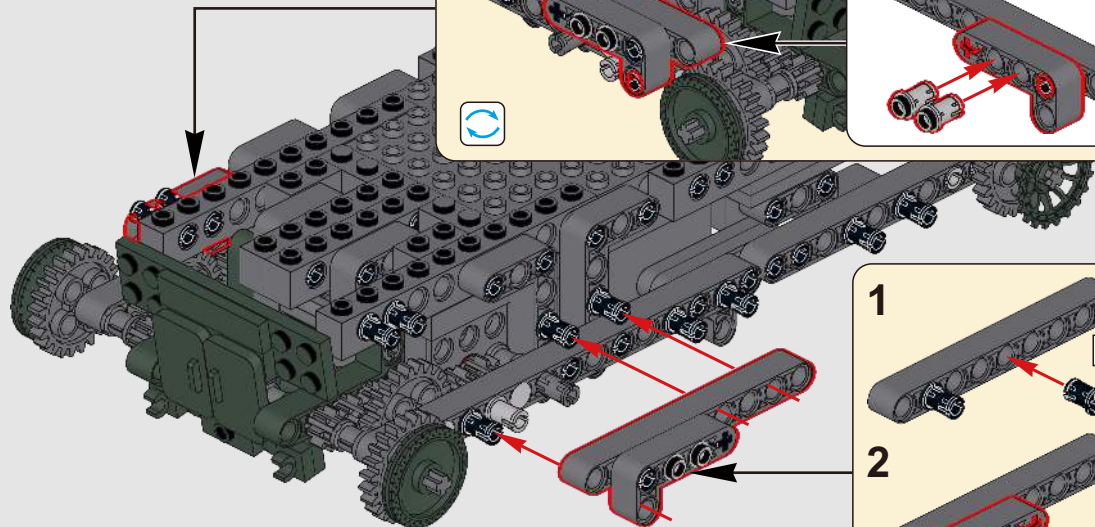

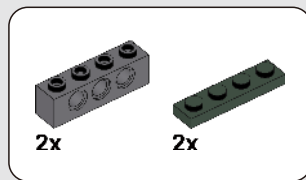

32

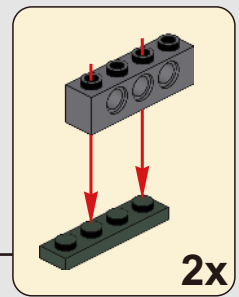
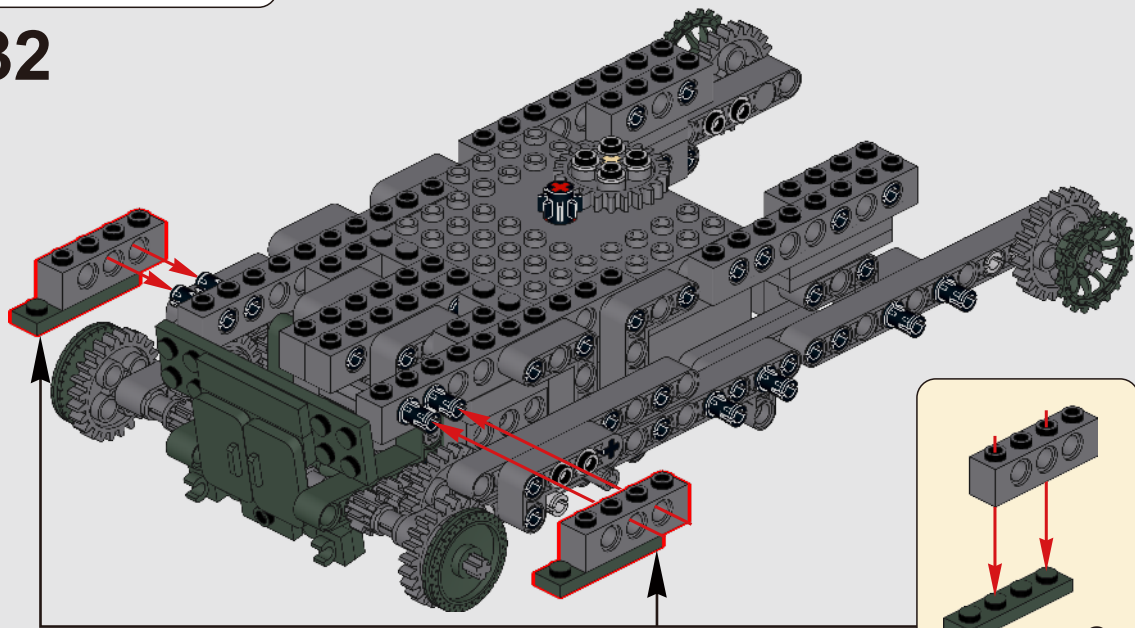

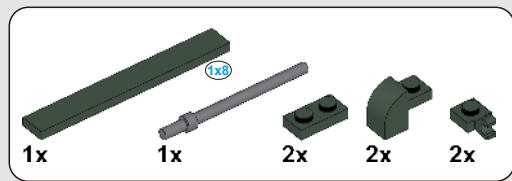

33

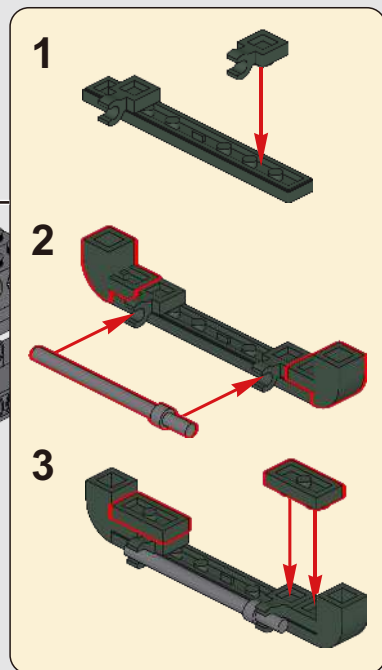
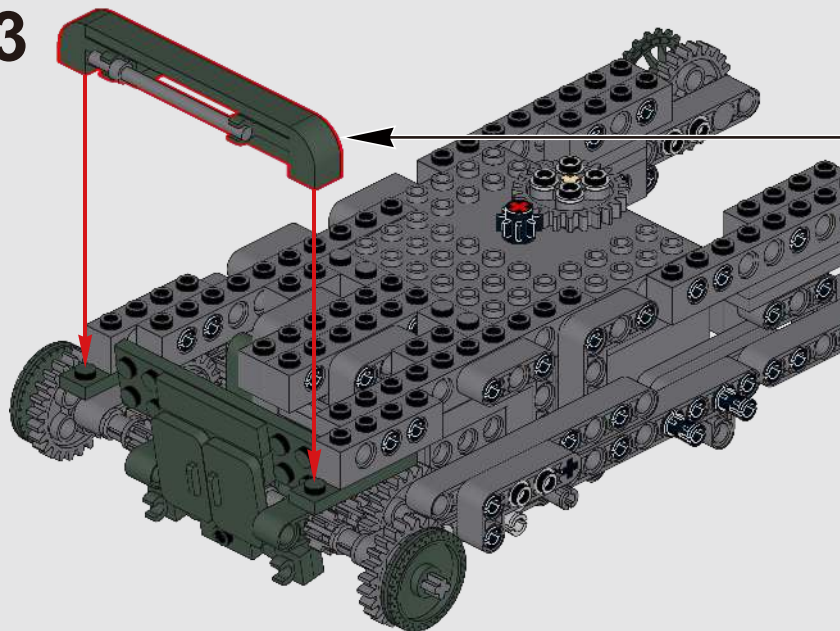

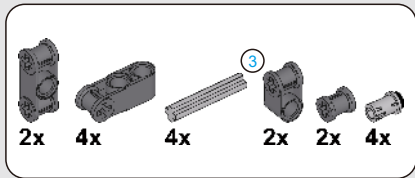

34

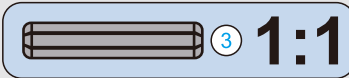
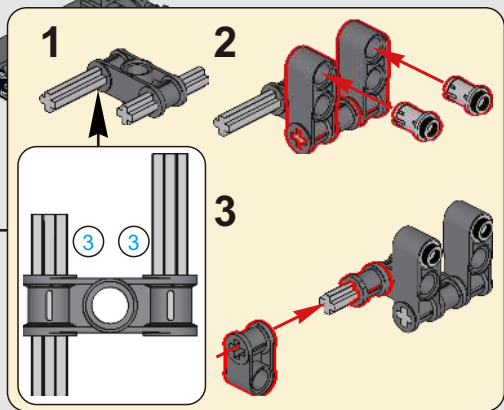
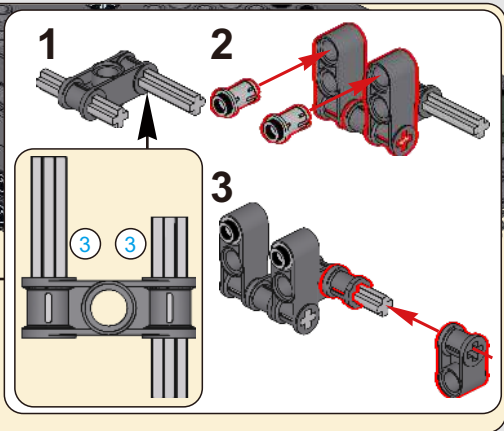
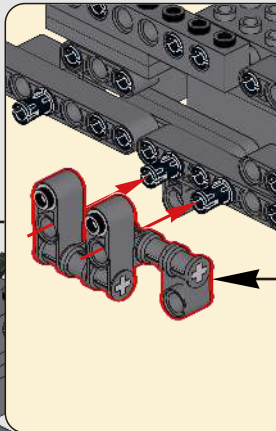
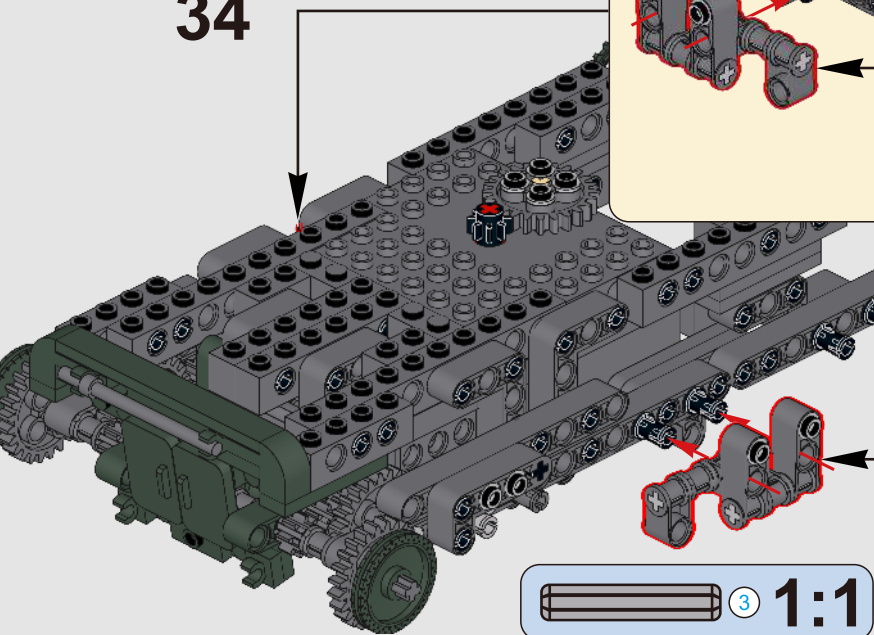

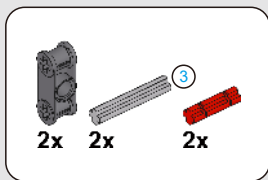
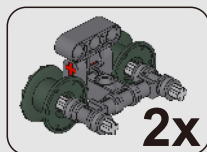

35

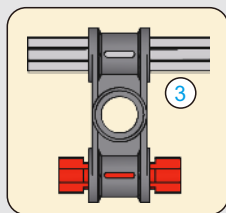
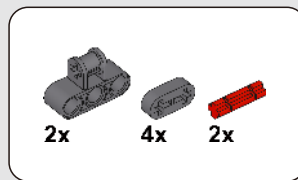

36

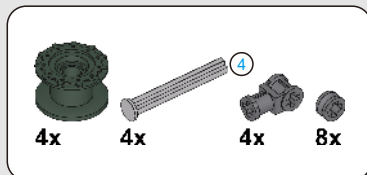
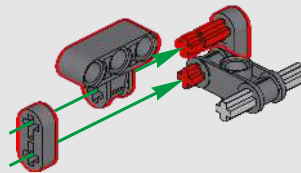
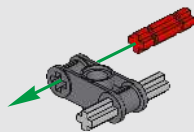

37

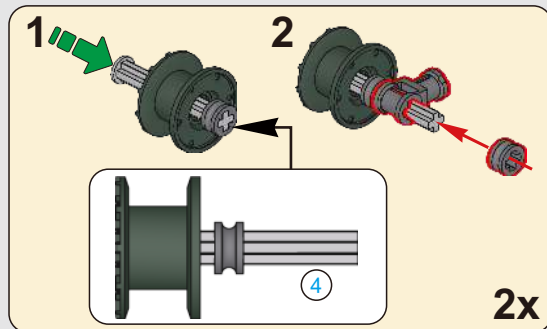
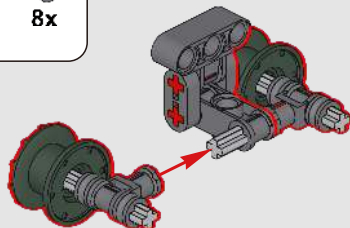

38

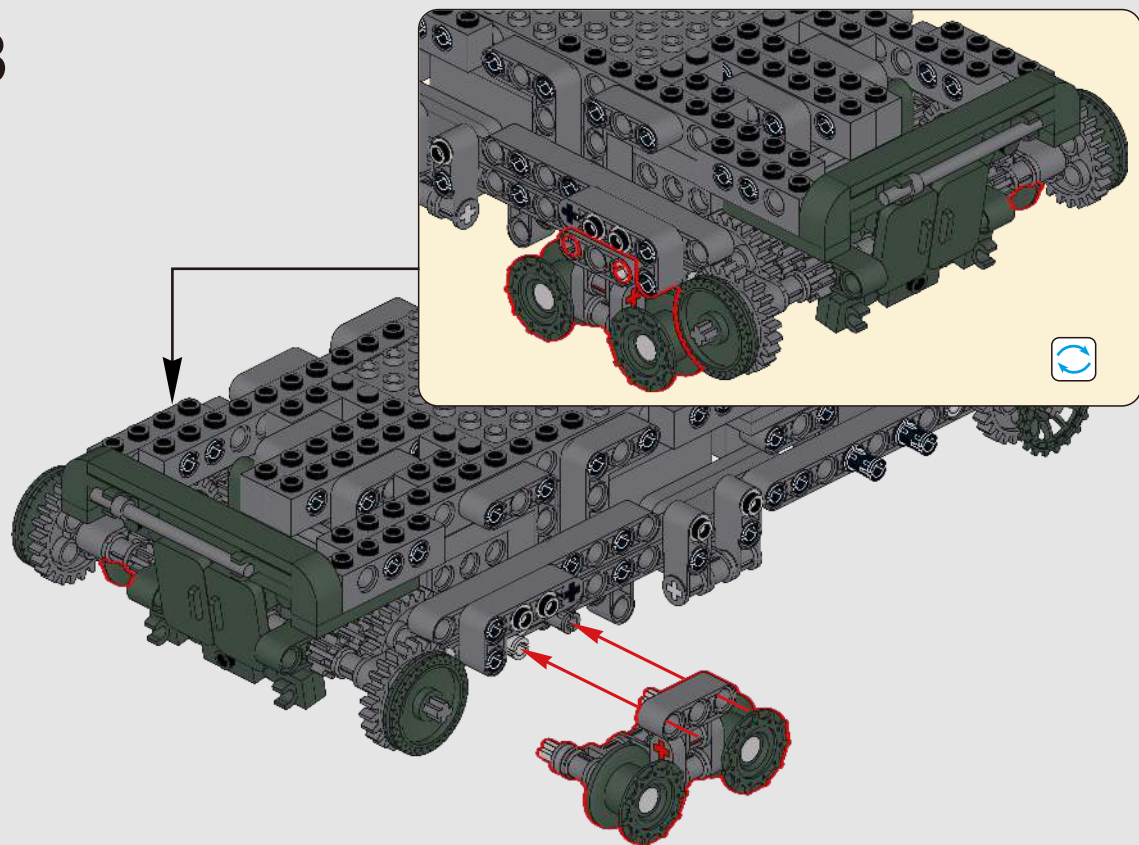

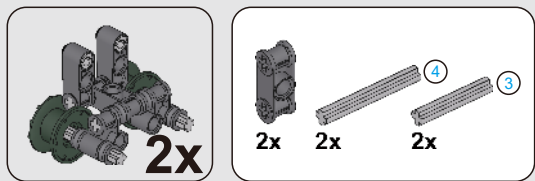

39

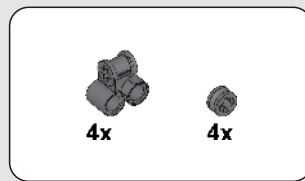

40

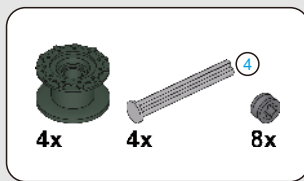
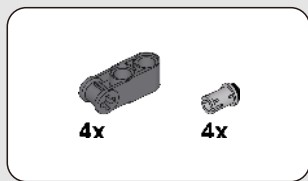
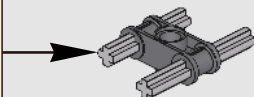
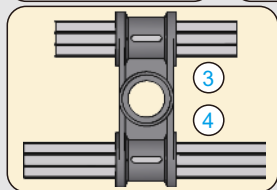
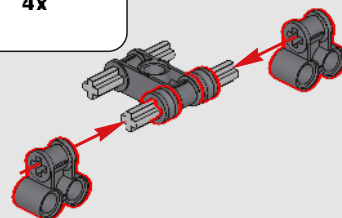

42

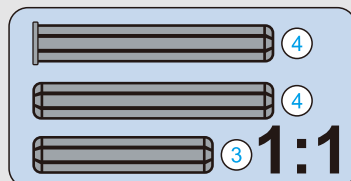

41

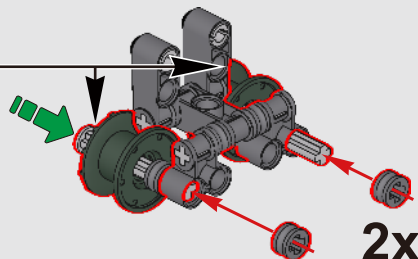
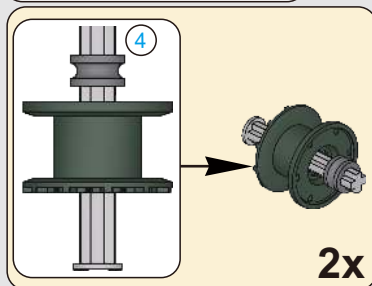
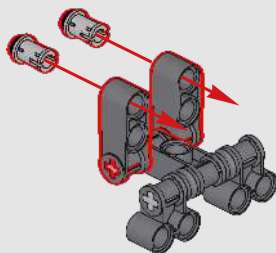

43

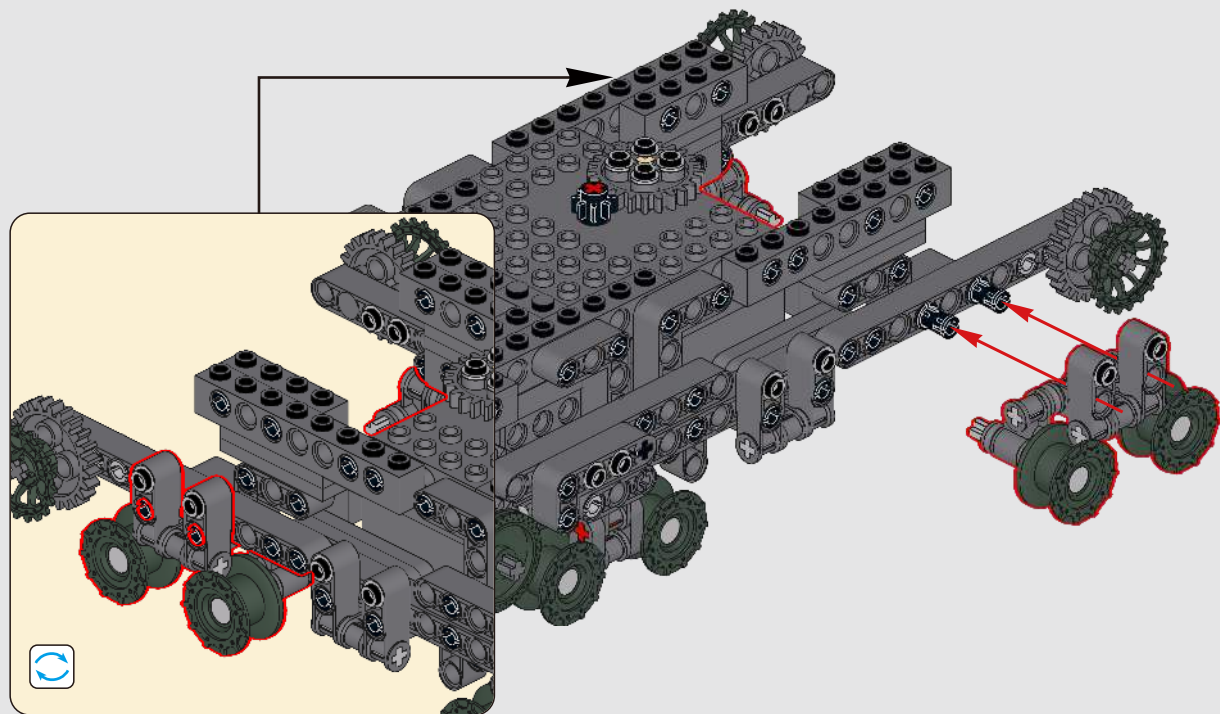

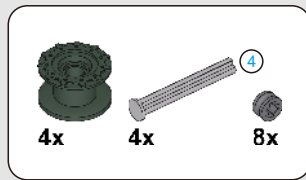
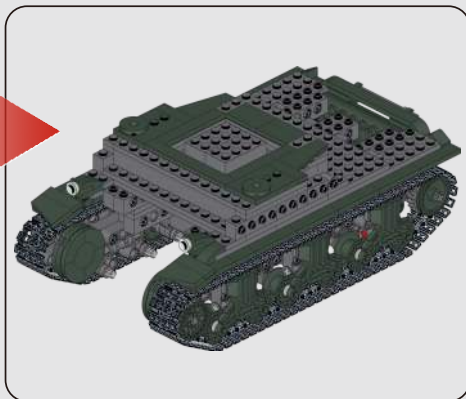
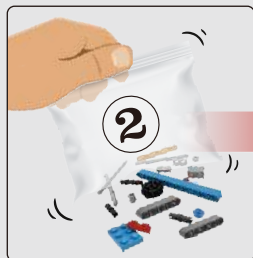

44

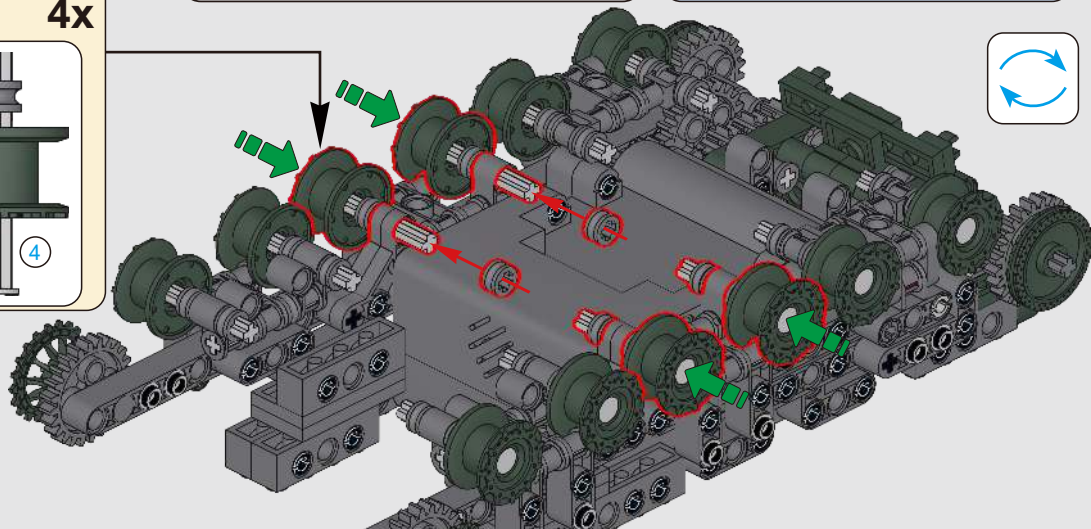
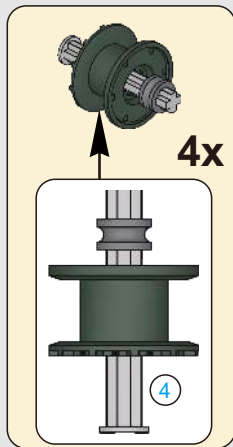
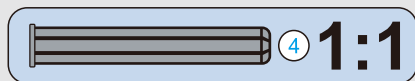

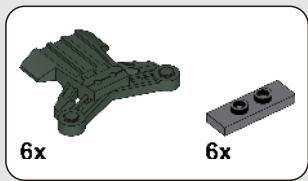

45

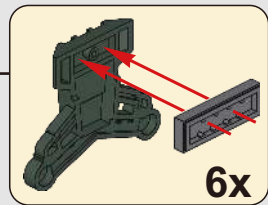
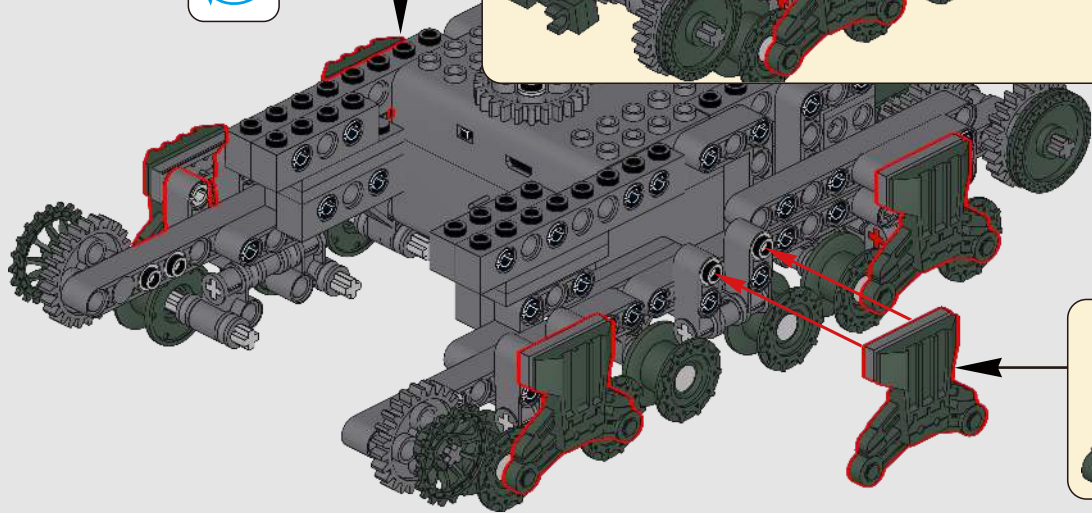
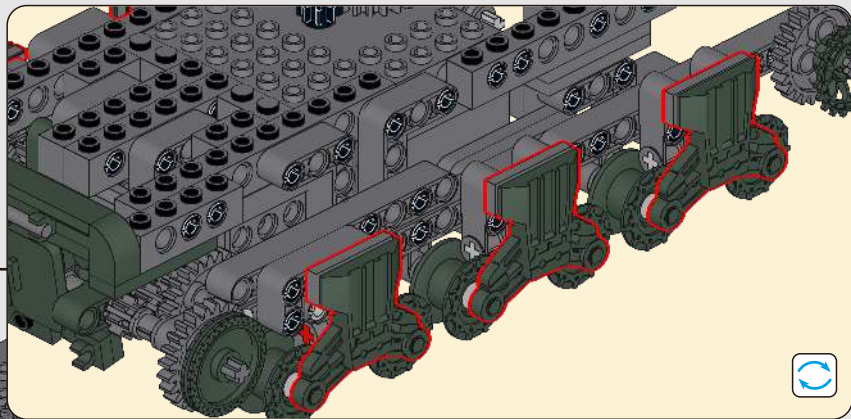

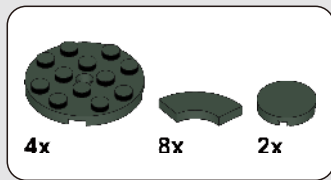

46

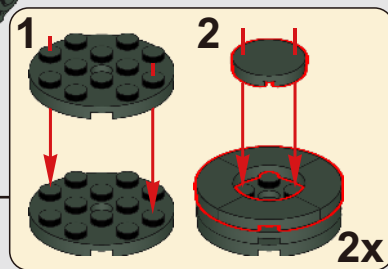
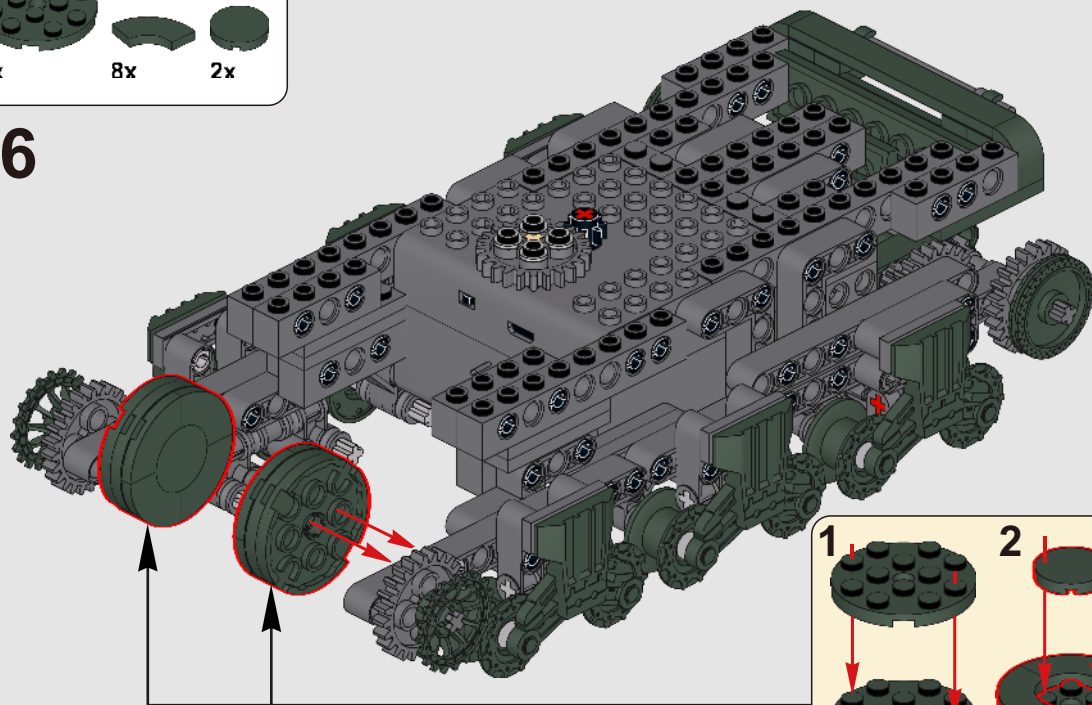

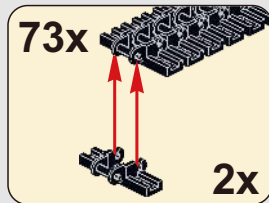

47

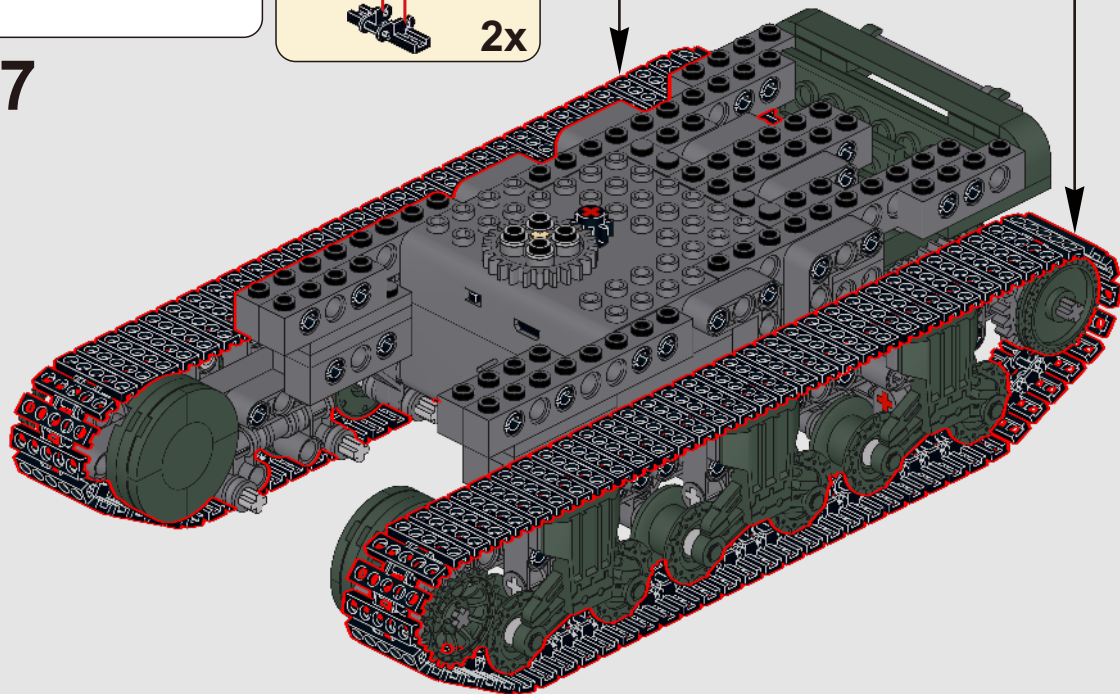

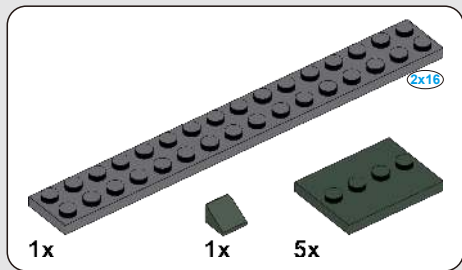
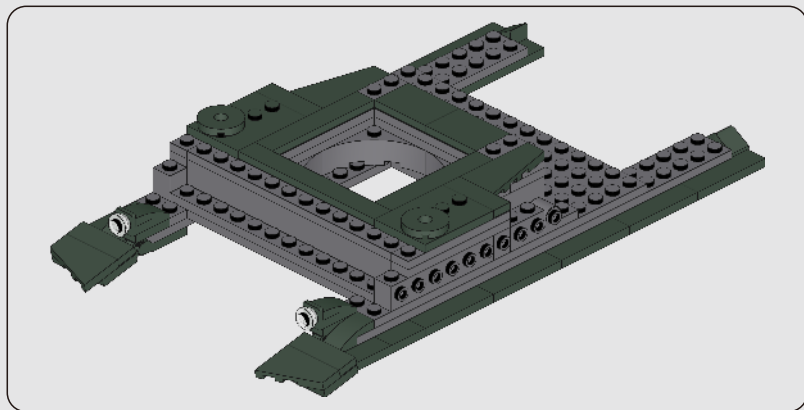

48

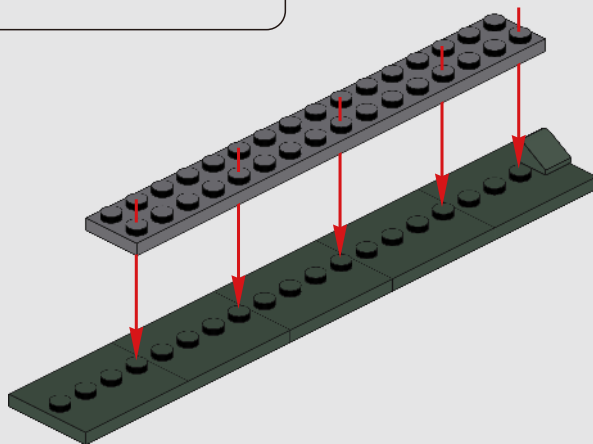

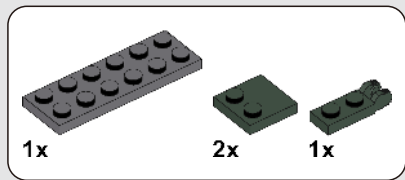

49

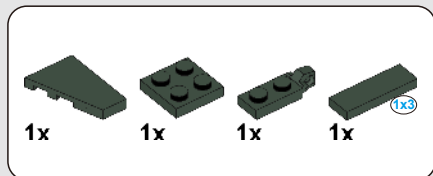
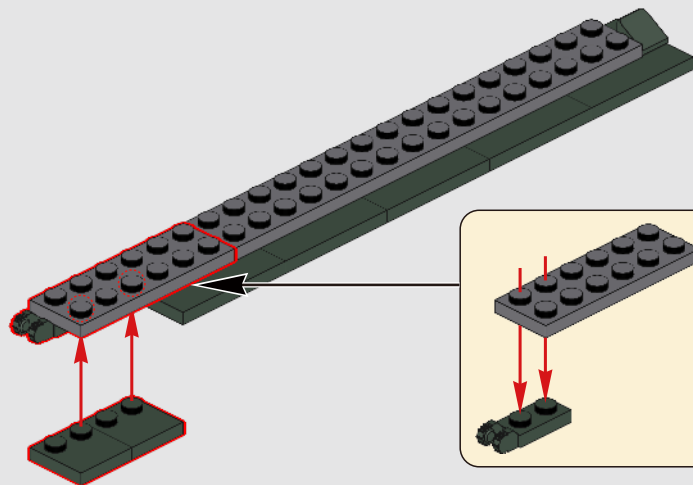

50

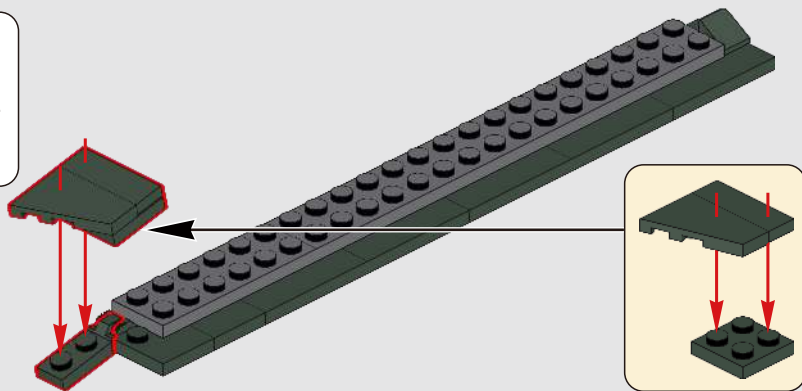

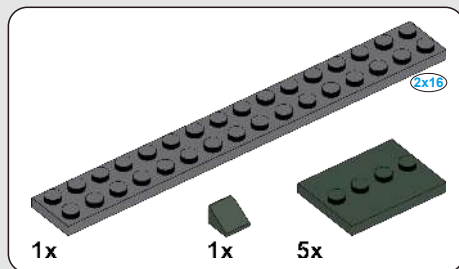
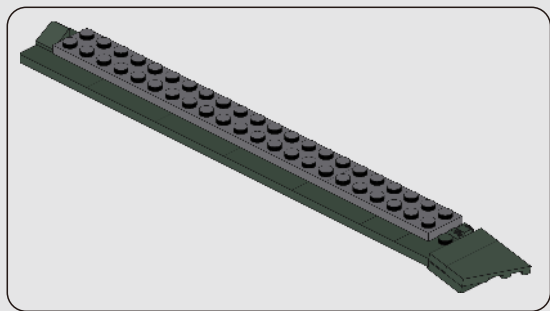

51

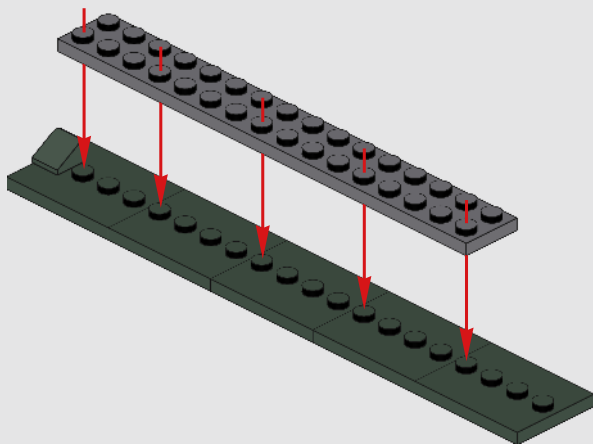

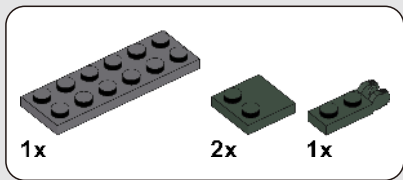

52

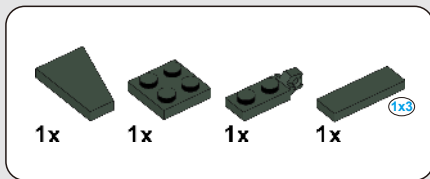
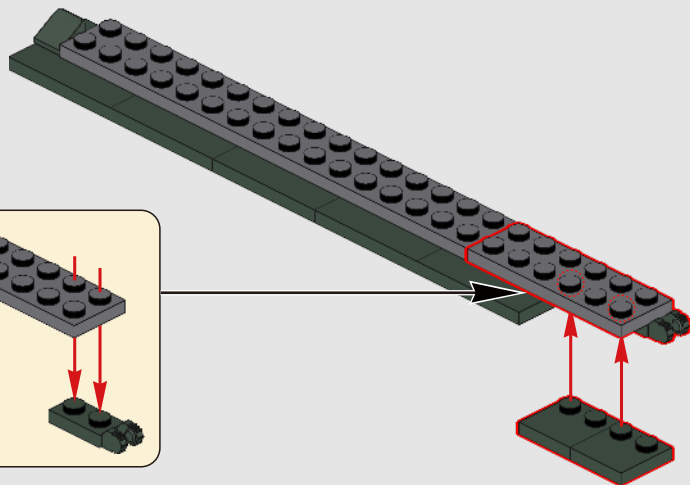
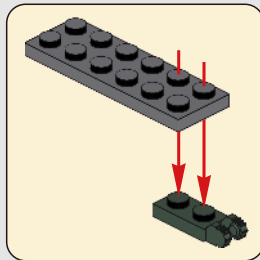

53

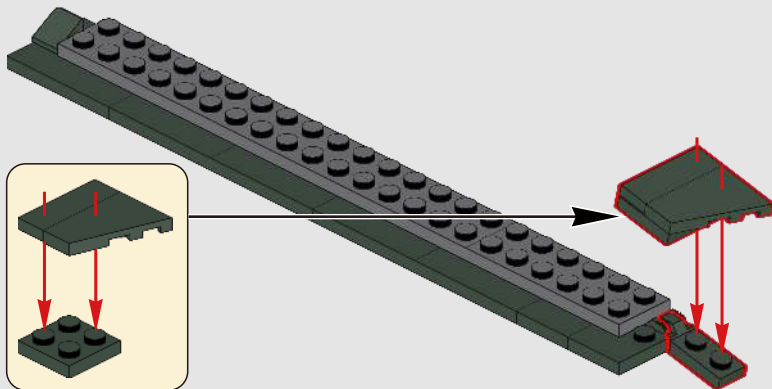
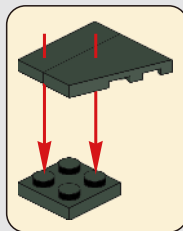

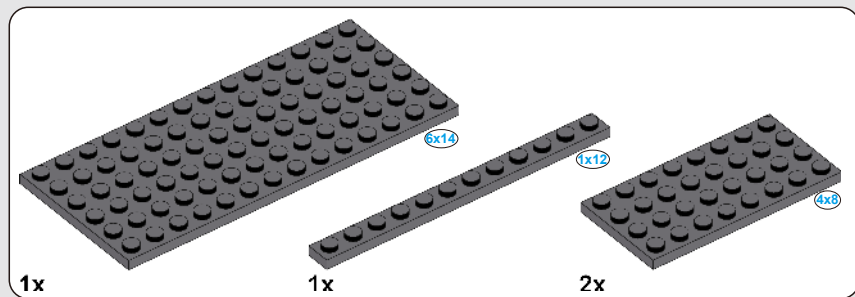

54

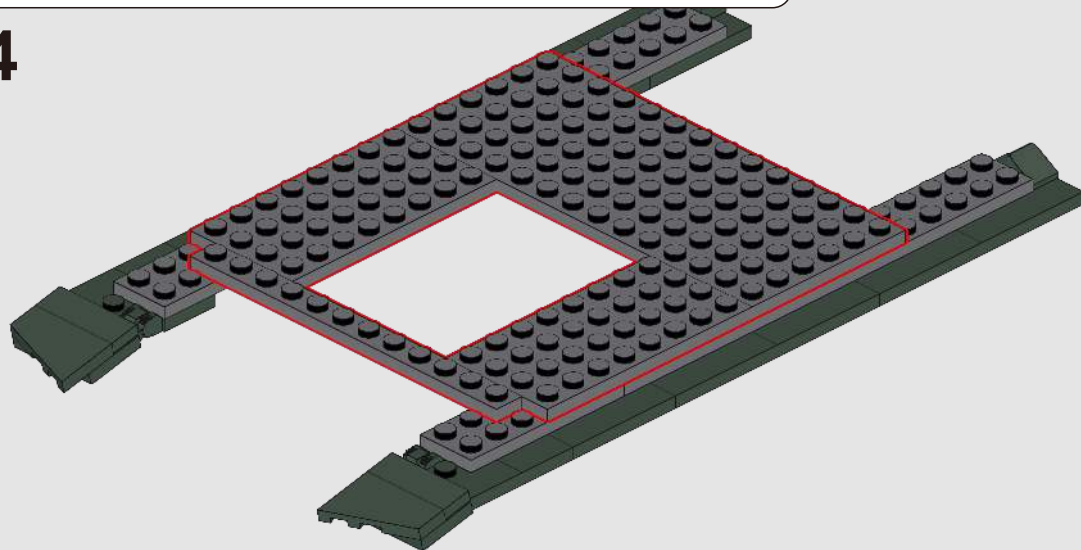

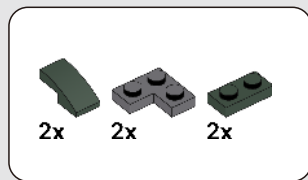

55

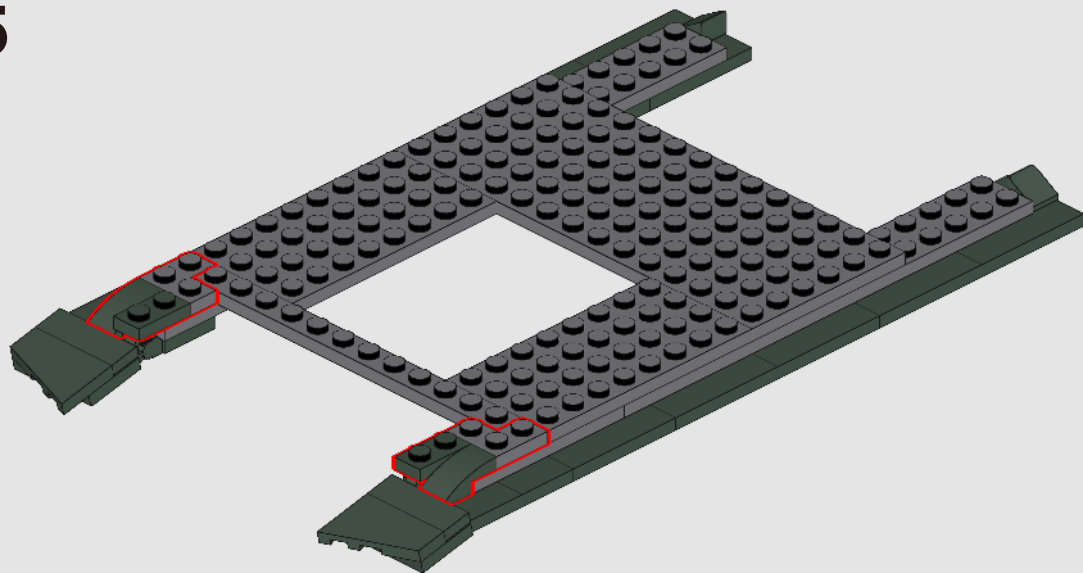

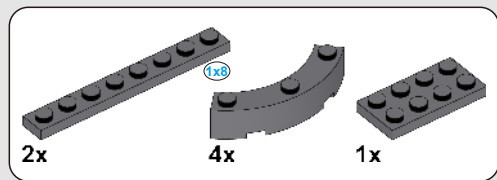

56

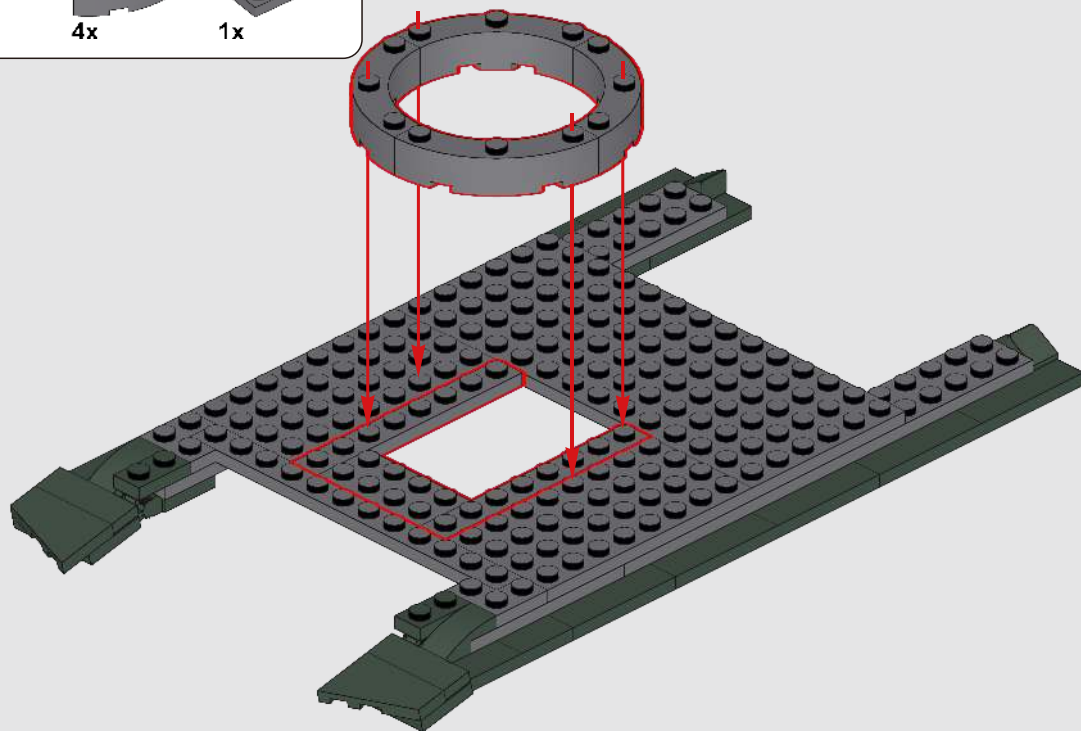

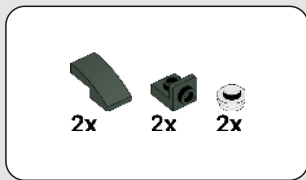

57

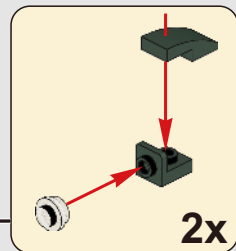
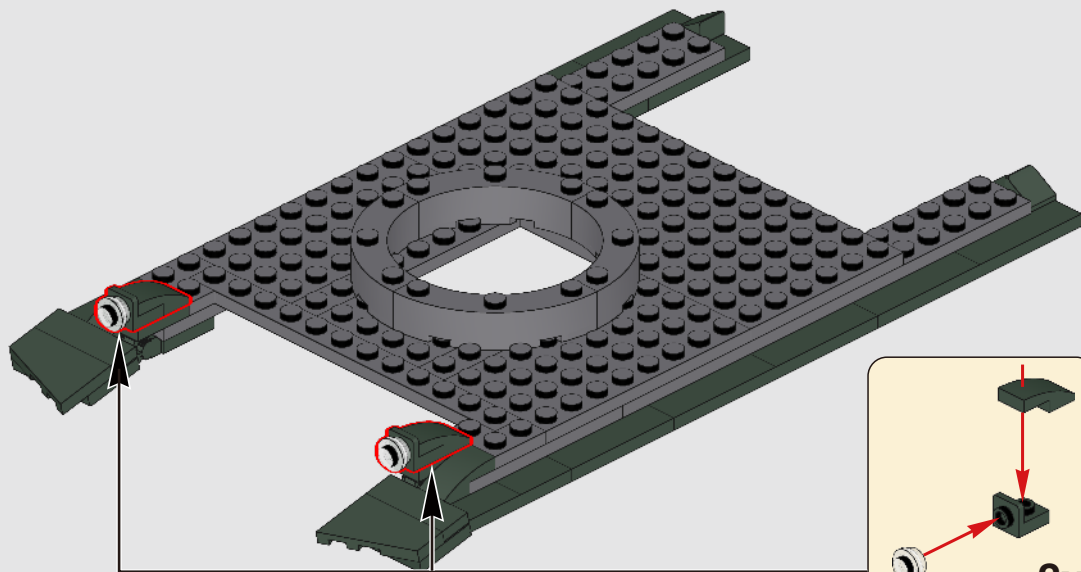

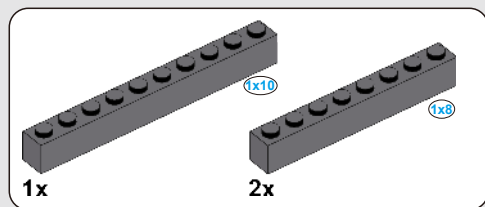

58

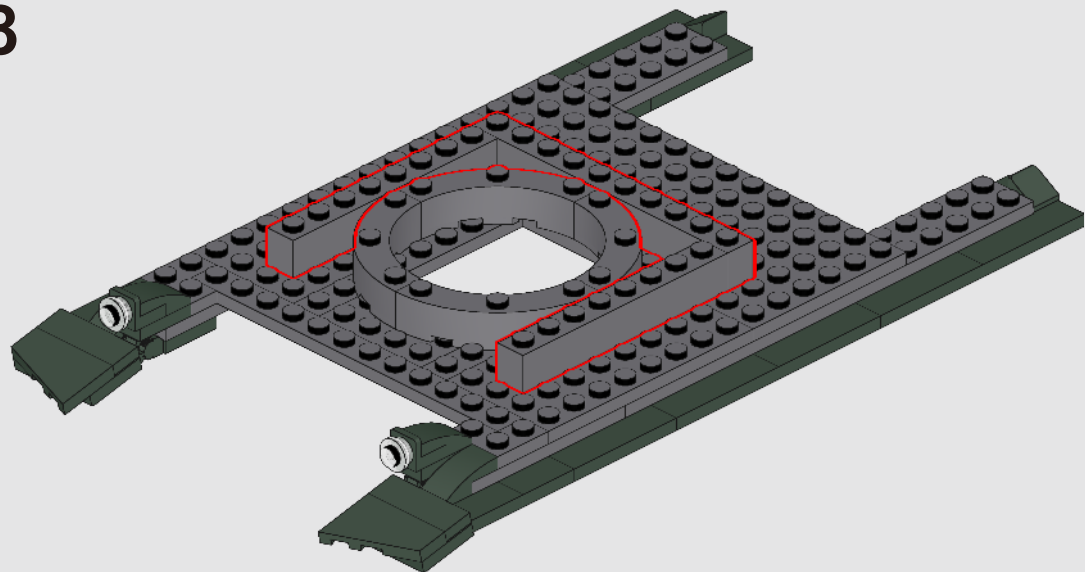

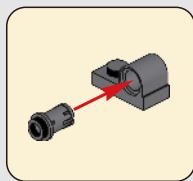
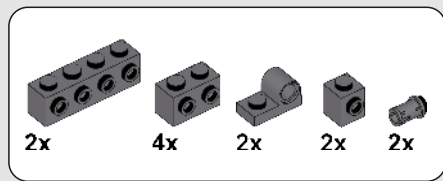

59

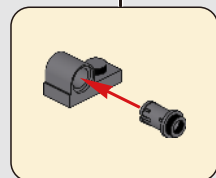
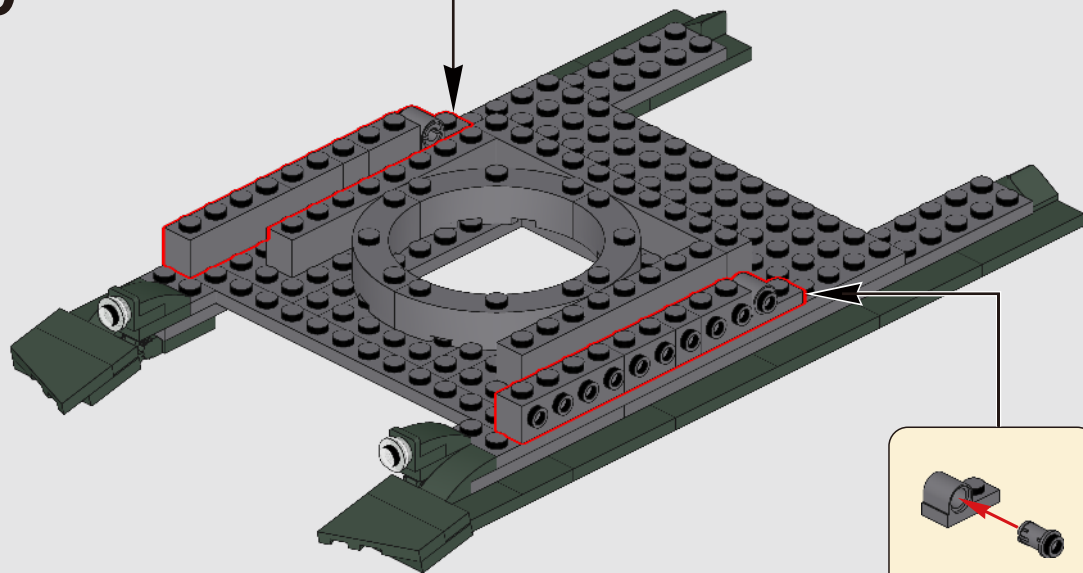

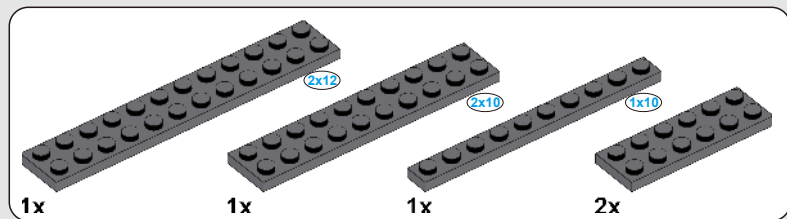

60

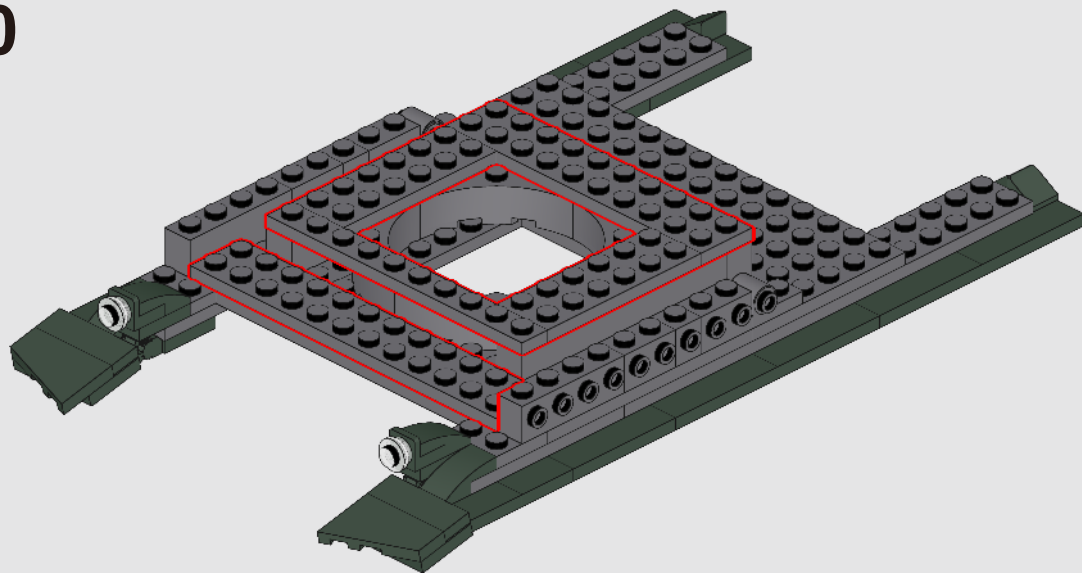

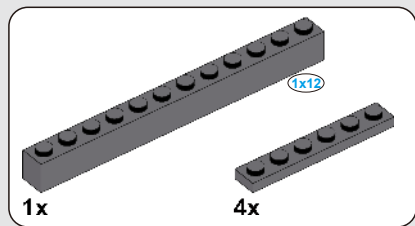

61

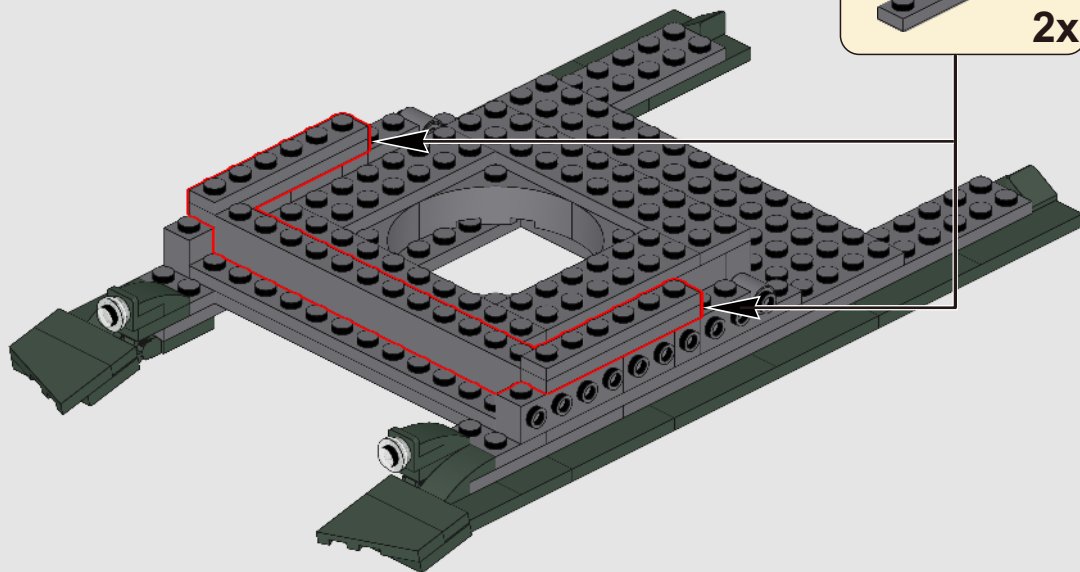
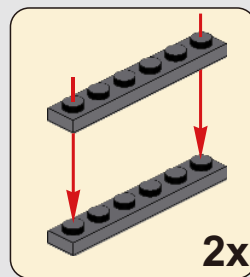

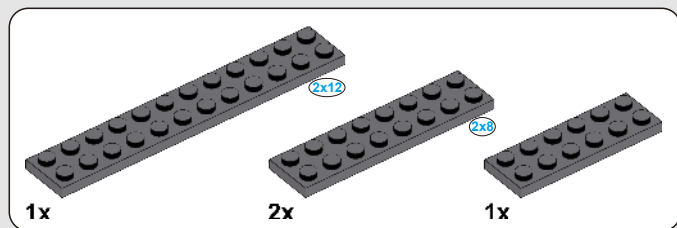

62

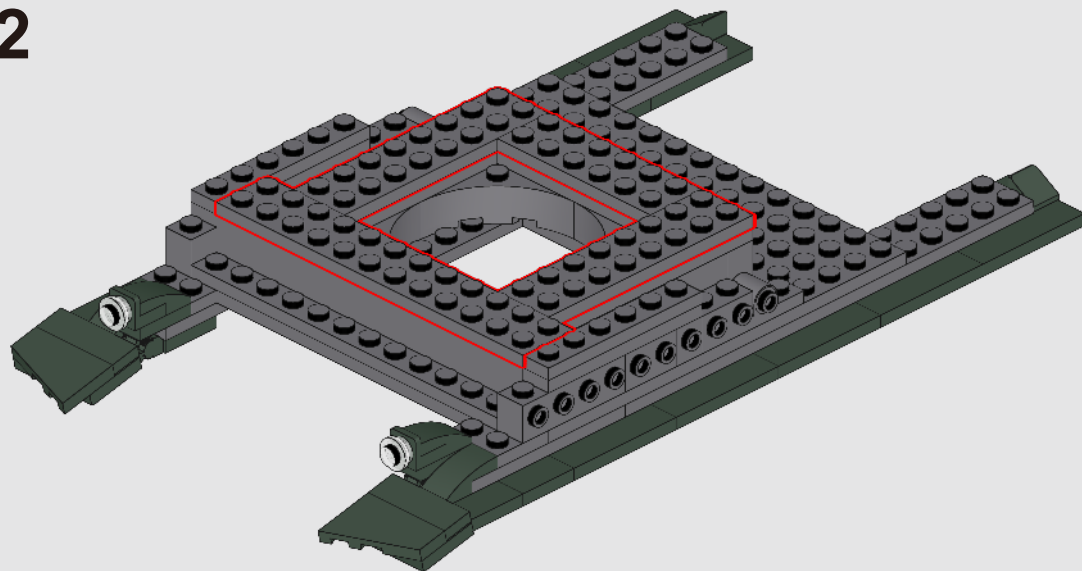

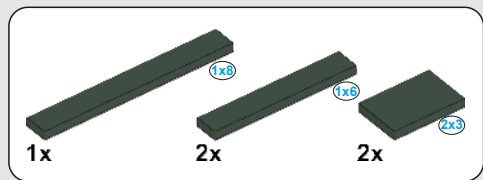

63

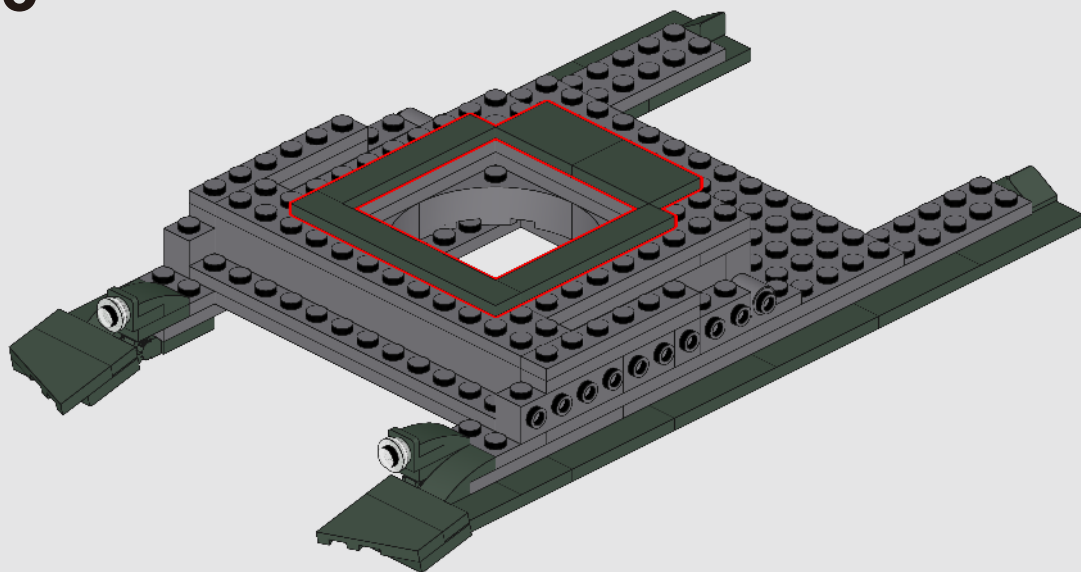

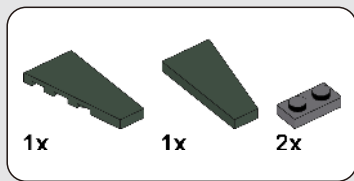

64

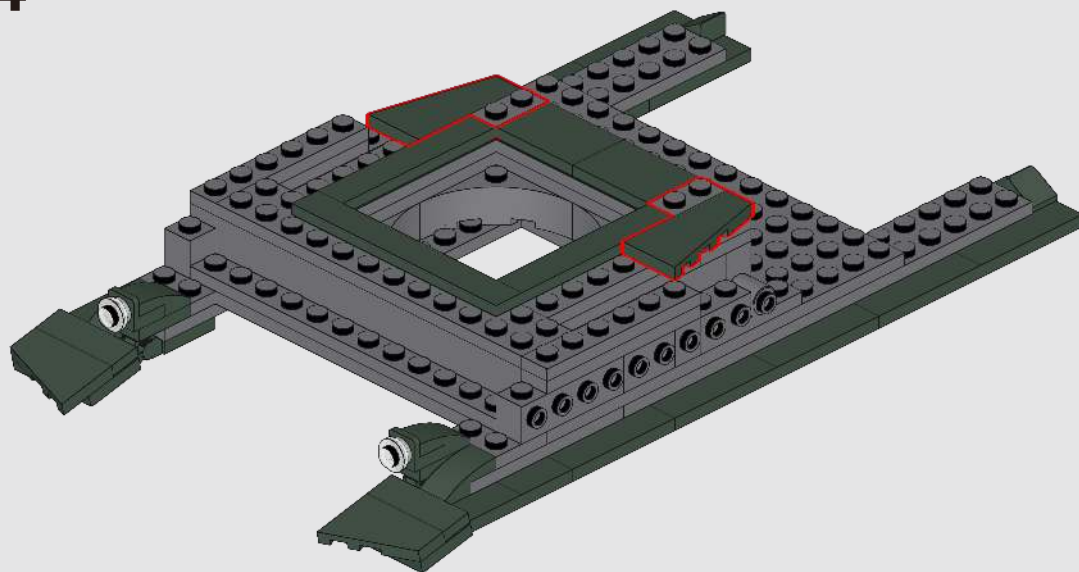

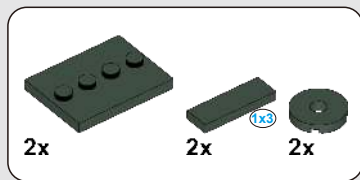

65

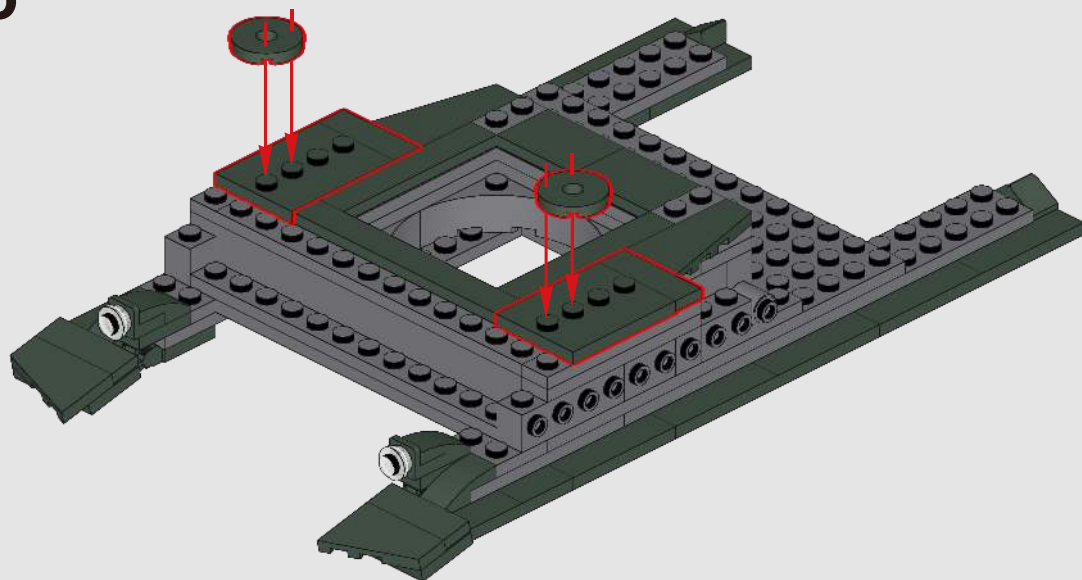

66

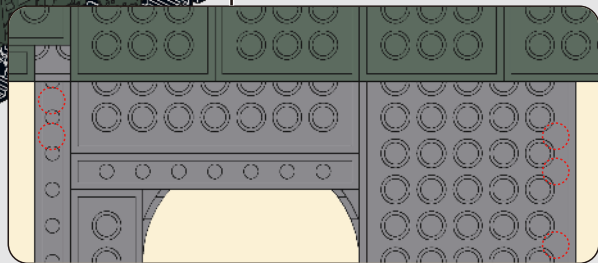
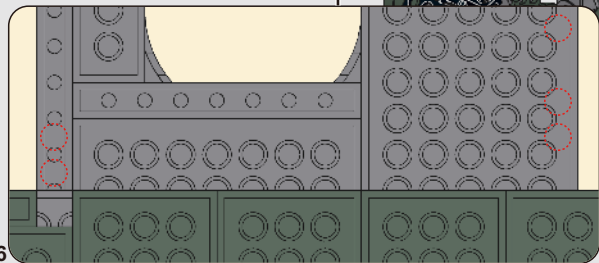
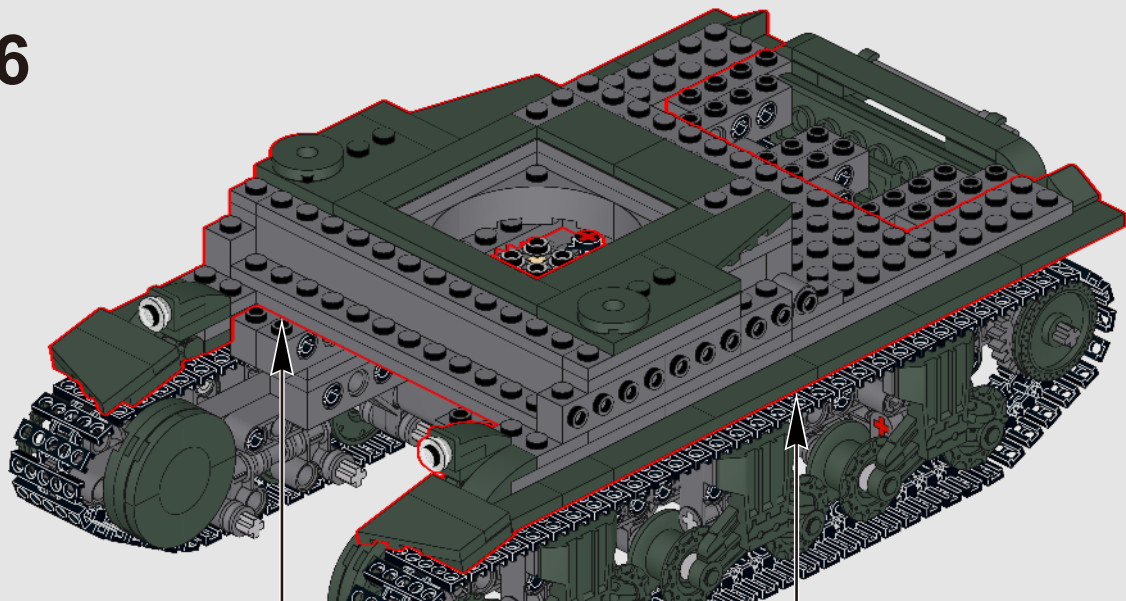

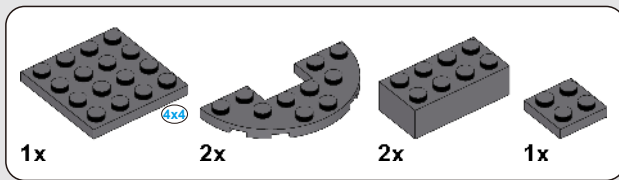

67

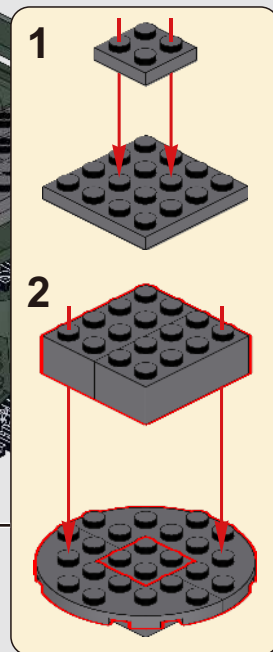
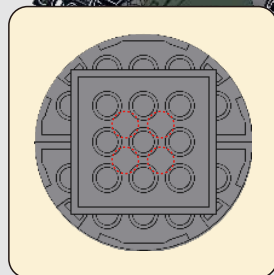
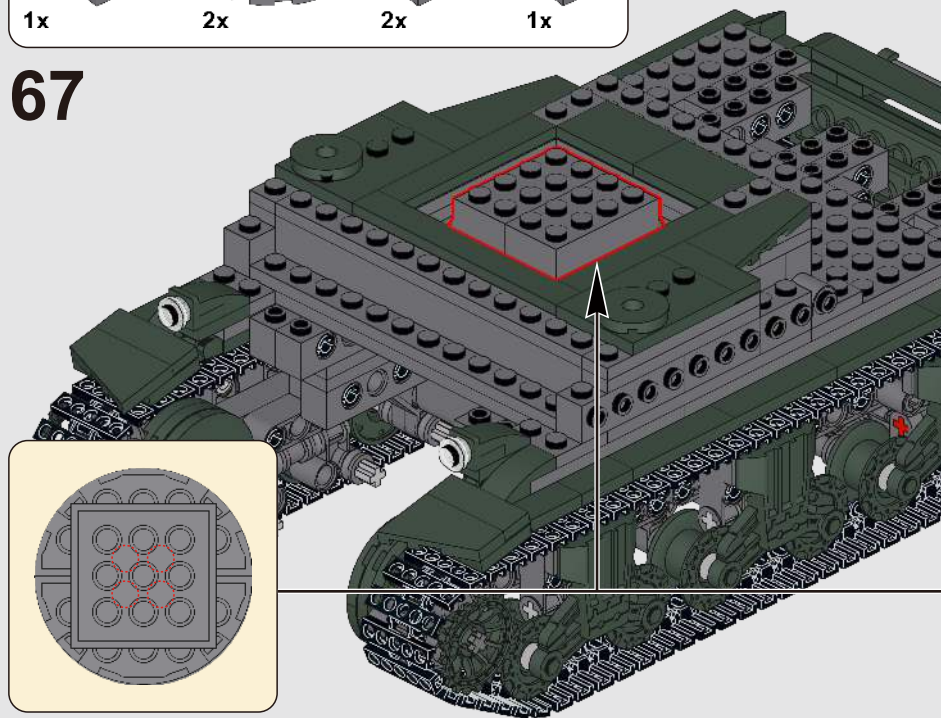

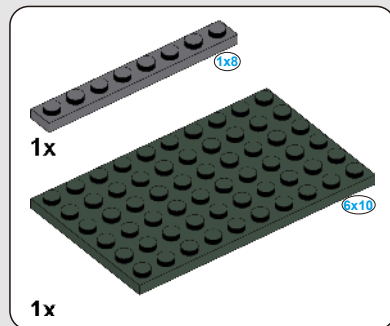

69

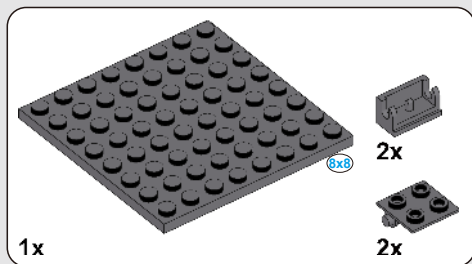

68

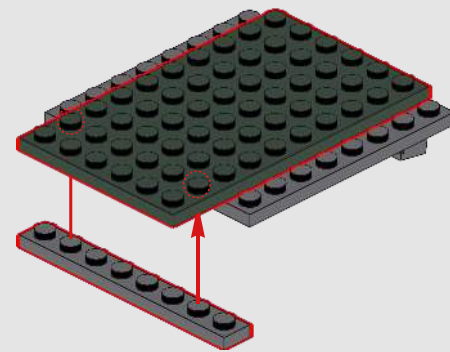
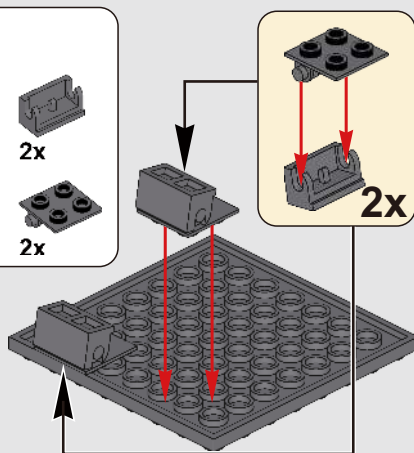

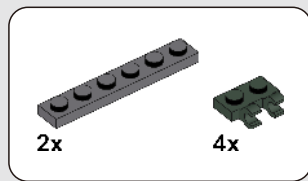

70

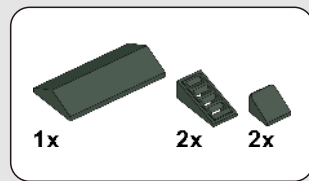
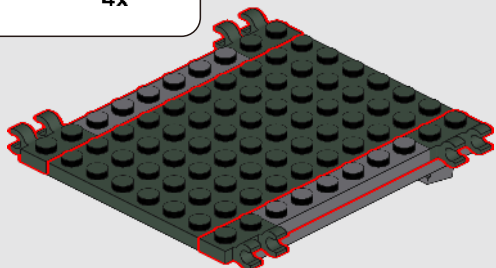

71

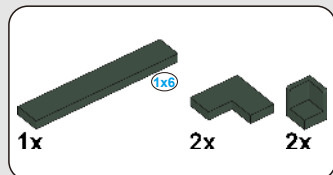
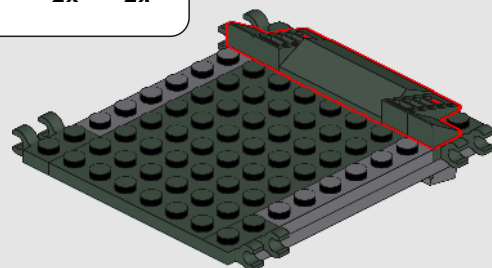

72

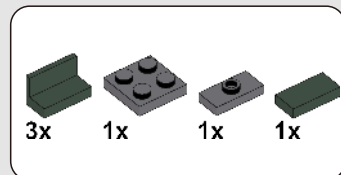
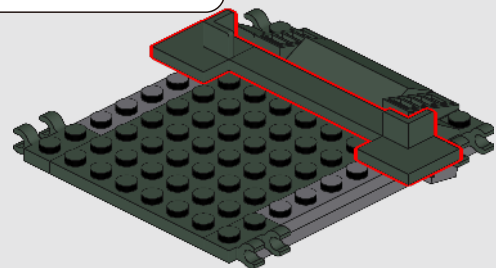

73

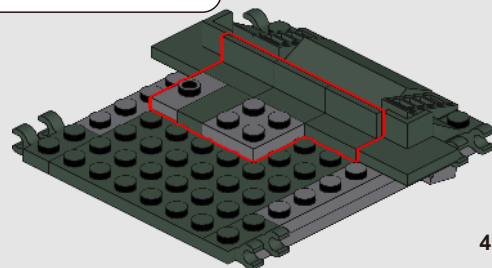

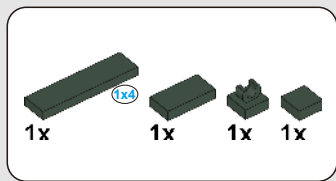

74

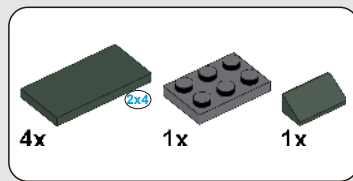
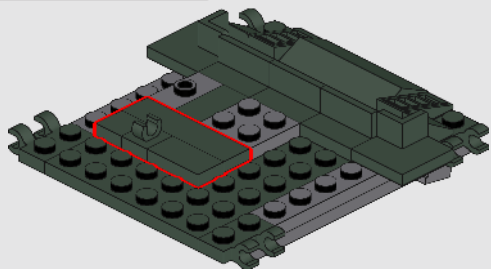

75

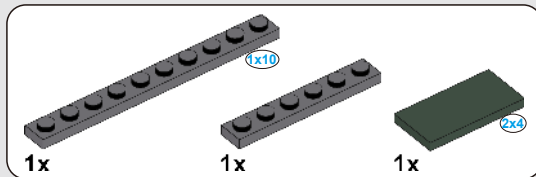
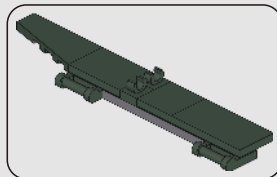
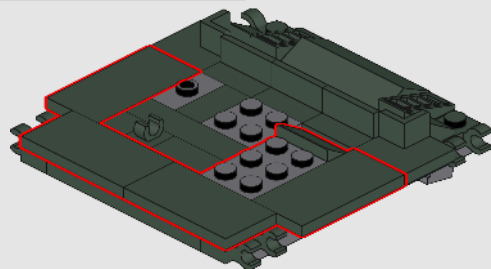

76

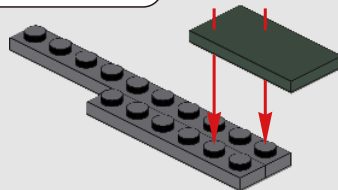

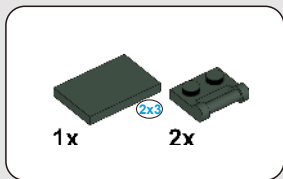

77

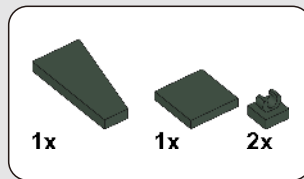
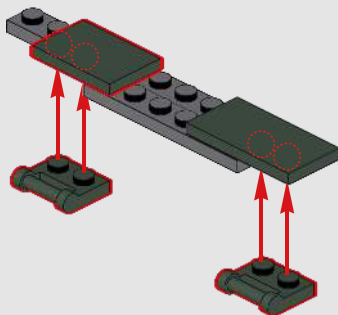

78

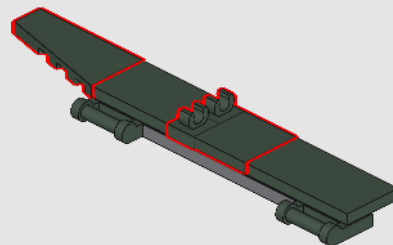

79

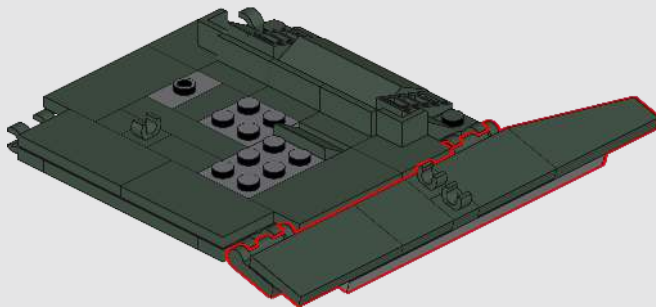

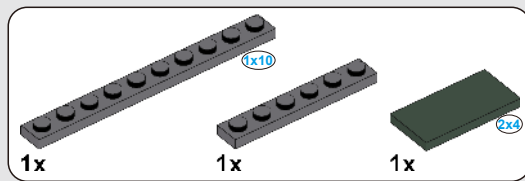
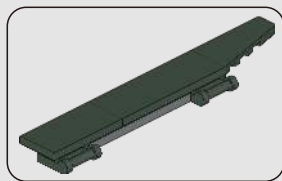

80

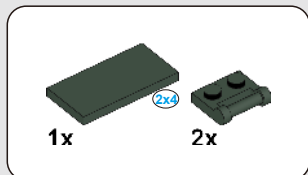
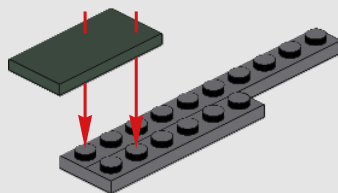

81

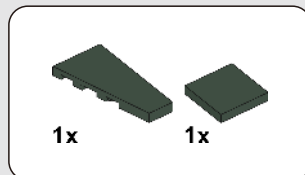
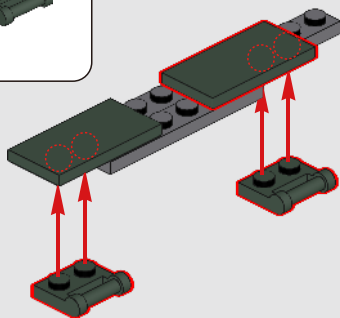

82

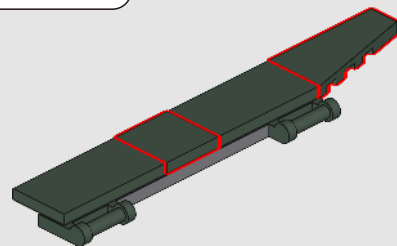

83

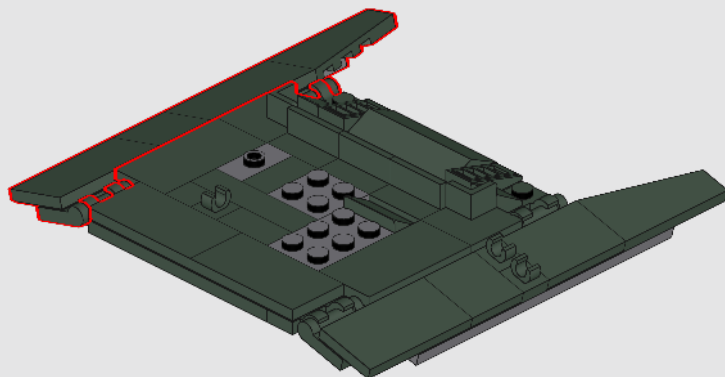

84

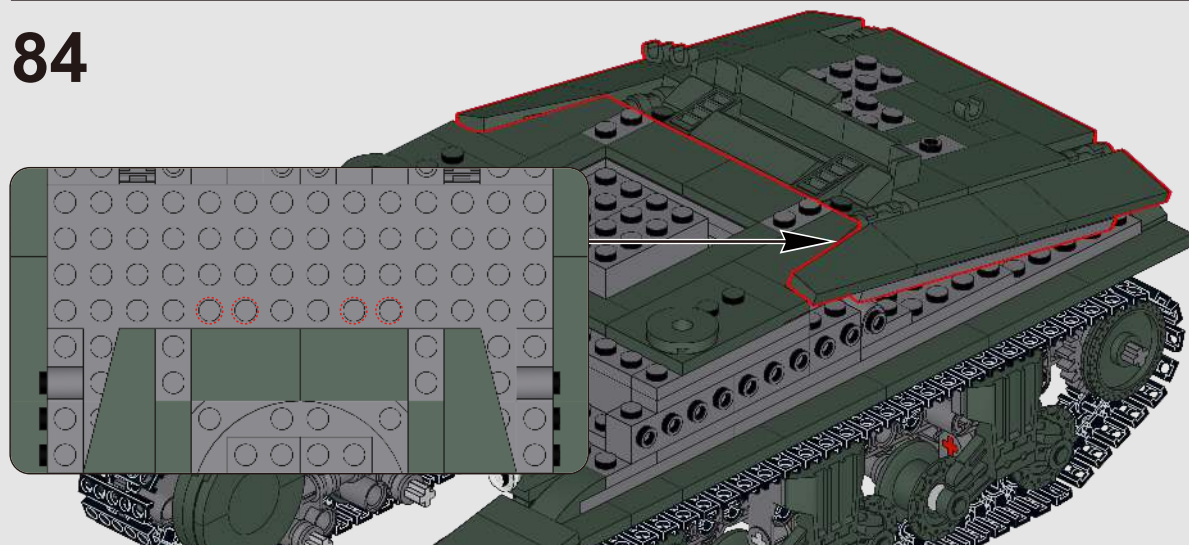

85

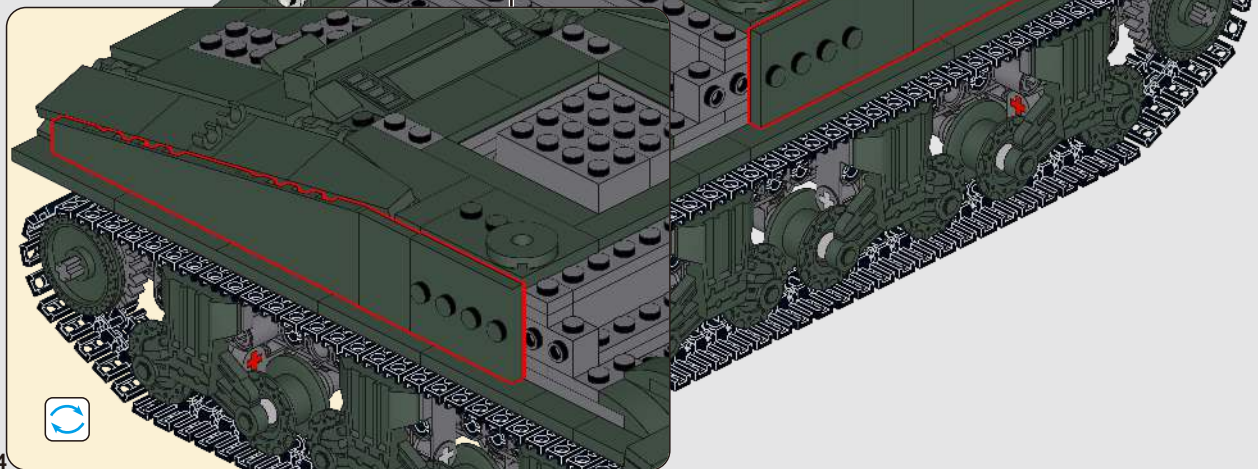
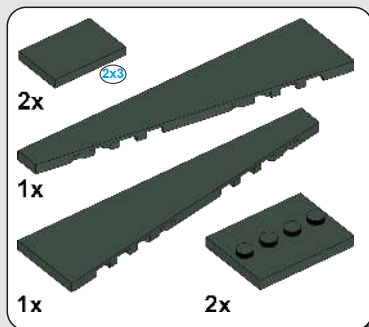

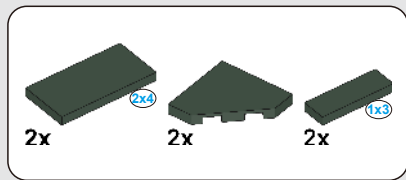

86

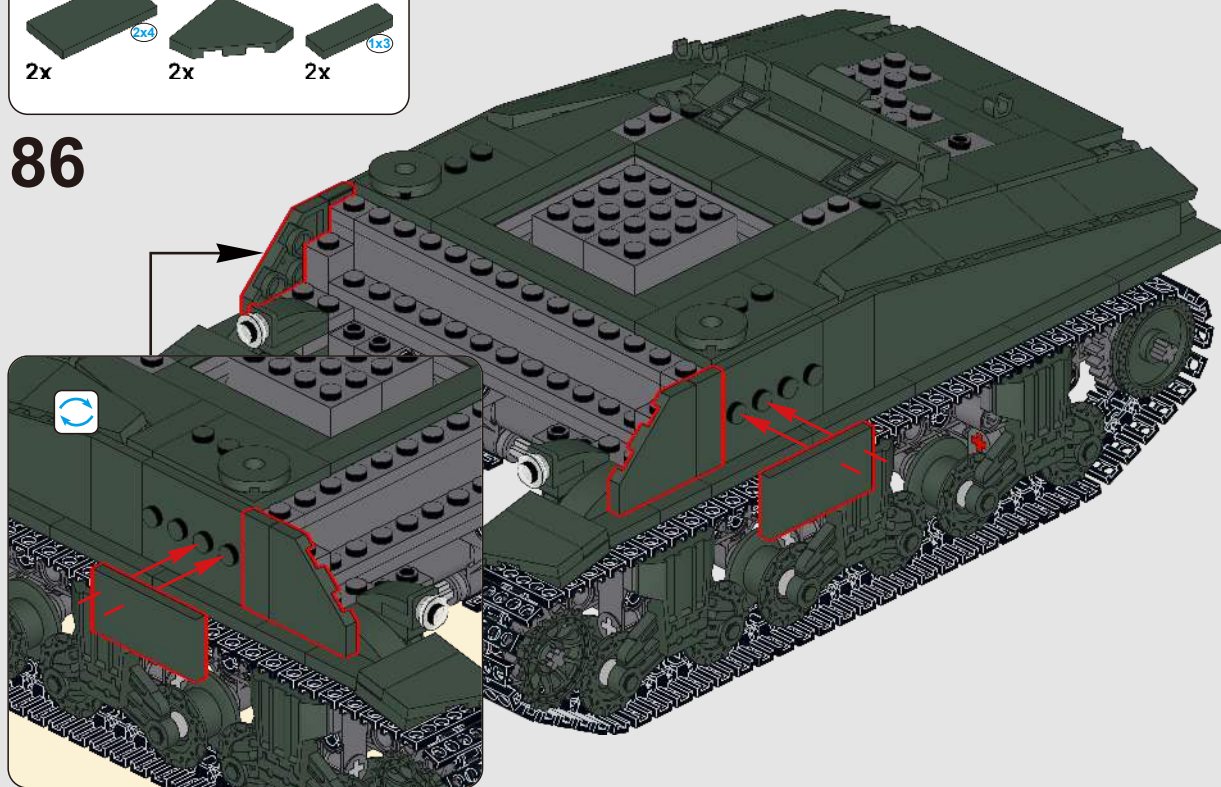

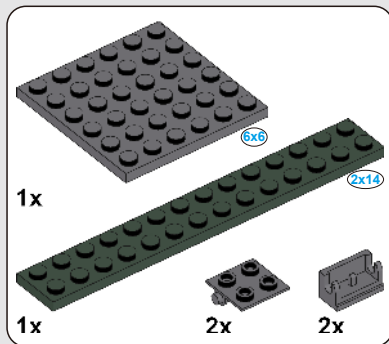
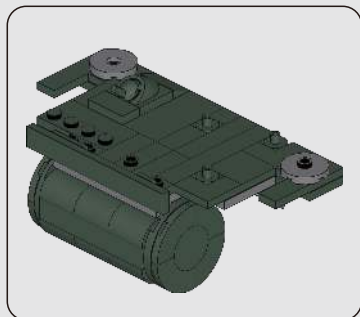

87

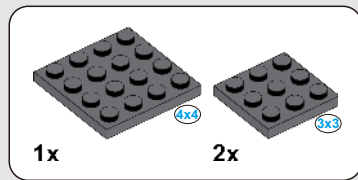
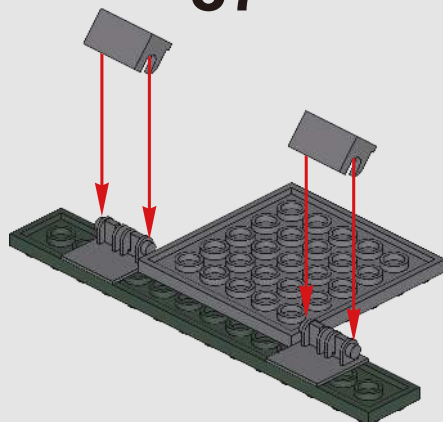

88

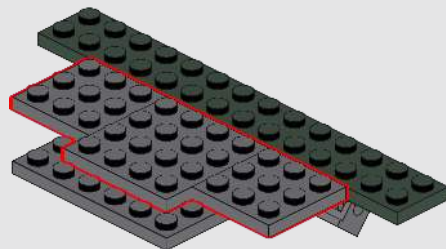

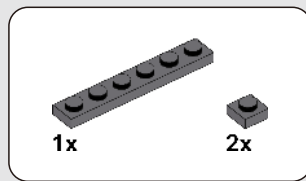

89

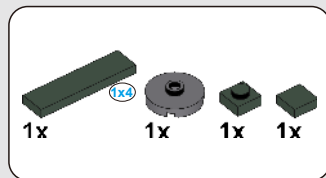
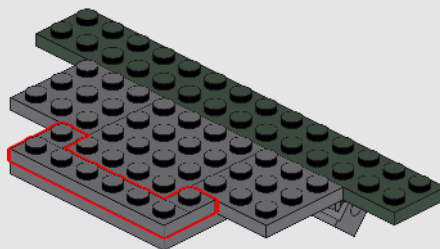

90

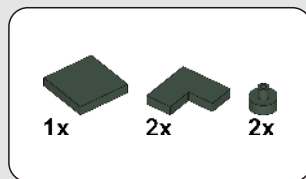
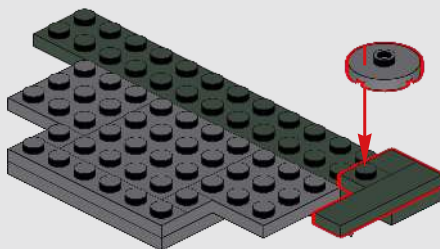

91

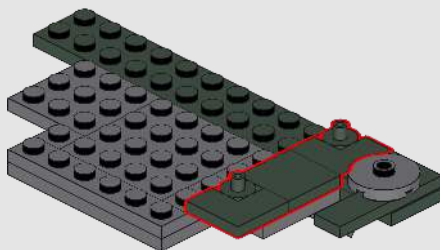

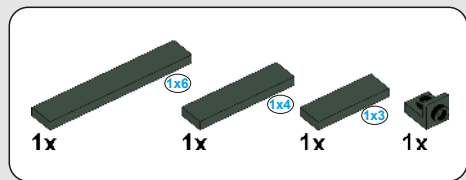

92

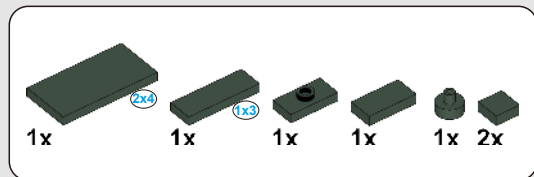
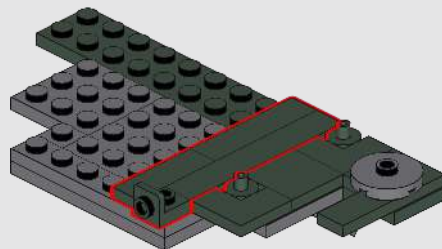

93

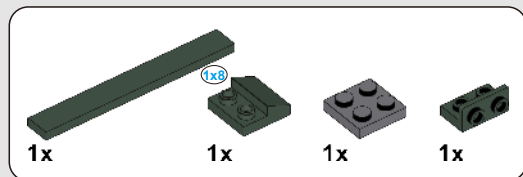
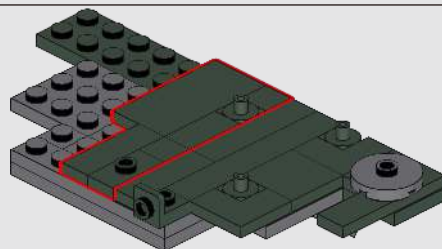

94

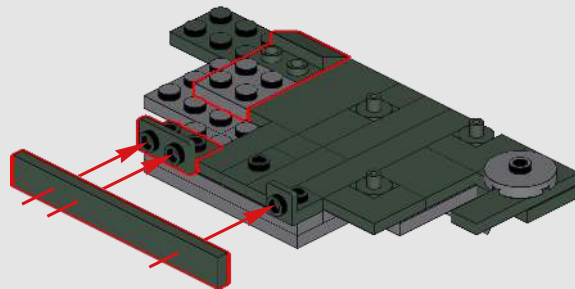

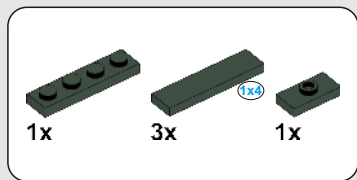

95

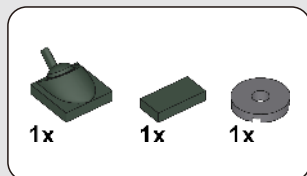
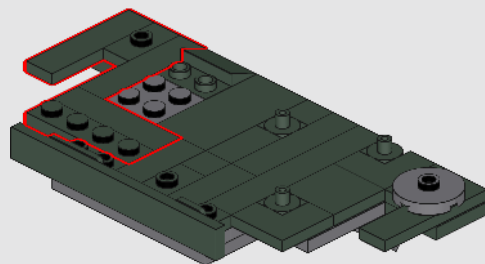

96

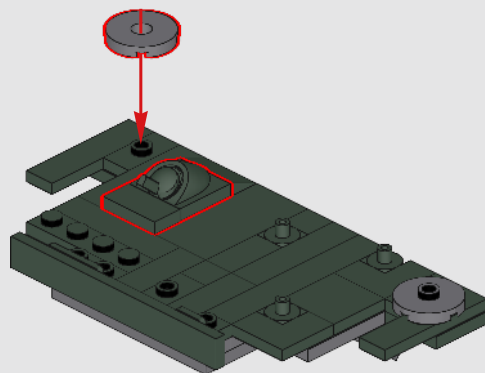

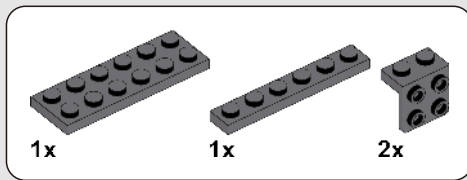
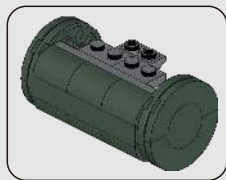

97

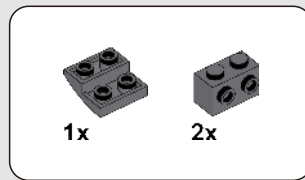
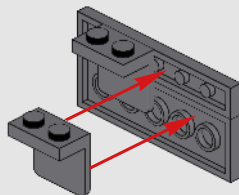

98

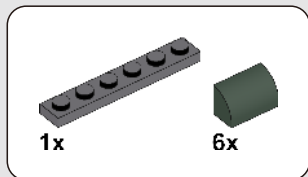
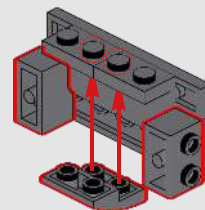

99

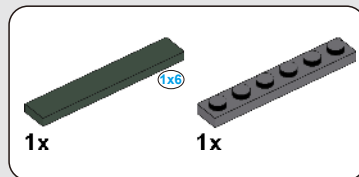
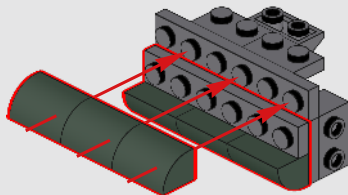

100

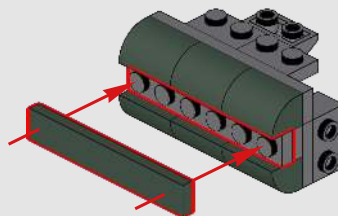

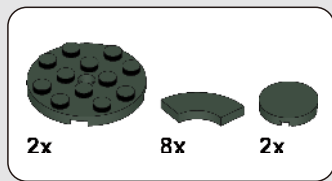

101

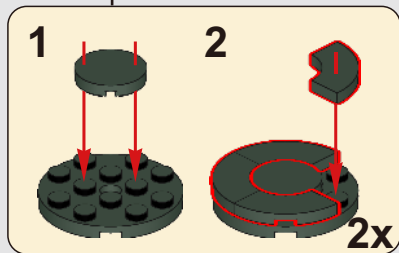
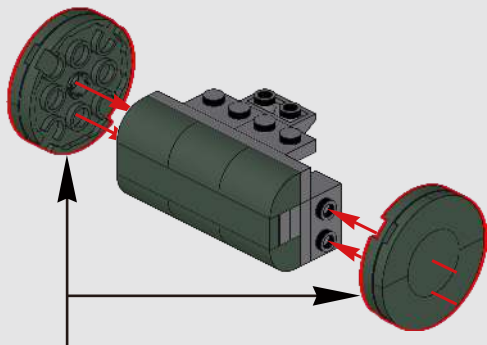

102

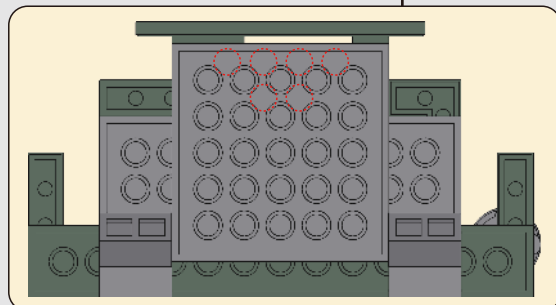
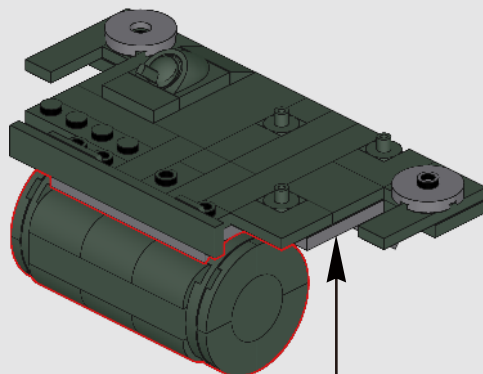

103

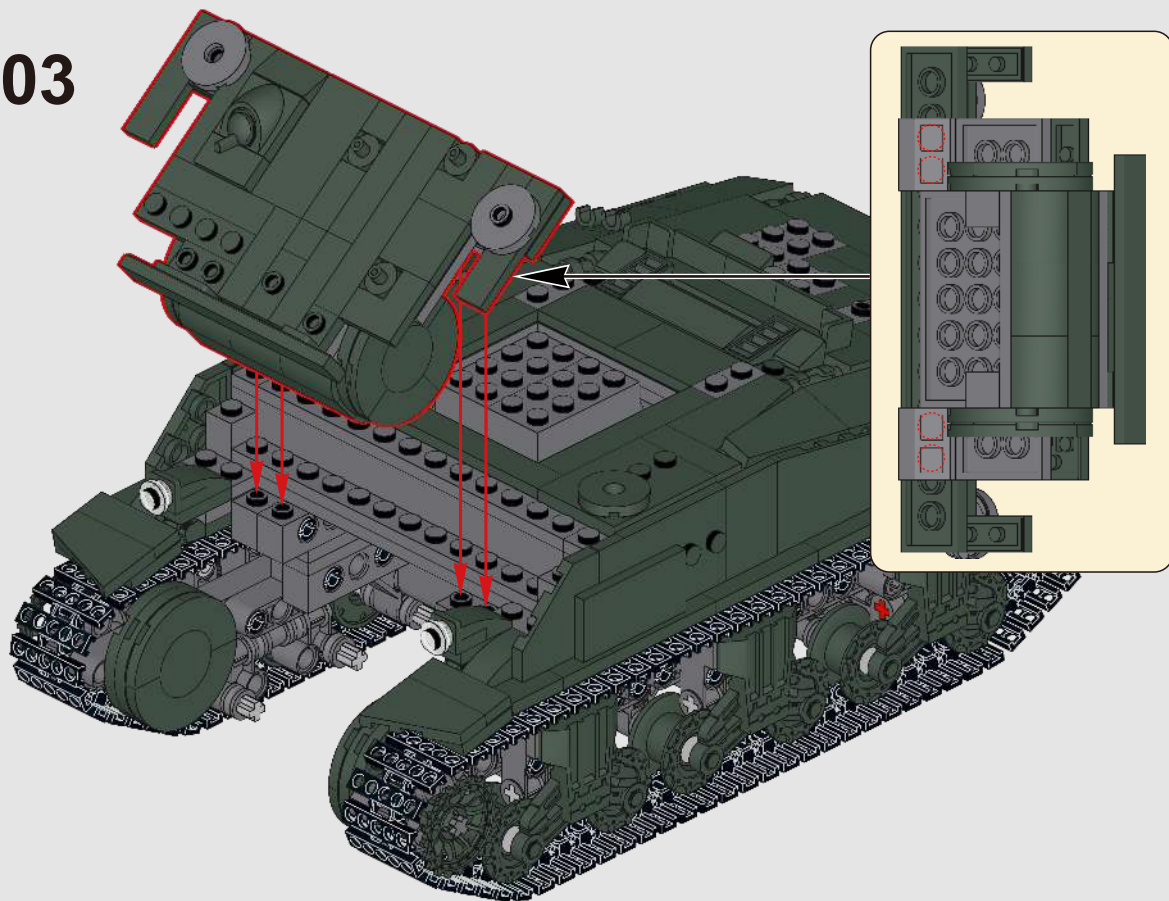

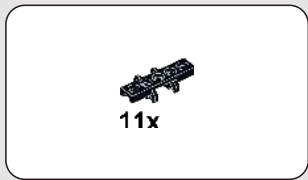

104

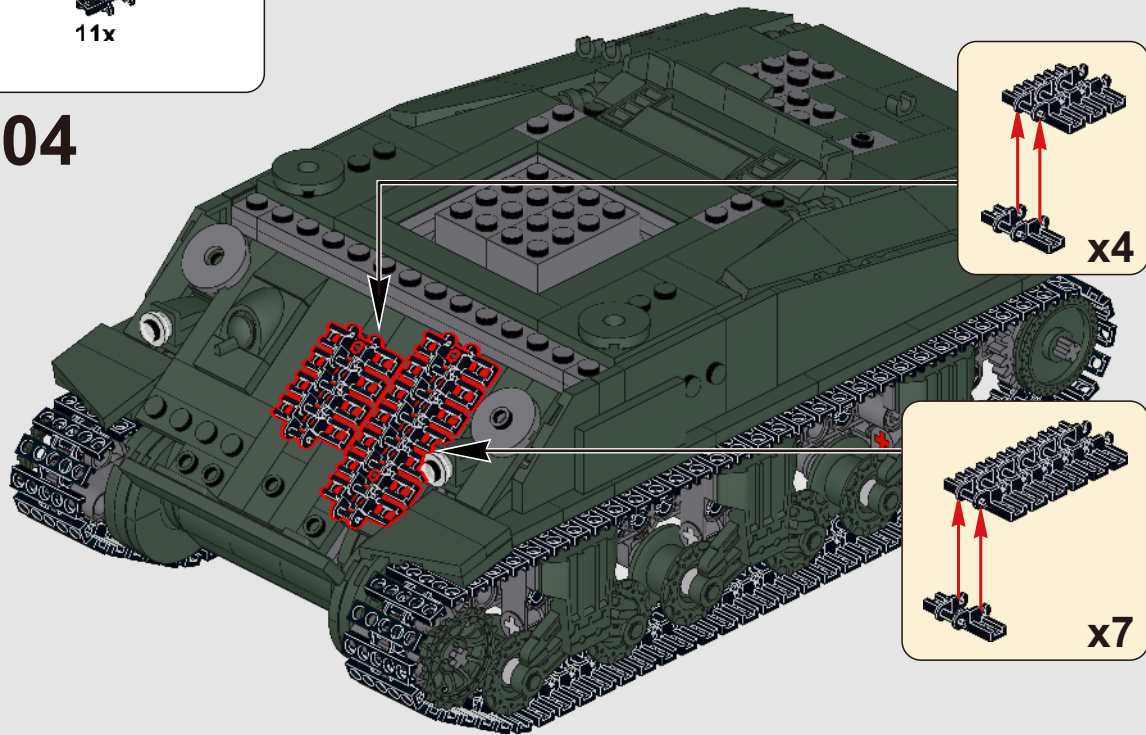

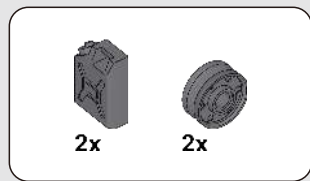

105

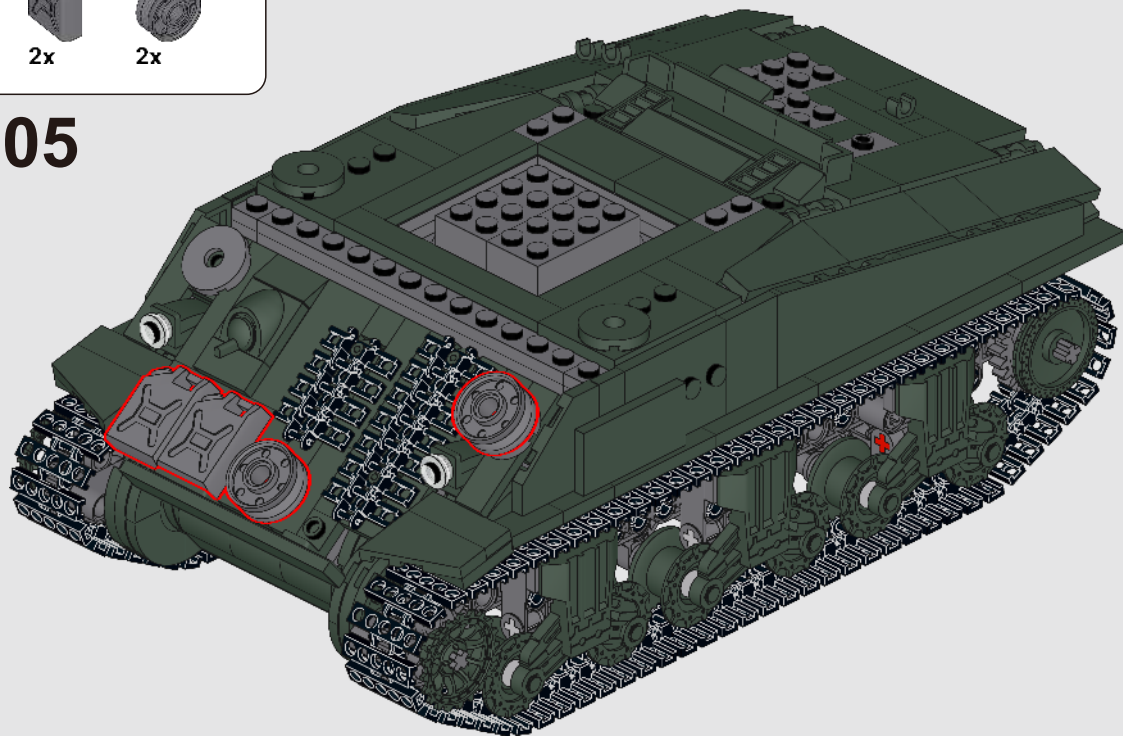

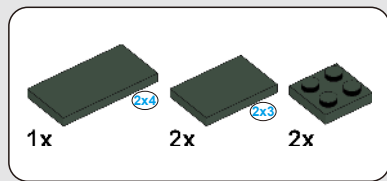

106

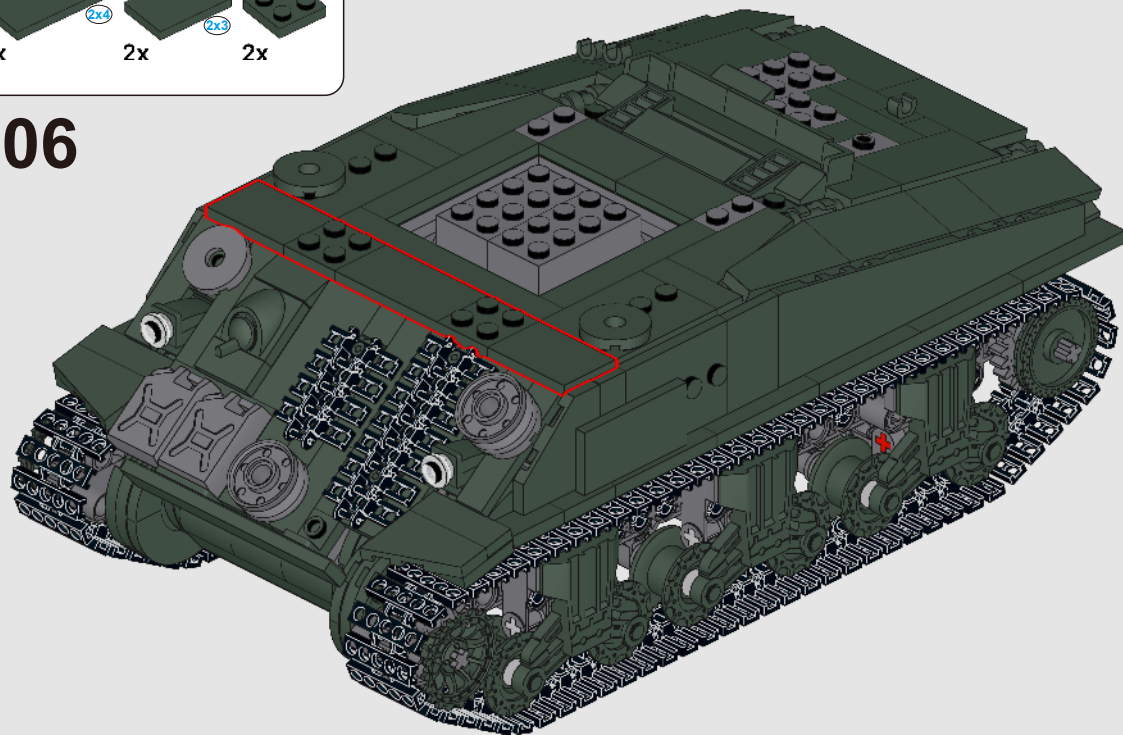

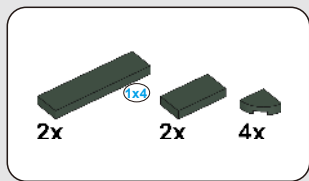

107

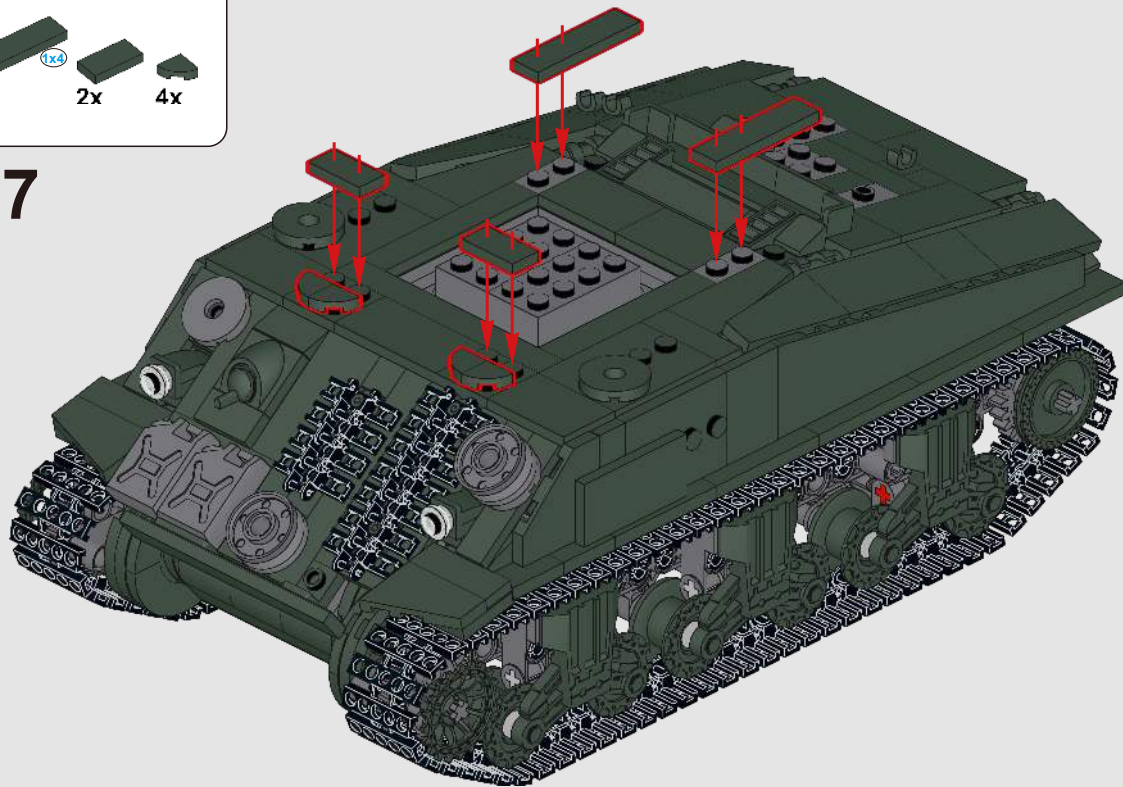

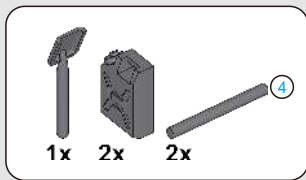

108

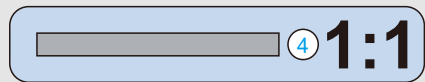
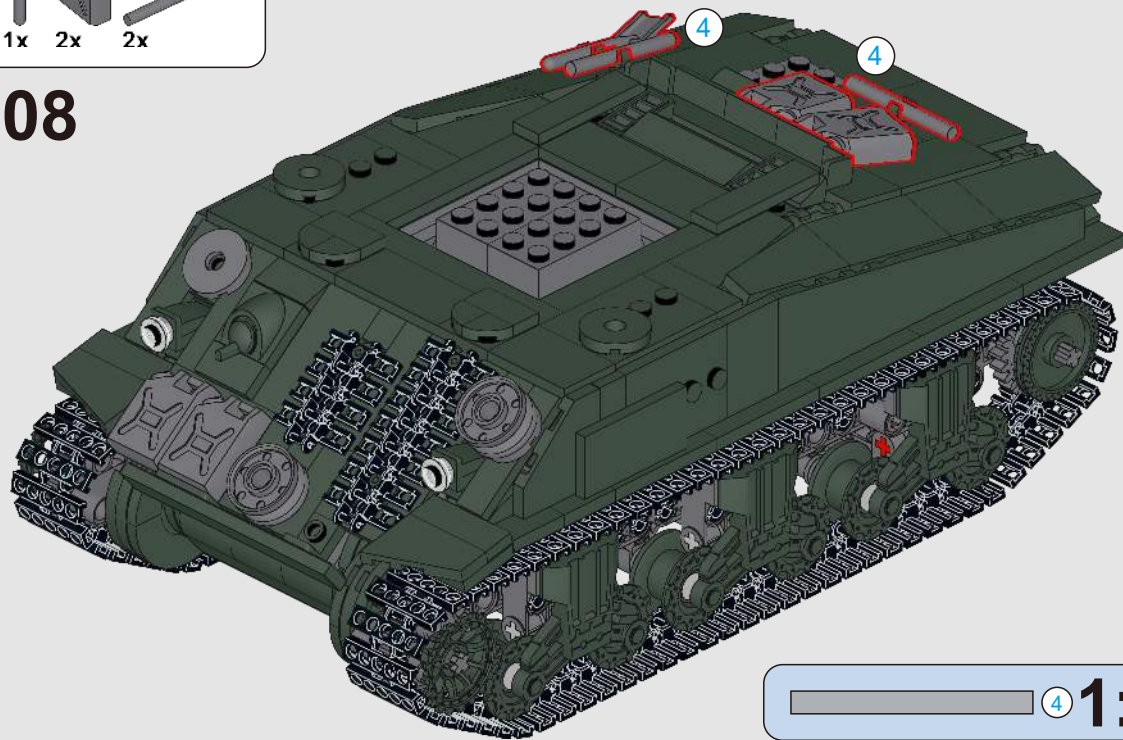

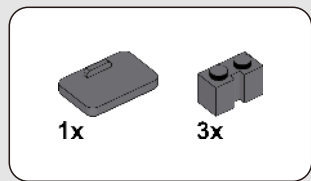

109

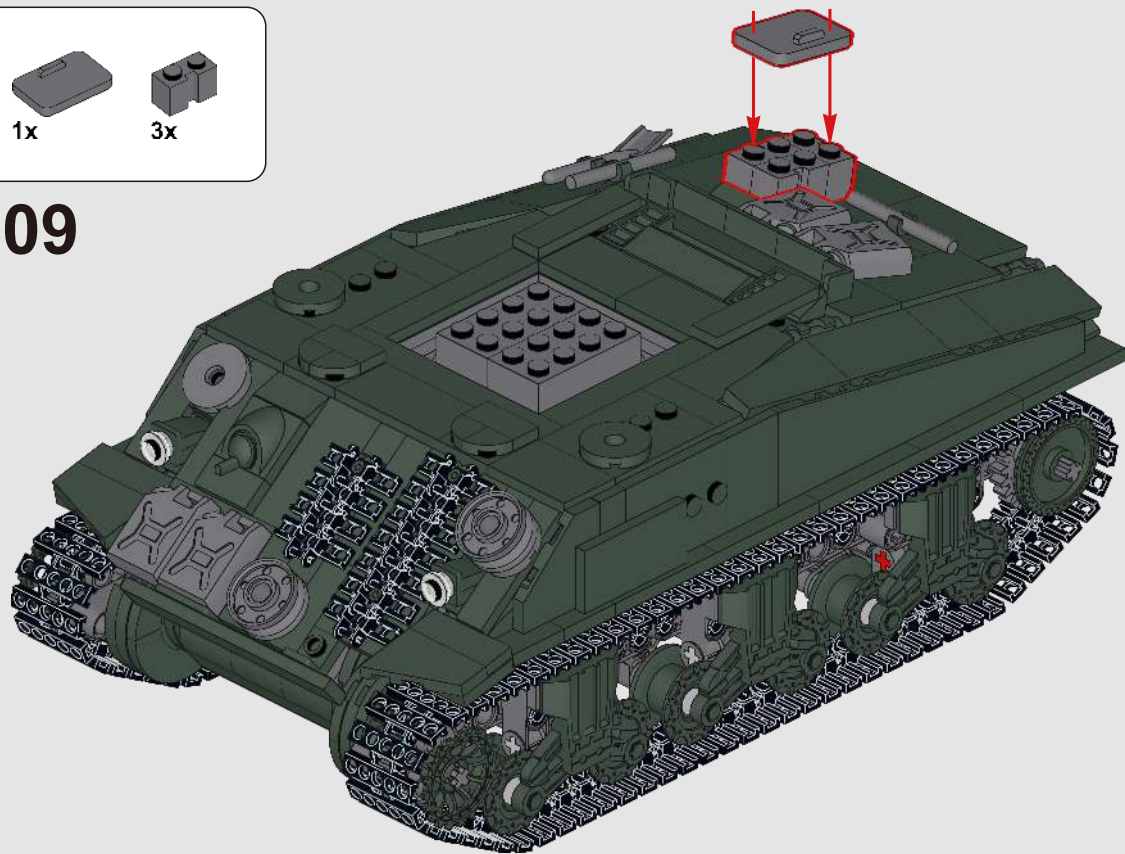

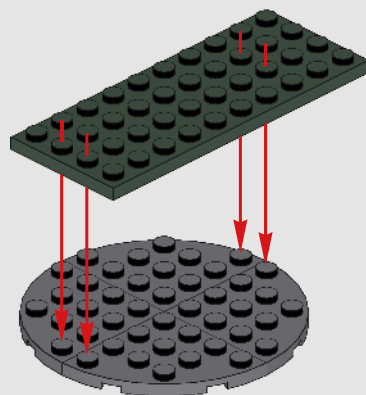
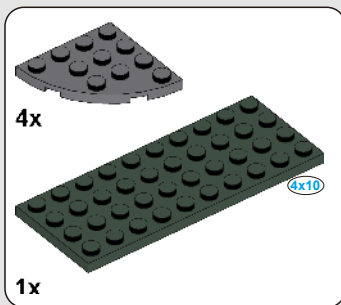

110

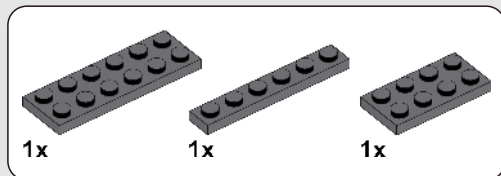

111

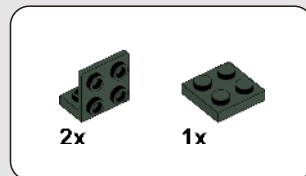
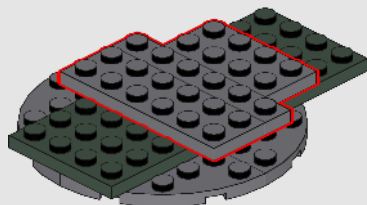

112

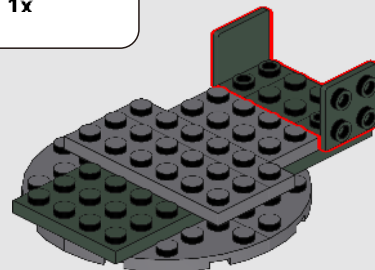

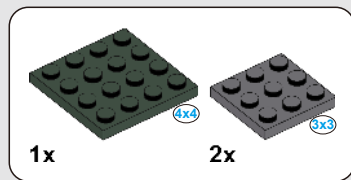

113

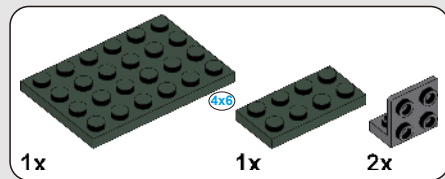
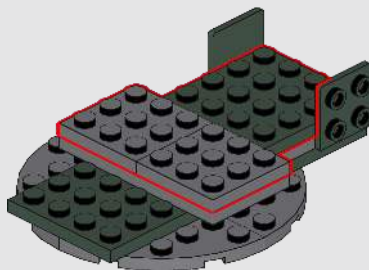

114

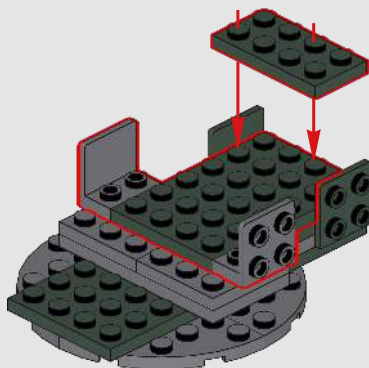

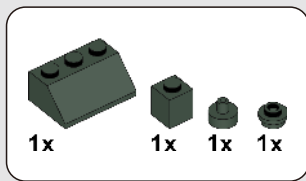

115

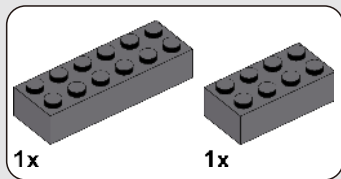
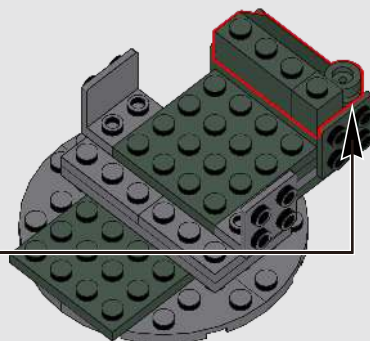
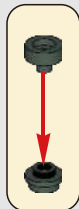

116

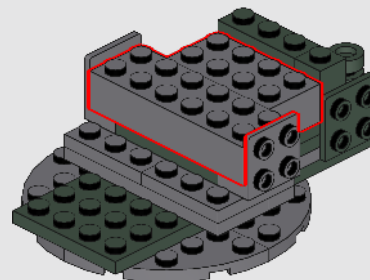

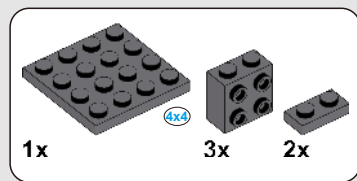

117

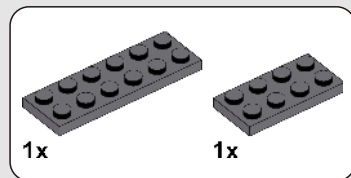
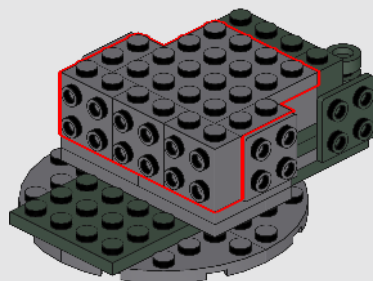

118

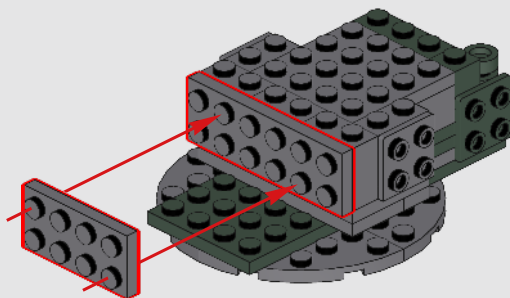

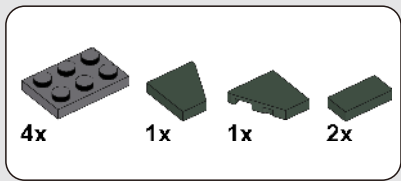

119

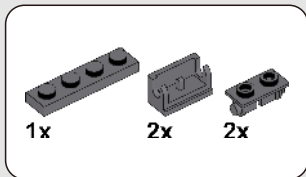
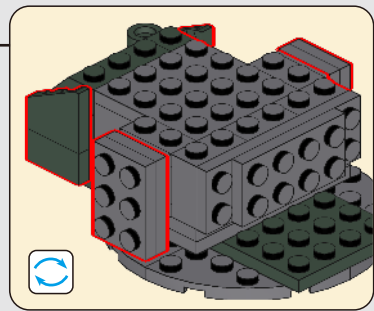
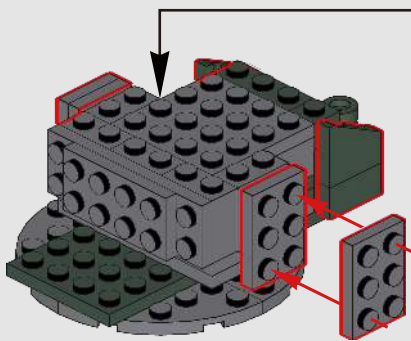

120

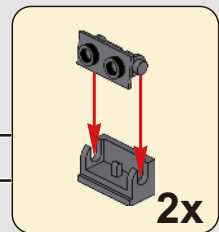
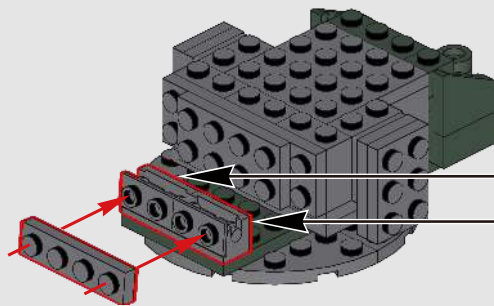

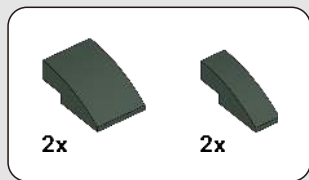

122

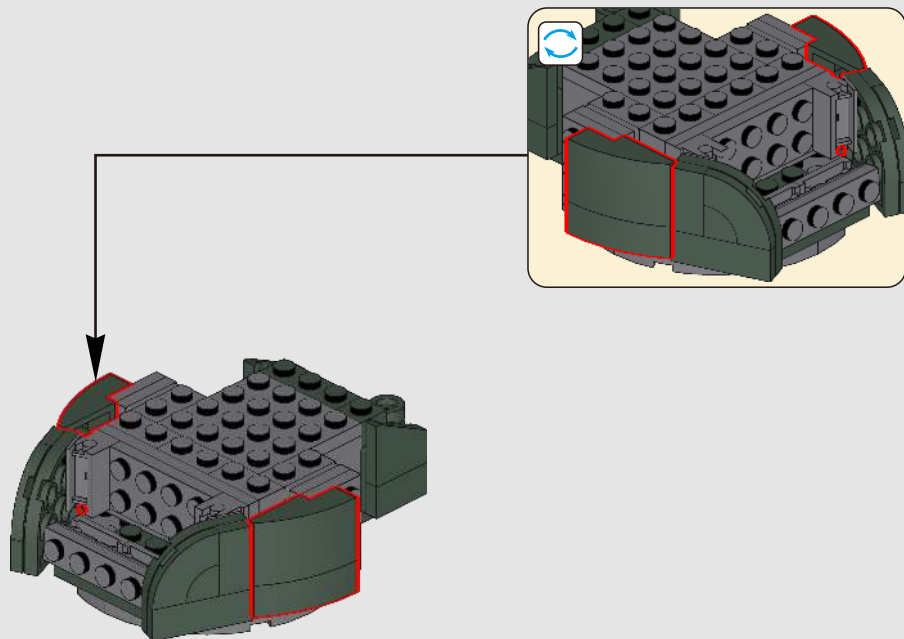

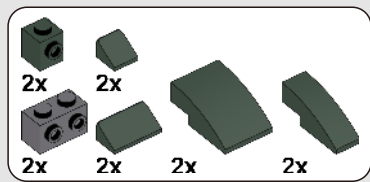

123

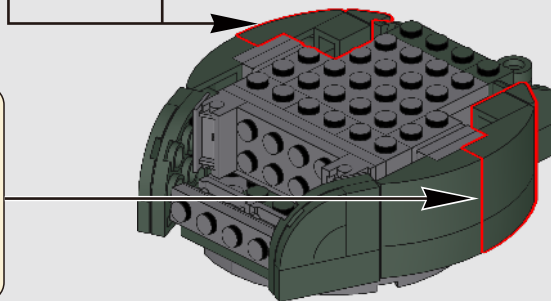
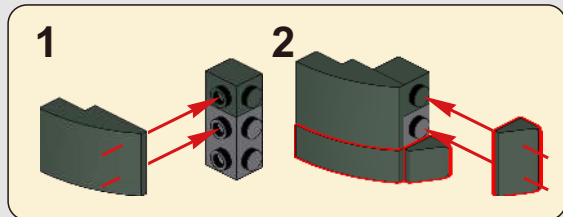
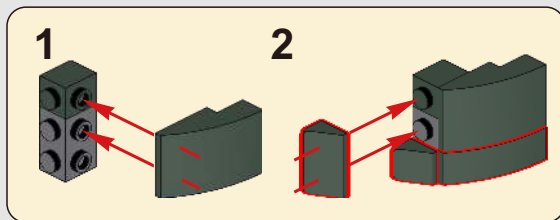
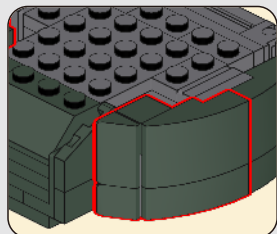

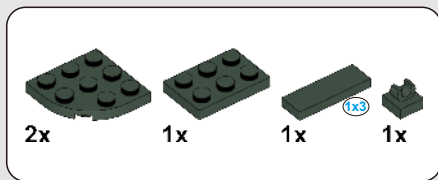

124

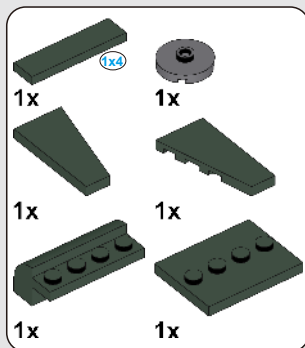
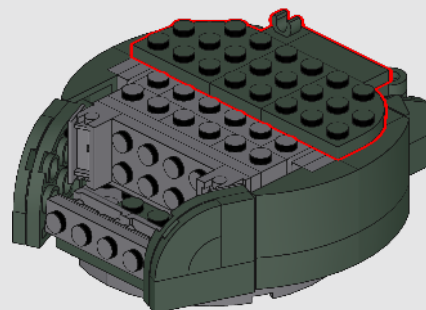

125

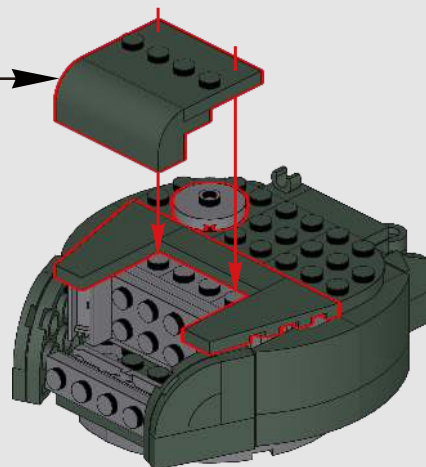
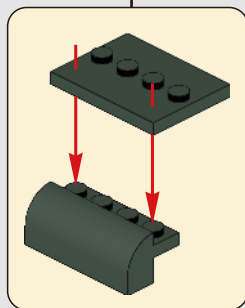

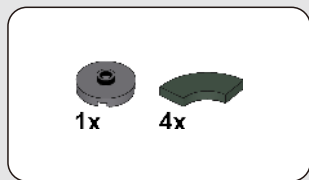

126

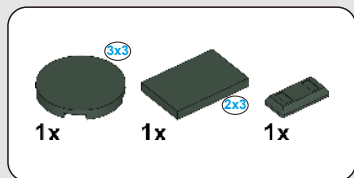
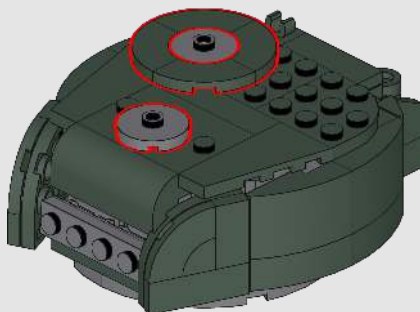

127

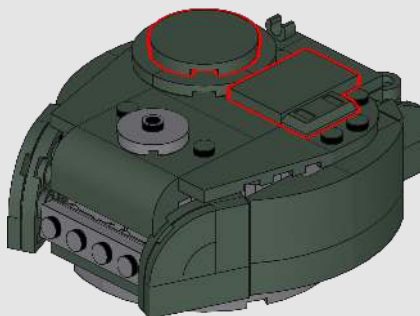

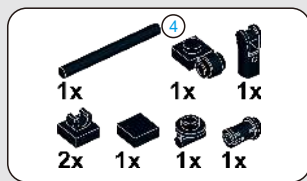

128

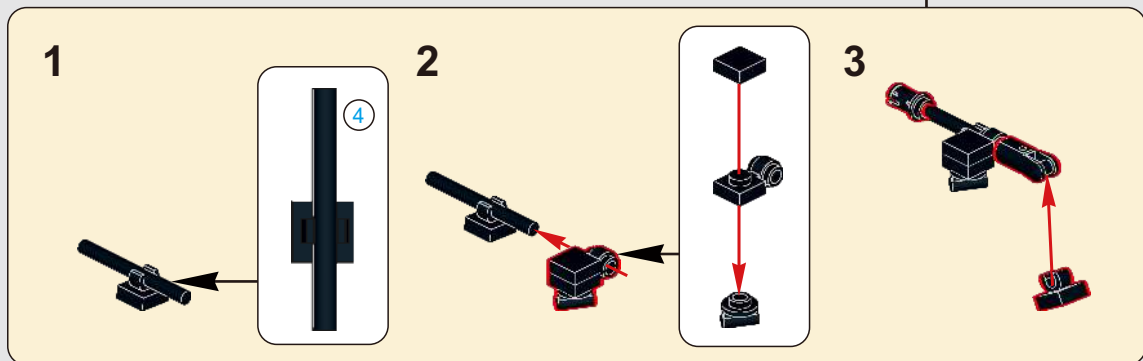
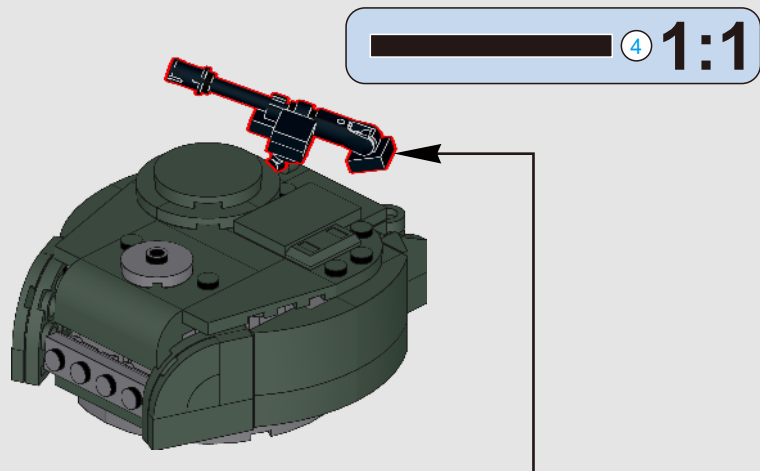

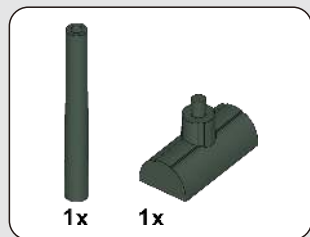

129

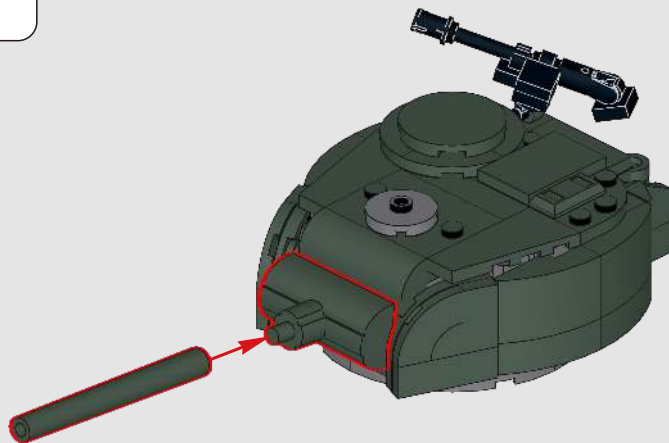

130

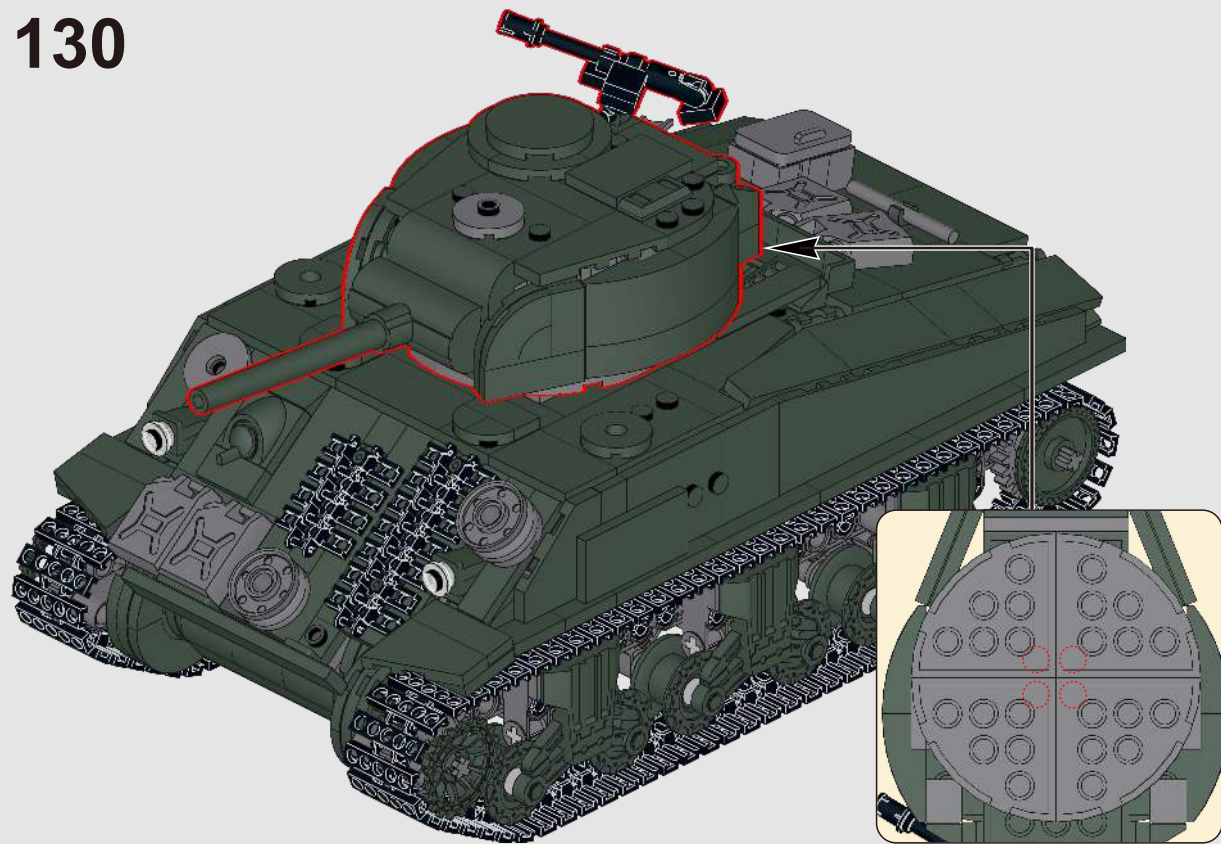

131

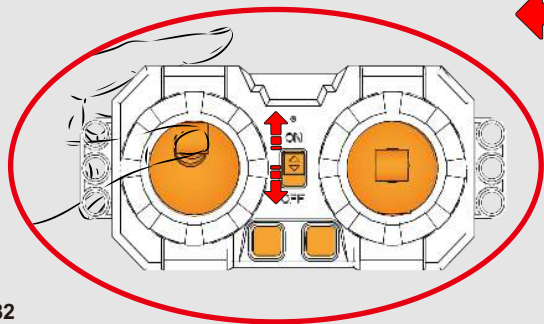
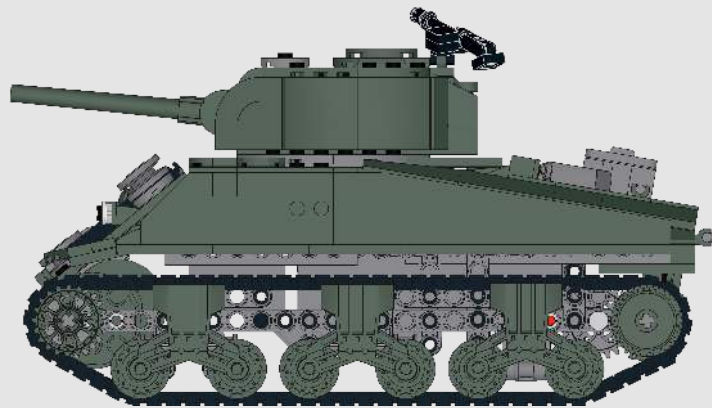

132

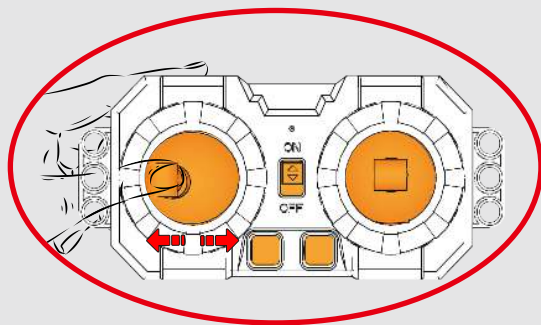
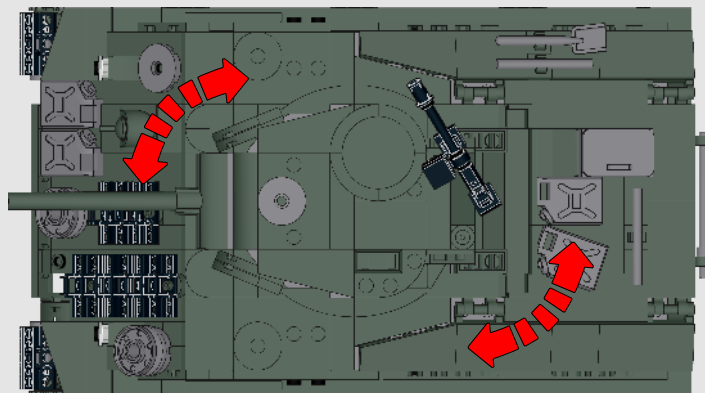

133

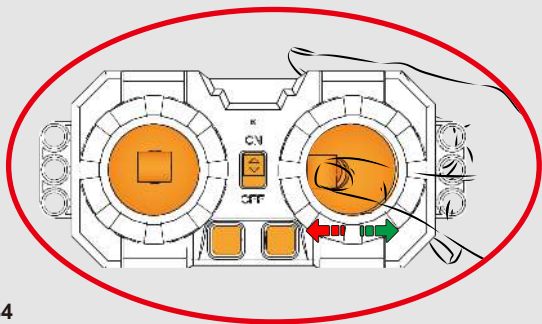
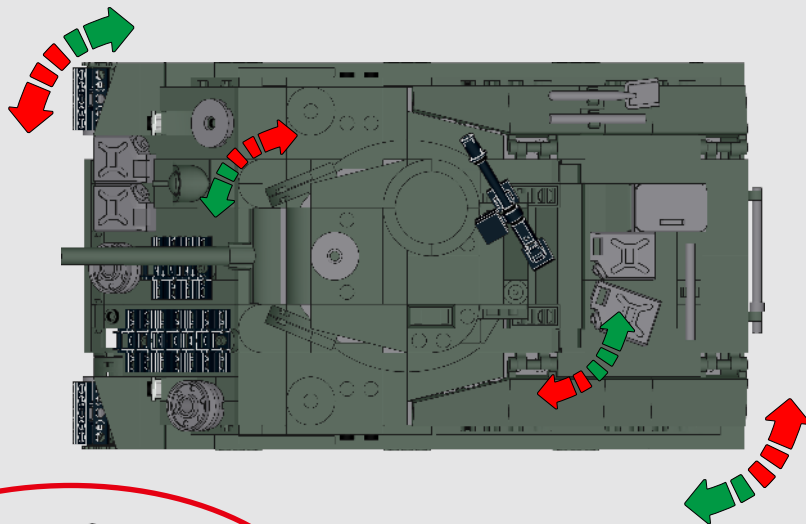

134

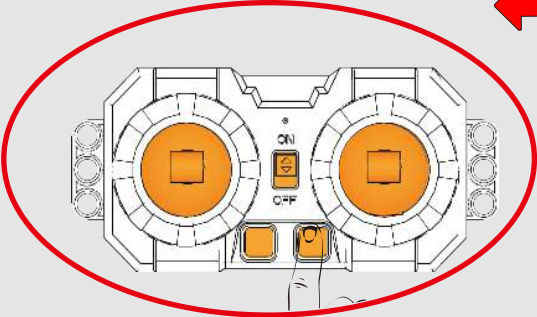
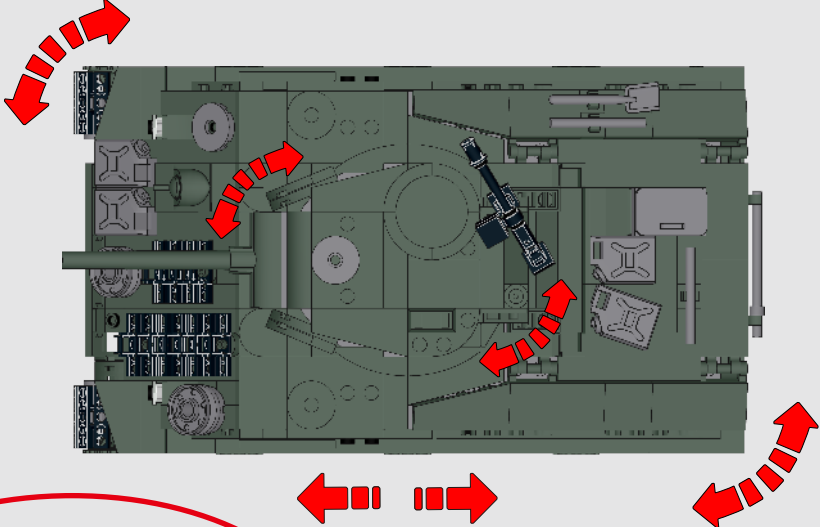

135

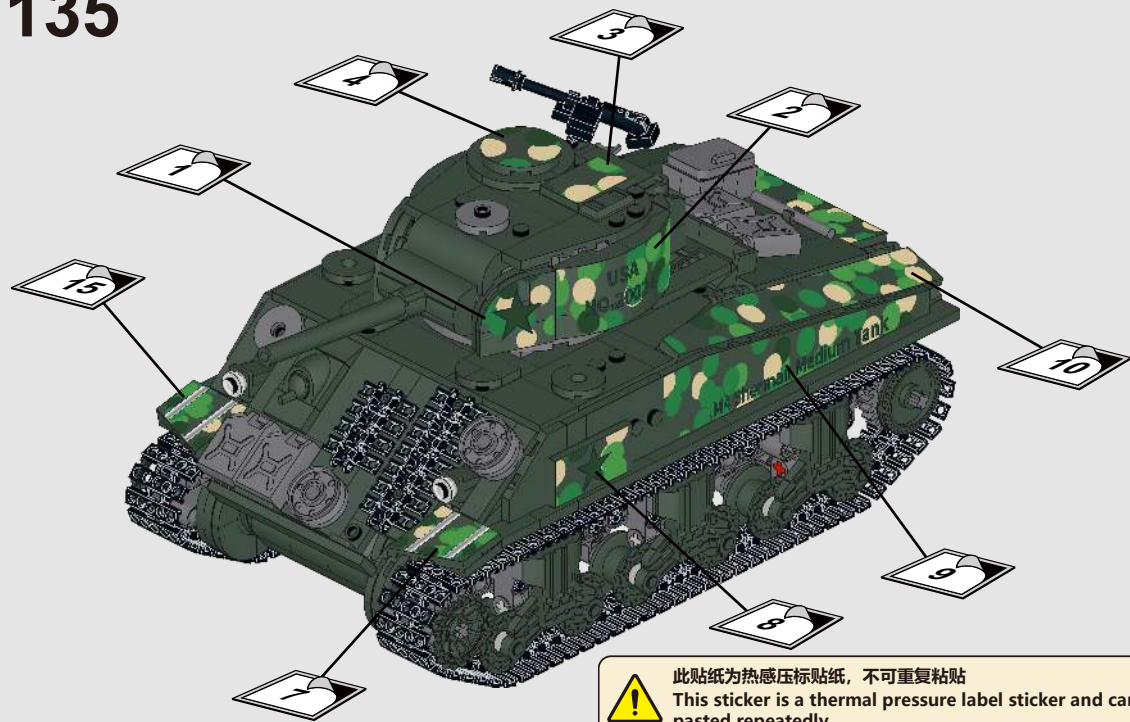

此贴纸为热感压标贴纸，不可重复粘贴

This sticker is a thermal pressure label sticker and cannot be pasted repeatedly

贴纸使用方法：撕起贴纸，对准位置随后均匀刮动，撕掉透明膜即可。

How to use the sticker: Tear off the sticker, align the position and then scrape it evenly, tear off the transparent film.

136

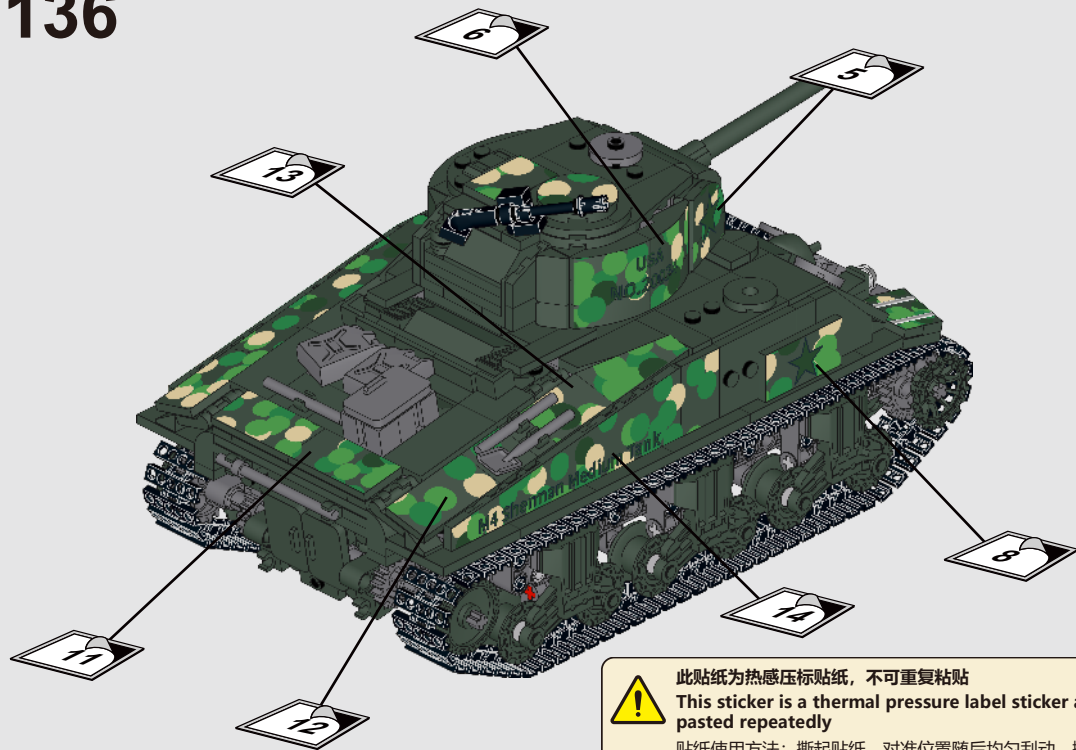

此贴纸为热感压标贴纸，不可重复粘贴

This sticker is a thermal pressure label sticker and cannot be pasted repeatedly

贴纸使用方法：撕起贴纸，对准位置随后均匀刮动，撕掉透明膜即可。

How to use the sticker: Tear off the sticker, align the position and then scrape it evenly, tear off the transparent film.

**MULD
KING**

®

宇 | 星 | 模 | 王

