



Ages/edades

6+

1302

WINDMILL

50 Pcs/pzs



# MECHANICAL ENGINEERING 工程机械

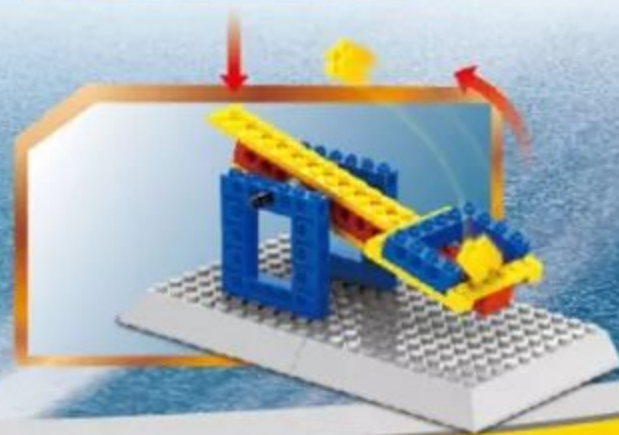

**3 IN 1**

## FUNCTION & FEATURES

风车功能及特点

- CHAIN GEARING/链式齿轮传动
- THE ROLE OF THE AXIS/轴心的作用
- THE ROLE OF THE IDLER GEAR/惰轮的作用

## WANGE SCI-TECH EDUCATION

### 万格科技教育

When a seed meets the soil, water and sunlight, life will magically begin to sprout. This natural growing instinct is permeating to the developments of all things. It goes the same to children's growth.

Wange education serves as the soil, knowledge is water, and interest and happiness will be the sunlight.

当种子偶遇土壤、水、和阳光，  
生命便神奇地开始发芽。  
这种自然成长的天性贯穿着所有事物的发展。  
儿童的成长也是如此。  
万格教育就是这片土壤，水是知识，  
而阳光是兴趣与快乐。

The educational philosophy of Wange is "Thinking with your hands"!

万格教育理念：“用手去思考”

“Thinking with your hands” actually is a binding process of using your brains to think about the question and working out the solution with your hands. They are just like two connected gears, converting and driving each other.

用手去思考，其实已经是大脑在思考问题，和动手实现解决问题的一个结合过程。手跟脑就是两个互咬的齿轮，相互转换，相互推动着。

And this is what Wange education has been focusing on throughout the learning process. Along the creating and building process, guiding children to independent learning, using interest and curiosity as the driving force, cultivate and develop their hands-on ability, observation ability, creativity, cooperation and coordination ability.

万格教育推崇的就是这样学习道理，在积木构建过程中，引导儿童自主学习，把兴趣与好奇心作为原始推动力，培养儿童的动手能力，动脑能力，观察能力，创造能力，合作协调能力。



荷兰大风车  
DUTCH WINDMILL

小朋友，有没有在大草坪上看到过有很多旋转的风车，风大的时候它转动得更快。

Hello, boys and girls, did you ever seen lots of windmills in the green lawn?  
When meeting the strong wind, They will rotate faster.

The educational philosophy of Wange is "Thinking with your hands"!  
万格教育理念：“用手去思考”



立式风车  
VERTICAL WINDMILL

那你有没有想过风车为什么会转呢？它是靠什么能量来维持自身的转动的？带着以上问题，让我们用积木来搭建一组风车，看它们是怎么运动的。

Did you ever think that why the windmill could do rotation? What energy did the windmill rely on to maintain its rotation? With these questions, let's using the blocks to build up a set of windmill and learning how it works.

<生活场景>  
SCENES OF LIFE

The definition of Gear: the tooth on the gear rim can continuously engage the mechanical components doing rotation.

齿轮定义：轮缘上有齿能连续啮合传递运动和动力的机械元件。

Gear driving is the most widely and common rotating form in the currently mechanical rotating. You could see the gear meshing in your daily life, like your watch, bicycle, or your old toys which could doing function. There is a driving gear box in the car's driving system, different size of gears are intermeshing in it, by the meshing of these different size's gears to achieve the purpose of changing the speed.

齿轮传动是目前机械传动中应用最广泛、最常见的一种传动形式。日常生活中，你可以在钟表、自行车，会动的旧玩具中看到齿轮的啮合传动。汽车的传动系统中有一个传动的齿轮箱，其中有不同大小的齿轮互相啮合，借着不同大小的齿轮啮合，达到变换速度的目的。

Wange education have series gears, like the **cylindrical gears**, **crown gears**, **bevel gears** and **worm gears**. **The spur gear**: the tooth ribs parallel to the axis of the straight cylindrical gears. The tooth in the same plane engaged each other to drive the transverse axis's rotation speed and direction. **Bevel gear**: the bevel gear is using for the transmission between intersecting axes. Single-stage driving ratio could reach to 6, the maximum is to 8, the driving efficiency normally is in 0.94 – 0.98. The tooth of the **crown gear** were display in the ends, normally is using in the machine's speed, reversing clutch, also widely using in the toys. The advantages as followings: small size, compact structure, large torque, and if just making a little part design in the axial positioning to makes it "slip" when overload, it could doing self-protection. **Worm gear**: as the big gear in the cross gear set, it meshed with the worm gear pairs.

万格齿轮常规有圆柱齿轮、冠齿轮、锥形齿轮、蜗轮四种齿型。正齿轮（直齿轮）齿筋平行于轴心之直线圆筒齿轮。直齿轮在同一平面互相啮合以传动平面轴的转速与方向。锥形齿轮也称为伞齿轮，锥齿轮用于相交轴间的传动。单级传动比可到6，最大到8，传动效率一般为0.94 – 0.98。冠齿轮的齿分布在端面，一般用在机械的变速、换向离合器上，在玩具上也有广泛的应用。它的优点是：体积小，结构紧凑传递扭矩大，只要在轴向定位部分稍作设计，可以使其过载时能“打滑”，有自我保护作用。蜗轮：作为交错轴齿轮副中的大齿轮，与配对蜗杆相啮合的齿轮。

In this experiment, we will use the 8 tooth cylindrical gear, the 24 tooth cylindrical gear and the 24 tooth crown gear.

在这个实验中，我们将会用到8齿圆柱齿轮，24齿圆柱齿轮及24齿冠齿轮。



▶ 齿轮比计算例子 ( GEAR RATIO CALCULATION ) :

$$\text{齿轮比} = \frac{\text{被动轮齿速}}{\text{主动轮齿速}} = \frac{\text{the tooth number of the passive gear}}{\text{the tooth number of the driving gear}}$$

$$= \frac{40}{24} = \frac{5}{3} (5:3)$$

Diagram illustrating a gear set. The larger gear is labeled "40齿被动齿轮 40 tooth passive gear" and the smaller gear is labeled "24齿主动齿轮 4 tooth driving gear". Red arrows indicate the direction of rotation for both gears.

▶ 齿轮啮合可以有效传达传动，红色的圆开是两个真正传动的圆直径，称为节圆，在节圆上的凹凸齿型确保啮合传送动力。

The gears meshed each other could doing effectively rotation, and the red circles on the diameters is two real rotating gears's diameter, called pitch circle, the convex tooth on the pitch diameter is using to ensure the engagement when doing rotation.



圆柱齿轮  
cylindrical gear



锥形齿轮  
bevel gears



冠齿轮  
crown gears



蜗轮  
worm gears

▶ 正齿轮组合：产生变速转动

Spur gears set: generating variable rotation.



▶ 蜗轮组合

Worm gear set



▶ 冠齿轮：将轮轴的平面传动转变成垂直转动

Crown gear: driving the plane rotation of the axle into vertical rotation.



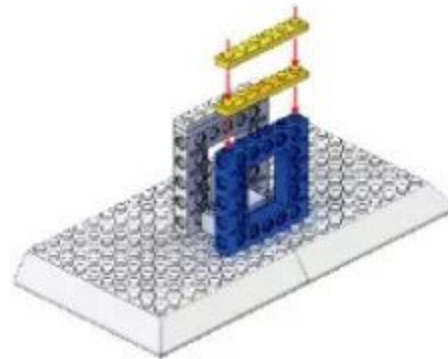
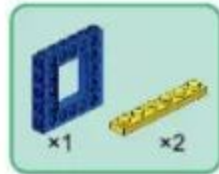
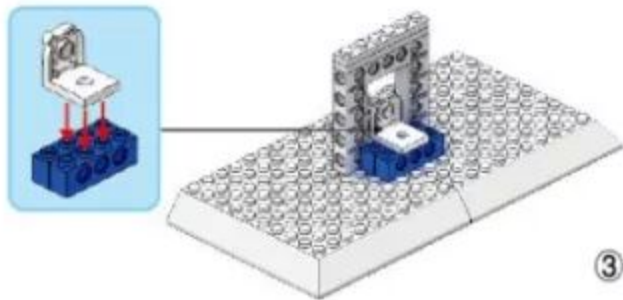
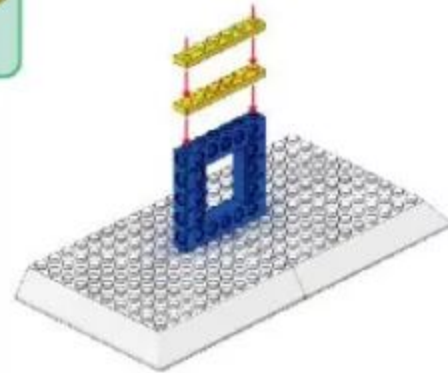
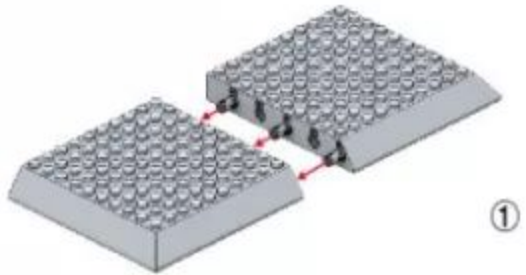
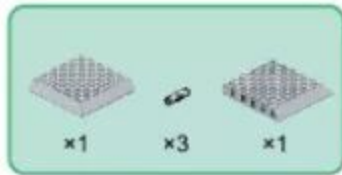



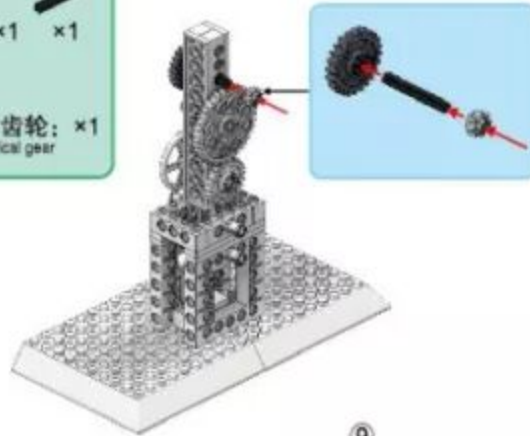

⑨

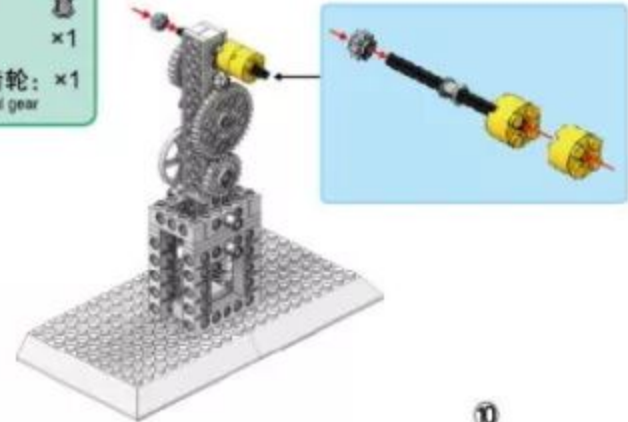

⑩

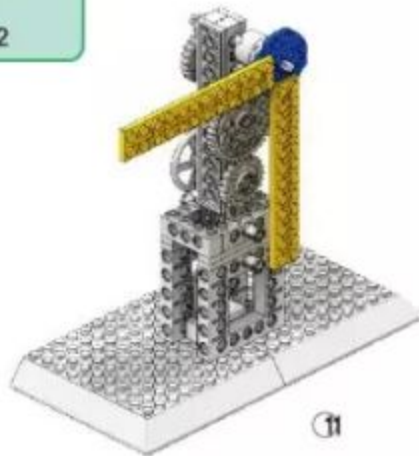
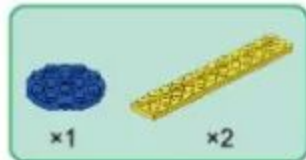

⑪

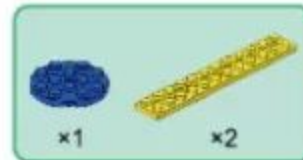

风车 (windmill)



⑫

本产品所含配件还可以搭建以下造型：THE CONTAINS ACCESSORIES OF THIS PRODUCT ALSO COULD BUILDING UP THE FOLLOWING MODELLINGS:

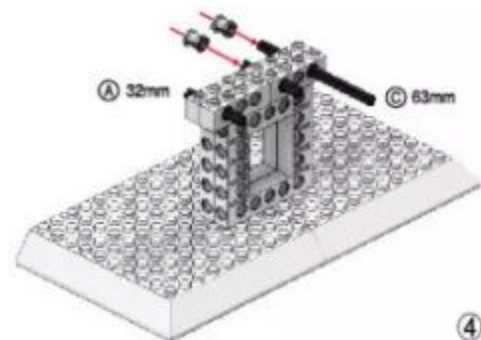
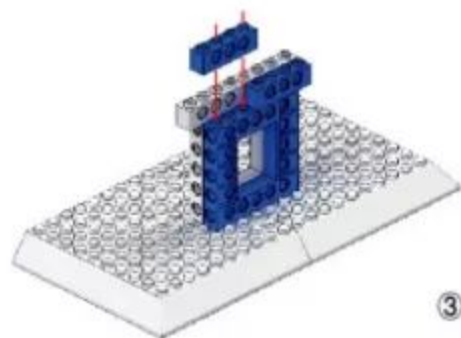
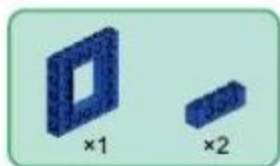
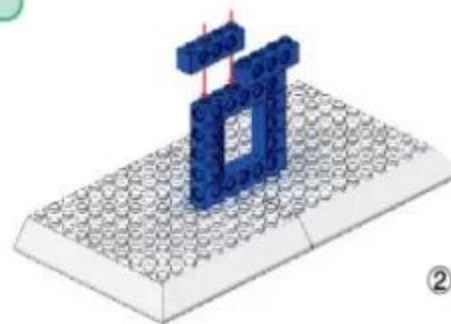
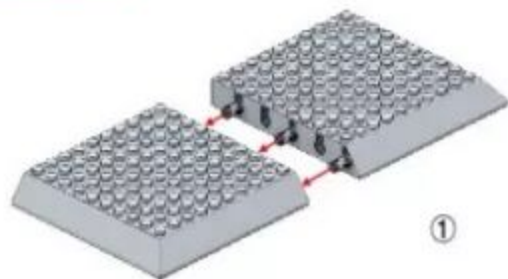
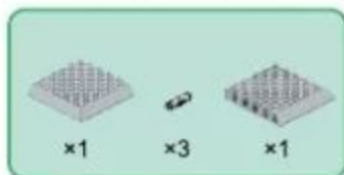

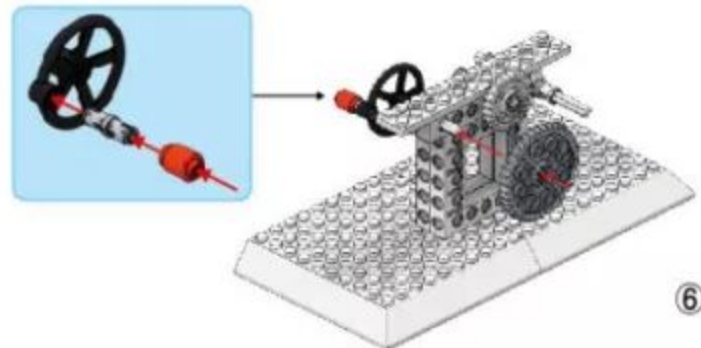
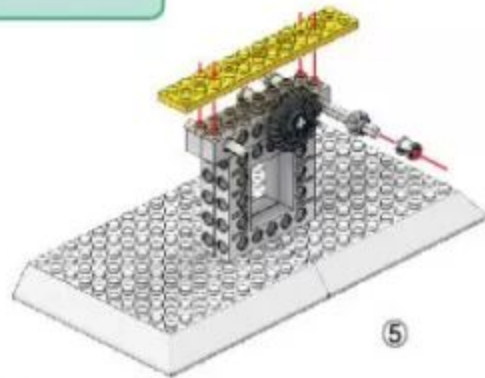

小风车 (small windmill)

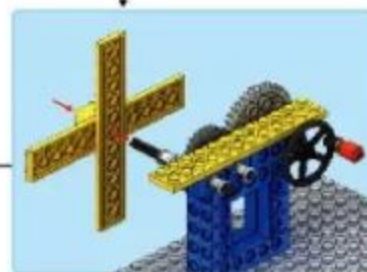
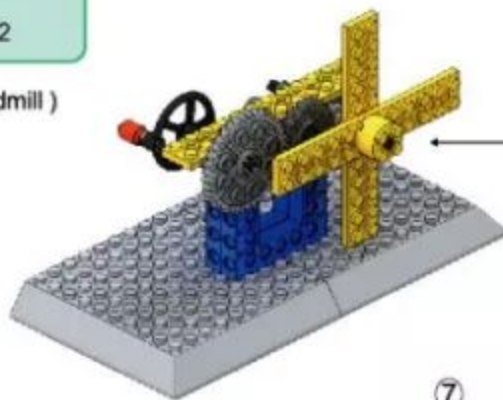

本产品所含配件还可以搭建以下造型：THE CONTAINS ACCESSORIES OF THIS PRODUCT ALSO COULD BUILDING UP THE FOLLOWING MODELLINGS:

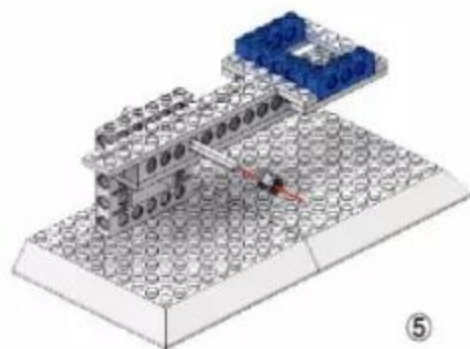
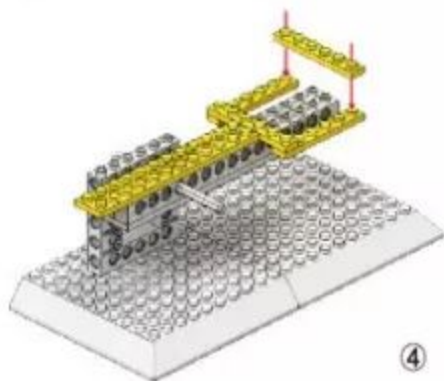
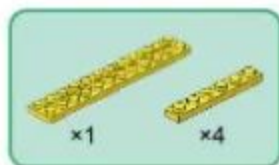
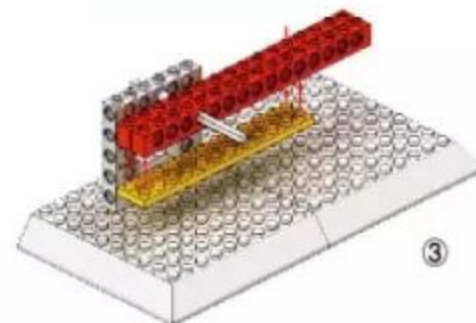
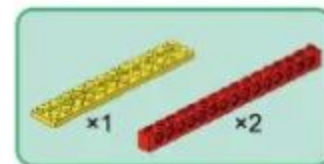
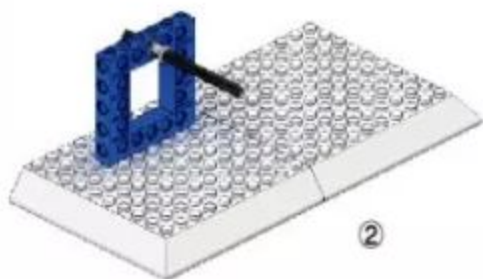
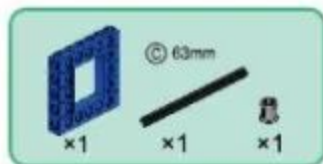
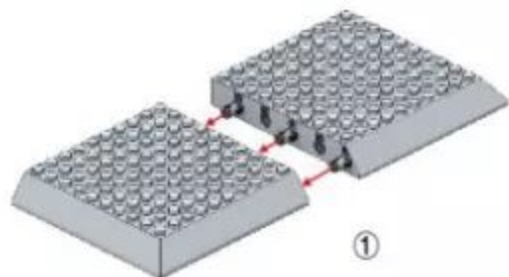
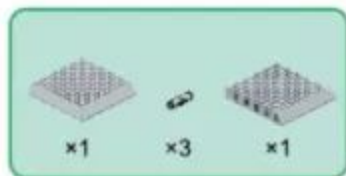

投弹器  
( bomb device )

