

Power Machinery

动力机械

A



1406

▶ WWW.WANGETOYS.COM



Power Machinery



®
Power Machinery
动力机械

长度的对比 length comparation

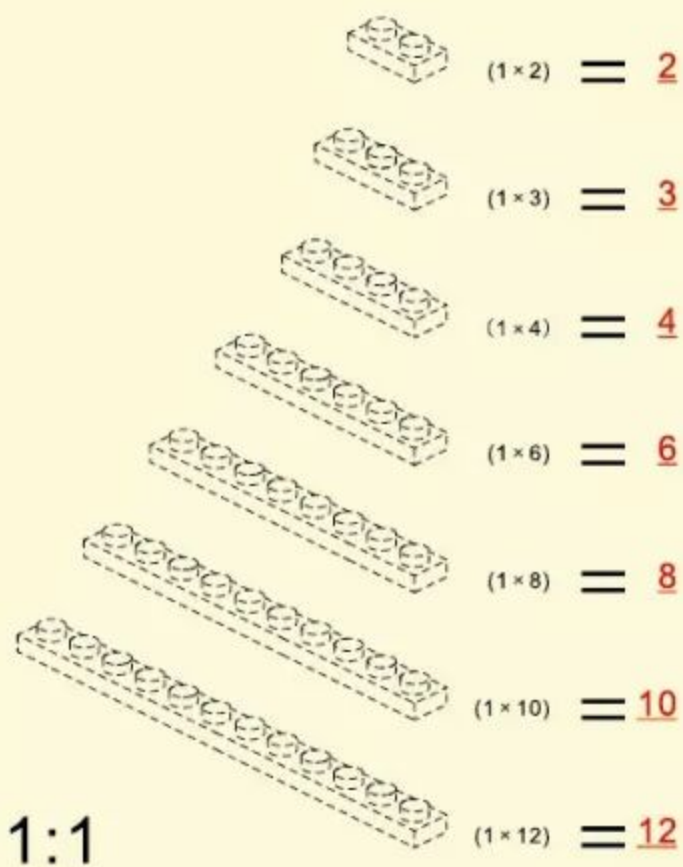

1

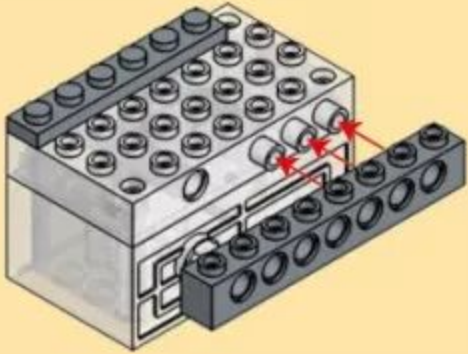
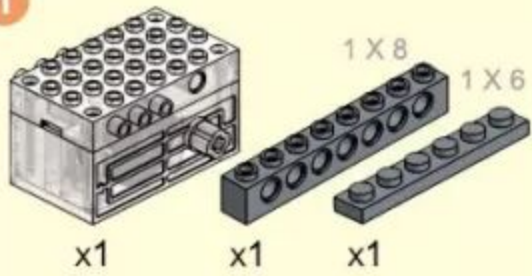

2

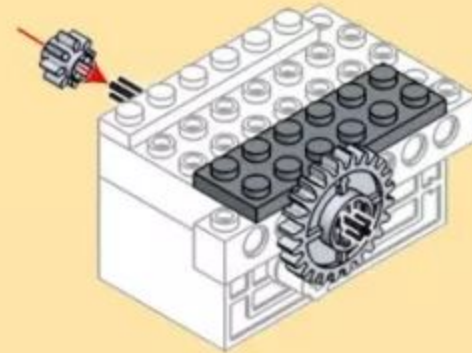
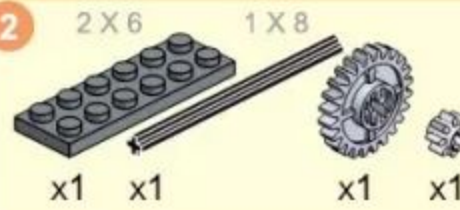

3

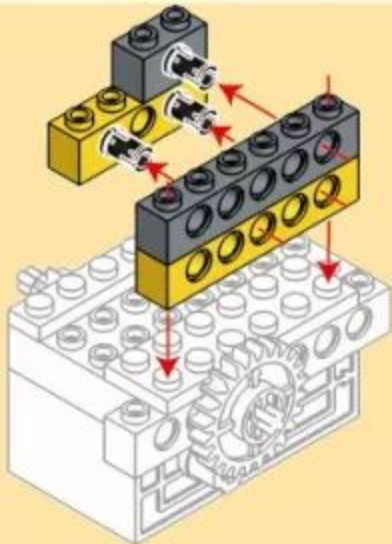
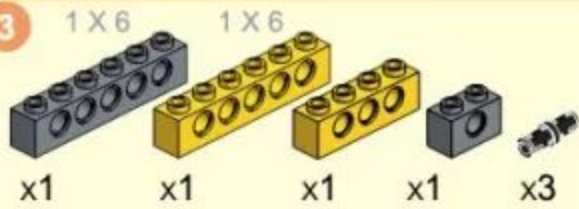

4

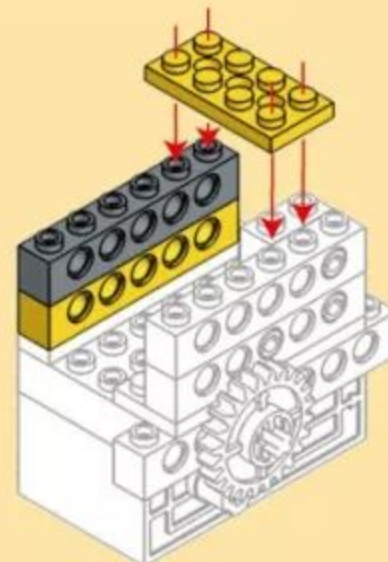
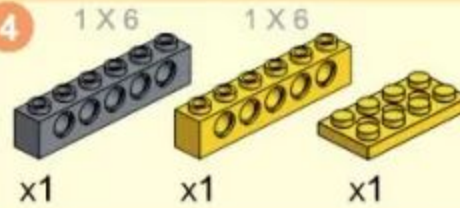

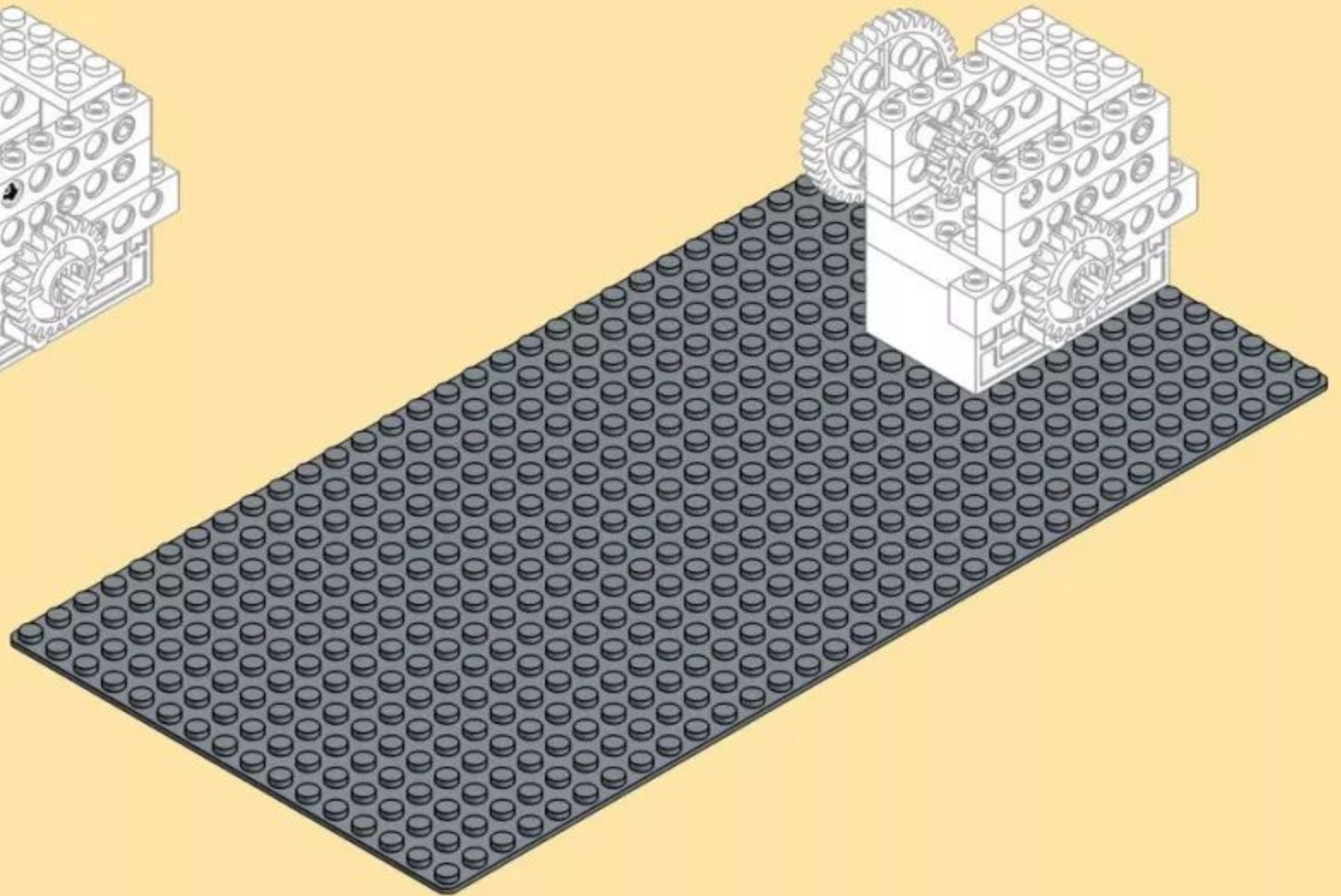
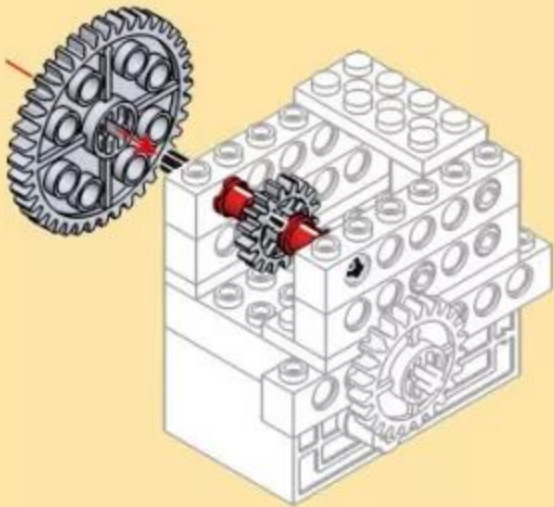
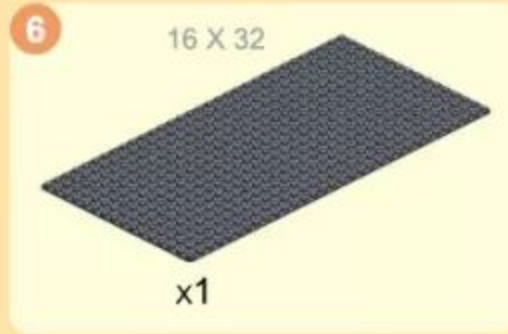
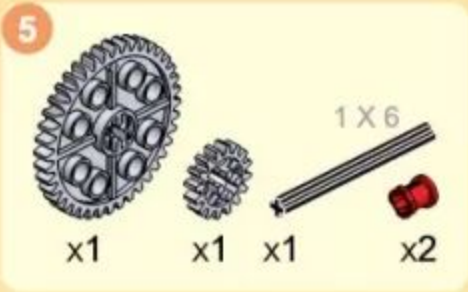

7

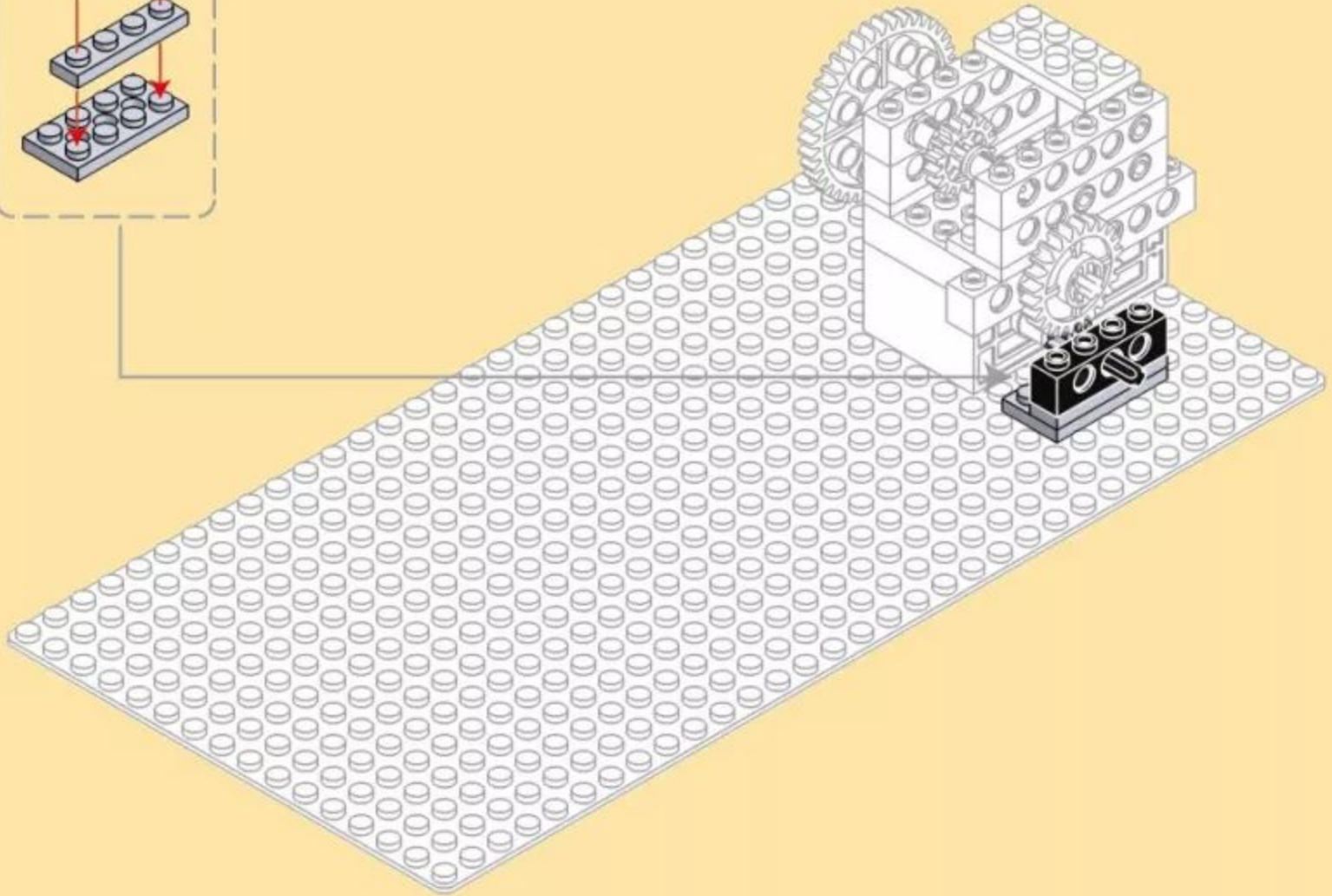
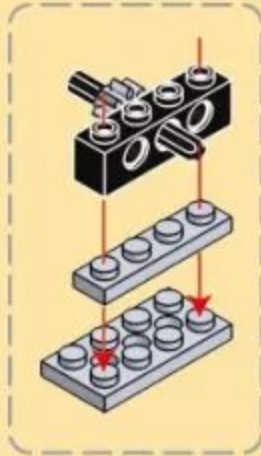
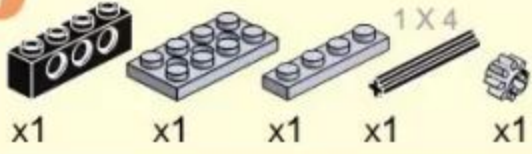

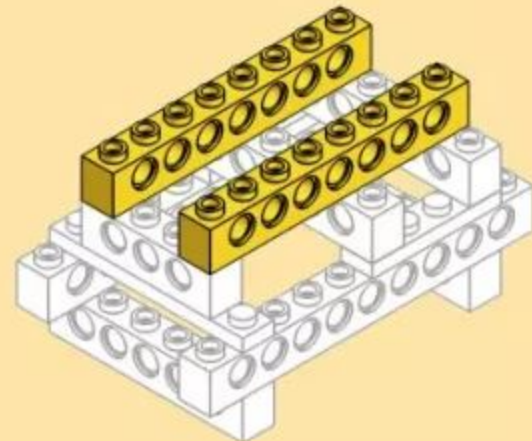
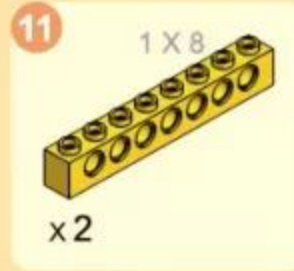
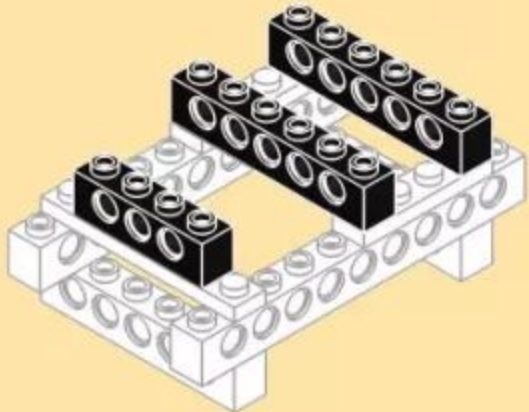
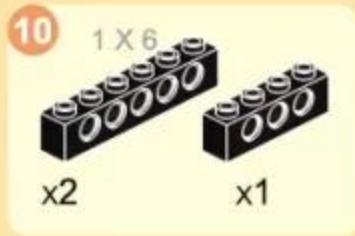
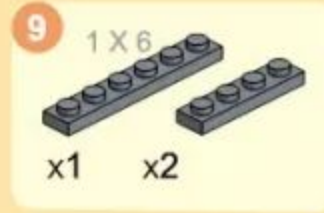
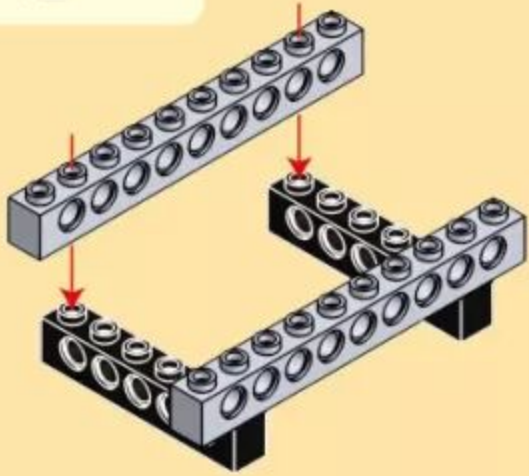
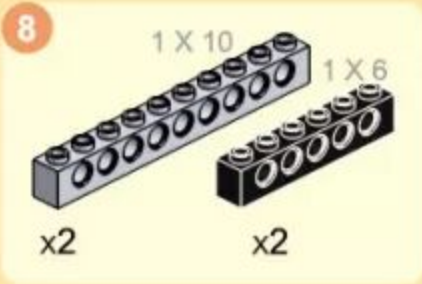

12

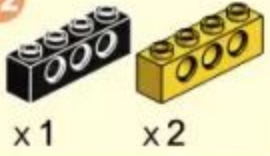

x1

x2



13

1 X 8



x2

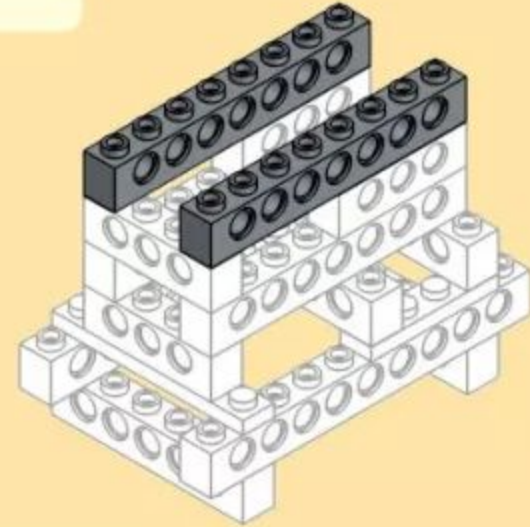

14

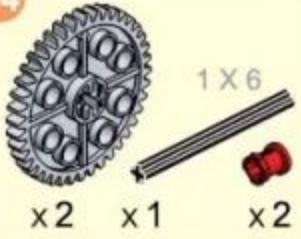

1 X 6

x2

x1

x2

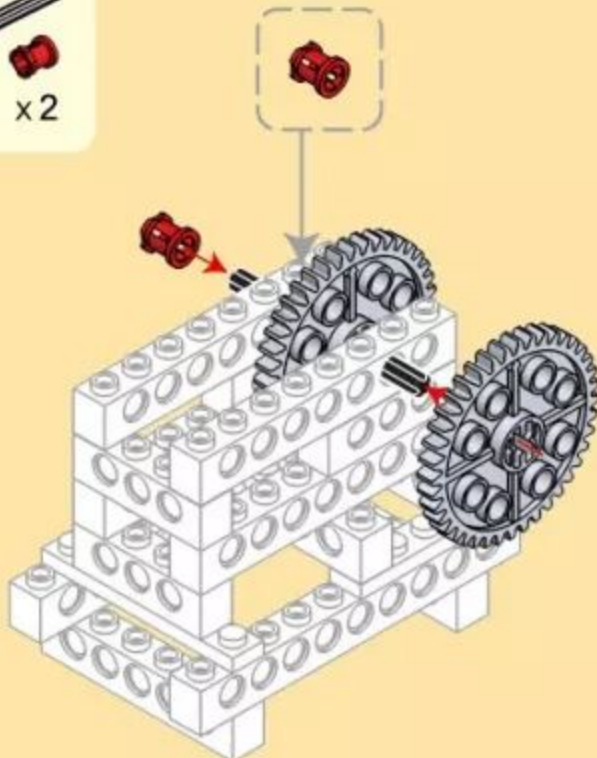

15

1 X 8



x1

x2



16



x1



x2



x2

17

7 + 16

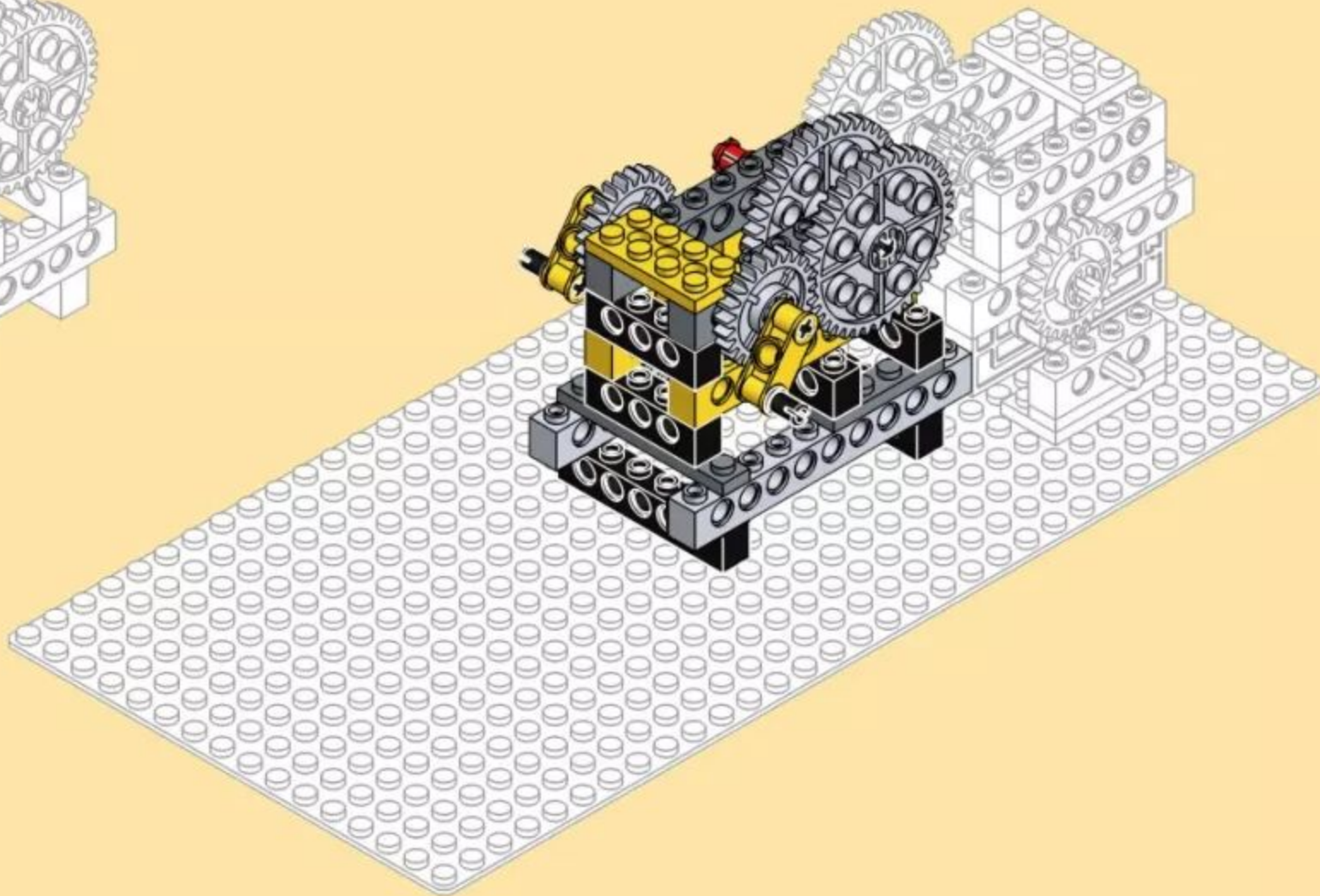
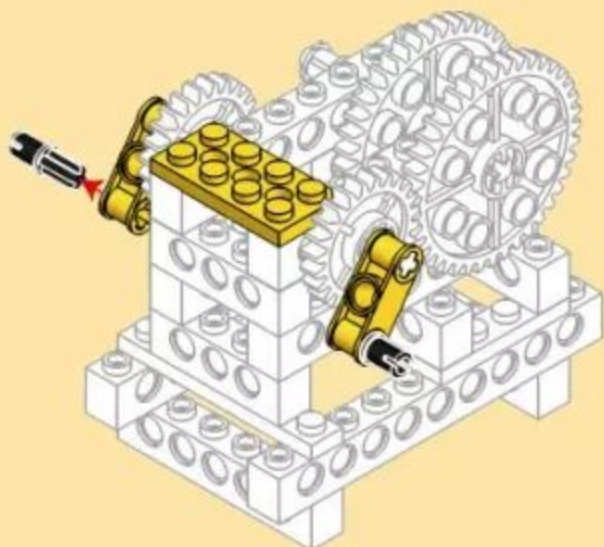

18
x27

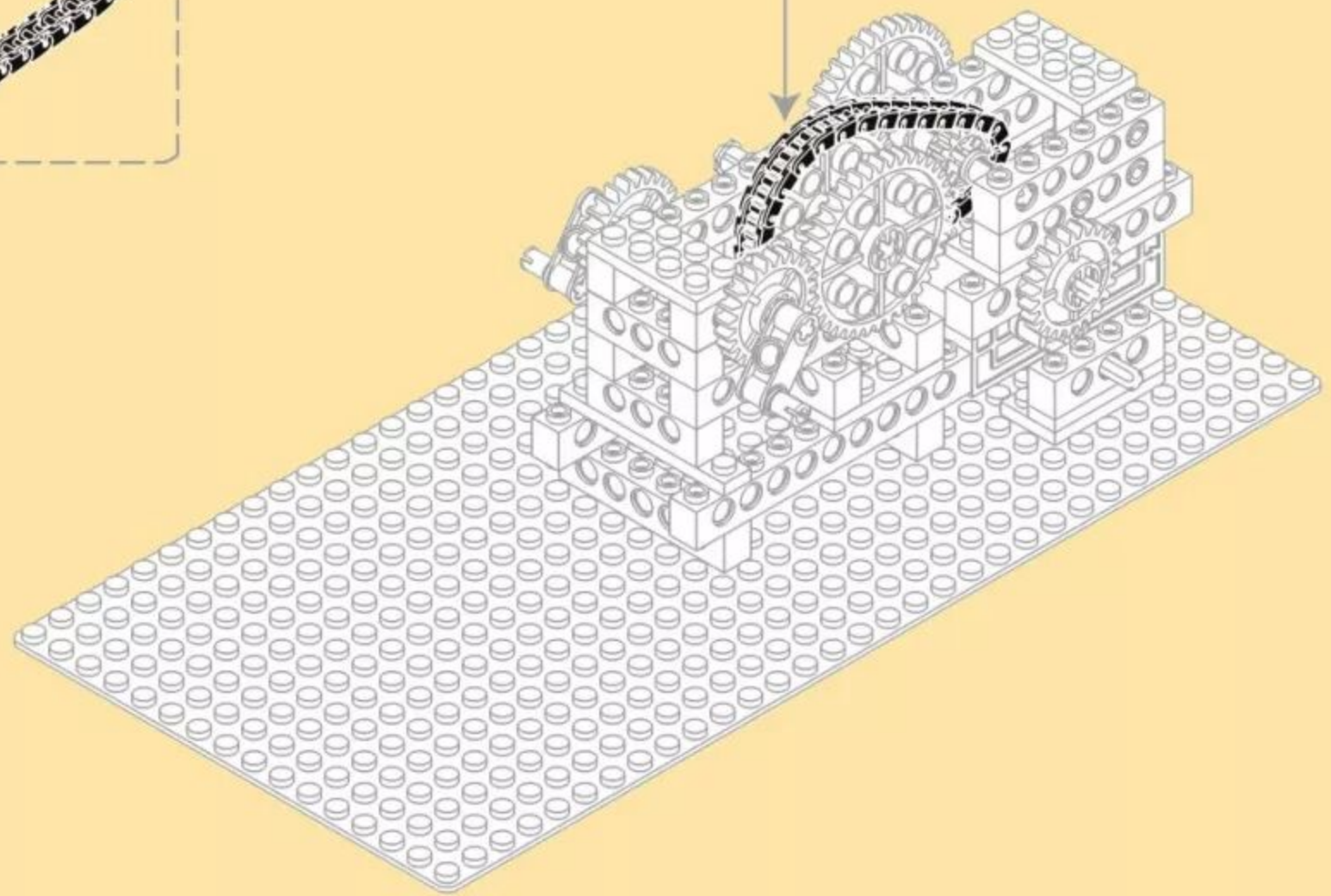

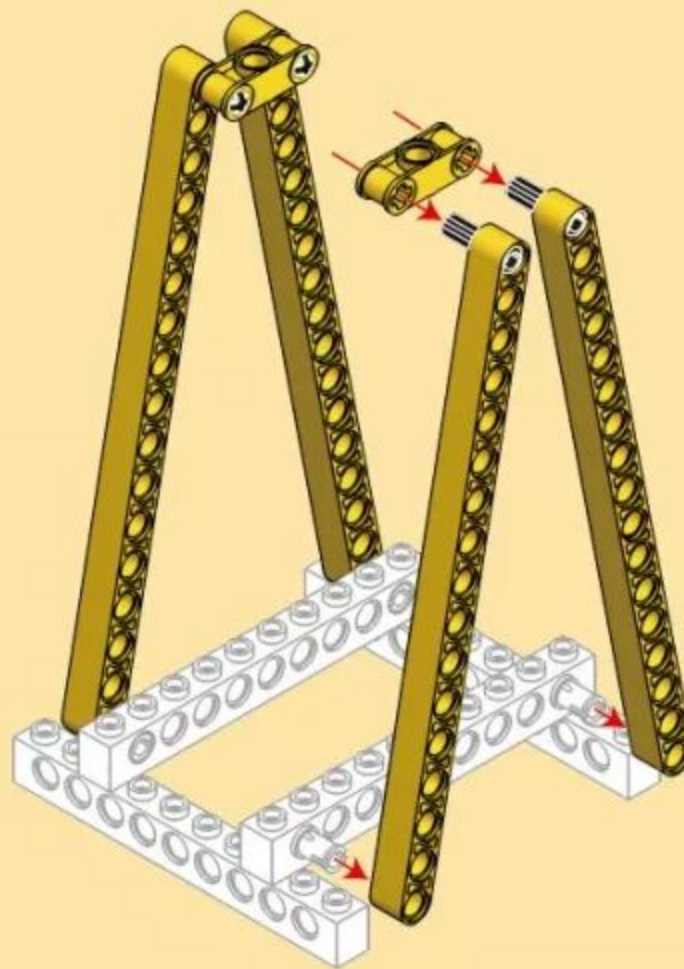
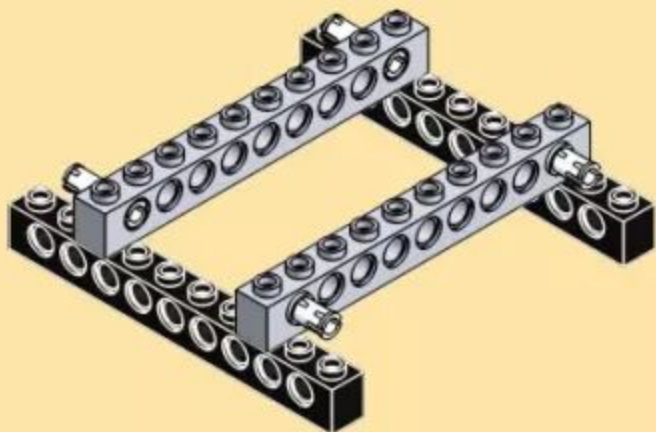
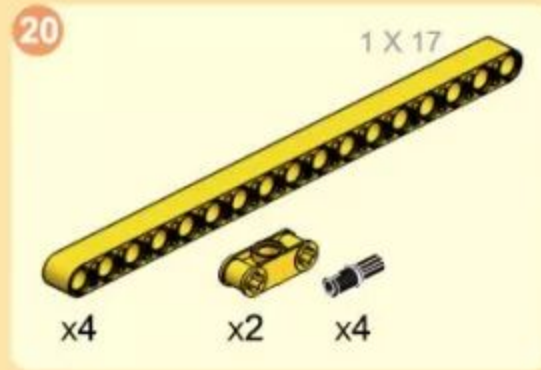
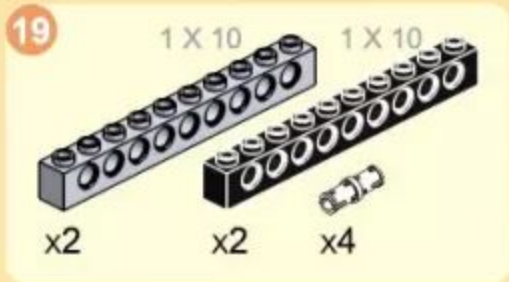

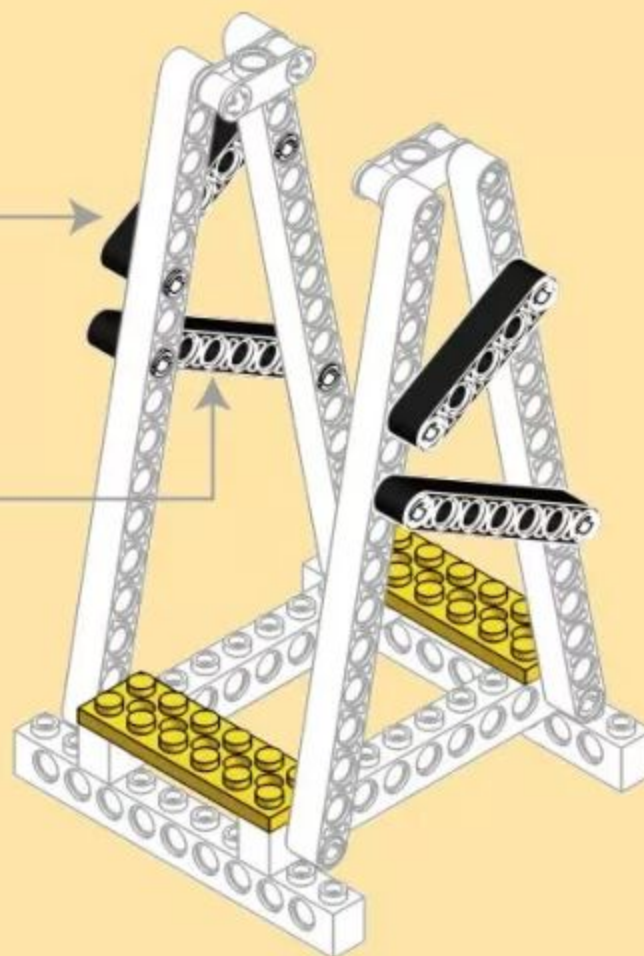
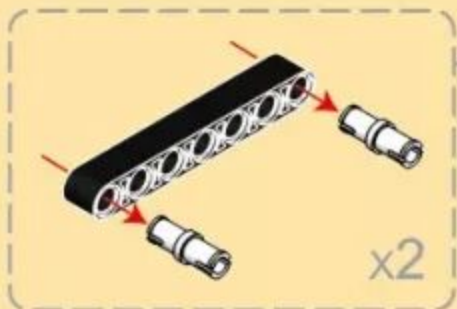
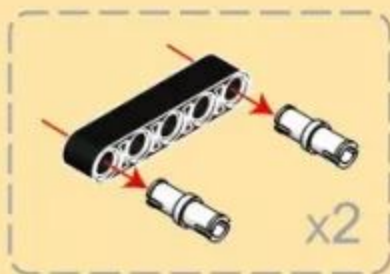
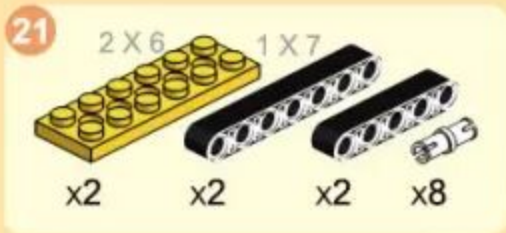

22



x2

x2

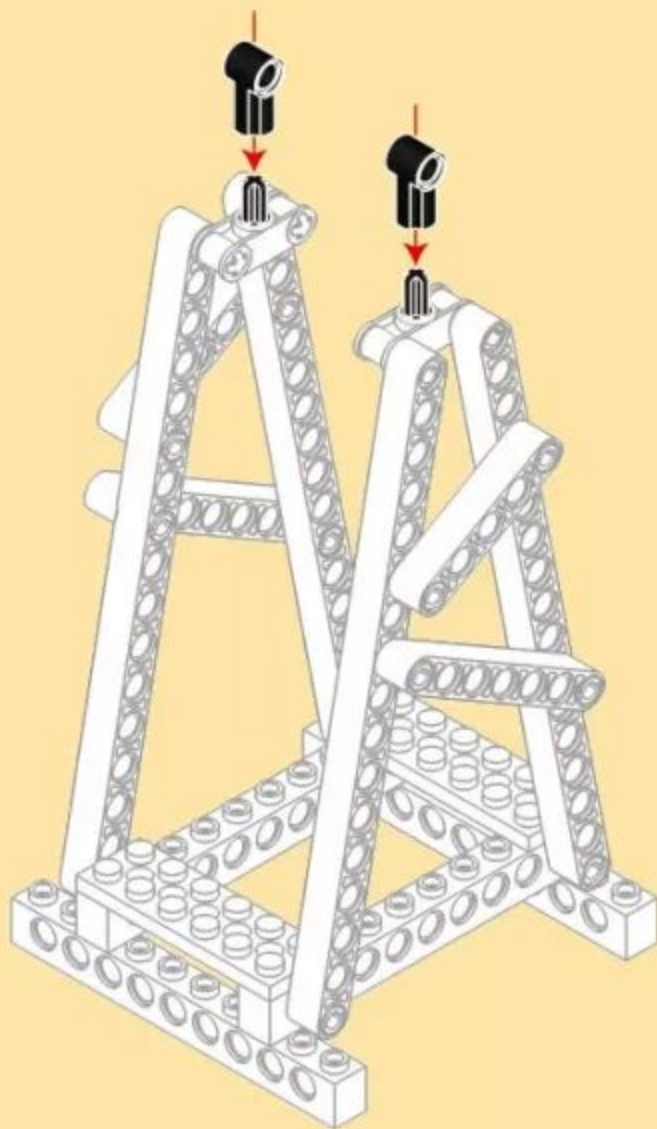

23

18 + 22

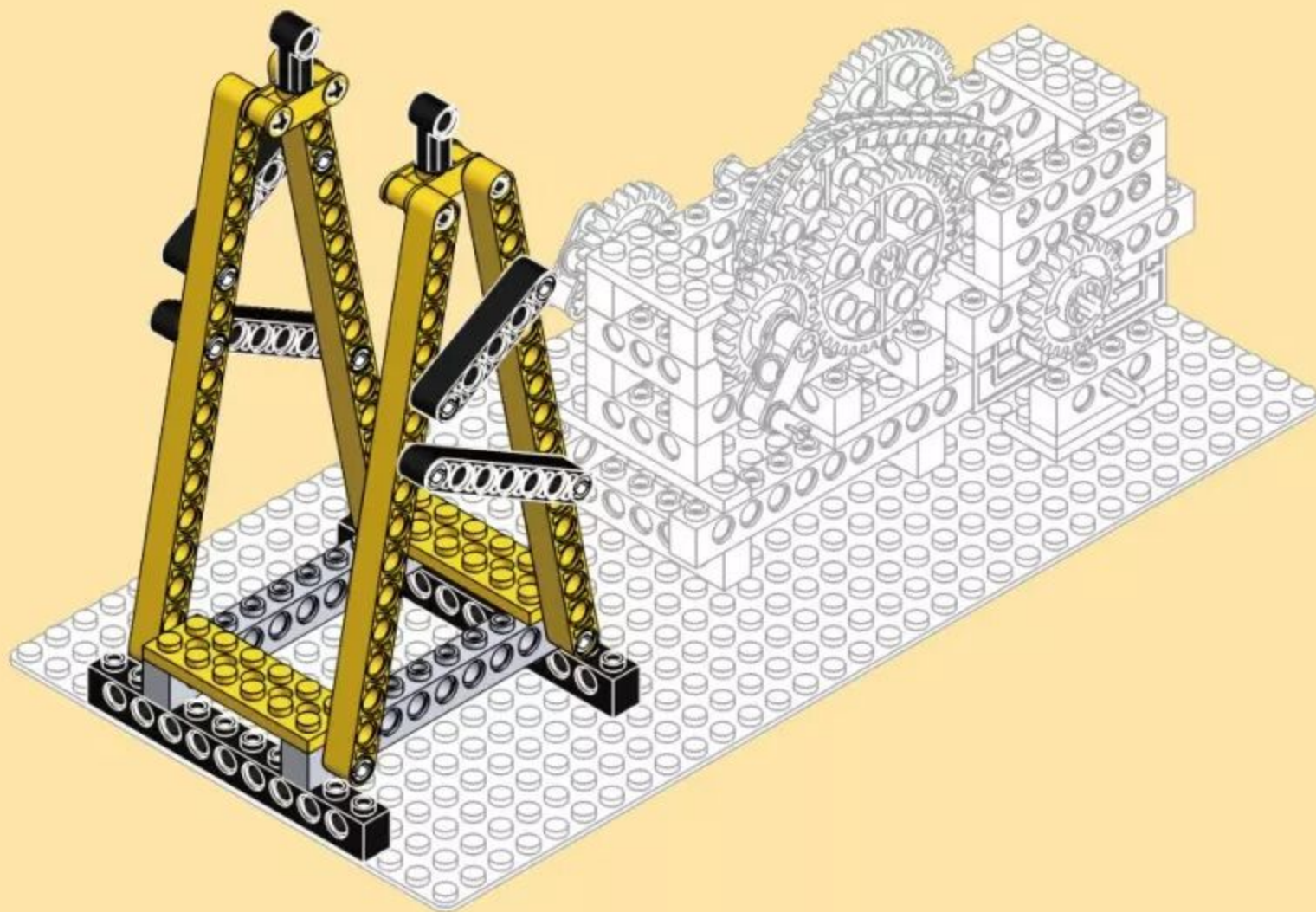

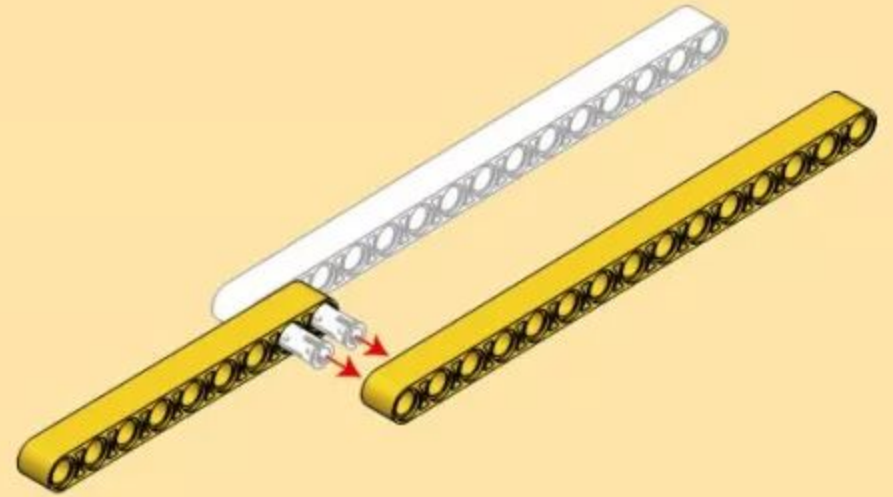
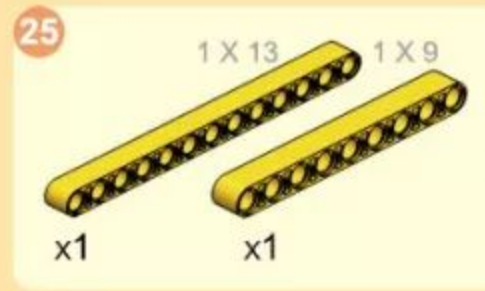
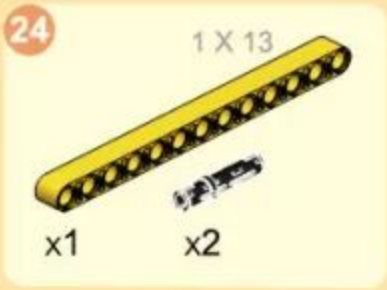

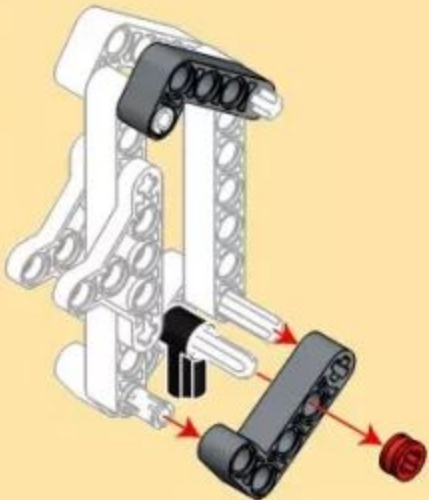
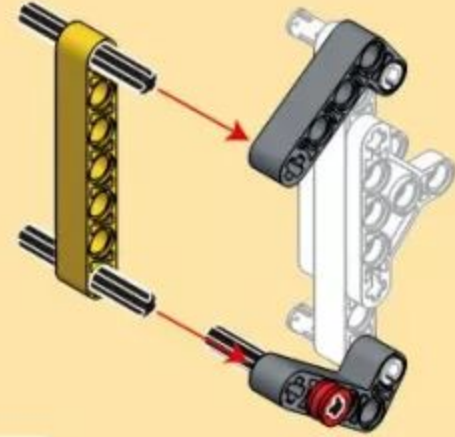
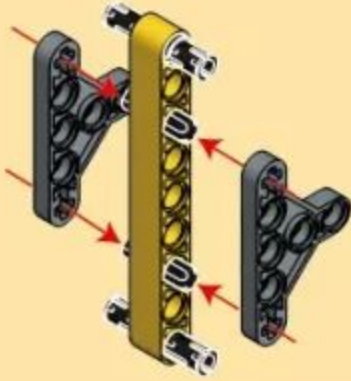
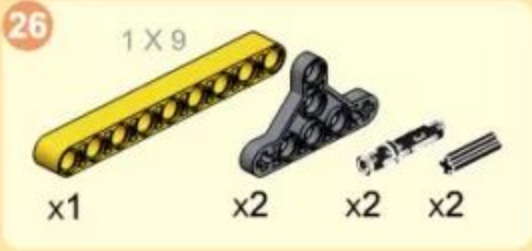

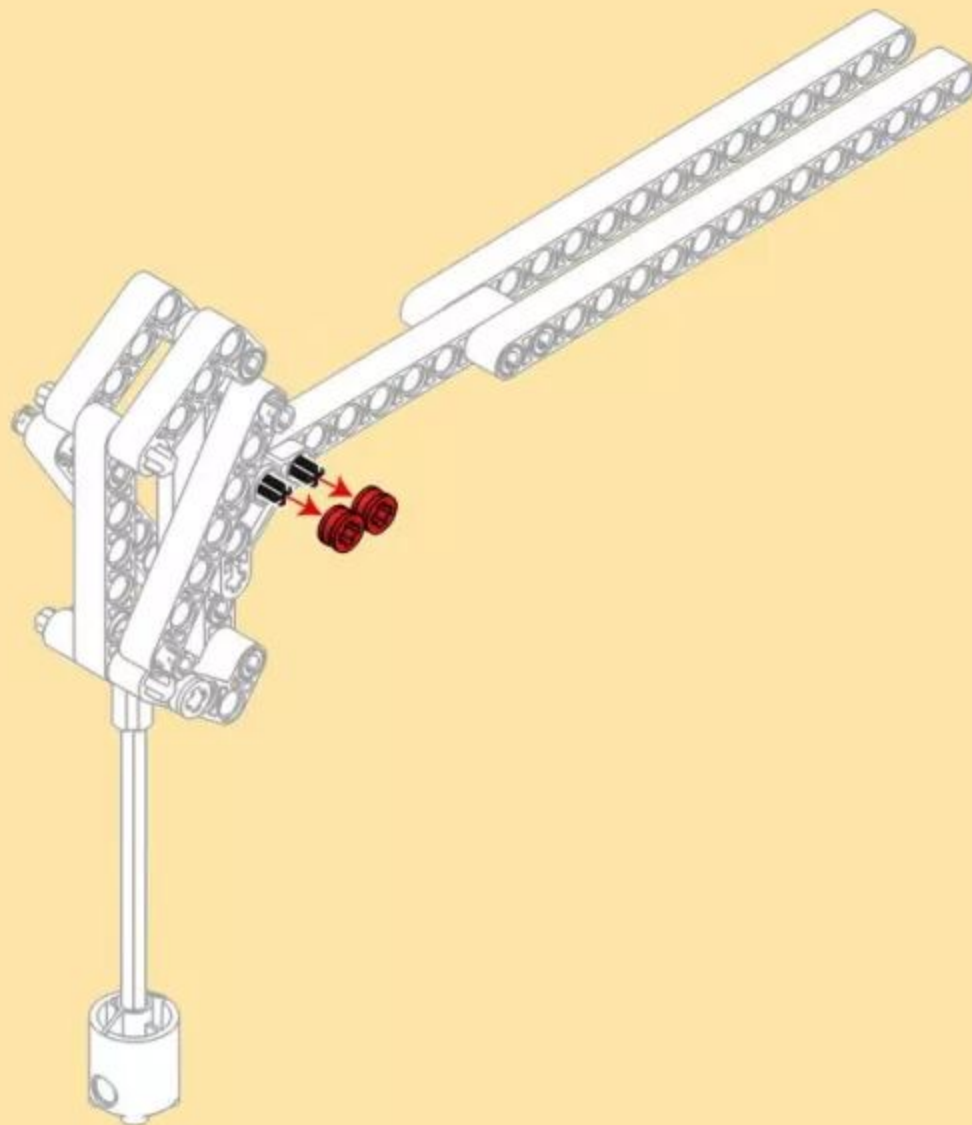
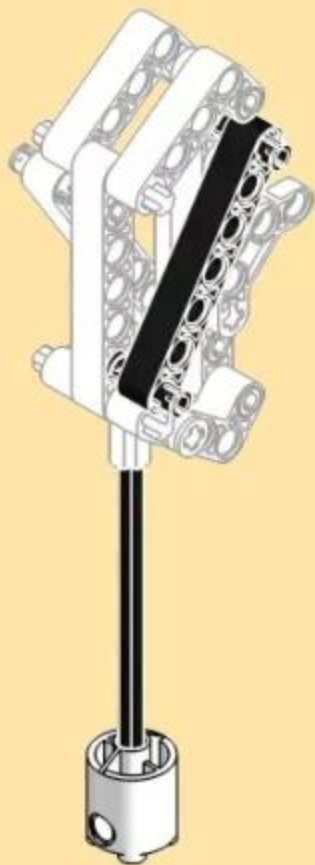
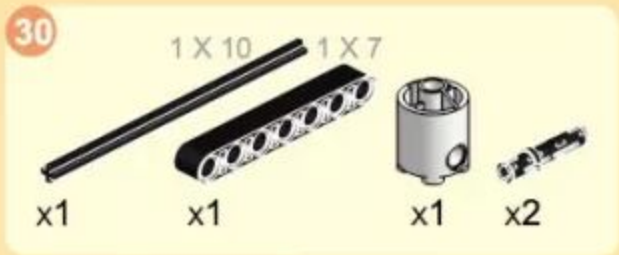

32



x2

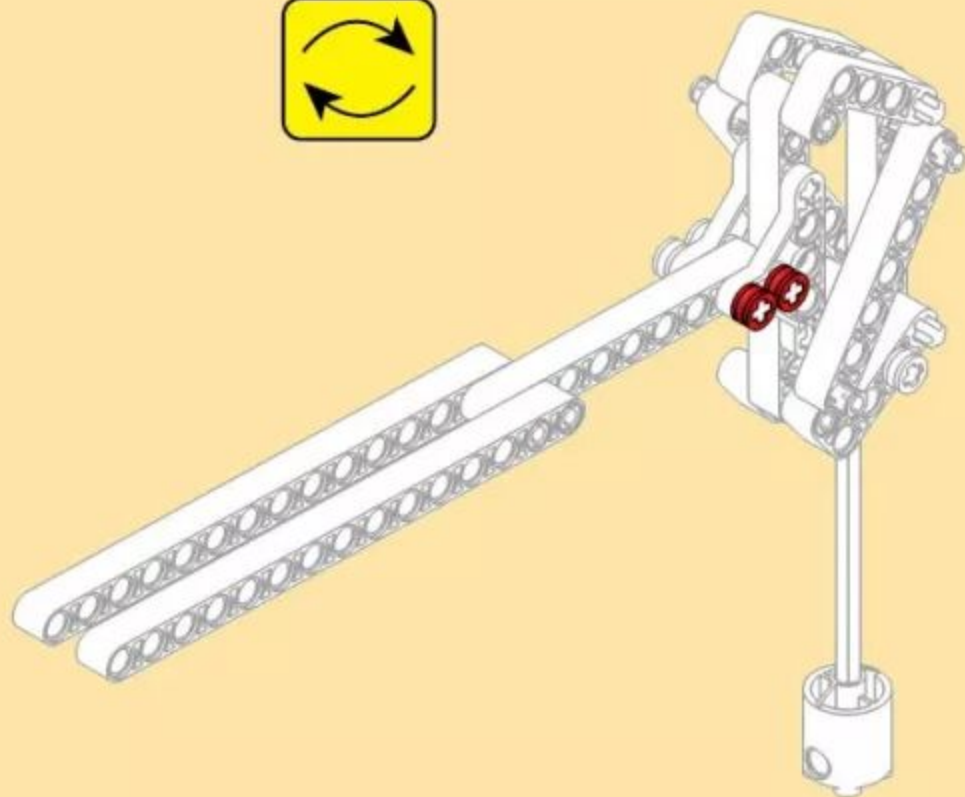

33

1 X 8



x1

x2

x2

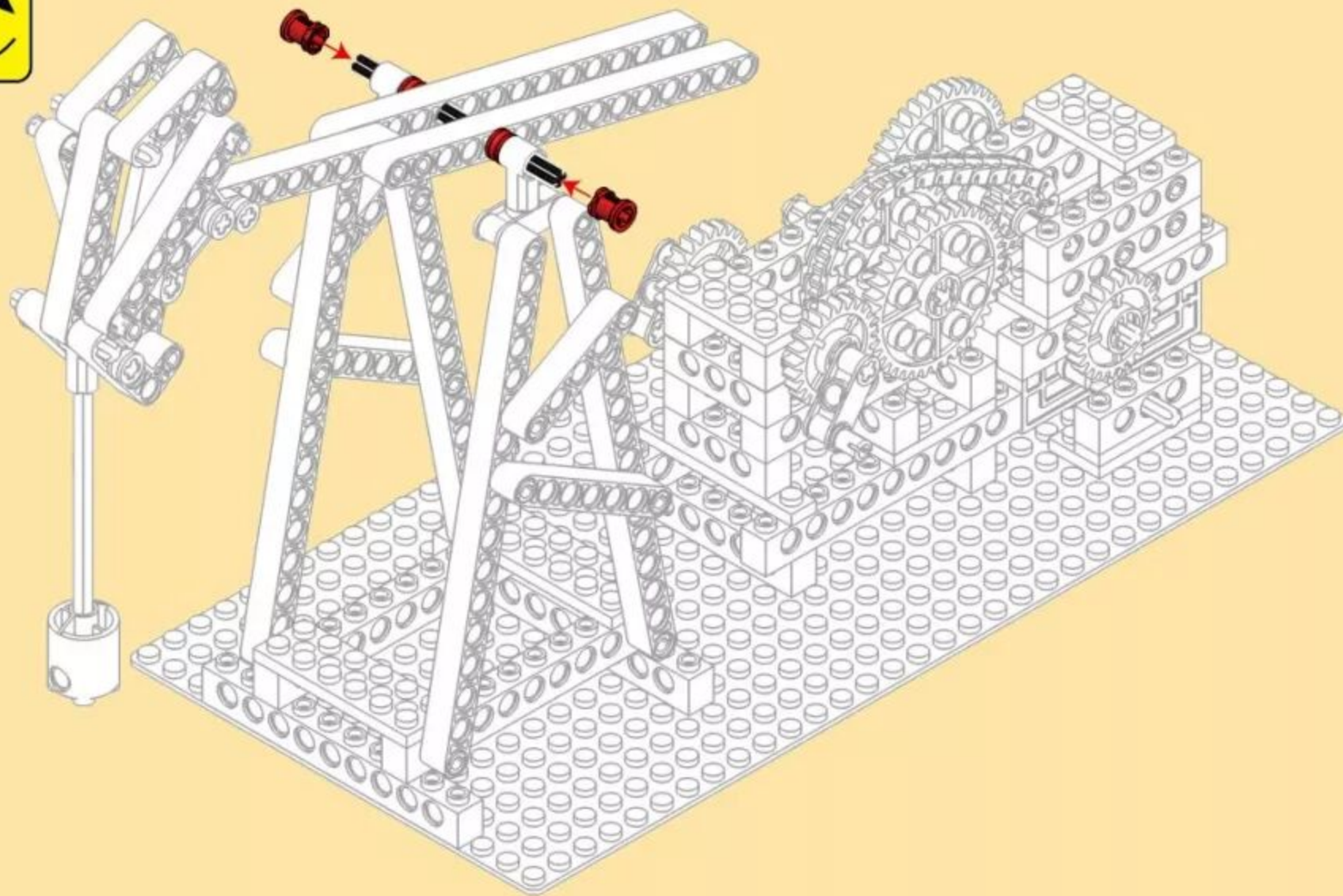

34

1 X 13

1 X 12



x2

x1

x2

x2

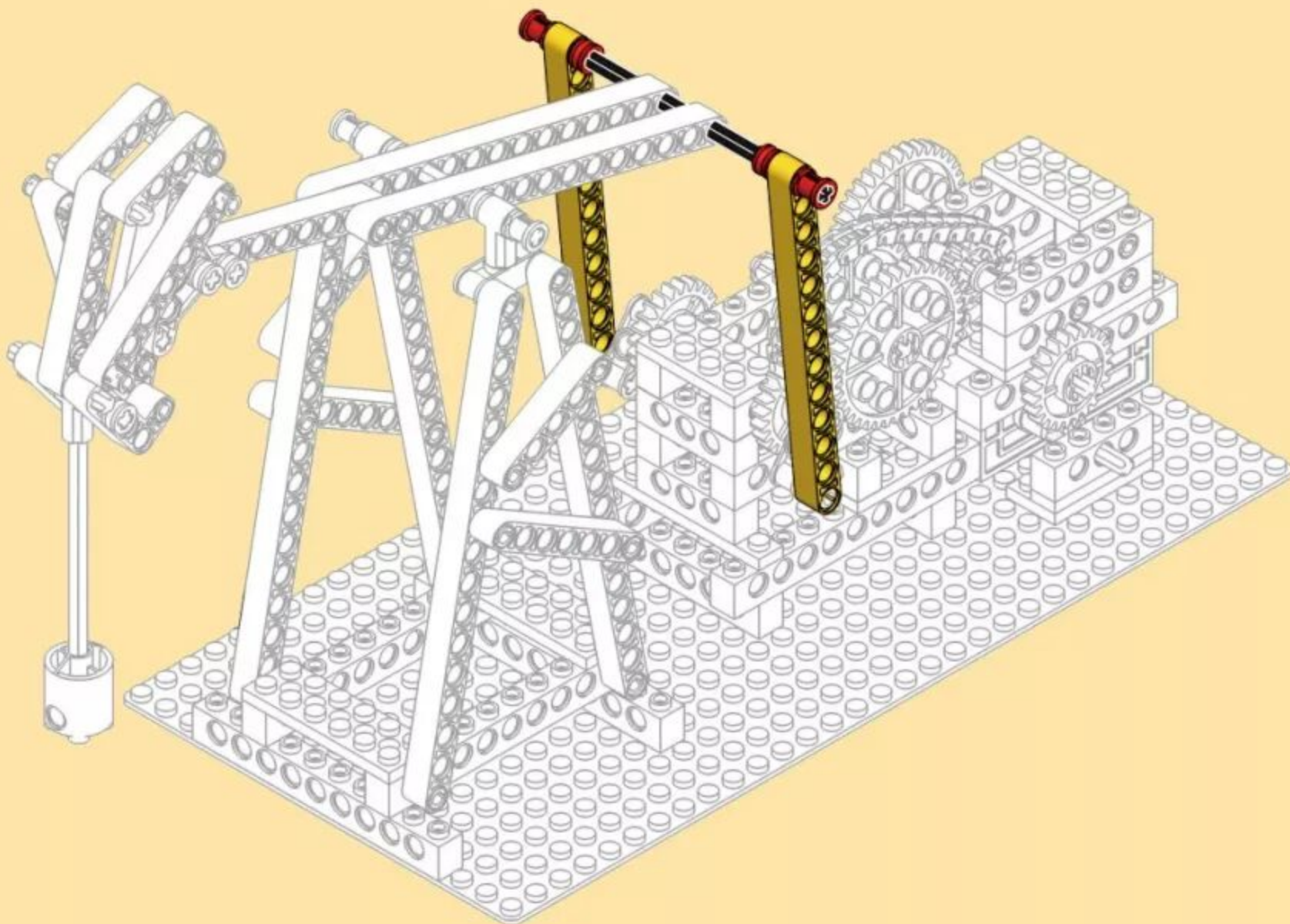

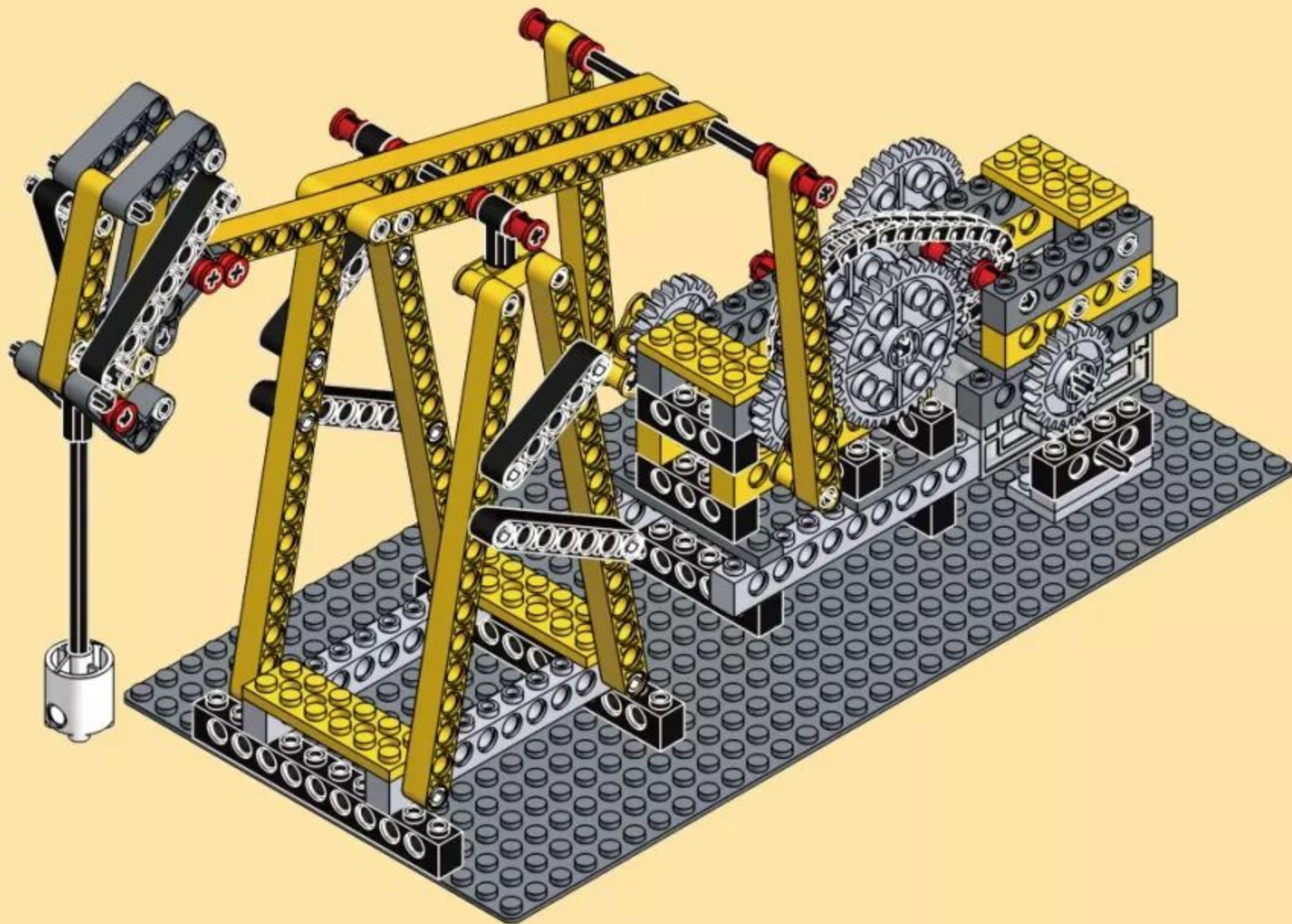

电池安装



1
使用十字螺丝刀将盒盖上的螺丝松开。

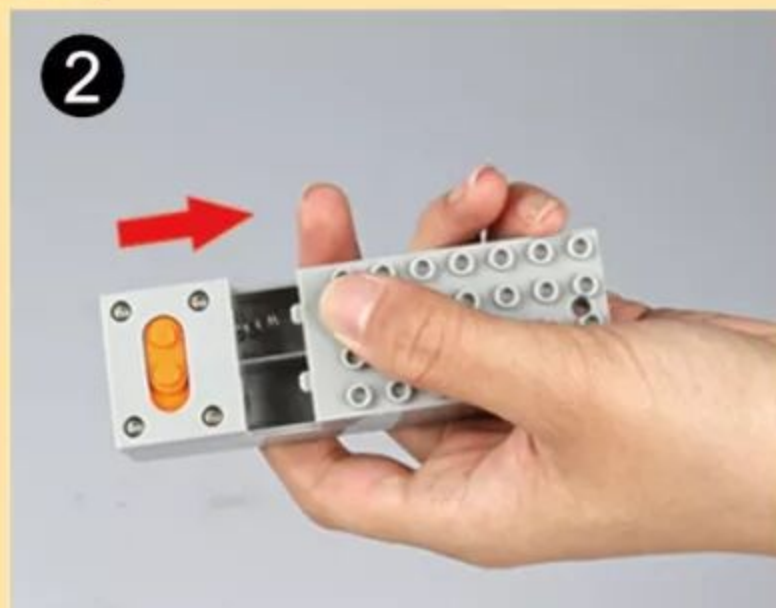

2
将电池盒子的盖子向下划开，打开电池盒。



3
将两颗5号电池分别按照正负极安装到电池盒上。

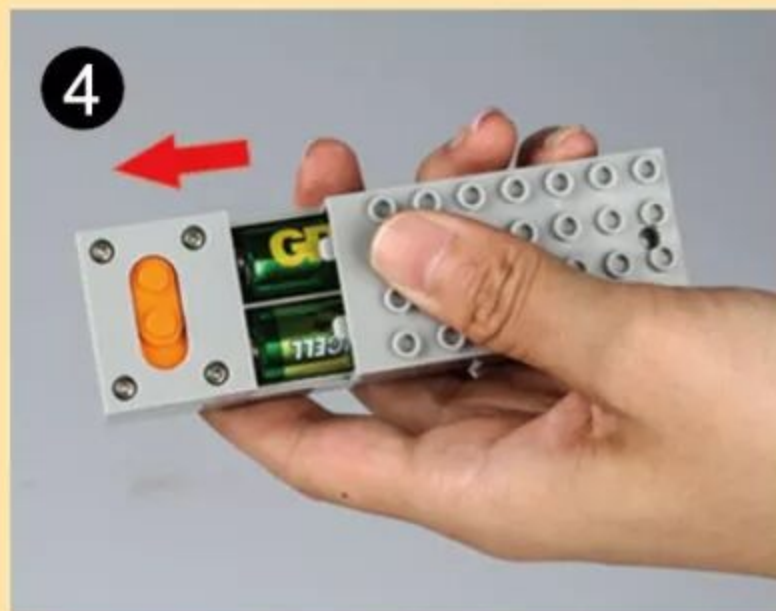

4
将电池盒盖安装回到电池盒子上，并将盒盖上的螺丝安装好。



x2



x1



x1



x3



x4



x4



x2



x2



x3



x4



x8



x2



x3



x8



x3



x2



x27



x1



x2



x1



x3



x1



x2



x2



x2



x4

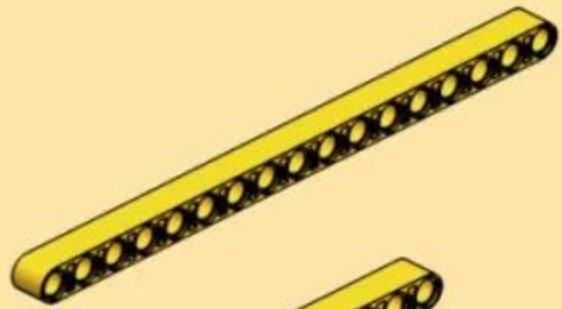

x4

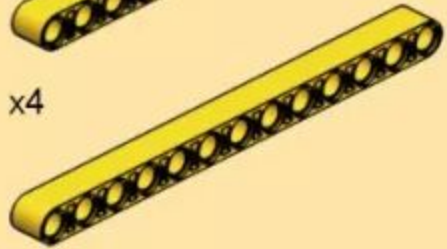

x4

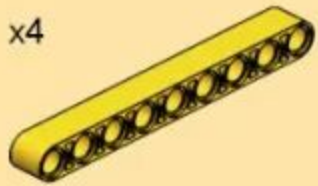

x2

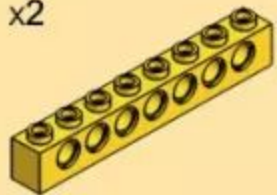

x2



x2

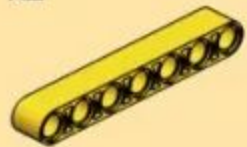

x1

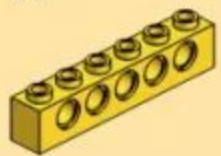

x2

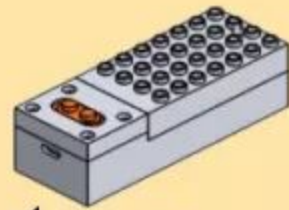

x1

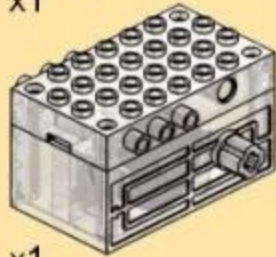

x1



x1



x1



x4



x8



x4



x3



x2



x4



x3



x1



x1



x3



x1



x2



x8



x10

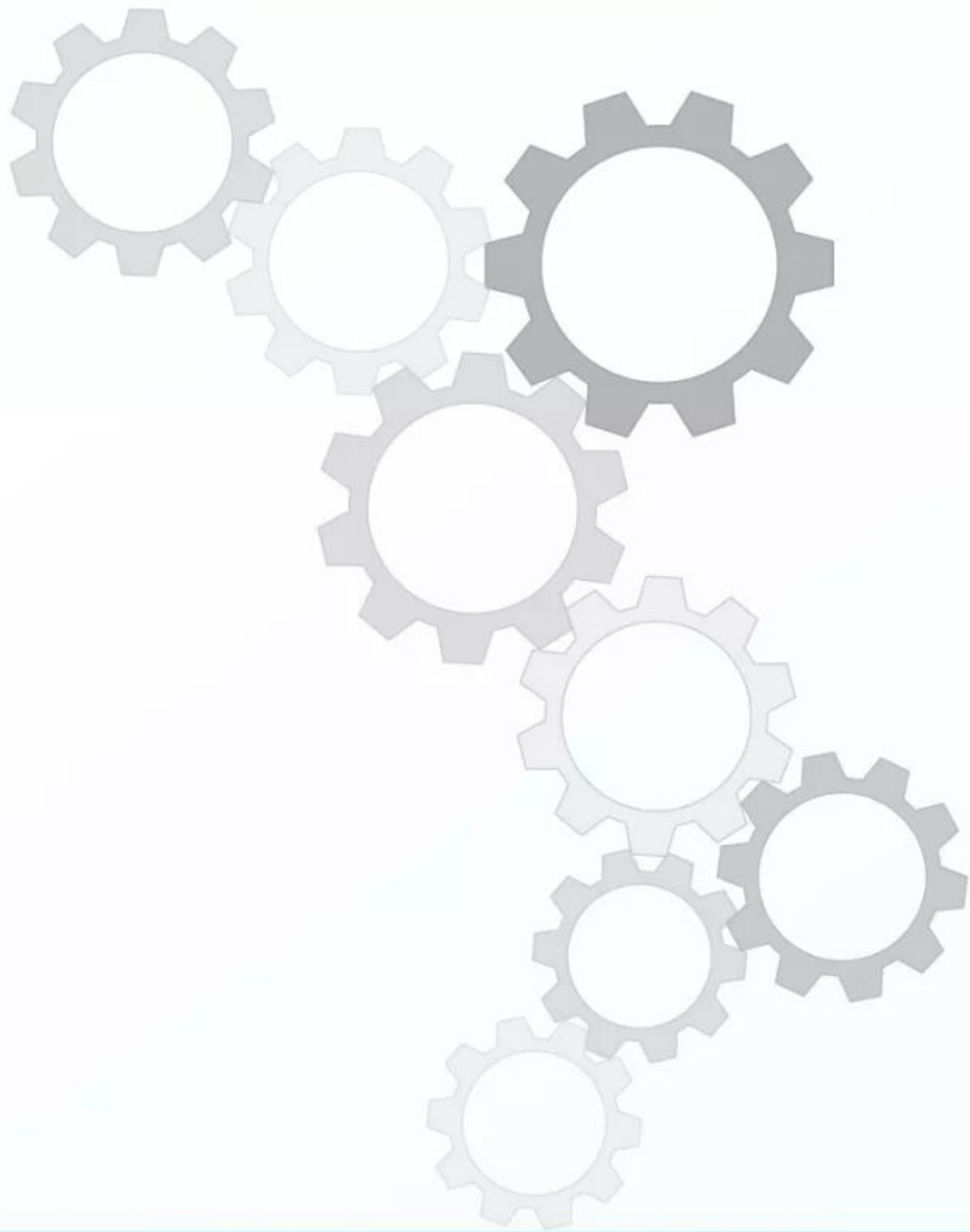

万格微信公众号



万格科技公众号



®

Power Machinery