



**1**

4x10      2x8

1x6      3x4      1x6

x1      x2      x4      x4

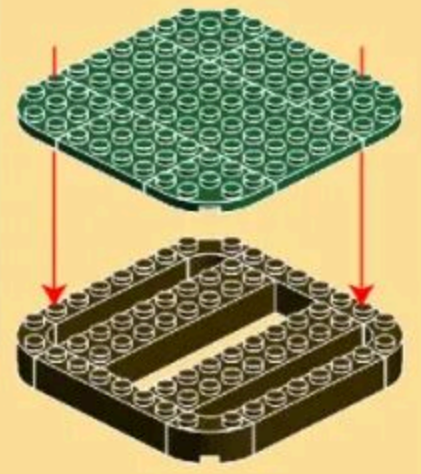

**2**

4x4      1x6      3x4

x1      x1      x1

x1      x1      x3      x1      x1



**3**

x1      x1      x1      x1      x1      x1



**4**

x1      x3      x1      x4      x1      x1

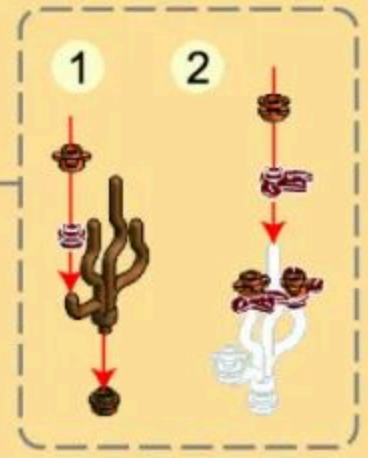

**5**

x1      x1      x1      x2      x2      x1      x1      x2

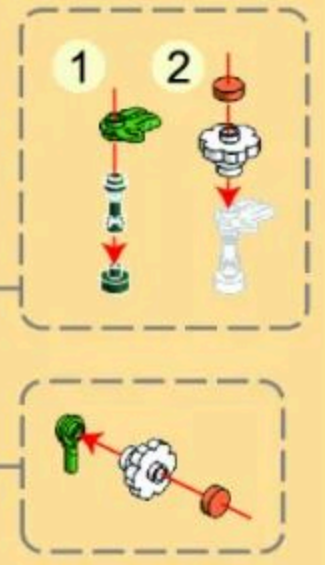
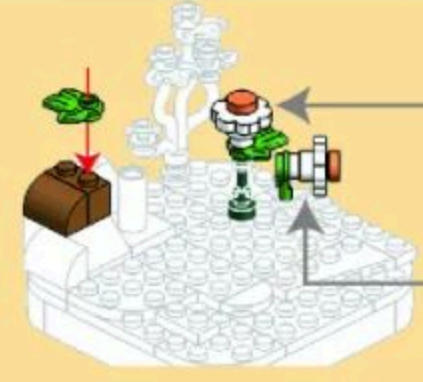

**6**

x1      x2      x1      x1      x2      x1

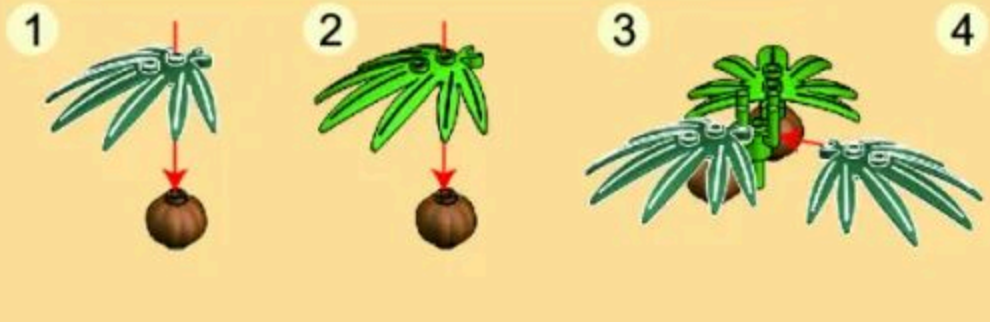

**7**

x1      x2      x2      x4      x2      x2

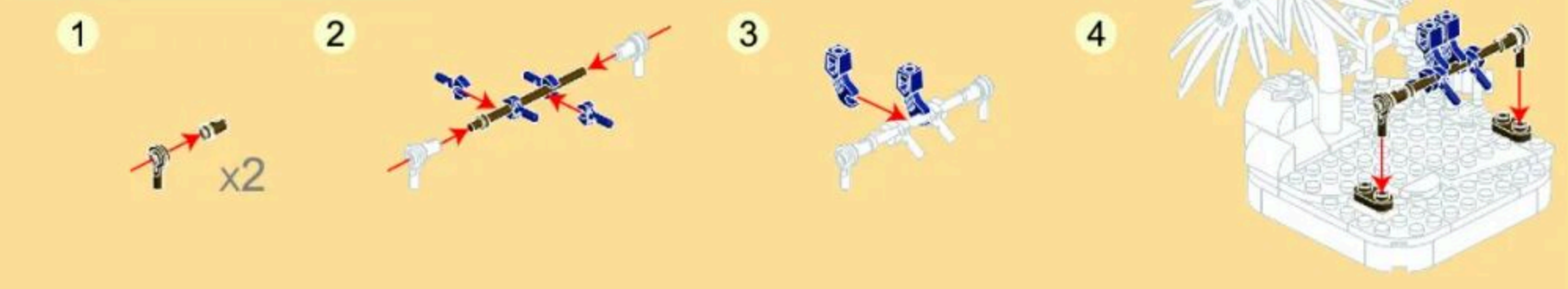

- 8
- x1
  - x1
  - x2
  - x4
  - x1
  - x1
  - x1



- 9
- x1
  - x1
  - x1
  - x2
  - x1
  - x1
  - x3
  - x1
  - x2
  - x2
  - x1
  - x2
  - x2
  - x2
  - x1
  - x2
  - x1
  - x1

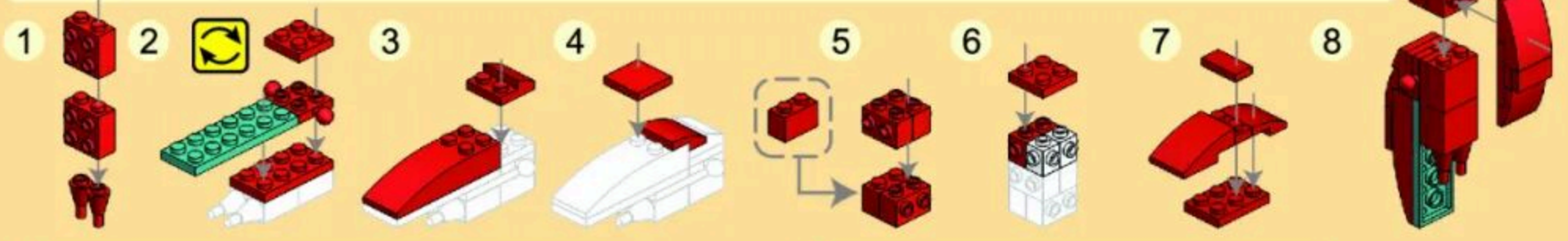

- 10
- x1
  - x1
  - x1
  - x1
  - x1
  - x1
  - x1
  - x1
  - x1
  - x1

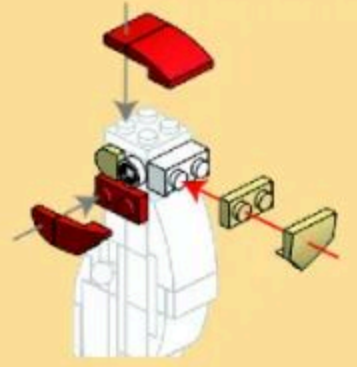

- 11
- x1
  - x1
  - x1
  - x1
  - x1
  - x1
  - x1
  - x1

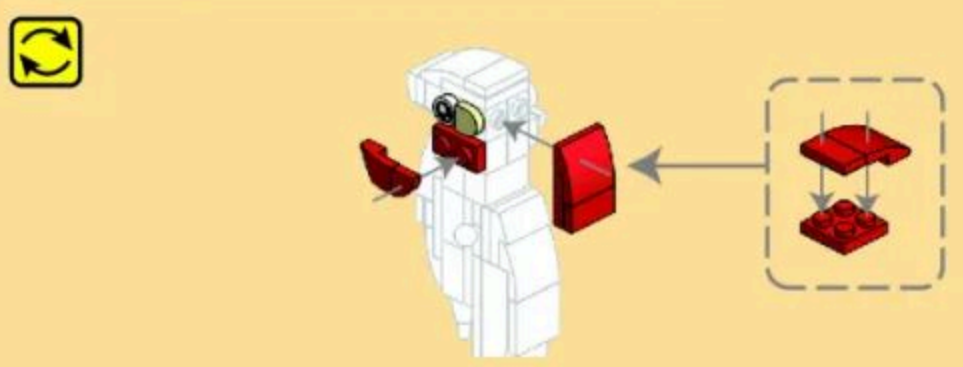

- 12
- x1
  - x1
  - x1
  - x1
  - x1
  - x1
  - x1
  - x1
  - x1
  - x1

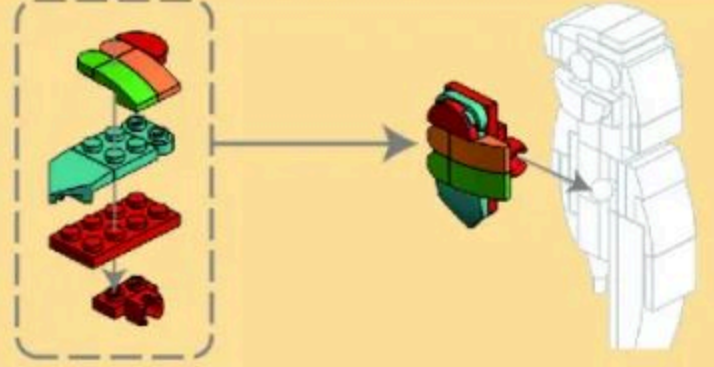

- 13
- x1
  - x1
  - x1
  - x1
  - x1
  - x1
  - x1
  - x1
  - x1
  - x1

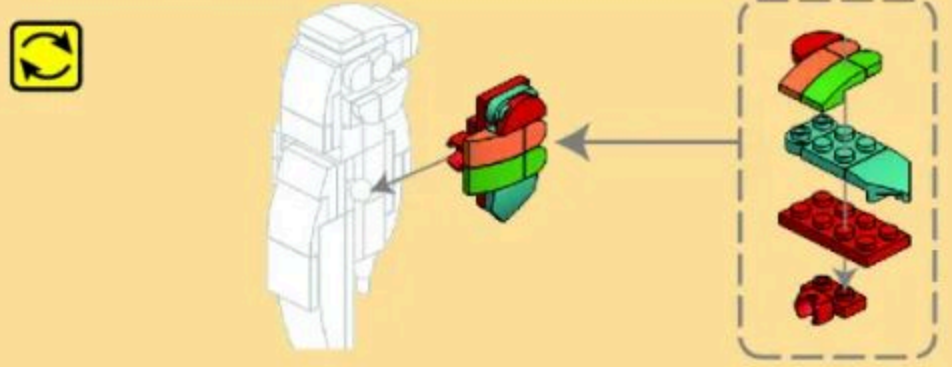

14 8 + 13

