



SUPERCAR

Can exercise the following abilities of baby
• Developing thinking / thinking skills / creativity and imagination skills / understanding using numbers
• Developing skills / fine motor skills / building skills / understanding of space / understanding of physics

2882



6+ | 143 PCS



- 1
x1 x1 x2 x1

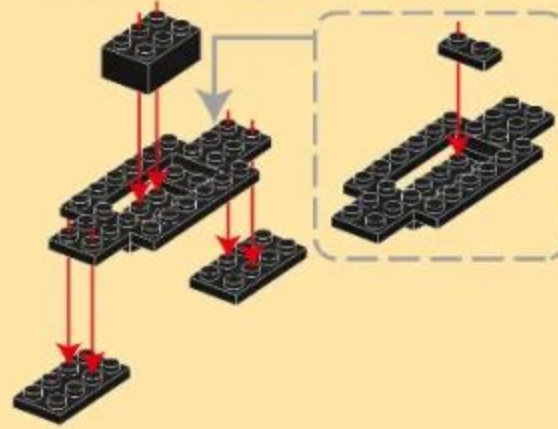

- 2
x1 x1 x1 x1 x2

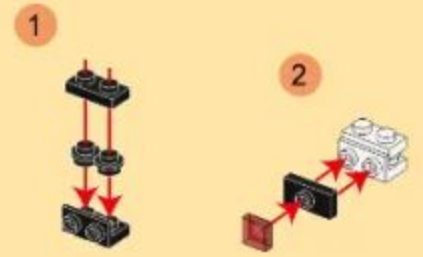

- 3
1 + 2

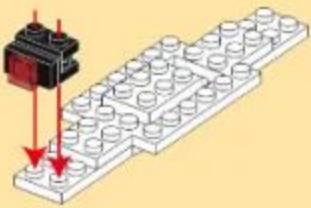

- 4
2x6 x2 1x3 x2 x2 x2 x2



- 5
3 + 4

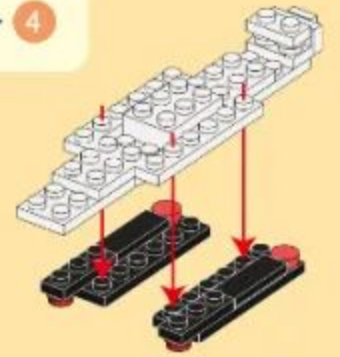

- 6
x2 x1 x2 x2 x1

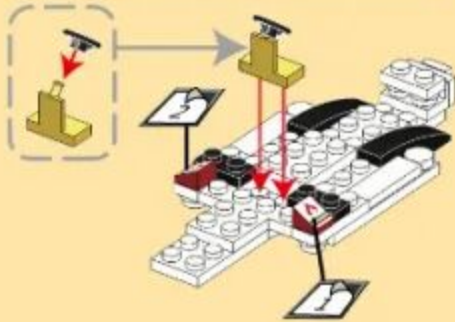

- 7
1x3 x4 x4 x8

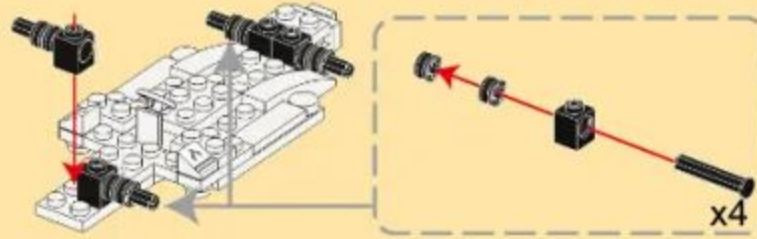

- 8
x3 x1 x1 x2

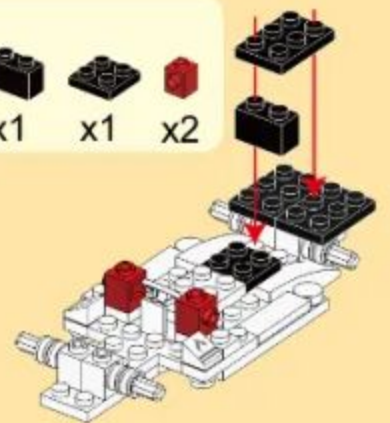

- 9
x2 x2 x2

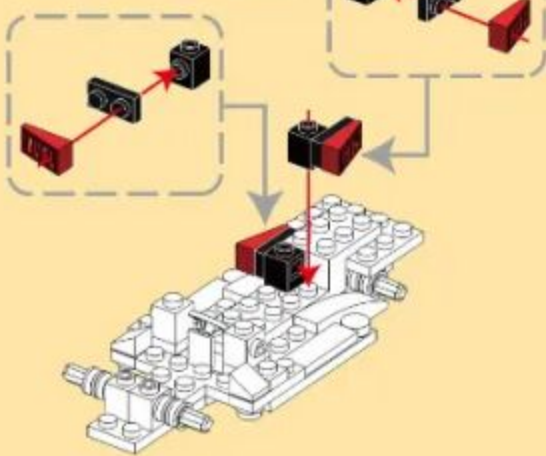

- 10
1x3 x2 x2 x2 x6

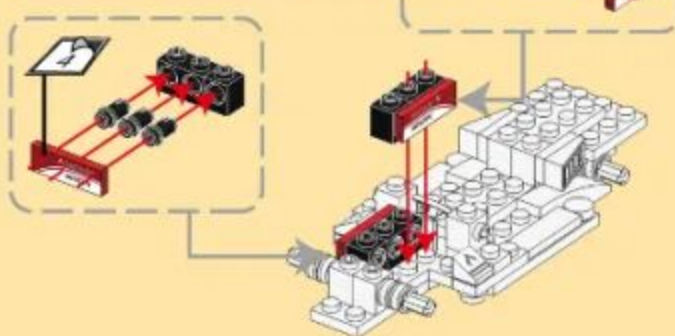

- 11
x2 x1 x2

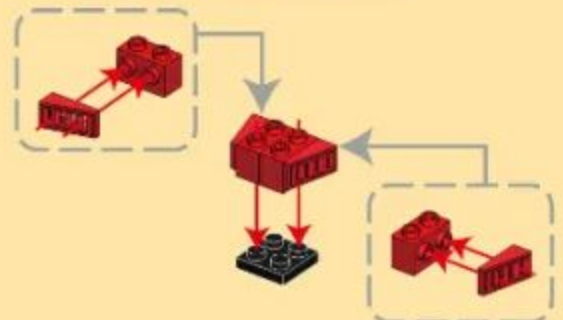

- 12
10 + 11

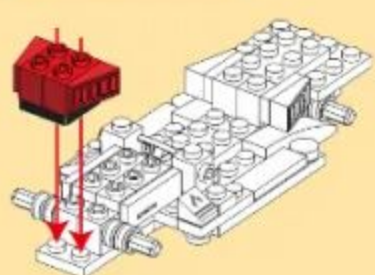



- 13
x2 x4 x2

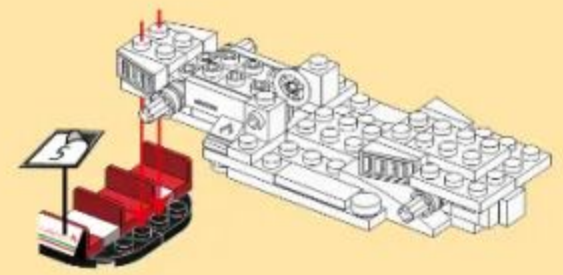

- 14
12 + 13



- 15  x1  x1 

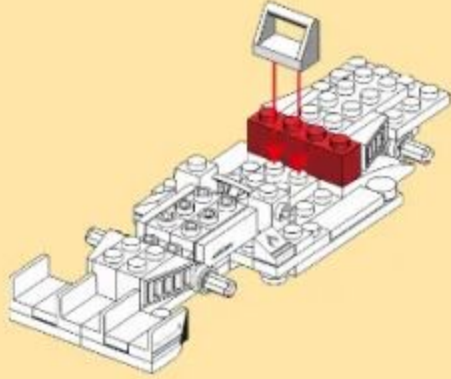

- 16  x1  x1  x1  x1  x1  x1  x1  x1  x1  x1  x1  x1  x1  x1  x1  x1 x1

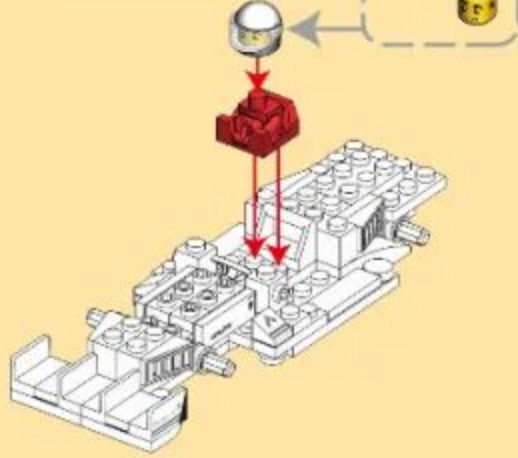

- 17  x1  x1  x2  x2

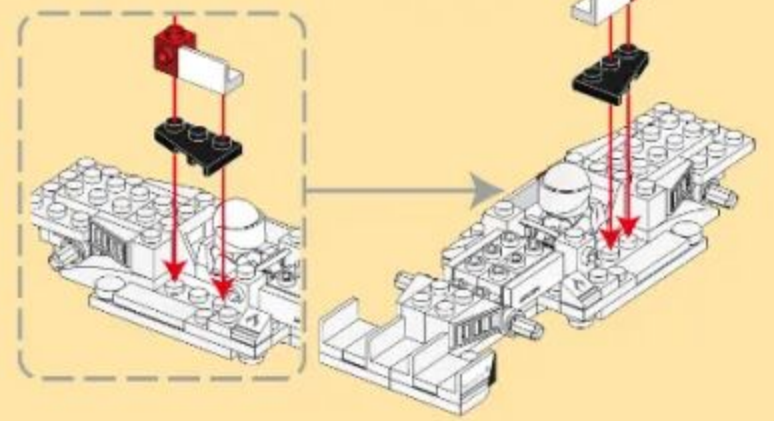

- 18  x2  x2  x2  x2  x2



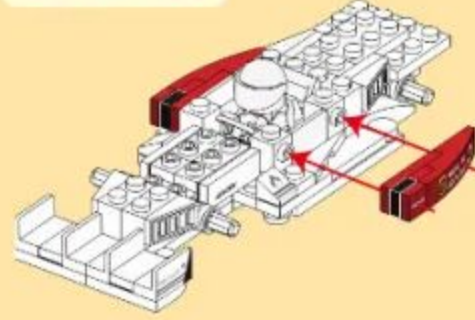

- 19 17 + 18

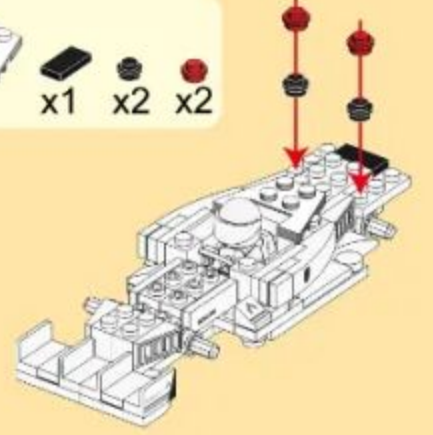

- 20  x1  x1  x2  x2



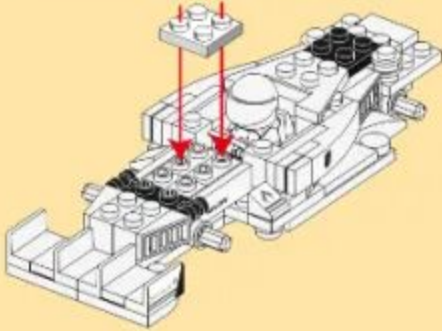

- 21  x1  x1  x1

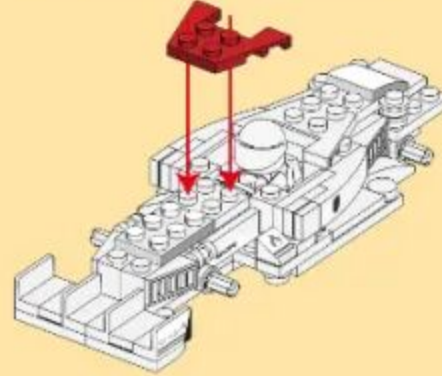

- 22  x1  x1  x1



- 23  1x3  x3  x1

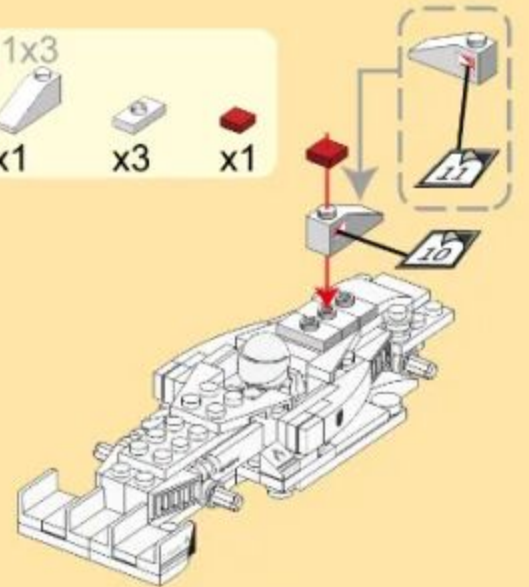

- 24  x2  1x4  1x4

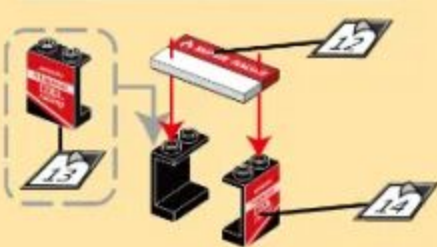

- 25 23 + 24

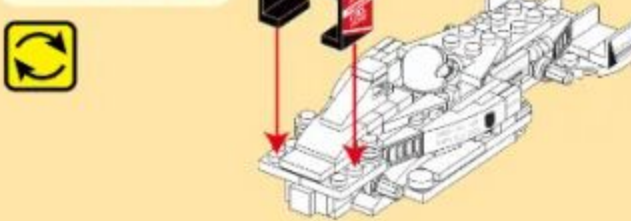

- 26  x1  x1  x1

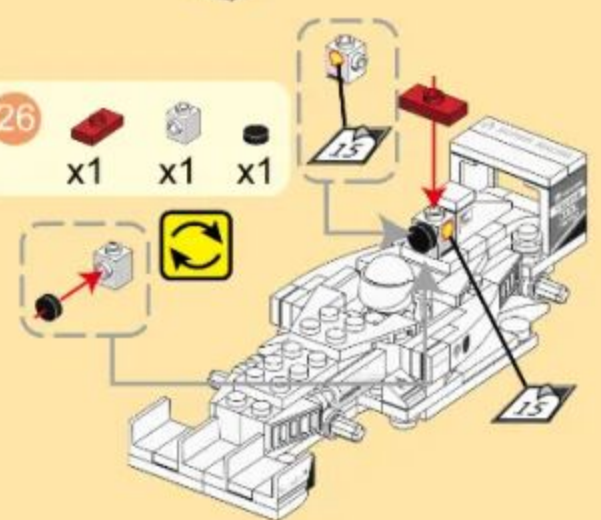

- 27  x1  2x2 x1

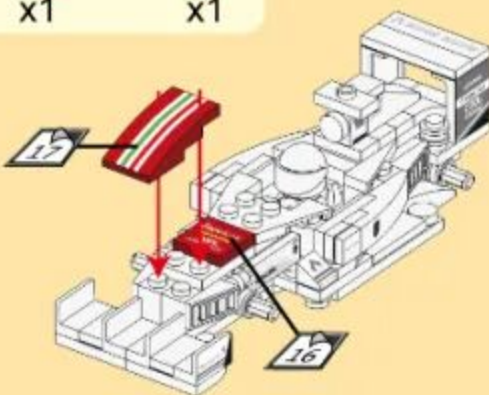

- 28  x4  x4  x4

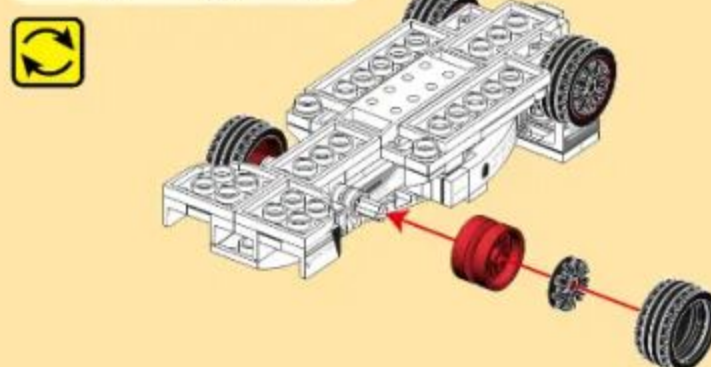

- 29

