



NO.3901

CRANE

165 PCS

AGES 6+



MECHANICAL ENGINEERING



3 IN 1

FUNCTIONS AND FEATURES

- APPLICATION OF THE RATCHET AND PAWL
- SPEED VARIABLE PRINCIPLE
- THE PULLEY

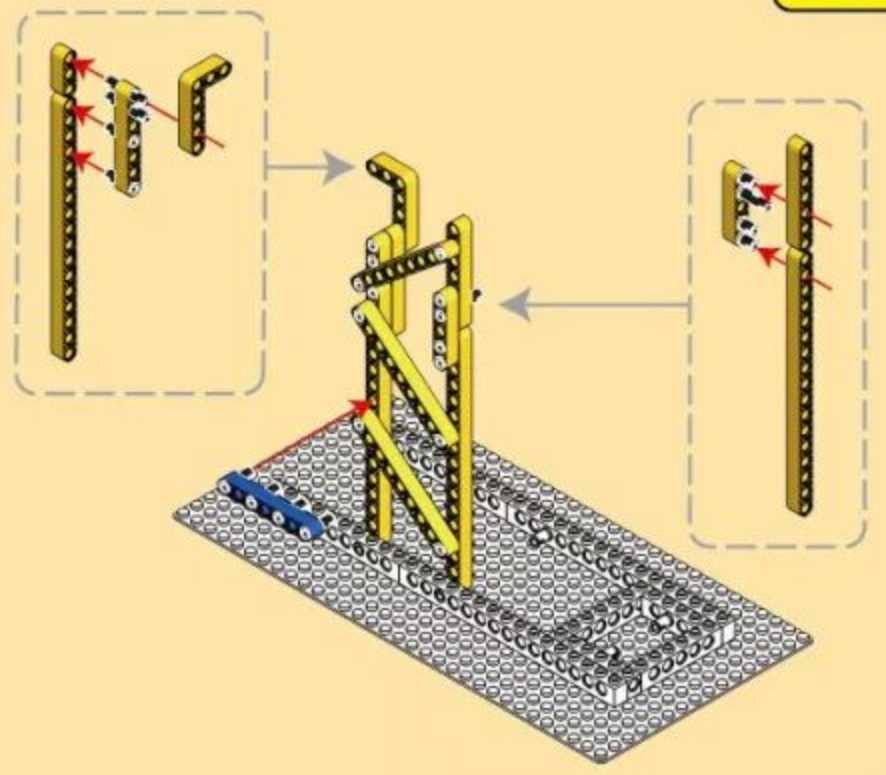
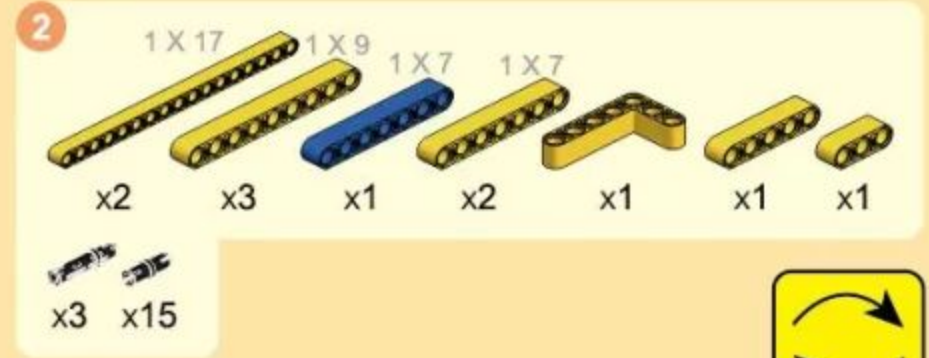
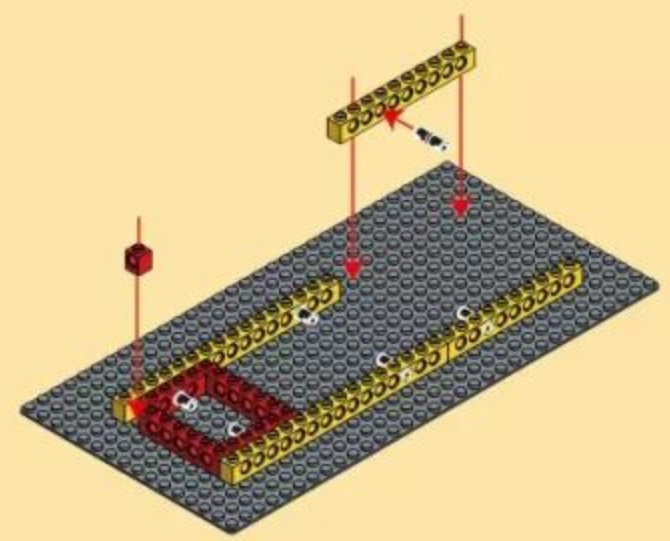
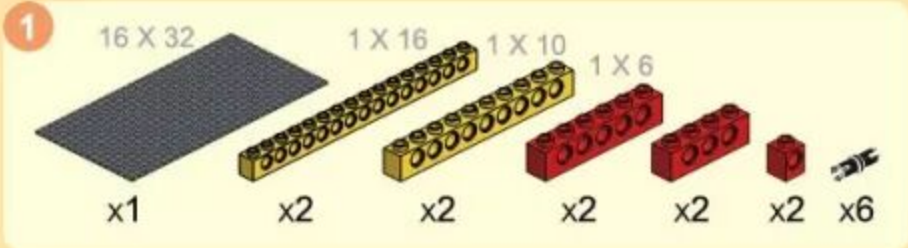

4
2 + 3

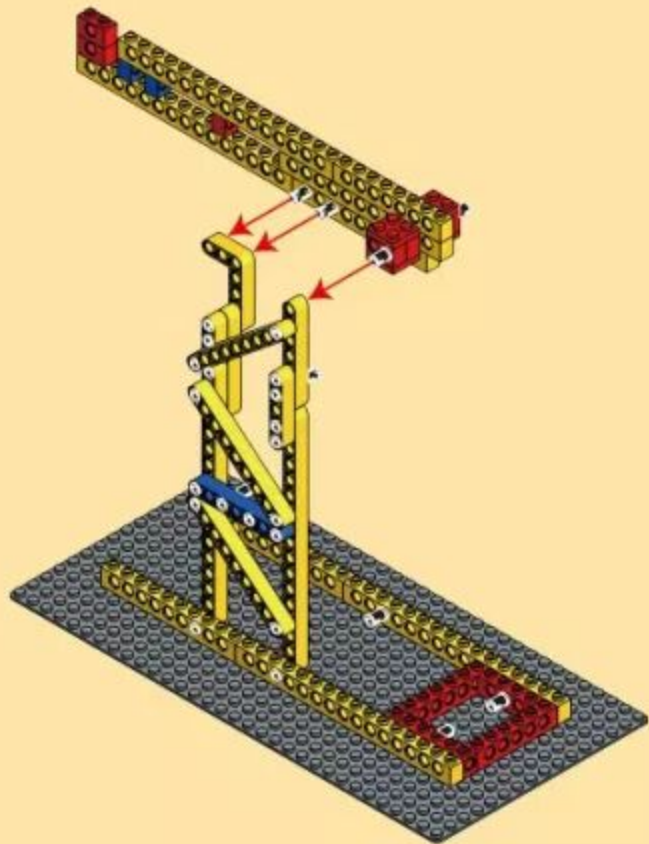

- 5
- 1 x 17
 - 1 x 7
 - x2
 - x2
 - x1
 - x1
 - x1
 - x3
 - x5

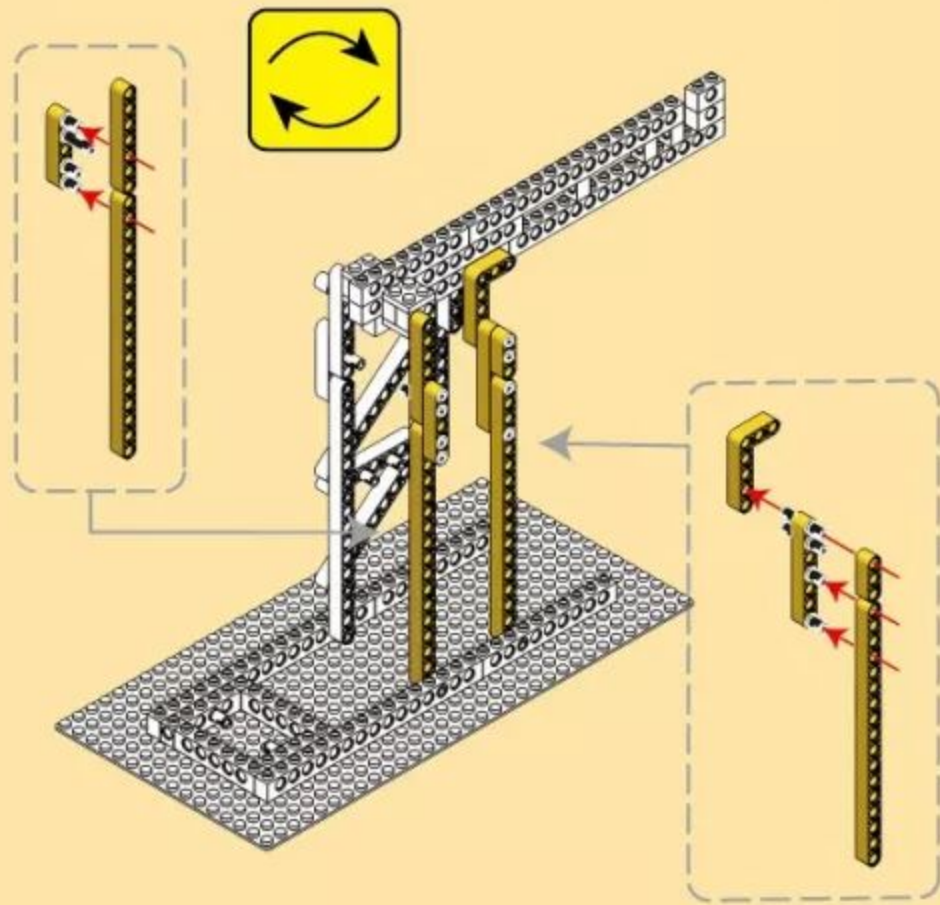

3

6

1 X 9
x3

1 X 7
x1

x1

x10

7

1 X 15
x2

1 X 7
x2

x4

x4

x4

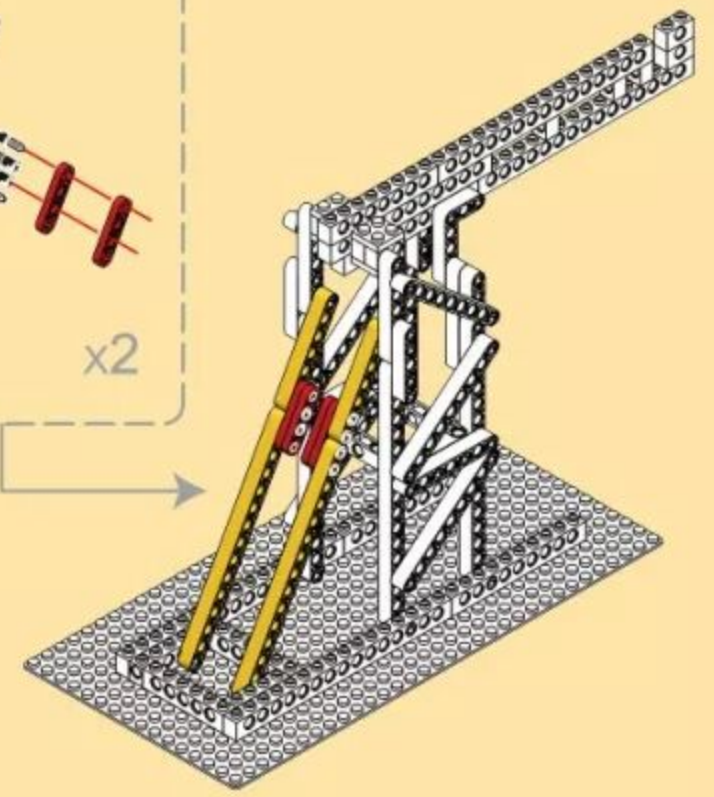
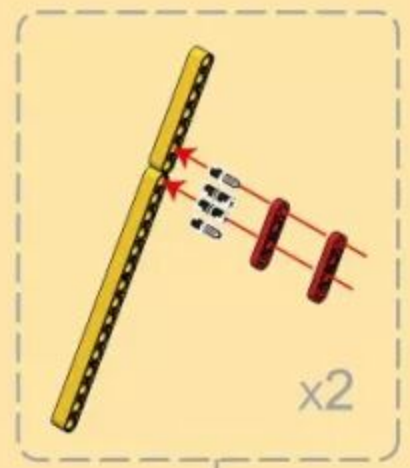
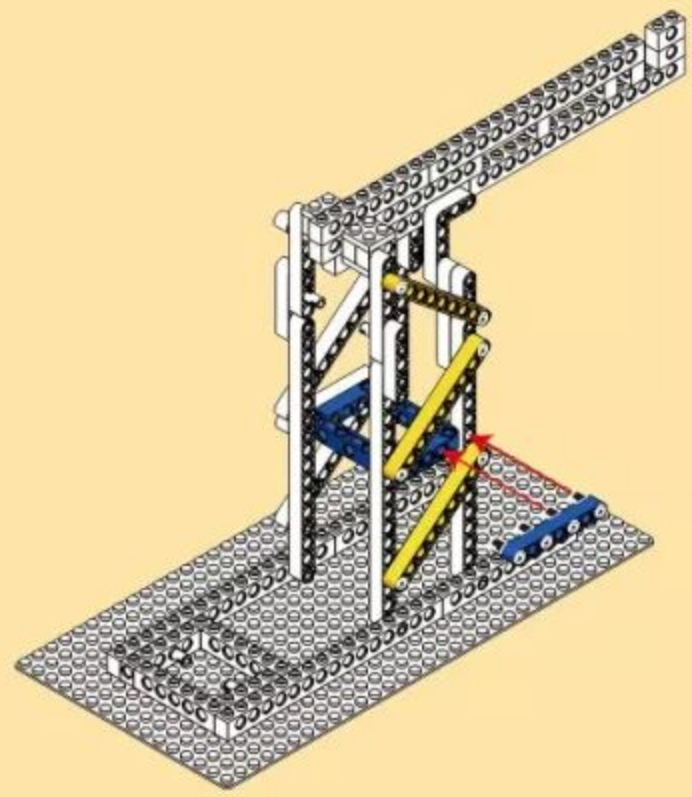

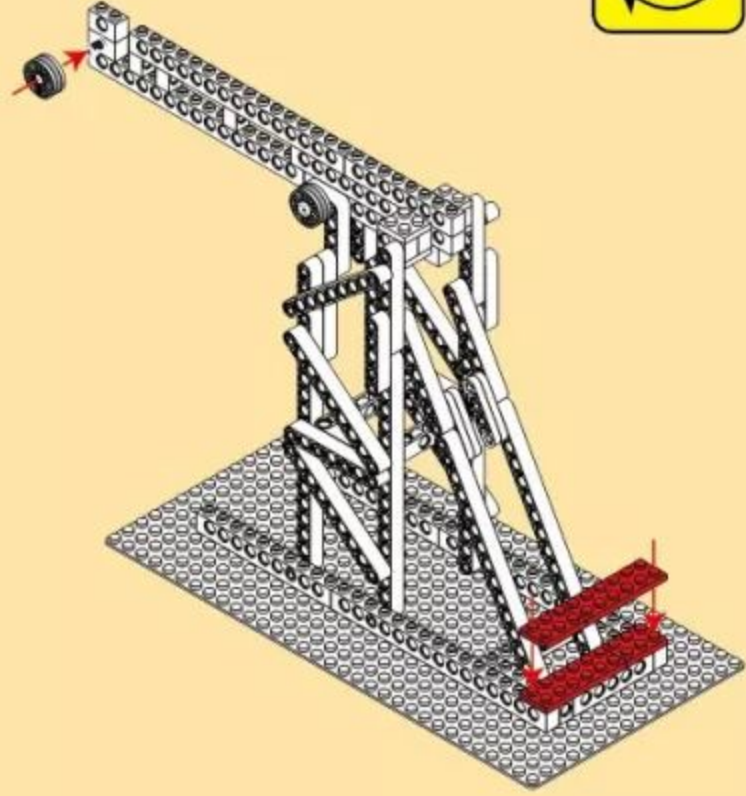

1

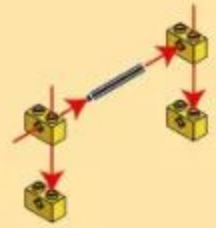

2



3



4



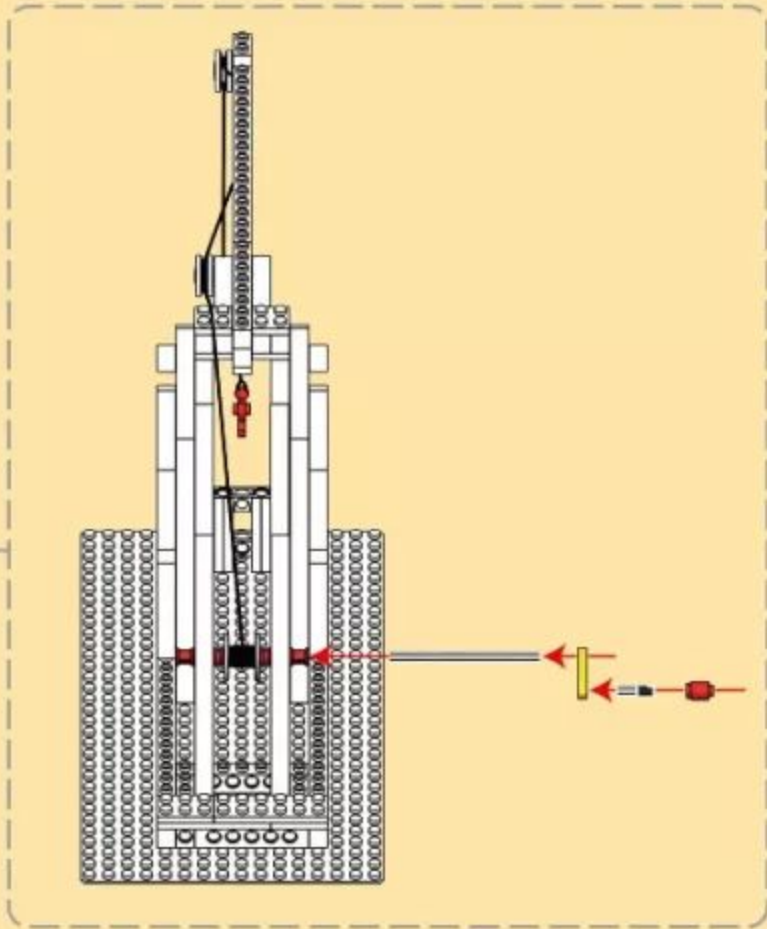
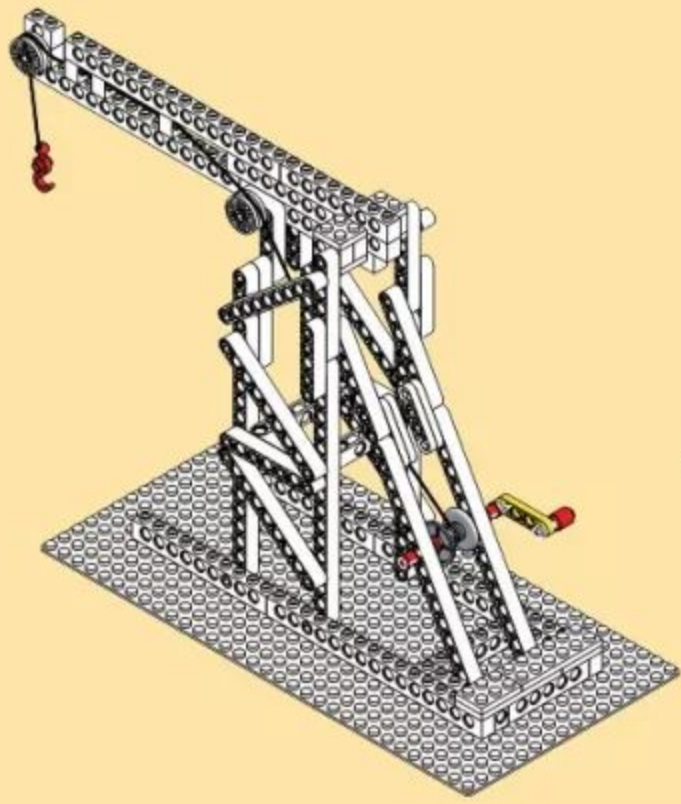

- 10 1 X 8
- 
x1
 - 
x1
 - 
x1
 - 
x1
 - 
x1
 - 
x1
 - 
x1
 - 
x2
 - 
x2

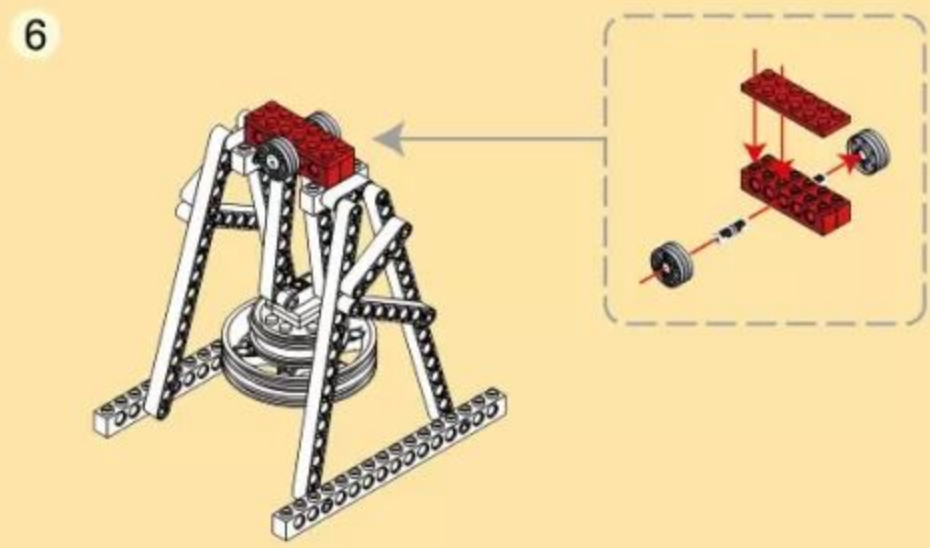
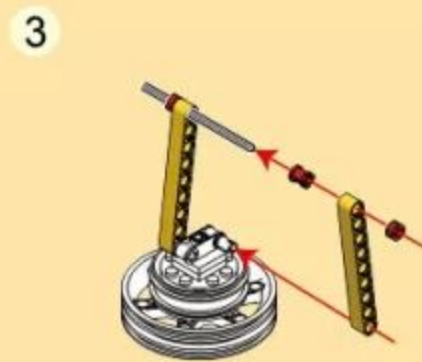
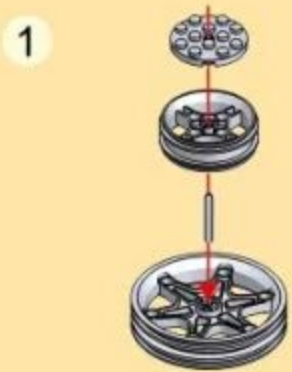
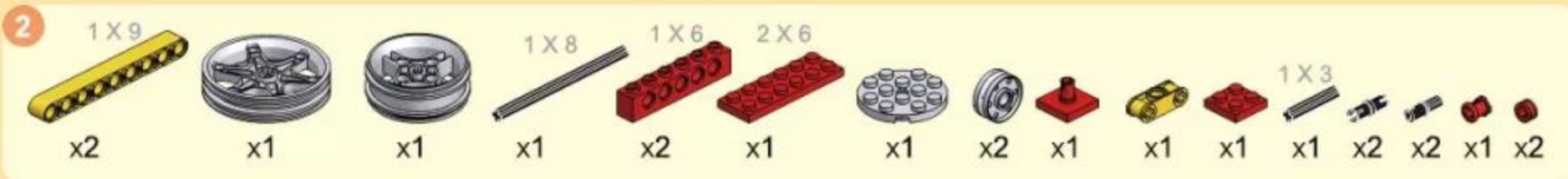

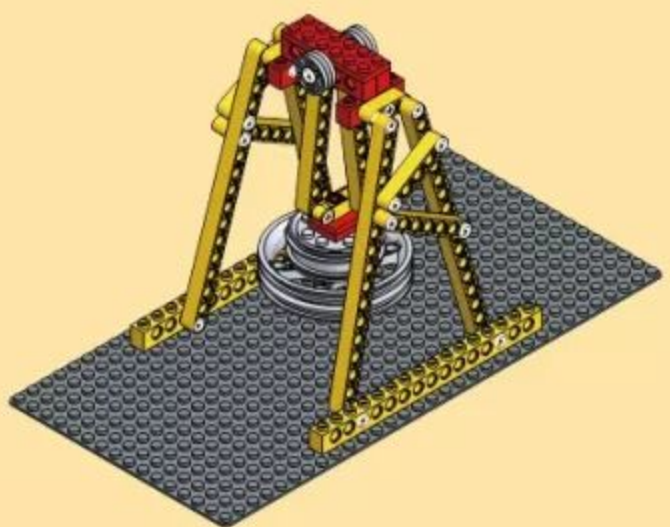
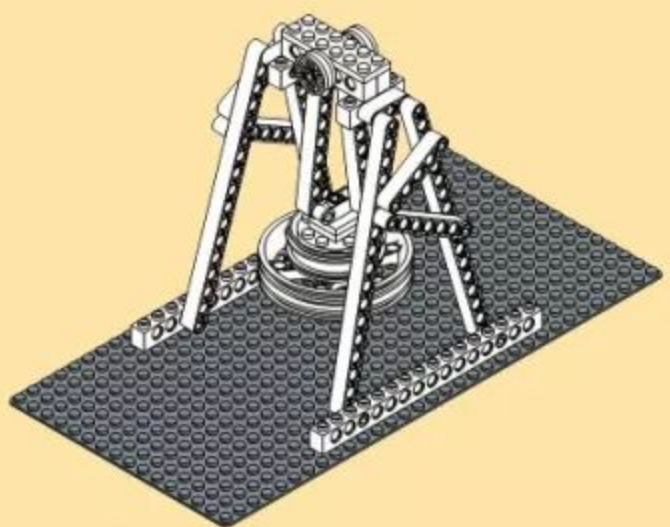

3 16 X 32
x1



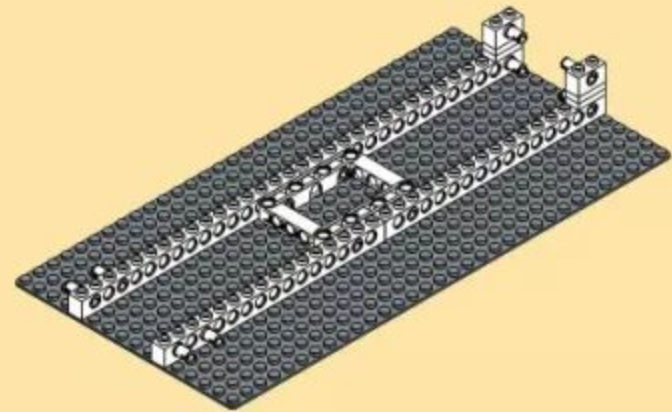
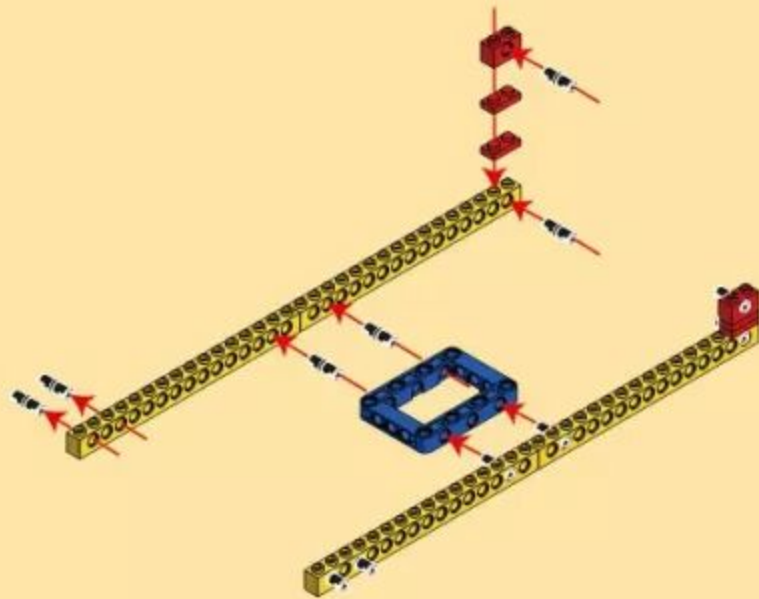
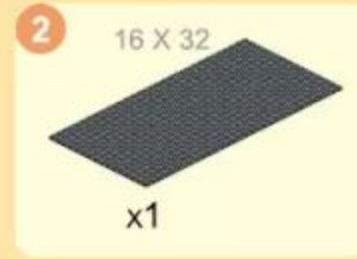
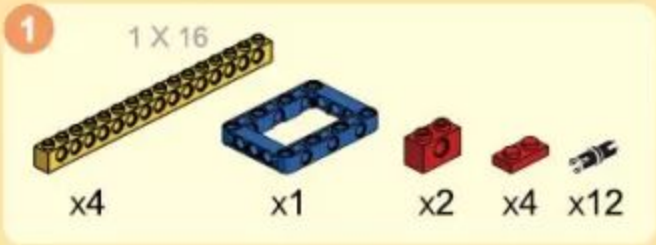

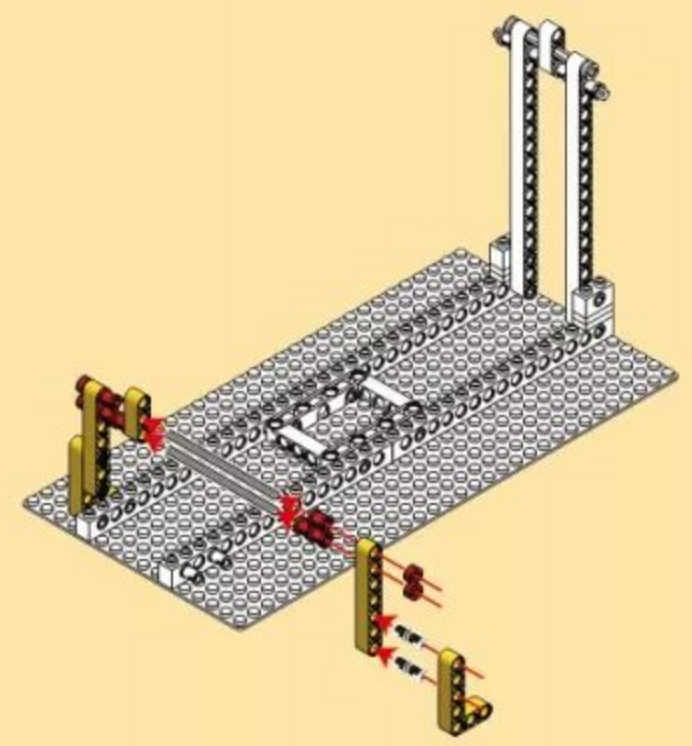
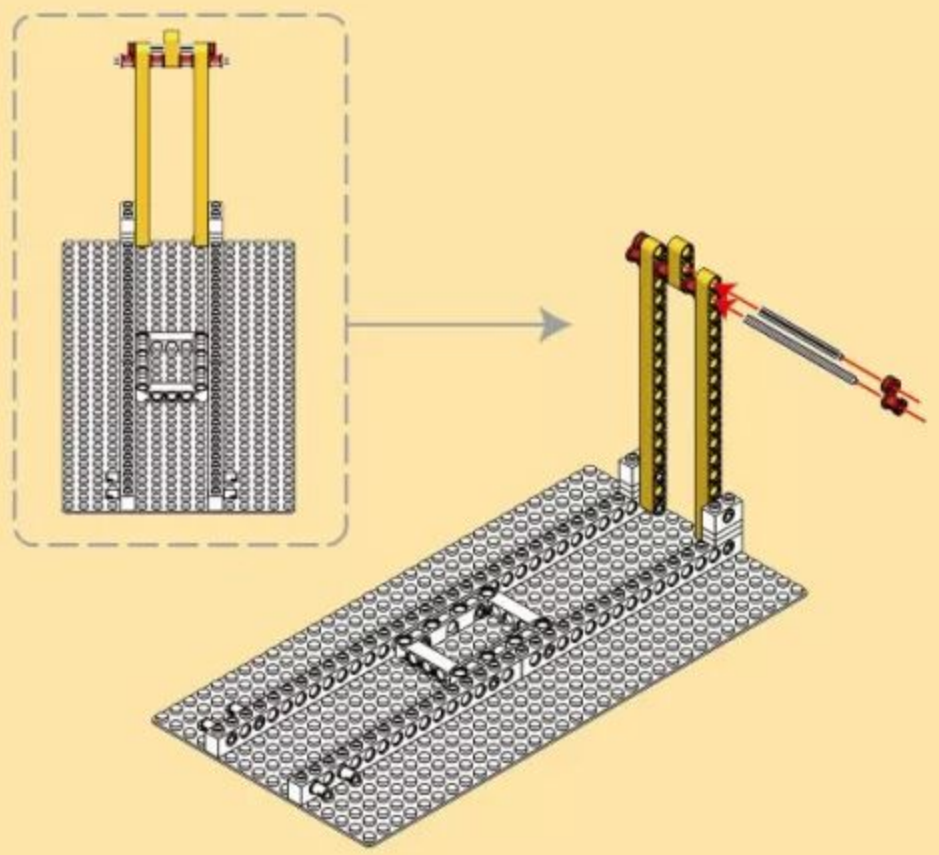
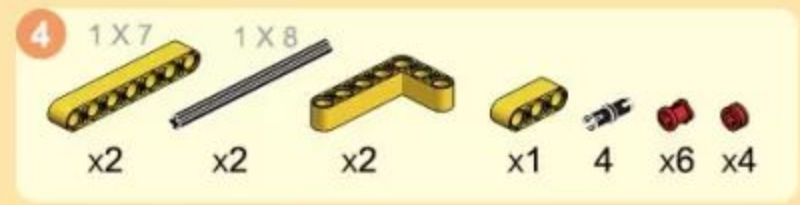
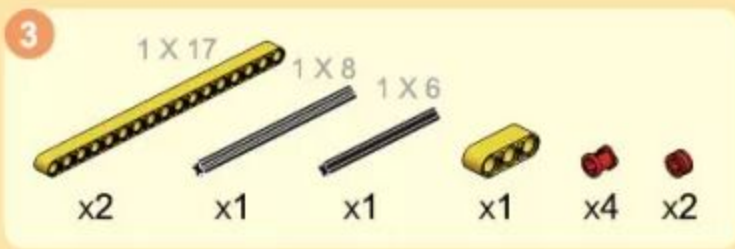

5



x1



x1



x2



x4



x1



1 X 4

x1



1 X 3

x1



x1

1









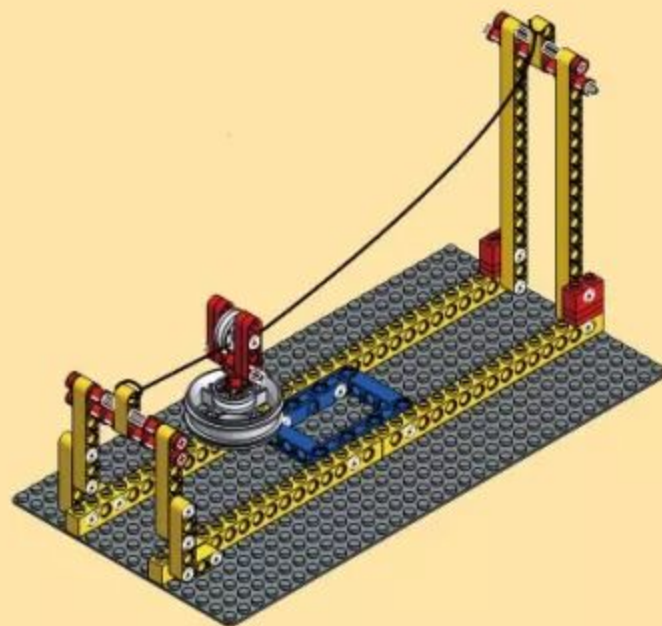



2



3











-  x2
-  x2
-  x1
-  x2
-  x2
-  x2
-  x2
-  x2
-  x2
-  x4
-  x1

-  x2
-  x1
-  x2
-  x4
-  x4
-  x1
-  x3
-  x10
-  x1
-  x6

-  x4
-  x2
-  x4
-  x6
-  x2
-  x3
-  x6
-  x2
-  x2
- x1

-  x1
-  x2
-  x1
-  x4
-  x1
-  x1
-  x1
-  x1

-  x1
-  x2
-  x1
-  x3
-  x1
-  x1
-  x1
-  x10
-  x44
- x5

Power Machinery

length comparison

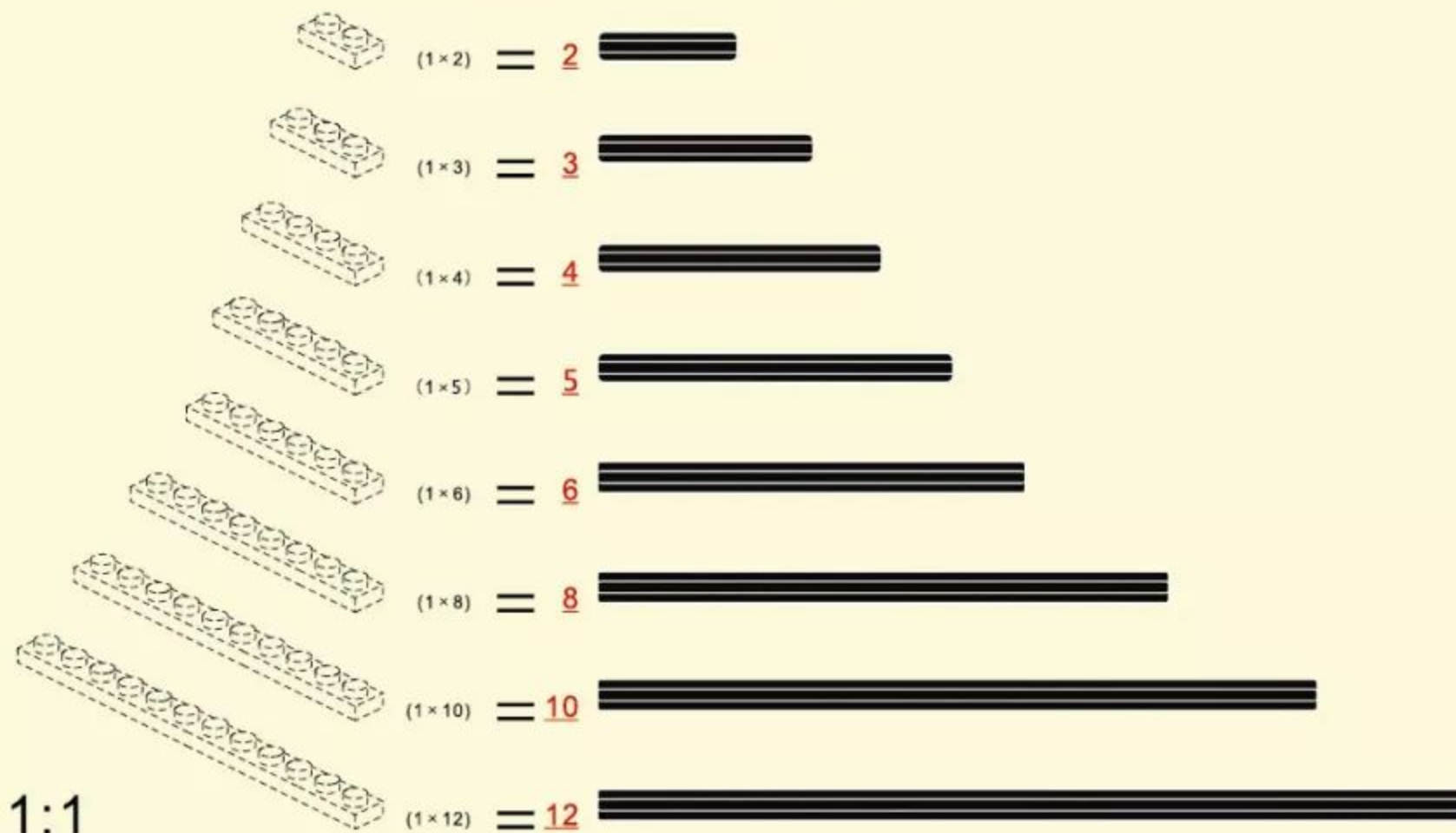

1:1



CRANE



GIANT FRISBEE



TELPHER

