



# School Bus

Can exercise the following abilities of baby

- ★ Processing visual input through some actions. Creativity and imagination help children keep trying new ideas.
- ★ Help them gradually form an innovative thinking and constantly find new ways to solve problems.
- ★ It is conducive to the development of "space wisdom".

3973



6+ | 367 PCS

**INTERCITY  
BUS**

**1** 4 X 12    4 X 6    2 X 6

x1    x1    x1    x3    x2

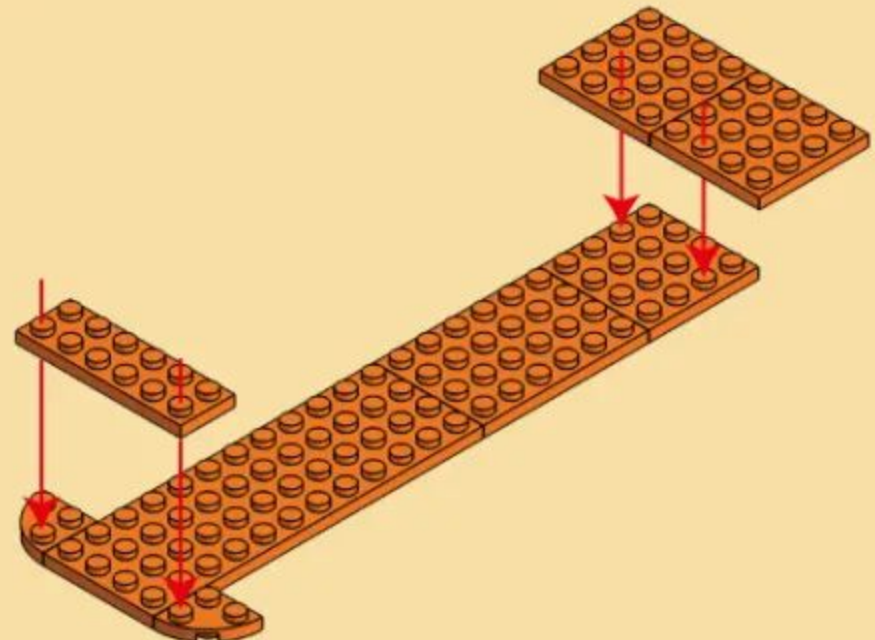

**2** 2 X 8    1 X 6

x2    x4    x4    x2

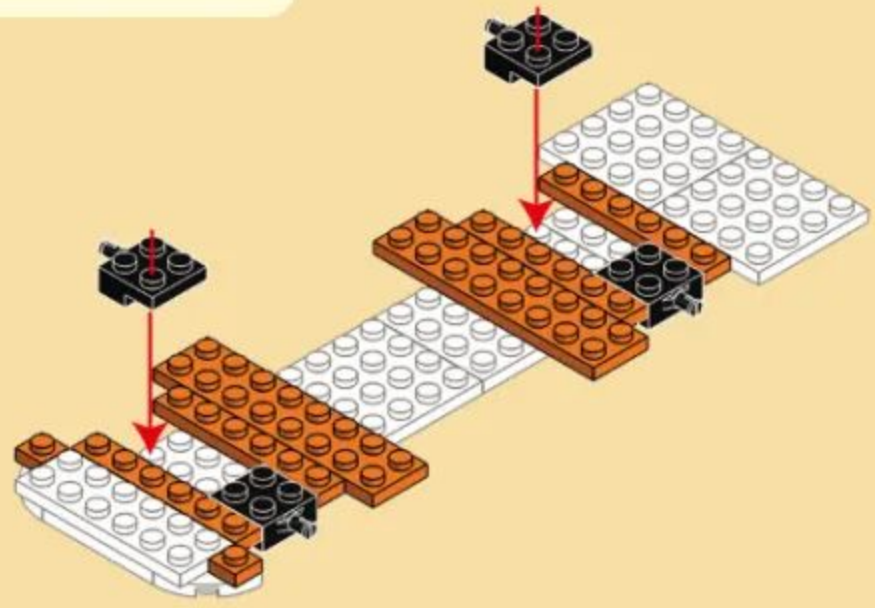

**3** 6 X 8    2 X 6    2 X 6

x1    x2    x1    x1    x1    x2    x2    x1    x1    x2

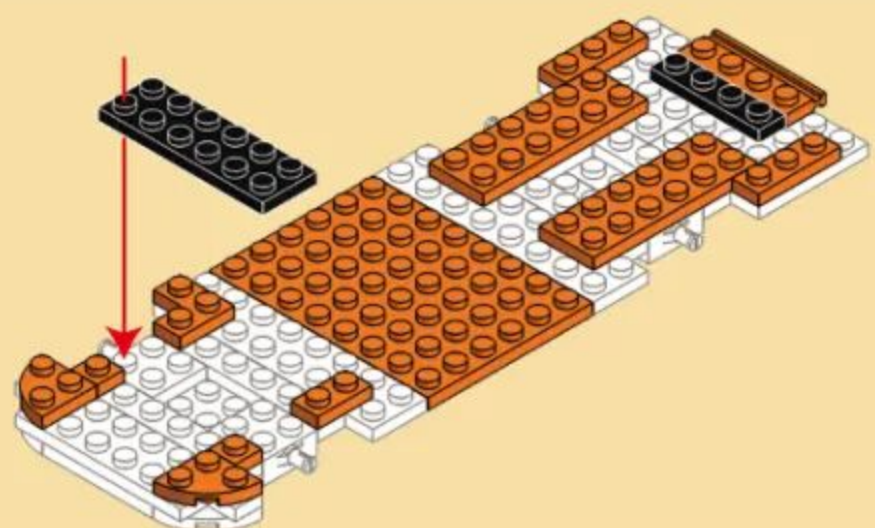

- 4
- 1 X 10 (orange) x1
  - 2 X 3 (orange) x1
  - 1 X 3 (orange) x1
  - 1 X 2 (orange) x1
  - 1 X 2 (orange) x2
  - 1 X 2 (orange) x2
  - 1 X 2 (orange) x1
  - 1 X 1 (orange) x1
  - 1 X 1 (white) x2
  - 1 X 1 (red) x2

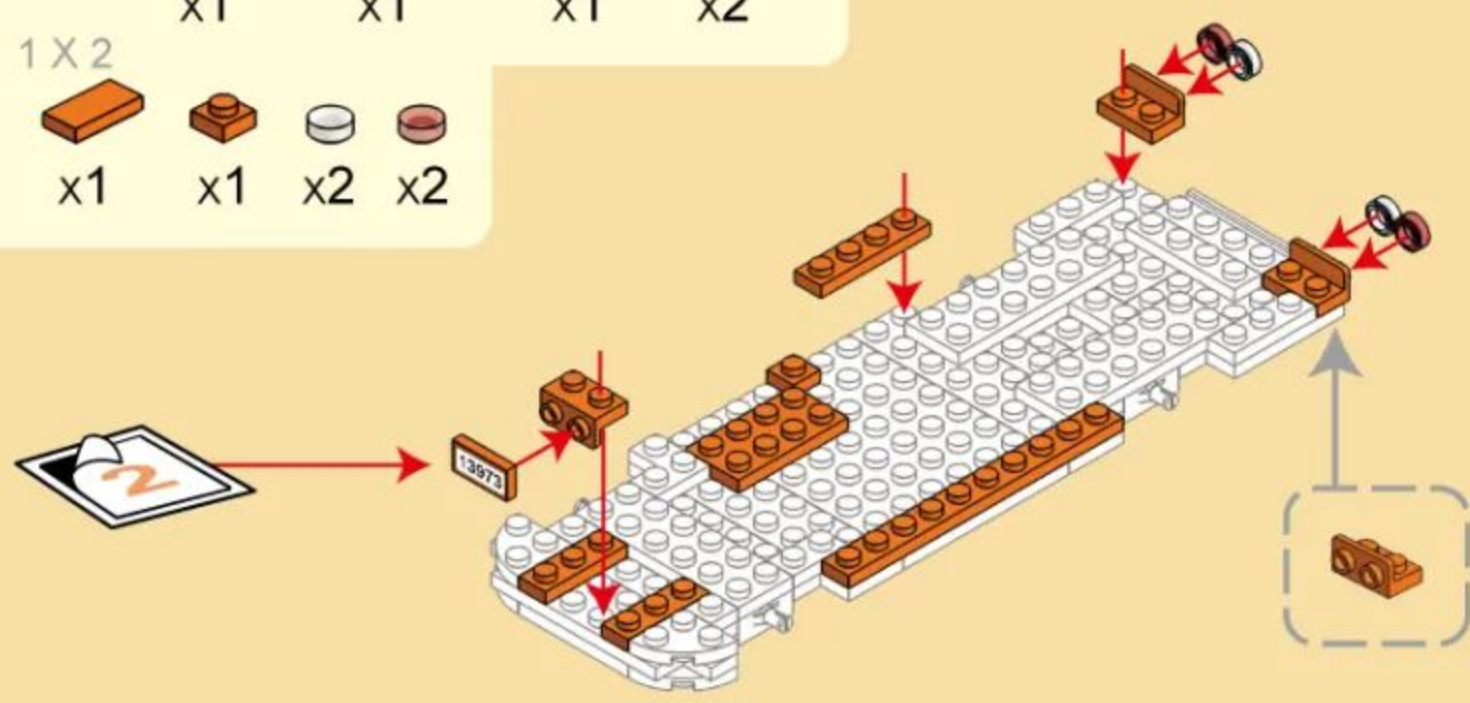

- 5
- 1 X 8 (orange) x1
  - 4 X 6 (orange) x1
  - 2 X 3 (orange) x2
  - 1 X 2 (orange) x1
  - 1 X 1 (black) x4
  - 1 X 1 (white) x4
  - 1 X 1 (orange) x1
  - 1 X 1 (orange) x1
  - 1 X 1 (orange) x2

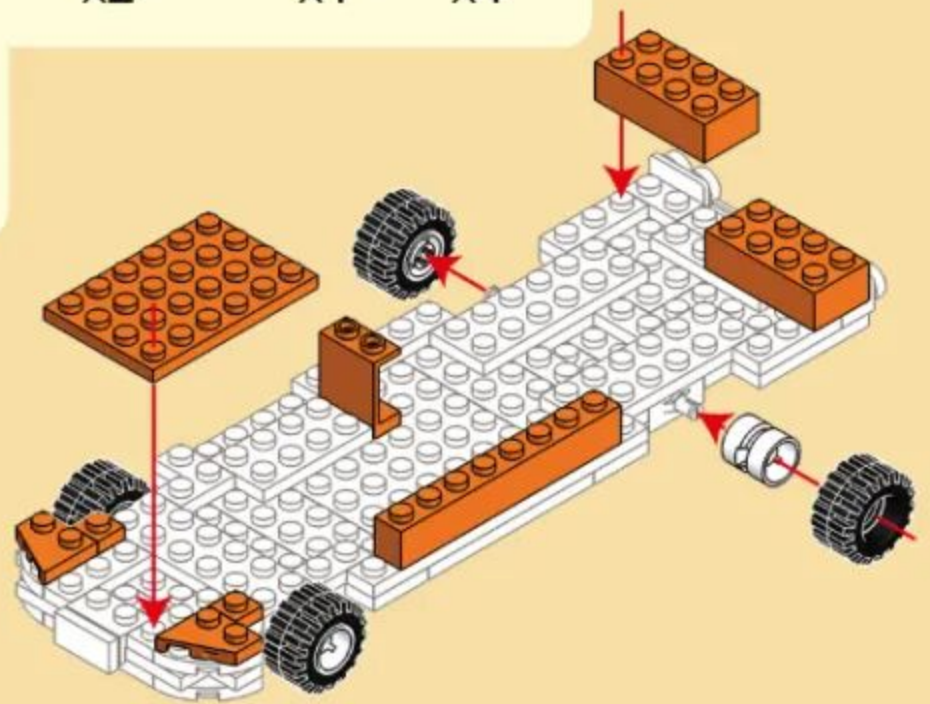

- 6
- 1 X 8 (orange) x1
  - 1 X 4 (black) x1
  - 2 X 3 (orange) x1
  - 1 X 2 (orange) x4
  - 1 X 4 (black) x2
  - 1 X 4 (orange) x1
  - 1 X 4 (black) x1
  - 1 X 1 (orange) x4
  - 1 X 1 (orange) x2
  - 1 X 1 (orange) x1
  - 1 X 1 (orange) x1

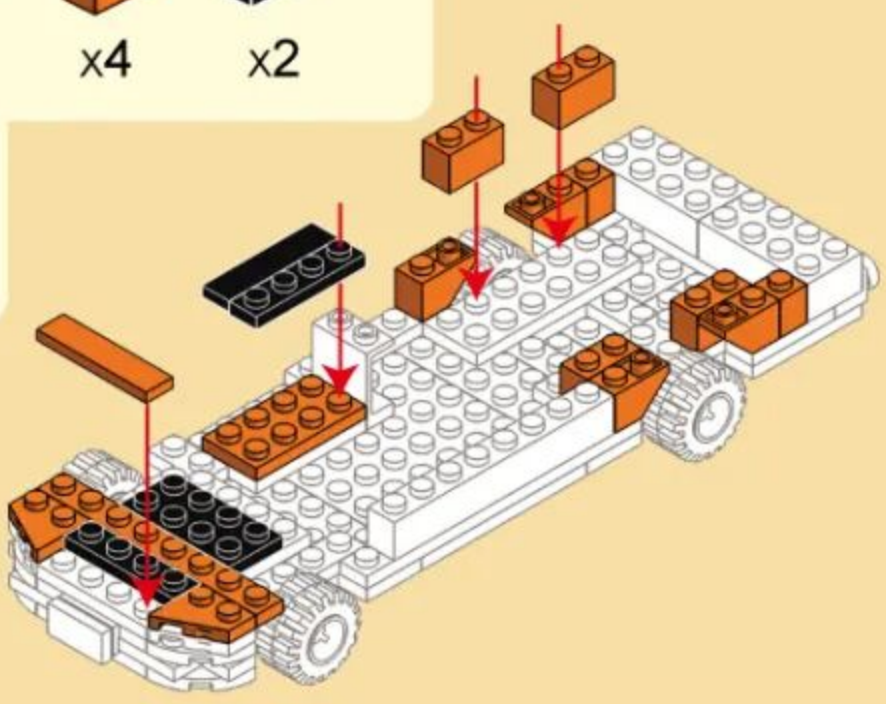

7



x1



x4

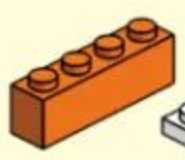

x1

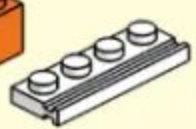

x1



x2



x2



x2



x2

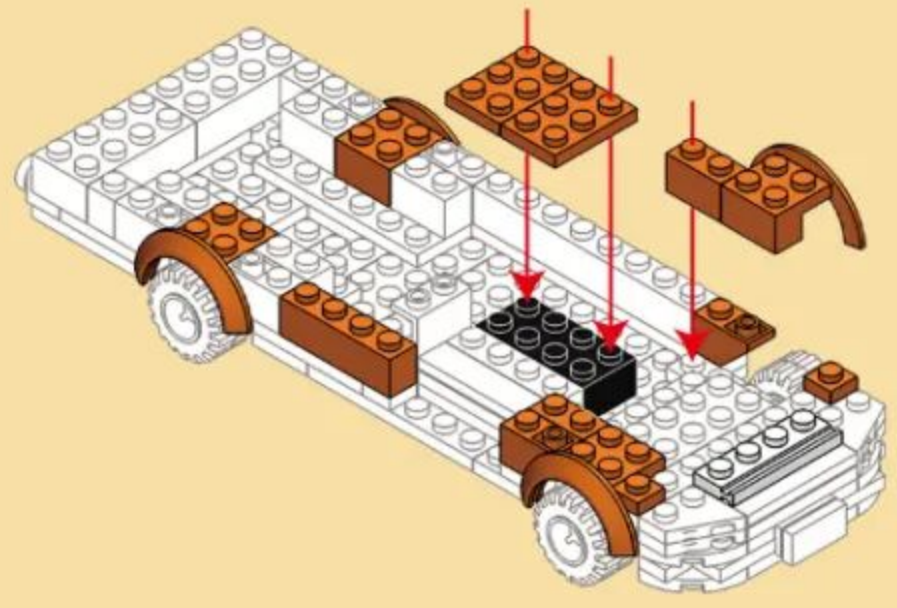

8

1 X 10

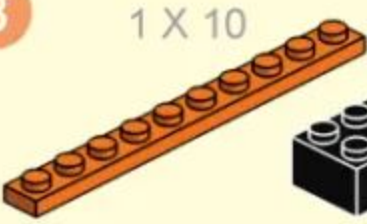

x2



x1

1 X 6



x1

1 X 6



x2



x1



x1



x1

1 X 4



x1



x2



x2

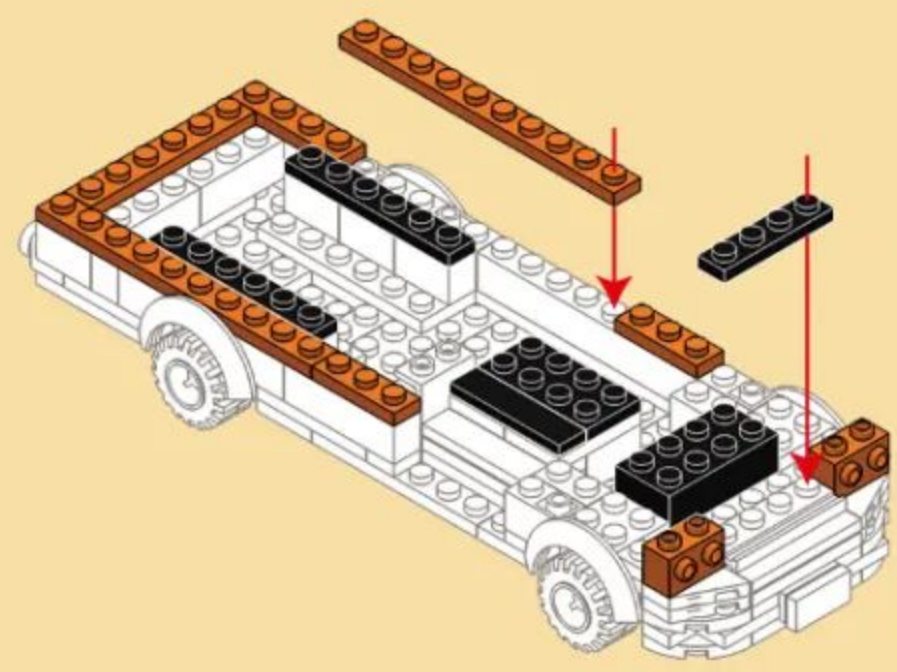

9

2 X 8

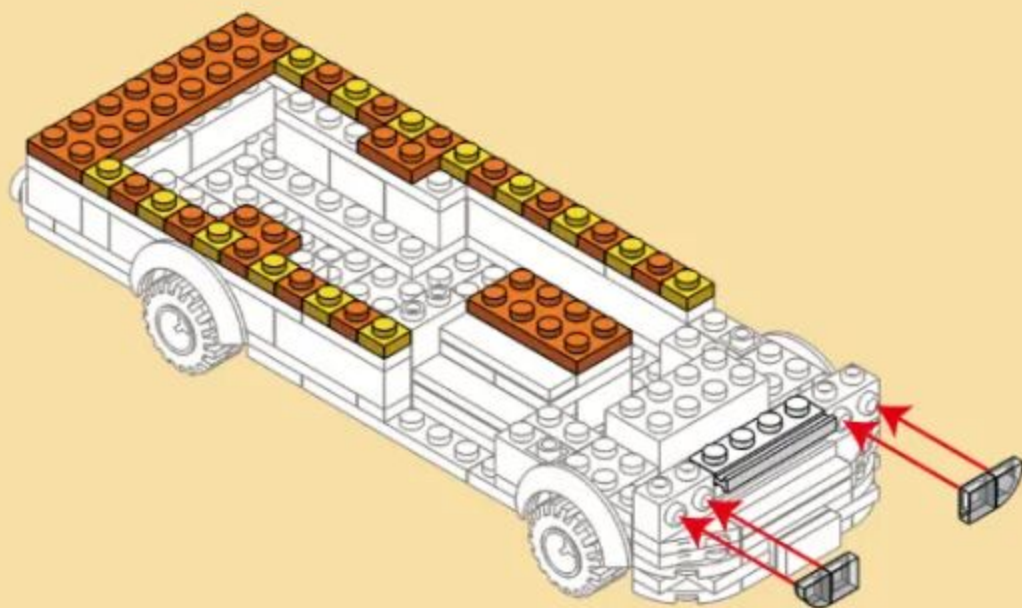
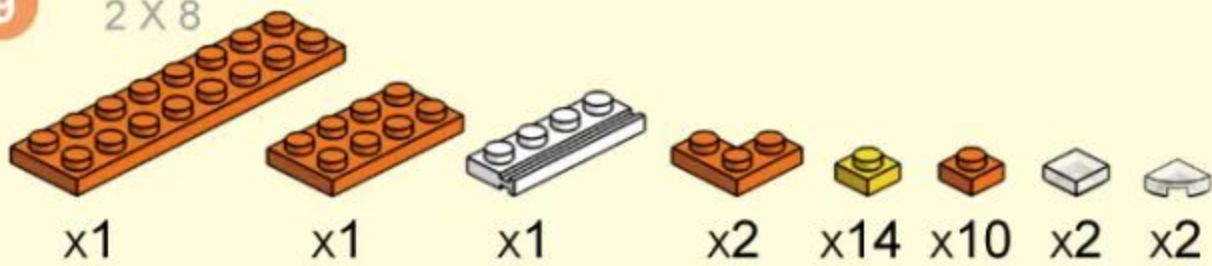

10

6 X 8

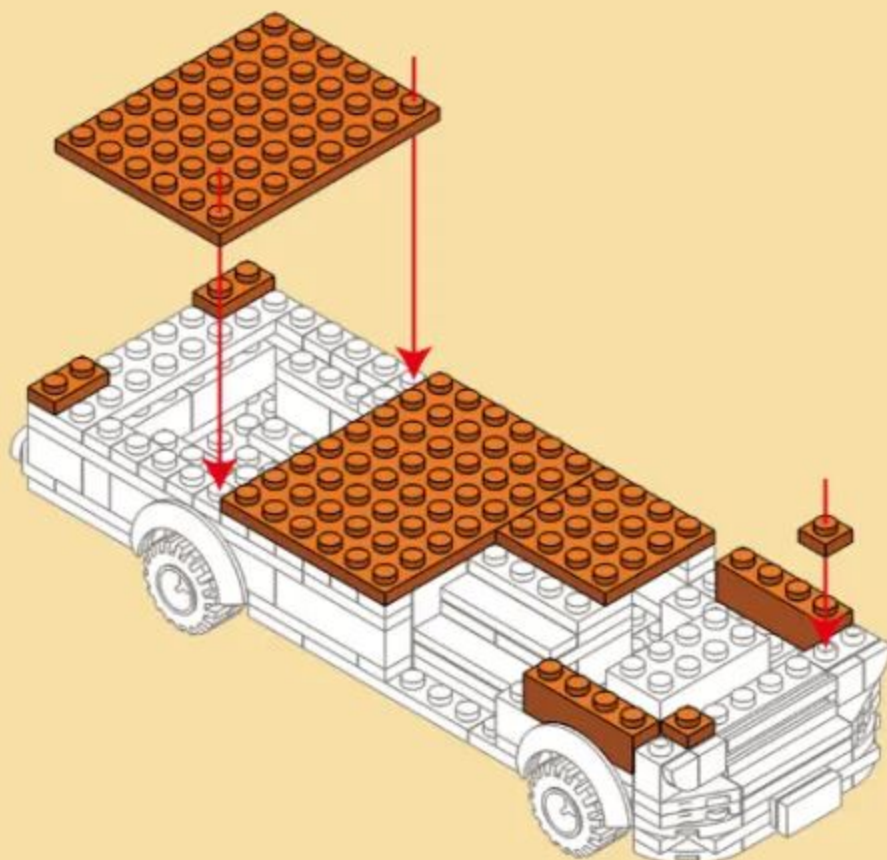
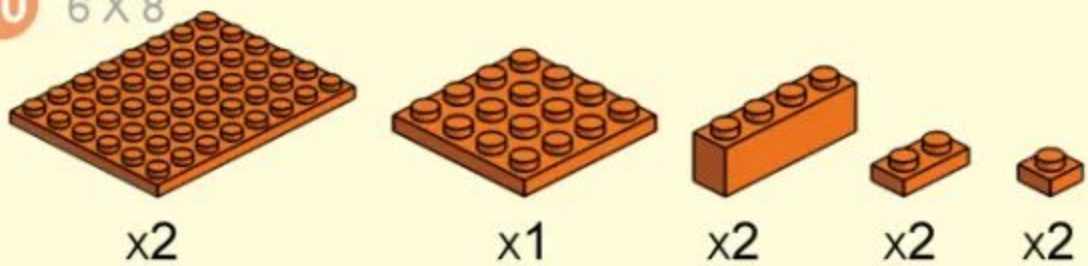

11

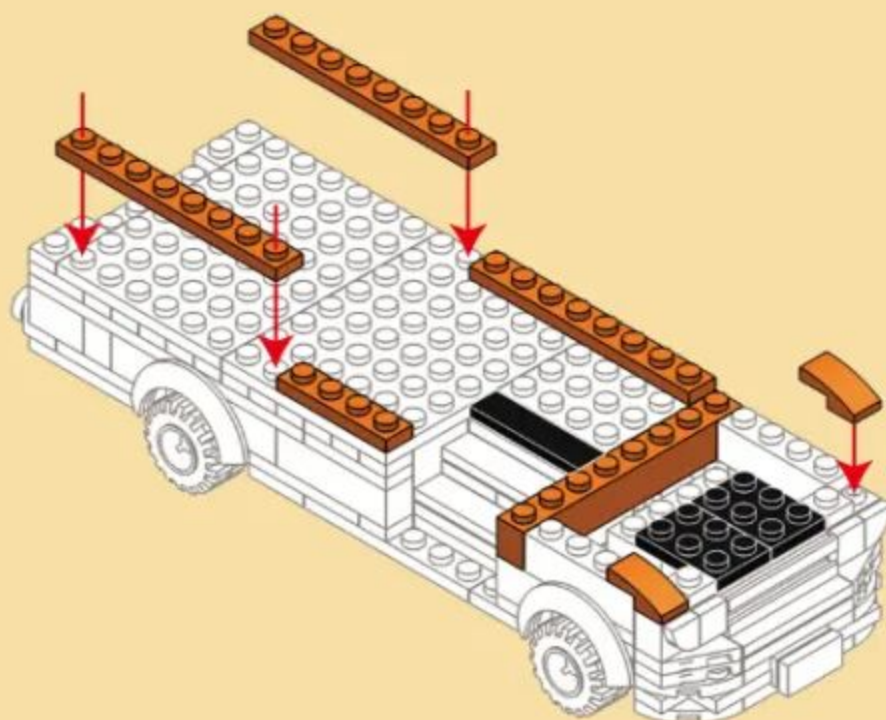
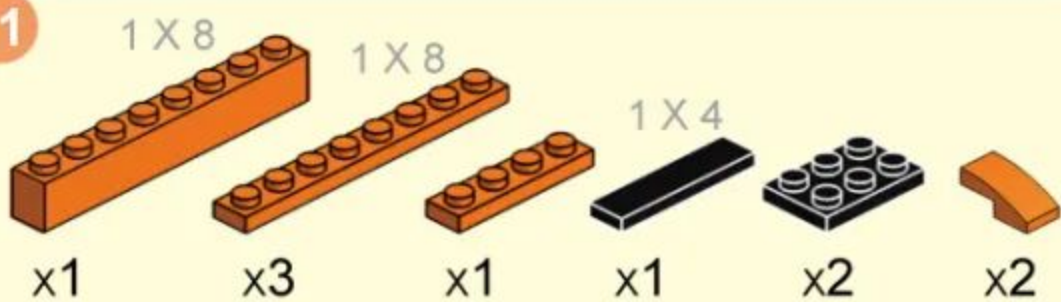

12

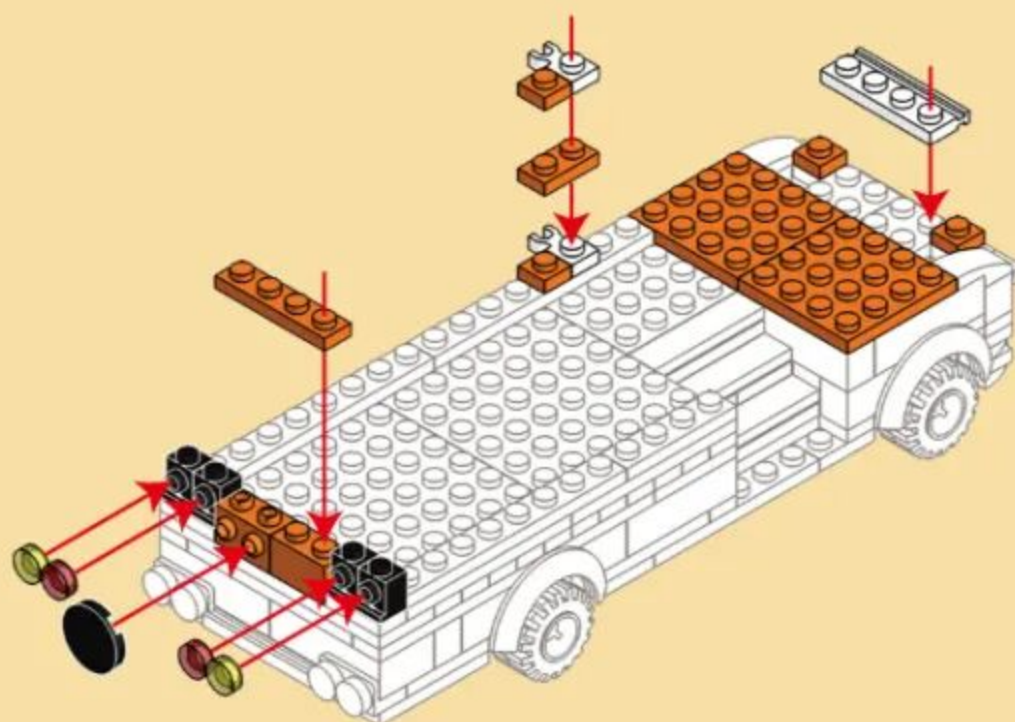
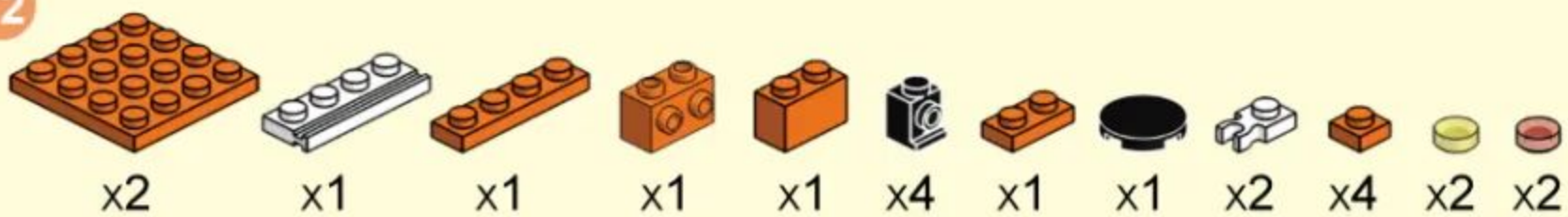

13

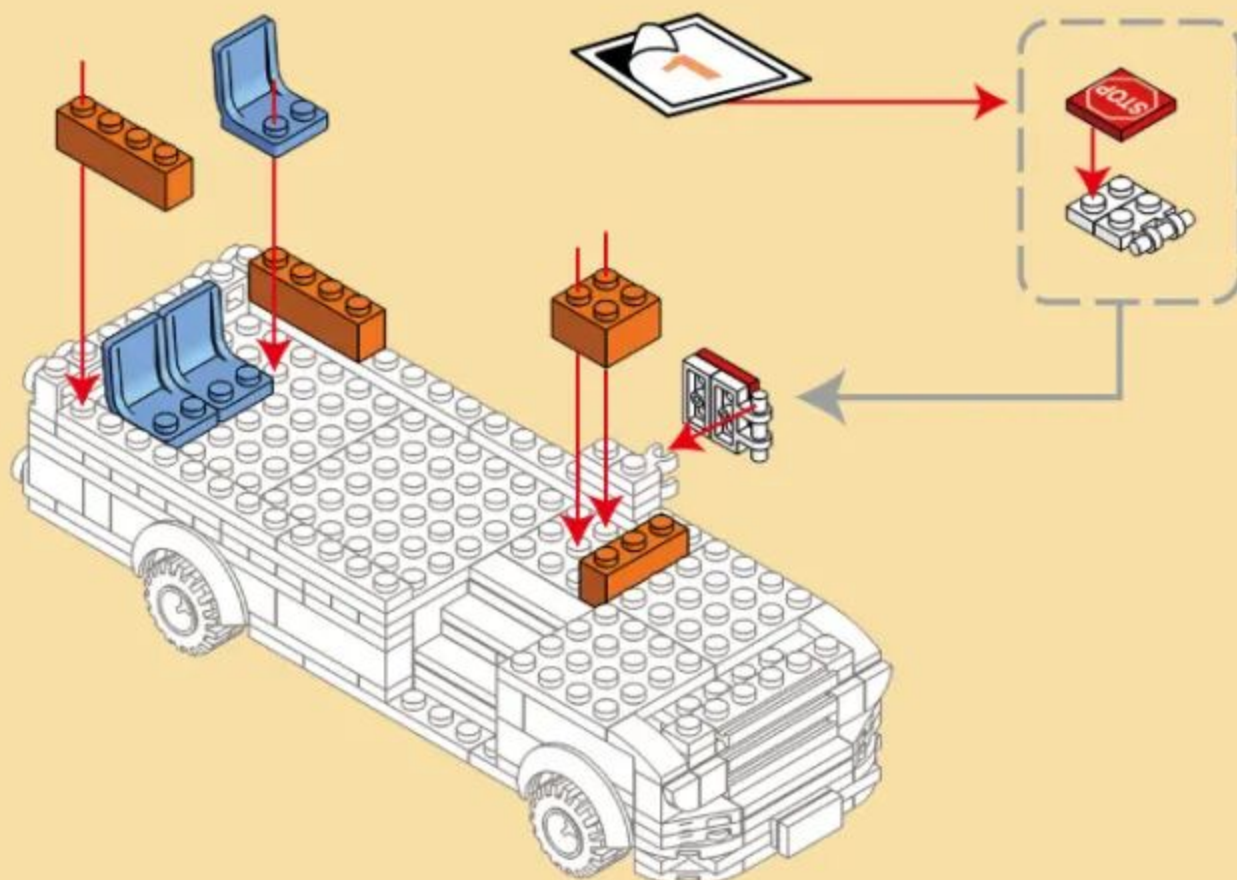
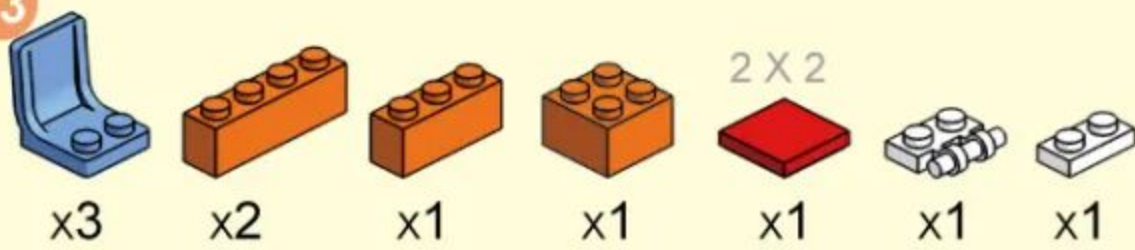

14

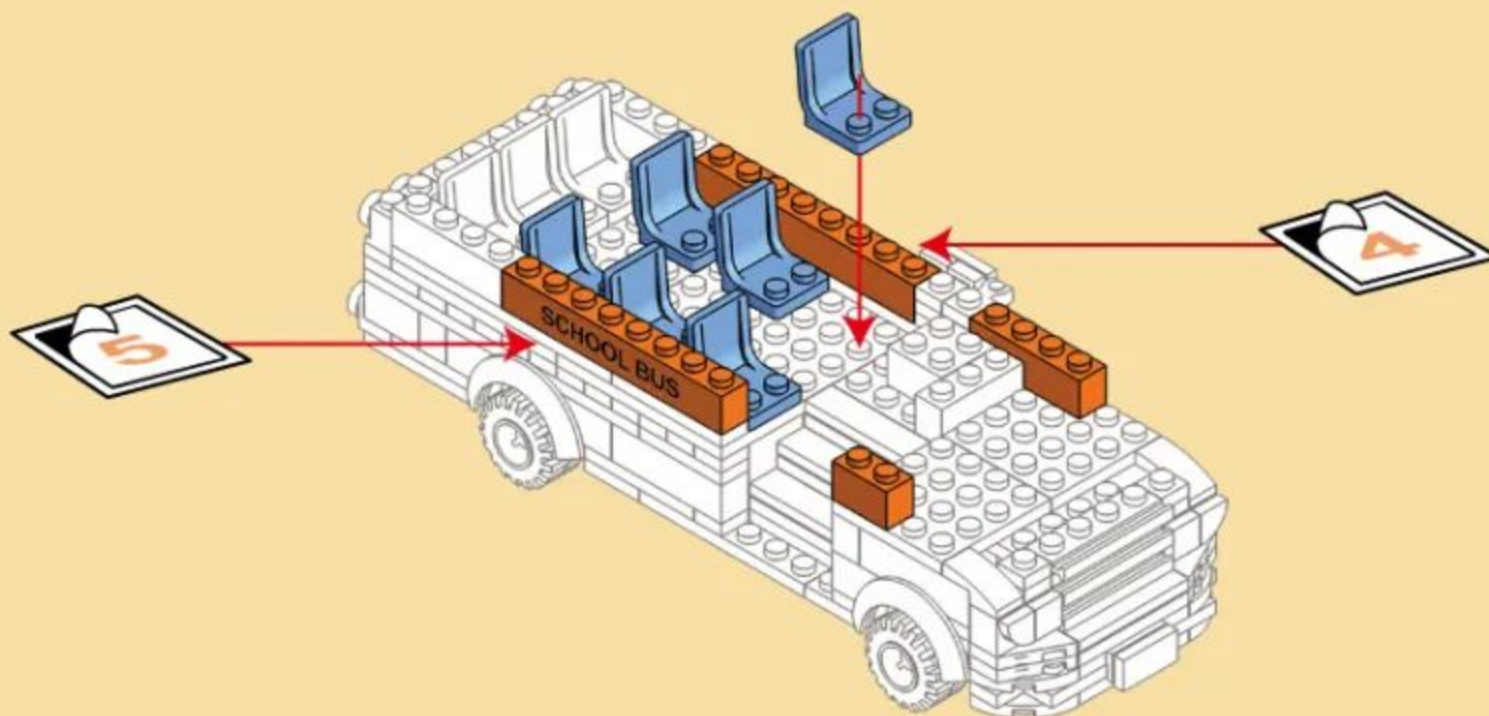
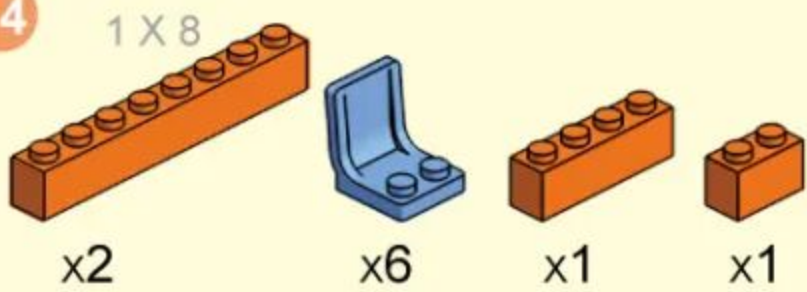

15

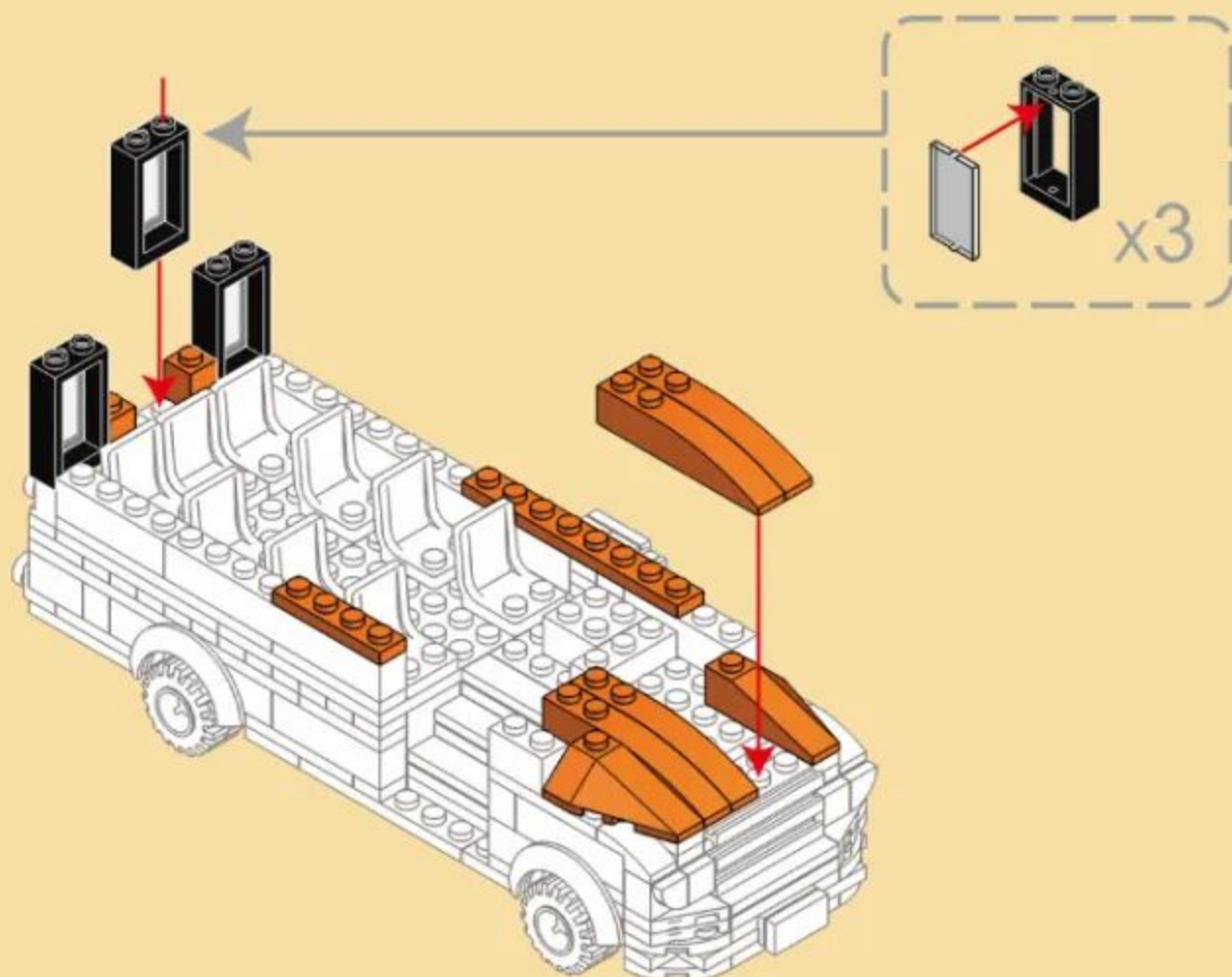
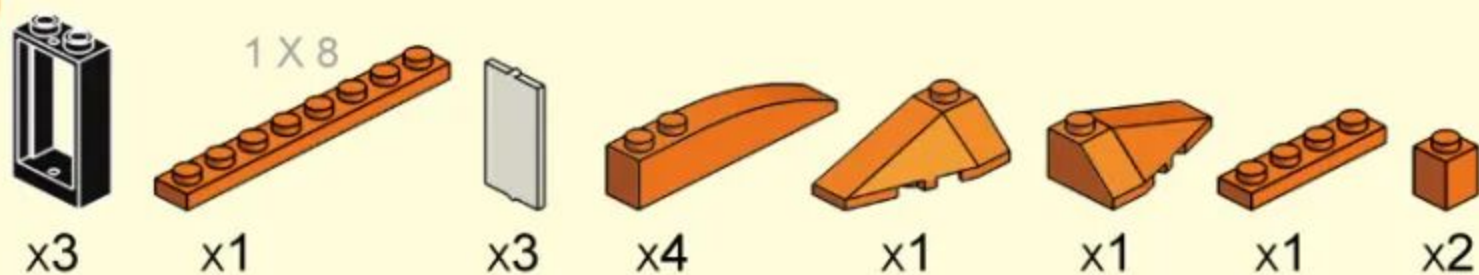

16

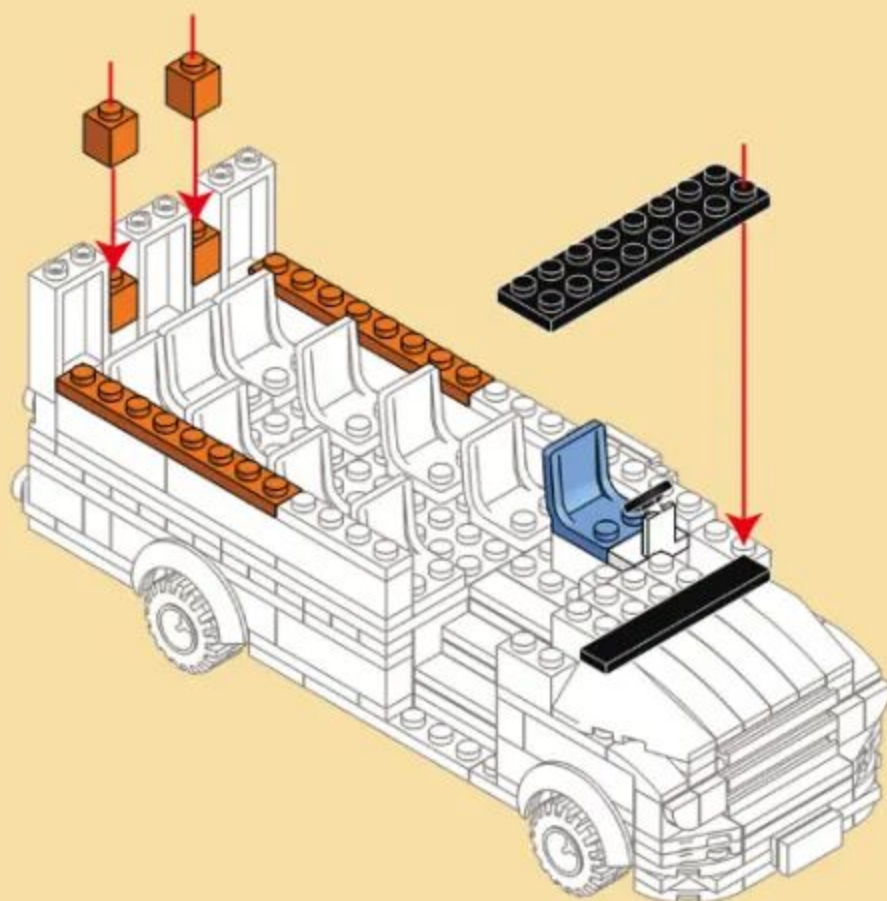
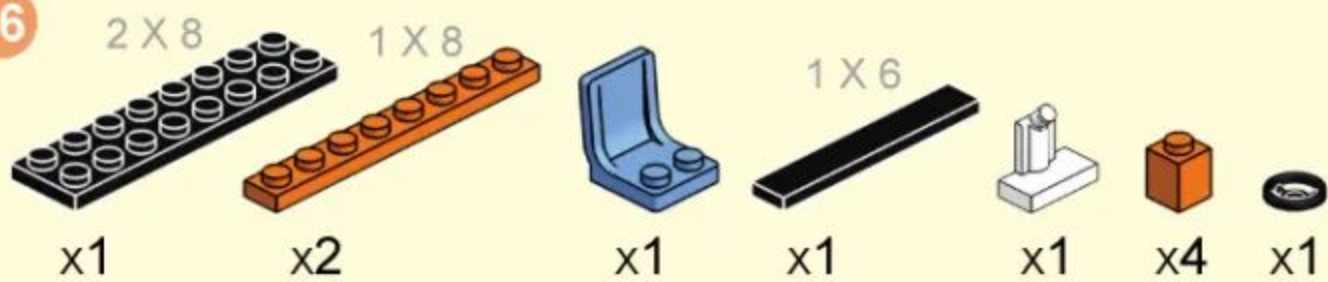

17

1 X 10

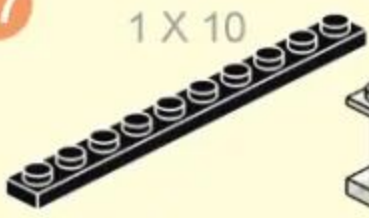

x2



x8

1 X 6



x1



x1



x1



x1

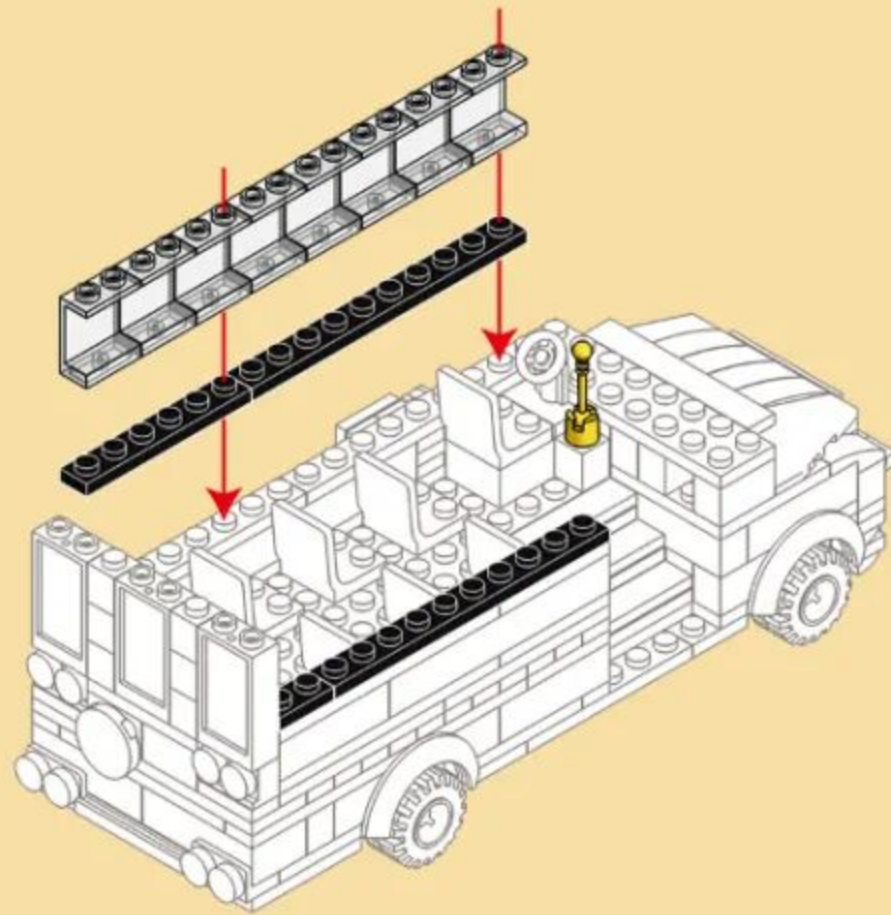

18



x1



x2



x6

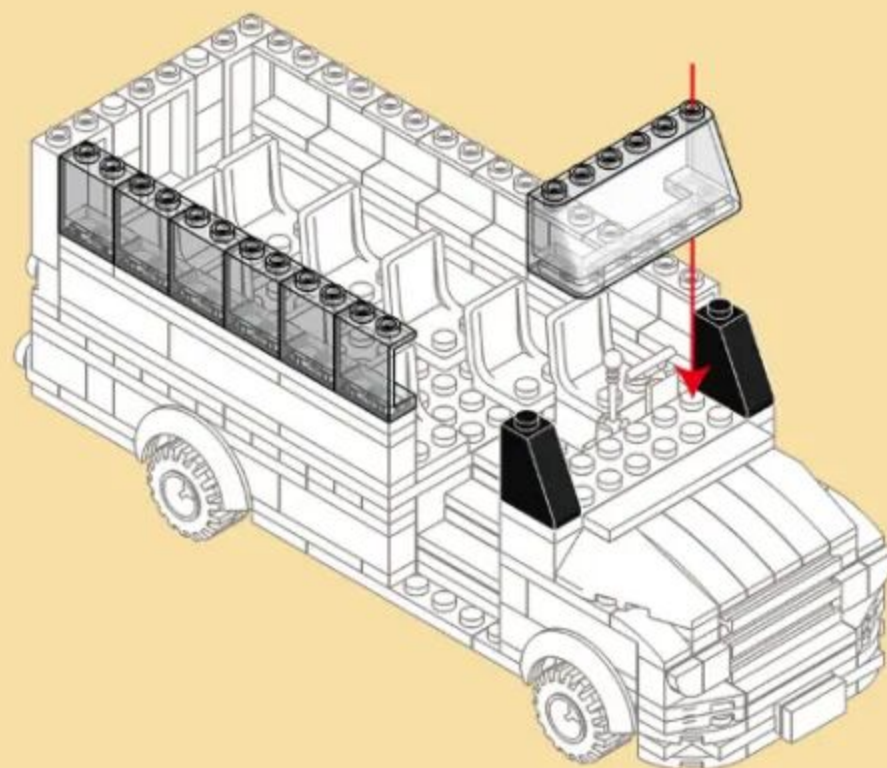

19



x1



x1

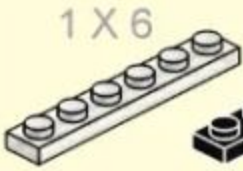

x1



x1



x2



x1

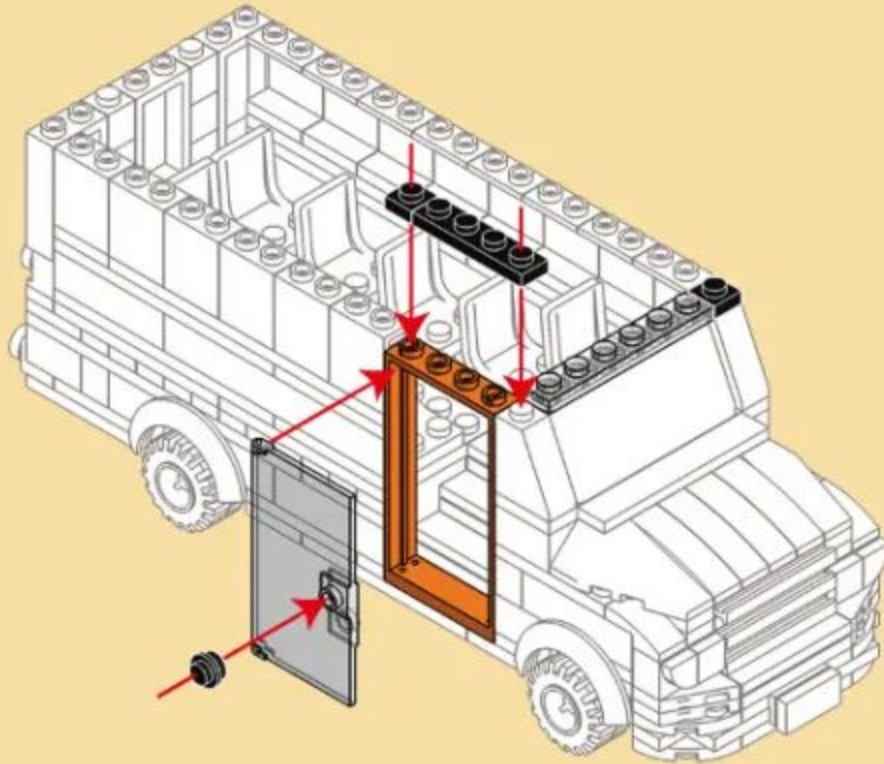

20

1 X 10

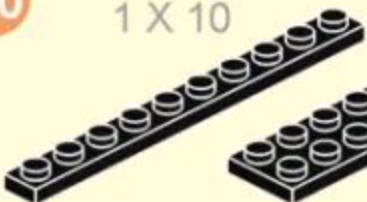

x4

2 X 8



x1

1 X 6



x2



x1



x1



x2



x2



x2

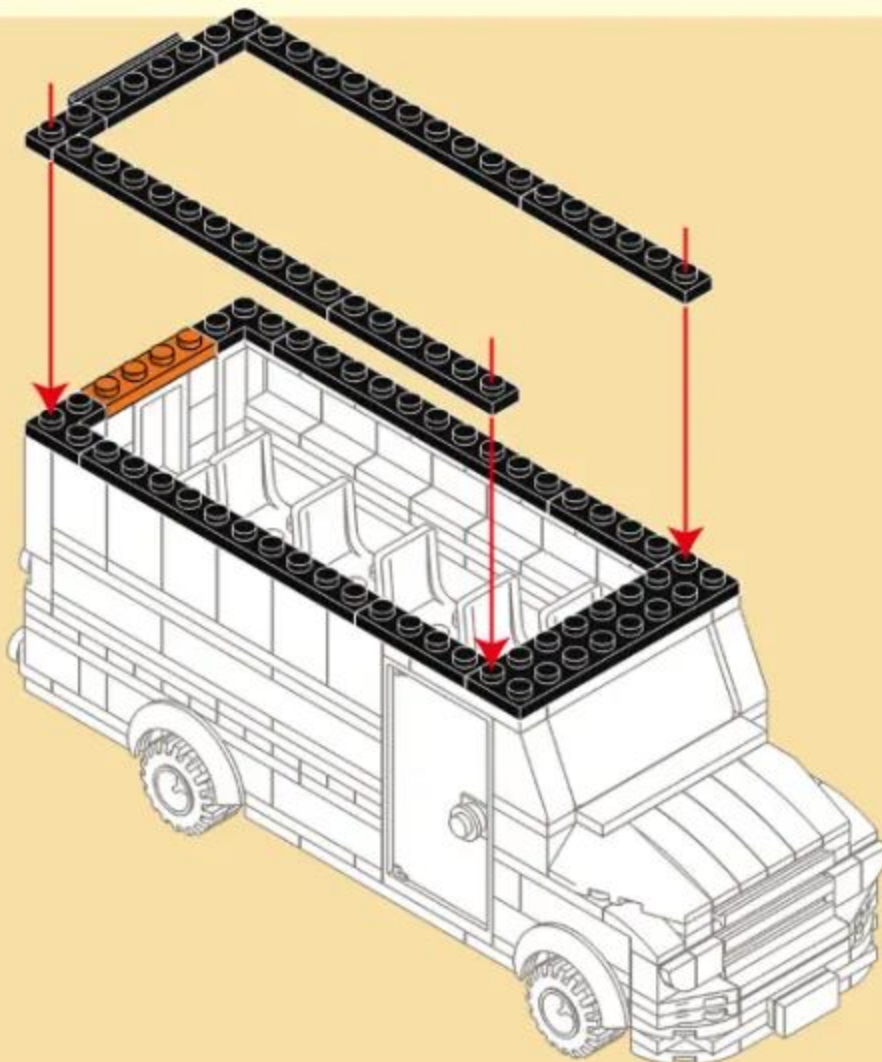

21

6 X 8

2 X 8

1 X 6

1 X 2

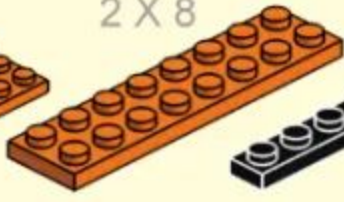

x2

x2

x1

x2

x1

x1

x1

x2

x2

x2

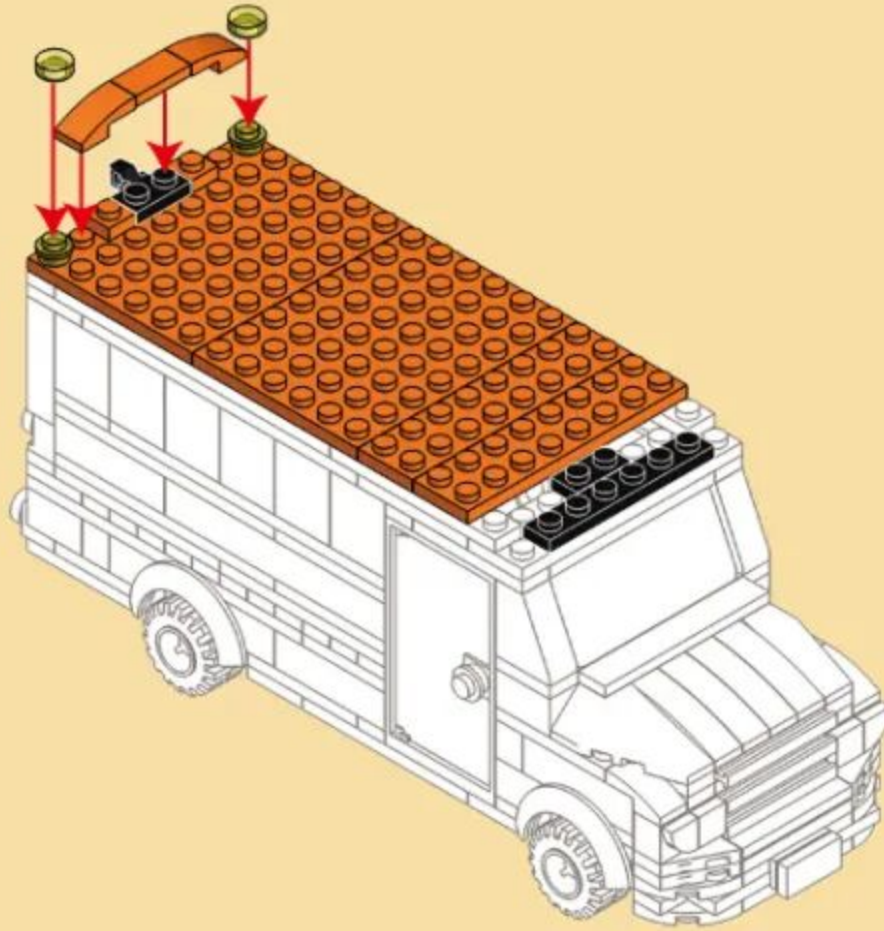

22

2 X 8

2 X 6

1 X 4

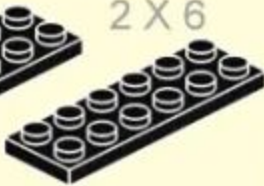

x2

x2

x2

x1

x1

x2

x2

x2

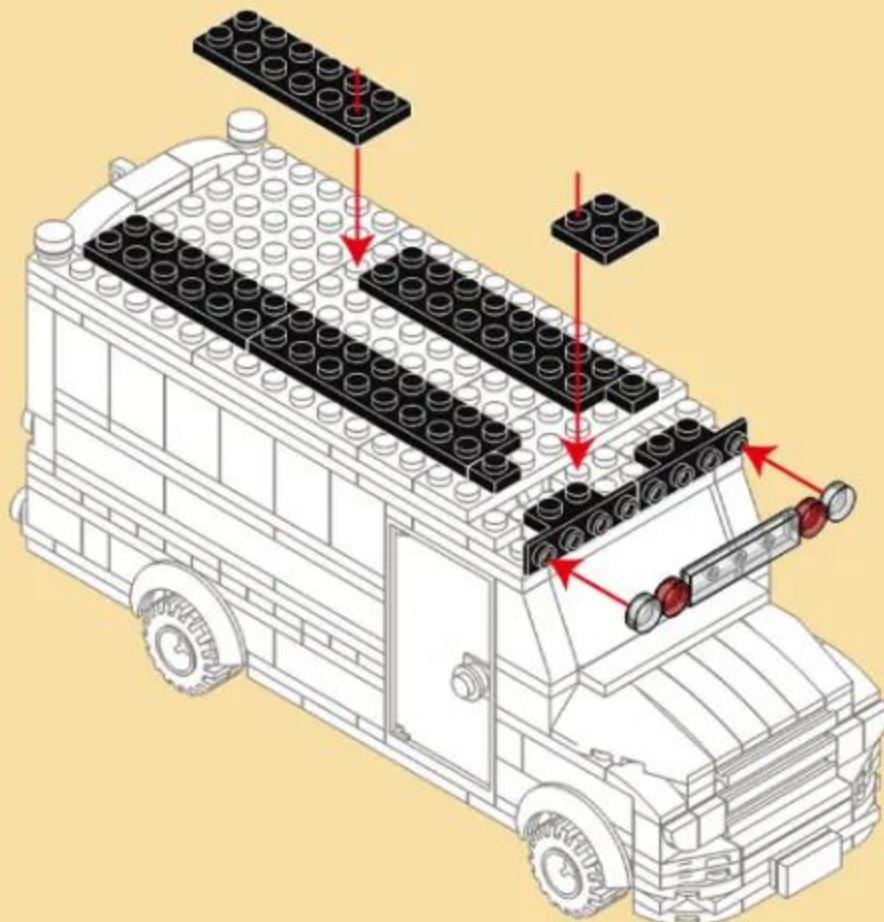

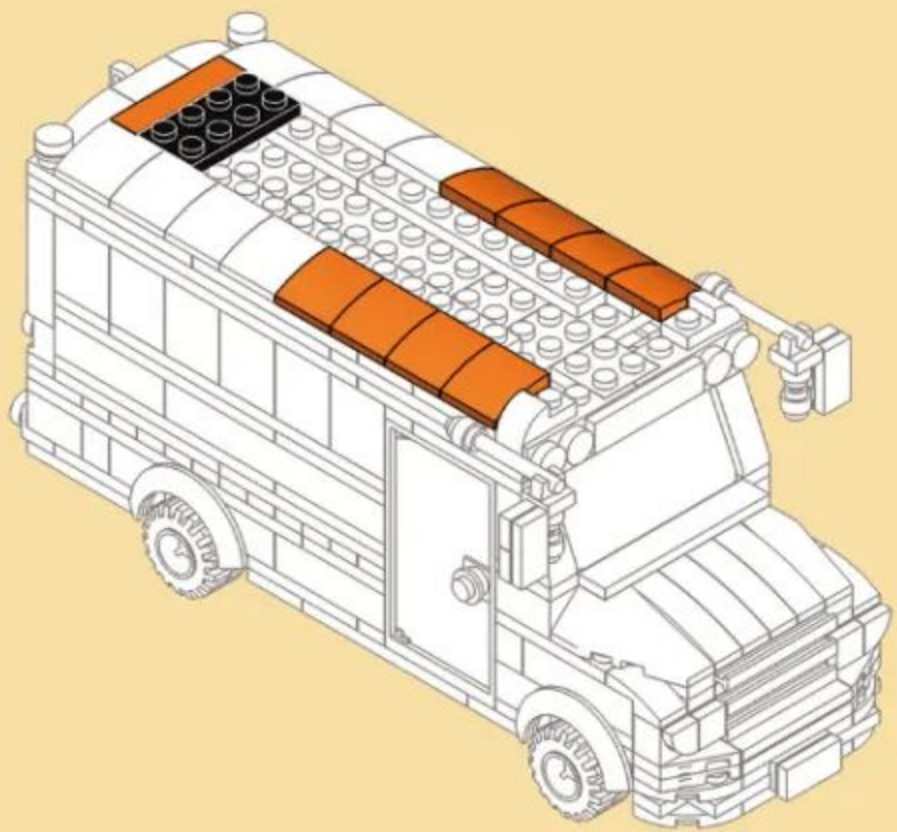
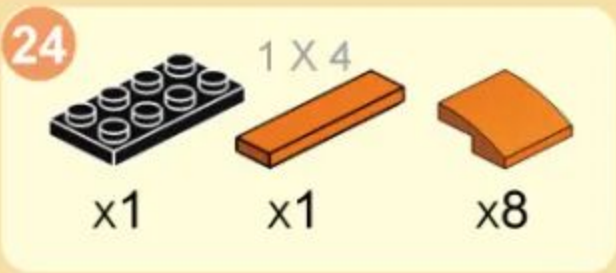
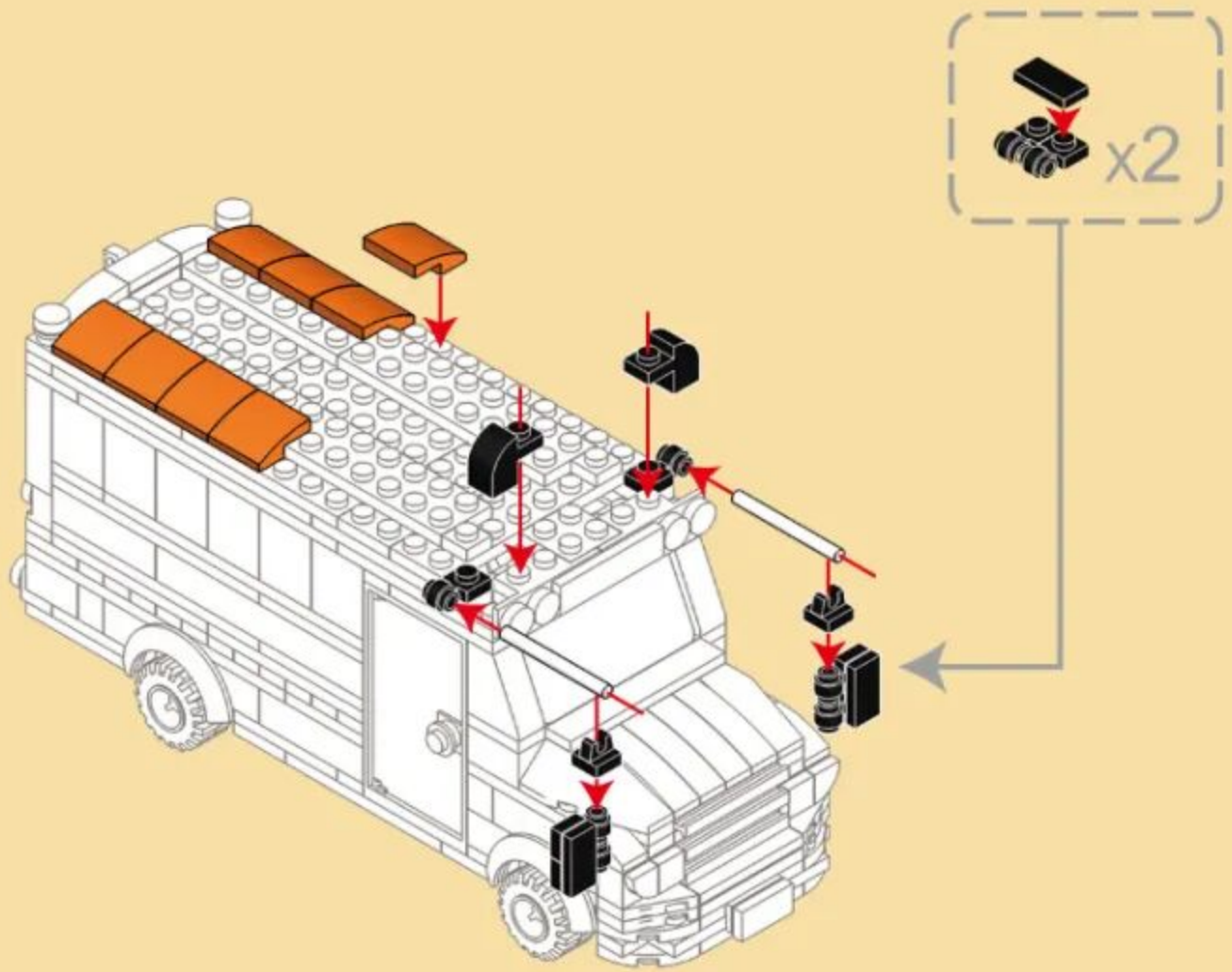

25

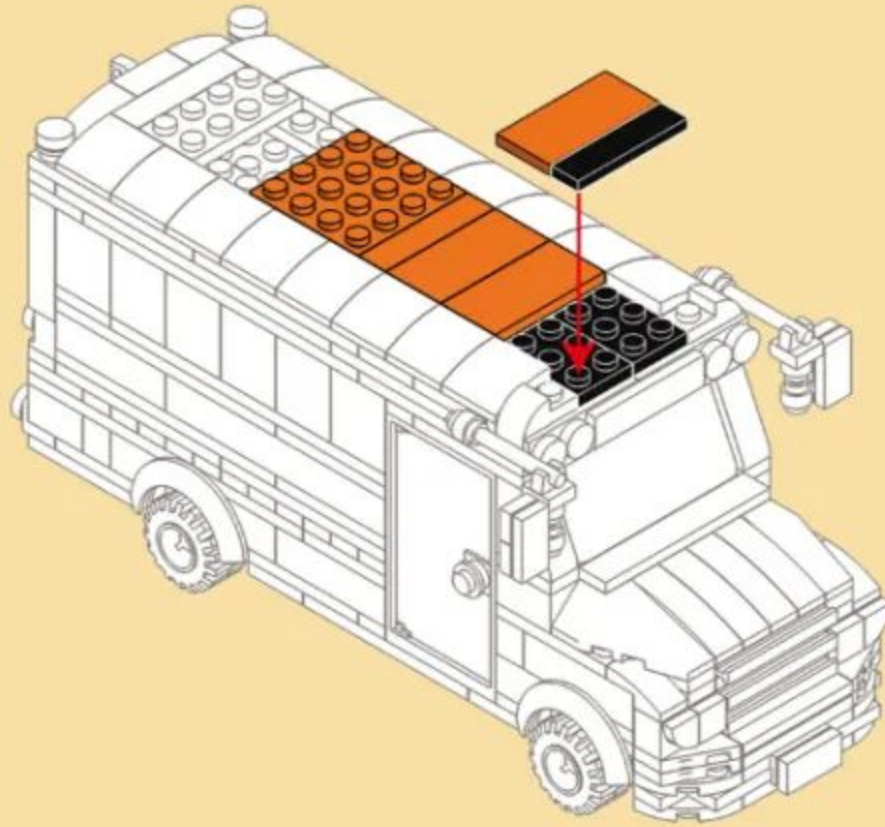
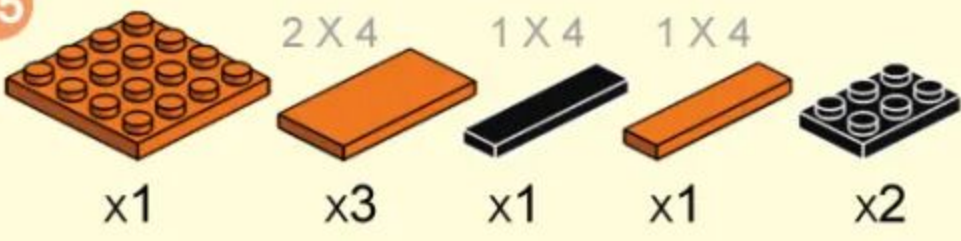

26

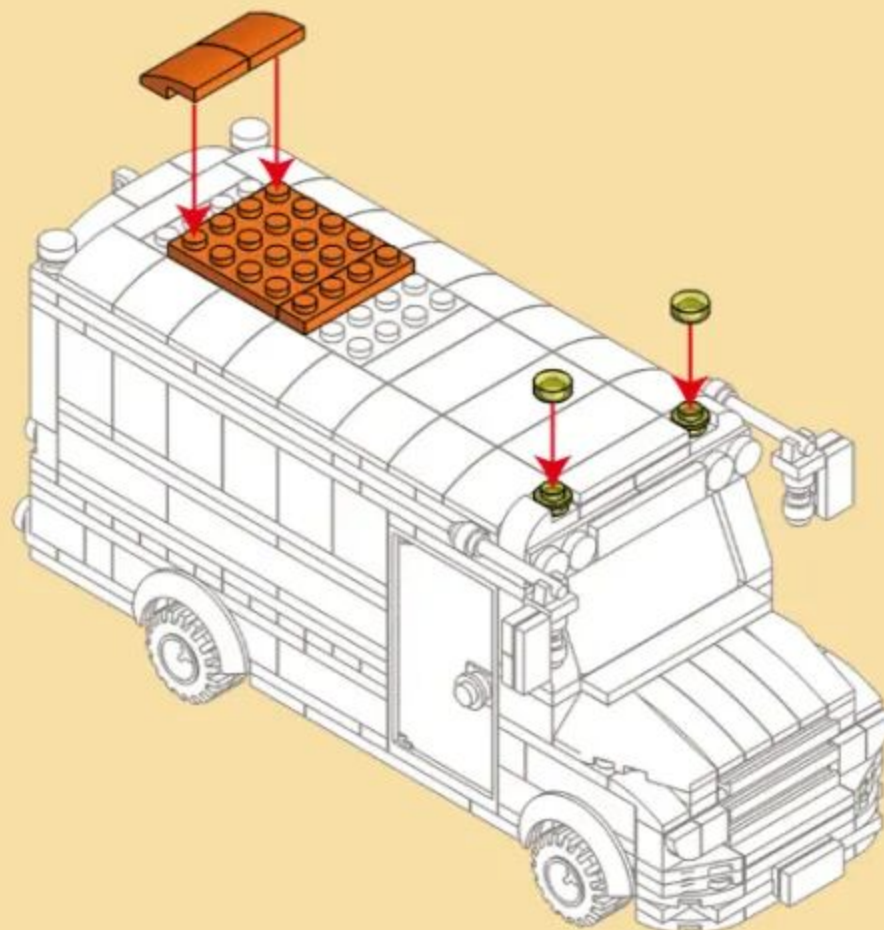
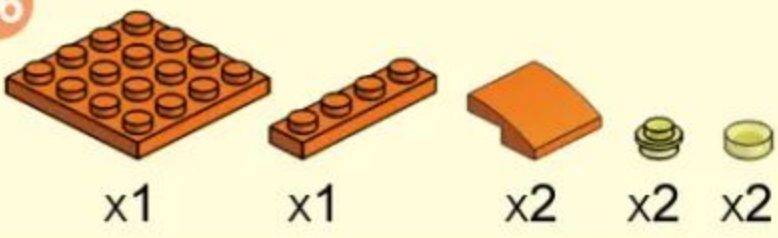



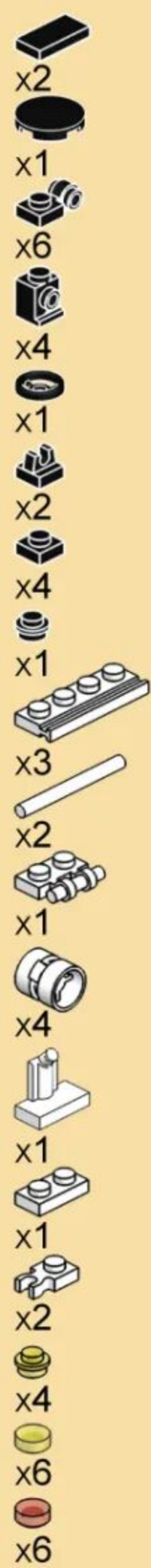
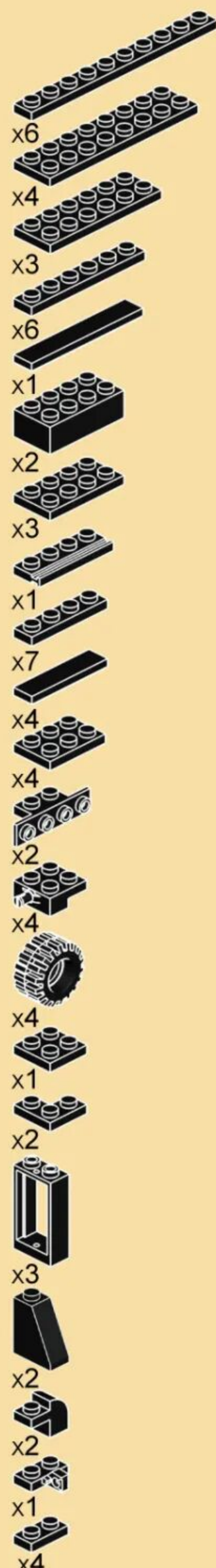
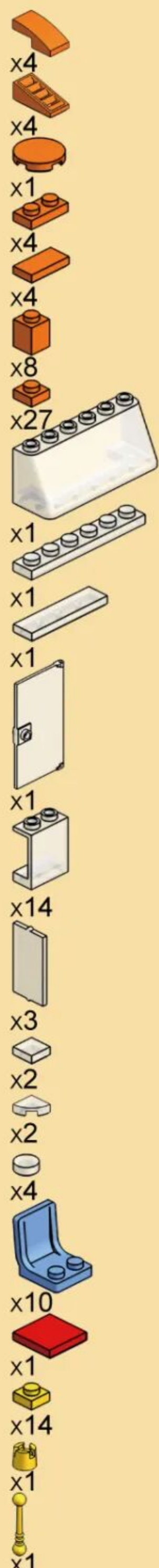
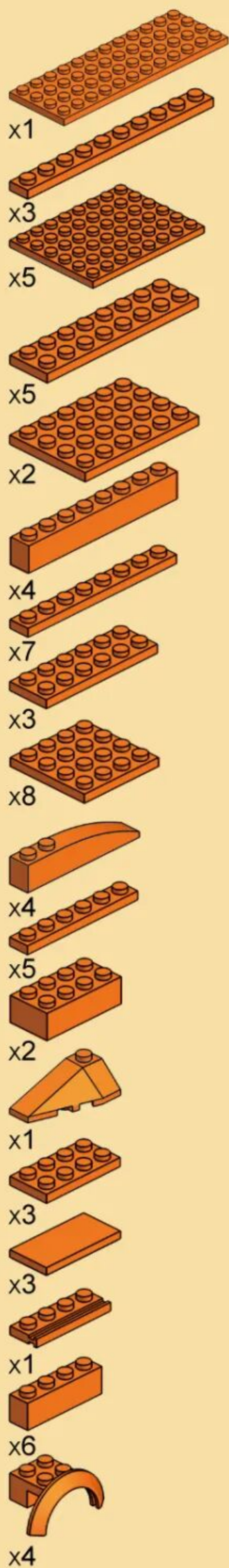

# School Bus

Can exercise the following abilities of baby

- ★ Processing visual input through some actions. Creativity and imagination help children keep trying new ideas.
- ★ Help them gradually form an innovative thinking and constantly find new ways to solve problems.
- ★ It is conducive to the development of "space wisdom".