



AIR FORCE

CARRIER-BASED FIGHTER

Building blocks model
Perfect shape, high simulation, classic collection



6+ / 4001 / 272PCS
Suitable Age / Product Number / Part Total

THIS PRODUCT DOES NOT CONTAIN BRACKET ACCESSORIES AND NEEDS TO BE PURCHASED SEPARATELY.

本品不含支架配件，需另外购买。

FLIGHT STAND

JX008

Perfect structure, easy assembly.

The Flight stand is compatible with our entire aircraft series.



EXTENDED GAMEPLAY



4001



CARRIER-BASED FIGHTER

1:54

4002



GUNSHIP

1:38

4003



HEAVY STEALTH FIGHTER

1:50

4004



INTERCEPTOR FIGHTER

1:48

4005



SR-71 BLACKBIRD

1:74

4006



P-51 MUSTANG FIGHTER

1:26

5005



AIRBORNE EARLY WARNING AND CONTROL AIRCRAFT

1:100

5006



TILTROTOR AIRCRAFT

1:44



微信扫一扫
补件更简单

Ver.400120220829

The Schematic of J-15 carrier-based fighter - 1

The Shenyang J-15 (Chinese: 歼-15), also known as Flying Shark (Chinese: 飞鲨, Feisha), is a heavy carrier-based fighter, with lots carrier-based aircraft characters like canard, folding wings, tail hook, etc. With high strength of the landing gear, dragging the front wheels could meet the ejection requirements.

General characteristics

Crew: 1
Length: 22.20 m
Height: 5.92m
Wingspan: 15.00 m
Wing area: 62.04 m²
Empty weight: 17500 kg
Max. takeoff weight: 32500 kg



The Schematic of J-15 carrier-based fighter -2

Performance

Service ceiling: 20000 m

Rate of climb: 325m/s

Mount point: 12

Air-to-air missiles: PL-12

Standard fuel: 5300kg

Maximum fuel: 9300kg

Powerplant: 2 × WS-10H afterburning turbofans

Max thrust with afterburner: 117.6 kN each

Emergency takeoff maximum thrust: 125.4 kN

Maximum speed: Mach 2.4

Range: 3500 km



PARTS LIST

配件清单



x1



x1



x1



x1



x1



x1



x2



x3



x2



x1



x1

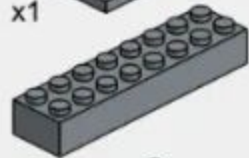

x2



x1



x1



x1



x1



x1



x3



x3

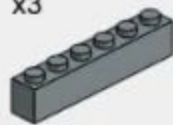

x2



x1

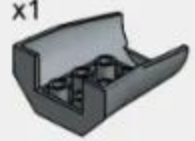

x1



x9

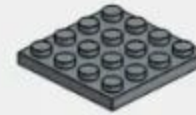

x4

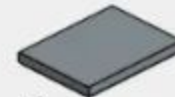

x2

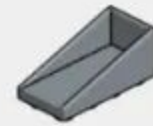

x2



x2



x4



x1



x5



x2



x1



x2



x2



x1



x4



x1



x1

PARTS LIST

配件清单

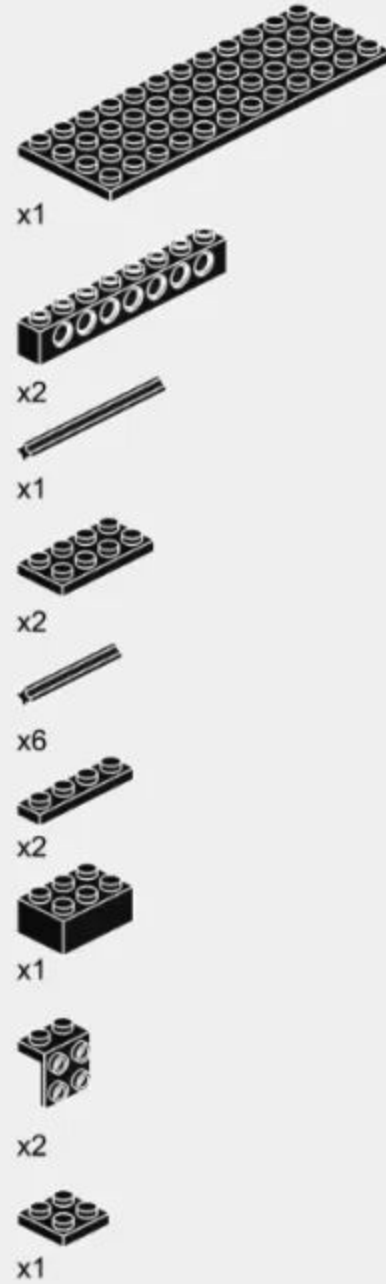
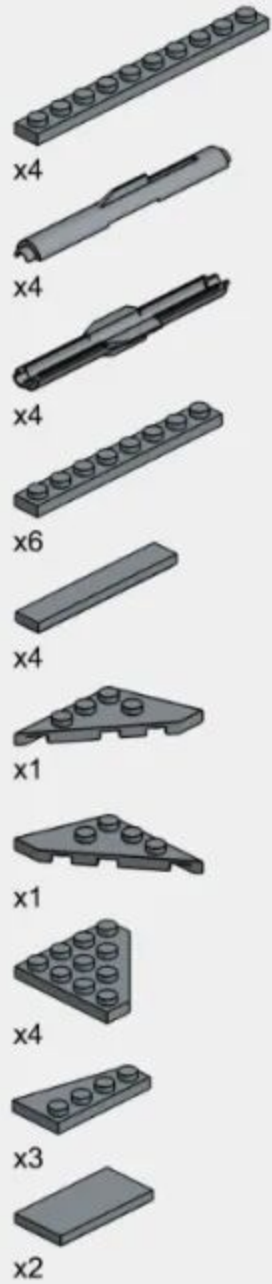

产品有增补件请以实物为准
 If product has additional parts, please in kind prevail.

1-1

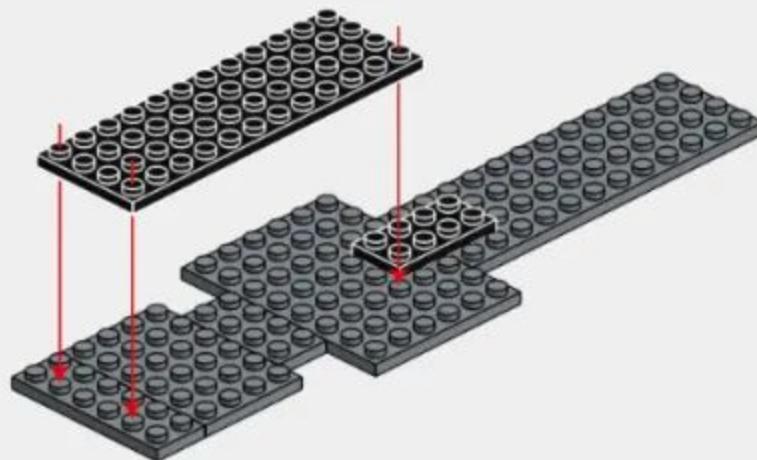
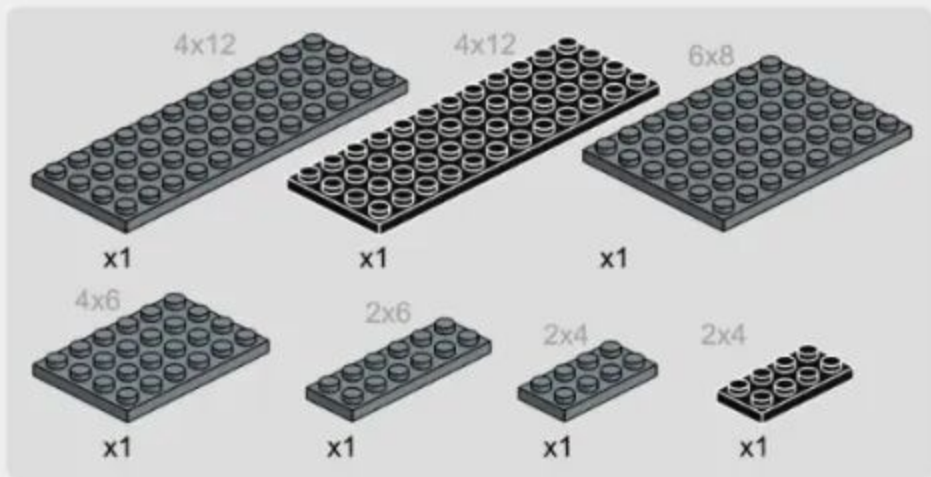

1-2

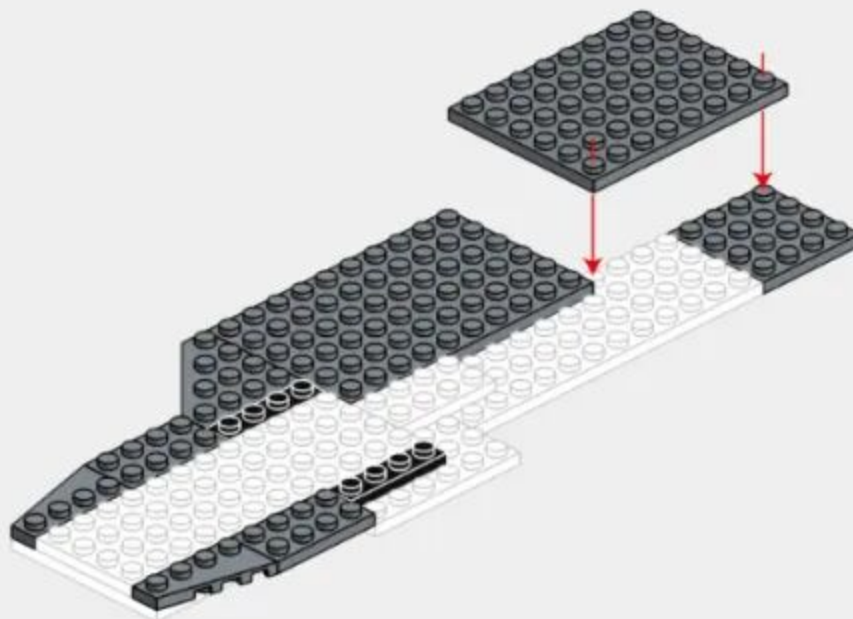
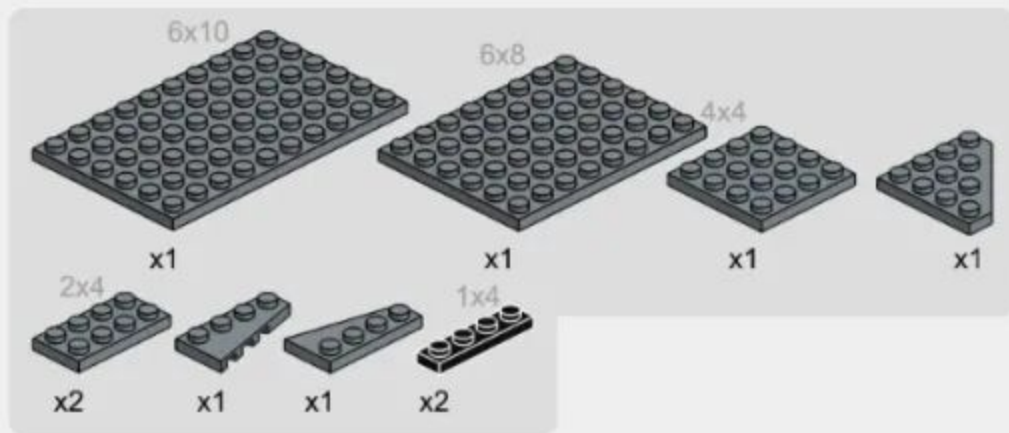

1-3

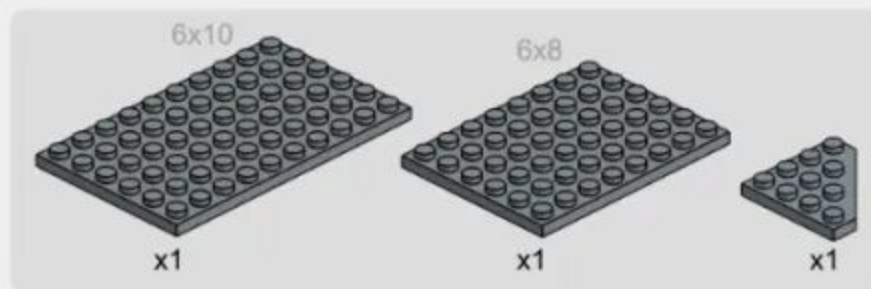

1-4

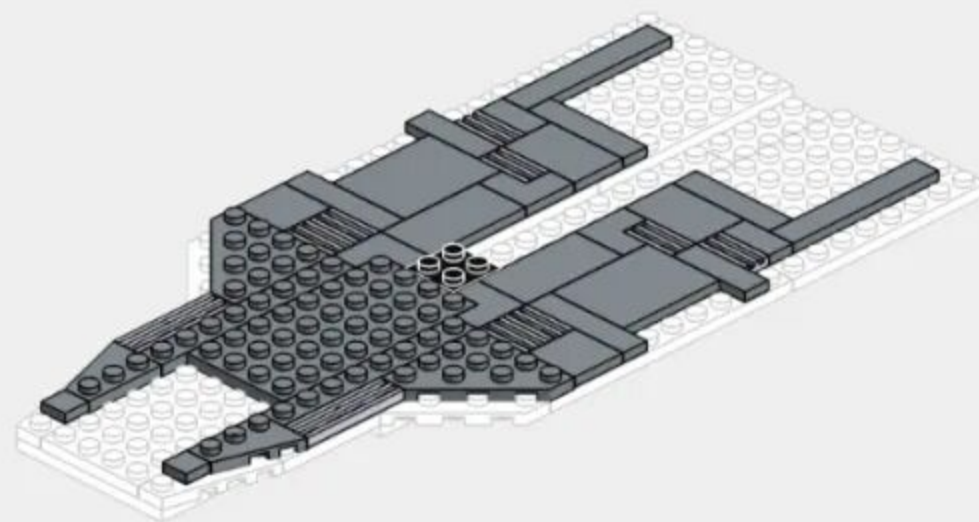
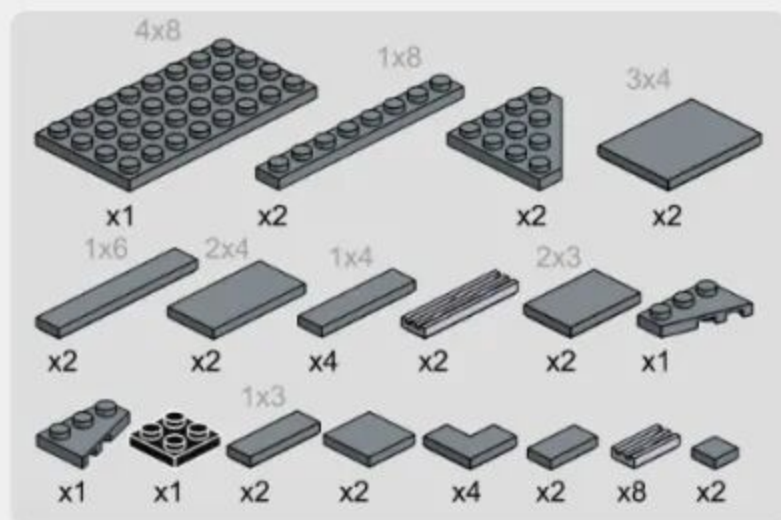

1-5

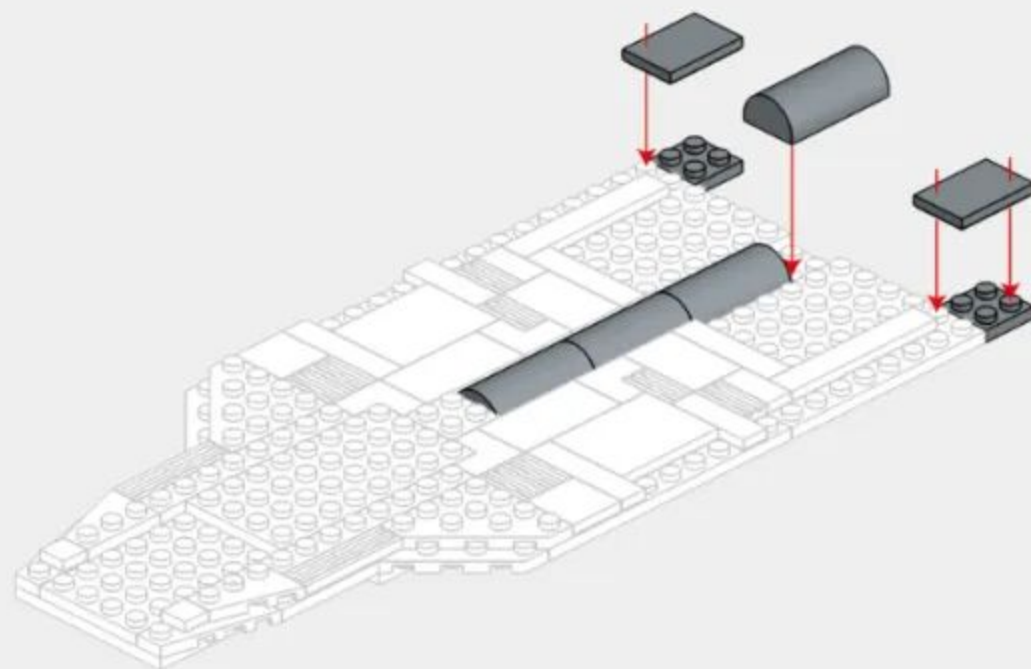
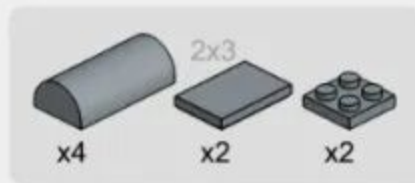

1-6

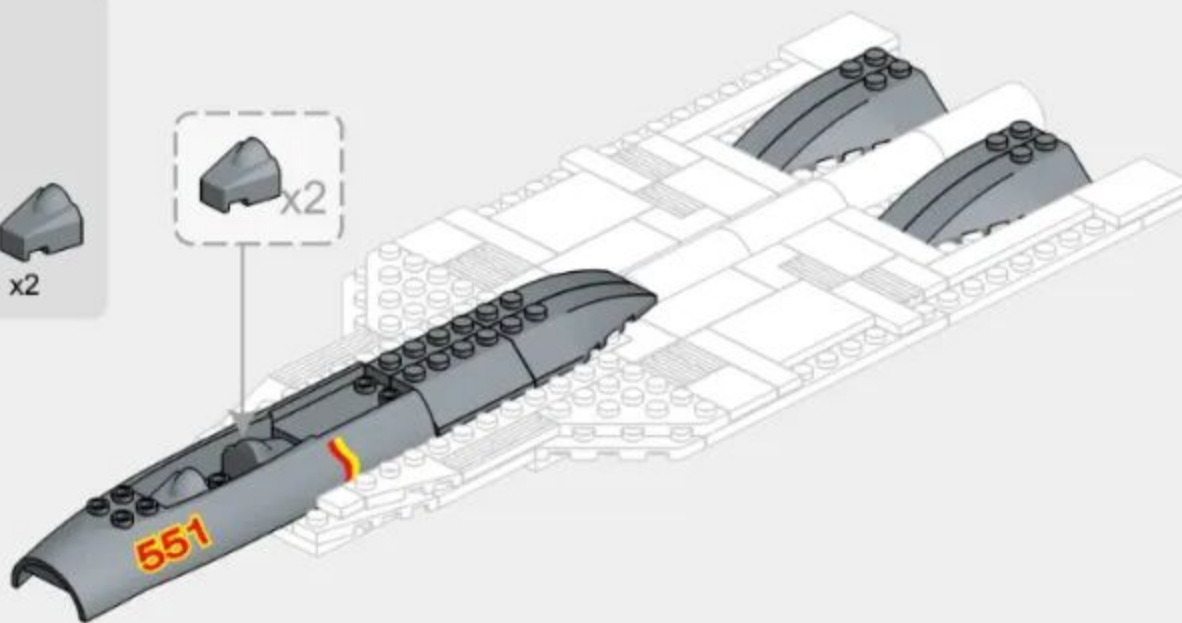
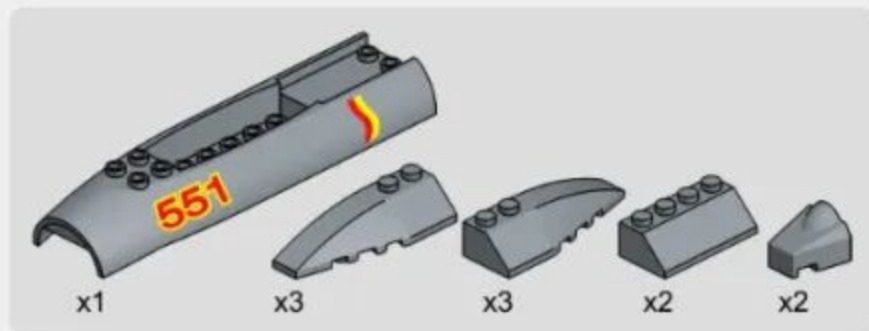

1-7

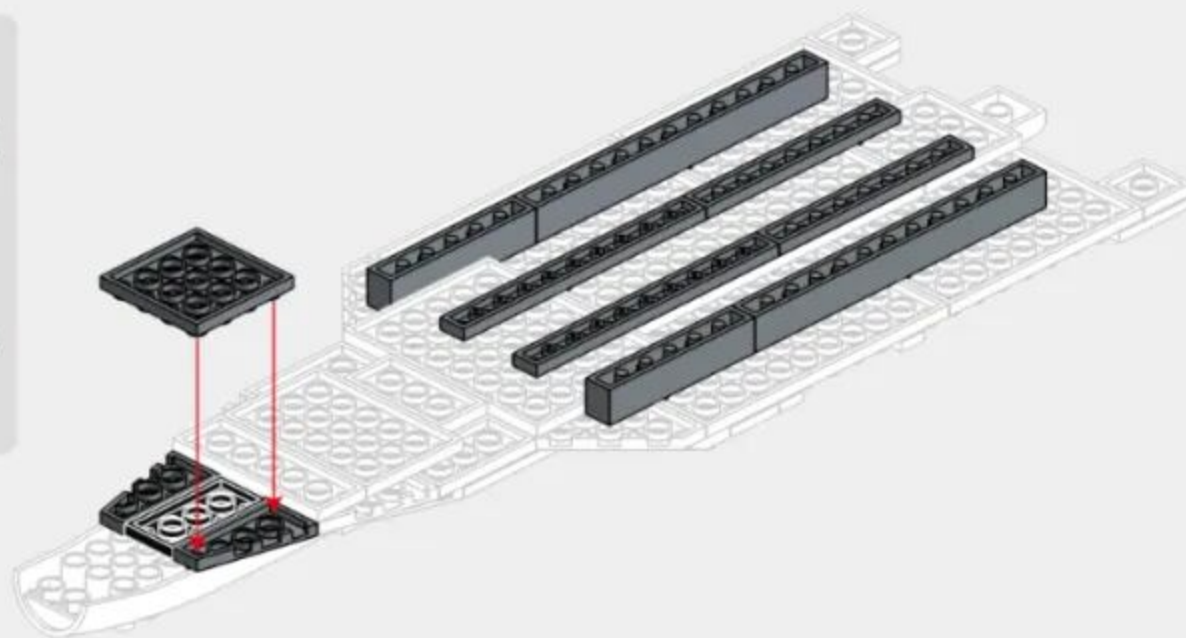
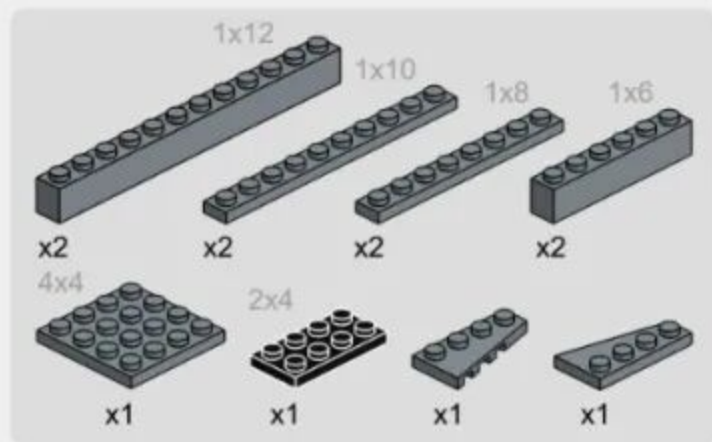

1-8

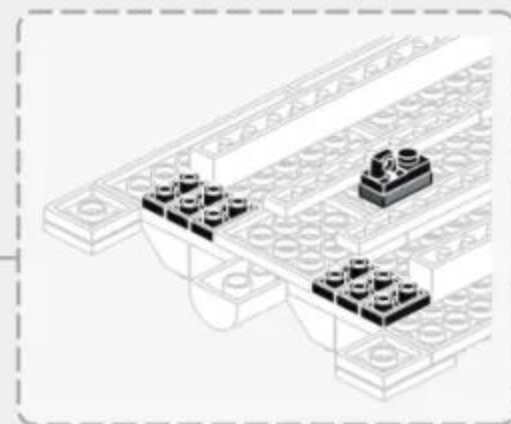
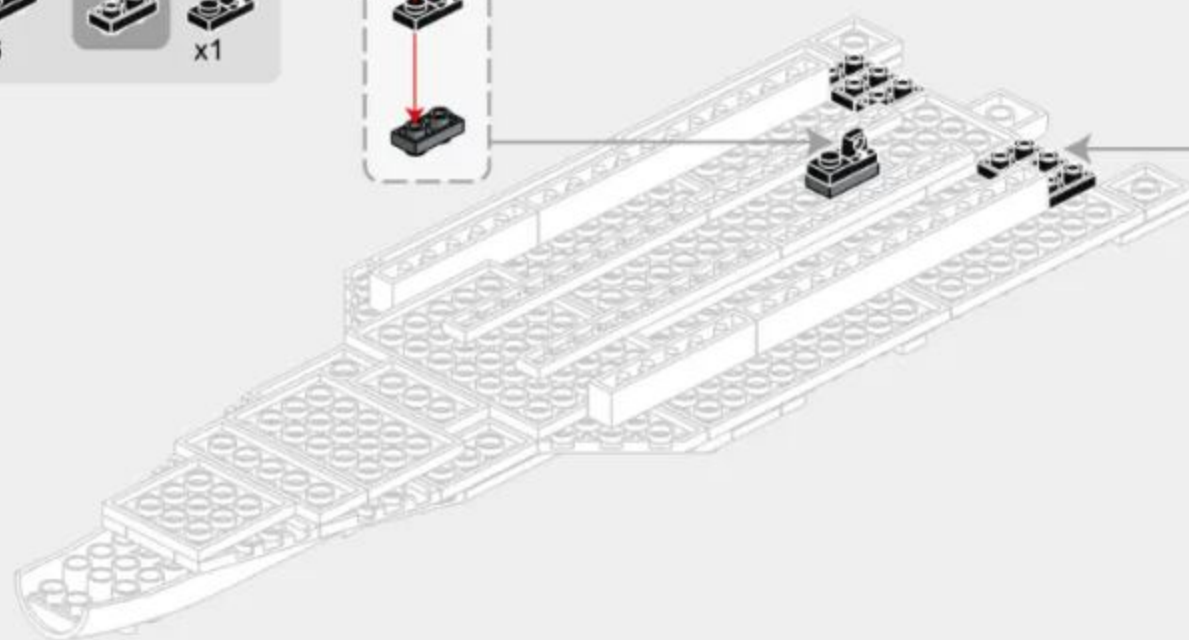

1-9

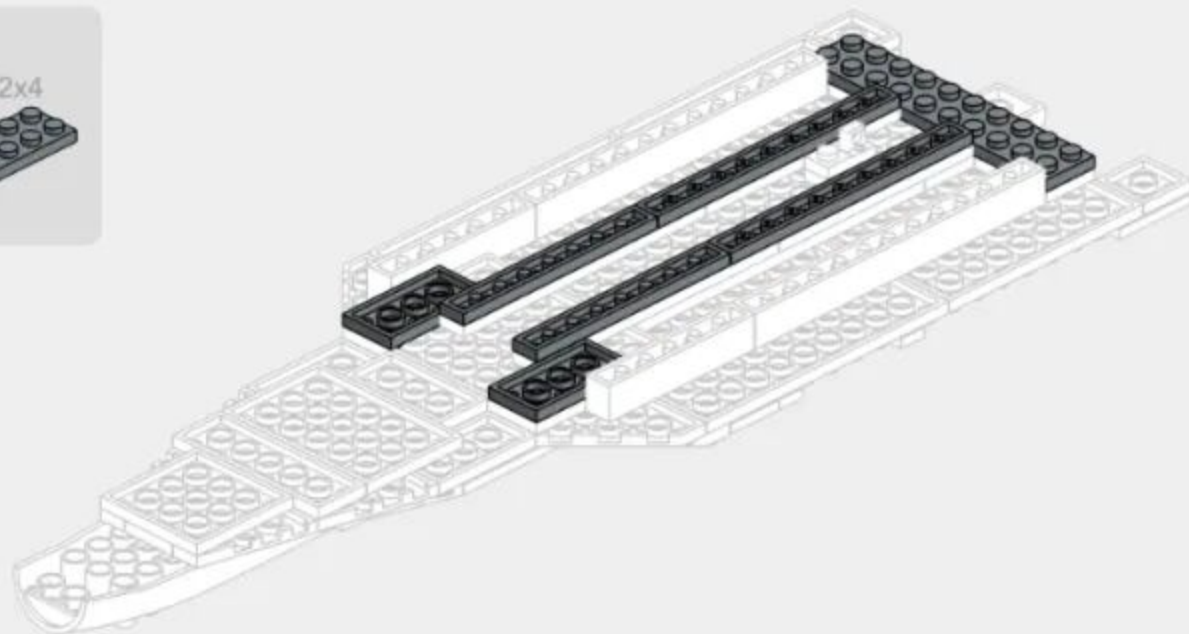
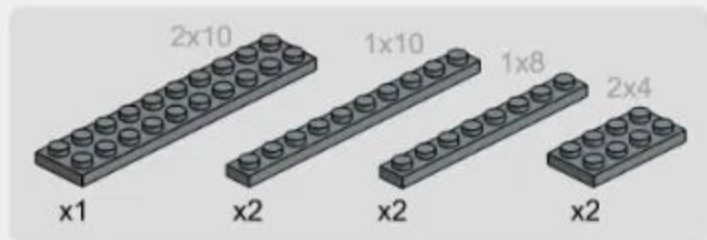

1-10

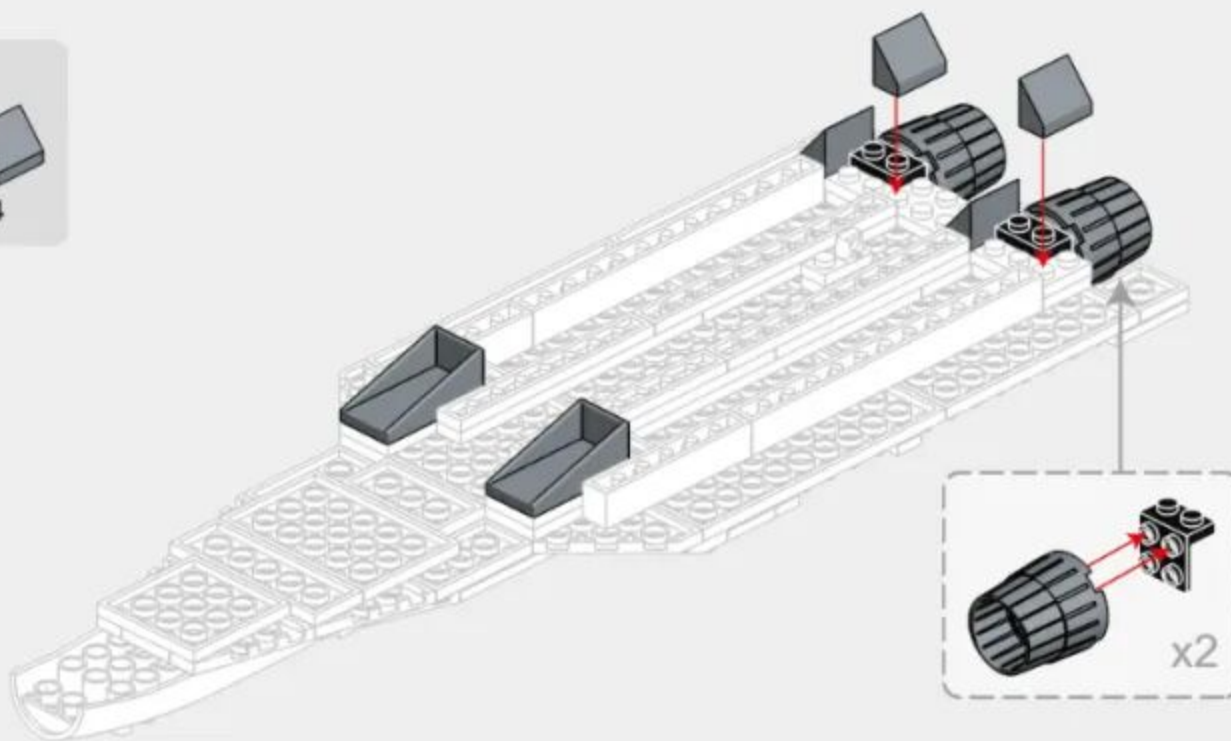
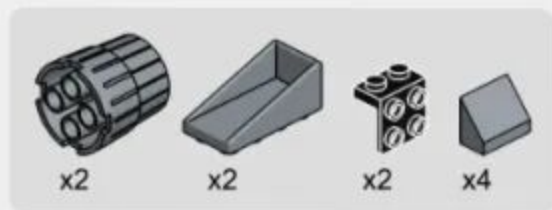

1-11

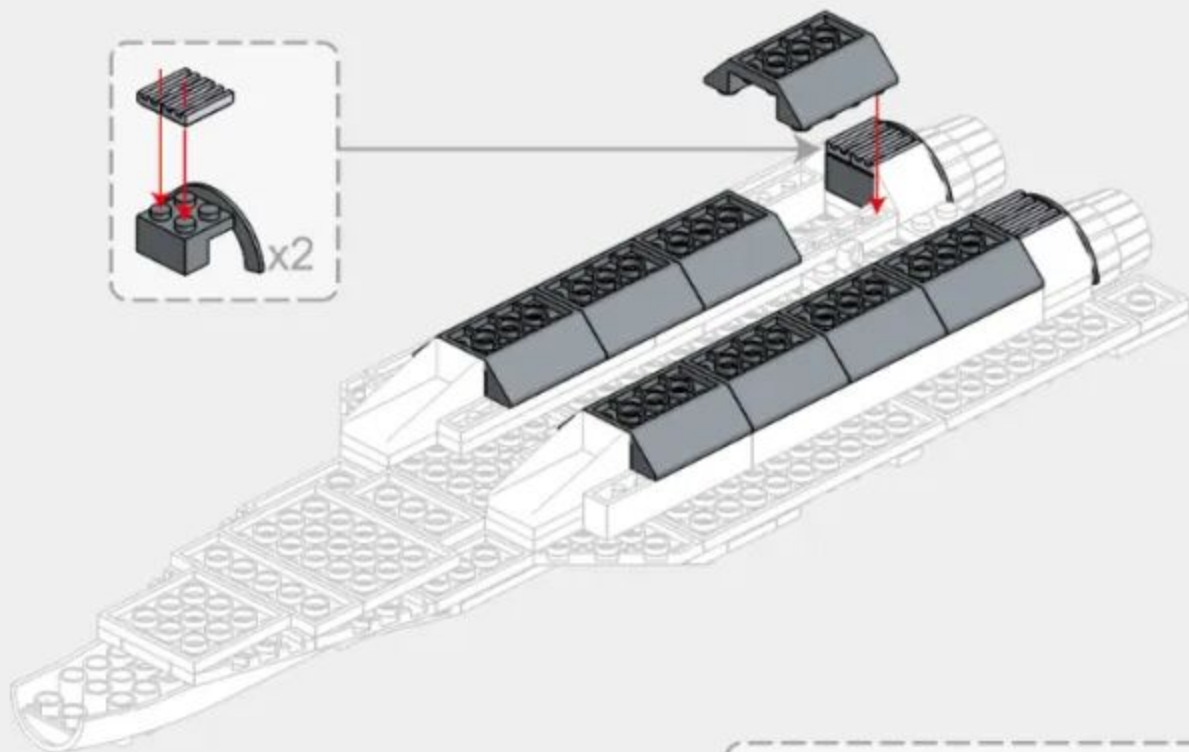
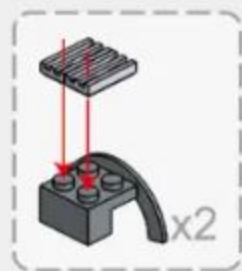
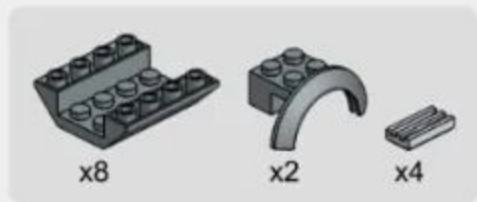

1-12

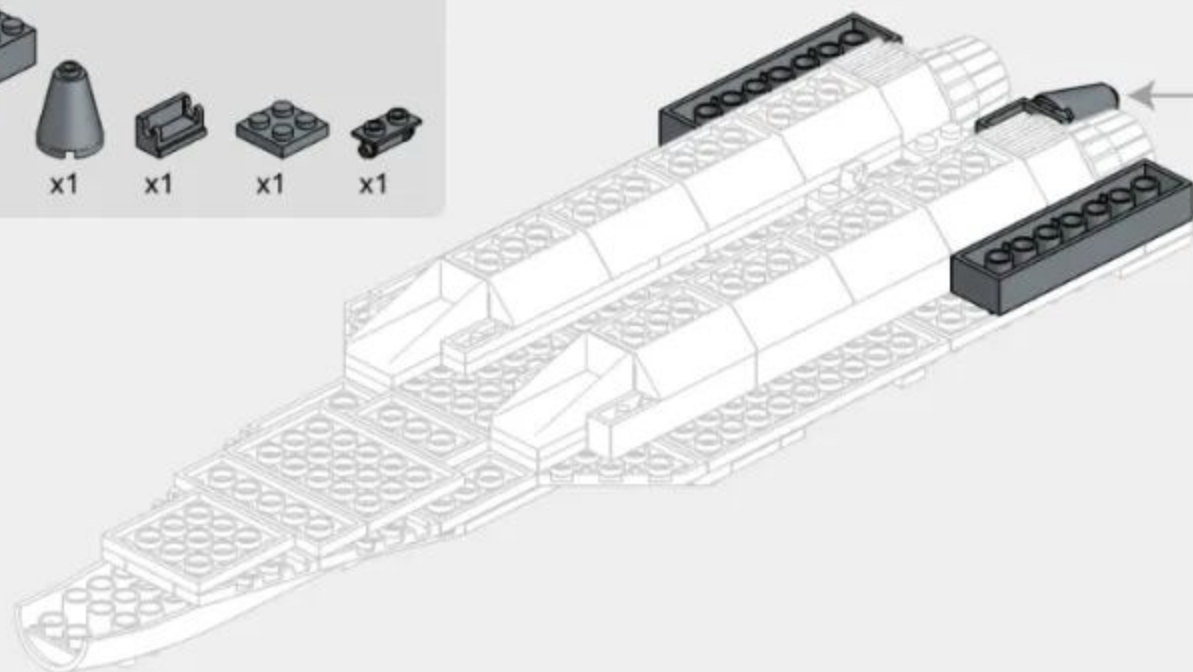
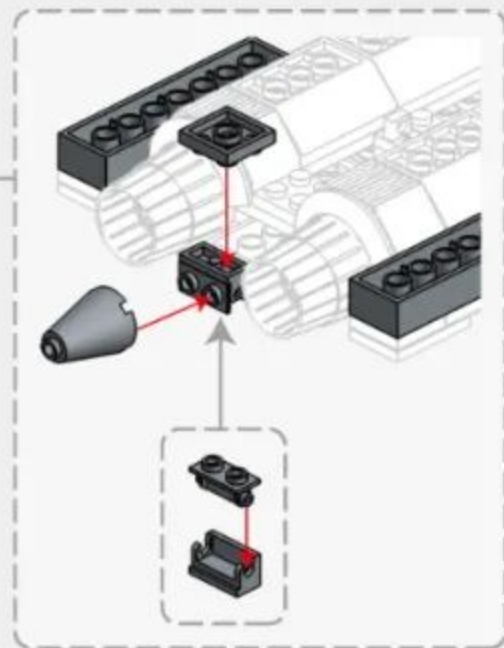
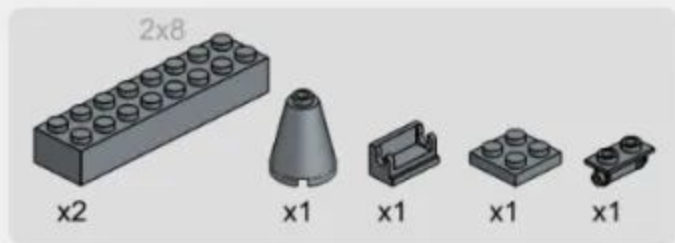

1-13

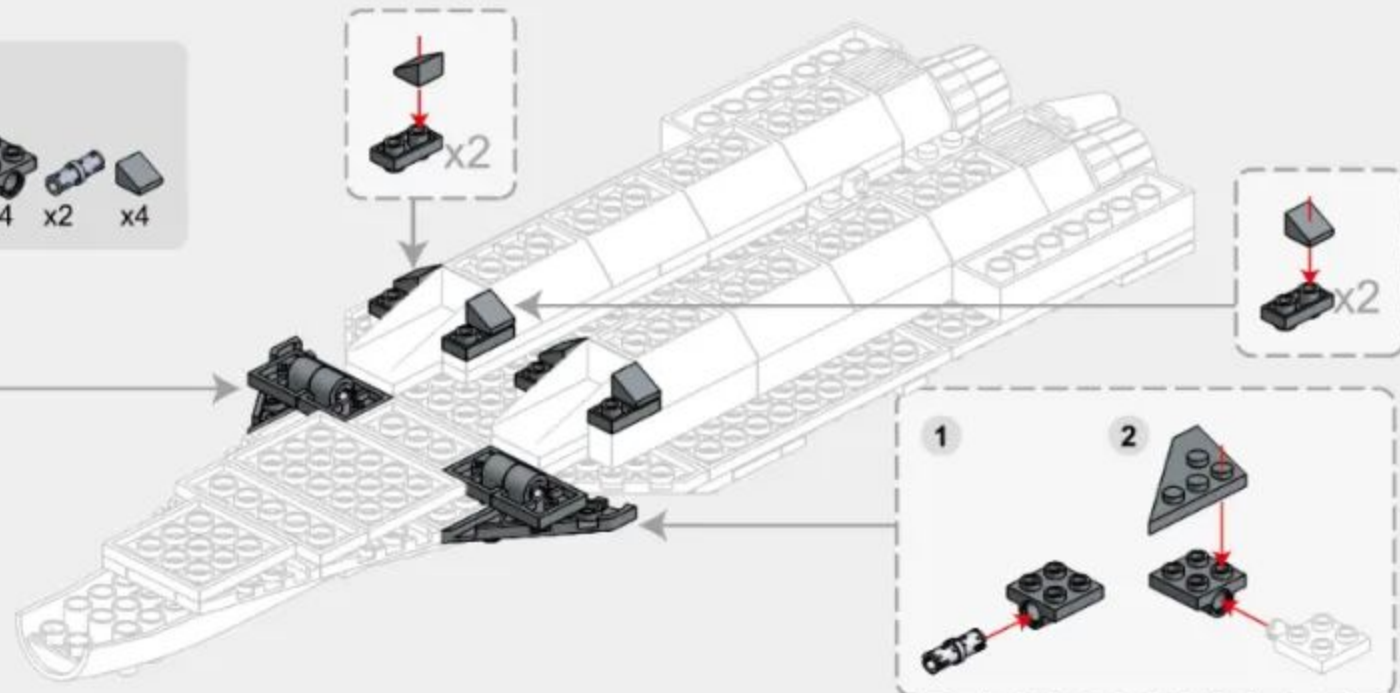
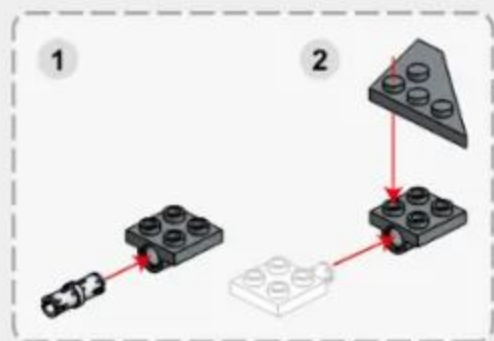
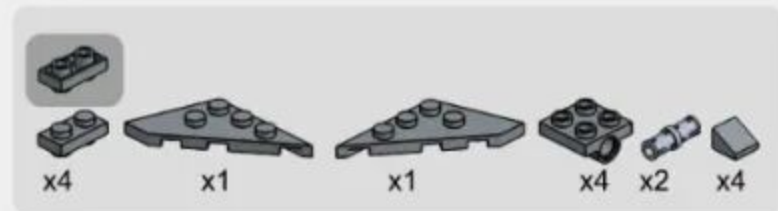

1-14

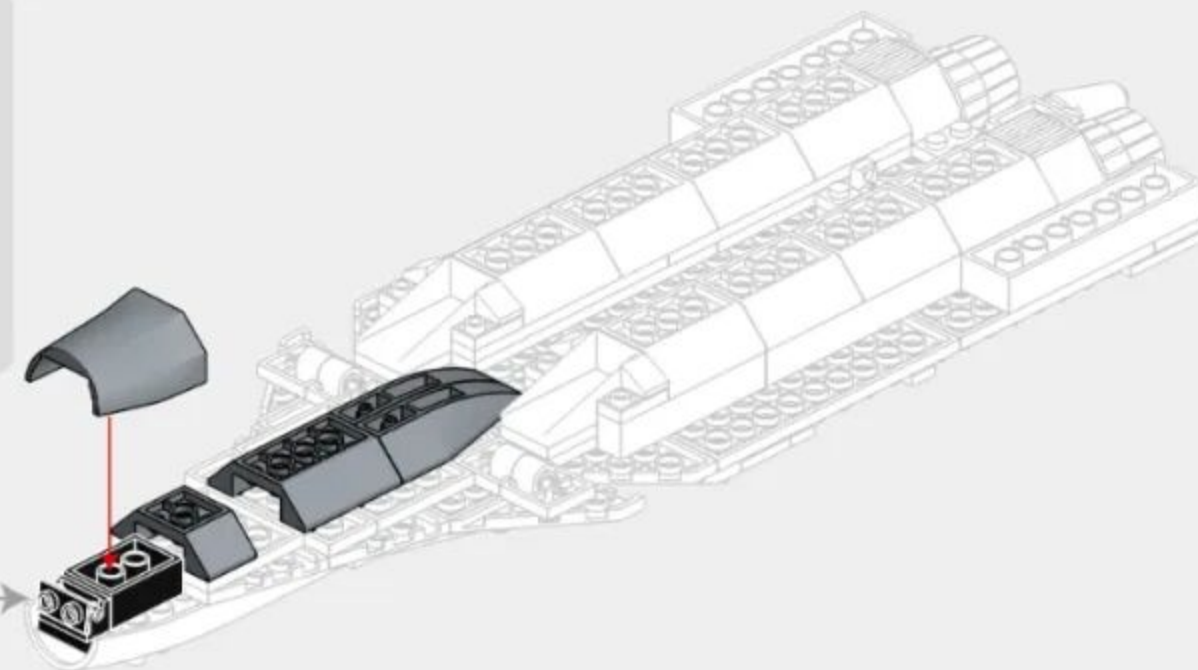
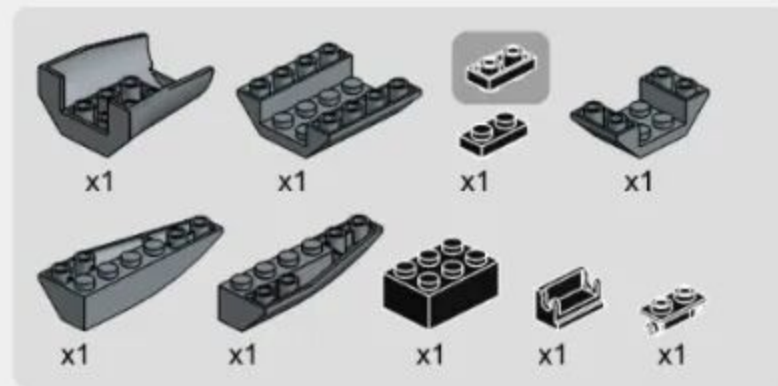

1-16

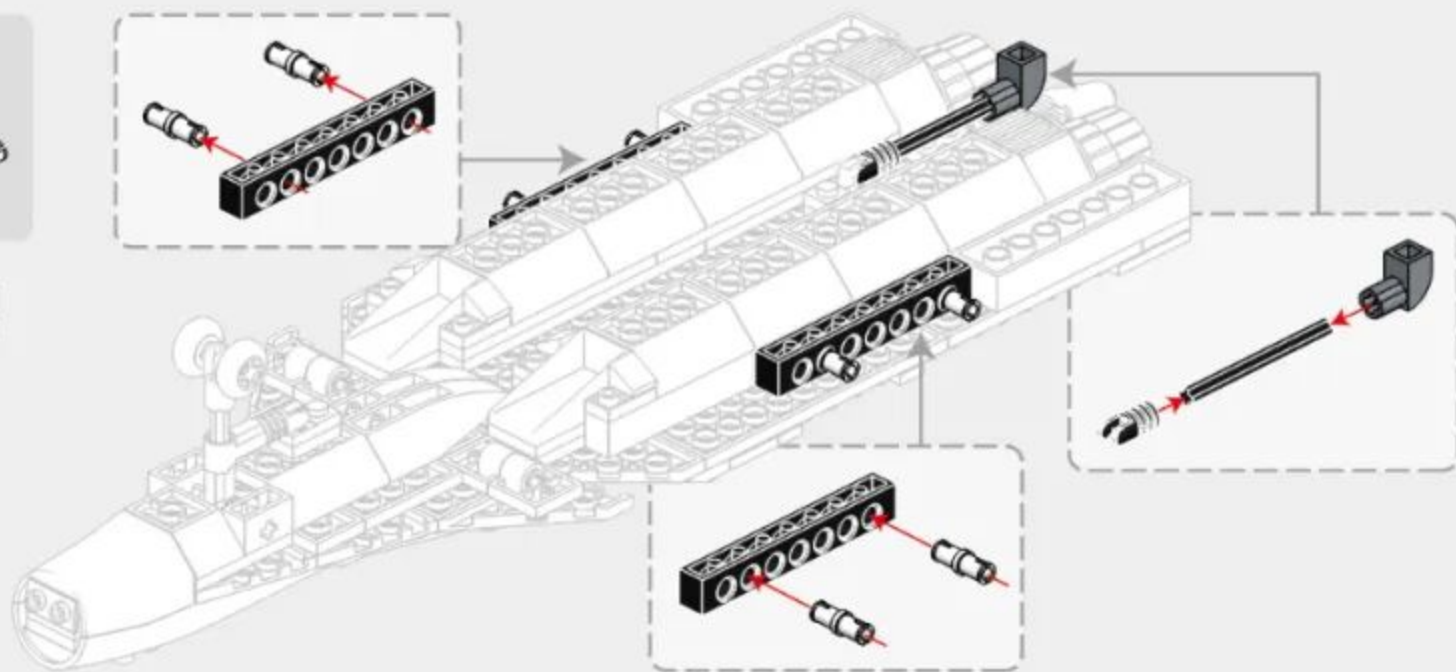

1-17

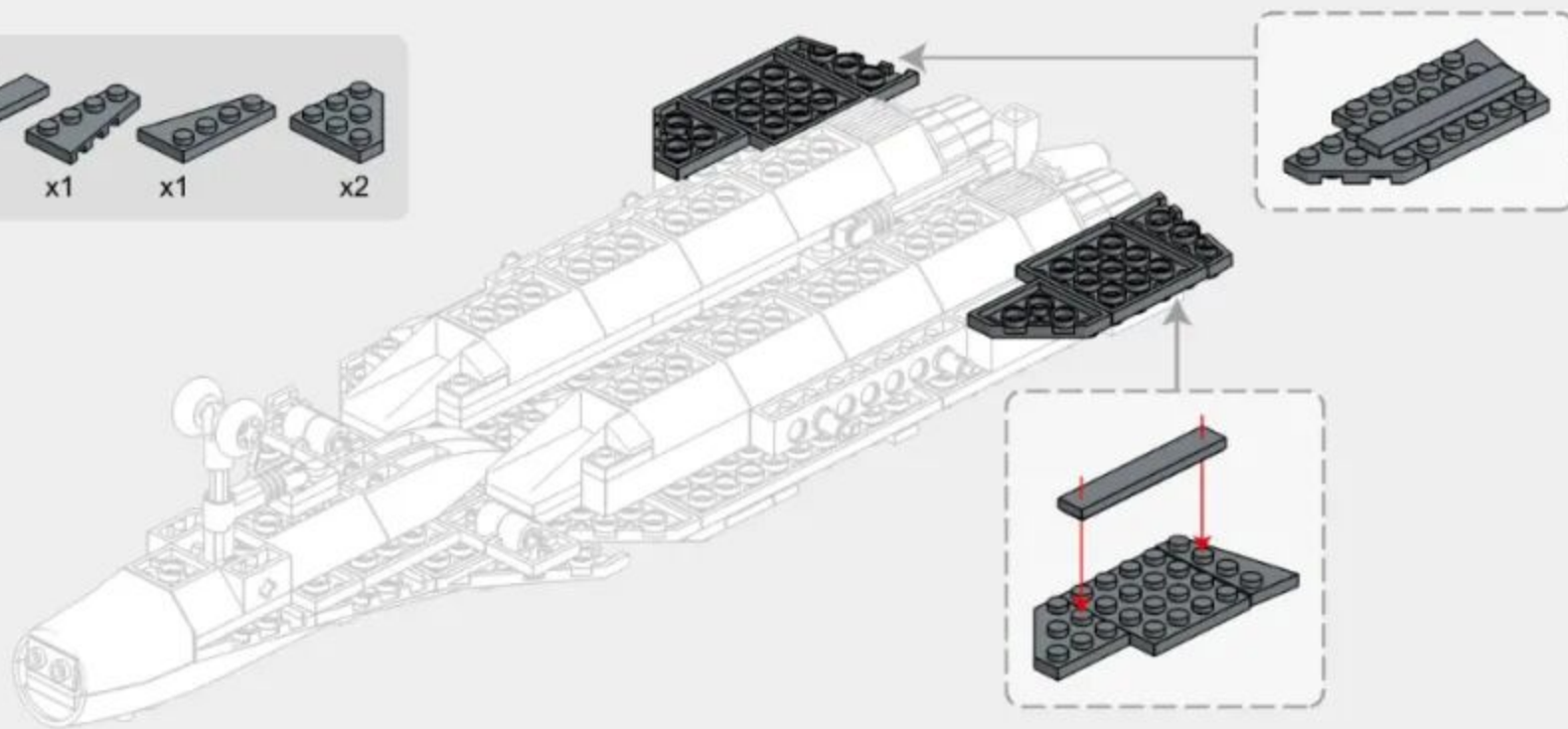
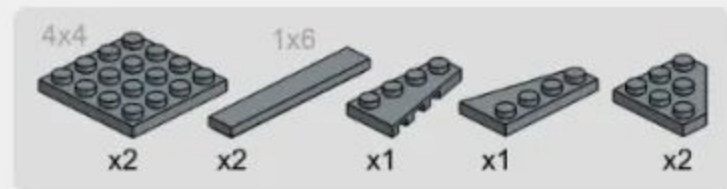

1-18

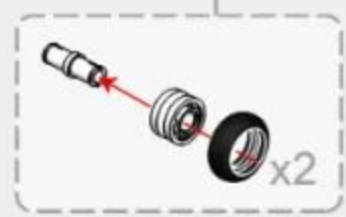
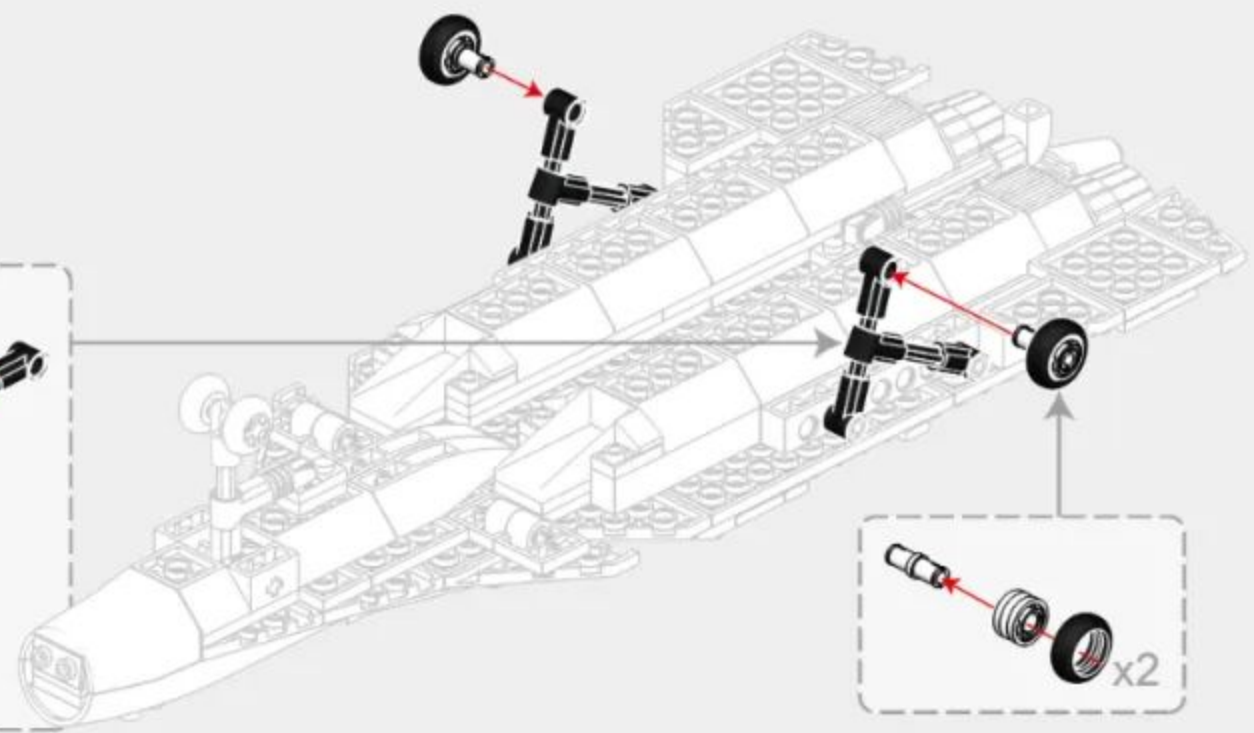
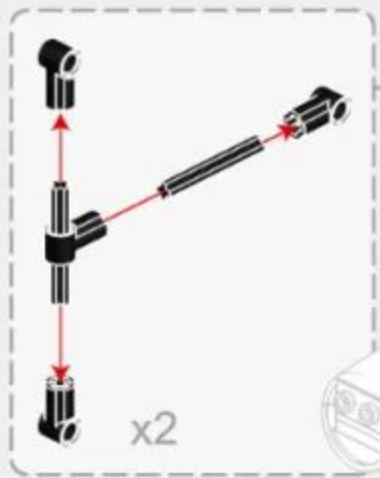

1-19

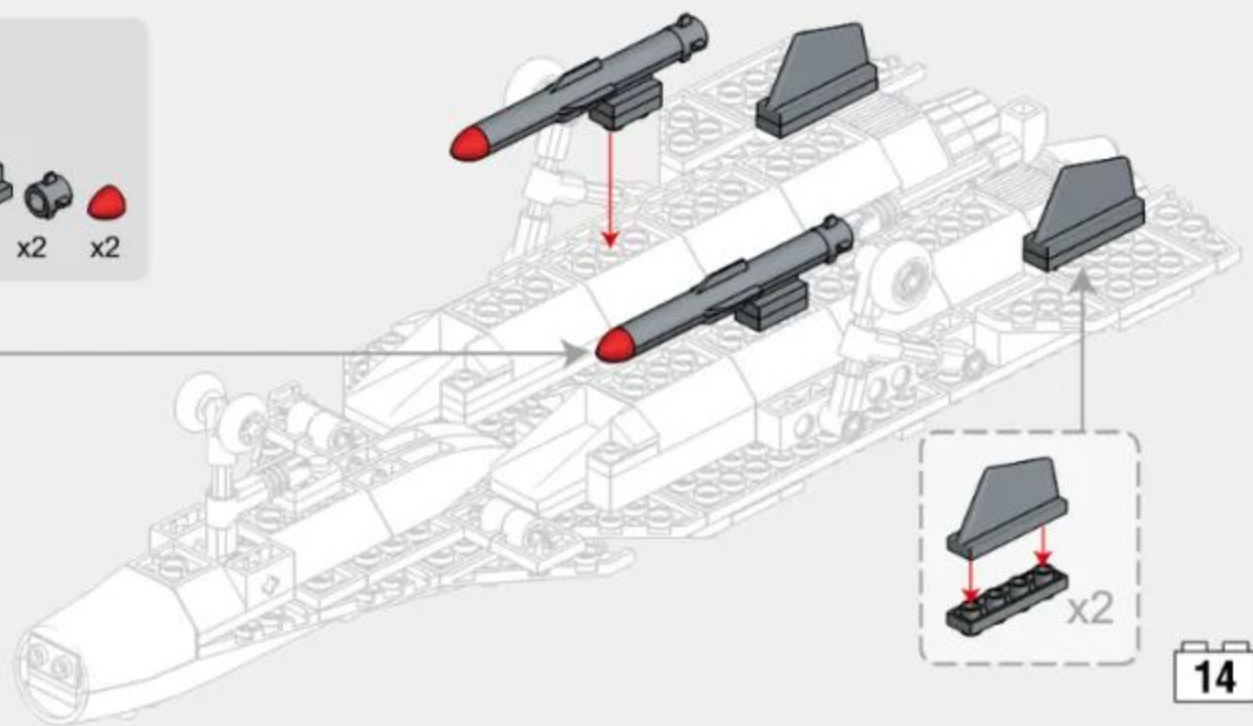
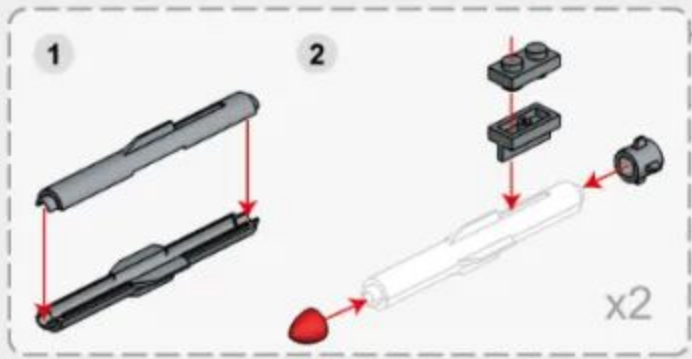
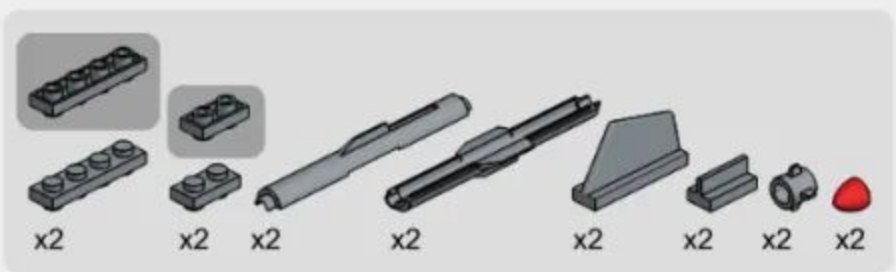

1-20

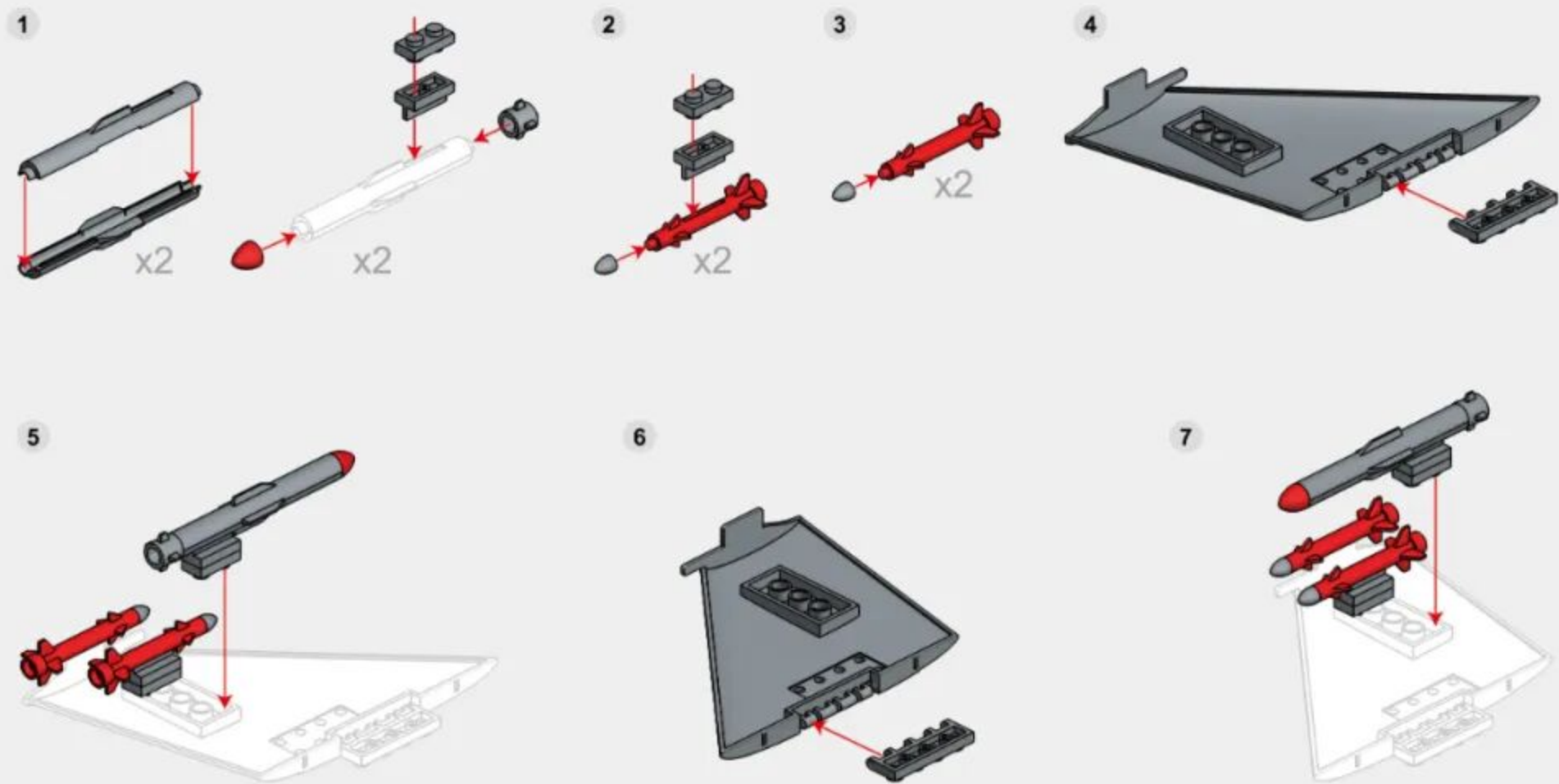
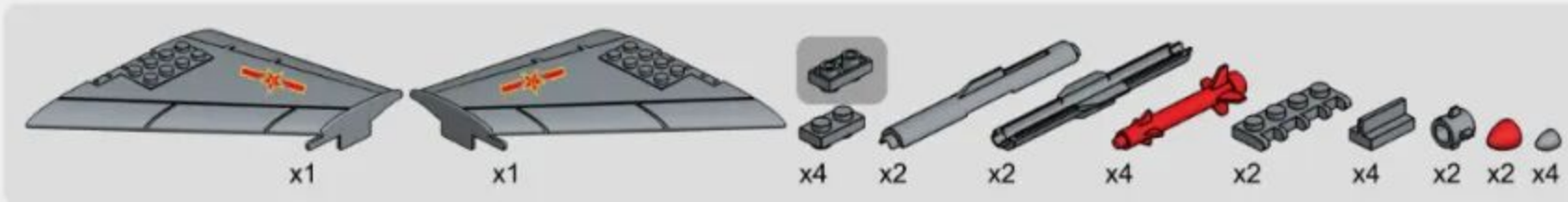

1-21

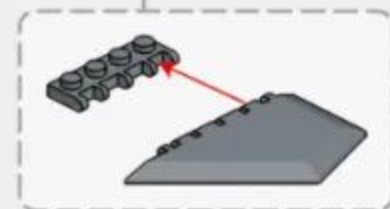
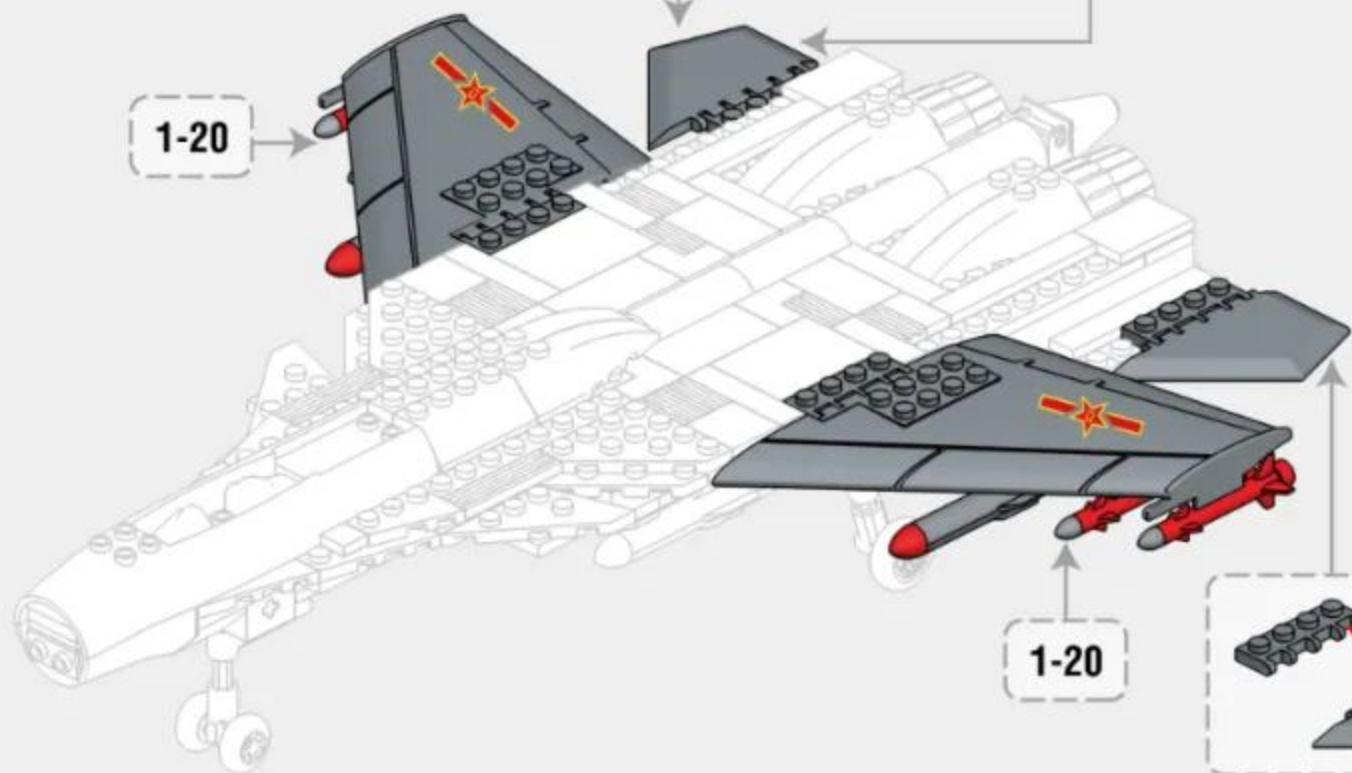
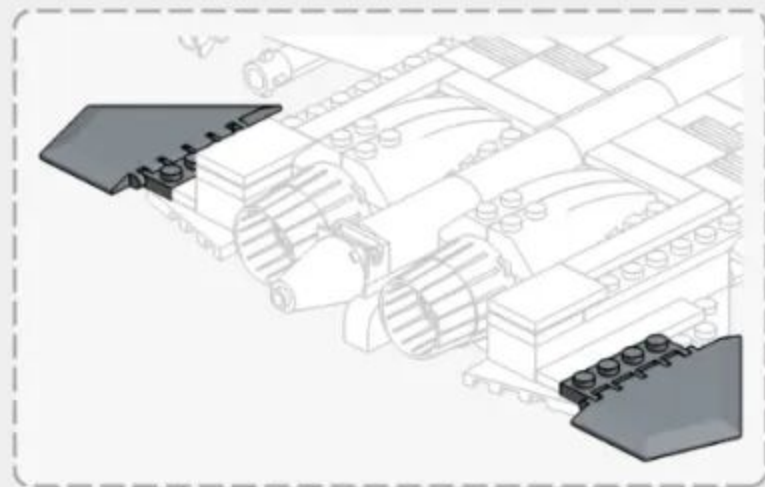
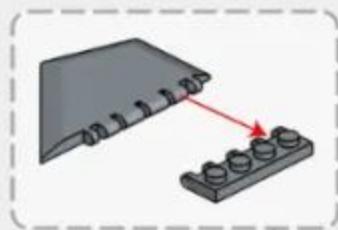
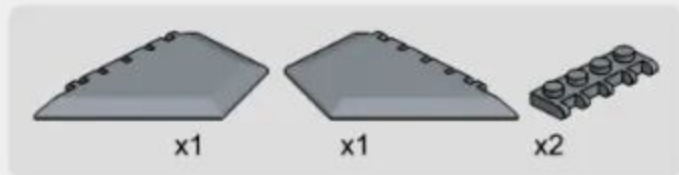

1-22

