

AIR FORCE

HEAVY STEALTH FIGHTER

Building blocks model
Perfect shape, high simulation, classic collection



6+ / 4003 / 229PCS
Suitable Age / Product Number / Parts Total

THIS PRODUCT DOES NOT CONTAIN BRACKET ACCESSORIES AND NEEDS TO BE PURCHASED SEPARATELY.

本品不含支架配件，需另外购买。

FLIGHT STAND

JX008

Perfect structure , easy assembly.

The Flight stand is compatible with our entire aircraft series.



EXTENDED GAMEPLAY



4001



CARRIER-BASED FIGHTER

1:54

4002



GUNSHIP

1:38

4003



HEAVY STEALTH FIGHTER

1:50

4004



INTERCEPTOR FIGHTER

1:48

4005



SR-71 BLACKBIRD

1:74

4006



P-51 MUSTANG FIGHTER

1:26

5005



AIRBORNE EARLY WARNING AND CONTROL AIRCRAFT

1:100

5006



TILTROTOR AIRCRAFT

1:44



微信扫一扫
补件更简单

The Schematic diagram of the J20 Heavy stealth fighter-1

Brief Introduction

The J-20 (Jian-20; simplified Chinese: 歼-20; nickname: Weilong; NATO codename: FIRE FANG) is a fifth-generation, single-seat, stealth, twin-engine fighter aircraft. It adopts a variety of low-observable designs like: its nose and fuselage cross section roughly pentagonal, outer inclined twin vertical tails, with storage cabin for the aerial refueling probes, magazine and landing gear cabins doors, coating the whole cockpit cover, etc. All these are the main features of the stealth fighter.

General Information

Crew: 1 pilot
Length: 19.6 m (not including the pitot tube)
Side magazine length: 3.6m
Main magazine length: 4.5m
Width: 12.88 m
Height: 4.45 m
Wingspan: 12.88 m
canard wingspan: 1.5m
Powerplant: 2 × WS-15 afterburning turbofans
Empty weight: 17000kg
Combat Weight: 25000kg
Max internal fuel: 12000kg
Max takeoff weight: 37000 kg

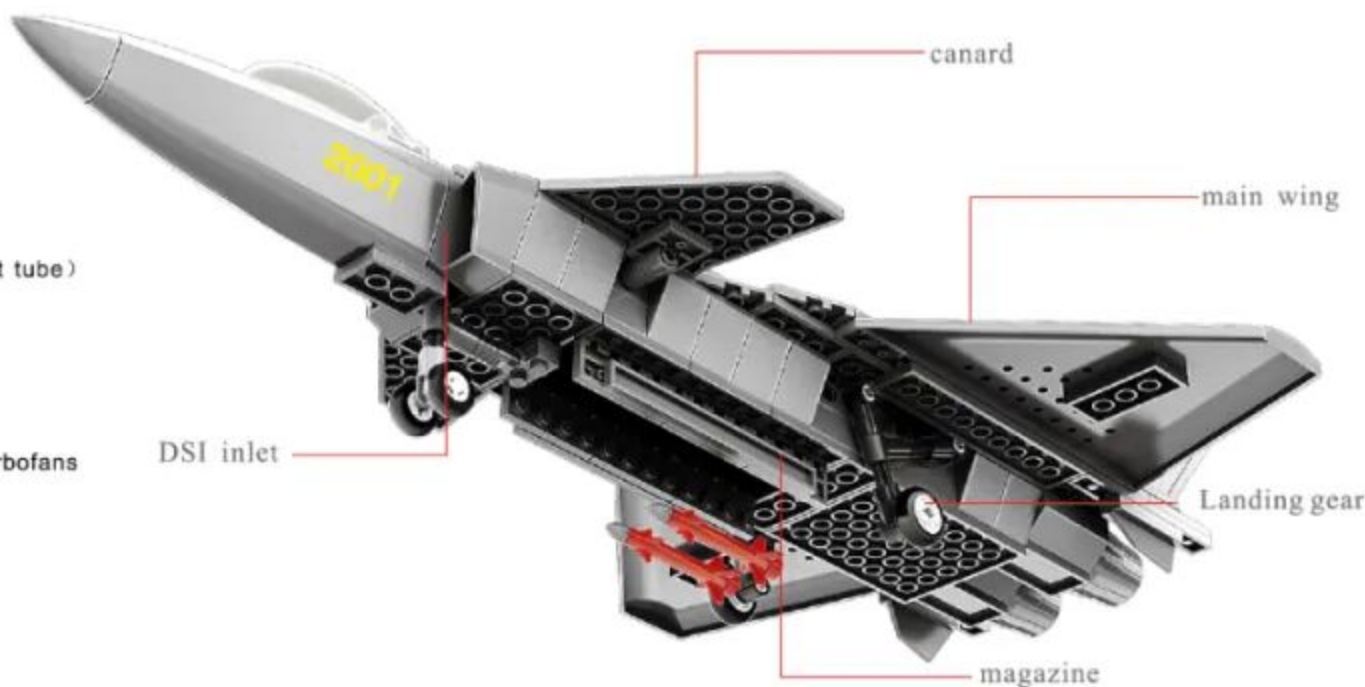

The Schematic diagram of the J20 Heavy stealth fighter-2

Performance

cruising speed: mach 1.83
Maximum speed: Mach 2.4
Service ceiling: 20000 m
Rang: 5500km (with two fuel tanks)
Maximum radius action: 2000km
Overload limit: +9g
Radar reflection area: <0.05m²

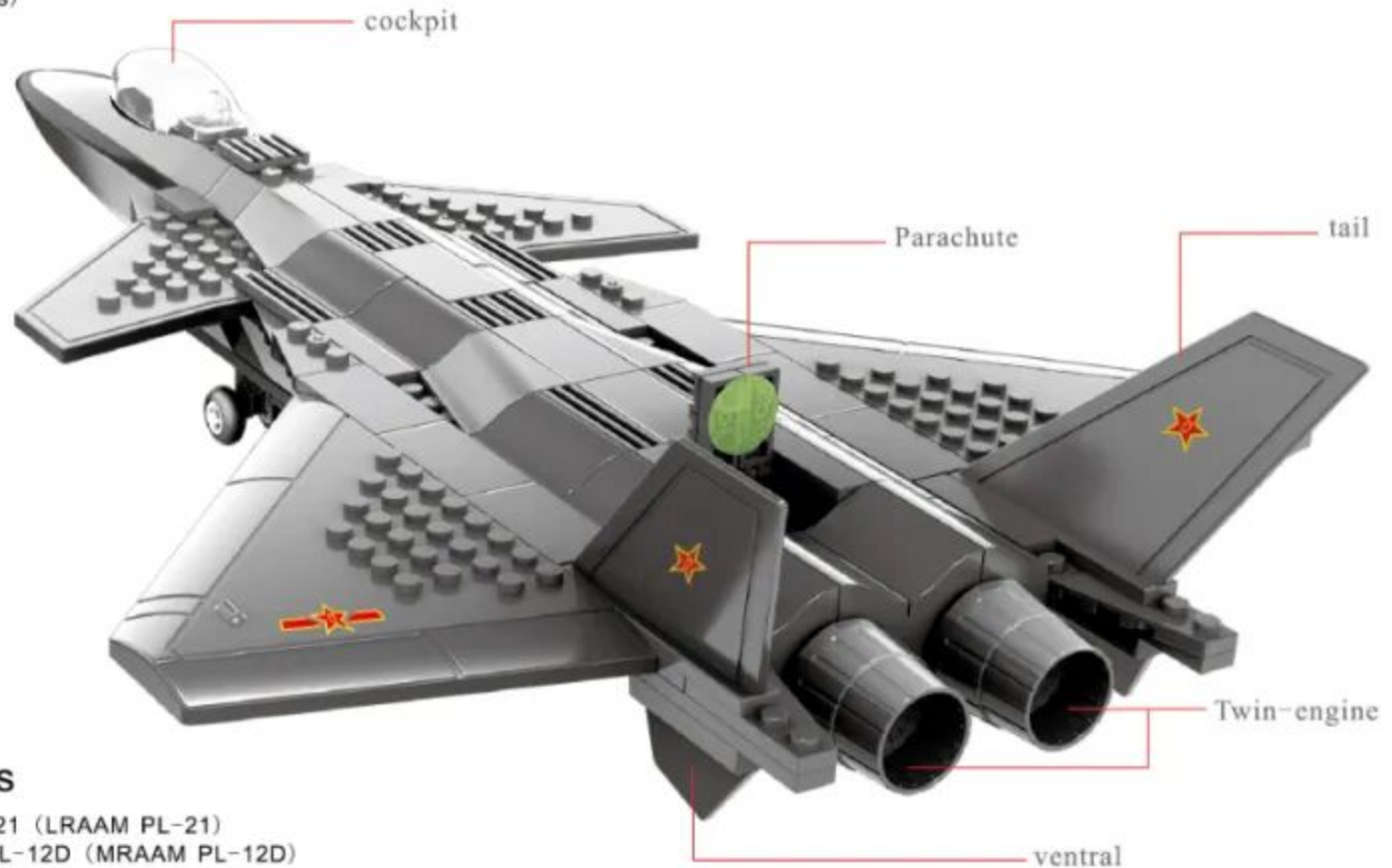

Weapons equipments

Long-range air-to-air missile: PL-21 (LRAAM PL-21)
medium-range air-to-air missile: PL-12D (MRAAM PL-12D)
short-range air-to-air missile: PL-10
short-range air-to-air combat missile: PL-8
Precision guided glide bomb: LS-6
Gun: one 23 mm Double-barreled cannon aviation

PARTS LIST

配件清单

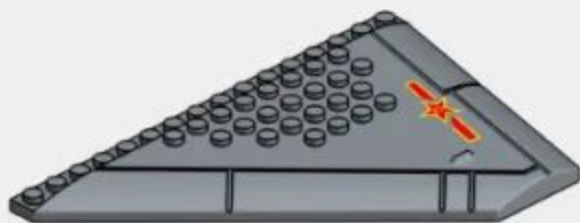

x1



x1



x2



x2



x2

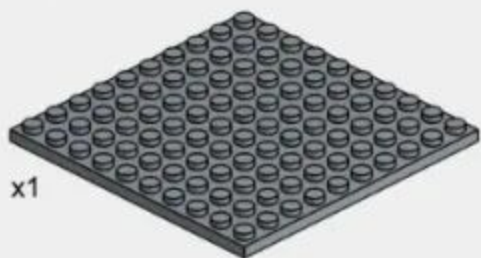

x1



x2



x2

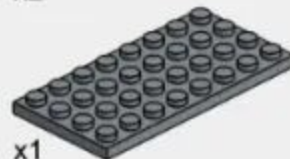

x1



x1



x2



x1

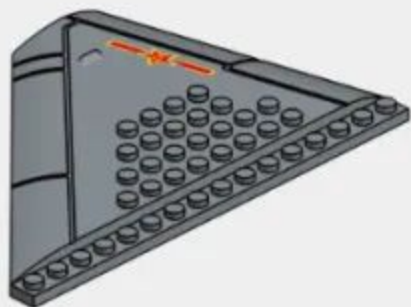

x1



x2



x2



x1



x1



x1



x1



x1



x1



x2

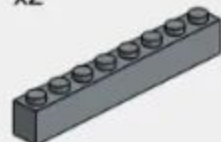

x1



x1



























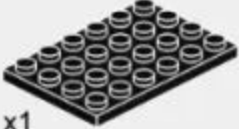











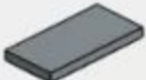

























x1

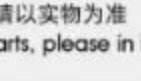

x2

PARTS LIST

配件清单

 x12	 x1	 x3	 x2	 x6	 x1	 x3	 x1	 x1
 x2	 x1	 x4	 x4	 x3	 x1	 x5	 x1	 x2
 x6	 x1	 x6	 x4	 x2	 x1	 x2	 x2	 x1
 x9	 x1	 x1	 x2	 x9	 x1	 x2	 x9	 x6
 x6	 x1	 x2	 x3	 x2	 x2	 x1	 x2	 x2
 x1	 x6	 x1	 x1	 x4	 x3	 x1	 x1	 x2
 x1	 x2	 x16	 x1	 x4	 x2	 x1	 x2	 x2

产品有增补件请以实物为准
If product has additional parts, please in kind prevail.

1-1

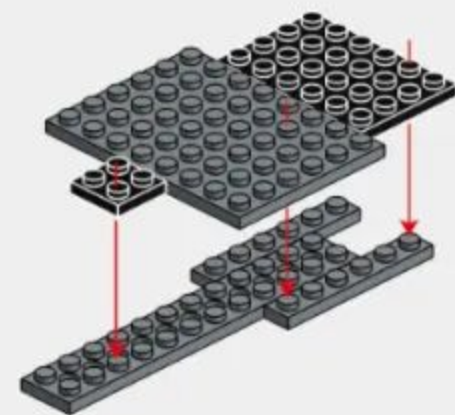
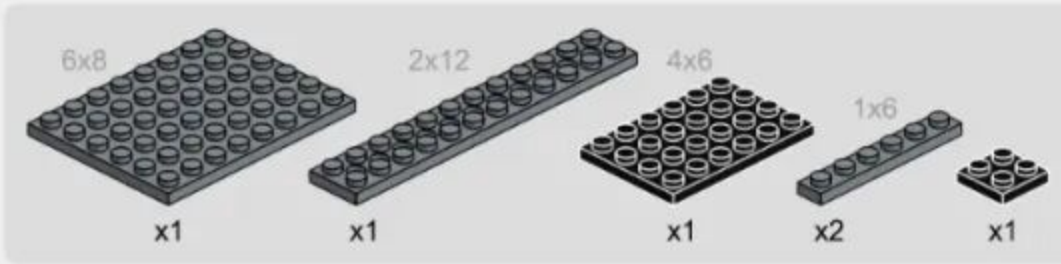

1-2

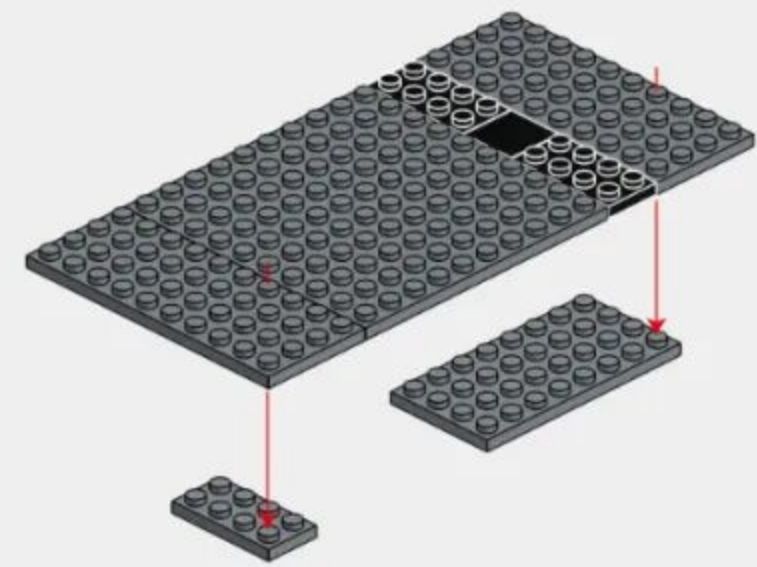
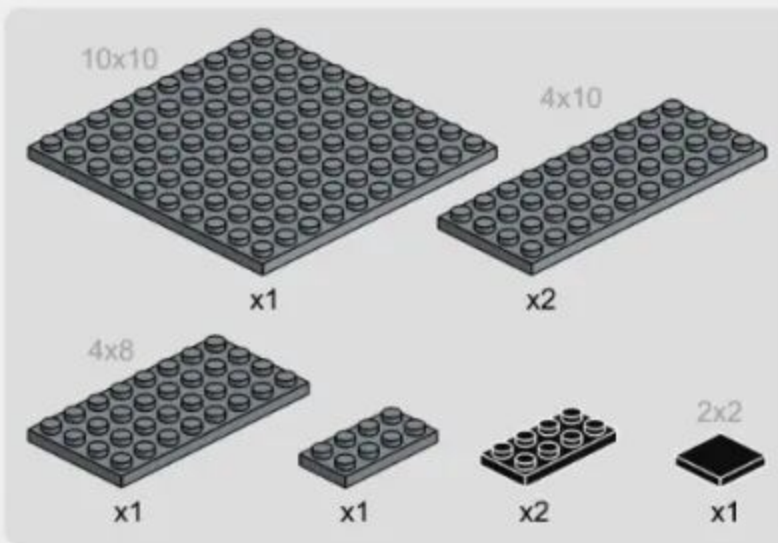

1-3

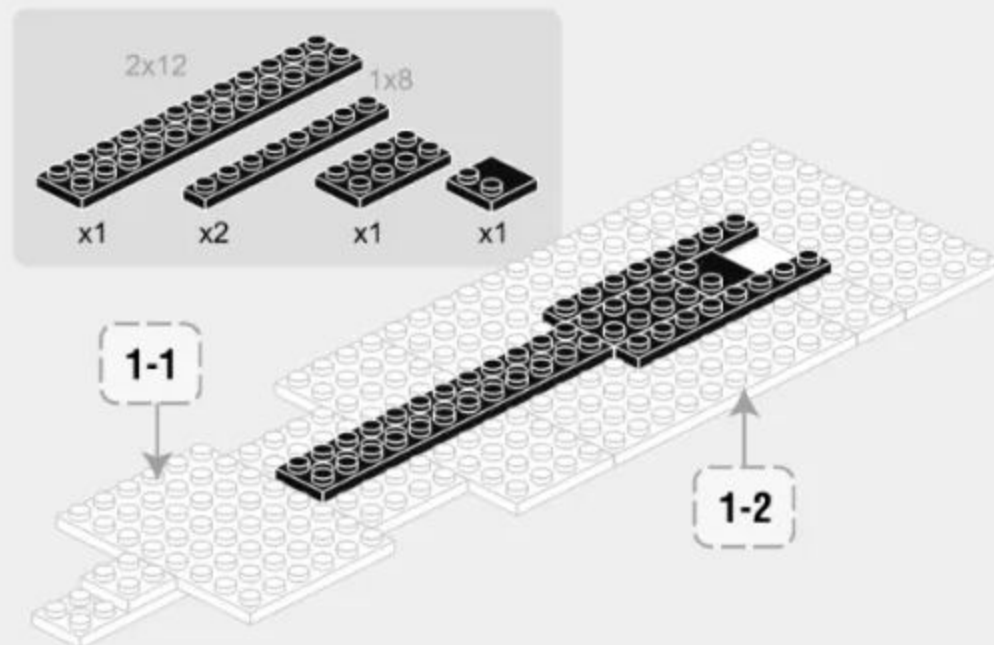

1-4

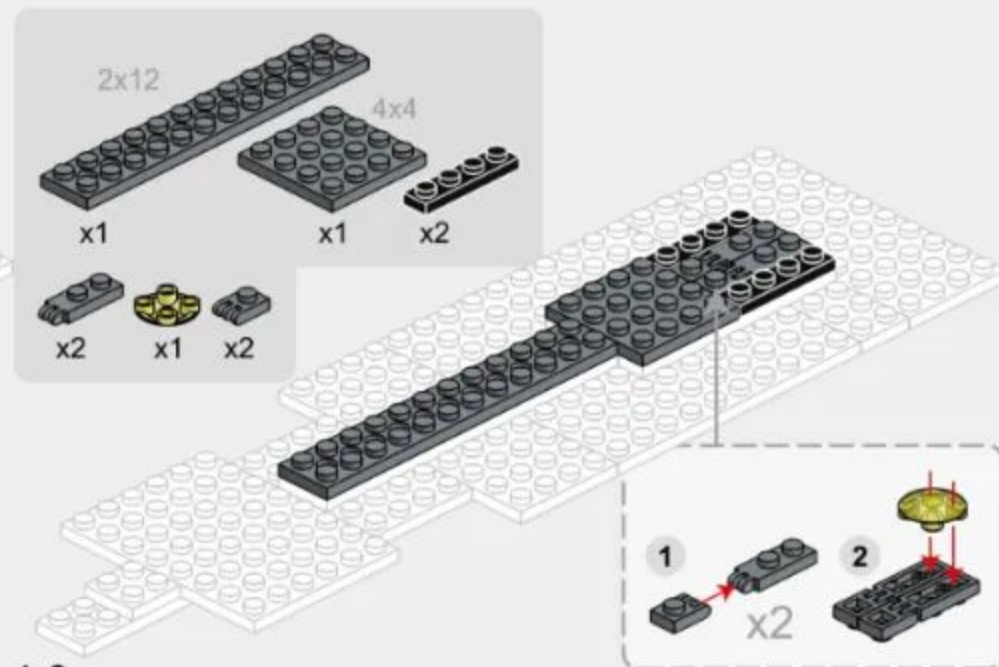

1-5

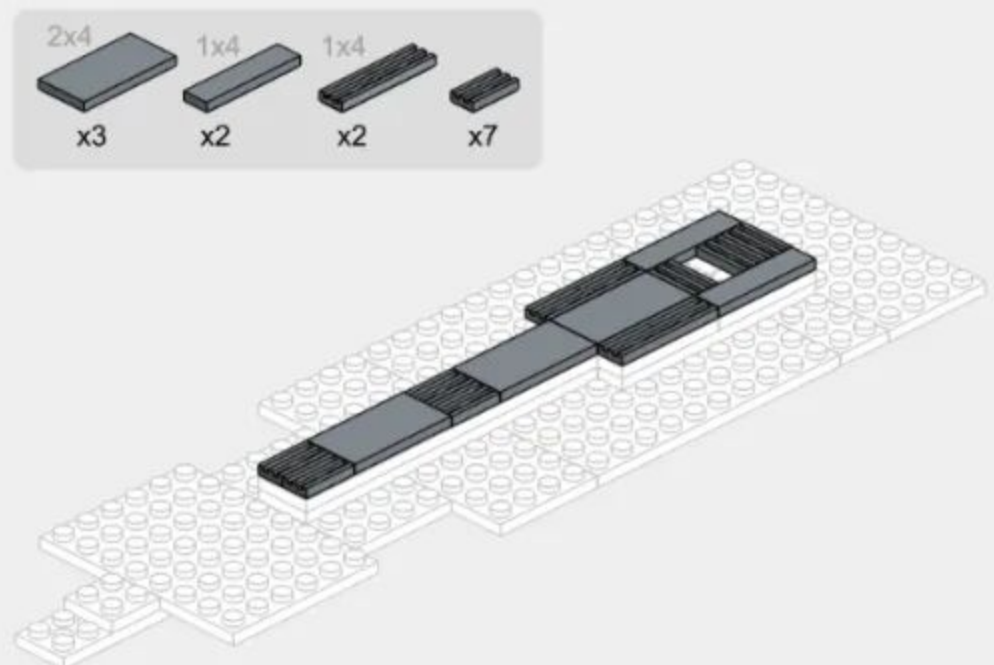

1-6

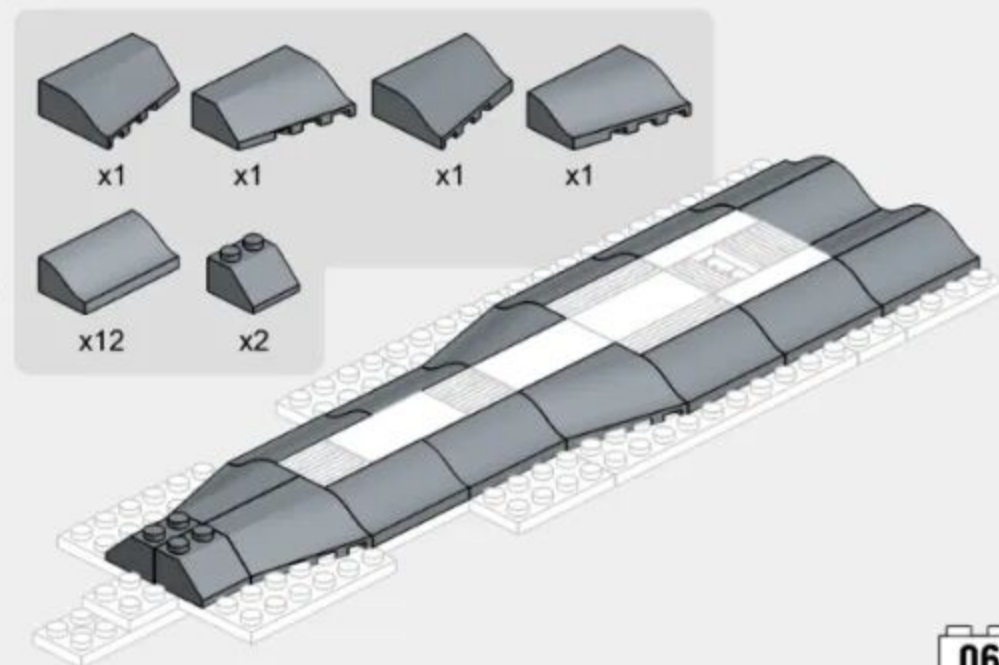

1-7

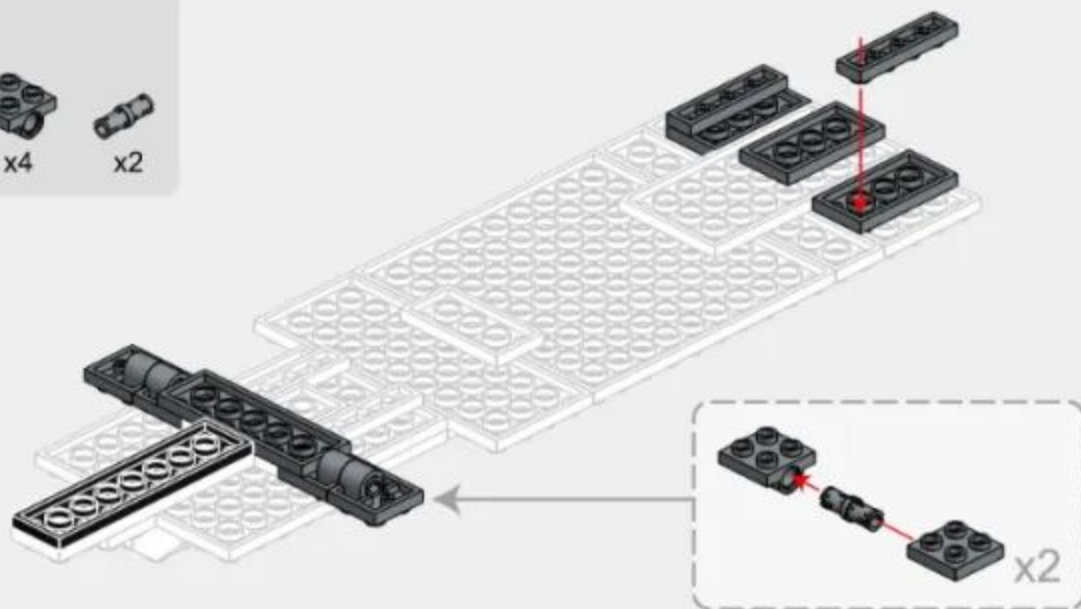
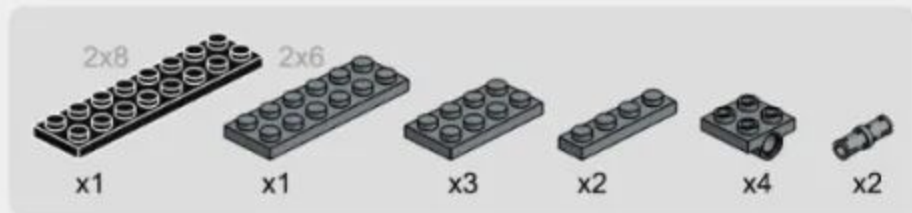

1-8

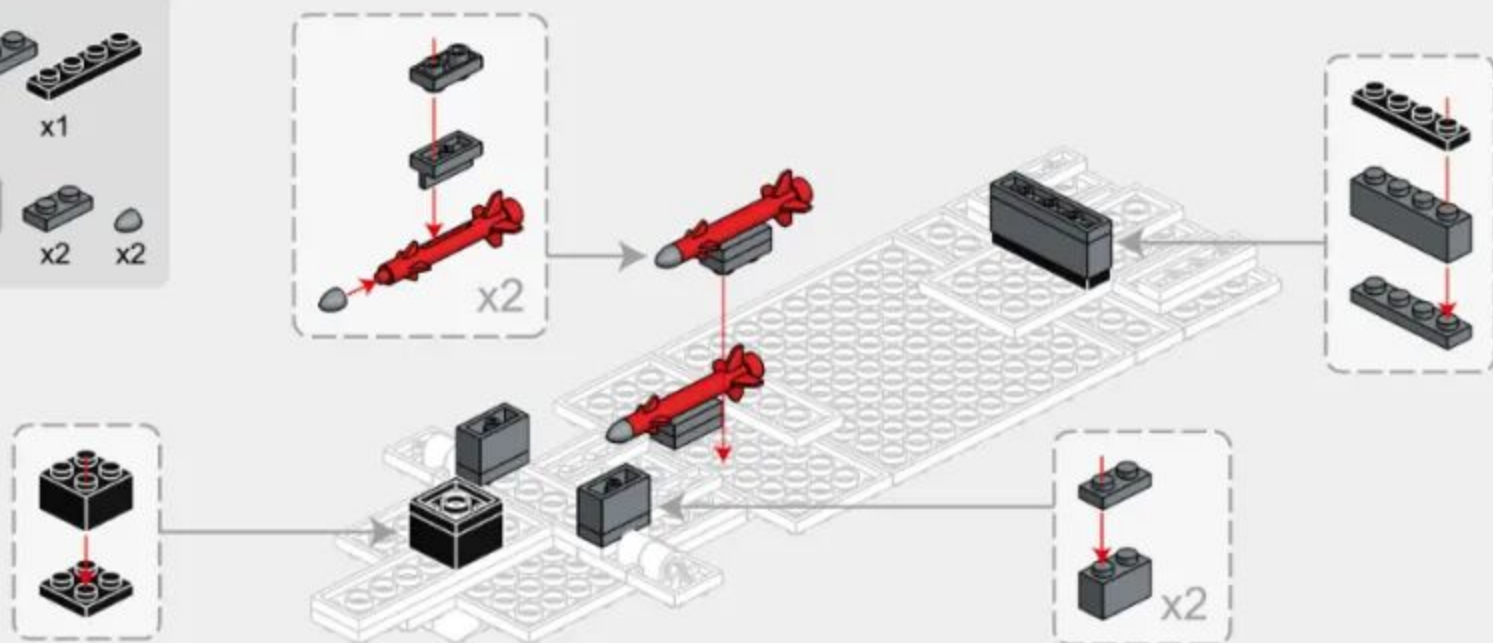
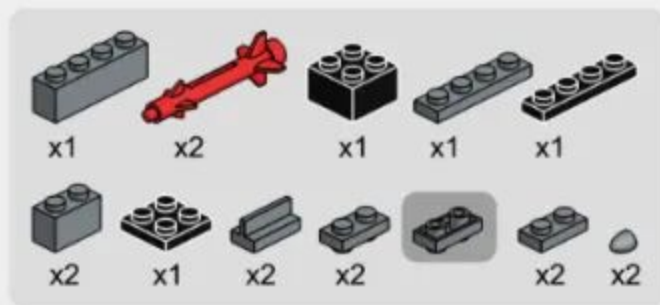

1-11

-  x2
-  x1
-  x5
-  x2
-  x2
-  x9
-  x1
-  x2
-  x1
-  x1
-  x1
-  x1
-  x2
-  x2
-  x1

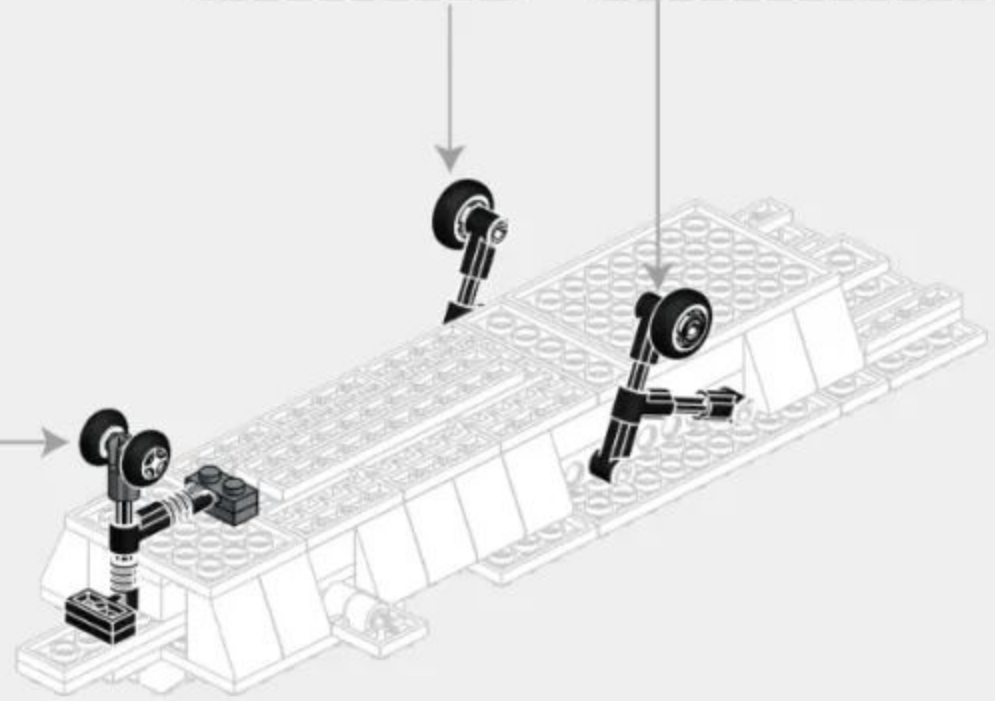

1-12

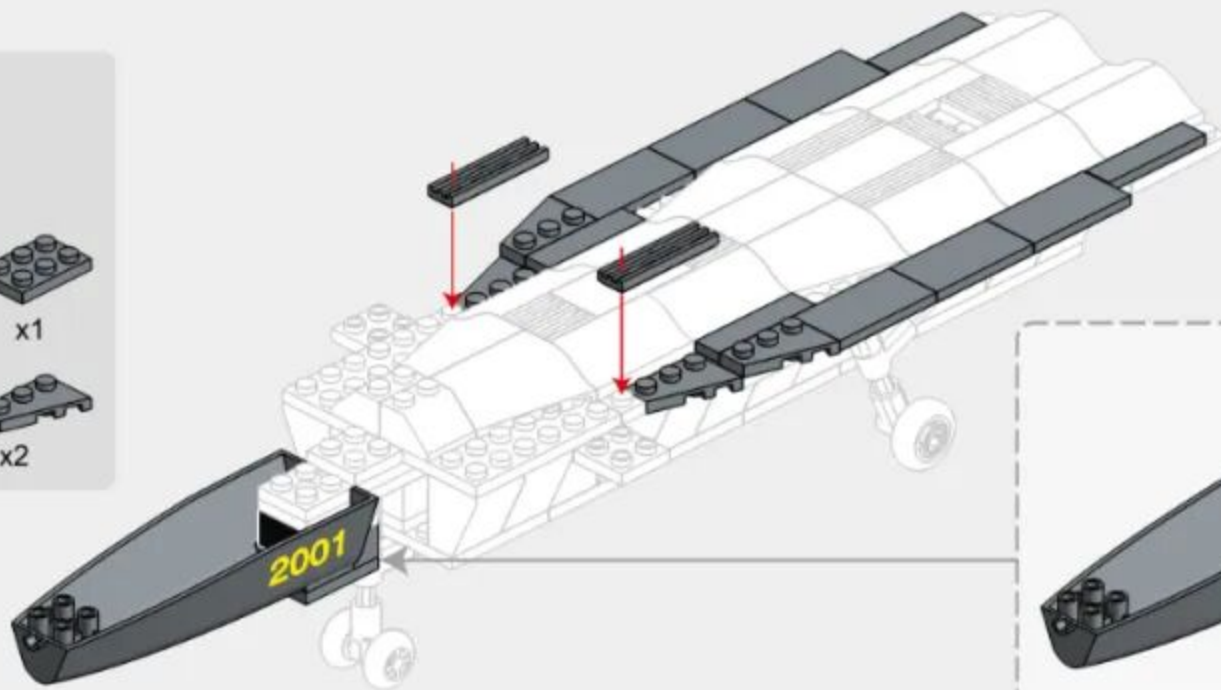
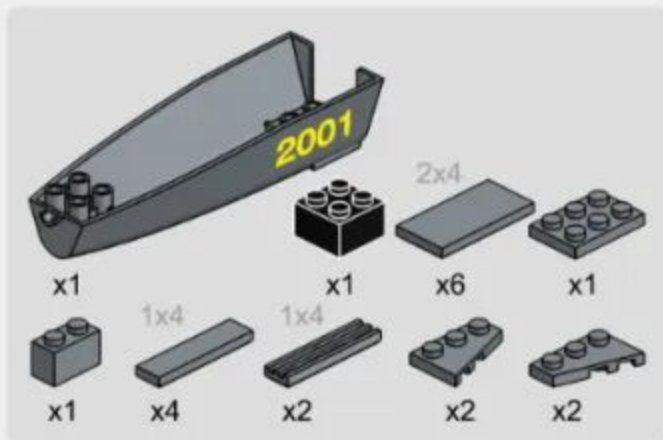

1-13

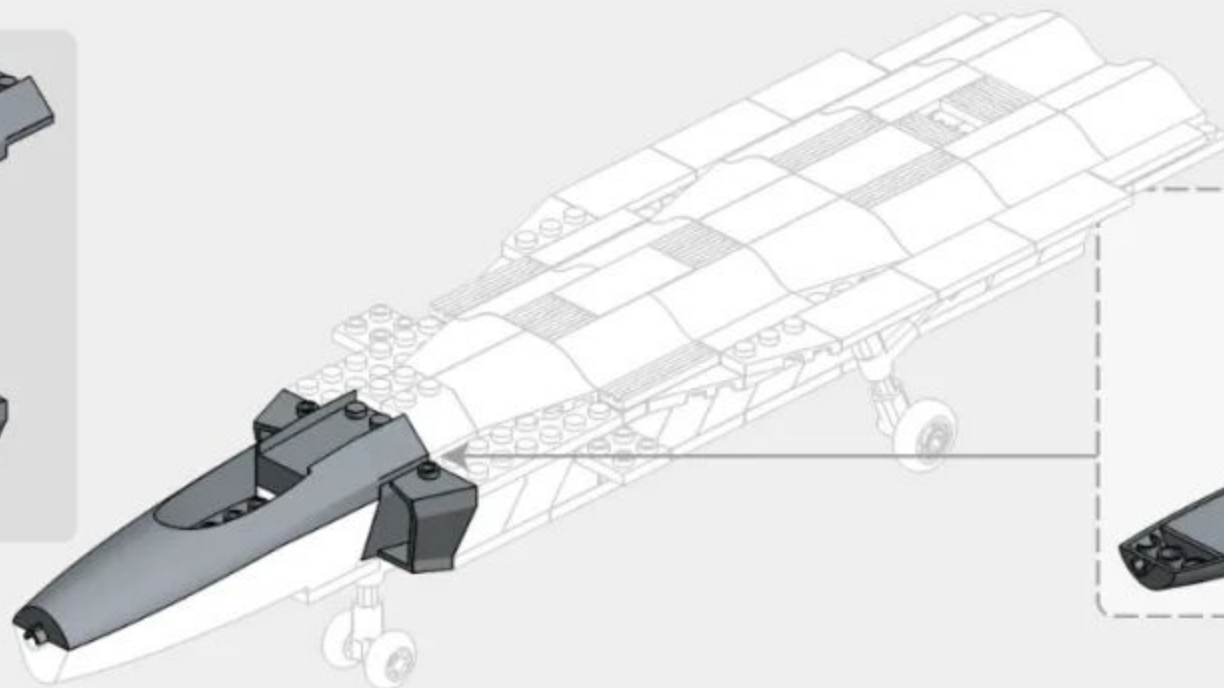
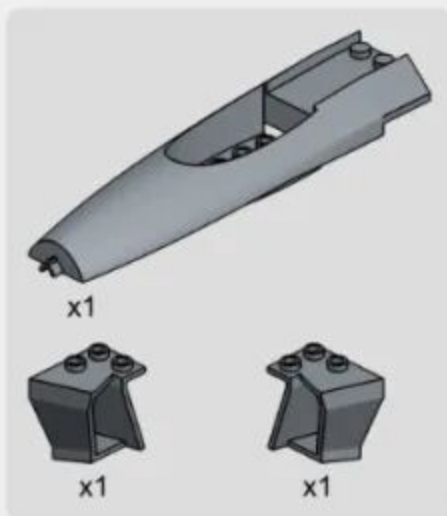

1-14

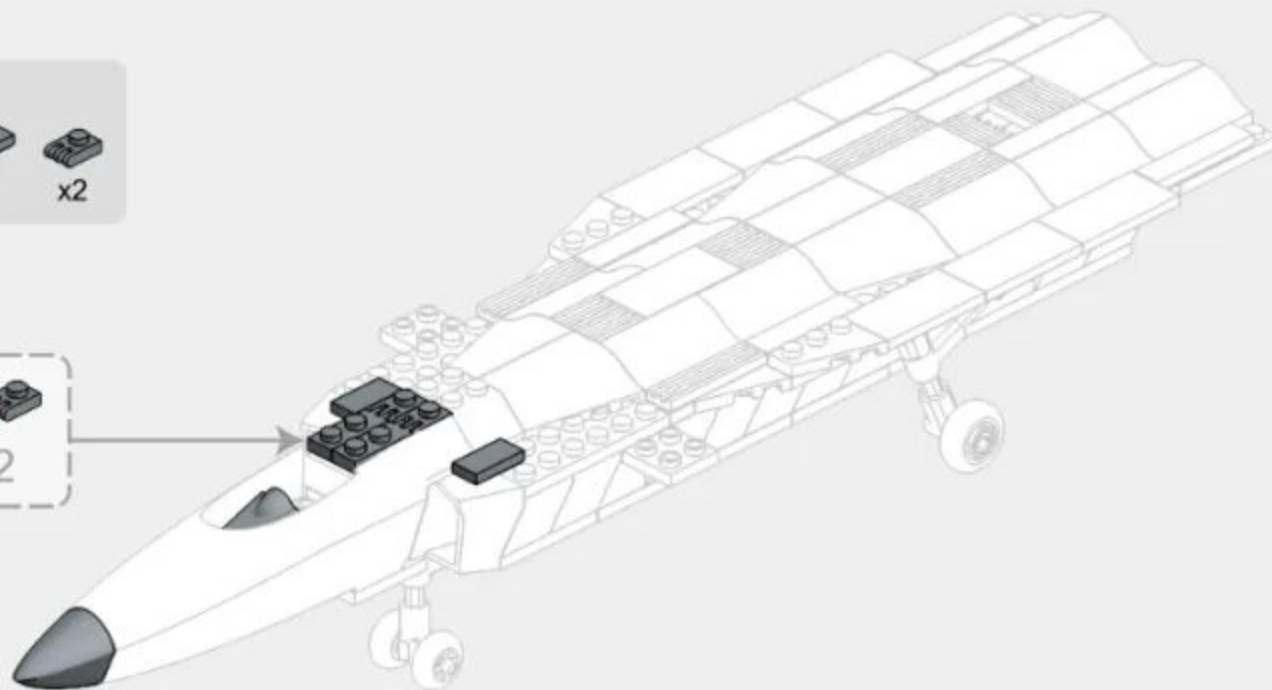
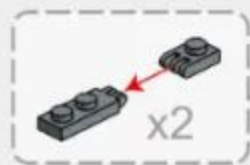

1-15

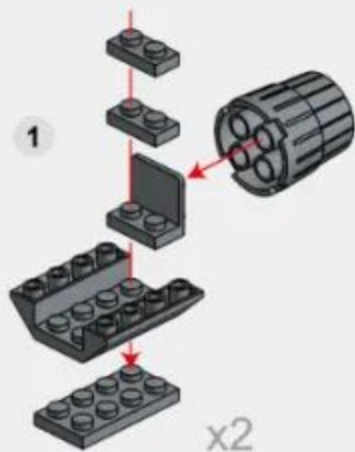
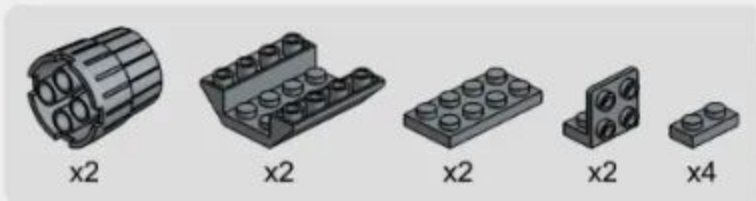

2

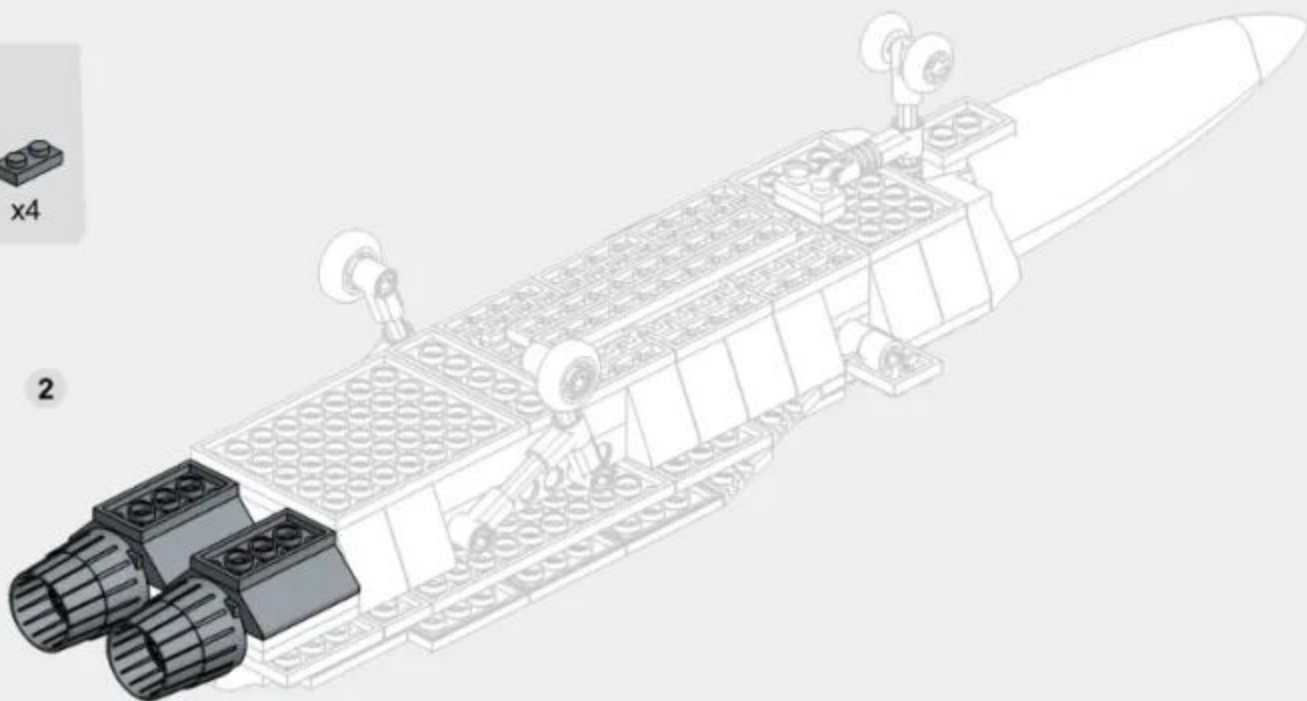

1-16

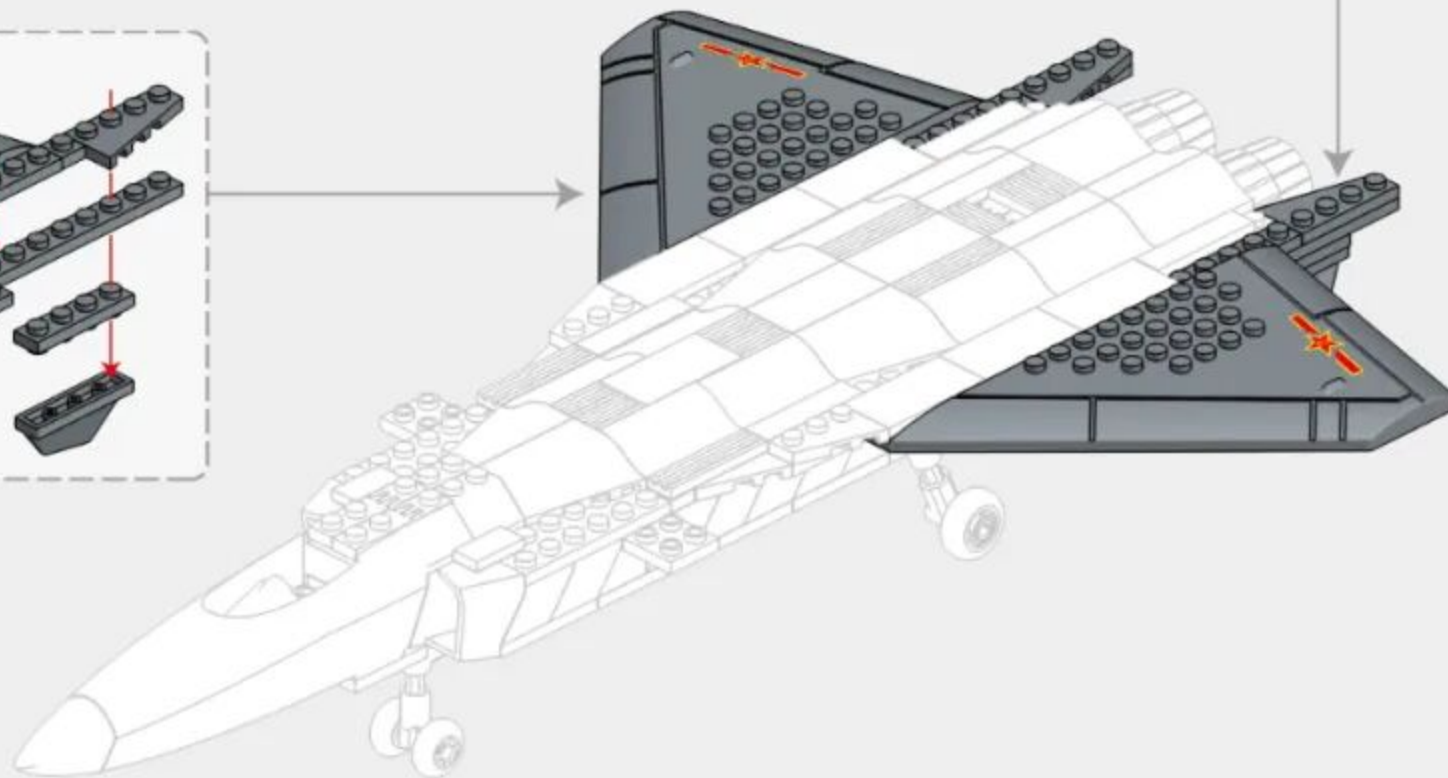
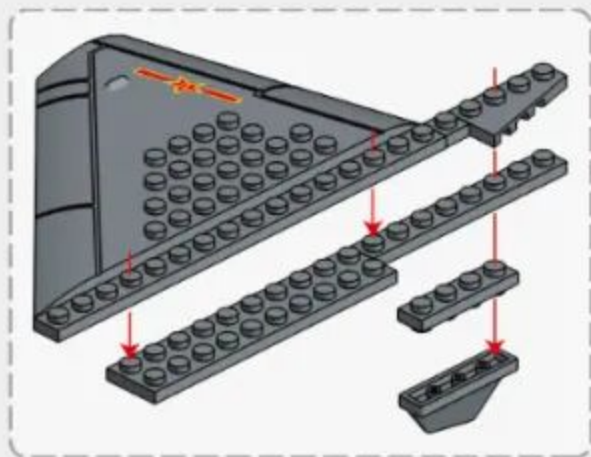
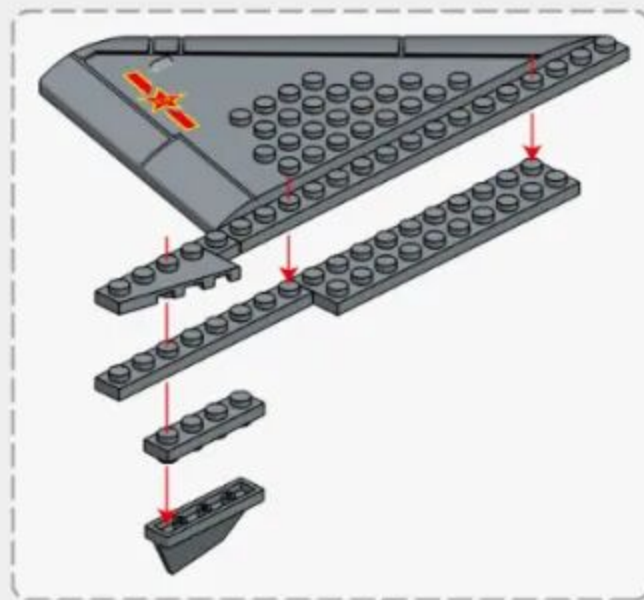
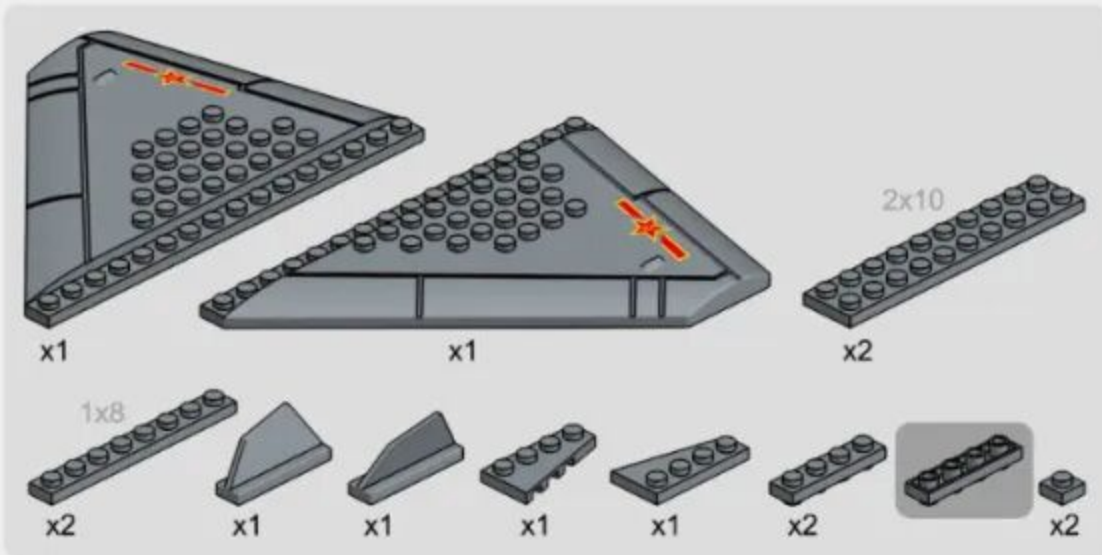

1-17

