



ELIZABETH TOWER

TORRE DE ISABEL

London, England

The world's great architecture



6+ / 4211 / 783PCS
Suitable Age / Product Number / Parts Total



Architecture

It will be a city...

这将构成一座城市...

ABOUT THE PRODUCT

关于产品

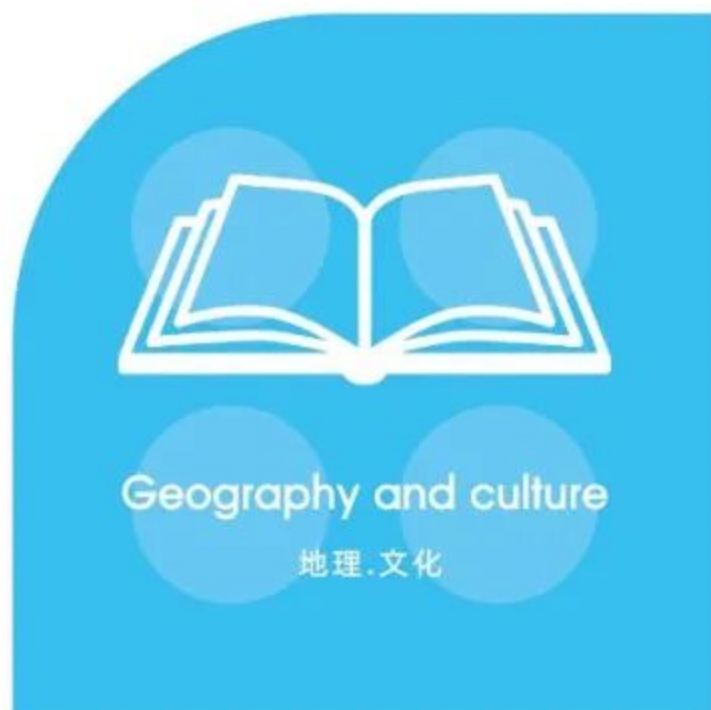

ARCHITECTURE

WANGE The world's great architect since 1991

Guangdong Baoge Educational Material Sci-Tech Co., Ltd.
©2014 Wange / Dubie. All Rights Reserved

Elizabeth Tower



The Elizabeth Tower, commonly known as Big Ben, is a landmark in London, England, located on the banks of the River Thames.

Elizabeth Tower



Geography and culture

地理·文化



Big Ben is a nickname for the clock tower located in the north of Westminster Palace in London, UK. It is the third tallest independent clock tower in the world.



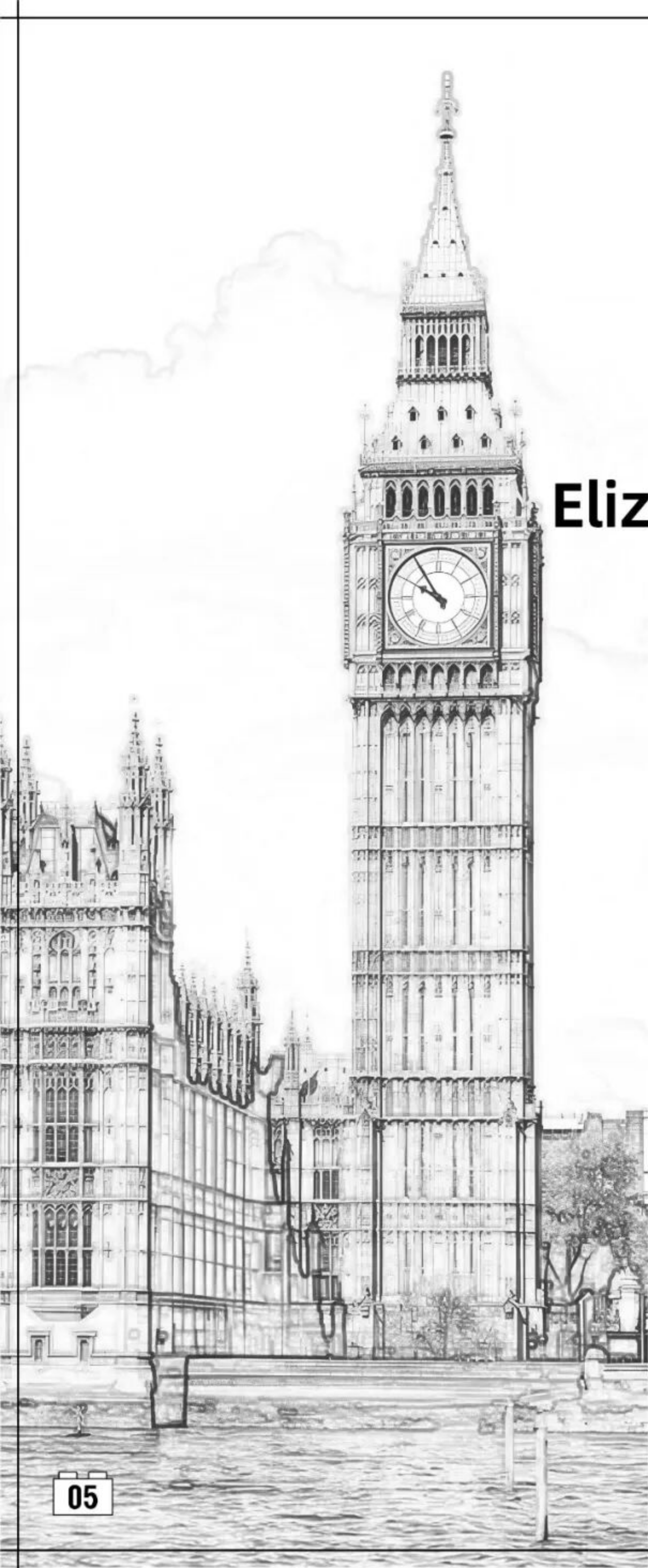

London

Elizabeth Tower ■

England

The contents of this chapter refer to the Wikipedia website.

本章内容参考维基百科网站，更多资讯可自行查阅。

The world's great architecture

Buildings and layout

■ 建筑物和布局



Big Ben is the nickname for the Great Bell of the striking clock at the north end of the Palace of Westminster in London and is usually extended to refer to both the clock and the clock tower. The official name of the tower in which Big Ben is located was originally the Clock Tower, but it was renamed Elizabeth Tower in 2012 to mark the Diamond Jubilee of Elizabeth II. The tower was designed by Augustus Pugin in a neo-Gothic style. When completed in 1859, its clock was the largest and most accurate four-faced striking and chiming clock in the world. The tower stands 315 feet (96 m) tall, and the climb from ground level to the belfry is 334 steps. Its base is square, measuring 39 feet (12 m) on each side. Dials of the clock are 23 feet (7.0 m) in diameter. On 31 May 2009, celebrations were held to mark the tower's 150th anniversary. Big Ben is the largest of the tower's five bells and weighs 13.5 long tons (13.7 tonnes; 15.1 short tons). It was the largest bell in the United Kingdom for 23 years. The origin of the bell's nickname is open to question; it may be named after Sir Benjamin Hall, who oversaw its installation, or heavyweight boxing champion Benjamin Caunt. Four quarter bells chime at 15, 30 and 45 minutes past the hour and just before Big Ben tolls on the hour. The clock uses its original Victorian mechanism, but an electric motor can be used as a backup. The tower is a British cultural icon recognised all over the world. It is one of the most prominent symbols of the United Kingdom and parliamentary democracy, and it is often used in the establishing shot of films set in London. The clock tower has been part of a Grade I listed building since 1970 and a UNESCO World Heritage Site since 1987. On 21 August 2017, a four-year schedule of renovation works began on the tower, which are to include the addition of a lift. There are also plans to re-glaze and repaint the clock dials. With a few exceptions, such as New Year's Eve and Remembrance Sunday, the bells are to be silent until the work is completed in 2021.



Structure

The clock tower where Big Ben is located is 96 meters high and is situated on the banks of the Thames River in London, England. It is part of the Palace of Westminster. The clock tower belongs to Gothic architecture, and together with the surrounding palace buildings, it forms a magnificent scene of the British Parliament building. The Gothic architectural style is known for its towering, sharp, and lightweight characteristics.

The body of Big Ben is huge, weighing 13.5 tons, with a dial diameter of 7 meters and four clock faces. The length of the hour hand and minute hand is 2.75 meters and 4.27 meters respectively, which is very conspicuous. It is still the location of the House of Lords and House of Commons in the British Parliament.



History

The birth of Big Ben: Big Ben was built in 1859 and installed on a 95 meter high clock tower on the east side of Westminster Palace. The circular clock dial on all four sides has a diameter of 6.7 meters and has become a traditional landmark of London. The Big Ben has won widespread acclaim for its accurate timekeeping and grand appearance. **Name change:** It is worth noting that in June 2012, the UK announced the renaming of the clock tower where Big Ben is located to "Eliza White Tower" in honor of Queen Elizabeth II. However, the name 'Big Ben' is still widely used and serves as one of the important symbols of London.

The clock tower where Big Ben is located was originally part of the Westminster Abbey building rebuilt during Queen Victoria's reign, but was later destroyed and rebuilt due to a fire. The Big Ben is named after Sir Benjamin Hall, the supervisor of the casting project, and was officially renamed "Eliza White Tower" in 2012, but people still habitually refer to it as "Big Ben".

Force Balance

受力平衡

Physical operations

物理运算

$$F = G \frac{m_1 m_2}{d^2}$$

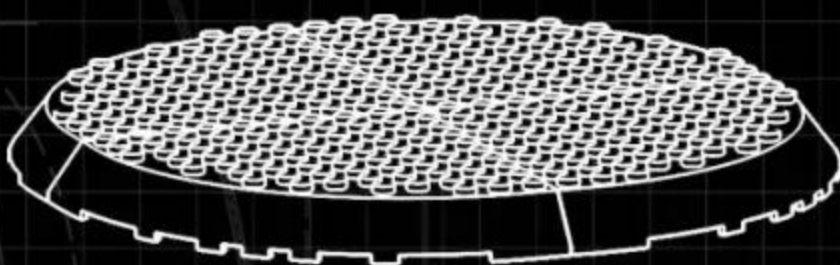
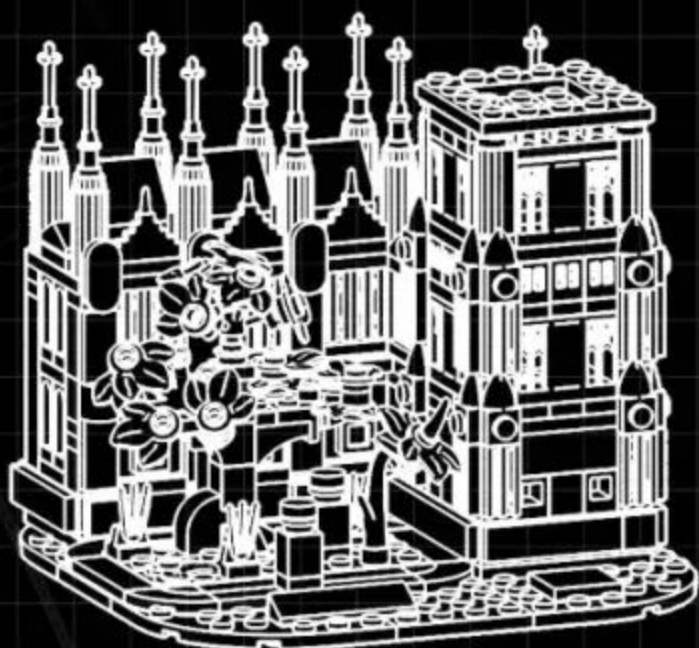
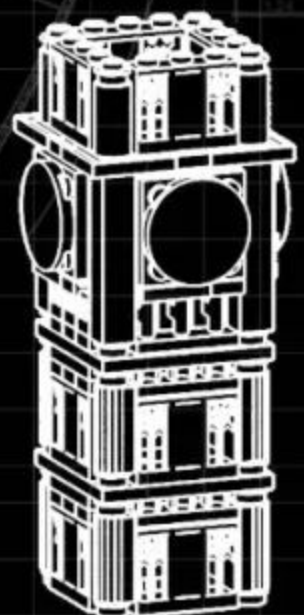

Creation and thinking

创作·思考

08

Special parts

特殊零件的开发利用

WG1642

欧式镂空墙2高3孔

$$S=4\pi \cdot r^2$$



$$a^2+b^2=c^2$$



WG1758

带槽矮孔



WG1531

椭圆后2孔



WG1750

小嫩芽



1527

灯笼穗1孔



1748

弯柱灯粒1孔



WG1782

2孔尖顶围栏

$$\sin^2 a + \cos^2 a = 1$$



features and functions

特点.功能

Main Color Matching

配色方案



Pantone Black 6C



Pantone 7500C



Pantone 348C



Pantone 2422C



Pantone Cool Gray 6C



Pantone 655C



Pantone 2312C



Pantone 477C

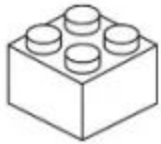

White



Pantone 7620C



Pantone 285C



Pantone 473C



Pantone 2300C



Pantone 7550C

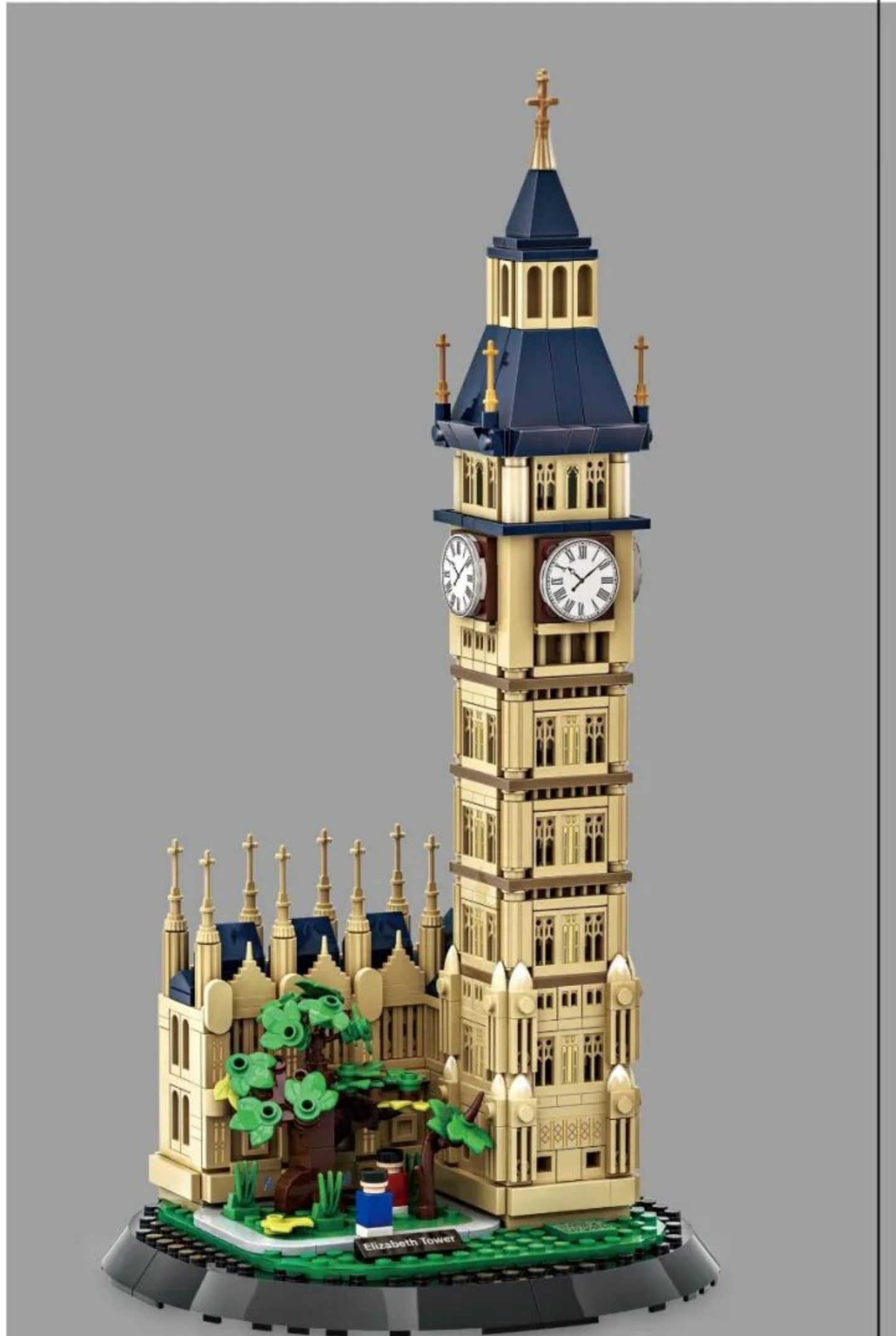

Color matching

Adopting 14 main colors, MidnightBlue, YellowRice and Dark Green as the main color, the more reasonable and bold color matching on the original building, making the product more atmospheric and the whole design is more reasonable.

Elizabeth Tower, London, UK

英国伦敦伊丽莎白塔



Front

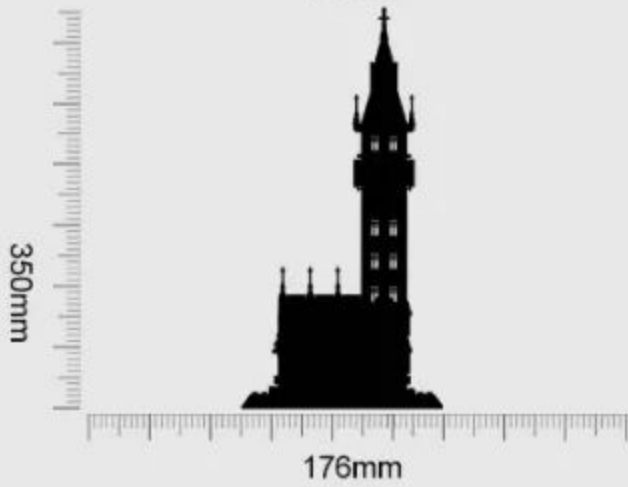

Left

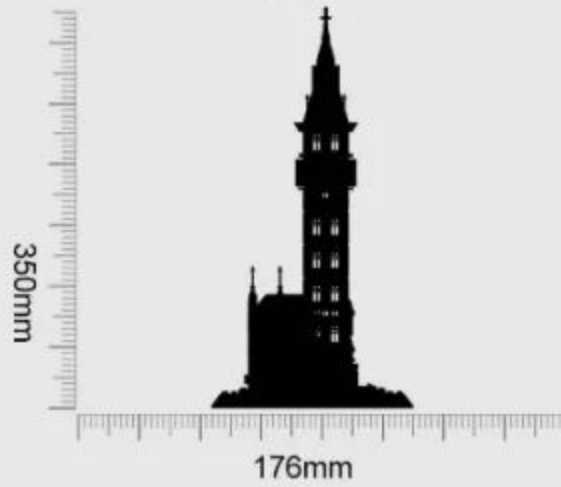

Back

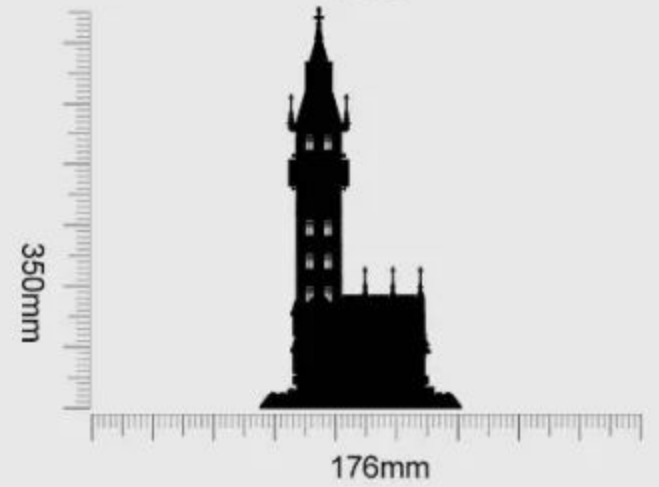

Product Size: 176X176X350mm



小提示：积木包分为底板包、整版配件包及普通配件包，底板包标识为A/B/C...，普通配件包编码与说明书对应，整版配件包无标识。
Tip: Building block packs are divided into baseplate packs, runner accessory packs, and standard accessory packs. Baseplate packs are labeled A/B/C..., regular accessory packs have codes that correspond to the instructions, and runner accessory packs have no labels.



- Open the product packaging correctly and classify the building block packs by type.

用正确方式拆解产品外包装,按积木包类型进行分类。



- Confirm the quantity of building block packs and cross-check them with the pack identifiers and the instructions.

确认积木包数量, 对照积木包标识和说明书步骤。



- Open the building block packs according to the pack identifier steps. Sort them in order by type and color for easier assembly.

按积木包标识步骤拆开积木包,按顺序以类型、颜色进行分类以便搭建。



- Assemble your building block model following the steps in the instruction manual.

按说明书步骤拼装并完成你的积木模型。



1:1 Physical Reference Table

十字棒配件1:1尺寸参照表



Instructions For Use

让安装更简单

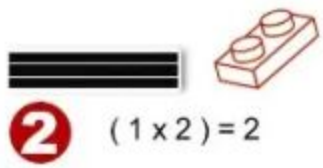

2 (1x2)=2

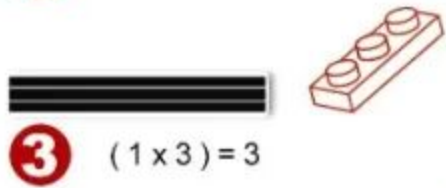

3 (1x3)=3

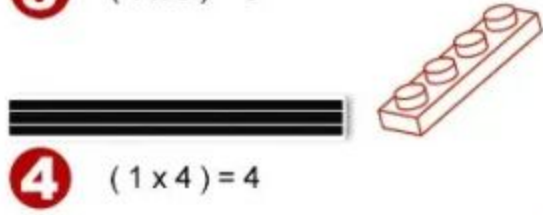

4 (1x4)=4

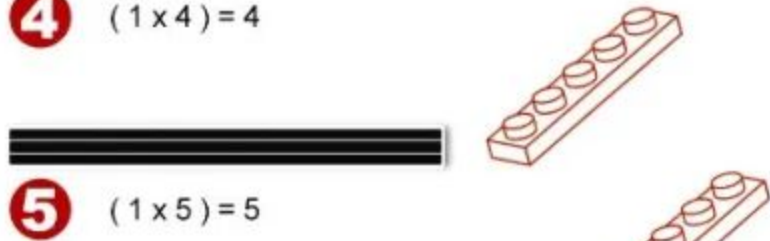

5 (1x5)=5



6 (1x6)=6



7 (1x7)=7



8 (1x8)=8



9 (1x9)=9



10 (1x10)=10



12 (1x12)=12











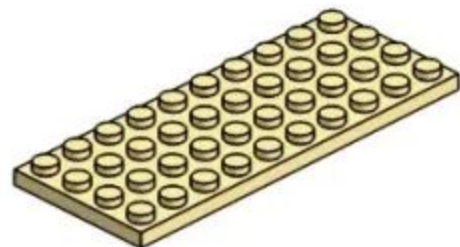
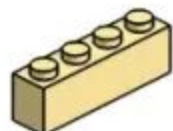





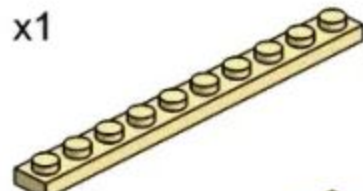





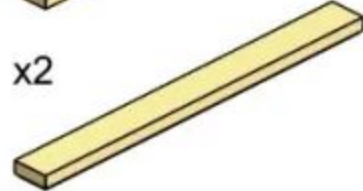





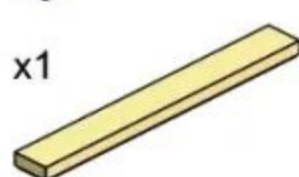
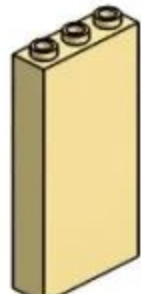











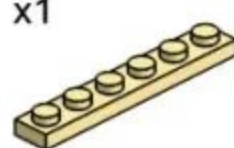





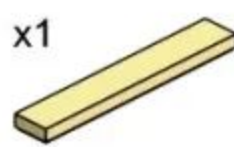





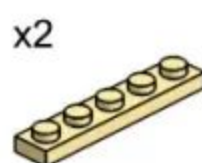













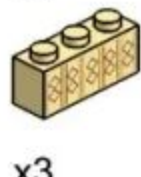

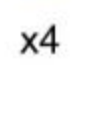



















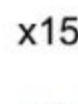

16 (1x16)=16



PARTS LIST

配件清单

						
x1	x6	x1	x18	x4	x5	x4
						
x1	x3	x4	x3	x3	x2	x4
						
x2	x9	x4	x6	x5	x1	x4
						
x1	x1	x4	x3	x39	x4	x6
						
x1	x3	x1	x4	x15	x1	x4
						
x1	x4	x3	x3	x11	x4	x11
						
x1	x15	x9	x11	x24	x4	x4
						
x2	x4	x10	x1	x9	x3	x16
						
x19	x4	x15	x3	x4	x1	x4
						
x1	x3	x3	x3	x32	x1	x4
						
x3	x11	x6	x13	x9	x1	x1
						
x2	x10	x12	x15	x9	x1	x3
						
x3	x20	x44	x6	x9	x5	x1
						
x3	x5	x10	x6	x9	x1	x1

产品有增补件请以实物为准

If product has additional parts, please in kind prevail.

PARTS LIST

配件清单

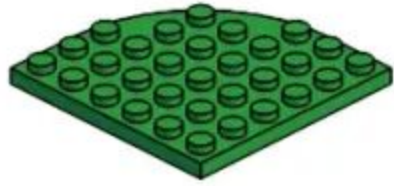

x4



x4

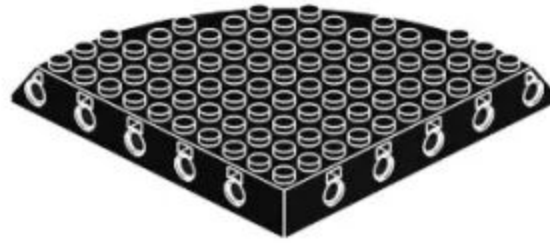

x4



x1



x1



x4



x1



x1



x4



x1



x1



x2



x2



x12



x1

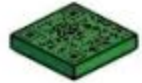

x1



x1



x2



x2



x1

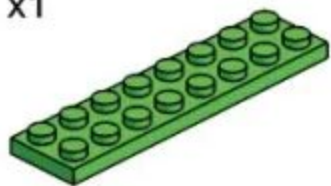

x2



x4



x7



x35



x1

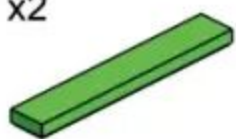

x2

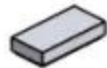

x1



x1



x1



x2



x14



x1



x6



x5



x1



x3



x4



x6



x2



x3



x3



x2



x5



x4



x1



x4



x2



x3



x2



x1



x5



x1



x4



x1



x2



288PCS

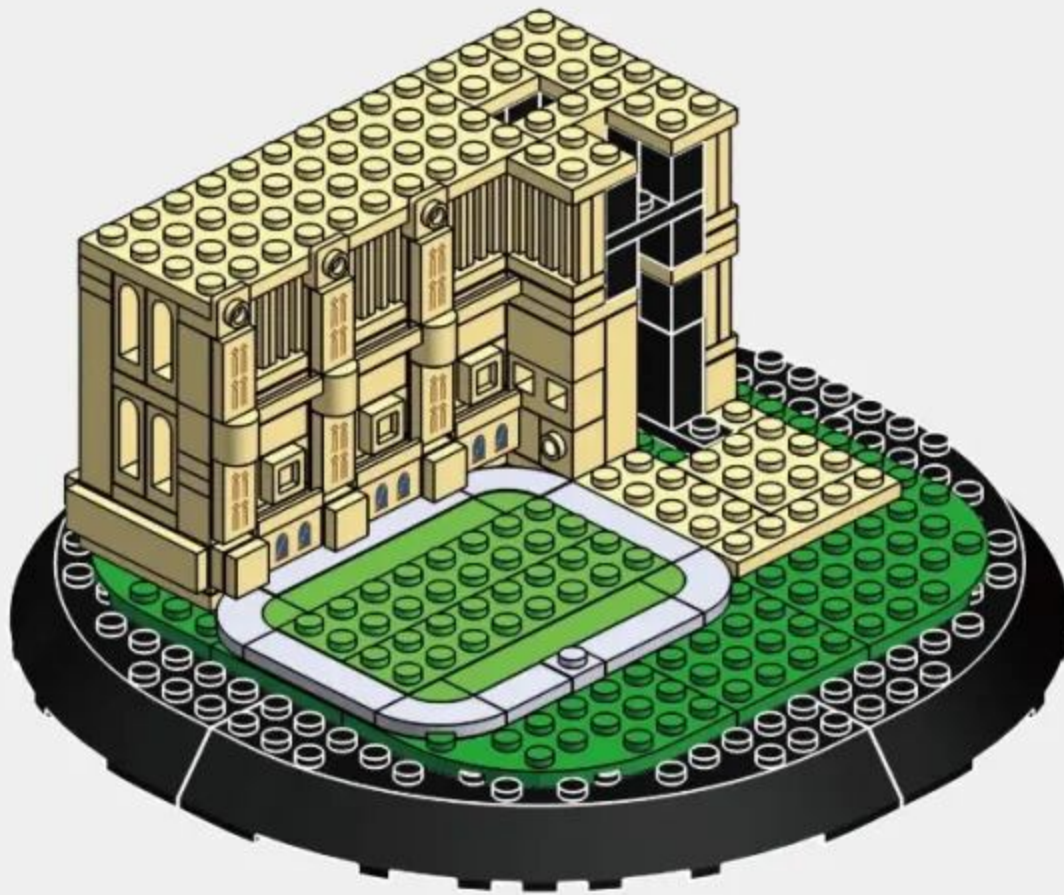

1-1

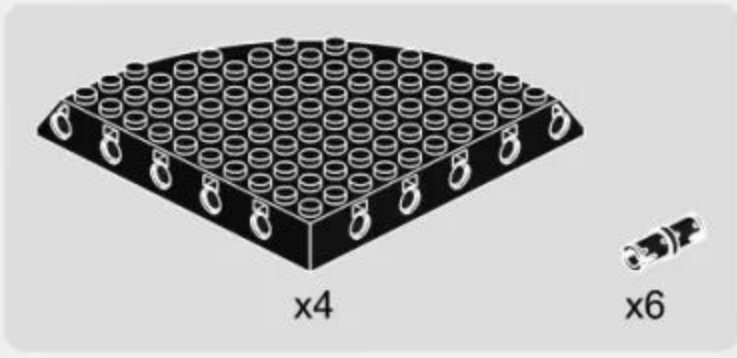

微信扫一扫
补件更简单

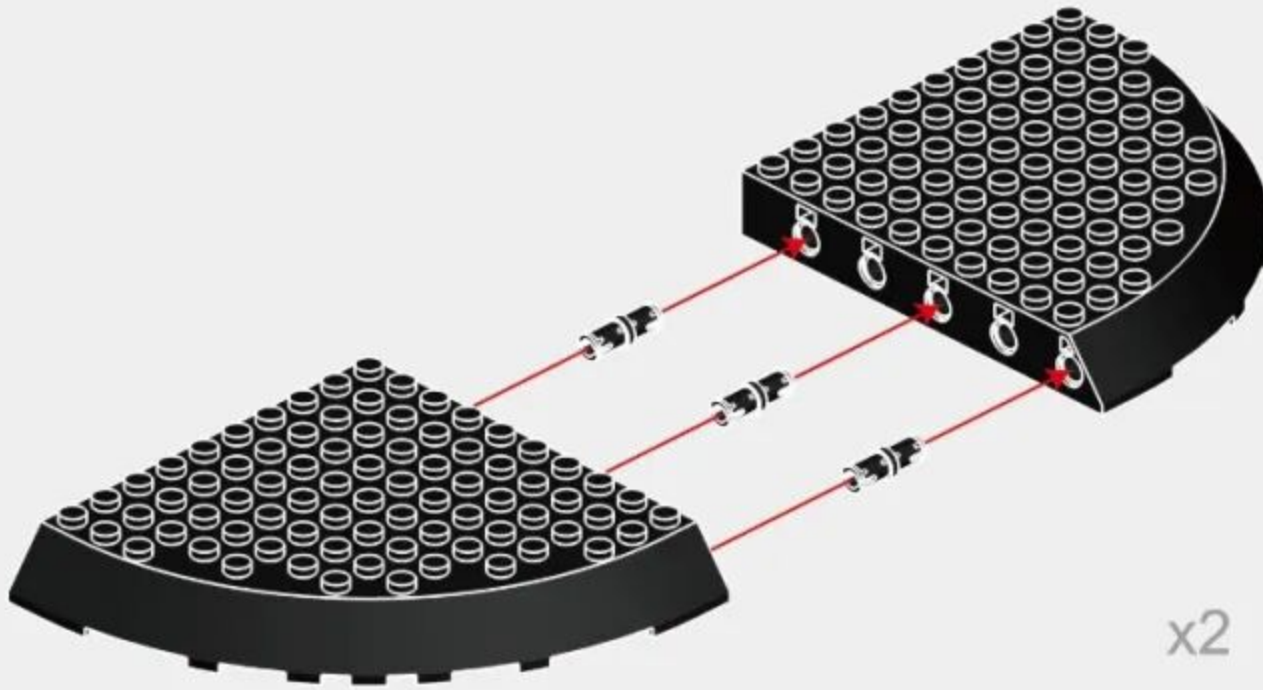

1-2

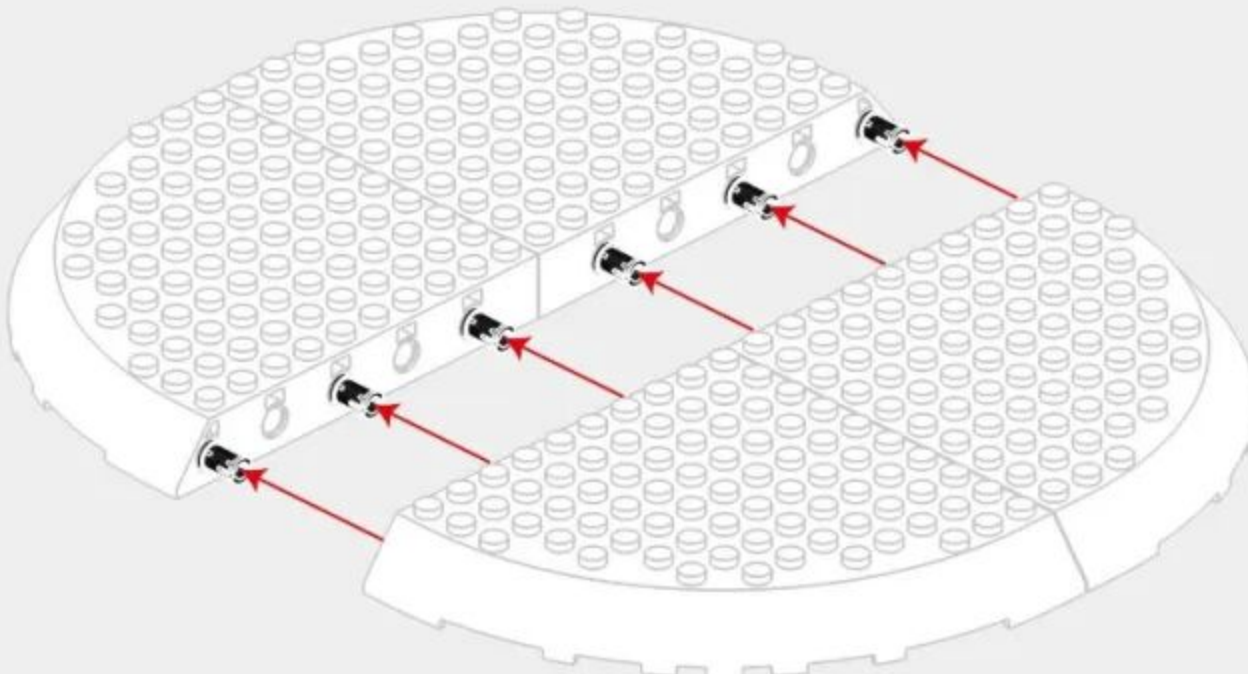

1-3

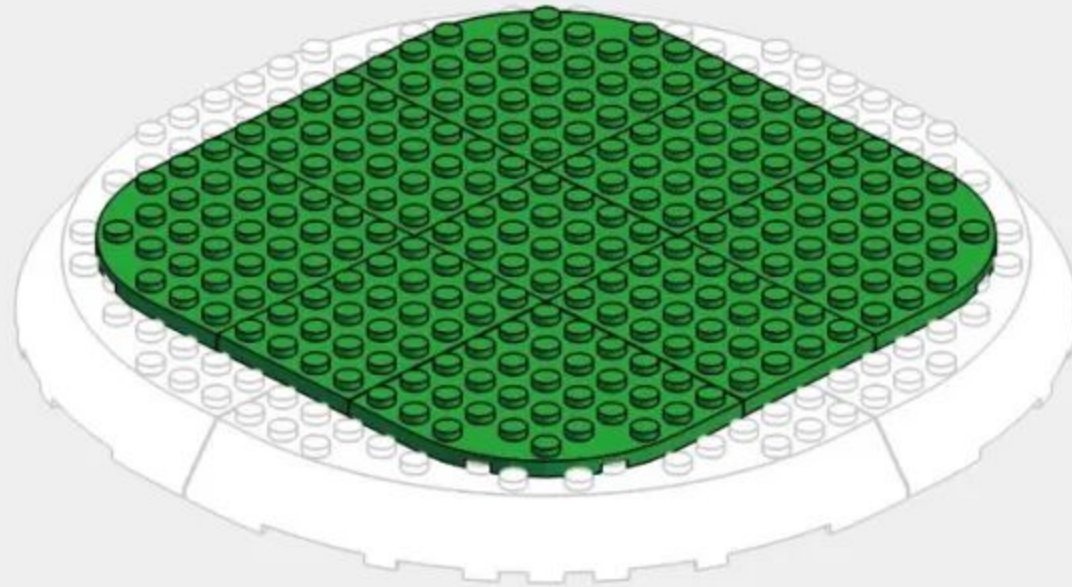
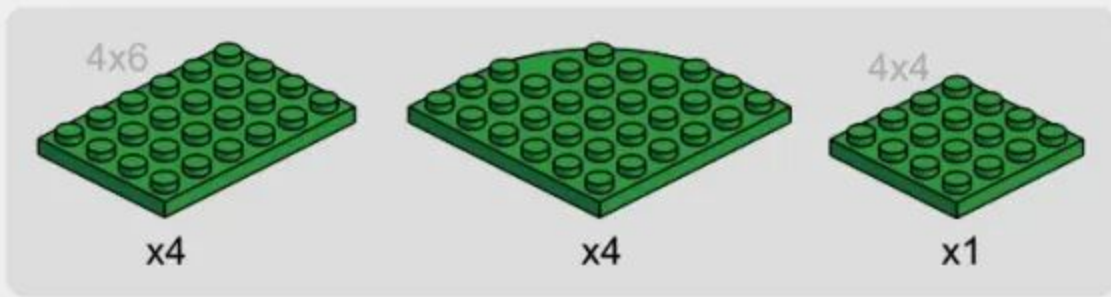

1-4

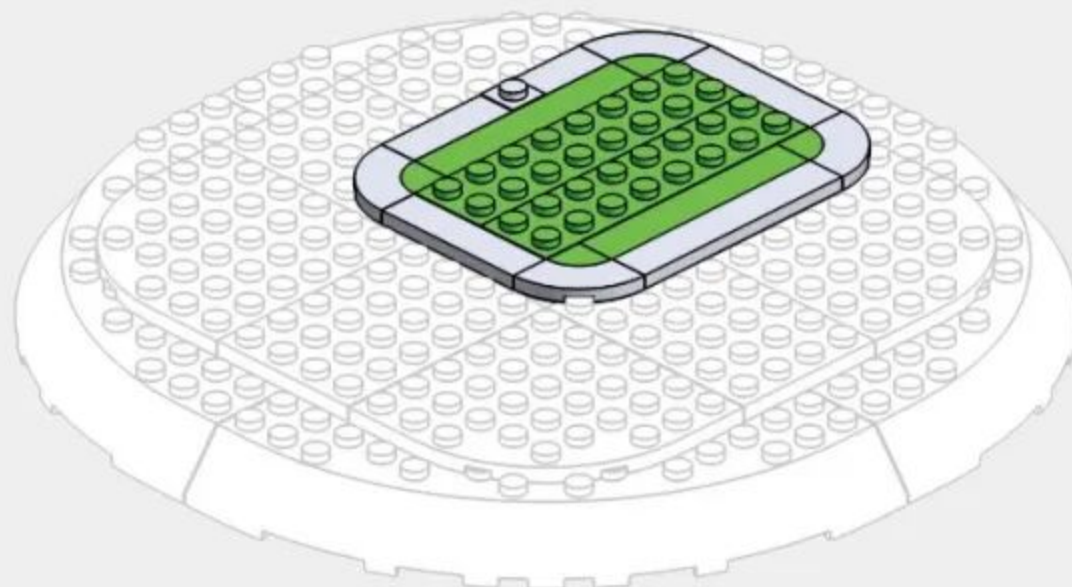
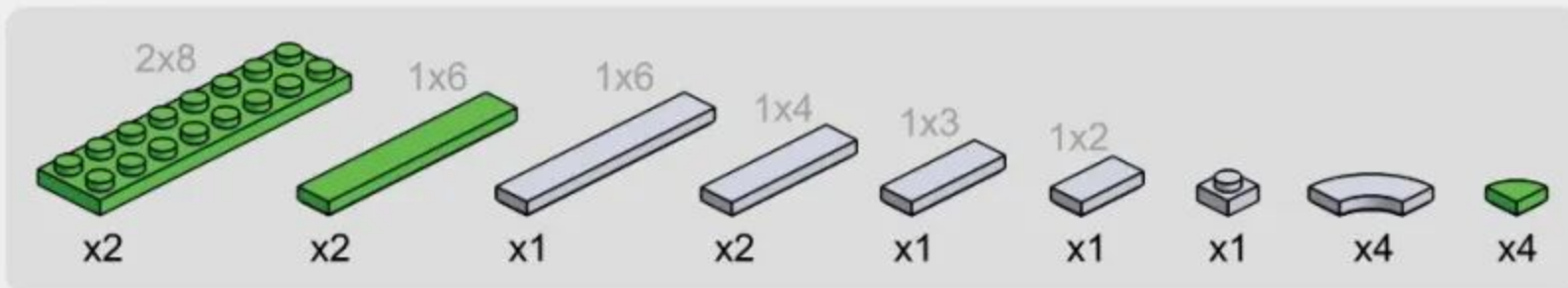

1-5

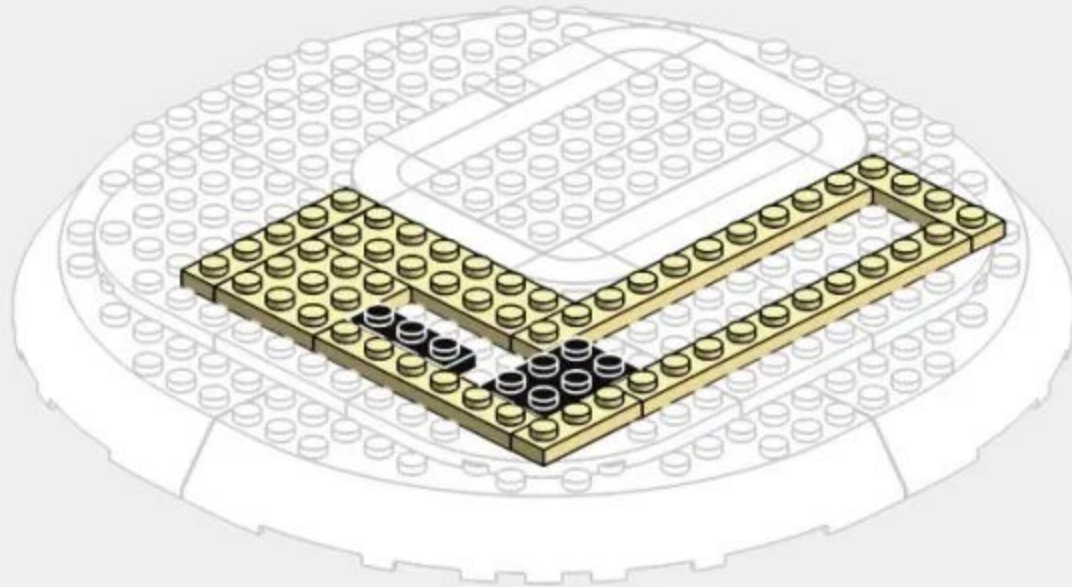
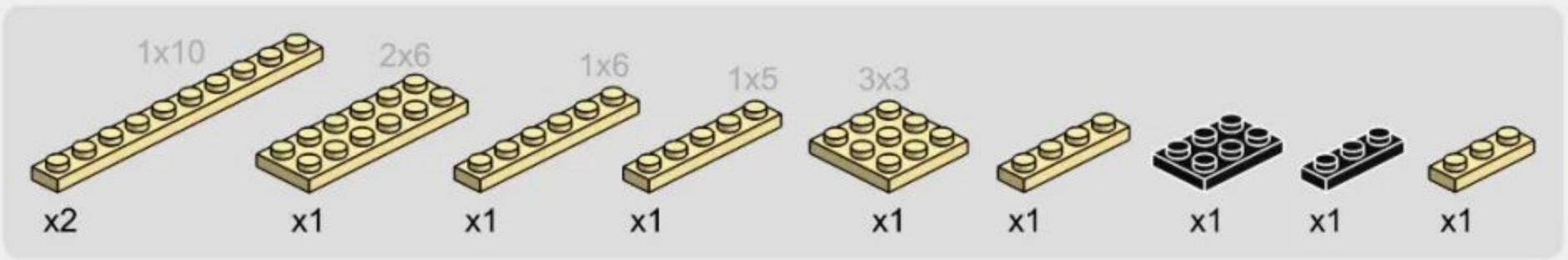

1-6

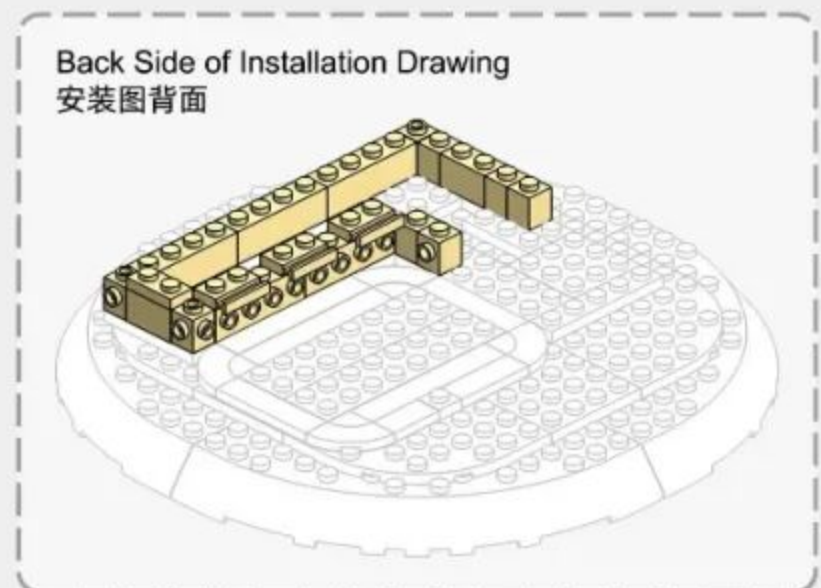
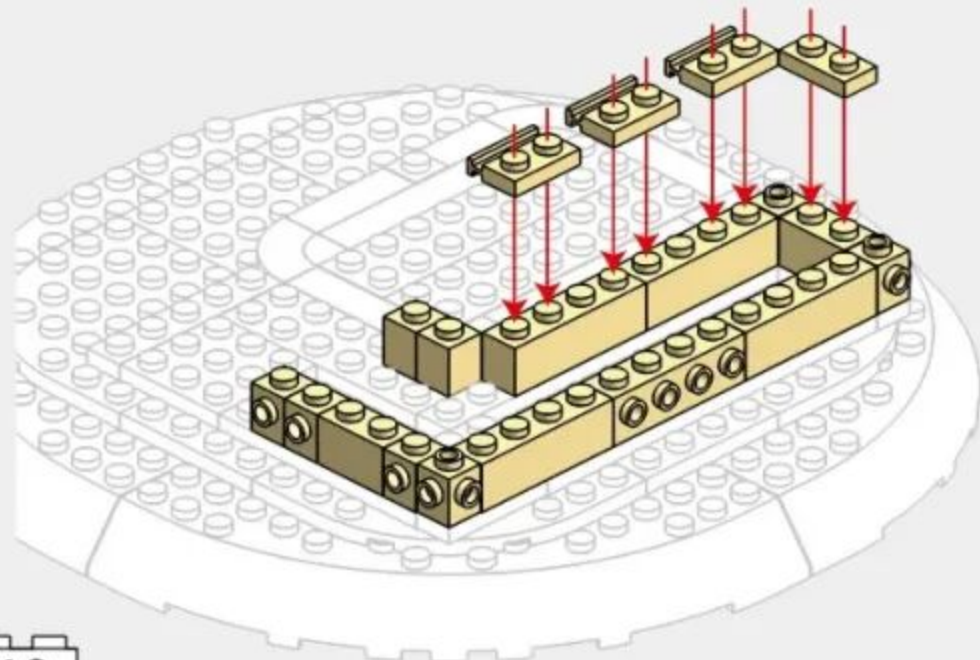
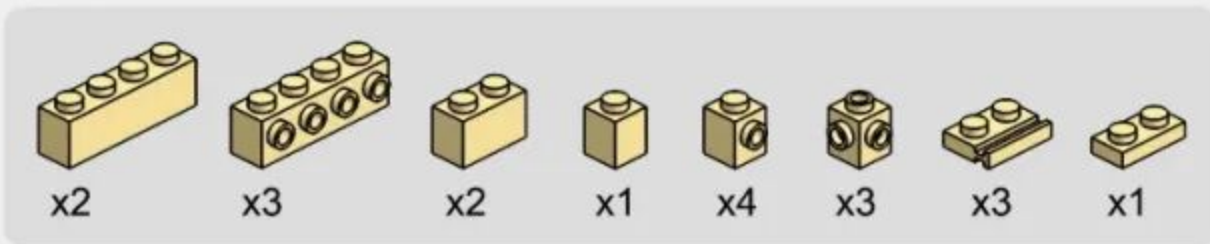

1-7

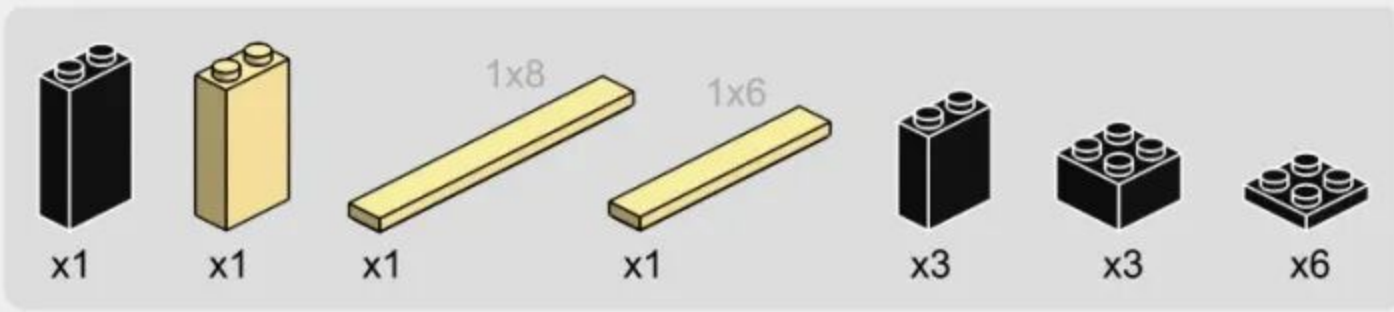

Vertical View of Installation Drawing
安装图顶面

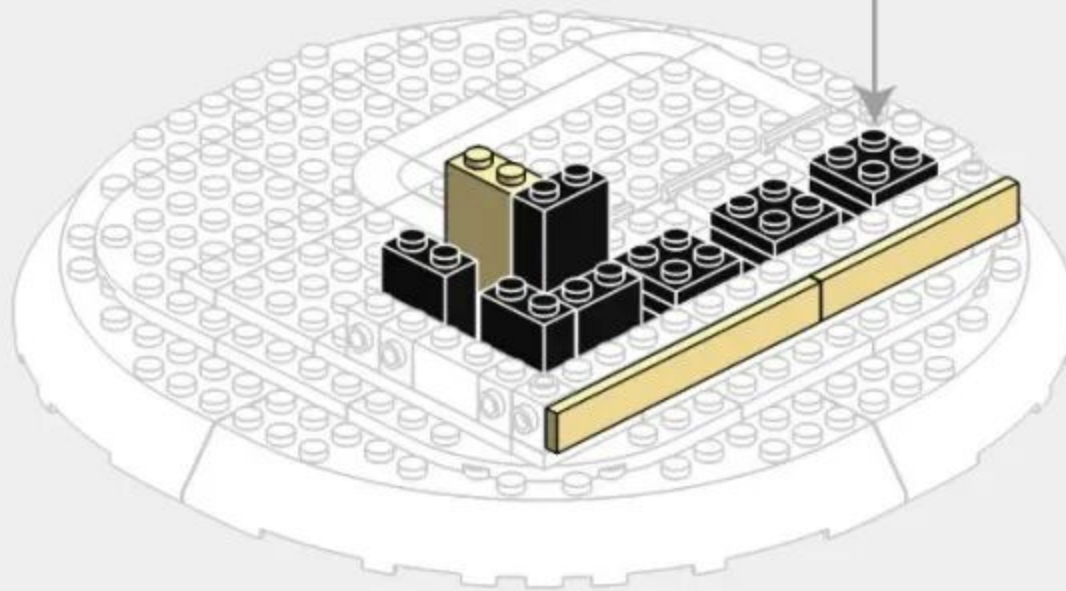
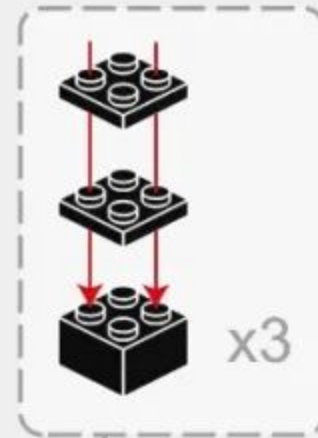
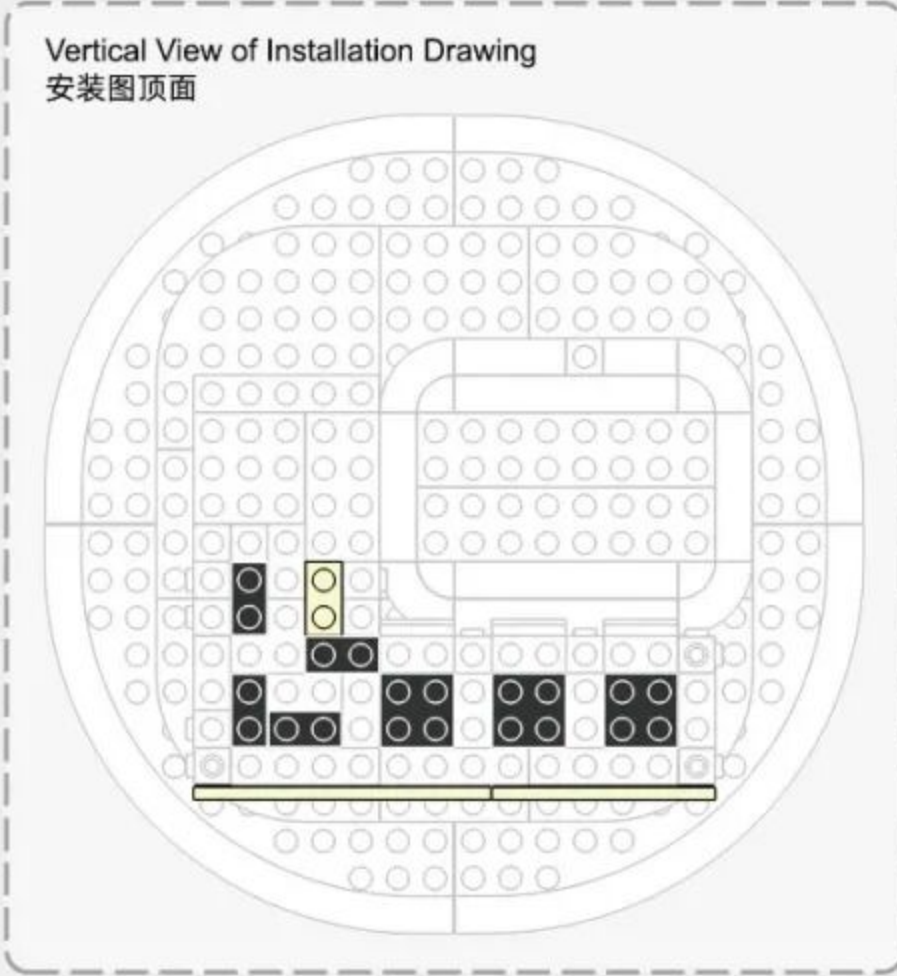

1-8

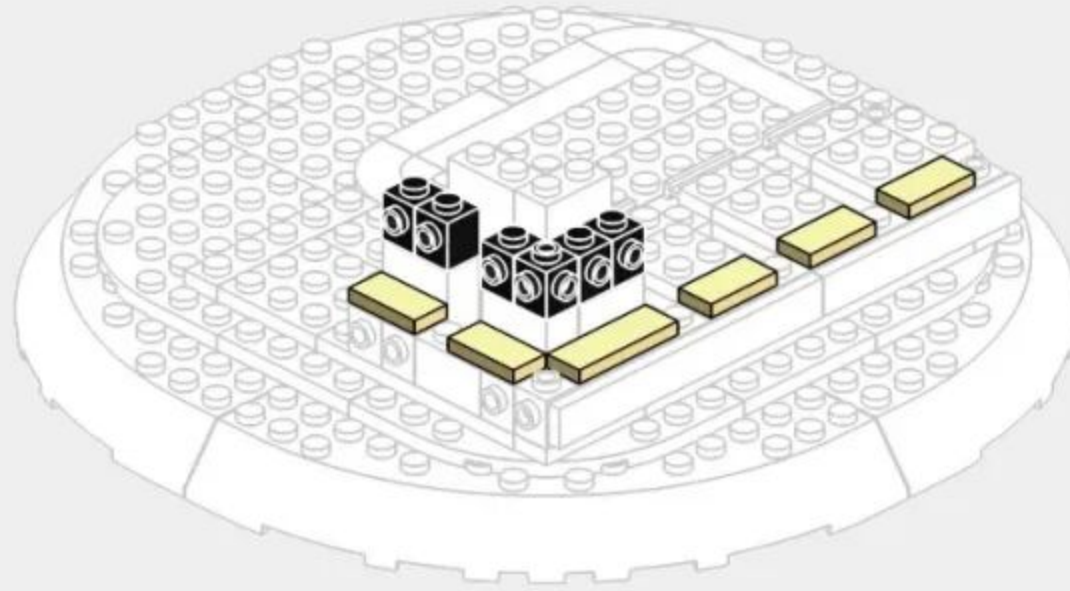

1-9

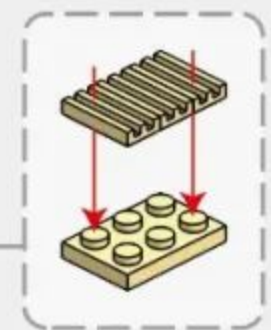
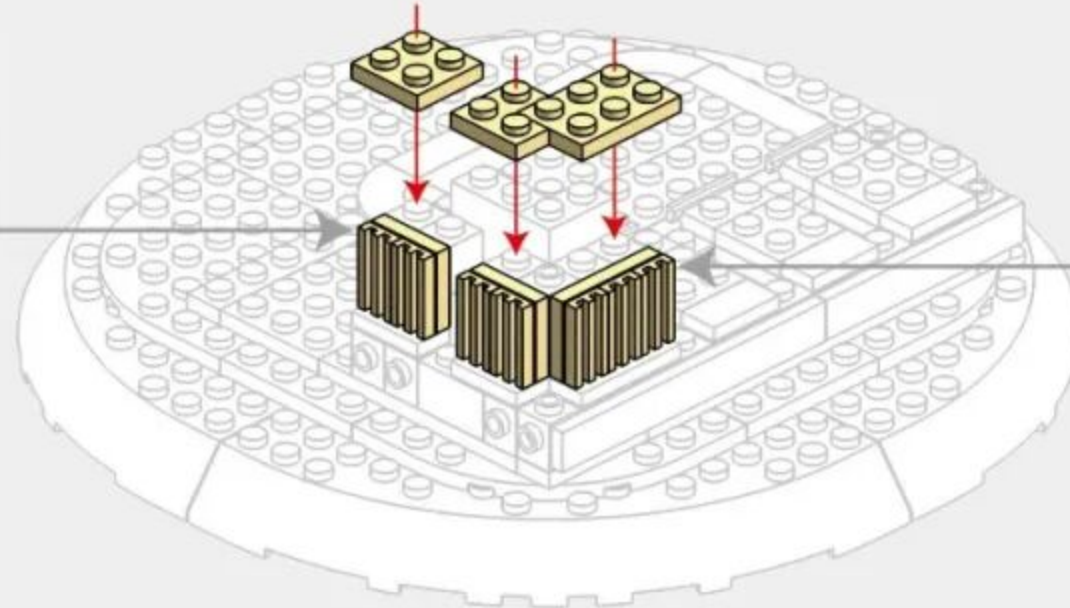
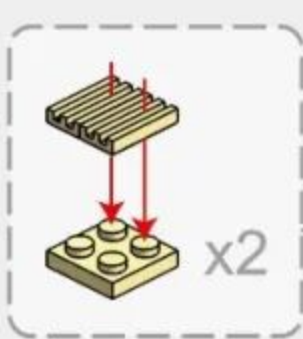
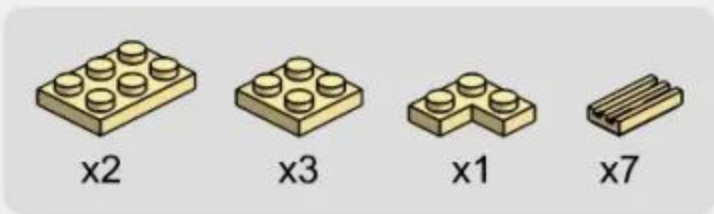

1-10

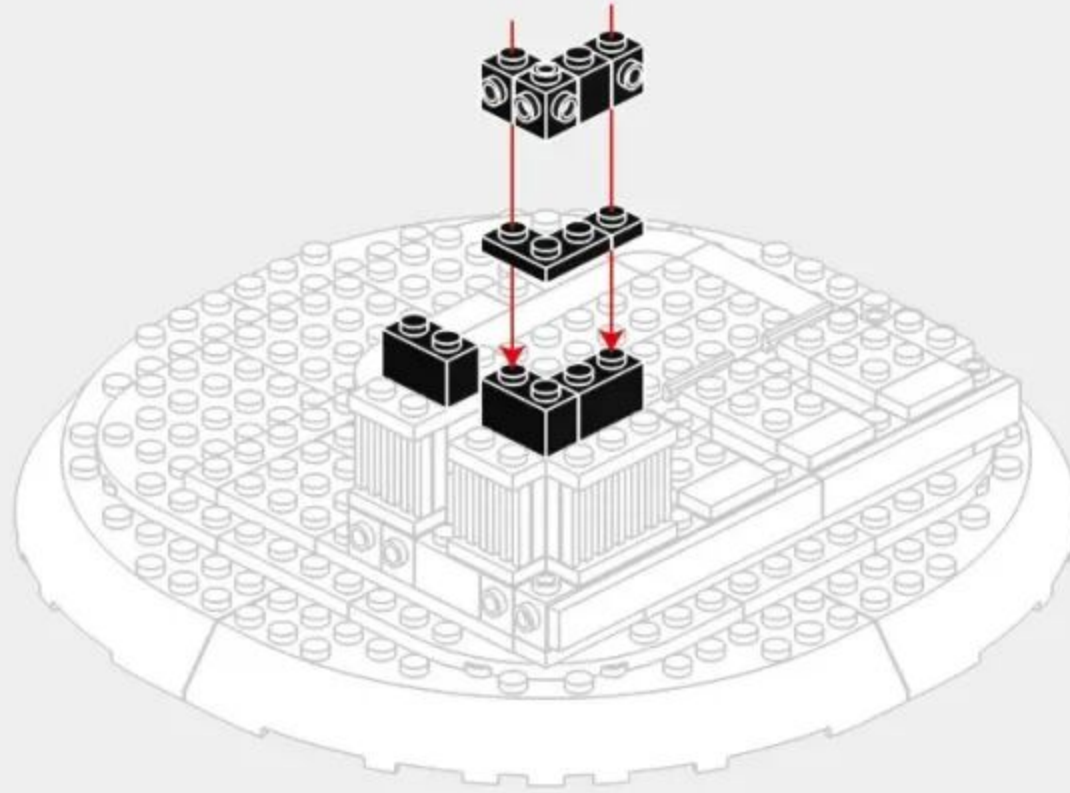

1-11

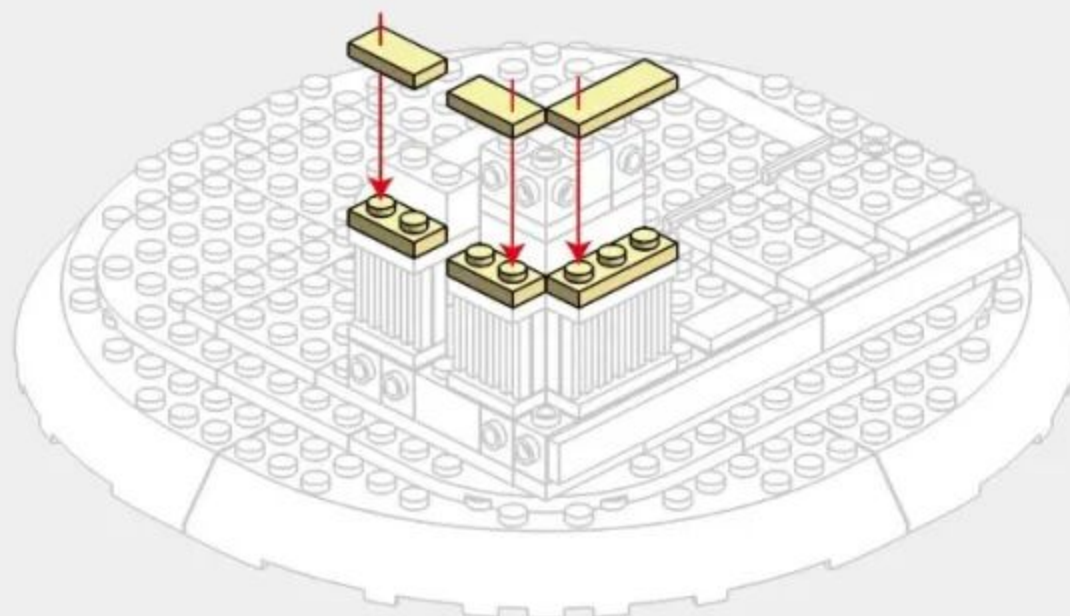

1-12

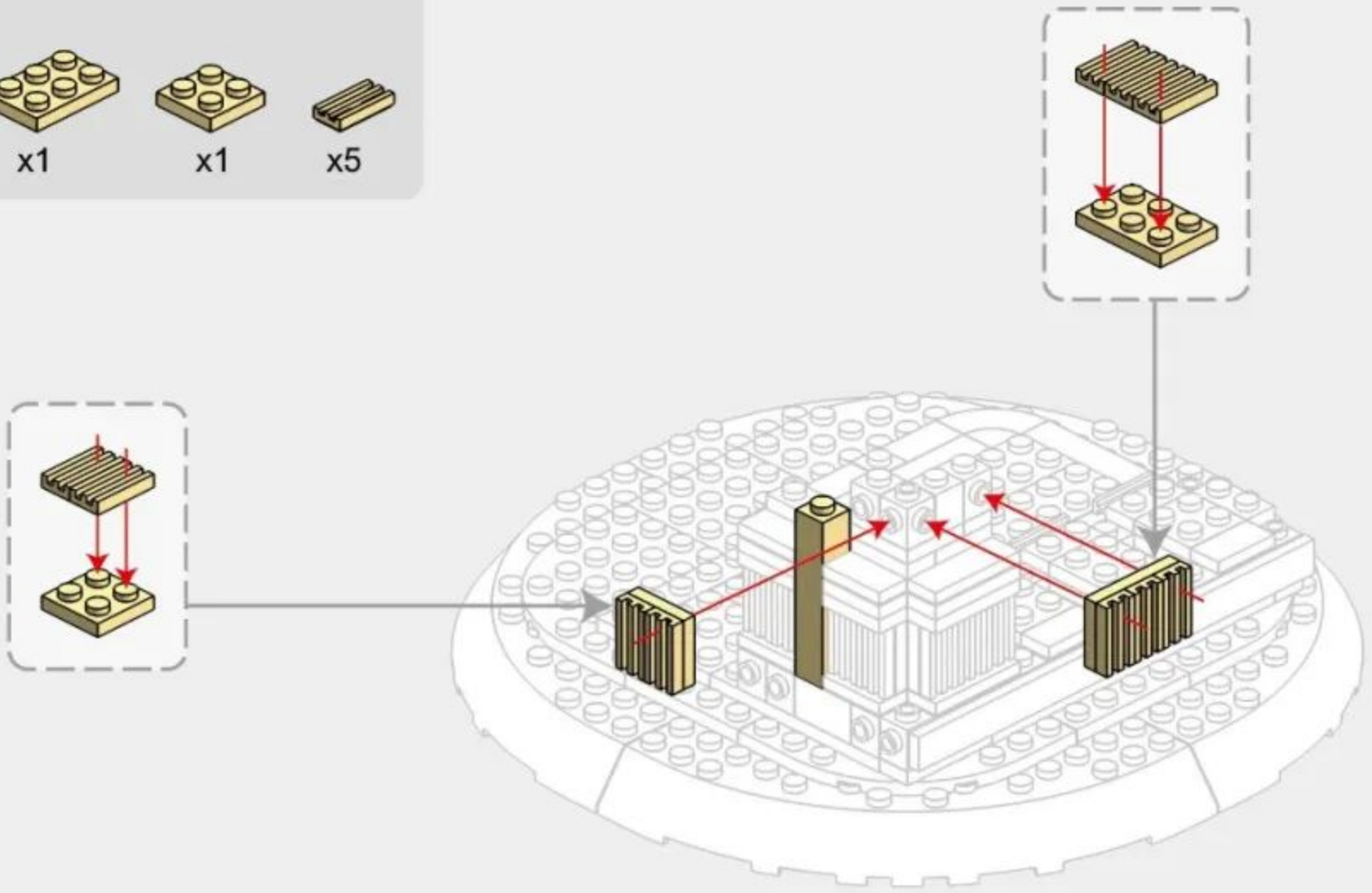
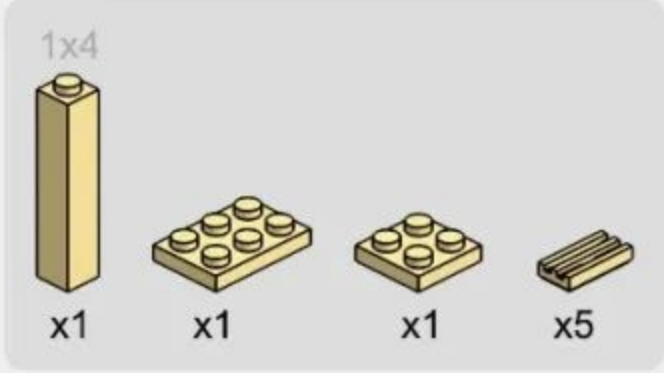

1-13

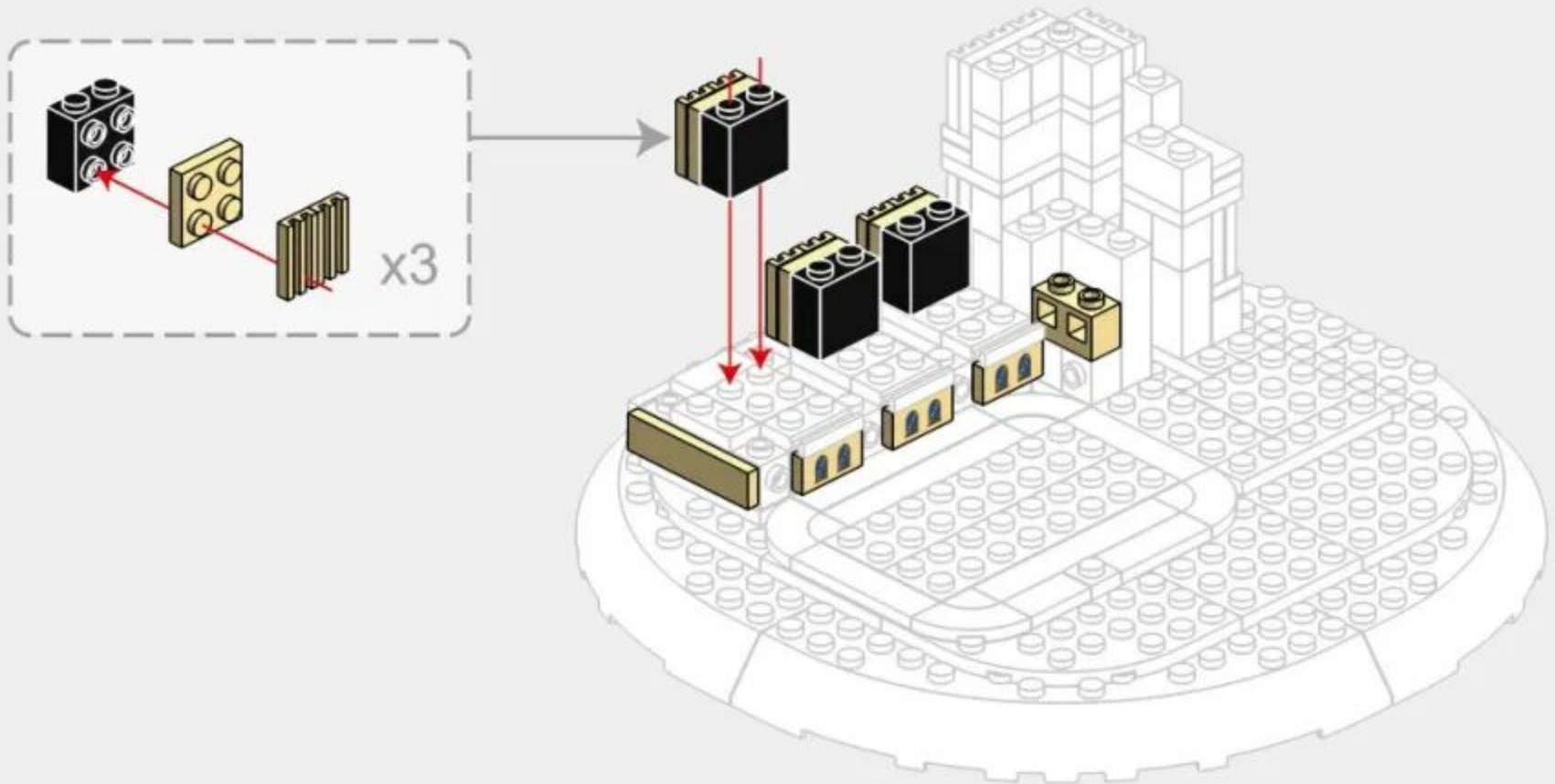
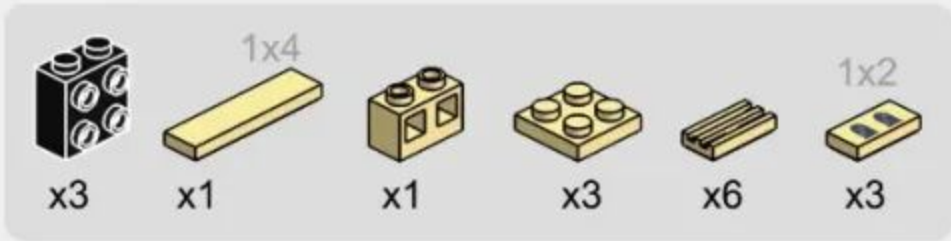

1-14

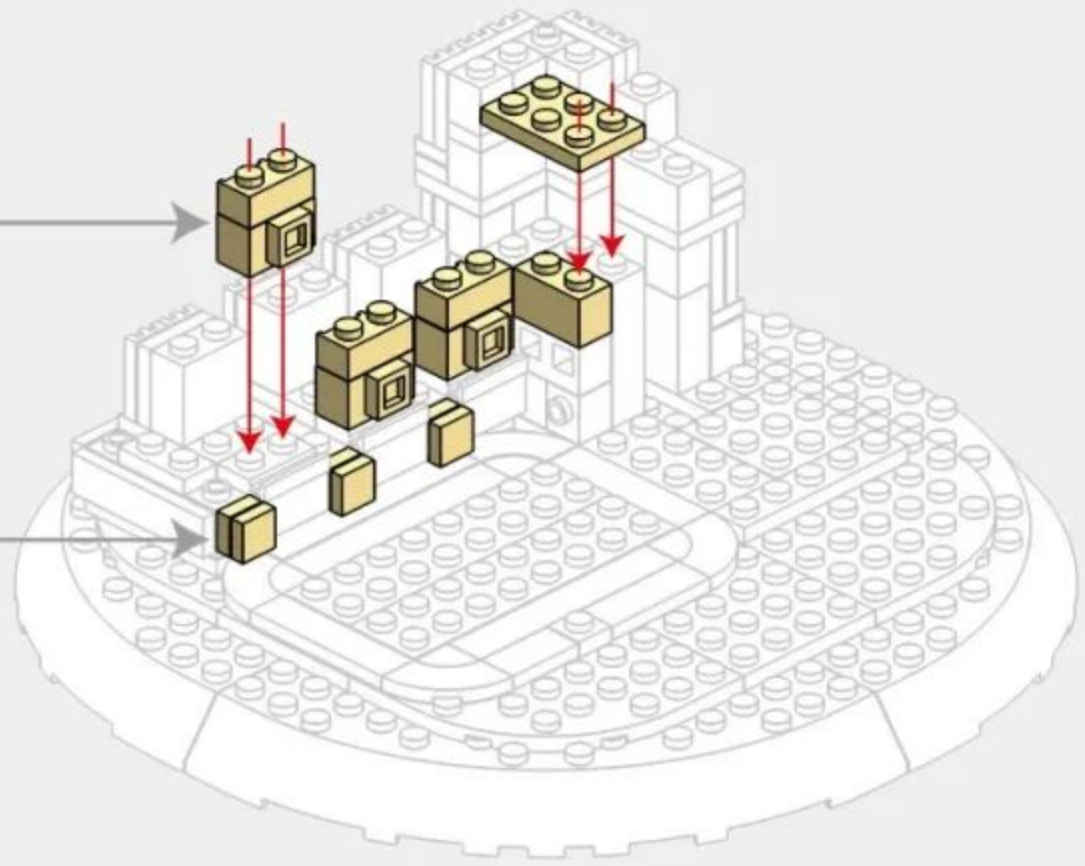
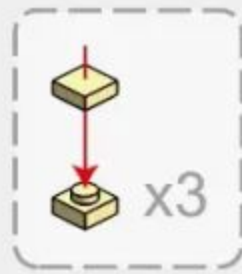
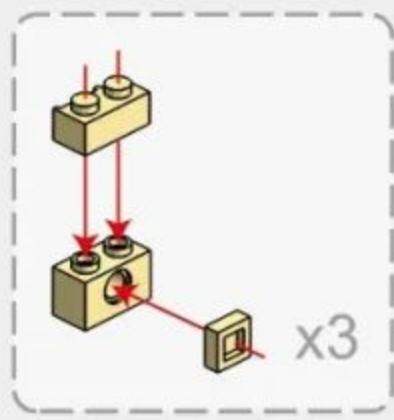
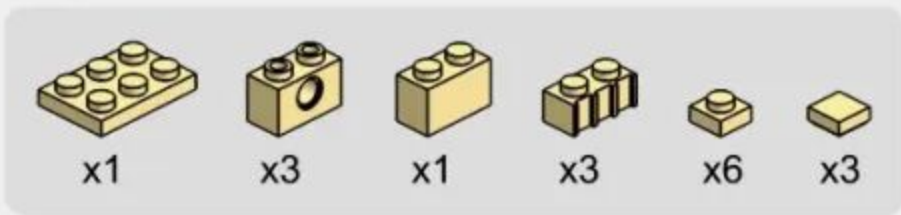

1-15

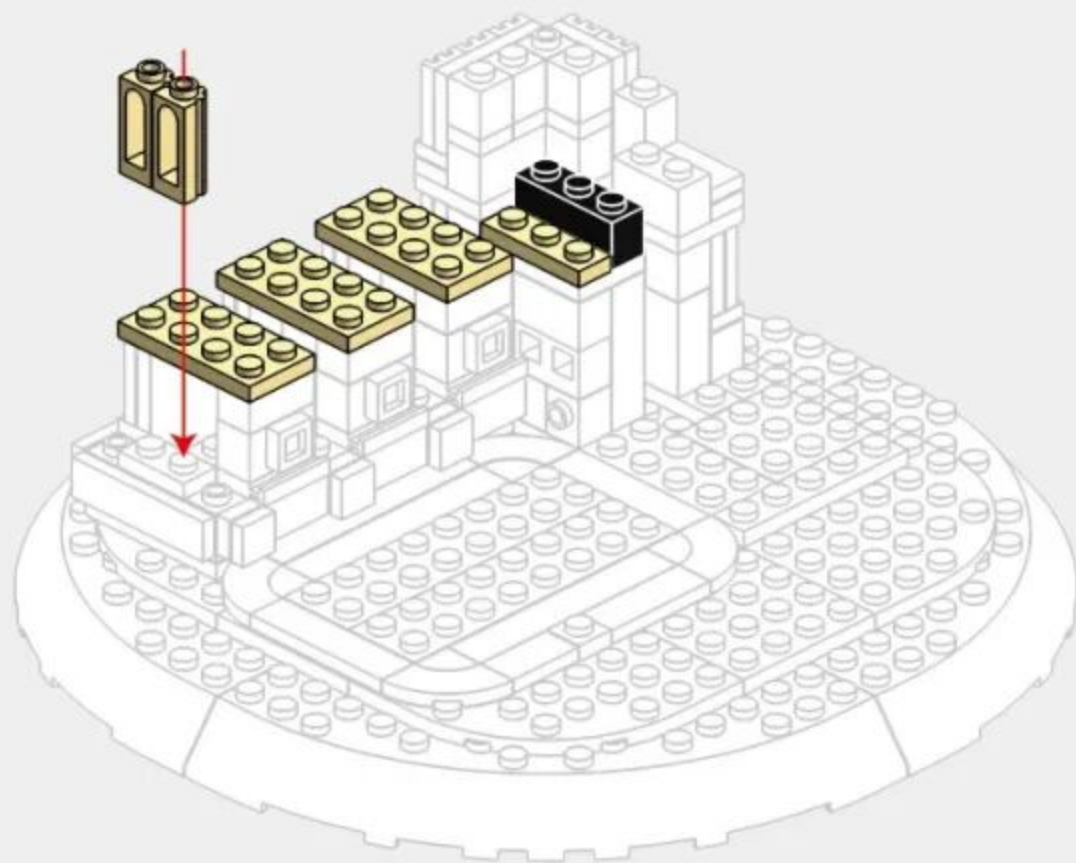
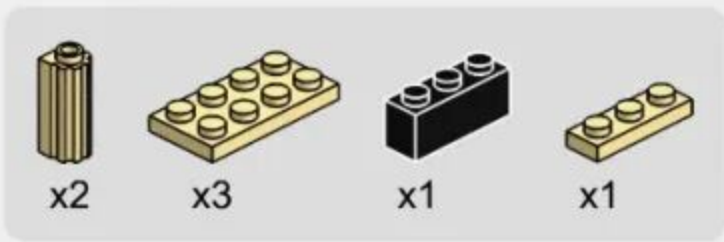

1-16

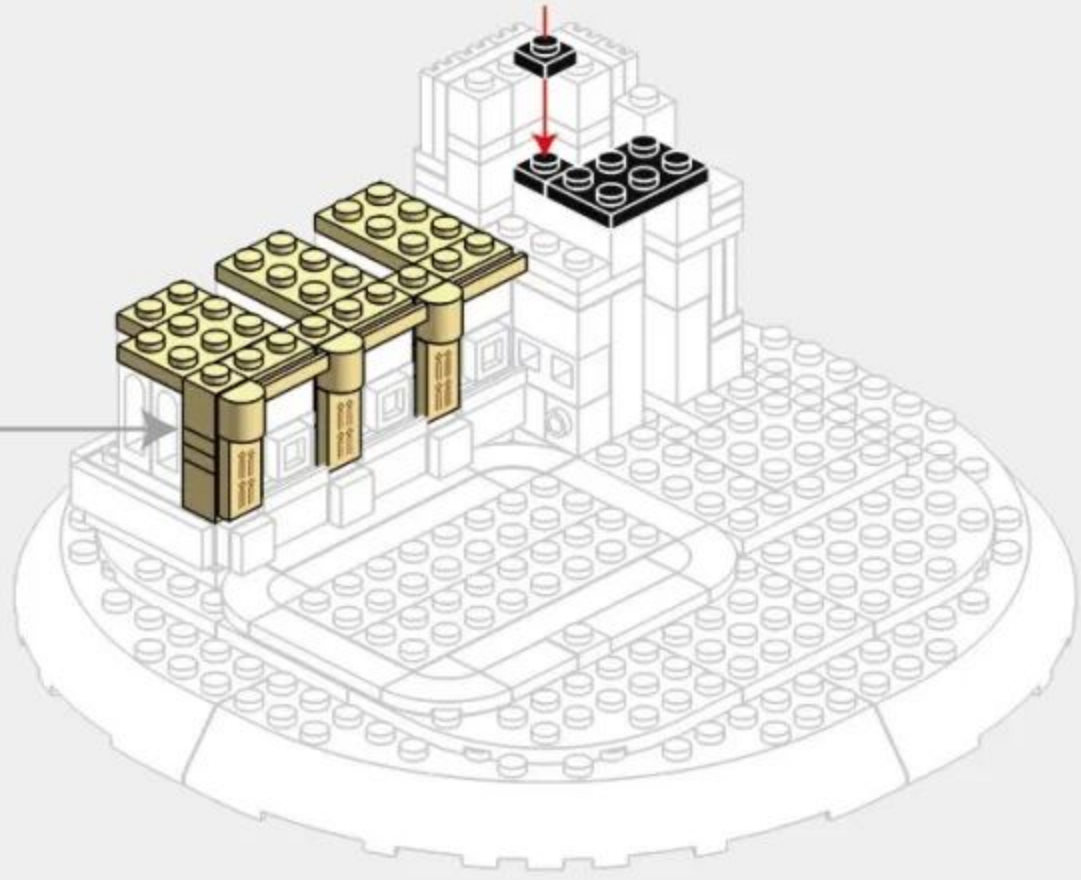
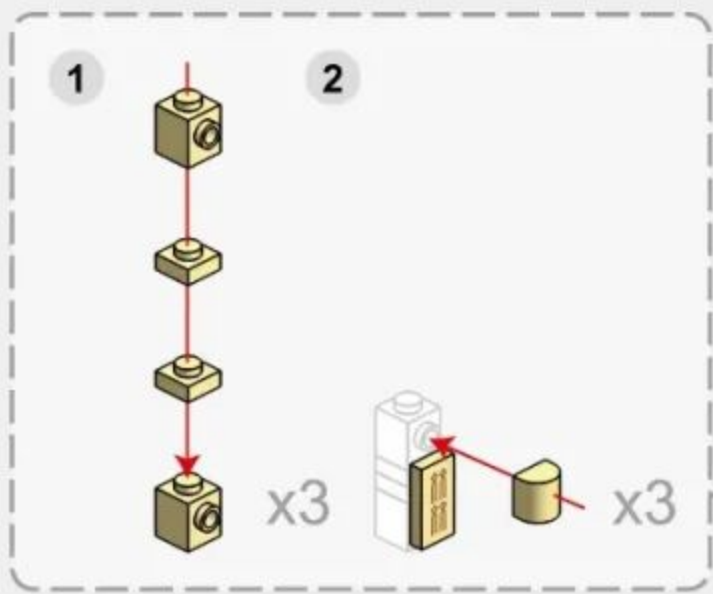

1-17

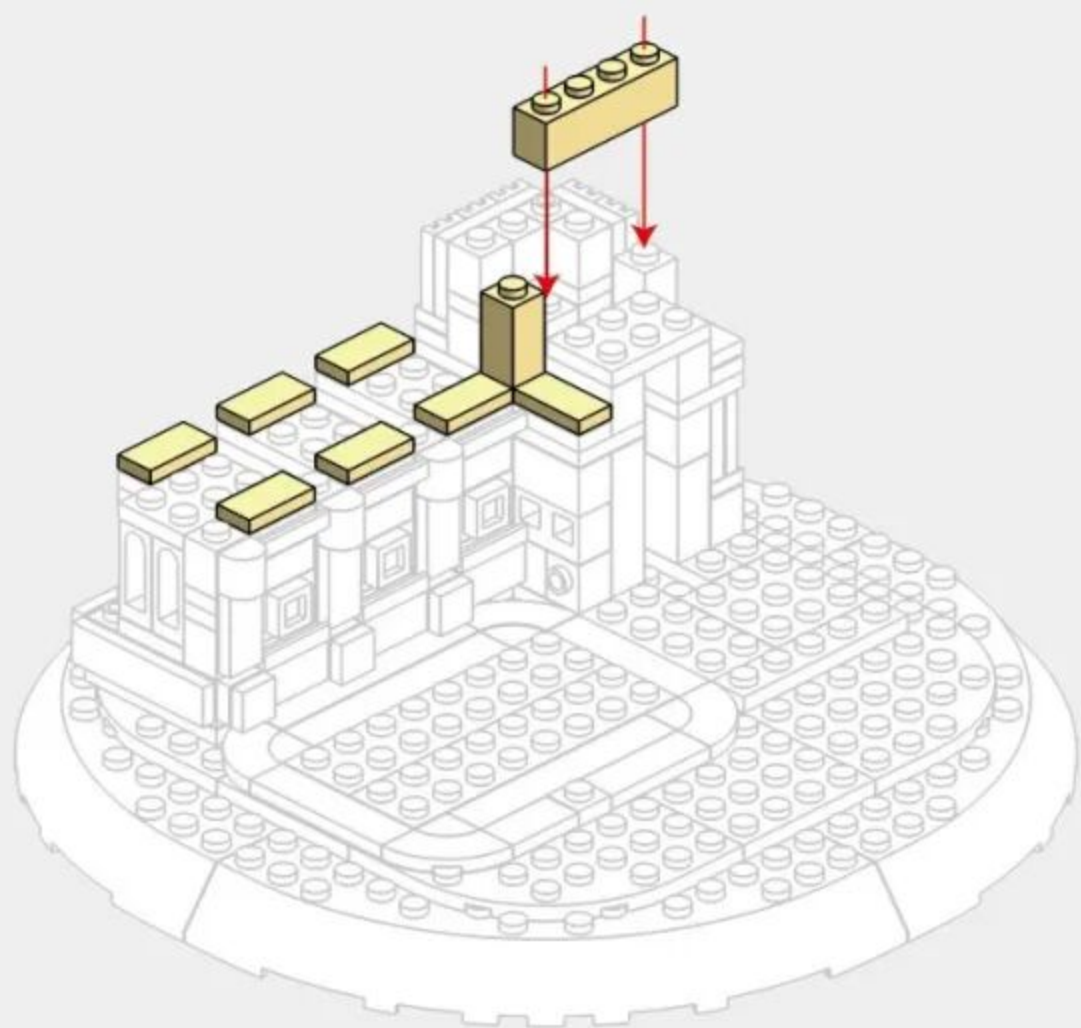
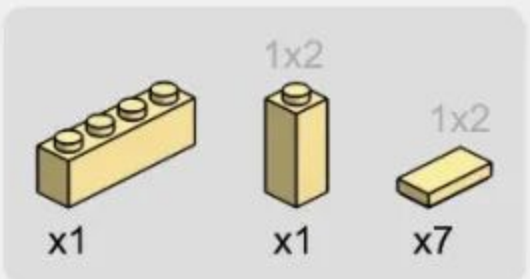

1-18

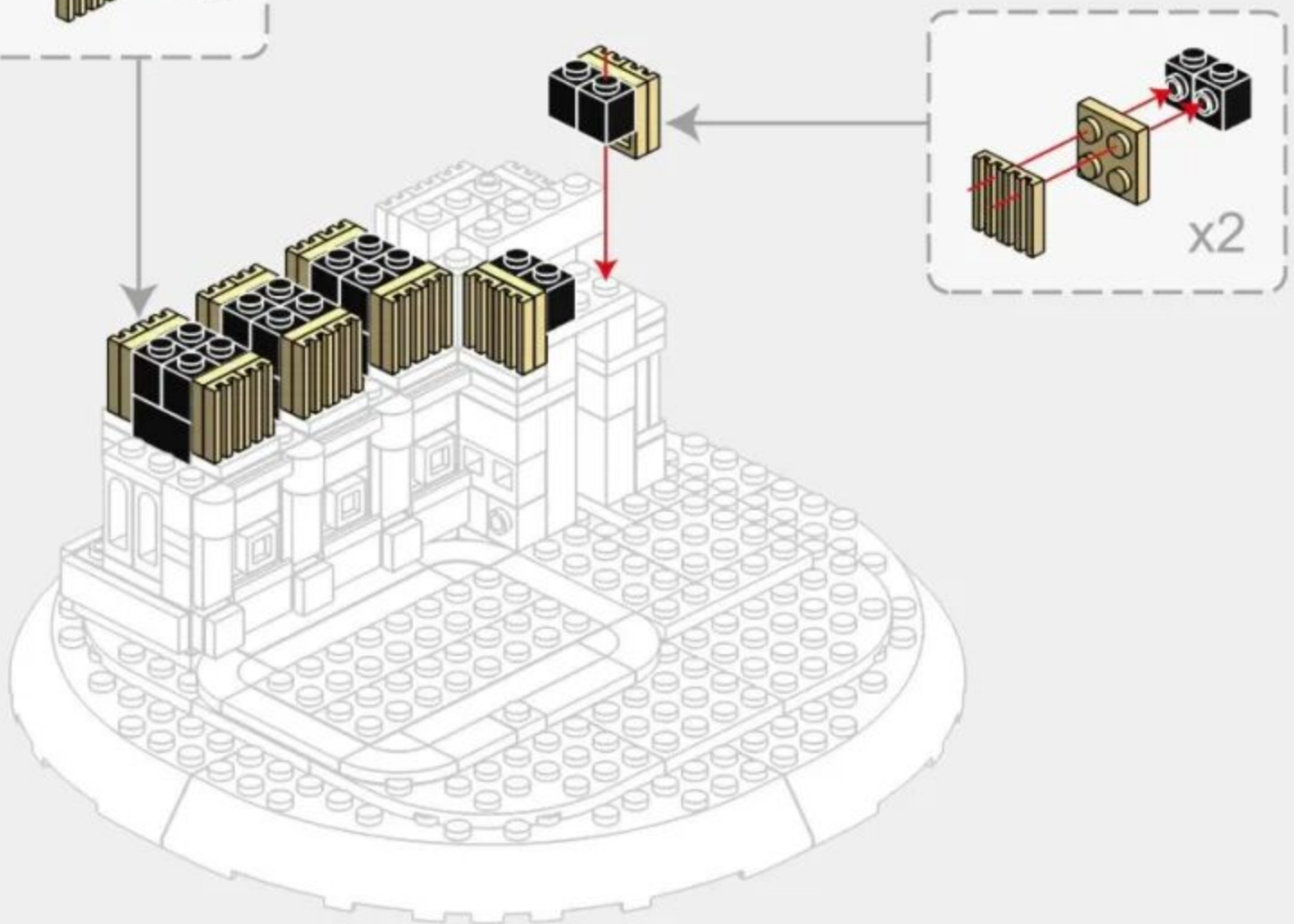
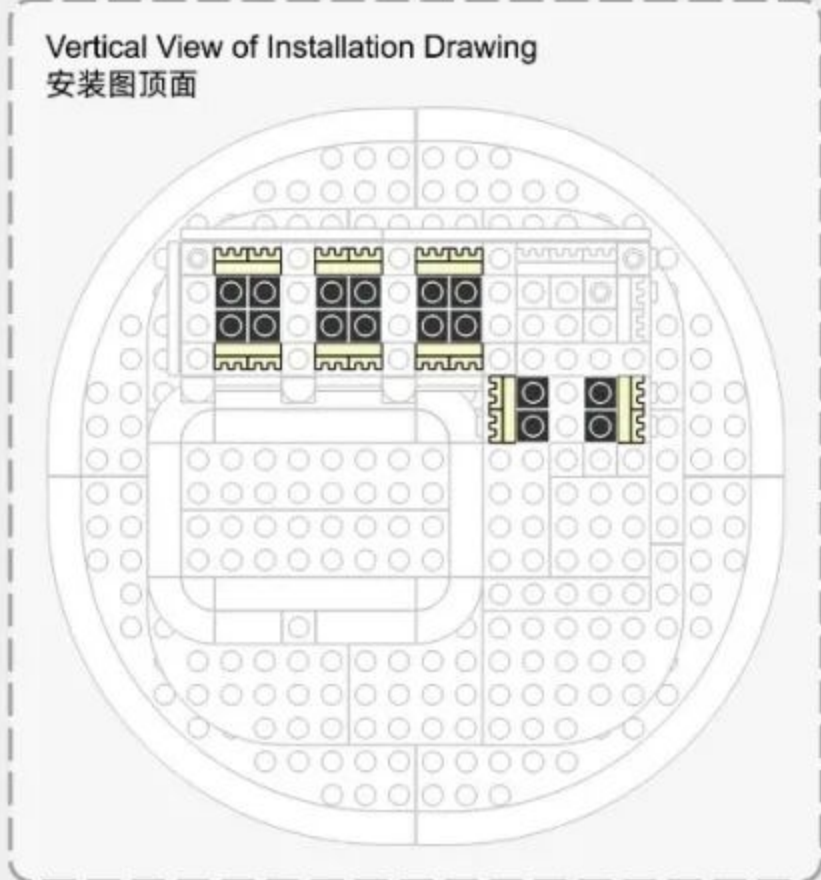
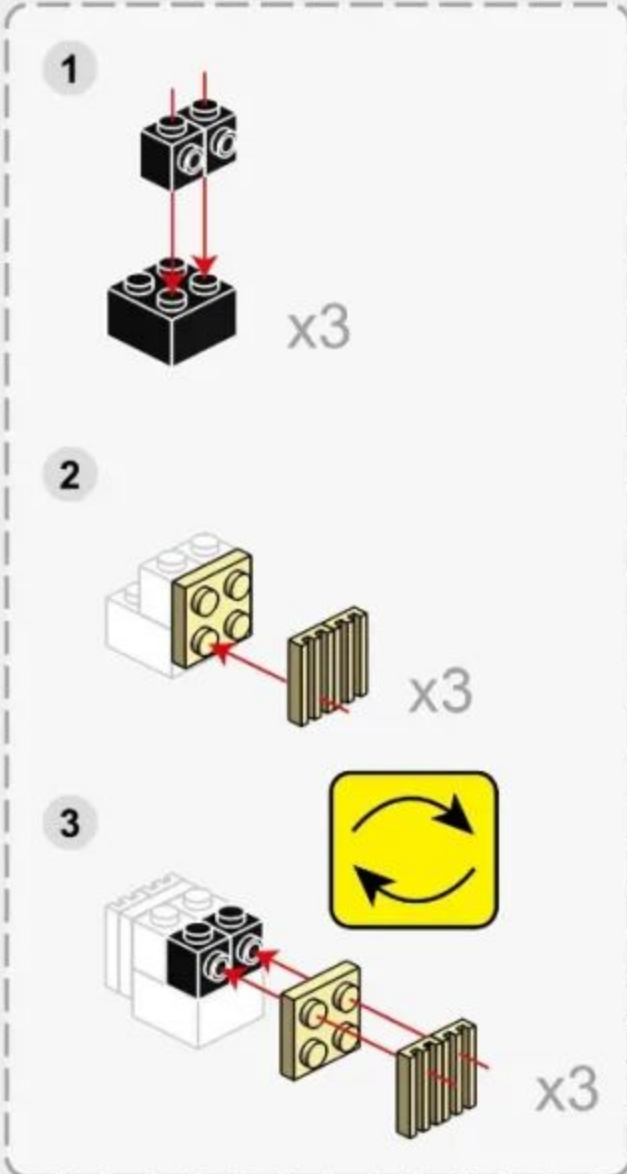

1-19

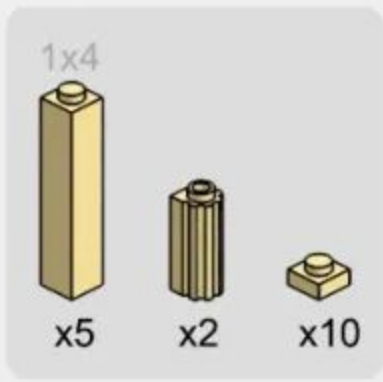

Back Side of Installation Drawing
安装图背面

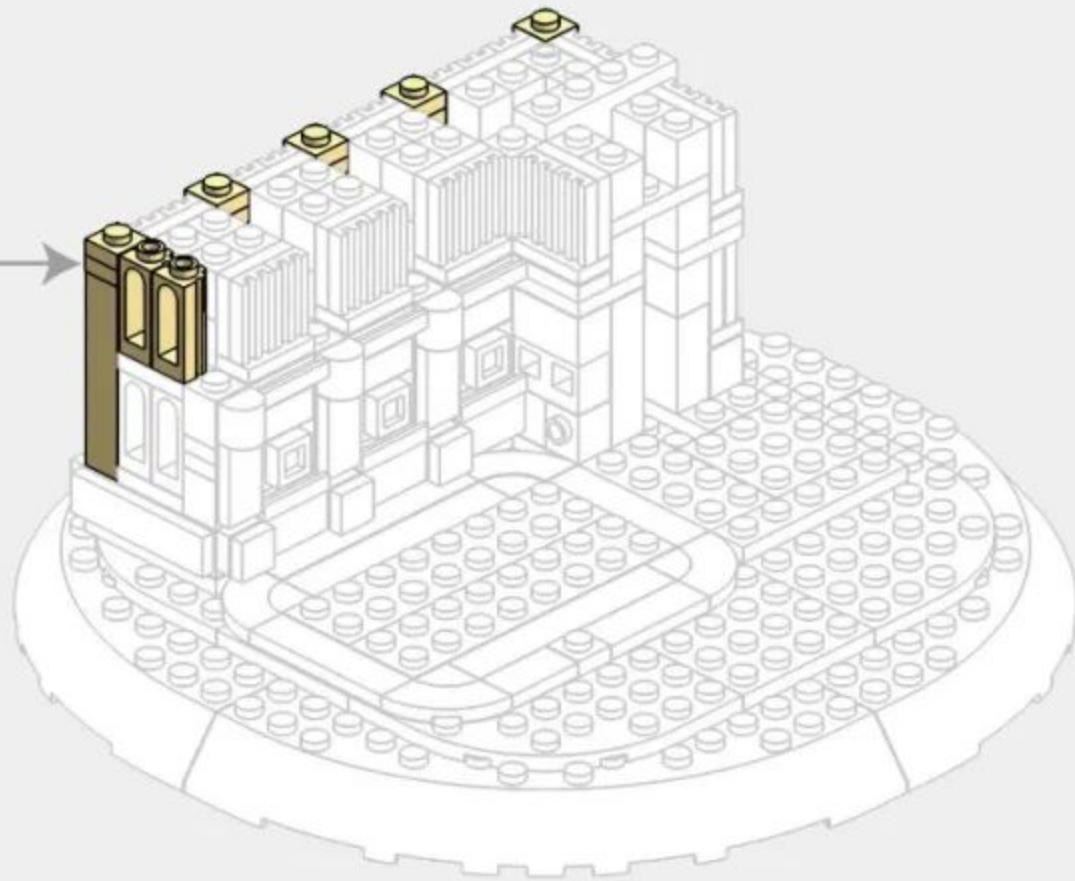
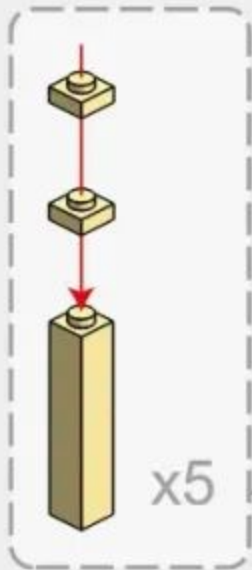
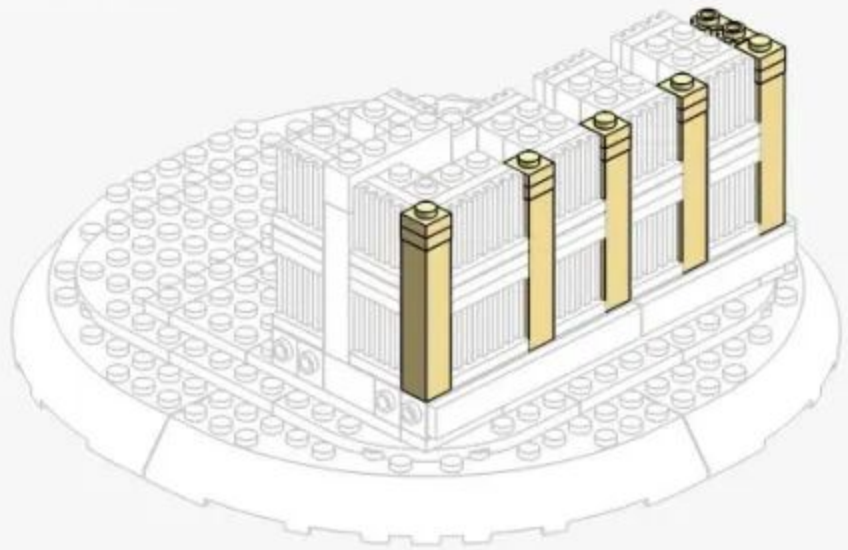

1-20

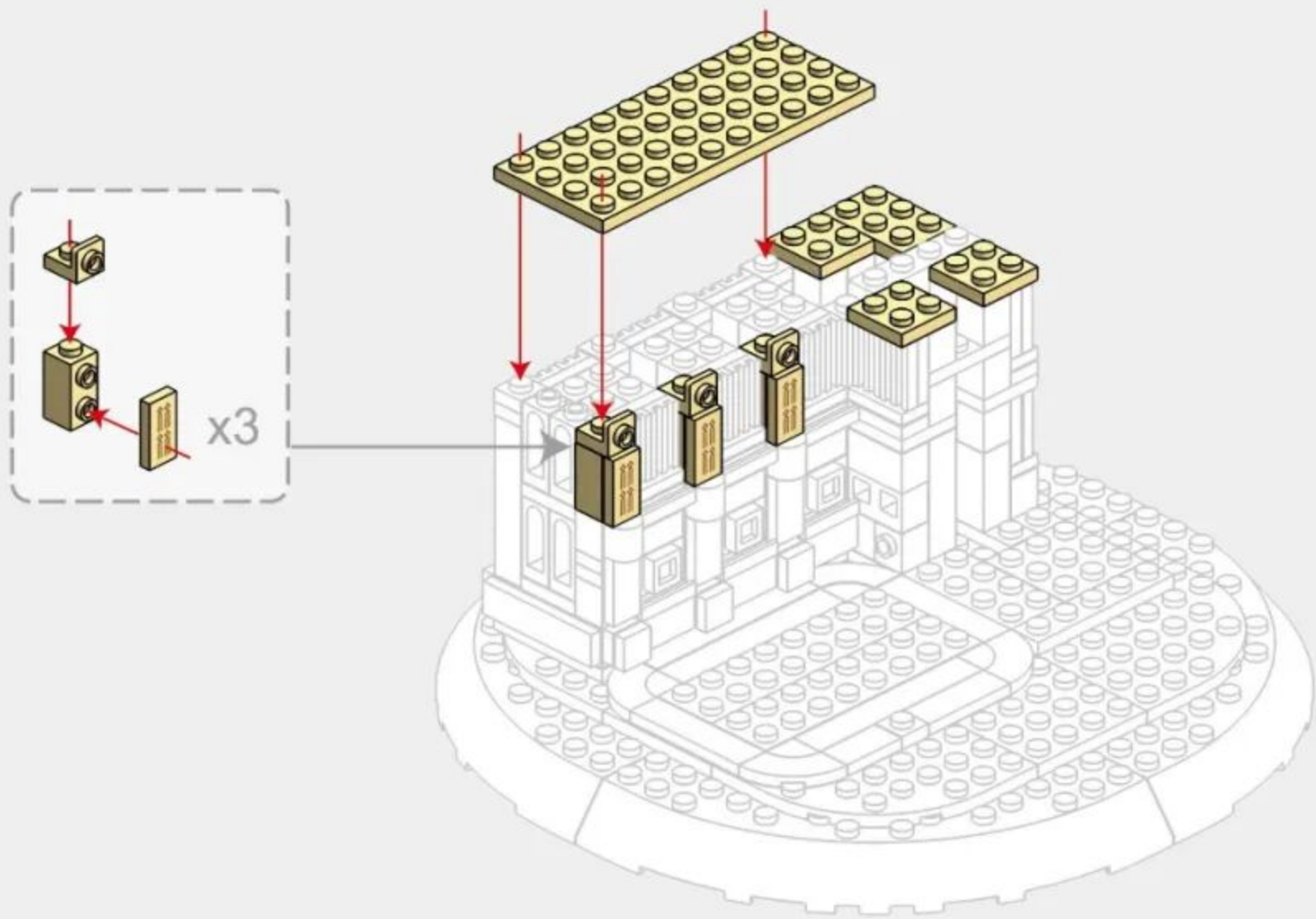
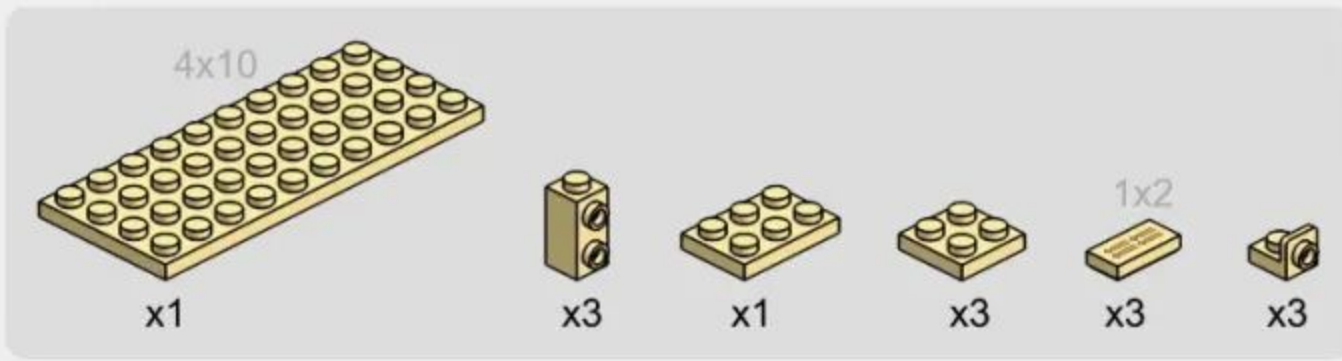



255PCS

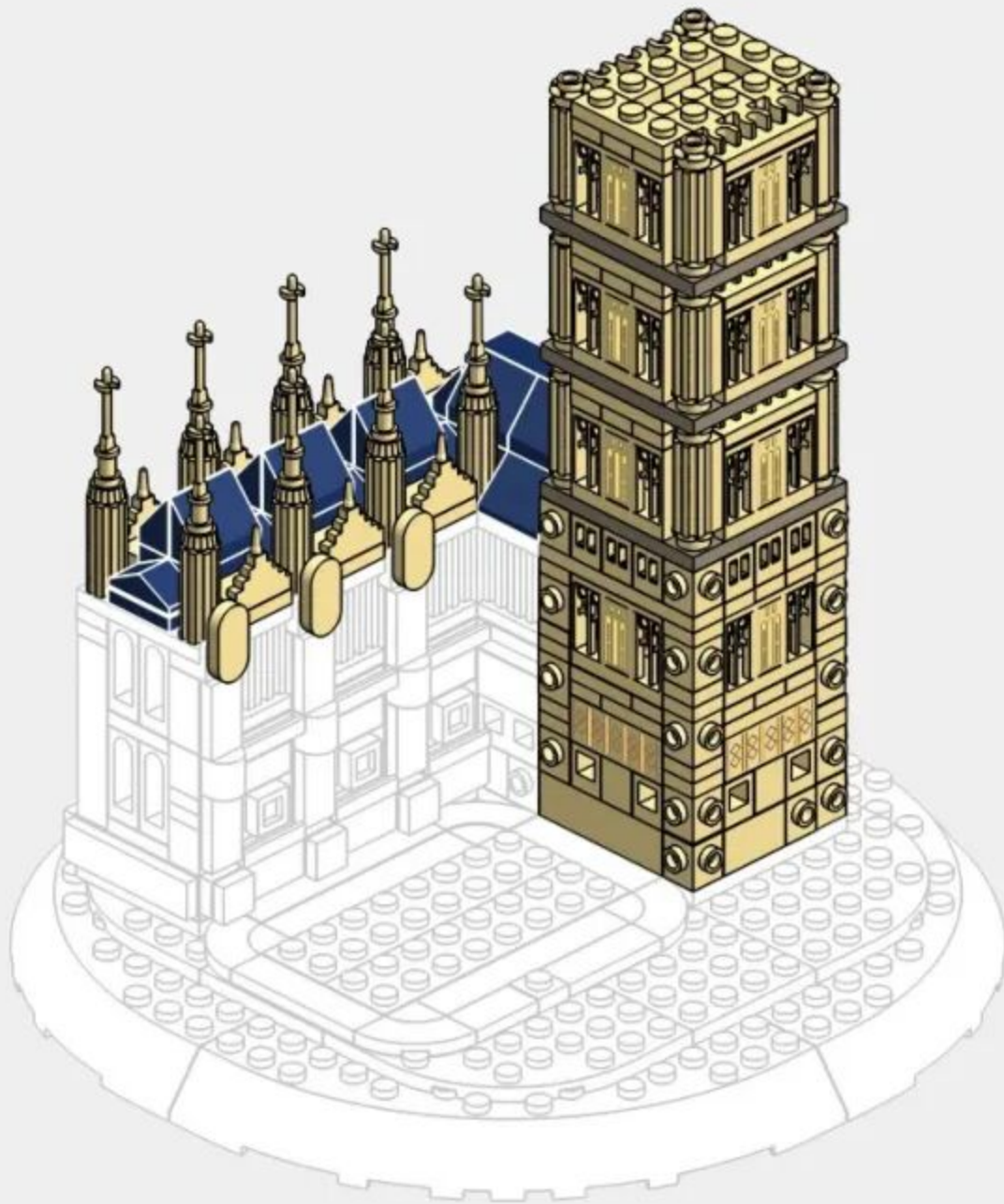

2-1

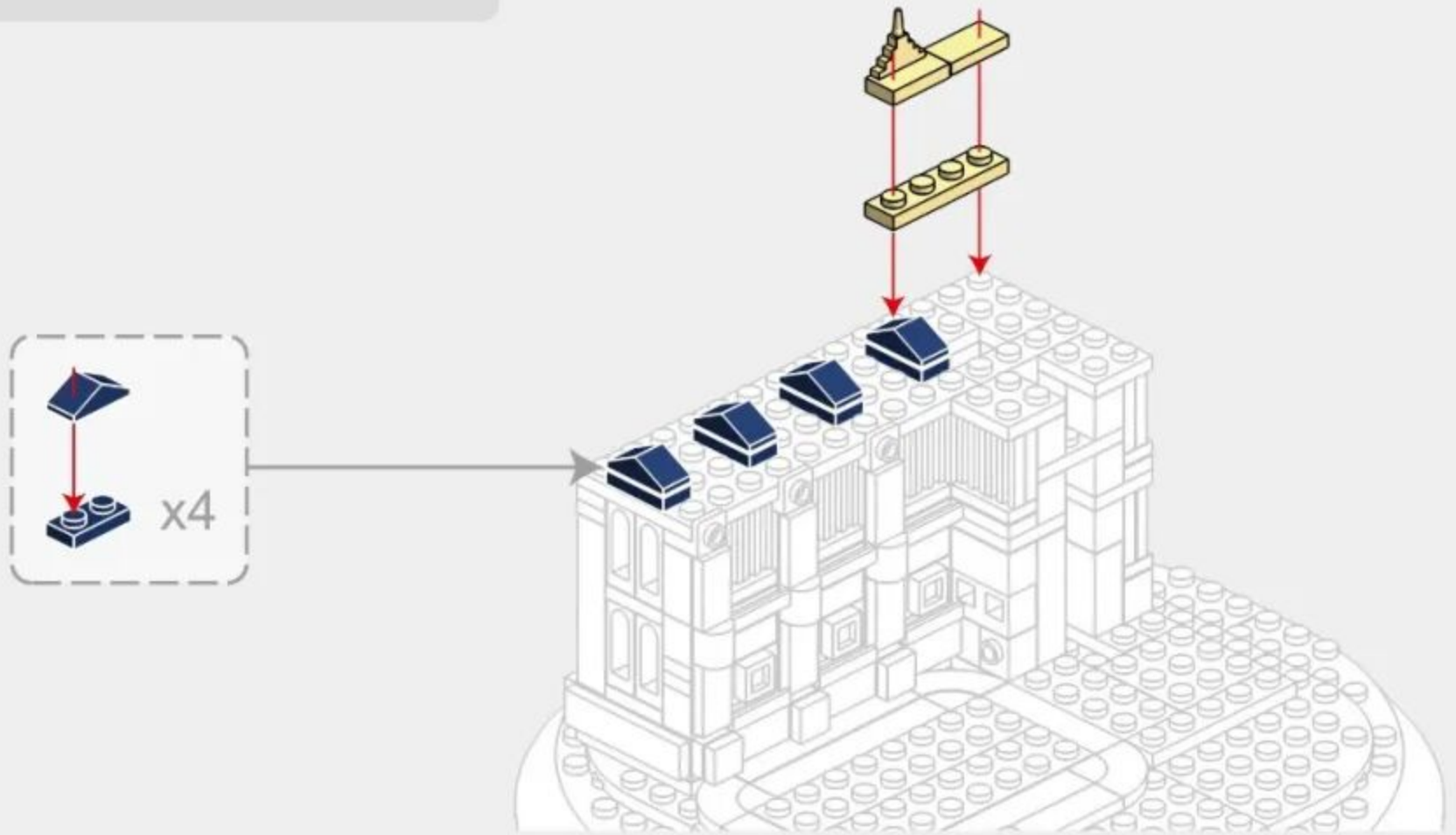
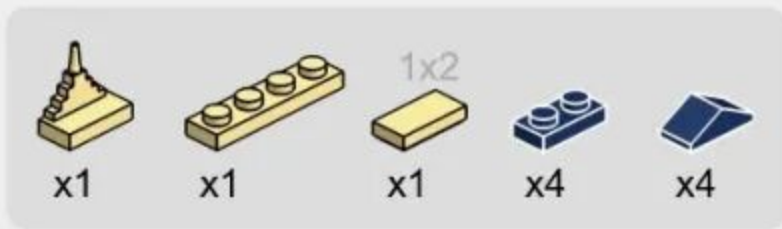

2-2

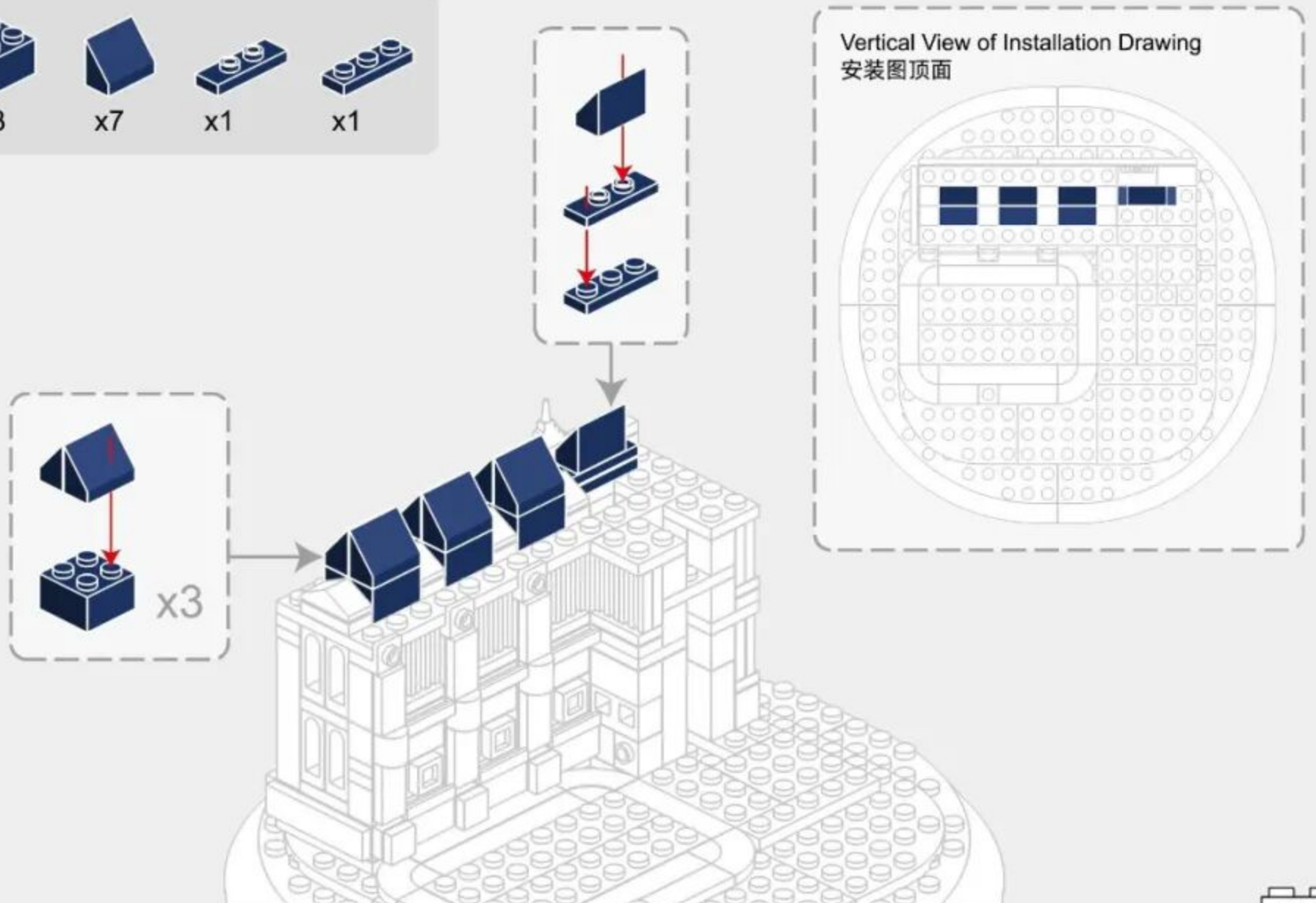

2-3

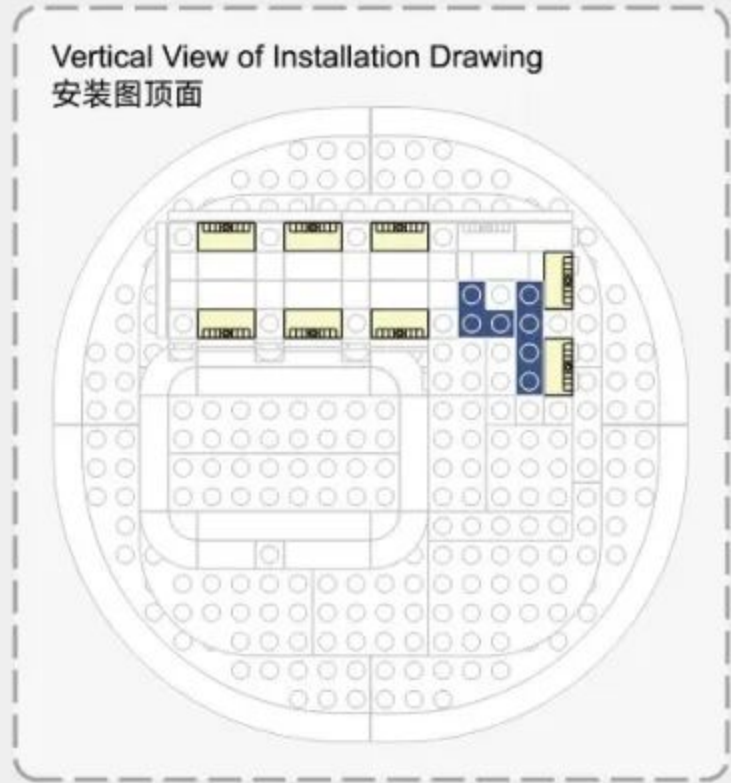
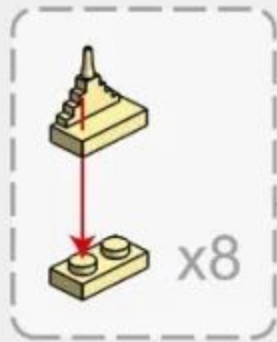

2-4

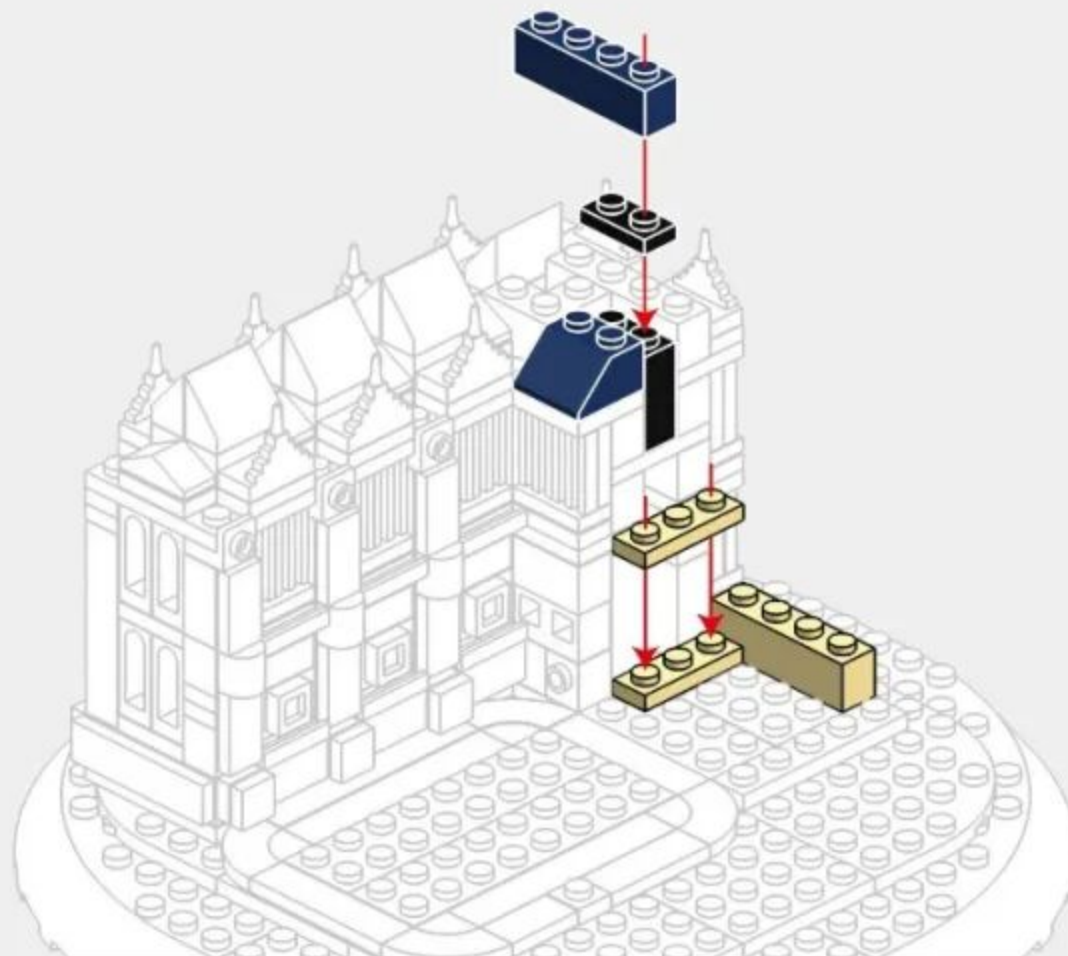
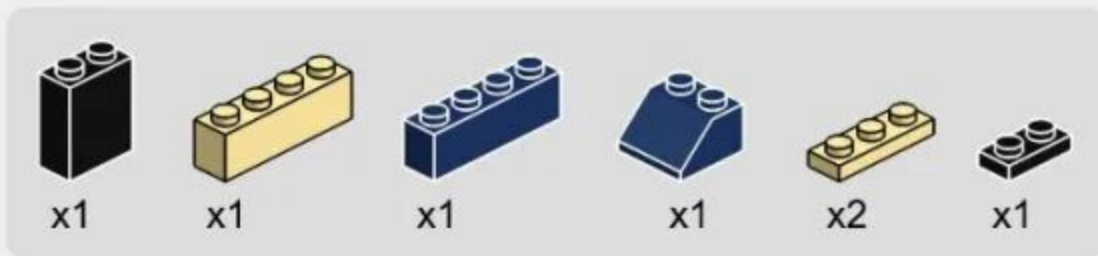

2-5

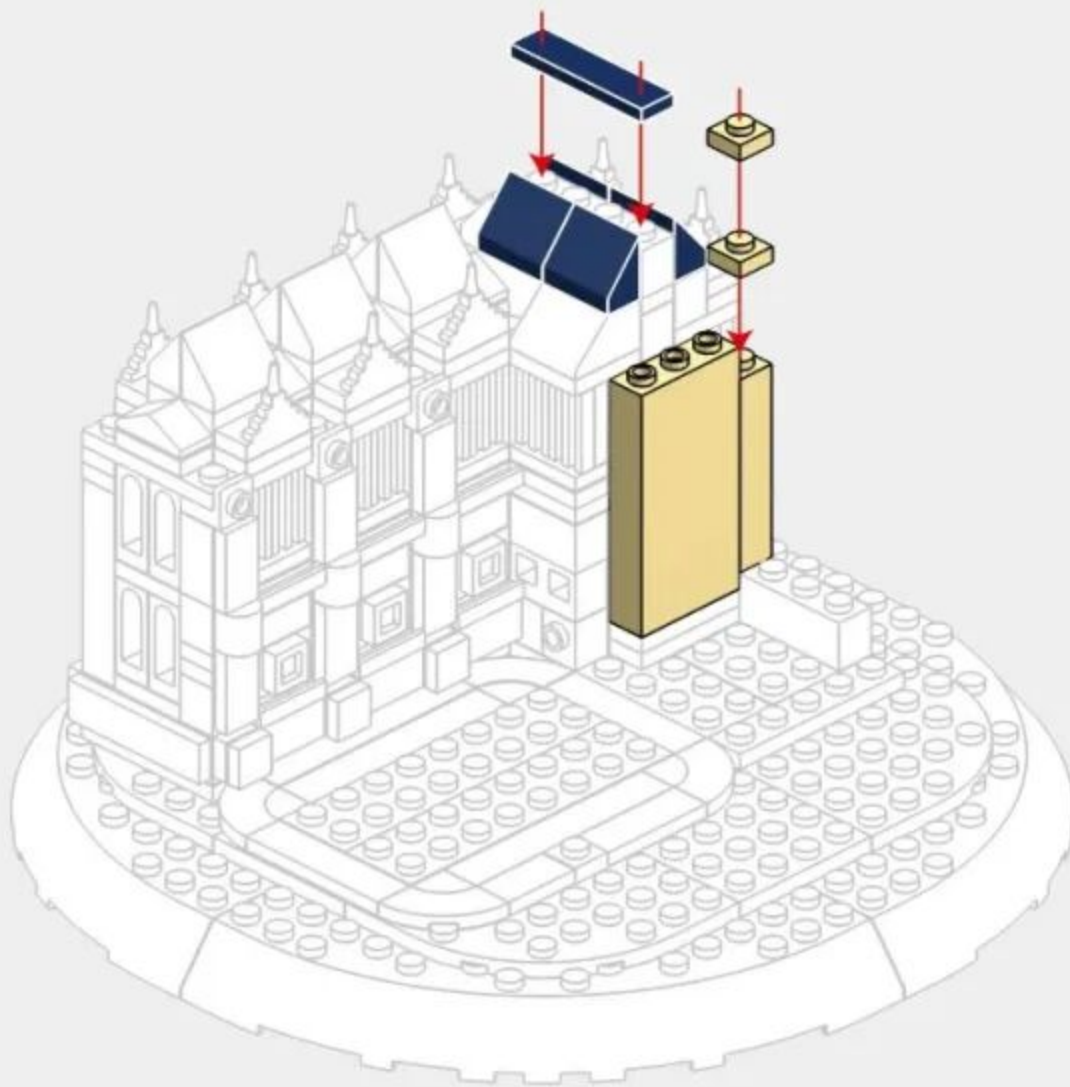
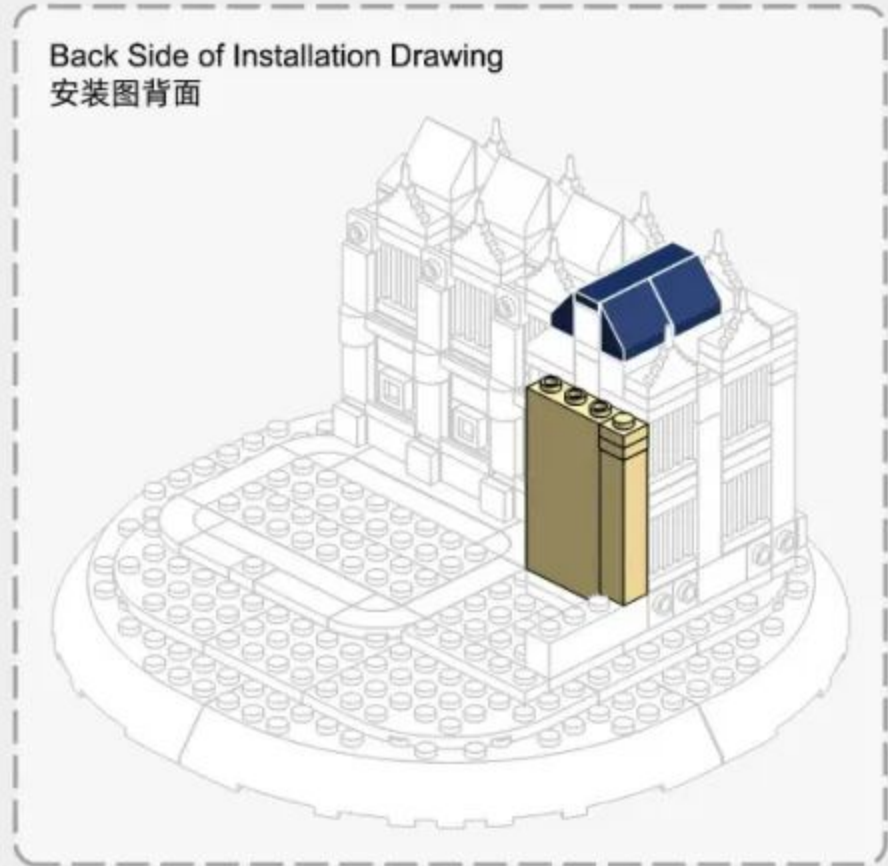
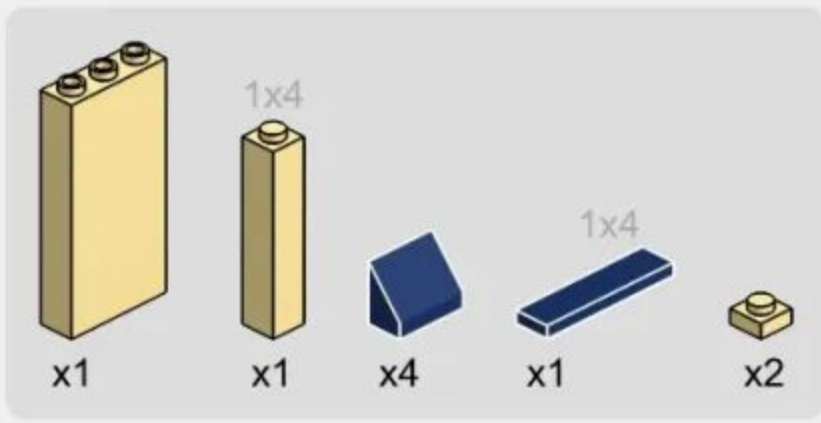

2-6

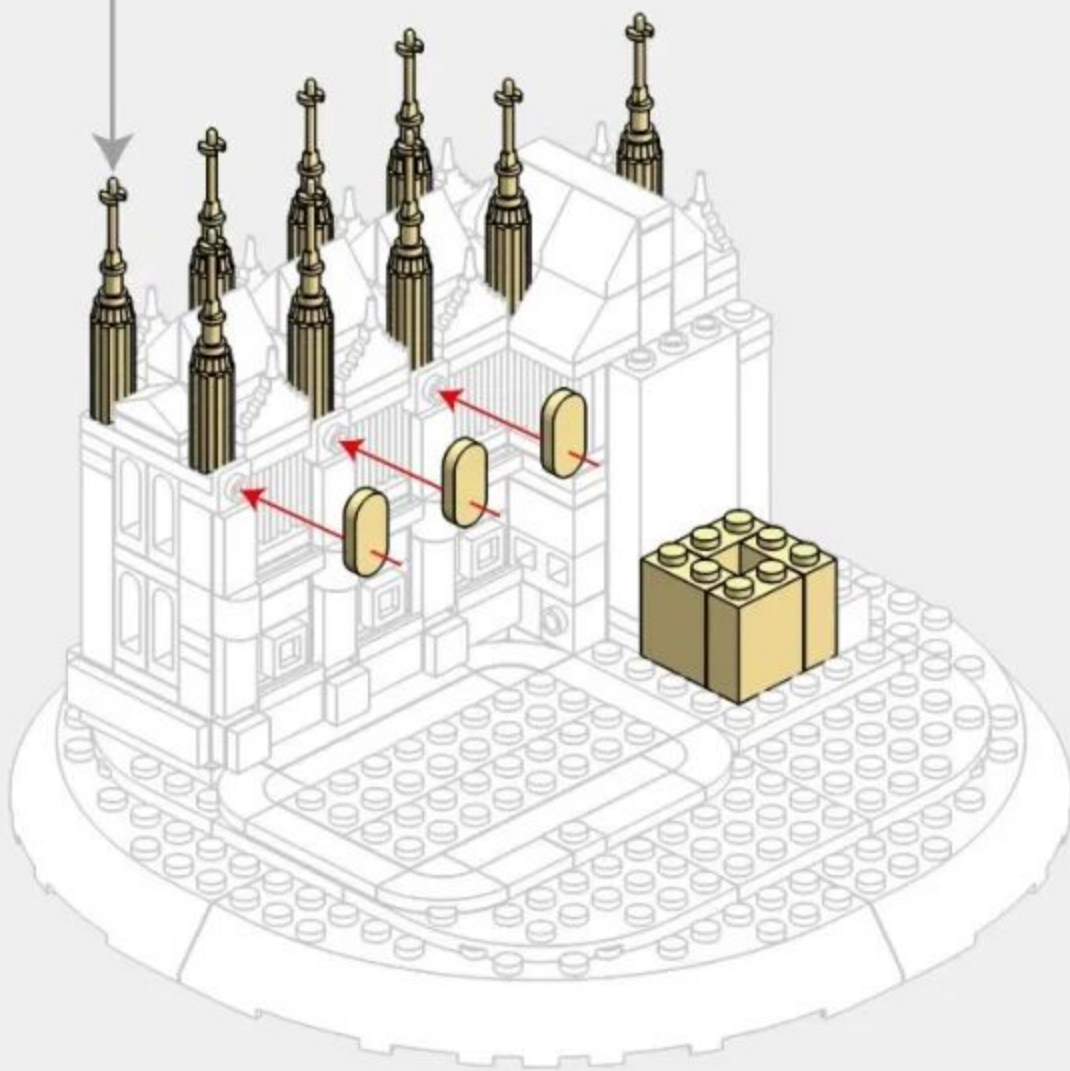
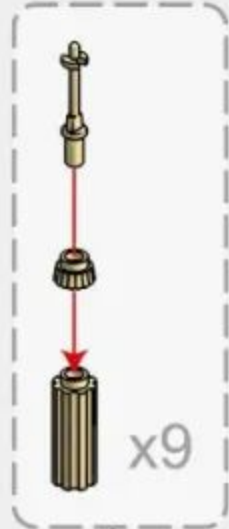
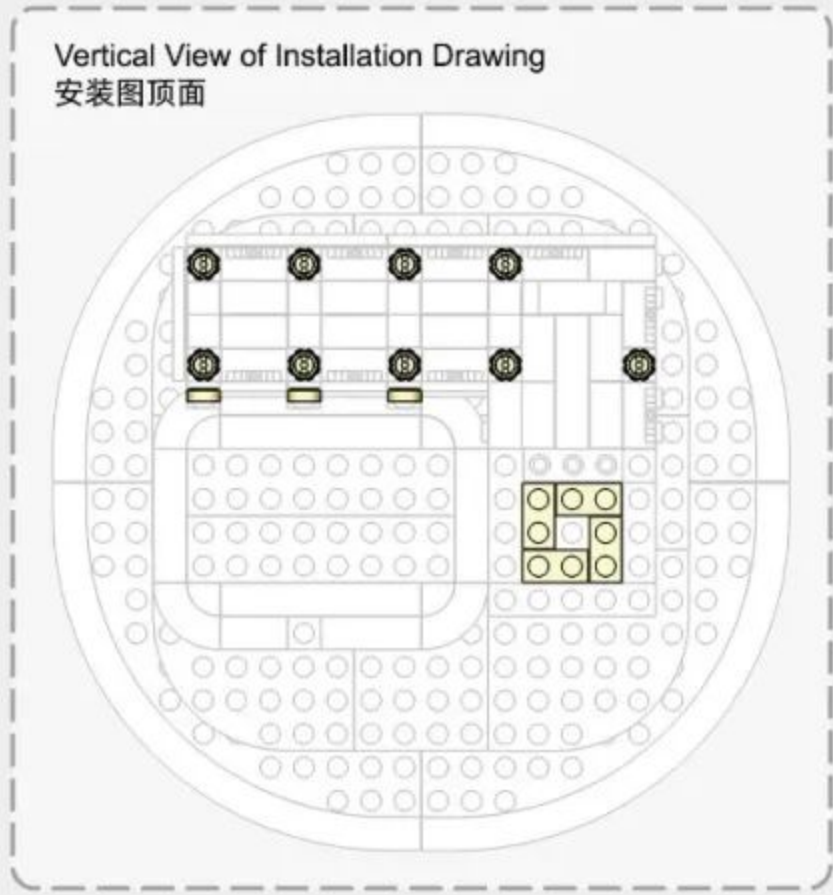

2-7

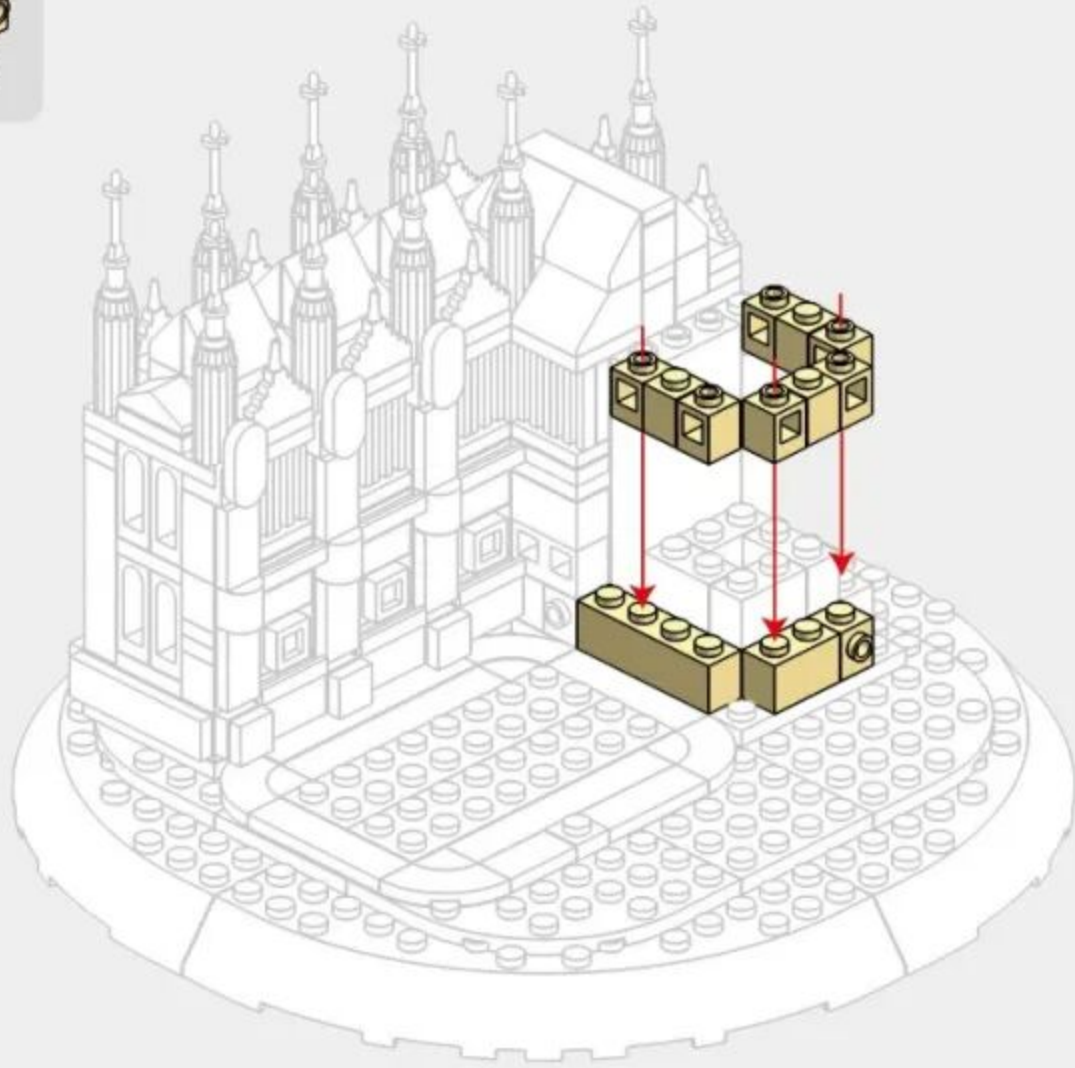

2-8

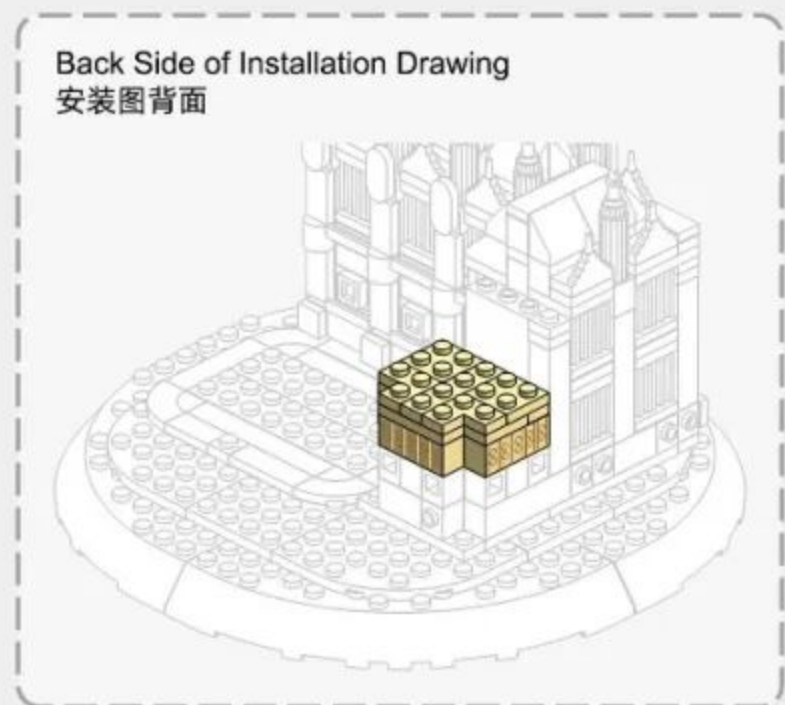
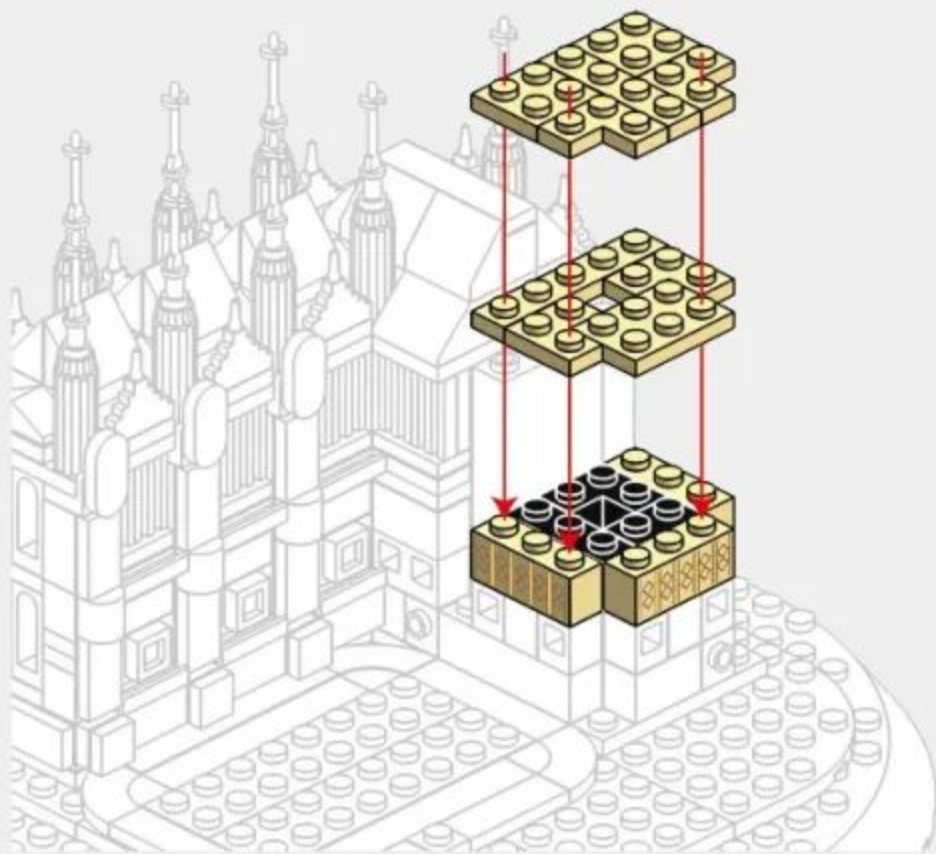
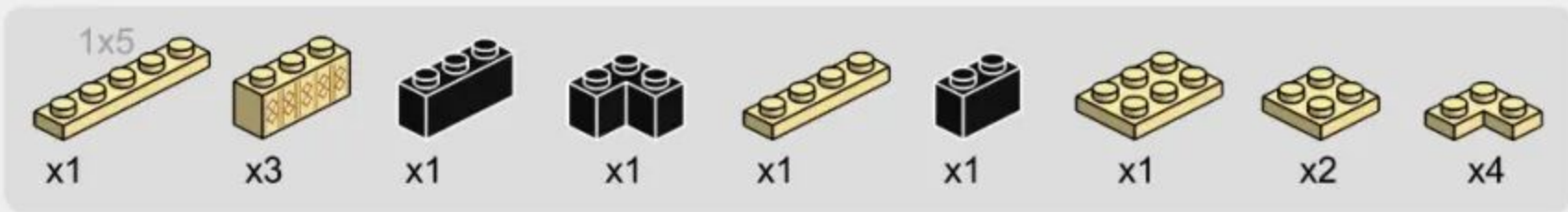

2-10

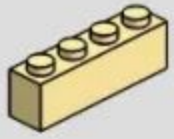

x1



x2



x1



x9

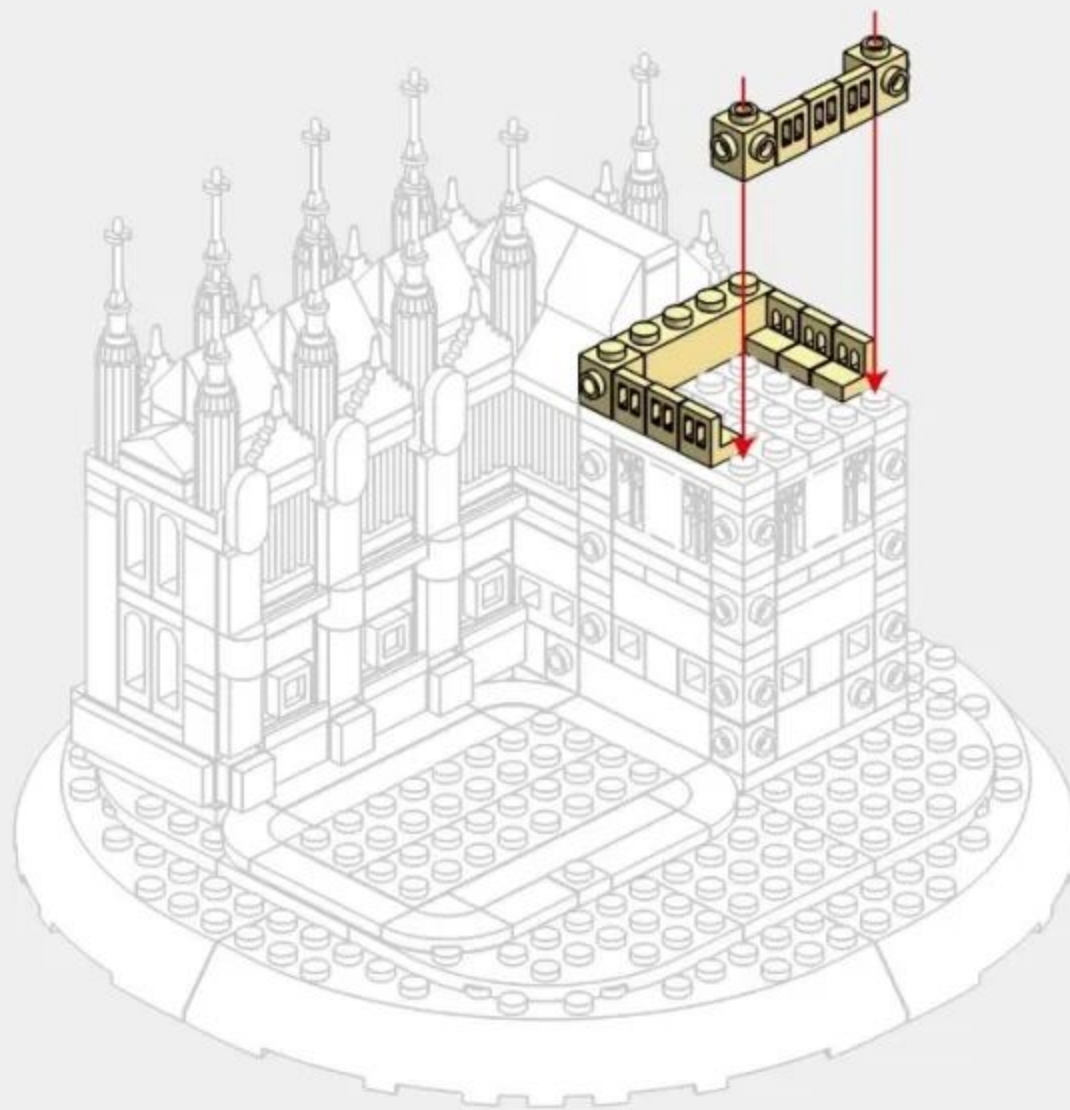

2-11

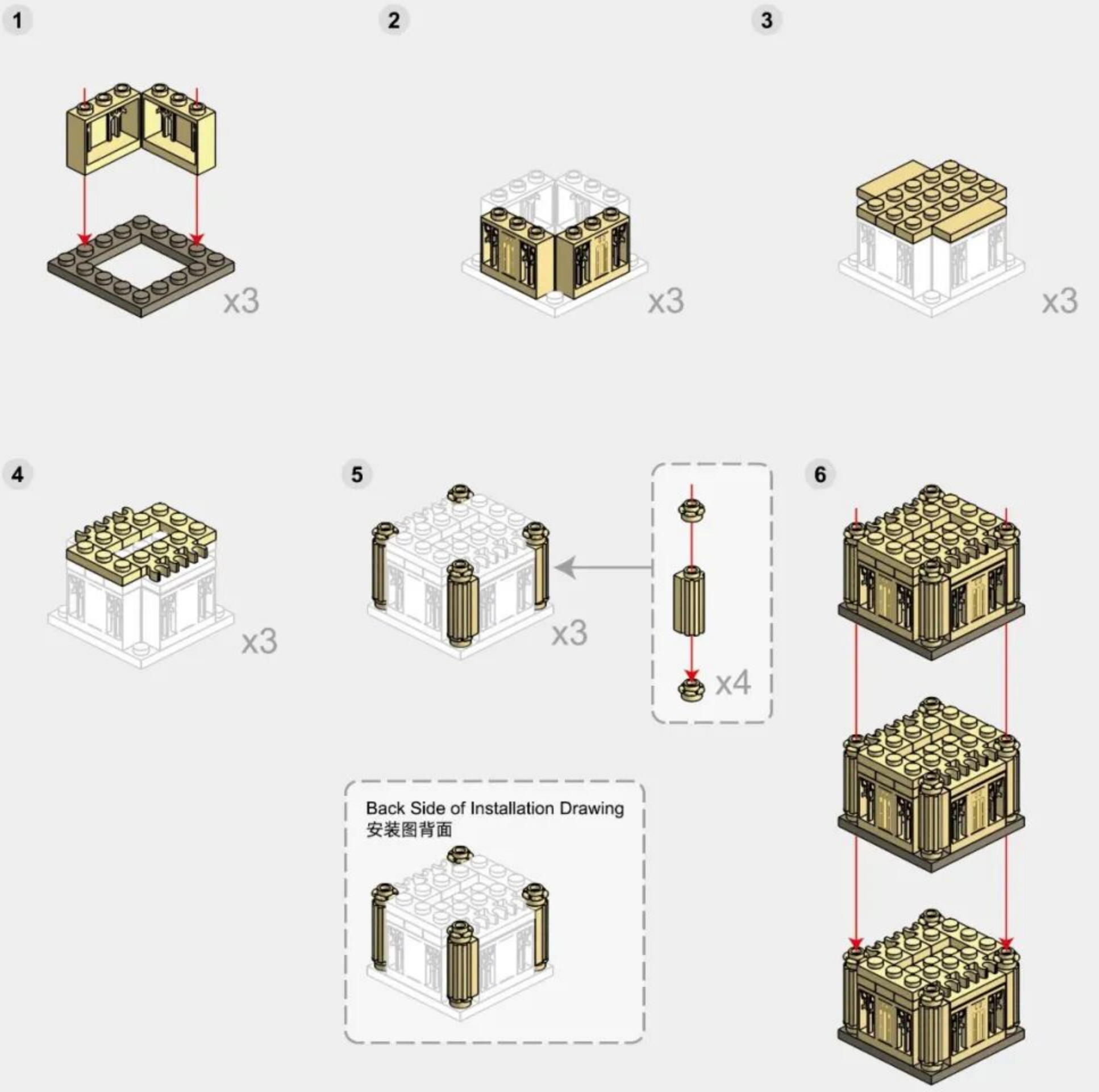
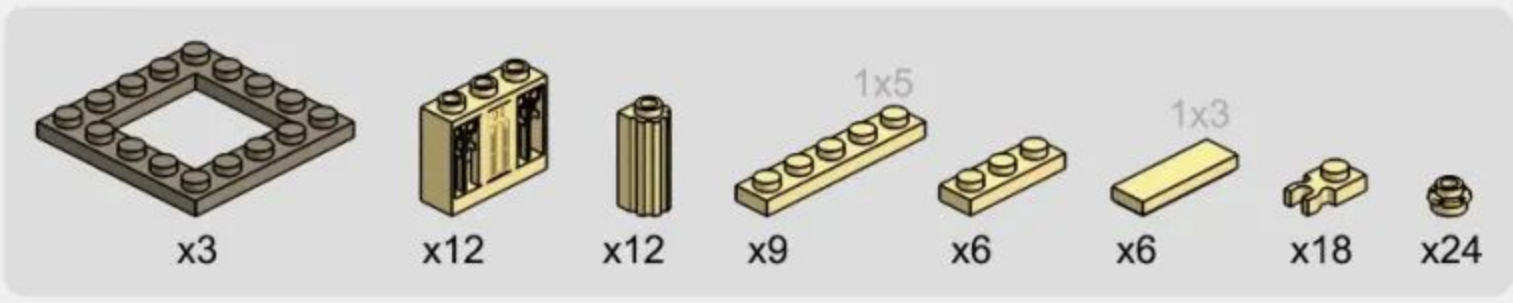

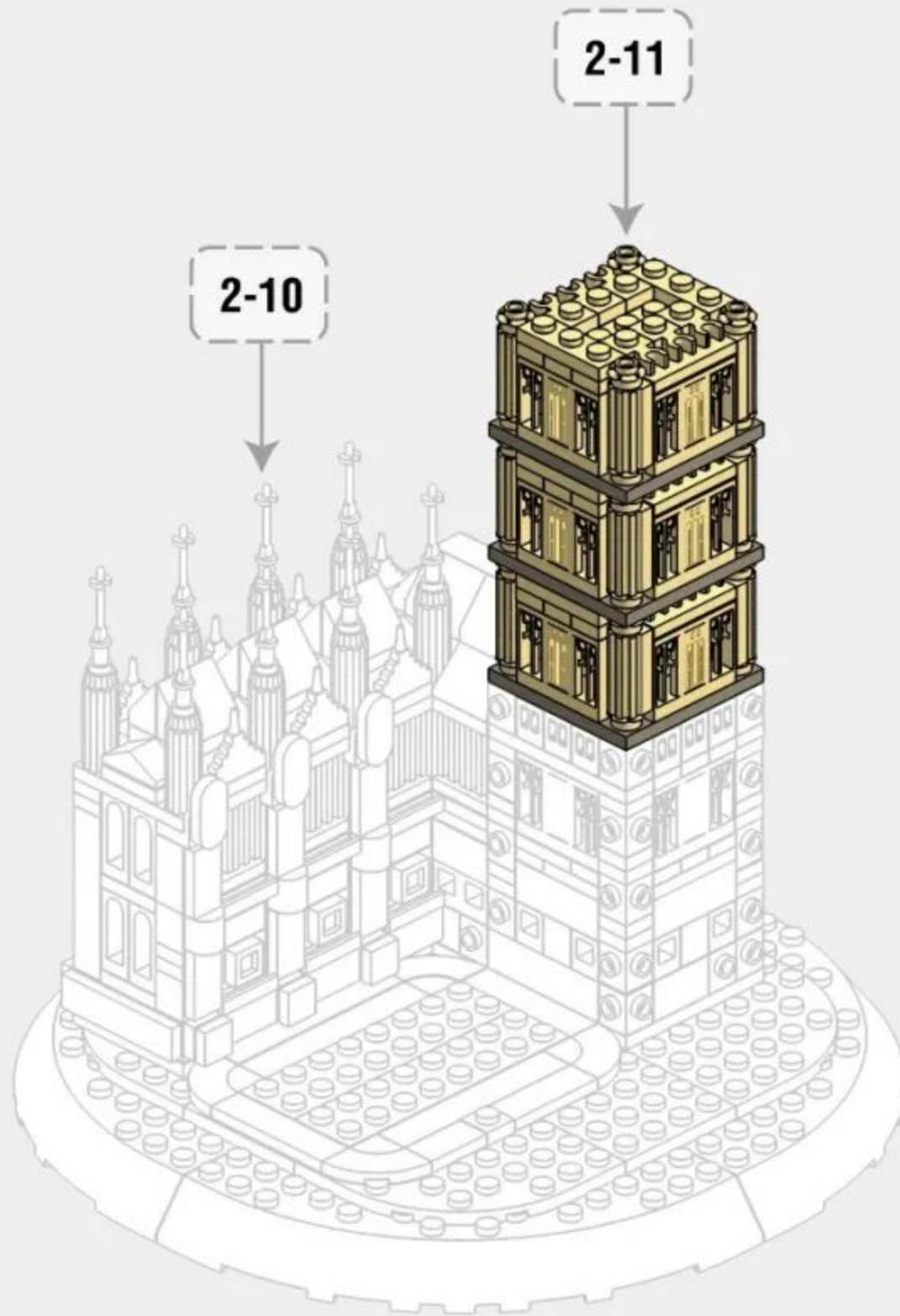



240PCS



3-1

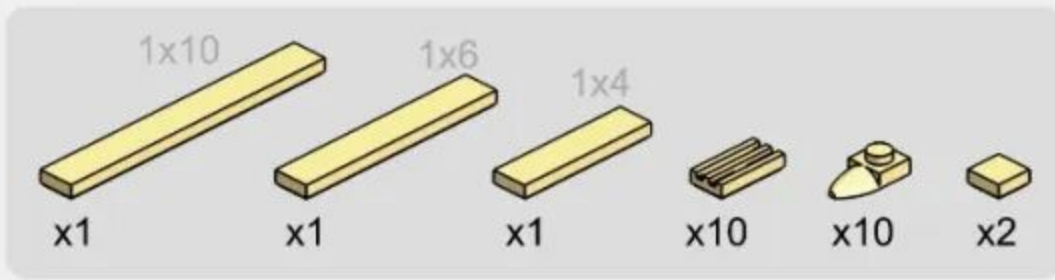

Back Side of Installation Drawing
安装图背面

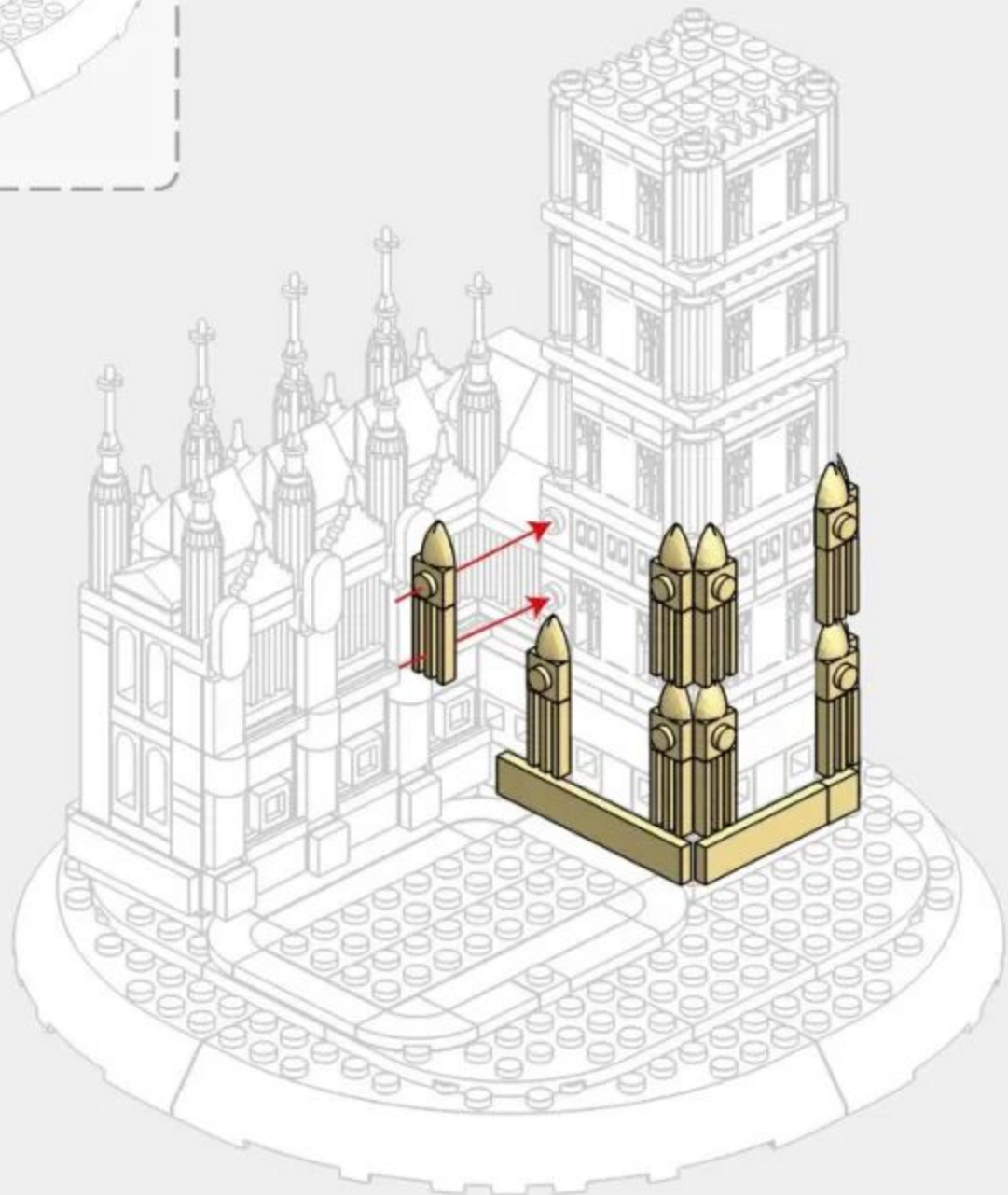
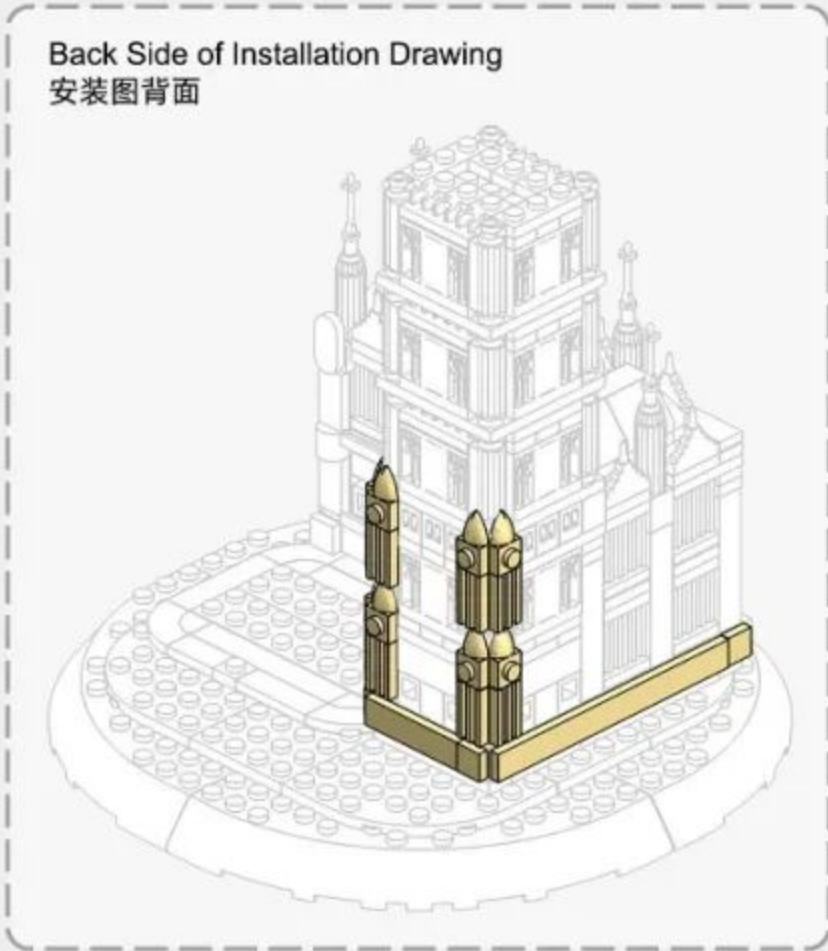

3-2



1

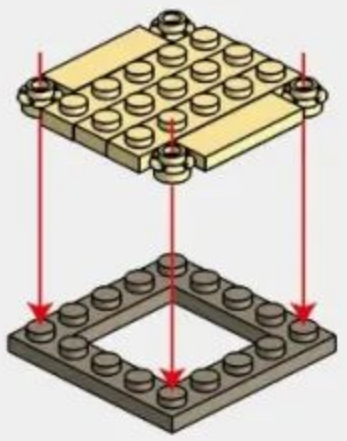

2

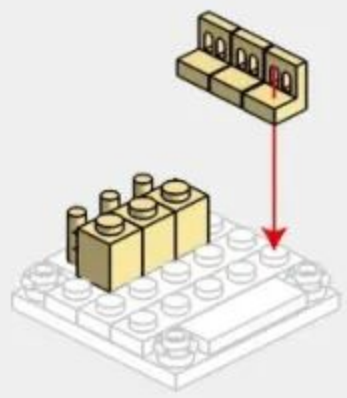

3

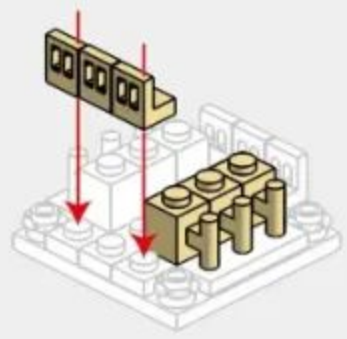

4

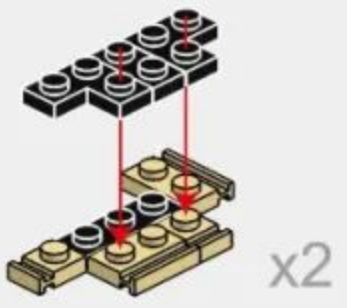

5

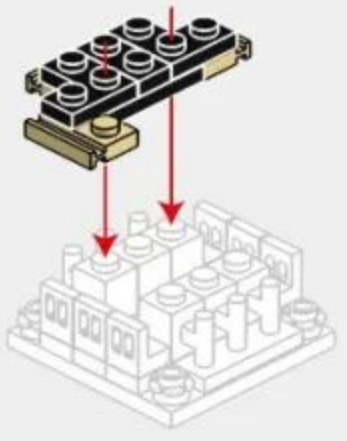

6

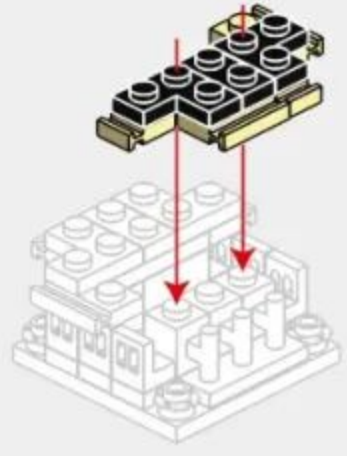

3-3

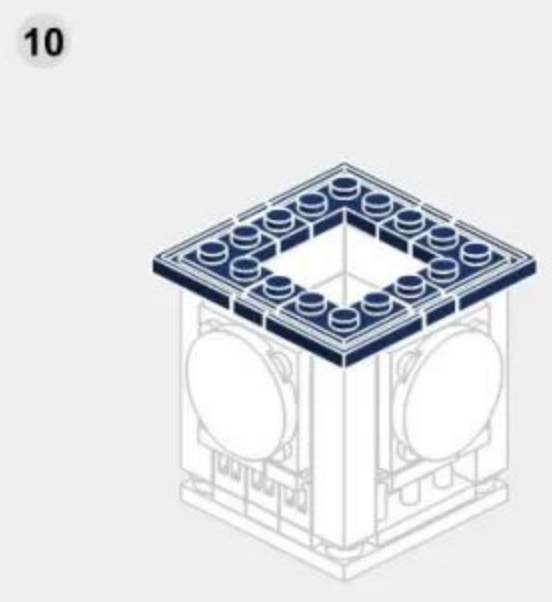
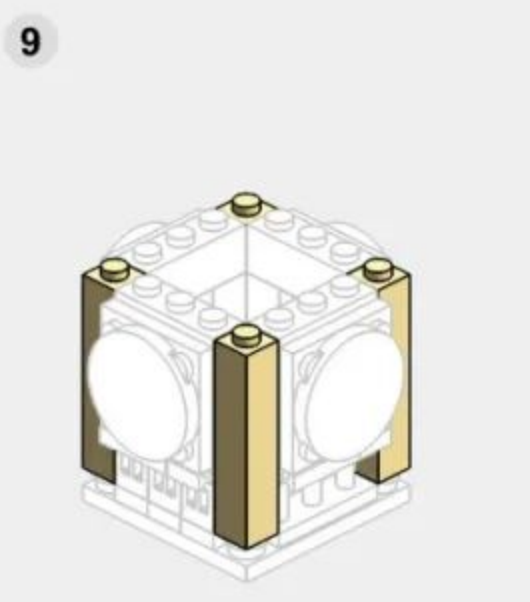
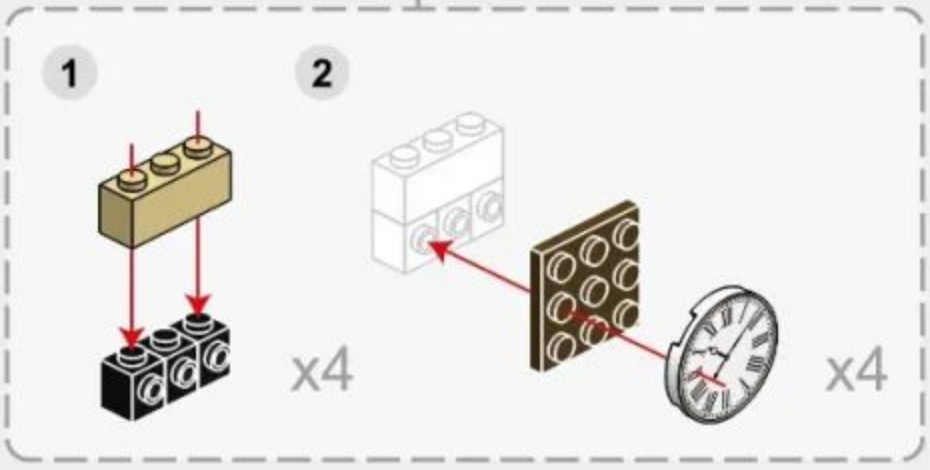
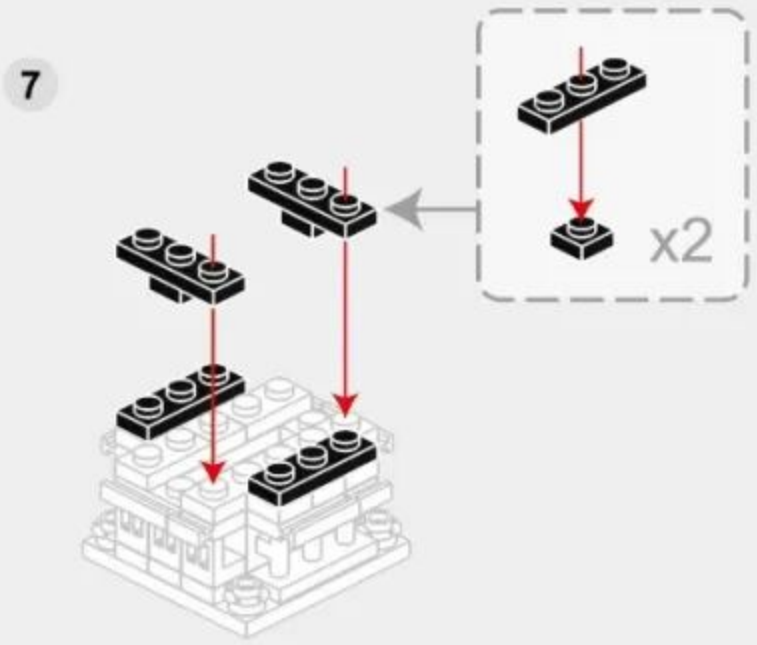

3-4



3-5

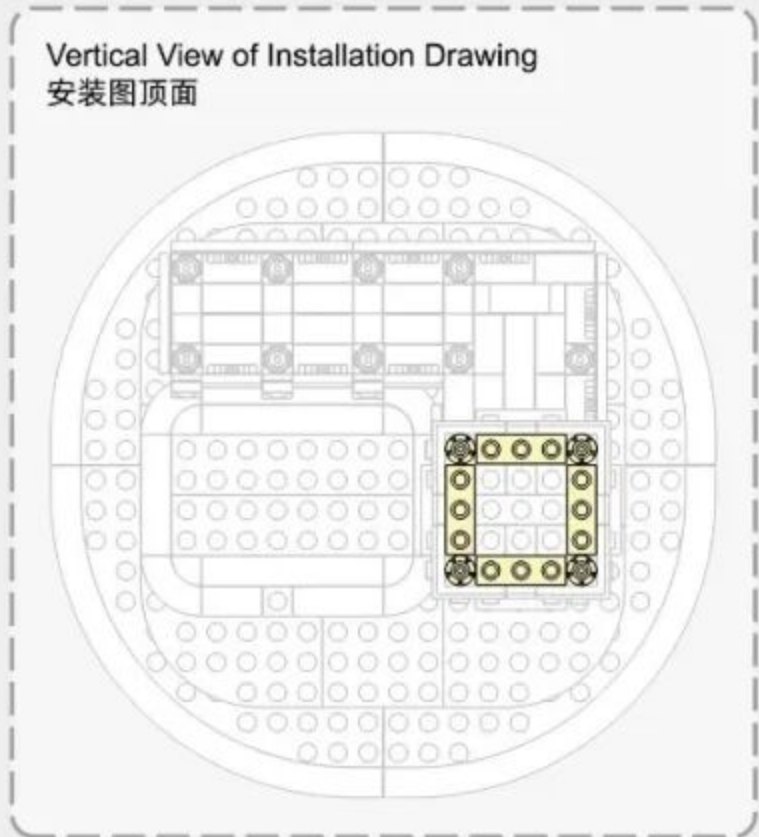
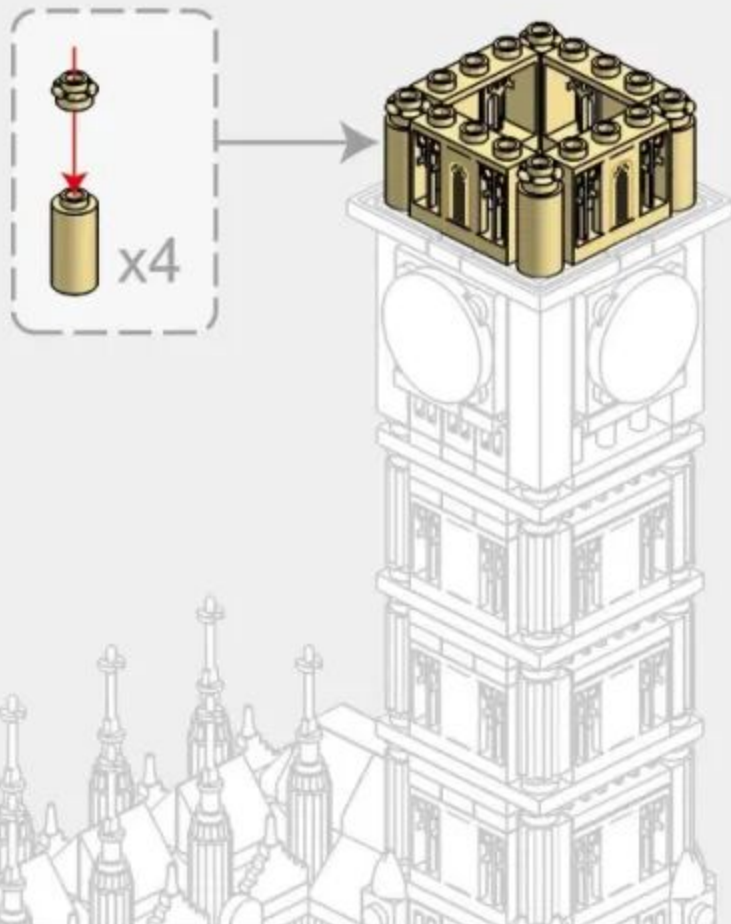

3-6

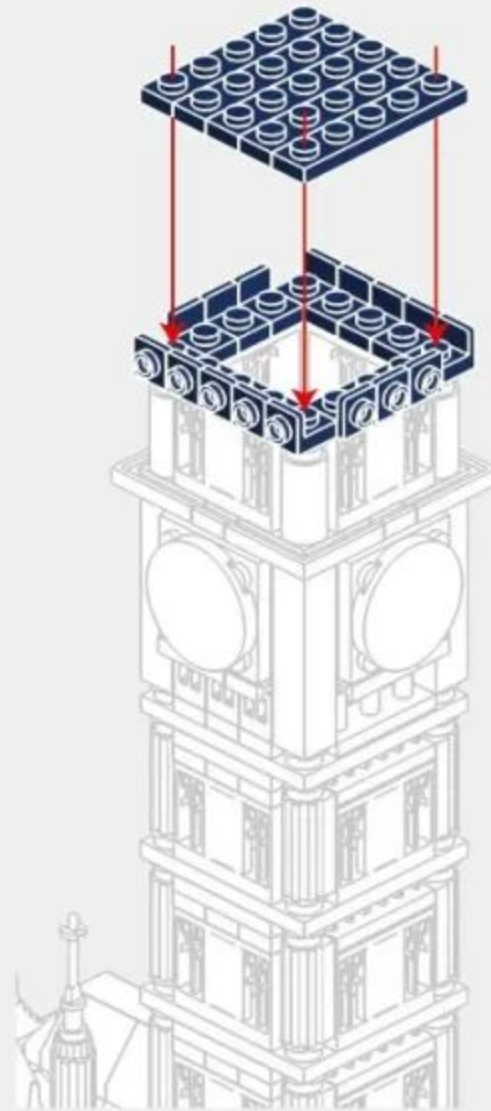
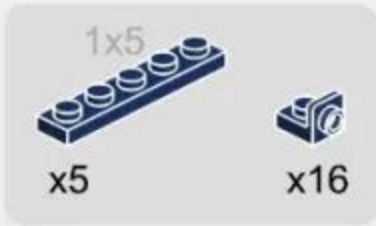

3-7

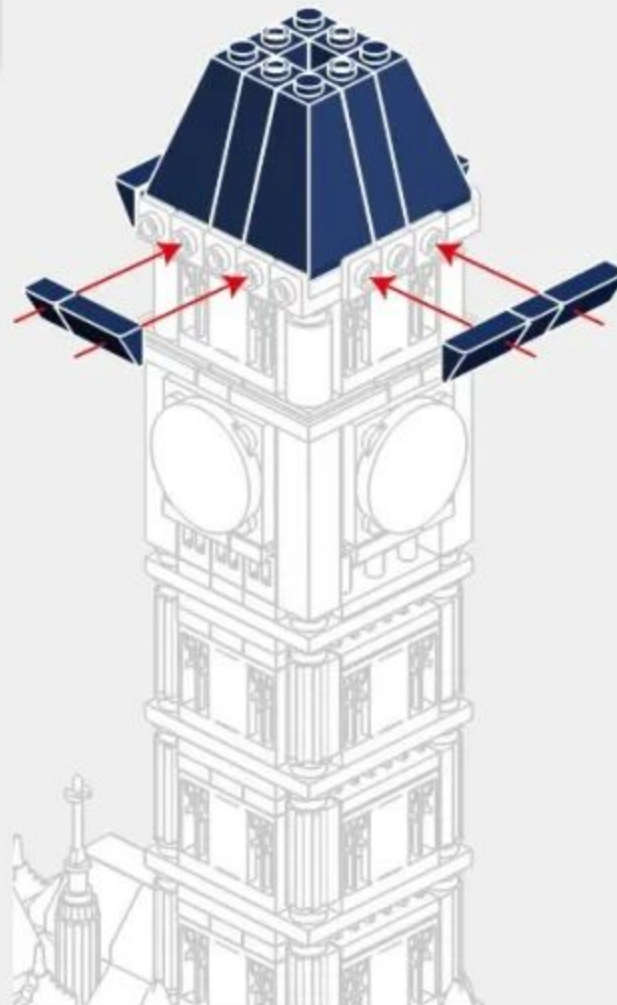
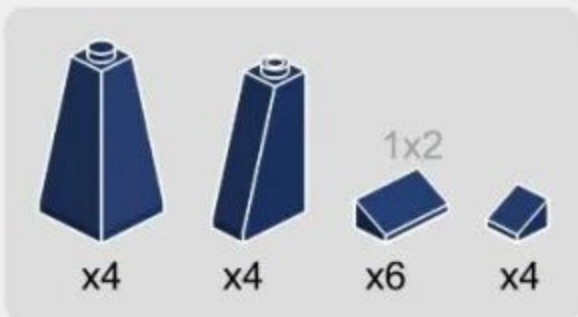

Back Side of Installation Drawing
安装图背面

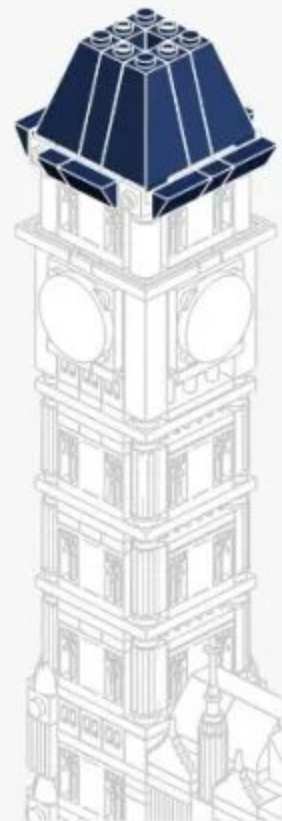

3-8

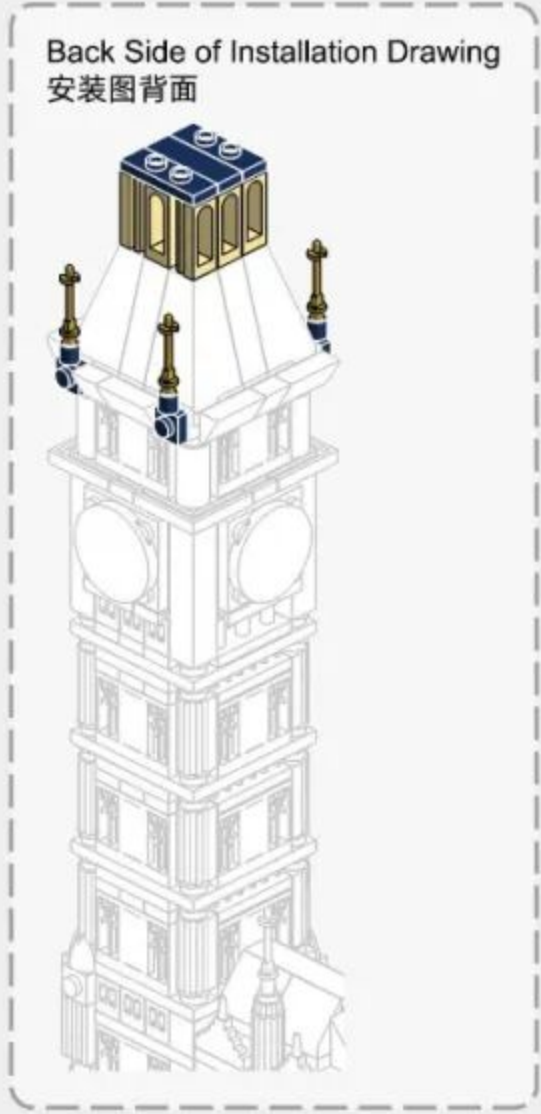
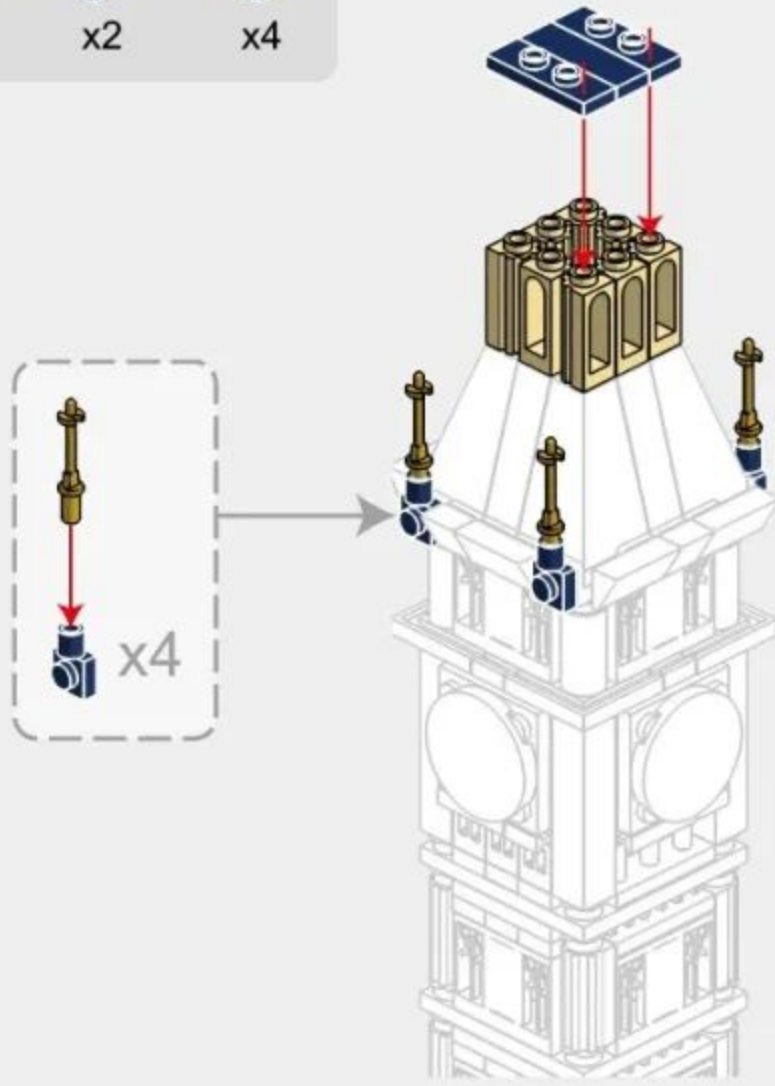
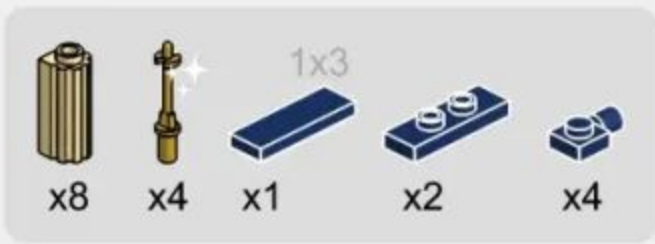

3-9



3-10

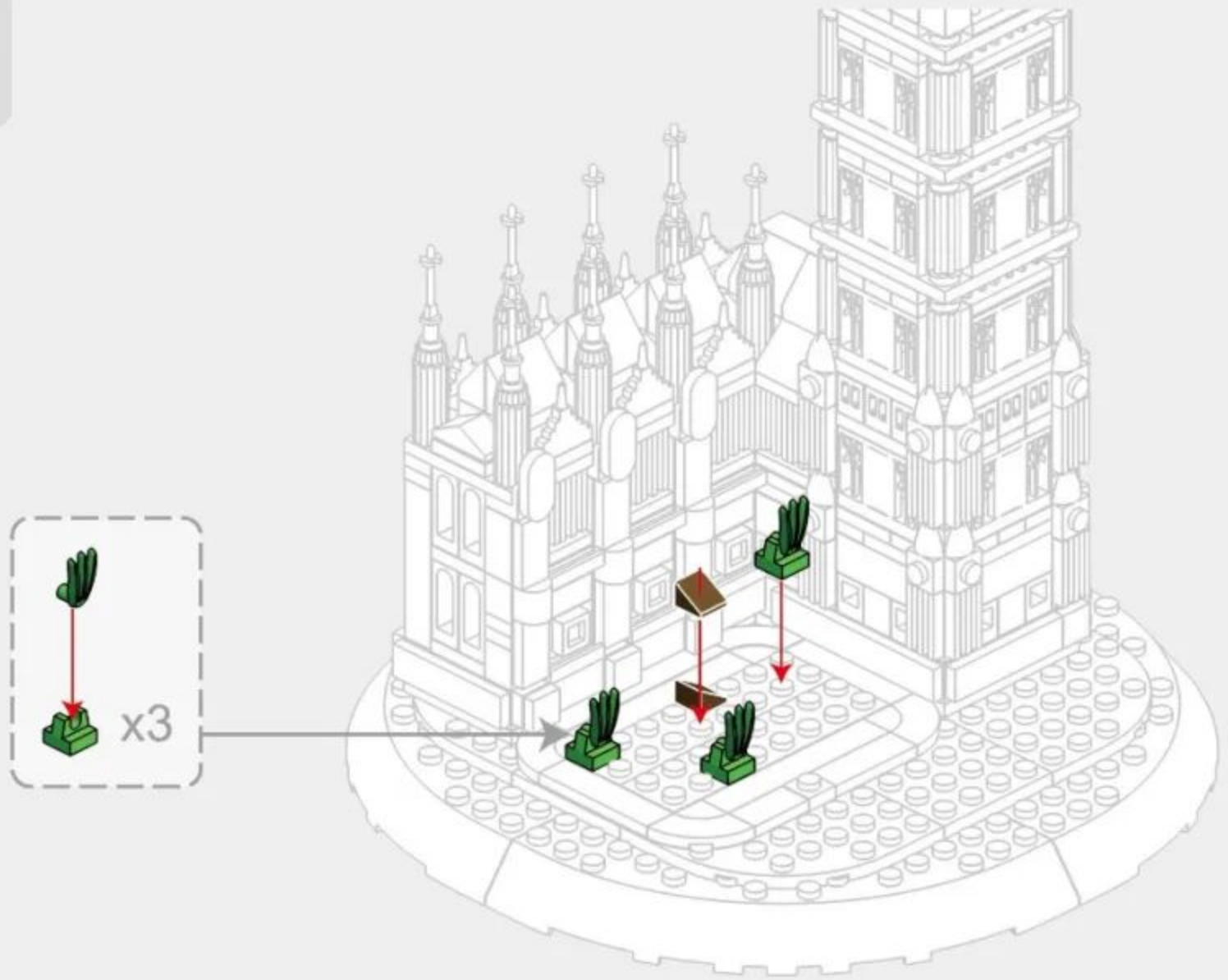

3-11

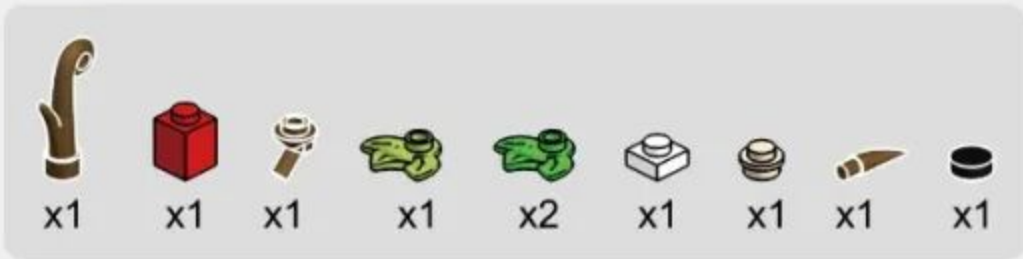

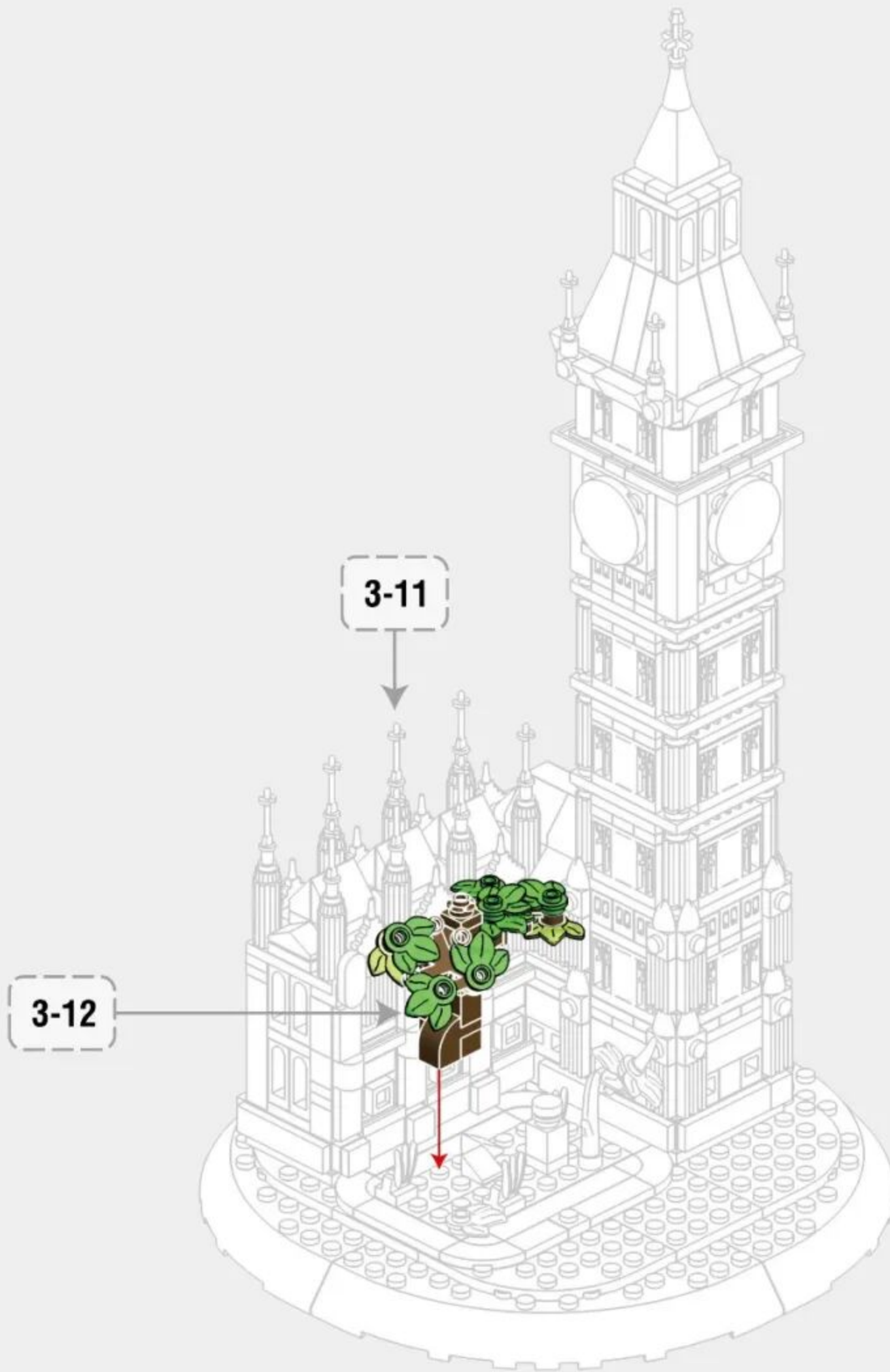

3-14

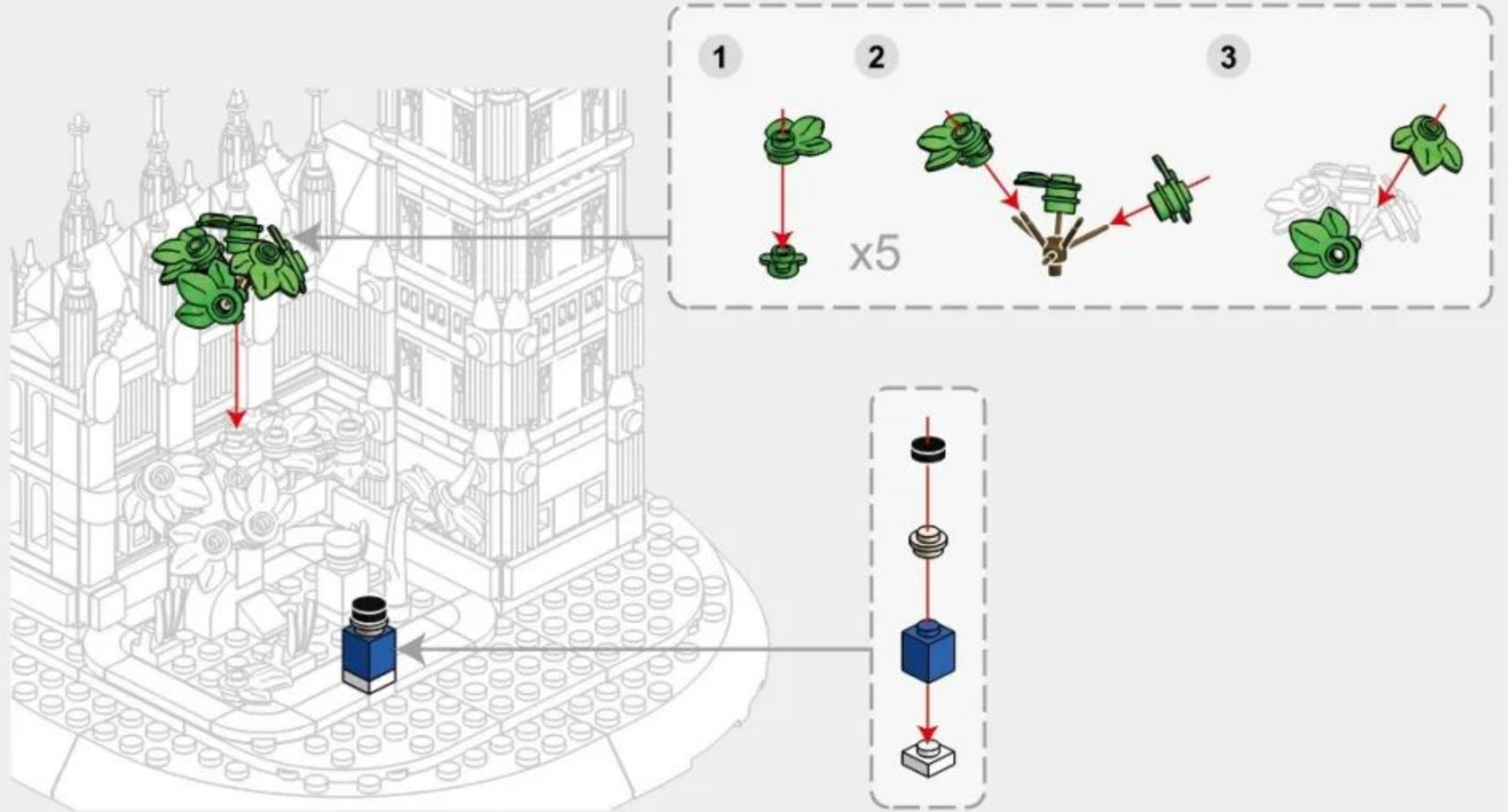

3-15

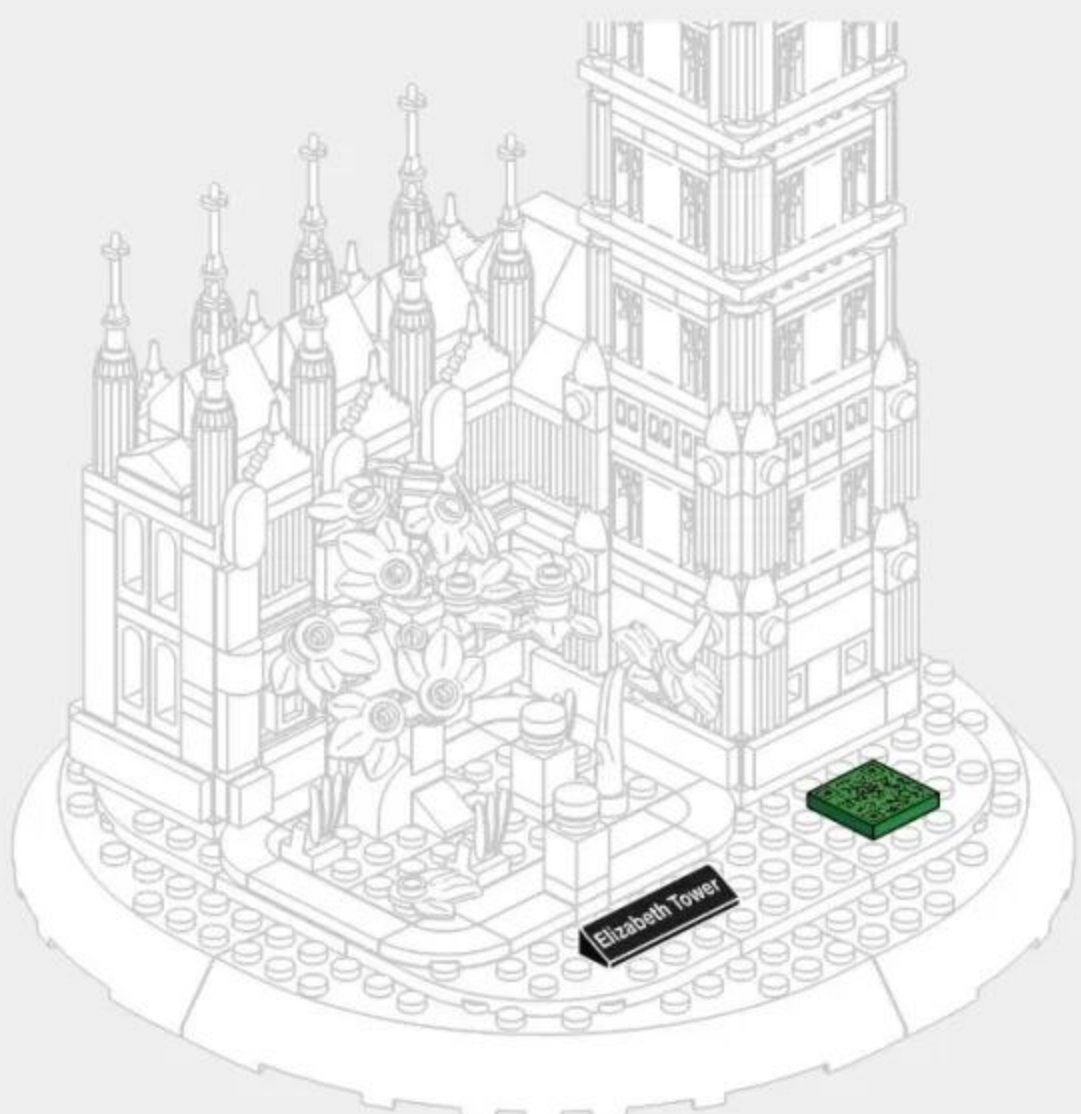
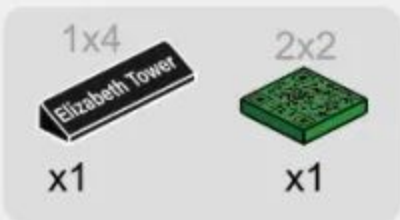





THE WILLIS TOWER

COUNTRY: England
CITY: London

