

# WHITE HOUSE

CASA BLANCA

Washington, D.C., America

The world's great architecture



6+ / 4214 / 894 PCS  
Suitable Age      Product Number      Parts Total



# Architecture

It will be a city...

这将构成一座城市...

# ABOUT THE PRODUCT

关于产品

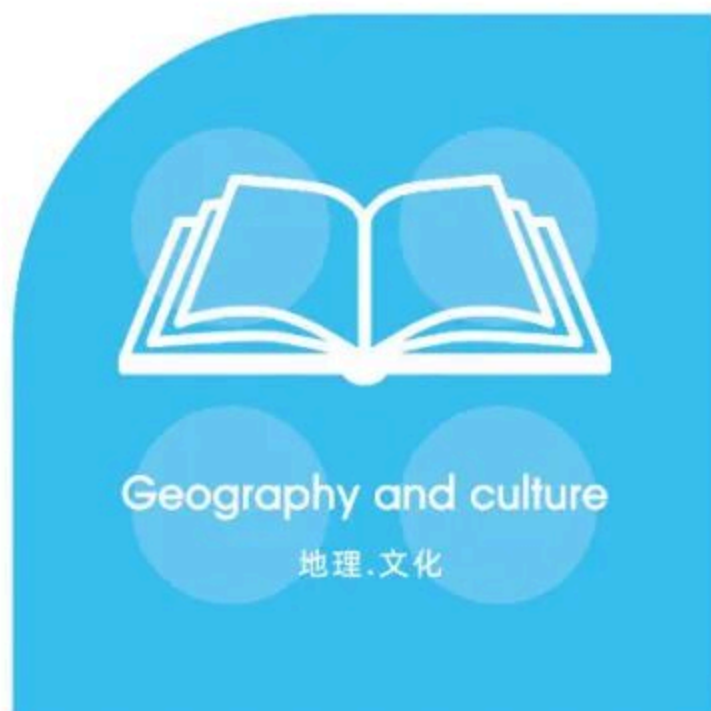

## ARCHITECTURE

WANGE The world's great architect since 1991

Guangdong Baoge Educational Material Sci-Tech Co., Ltd.  
©2014 Wange / Dubie. All Rights Reserved

Geography and culture

地理·文化

# White House



The White House is the official residence and workplace of the president of the United States. Located at 1600 Pennsylvania Avenue NW in Washington, D.C..



# White House



## Geography and culture

地理·文化



Located at 1600 Pennsylvania Avenue NW in Washington, D.C., it has served as the residence of every U.S. president since John Adams in 1800 when the national capital was moved from Philadelphia.



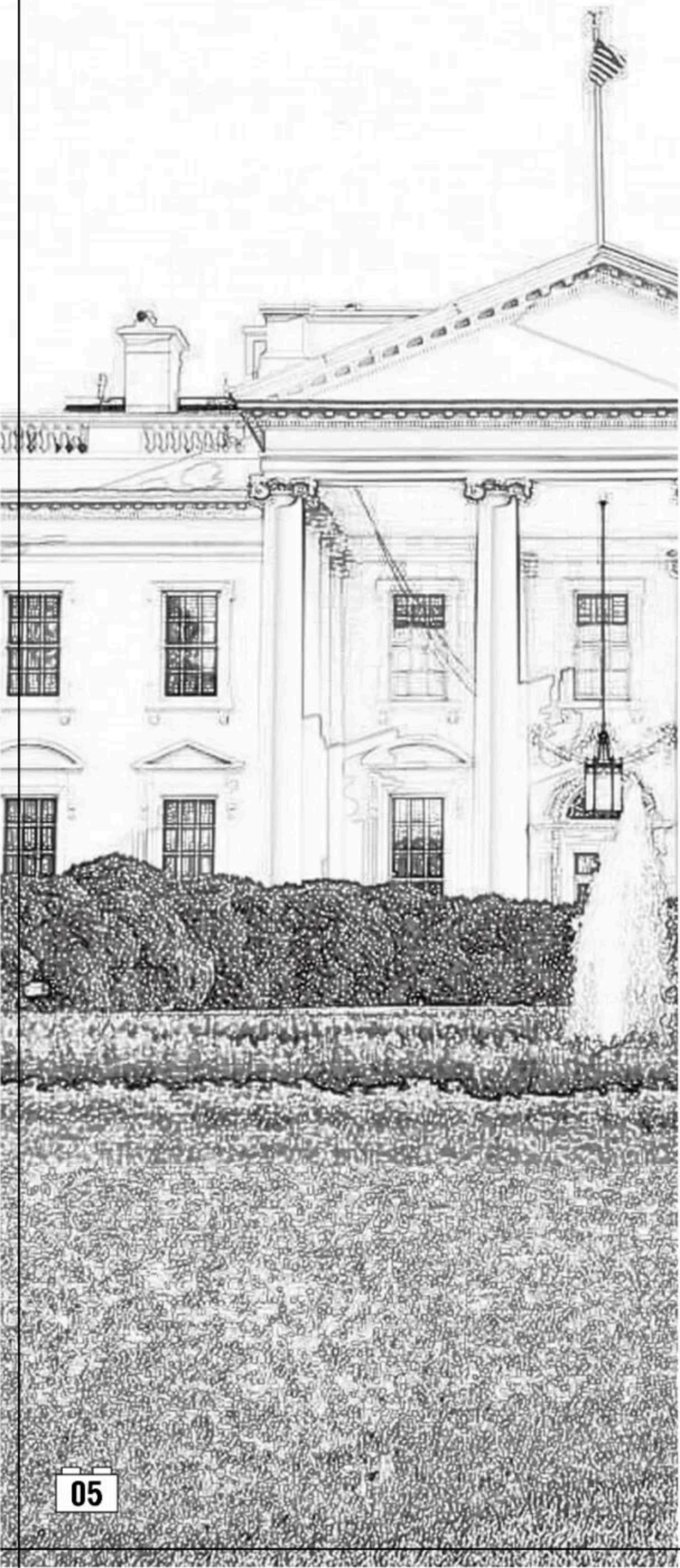

Washington, D.C.

# White House ■

USA

The contents of this chapter refer to the Wikipedia website.

本章内容参考维基百科网站，更多资讯可自行查阅。

The world's great architecture

# Buildings and layout

■ 建筑物和布局



The White House is the official residence and workplace of the president of the United States. Located at 1600 Pennsylvania Avenue NW in Washington, D.C., it has served as the residence of every U.S. president since John Adams in 1800 when the national capital was moved from Philadelphia. "The White House" is also used as a metonym to refer to the Executive Office of the President of the United States.

The property is a National Heritage Site owned by the National Park Service and is part of President's Park. In 2007, it was ranked second on the American Institute of Architects list of America's Favorite Architecture.

La Casa Blanca es la residencia oficial y lugar de trabajo del presidente de los Estados Unidos. Está situada en el cuadrante noroeste de la 1.600 Avenida de Pensilvania en Washington D. C. y ha sido la residencia de todos los presidentes de Estados Unidos desde John Adams en 1800, cuando la capital nacional se trasladó de Filadelfia a Washington D. C. El término "Casa Blanca" se utiliza habitualmente como metonimia para referirse al presidente y a sus asesores.



## Structure

The residence was designed by Irish-born architect James Hoban in the Neoclassical style. Hoban modeled the building on Leinster House in Dublin, a building which today houses the Oireachtas, the Irish legislature. Constructed between 1792 and 1800, its exterior walls are Aquia Creek sandstone painted white. The Neoclassical design of the White House is based primarily on architectural concepts inherited from the Roman architect Vitruvius and the Venetian architect Andrea Palladio.

La residencia fue diseñada por el arquitecto Irlandés James Hoban en estilo neoclásico. Hoban modeló el edificio basándose en el Leinster House de Dublín, un edificio que en la actualidad alberga al Oireachtas, la legislatura Irlandesa. La construcción se llevó a cabo entre 1792 y 1800, con un exterior de arenisca de Aquia Creek pintado de blanco.



## History

Following his inauguration on April 30, 1789, President George Washington occupied two private houses in New York City, which served as the nation's first executive mansion. He lived at the first, Walter Franklin House, which was owned by Treasury Commissioner Samuel Osgood, at 3 Cherry Street, through late February 1790. The executive mansion moved to the larger quarters at Alexander Macomb House at 39-41 Broadway, where Washington stayed with his wife Martha and a small staff until August 1790. In May 1790, construction began on Government House, a new official residence in Manhattan.

En la Residencia Ejecutiva, en 1927 el ático del tercer piso se convirtió en vivienda aumentando el tejado a cuatro aguas existente con extensas buhardillas. Un Ala Este recién construida se utilizó como área de recepción para eventos sociales. Las columnatas de Jefferson conectaban las nuevas alas. Las modificaciones del Ala Este se completaron en 1946, creando un espacio de oficinas adicional. En 1948 se descubrió que los muros de carga y las vigas de madera de la residencia estaban al borde del fracaso. Bajo la presidencia de Harry S. Truman, las habitaciones interiores se desmantelaron por completo y se construyó una nueva estructura interna de acero de carga dentro de las paredes. En el exterior se añadió el Balcón de Truman.

# Force Balance

受力平衡

Physical operations

物理运算

$$F = G \frac{m_1 m_2}{d^2}$$

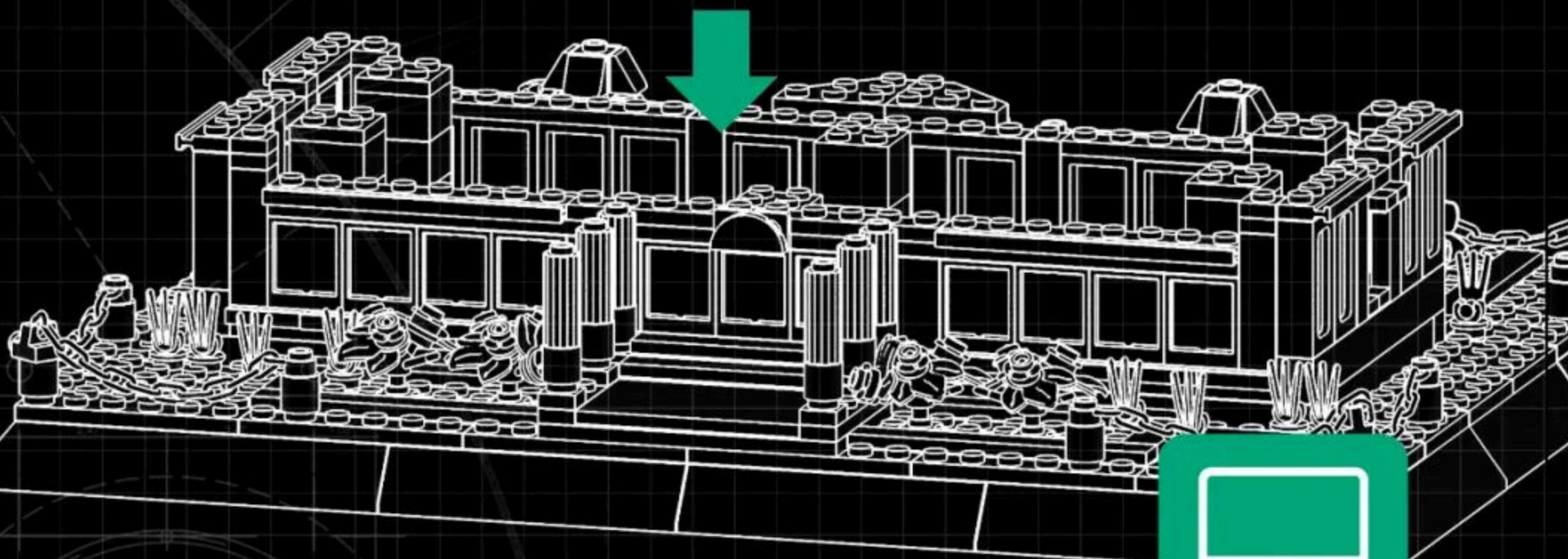
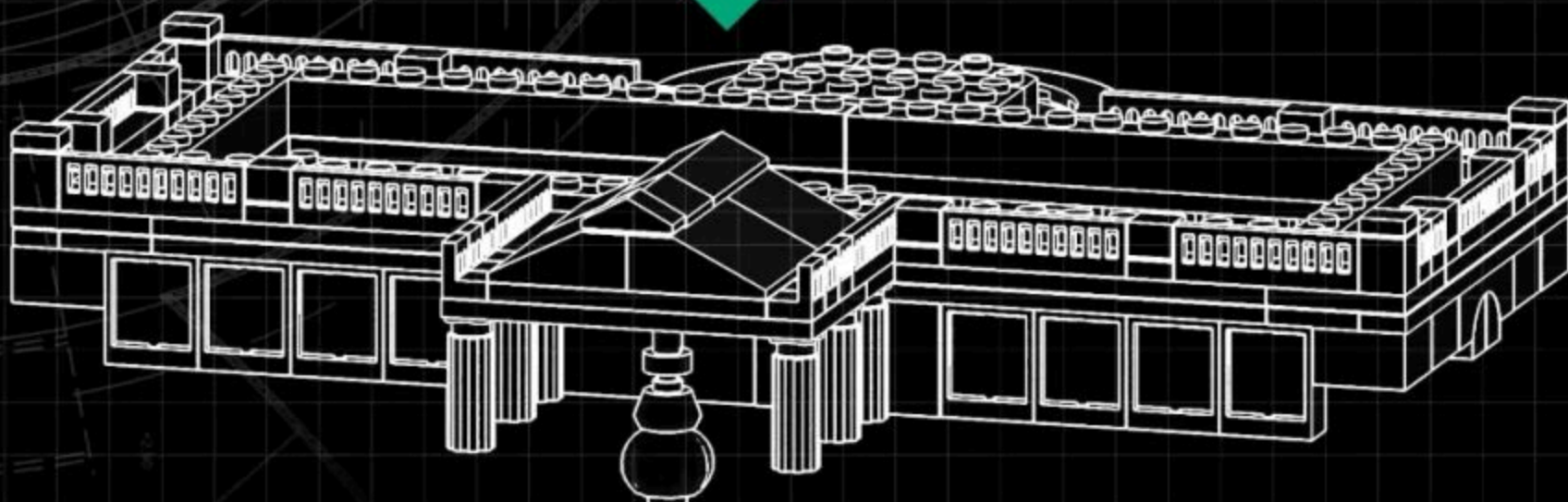
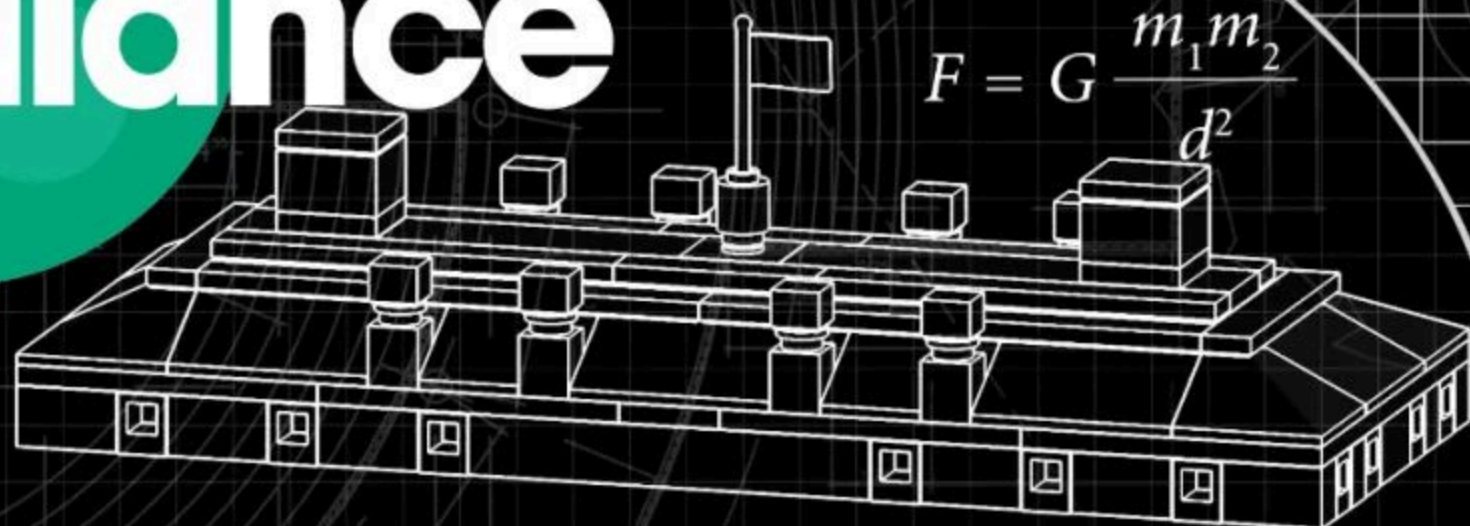

Creation and thinking

创作·思考

08

# Special parts

特殊零件的开发利用

$$S=4\pi \cdot r^2$$

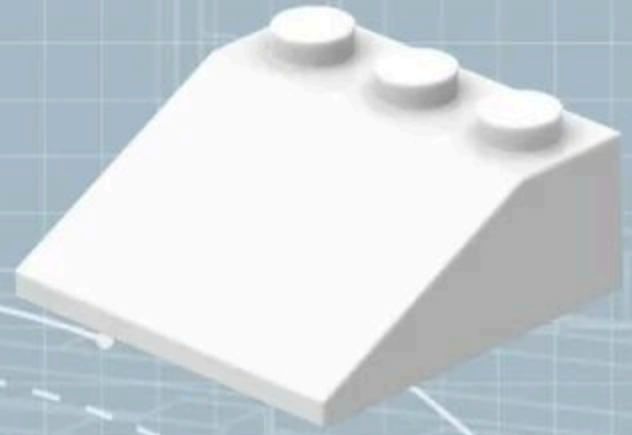

**WG1551**  
中斜3X3孔25°

$$a^2+b^2=c^2$$



**WG1604**  
三叶草

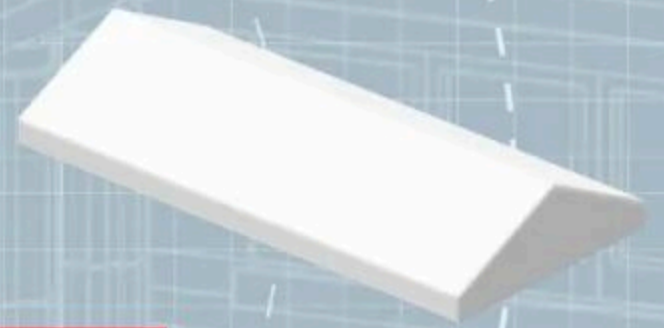

**WG1587**  
双泻水2X4



**WG1623**  
直角矮5孔



**WG1612**  
圆角矩形镂空窗

$$\sin^2 a + \cos^2 a = 1$$



**WG1668**  
1高弯角1孔



features and functions

特点.功能

# Main Color Matching

配色方案



Pantone Black 6C



Pantone 655C



Pantone 477C



Pantone 431C



Pantone Cool Gray 6C



Pantone 3435C



Pantone 383C



Pantone 348C



Pantone 2300C



Pantone 123C



Pantone 7500C

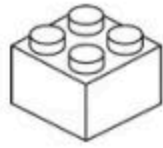

White



## Color matching

Adopting 3 main colors, dark blue, white, and green, with small amounts of gray and beige. The improved color arrangement on the original architecture enhances the product's grandeur and makes the overall design more refined and harmonious.

# White House

美国华盛顿白宫



Front

Left

Back

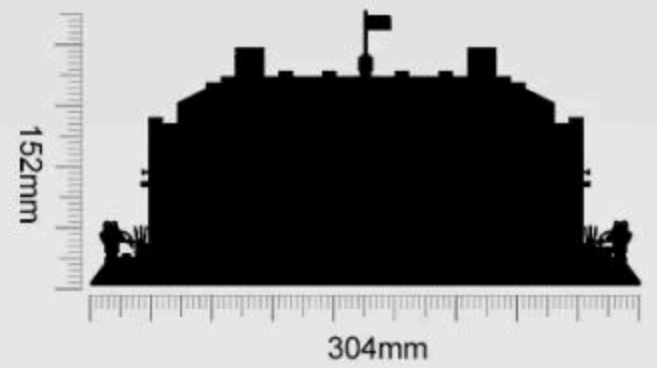
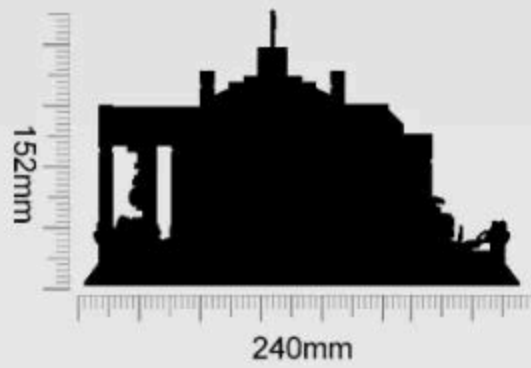
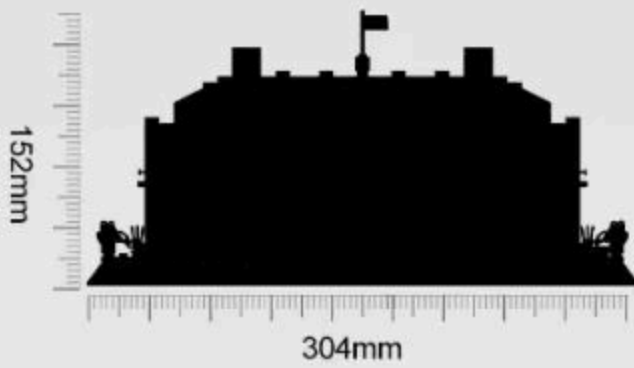

Product Size:304X240X152mm



小提示：积木包分为底板包、整版配件包及普通配件包,底板包标识为A/B/C...,普通配件包编码与说明书对应,整版配件包无标识。  
Tip: Building block packs are divided into baseplate packs, runner accessory packs, and standard accessory packs. Baseplate packs are labeled A/B/C..., regular accessory packs have codes that correspond to the instructions, and runner accessory packs have no labels.



- Open the product packaging correctly and classify the building block packs by type.

用正确方式拆解产品外包装,按积木包类型进行分类。



- Confirm the quantity of building block packs and cross-check them with the pack identifiers and the instructions.

确认积木包数量,对照积木包标识和说明书步骤。



- Open the building block packs according to the pack identifier steps. Sort them in order by type and color for easier assembly.

按积木包标识步骤拆开积木包,按顺序以类型、颜色进行分类以便搭建。



- Assemble your building block model following the steps in the instruction manual.

按说明书步骤拼装并完成你的积木模型。



# 1:1 Physical Reference Table

十字棒配件1:1尺寸参照表



Instructions For Use

让安装更简单

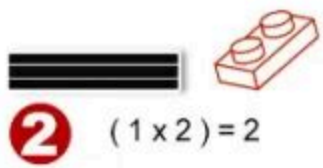

**2** (1x2)=2

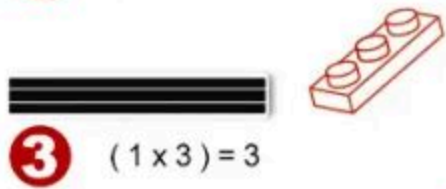

**3** (1x3)=3

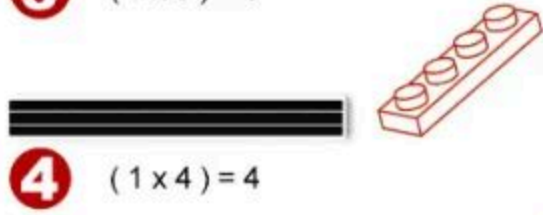

**4** (1x4)=4



**5** (1x5)=5



**6** (1x6)=6



**7** (1x7)=7



**8** (1x8)=8



**9** (1x9)=9



**10** (1x10)=10



**12** (1x12)=12











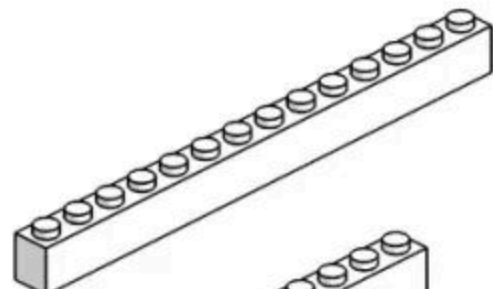
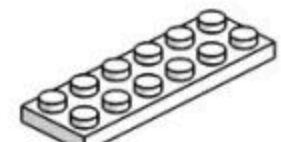



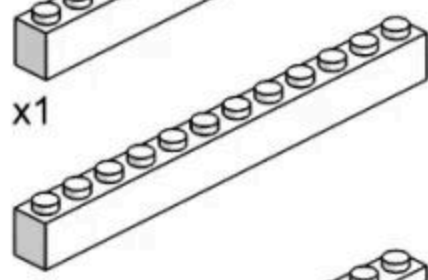

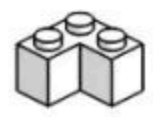

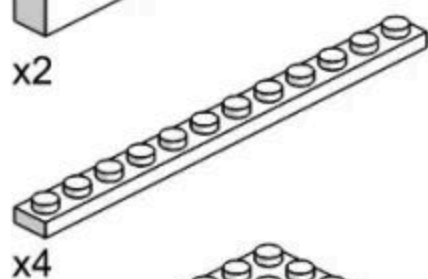

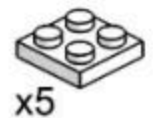

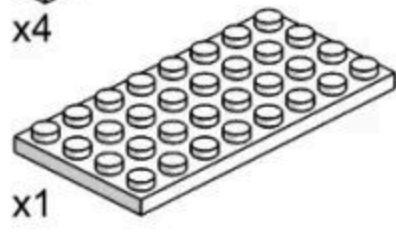
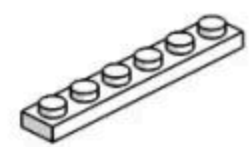



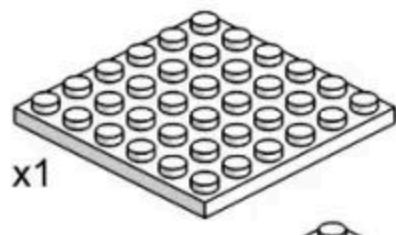
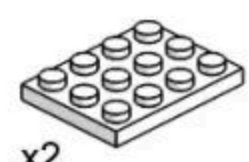
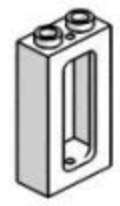
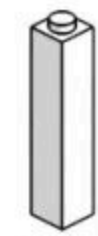

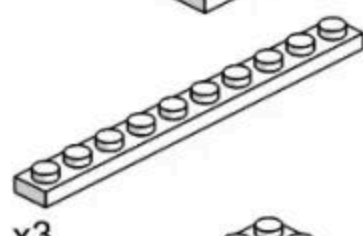
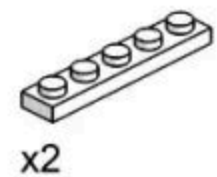

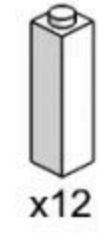

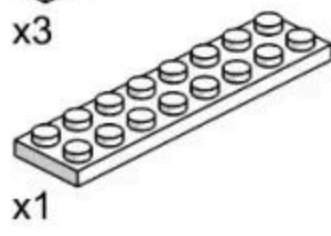
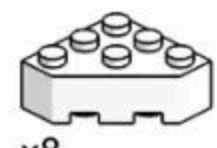
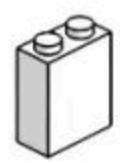

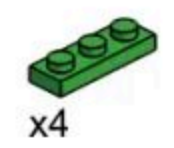
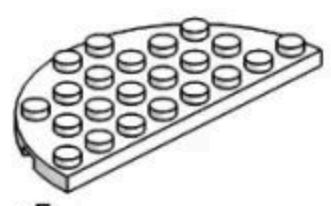
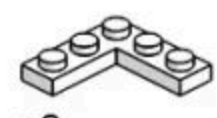
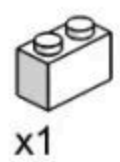
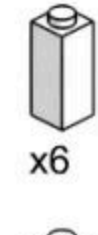

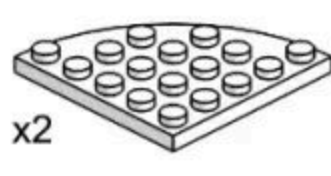
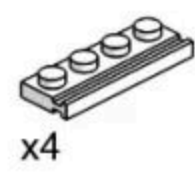
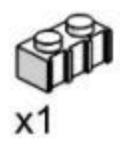

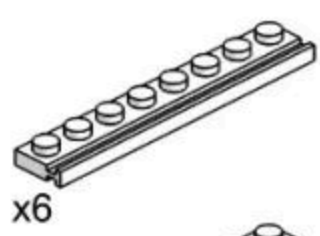
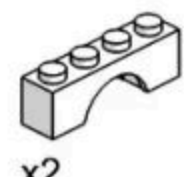

**16** (1x16)=16

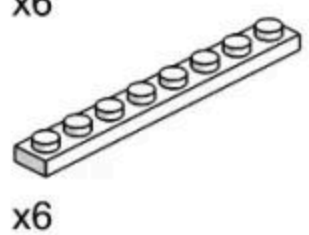
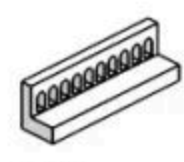
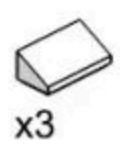

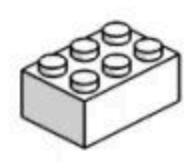
# PARTS LIST

配件清单

 x1	 x2	 x2	 x18	 x28
 x2	 x4	 x4	 x4	 x4
 x4	 x2	 x5	 x2	 x12
 x1	 x3	 x2	 x1	 x24
 x1	 x2	 x8	 x2	 x7
 x3	 x2	 x44	 x12	 x8
 x1	 x8	 x4	 x8	 x4
 x5	 x2	 x1	 x6	 x4
 x2	 x4	 x1	 x18	 x2
 x6	 x2	 x8	 x10	 x28
 x6	 x12	 x3	 x14	 x12
	 x4	 x4	 x18	 x2

产品有增补件请以实物为准  
If product has additional parts, please in kind prevail.

# PARTS LIST

配件清单

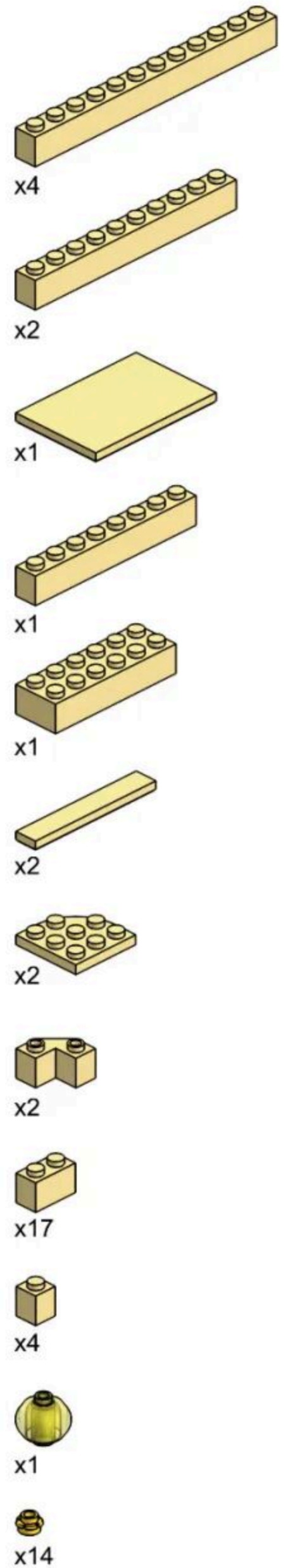
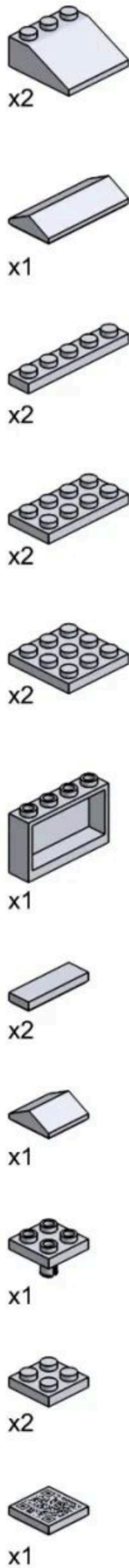
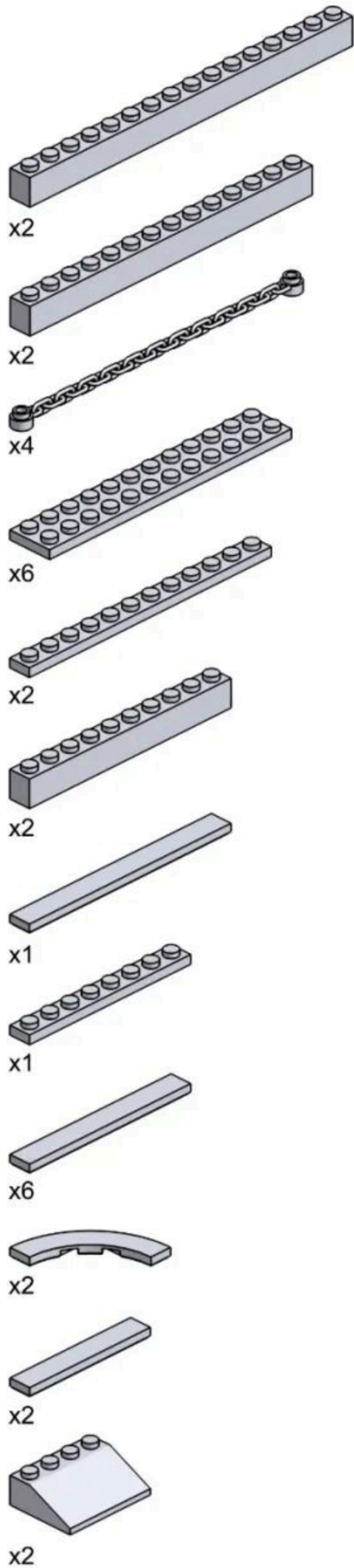

# PARTS LIST

配件清单

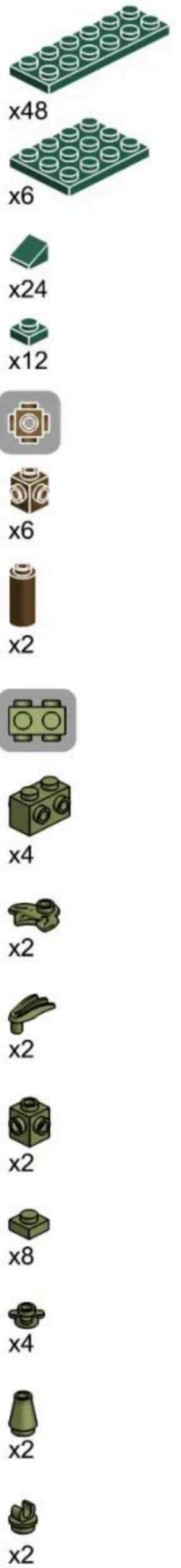
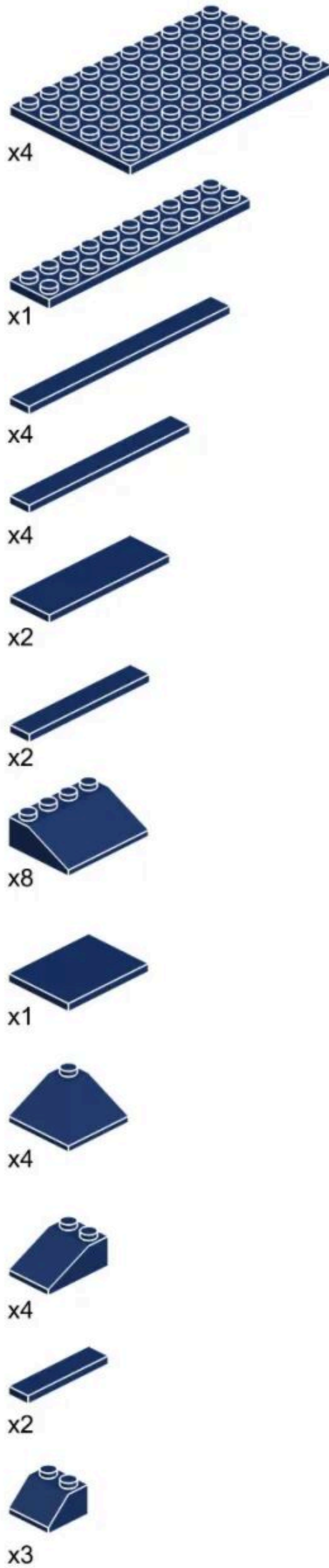
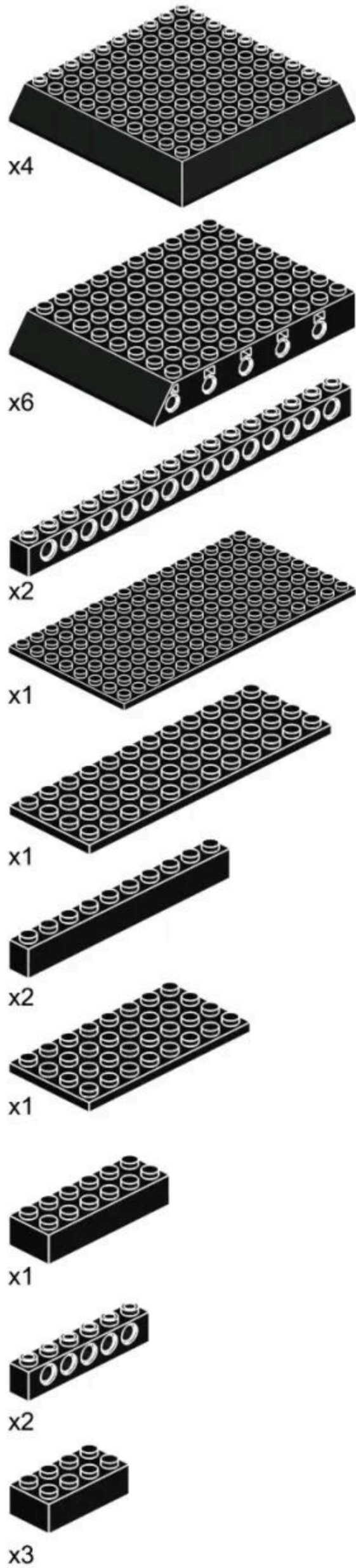

产品有增补件请以实物为准  
If product has additional parts, please in kind prevail.



284PCS

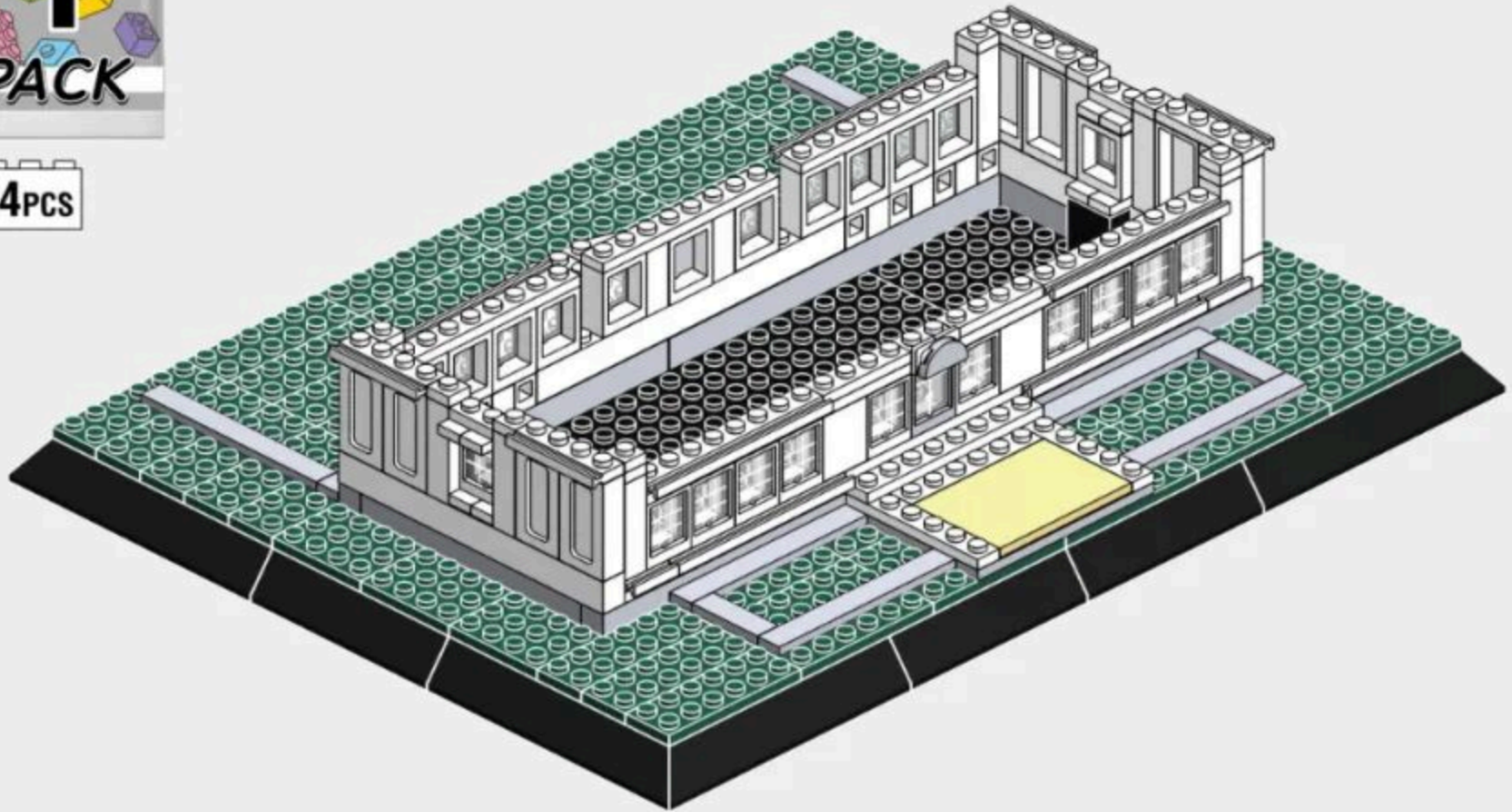

1-1

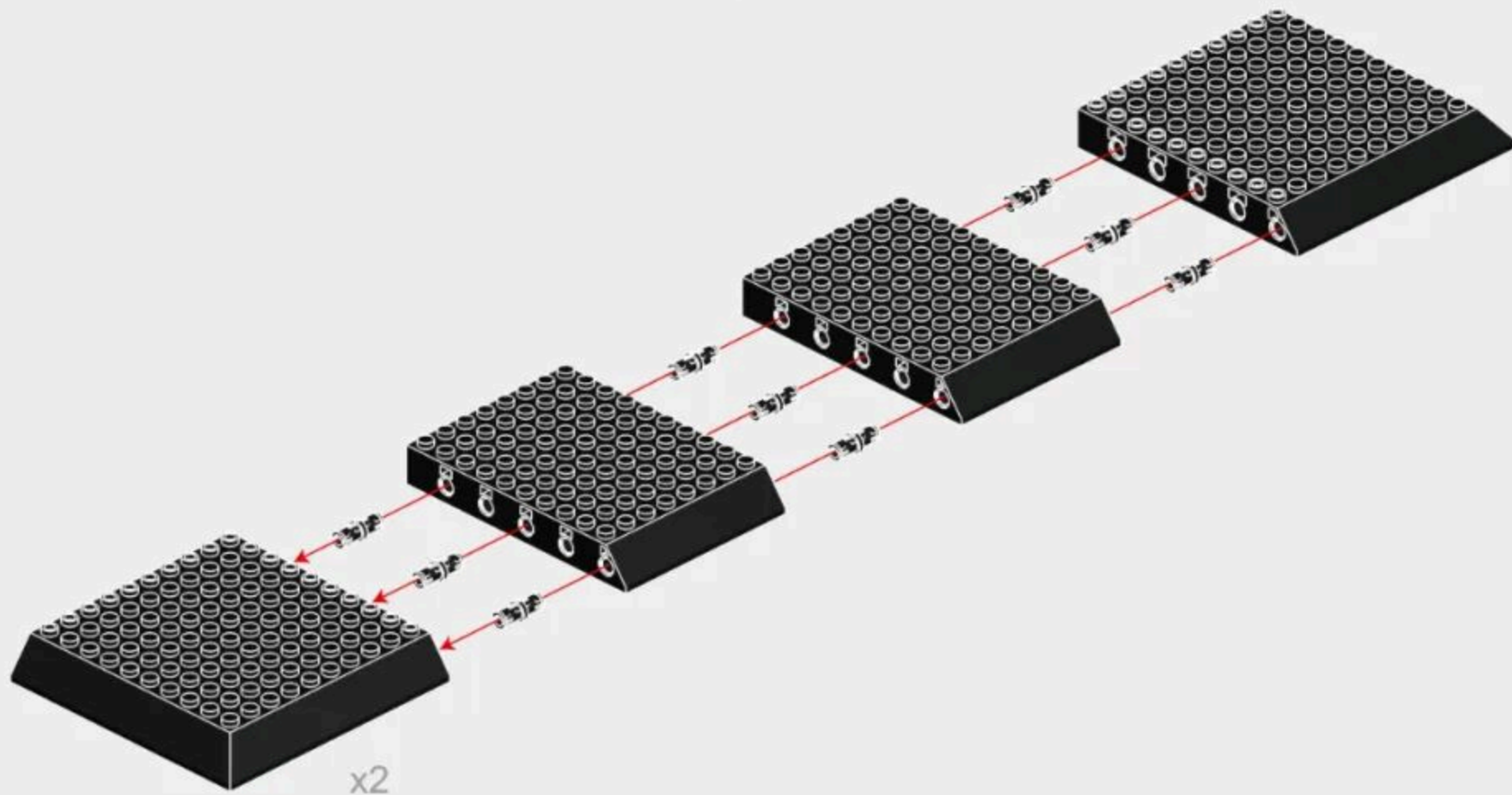
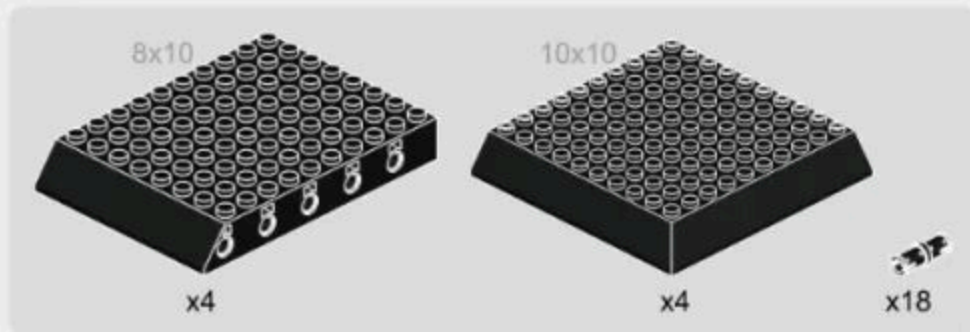

1-2

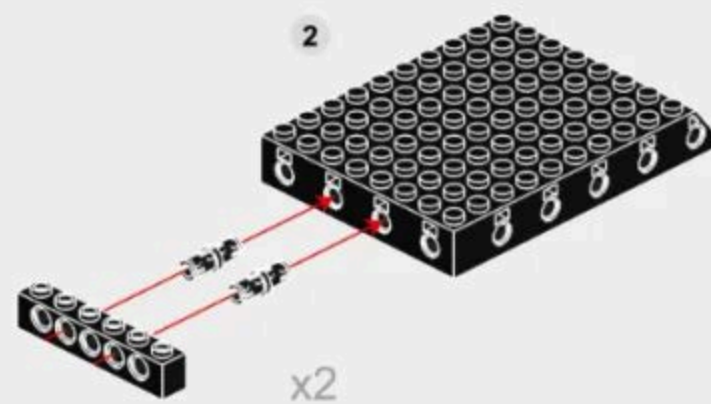
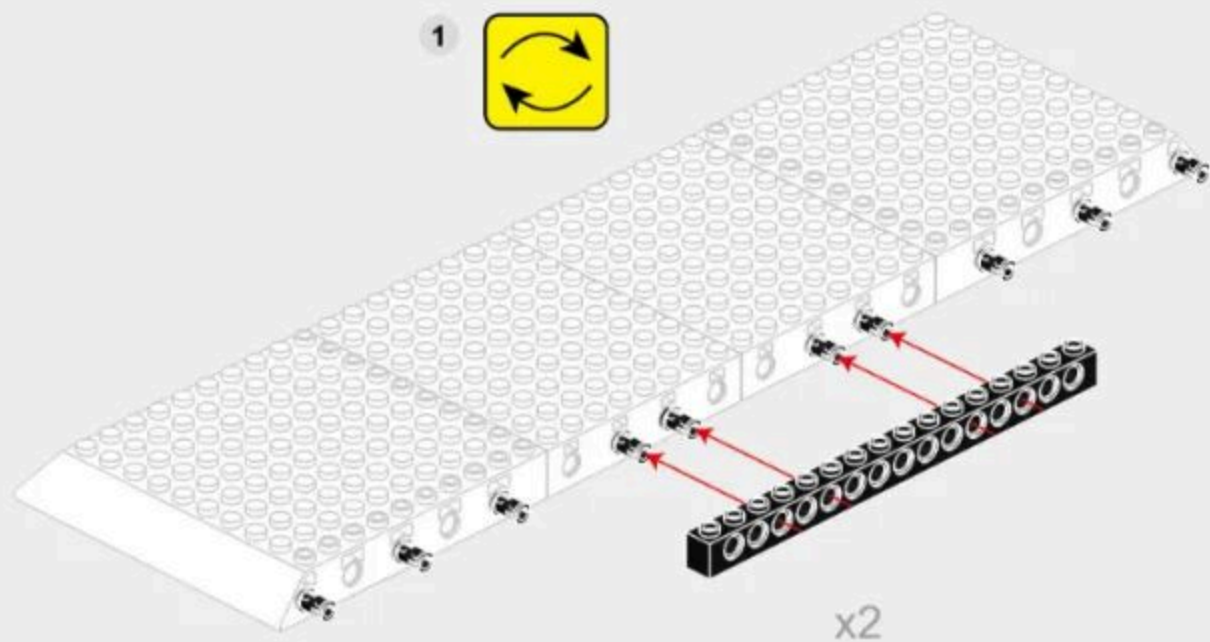
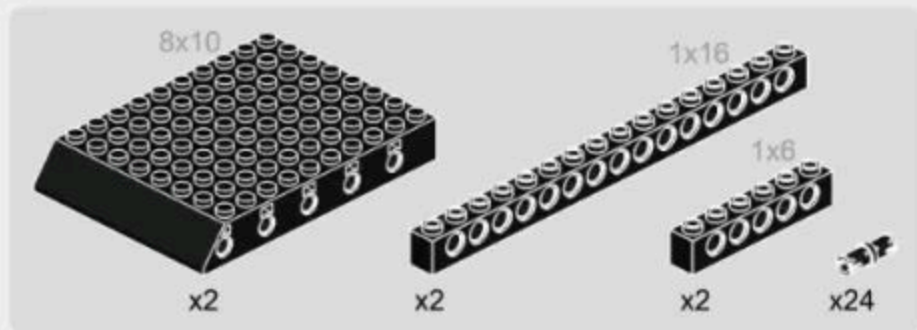

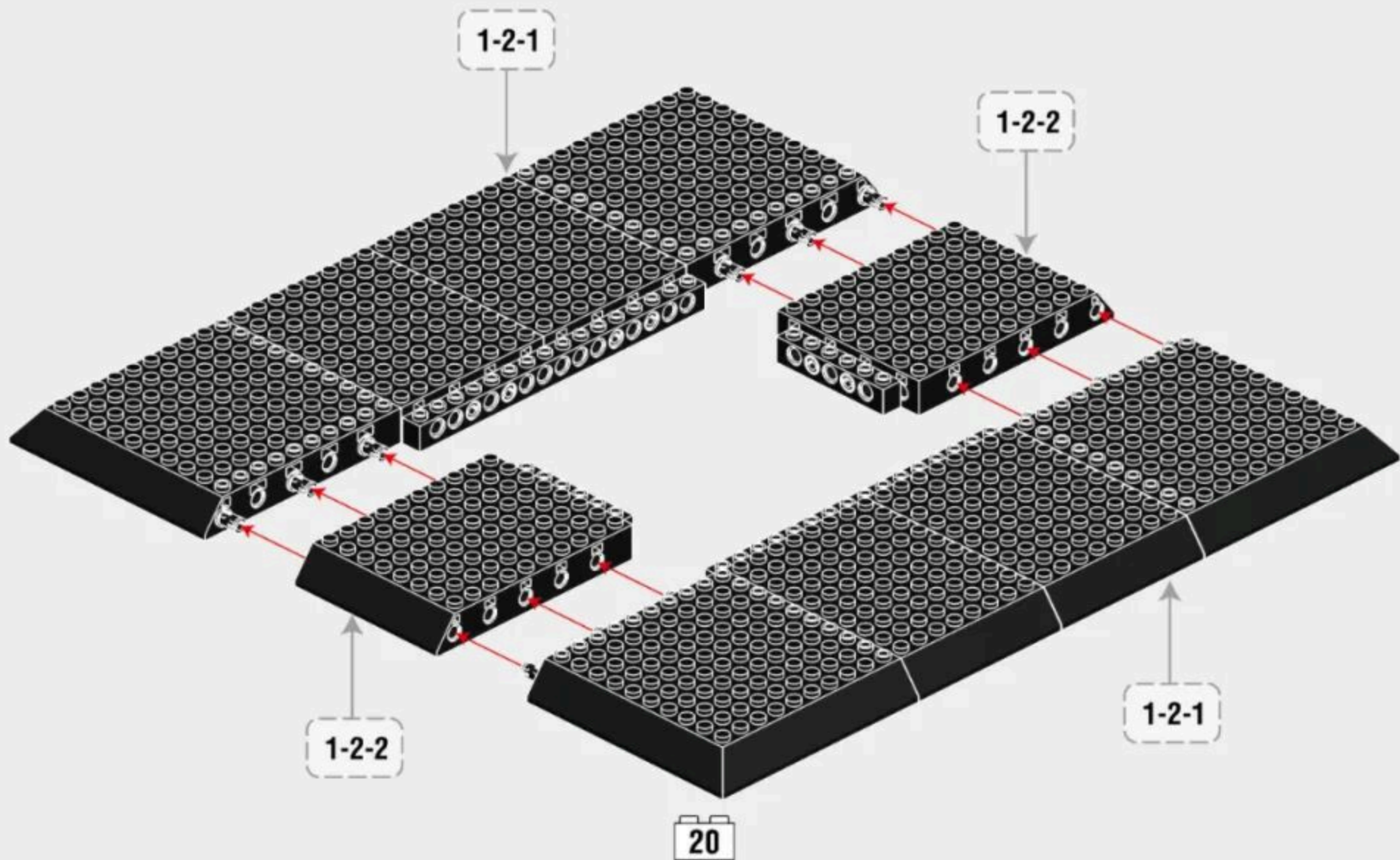

1-4

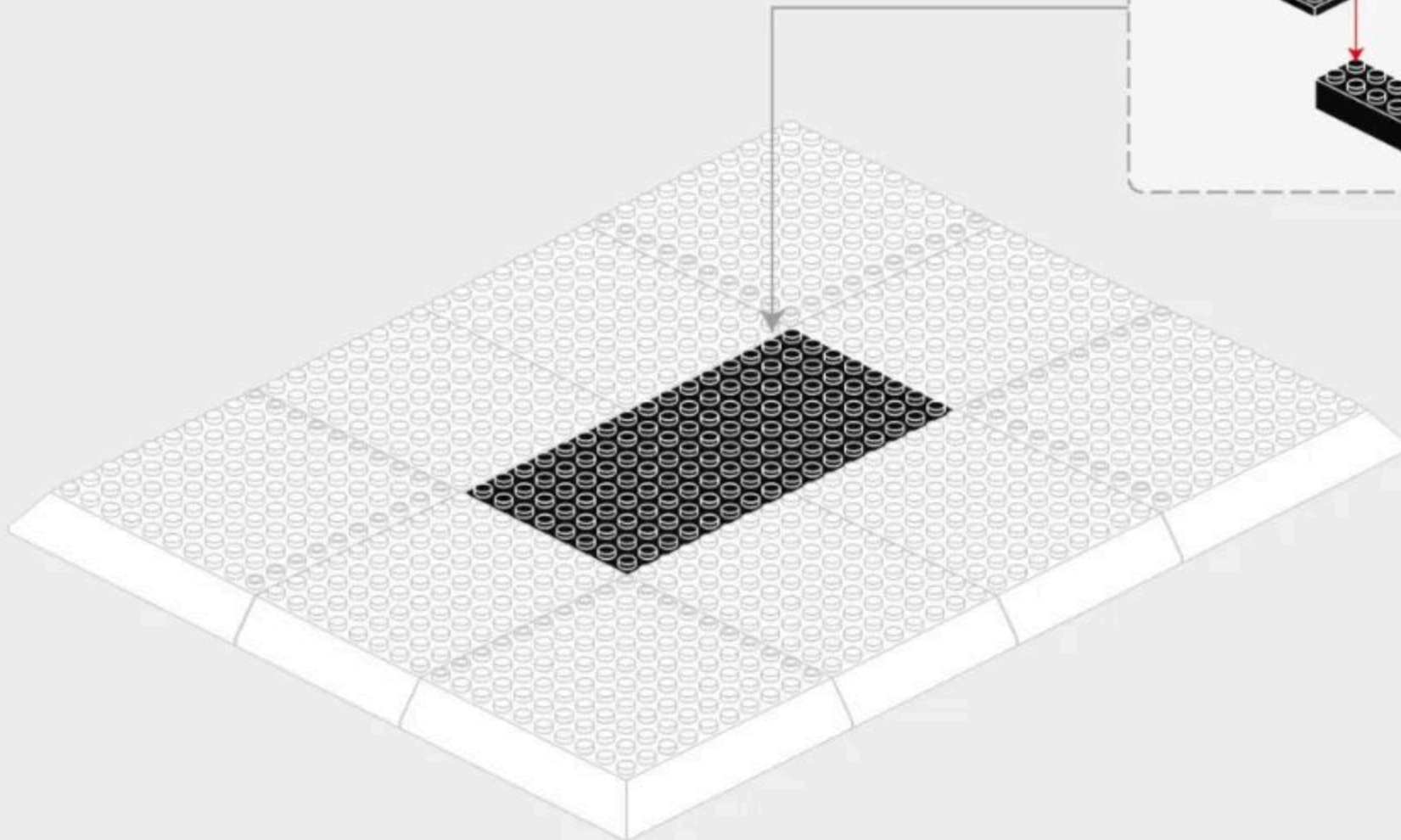
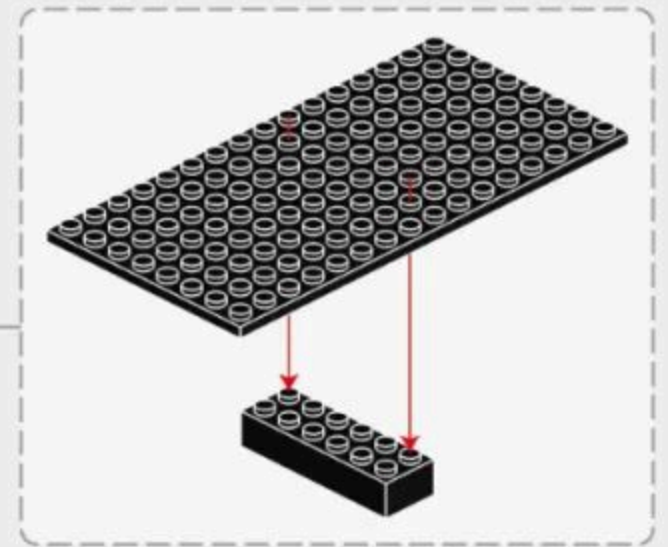
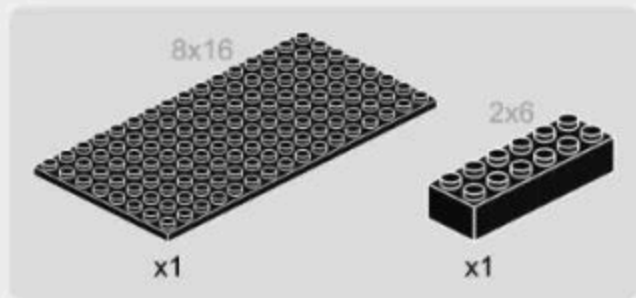

1-5

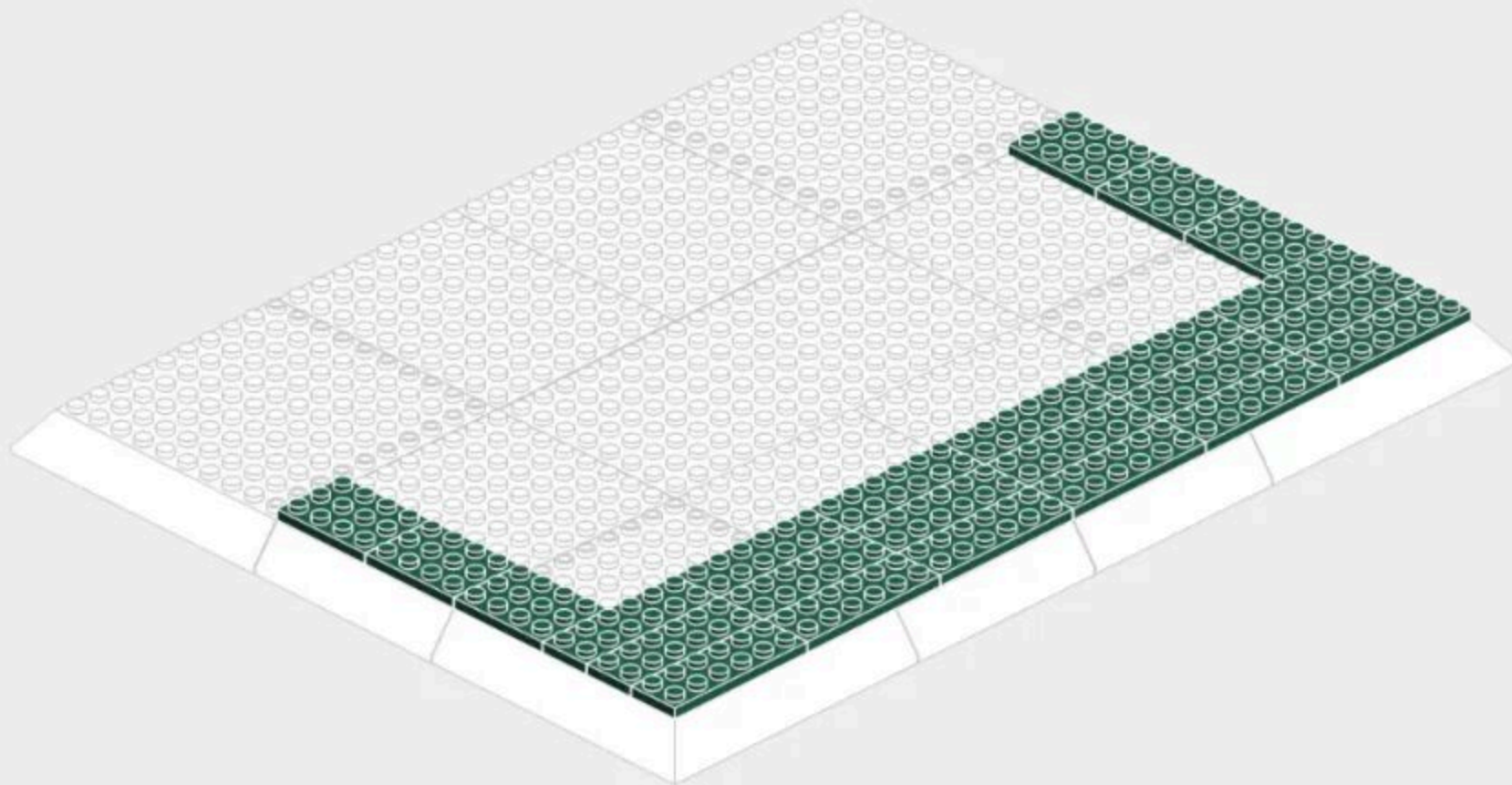
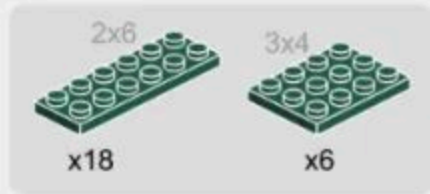

1-6

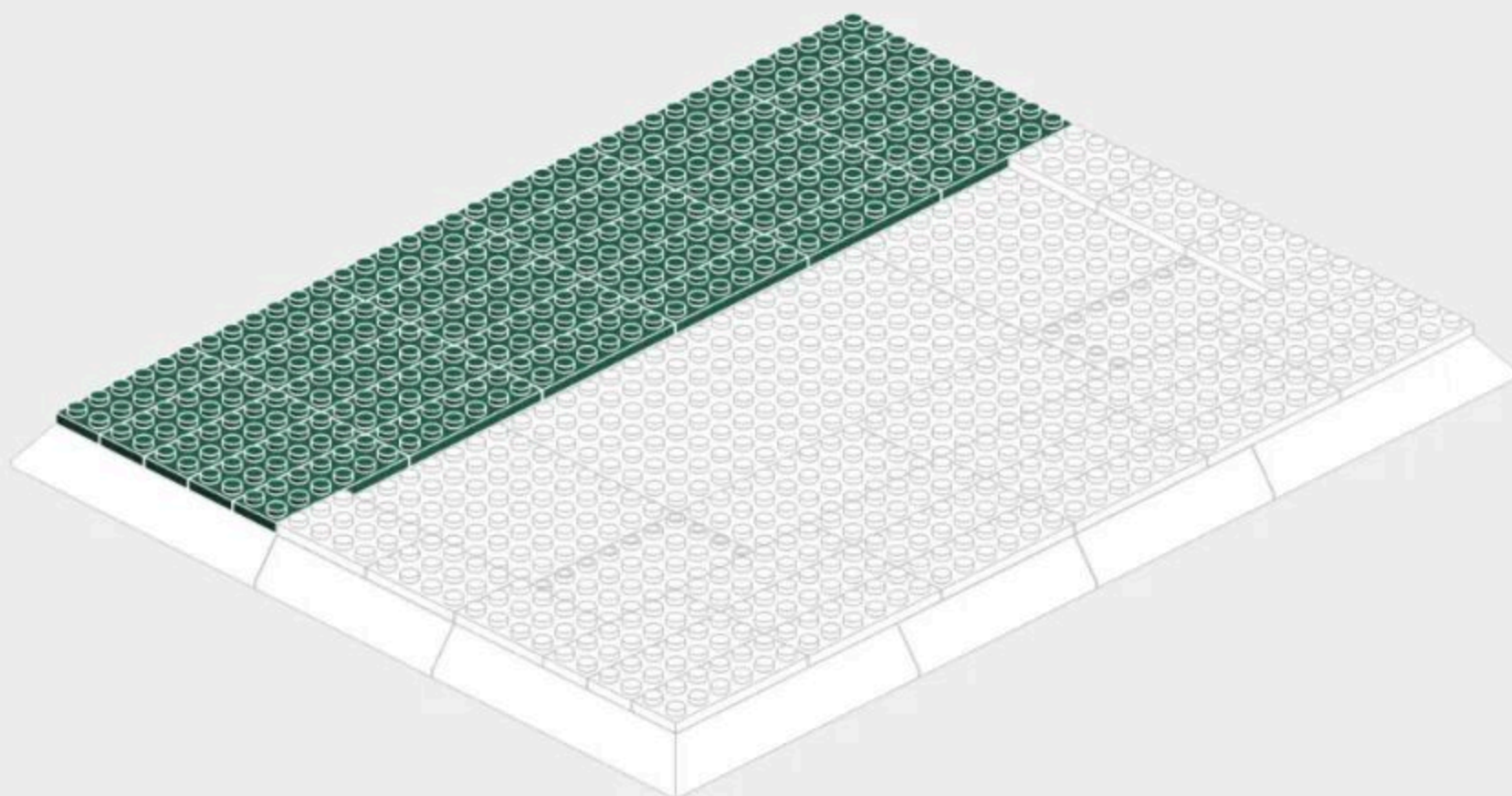

1-7

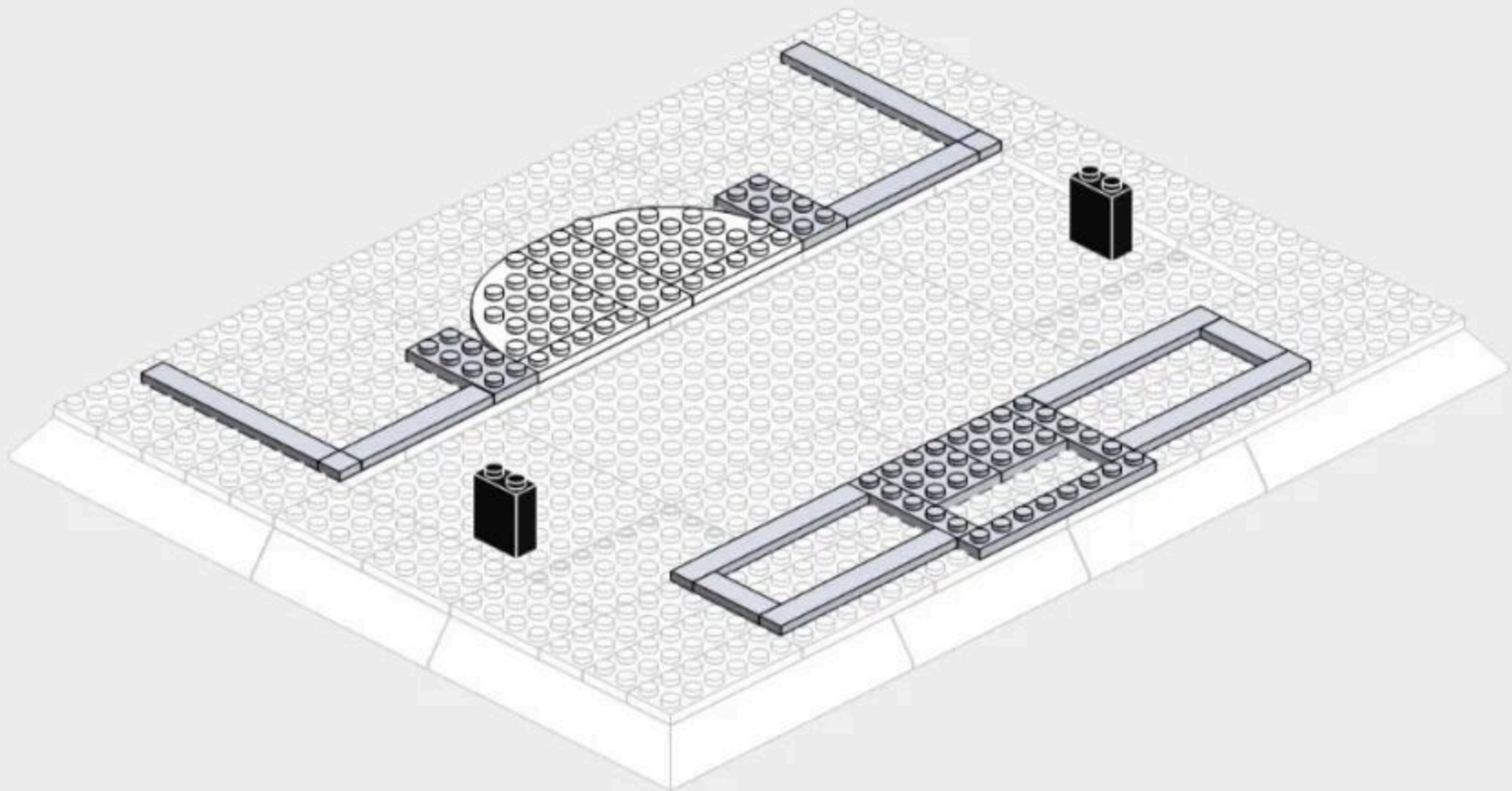
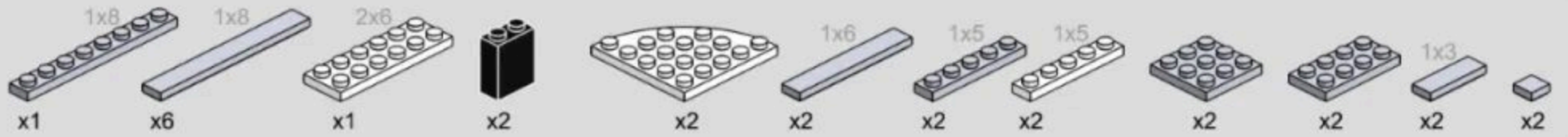

1-8

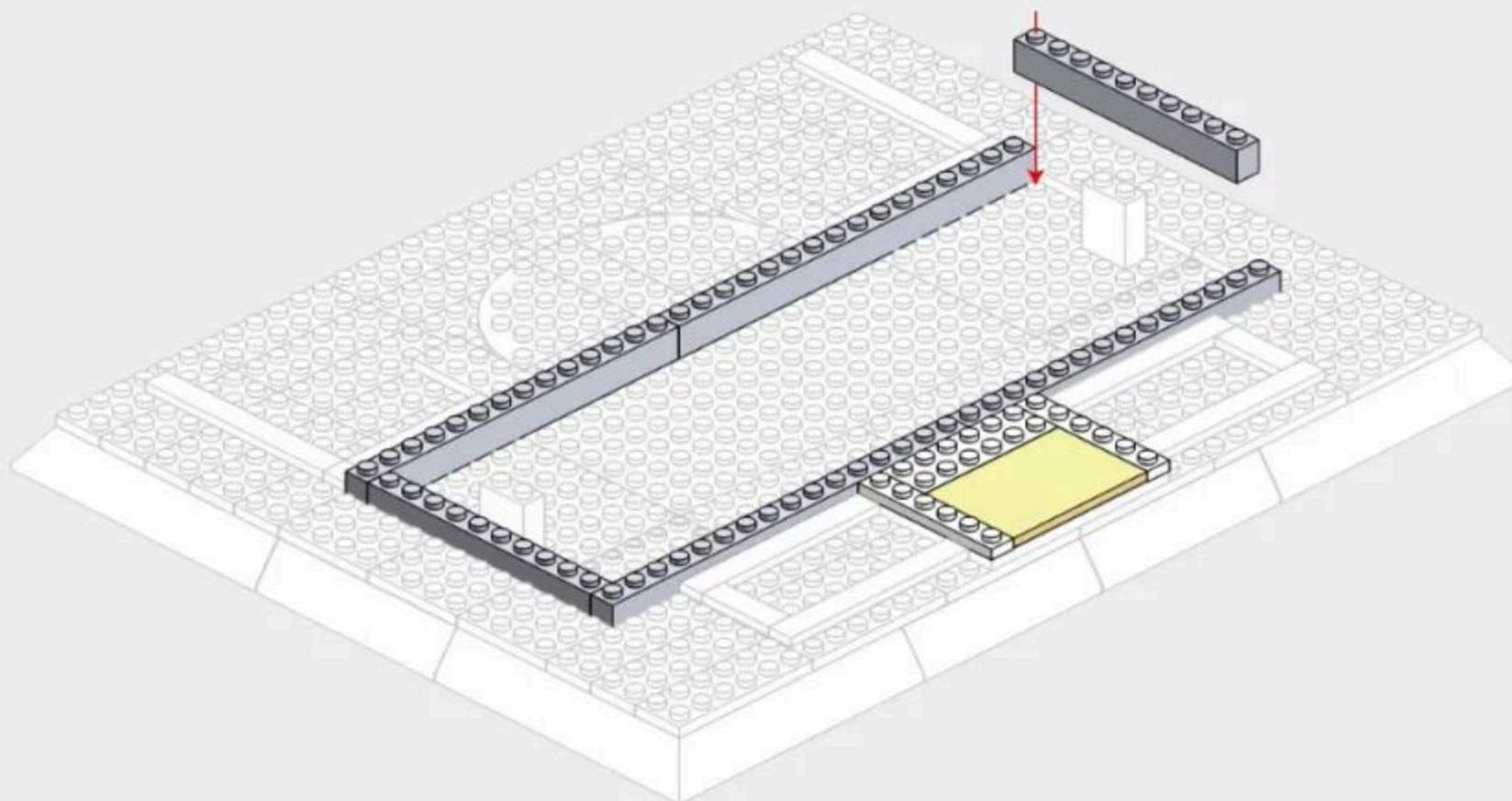
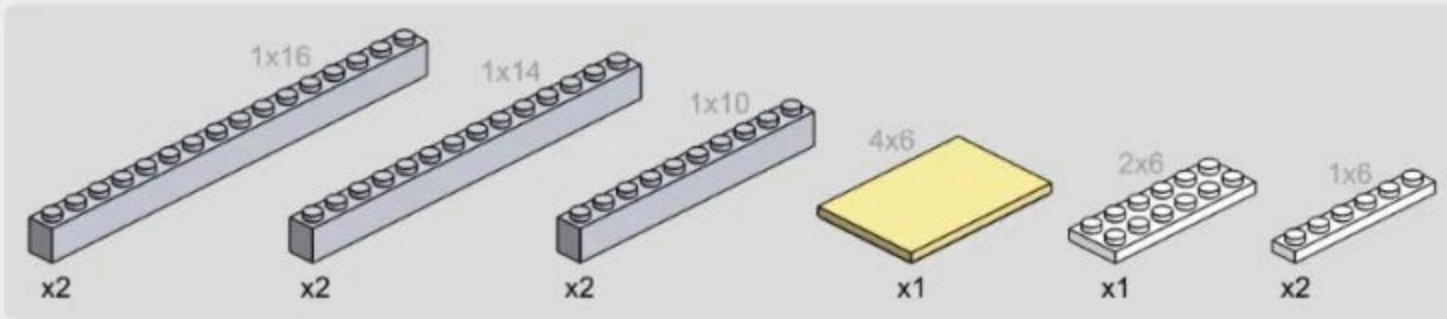



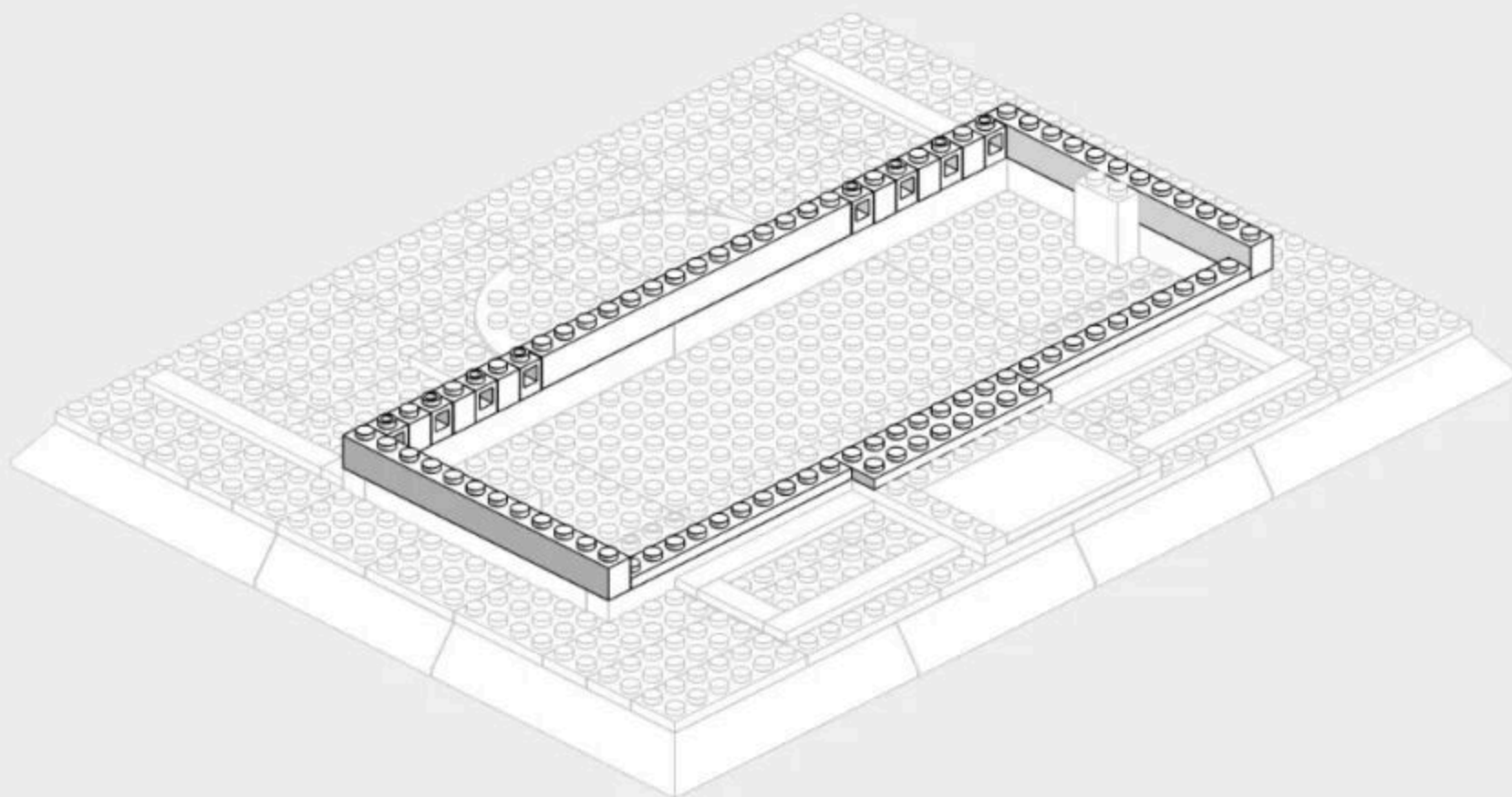
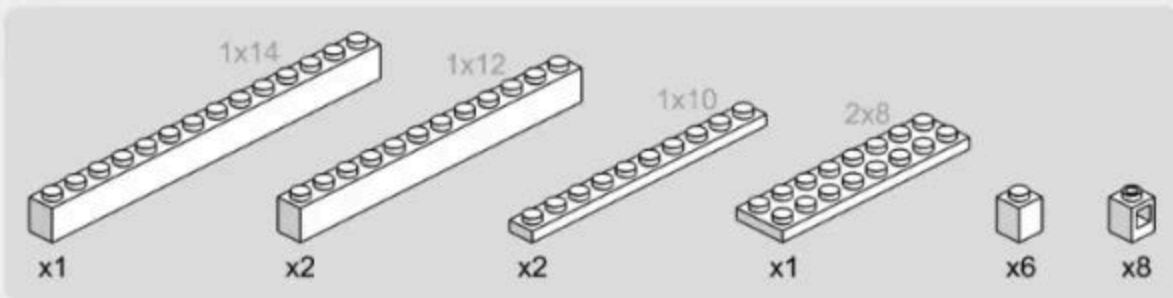



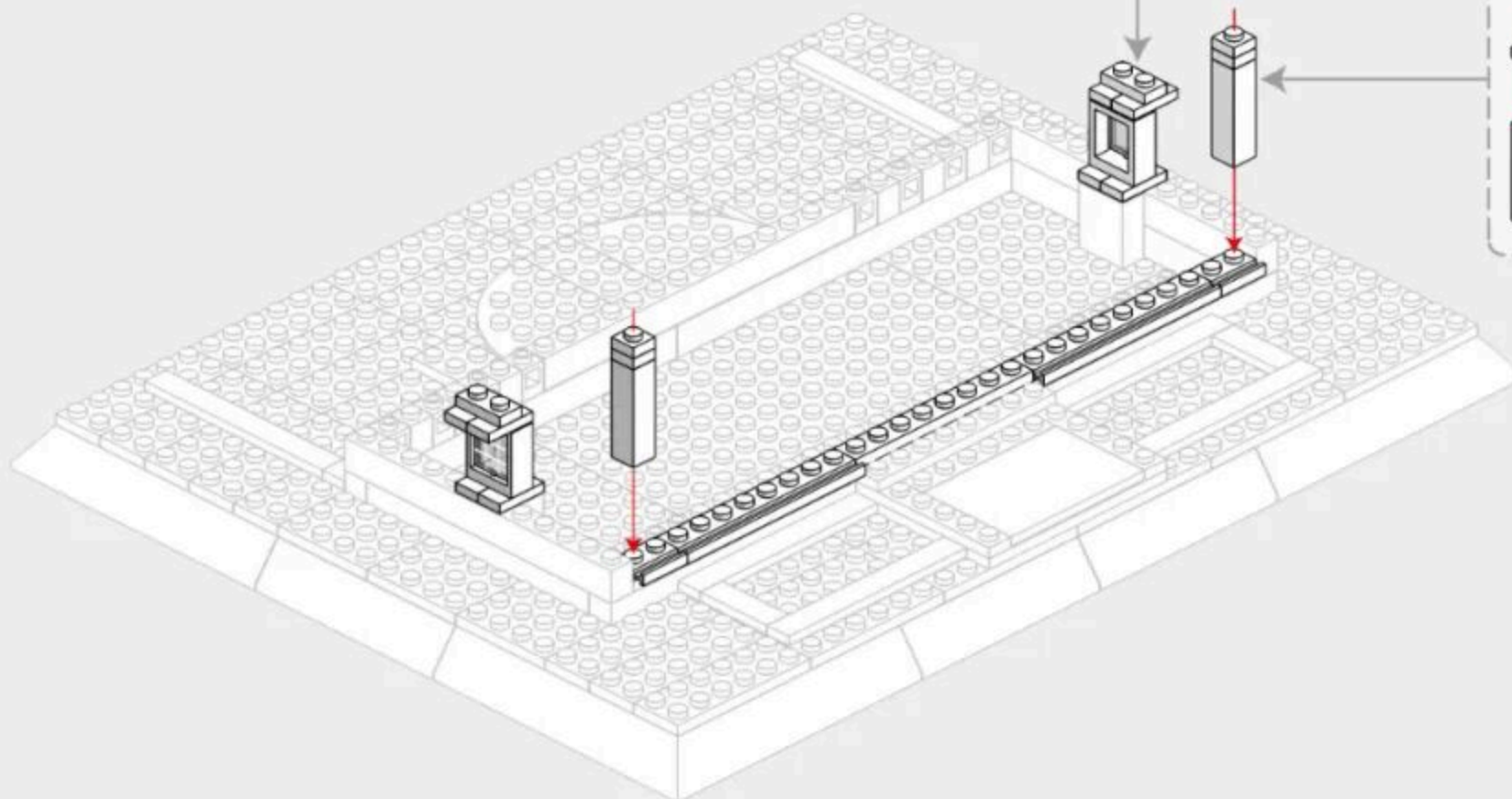
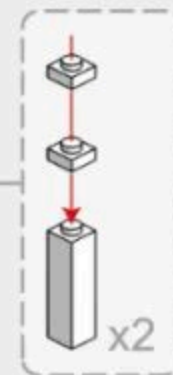
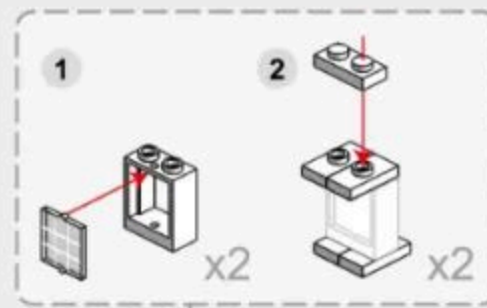
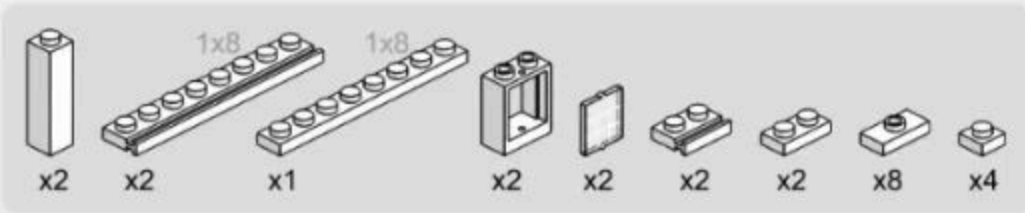

1-9



# 1-10



# 1-11

-  x6
-  x2
-  x21
-  x1
-  x2
-  x18
-  x1
-  x3
-  x6

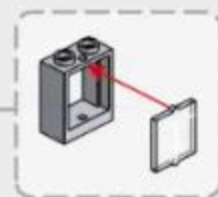
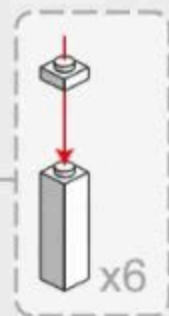
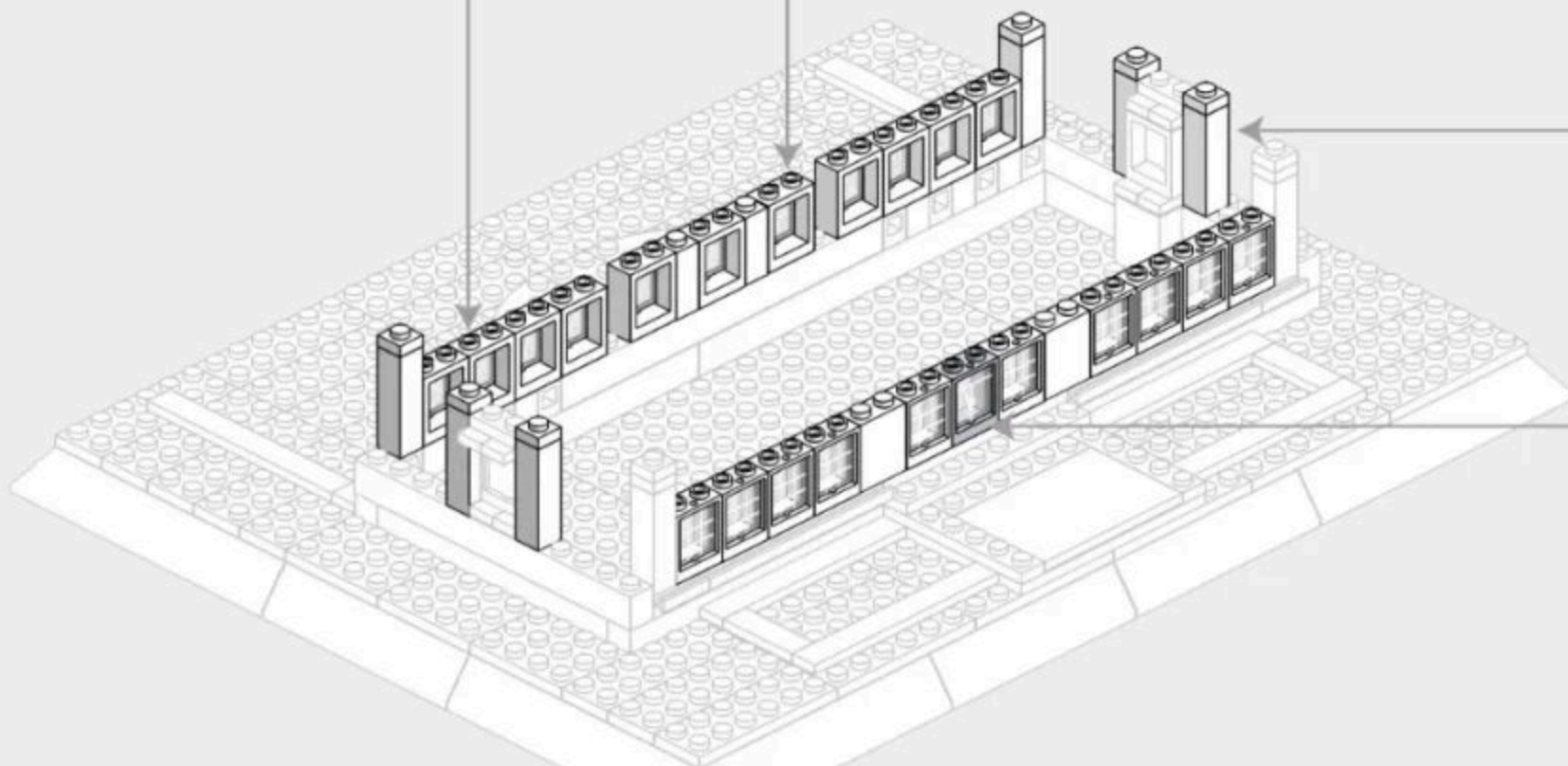
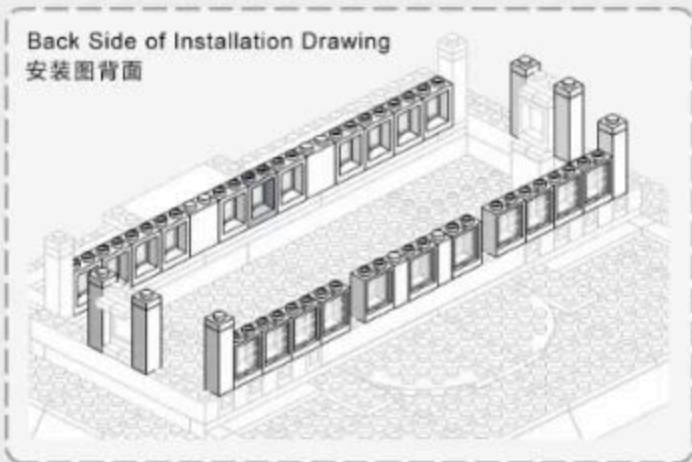
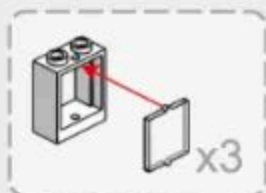
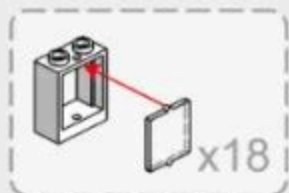

1-12

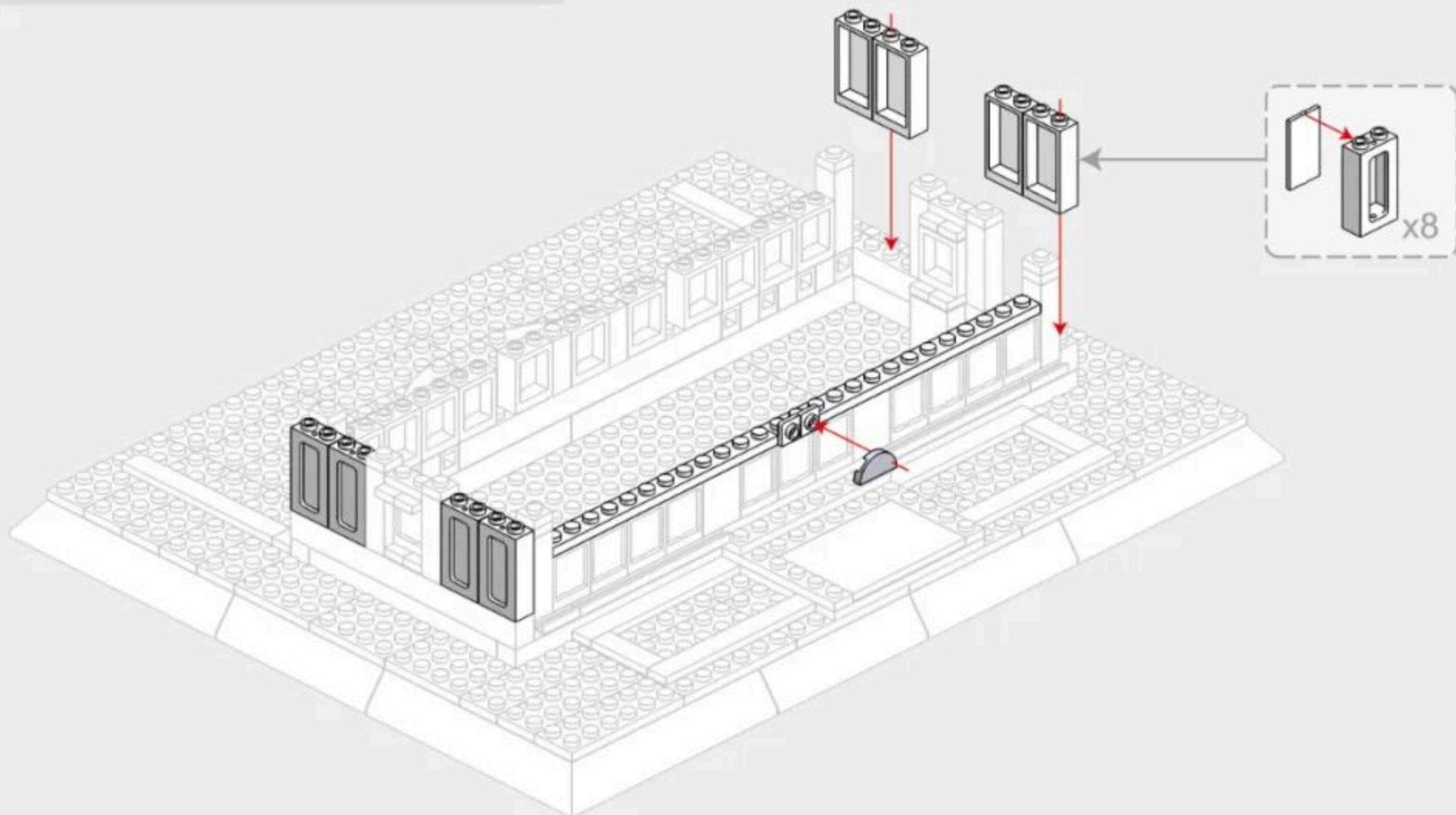
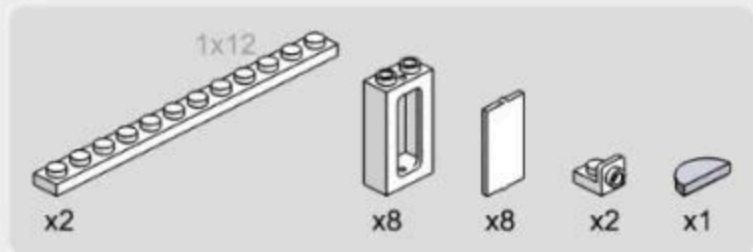

1-13

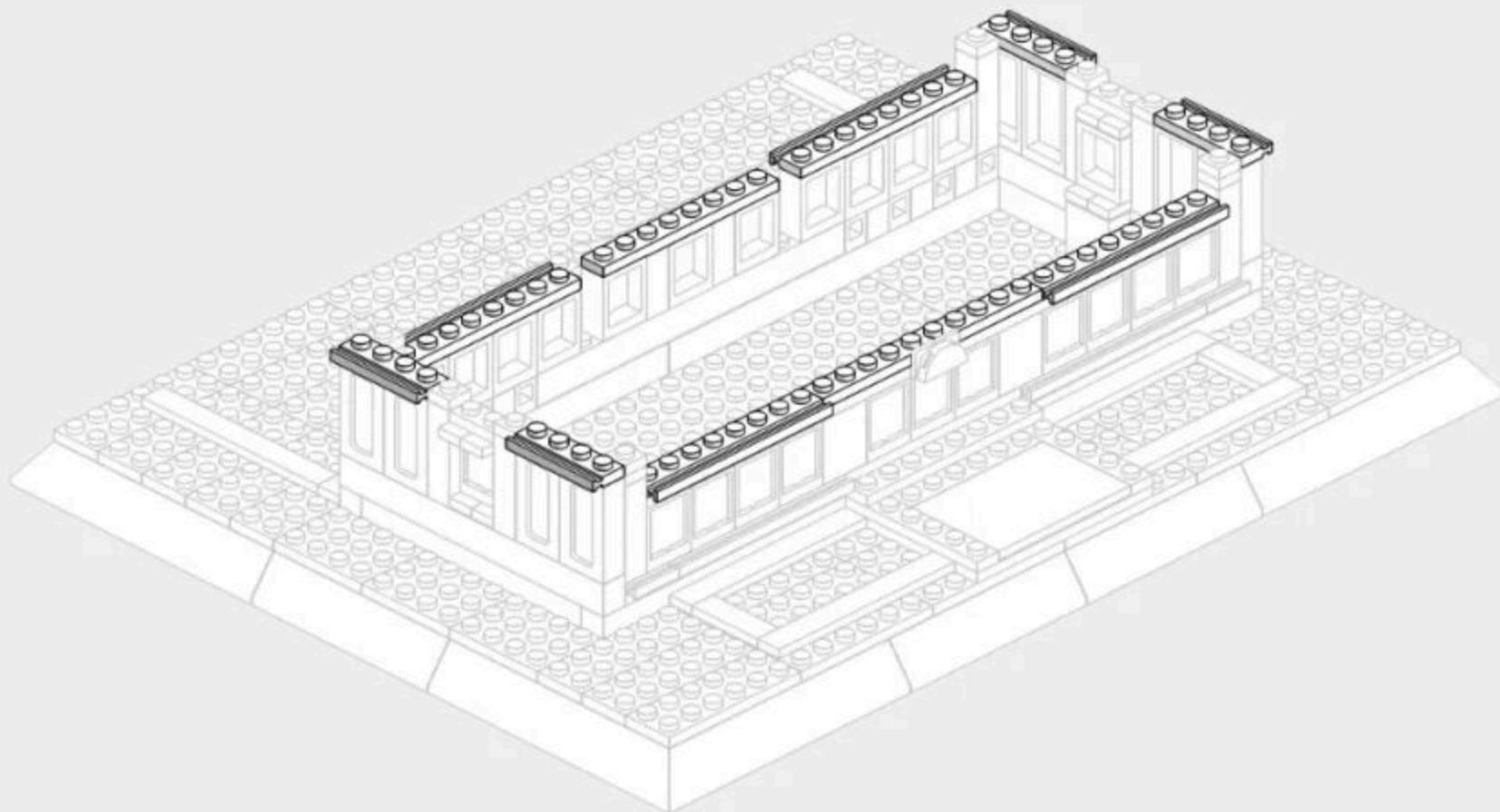
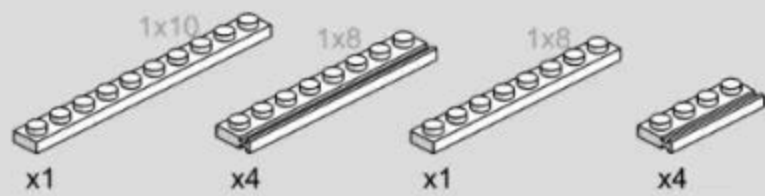



282PCS

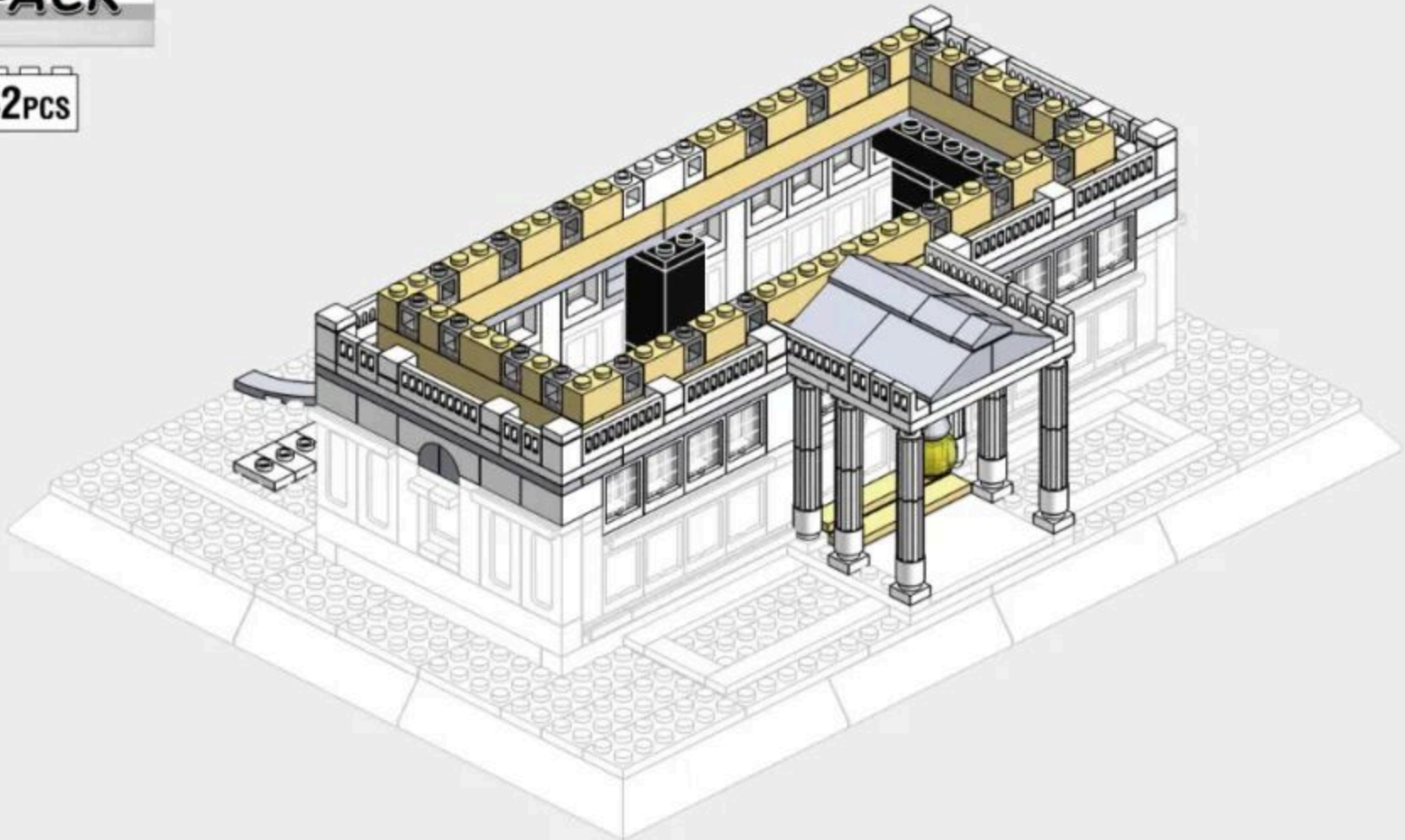

2-1

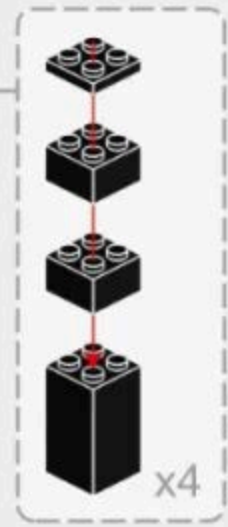
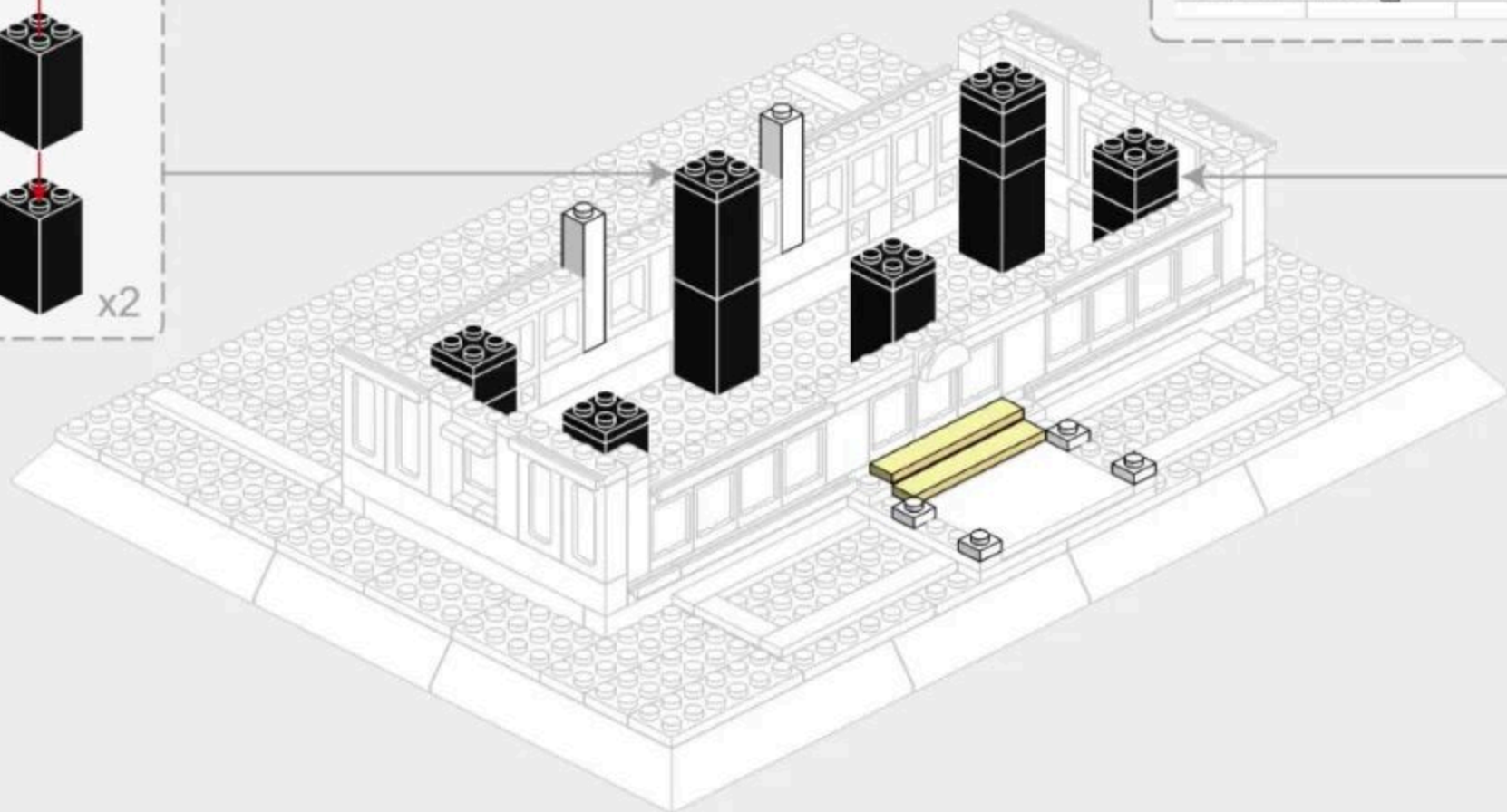
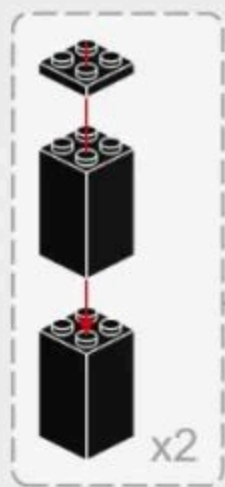
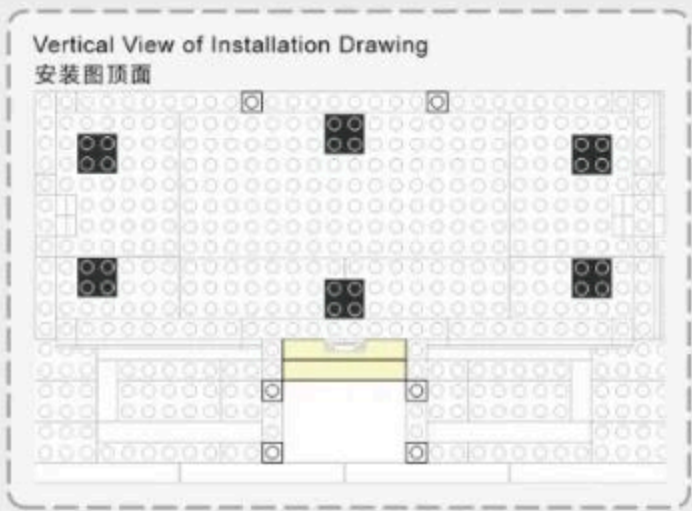
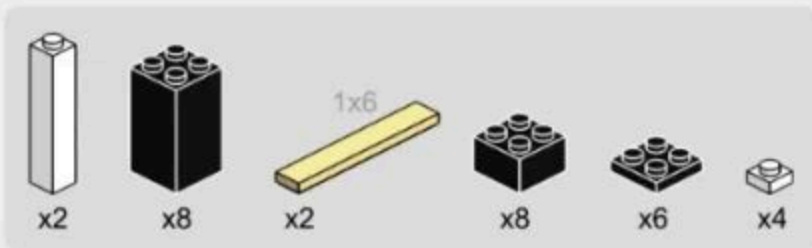

2-2

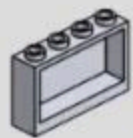

x1



x2



x21



x19



x2



x4



x2

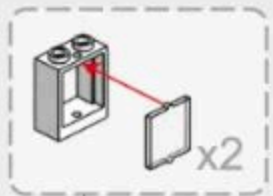

Back Side of Installation Drawing  
安装图背面

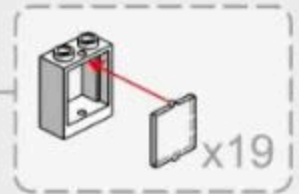
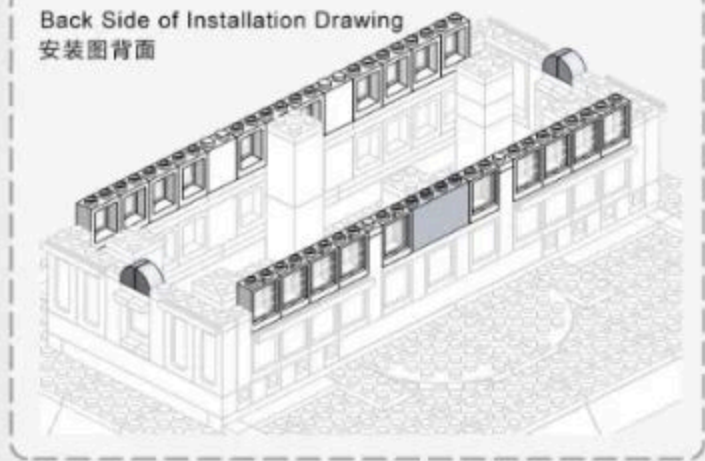

2-3

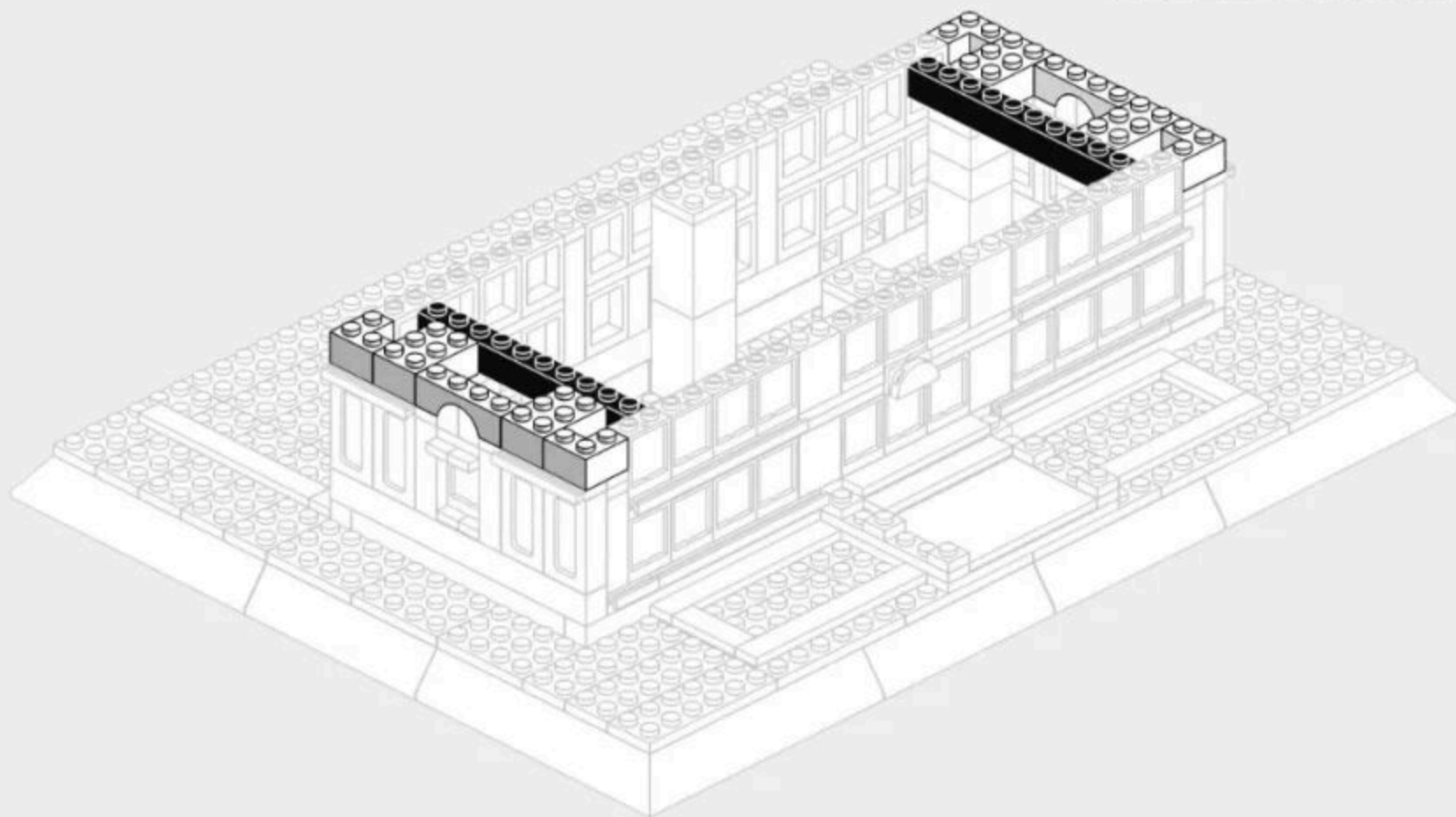
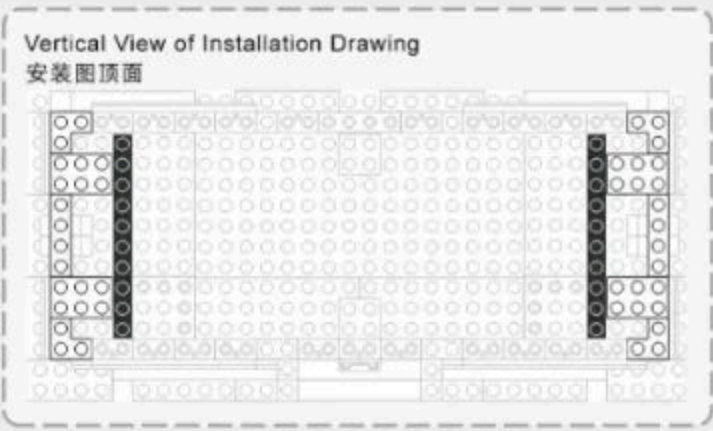
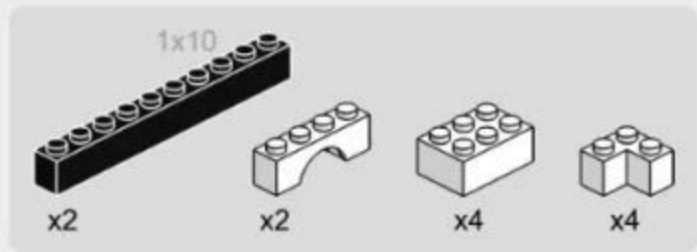

2-4

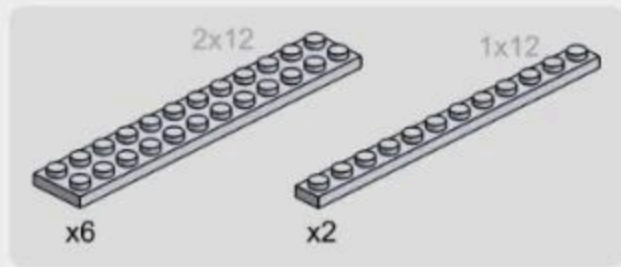

2-5

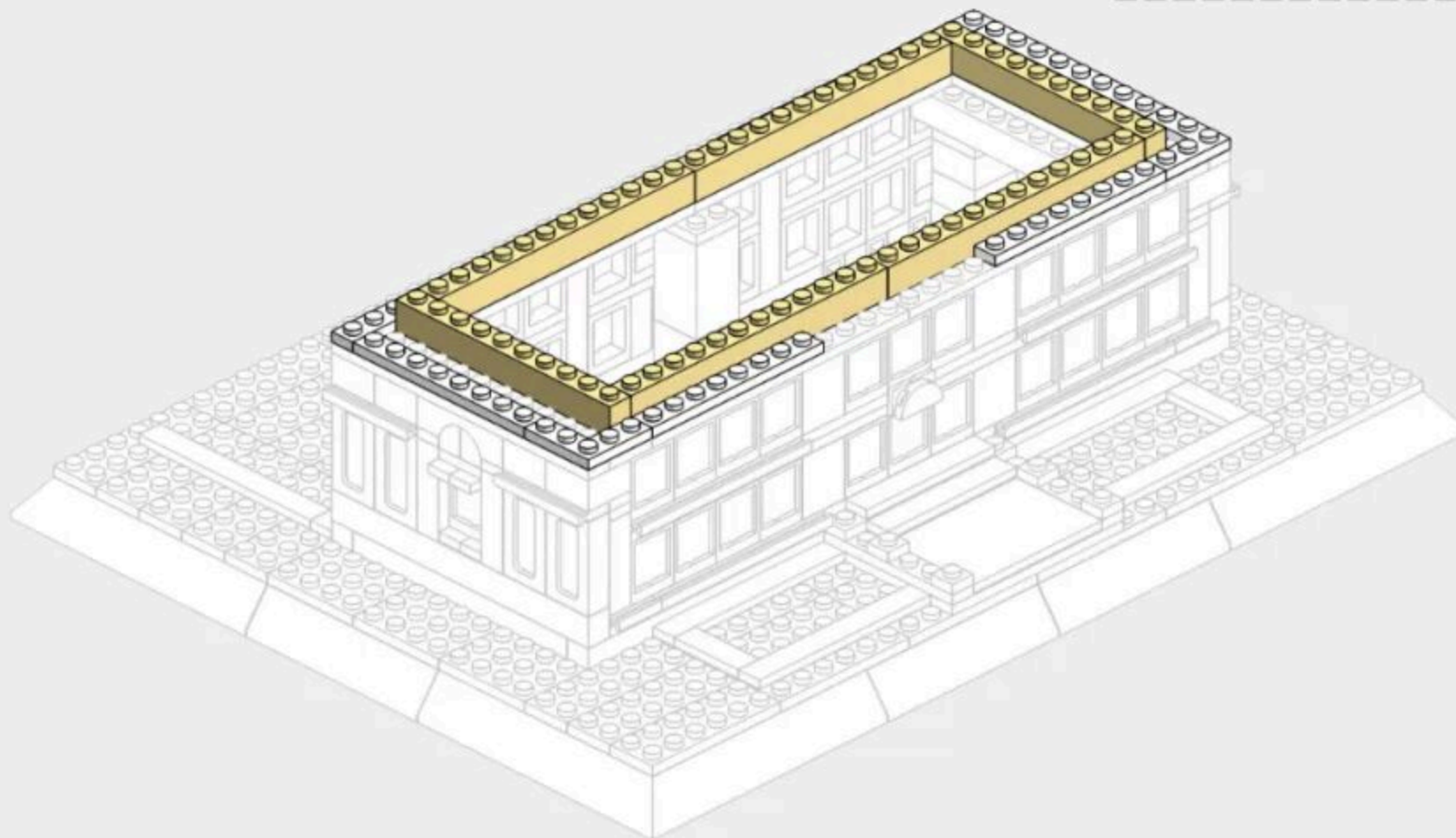
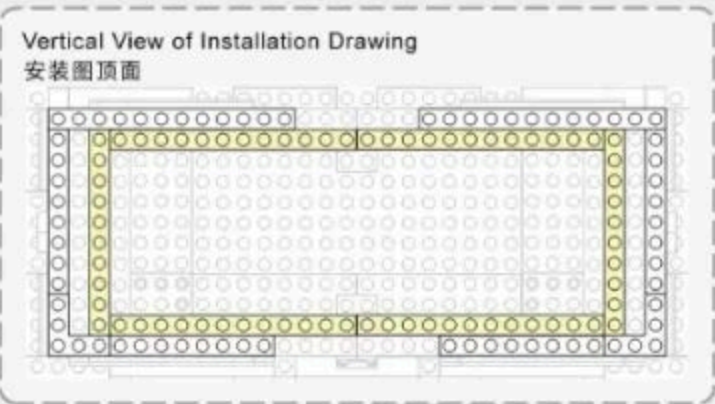
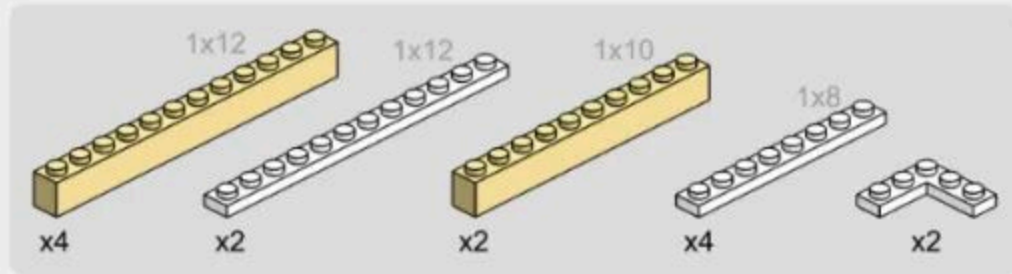

2-6



x10



x4



x8



x10



x10



x4

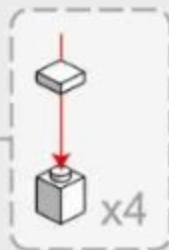
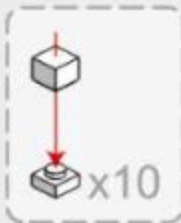

2-7

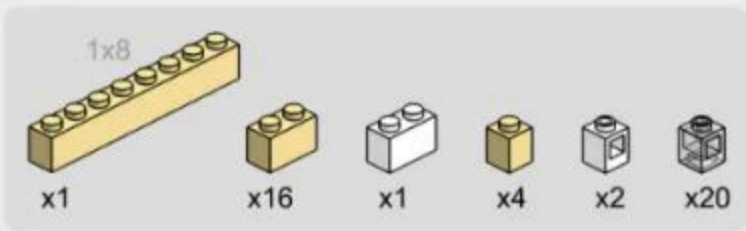

2-8

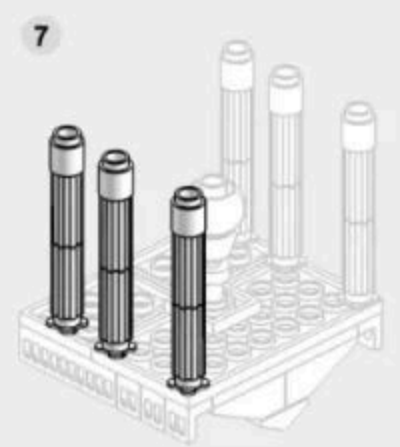
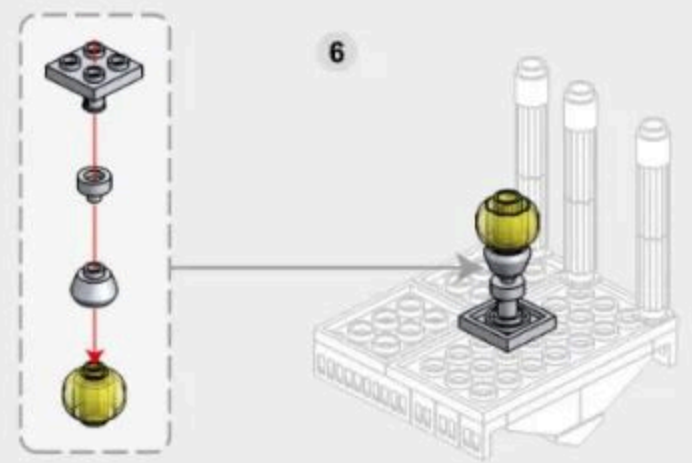
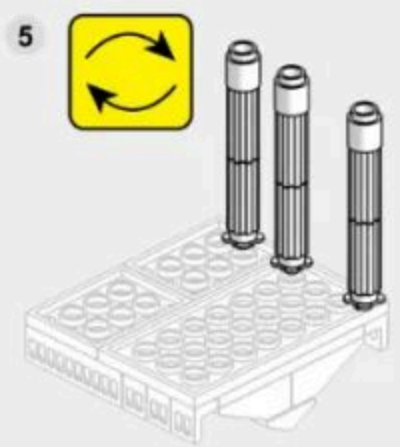
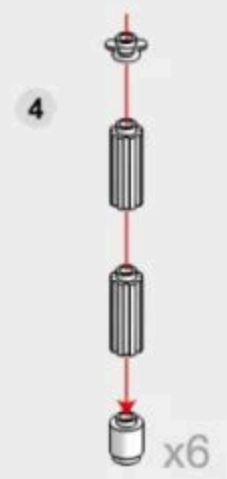
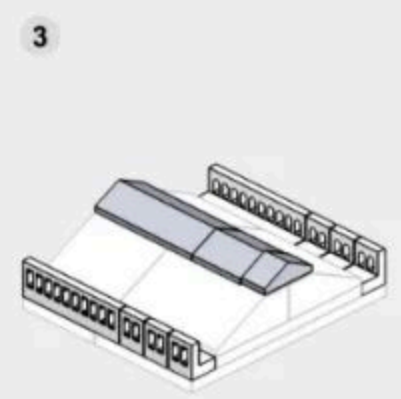
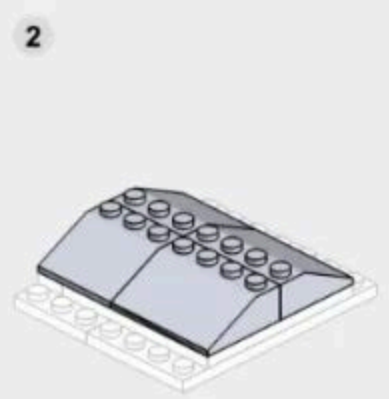
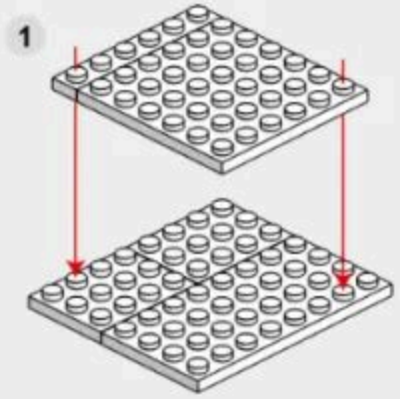
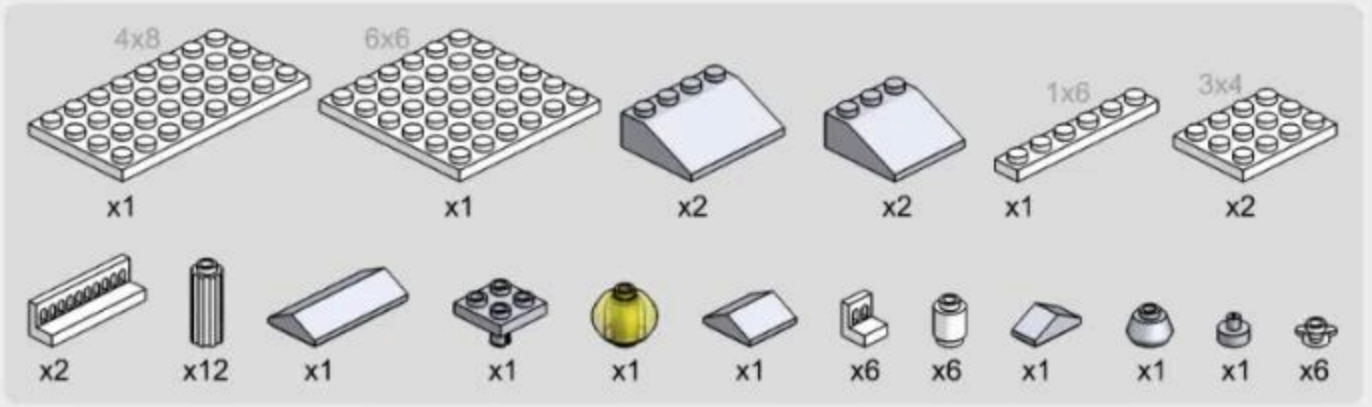

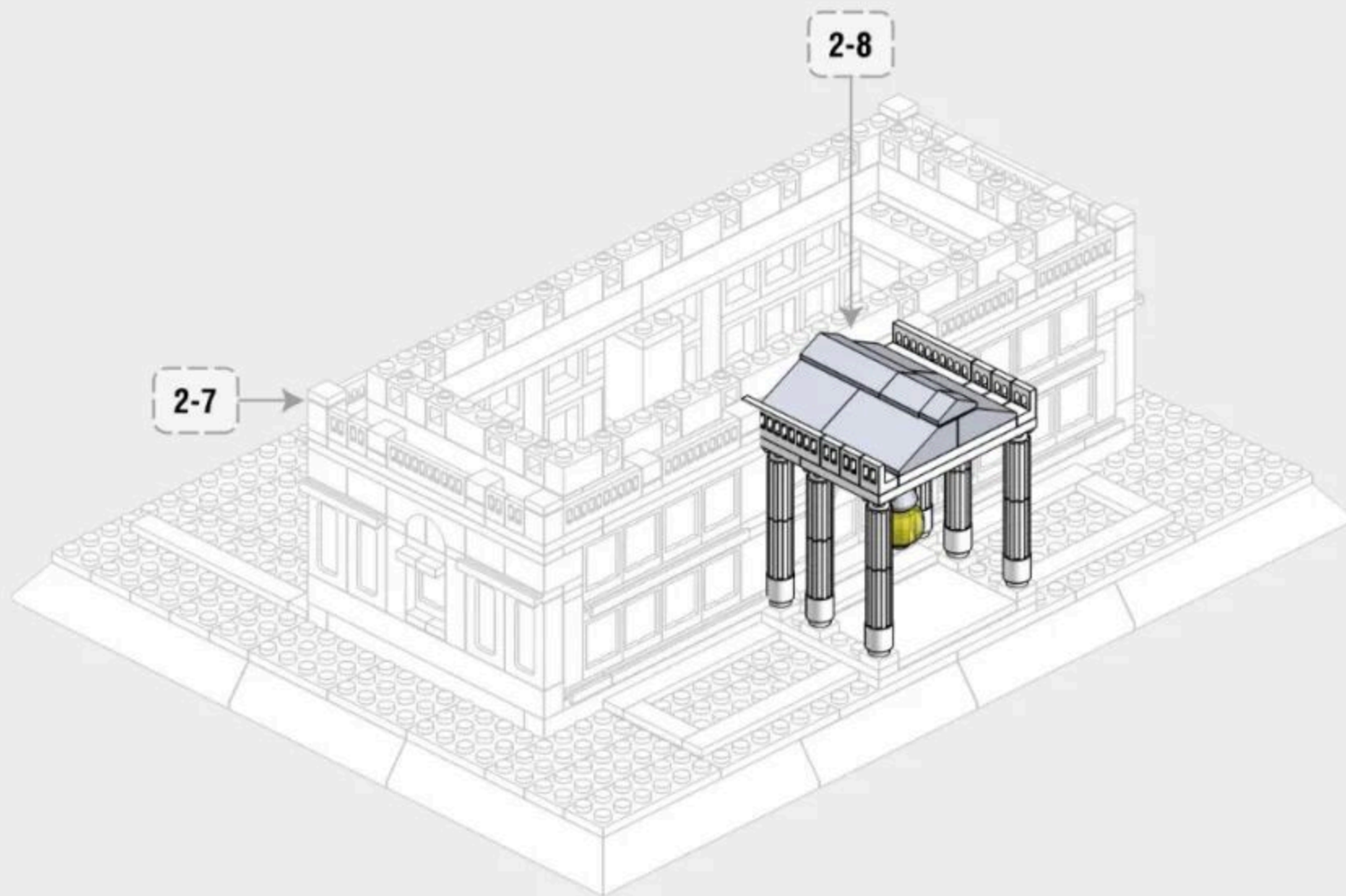

2-10

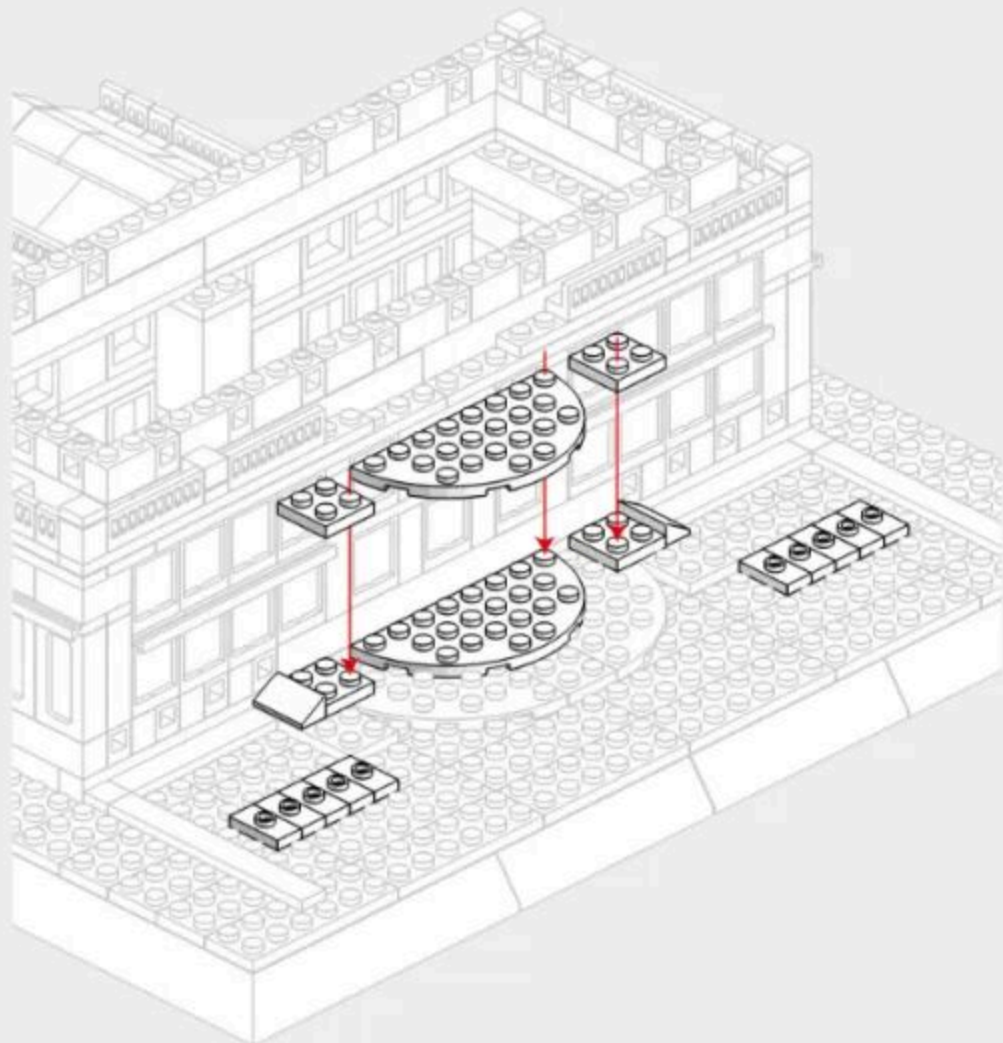

2-11

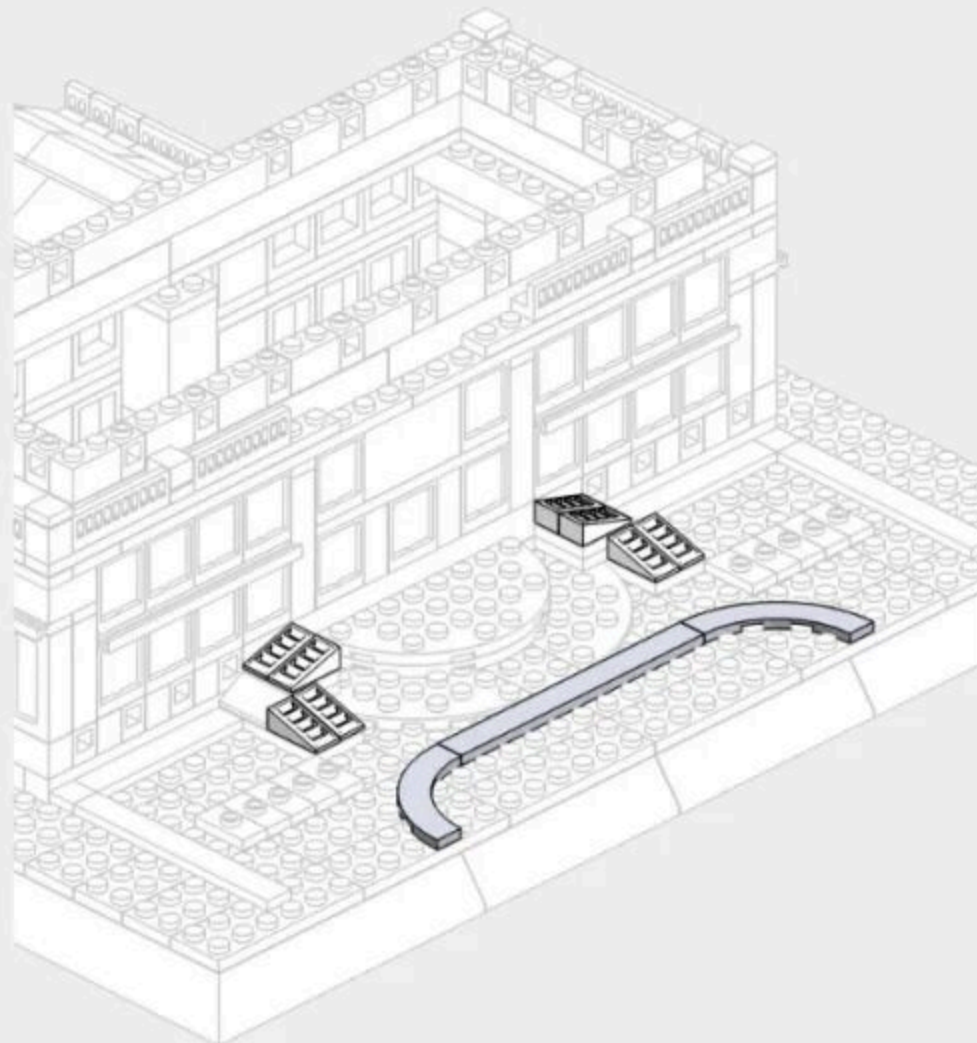
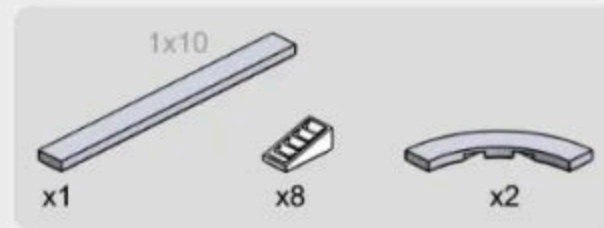



242PCS

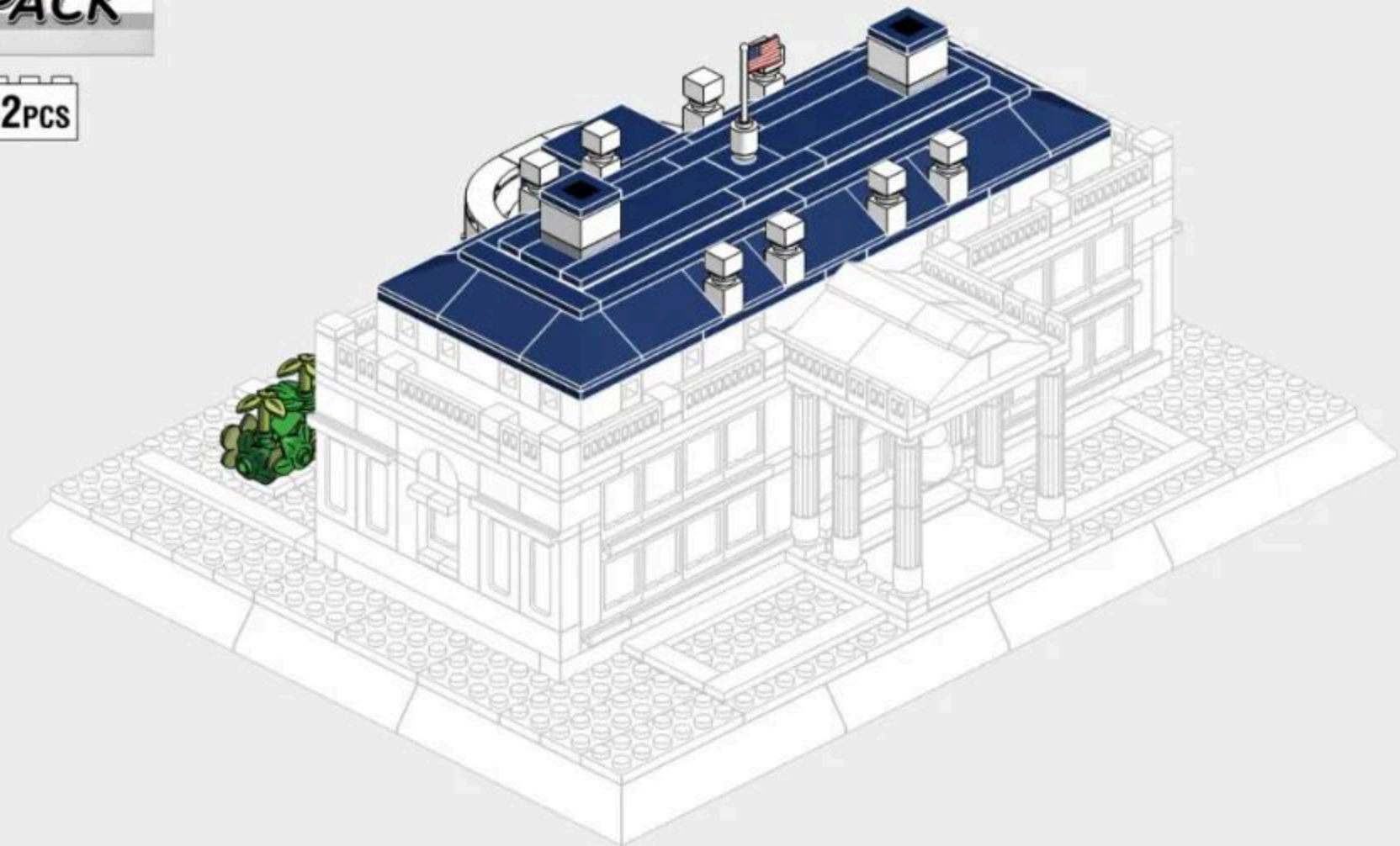

3-1

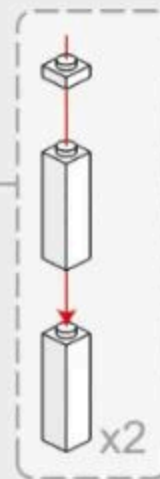
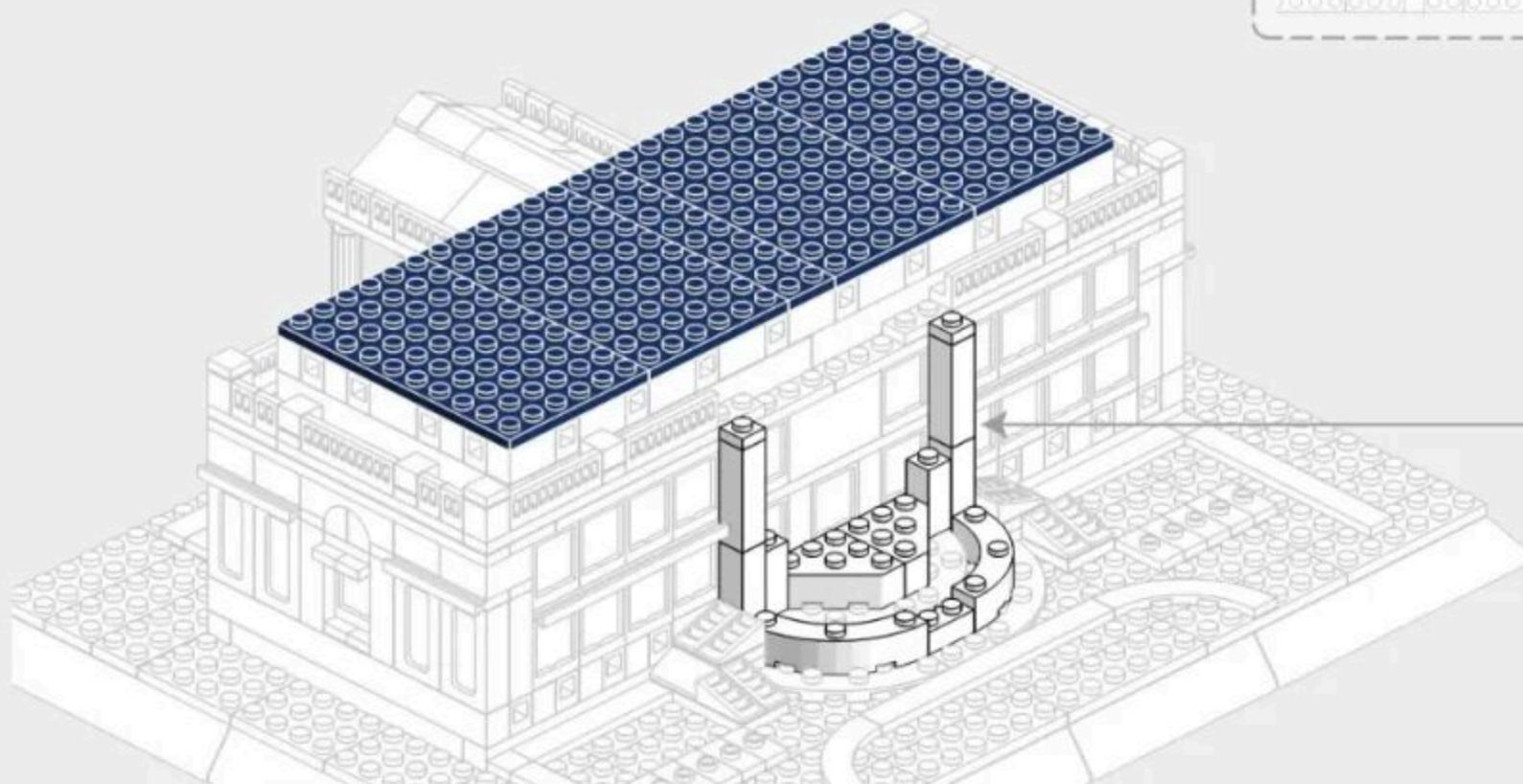
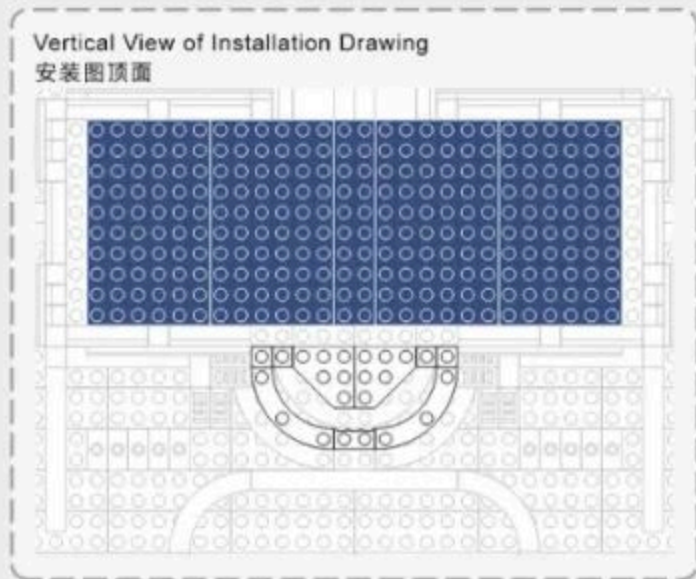
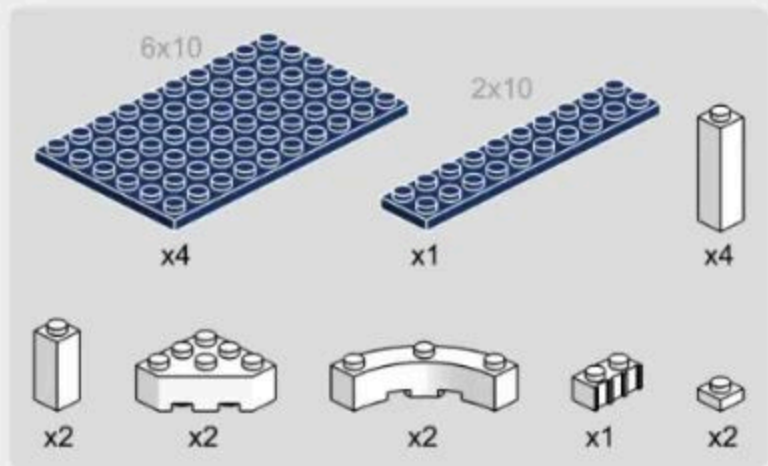

# 3-2

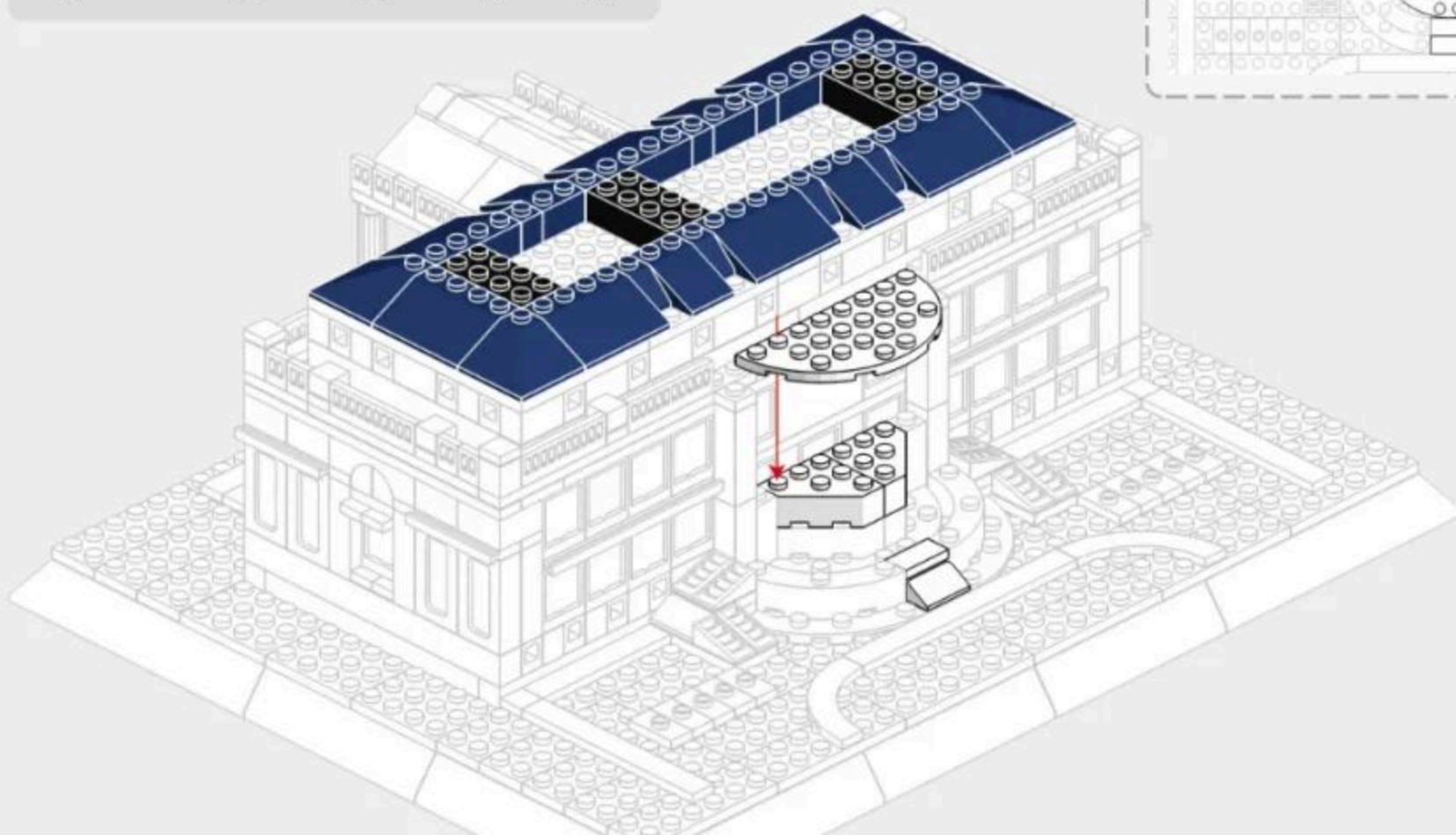
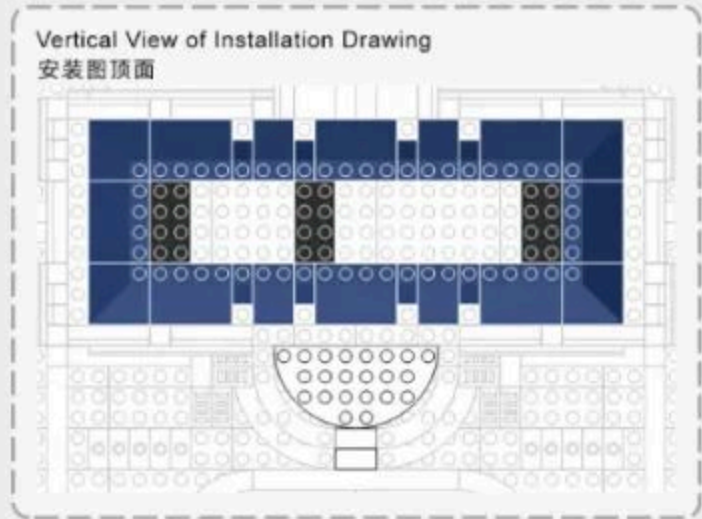
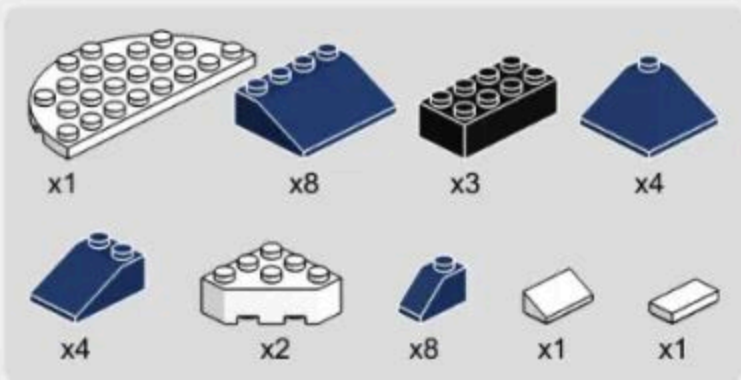

3-3

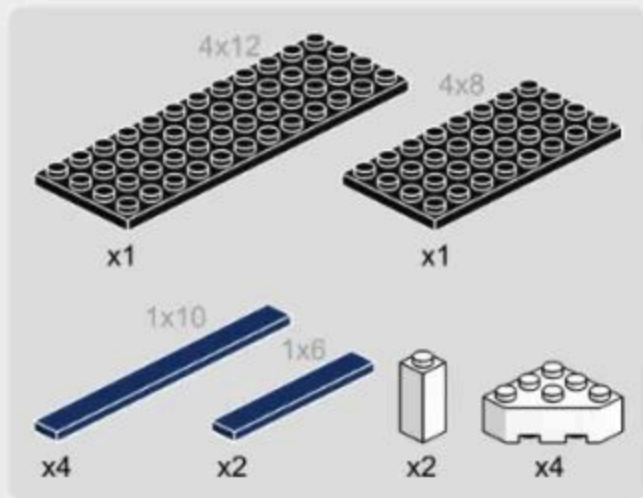

3-4

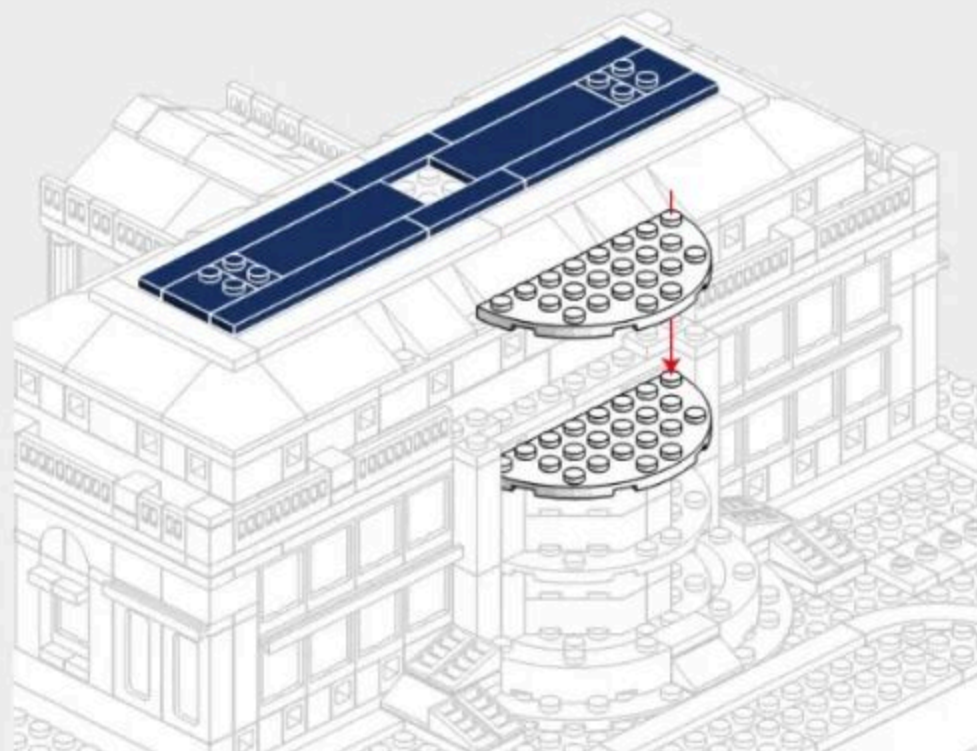
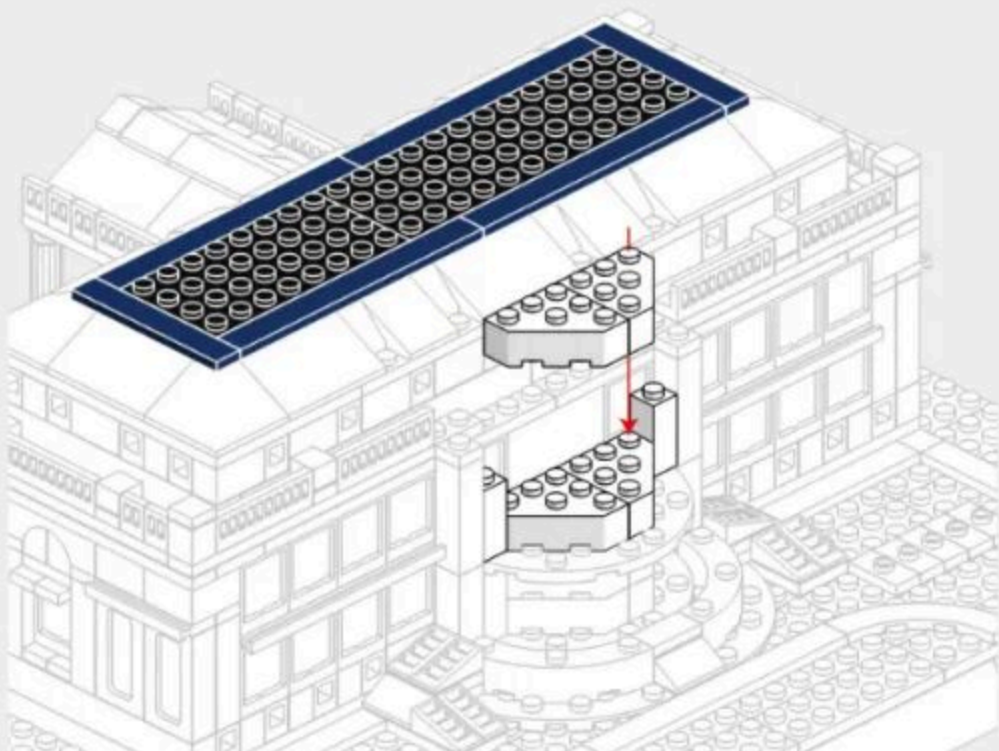
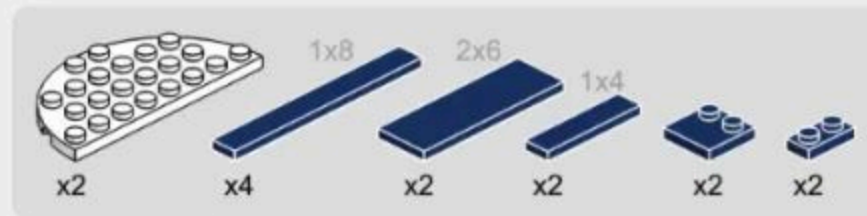

3-5



x12



x2



x1



x8



x8



x8



x6

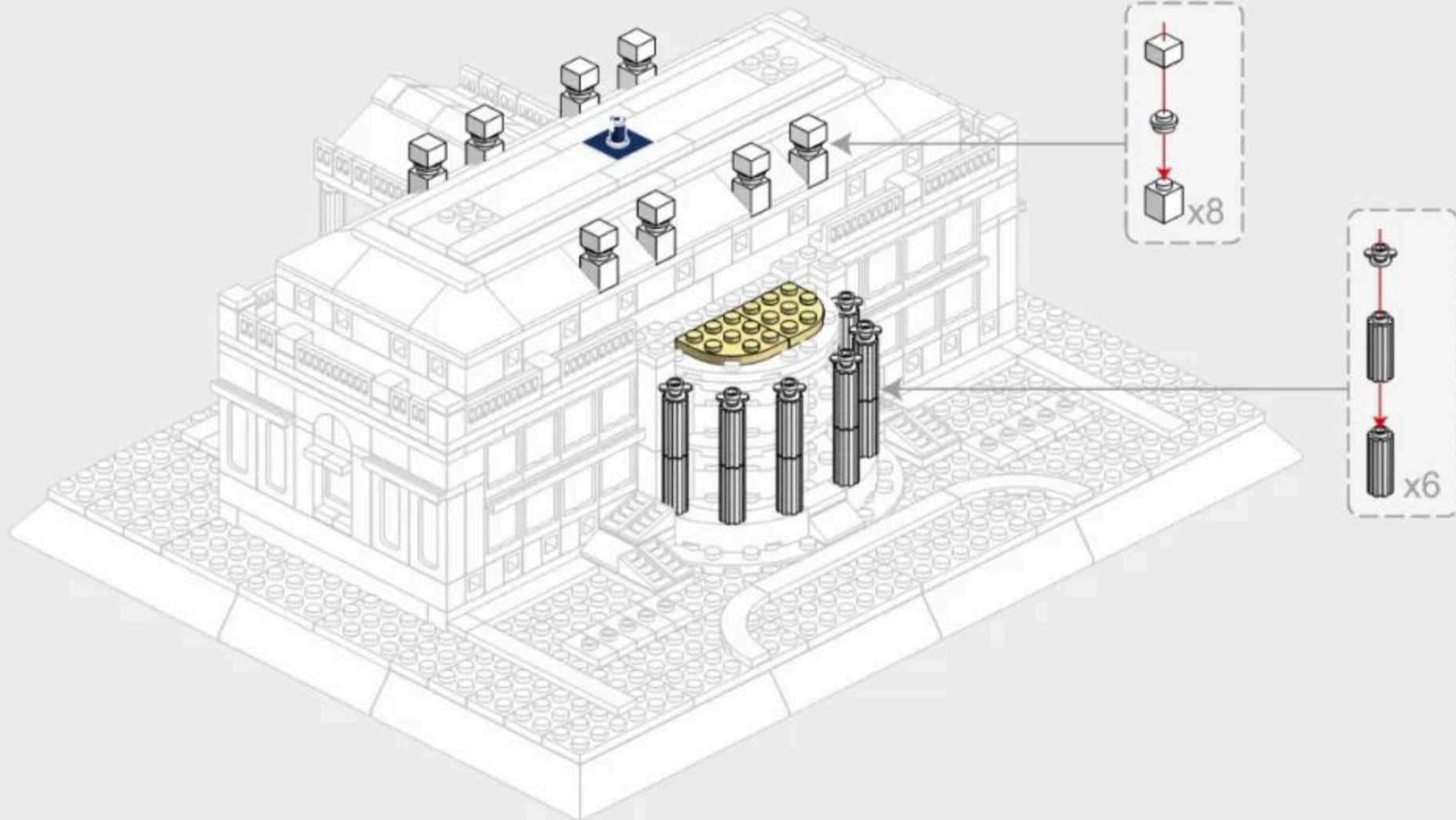

3-6

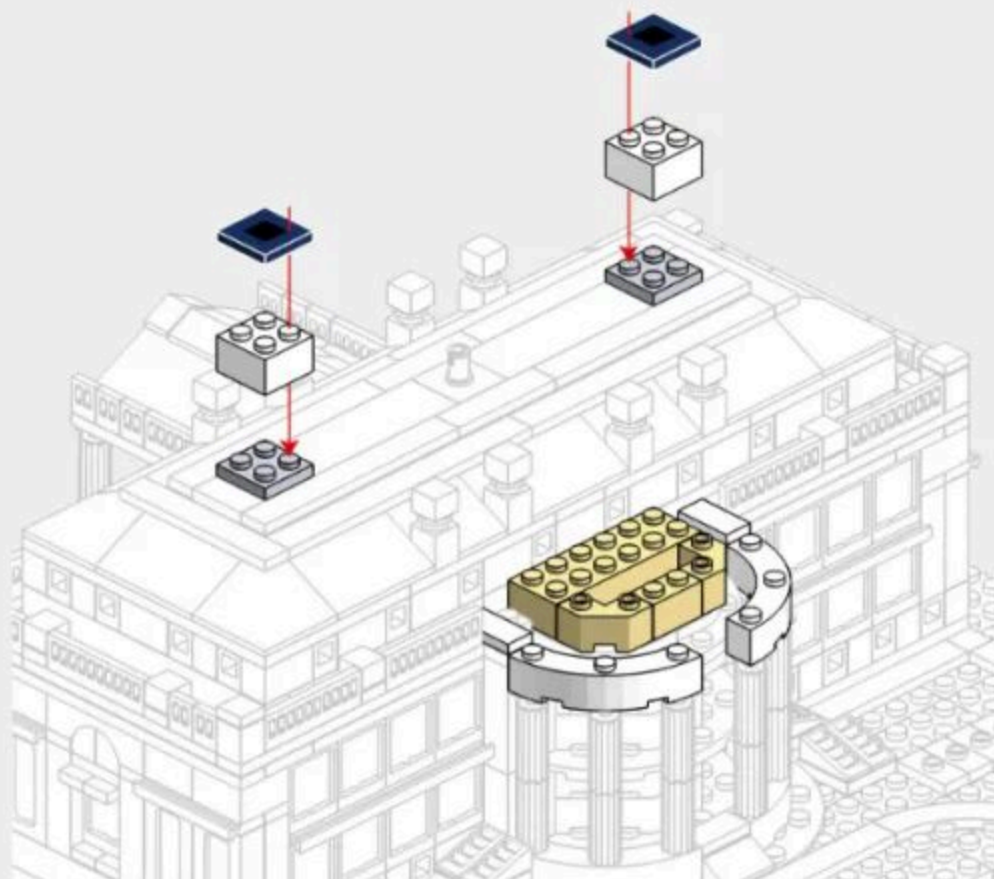
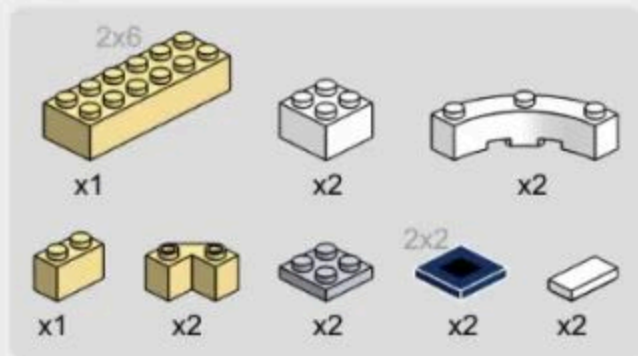

3-7

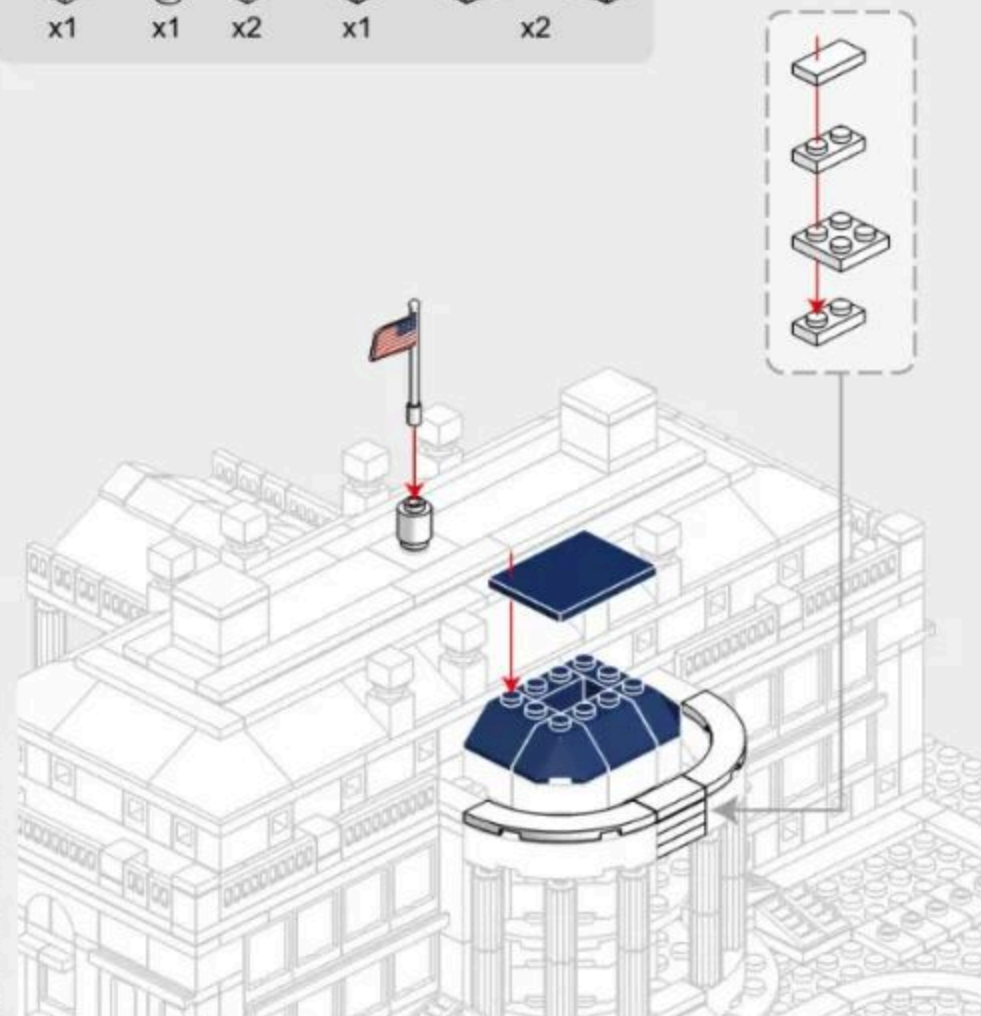

3-8

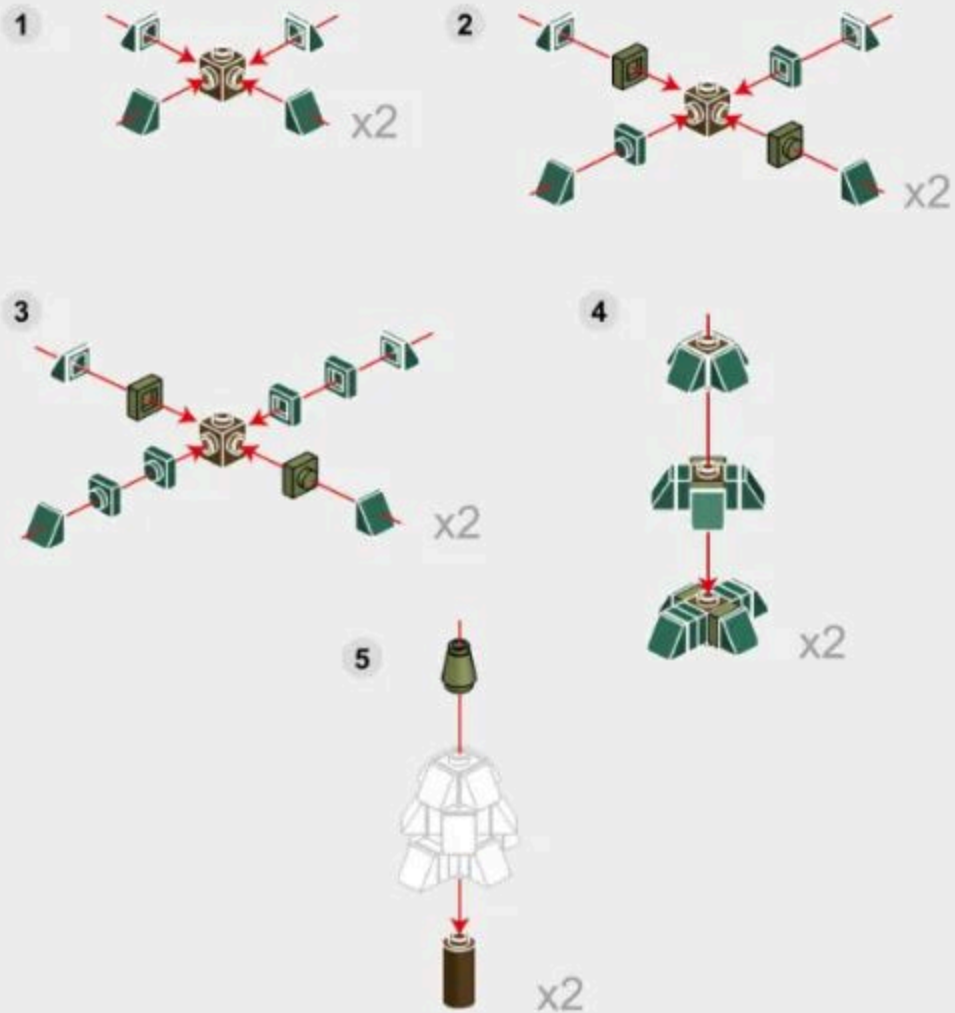

3-9

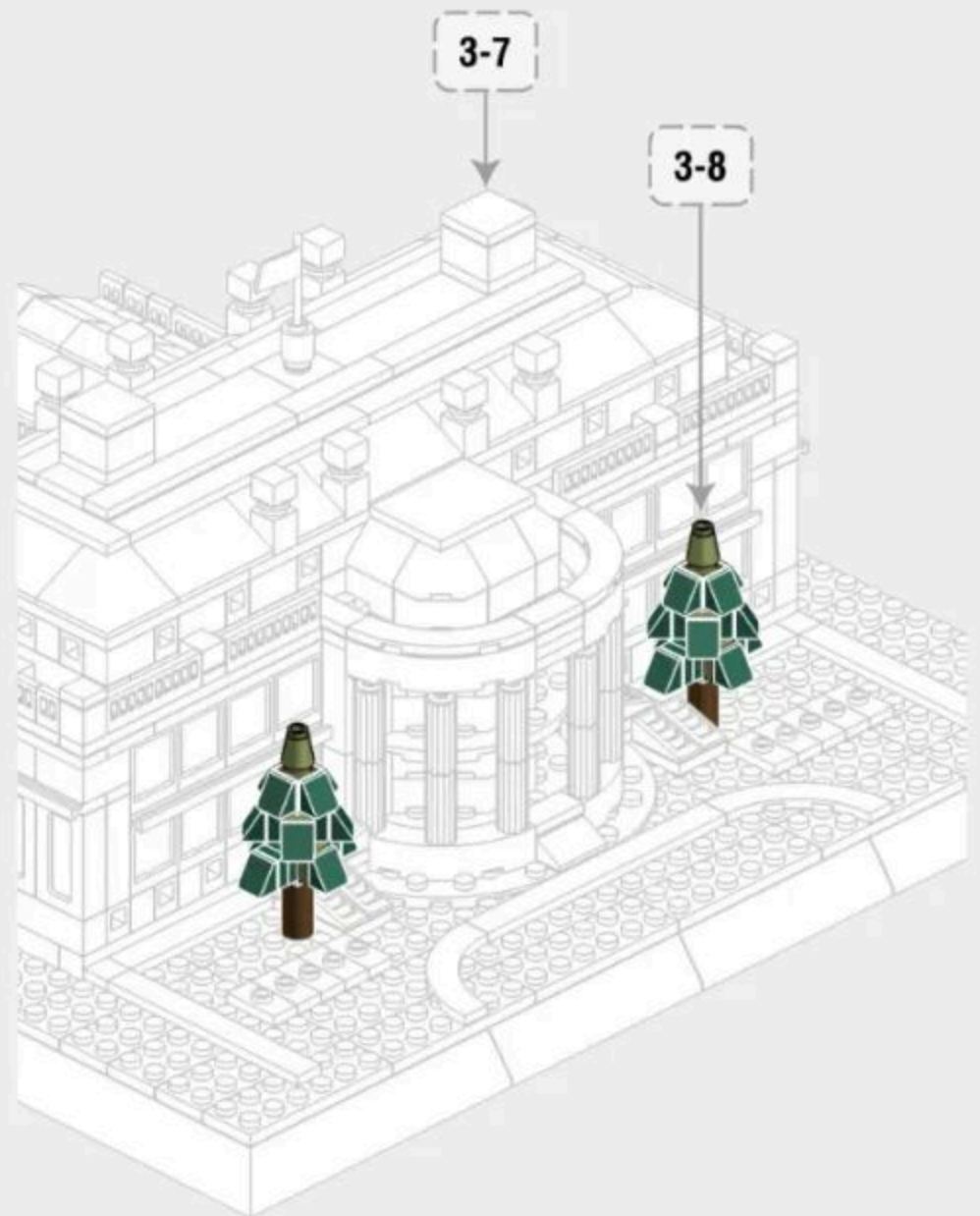

3-10

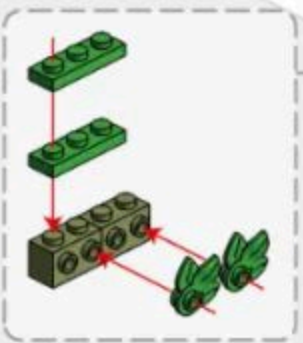
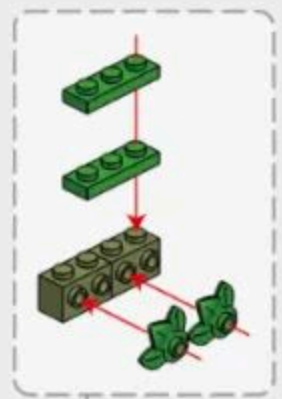

3-11

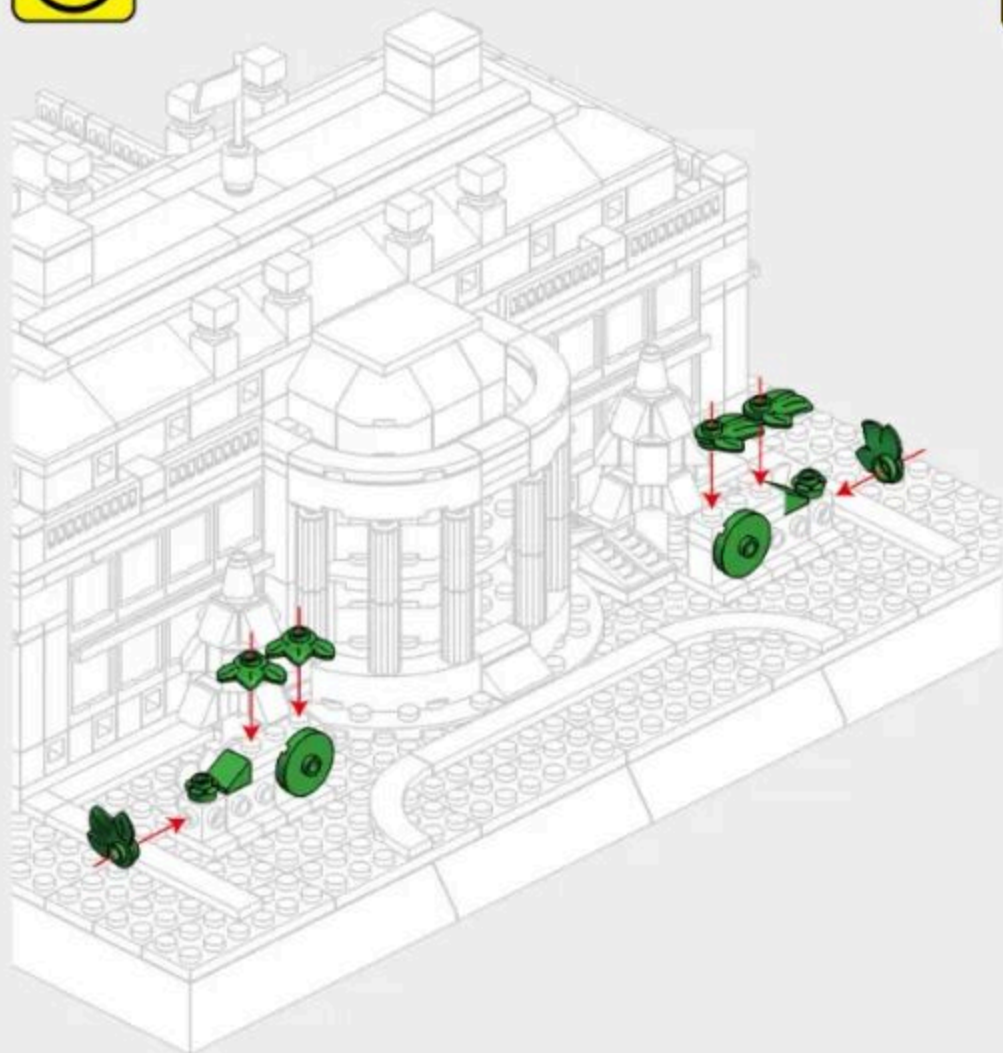

3-12

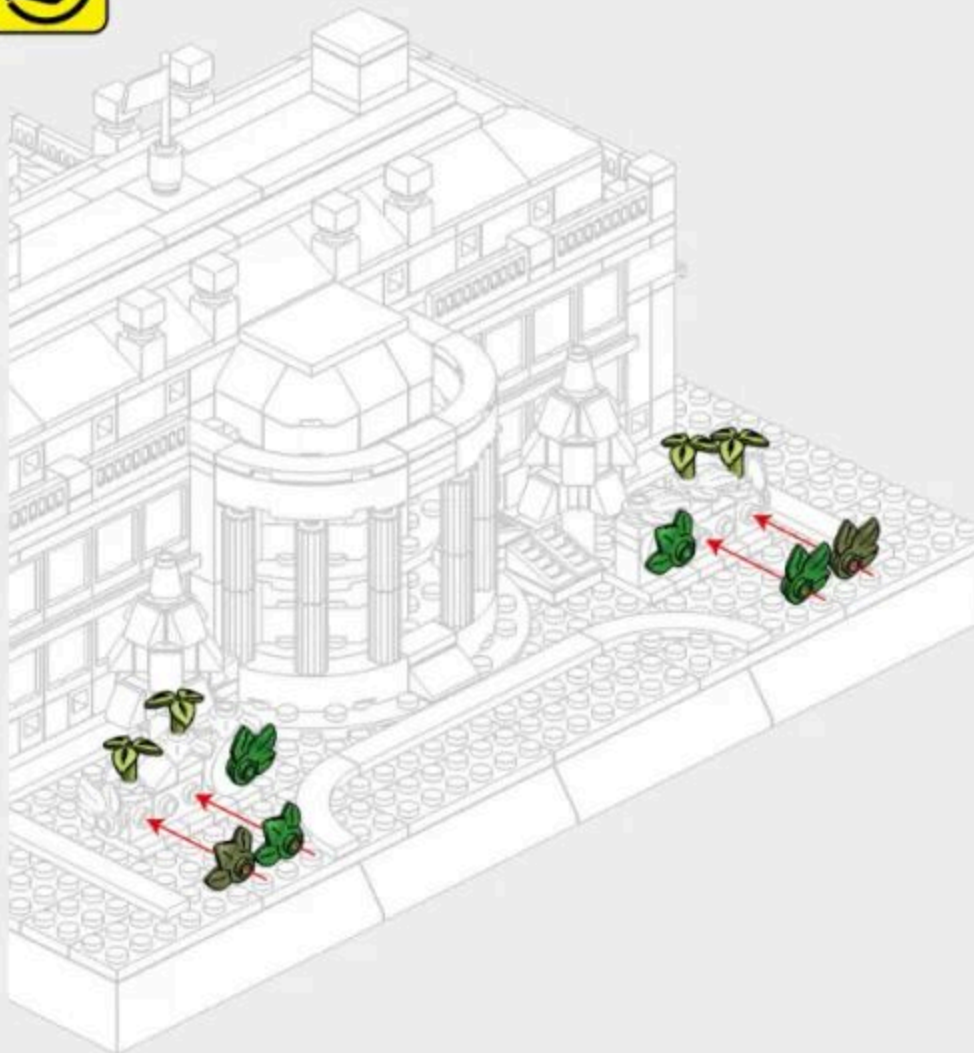



86PCS



51

4-1



Vertical View of Installation Drawing  
安装图顶面

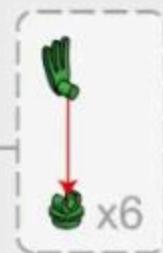
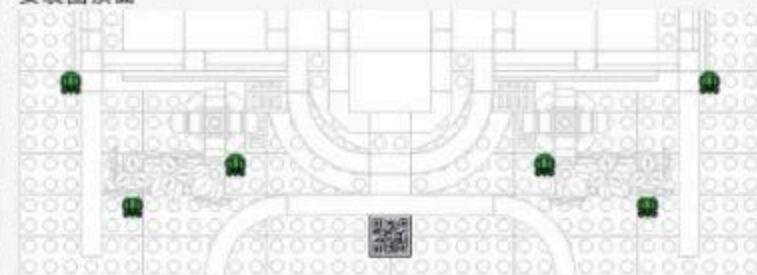

4-2

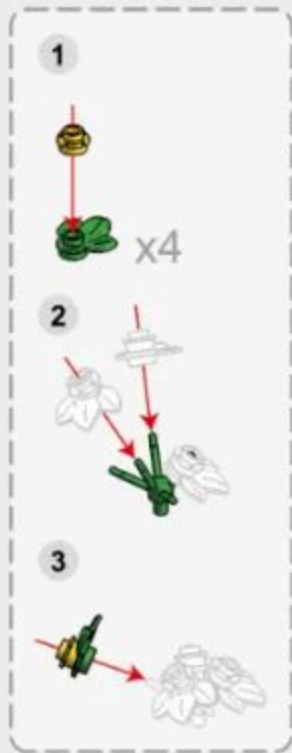
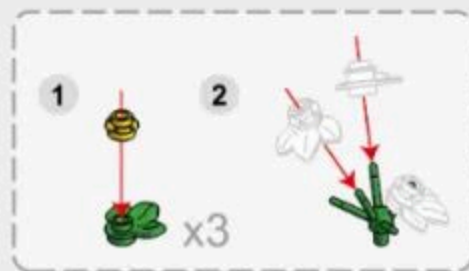
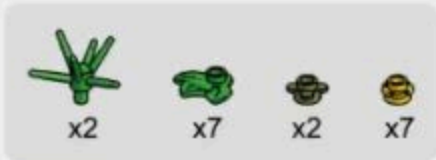

4-3

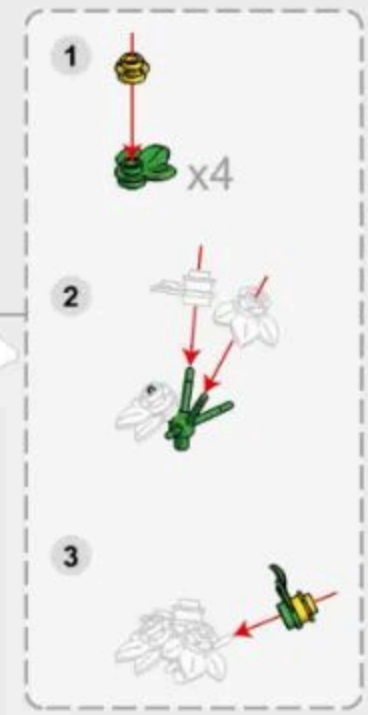
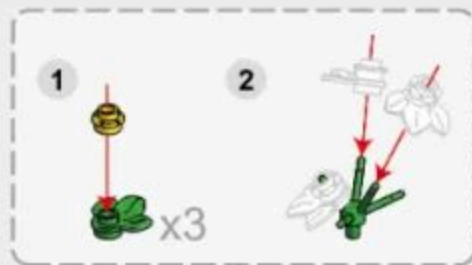
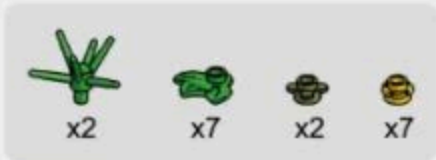

4-4



Vertical View of Installation Drawing  
安装图顶面

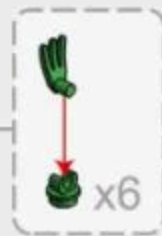
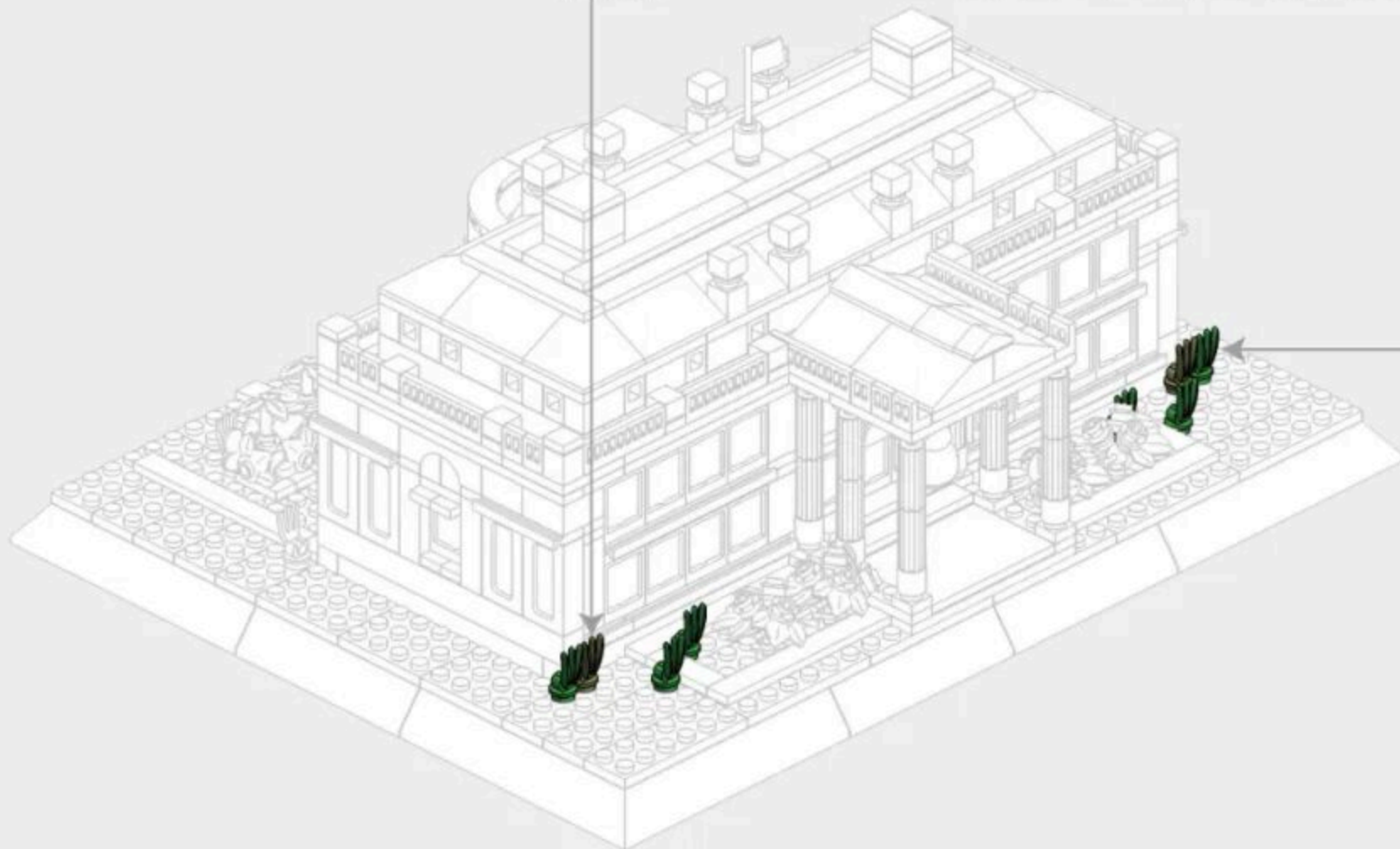
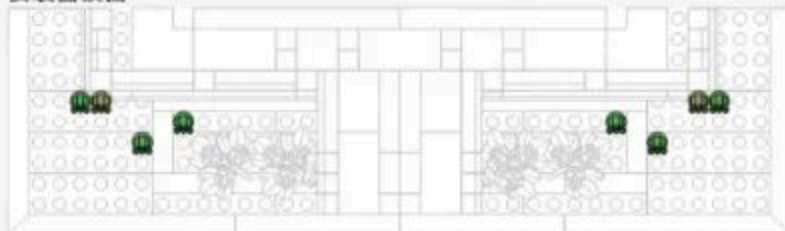

4-5



Vertical View of Installation Drawing  
安装图顶面

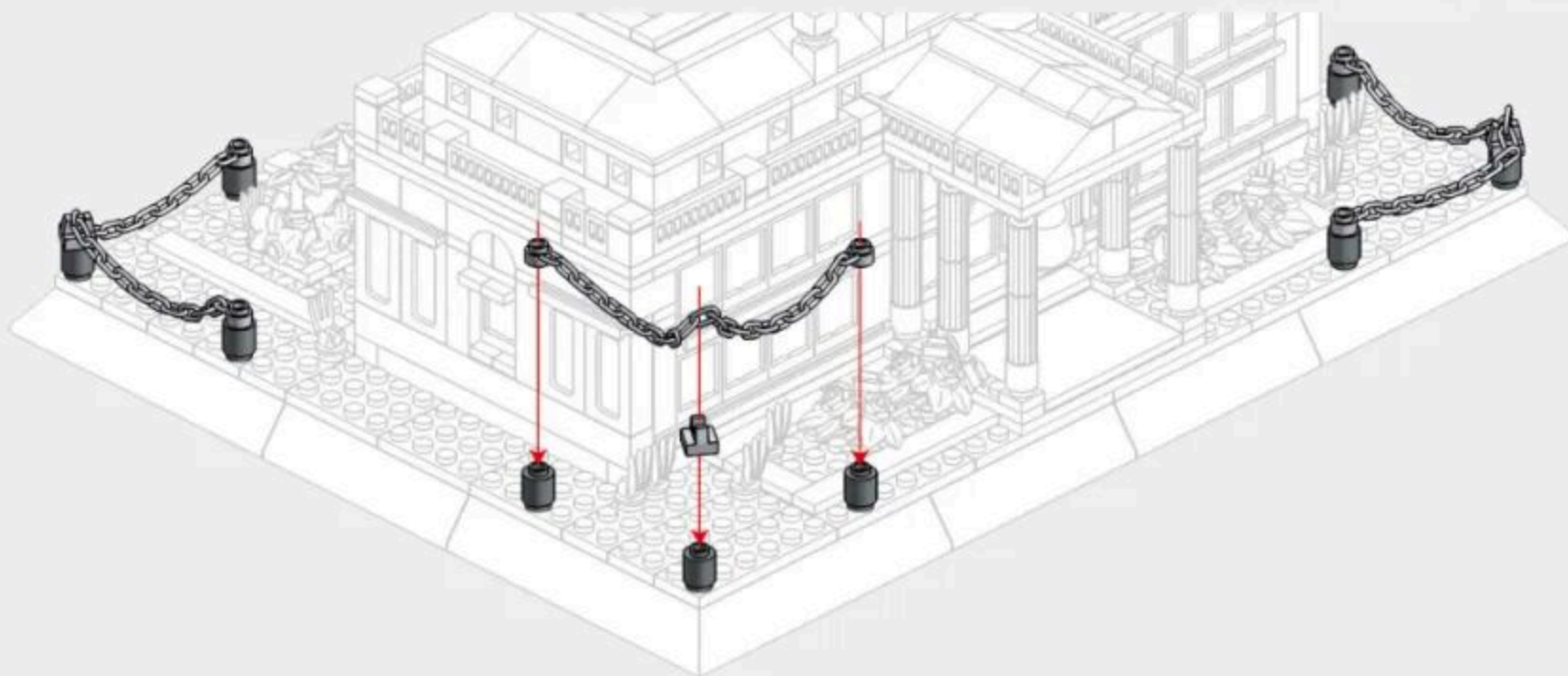
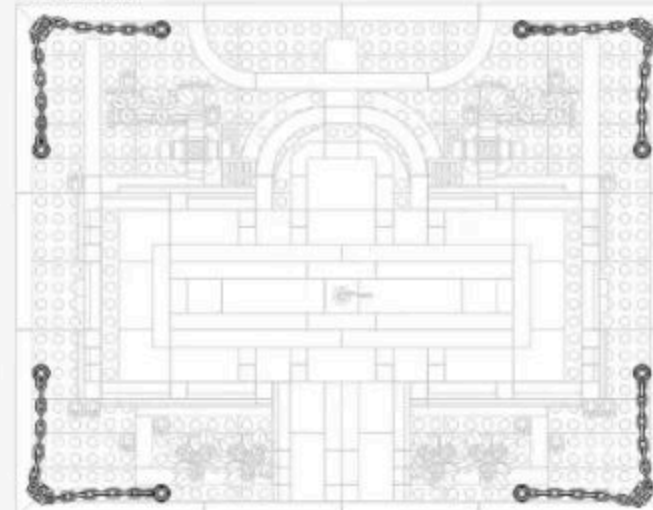

4-6

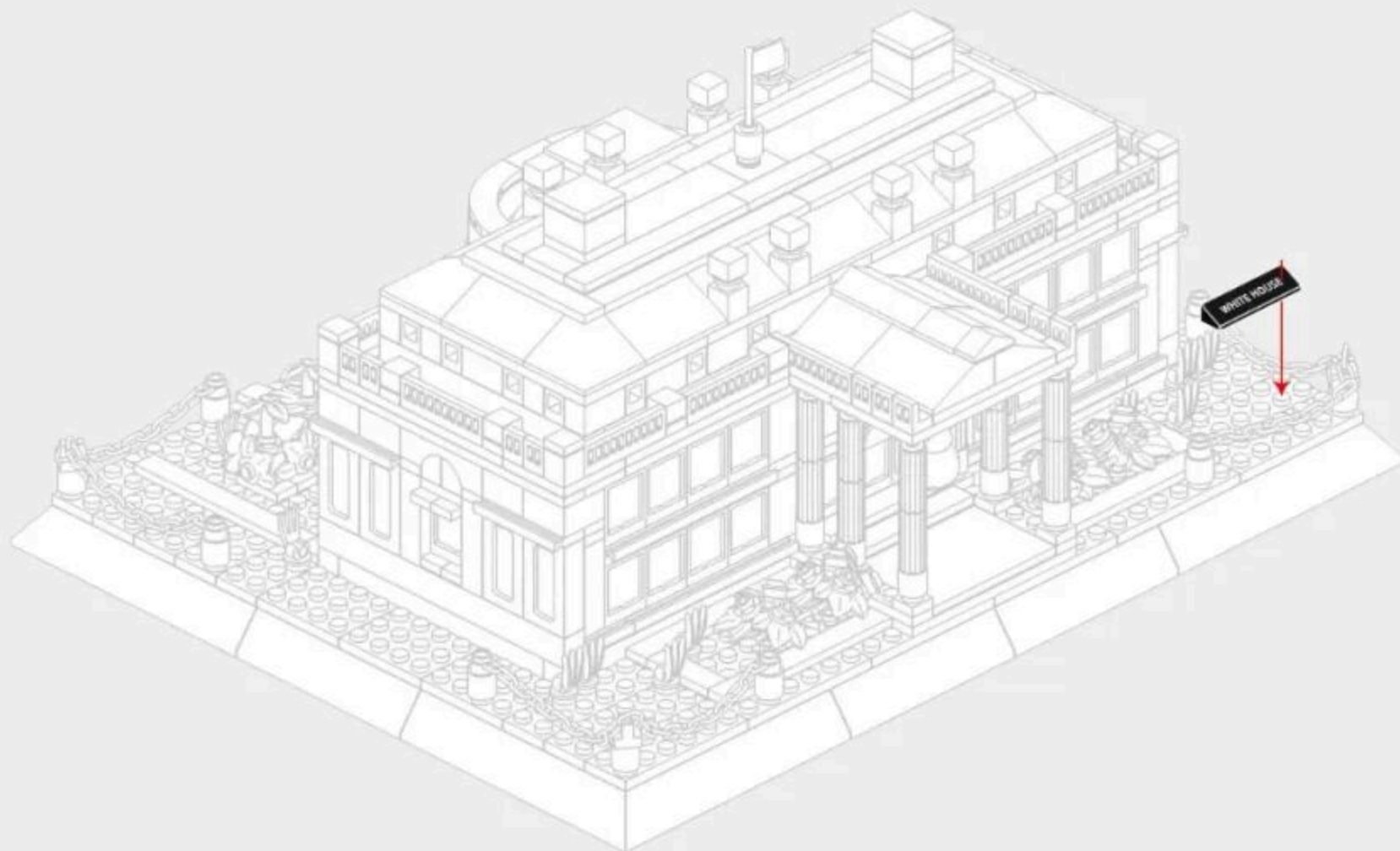

57



# WHITE HOUSE

COUNTRY: America

CITY: Washington, D.C.

