



THE CN TOWER OF TORONTO

Canada
The world's great architecture

Ages
6+



NO.4215
400 PCS

1 10 X 10

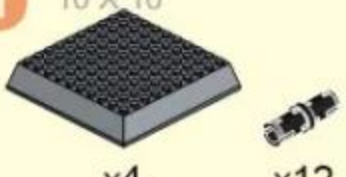

x4 x12

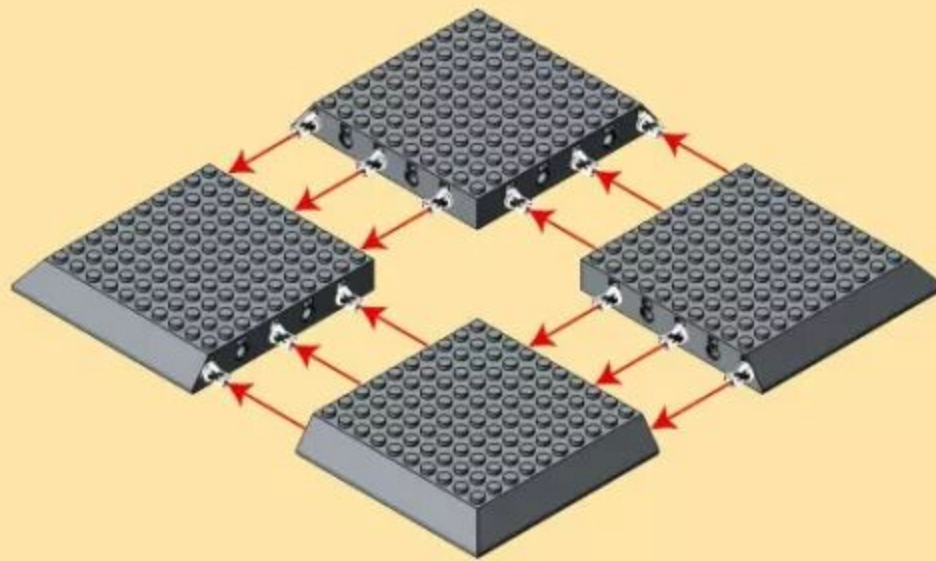

2



x2 x1 x1 x2 x6 x1 x2

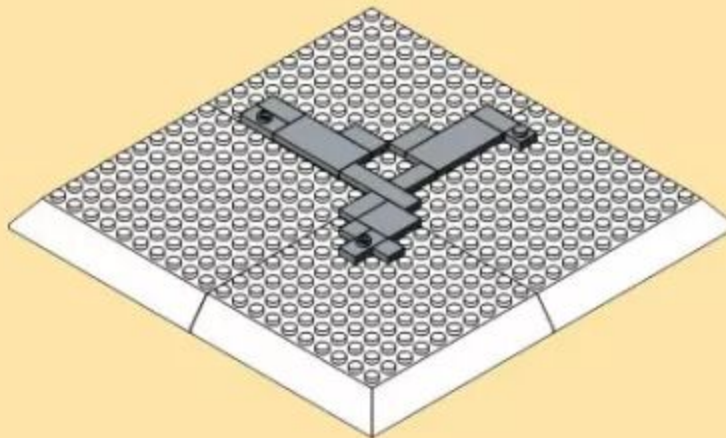

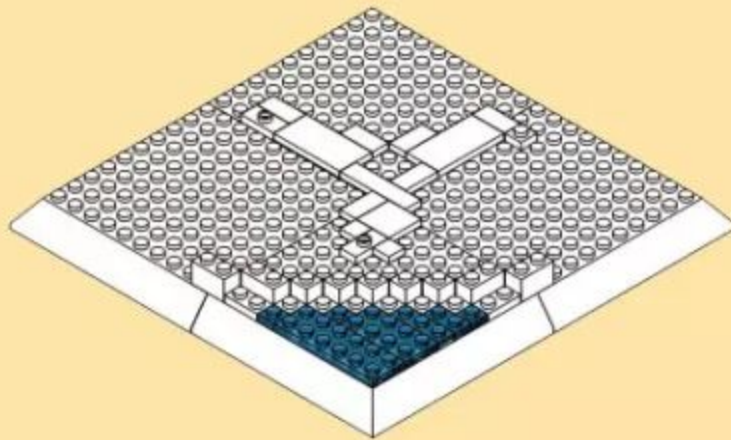
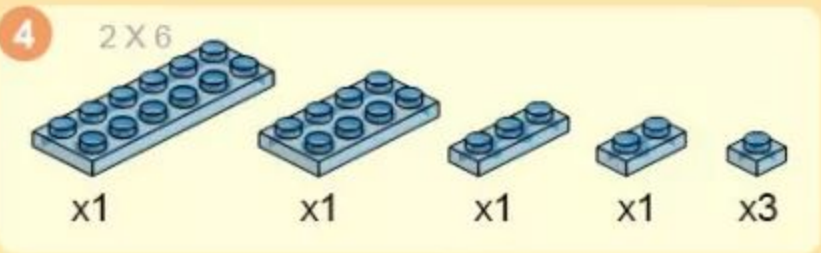
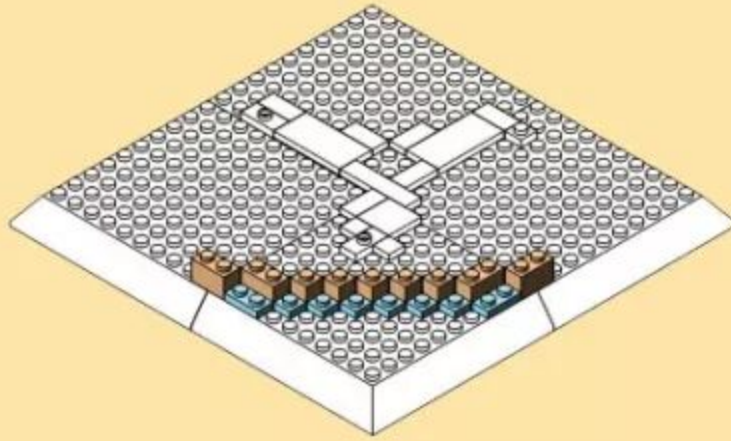
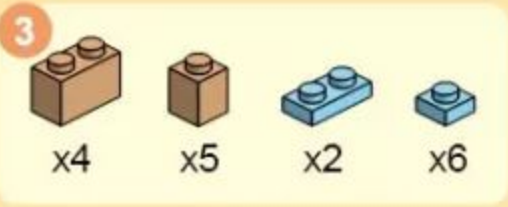

7

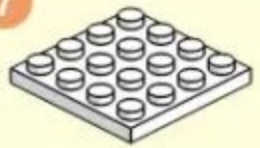

x1



x1



x1

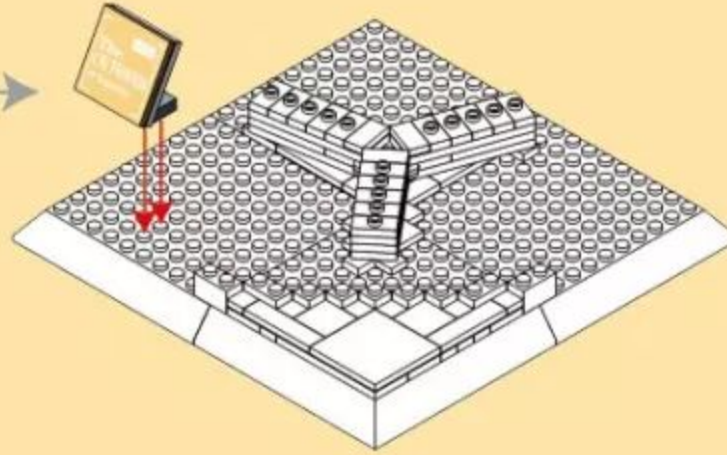

8

1 X 6



x3



x6



x3



x3



x3



x3

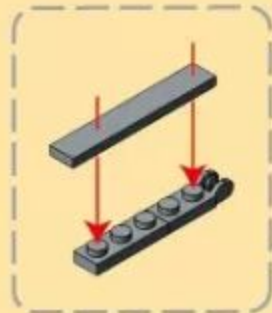

x3

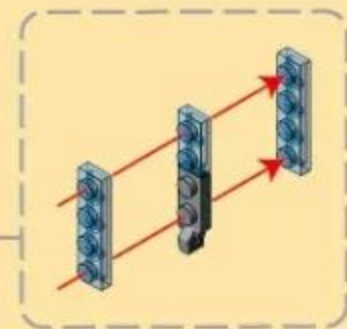

9

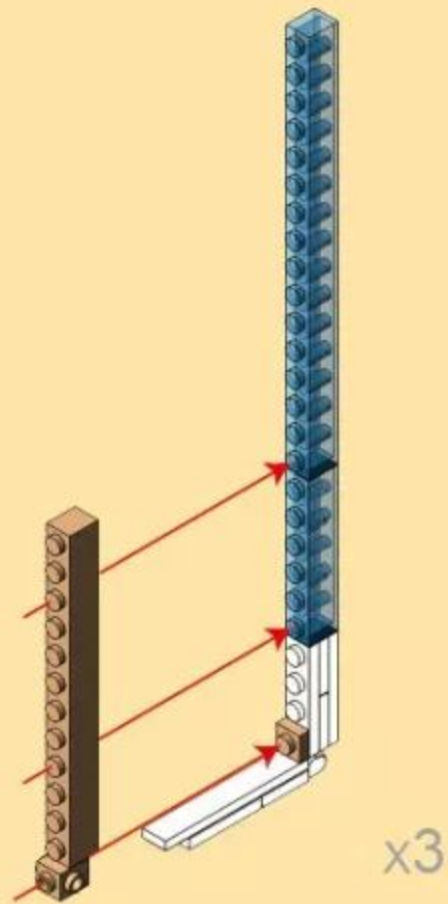
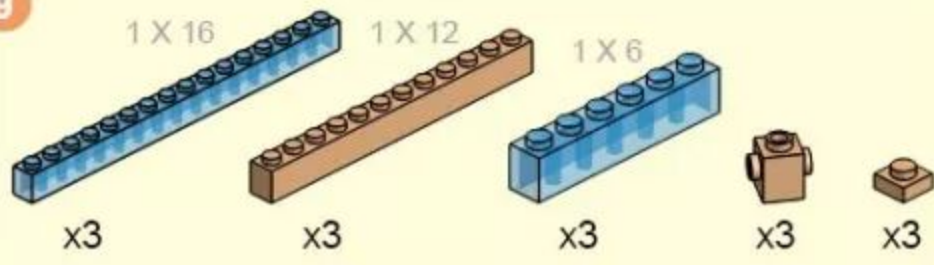

10

1 X 16

1 X 16

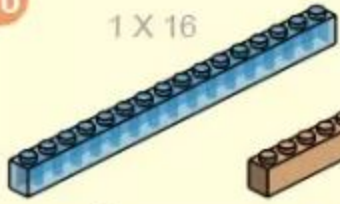

x3

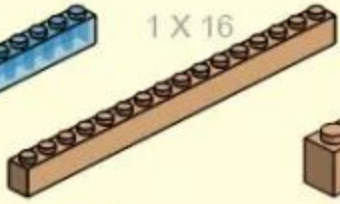

x3



x3



x6

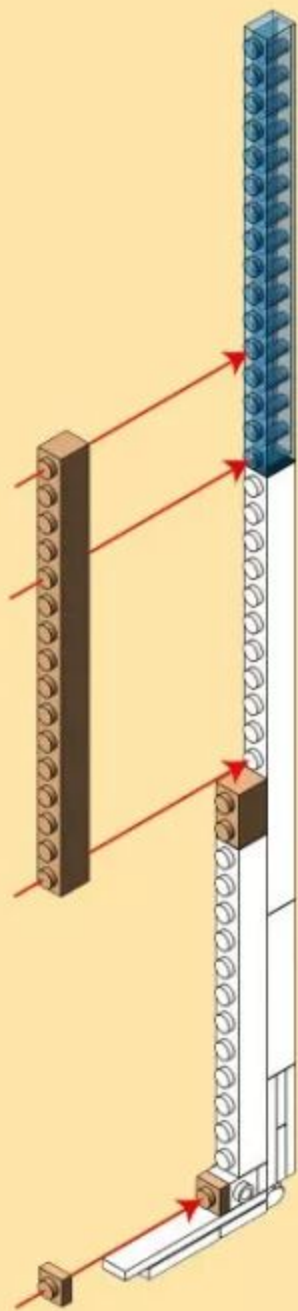

x3

11

1 X 16

1 X 12

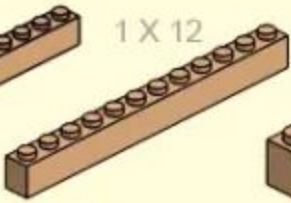
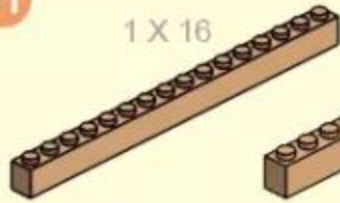

x3

x3

x3

x3

x3

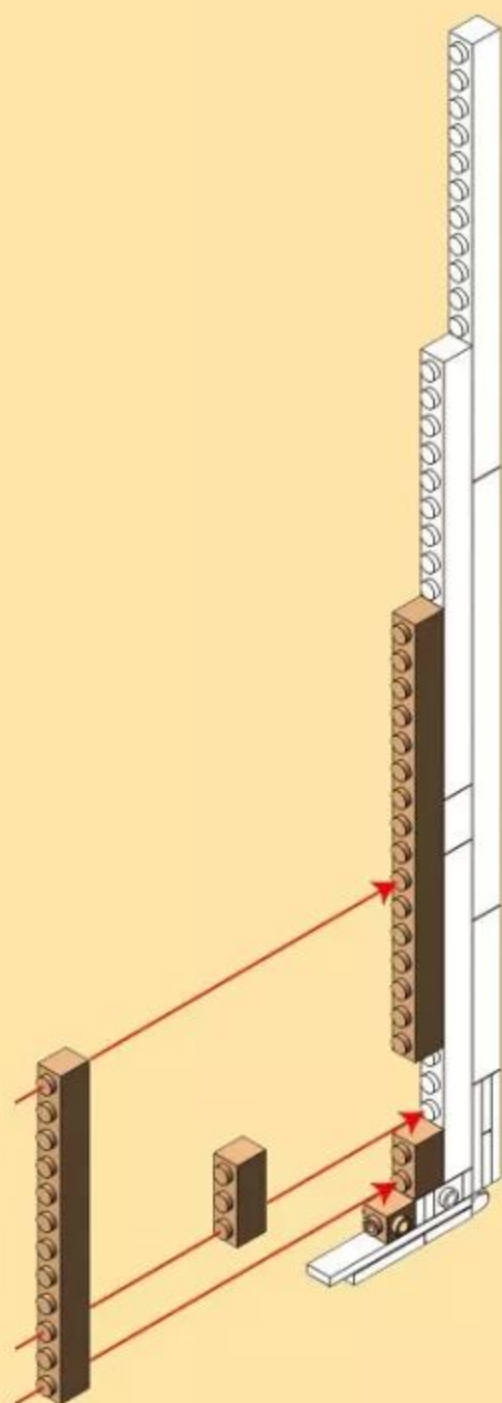

x3

12

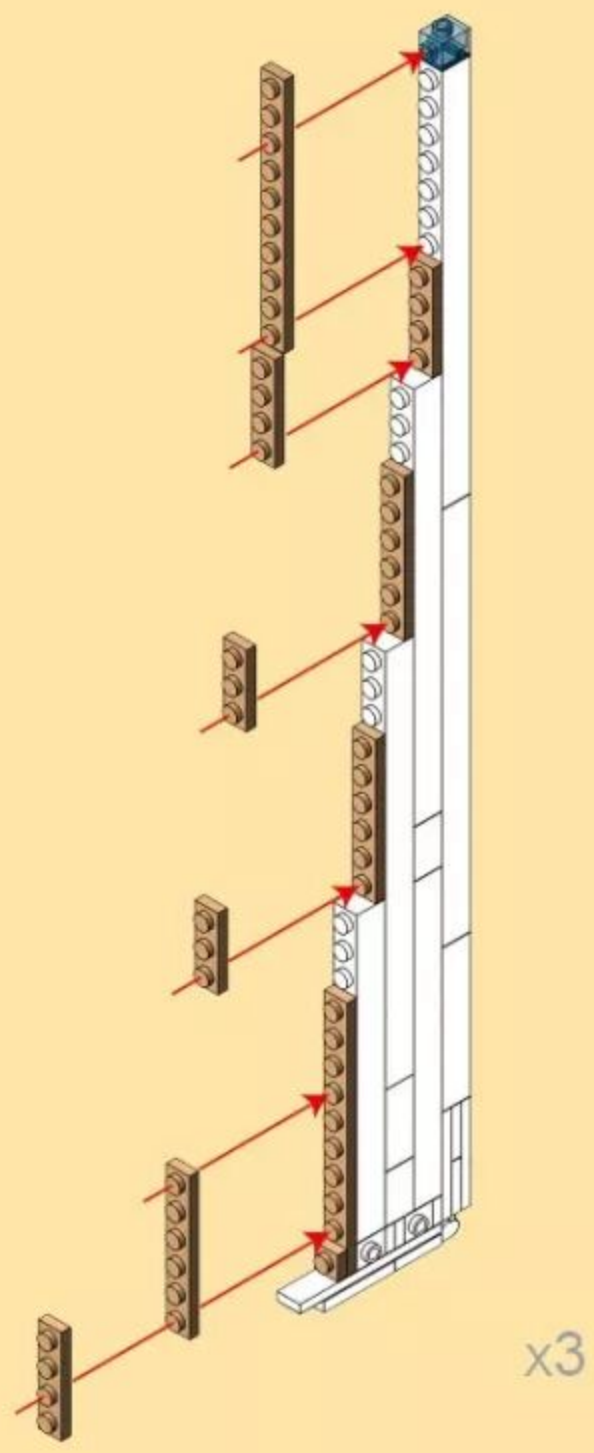
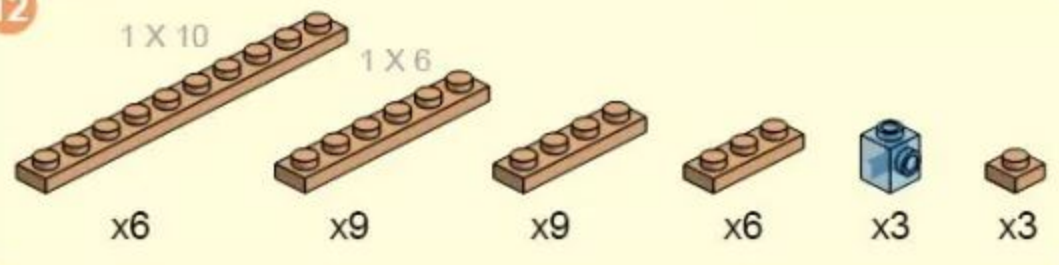

13



x27



x15

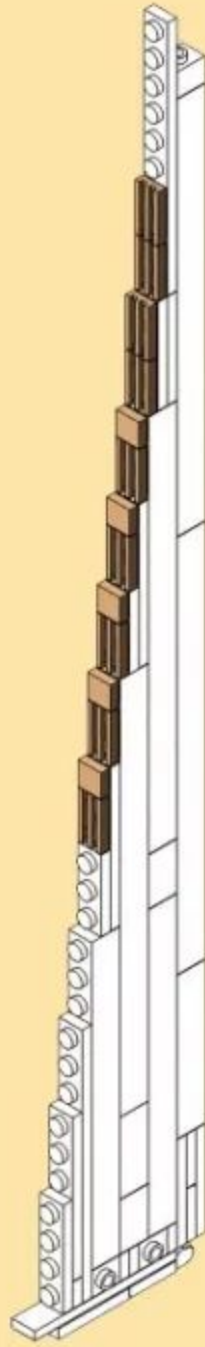

x3

14

1 X 6

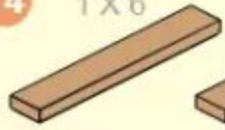

x6



x3



x15



x3



x15

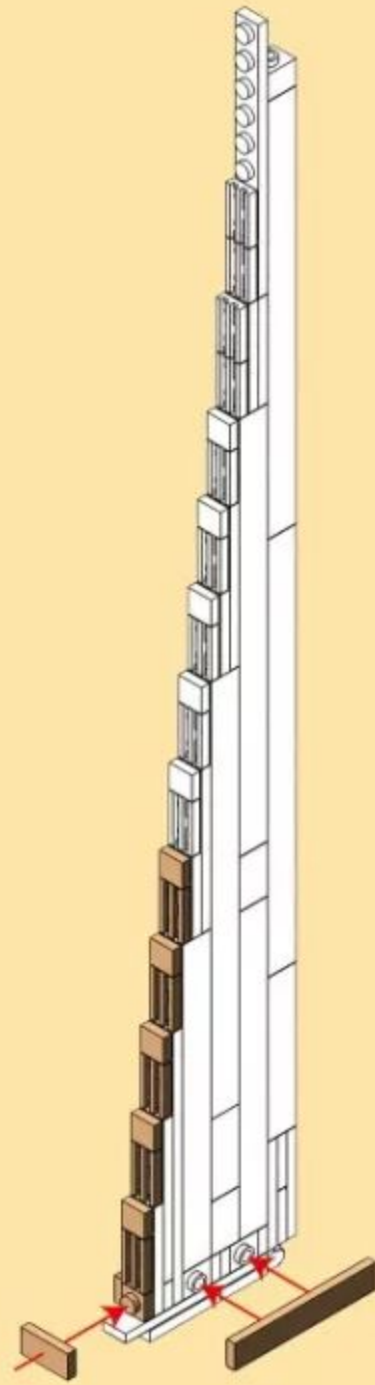

x3

15

7 + 14

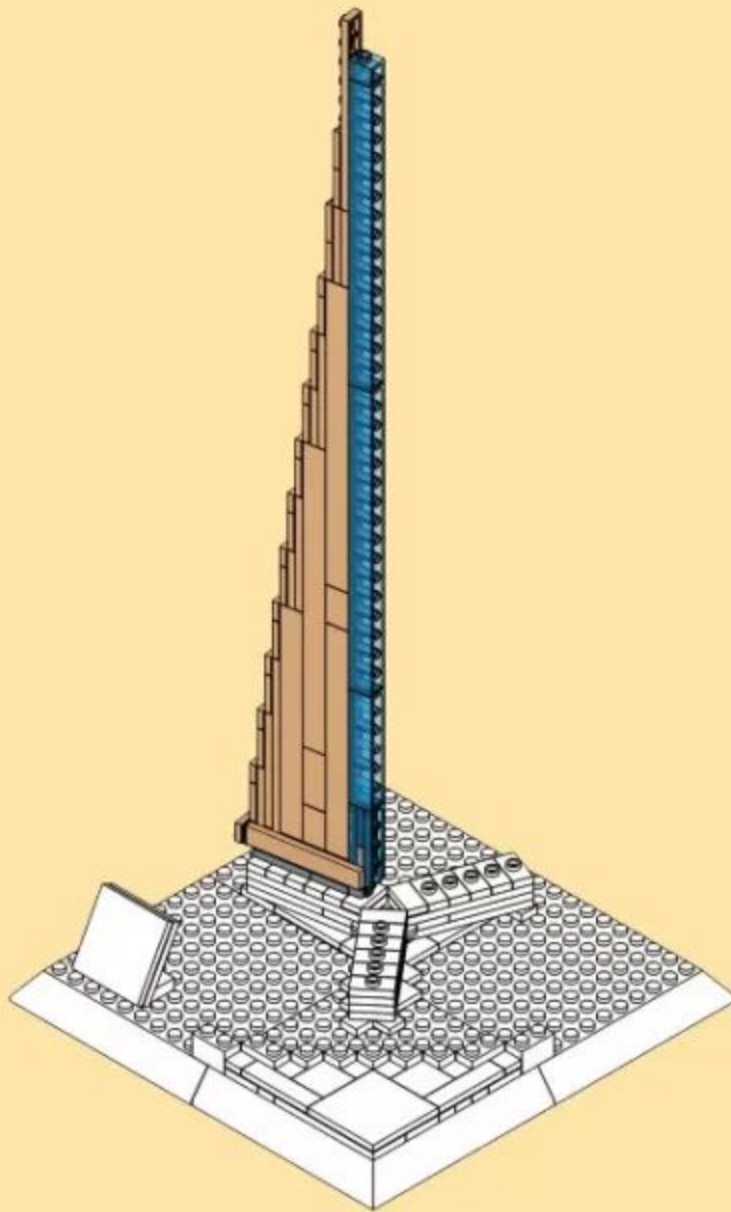

16

14 + 15

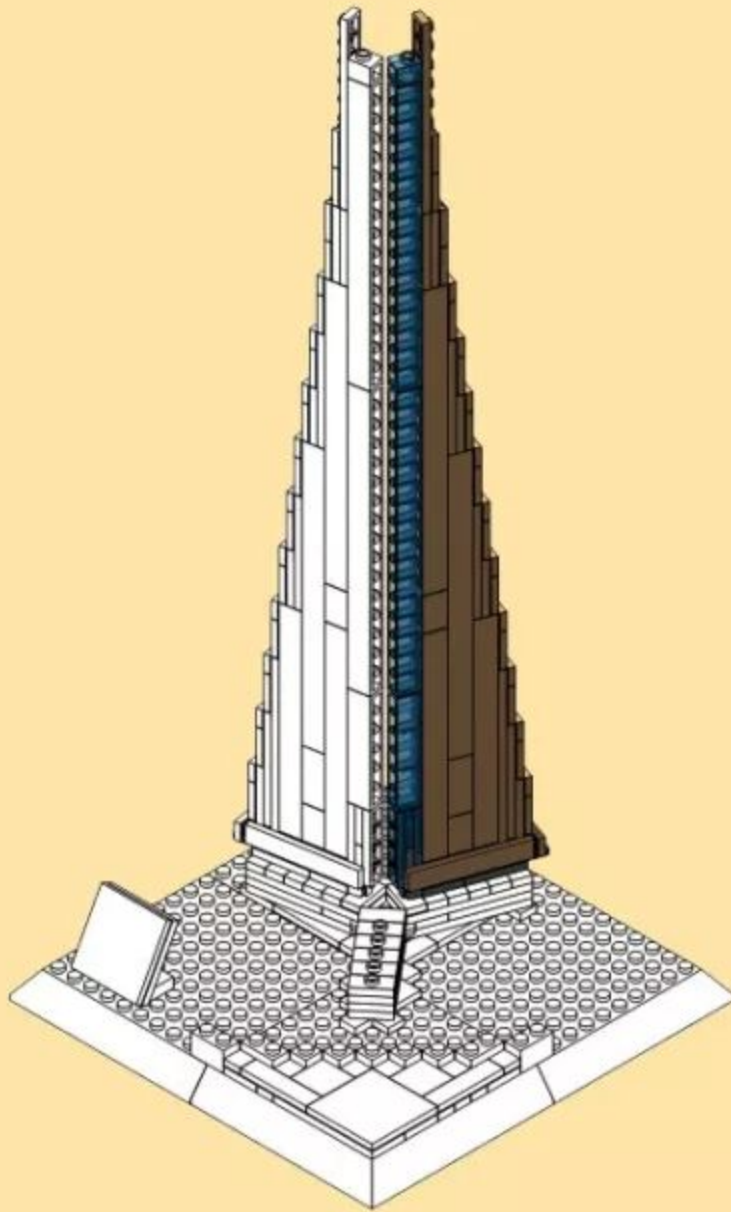

17

14 + 16

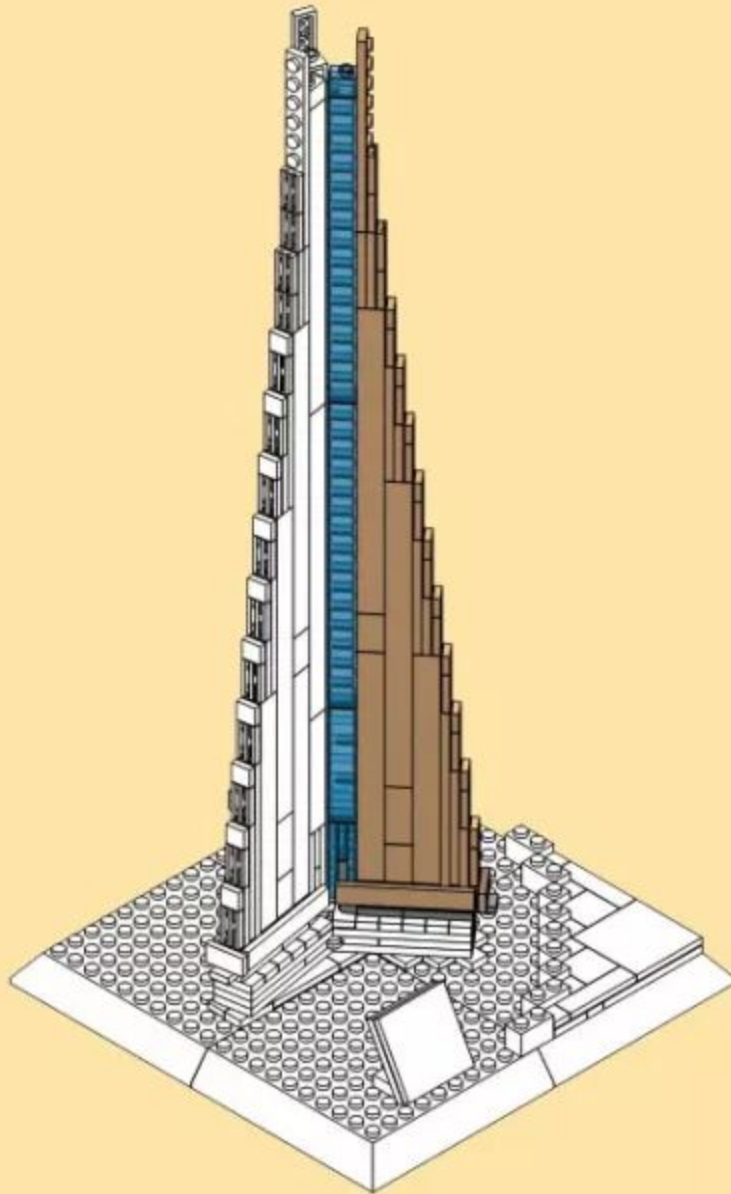

18



x3



x1



x3



x3

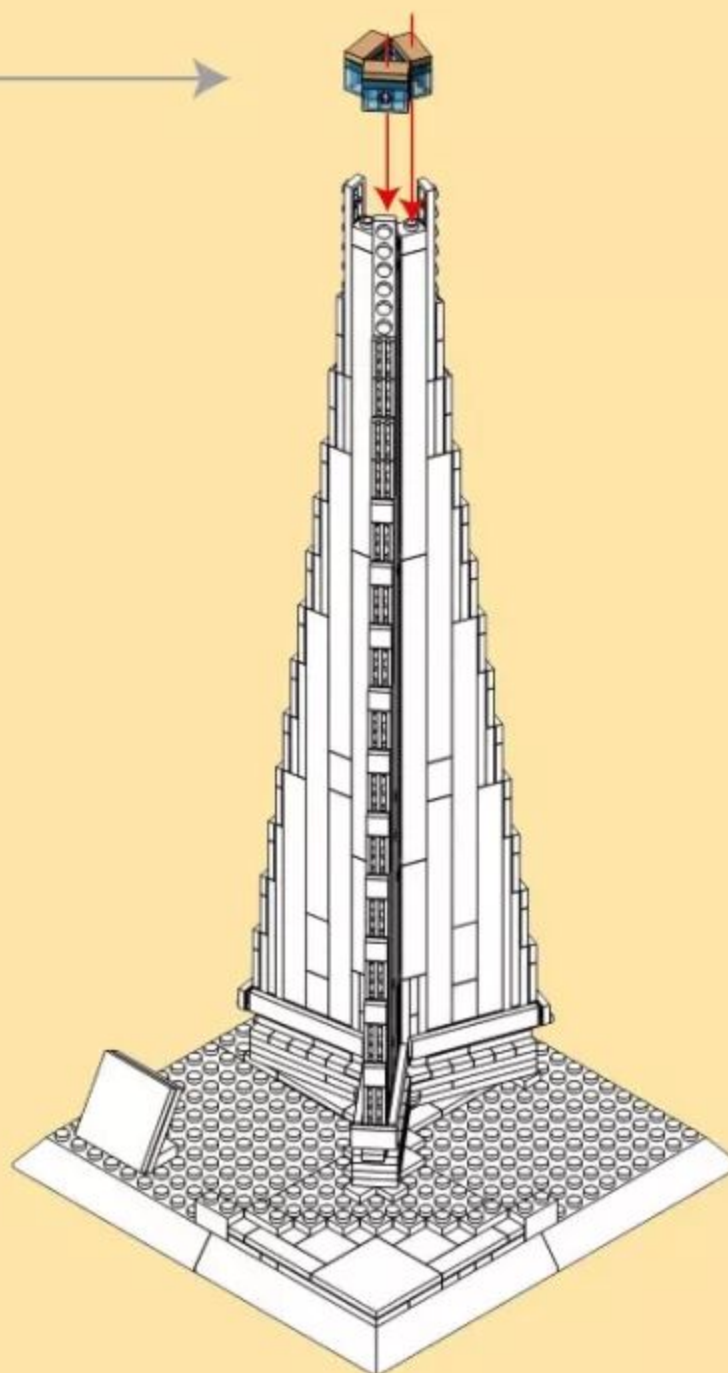
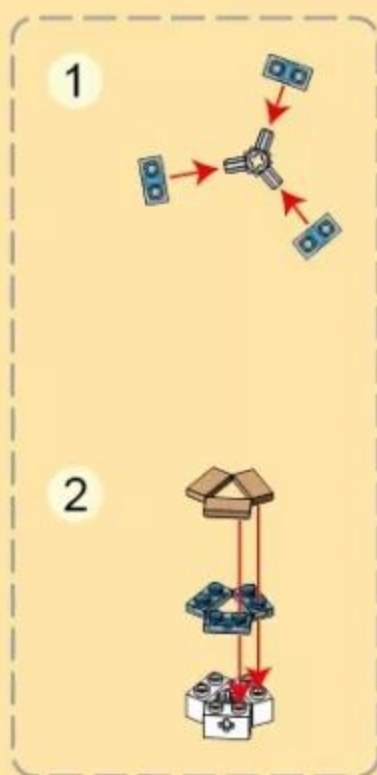

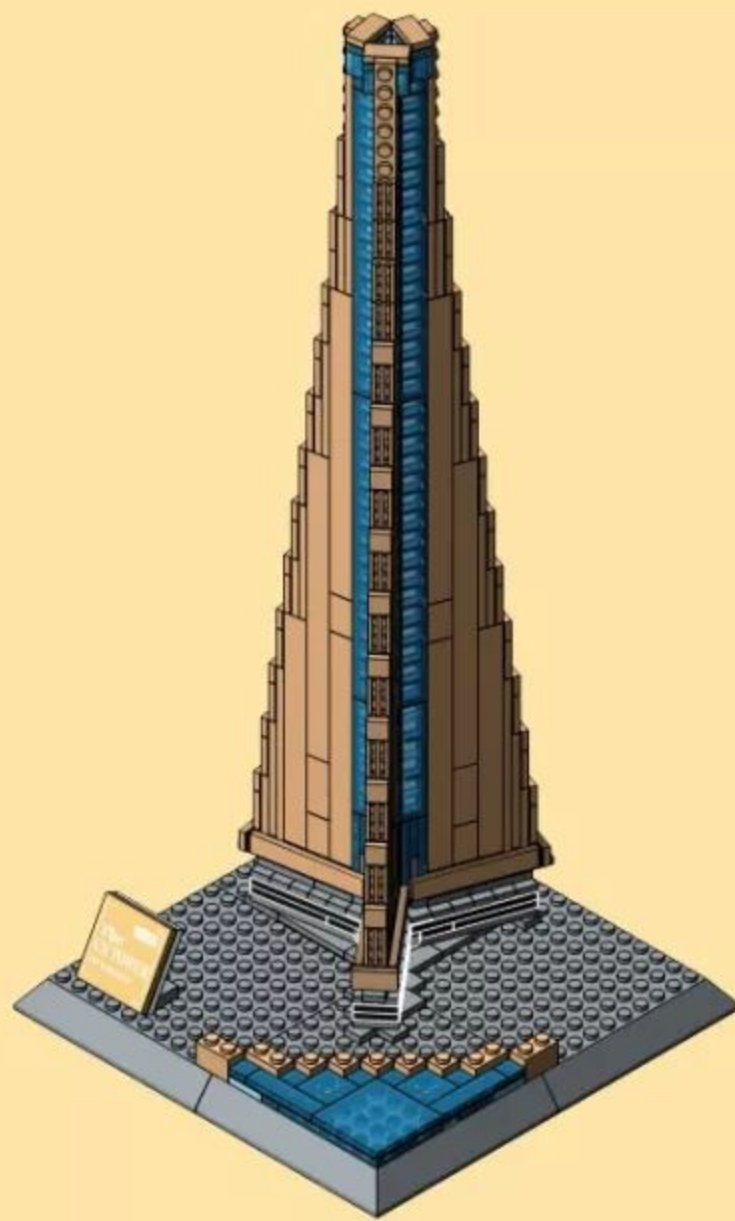

20



x1



x1



x6



x8



x1



x1

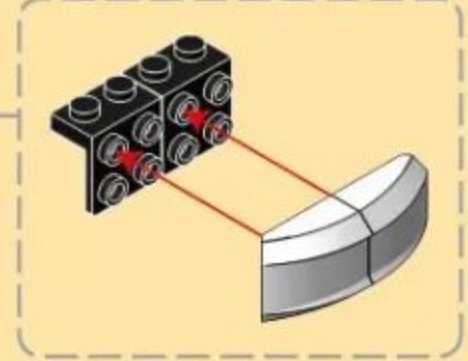
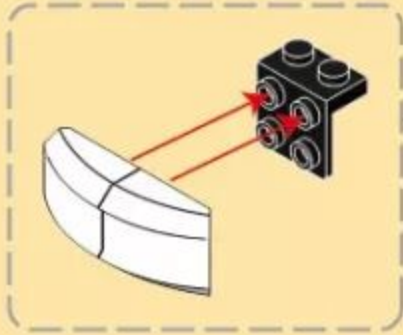

21



x4



x4



x8

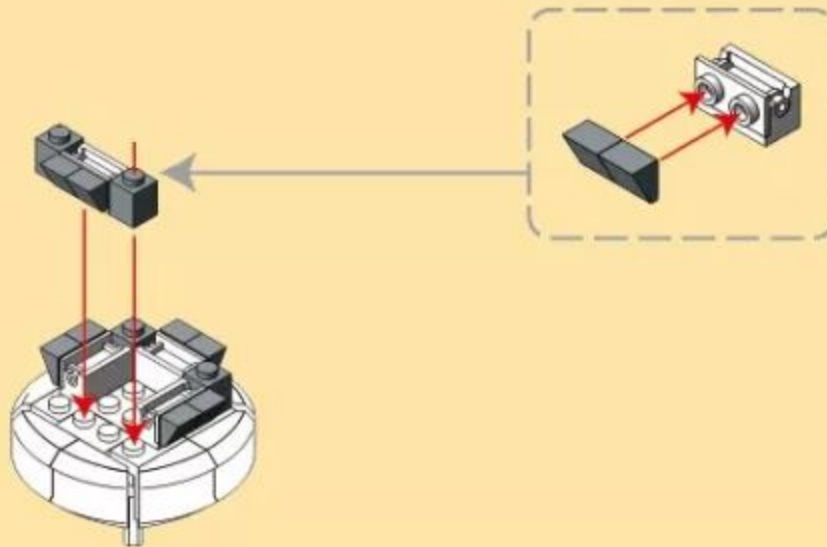

22



x12



x4



x4

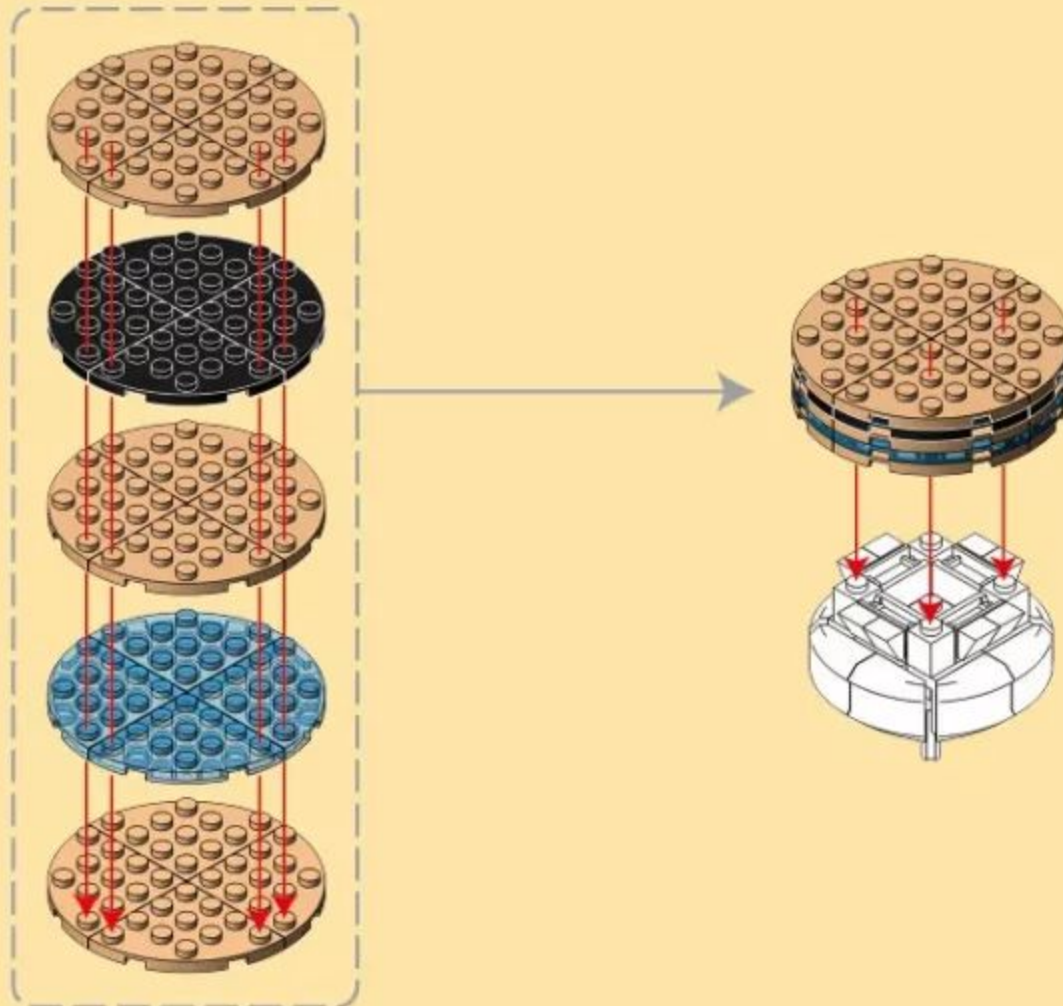

25

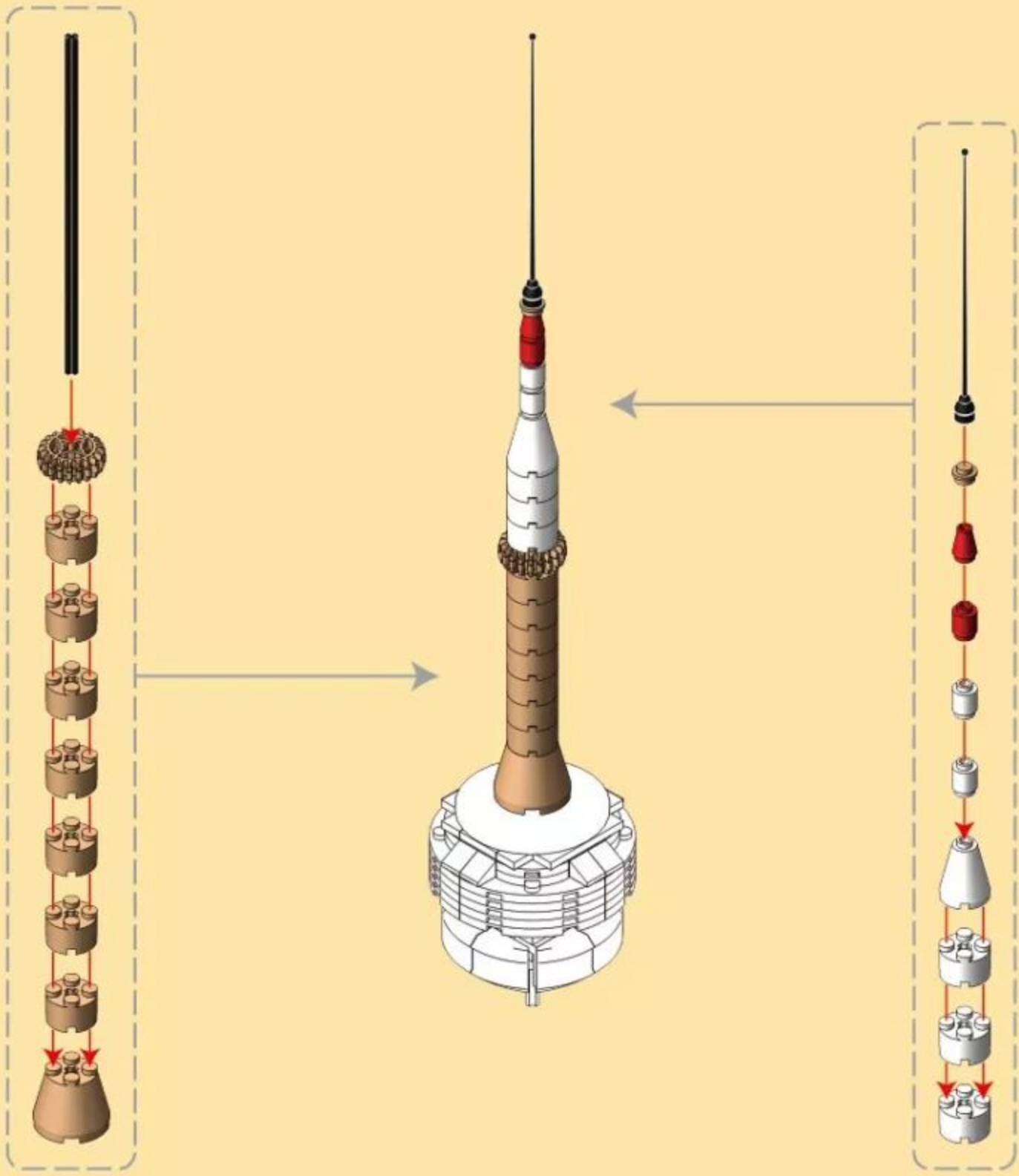

26

19 + 25





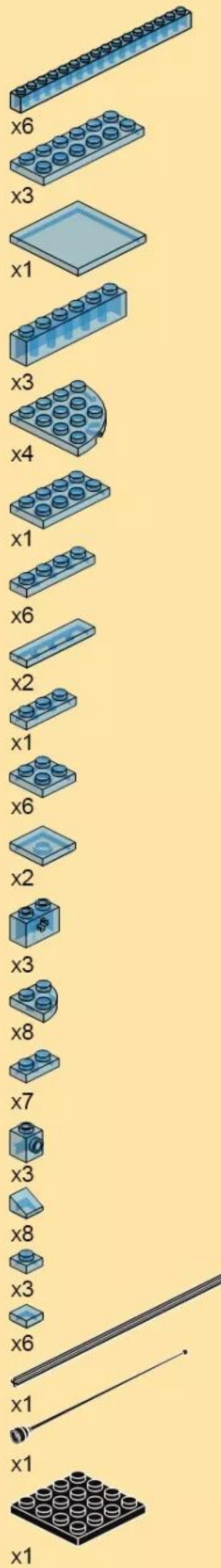
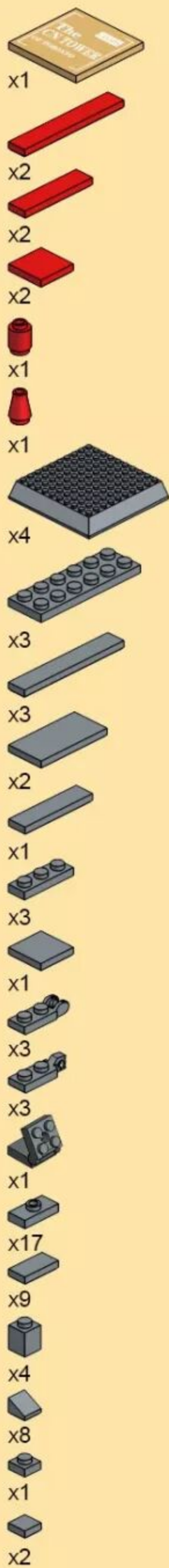



THE CN TOWER OF TORONTO

INTRODUCTION

The CN Tower (French: Tour CN) is a 553.33 m-high (1,815.4 ft) concrete communications and observation tower in downtown Toronto, Ontario, Canada. It was completed in 1976, becoming the world's tallest free-standing structure and world's tallest tower at the time. It held both records for 34 years until the completion of Burj Khalifa and Canton Tower in 2010. It is now the 3rd tallest tower in the world and remains the tallest free-standing structure in the Western Hemisphere, a signature icon of Toronto's skyline, and a symbol of Canada.

Its name "CN" originally referred to Canadian National. Since the name CN Tower became common in daily usage, the abbreviation was eventually expanded to Canadian National Tower or Canada's National Tower. However, neither of these names is commonly used. In 1995, the CN Tower was declared one of the modern Seven Wonders of the World by the American Society of Civil Engineers. It also belongs to the World Federation of Great Towers, where it holds second-place ranking.

