



MARINA BAY SANDS

MARINA BAY SANDS

Singapore

The world's great architecture

Construction Difficulty

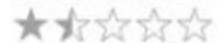

6+ / 4217 / 1154 PCS
Age Product Number Parts Total

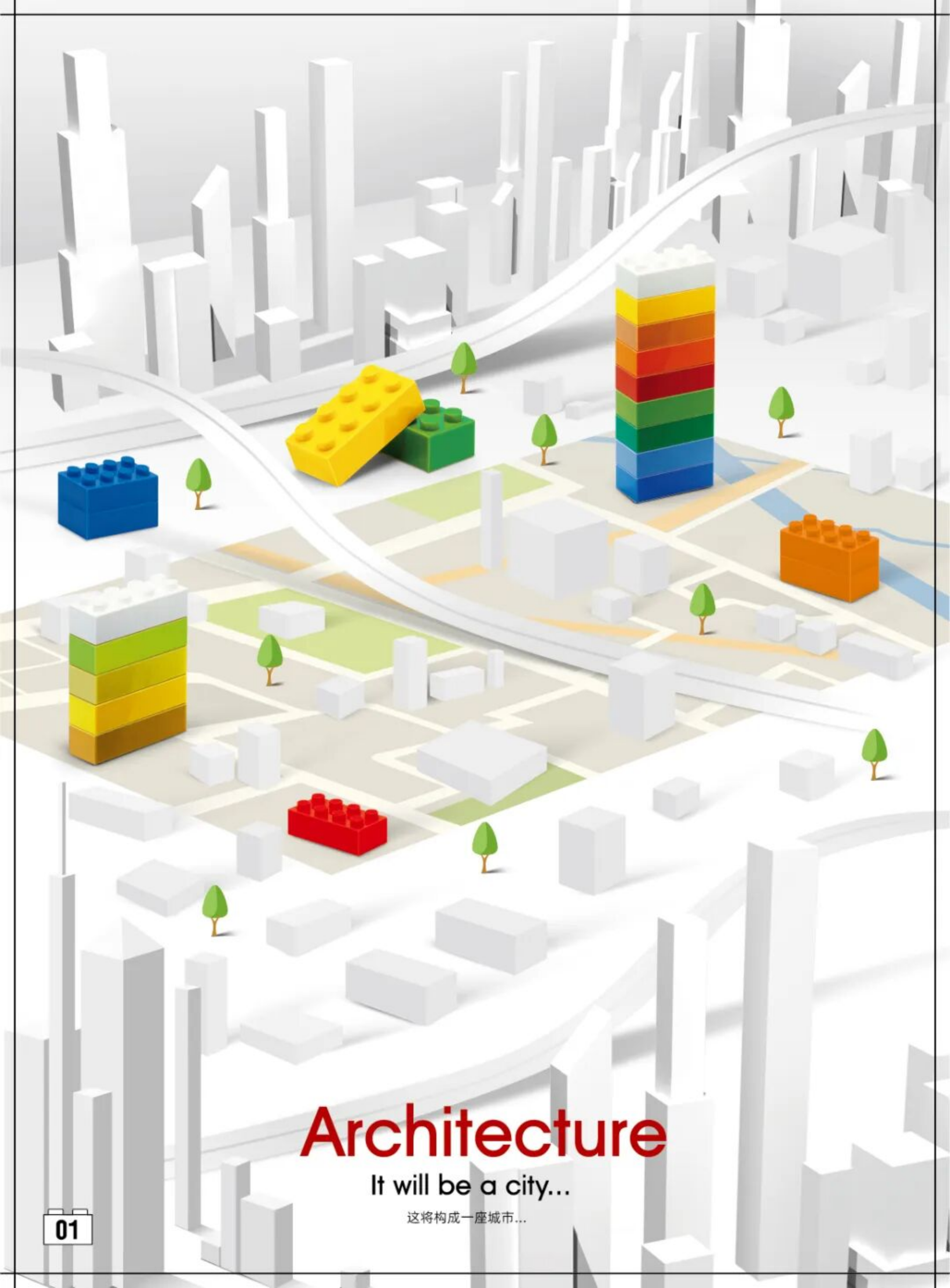

Architecture

It will be a city...

这将构成一座城市...

ABOUT THE PRODUCT

关于产品

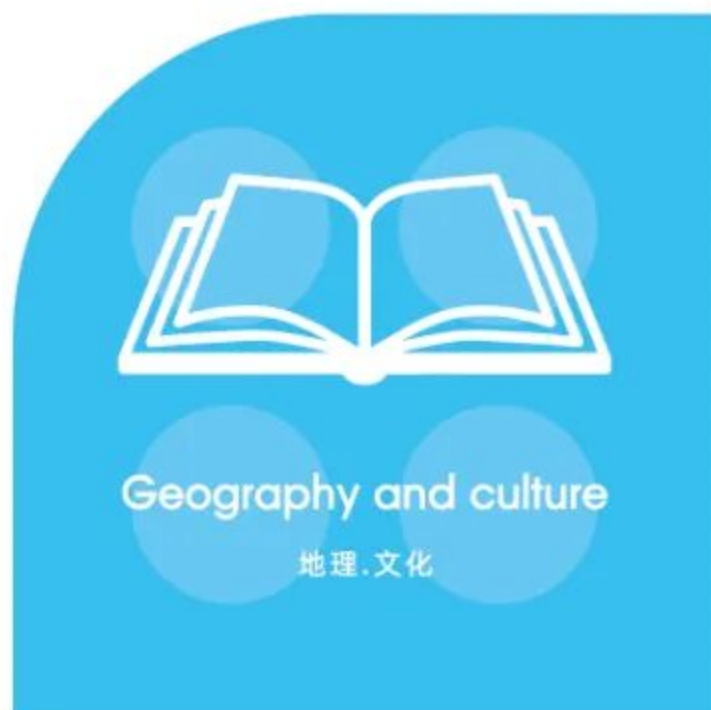

ARCHITECTURE

WANGE The world's great architect since 1991

Marina Bay Sands



Marina Bay Sands is an integrated resort fronting Marina Bay in Singapore and a landmark of the city.

Marina Bay Sands



Geography and culture

地理.文化



Marina Bay Sands sits at the heart of Marina Bay and opened in 2010. It symbolizes Singapore's modern, multicultural identity and serves as a major hub for art, entertainment, and tourism.



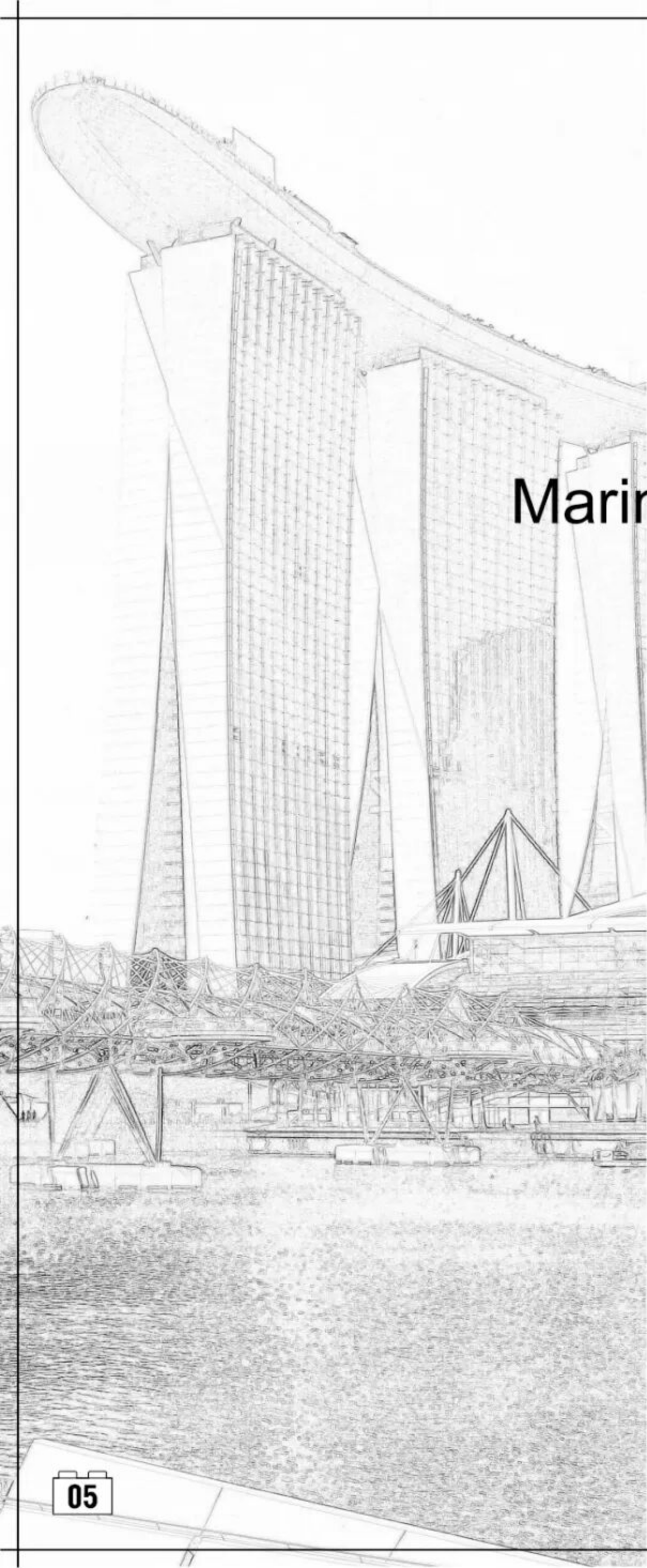

Marina Bay Sands

Marina Bay Sands ■

Singapore

The contents of this chapter refer to the Wikipedia website.

本章内容参考维基百科网站，
更多资讯可自行查阅。

The world's great architecture

Design and construction

■ 设计与施工



The resort is designed by Moshe Safdie, who says it was initially inspired by card decks. The prominent feature of the design is the three hotel towers, which have 1,850 rooms and suites, and a continuous lobby at the base linking the three towers. The casino has a four-storey central atrium with four levels of gaming and entertainment in one space. In addition to the hotel and the casino, other buildings include a 19,000 m² (200,000 sq ft) ArtScience Museum, and Sands Expo & Convention Centre with 110,000 m² (1,200,000 sq ft) of space, capable of accommodating up to 45,000 people. The resort's architecture and major design changes along the way were also approved by its feng shui consultants, the late Chong Swan Lek and Louisa Ong-Lee. Aedas were responsible for employing all consultants and for developing, co-ordinating and implementing the design. The structural engineering for the project was handled by Arup with Parsons Brinckerhoff the MEP engineers. The main contractor was Ssangyong Engineering and Construction.



Facilities

Marina Bay Sands has three 55-storey hotel towers which were topped out in July 2009. The three towers are connected by a 1.2 hectare rooftop cantilever, Sands SkyPark. The Skypark observation deck provides panoramic views across the bay.

The SkyPark has the world's longest elevated swimming pool, with a 146-metre (479 ft) vanishing edge (a concept called an infinity pool) located 191 metres (627 ft) above ground. The pools are made up of 422,000 pounds (191,000 kg) of stainless steel and can hold 376,500 US gallons (1,425 cubic metres) of water. The SkyPark also has rooftop nightclubs such as Lavo (New York, Vegas) and Cé La Vi, gardens, hundreds of trees and plants, and a public observatory deck on the cantilever with 360-degree views of the Singapore skyline. The SkyPark is accessible only to hotel guests for security reasons.



Attraction

In 2011, Marina Bay Sands launched a nightly light and water show, titled Wonder Full, a multimedia show designed by the Australian multimedia company Laservision and incorporated various Laservision technology such as the Stella Ray. The show starts off with a single drop of water, representing the birth of life. It later stages through important stages of a person's life such as childhood, development through age and adulthood.

In 2017, Wonder Full was replaced with a new light and water show, titled Spectra. Set to an original orchestral soundtrack composed by Singaporean producer and composer Kenn C., Spectra is a state-of-the-art multimedia experience that is dramatic in scale and unique in style. The 15-minute show is currently staged every night at 8pm and 9pm (Sundays to Thursdays), with a third show at 10pm on Fridays and Saturdays.

Force Balance

受力平衡

Physical operations

物理运算

$$F = G \frac{m_1 m_2}{d^2}$$

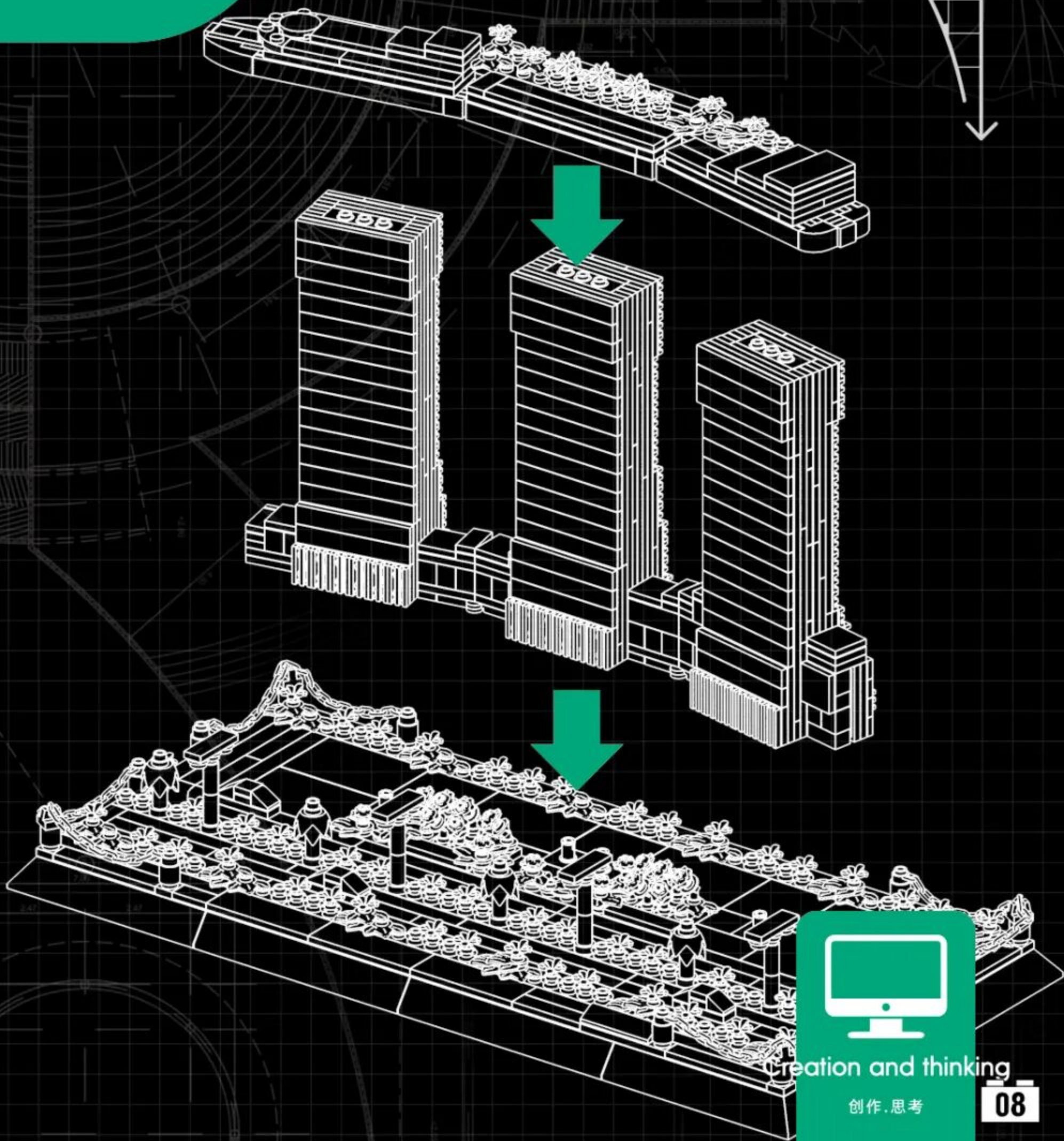

Creation and thinking

创作·思考

Special parts

特殊零件的开发利用

$$S=4\pi \cdot r^2$$

$$a^2+b^2=c^2$$

WG1783

1孔转角尖顶围栏

WG1401

双面矮4孔

WG1345

竖纹2倍2孔

WG1355

双面矮1孔

WG1627

双面连接圆环

WG1377

矮3X4孔

WG0711

单边加长轴承

WG1273

4倍半斜

$$\sin^2 a + \cos^2 a = 1$$

WG1303

无孔后10孔



features and functions

特点.功能

Main Color Matching

配色方案



Color matching Adopting 3 main colors, Black, gray and green as the main color, the more reasonable and bold color matching on the original building, making the product more atmospheric and the whole design is more reasonable.

Marina Bay Sands

新加坡金沙酒店



Front

Left

Back

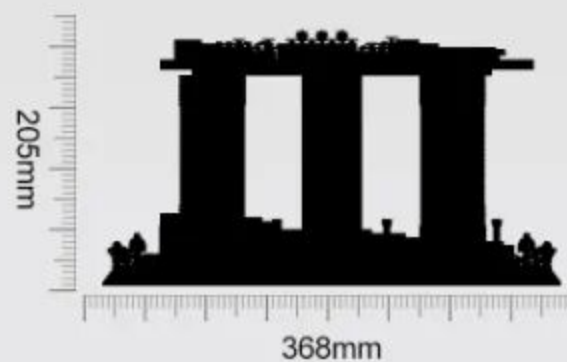
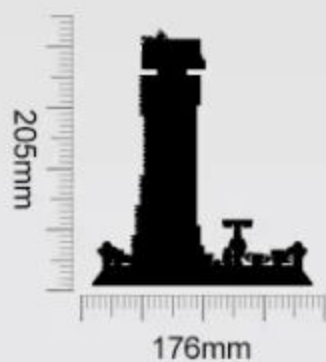
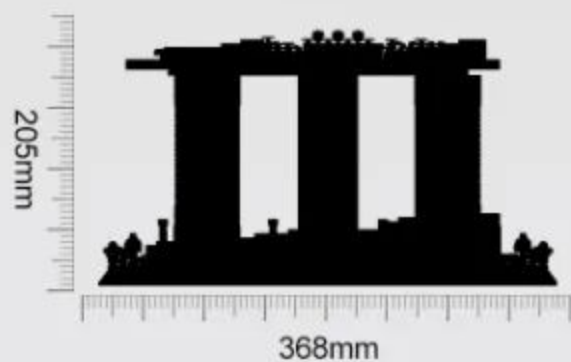

Product Size:368X176X205mm



Instructions For Use

积木起件器使用说明
Brickseparator

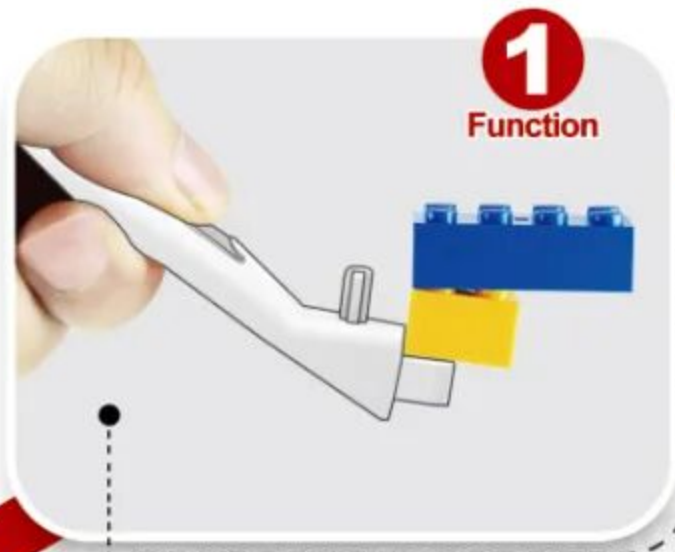

4 ways to make installation easier
让安装更简单

小提示：积木包分为底板包、整版配件包及普通配件包，底板包标识为A/B/C...，普通配件包编码与说明书对应，整版配件包无标识。
Tip: Building block packs are divided into baseplate packs, runner accessory packs, and standard accessory packs. Baseplate packs are labeled A/B/C..., regular accessory packs have codes that correspond to the instructions, and runner accessory packs have no labels.



- Open the product packaging correctly and classify the building block packs by type.

用正确方式拆解产品外包装,按积木包类型进行分类。



- Confirm the quantity of building block packs and cross-check them with the pack identifiers and the instructions.

确认积木包数量,对照积木包标识和说明书步骤。



- Open the building block packs according to the pack identifier steps. Sort them in order by type and color for easier assembly.

按积木包标识步骤拆开积木包,按顺序以类型、颜色进行分类以便搭建。



- Assemble your building block model following the steps in the instruction manual.

按说明书步骤拼装并完成你的积木模型。



1:1 Physical Reference Table

十字棒配件1:1尺寸参照表



Instructions For Use

让安装更简单

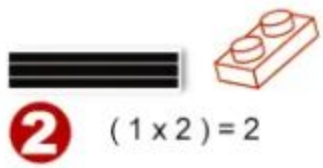

2 (1x2)=2

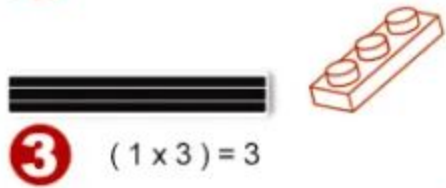

3 (1x3)=3

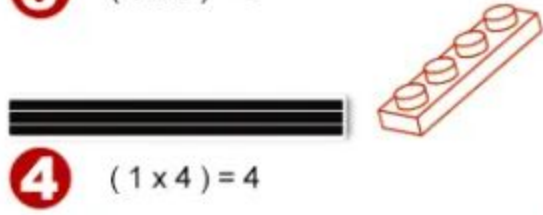

4 (1x4)=4



5 (1x5)=5



6 (1x6)=6

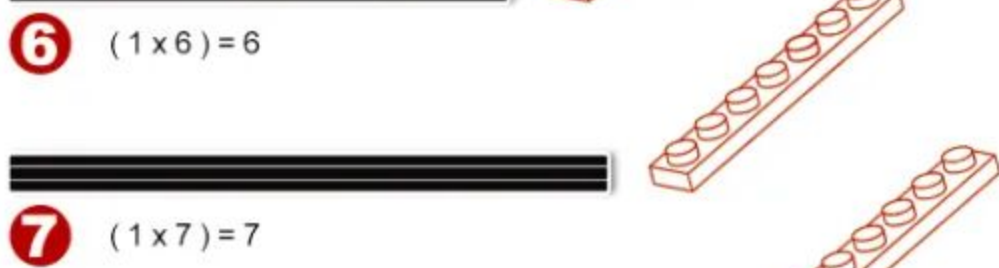

7 (1x7)=7



8 (1x8)=8



9 (1x9)=9



10 (1x10)=10



12 (1x12)=12



16 (1x16)=16



PARTS LIST

配件清单



x4

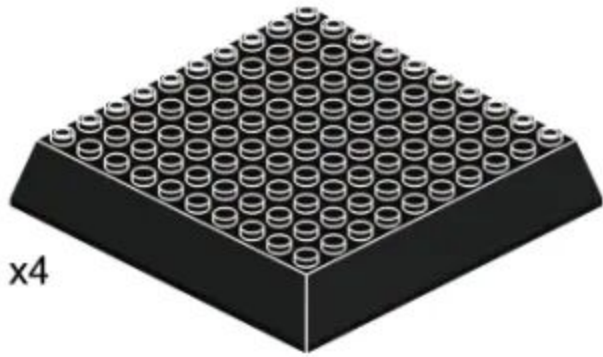

x4



x4



x5



x31



x9



x4



x4



x8



x16



x11



x5



x5

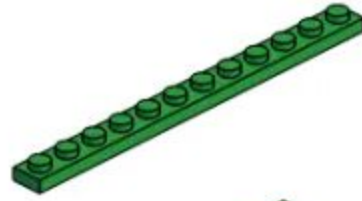

x9



x4



x1



x3



x2



x2



x7



x1

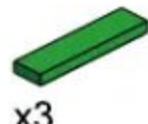

x3



x3



x33



x9



x22



x10



x5

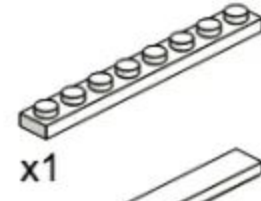

x1



x1

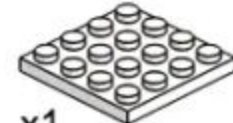

x1



x2



x3



x1

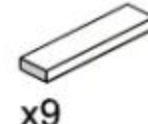

x9

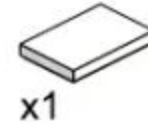

x1

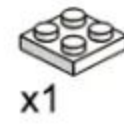

x1

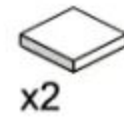

x2



x1



x10



x8



x13



x8



x12



x6



x8



x1



x1



x1

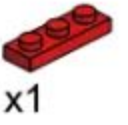

x1



x1



x1



x9

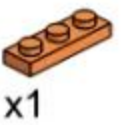

x1



x1



x1



x8

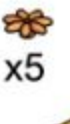

x5

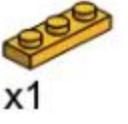

x1



x1



x1



x8



x6



x24



x3



x85

产品有增补件请以实物为准

If product has additional parts, please in kind prevail.



156PCS

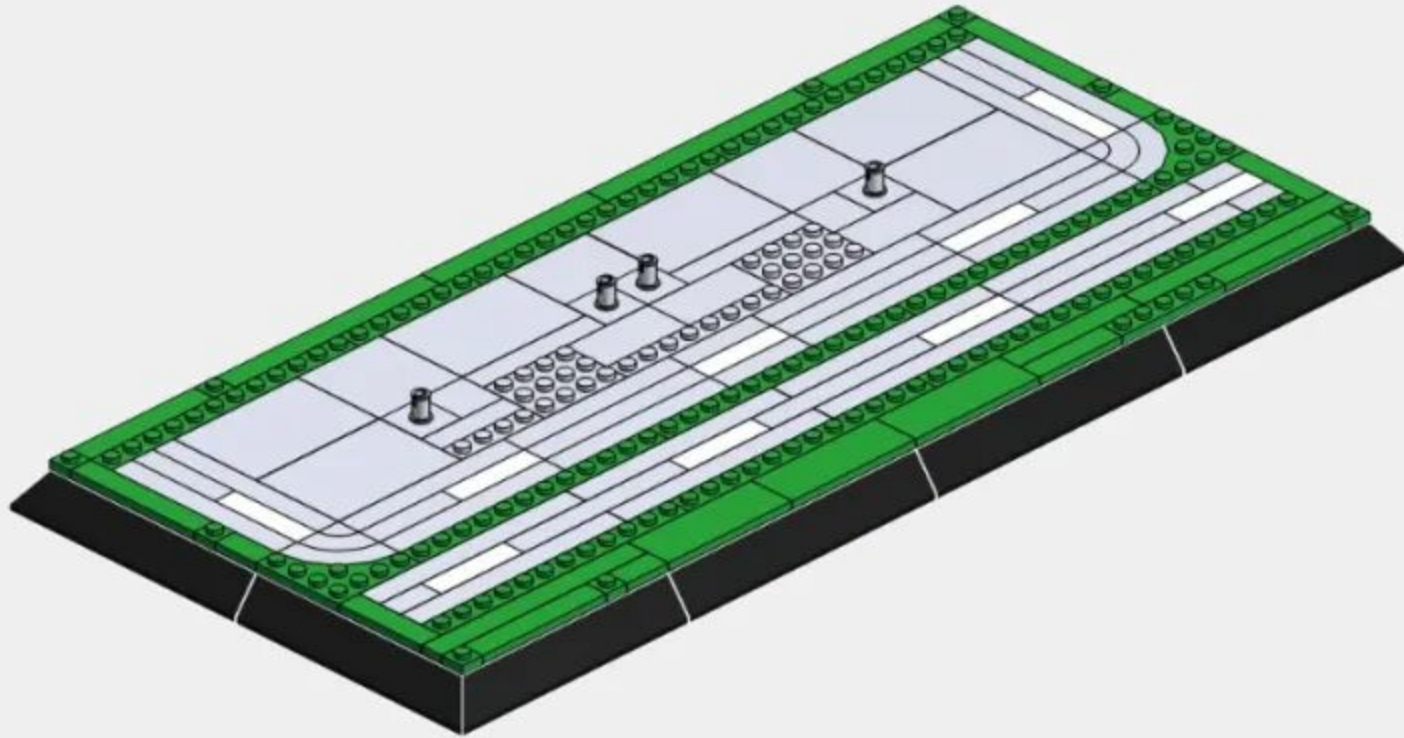

1-1

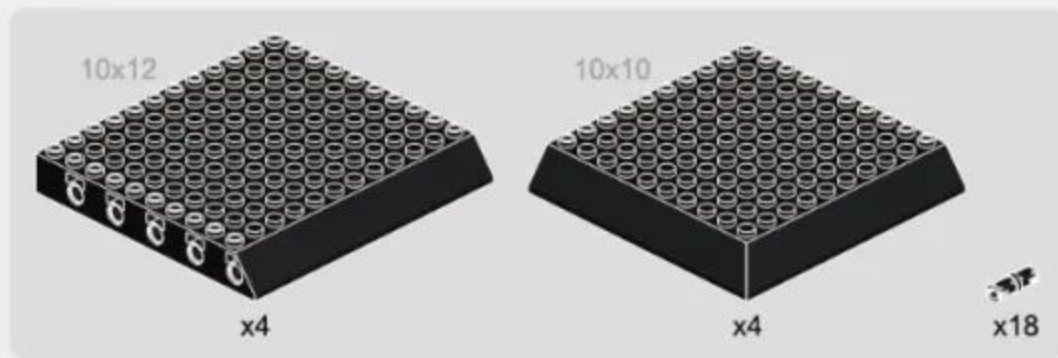

微信扫一扫
补件更简单

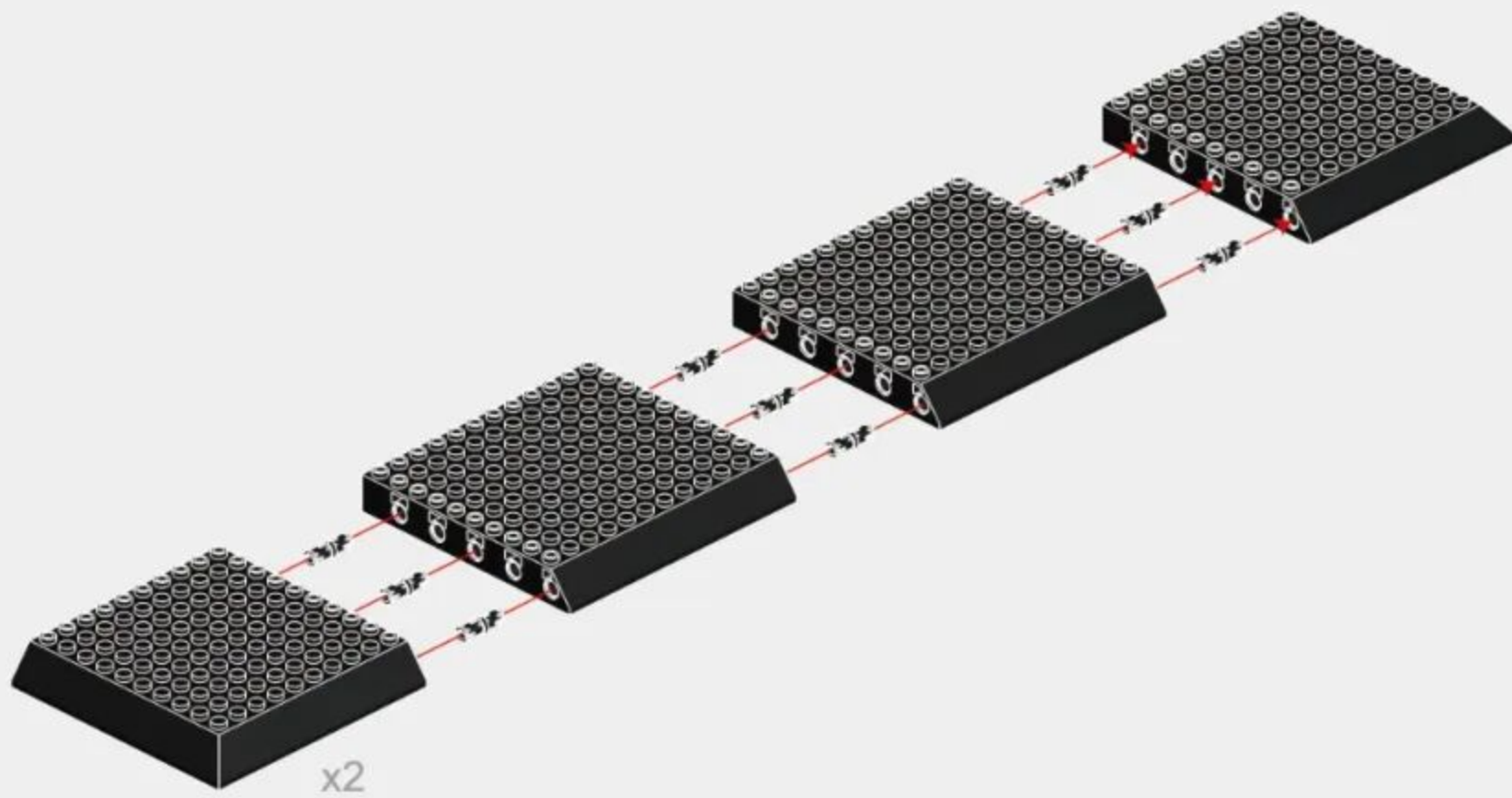

1-2

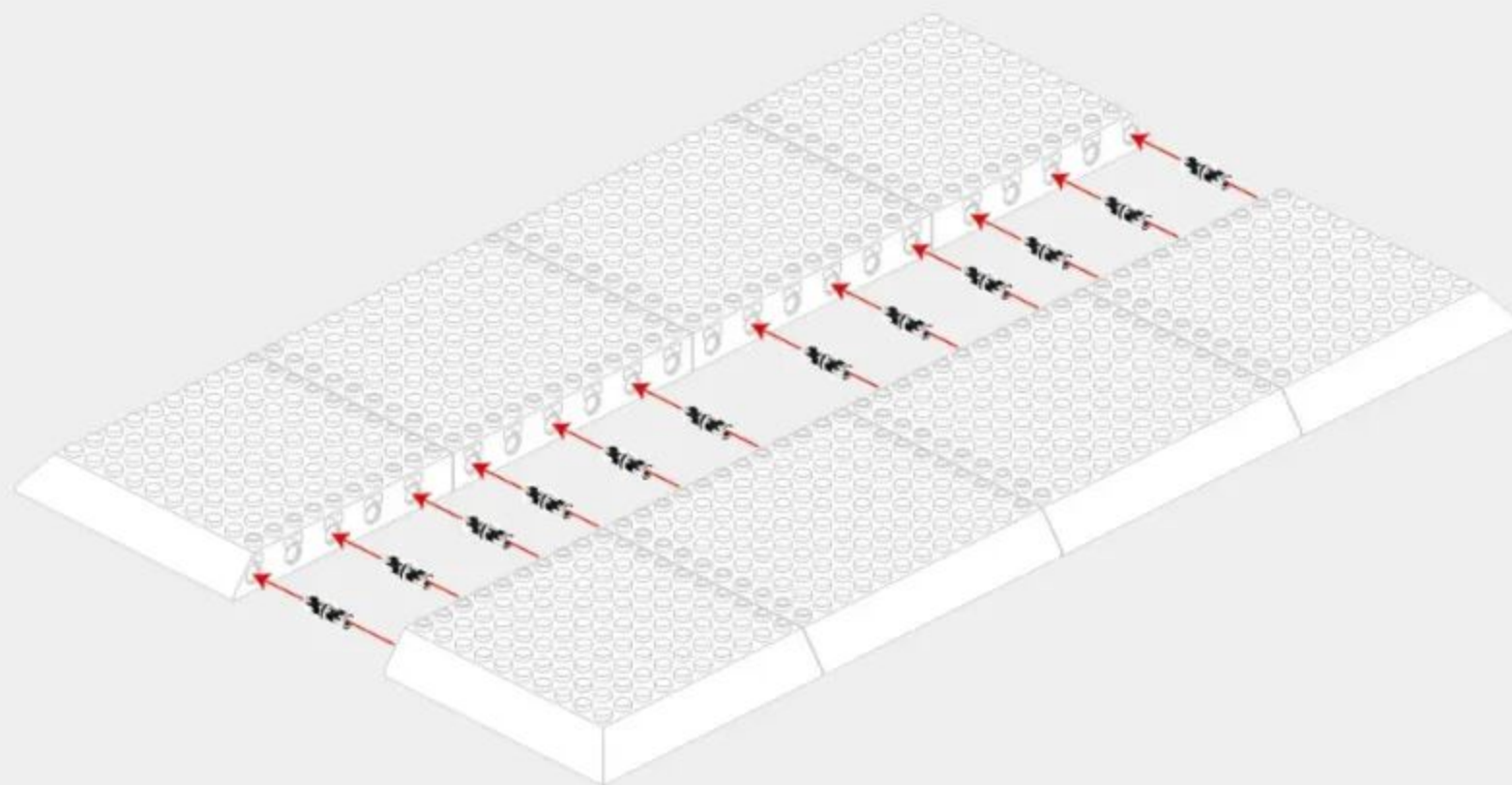

1-3

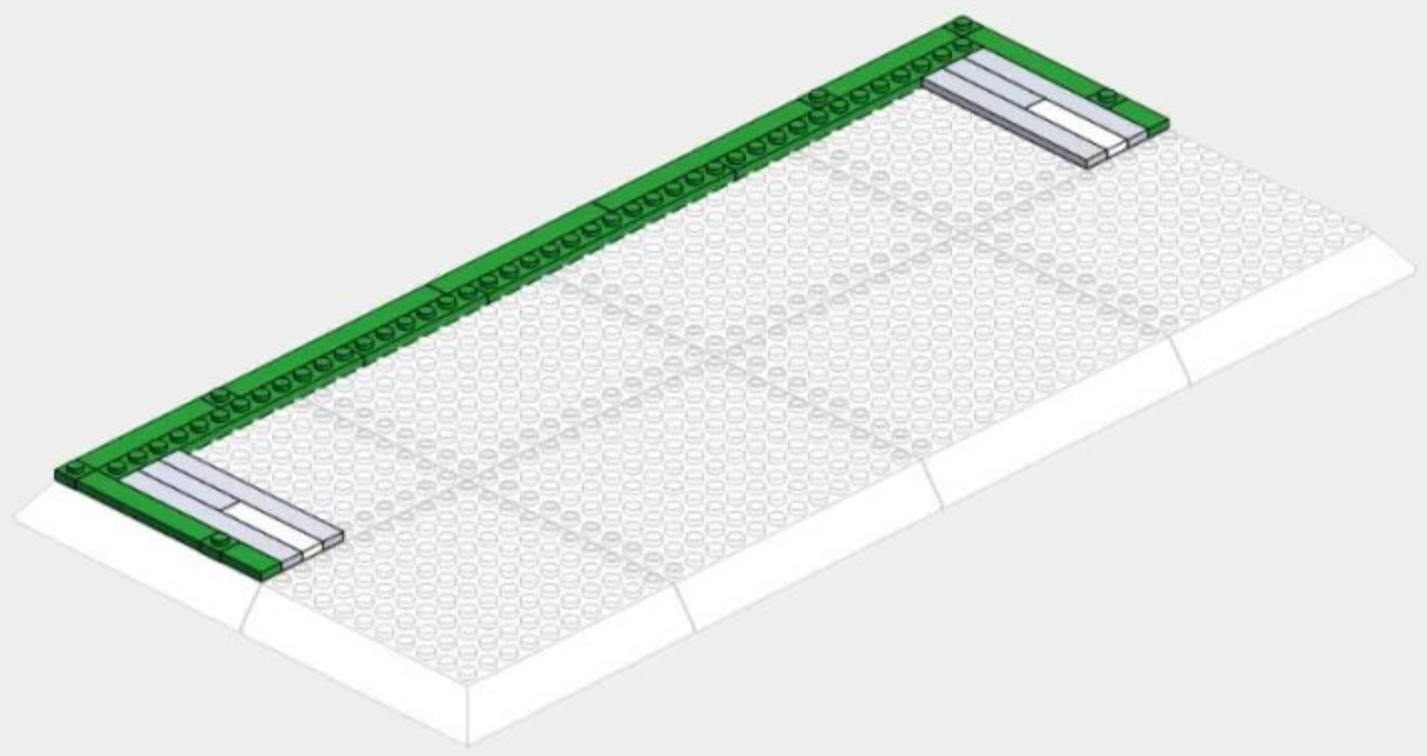
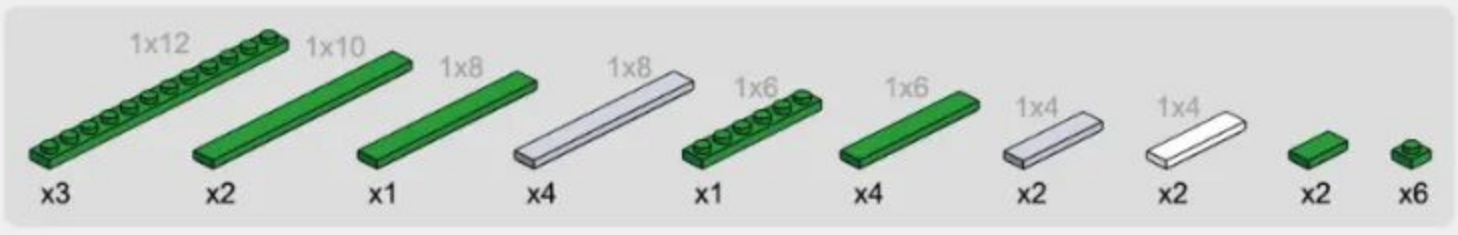

1-4

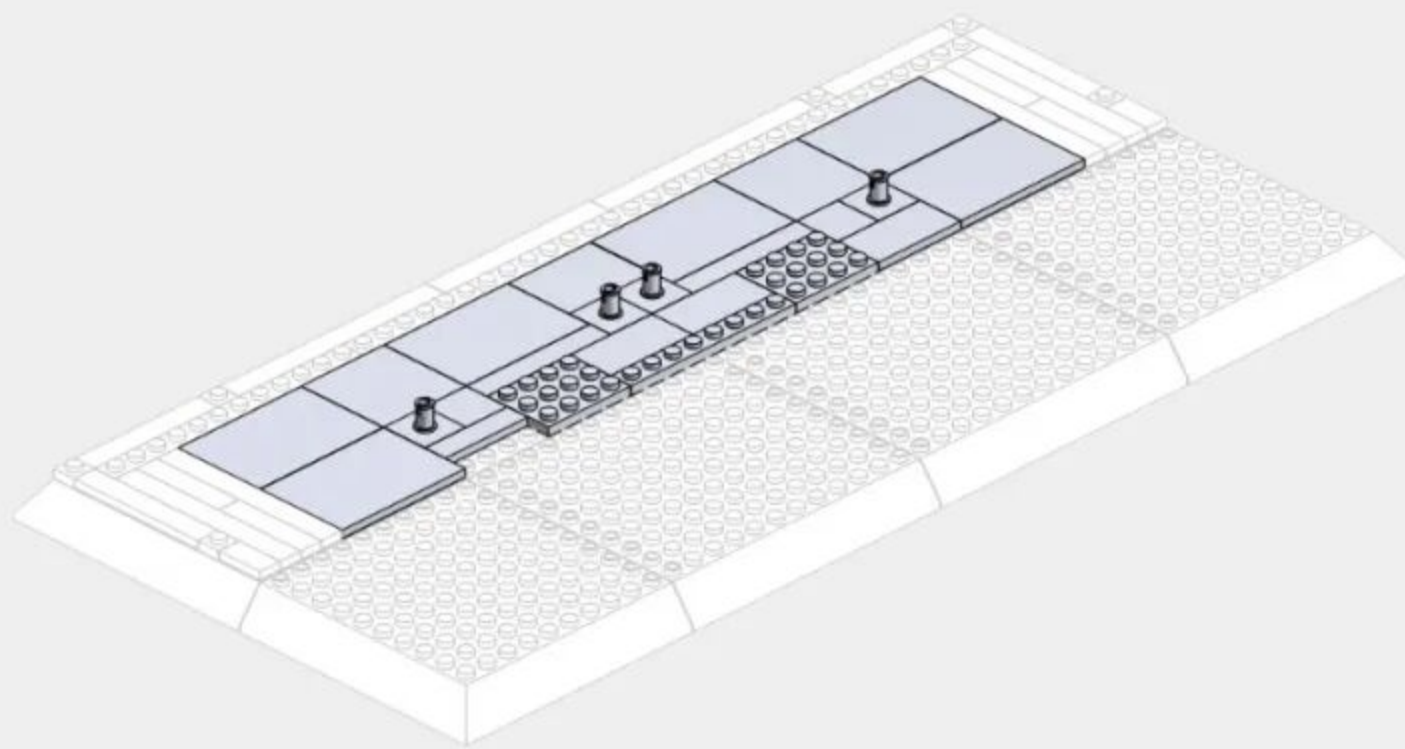
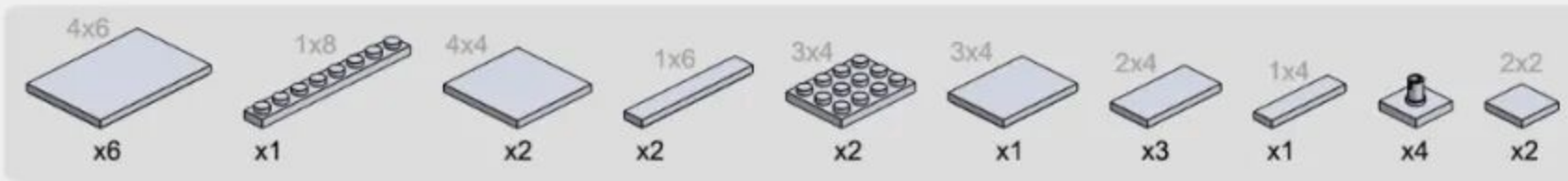

1-5

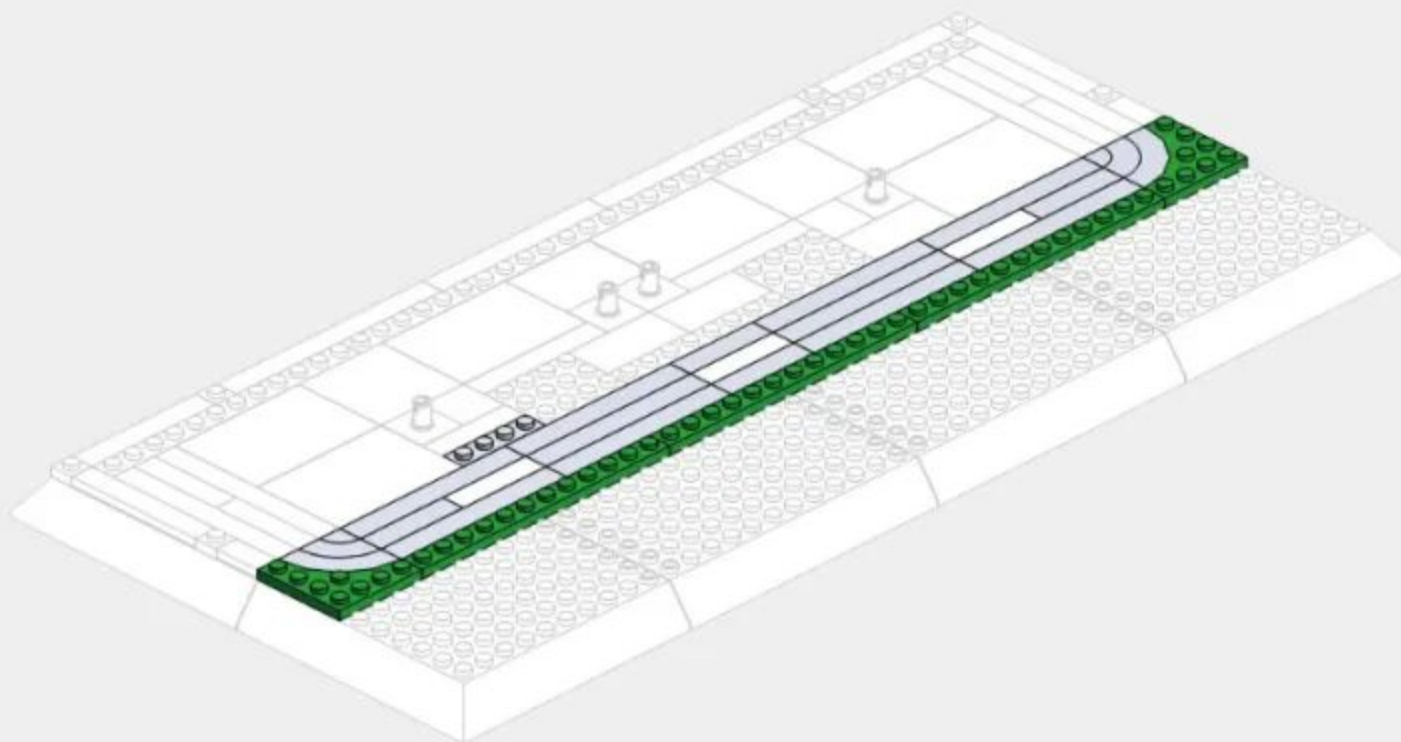
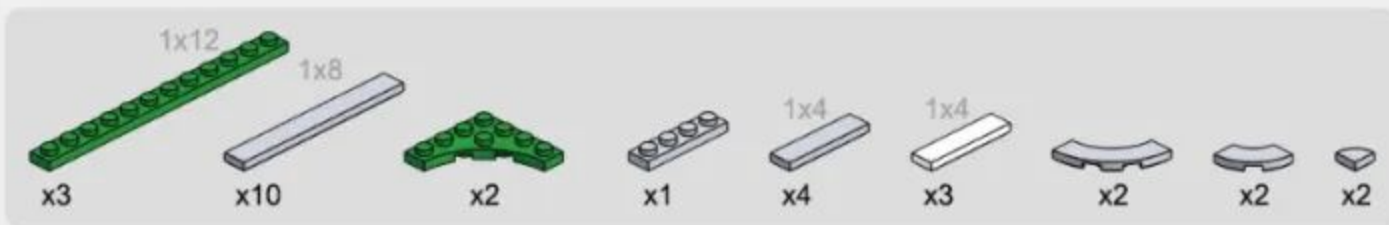

1-6

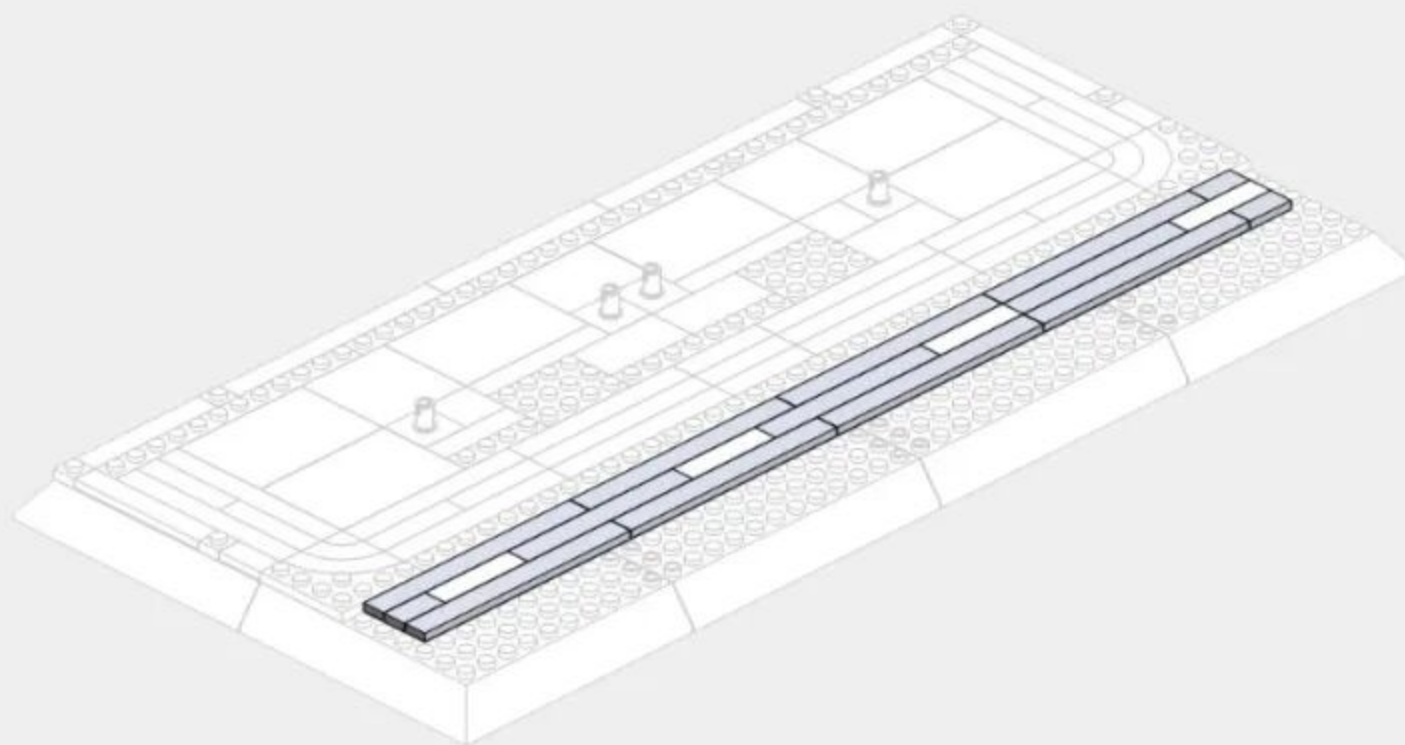
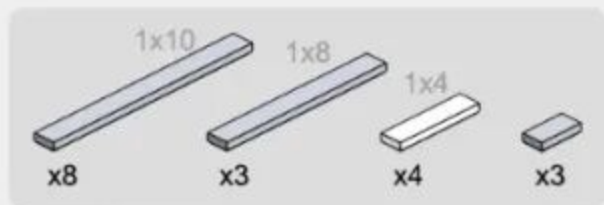

1-7

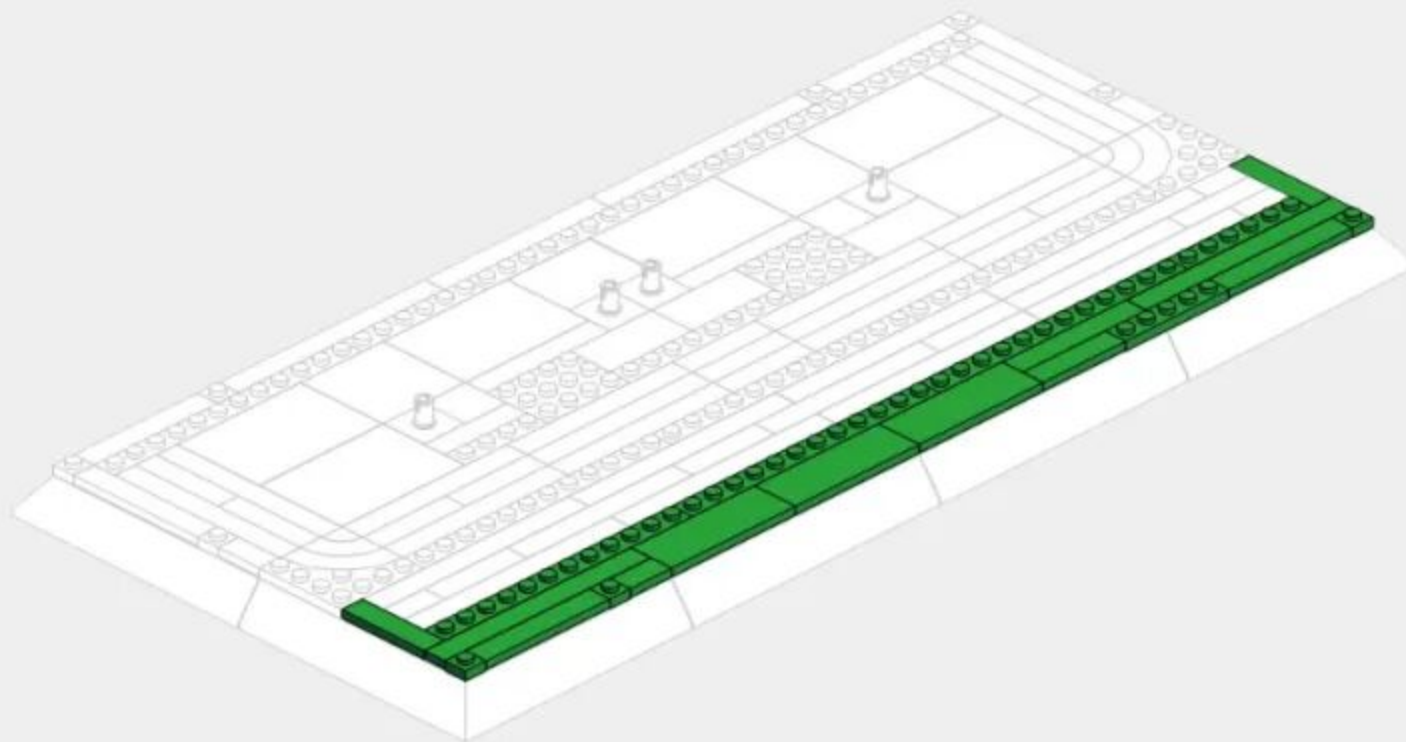
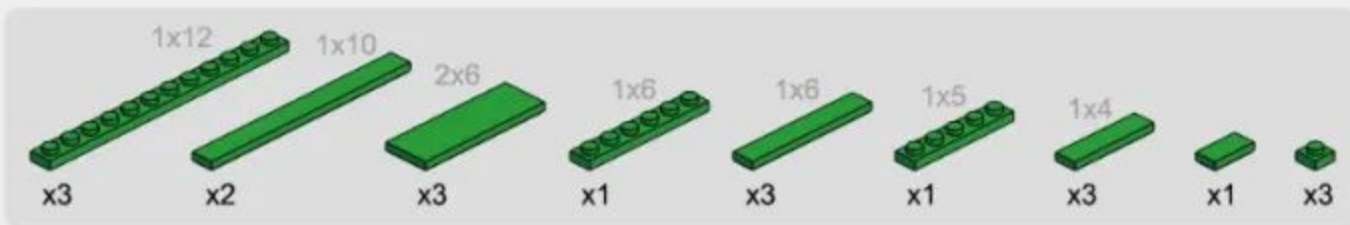



174PCS



2-1

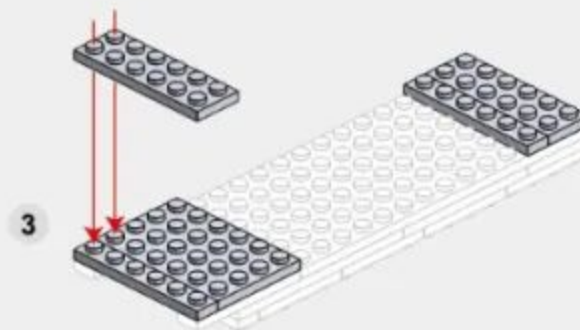
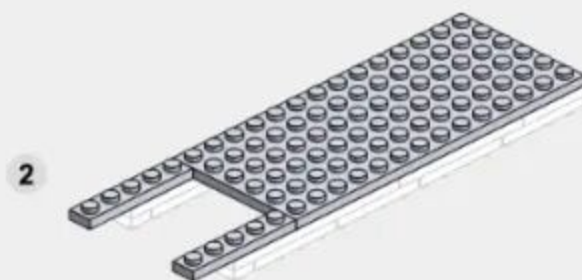
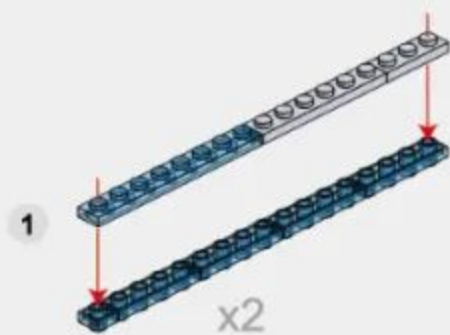
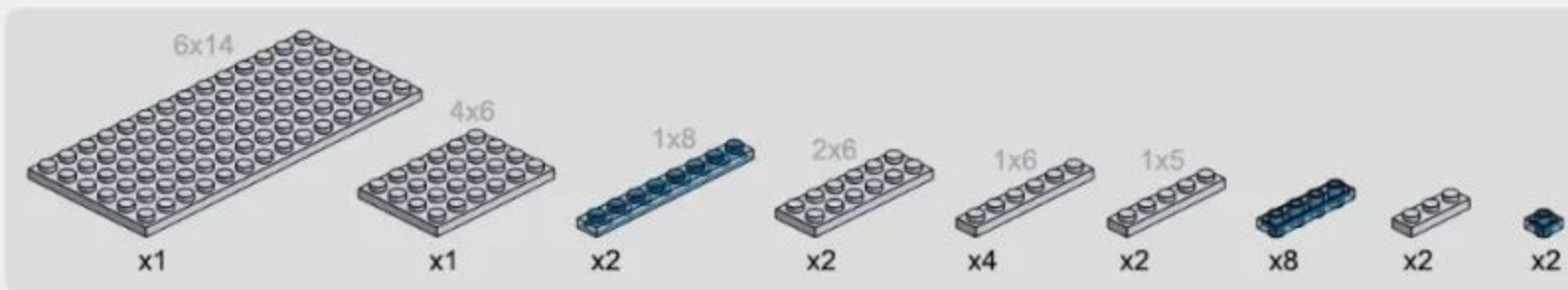

2-4

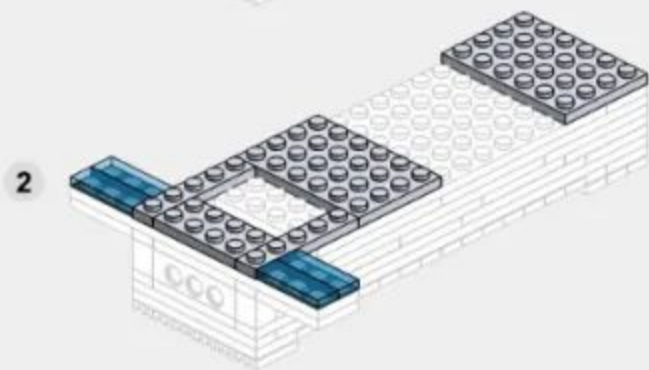
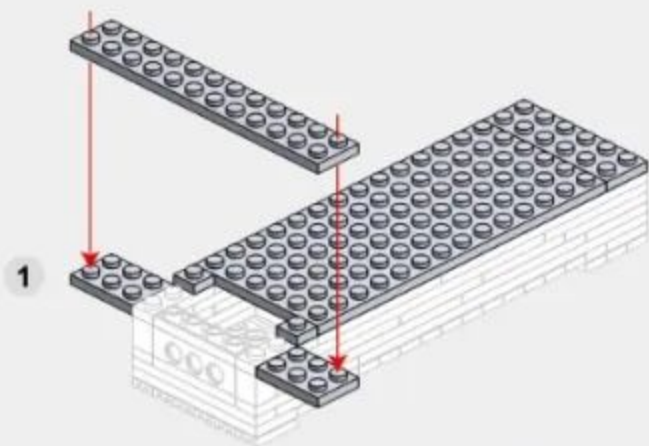
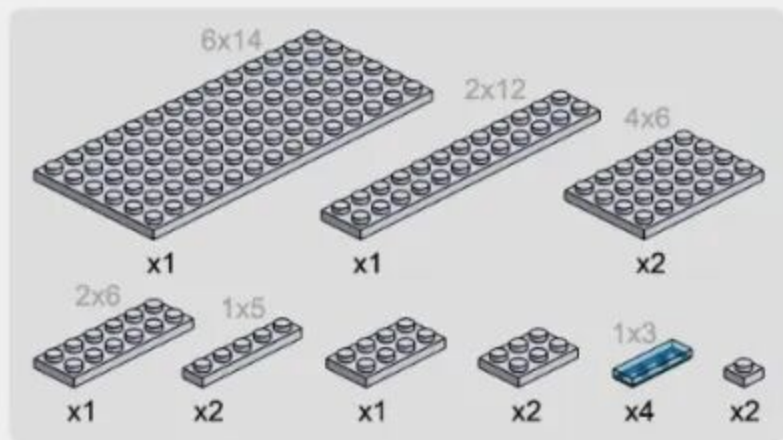

2-5

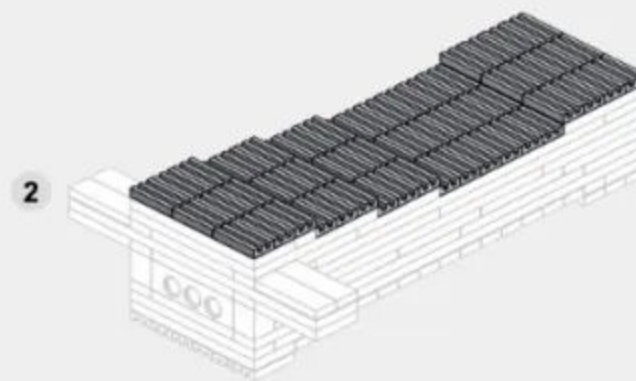
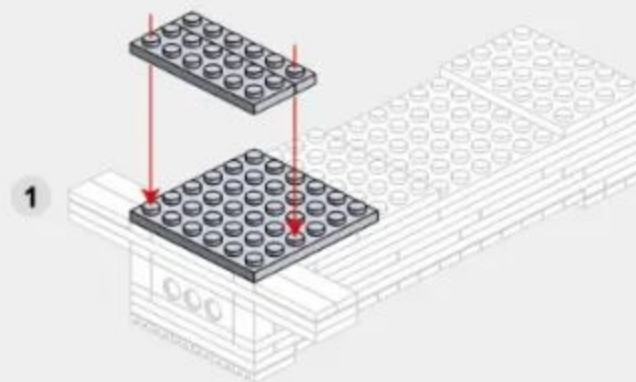
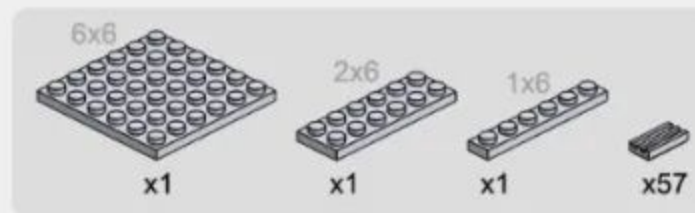

2-6

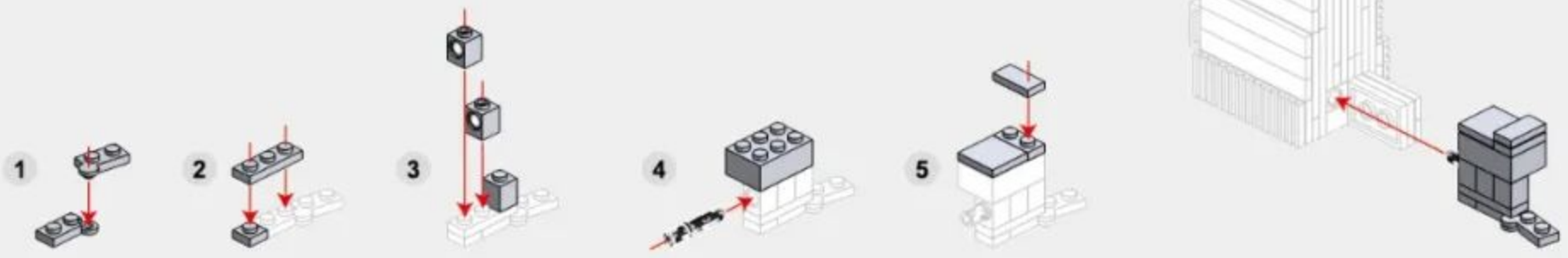

2-7

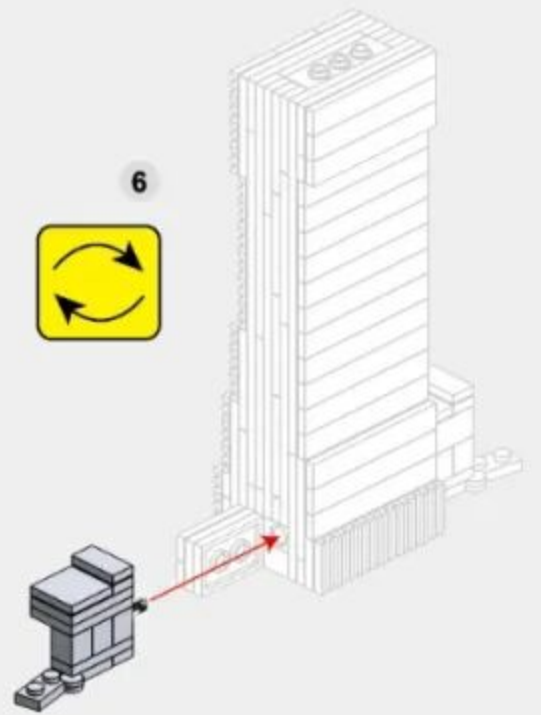
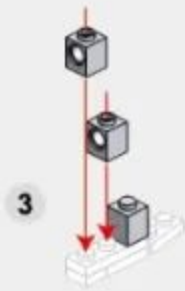

2-8

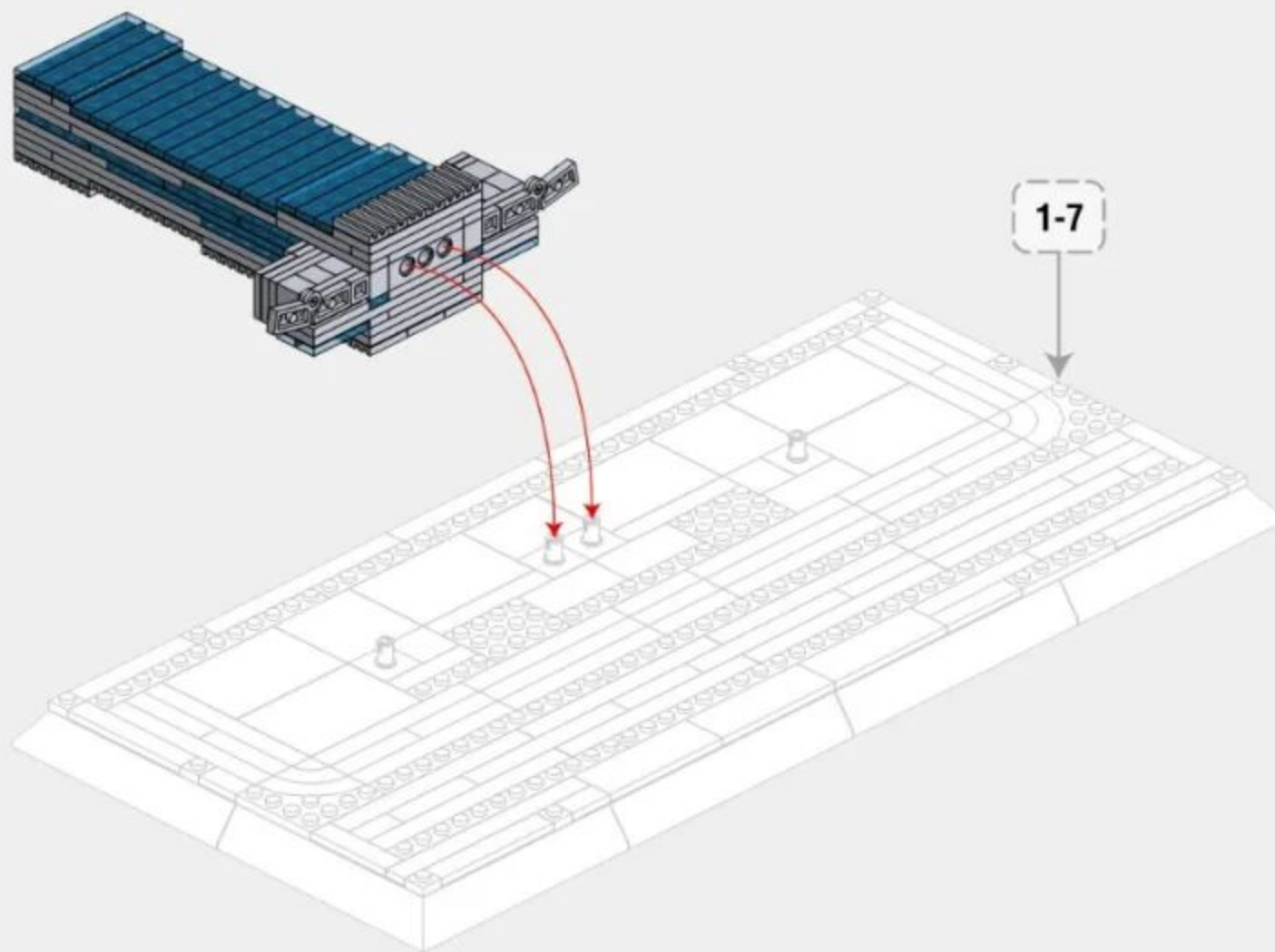



185PCS

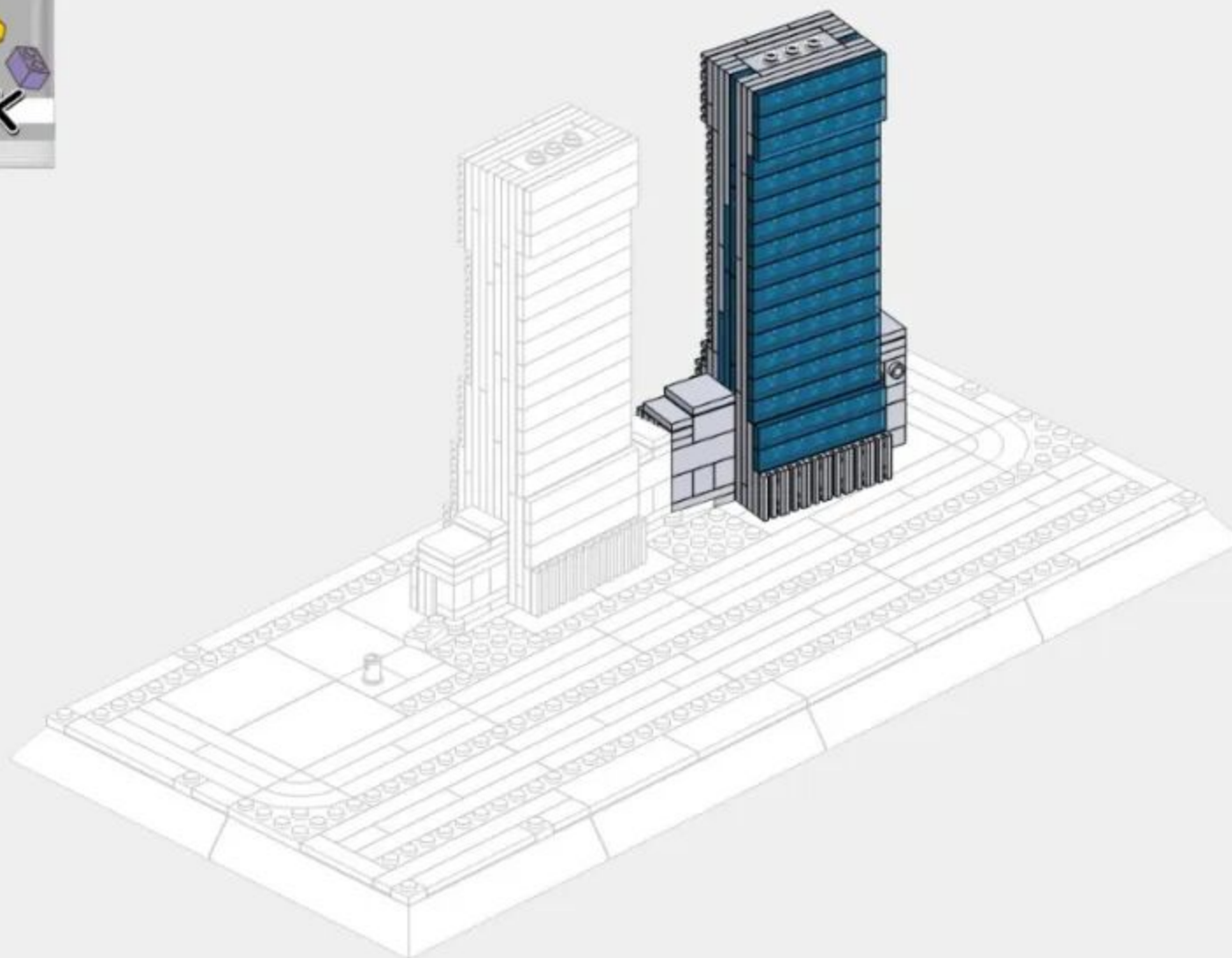

3-1

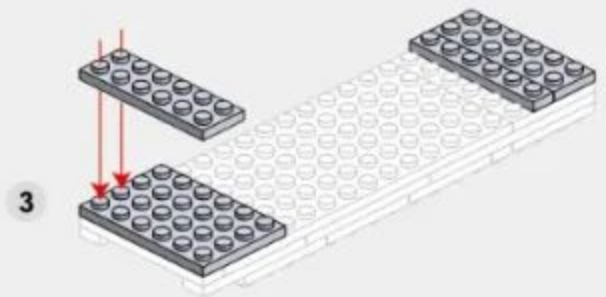
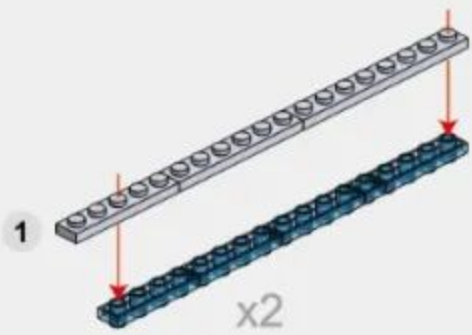
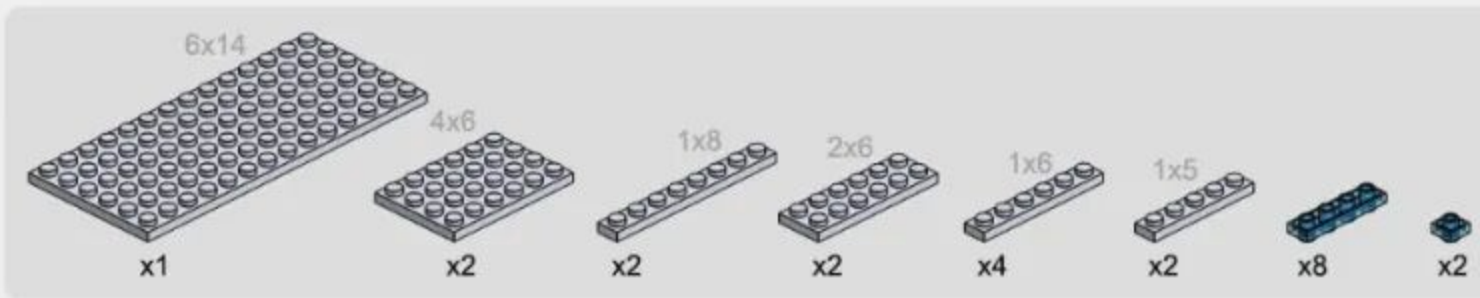

3-2

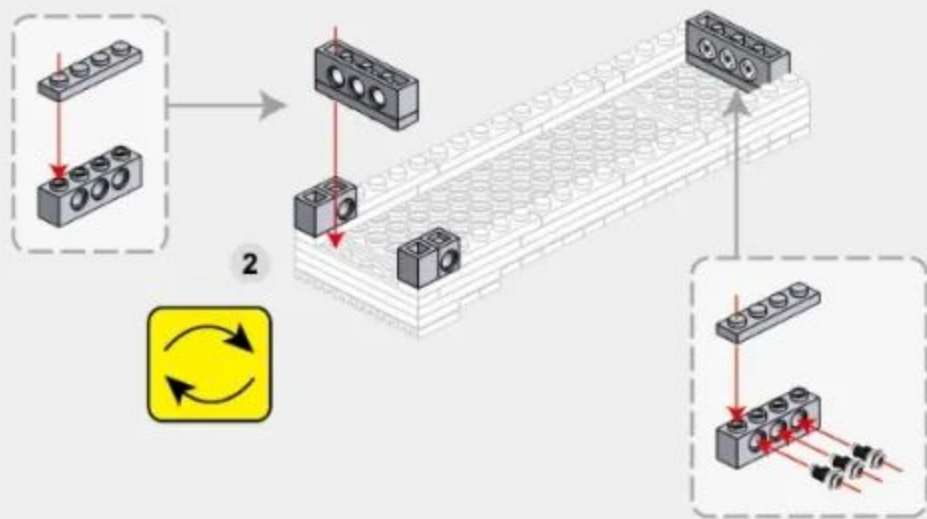
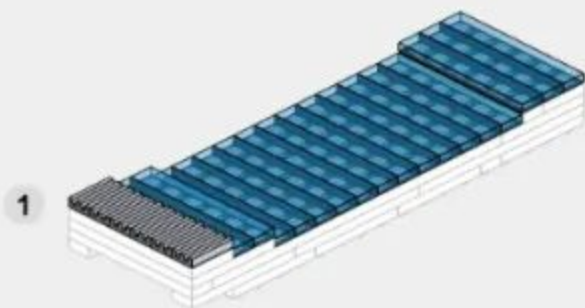

3-3

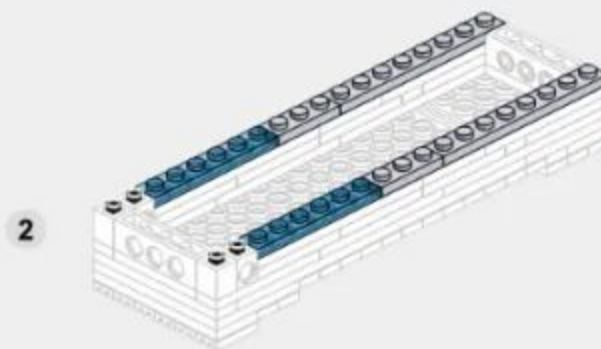
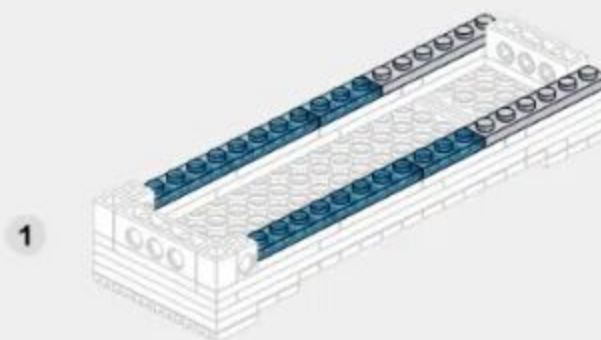
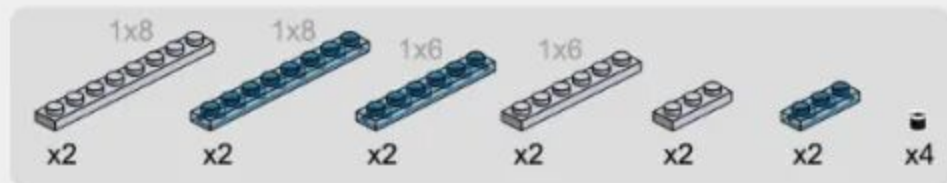

3-4

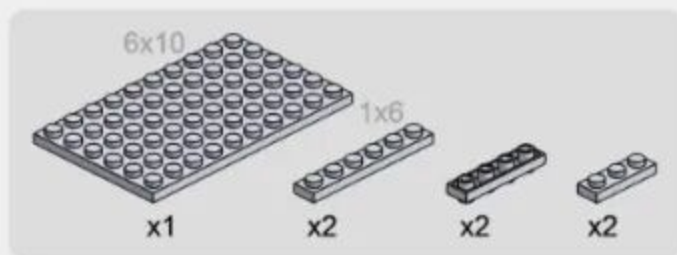

3-5

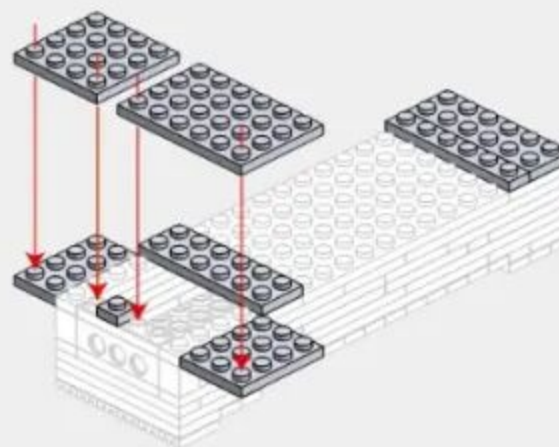
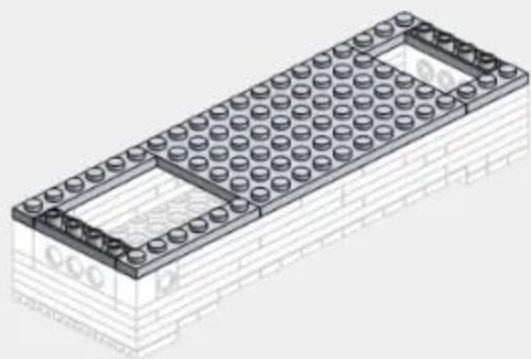
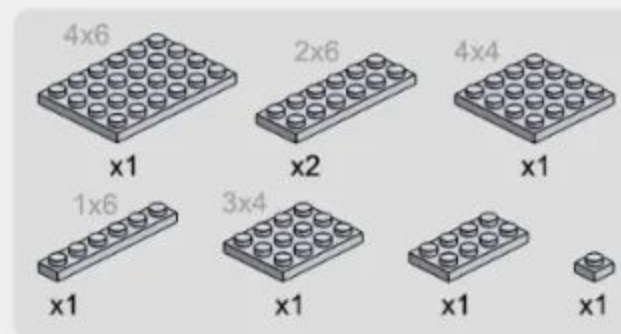

3-6

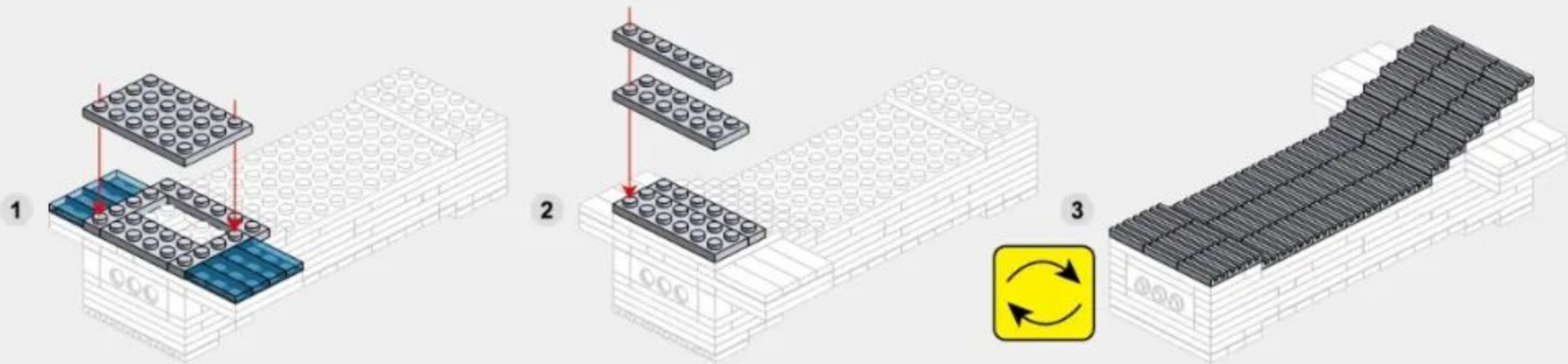
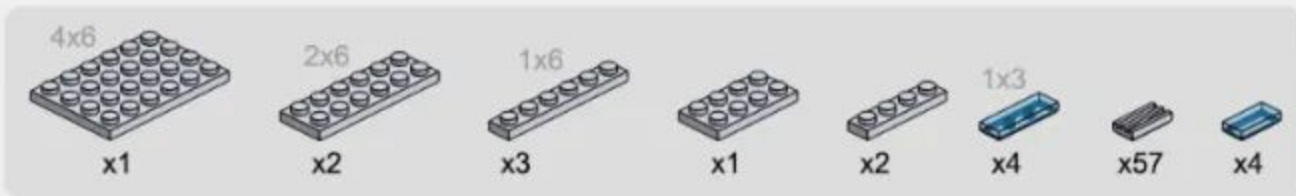

3-7

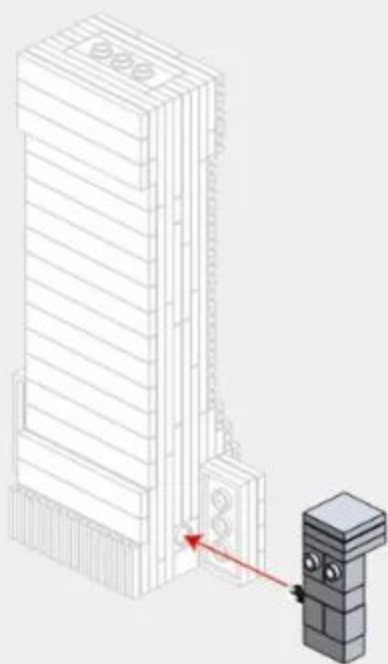
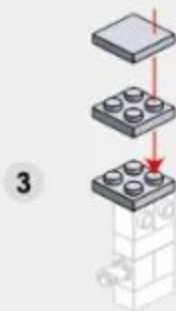
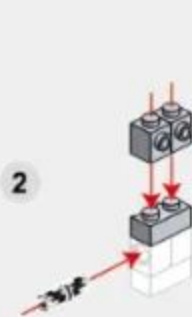
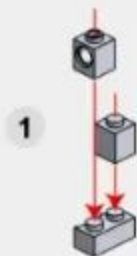

3-8

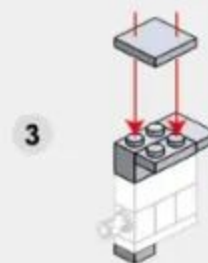
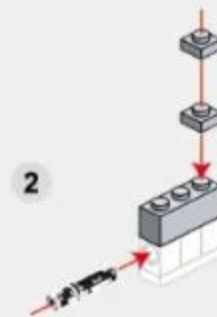
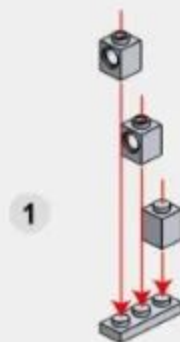

3-9

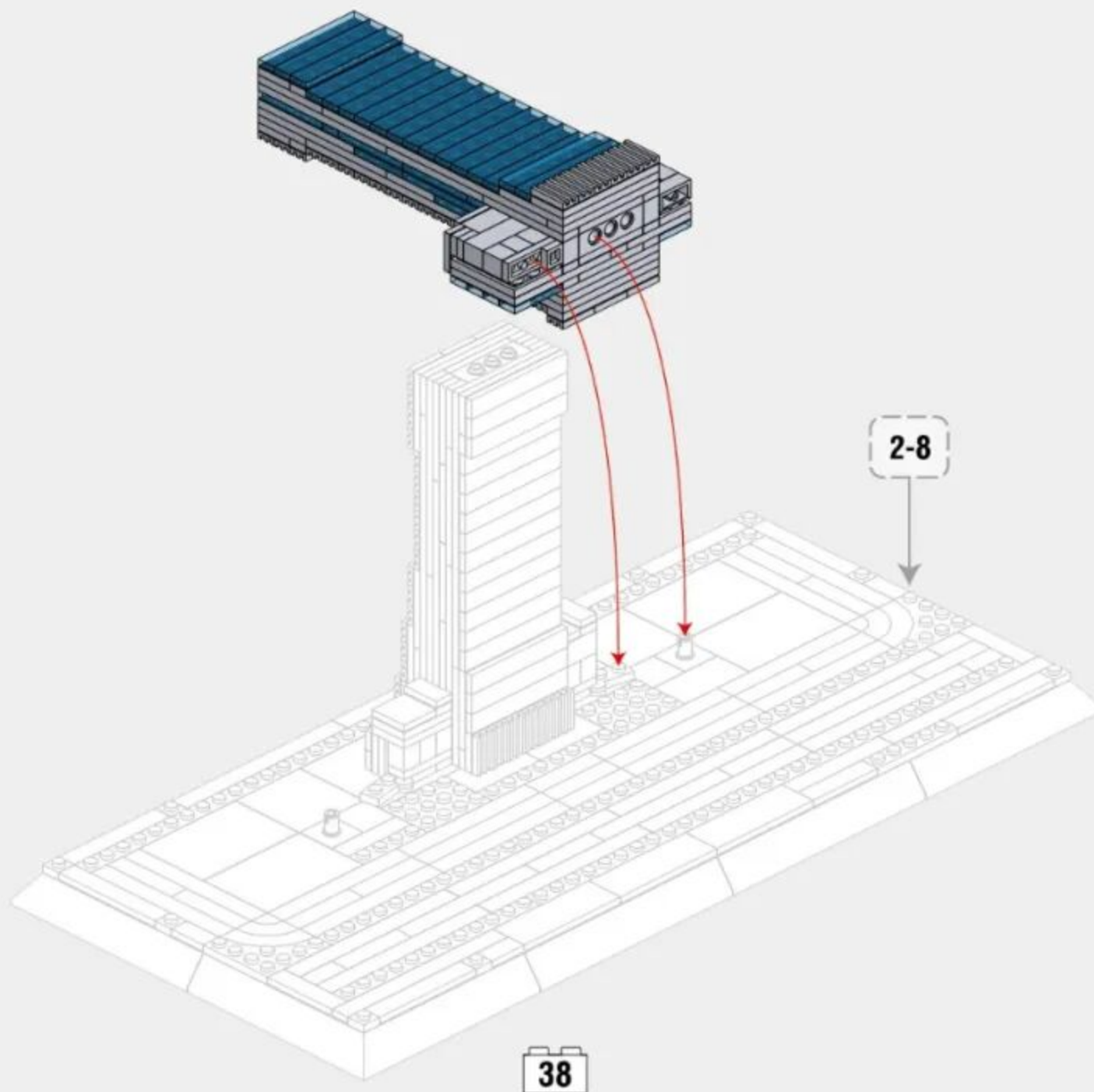



163PCS



4-1

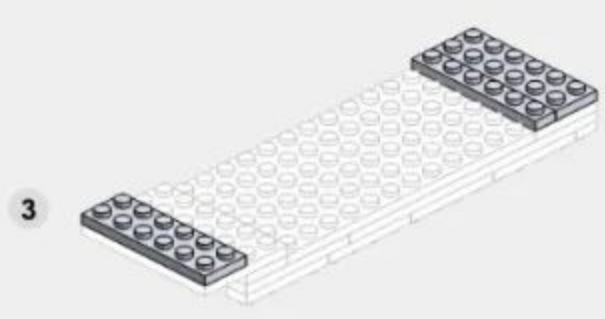
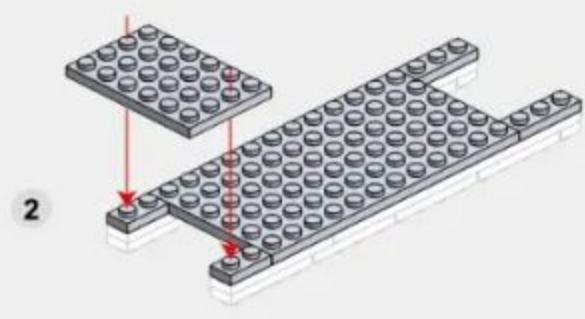
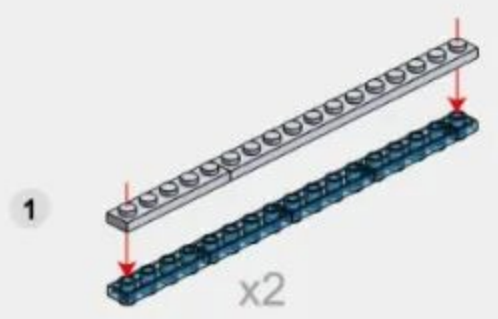
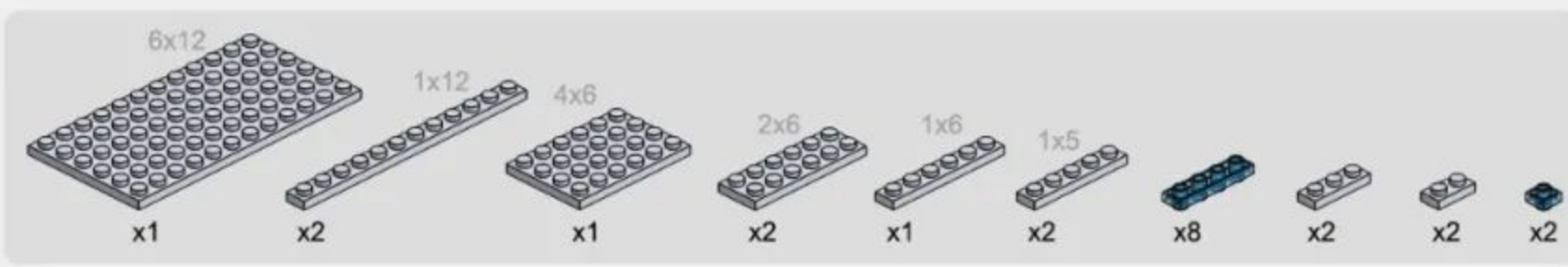

4-2

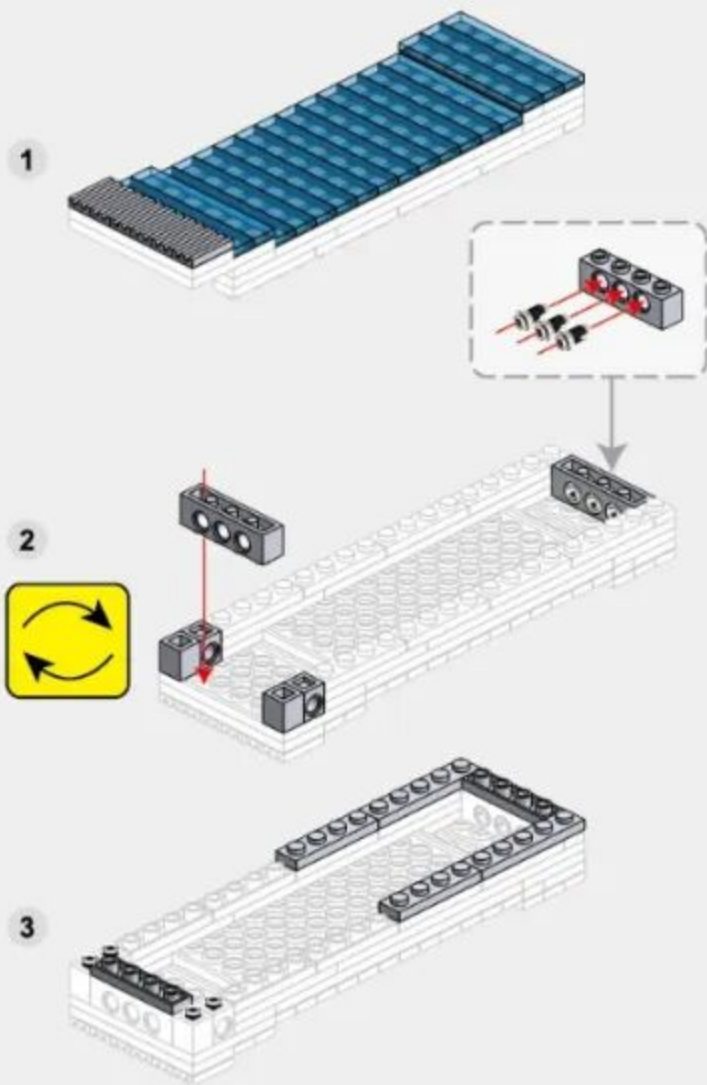
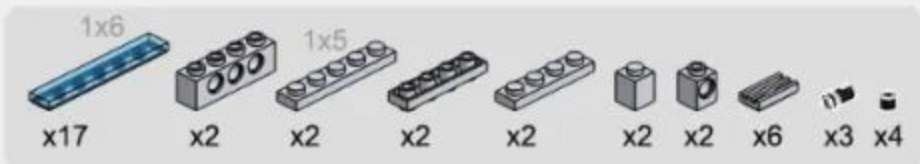

4-3

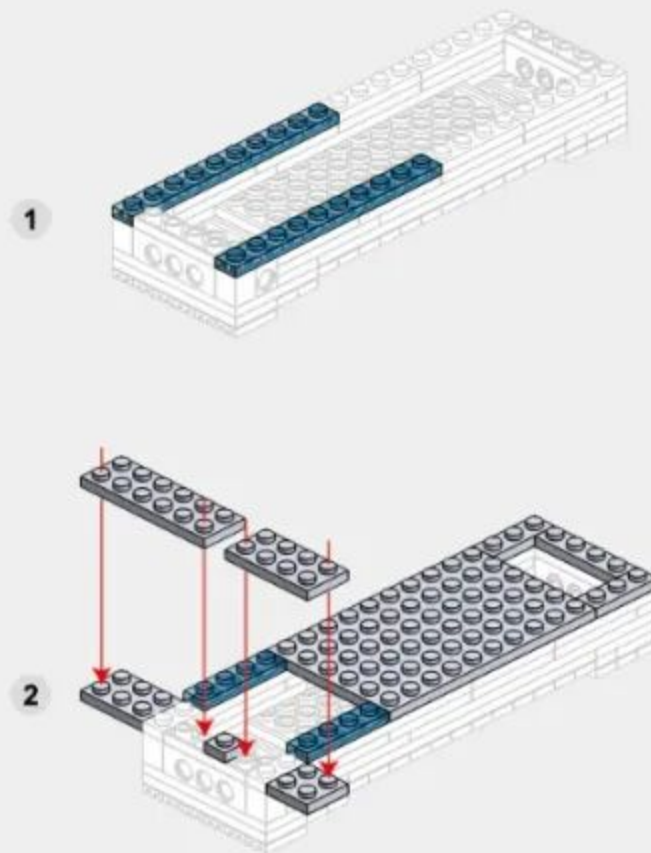
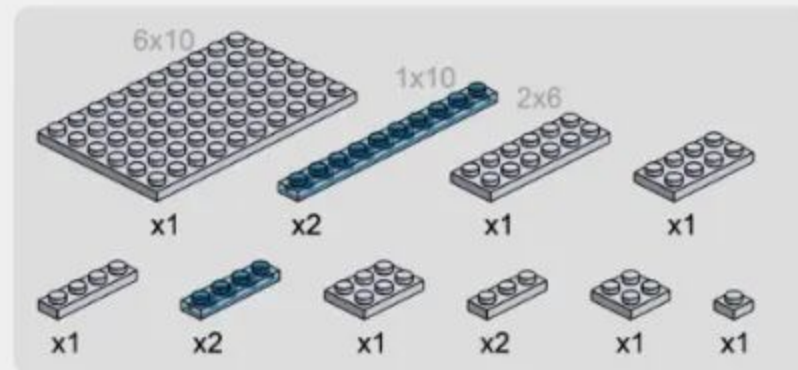

4-4

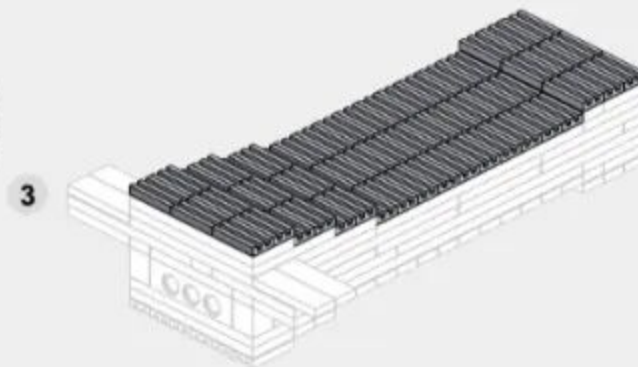
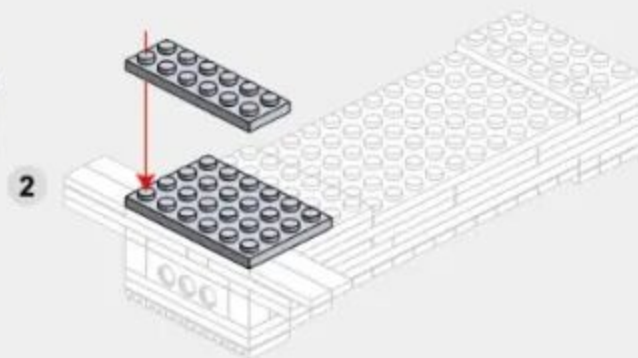
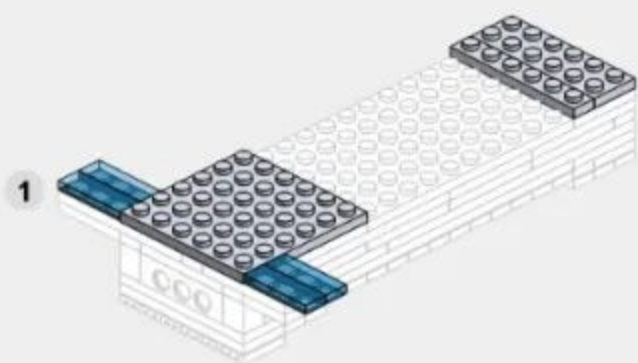
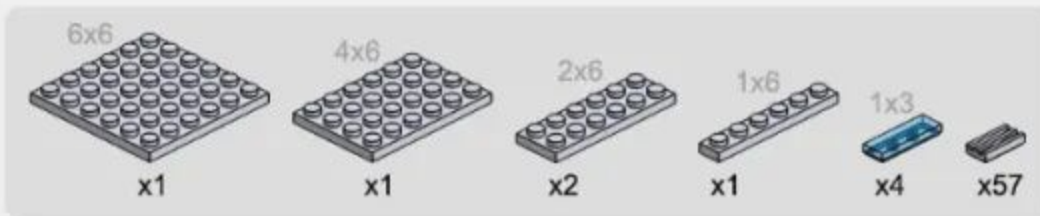

4-5

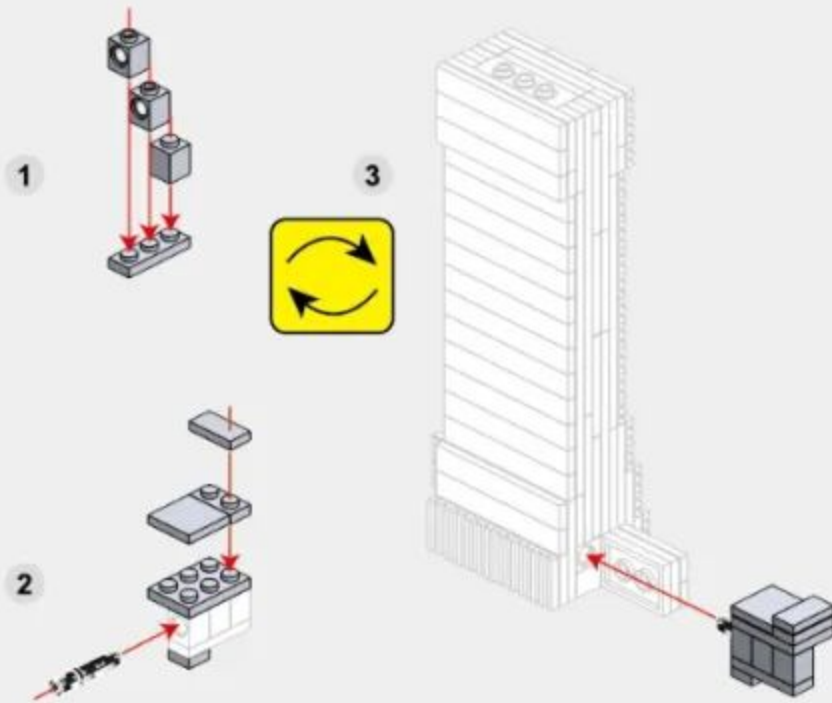

4-6

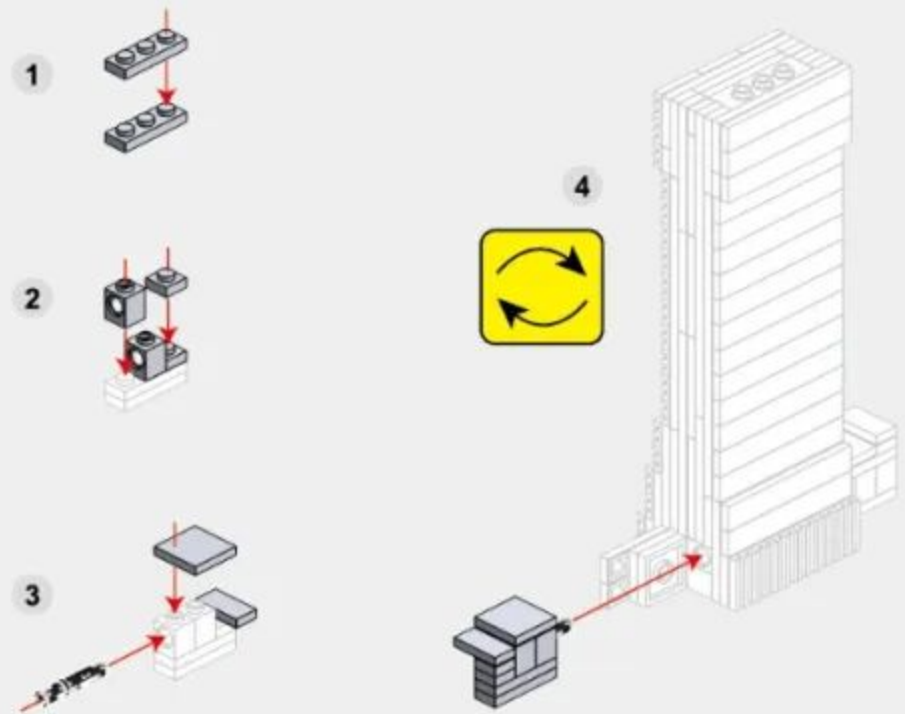

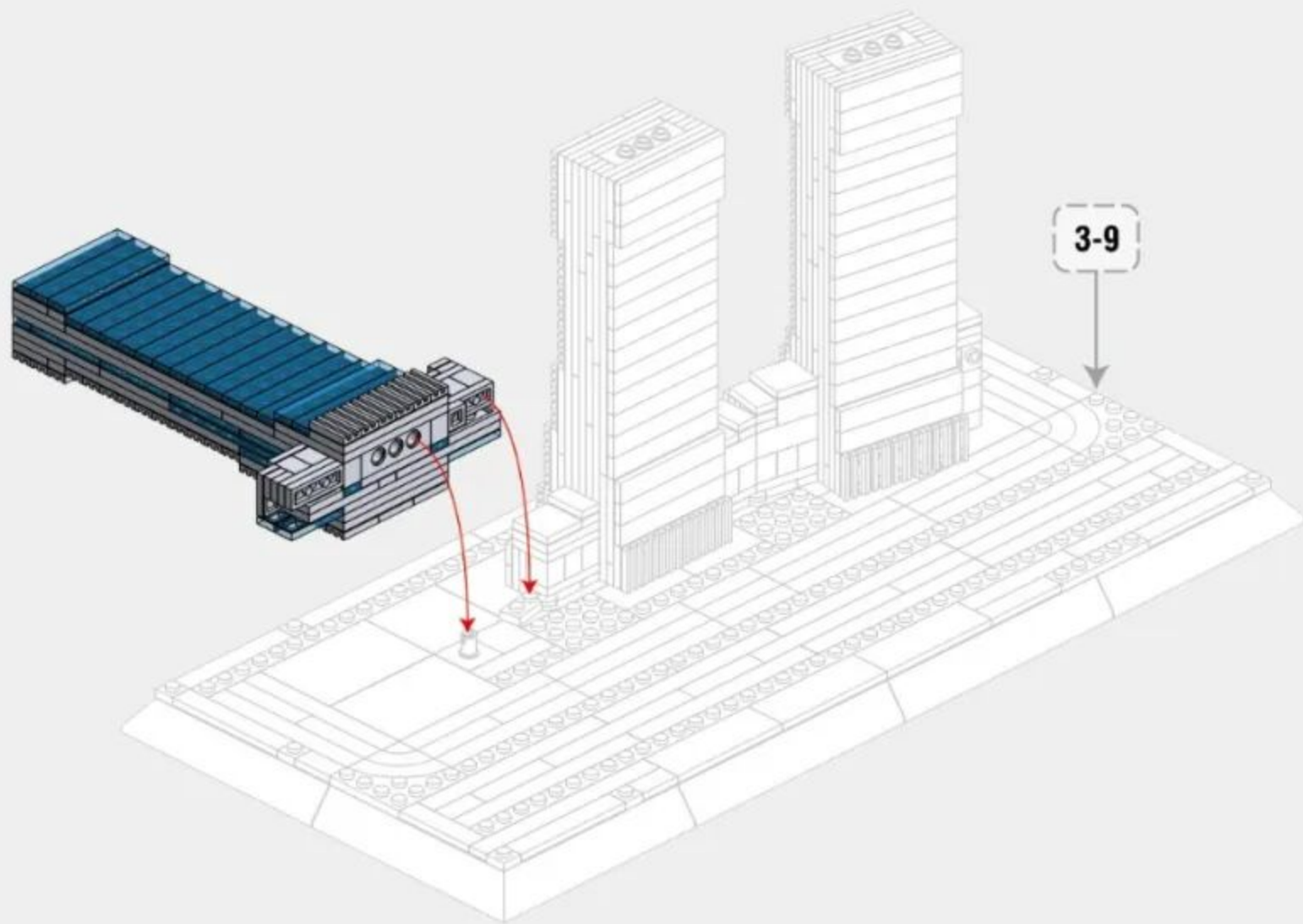



213PCS

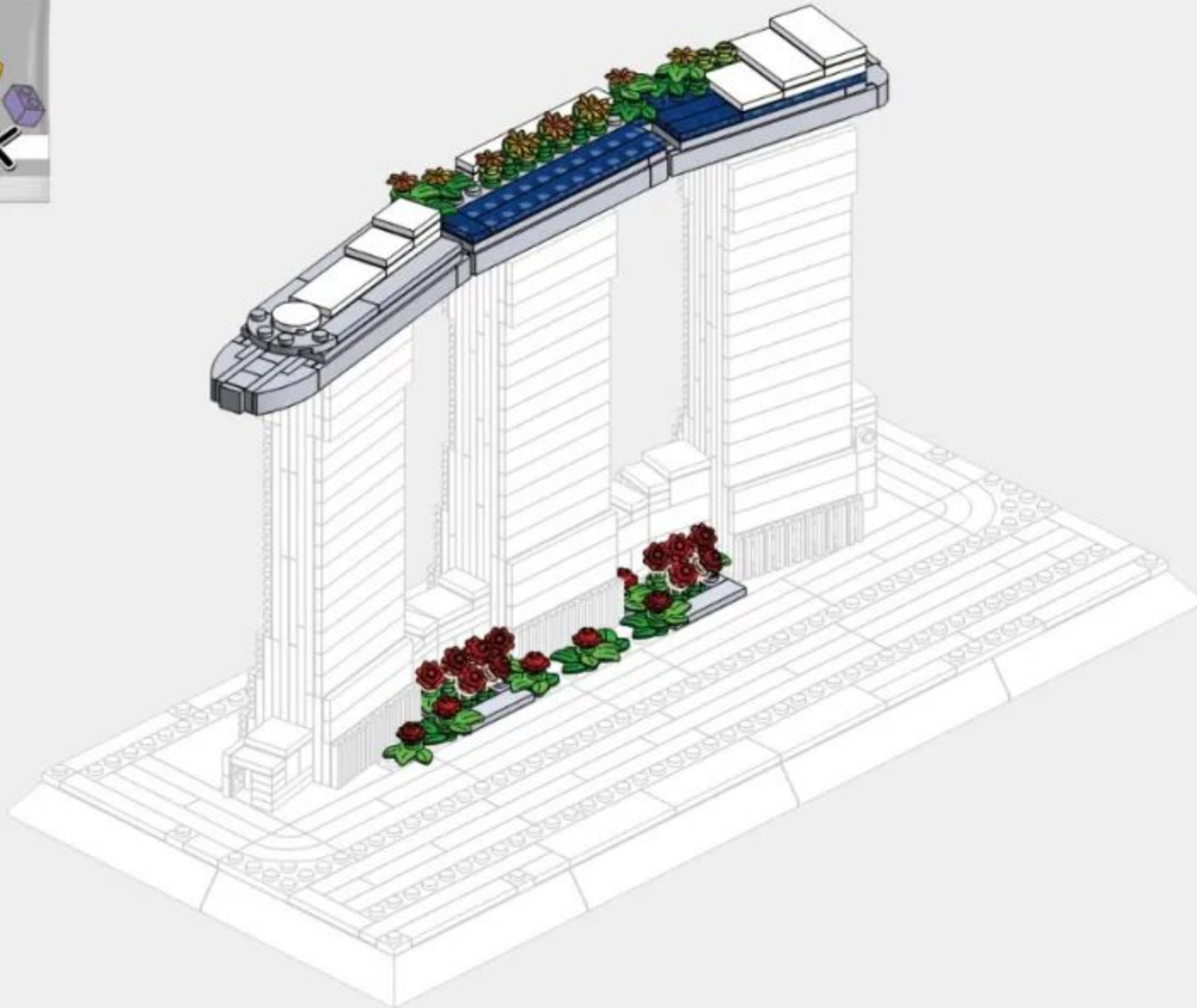

45

5-1

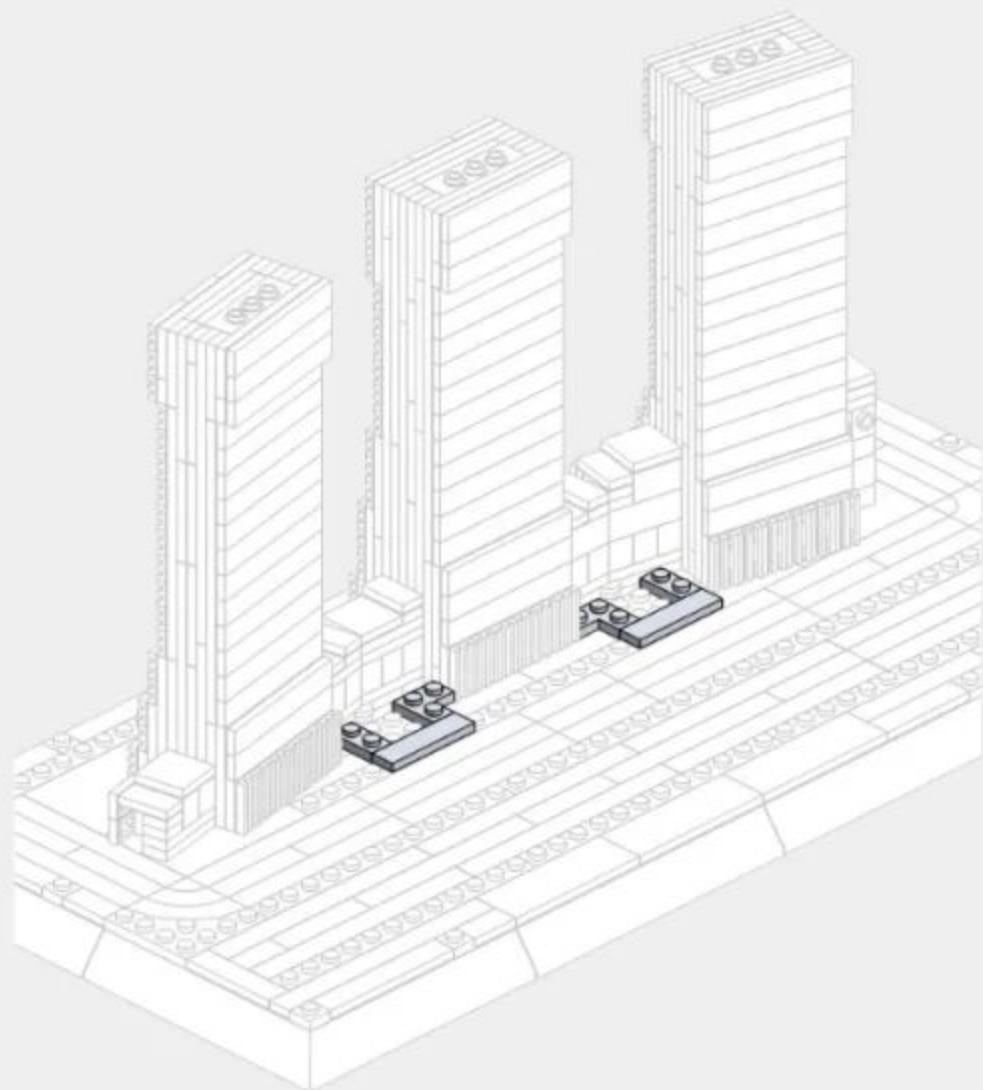

5-2

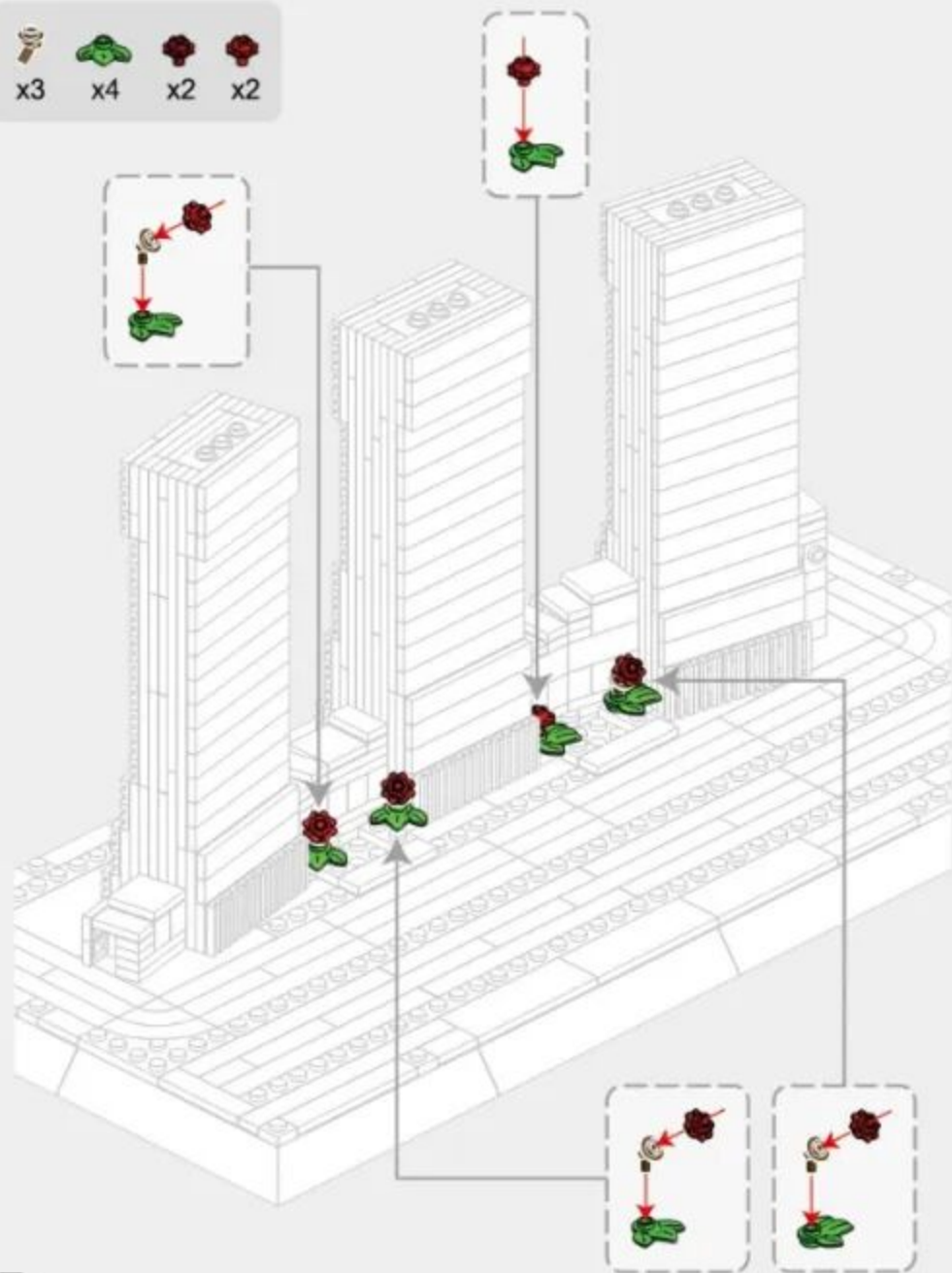
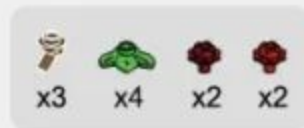

5-3

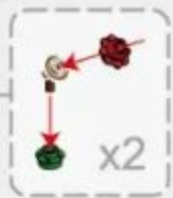
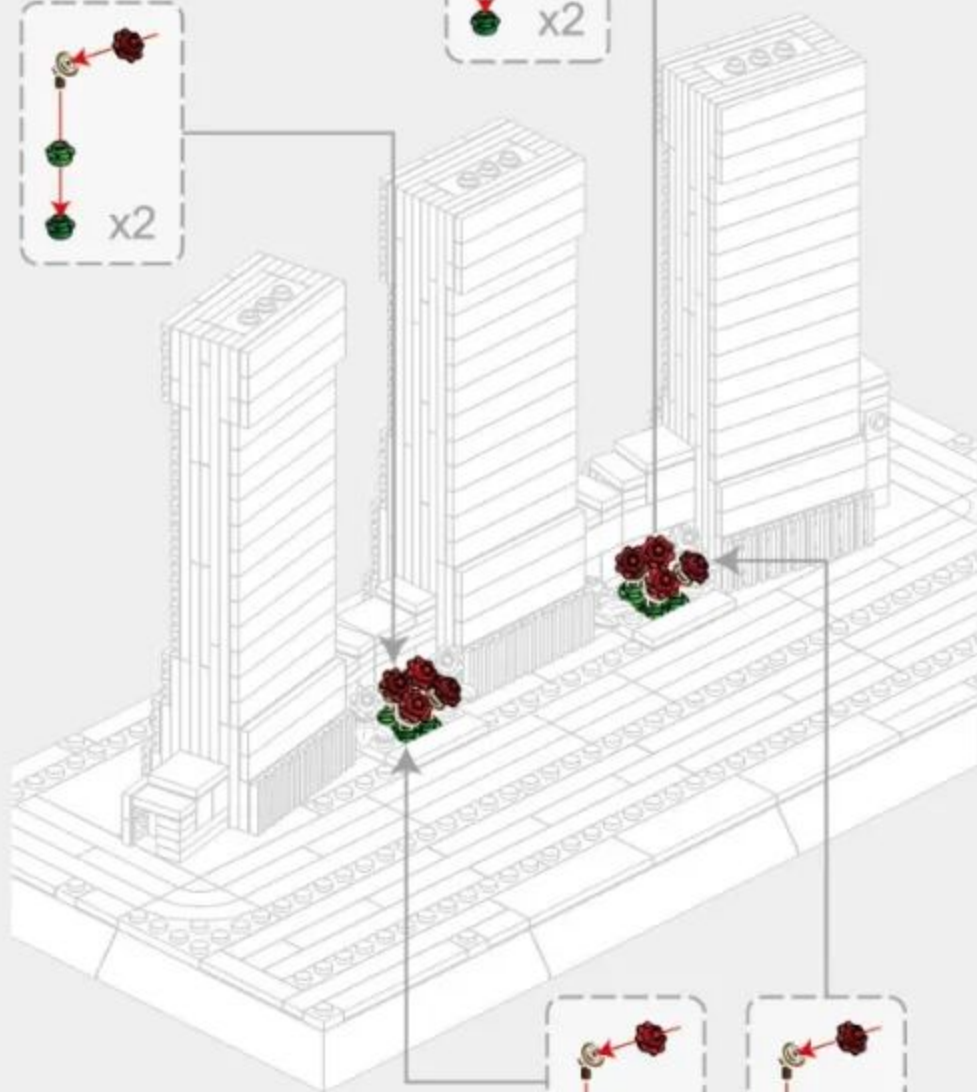
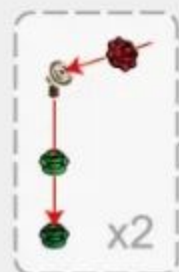
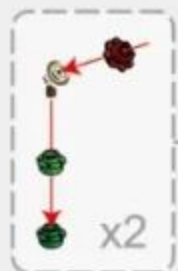
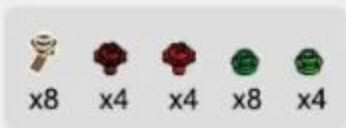

5-4

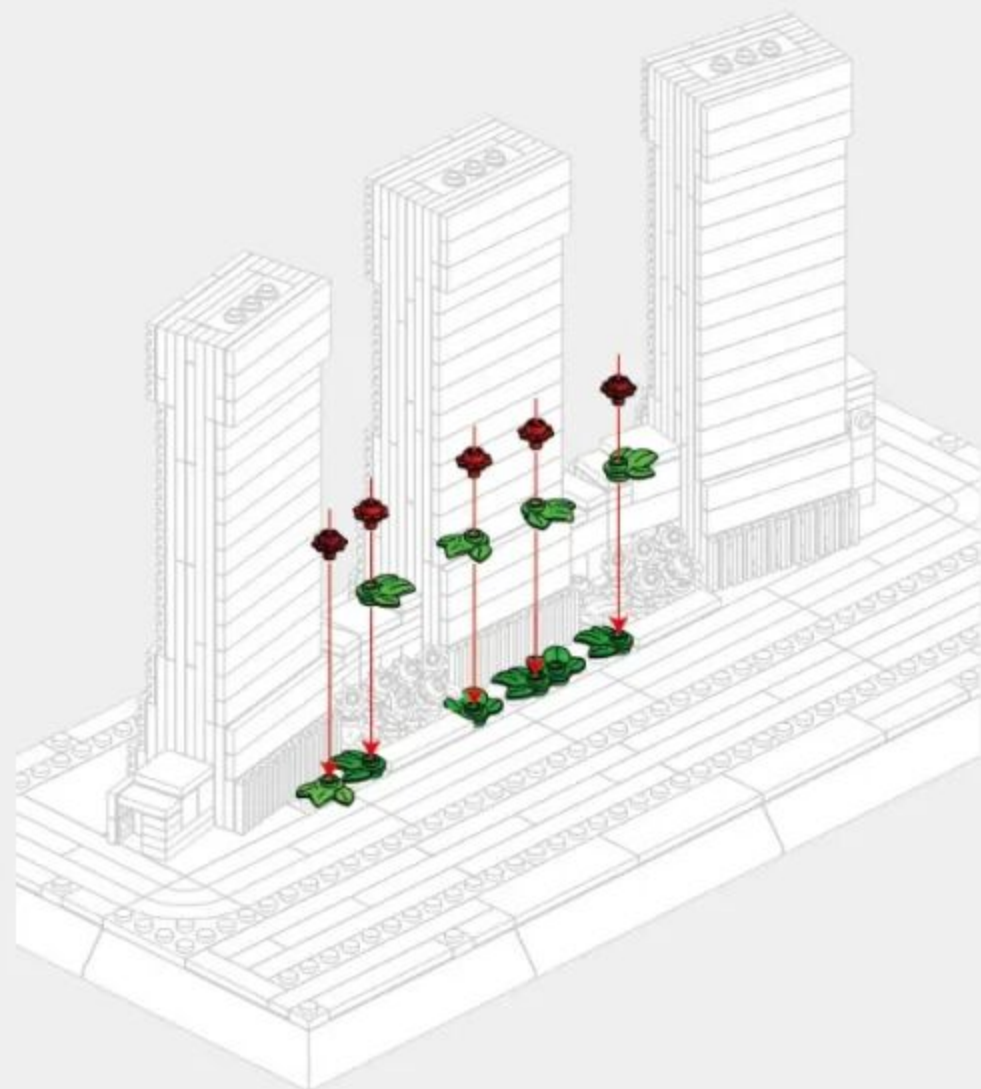
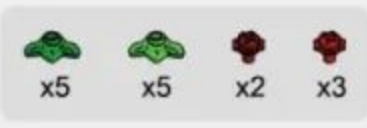

5-5

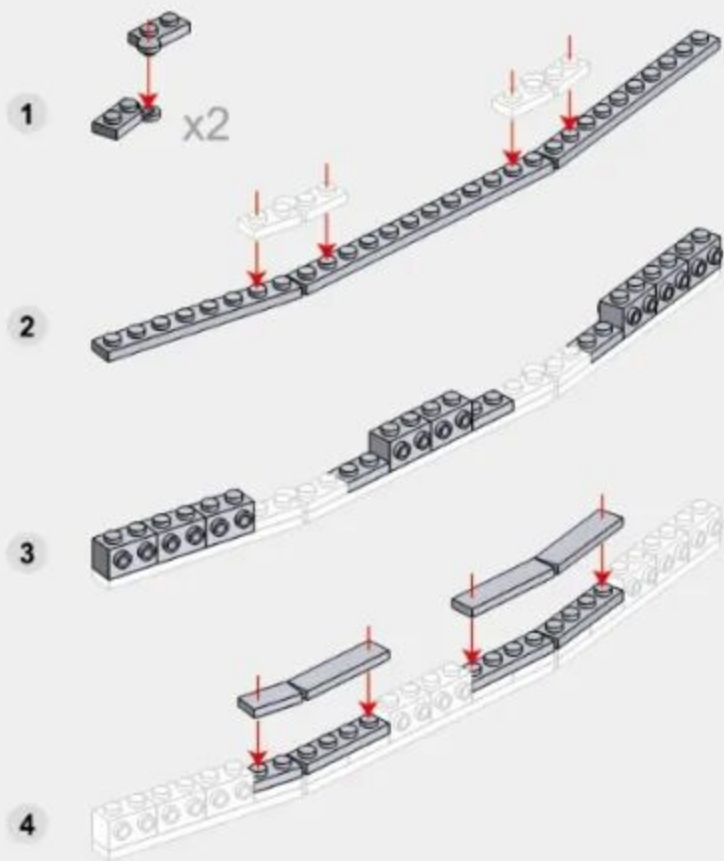
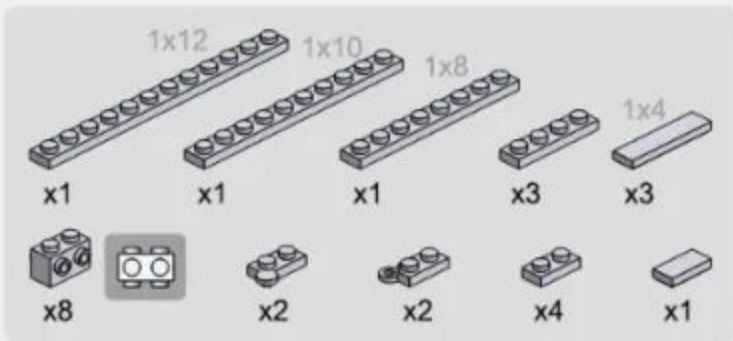

5-6

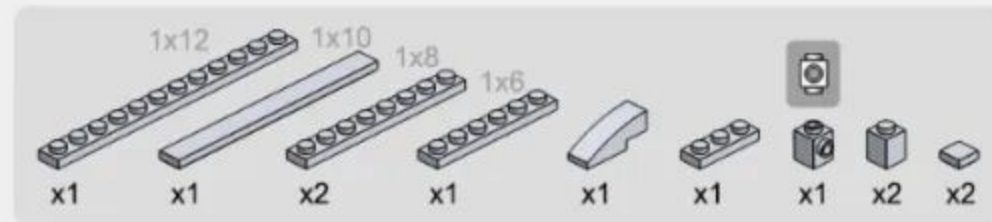

5-7

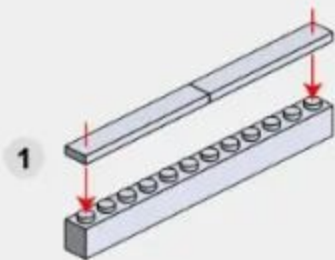
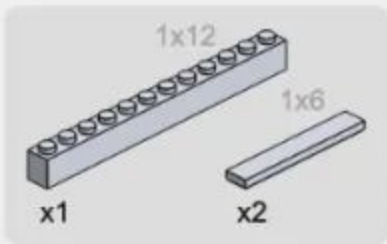

1

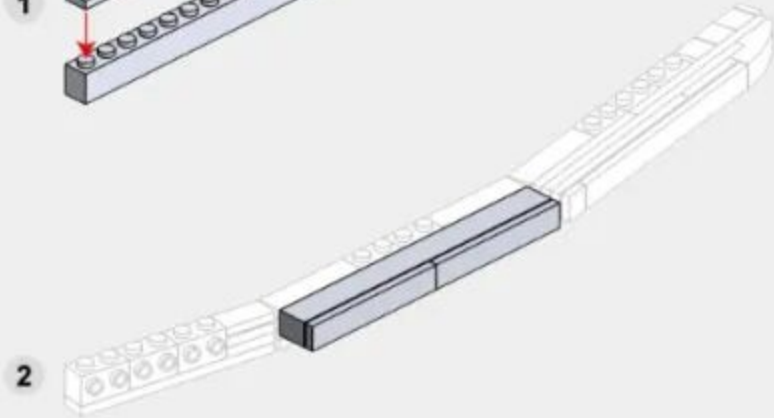

2

5-8

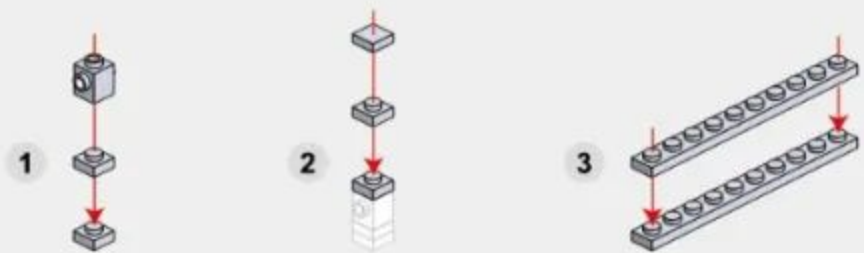

1



2

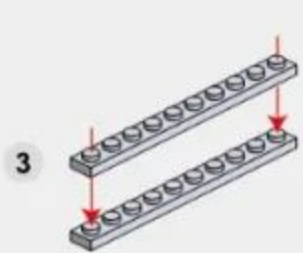

3

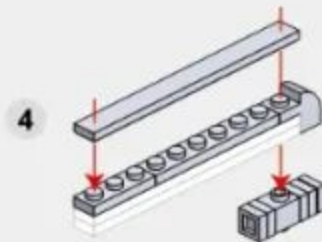

4

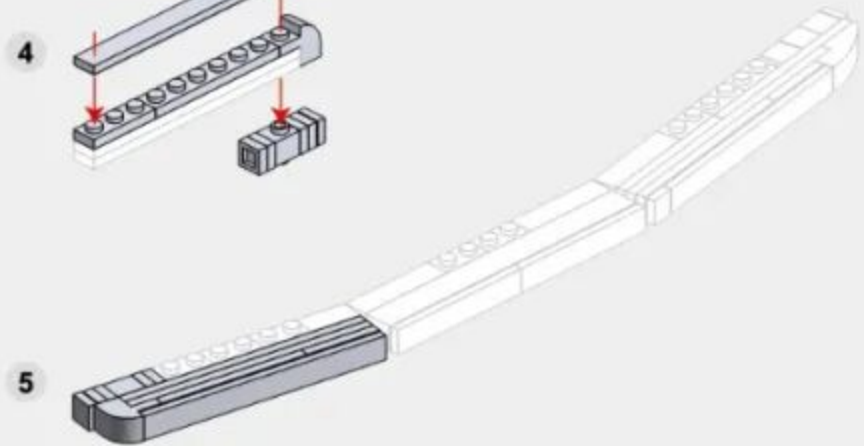

5

5-9

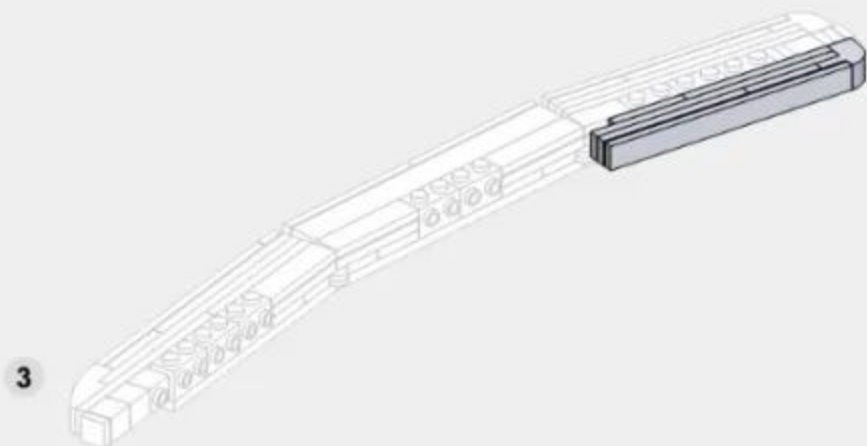
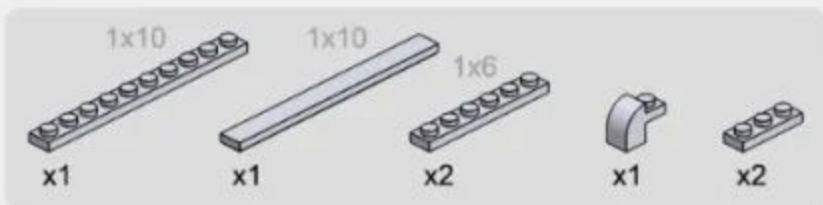

5-10

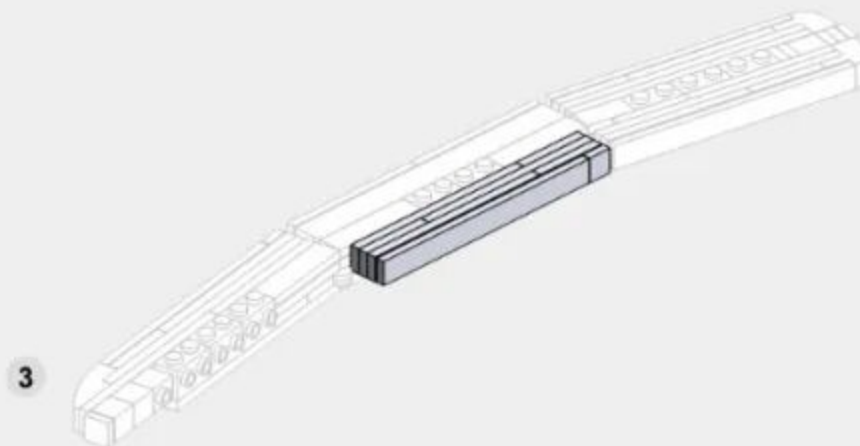
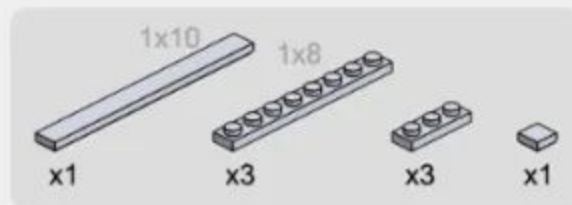

5-11

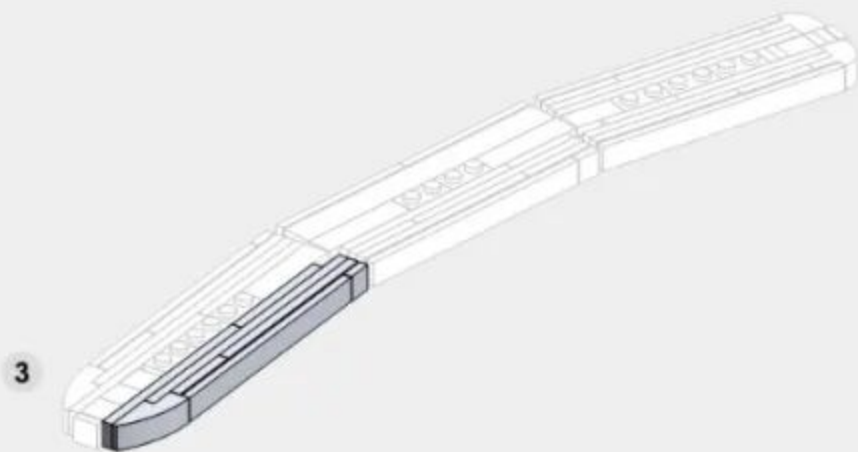
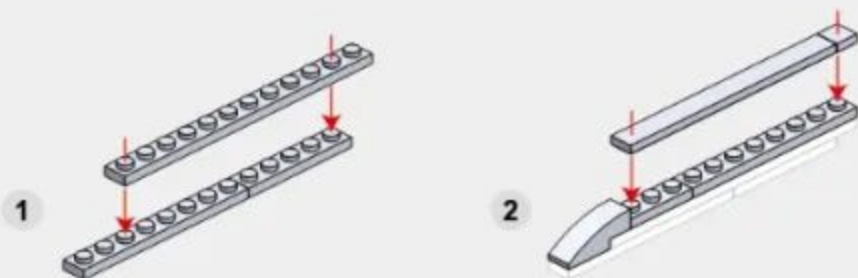
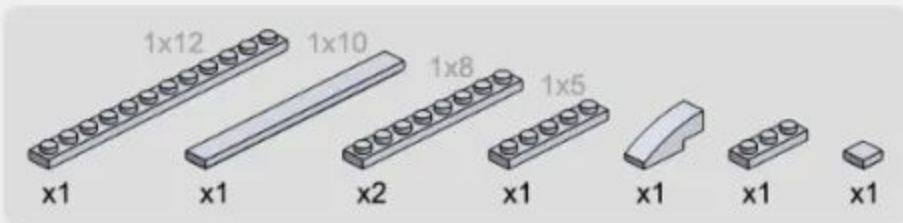

5-12

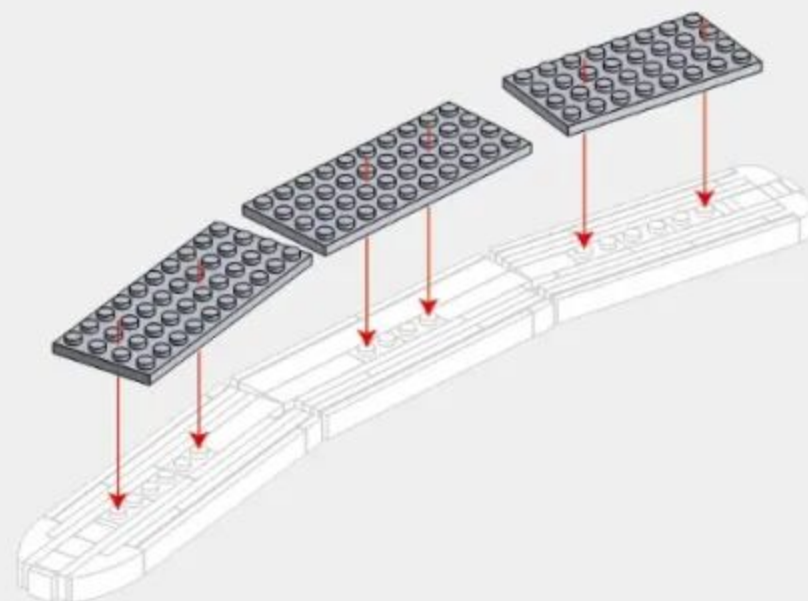
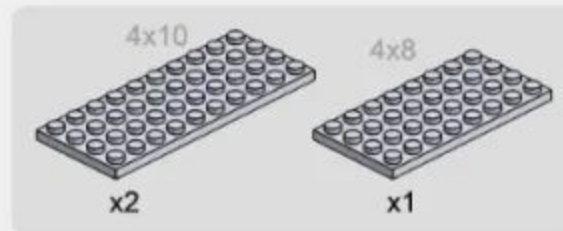

5-13

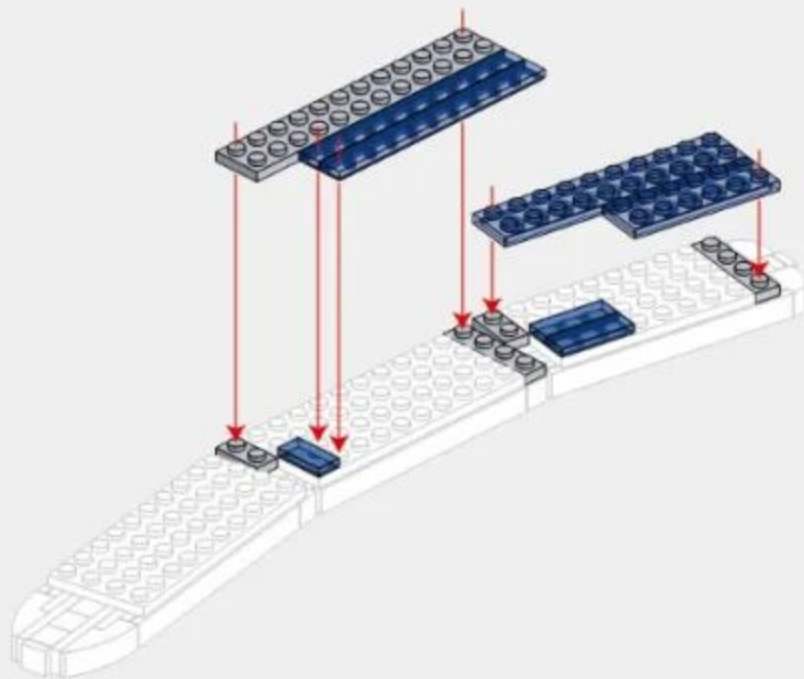
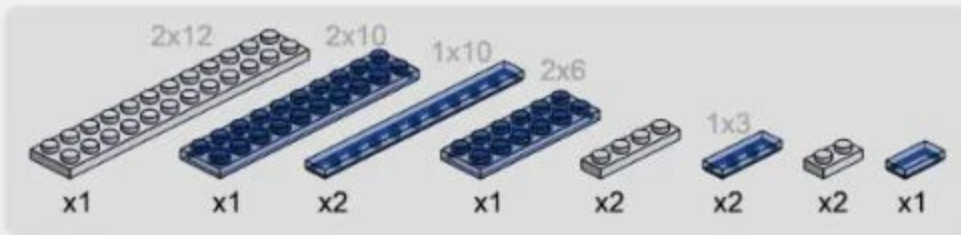

5-14

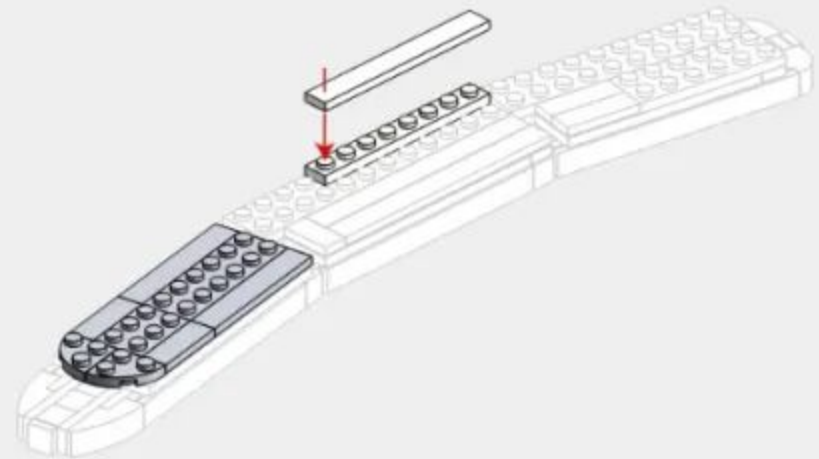
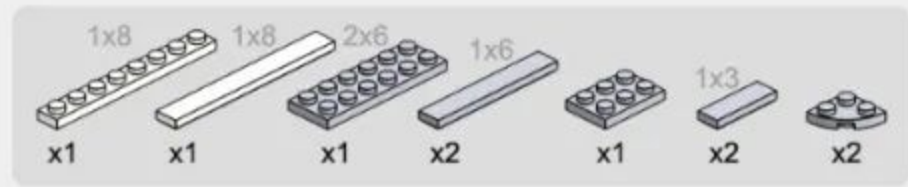

5-15

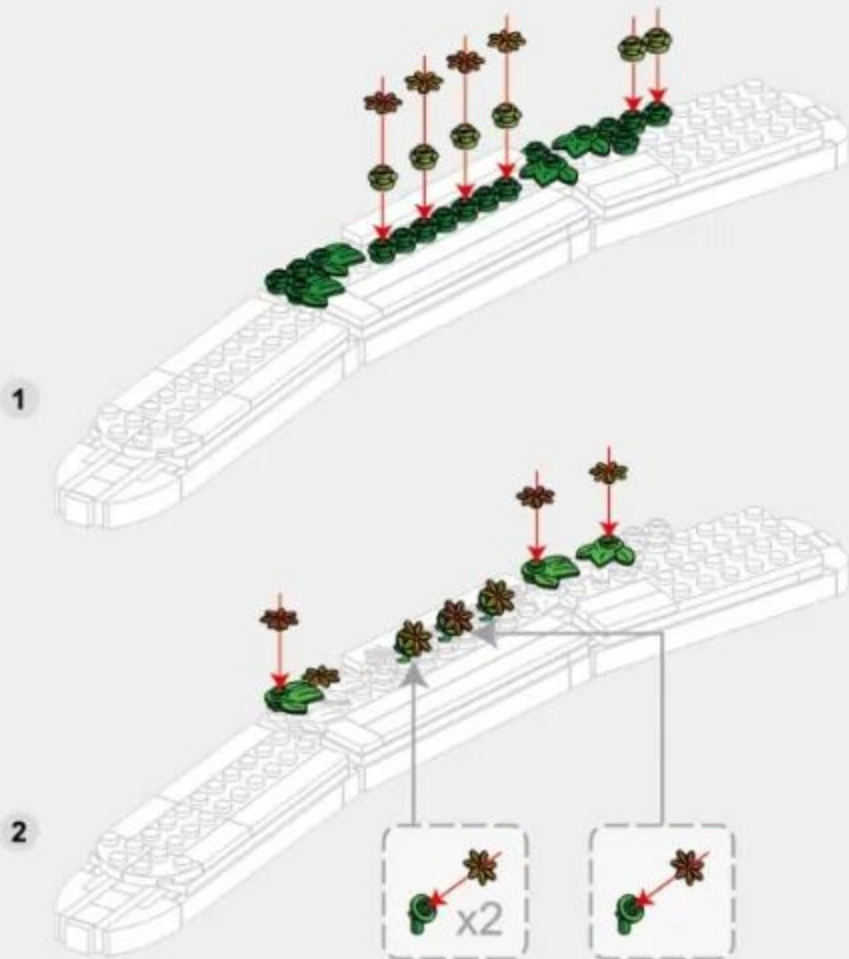
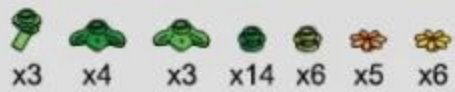

5-16

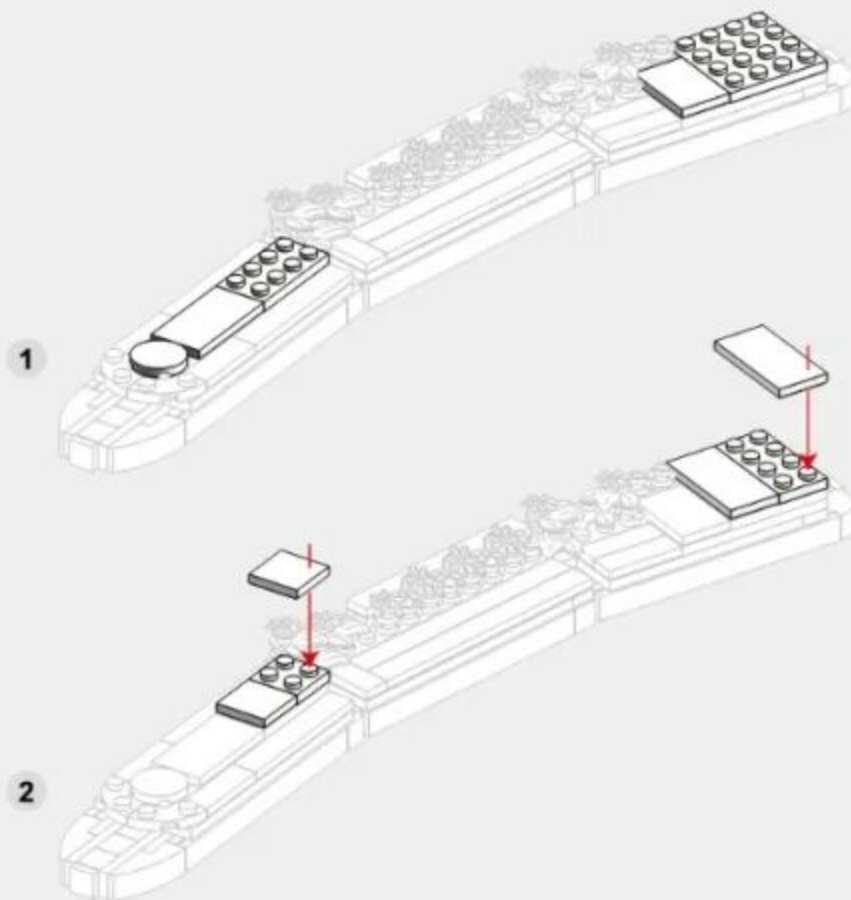
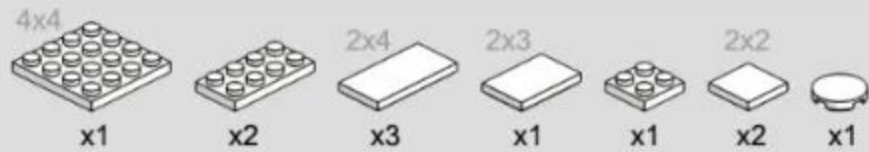

5-17

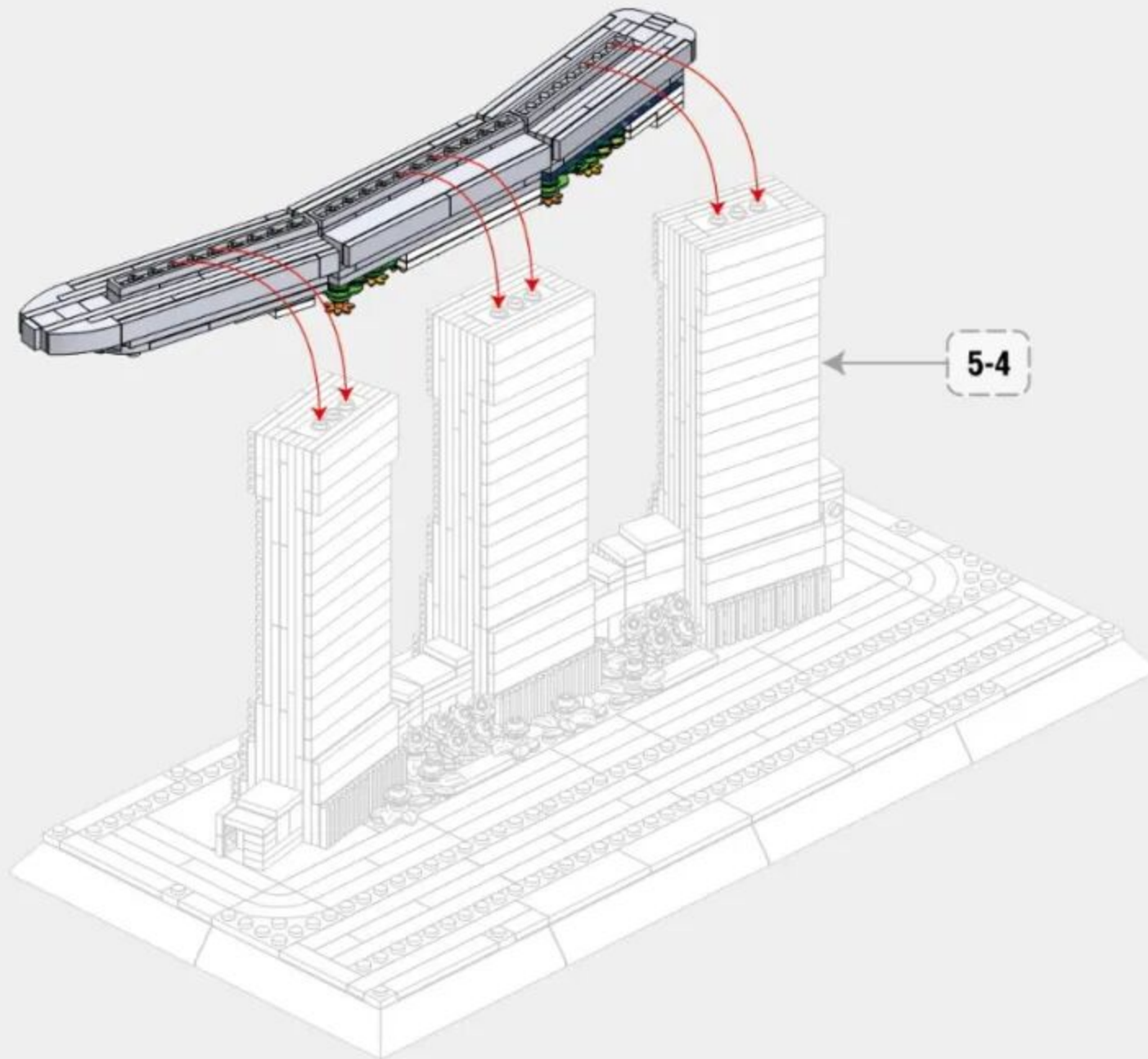

54



263PCS

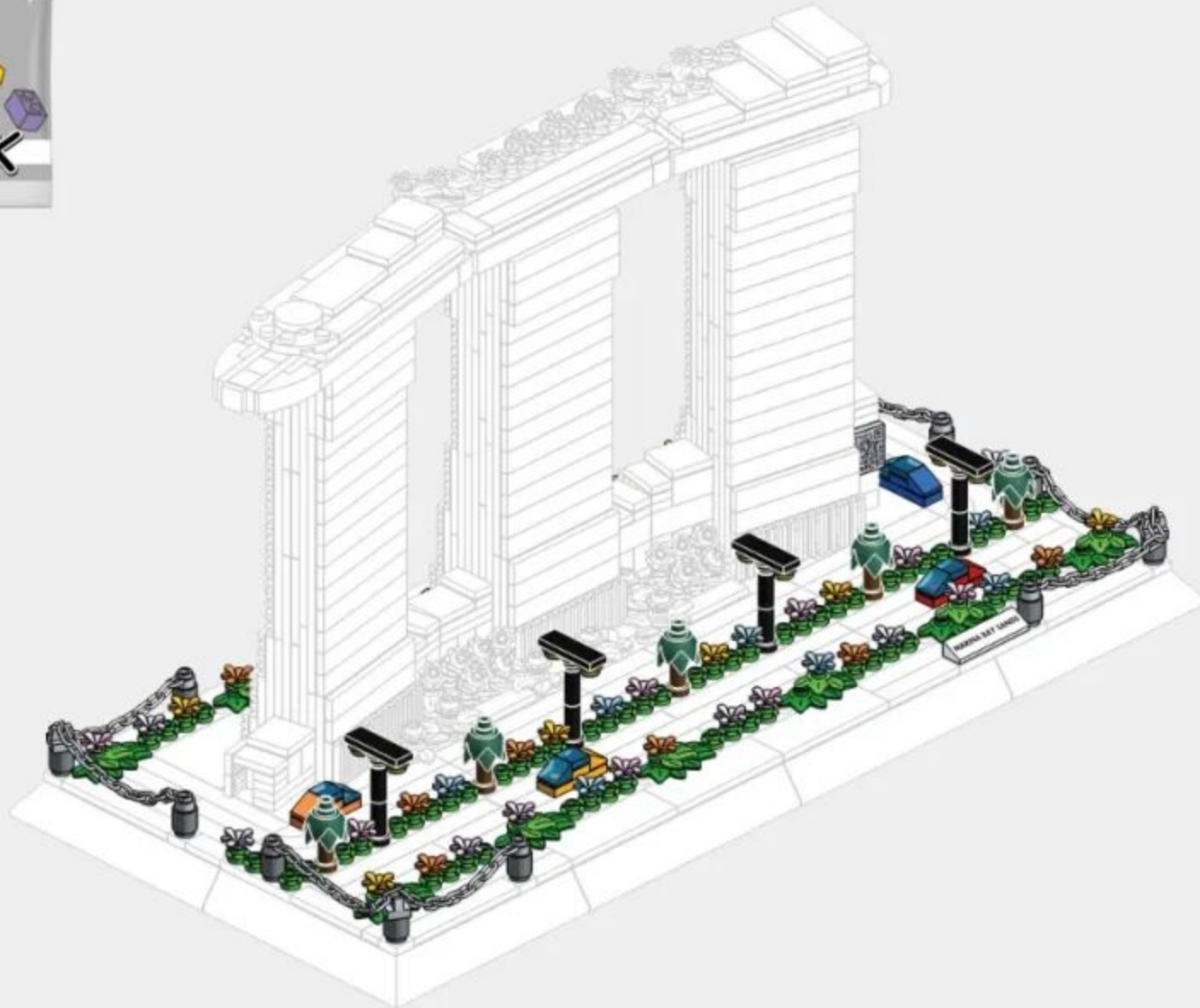

55

6-1

x20



56

6-2



x12



x6



6-3

-  x2
-  x3
-  x3
-  x3
-  x5



6-4

x61

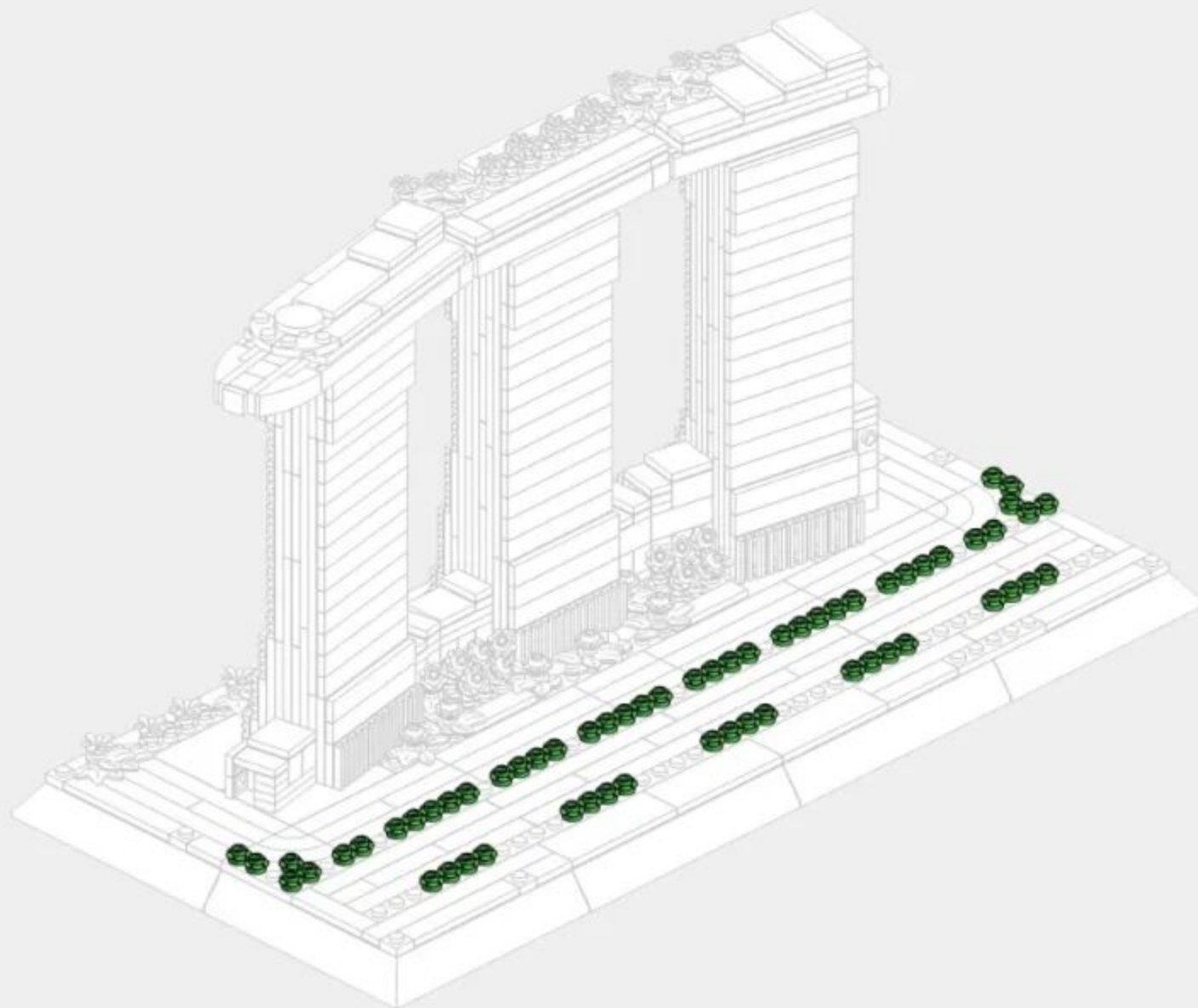

6-5







x12

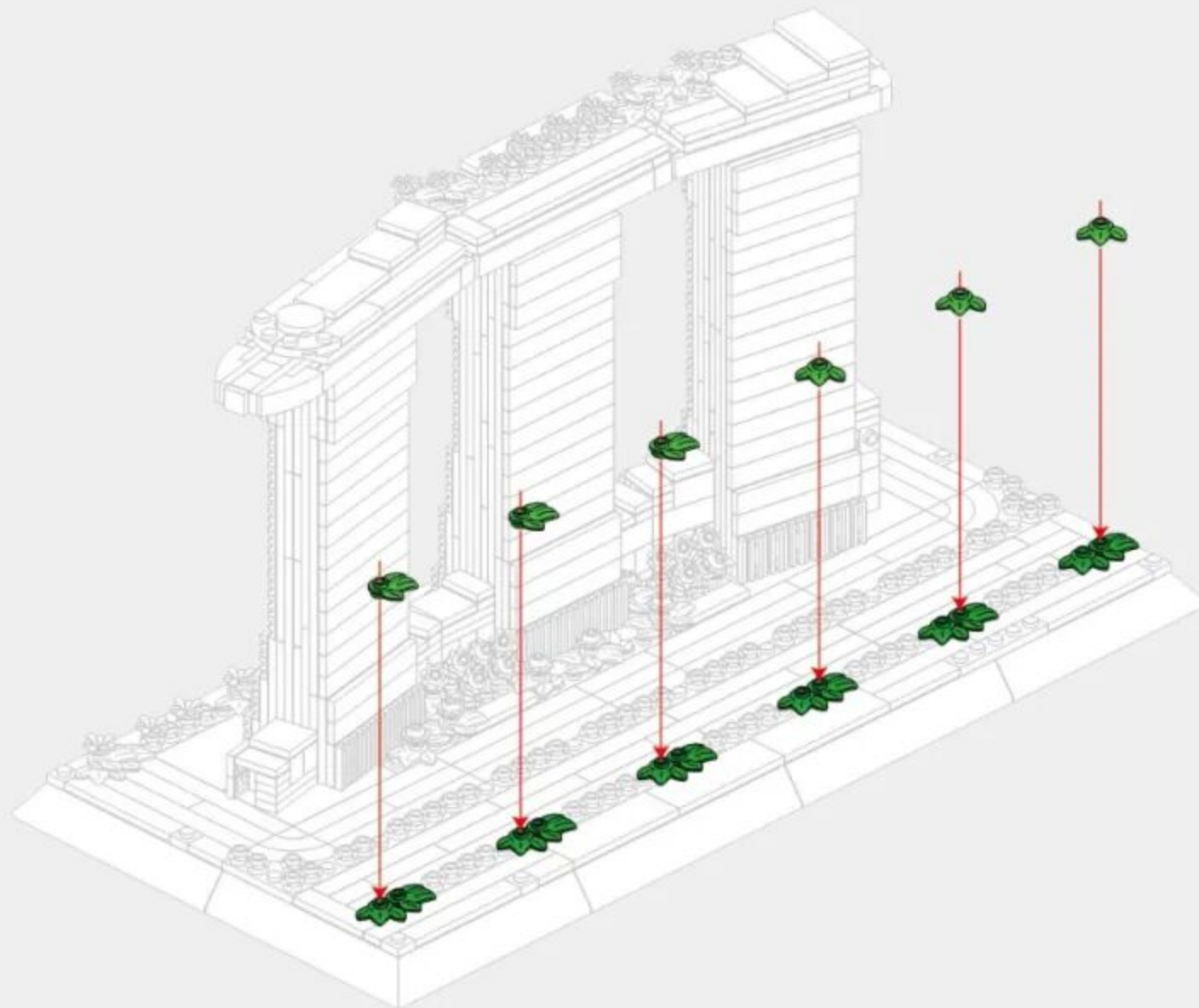

x6



6-6

-  x6
-  x5
-  x7
-  x5
-  x8



6-7

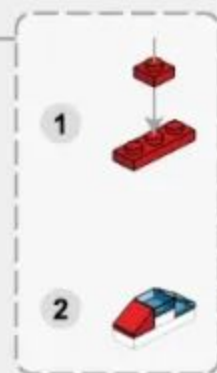
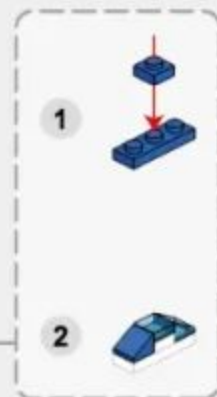
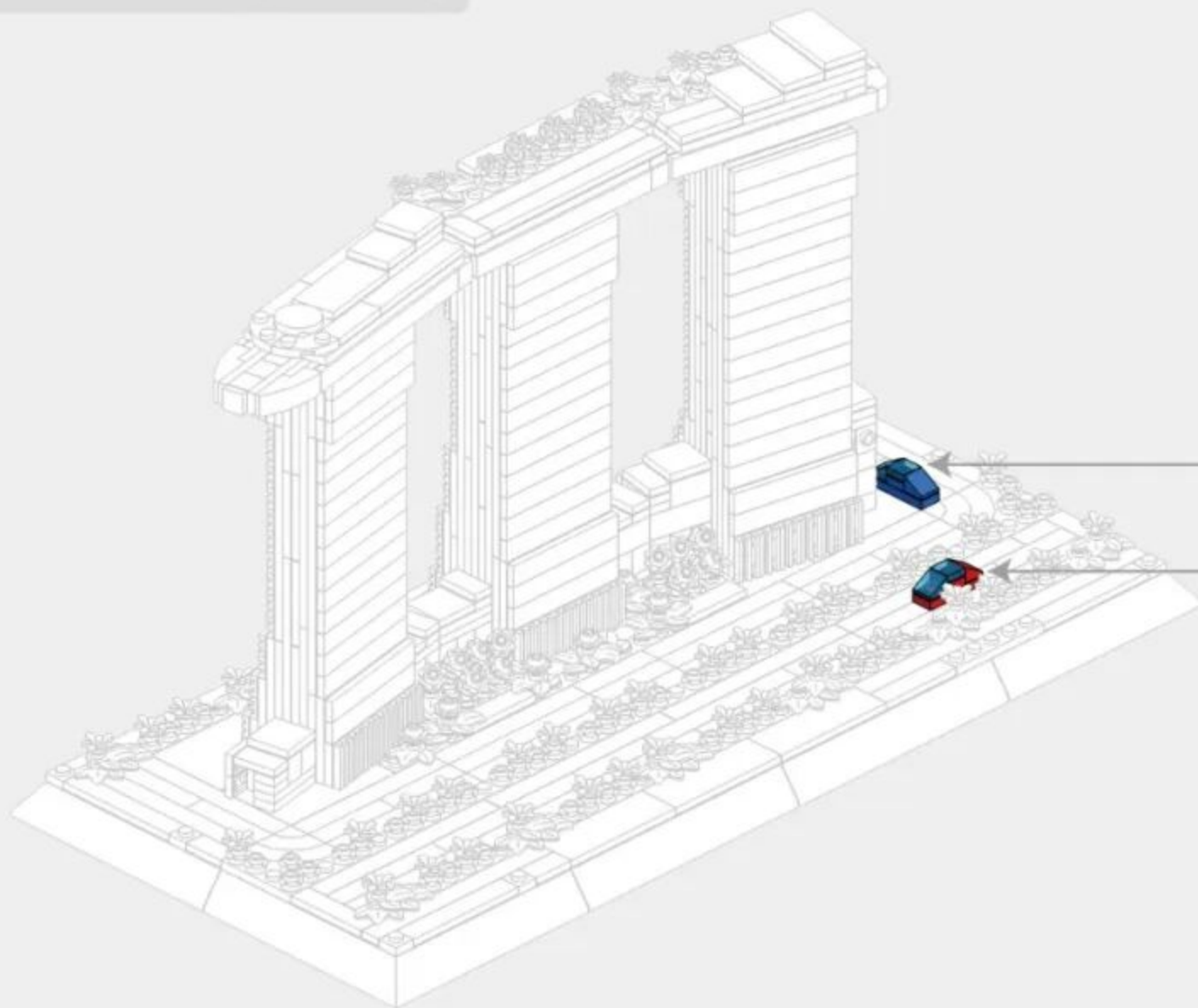

6-8

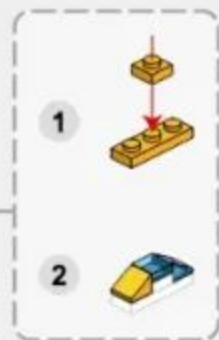
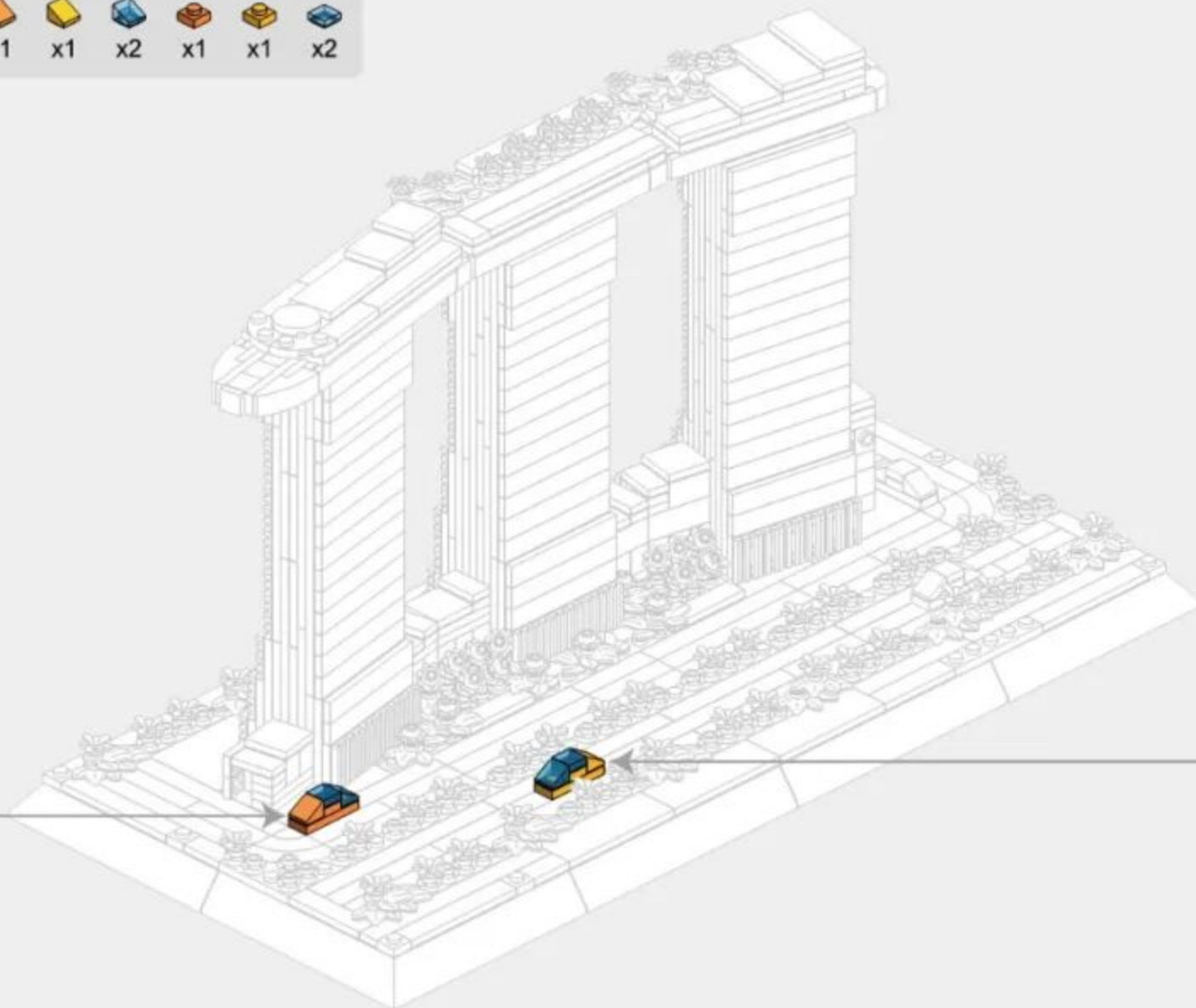
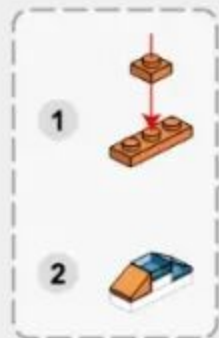

6-9

- x8
- x5
- 1x3 x4
- x10
- x4
- x5
- x4
- x8
- x4
- x5



6-10

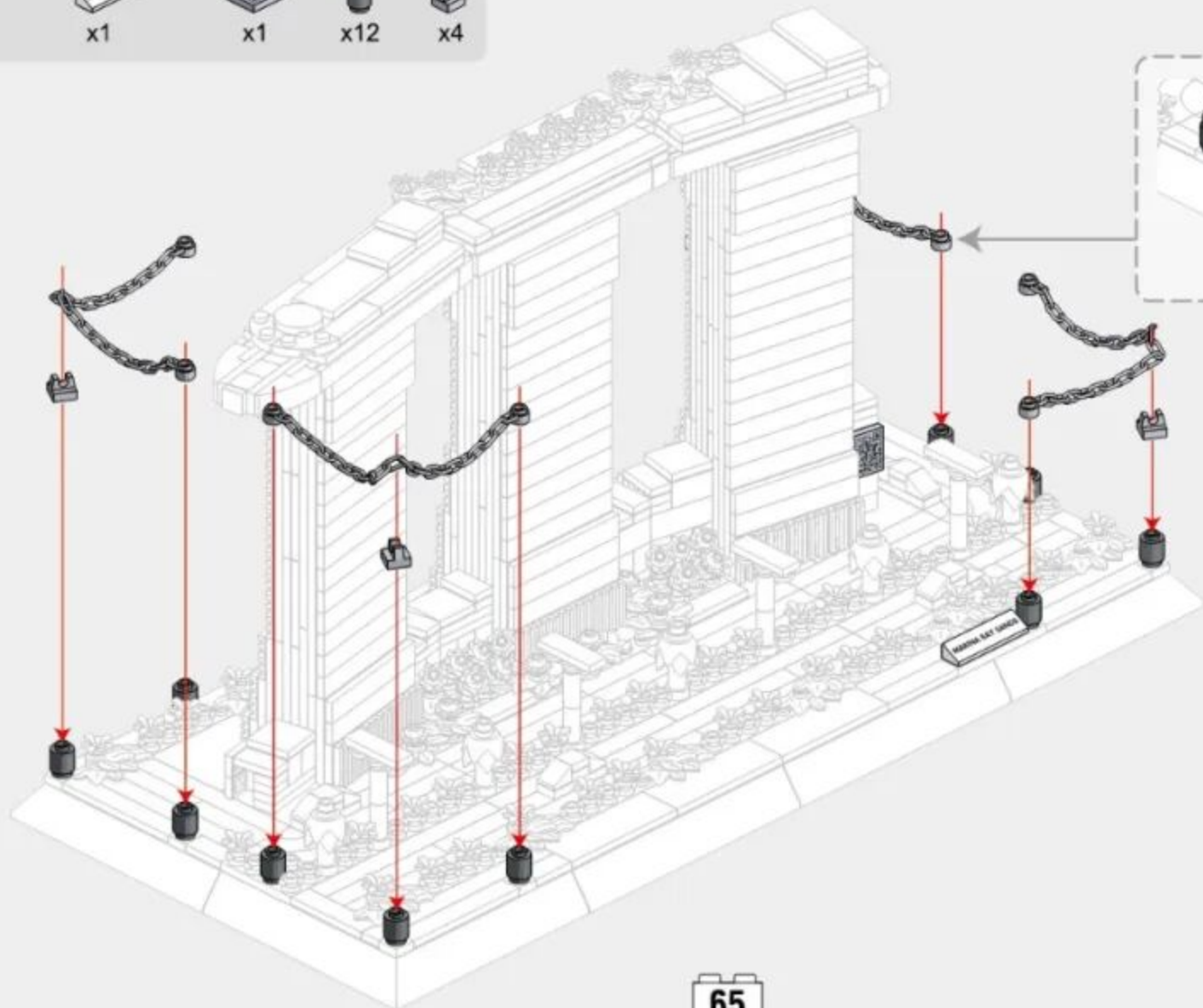
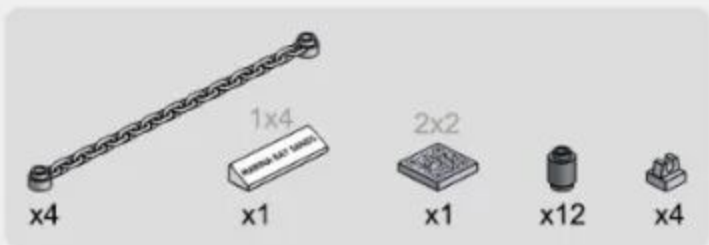



MARINA BAY SANDS

MARINA BAY SANDS

Singapore

The world's great architecture

Construction Difficulty



INTRODUCTION

Marina Bay Sands is an integrated resort fronting Marina Bay in Singapore, owned by the Las Vegas Sands corporation. At its opening in 2010, it was billed as the world's most expensive standalone casino property at \$5.8 billion (\$5.88 billion USD), including the land cost. The resort includes a 2,561-room hotel, a 120,000-square-metre (1,300,000 sq ft) convention-exhibition centre, the 74,000-square-metre (800,000 sq ft) The Shoppes at Marina Bay Sands mall, a museum, two large theatres, "celebrity chef" restaurants, two floating Crystal Pavilions, art-science exhibits, and the world's largest atrium casino with 500 tables and 1,600 slot machines. The complex is topped by a 340-metre-long (1,120 ft) SkyPark with a capacity of 3,900 people and a 150 m (490 ft) infinity swimming pool, set on top of the world's largest public cantilevered platform, which overhangs the north tower by 67 m (220 ft). The 20-hectare resort was designed by Moshe Safdie architects.

Marina Bay Sands was originally set to open in 2009, but its construction faced delays caused by escalating costs of material and labour shortages from the outset. The global financial crisis also pressured the owners, Las Vegas Sands, to delay its projects elsewhere to complete the integrated resort. Its owner decided to open the integrated resort in stages, and it was approved by the Singapore authorities. The resort and SkyPark were officially opened on 23 and 24 June 2010 as part of a two-day celebration, following the casino's opening on 27 April that year. The SkyPark opened the following day. The theatres were completed in time for the first performance of *Riverdance* on 30 November. The indoor skating rink, which uses artificial ice, opened to a performance by Michelle Kwan on 18 December. The ArtScience Museum opened to the public and the debut of a 13-minute light, laser and water show called *Wonder Fall* on 19 February 2011 marked the full completion of the integrated resort. The opening of Marina Bay Sands was held on 17 February 2011. It also marked the opening of the seven celebrity chef restaurants. The last portion of the Marina Bay Sands, the floating pavilions, were finally opened to the public when the two tenants, Louis Vuitton and Pangaea Club, opened on 18 and 22 September 2011, respectively. Marina Bay Sands is set to have a fourth tower constructed in the near future.

