



# THE MARINA BAY SANDS OF SINGAPORE CITY

Singapore  
The world's great architecture

Ages  
**6+**



NO.4217  
**881 PCS**

1

10 X 12

10 X 10

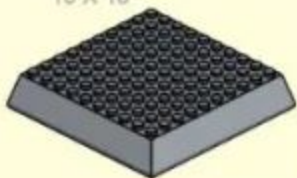

x4

x4

x24

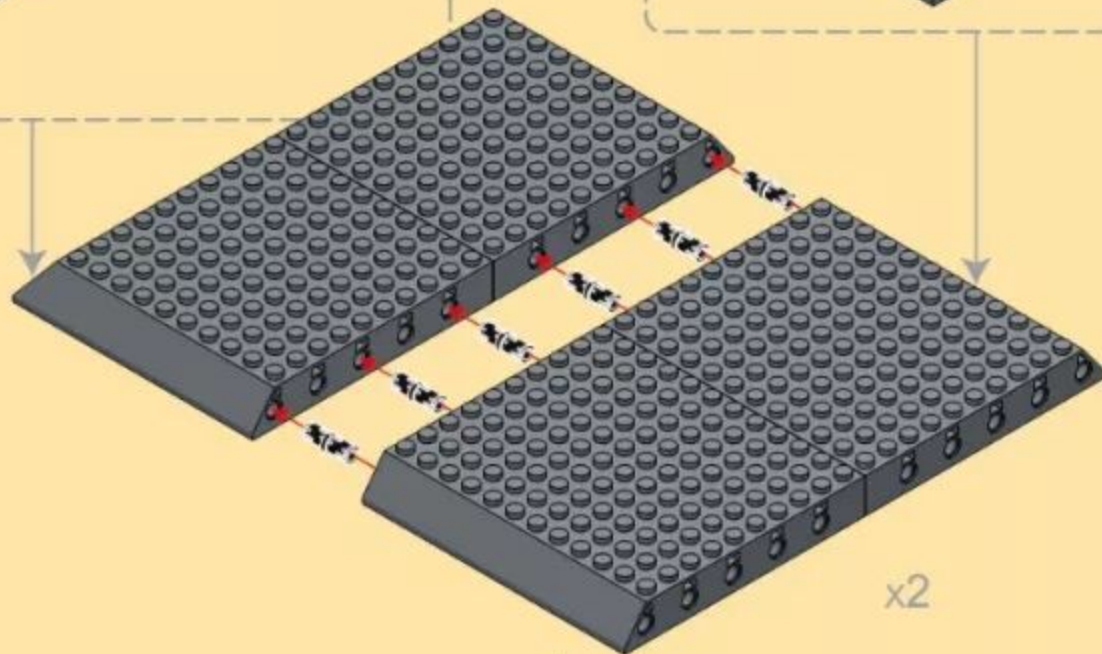
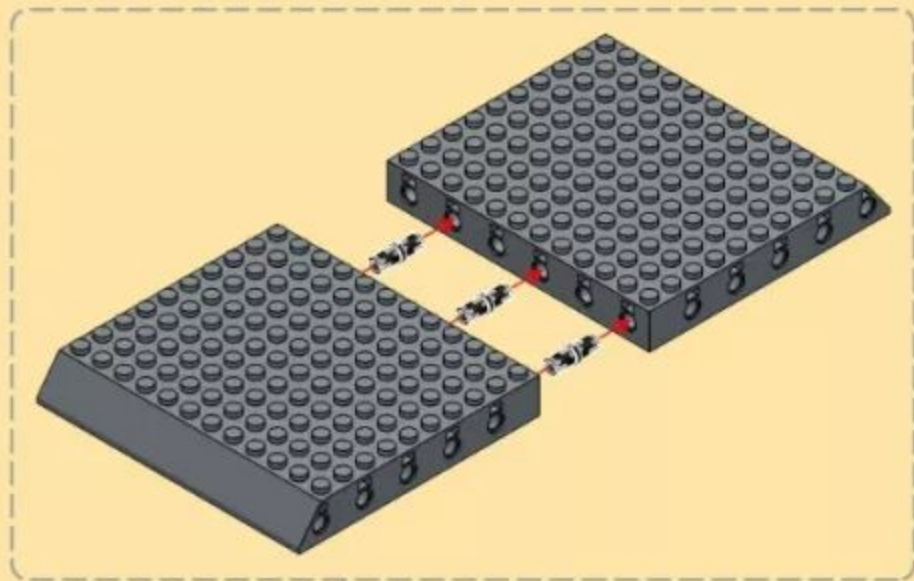
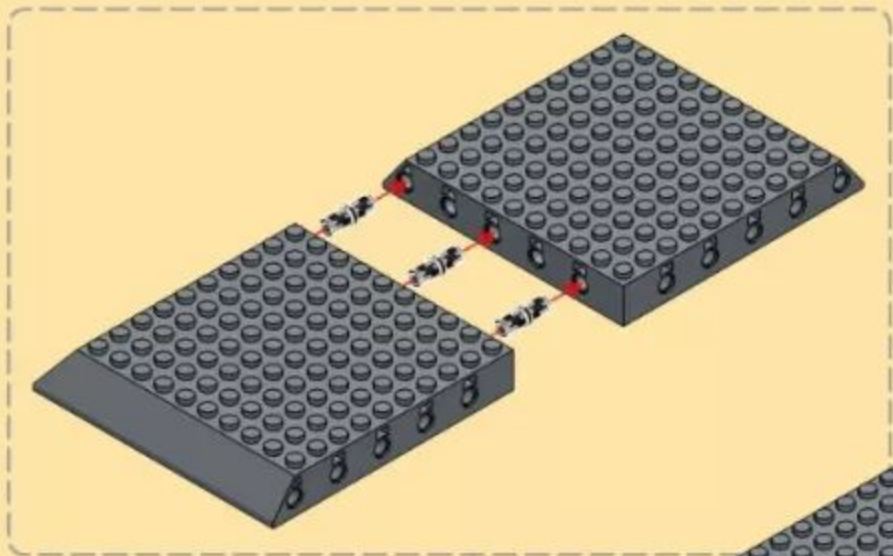

x2

1

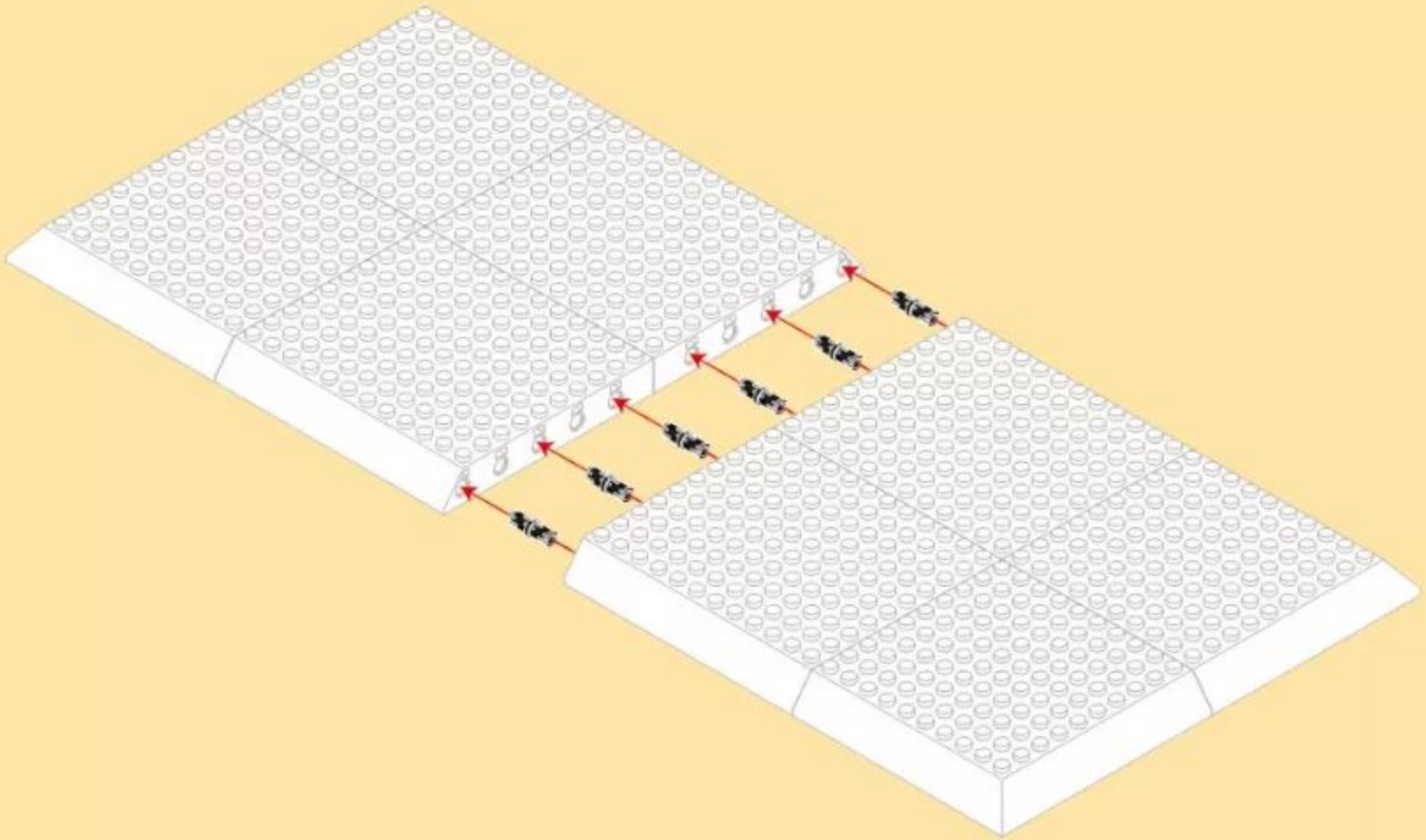

3

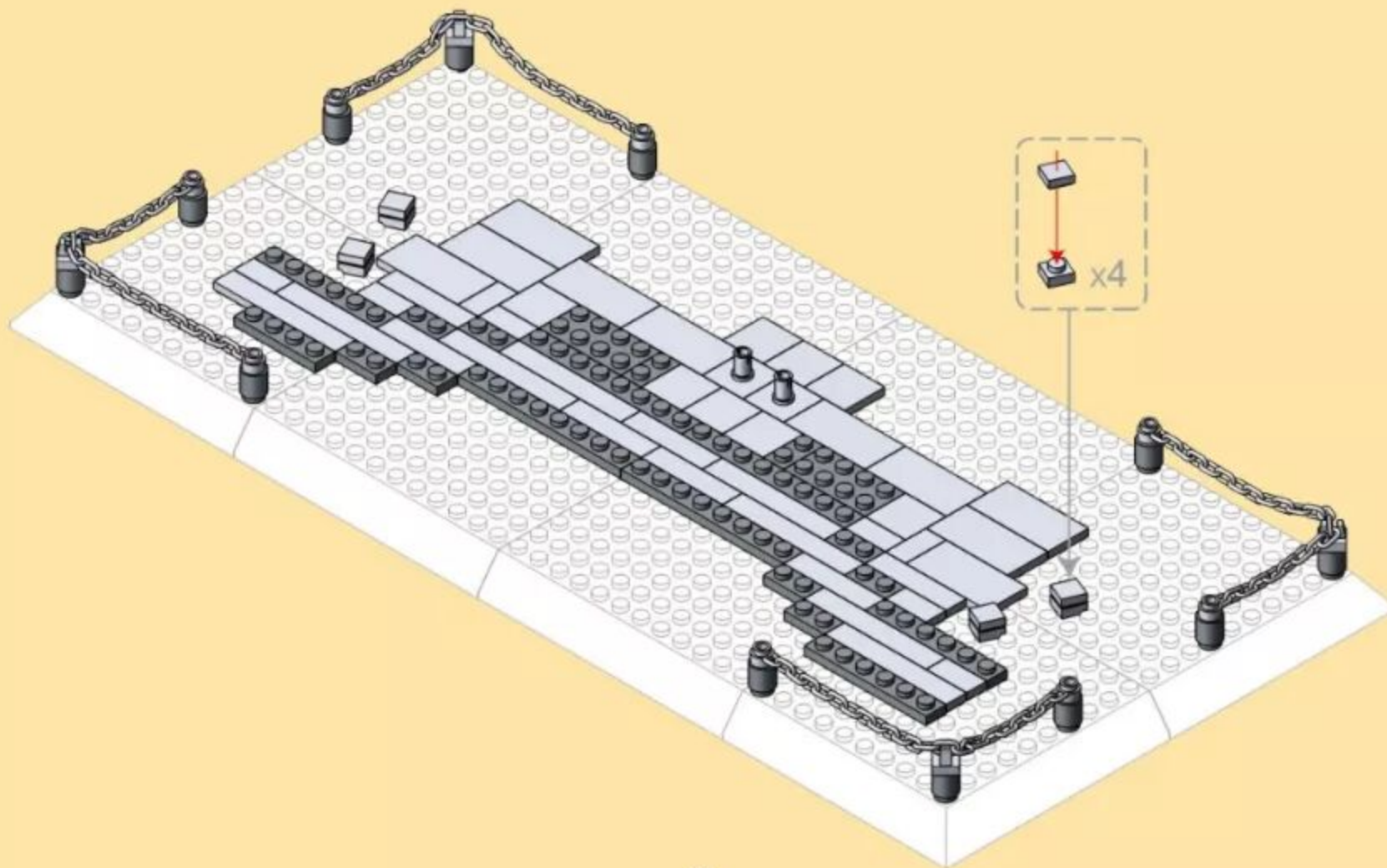
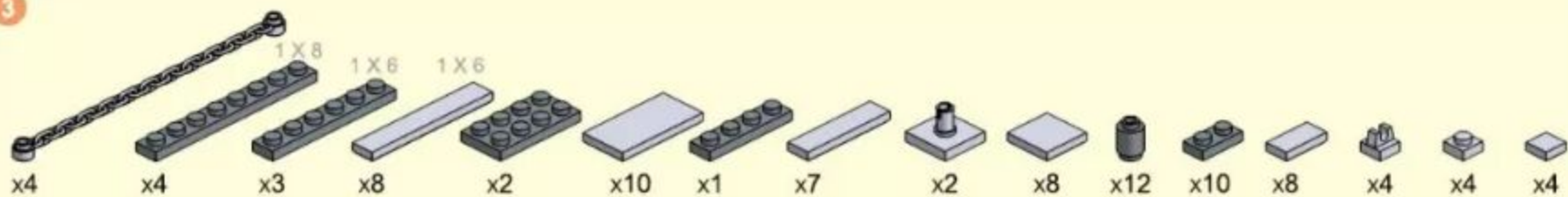

3

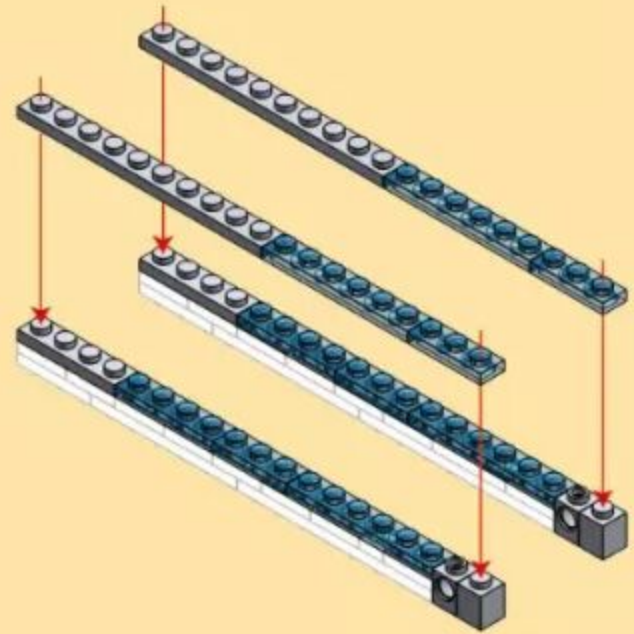
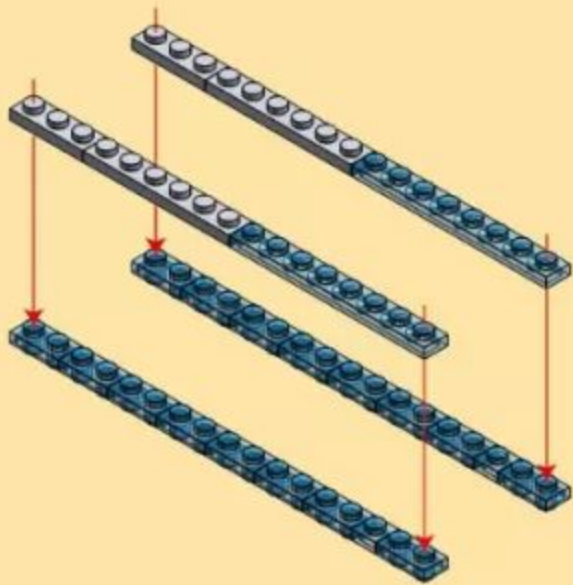
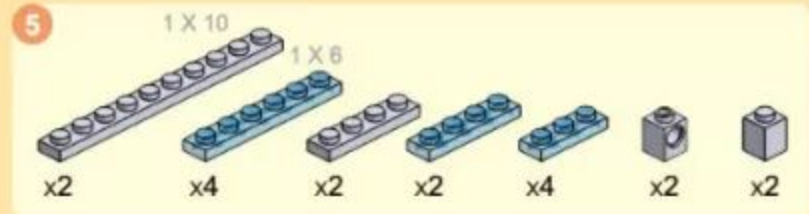
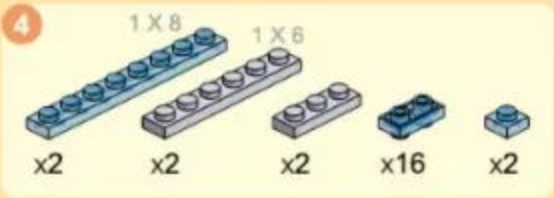

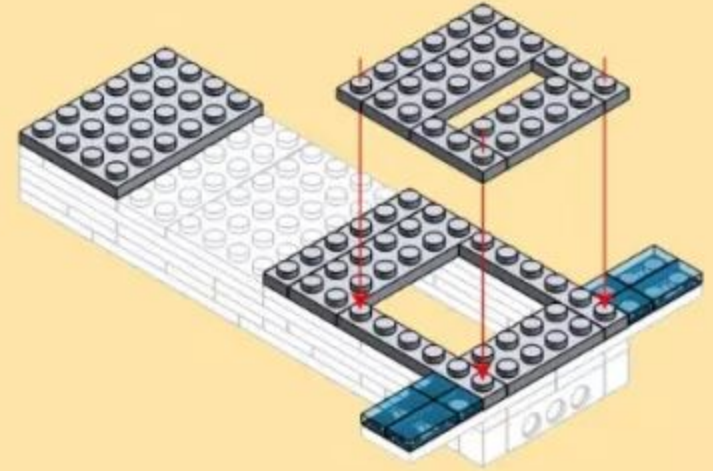
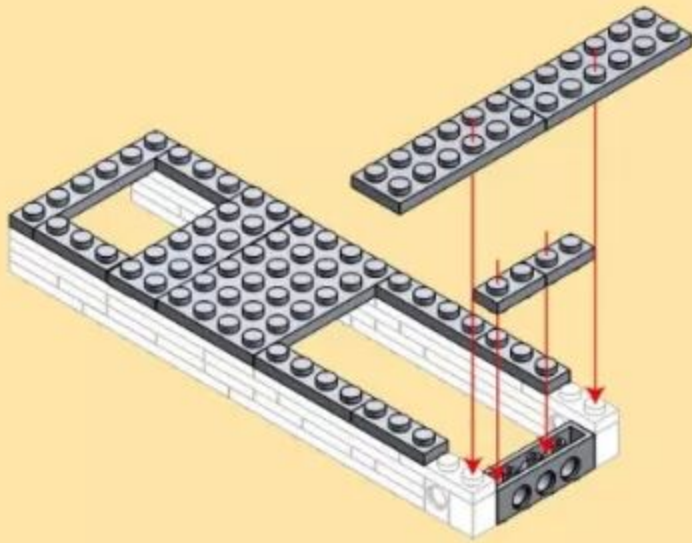
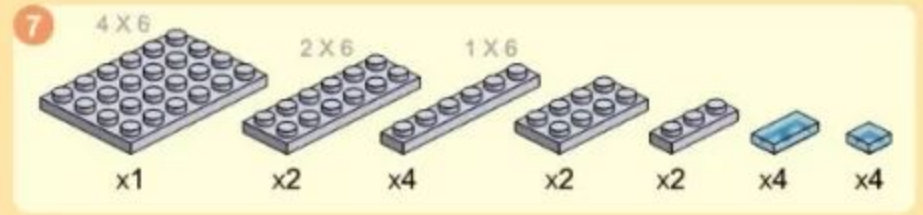
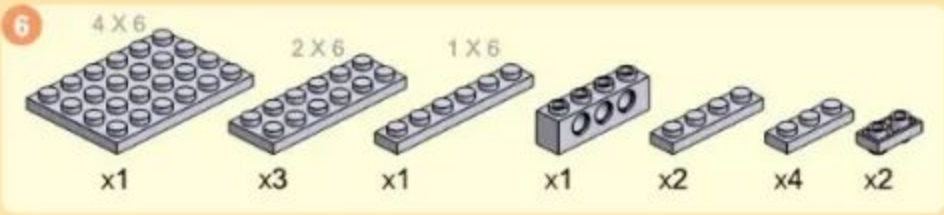

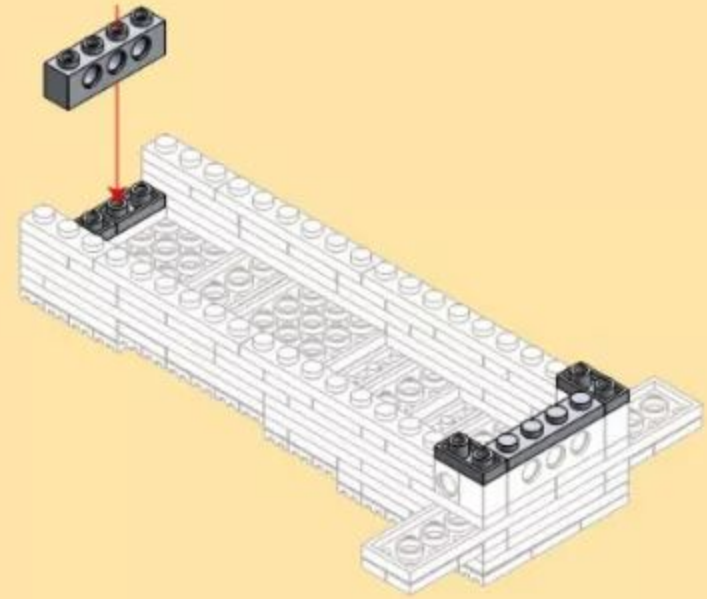
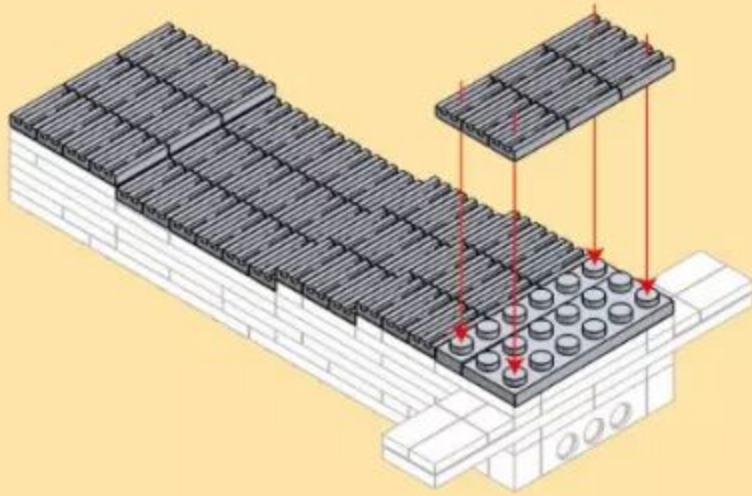
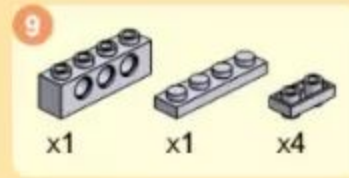
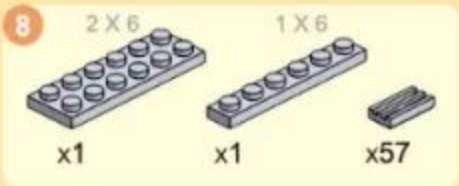

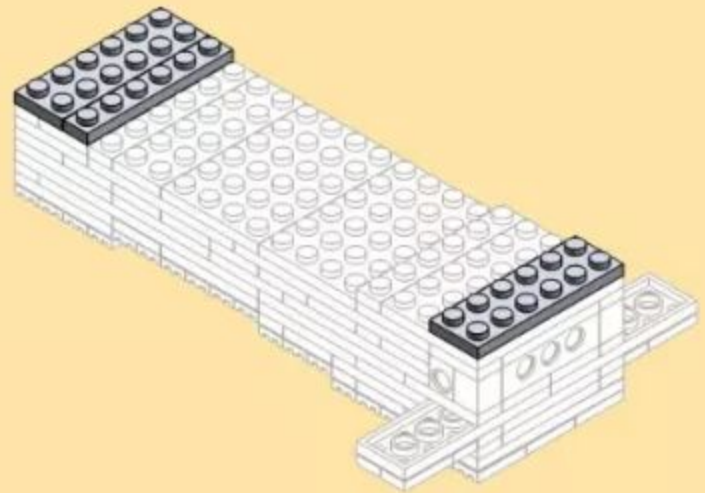
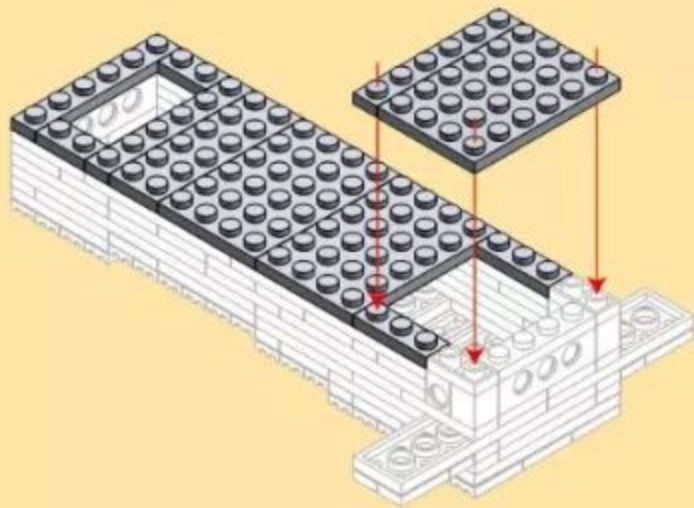
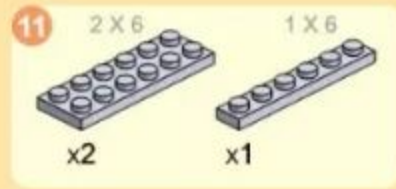
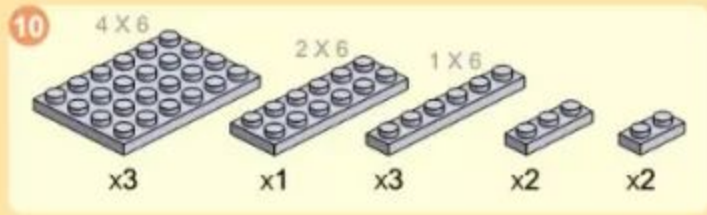

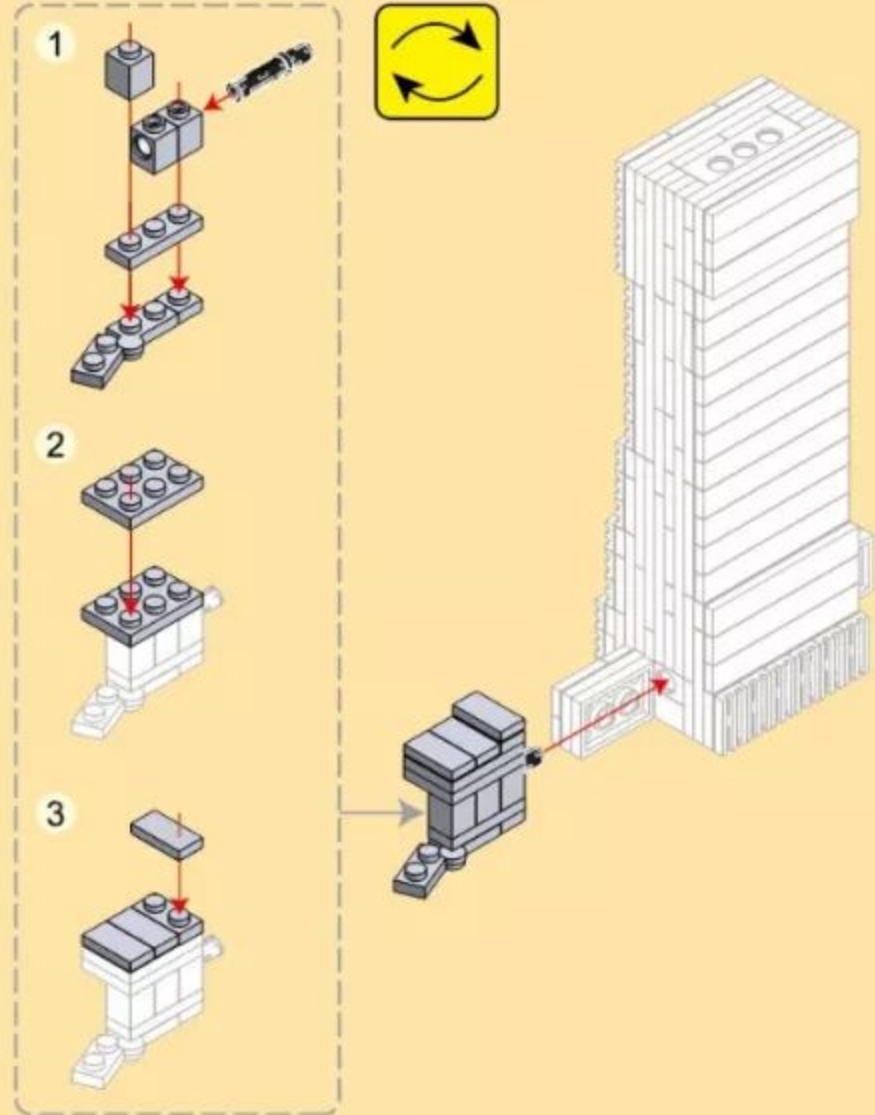
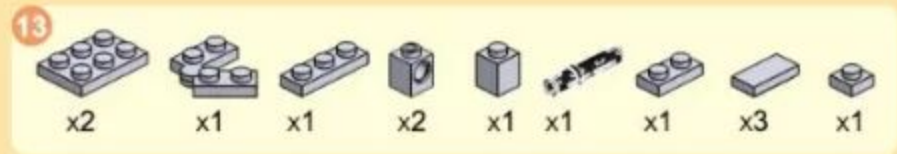
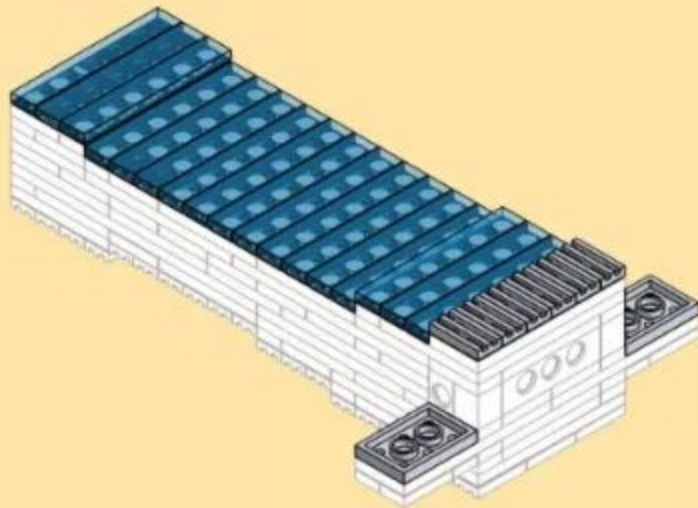

14

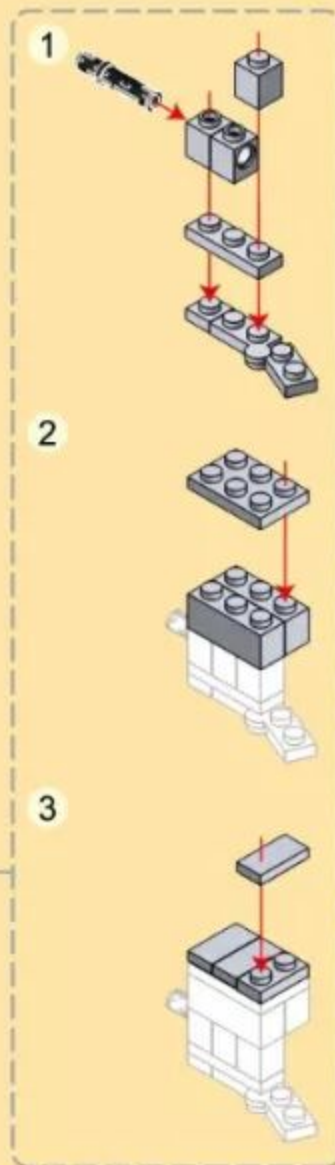
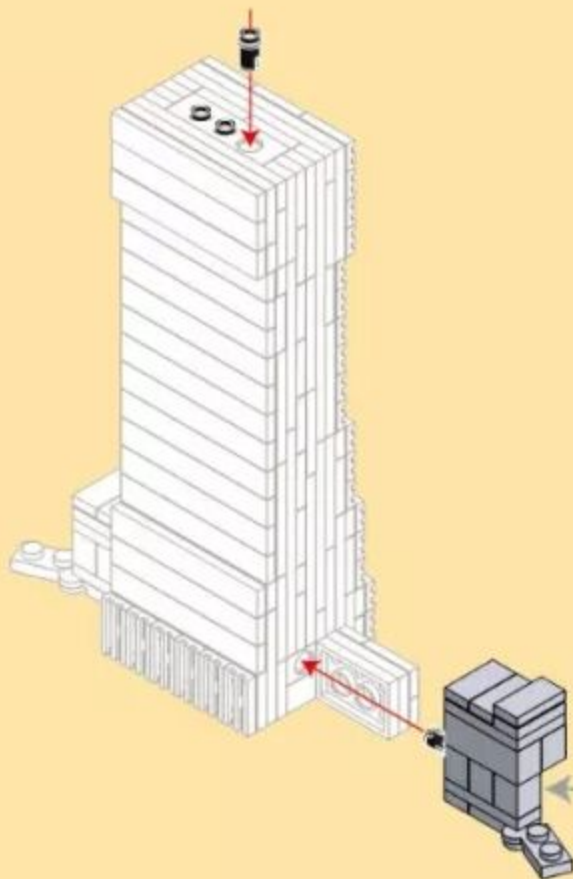
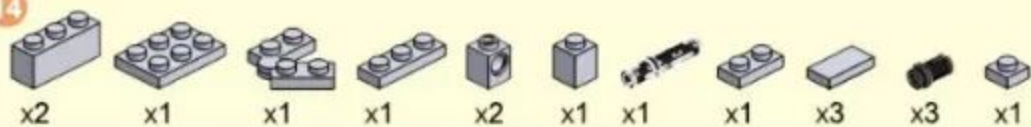

15

3 + 14

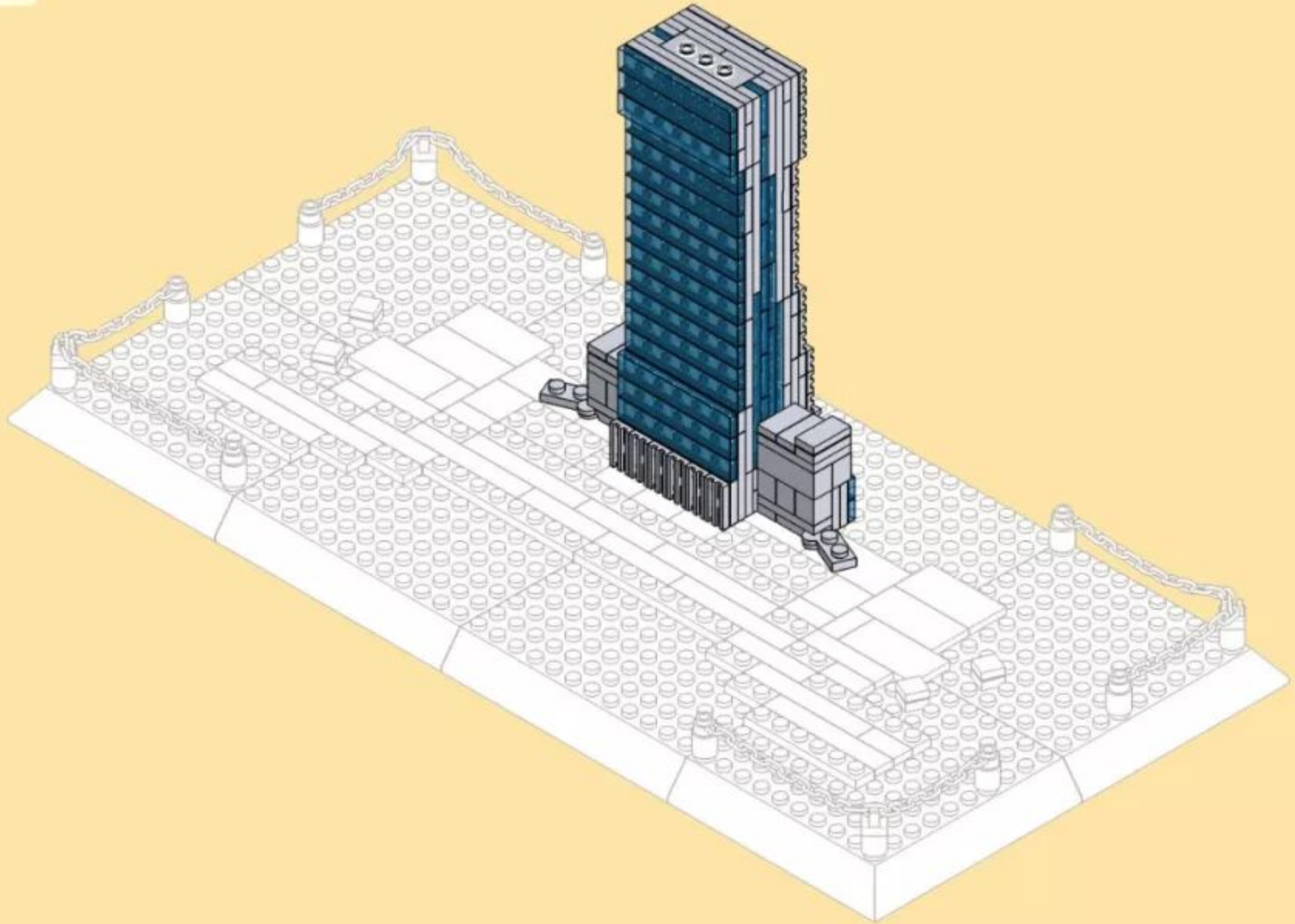

16

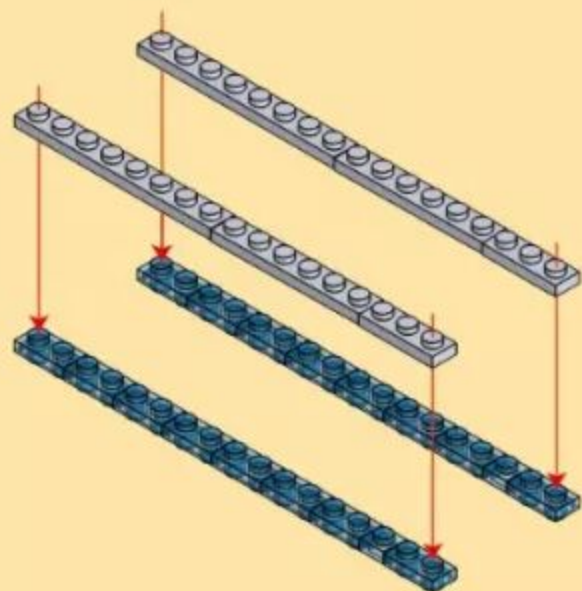
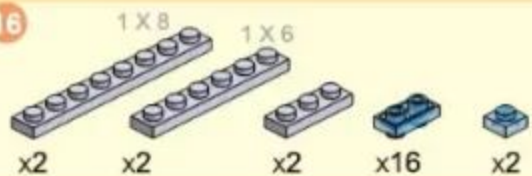

17

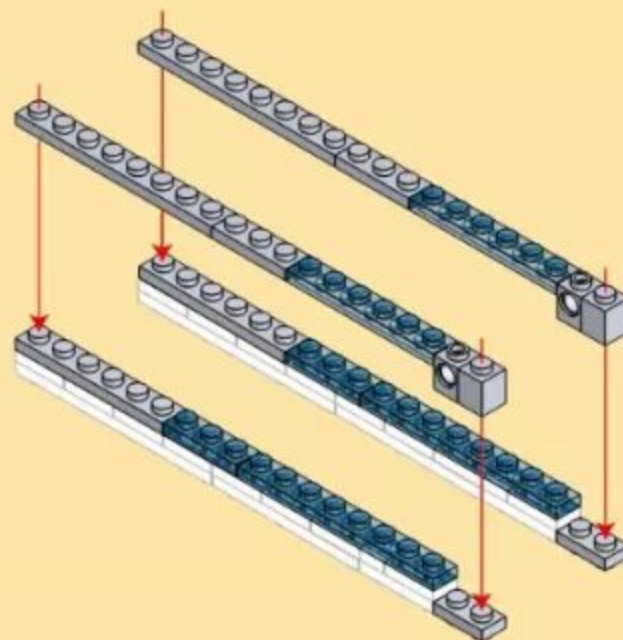
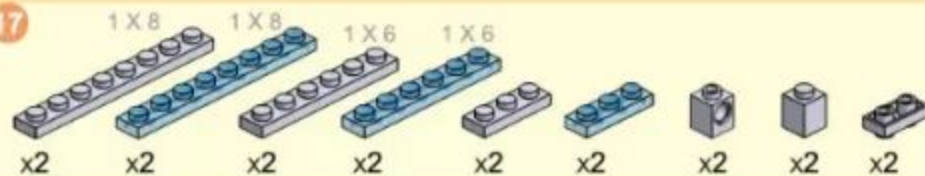

18

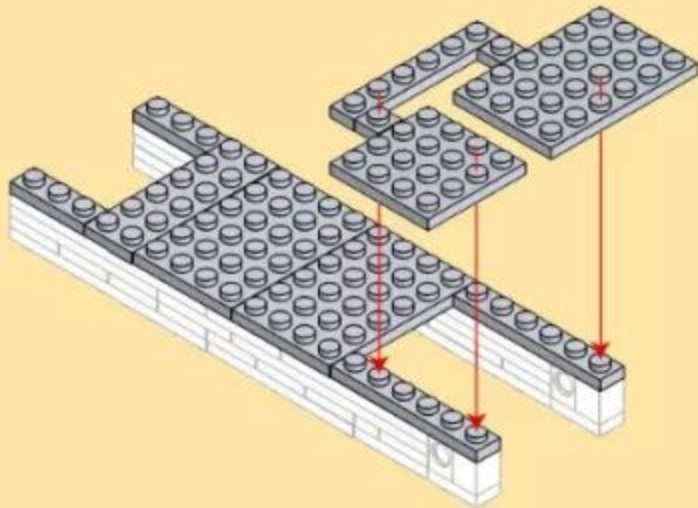
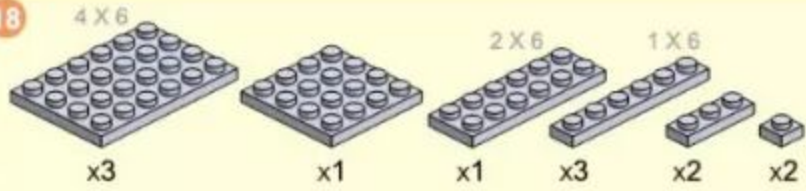

19

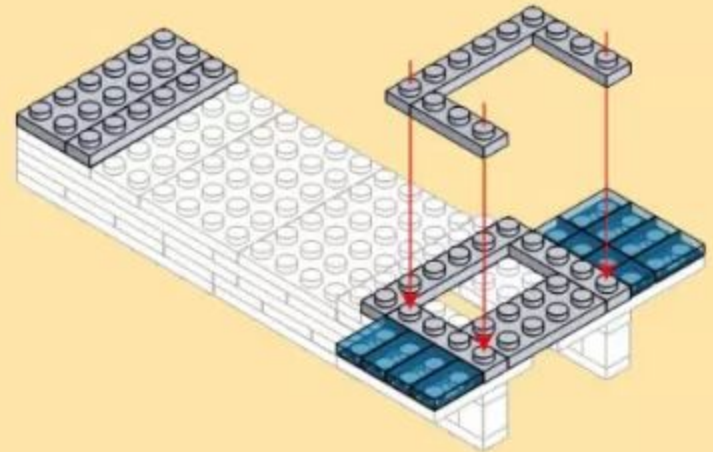
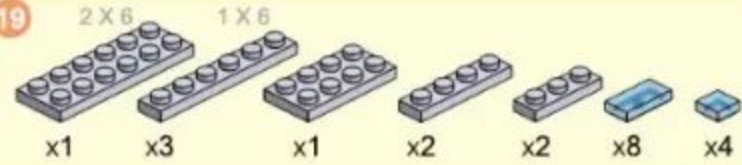

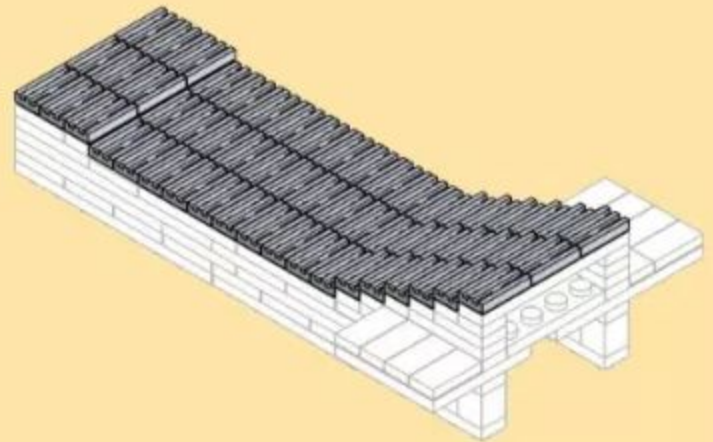
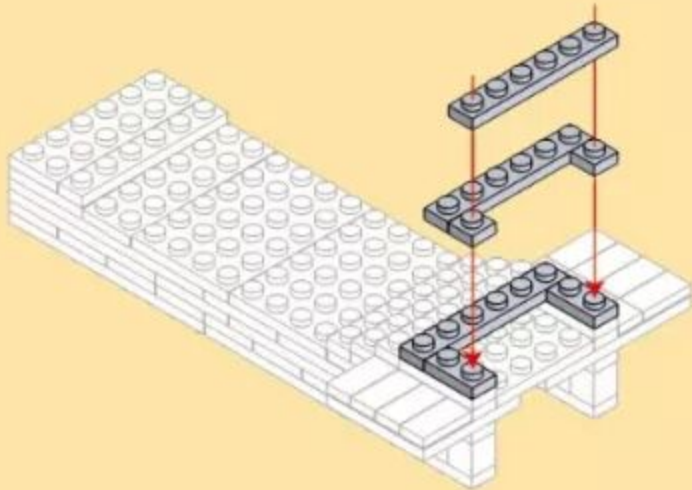
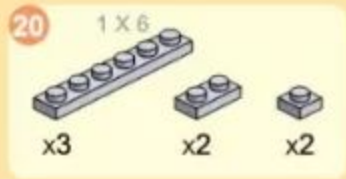

22

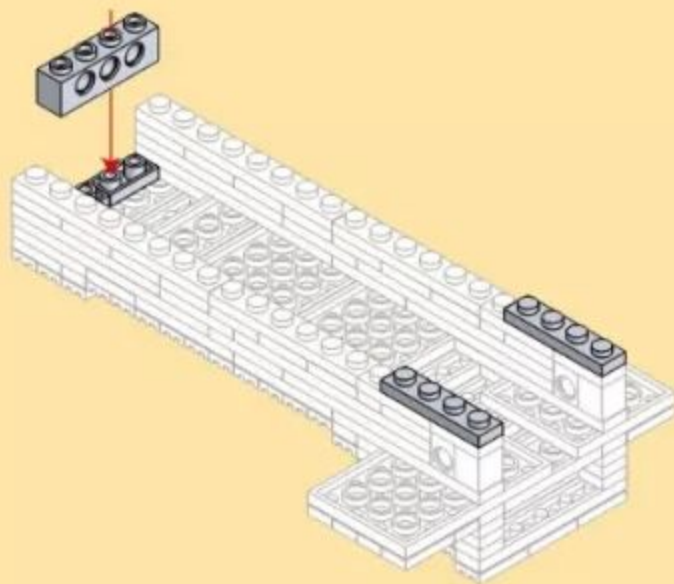
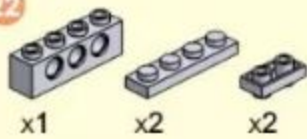

23

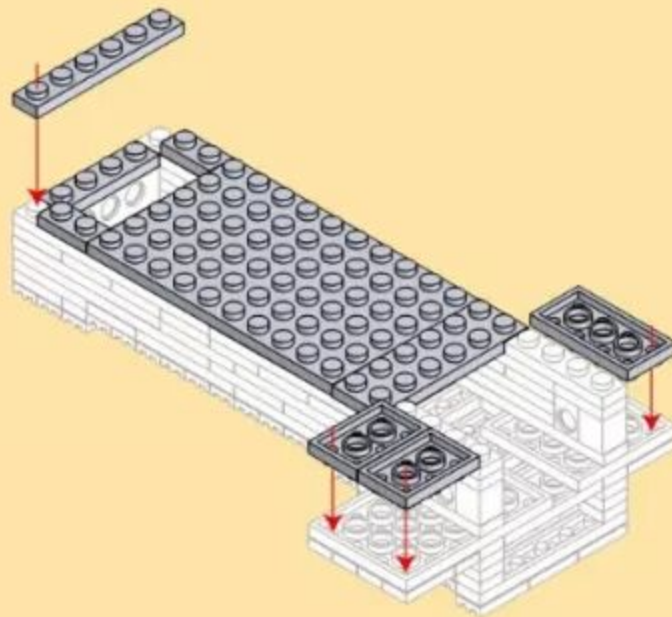
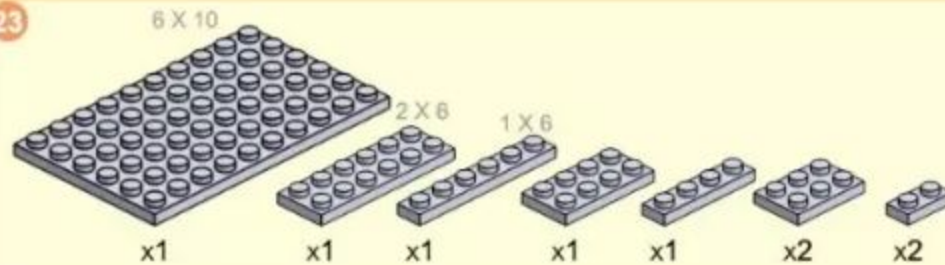

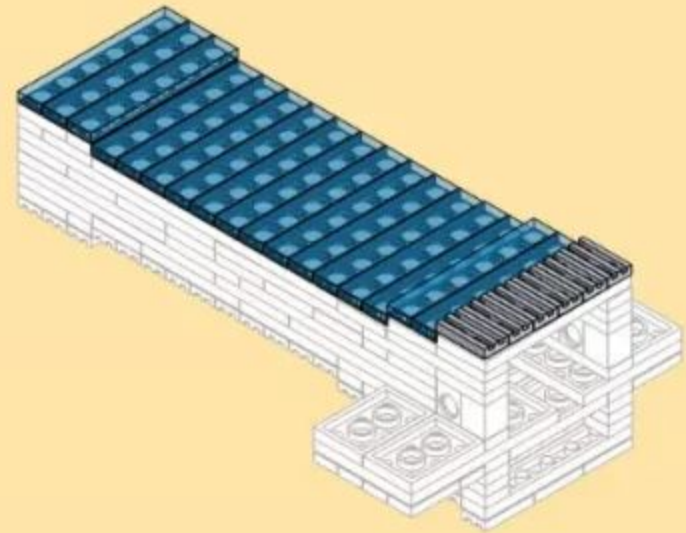
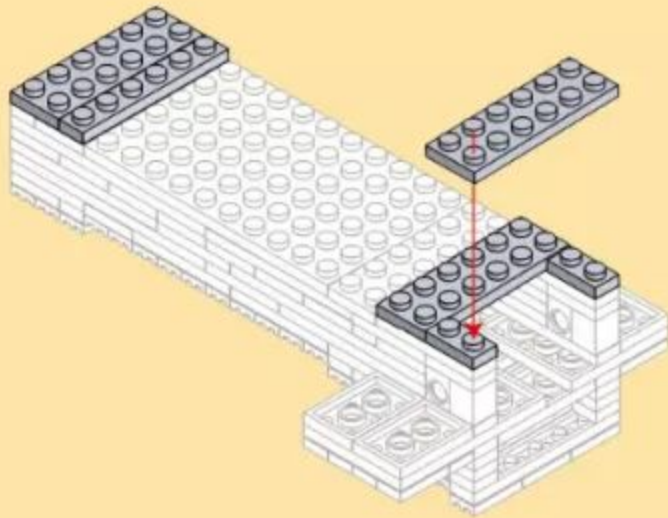
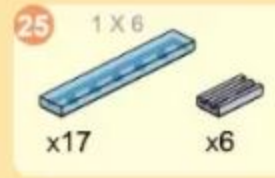
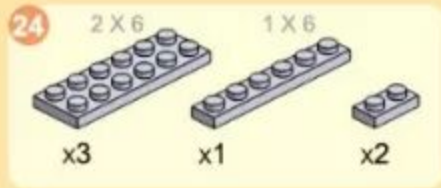

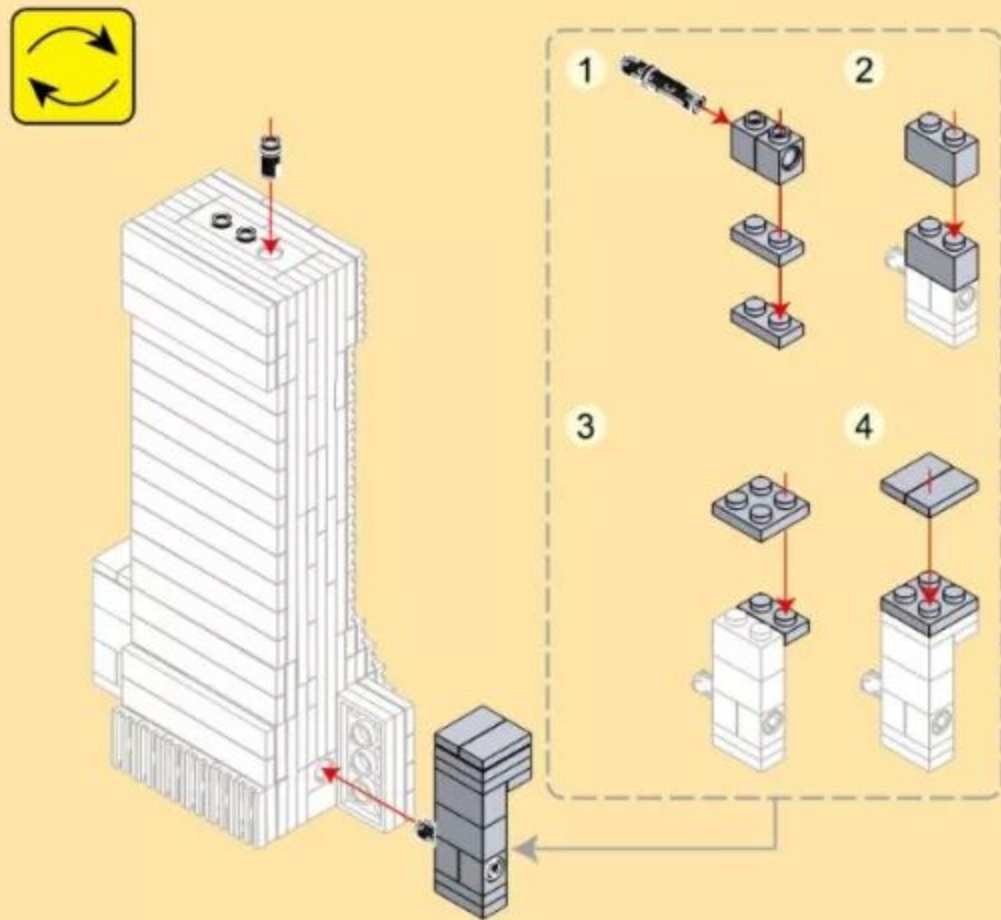
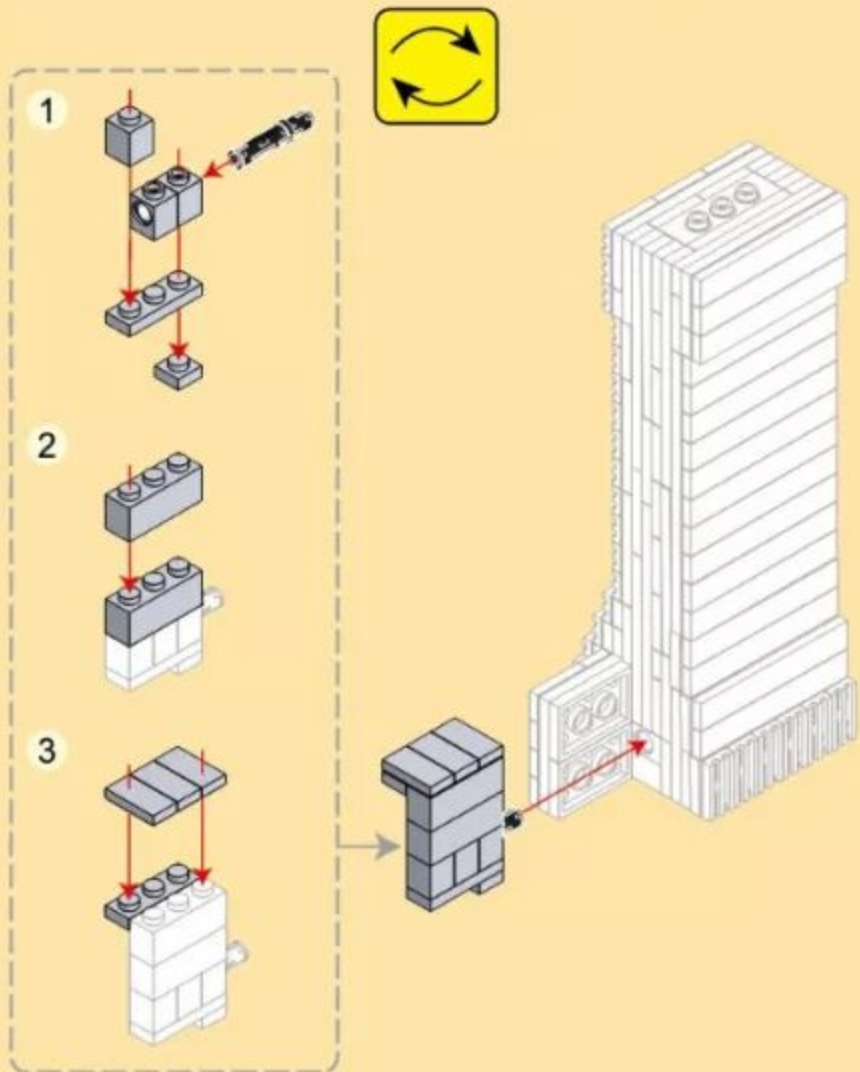
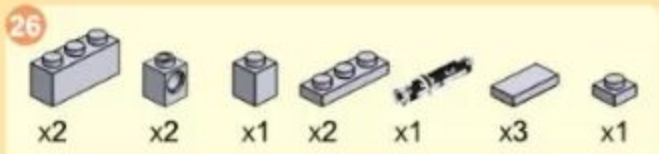

28

15 + 27

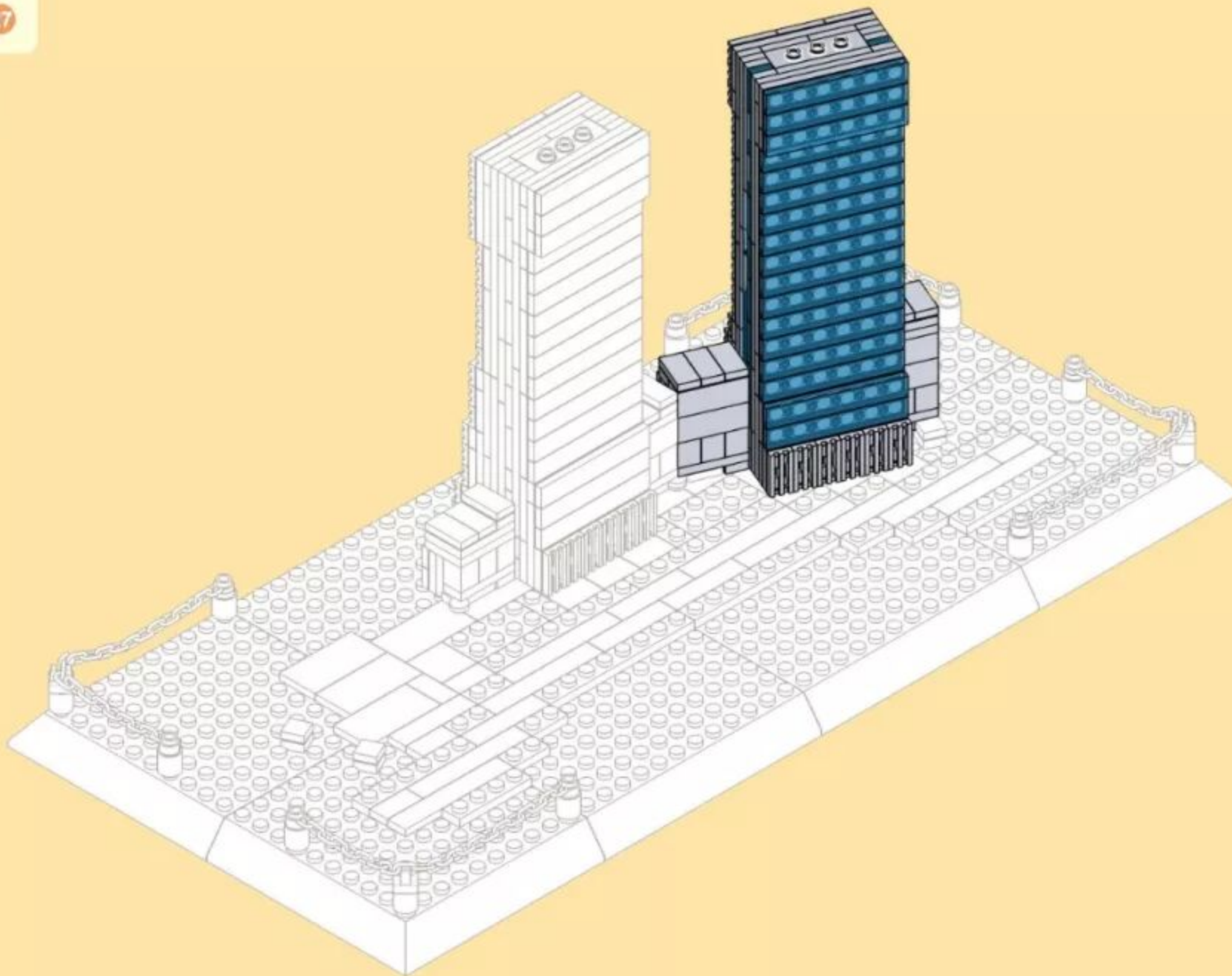

29

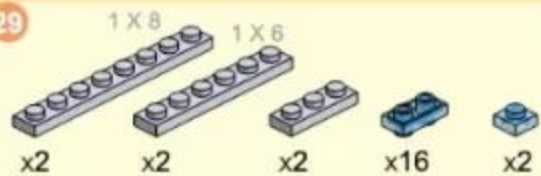

30

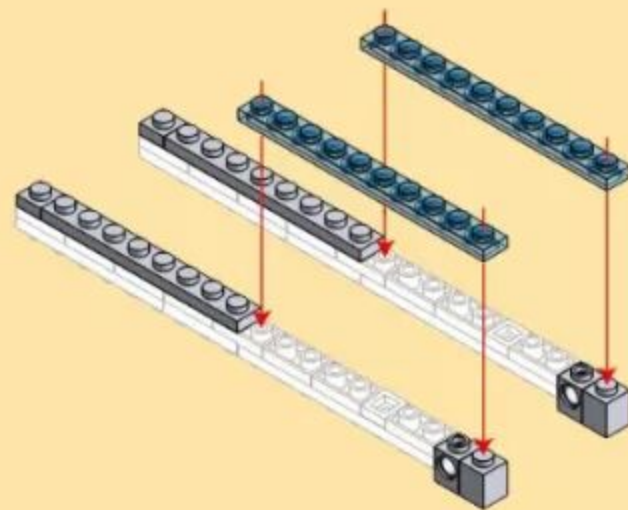
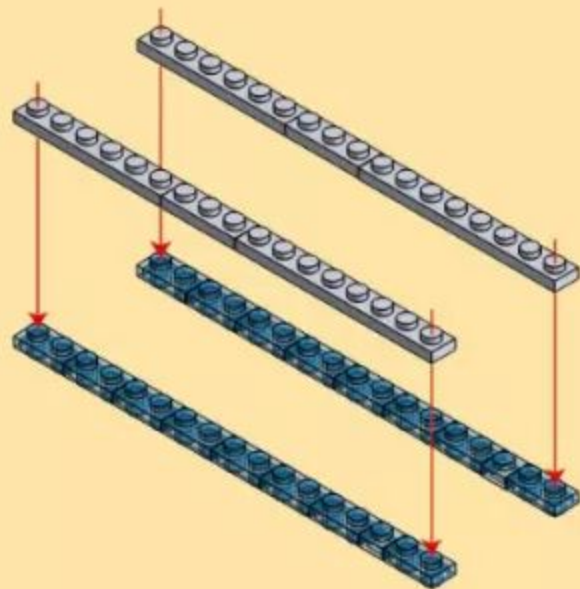
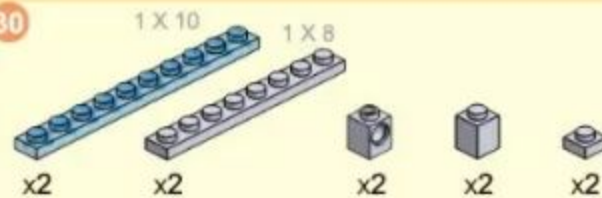

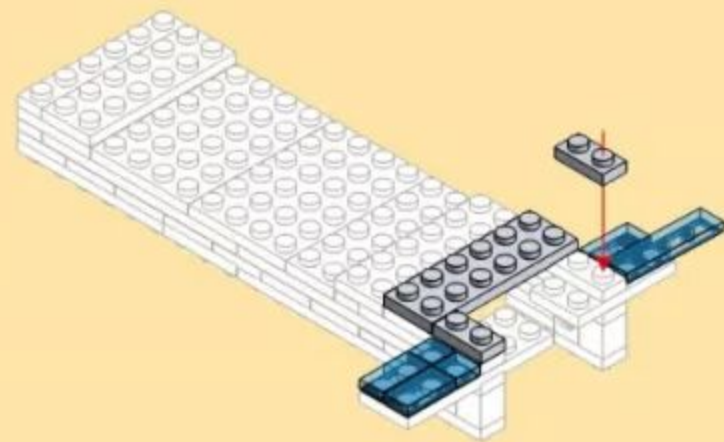
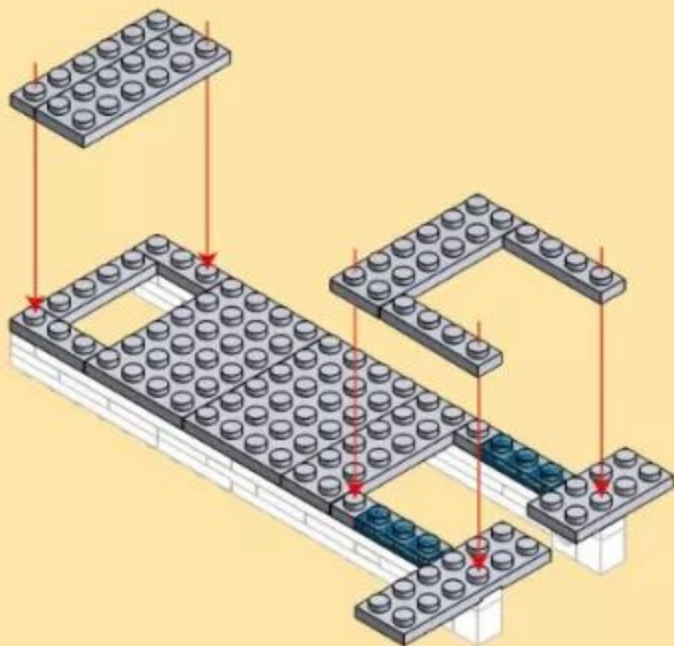
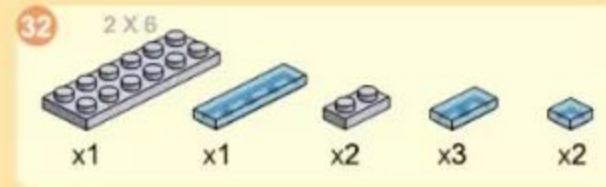
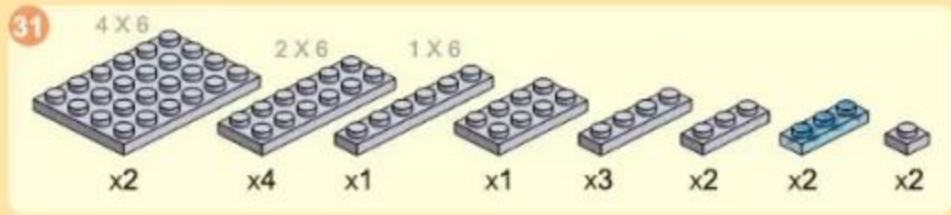

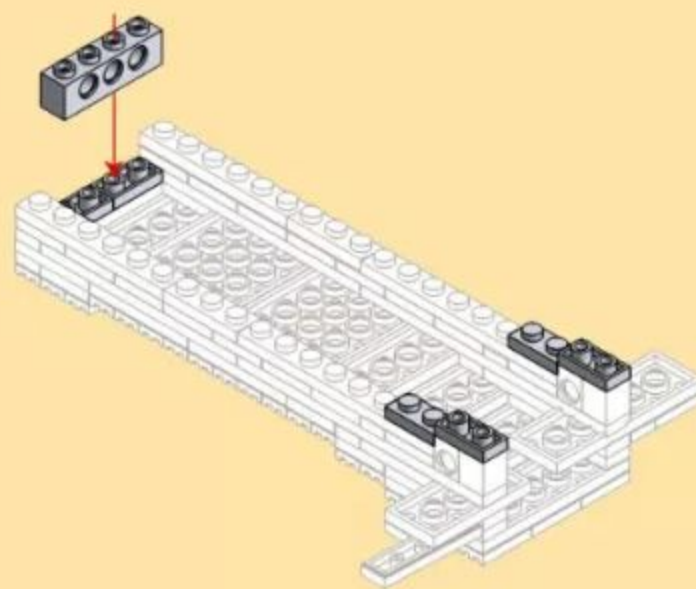
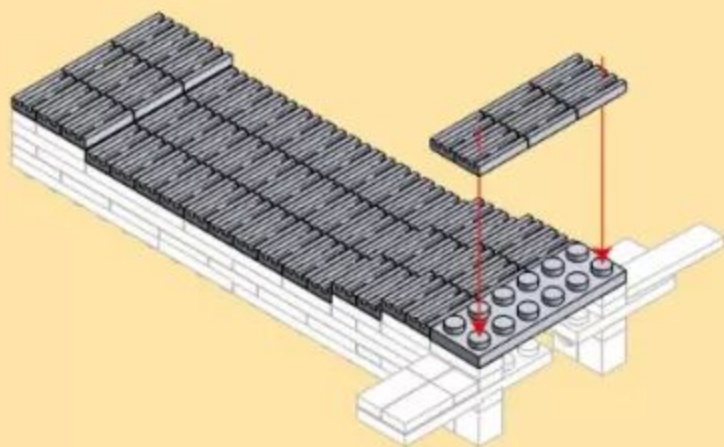
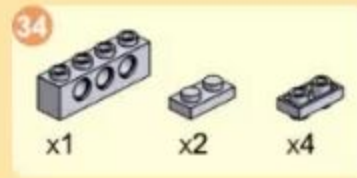
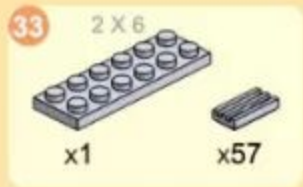

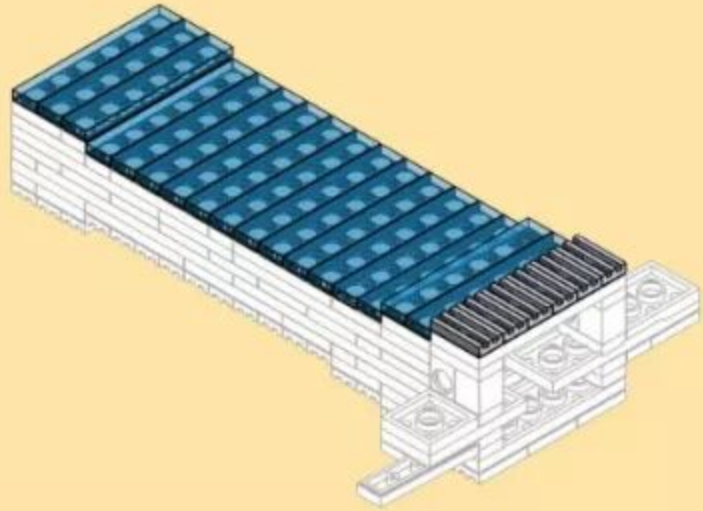
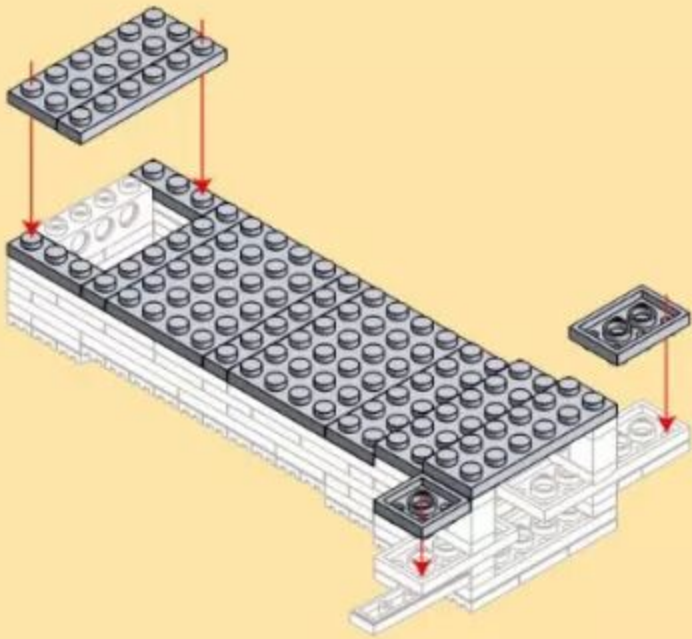
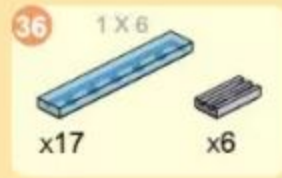
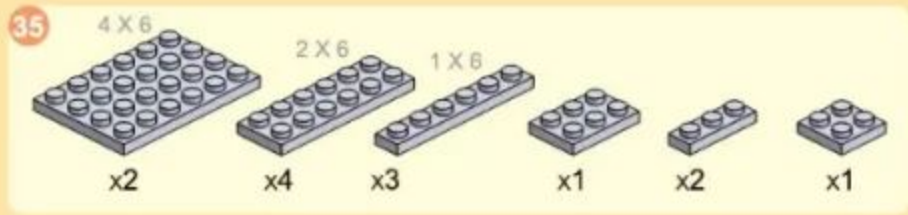

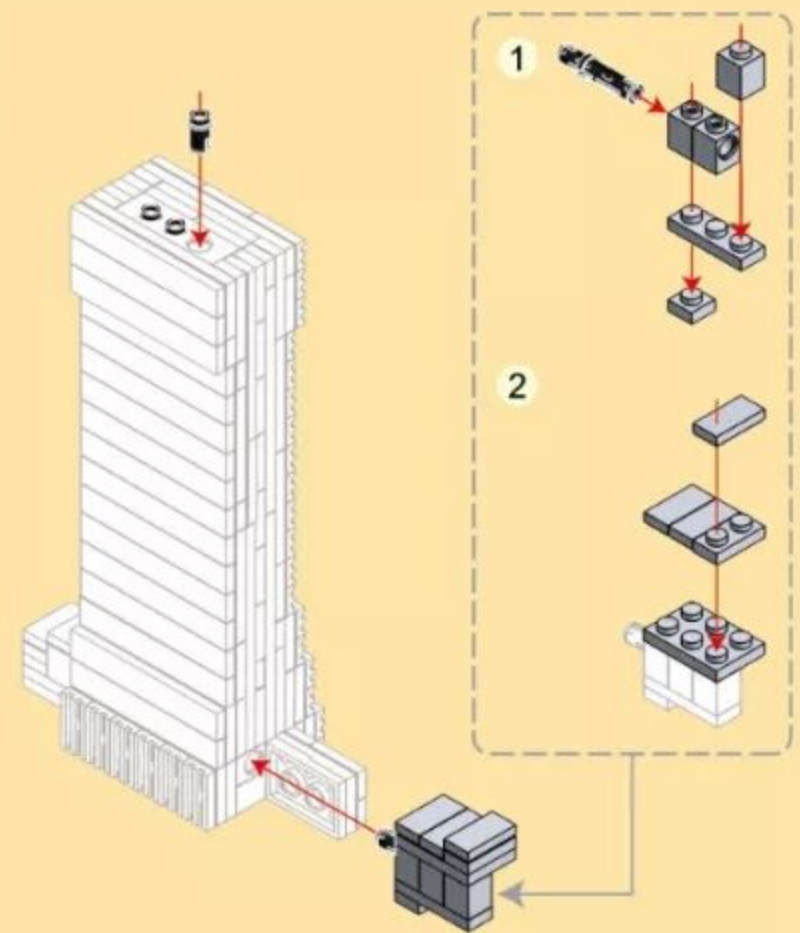
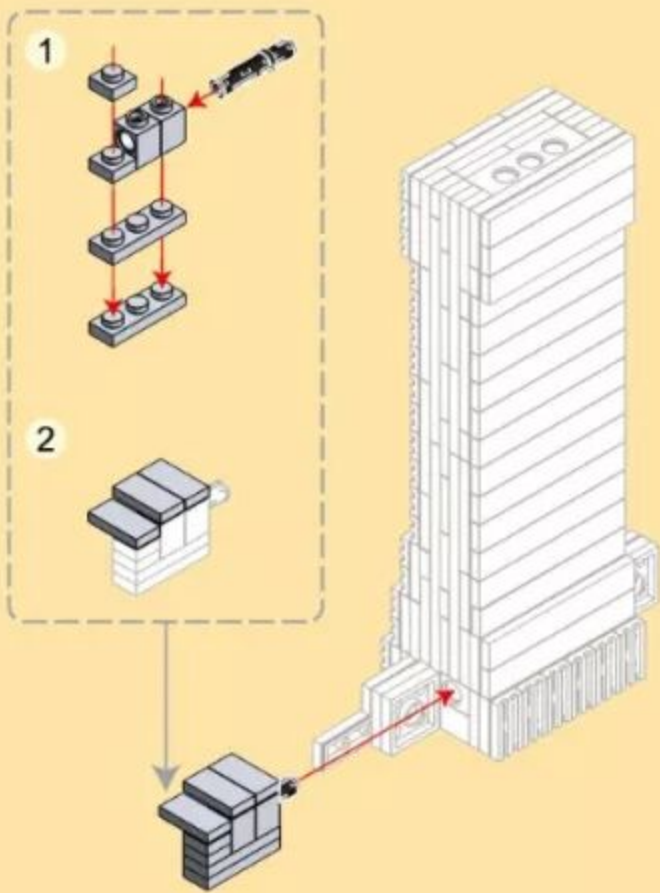

39

28 + 38

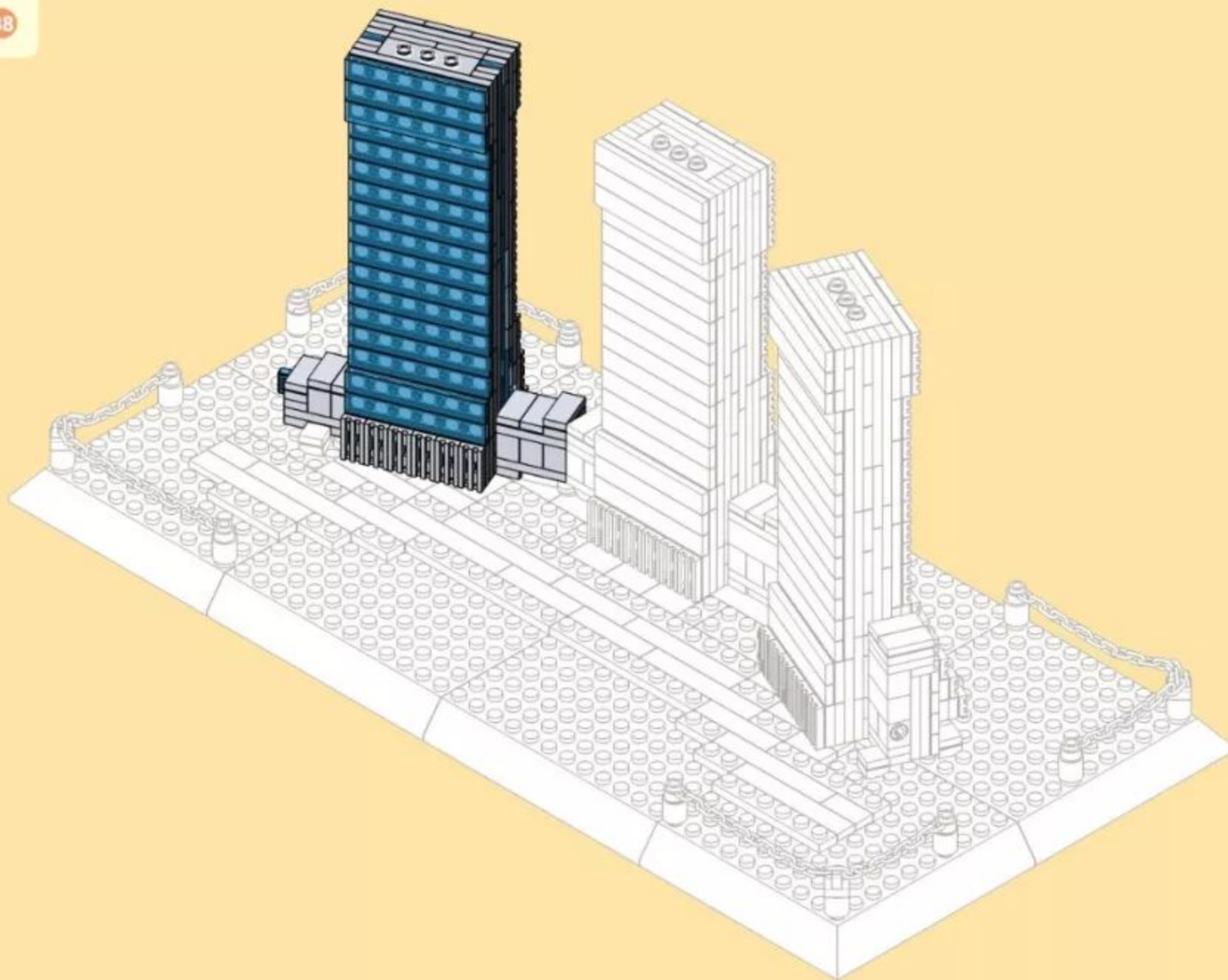



41

- 1 X 10
- 1 X 8
- 1 X 6
- 1 X 6
- x2
- x6
- x1
- x3
- x1
- x3
- x5
- x1
- x1
- x1
- x2

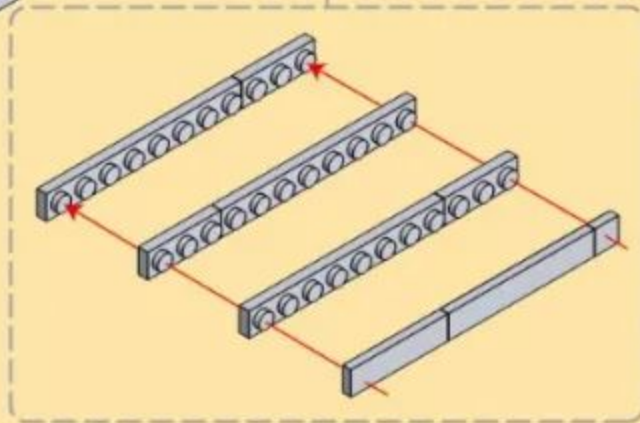
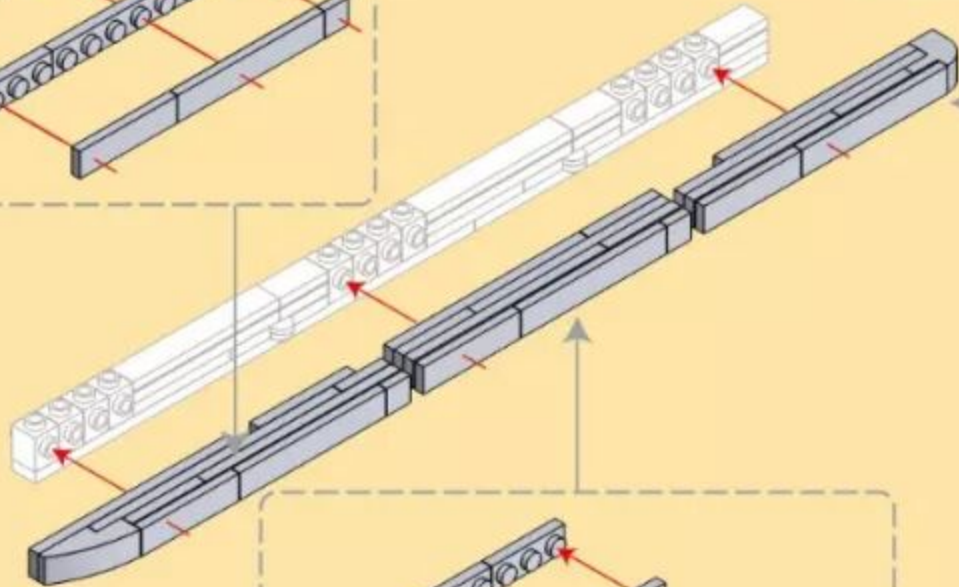
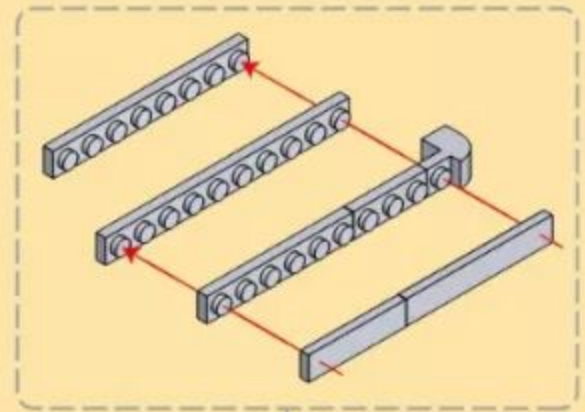
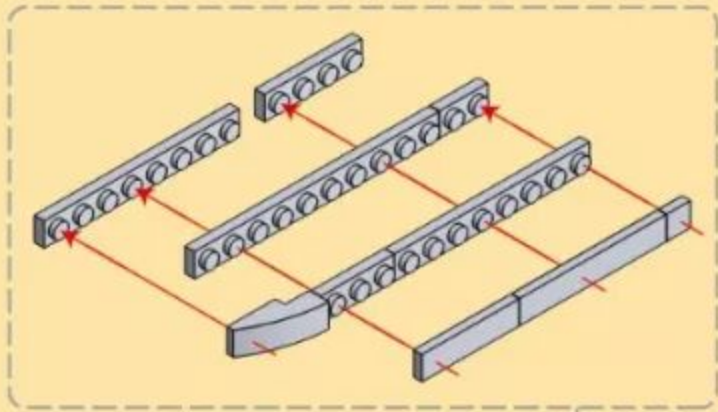

42

- 1 X 10
- 1 X 8
- 1 X 6
- 1 X 6
- x2
- x2
- x5
- x4
- x7
- x2
- x2
- x1
- x2
- x2
- x1
- x1
- x2
- x3

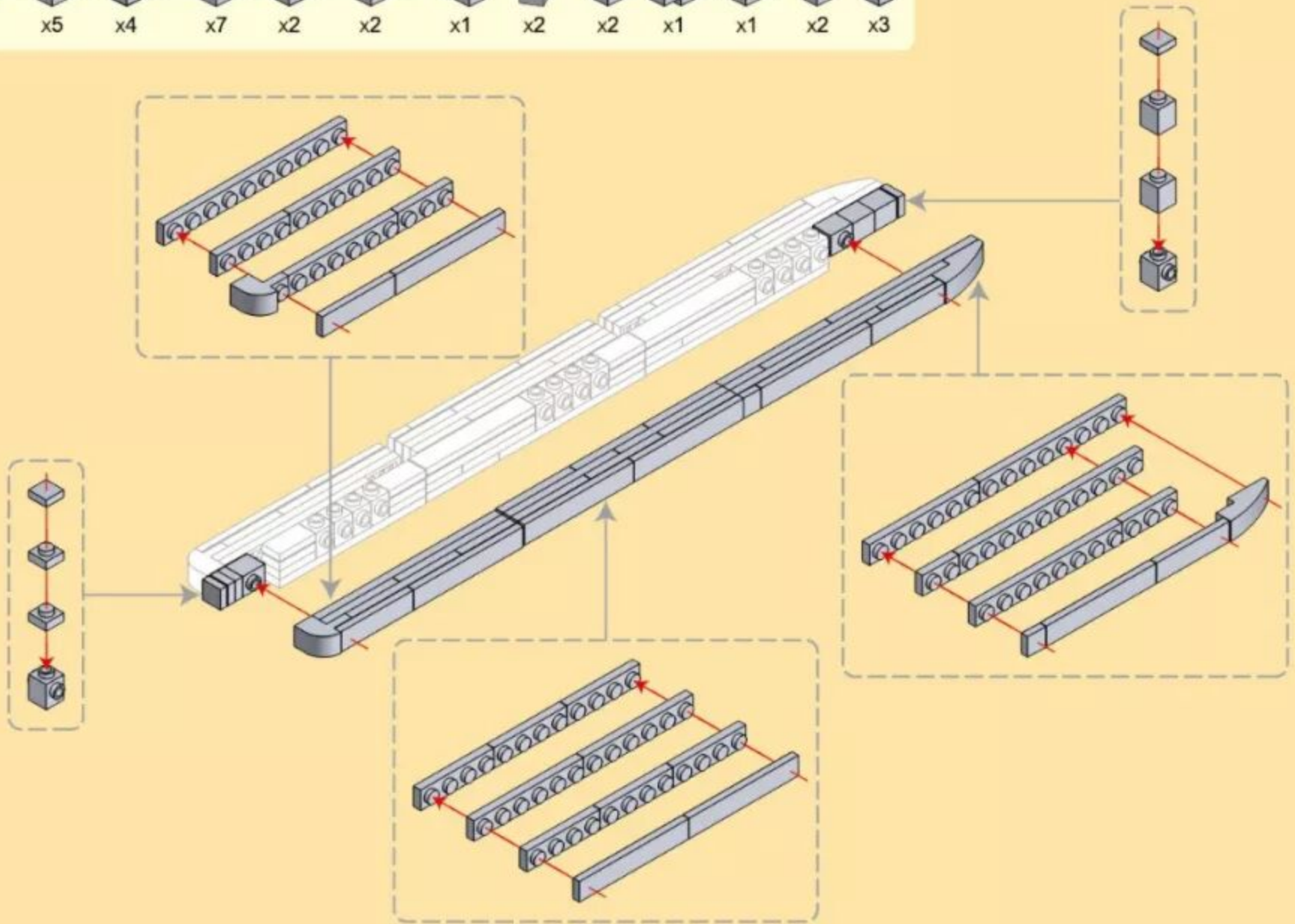

26

43

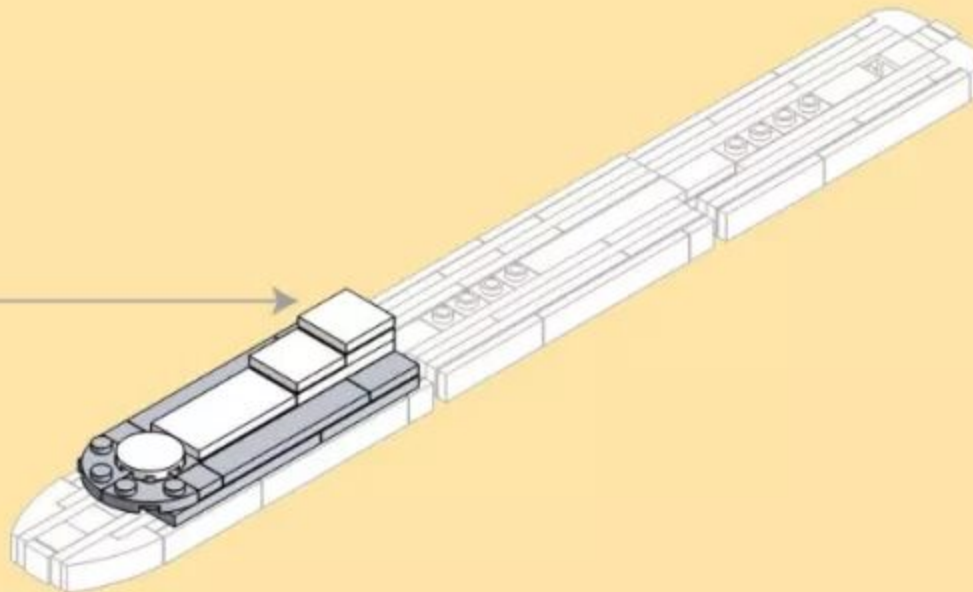
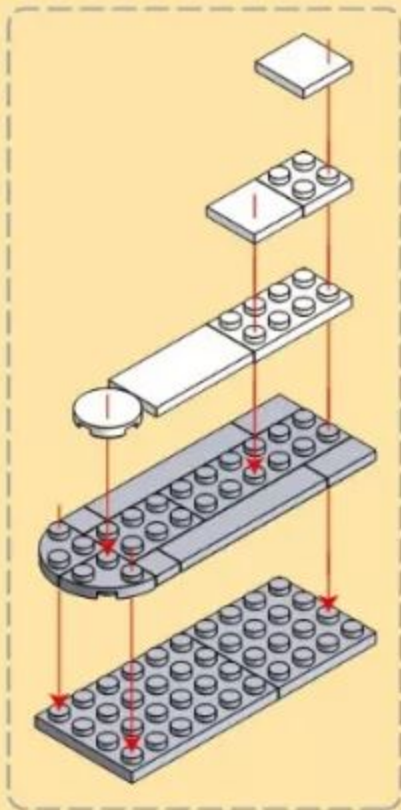
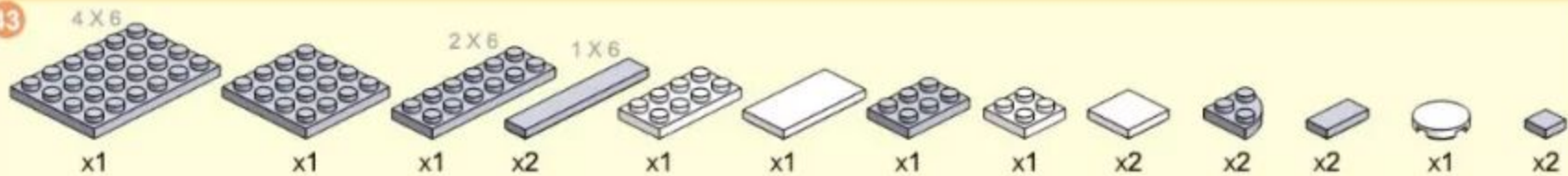

44

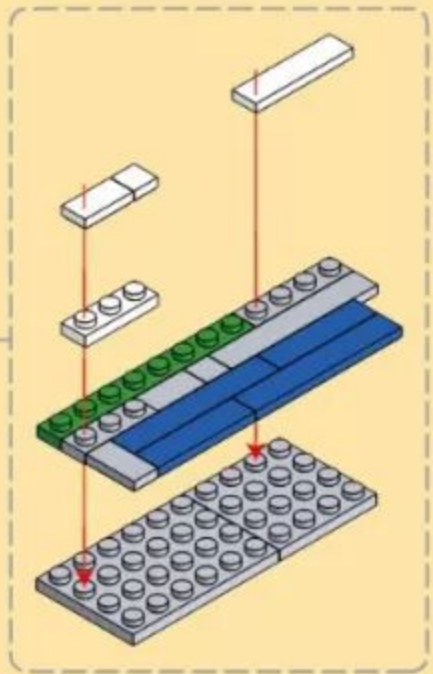
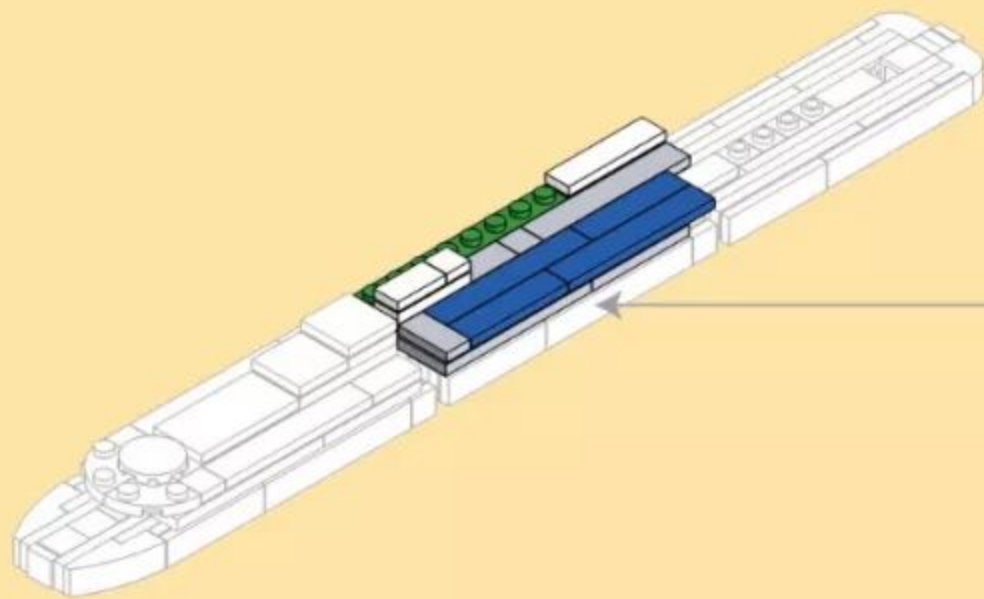
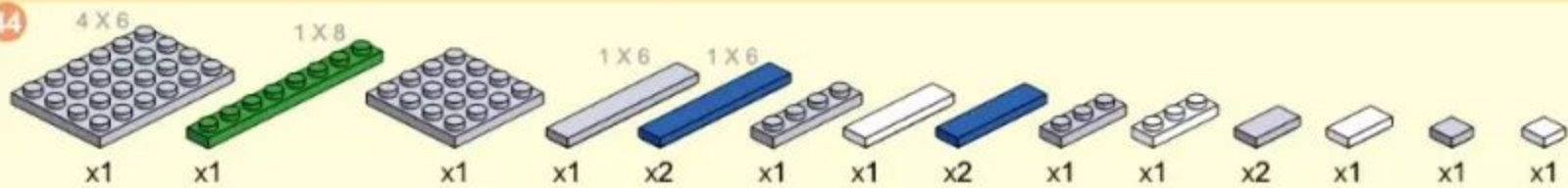

45

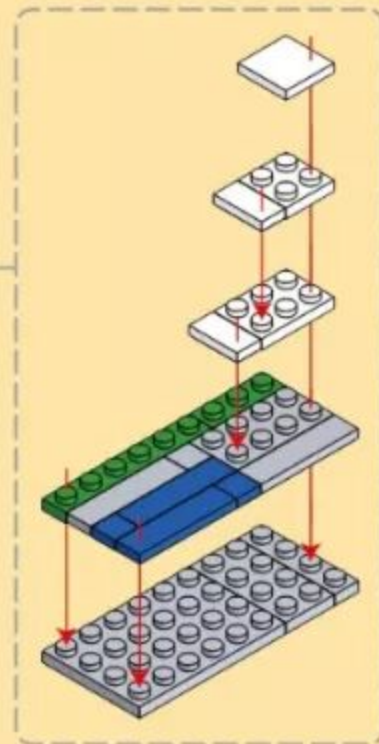
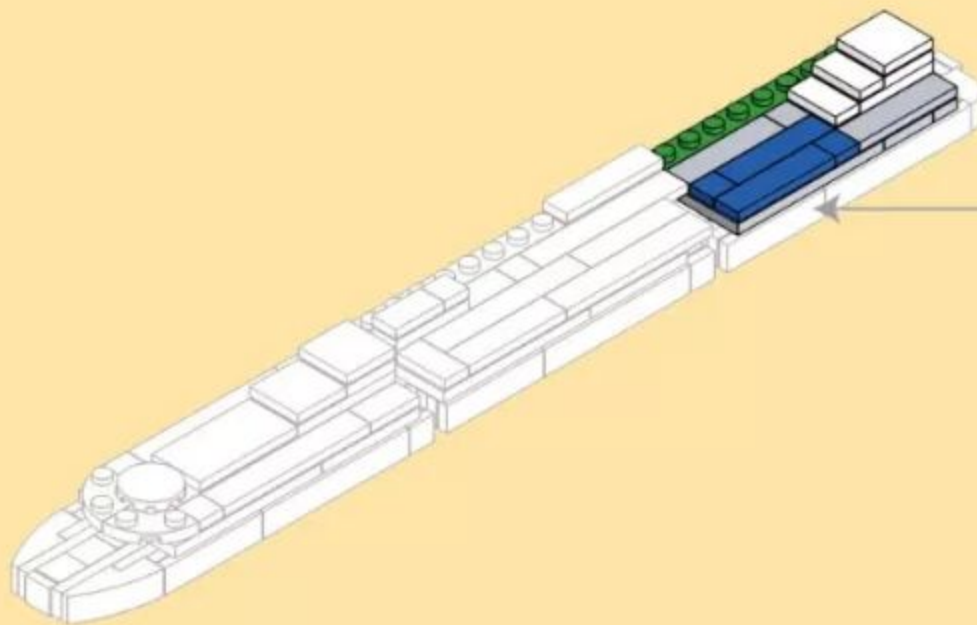
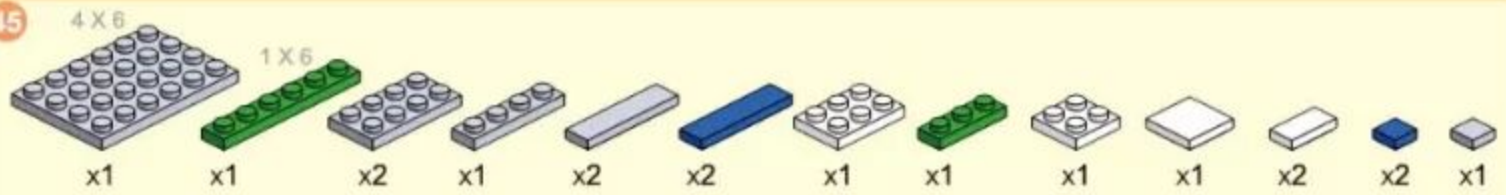

46

39 + 45

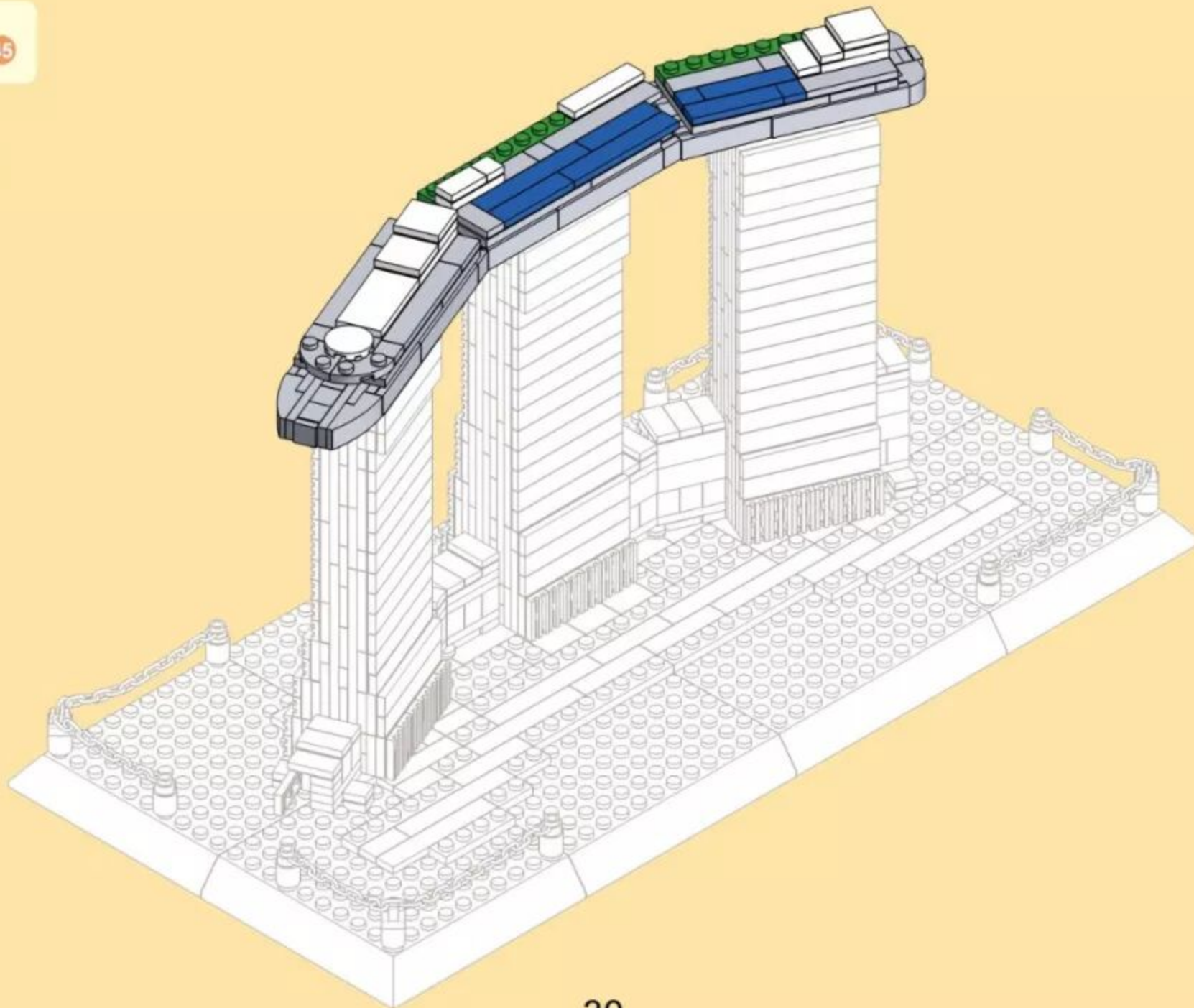

47



x1



x1



x1

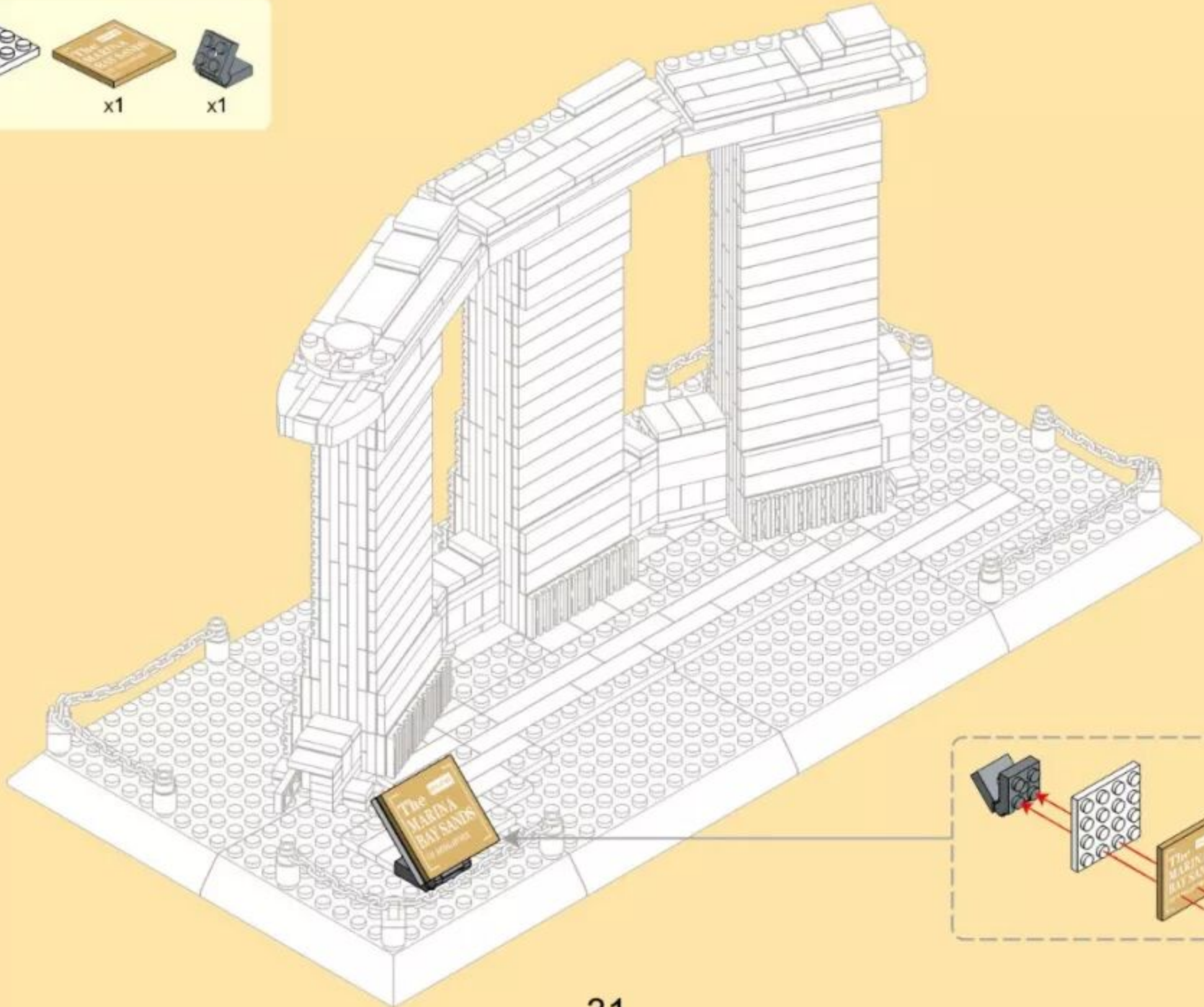

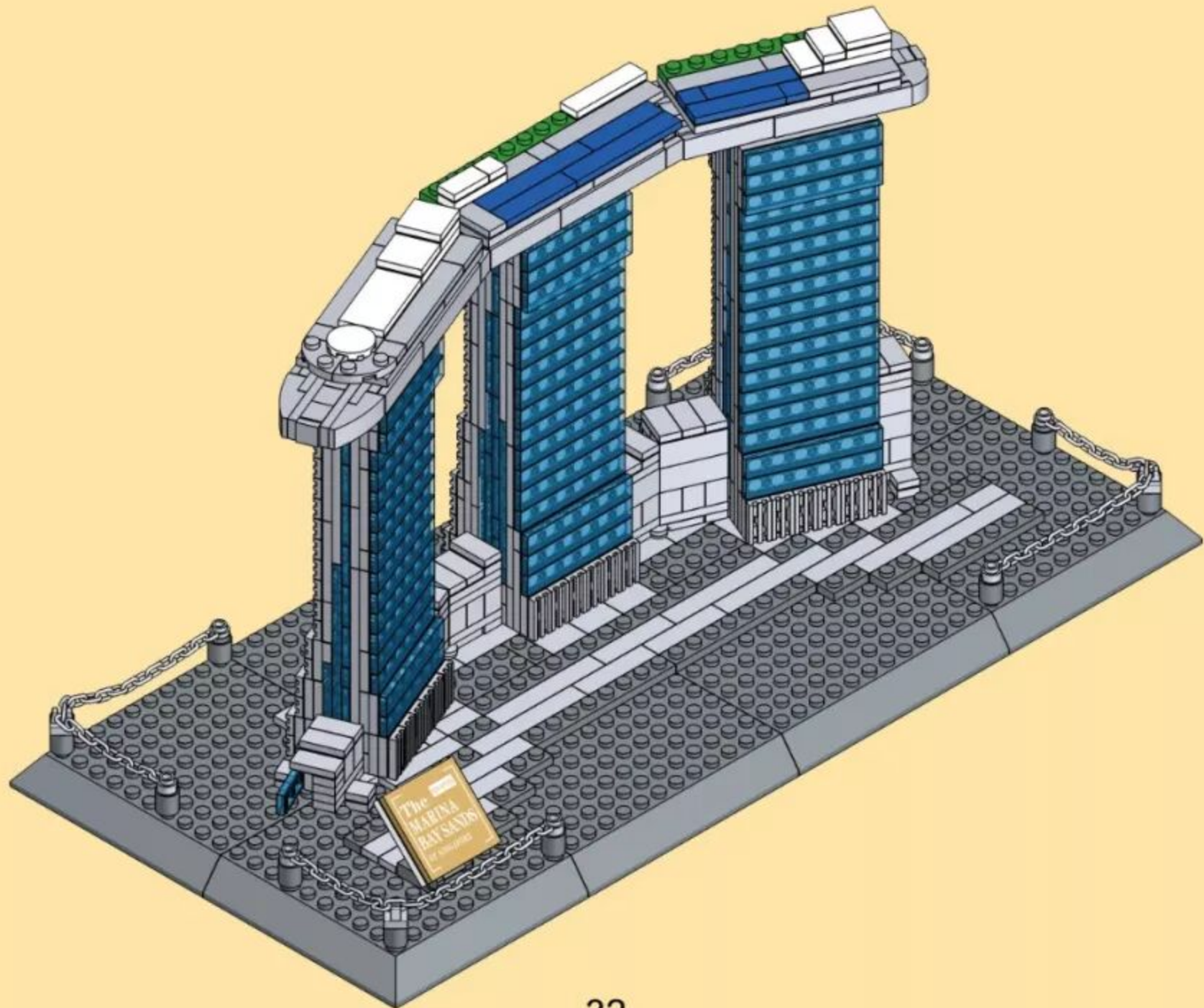



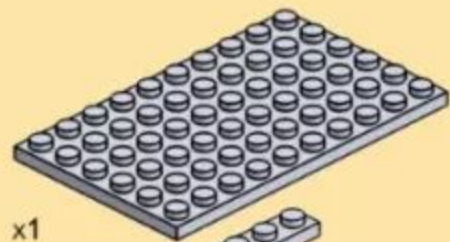

x1

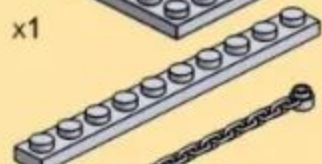

x7

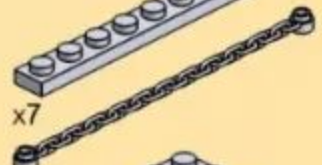

x4



x15



x18



x3



x26

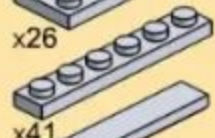

x41



x20

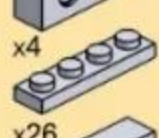

x4



x26

x14



x7



x10

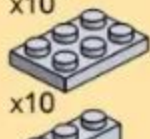

x10



x4



x39



x2



x3

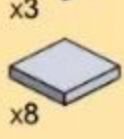

x8

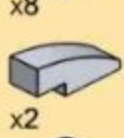

x2



x4



x2



x2



x2



x32



x24



x189



x14



x14



x18



x12



x4



x20



x13



x1



x1



x1



x1



x1



x1



x2



x3



x3



x1



x1



x4



x4



x4



x3



x2



x1



x1



x10



x12

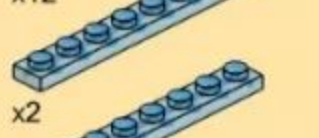

x2

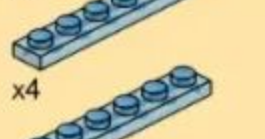

x4



x6



x51



x2

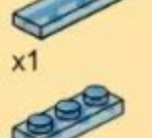

x1



x8



x48



x15



x6



x10



x1



x1

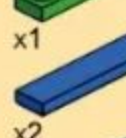

x2

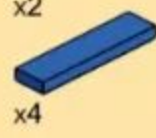

x4



x2



x9



x6



x30



x1

# THE MARINA BAY SANDS OF SINGAPORE CITY

## INTRODUCTION

Marina Bay Sands is an integrated resort fronting Marina Bay in Singapore. At its opening in 2010, it was billed as the world's most expensive standalone casino property at S\$8 billion, including the land cost. The resort includes a 2,561-room hotel, a 120,000-square-metre (1,300,000 sq ft) convention-exhibition centre, the 74,000-square-metre (800,000 sq ft) The Shoppes at Marina Bay Sands mall, a museum, two large theatres, "celebrity chef" restaurants, two floating Crystal Pavilions, art/science exhibits, and the world's largest atrium casino with 500 tables and 1,600 slot machines. The complex is topped by a 340-metre-long (1,120 ft) SkyPark with a capacity of 3,900 people and a 150 m (490 ft) infinity swimming pool, set on top of the world's largest public cantilevered platform, which overhangs the north tower by 67 m (220 ft). The 20-hectare resort was designed by Moshe Safdie architects. The architect was Aedas, and they were responsible for employing all consultants and for developing, co-ordinating and implementing the design. Engineering was provided by Arup and Parsons Brinkerhoff (MEP). The main contractor was Ssangyong Engineering and Construction.

