



THE FLATIRON BUILDING OF NEW YORK

America
The world's great architecture

Ages
6+



- Creative Ability
- Family Interaction
- Observation Ability
- Thinking Ability
- Practical Ability

NO.4220
838 PCS

Perseverance

积木匠心. 颗粒匠者



The Temple of Heaven



The Eiffel Tower



The Brandenburg Gate



The Leaning Tower Of Pisa



The Taj Mahal



The Big Ben



The White House



The Burj Al-Arab Hotel



The Golden Gate Bridge



The CN Tower



The Spasskaya Tower



The Triumphal Arch





It will be a city...
这将构成一座城市...

Architecture

Structure

剖析结构与实物数据比例

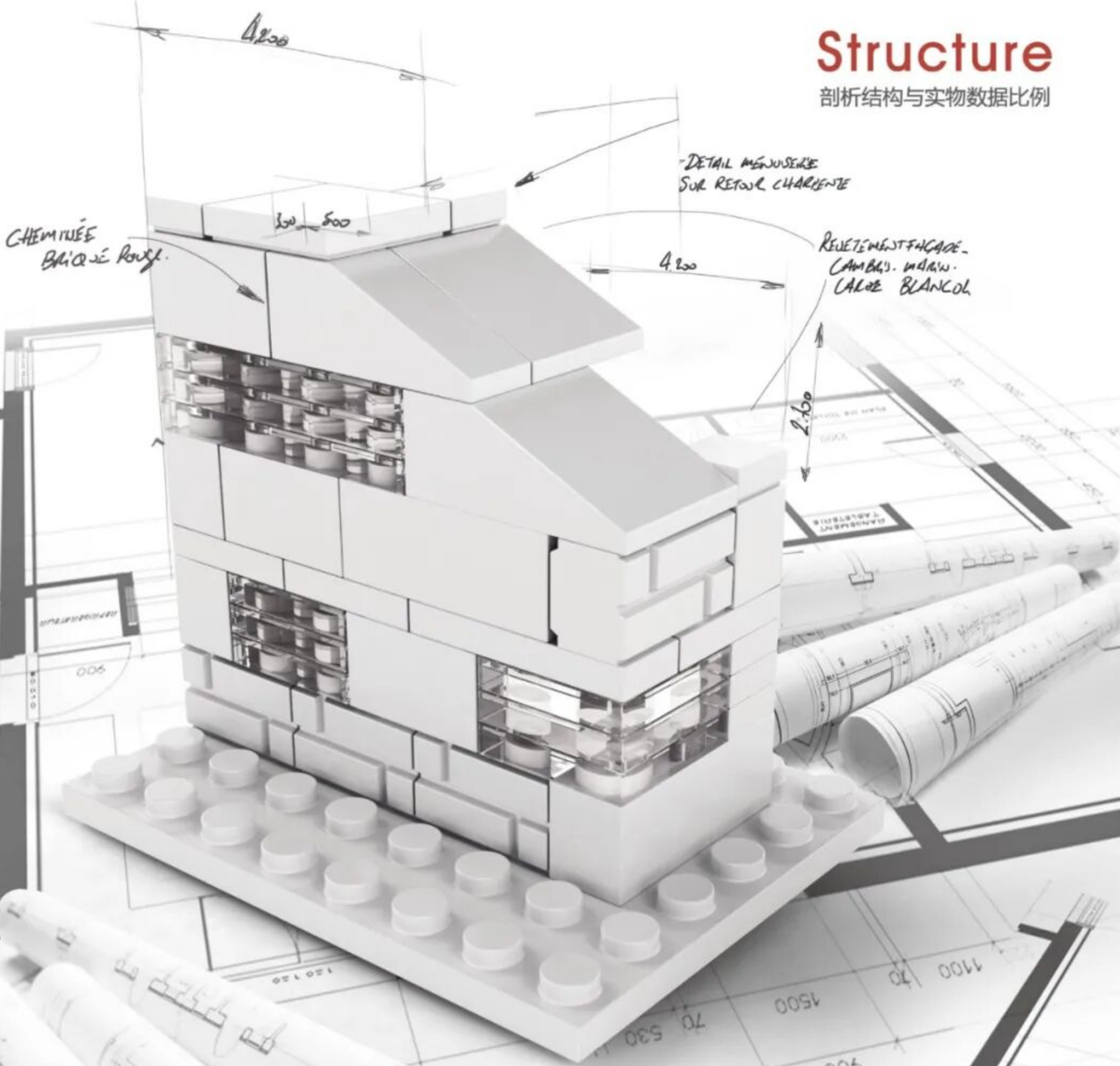

Anatomy

Analyze the ratio of product structure to physical data



Building Block

The world's great architecture
3D construction

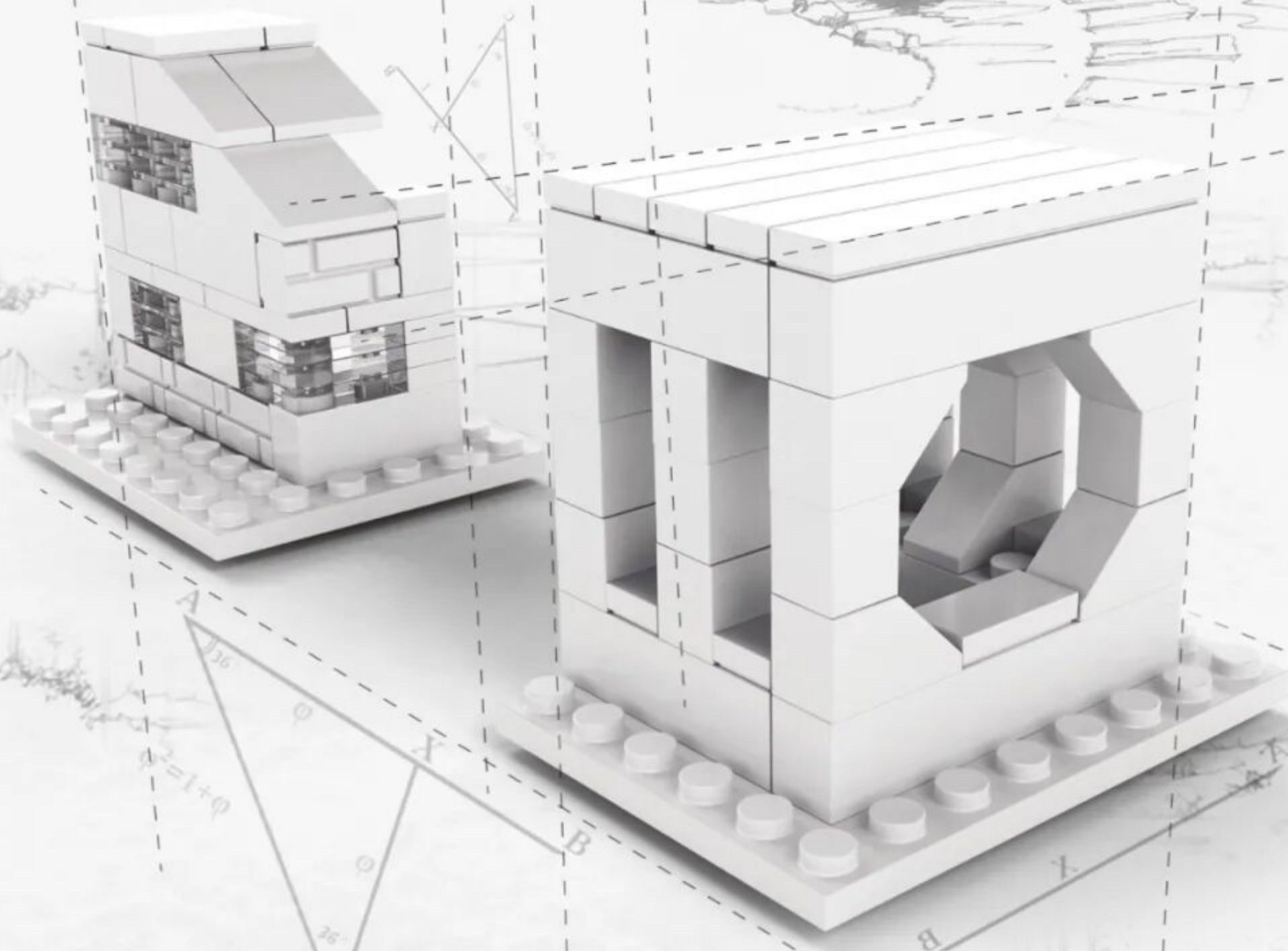

proportion

对产品精确分析运用3维技术最大限度还原实物比例

Accurate analysis of the product, using 3D technology to maximize the reduction of physical objects.

Creativity

外观设计结合黄金比例更好展现美感

DETAIL MENUSERIE
SUR RETOUR CHARENTE

REVETEMENT FACADE -
CAMBIS. MARIN.
CALOE BLANCOL

CHEMINÉE
Brique rouge.

$$\varphi = \frac{a+b}{a} = \frac{a}{b} = 1,61803398875$$

Architecture

Use the golden ratio in the design and development of the product to better show the beauty of the product.

Brickseparator

积木起件器使用说明

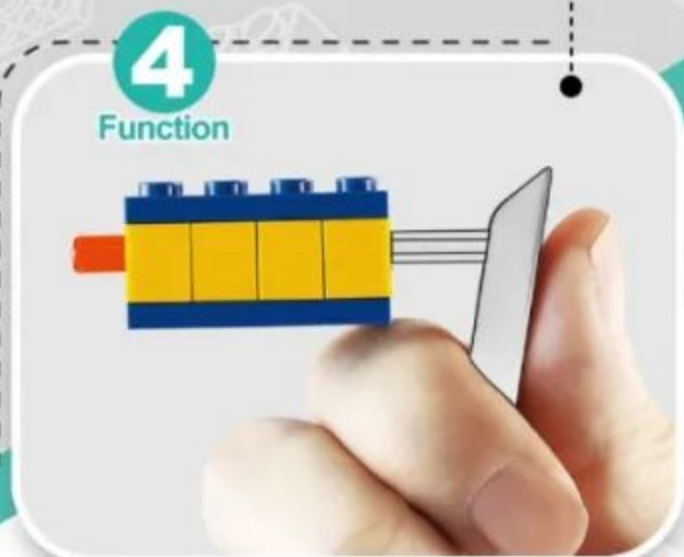
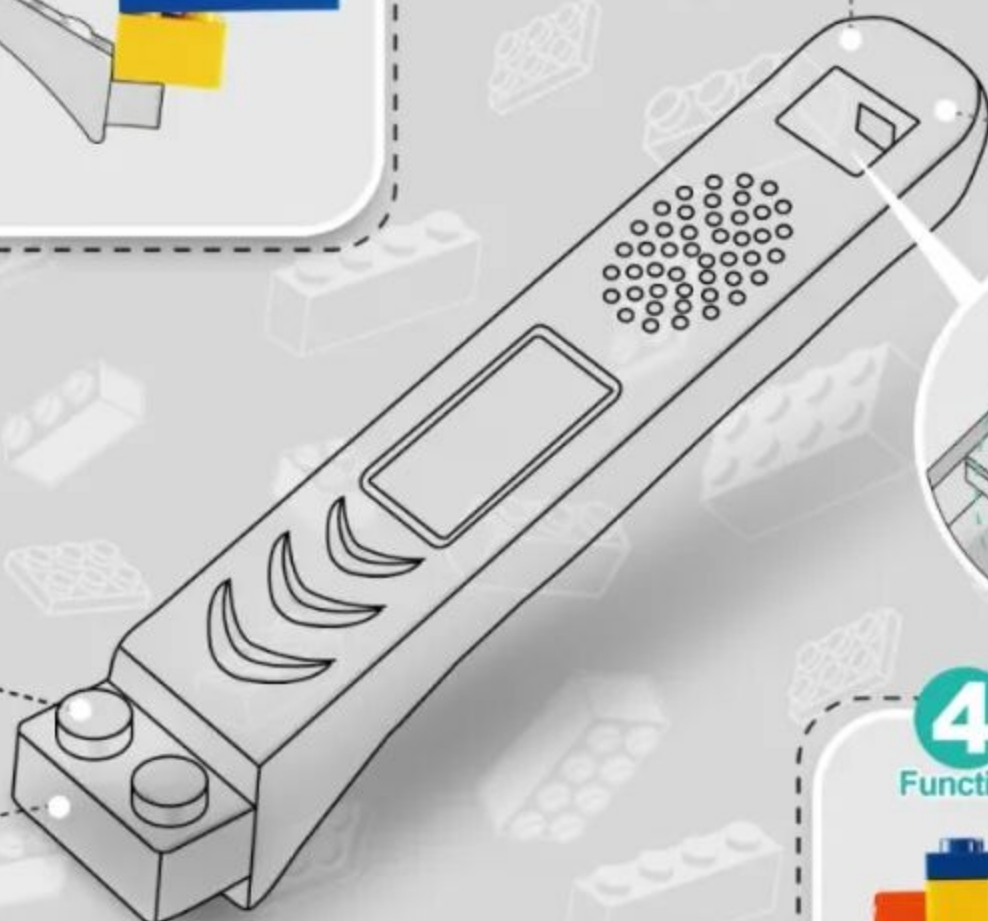
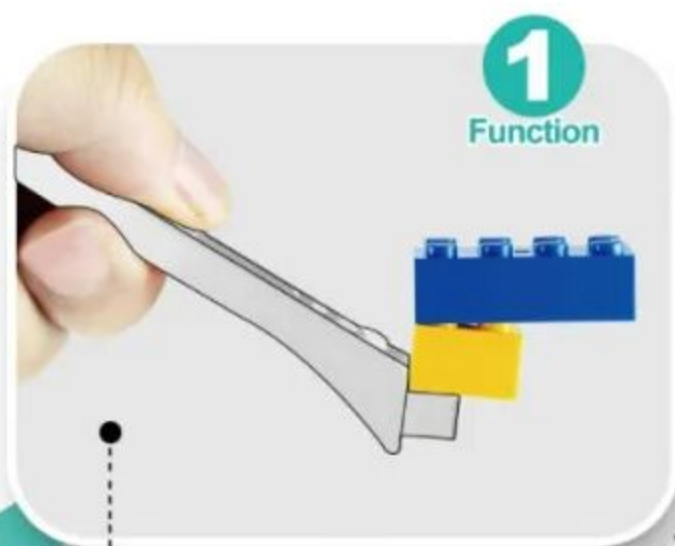

4 ways to make installation easier
让安装更简单

Building Blocks

拼装小技巧



- First open the product packaging according to the instructions.

按指导用正确方式拆解产品外包装。



- Summarize all parts to count the number of familiar accessories.

拆开积木包装对照说明书清单确认积木数量。



- Arranging all accessories by color helps to quickly install the product.

把确认好的积木以颜色进行分类排好以便安装。









- Carefully install the product and learn about building.

按说明书步骤拼装并完成你的积木模型。

INSTALLATION
TIPS

1:1 Physical Reference Table

十字棒配件1:1尺寸参照表

2	$(1 \times 2) = 2$	
3	$(1 \times 3) = 3$	
4	$(1 \times 4) = 4$	
5	$(1 \times 5) = 5$	
6	$(1 \times 6) = 6$	
7	$(1 \times 7) = 7$	
8	$(1 \times 8) = 8$	
9	$(1 \times 9) = 9$	
10	$(1 \times 10) = 10$	
12	$(1 \times 12) = 12$	
16	$(1 \times 16) = 16$	



1:1

Instructions For Use

让安装更简单

PARTS LIST

配件清单

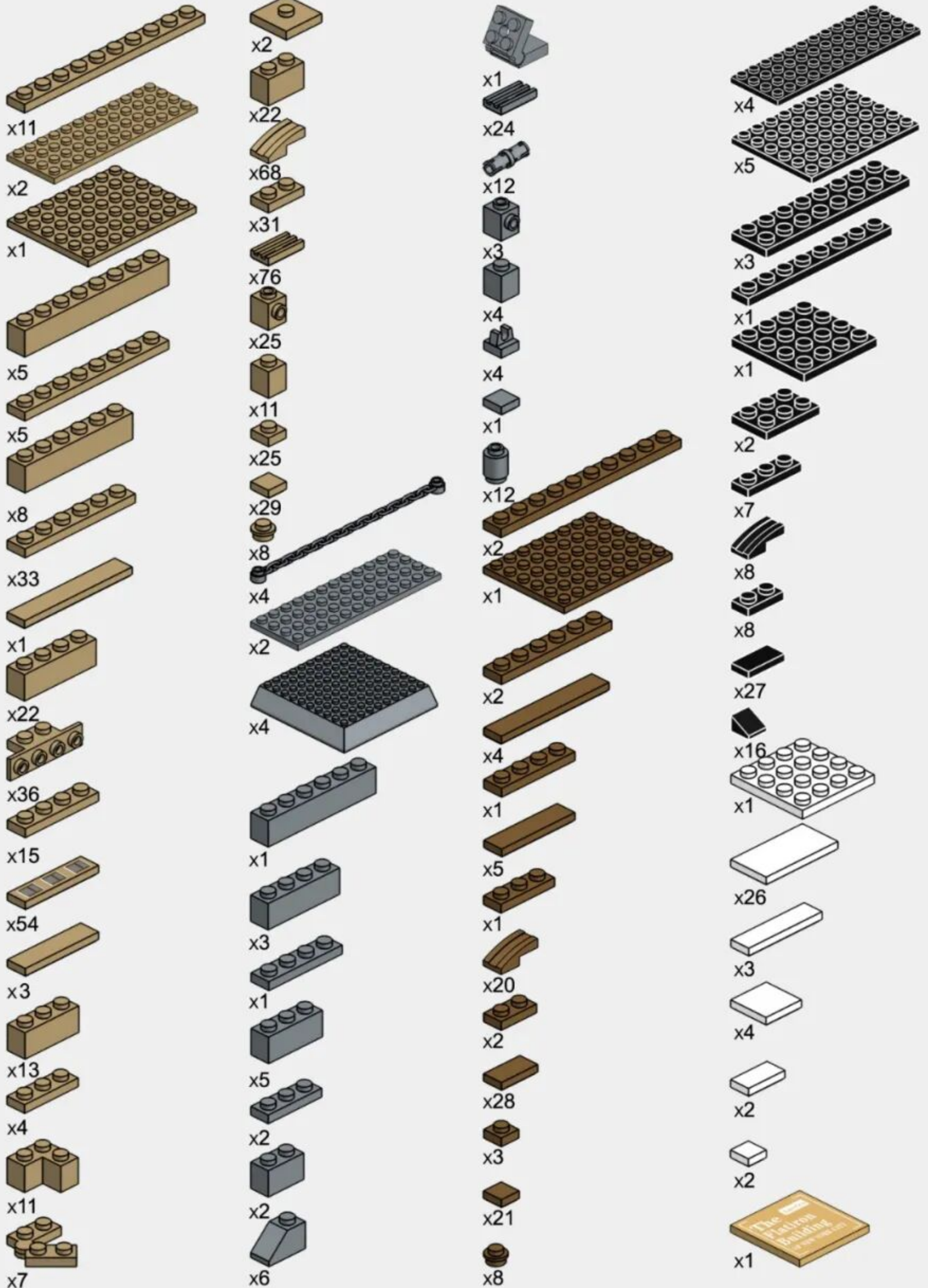

产品有增补件请以实物为准

Product has additional parts, please prevail in kind.

The Flatiron Building

America



Front

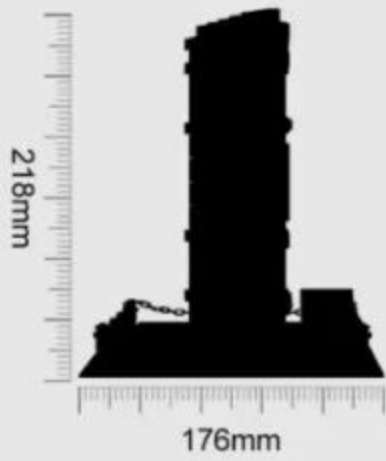

Left

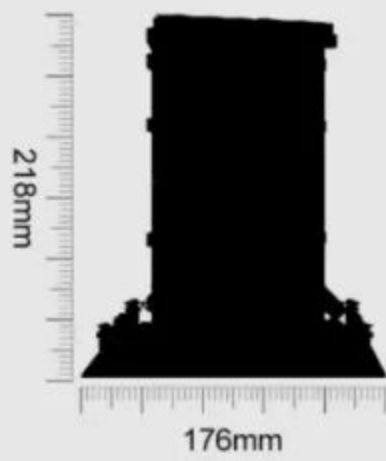

Back

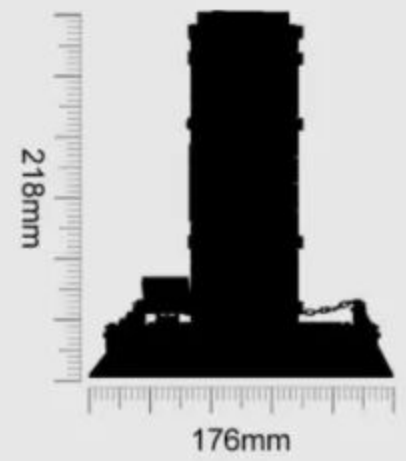

Product Size: 176X176x218mm



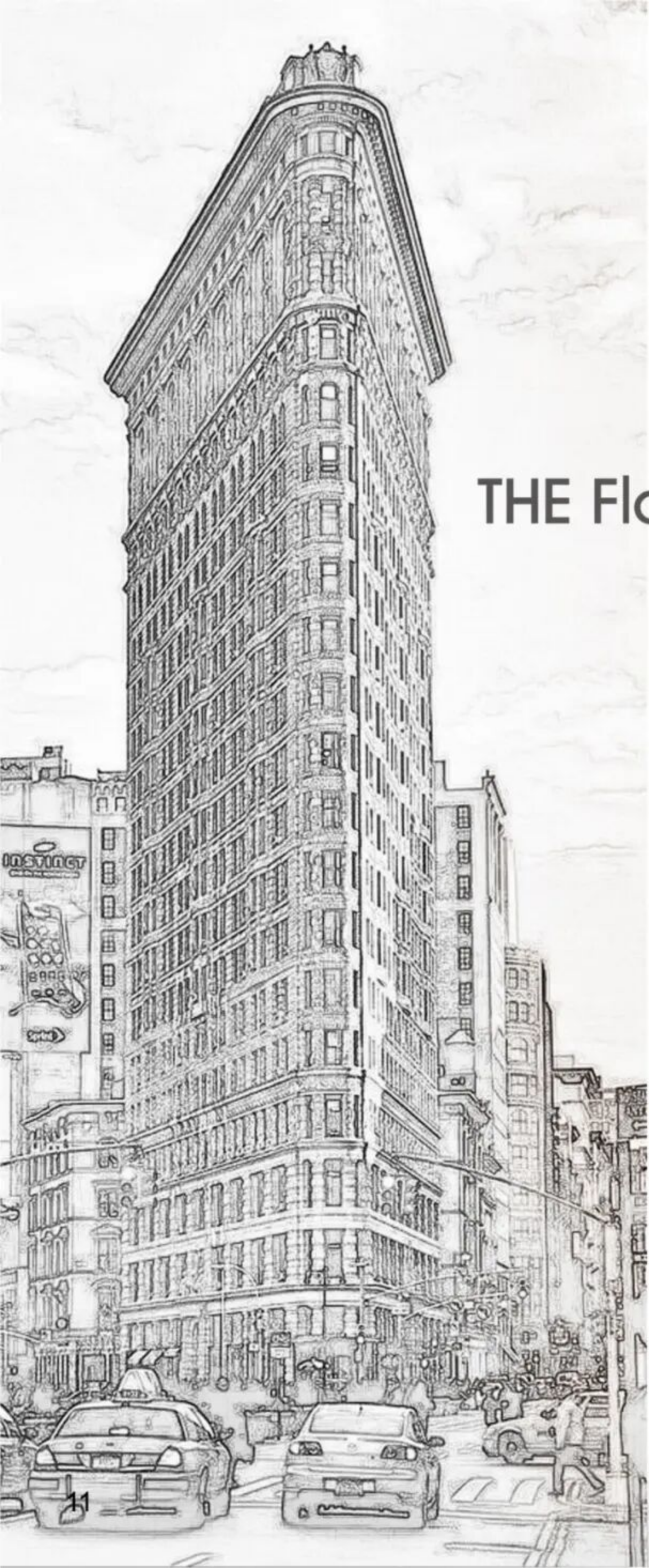

美国熨斗大厦

THE Flatiron Building ■

America

The contents of this chapter refer to the Wikipedia website.

本章内容参考维基百科网站，更多资讯可自行查阅。

The world's great architecture

About The Building



The Flatiron Building, originally the Fuller Building, is a triangular 22-story, 285-foot (87m) tall steel-framed landmarked building located at 175 Fifth Avenue in the borough of Manhattan, New York City, which is considered to be a groundbreaking skyscraper. Early sketches by Daniel Burnham show a design with an (unexecuted) clockface and a far more elaborate crown than in the actual building. Though Burnham maintained overall control of the design process, he was not directly connected with the details of the structure as built; credit should be shared with his designer Frederick P. Dinkelberg, a Pennsylvania-born architect in Burnham's office, who first worked for Burnham in putting together the 1893 World's Columbian Exposition in Chicago, for which Burnham was the chief of construction and master designer. Working drawings for the Flatiron Building, however, remain to be located, though renderings were published at the time of construction in *American Architect* and *Architectural Record*.



Design and construction

Early sketches by Daniel Burnham show a design with an (unexecuted) clockface and a far more elaborate crown than in the actual building. Though Burnham maintained overall control of the design process, he was not directly connected with the details of the structure as built; credit should be shared with his designer Frederick P. Dinkelberg, a Pennsylvania-born architect in Burnham's office, who first worked for Burnham in putting together the 1893 World's Columbian Exposition in Chicago, for which Burnham was the chief of construction and master designer.



Initial response

The Flatiron Building has become an icon of New York City, and the public response to it was enthusiastic, but the critical response to it at the time was not completely positive, and what praise it garnered was often for the cleverness of the engineering involved. Montgomery Schuyler, editor of *Architectural Record*, said that its "awkwardness [is] entirely undisguised, and without even an attempt to disguise them, if they have not even been aggravated by the treatment. ... The treatment of the tip is an additional and it seems wanton aggravation of the inherent awkwardness of the situation." He praised the surface of the building, and the detailing of the terra-cotta work, but criticized the practicality of the large number of windows in the building: "[The tenant] can, perhaps, find wall space within for one roll top desk without overlapping the windows, with light lose in front of him and close behind him and close on one side of him.



The Fuller Company originally took the 19th floor of the building for its headquarters. In 1910, Harry Black moved the company to Francis Kimball's Trinity Building at 111 Broadway, where its parent company, U.S. Realty, had its offices. They moved them back to the Flatiron in 1916, and left permanently for the Fuller Building on 57th Street in 1929. The Flatiron's other original tenants included publishers (magazine publishing pioneer Frank Munsey,

Original tenants and subsequent history



American Architect and Building News and a vanity publisher), an insurance company (the Equitable Life Assurance Society), small businesses (a patent medicine company, Western Specialty Manufacturing Company and Whitehead & Hoag, who made celluloid novelties), music publishers (overflow from "Tin Pan Alley" up on 28th Street), a landscape architect, the Imperial Russian Consulate, the Bohemian Guides Society, the Roebling Construction Company, owned by the sons of Tammany Hall boss Richard Croker, and the crime syndicate, Murder, Inc.

Main Color Matching

配色方案



Pantone 4625C

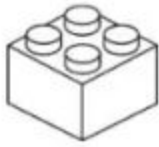

White



Pantone 468C

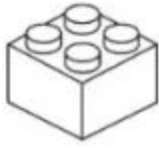

Pantone 459C

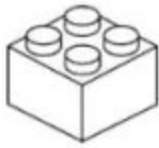

Pantone black6C

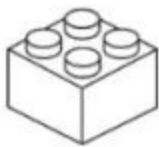

Pantone cool gray10C

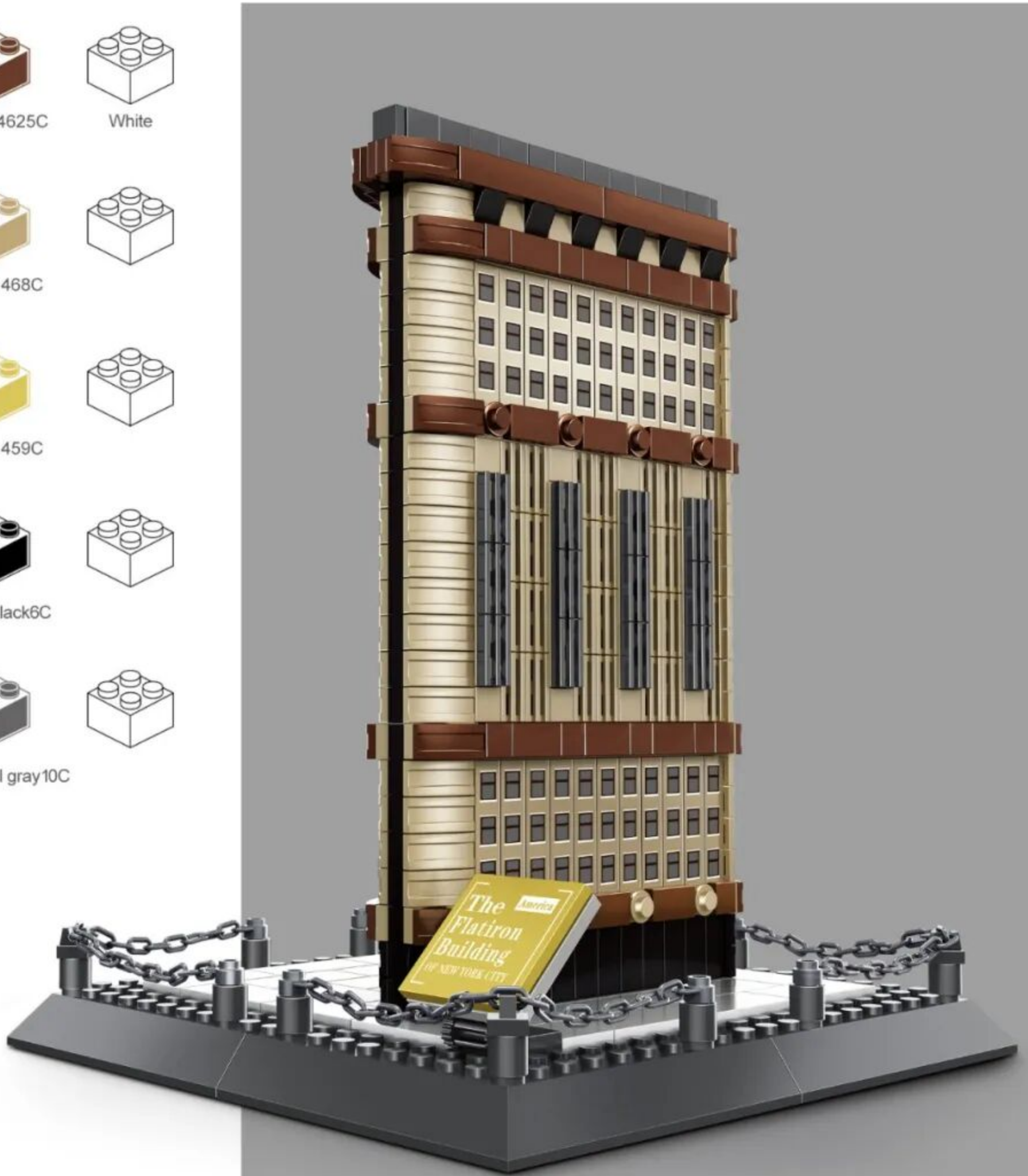
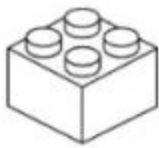

Color matching

Adopting 3 main colors, beige, brown and gray as the main color, the more reasonable and bold color matching on the original building, making the product more atmospheric and the whole design is more reasonable.

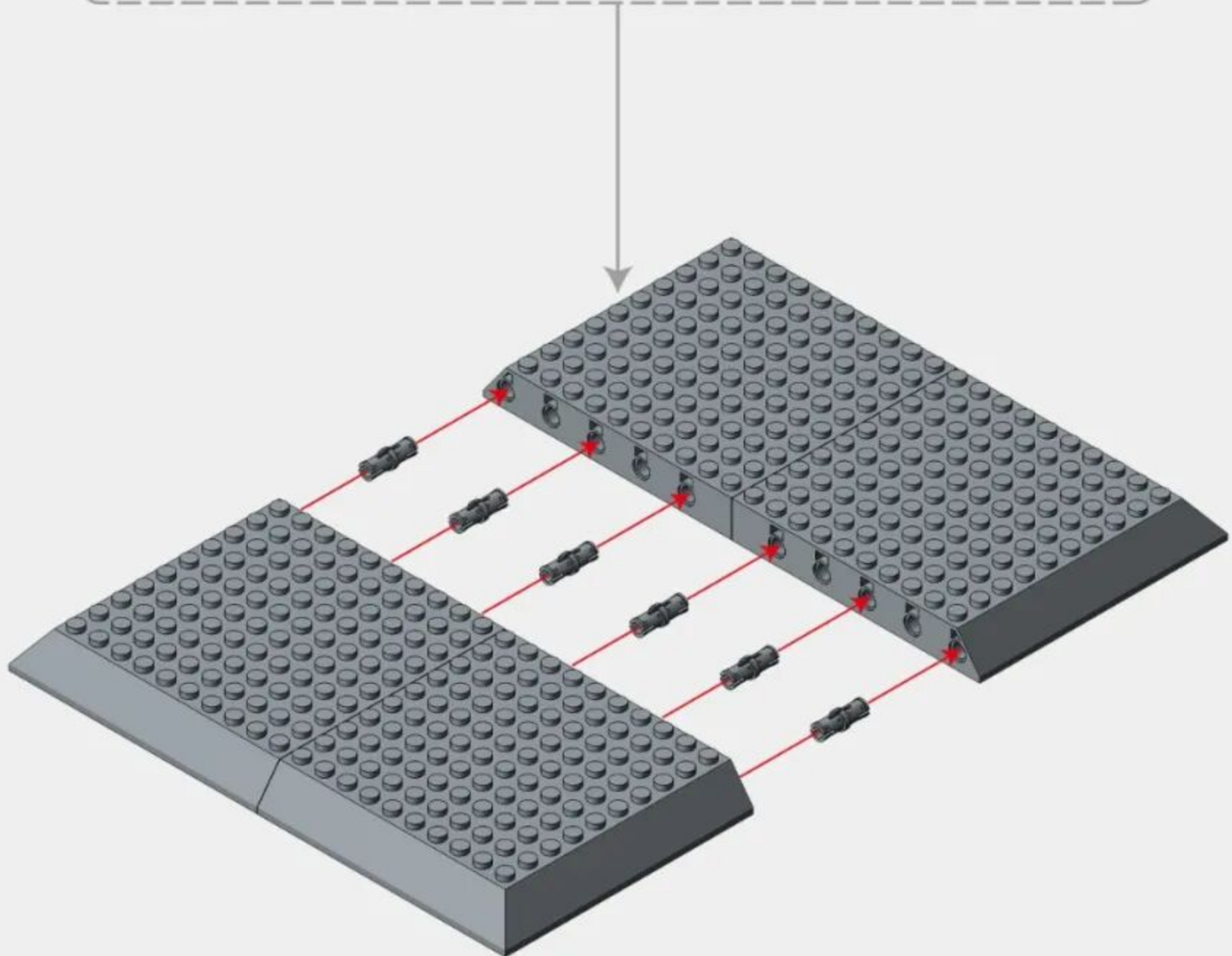
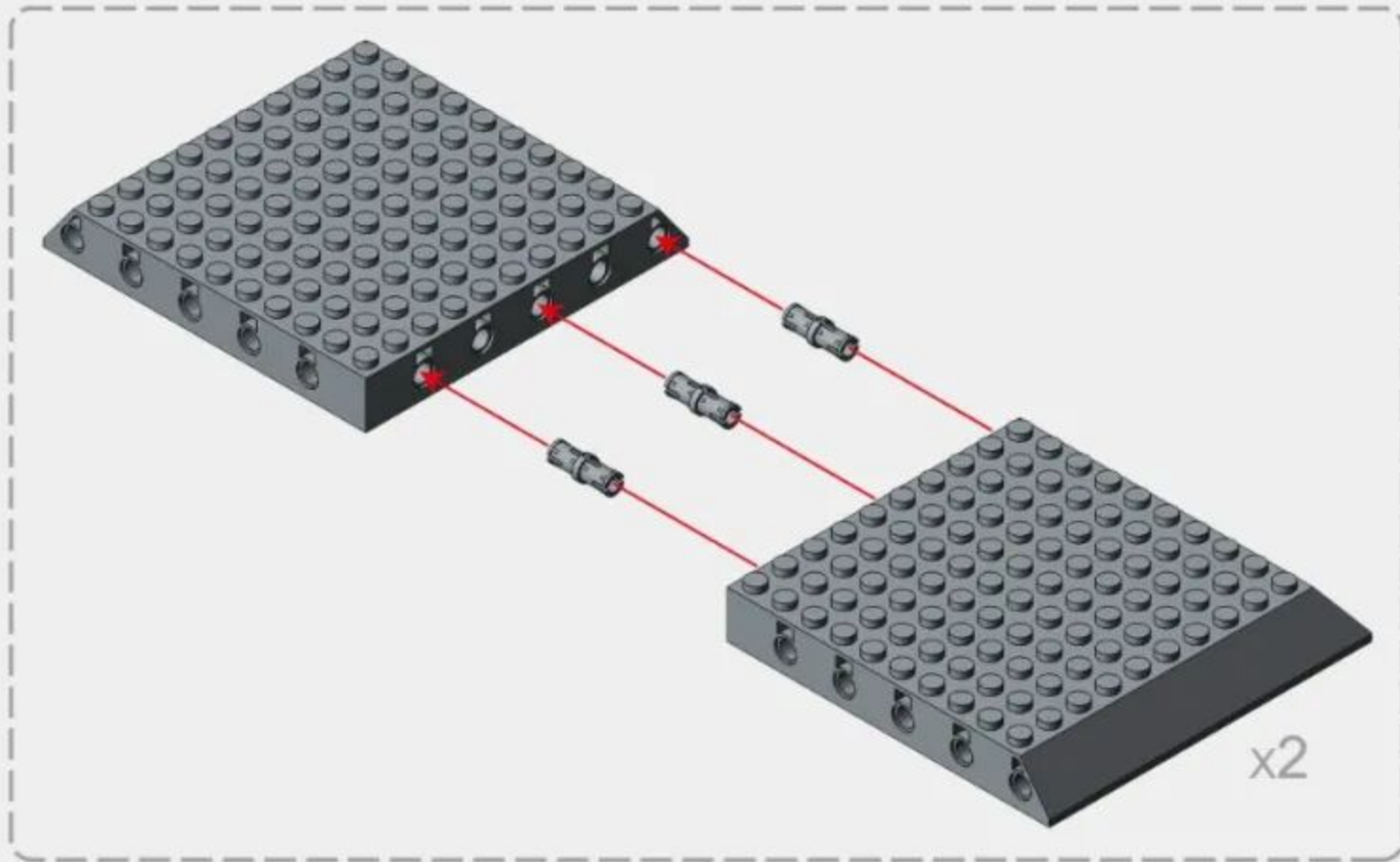
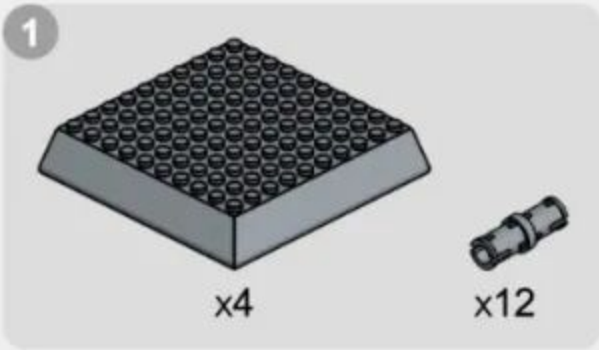

2

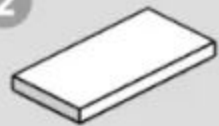

x19



x1

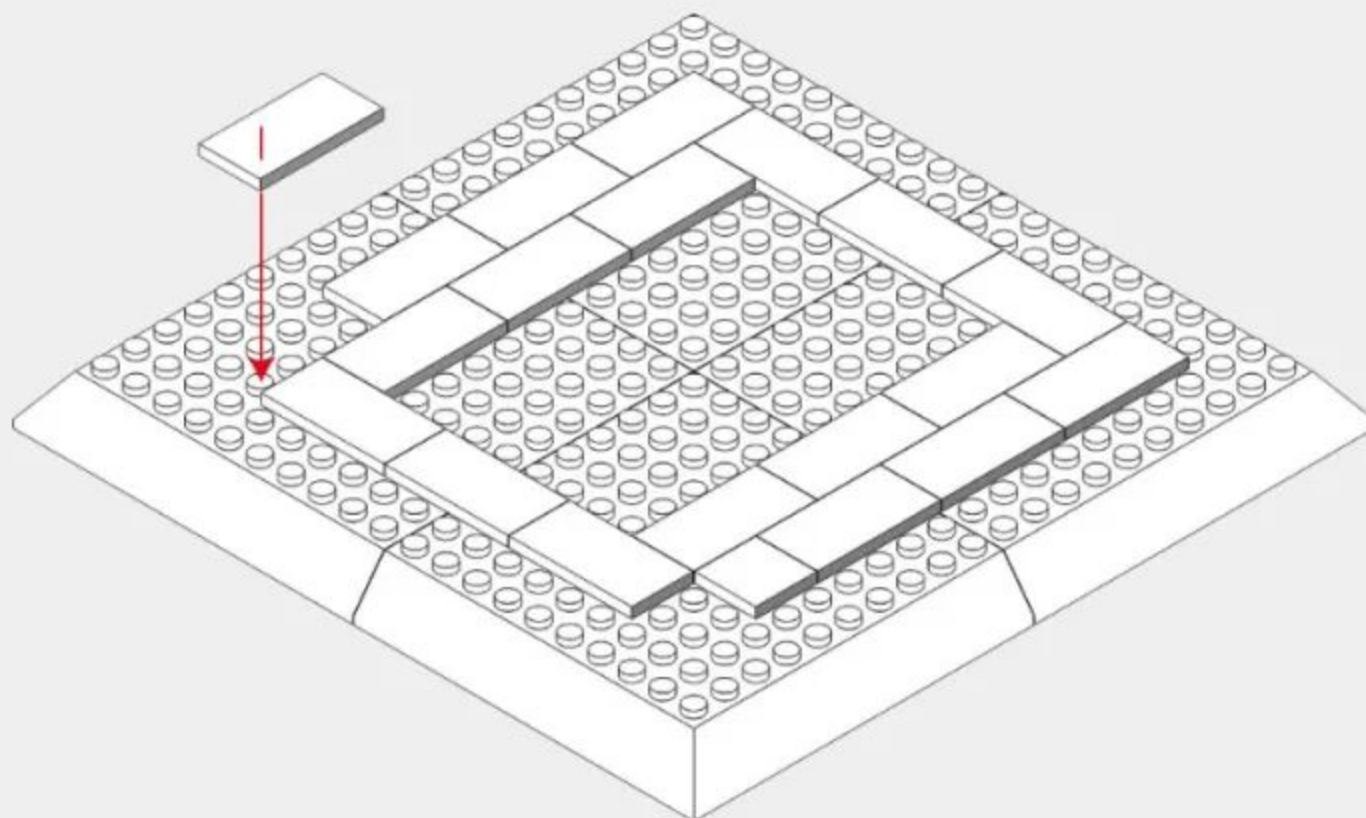

3

1 X 8

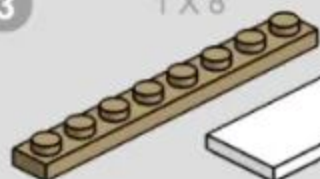

x1



x7



x3



x3



x1



x1

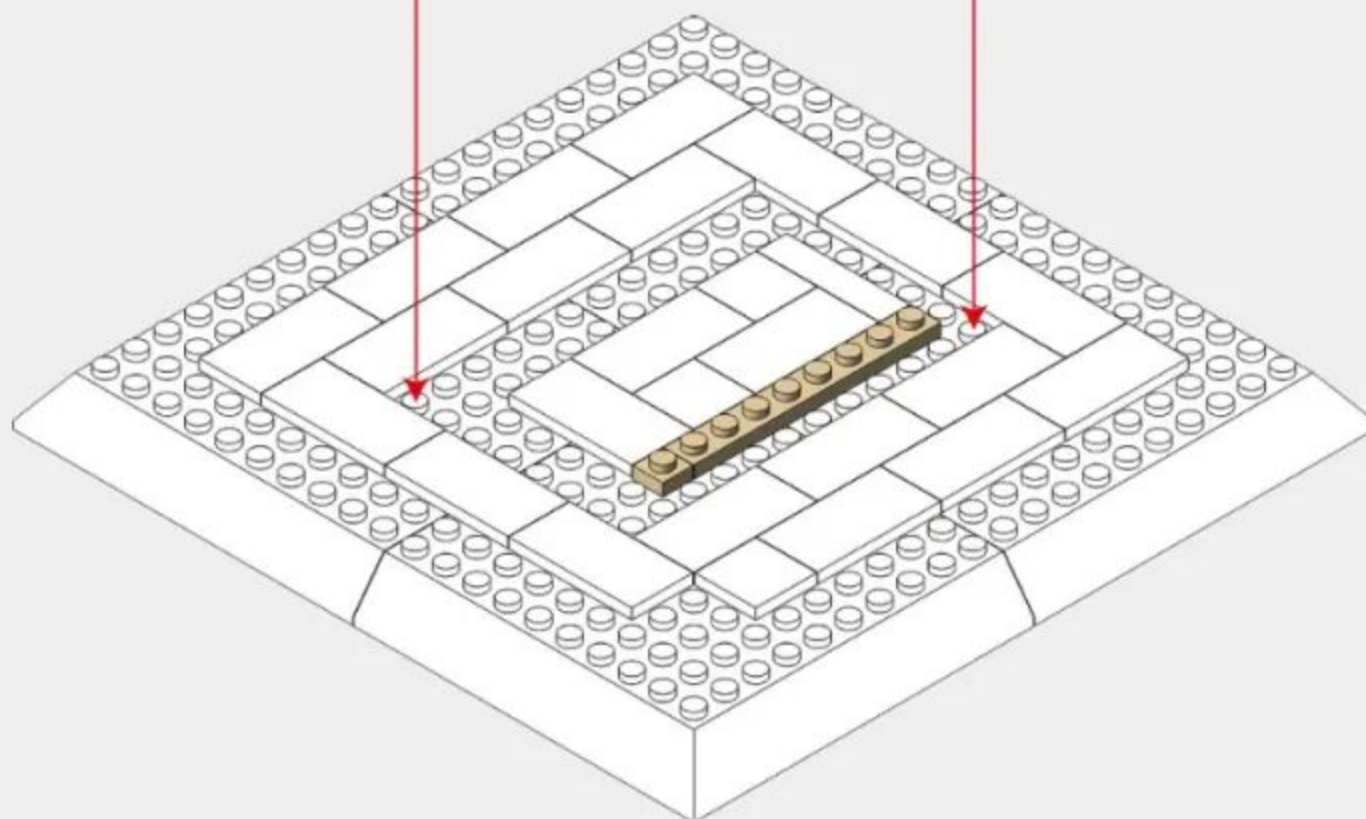
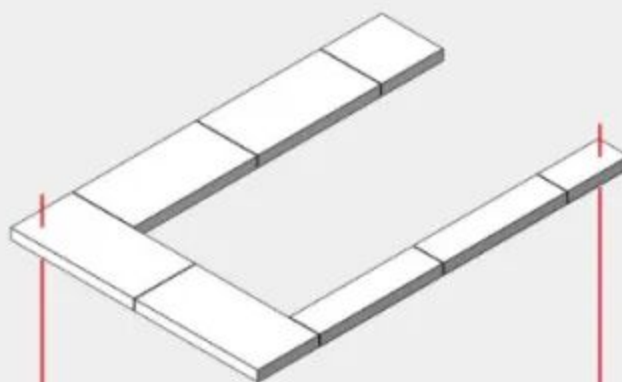

4

1 X 6

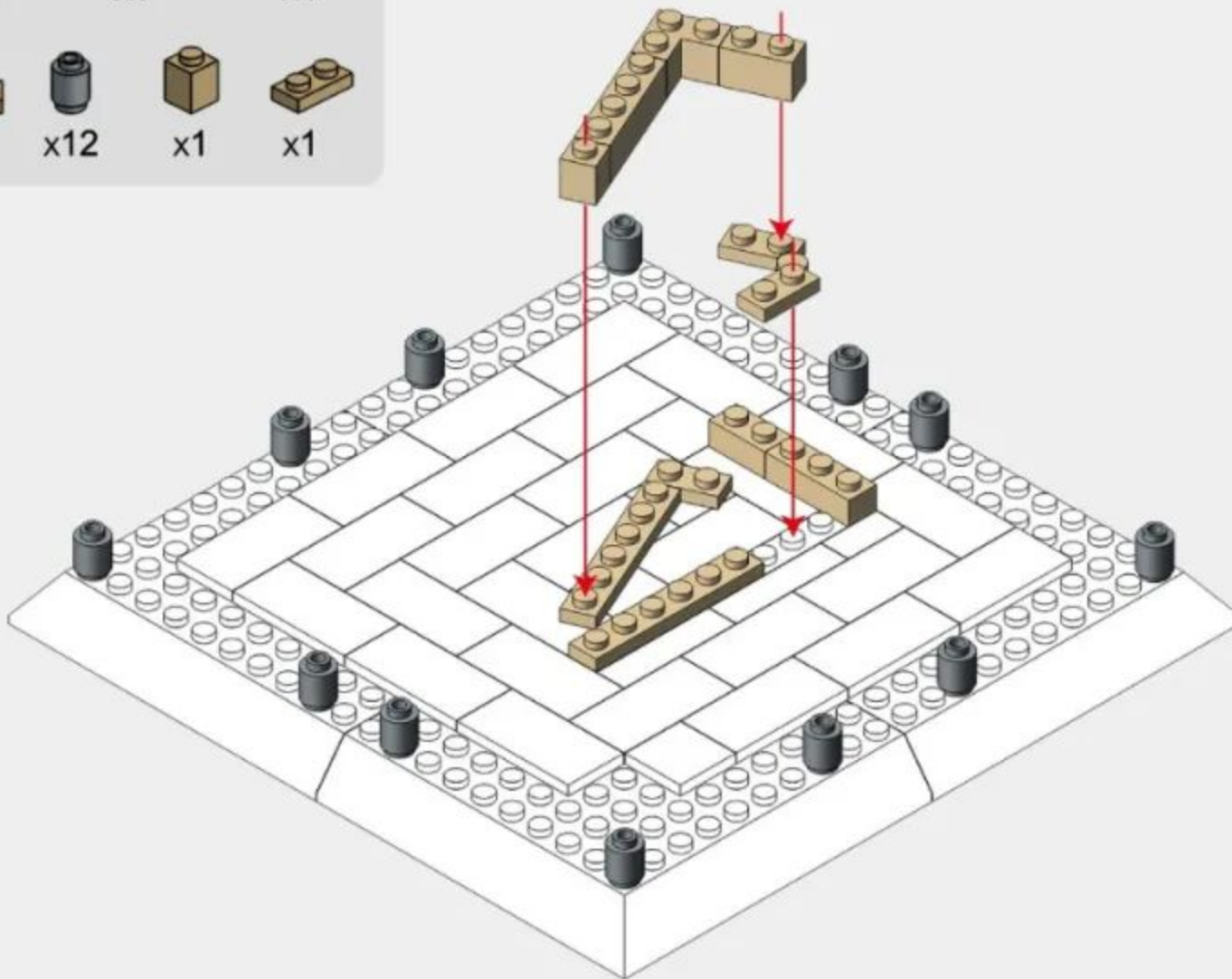
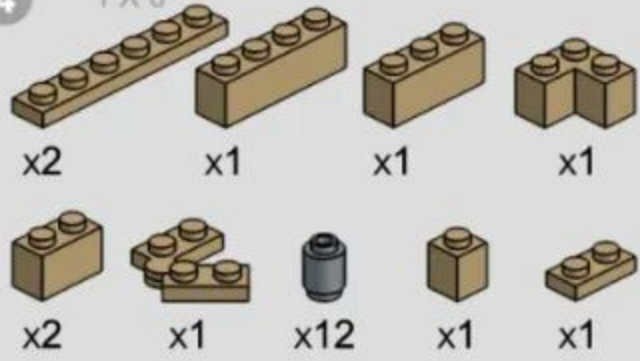

5

1 X 6

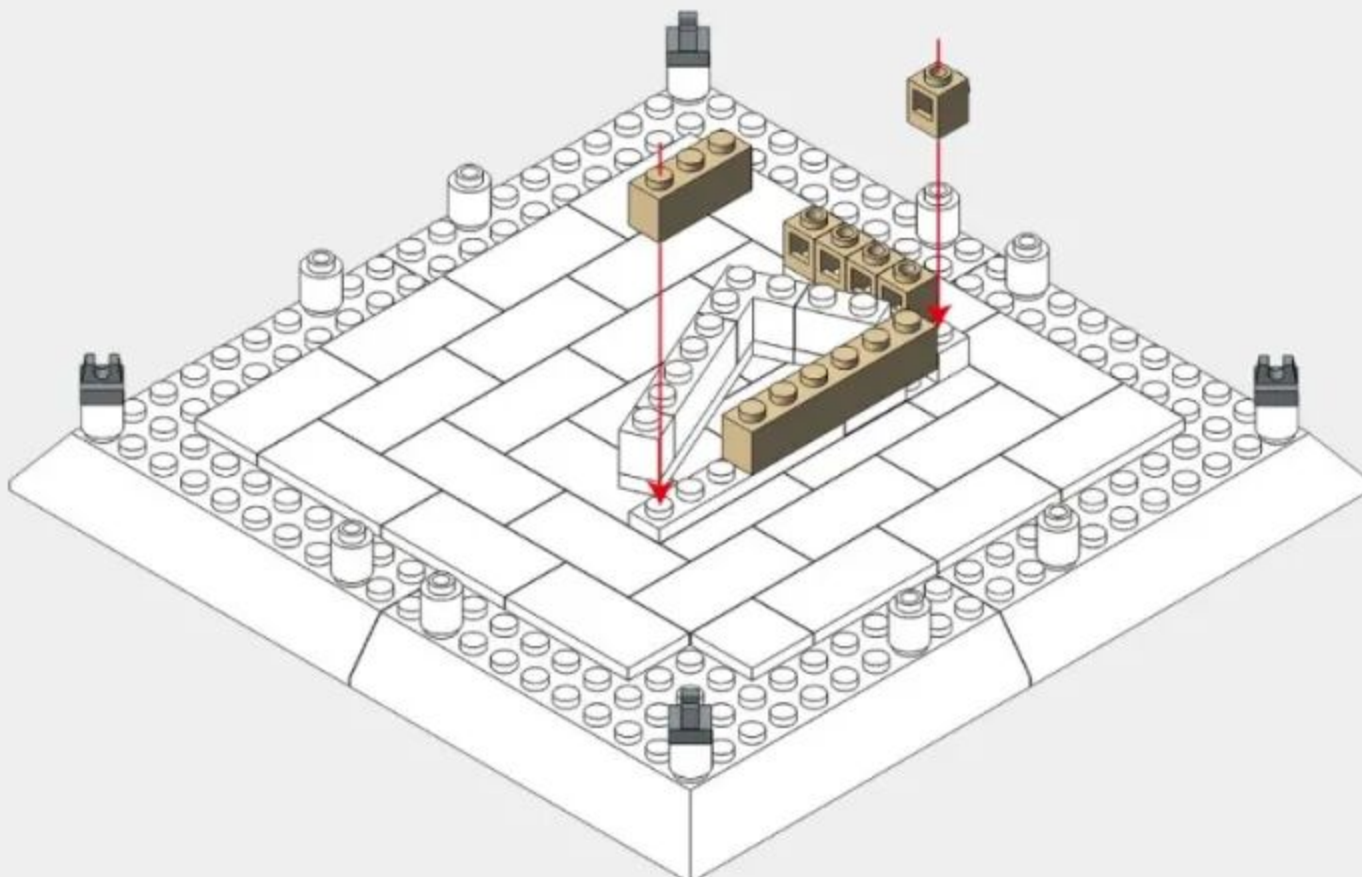
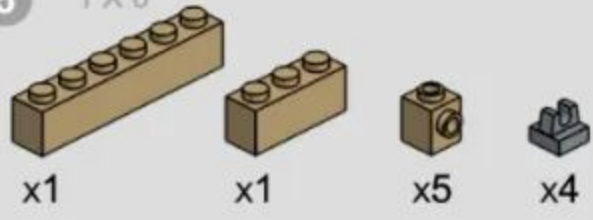

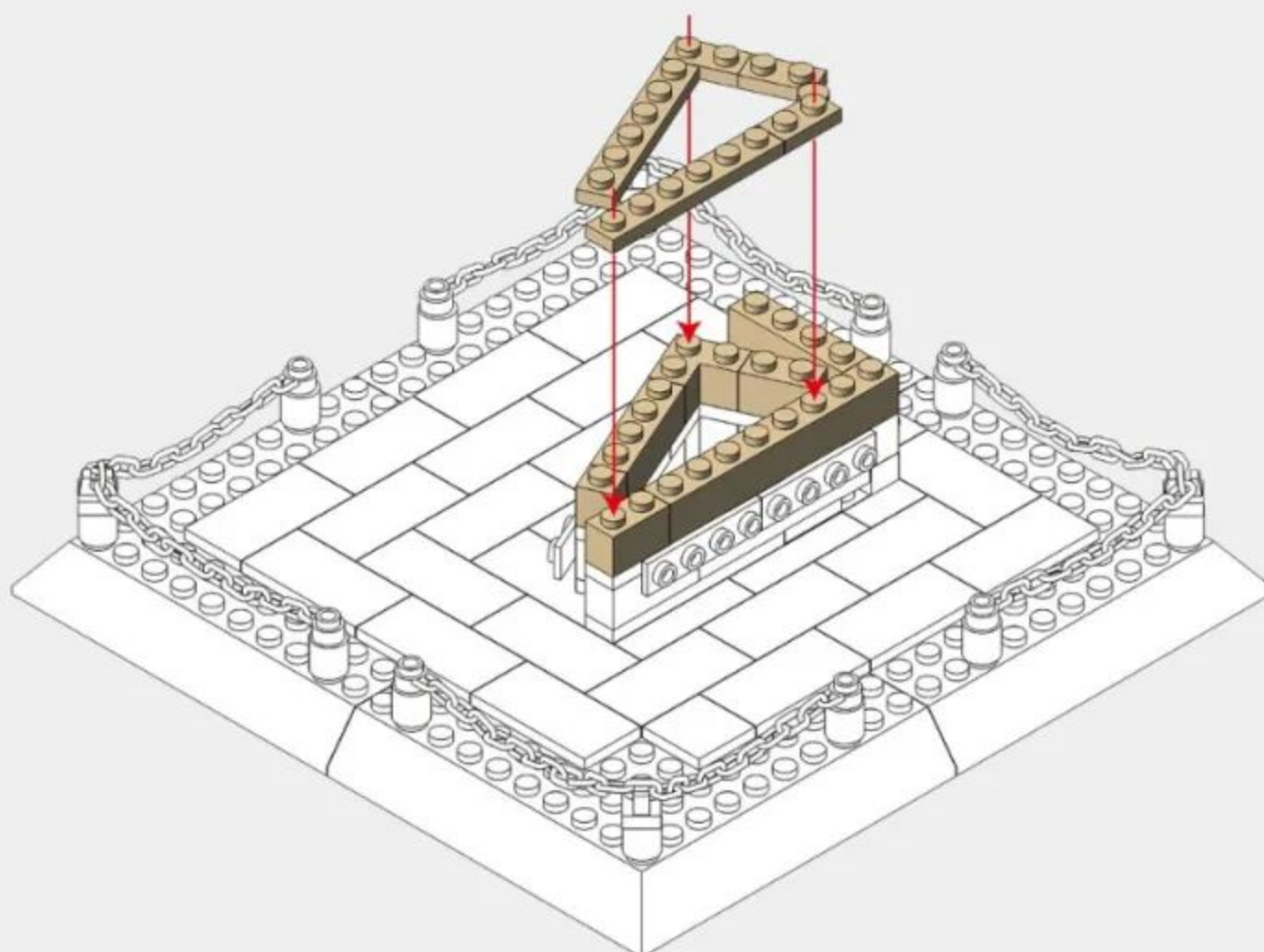
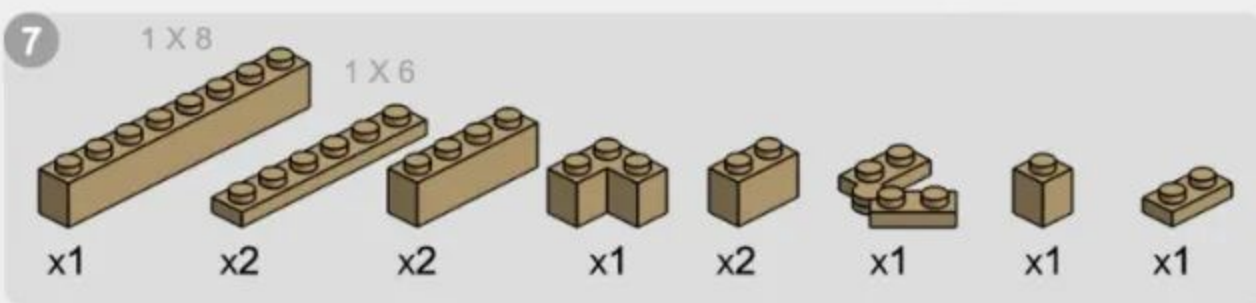
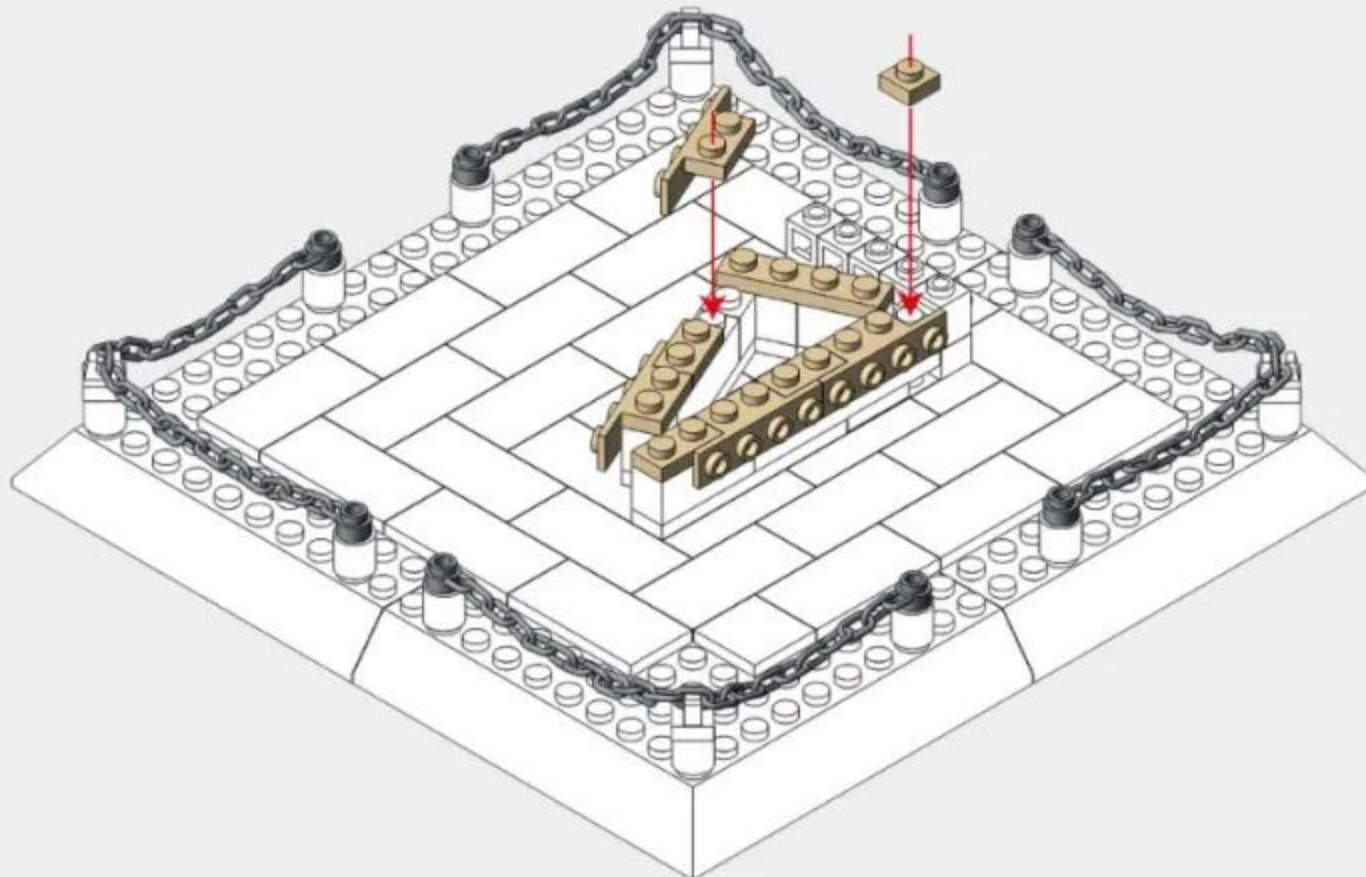
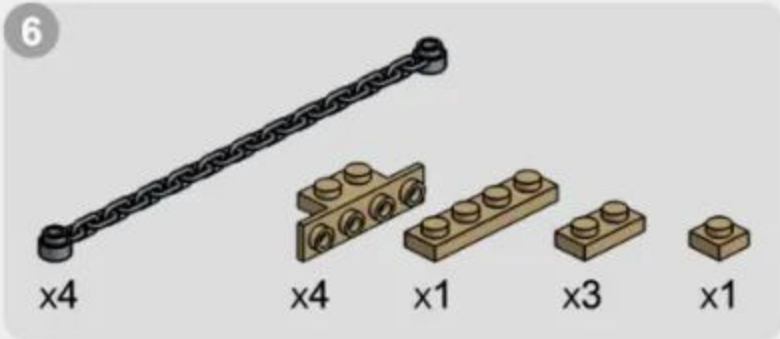

8

1 X 8

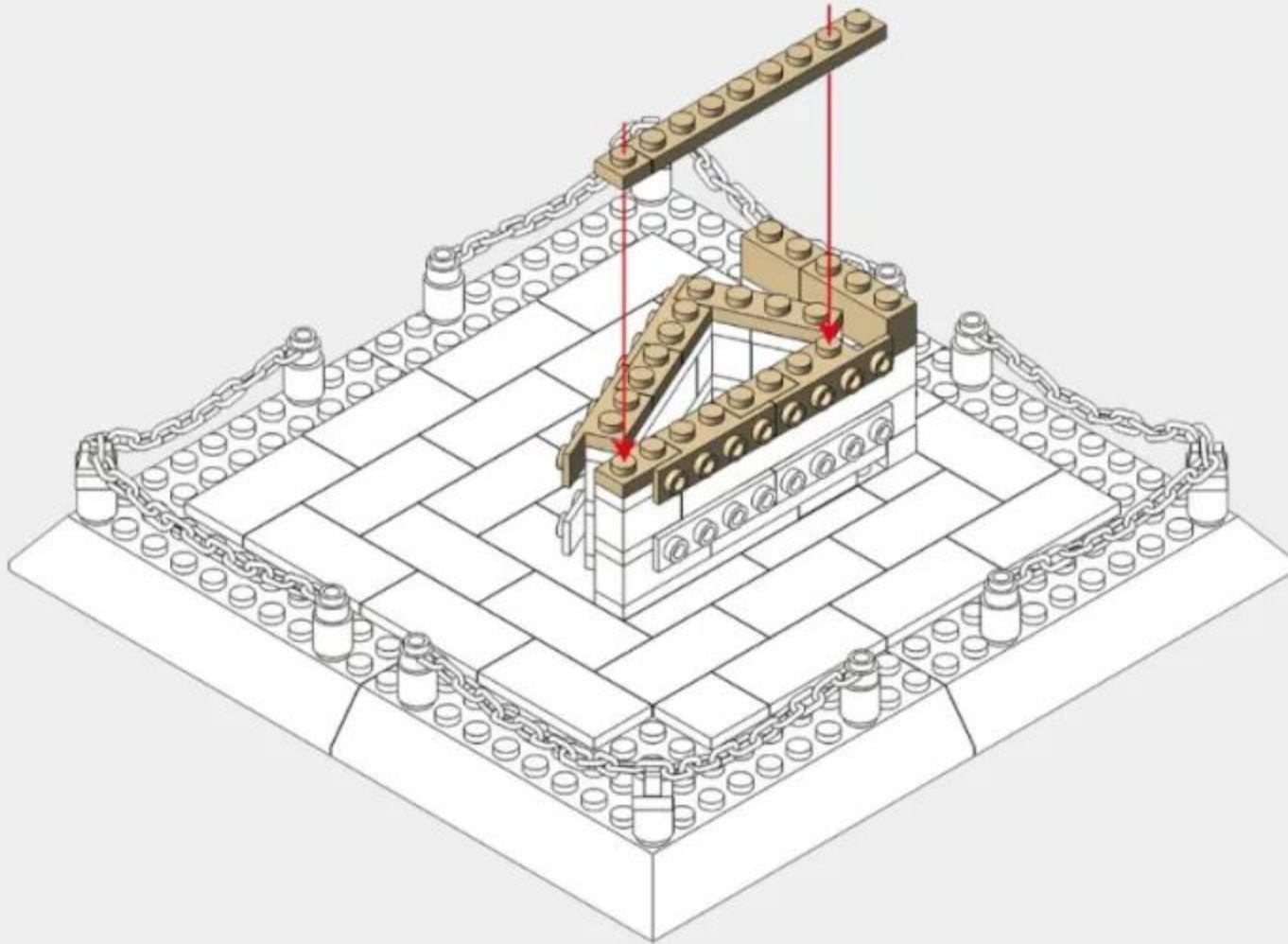
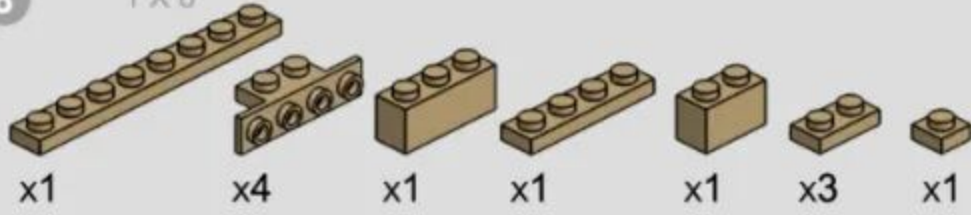

9

1 X 6

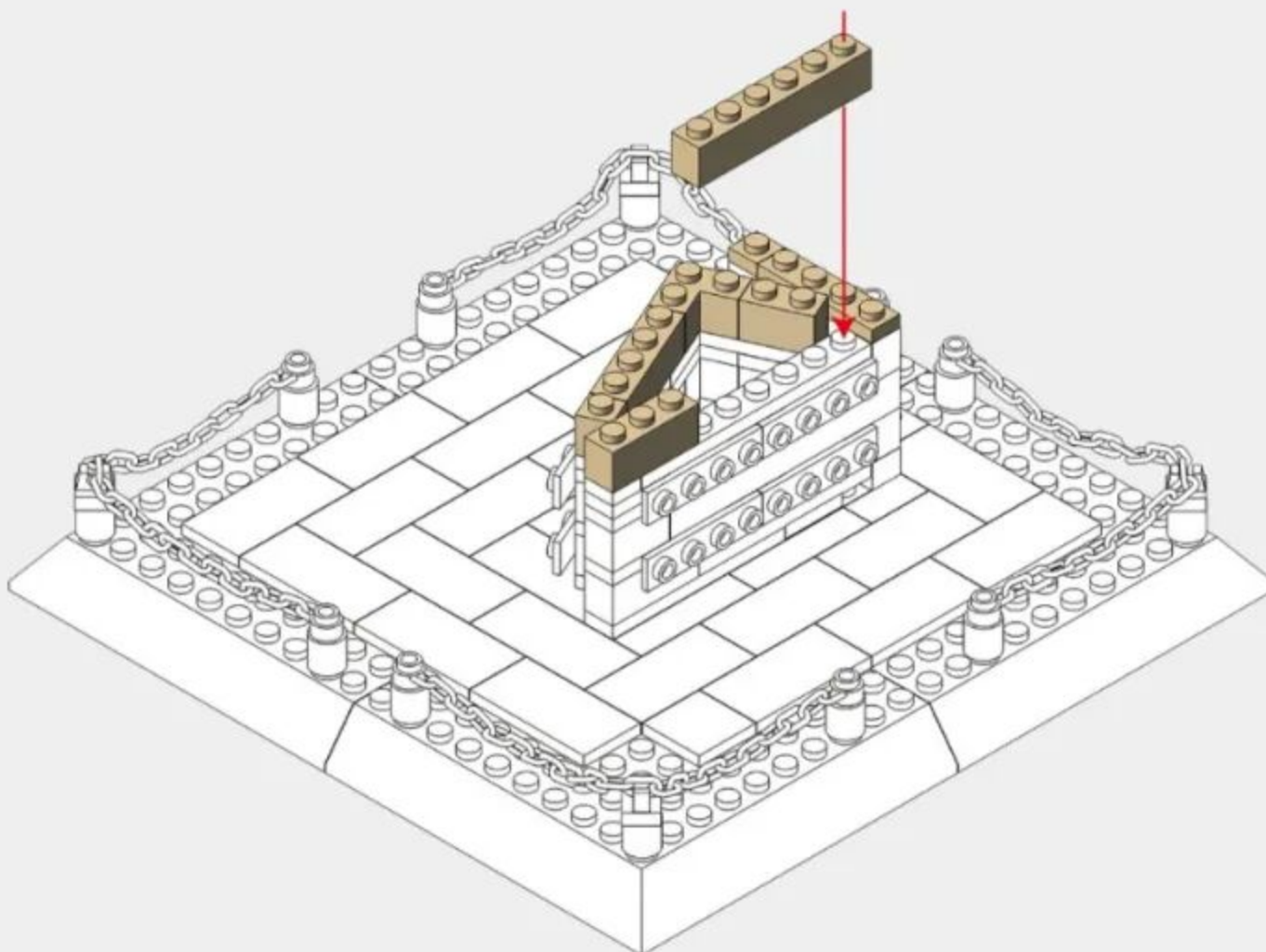
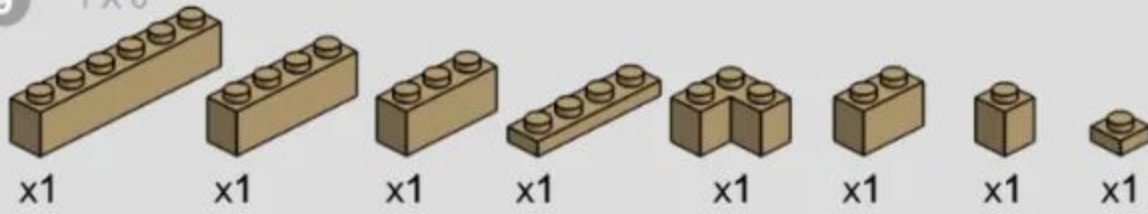

10

1 X 6

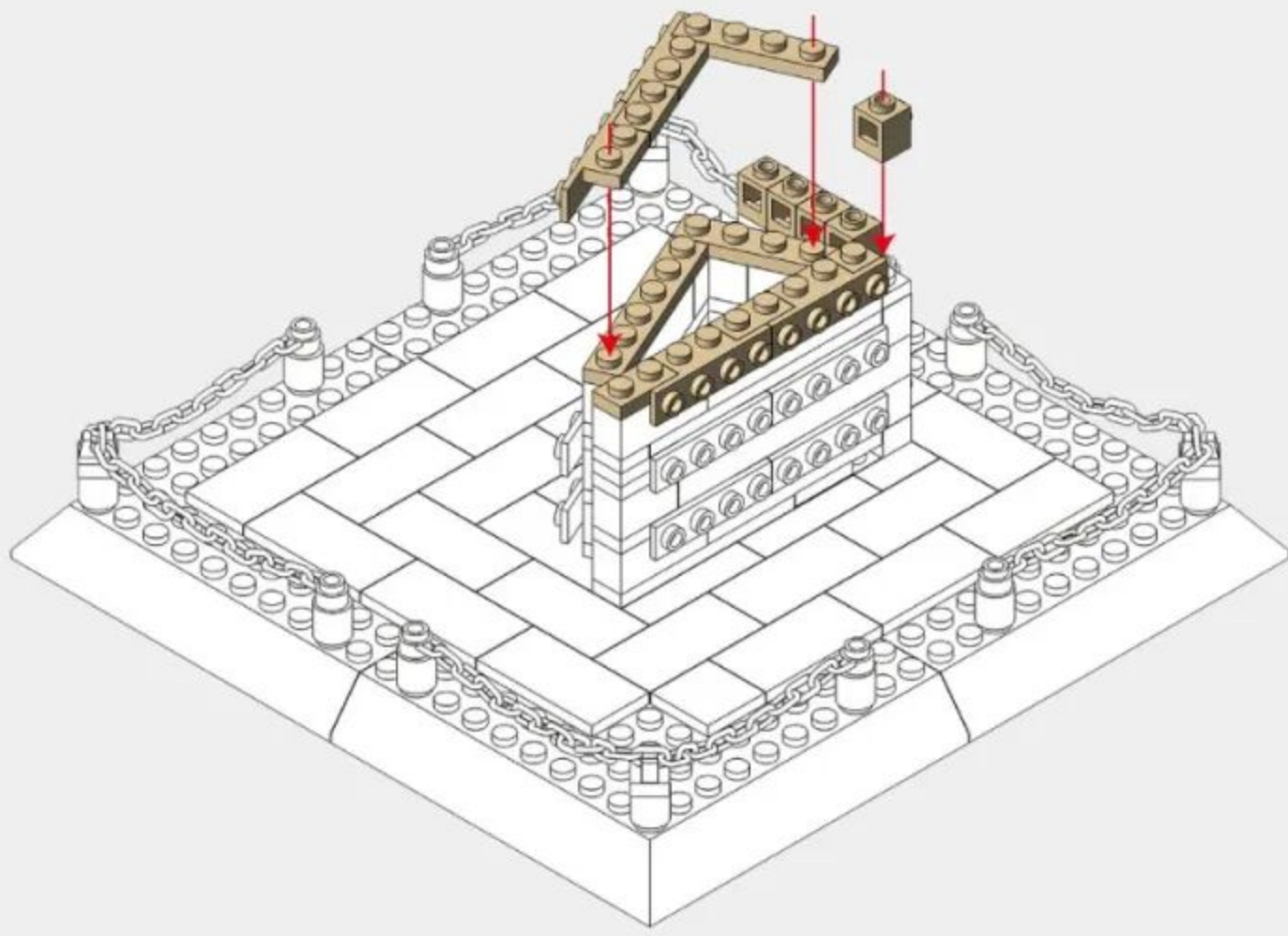

11

1 X 8

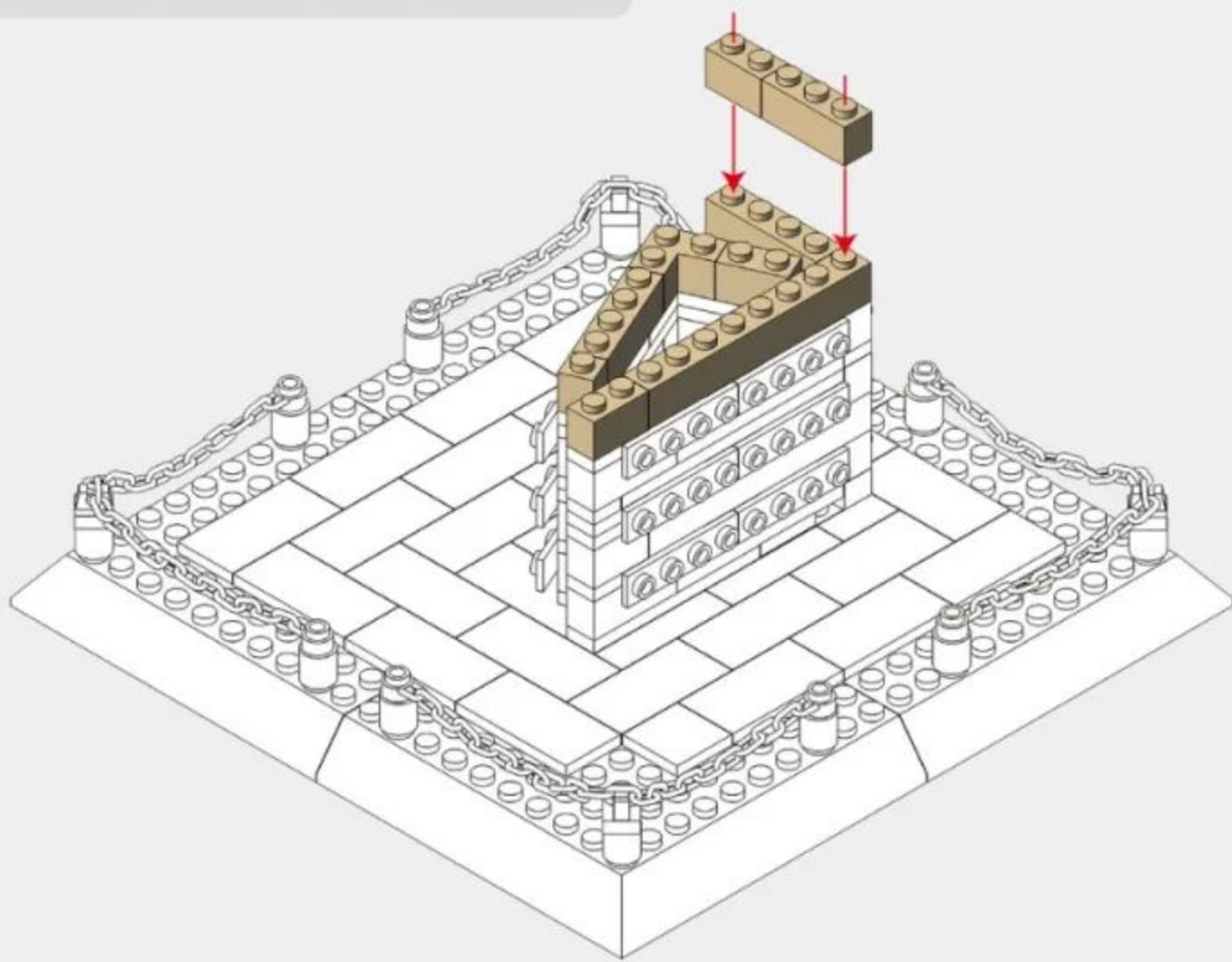
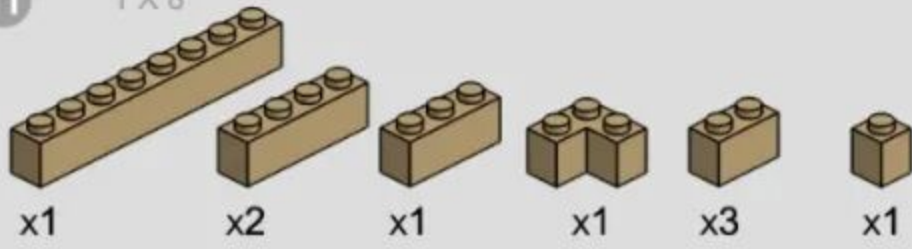

14

1 X 8

1 X 6

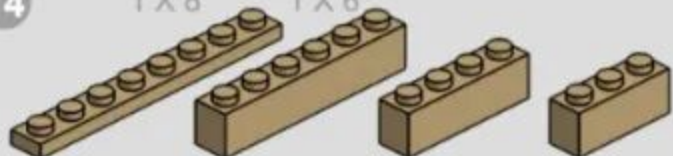

x1

x1

x1

x1



x1



x1



x1



x1

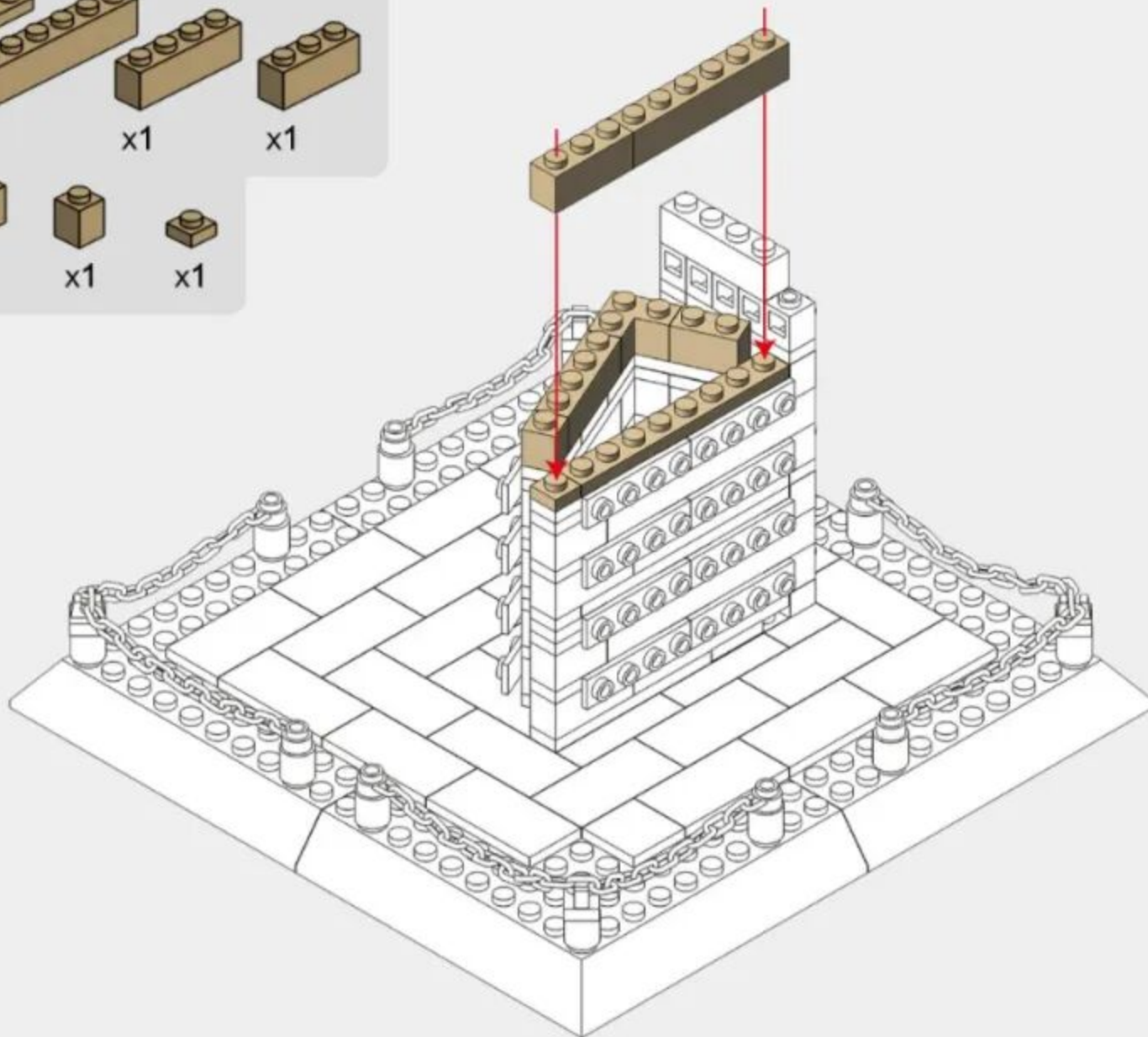

15

1 X 6



x1



x2



x2



x1

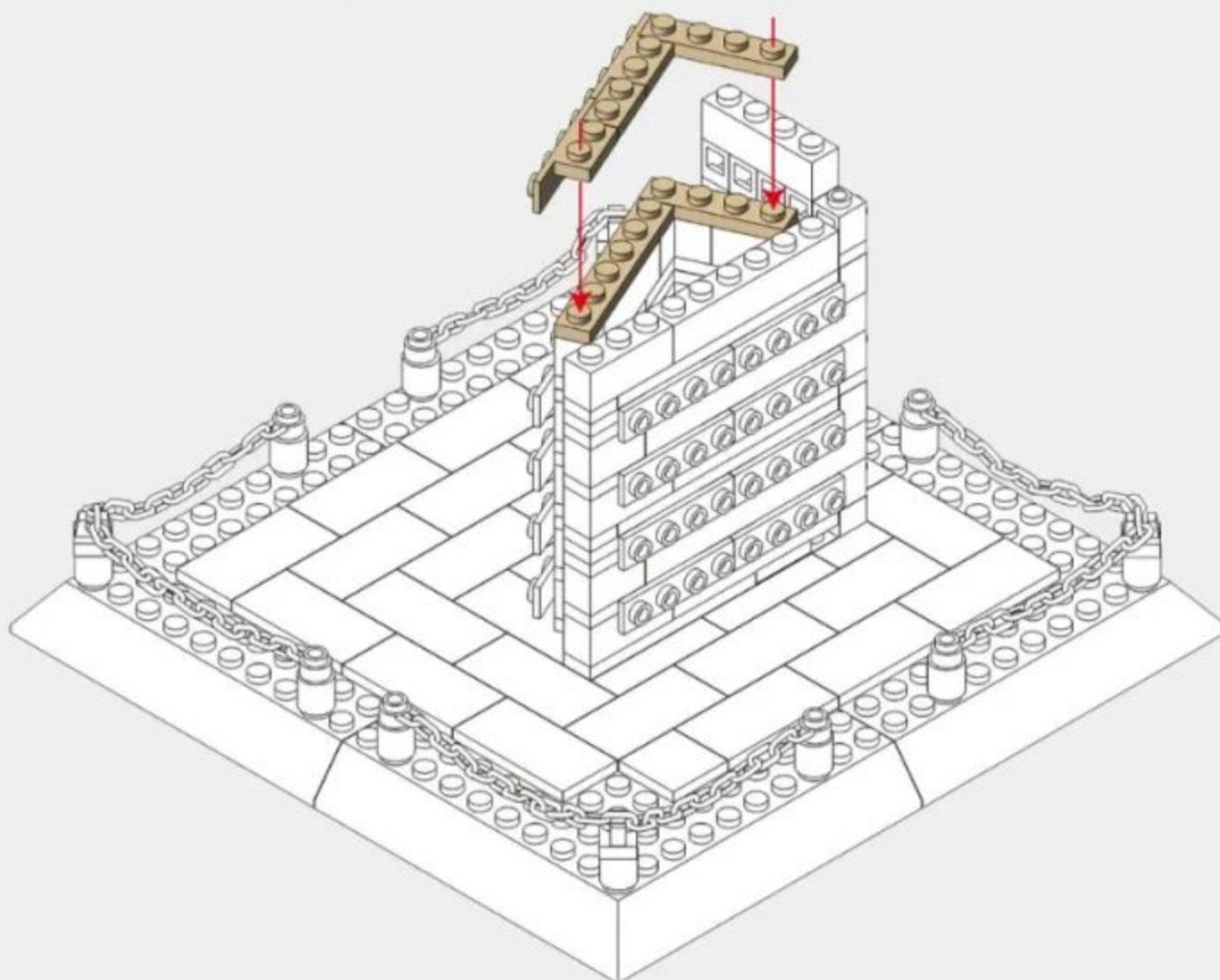

16

1 X 8

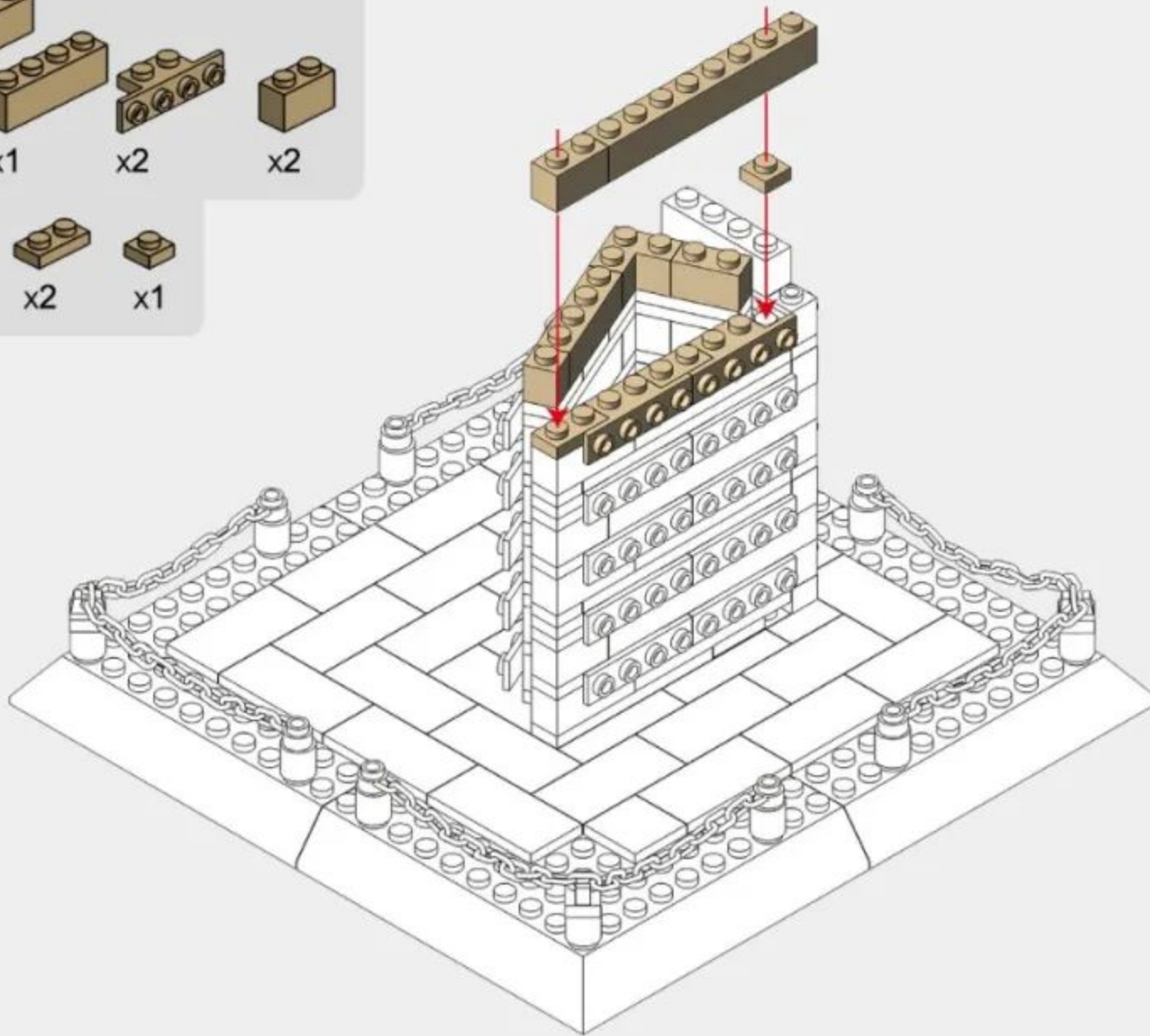
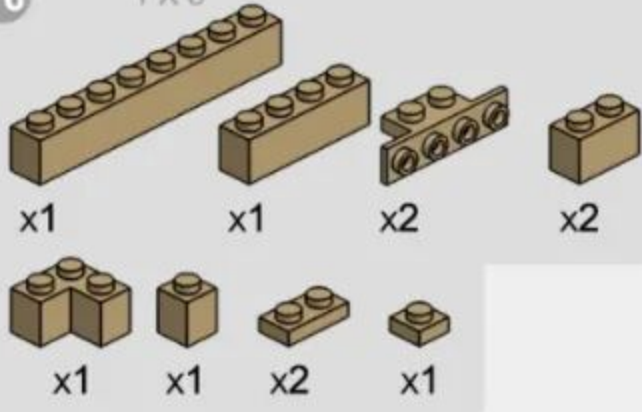

17

4 X 12

1 X 10

2 X 8

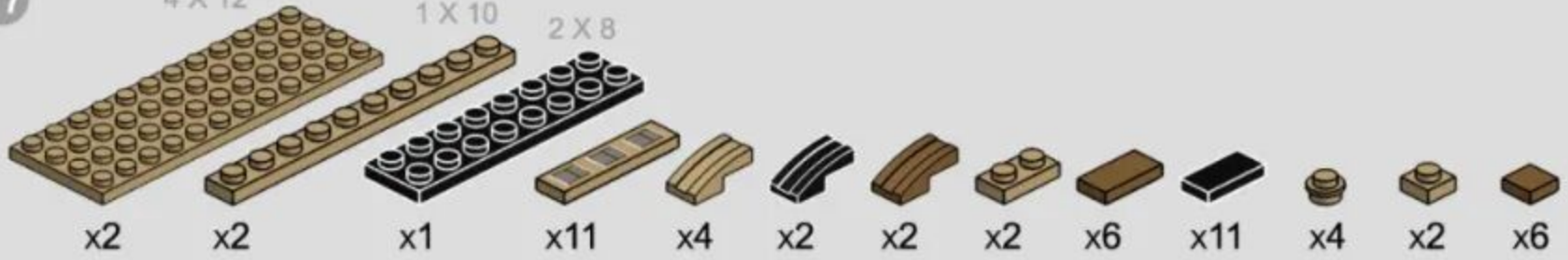

1

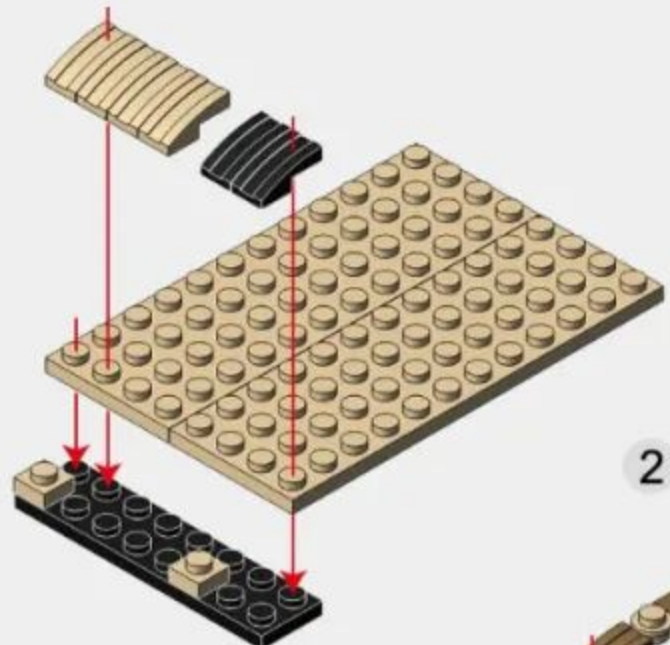

2

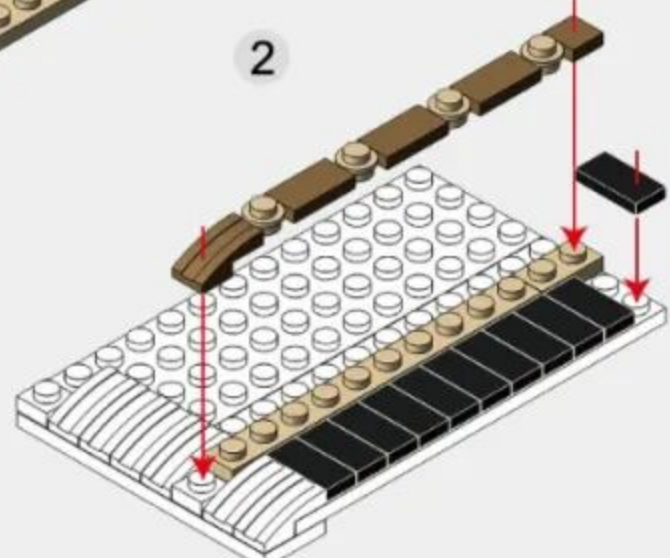

3

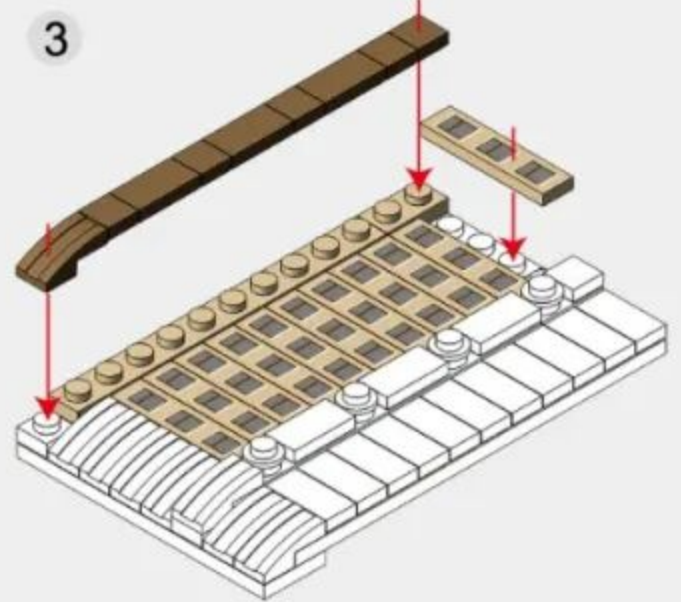

18

16 + 17

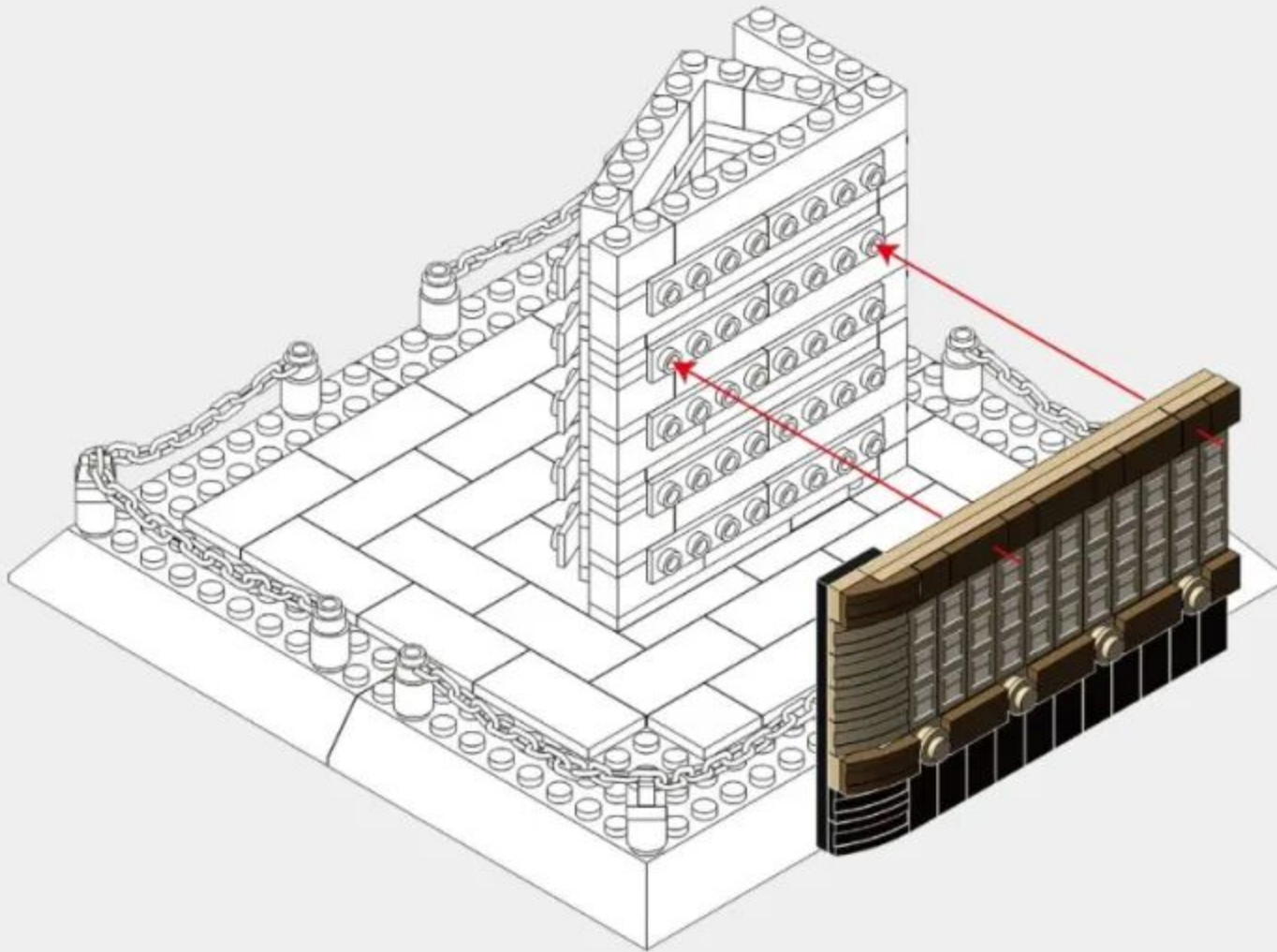

19

6 X 8

1 X 6

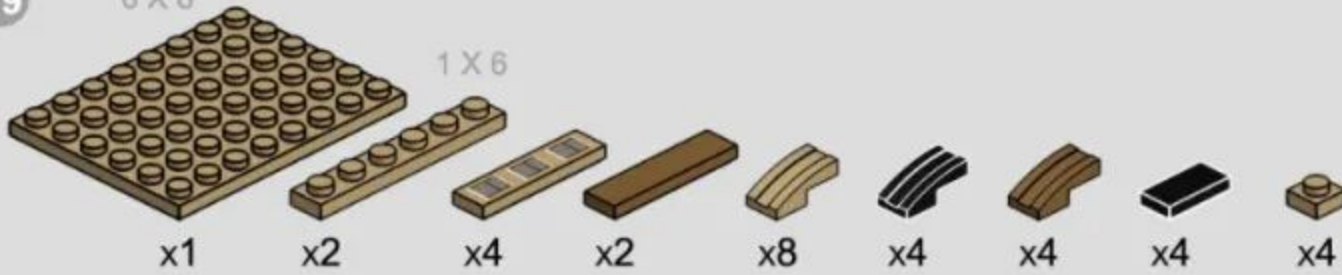

1

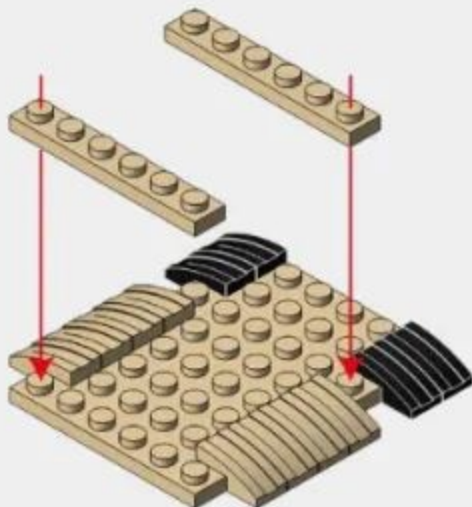

2

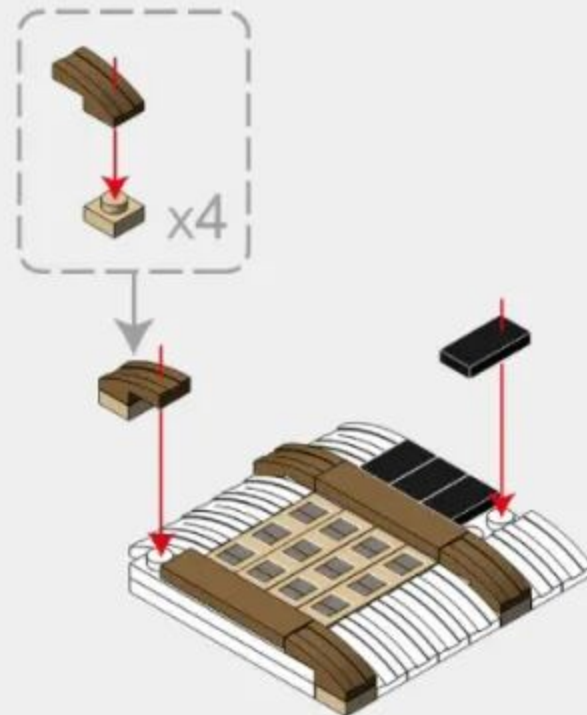

20

18 + 19

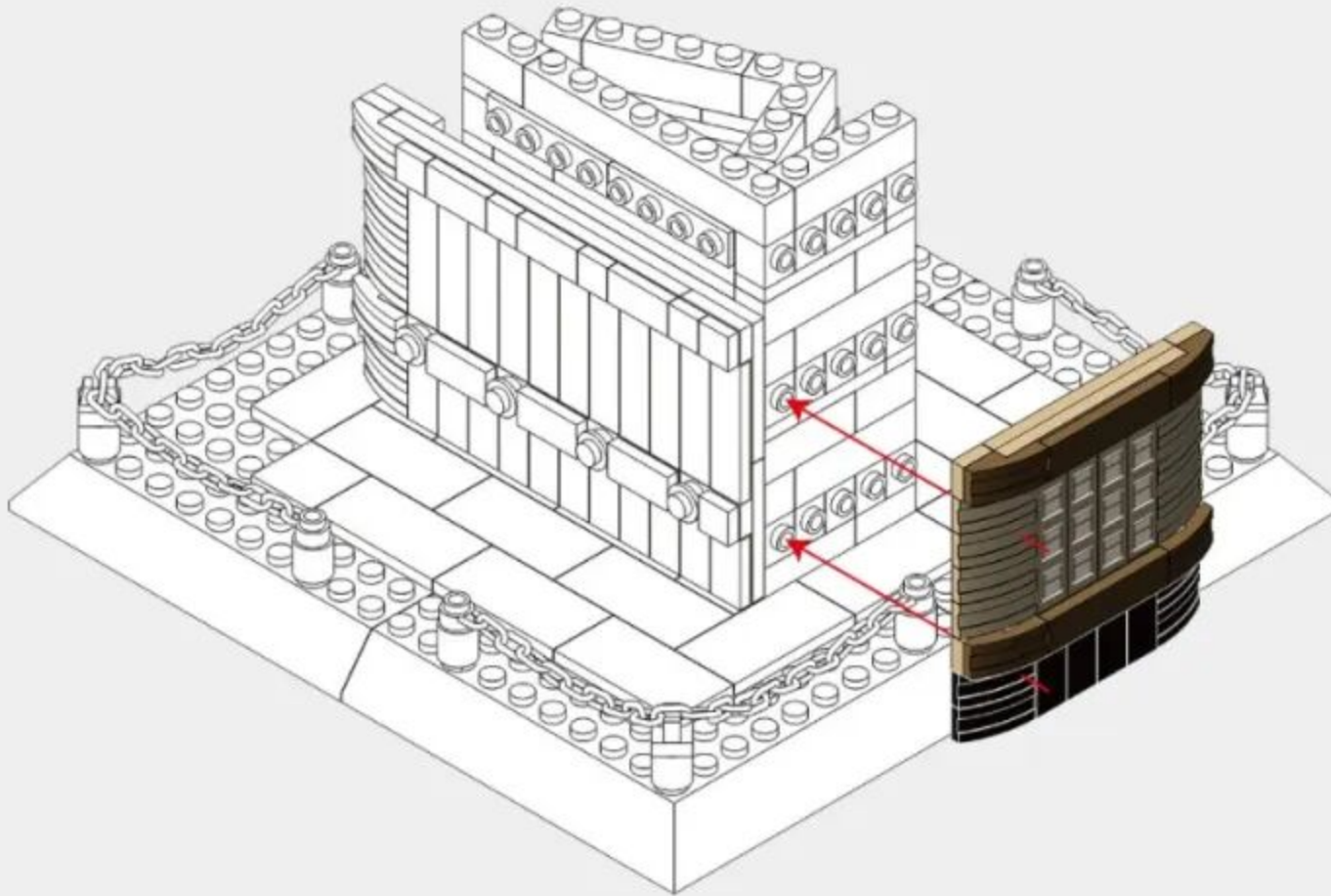

21

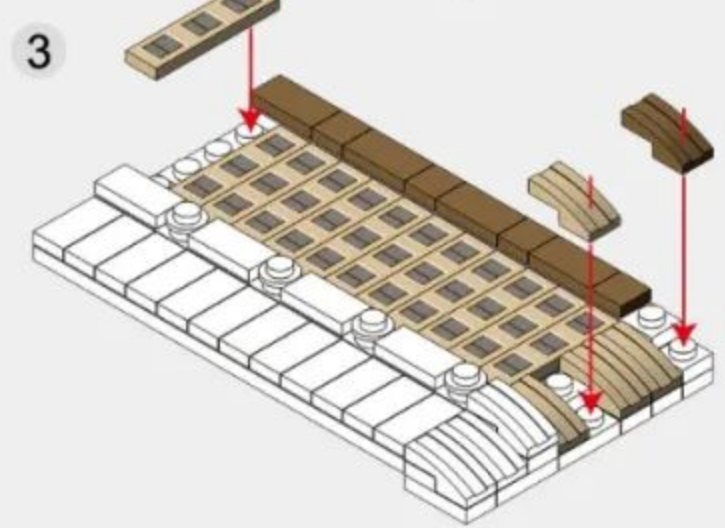
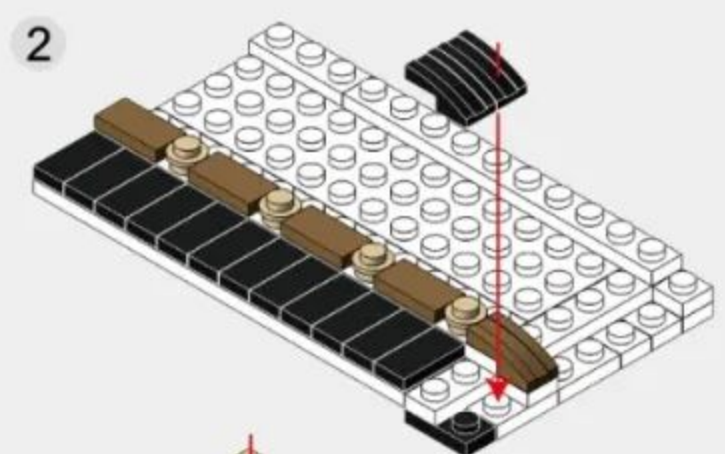
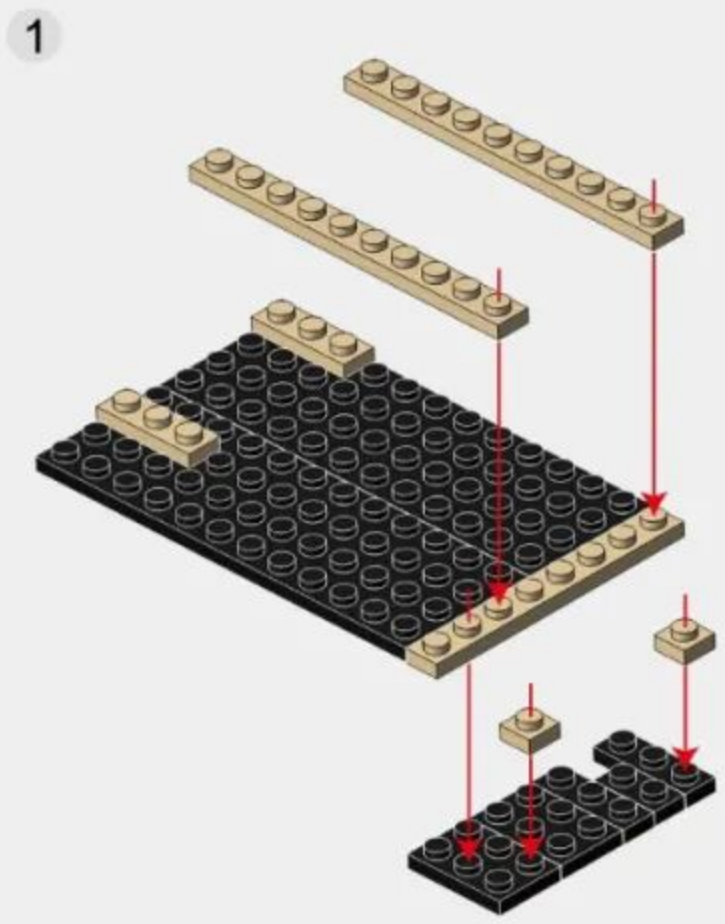
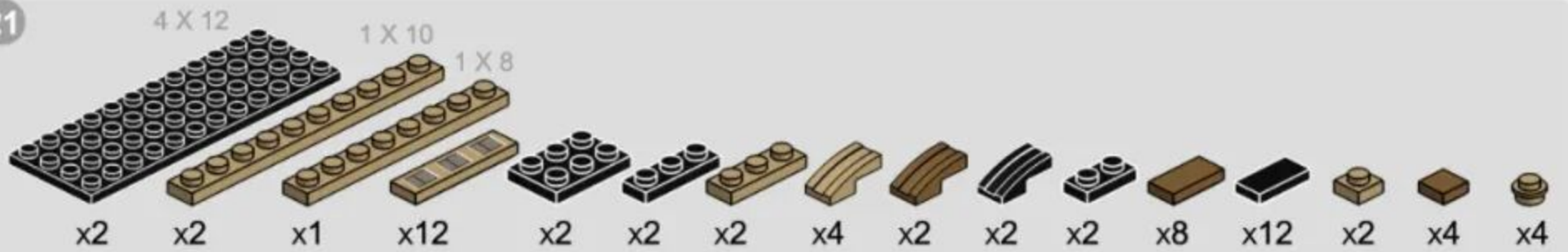

22

20 + 21

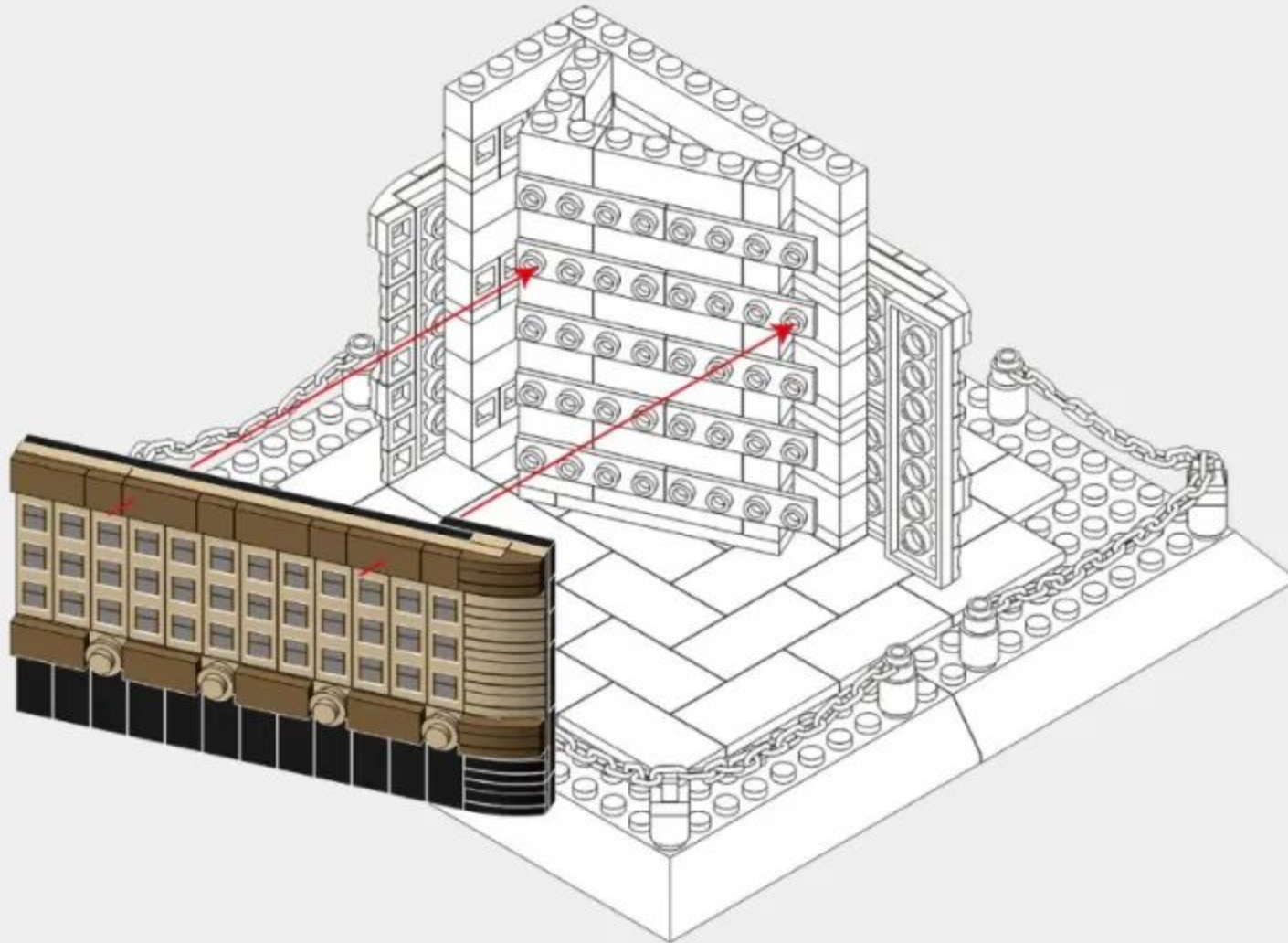

23

1 X 8

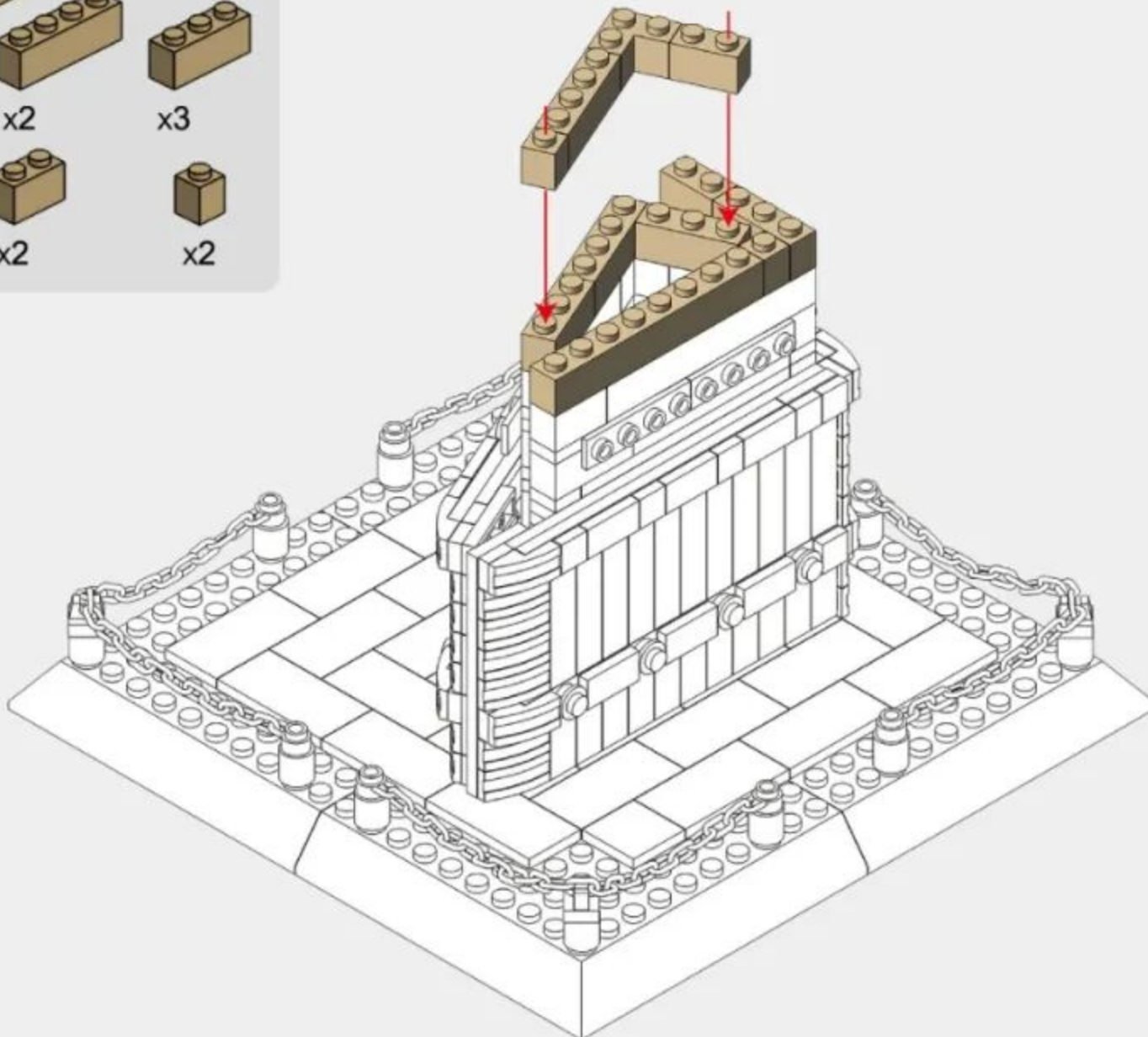
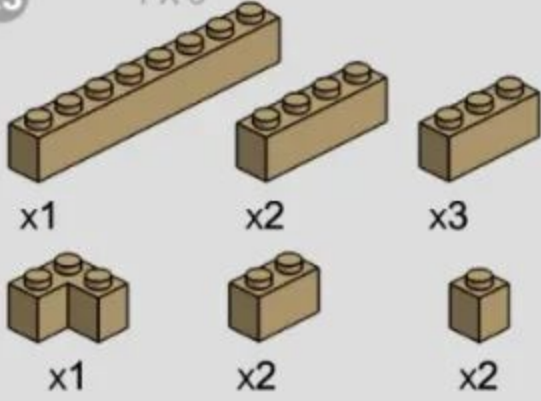

24

1 X 8

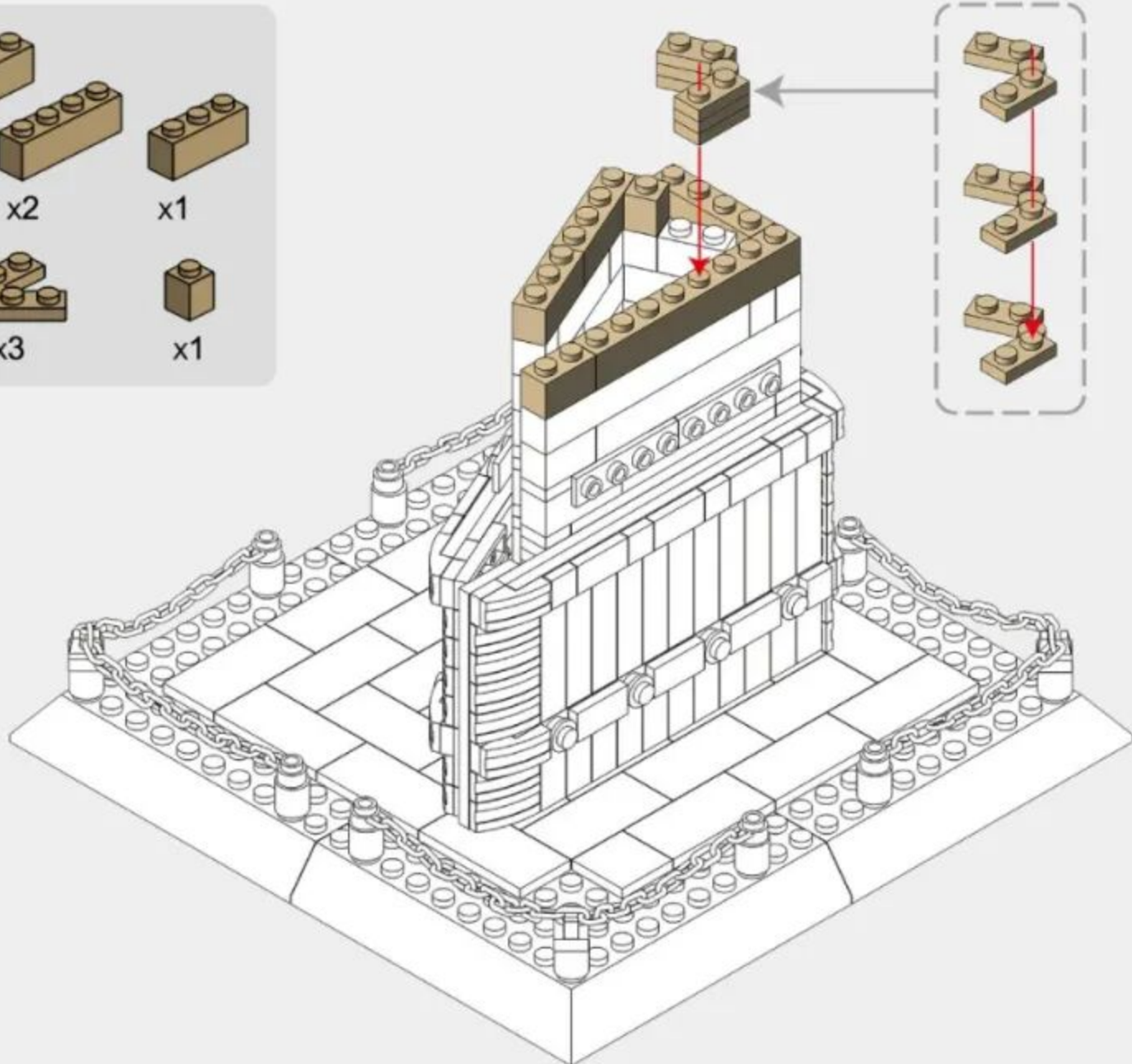
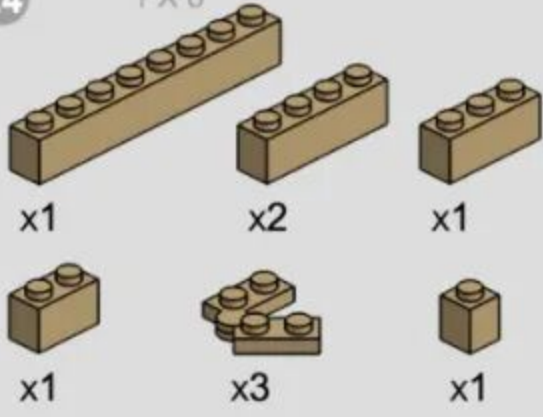

25

1 X 6

1 X 6

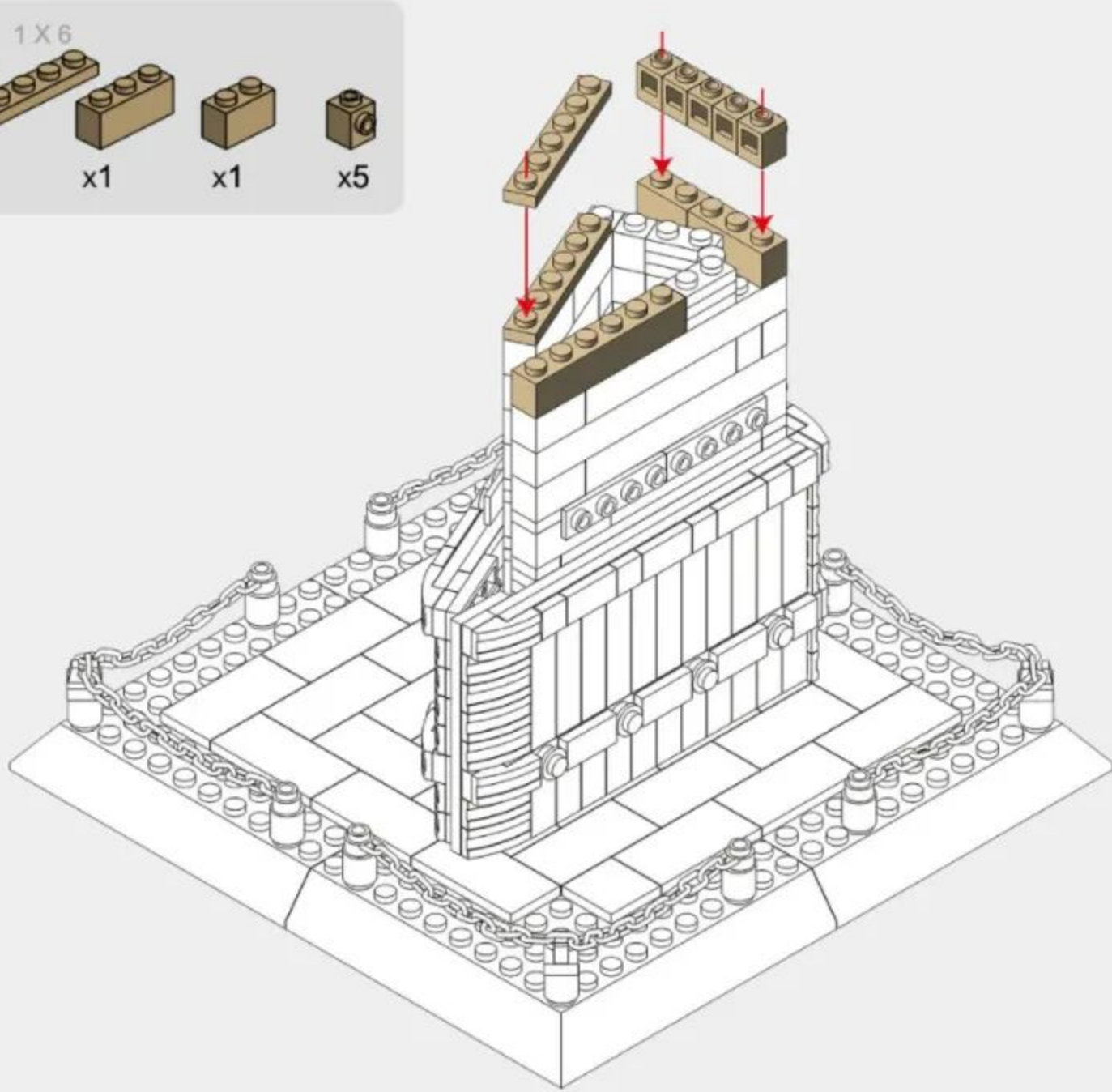
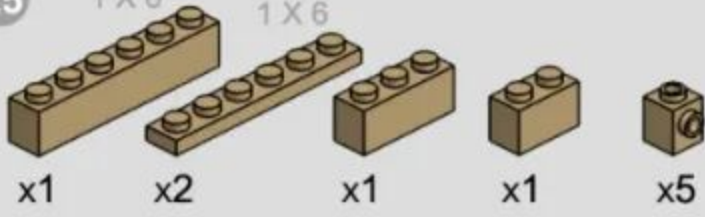

26

1 X 6

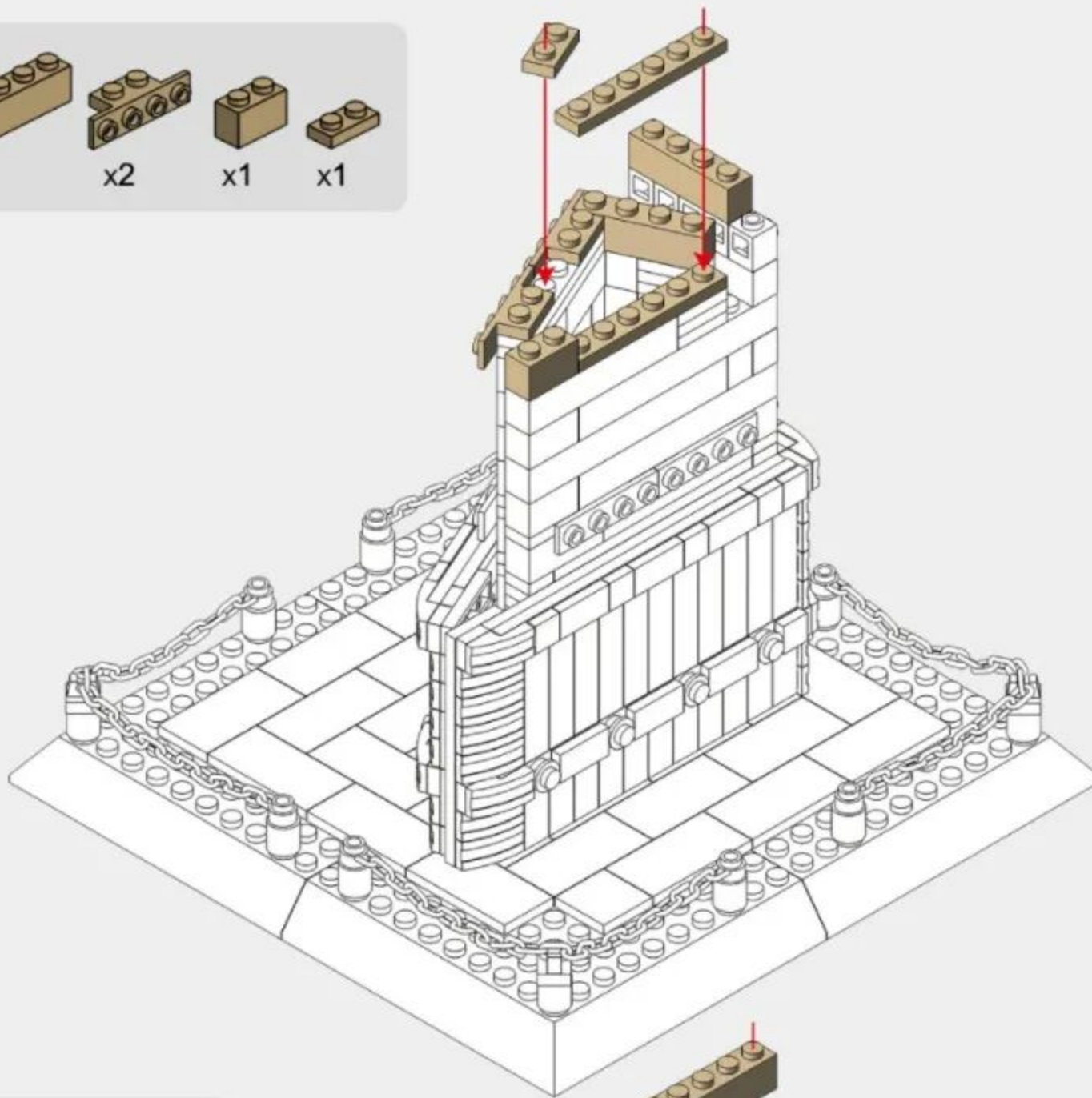
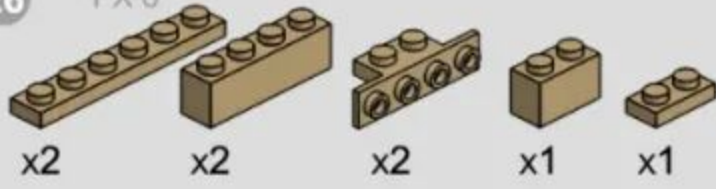

27

1 X 6

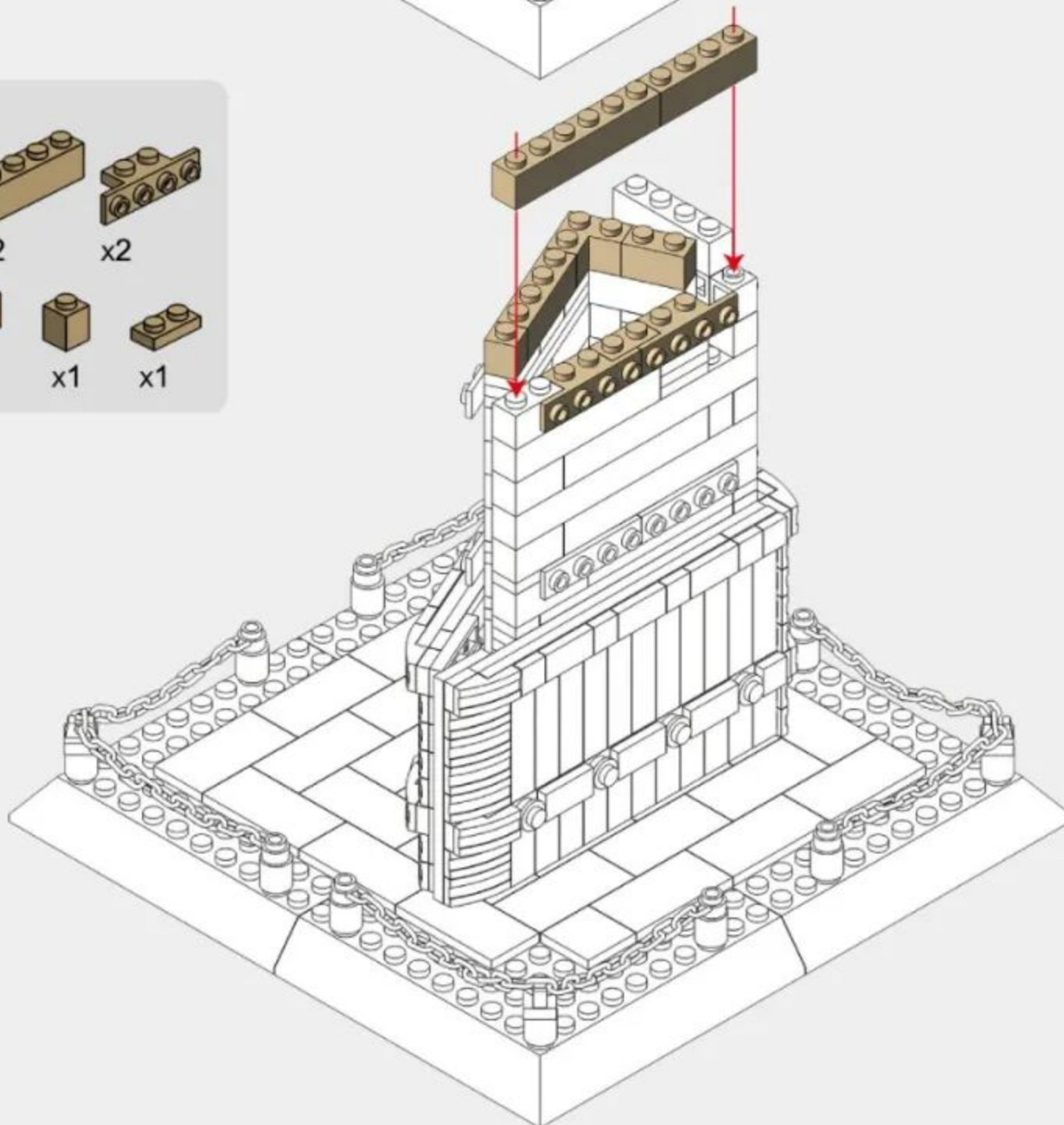
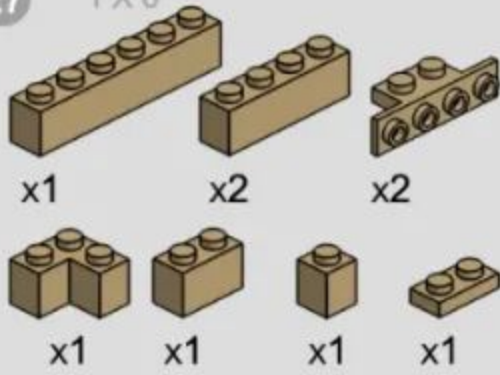

28

1 X 6



x2



x1



x1



x1



x1

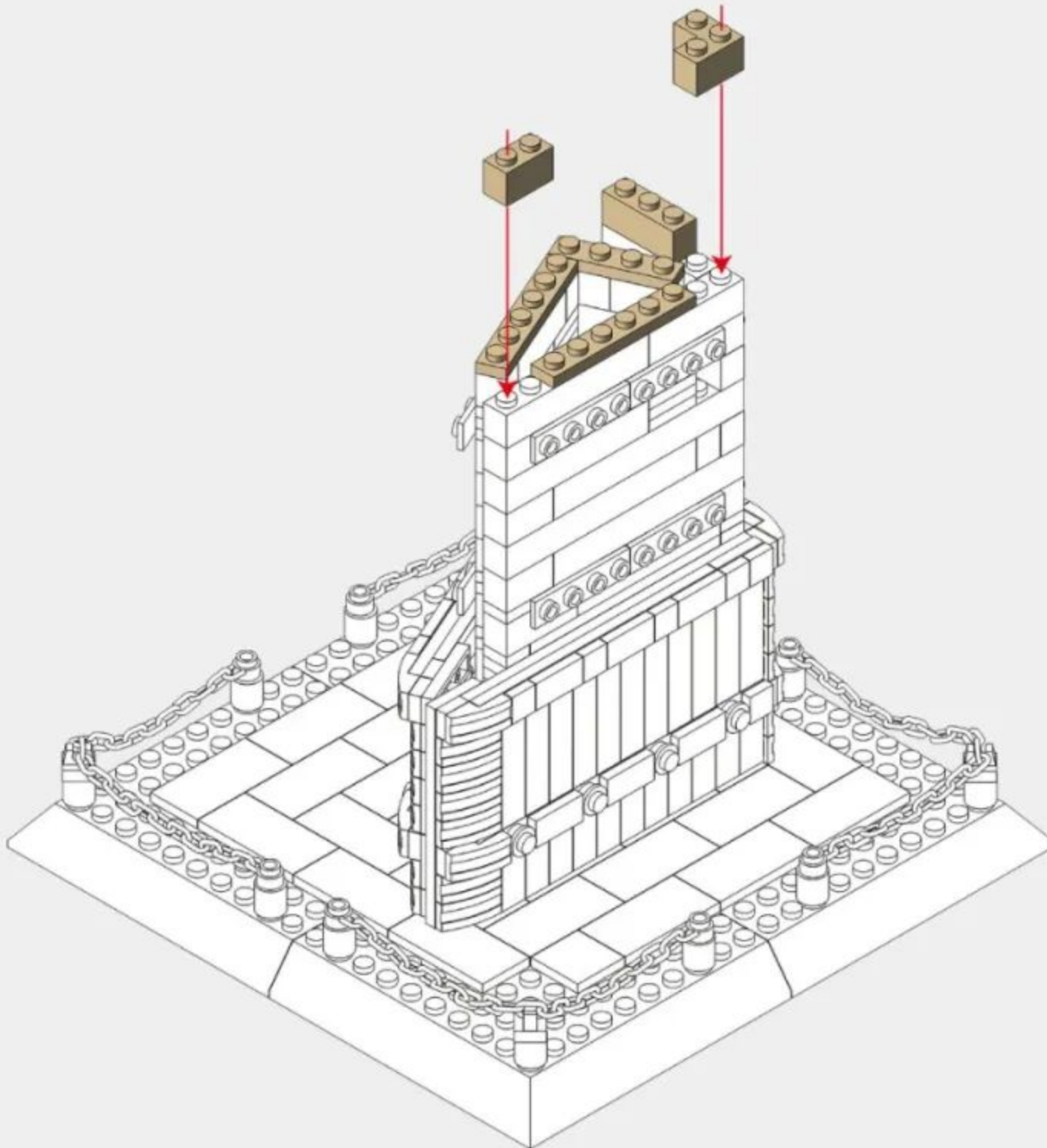

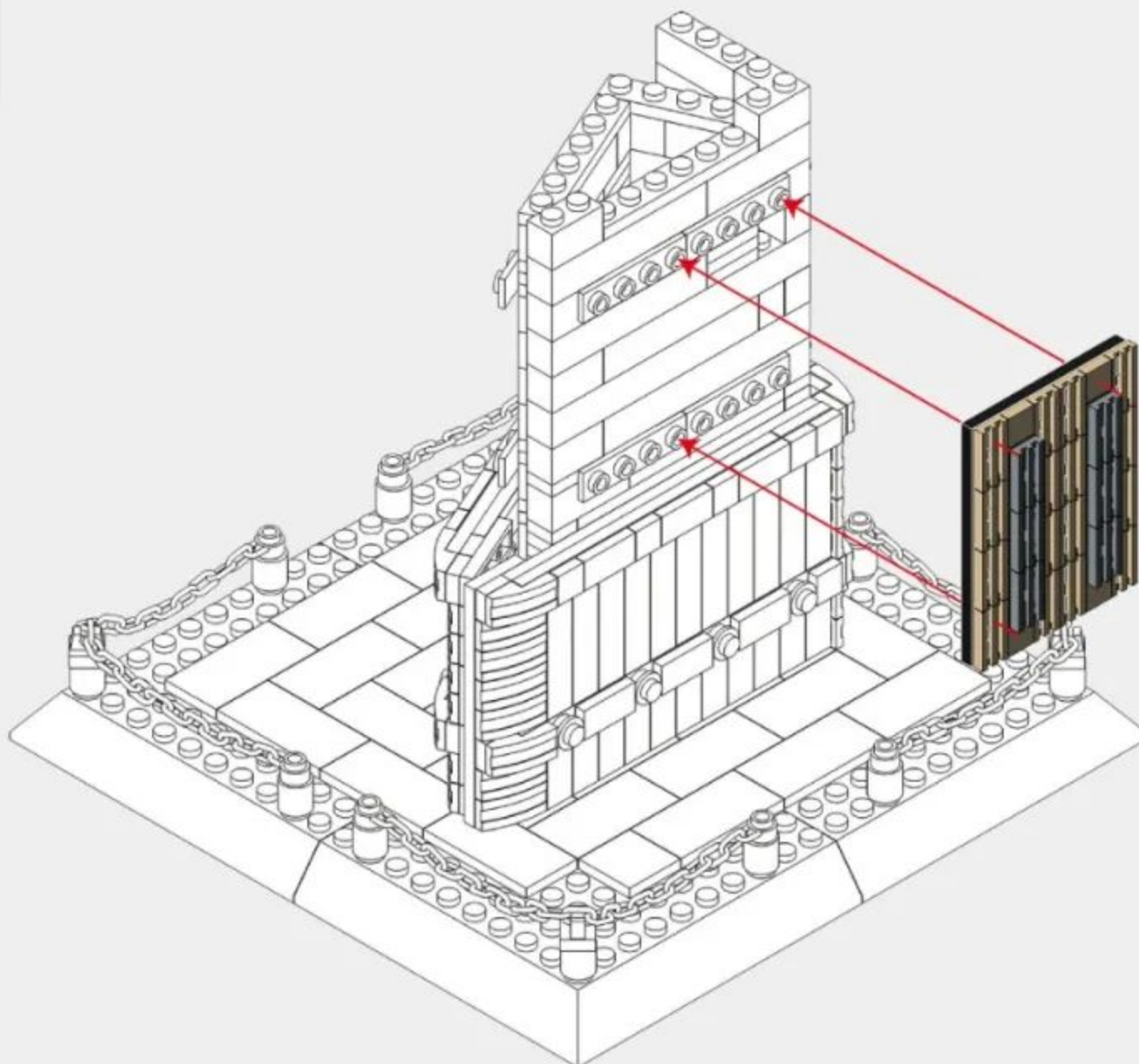
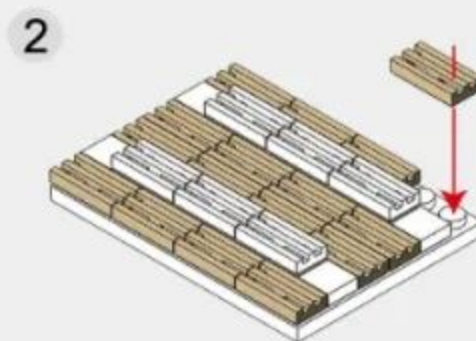
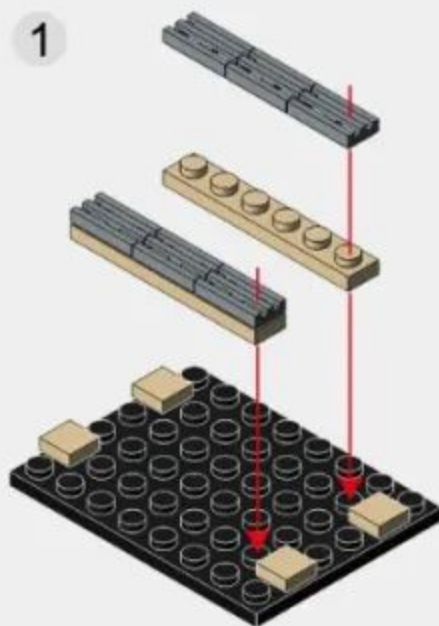
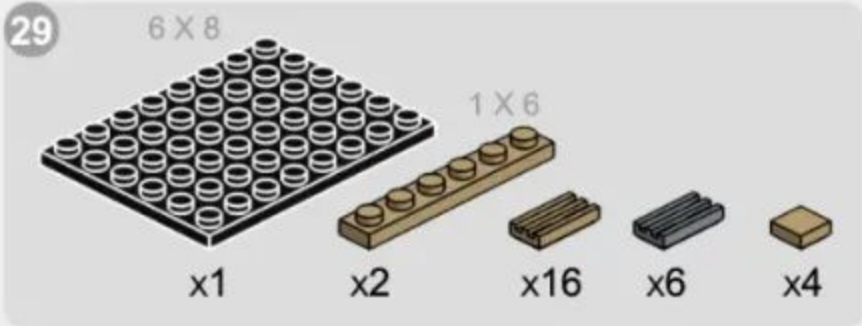

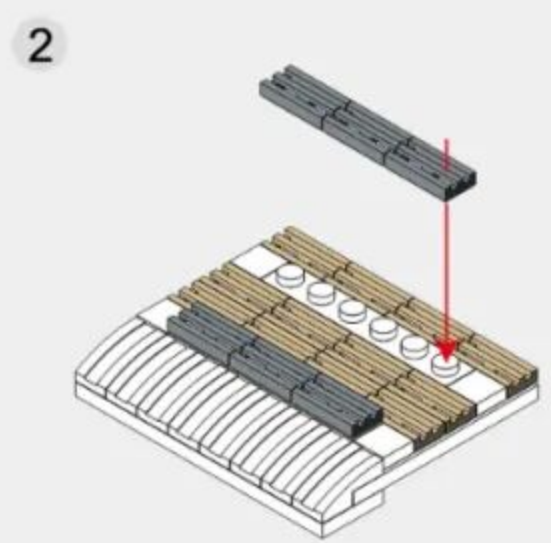
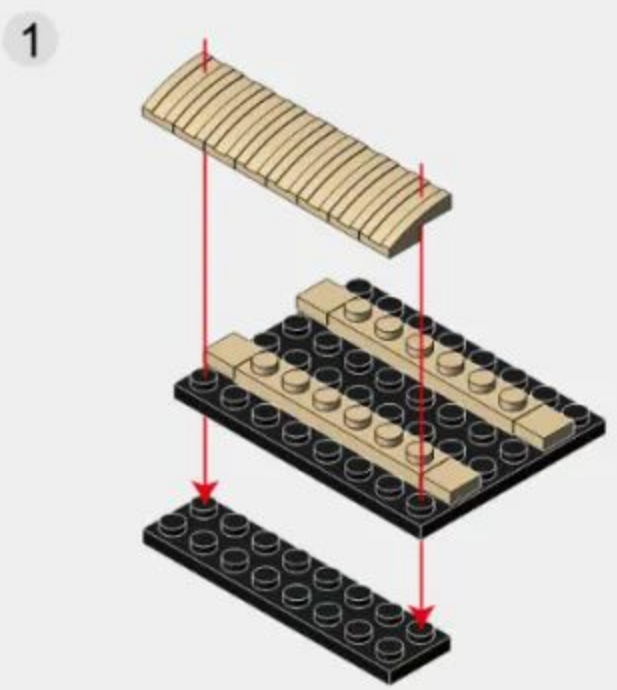
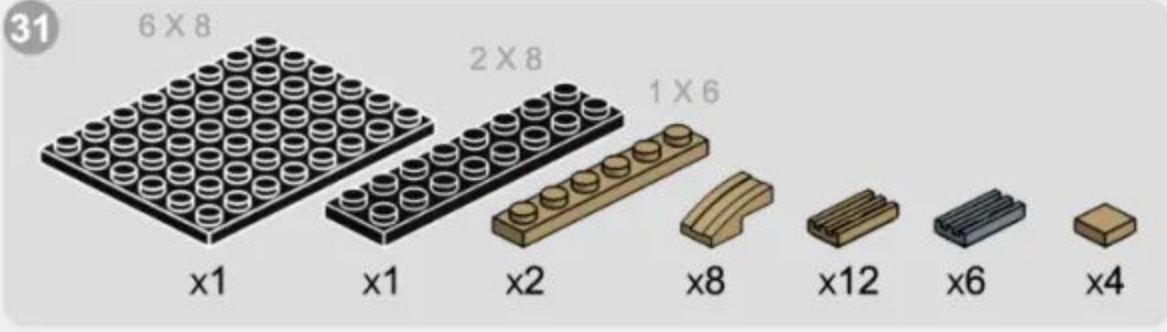

32

30 + 31

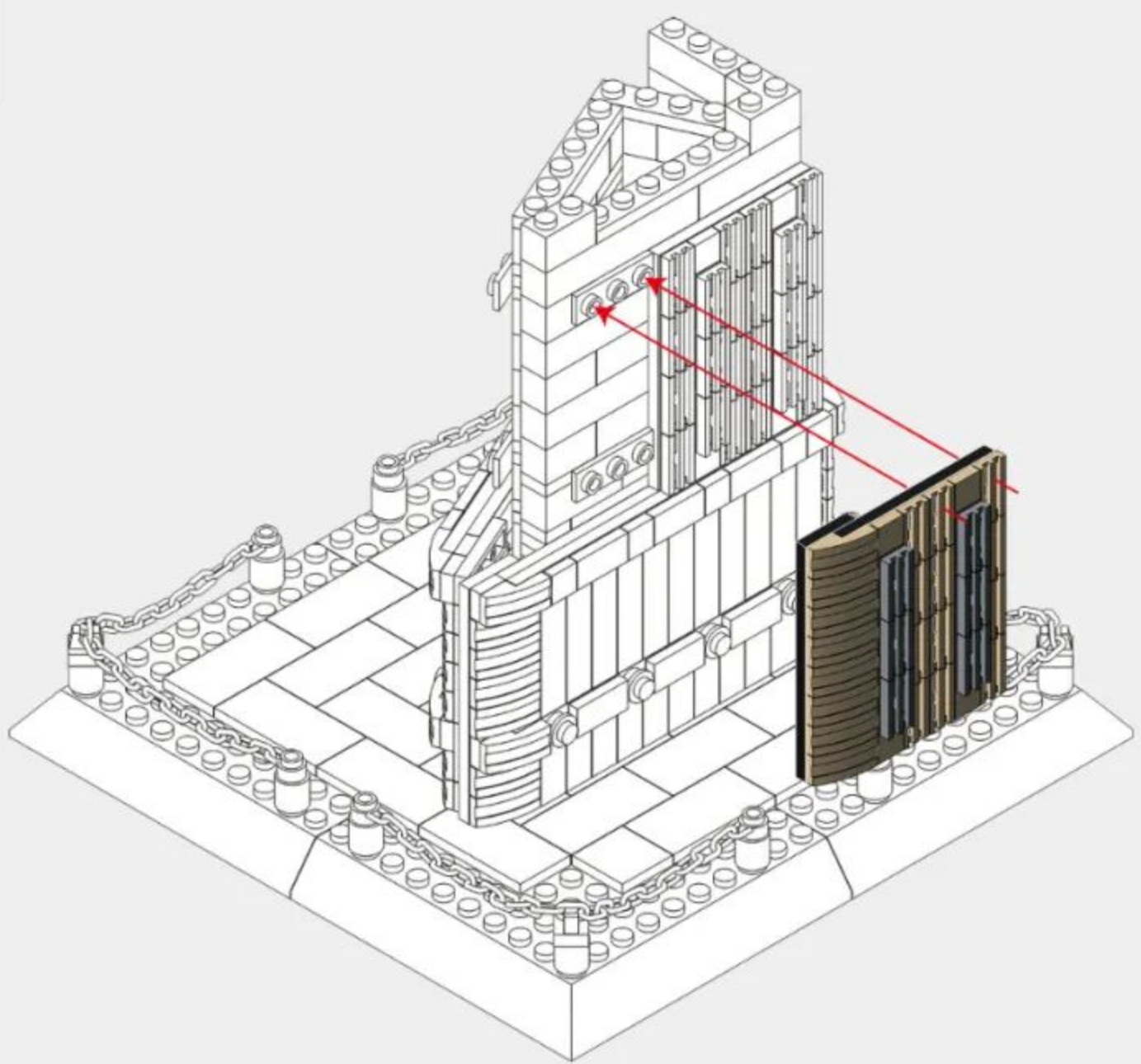

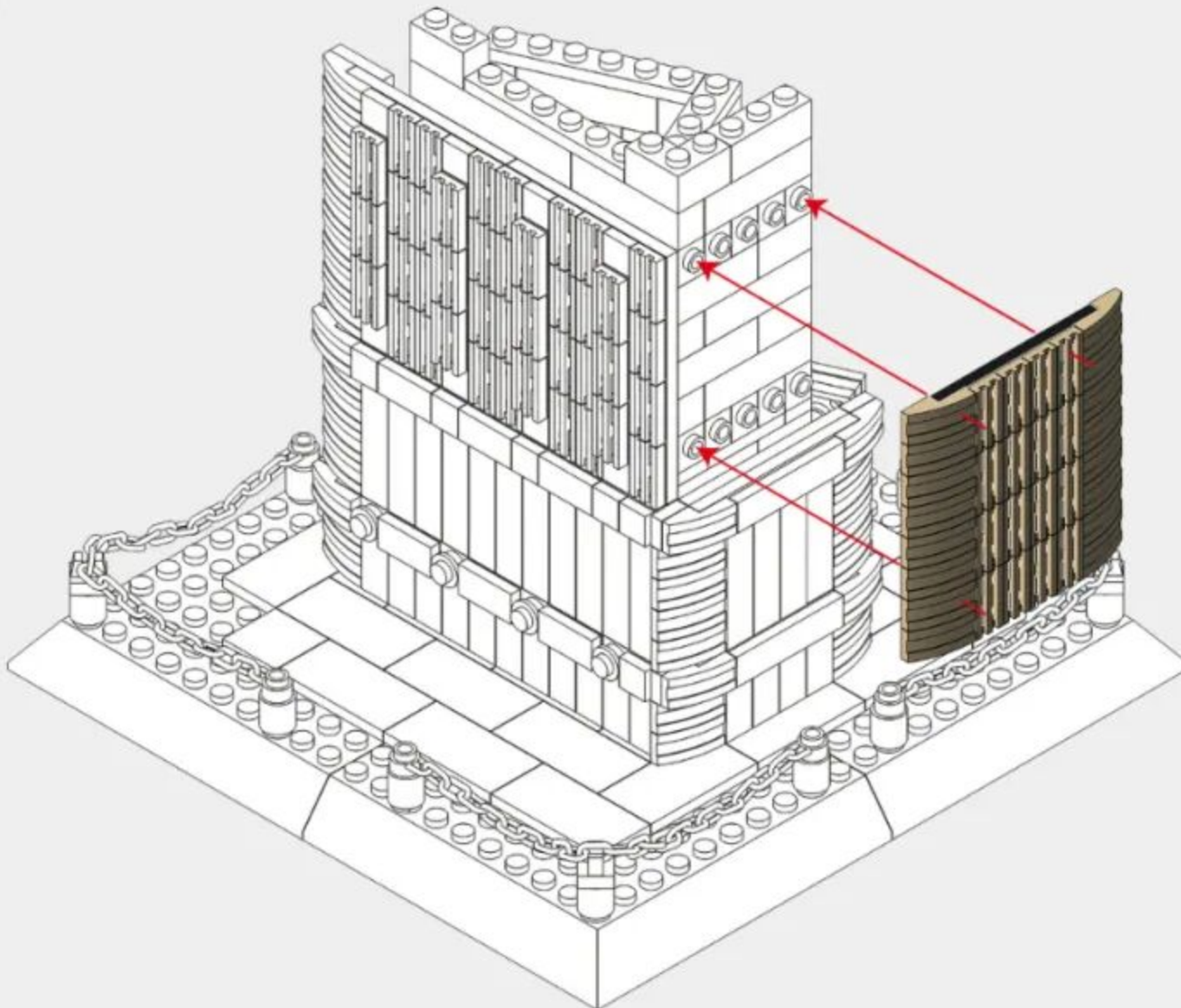
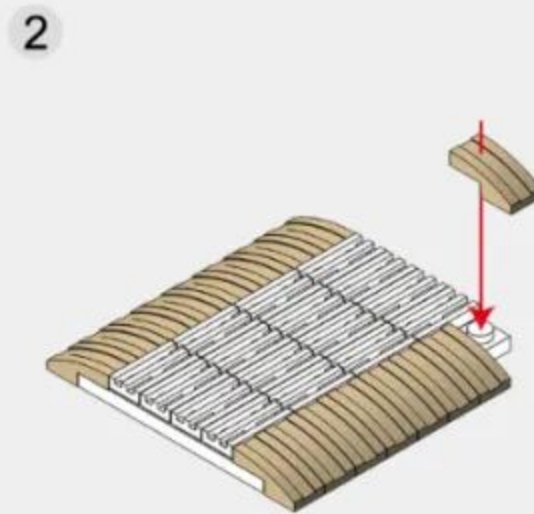
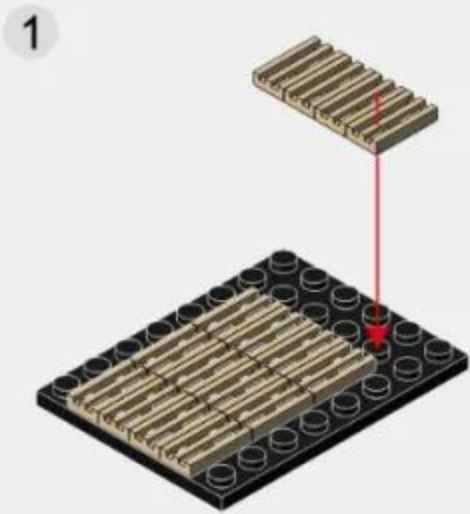
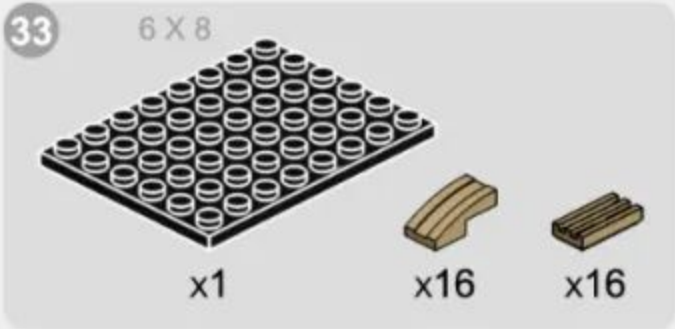

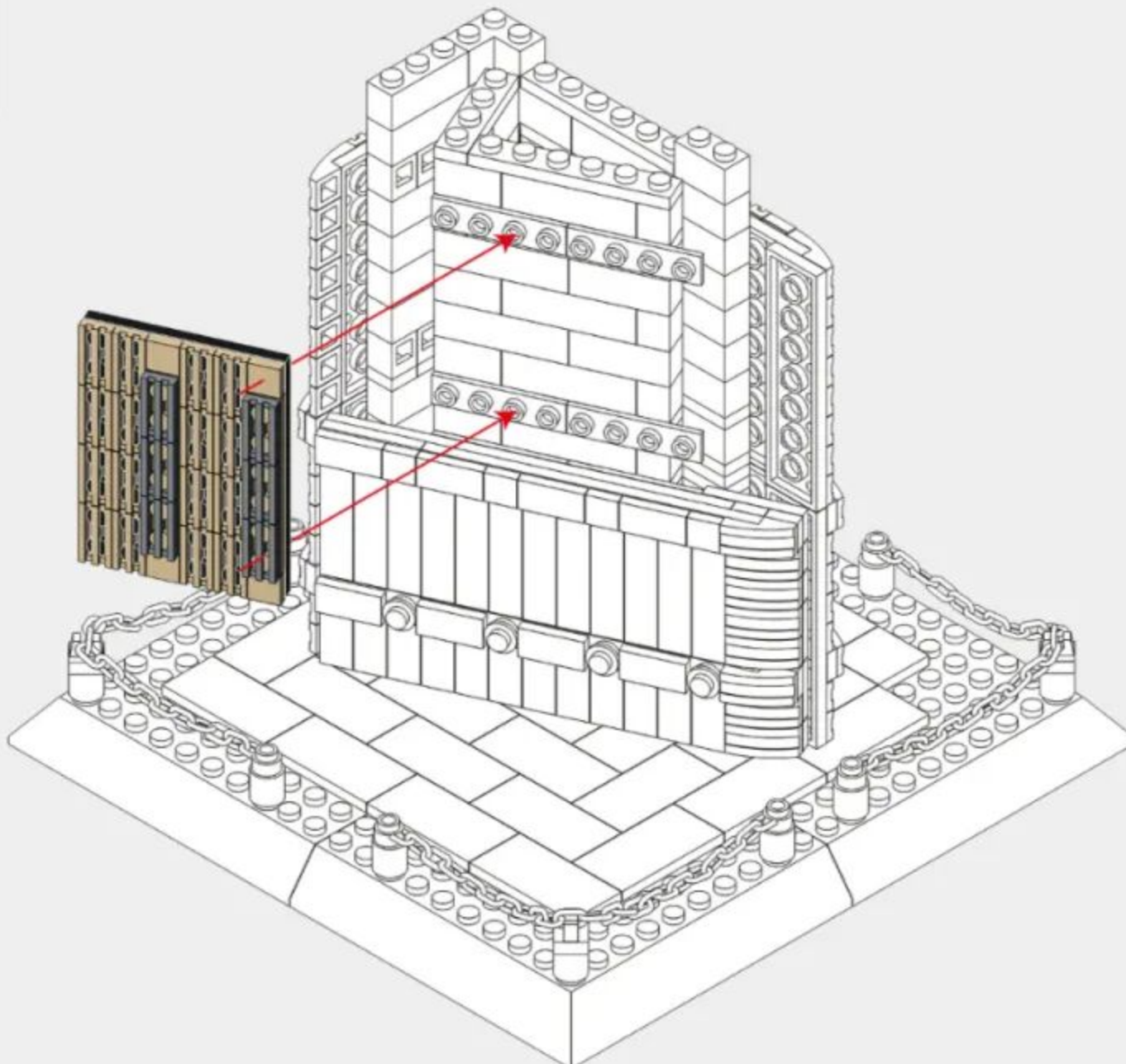
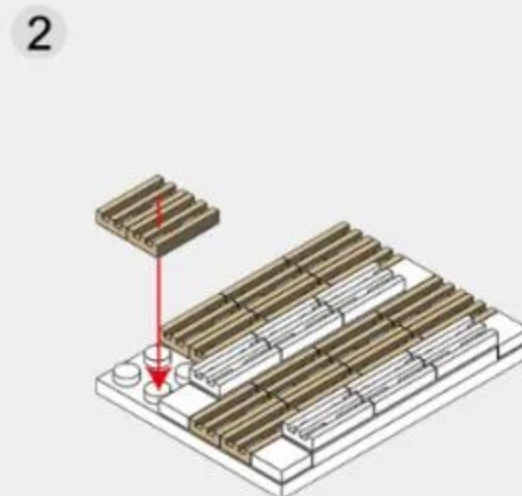
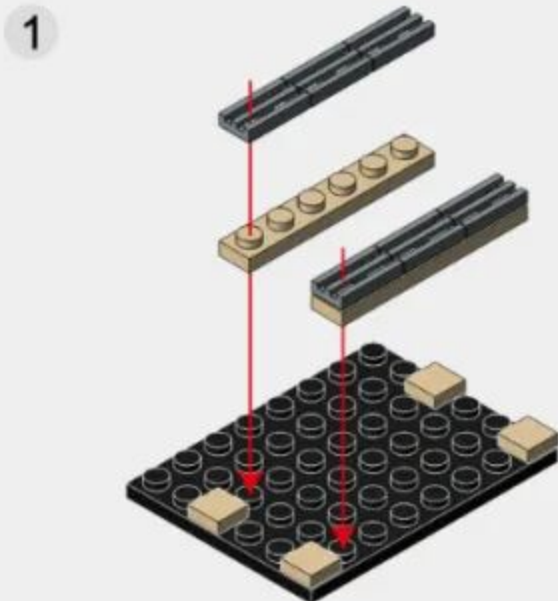
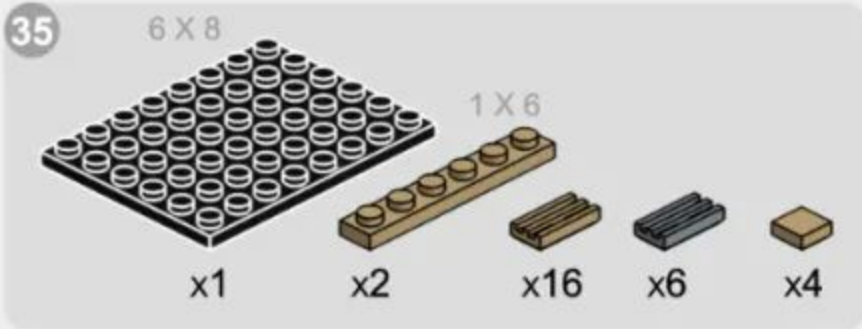

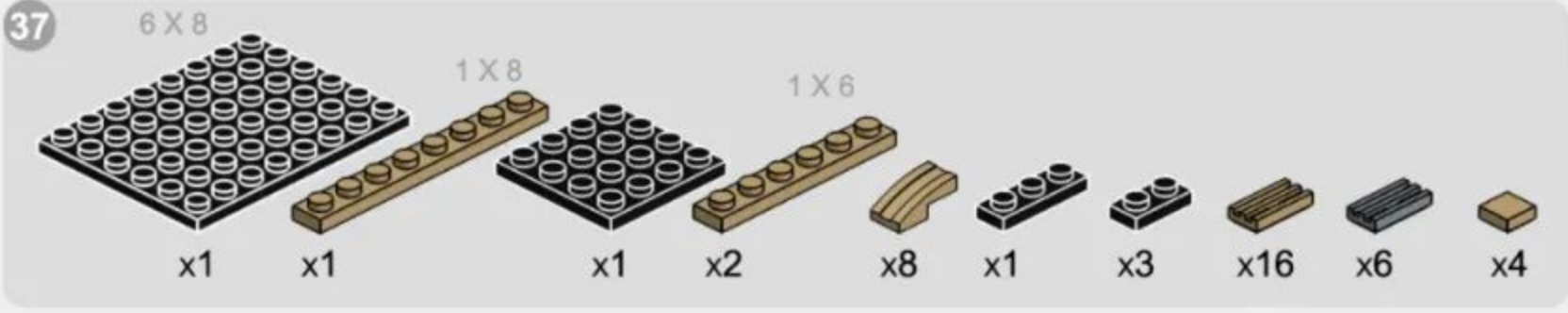

1

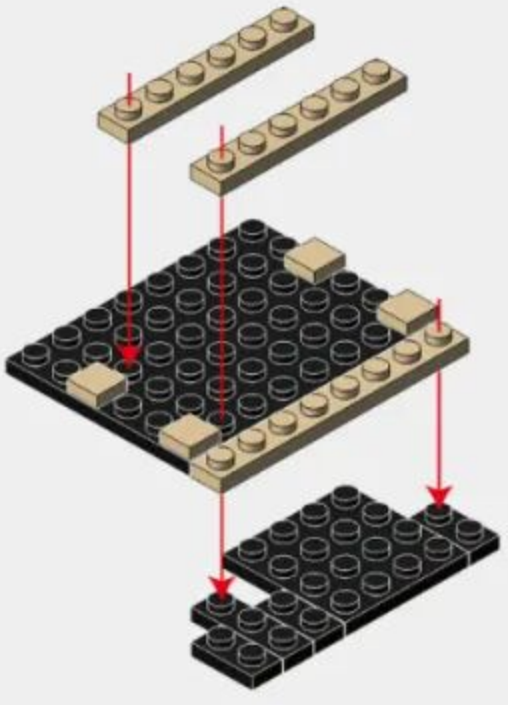

2

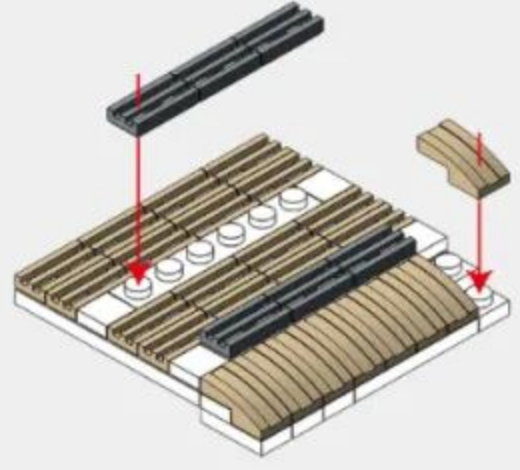

38

36 + 37

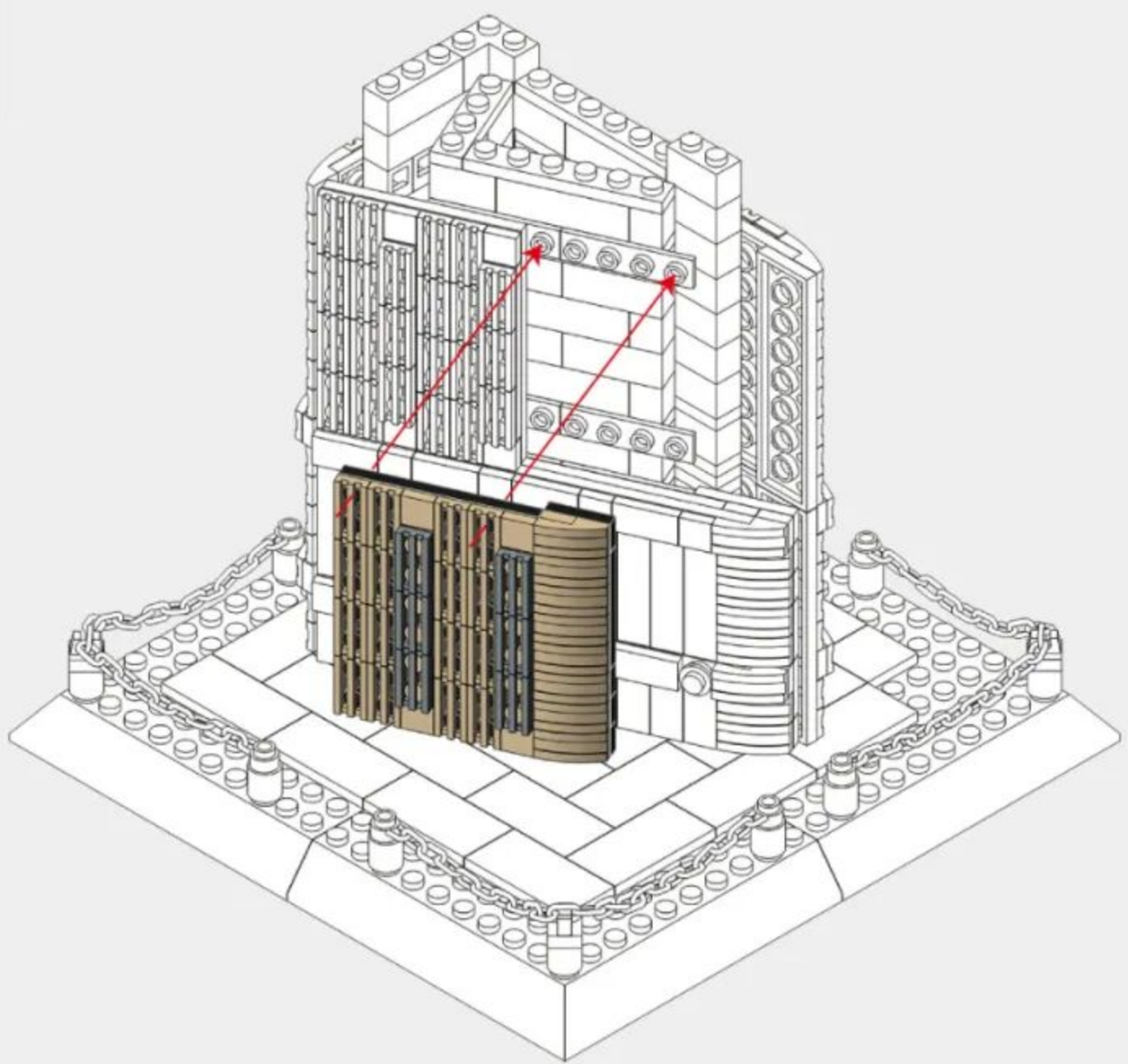

39



x4



x1



x2

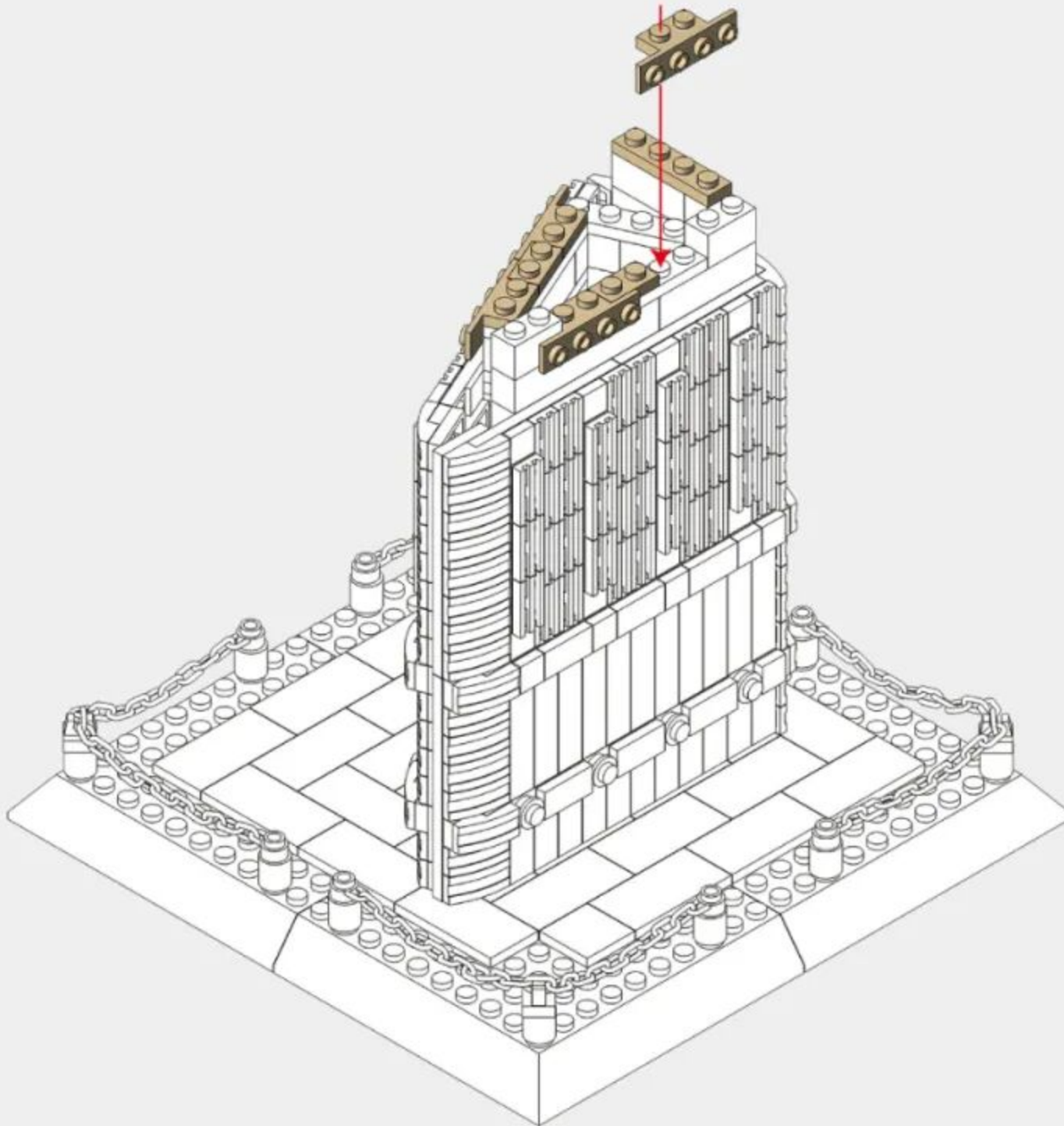

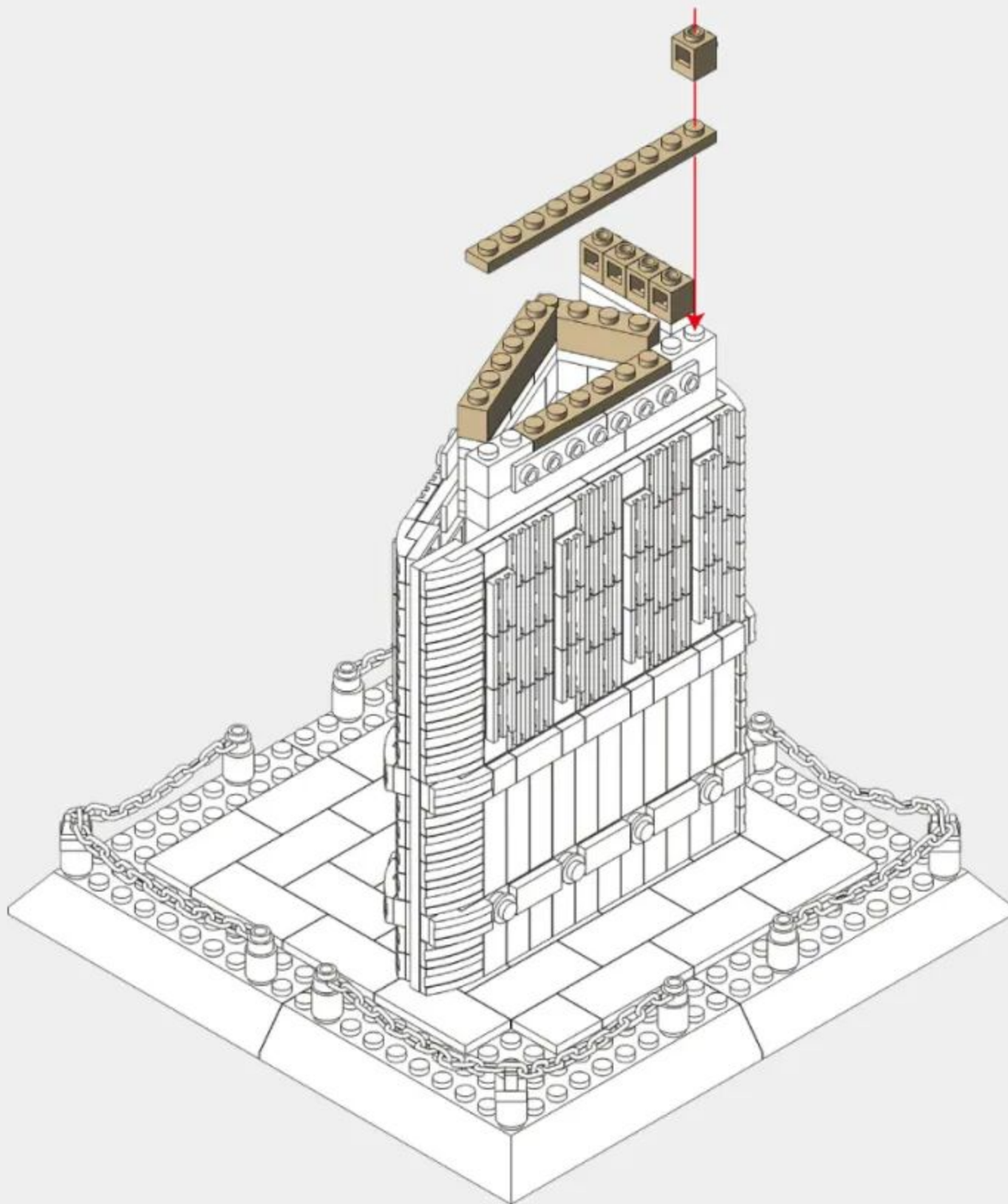
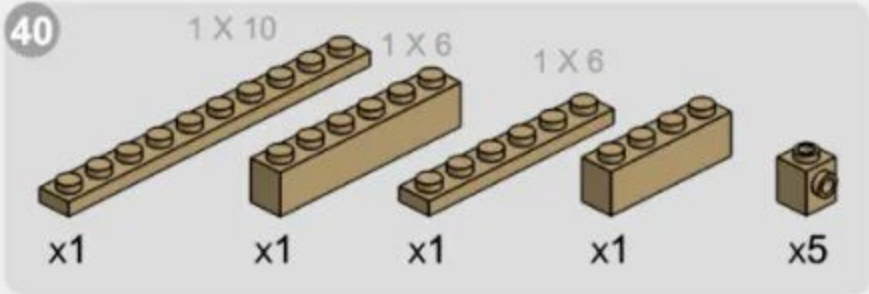

41

1 X 6



x2

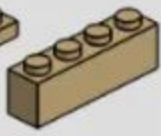

x1

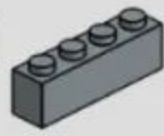

x1



x2



x1



x1

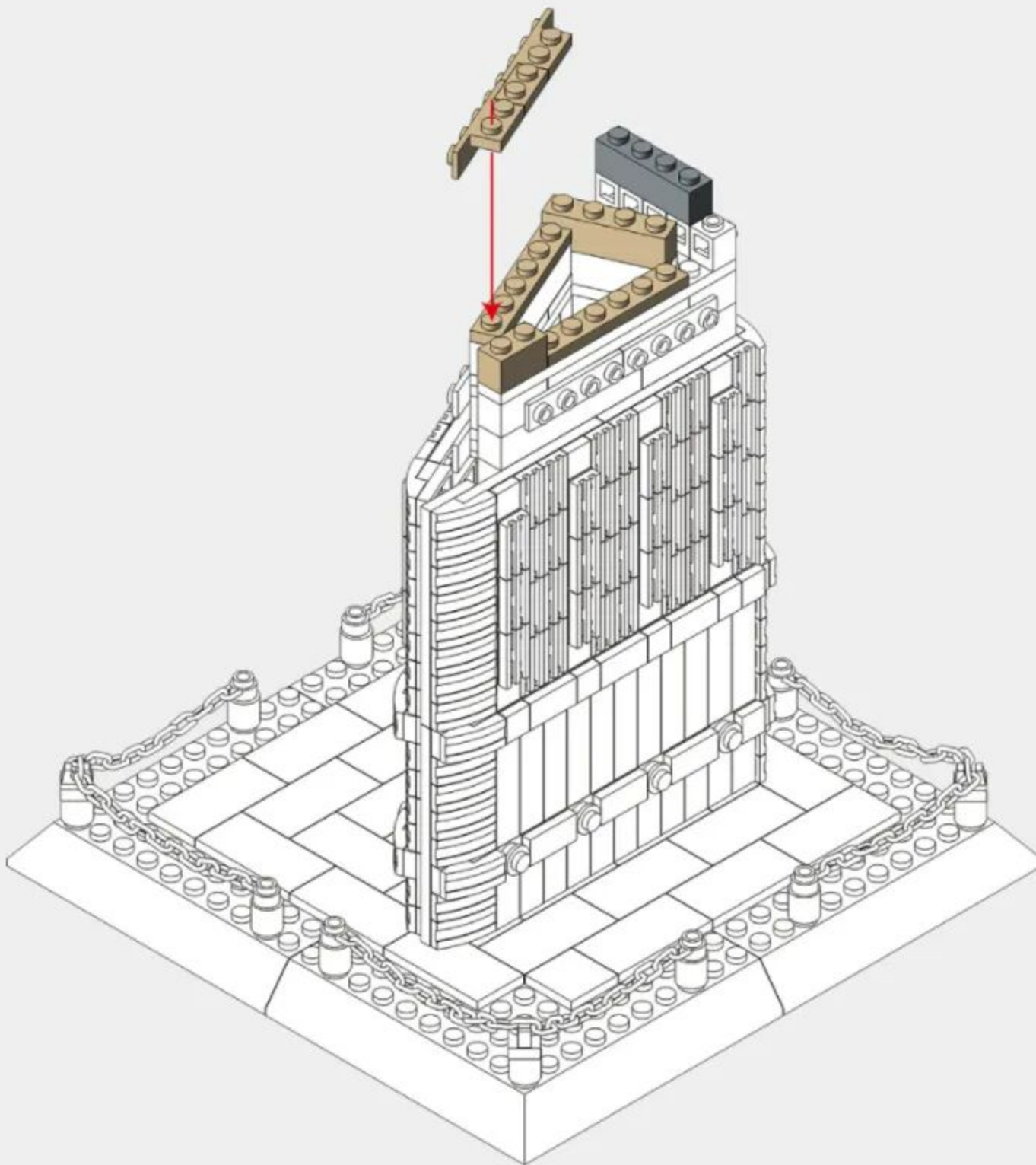

42

1 X 6



x1

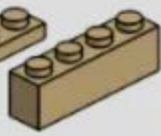

x1



x1



x2



x1



x1



x1



x1

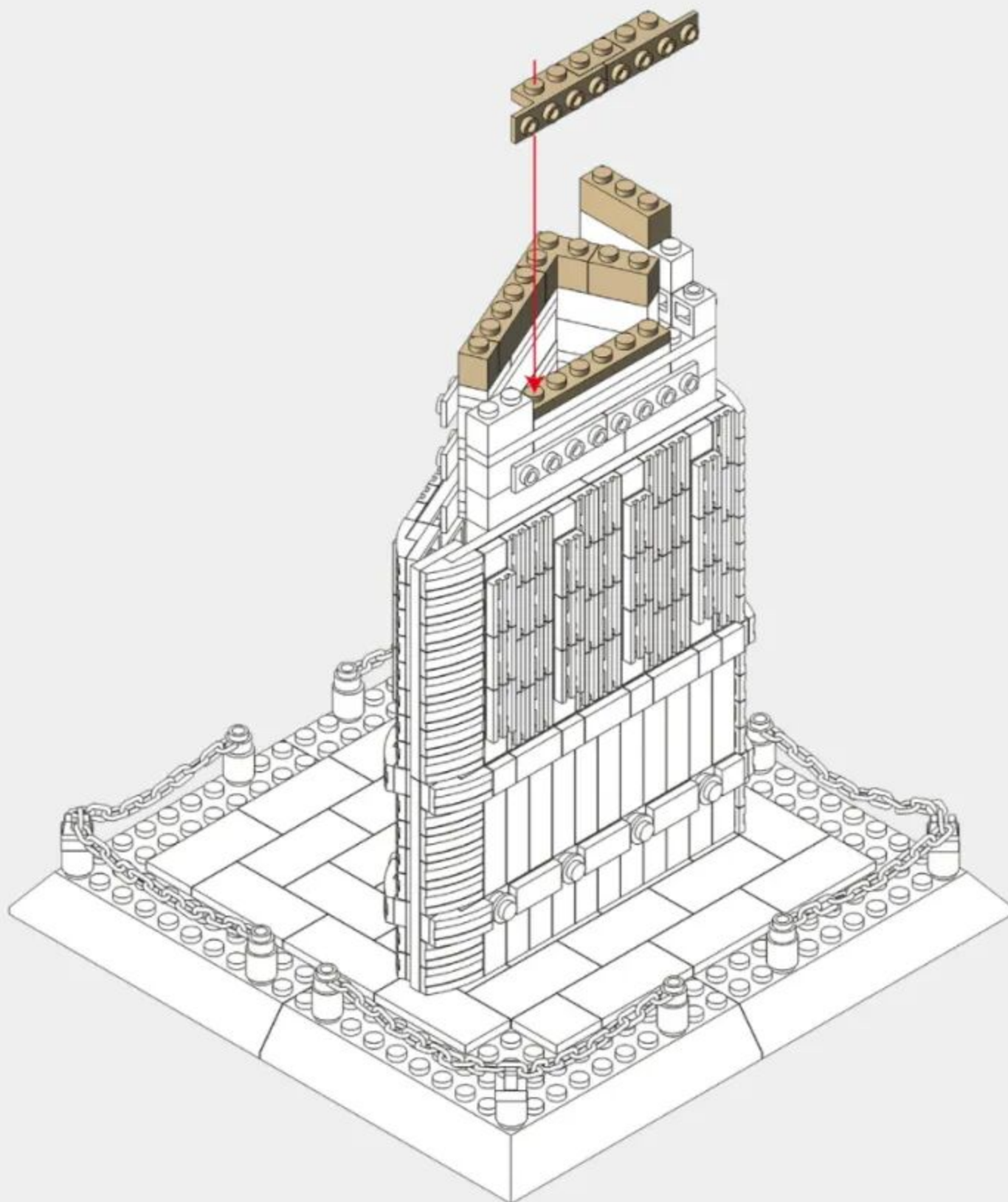

43

1 X 6

1 X 6

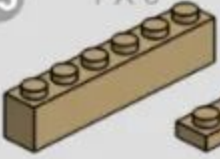

x1

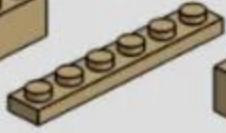

x2



x1



x1



x1

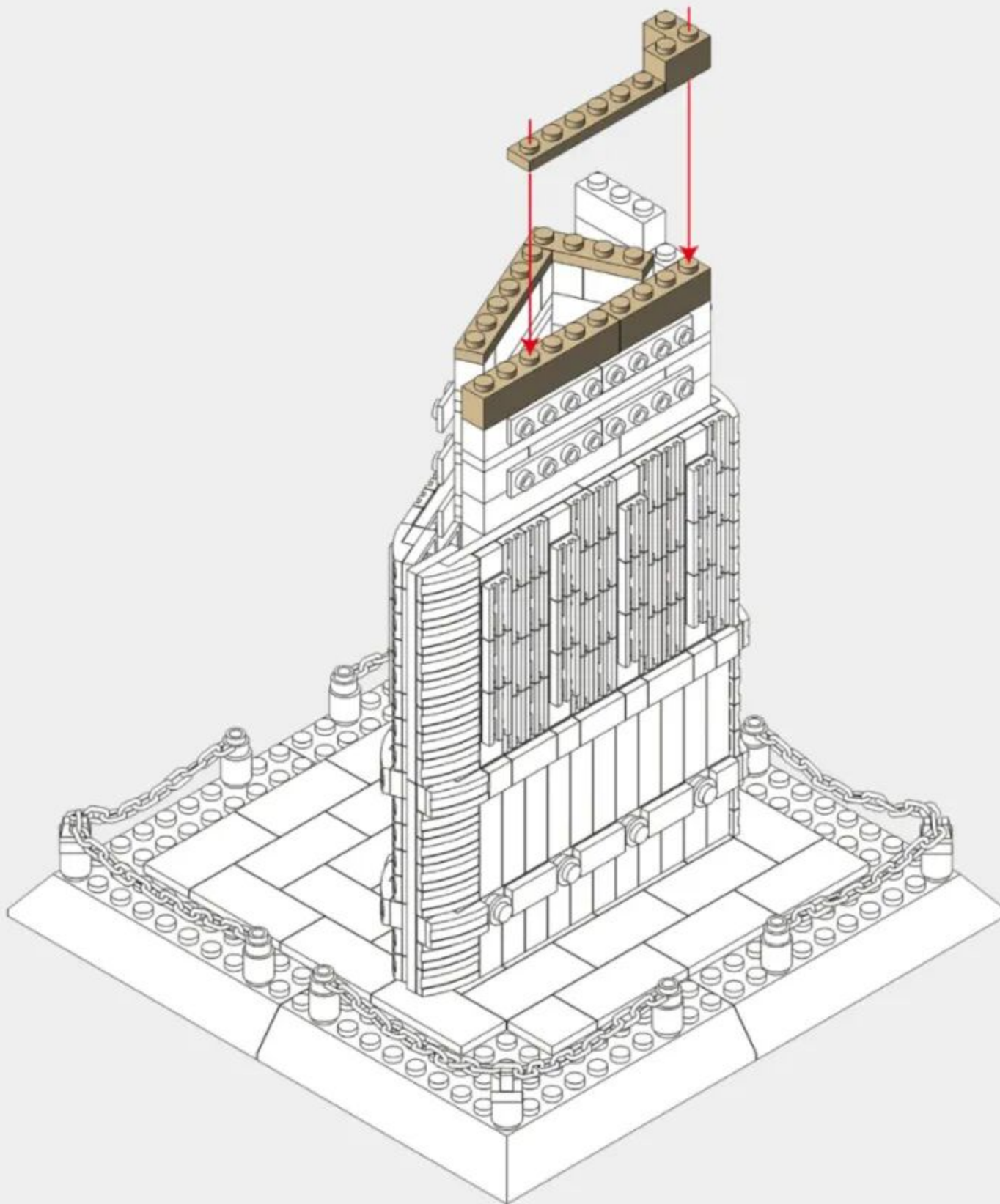

44



x4



x1



x1



x2

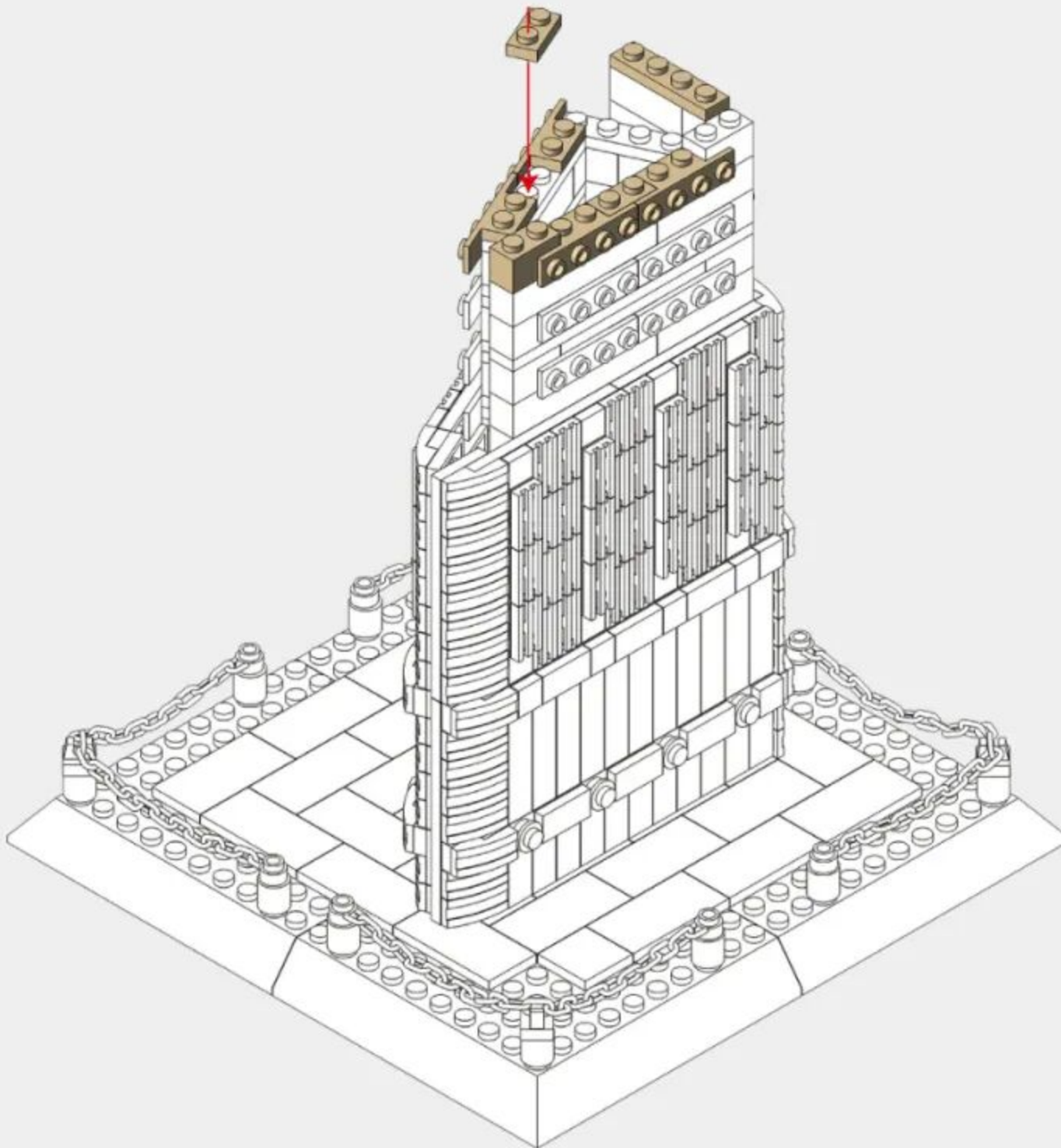

45

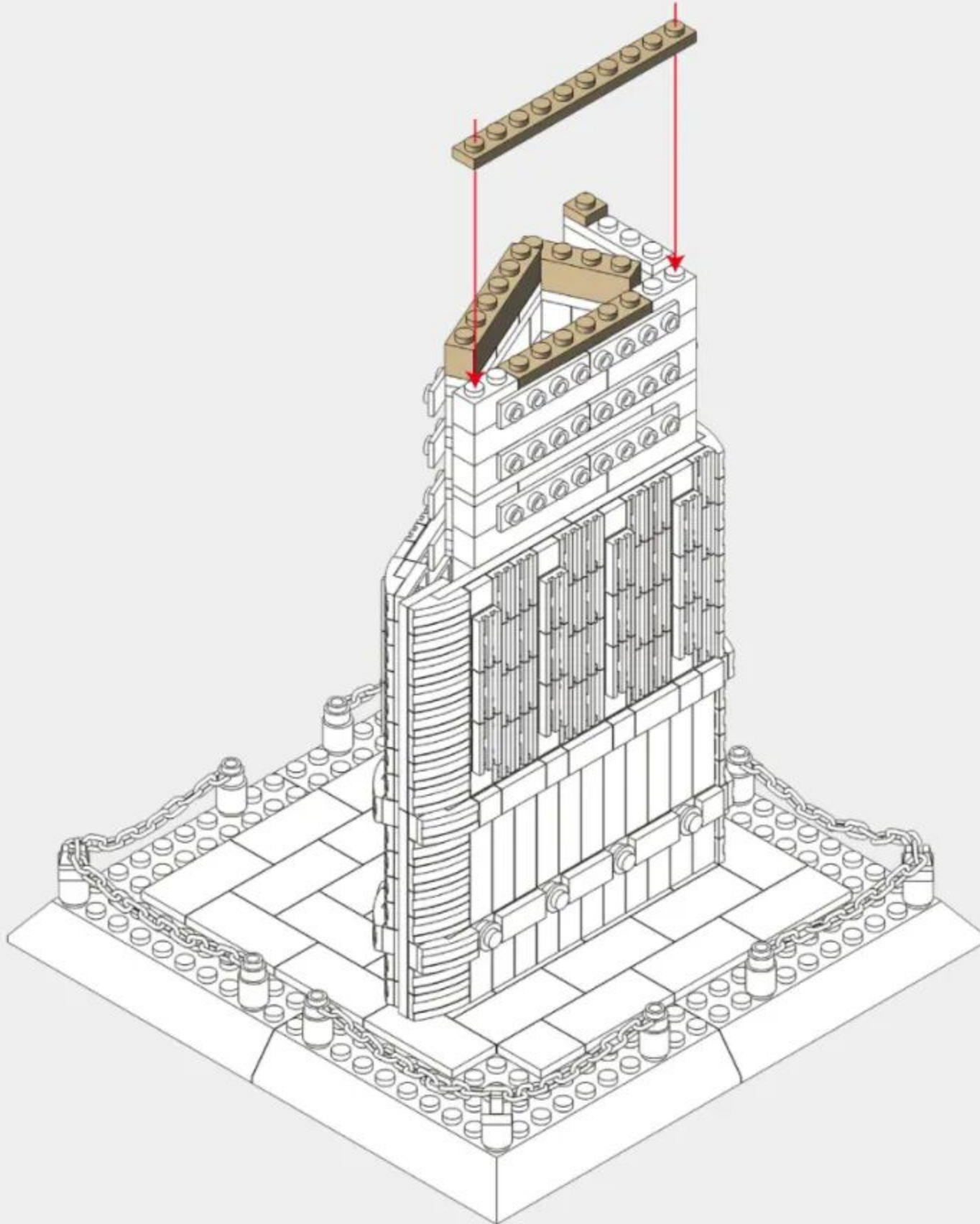
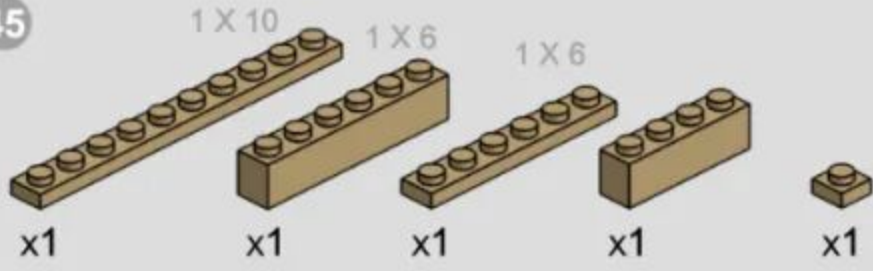

46

1 X 6

1 X 6



x1

x1

x2

x1

x1

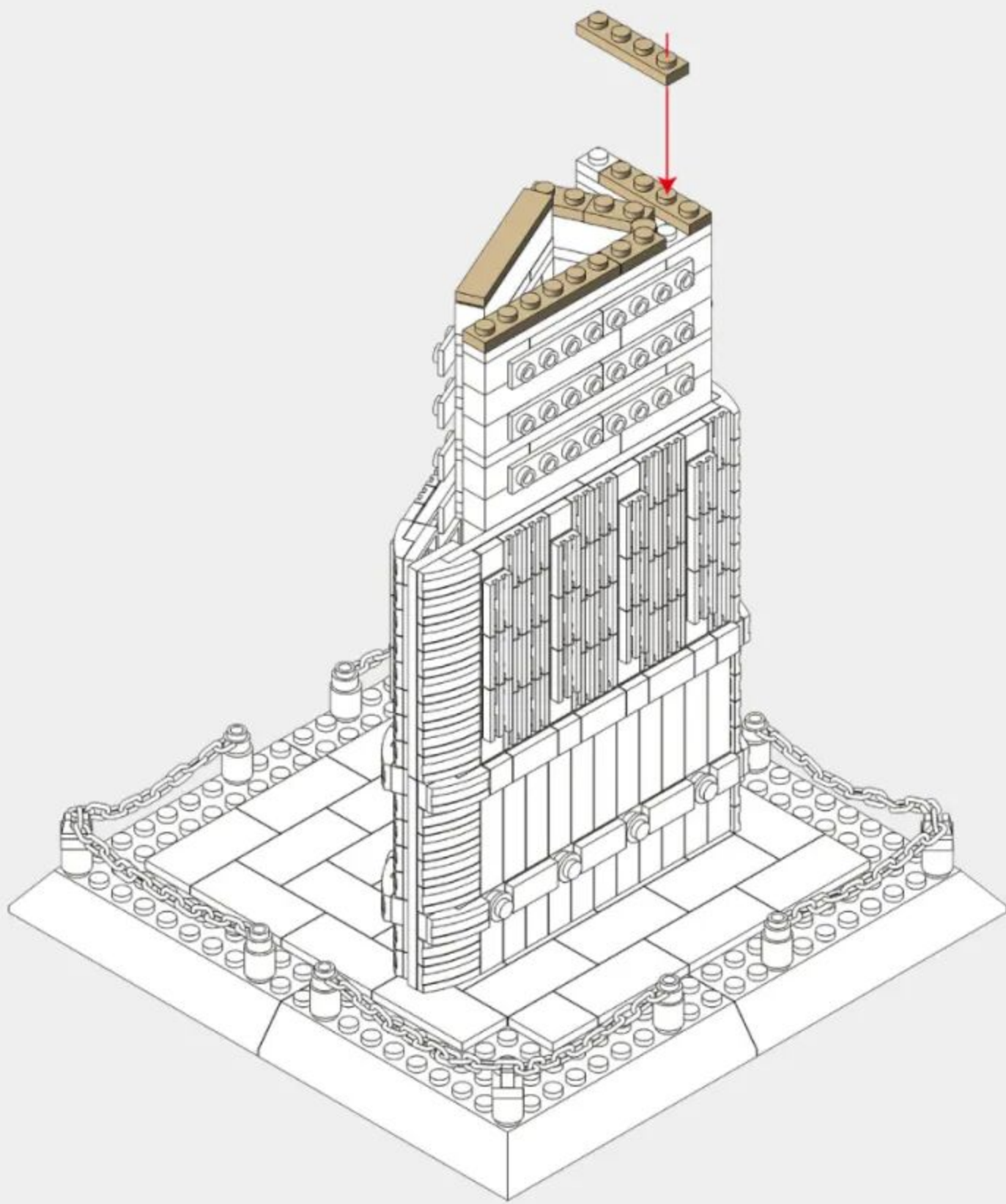

47

1 X 10



x1



x3



x2

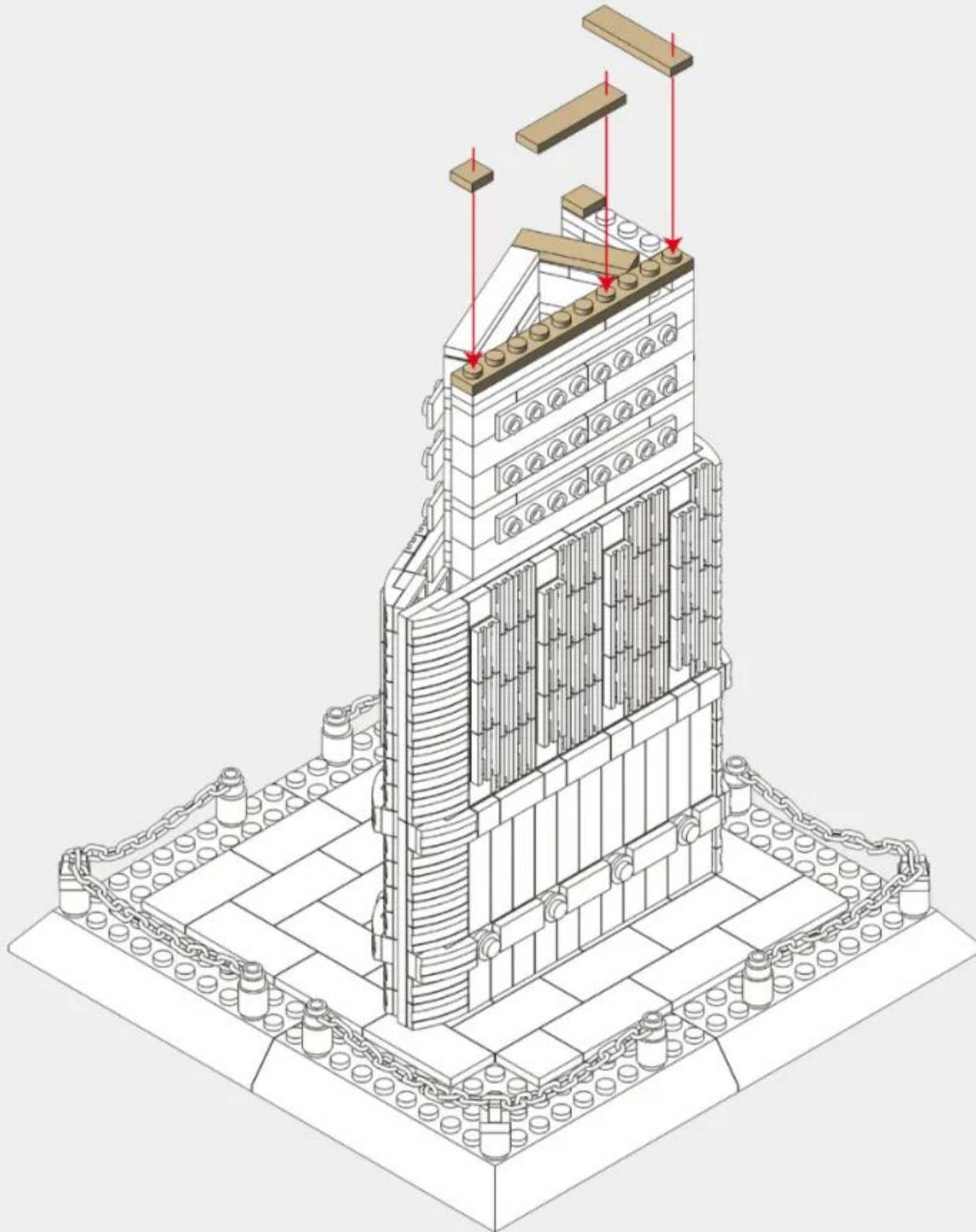

48



1

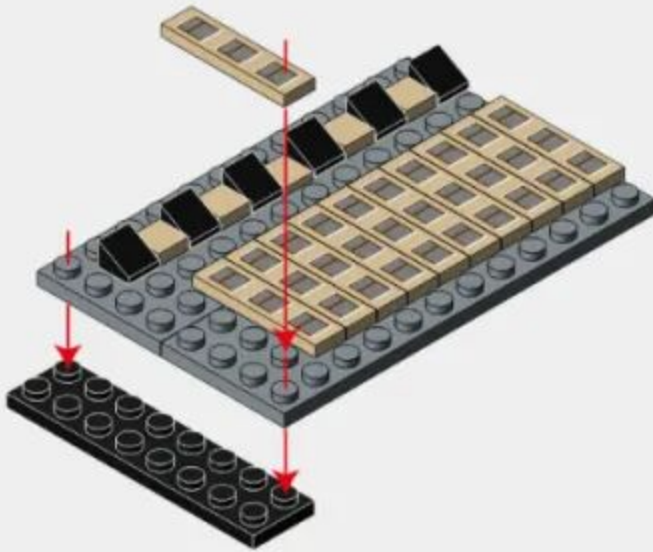

2

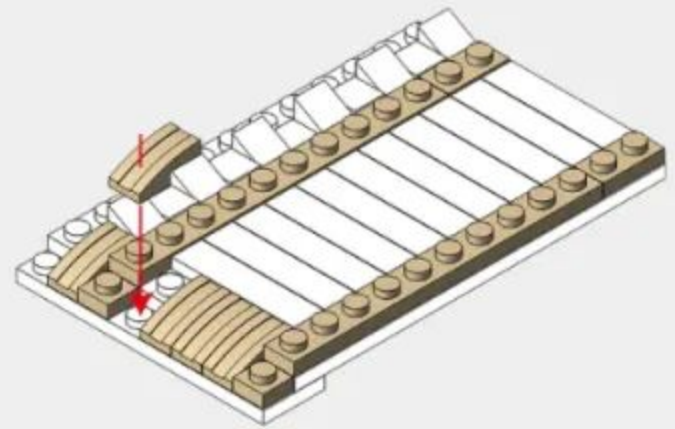

3

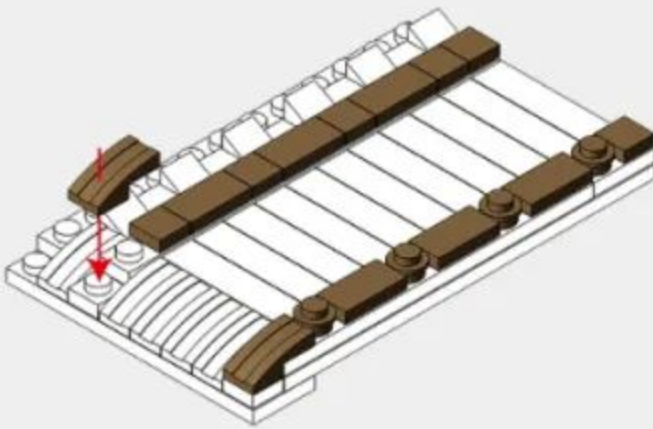

4

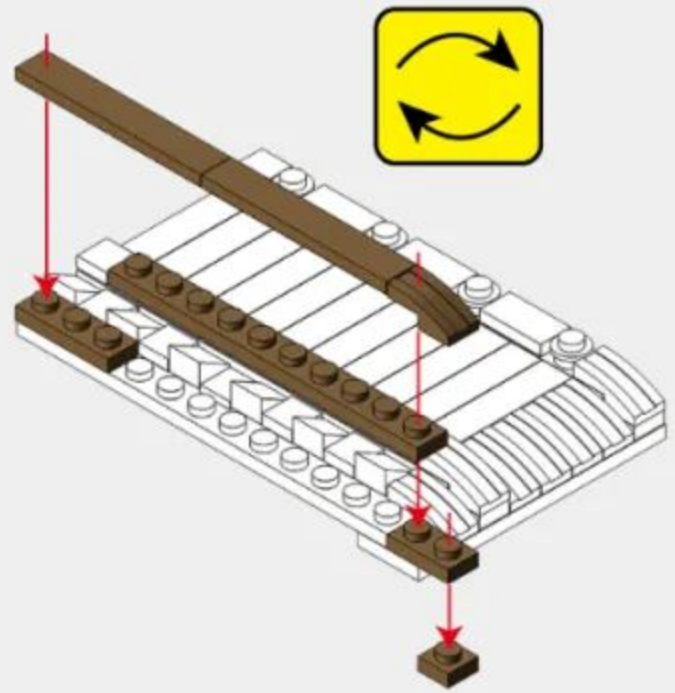

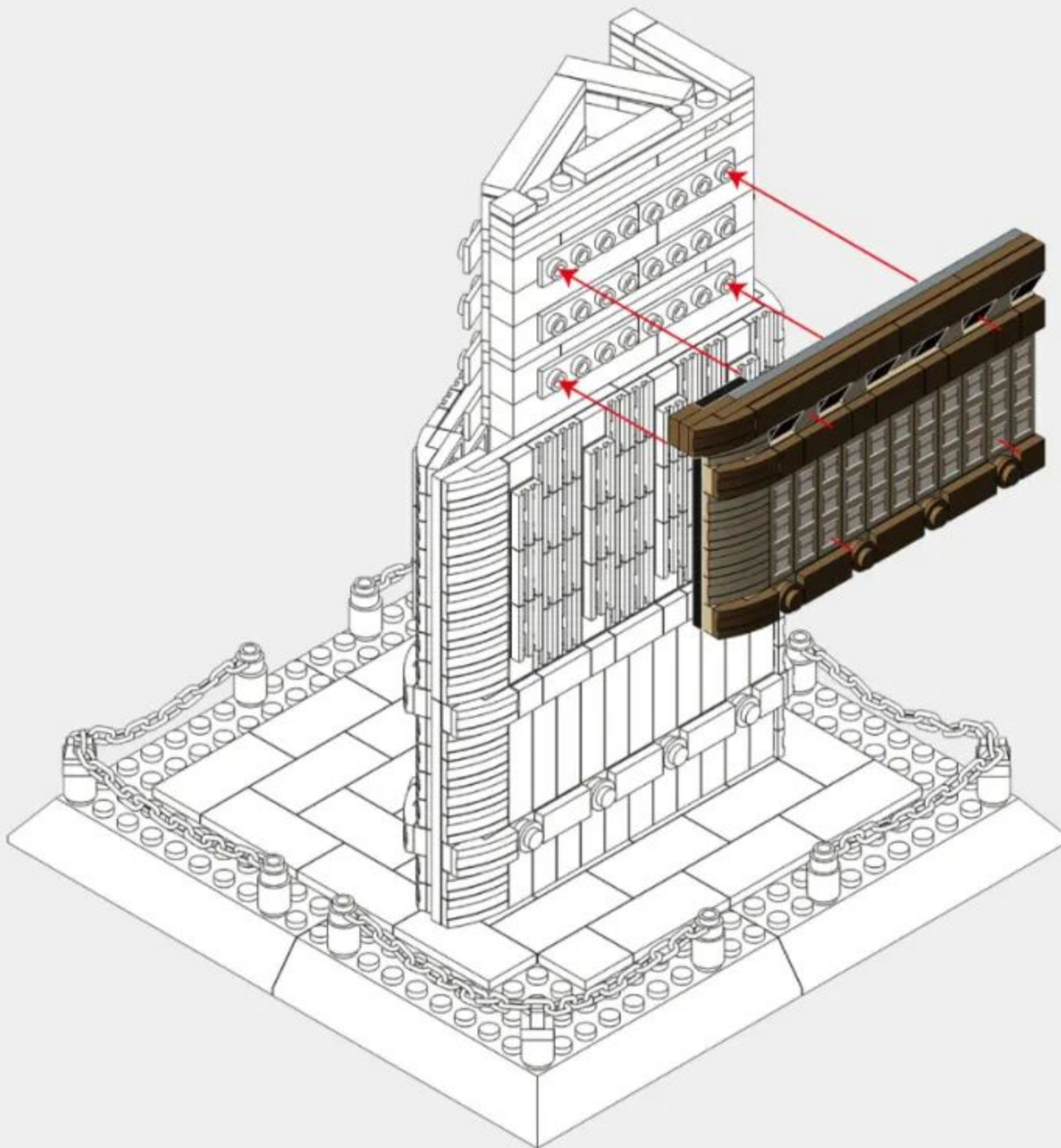

50 6 X 8

1 X 6 1 X 6

x1 x1 x2 x3 x4 x6 x10 x4 x2 x4

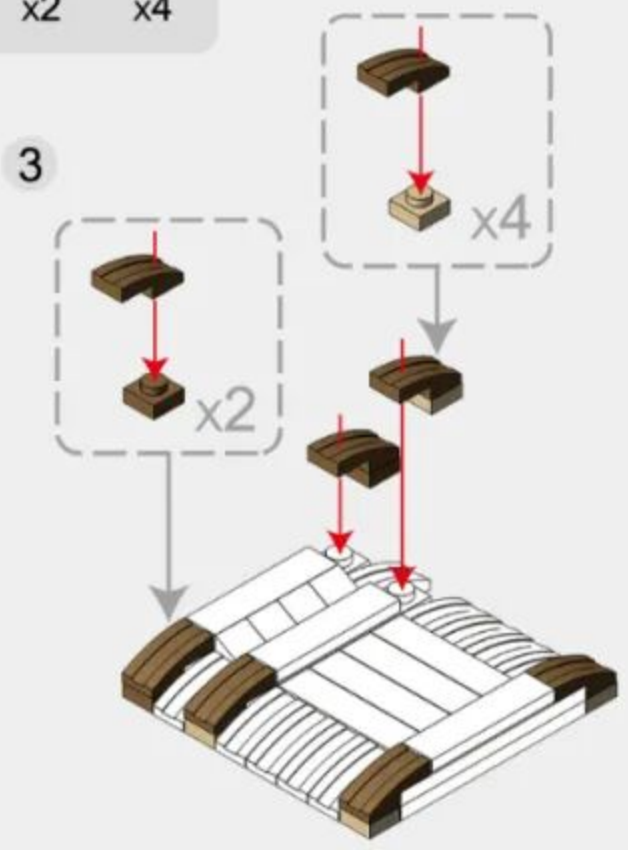
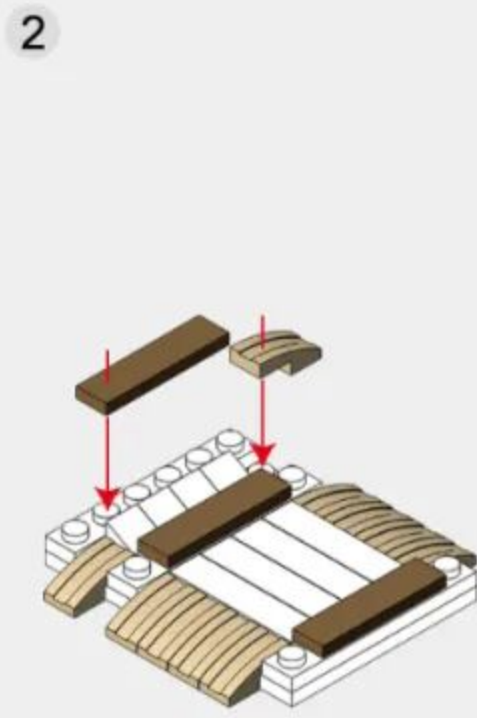
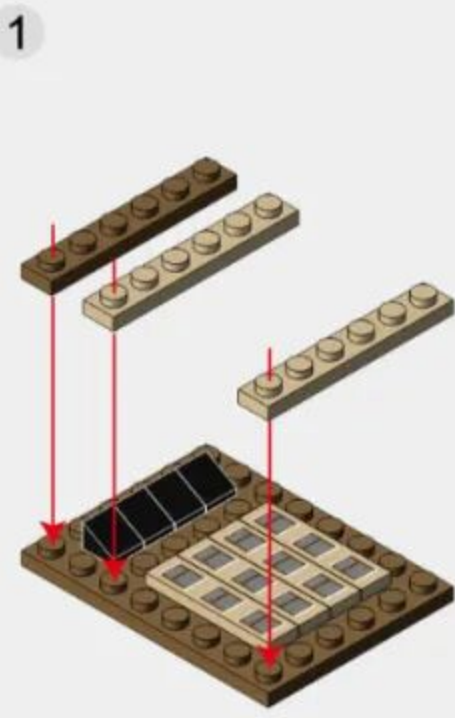

51

49 + 50

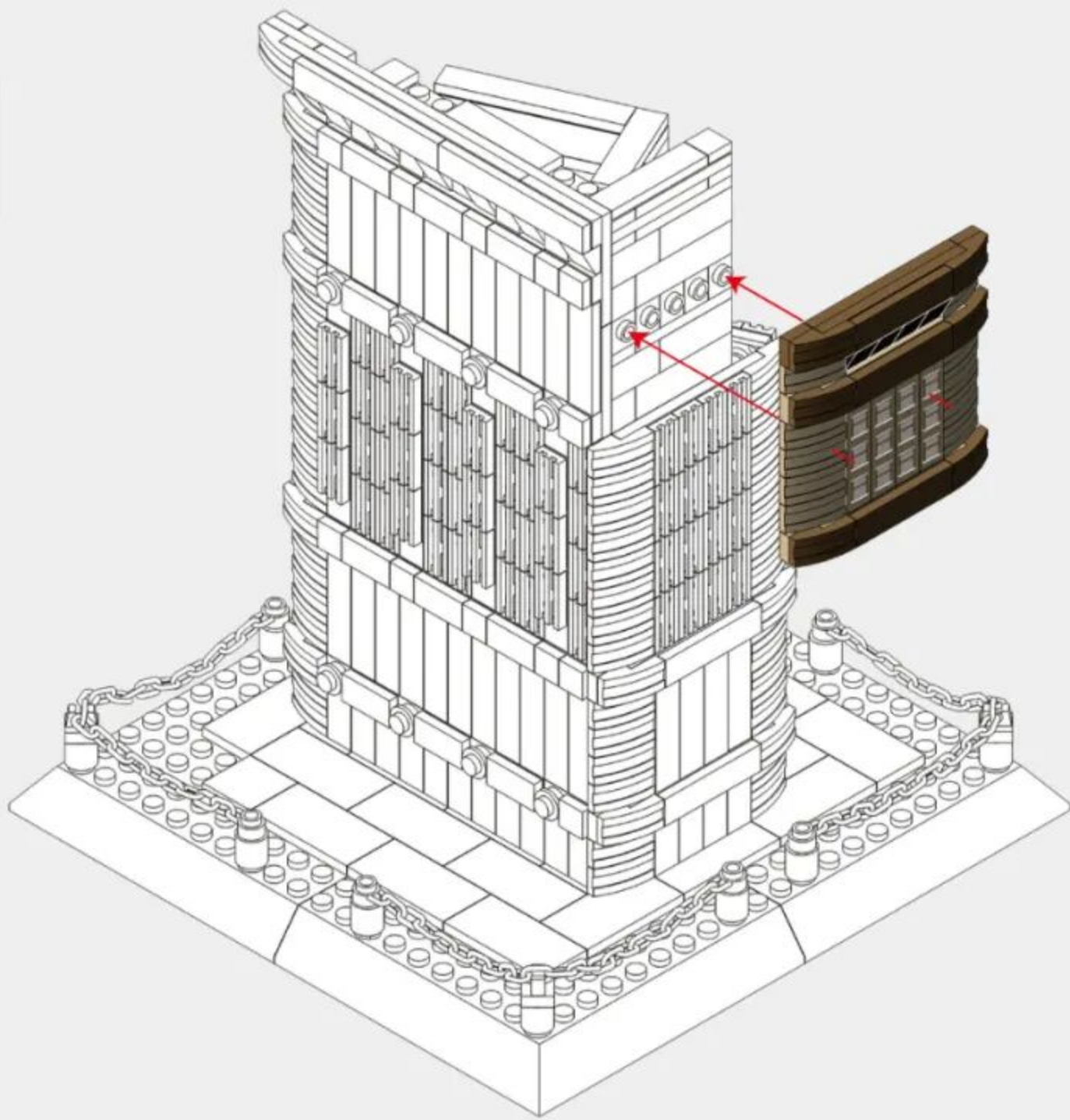

52

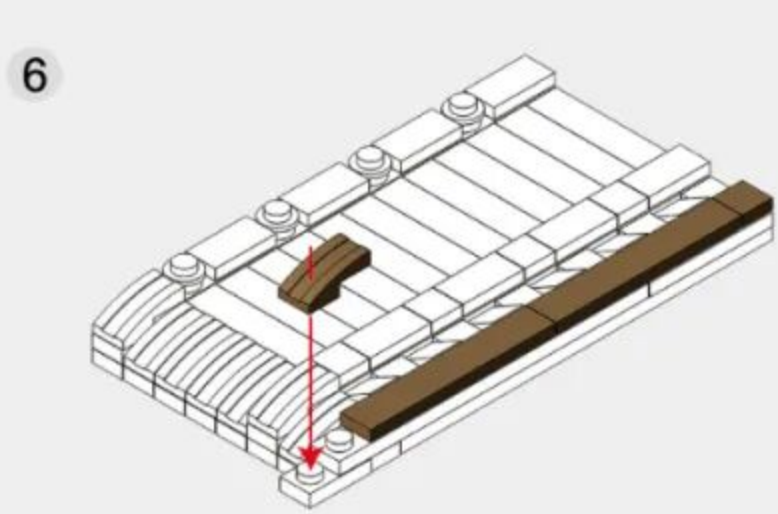
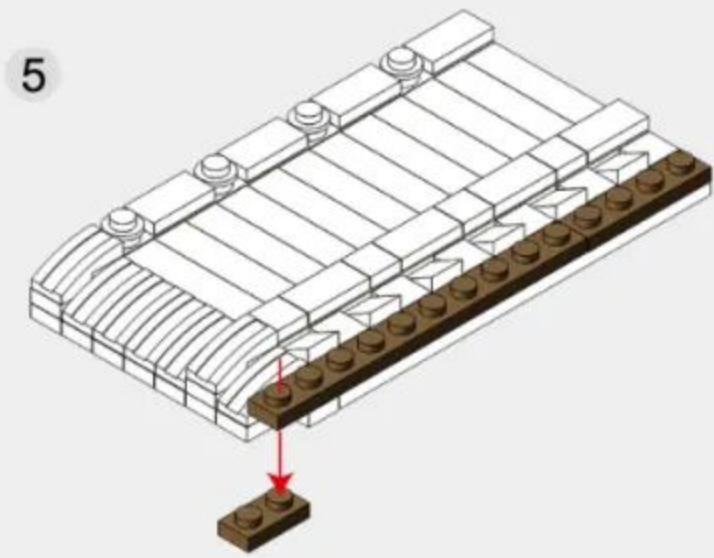
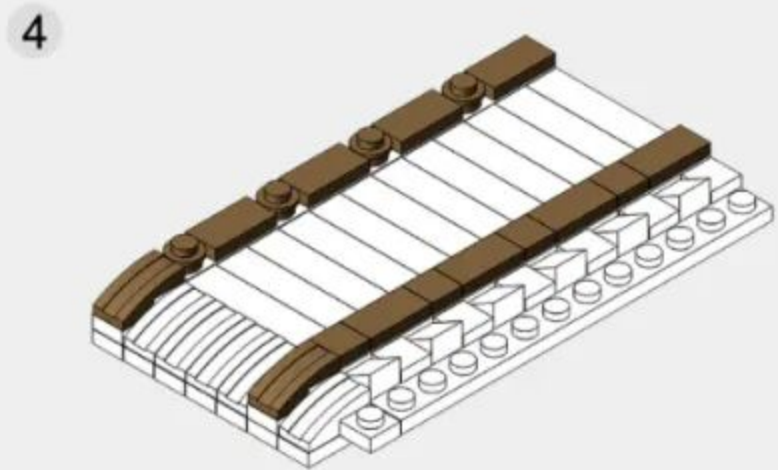
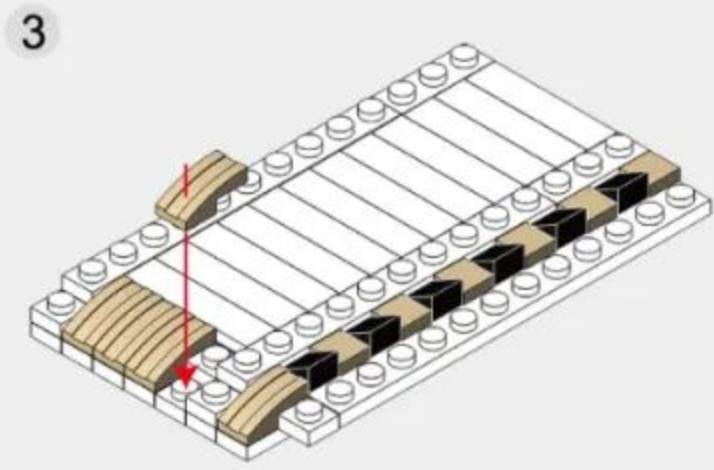
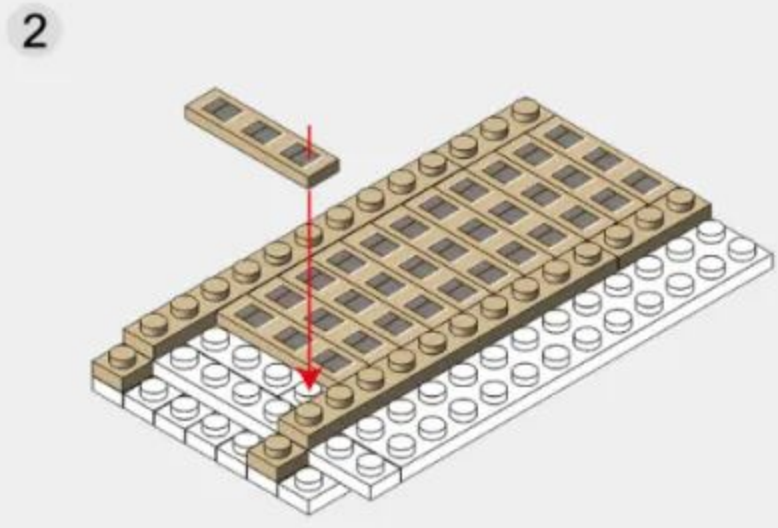
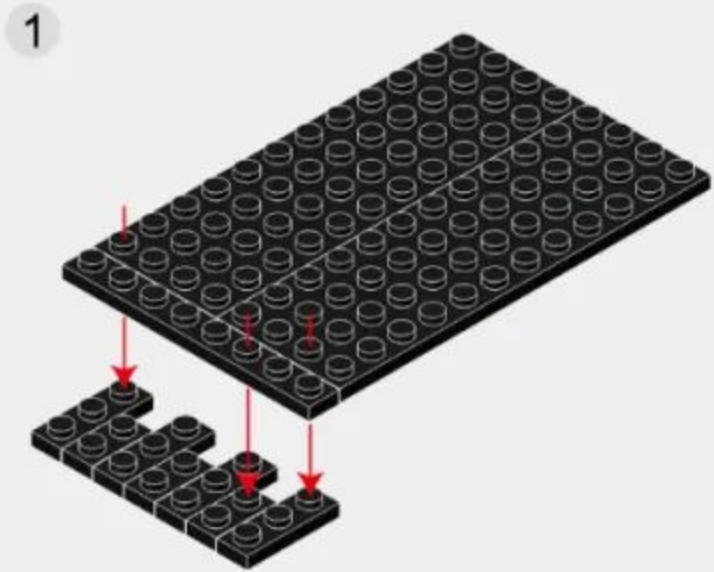
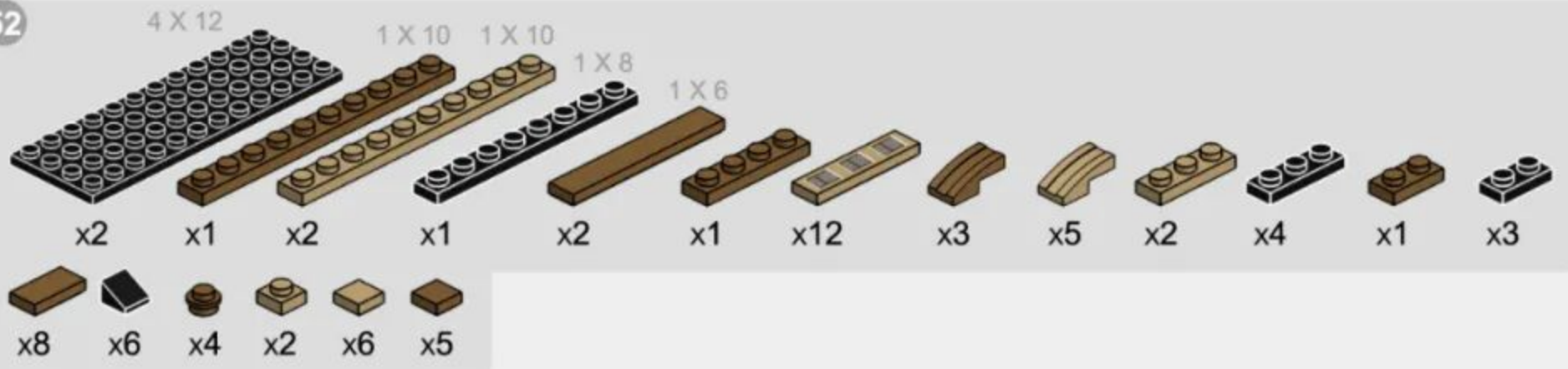

53

51 + 52

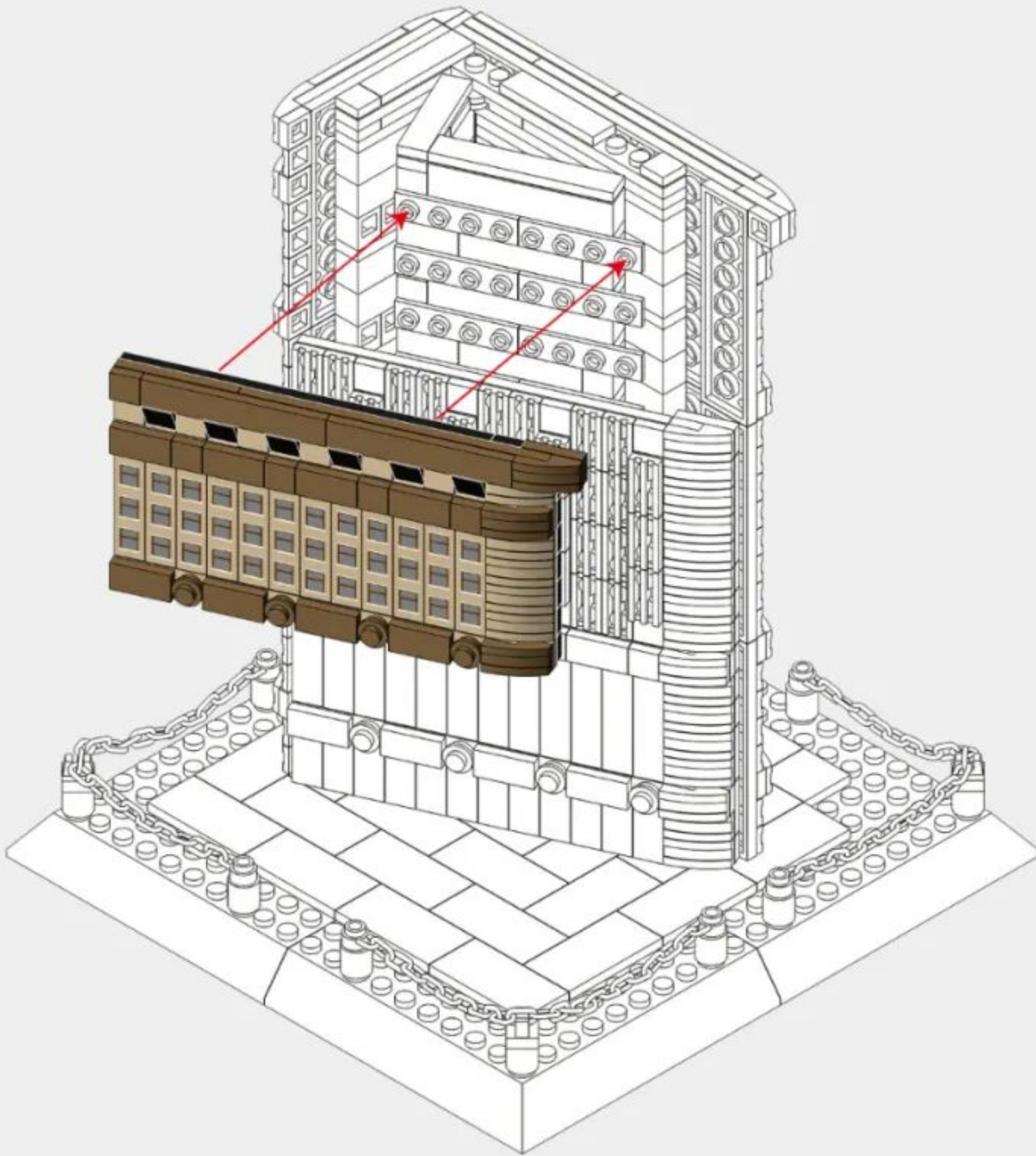

54 1 X 6

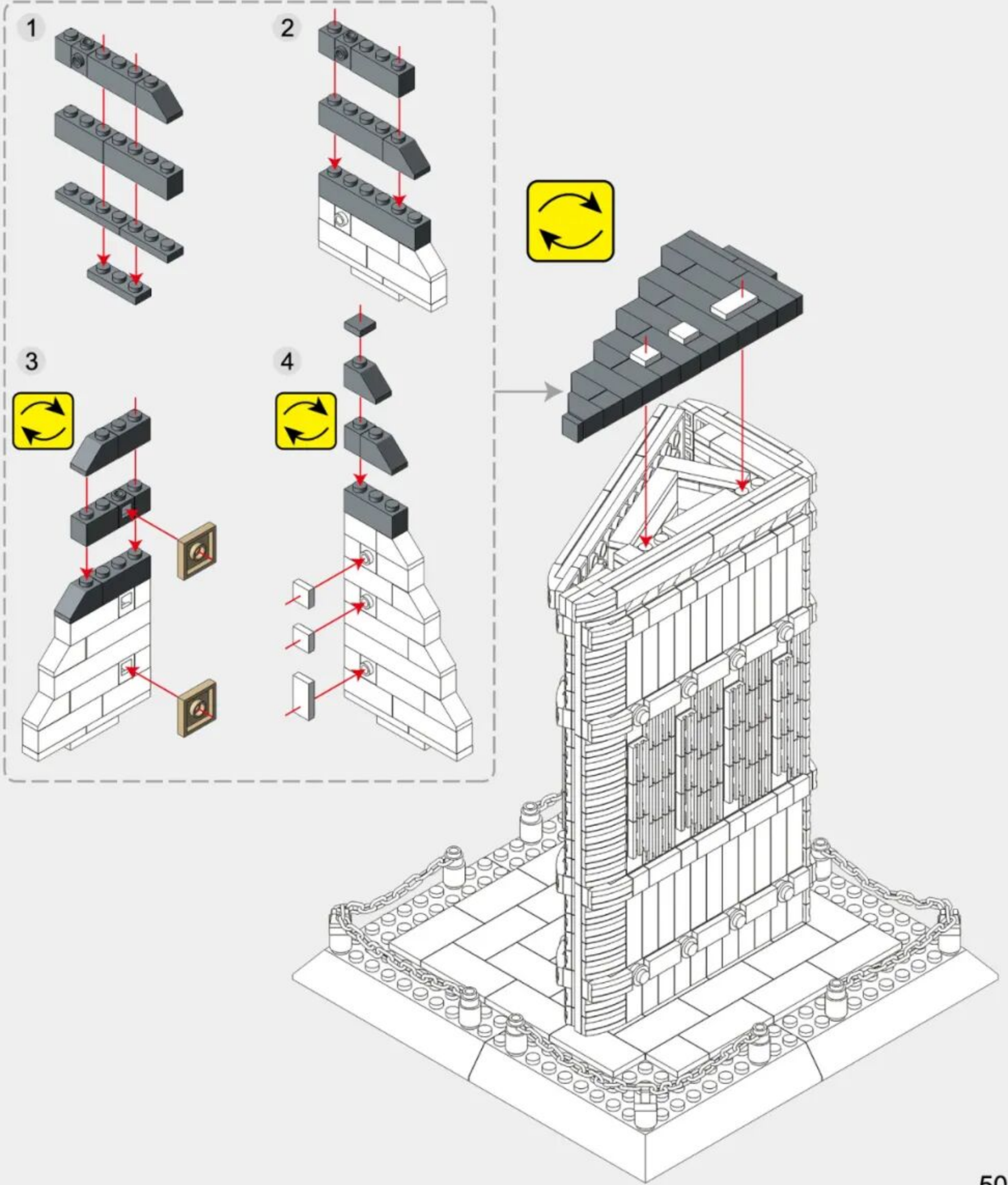
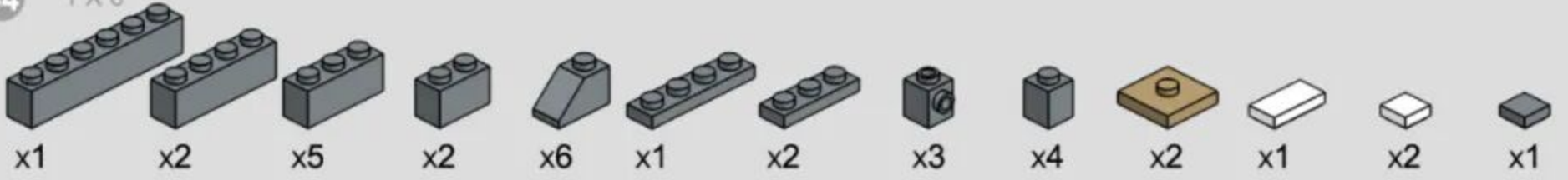

55

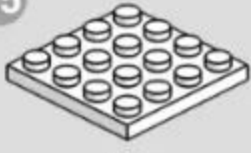

x1



x1



x1

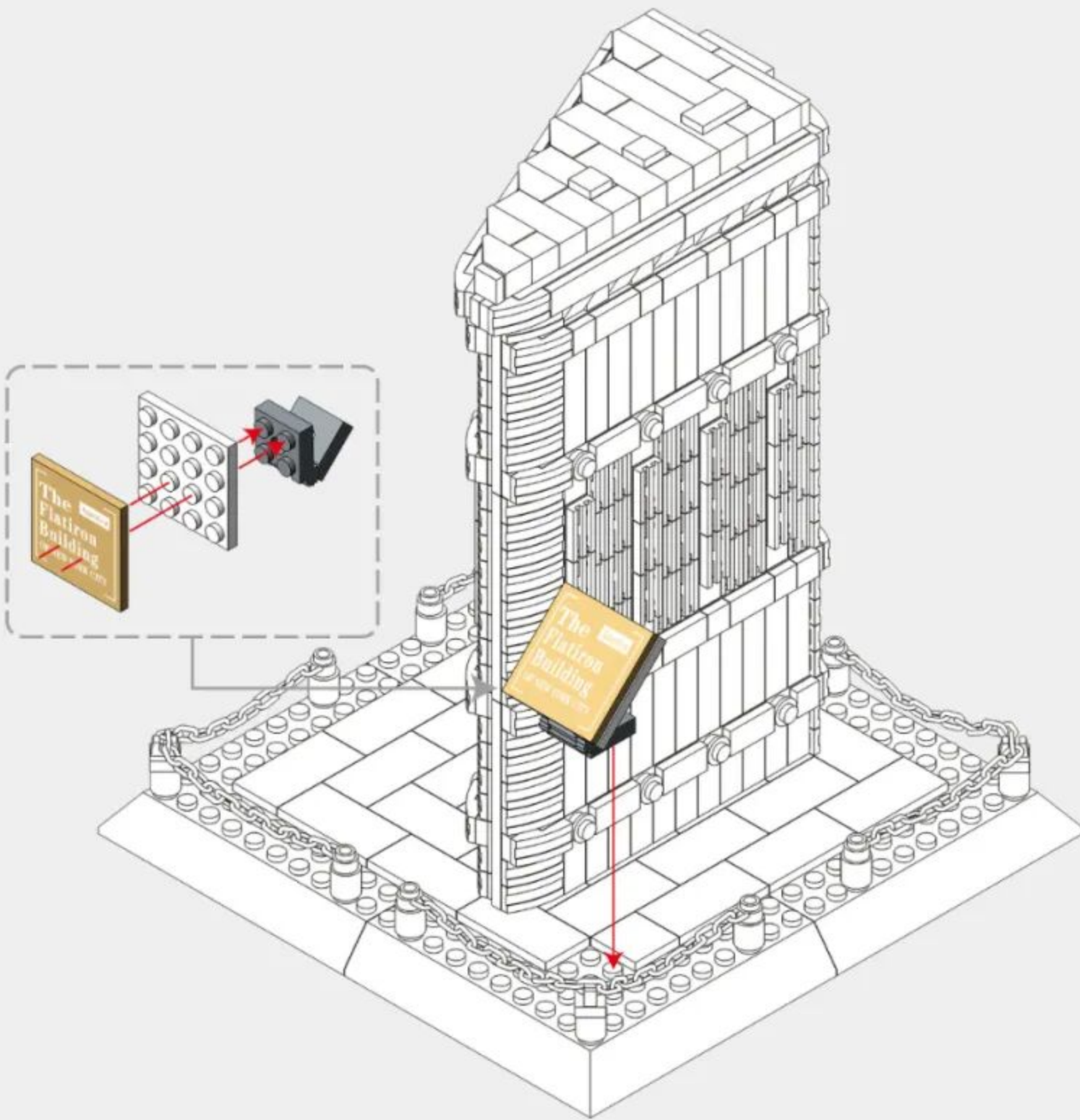

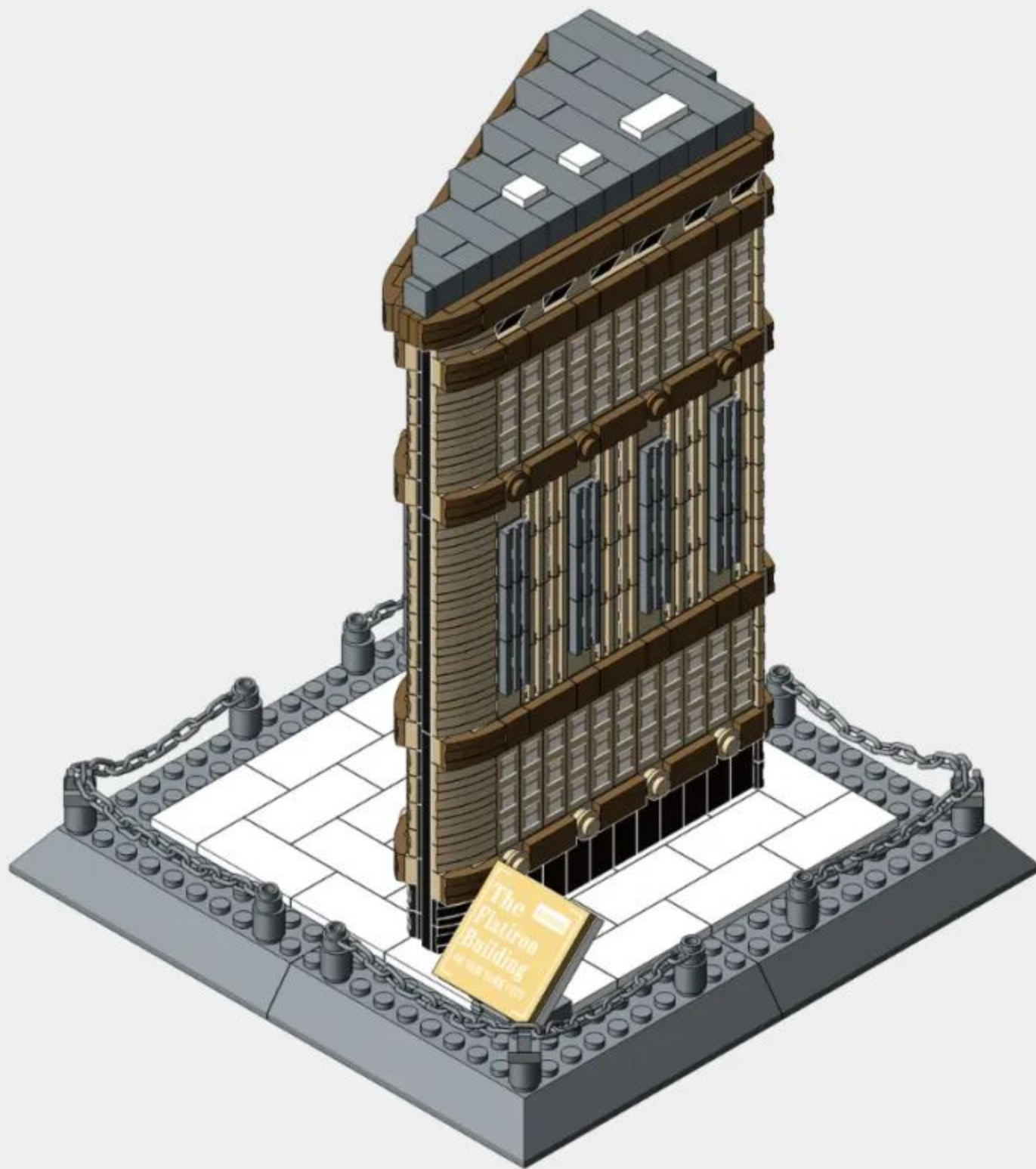

ARCHITECTURE

The World's great architecture

- Shaping Skills
- Imagination & Curiosity
- Mathematical
- Self Discovery & Perception
- Parent-Child Interaction
- Problem Solving
- Creativity



✦ GREAT PYRAMIDS OF GIZA
Item NO.4210 30X40X7MM 643PCS
埃及吉萨金字塔



✦ ELIZABETH TOWER
Item NO.4211 30X40X7MM 910PCS
英国伦敦伊丽莎白塔



✦ FONTANA DI TREVÌ
Item NO.4212 30X40X7MM 688PCS
罗马许愿池



✦ THE LOUVRE
Item NO.4213 30X40X7MM 821PCS
法国巴黎卢浮宫



✦ THE WHITE HOUSE
Item NO.4214 30X40X7MM 979PCS
美国华盛顿白宫



✦ THE CN TOWER-CANADA
Item NO.4215 30X40X7MM 400PCS
加拿大多伦多电视塔



✦ LINCOLN MEMORIAL
Item NO.4216 30X40X7MM 979PCS
美国林肯纪念馆



✦ MARINA BAY SANDS
Item NO.4217 30X40X7MM 881PCS
新加坡金沙酒店

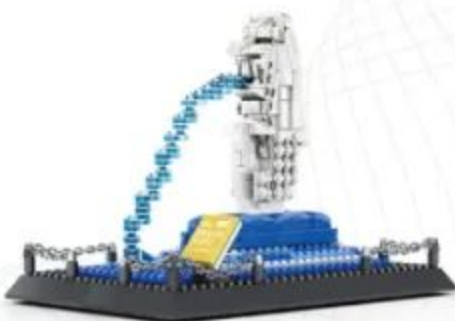

✦ MERLION STATUE-SINGAPORE
Item NO.4218 30X40X7MM 503PCS
新加坡鱼尾狮雕像



✦ THE TOWER BRIDGE OF LONDON
Item NO.4219 30X40X7MM 969PCS
伦敦塔桥



✦ FLATIRON BUILDING
Item NO.4220 30X40X7MM 838PCS
美国熨斗大厦



✦ NOTRE-DAME DE PARIS
Item NO.5210 45X30X9MM 1380PCS
法国巴黎圣母院大教堂



✦ **TAJ MAHAL OF AGRA**
Item NO.5211 45X30X9MM 1505PCS
印度阿格拉泰姬陵



✦ **EMPIRE STATE BUILDING**
Item NO.5212 45X30X9MM 1995PCS
美国纽约帝国大厦



✦ **PETRONAS TOWERS**
Item NO.5213 45X30X9MM 1160PCS
马来西亚吉隆坡国油双峰塔

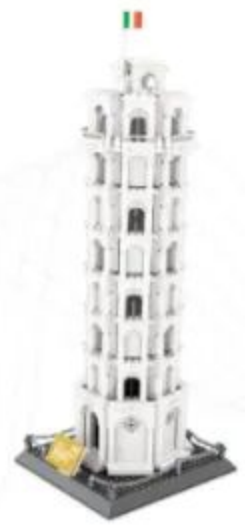

✦ **THE LEANING TOWER**
Item NO.5214 45X30X9MM 1392PCS
意大利比萨斜塔



✦ **THE TOWER BRIDGE**
Item NO.5215 45X30X9MM 1033PCS
英国伦敦双子桥



✦ **THE BIG BEN**
Item NO.5216 45X30X9MM 1642PCS
英国伦敦大笨钟



✦ **THE EIFFEL TOWER**
Item NO.5217 45X30X9MM 978PCS
法国巴黎埃菲尔铁塔



✦ **THE TIAN AN MEN**
Item NO.5218 45X30X9MM 758PCS
中国北京天安门



✦ **THE SPASSKAYA TOWER**
Item NO.5219 45X30X9MM 1044PCS
俄罗斯克里姆林宫



✦ **THE BURJAL ARAB HOTEL**
Item NO.5220 45X30X9MM 1307PCS
迪拜帆船酒店



✦ **THE TAIPEL 101**
Item NO.5221 45X30X9MM 1511PCS
中国台北101大楼



✦ **THE TEMPLE OF HEAVEN**
Item NO.5222 45X30X9MM 1052PCS
中国北京故宫天坛



✦ **THE TRIUMPHAL ARCH**
Item NO.5223 45X30X9MM 1401PCS
法国巴黎凯旋门



✦ **THE ORIENTAL PEARL TOWER**
Item NO.5224 45X30X9MM 1109PCS
中国上海东方明珠



✦ **THE GOLDEN GATE BRIDGE**
Item NO.6210 54X42X10MM 1977PCS
美国旧金山金门大桥



✦ **THE BRANDENBURG**
Item NO.6211 54X42X10MM 1552PCS
德国勃兰登堡门



THE FLATIRON BUILDING OF NEW YORK

INTRODUCTION

The Flatiron Building, originally the Fuller Building, is a triangular 22-story, 285-foot (87 m) tall steel-framed landmarked building located at 175 Fifth Avenue in the borough of Manhattan, New York City, which is considered to be a groundbreaking skyscraper. Upon completion in 1902, it was one of the tallest buildings in the city at 20 floors high and one of only two skyscrapers north of 14th Street – the other being the Metropolitan Life Insurance Company Tower, one block east. The building sits on a triangular block formed by Fifth Avenue, Broadway, and East 22nd Street – where the building's 87-foot (27 m) back end is located – with East 23rd Street grazing the triangle's northern (uptown) peak. As with numerous other wedge-shaped buildings, the name "Flatiron" derives from its resemblance to a cast-iron clothes iron. The building, which has been called "one of the world's most iconic skyscrapers and a quintessential symbol of New York City", anchors the south (downtown) end of Madison Square and the north (uptown) end of the Ladies' Mile Historic District. The neighborhood around it is called the Flatiron District after its signature building, which has become an icon of New York City. The Flatiron Building was designated a New York City landmark in 1966, was added to the National Register of Historic Places in 1979, and was designated a National Historic Landmark in 1989.

