

# MOSCOW STATE UNIVERSITY

МОСКОВСКИЙ ГОСУДАРСТВЕННЫЙ УНИВЕРСИТЕТ

Moscow, Russia

The world's great architecture



6+  
Minimum Age

4227  
Parts  
Number

875 PCS  
Parts  
Total



# Architecture

It will be a city...

这将构成一座城市...

# ABOUT THE PRODUCT

关于产品

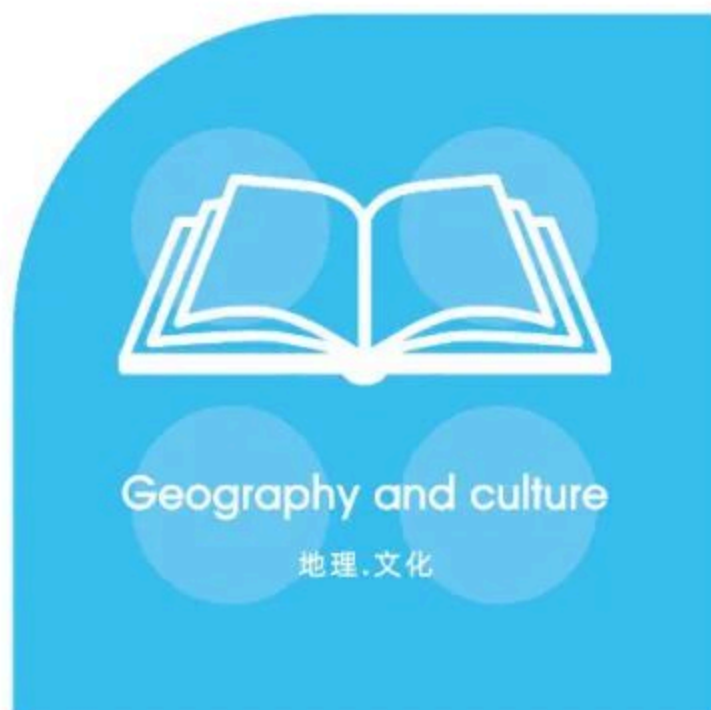

## ARCHITECTURE

WANGE The world's great architect since 1991

# Moscow State University



Moscow State University is a public research university in Moscow, Russia. The full official name is M. V. Lomonosov Moscow State University.

# Moscow State University



## Geography and culture

地理.文化



The university includes 15 research institutes, 43 faculties, more than 300 departments, and six branches. Alumni of the university include past leaders of the Soviet Union and other governments.



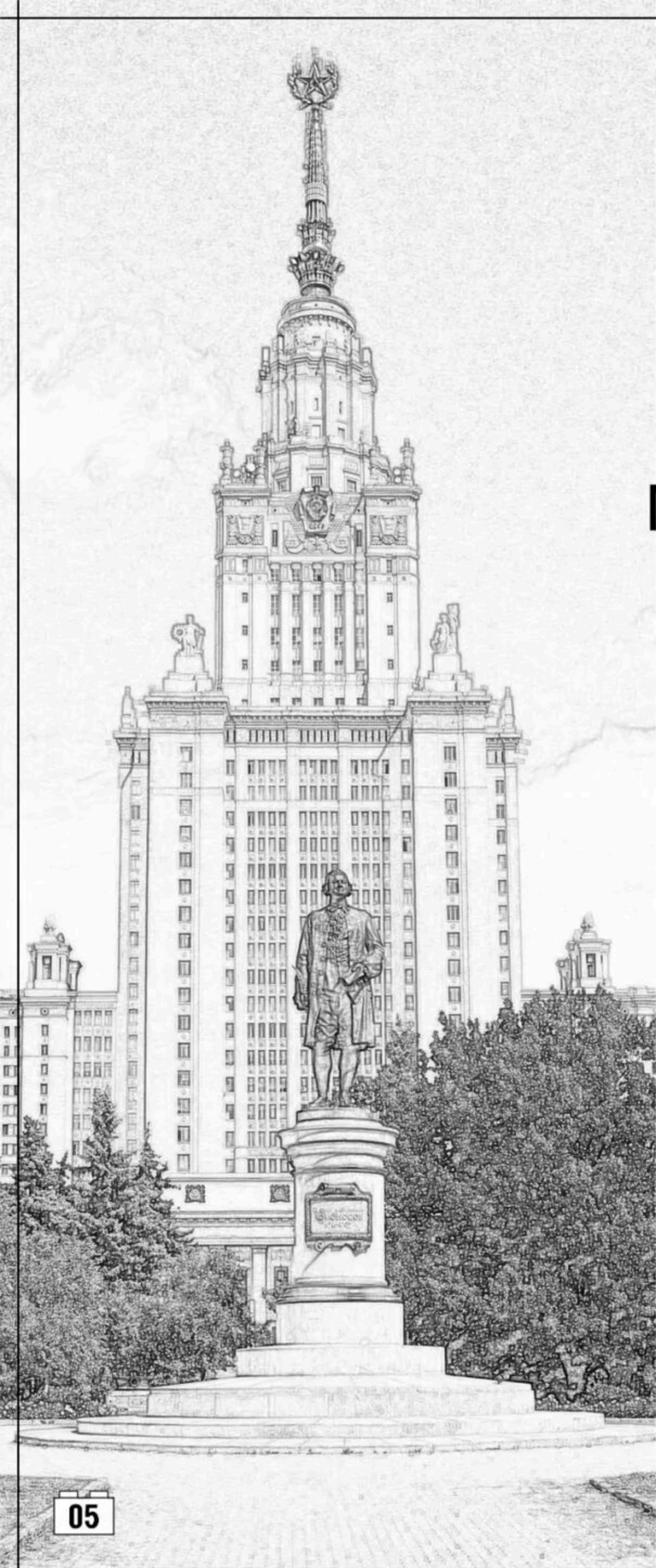

俄罗斯莫斯科国立大学

# Moscow State ■ University Russia

The contents of this chapter refer to the Wikipedia website.

本章内容参考维基百科网站，  
更多资讯可自行查阅。

The world's great architecture

# Buildings and layout

■ 建筑物和布局



Since 1953, most of the faculties have been situated on Sparrow Hills, in southwest Moscow. In the post-war era, Joseph Stalin ordered seven tiered neoclassic towers to be built around the city. It was built using Gulag labour, as were many of Stalin's Great Construction Projects in Russia. The MSU main building was the tallest building in Europe until 1990. The central tower is 240 m tall, 36 stories high.

Университет имеет в своём распоряжении более 600 зданий и сооружений, включая Главное здание на Воробьёвых горах. Их общая площадь составила около 1 млн м<sup>2</sup>. Только в Москве территория, занимаемая МГУ, составляет 205,7 га. Новая территория университета, выделенная правительством Москвы и составляющая 120 га, начиная с 2003 года активно застраивается. В 2005 году было построено здание Интеллектуального центра — Фундаментальной библиотеки. 1 сентября 2007 года мэр Москвы Ю. М. Лужков и ректор МГУ В. А. Садовничий торжественно открыли сразу два крупных и значимых для университета здания. Был открыт Первый учебный корпус МГУ на Ломоносовском проспекте, в который переехали три факультета: исторический, философский и факультет государственного управления. Выделенный из философского факультета в 2008 году факультет политологии также расположился в 1-м учебном корпусе.



## Campus

Along with the university administration, the Museum of Earth Sciences and faculties of Mechanics and Mathematics, Geology, Geography, and Fine and Performing Arts are in the main building. The building on Mokhovaya Street houses the Faculty of Journalism, the Faculty of Psychology, and Institute of Asian and African Countries. A number of faculty buildings are located near Manege Square in the centre of Moscow and a number of campuses abroad in Ukraine, Kazakhstan, Tajikistan and Uzbekistan.

В главном здании, помимо администрации университета, находятся Музей наук о Земле, механико-математический, геологический, географический, факультеты изобразительных и исполнительских искусств. В здании на Моховой улице находятся факультет журналистики, факультет психологии и Институт стран Азии и Африки. Ряд зданий факультета расположены недалеко от Манежной площади в центре Москвы, а также ряд кампусов за рубежом — на Украине, в Казахстане, Таджикистане и Узбекистане.



## Academic reputation

In world rankings, MSU was ranked 101st–150th by the Academic Ranking of World Universities 2022, #75 by QS World University Rankings 2023, and #355 by U.S. News & World Report 2023. According to the some international rankings MSU is the highest-ranked Russian university (with the nearest Russian competitor being Saint Petersburg State University), but it was consistently ranked outside the top 5 nationally in 2010–11 by Forbes and Ria Novosti / HSE, with both ratings based on data set collected by HSE from Russian Unified State Exam scores averaged per all students and faculties of university.

В мировых рейтингах МГУ занимал 101–150-е место в Academic Ranking of World Universities 2022, 75-е место в QS World University Rankings 2023 и 355-е место в U.S. News & World Report 2023. Согласно некоторым международным рейтингам, МГУ является российским университетом с самым высоким рейтингом (ближайшим российским конкурентом является Санкт-Петербургский государственный университет), но в 2010–2011 годах он неизменно находился за пределами первой пятерки в национальном рейтинге по версии Forbes и РИА Новости/НИУ ВШЭ, причем оба рейтинга основаны на наборе данных, собранных НИУ ВШЭ из средних баллов ЕГЭ по всем студентам и факультетам университета.

# Force Balance

受力平衡

Physical operations

物理运算

$$F = G \frac{m_1 m_2}{d^2}$$

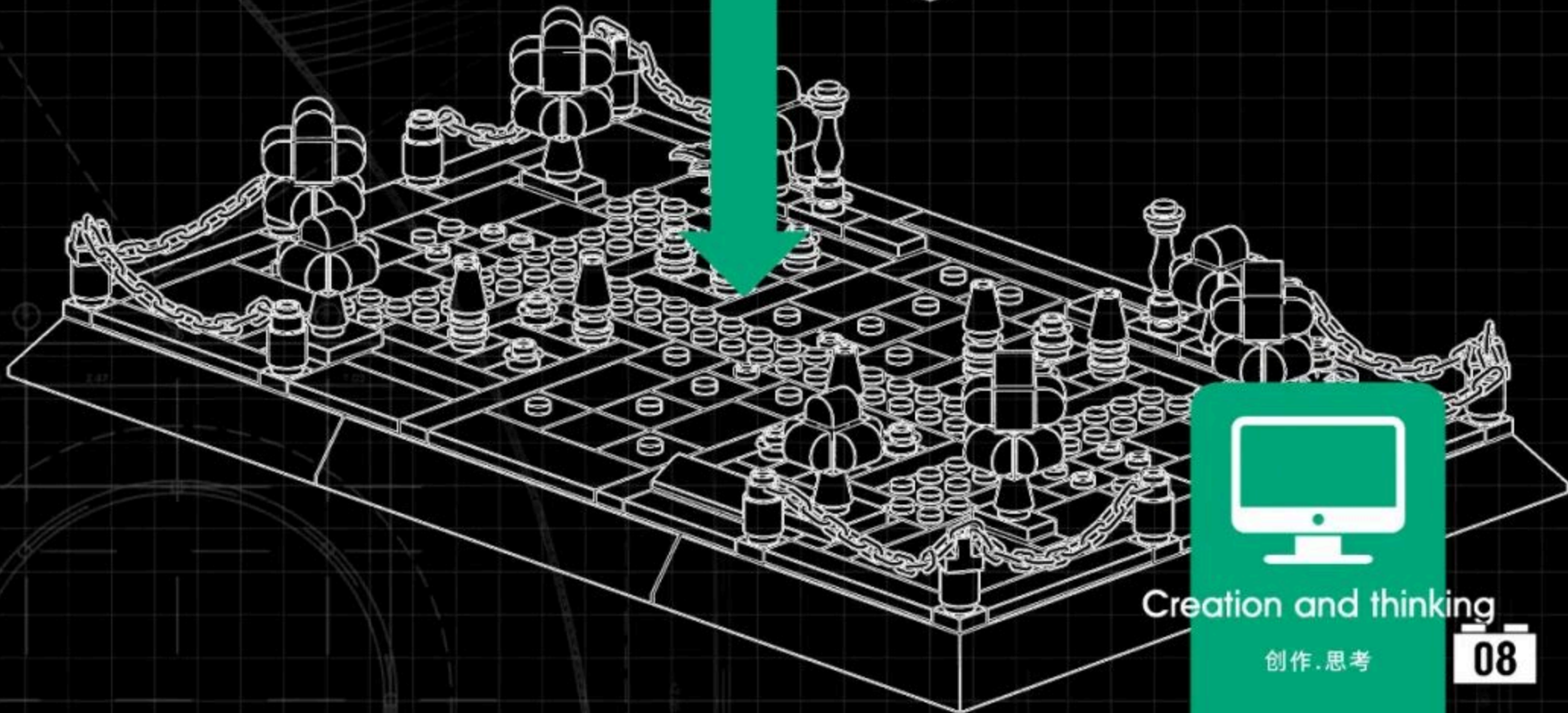

Creation and thinking

创作·思考

08

# Special parts

特殊零件的开发利用

$$S=4\pi \cdot r^2$$

$$a^2+b^2=c^2$$



**WG1250**

无孔2分圆



**WG1508**

带槽直角矮3孔



**WG1628**

口红



**WG1627**

双面连接圆环



**WG1527**

灯笼穗1孔



**WG1011**

欧式柱



**WG1345**

竖纹2倍2孔



**WG1344**

方形通孔



**WG1391**

无孔3X6

$$\sin^2 a + \cos^2 a = 1$$



features and functions

特点.功能

# Main Color Matching

配色方案



Pantone 431C



Pantone Cool Gray 8C



Pantone Cool Gray 6C

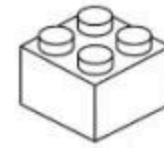

White



Pantone 7550C



Pantone 723C



Pantone 472C



Pantone 7500C



Pantone Black 6C



Pantone 477C



Pantone 3435C



Pantone 348C



## Color matching

Adopting 3 main colors, Beige, Dark Gray and brown as the main color, the more reasonable and bold color matching on the original building, making the product more atmospheric and the whole design is more reasonable.

# Moscow State University

俄罗斯莫斯科国立大学



Front

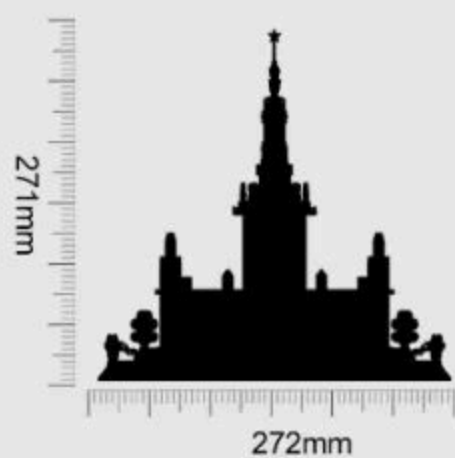

Left

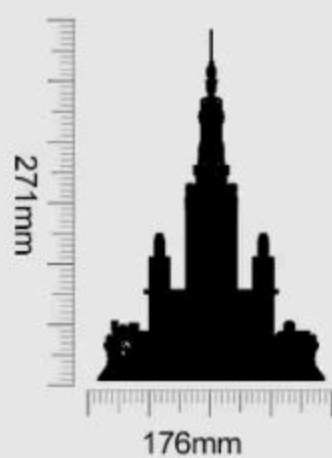

Back

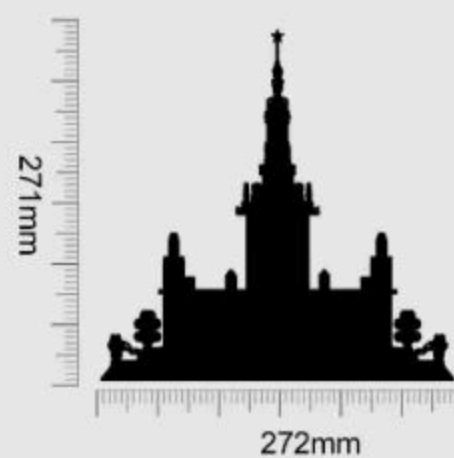

Product Size:272X176X271mm





■ First open the product packaging according to the instructions.

按指导用正确方式拆解产品外包装。



■ Summarize all parts to count the number of familiar accessories.

对照说明书清单确认积木包数量与积木数量。



■ Arranging all accessories by color helps to quickly install the product.

把确认好的积木以类型、颜色进行分类排好以便安装。



■ Carefully install the product and learn about building.

按说明书步骤拼装并完成你的积木模型。



# 1:1 Physical Reference Table

十字棒配件1:1尺寸参照表



Instructions For Use

让安装更简单

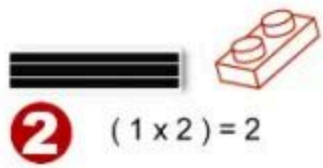

**2**  $(1 \times 2) = 2$

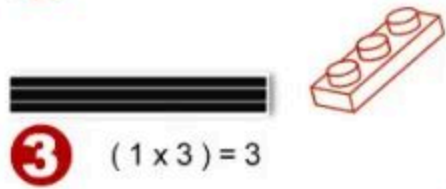

**3**  $(1 \times 3) = 3$

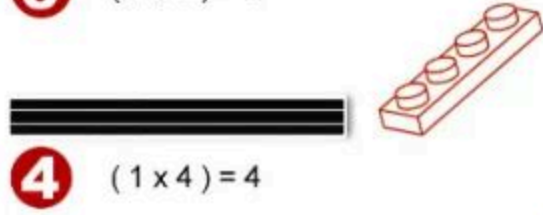

**4**  $(1 \times 4) = 4$



**5**  $(1 \times 5) = 5$



**6**  $(1 \times 6) = 6$

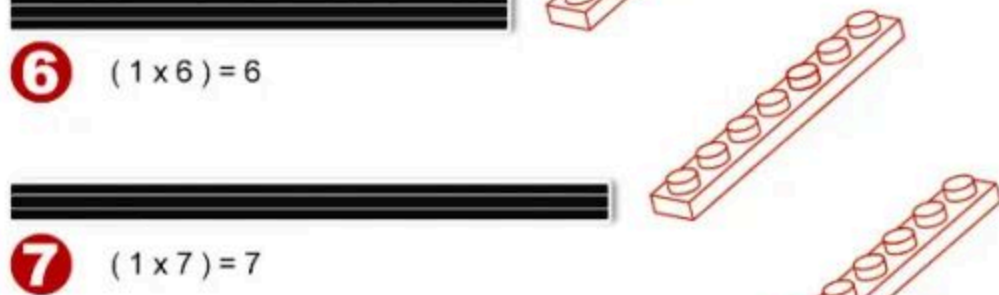

**7**  $(1 \times 7) = 7$

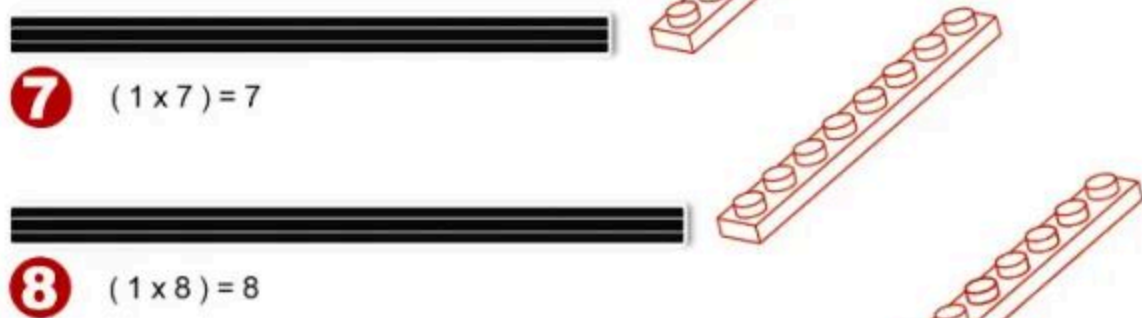

**8**  $(1 \times 8) = 8$

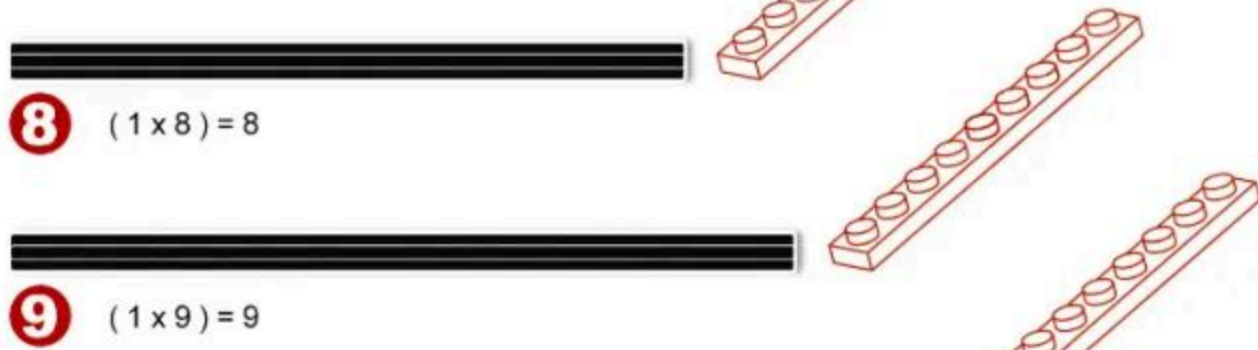

**9**  $(1 \times 9) = 9$

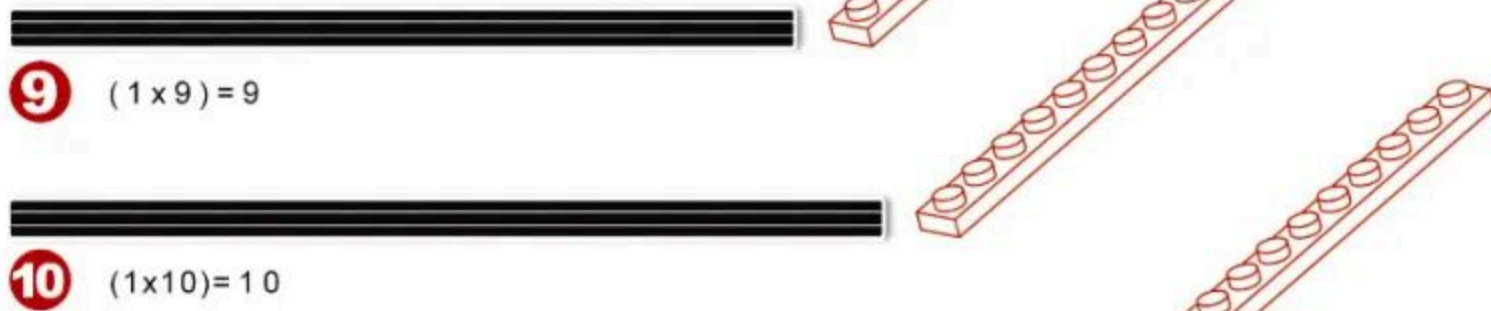

**10**  $(1 \times 10) = 10$

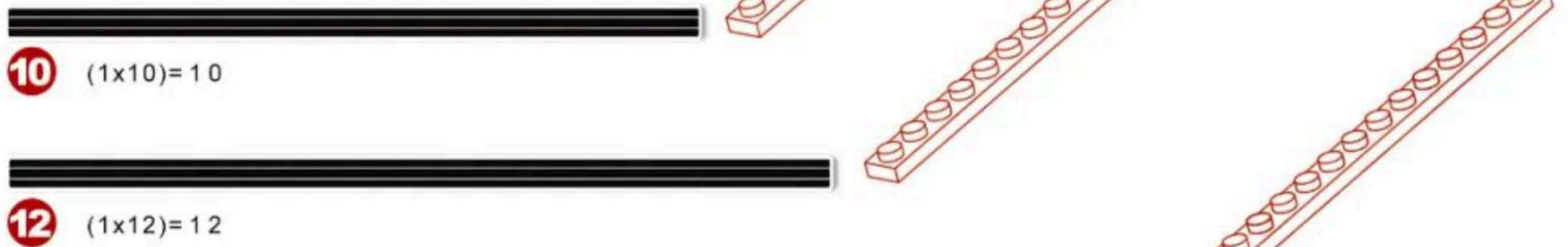

**12**  $(1 \times 12) = 12$



**16**  $(1 \times 16) = 16$



# PARTS LIST

配件清单

x2	x5	x2	x2	x6		
x2	x4	x4	x12	x4		
x2	x14	x12	x12	x4		
x4	x13	x5	x2	x2		
x1	x2	x4	x4	x4		
x4	x2	x4	x2	x4		
x16	x2	x2	x40	x40		
x4	x2	x14	x17	x17		
x1	x1	x6	x4	x4		
x1	x6	x15	x17	x17		
x1	x4	x8	x4	x4		
x12	x1	x24	x4	x4		
x13	x6	x4	x4	x4		

产品有增补件请以实物为准

If product has additional parts, please in kind prevail.

# PARTS LIST

配件清单

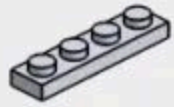

x3



x7

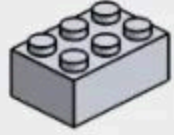

x6



x4



x10

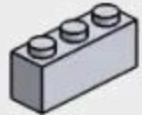

x6



x2



x6



x10



x4

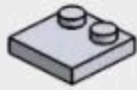

x2



x14

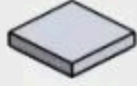

x5



x4



x2



x4



x14



x10



x4



x18

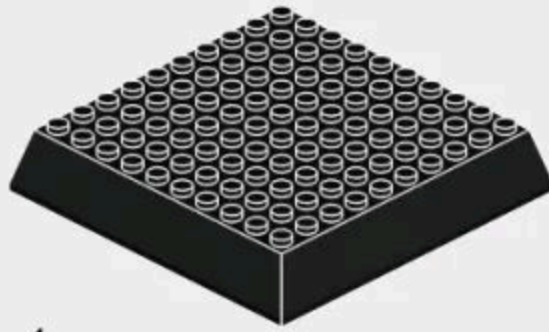

x4

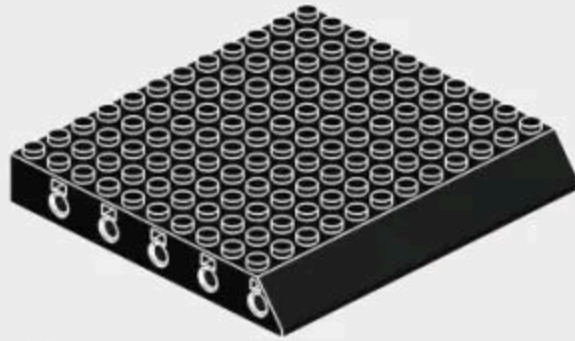

x2



x2



x2



x1



x2



x4



x1

3



x1



x1



x2



x2



x16



x1



x1



x2



x16

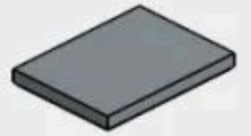

x2

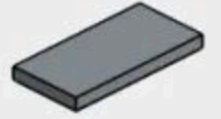

x4

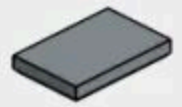

x5



x3



x4

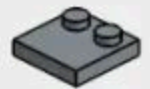

x6

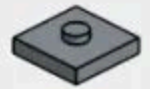

x1

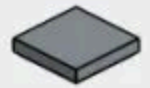

x2

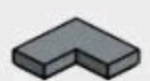





x4

产品有增补件请以实物为准

If product has additional parts, please in kind prevail.

# PARTS LIST

配件清单

				
x4	x2	x2	x1	x16
				
x10	x4	x2	x1	
				
x12	x12	x1	x1	x8
				
x4	x4	x2	x1	
				
x2	x2	x4	x1	x4
				
x4	x8	x2	x12	x4
				
x3	x56	x4	x8	x4
				
x2	x8	x4	x14	x2
				
x4	x4	x2	x1	x4
				
	x4	x2	x1	x10
				
	x4	x4		

产品有增补件请以实物为准

If product has additional parts, please in kind prevail.



279PCS

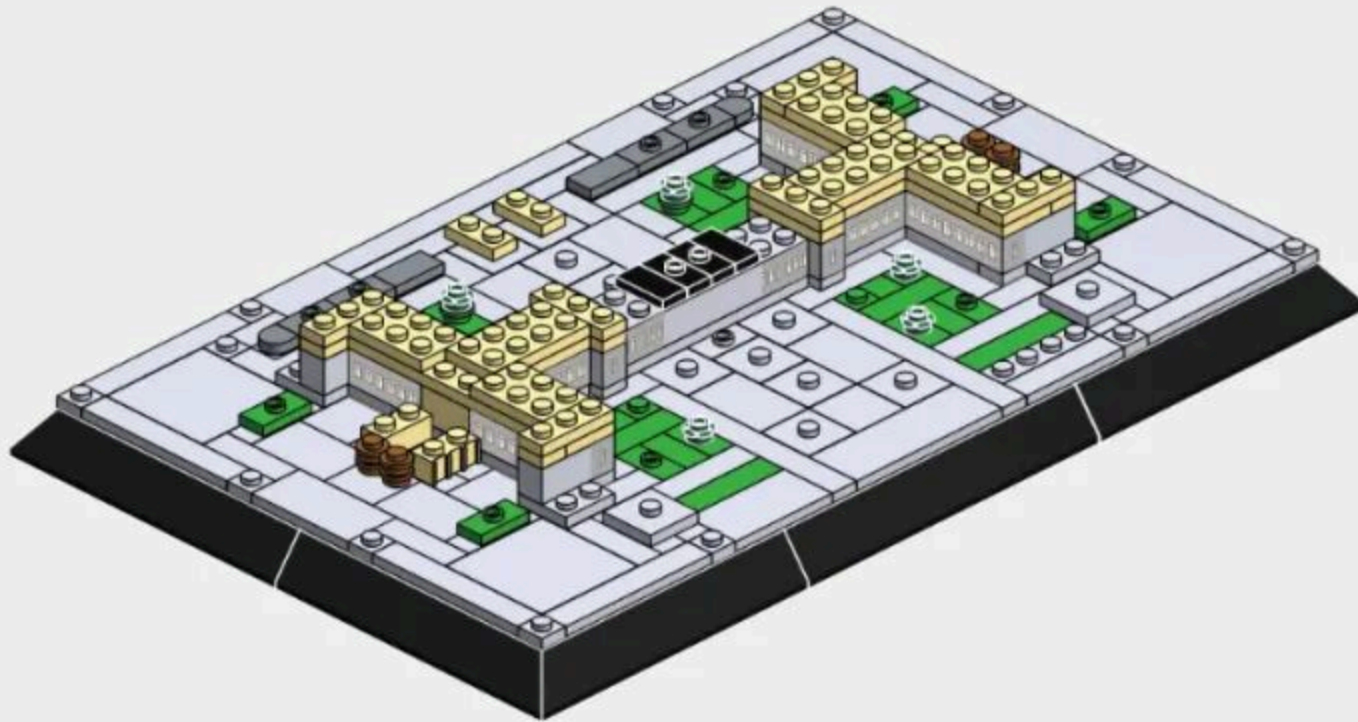

1-1

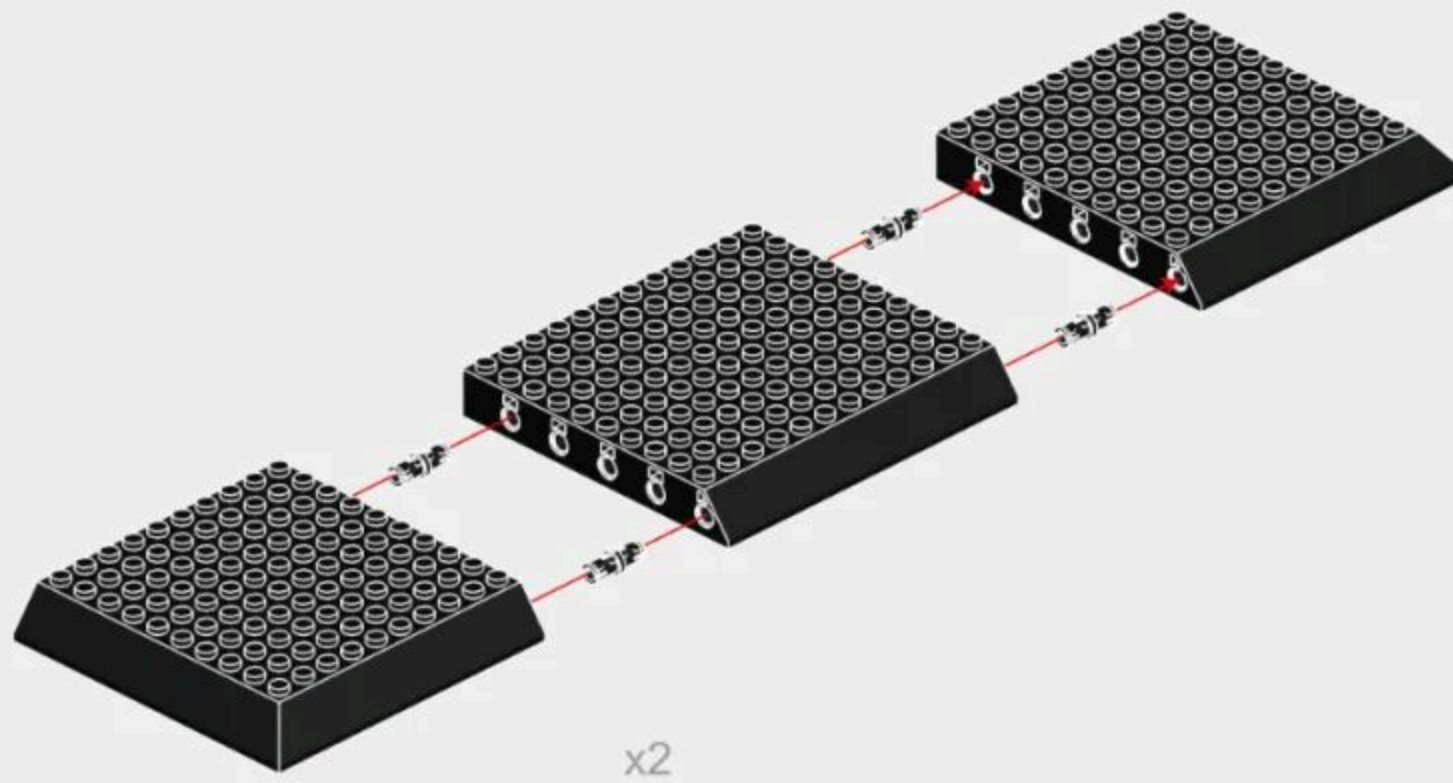
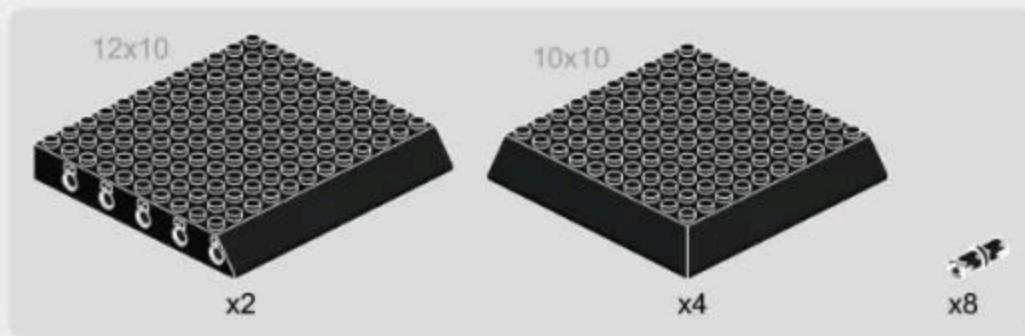

1-2

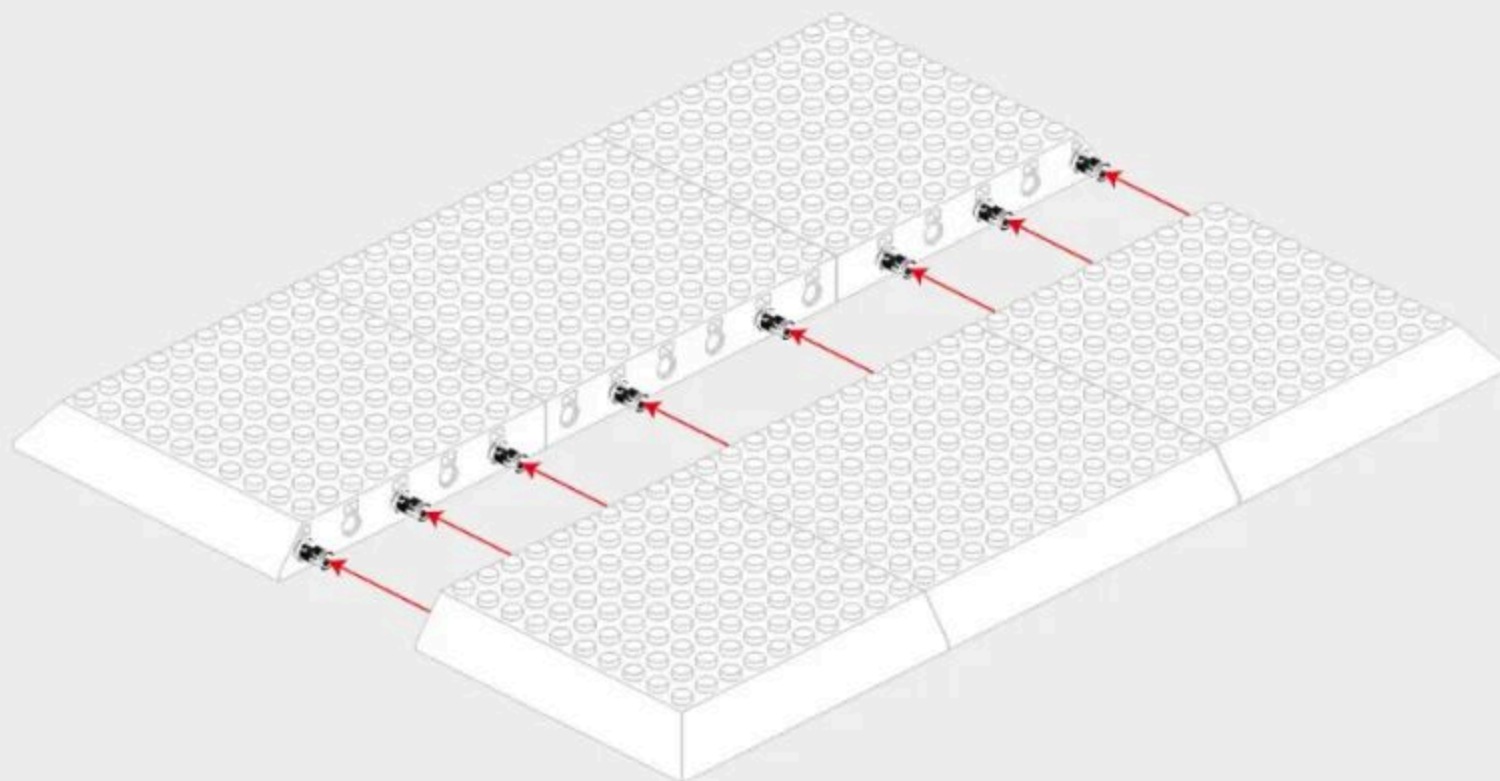



# 1-4

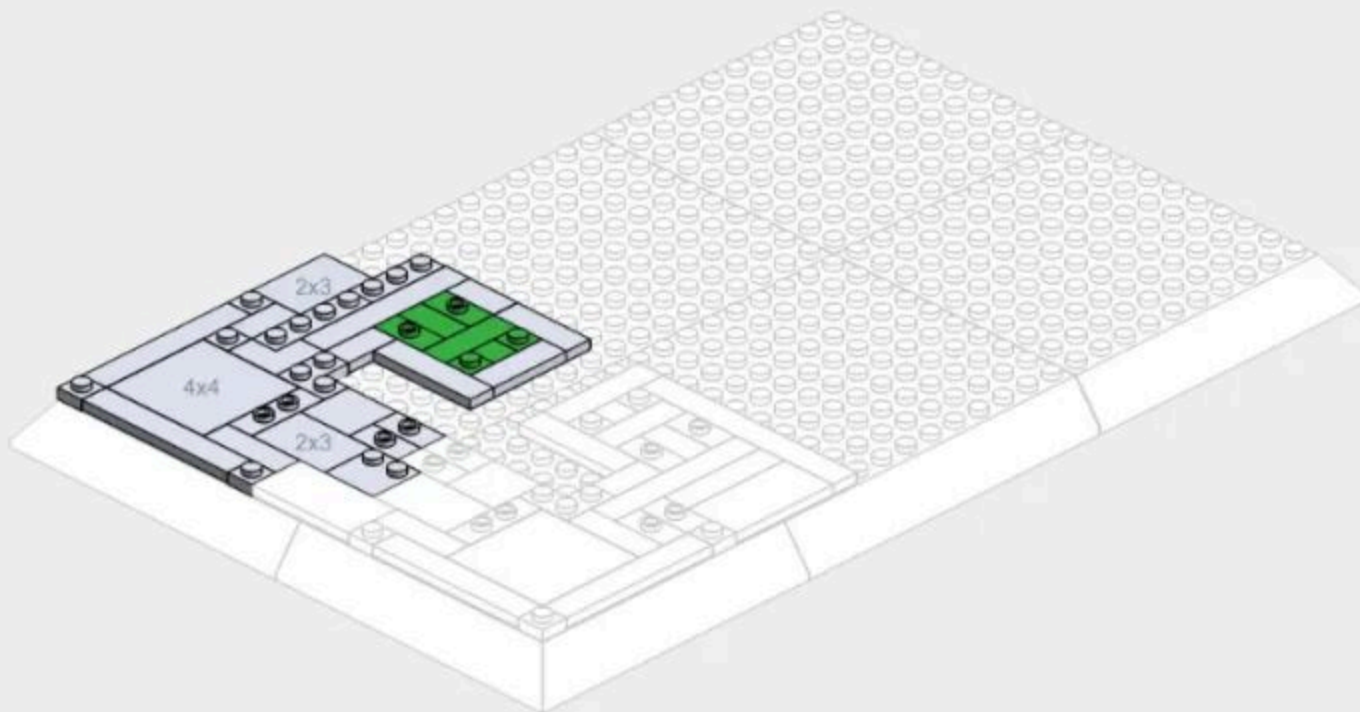
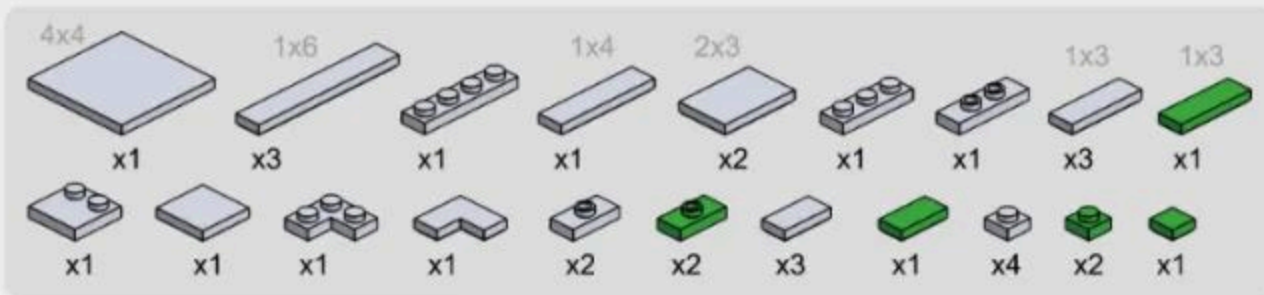





1-7

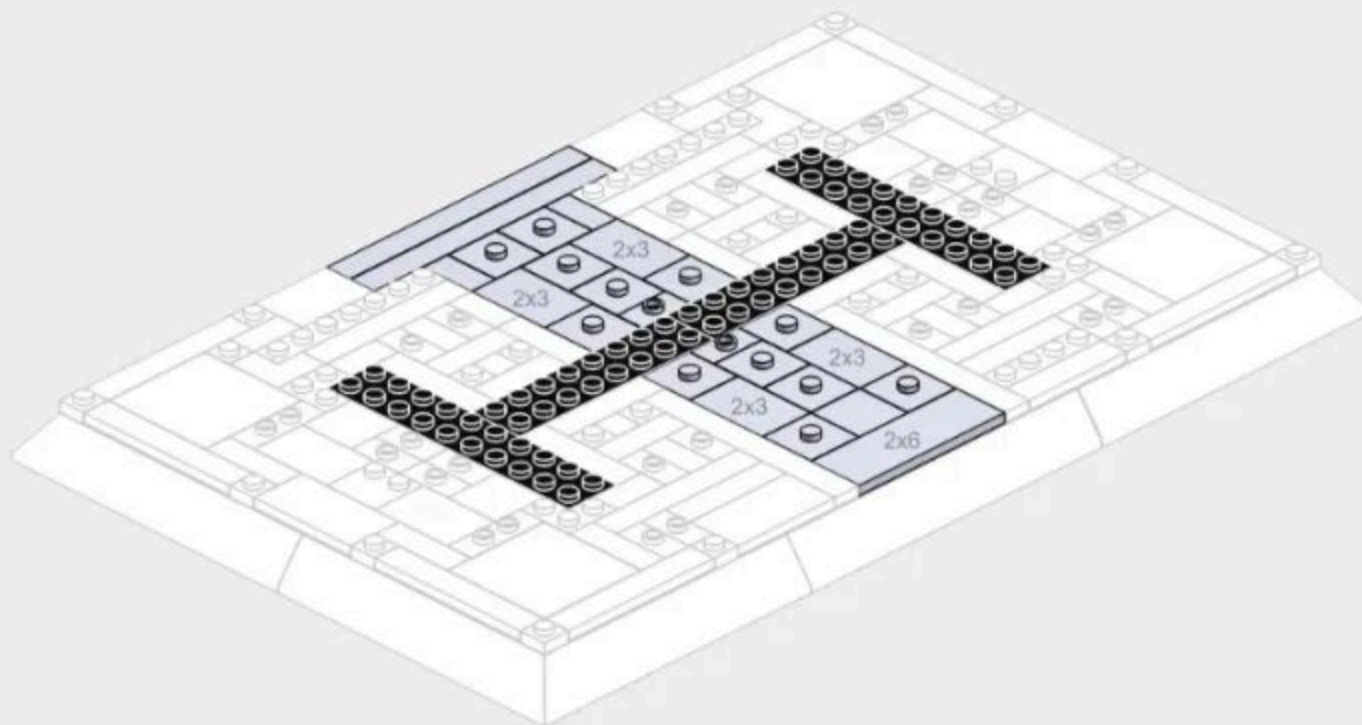
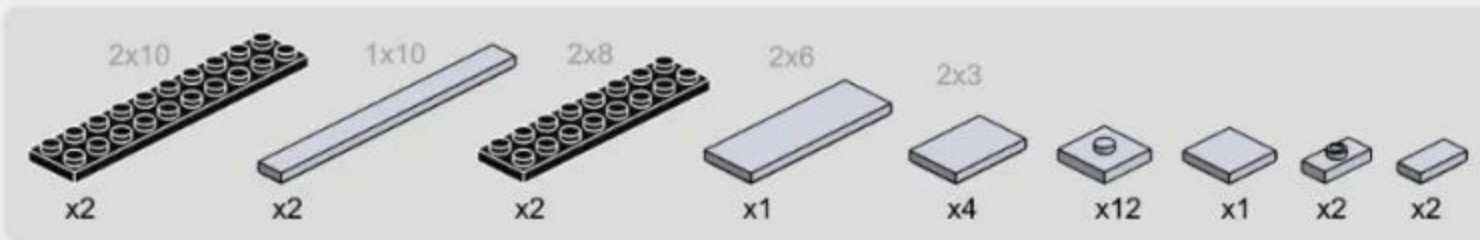

1-8

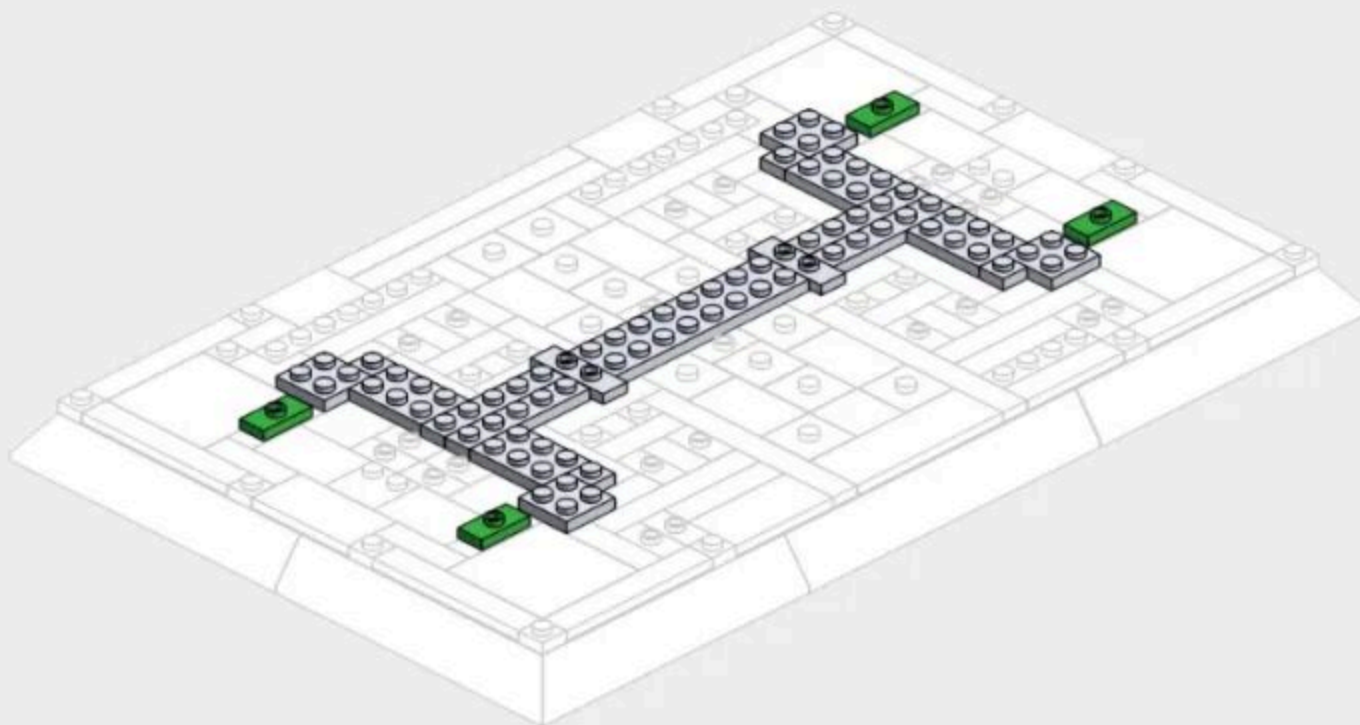

1-9



x2



x4



x2



x4



x2



x8

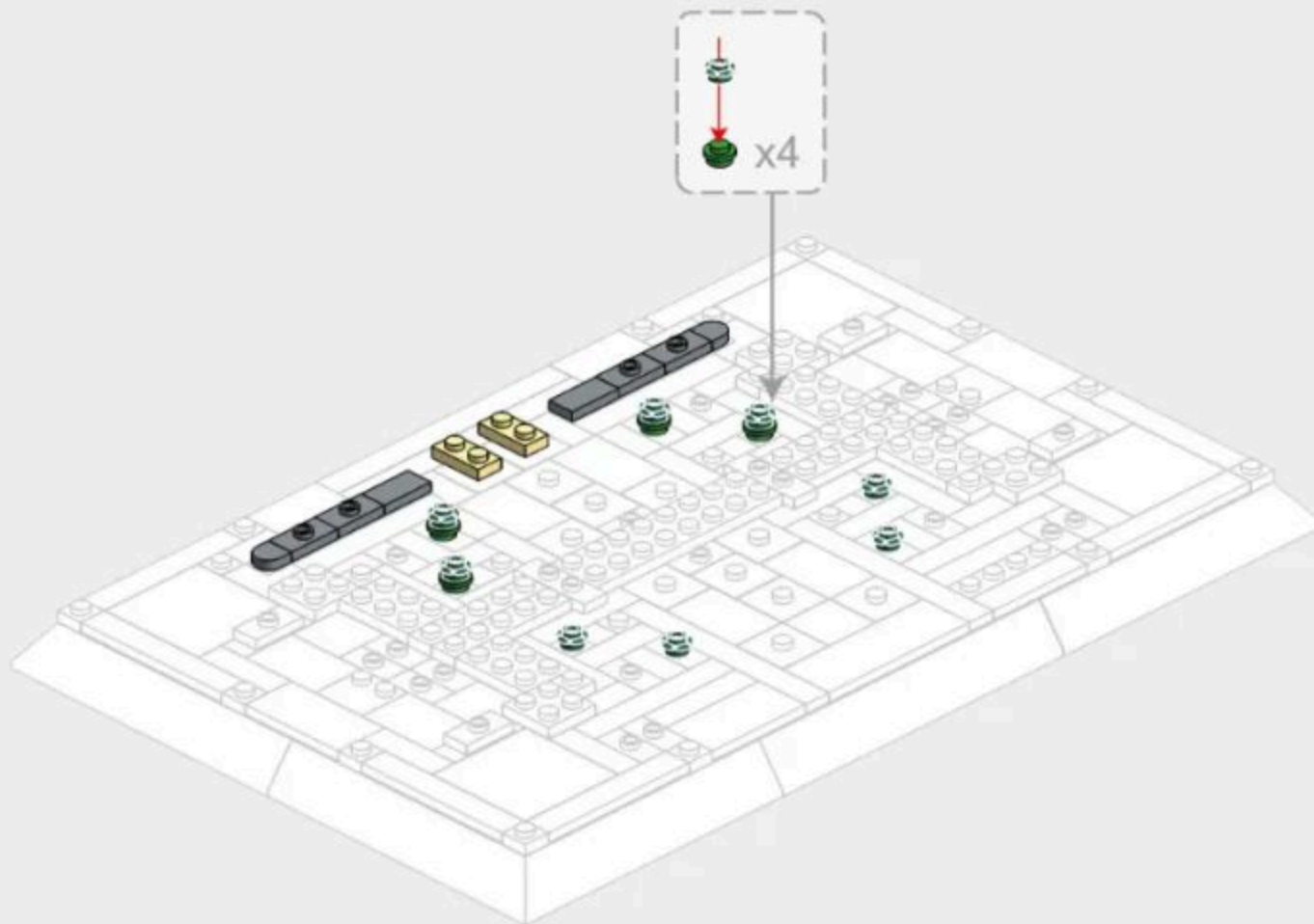

# 1-10

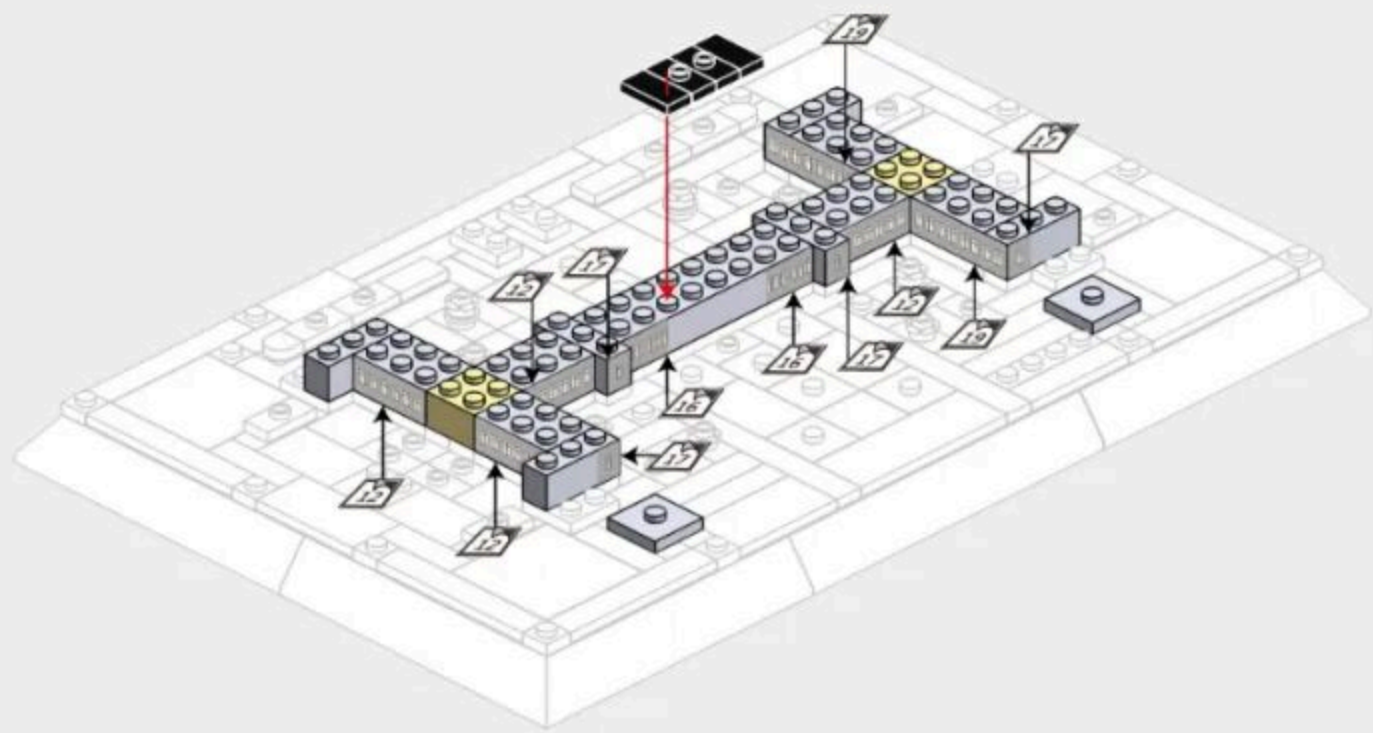
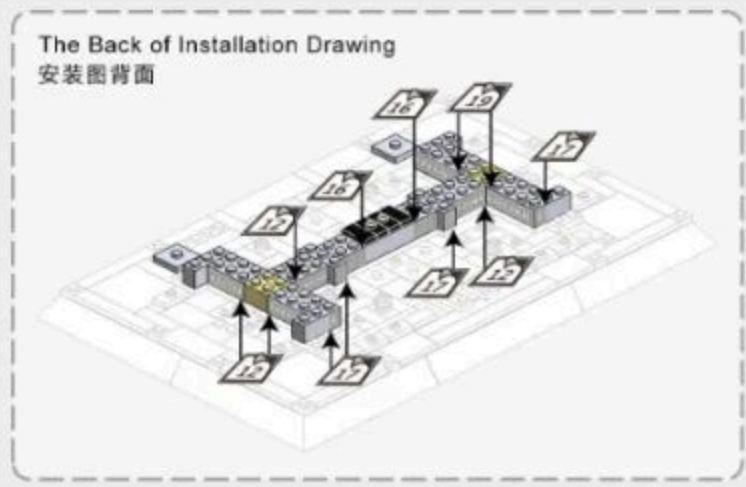
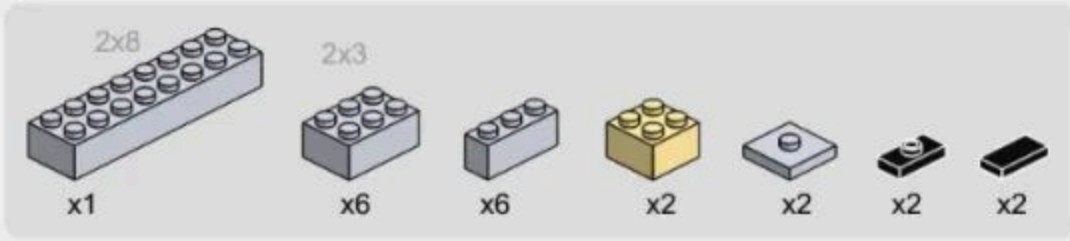

# 1-11

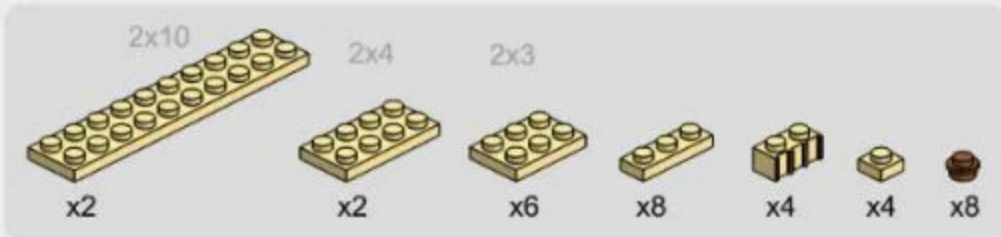



268PCS



2-1

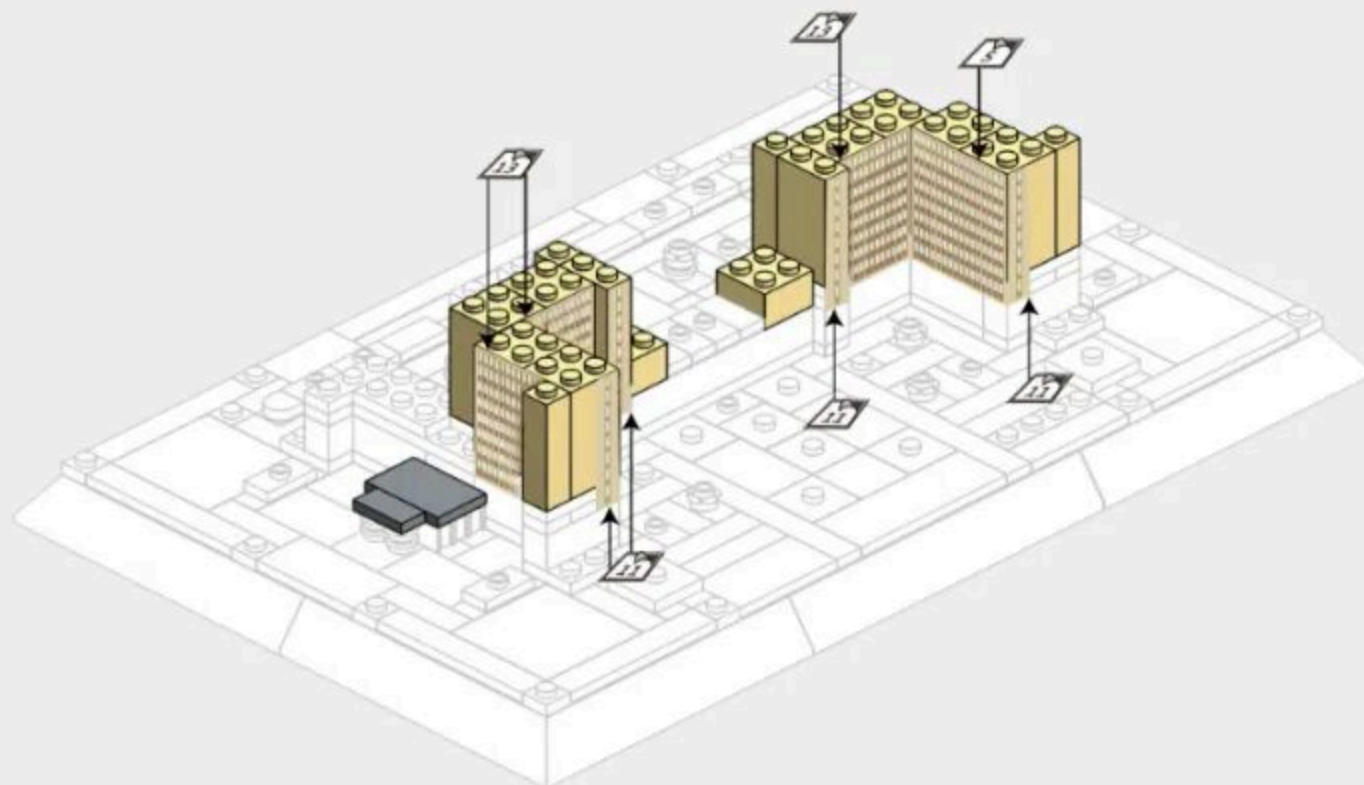
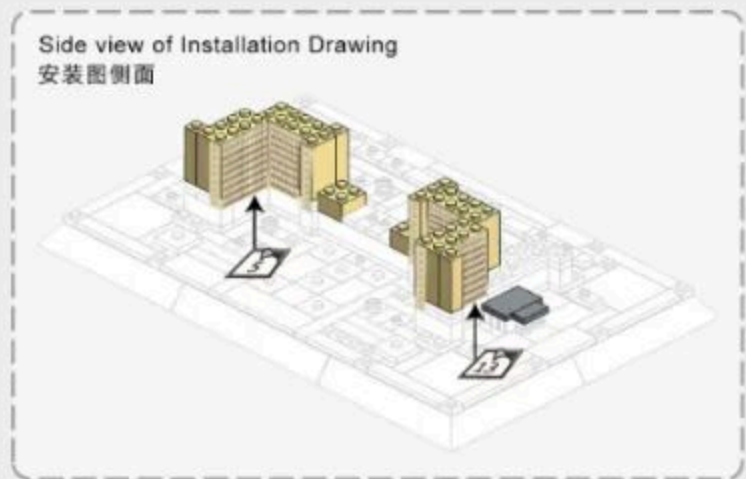



2-3

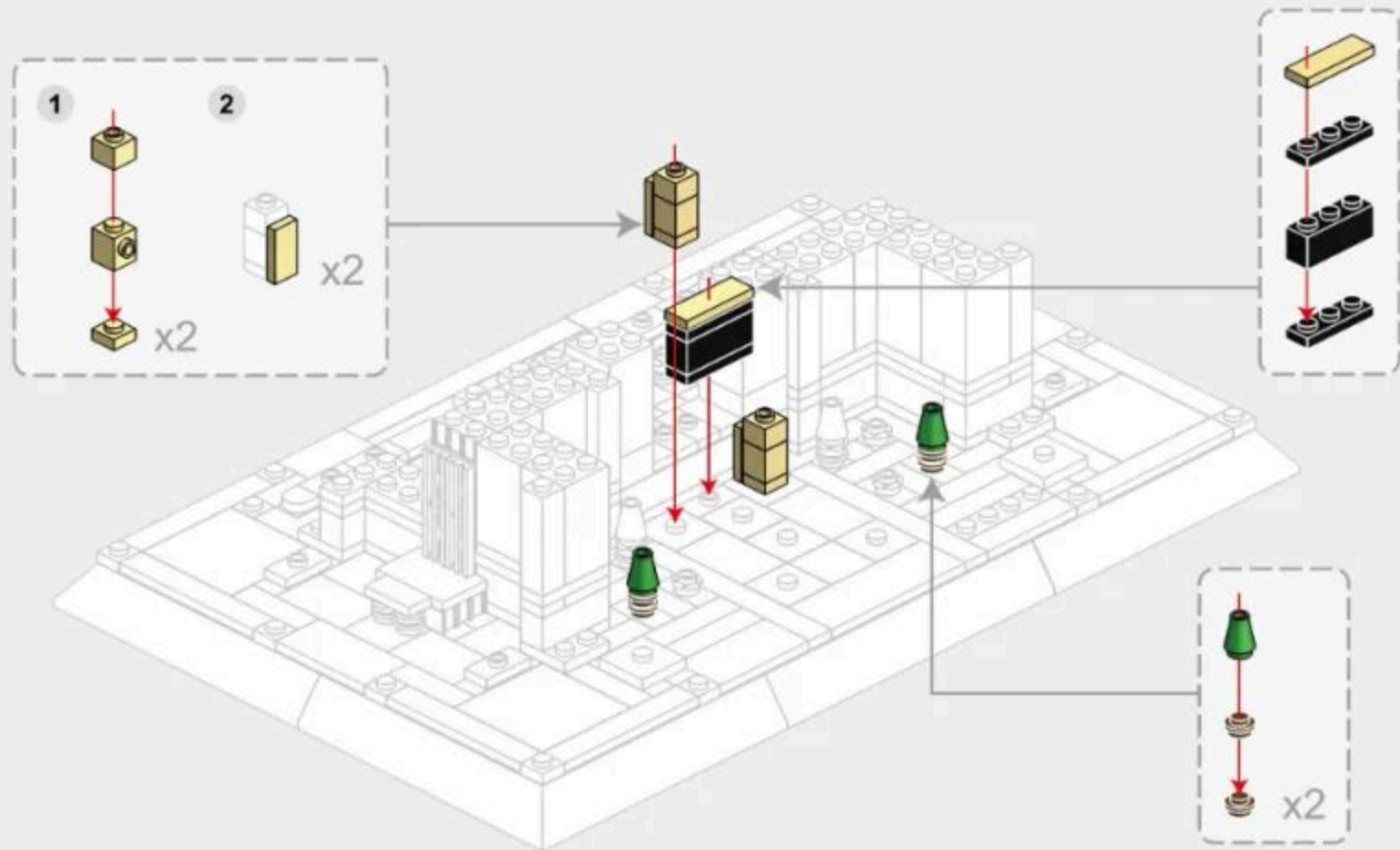

2-4

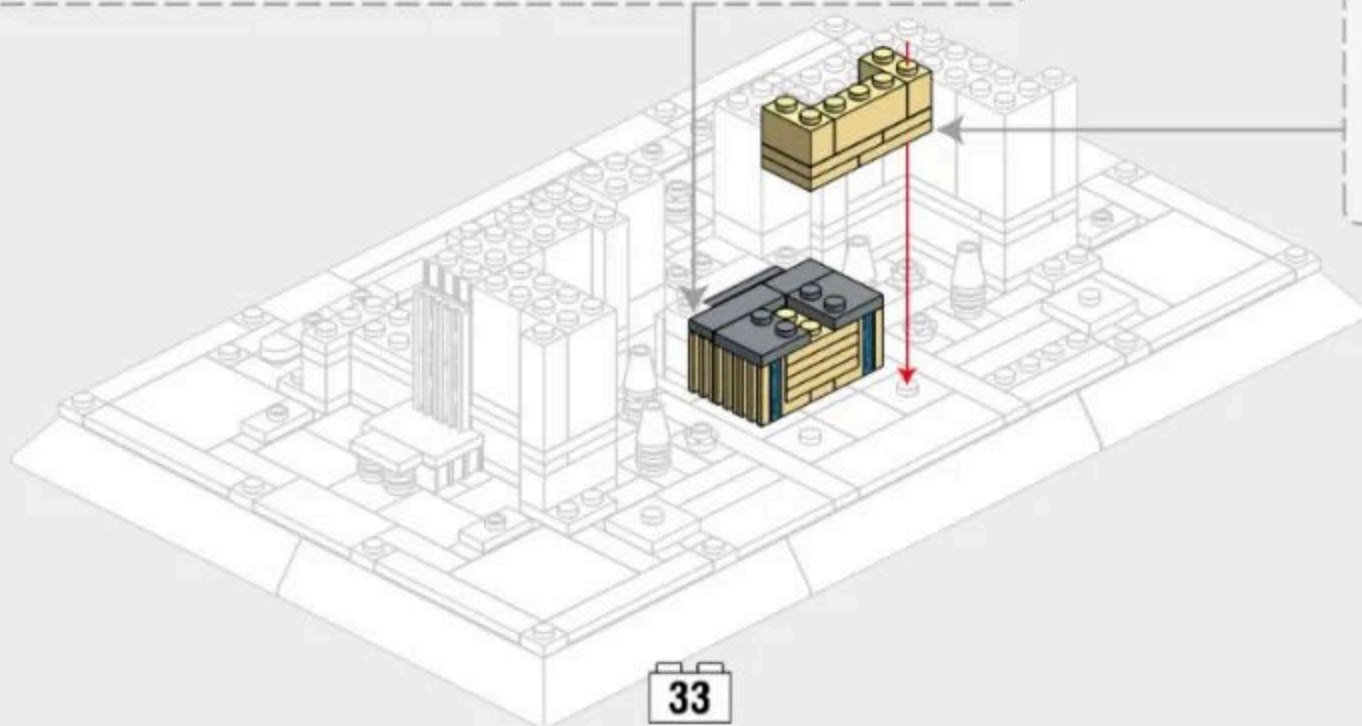
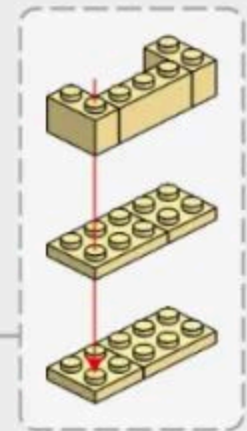
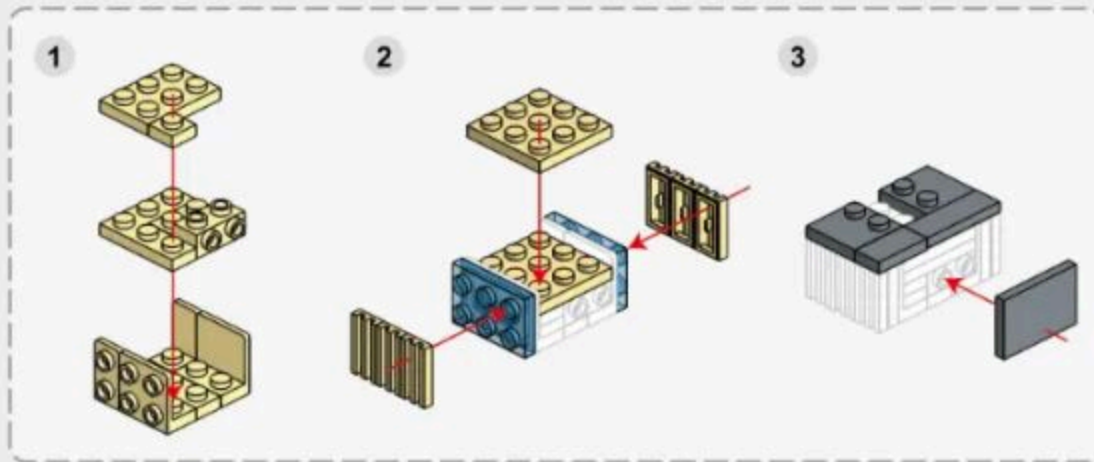
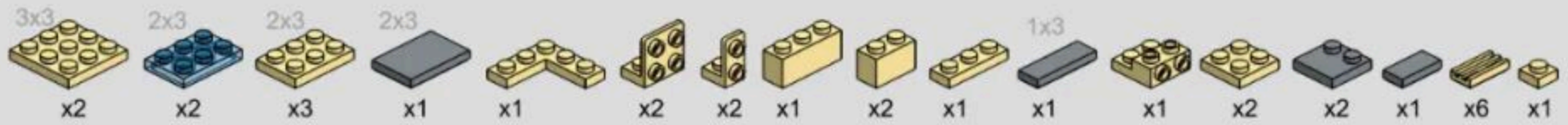

# 2-5

- 3x4 x1
- 3x3 x1
- 2x3 x1
- 1x3 x2
- Battery x9
- Grey Plate x1
- Grey L-Shape x2
- Motor x1
- Grey Plate x1
- Grey Plate x1
- Grey Plate x1
- Black Pin x9

Side view of Installation Drawing  
安装图侧面

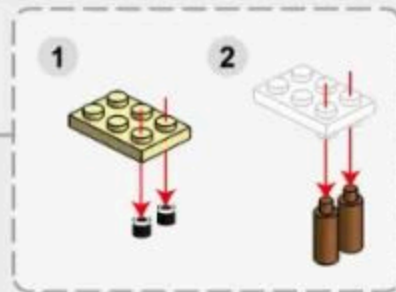
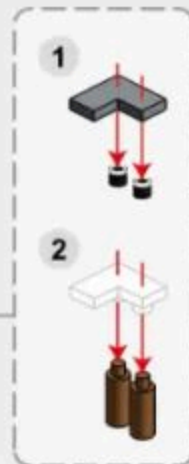
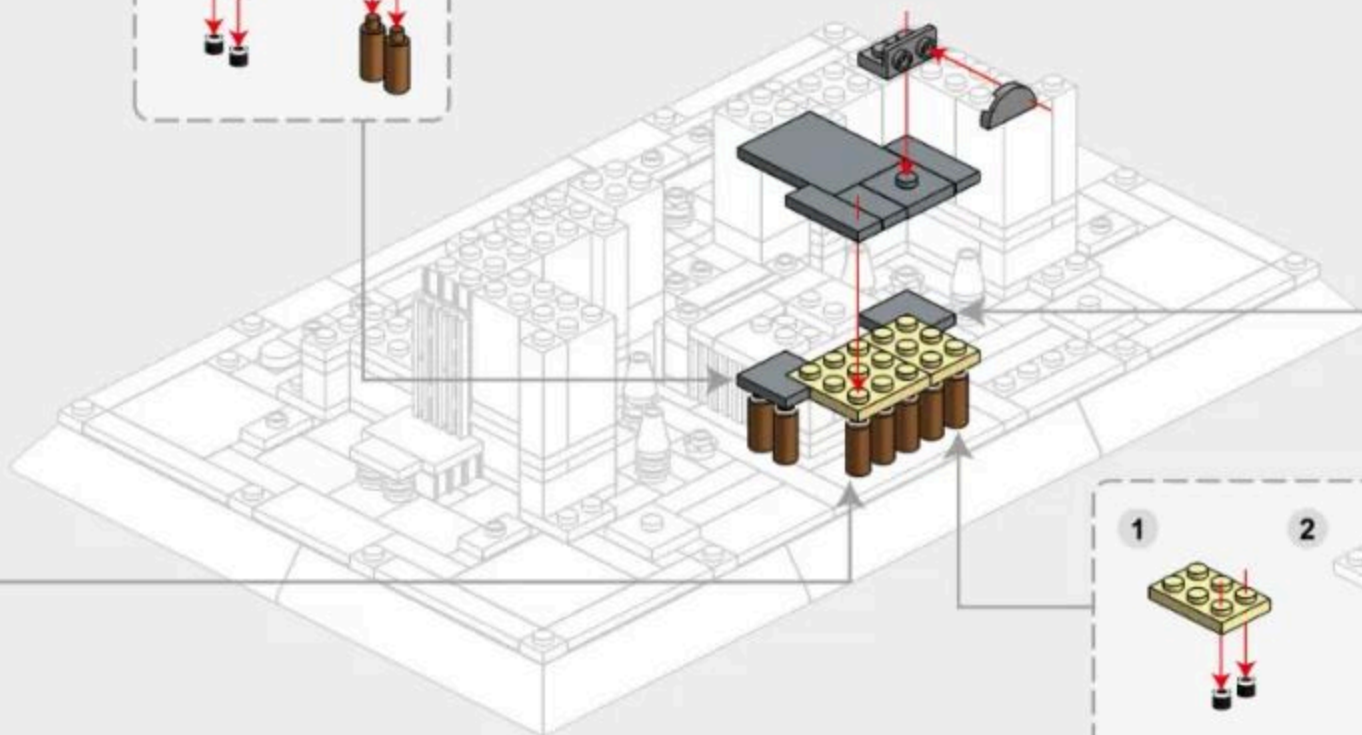
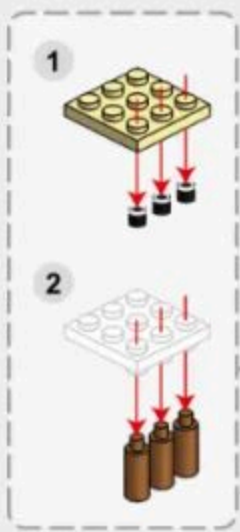
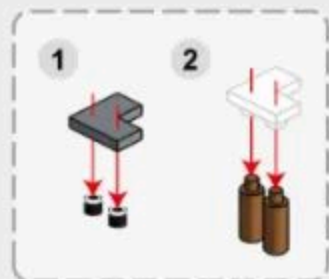

# 2-6

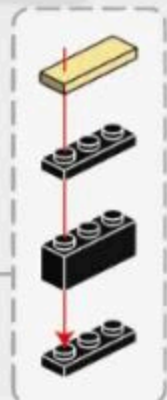
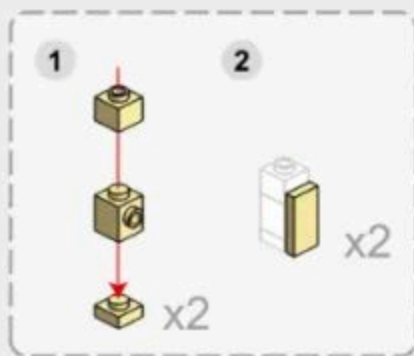
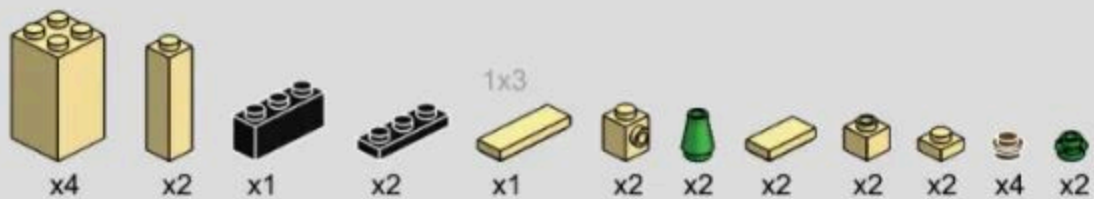

Side view of Installation Drawing  
安装图侧面

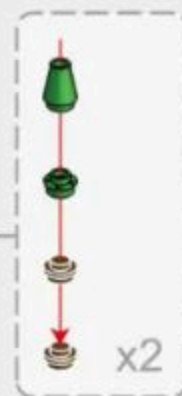
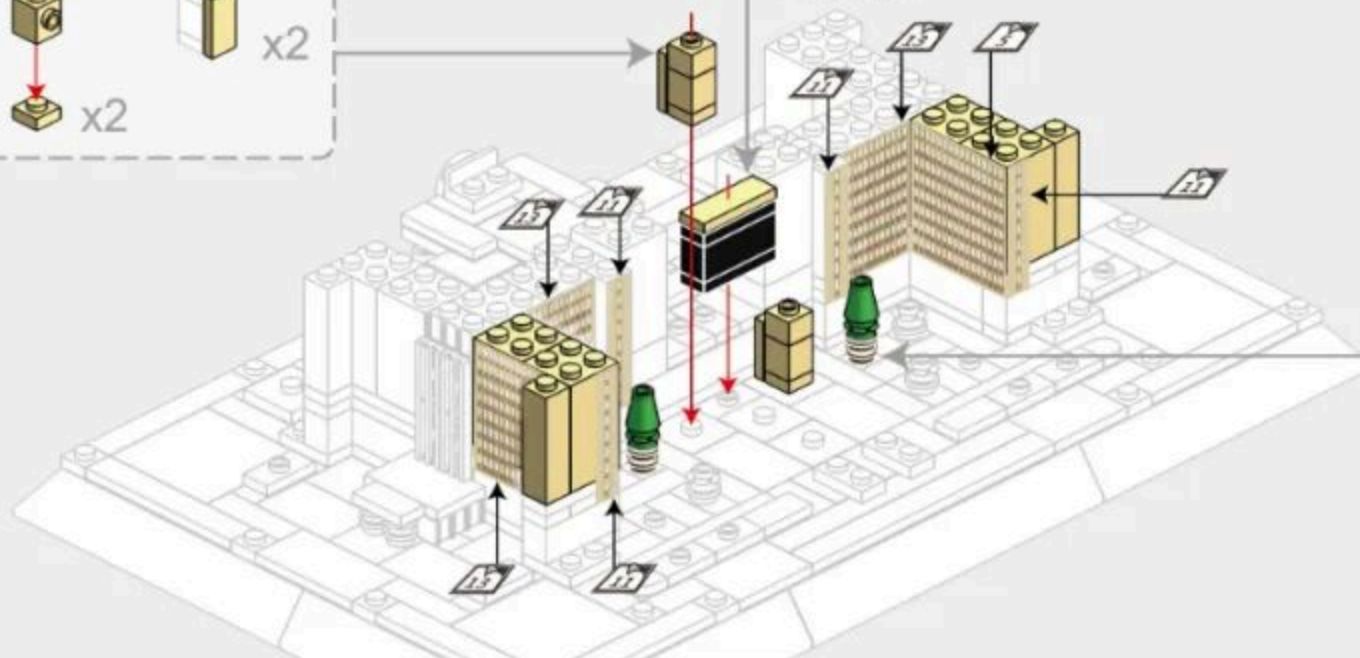
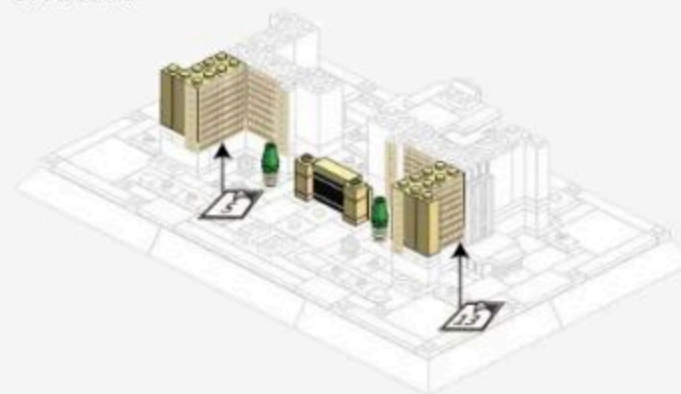



2-8

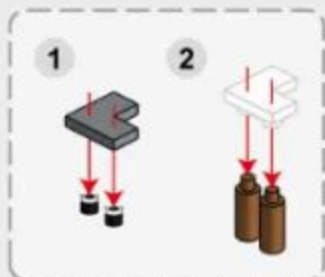

Side view of Installation Drawing  
安装图侧面

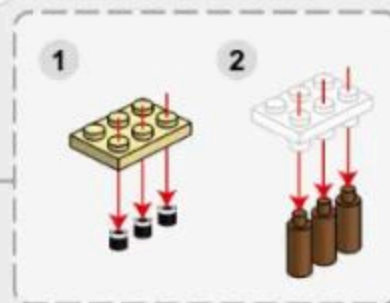
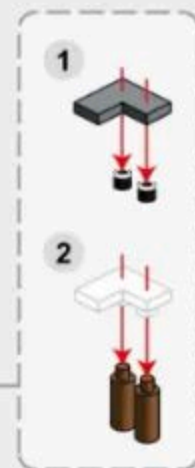
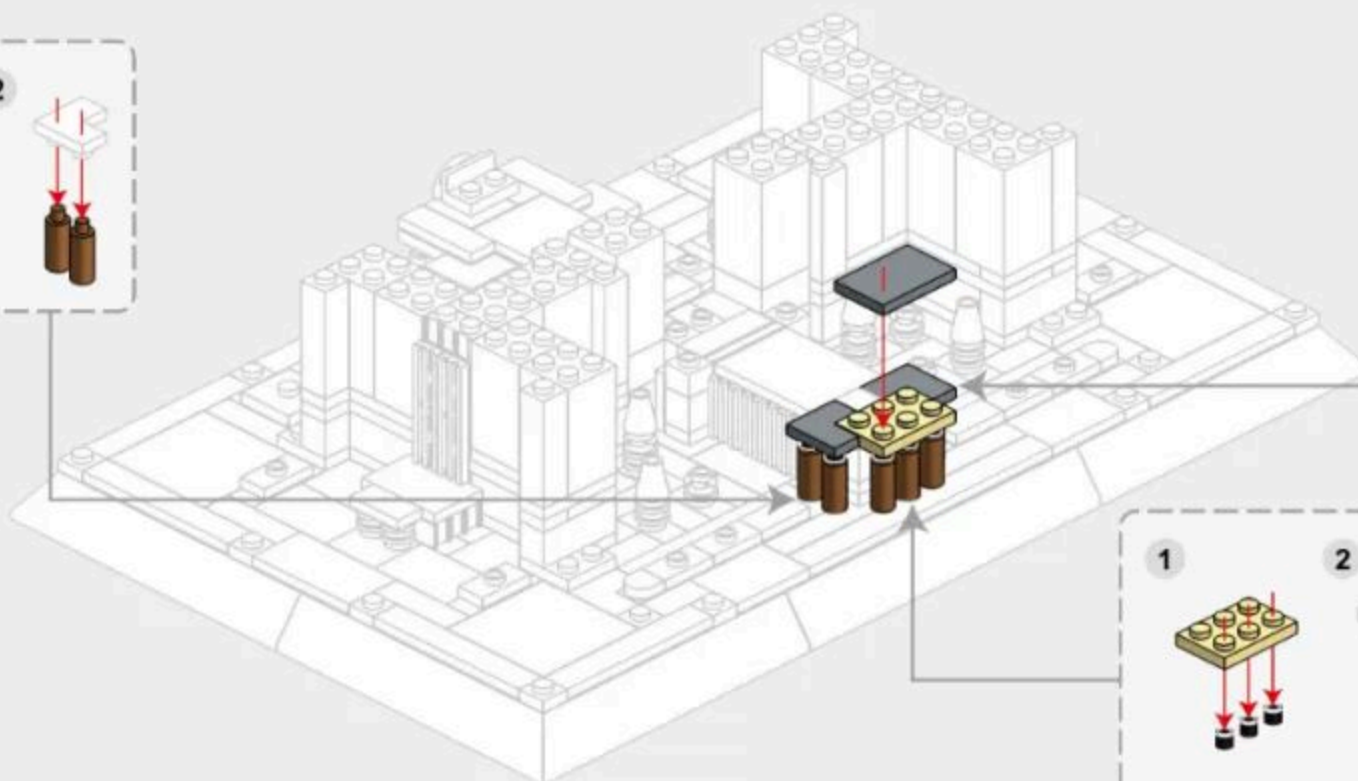
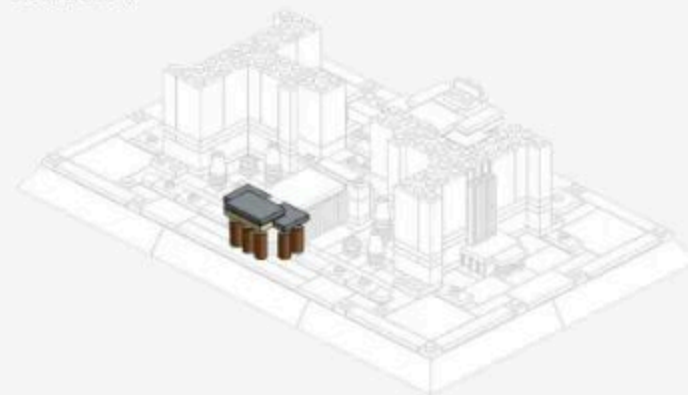

2-9

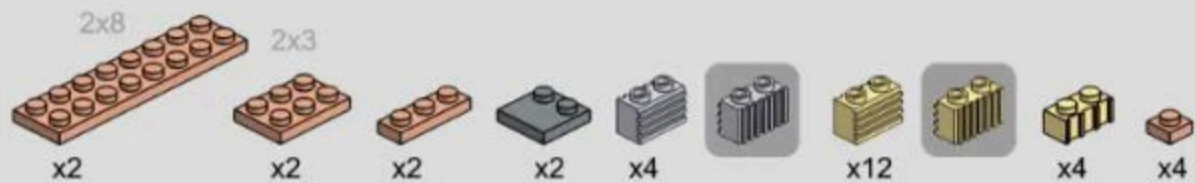

The Back of Installation Drawing  
安装图背面

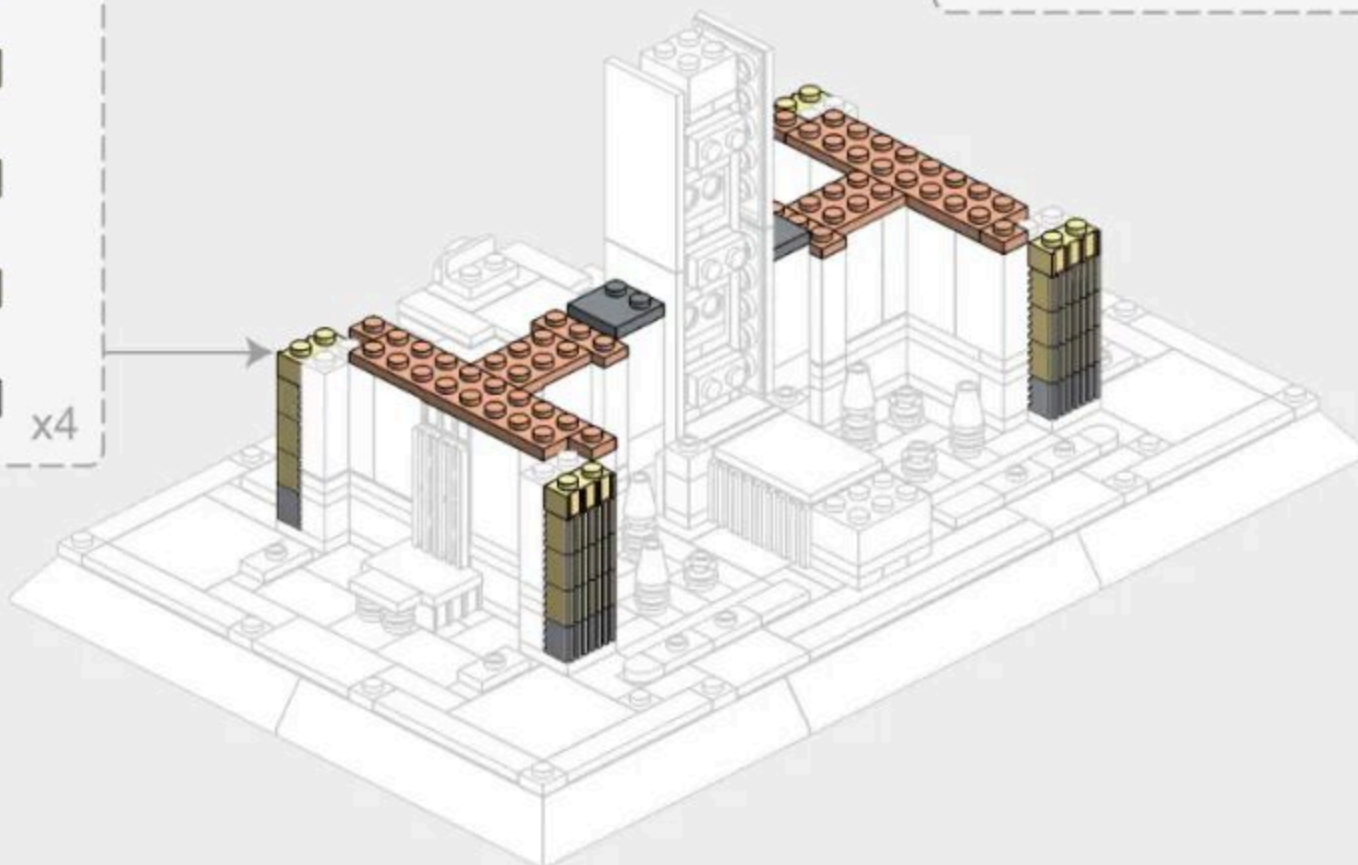
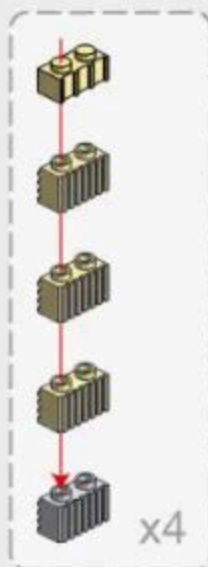

# 2-10

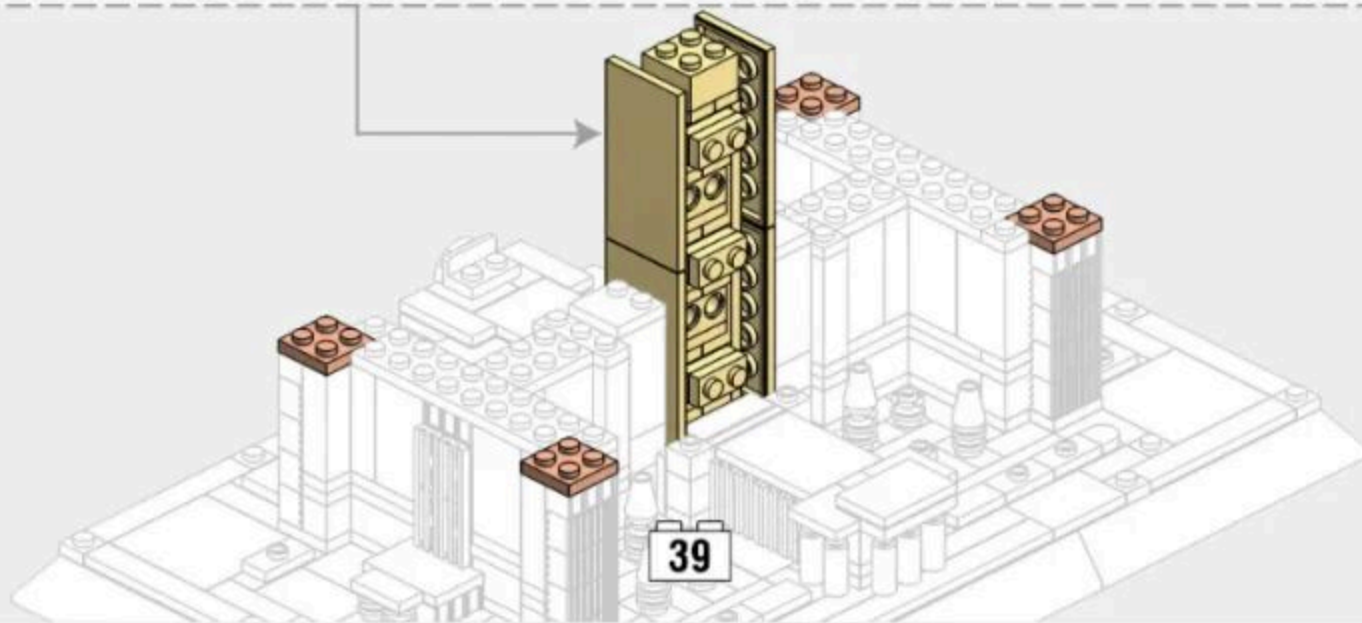
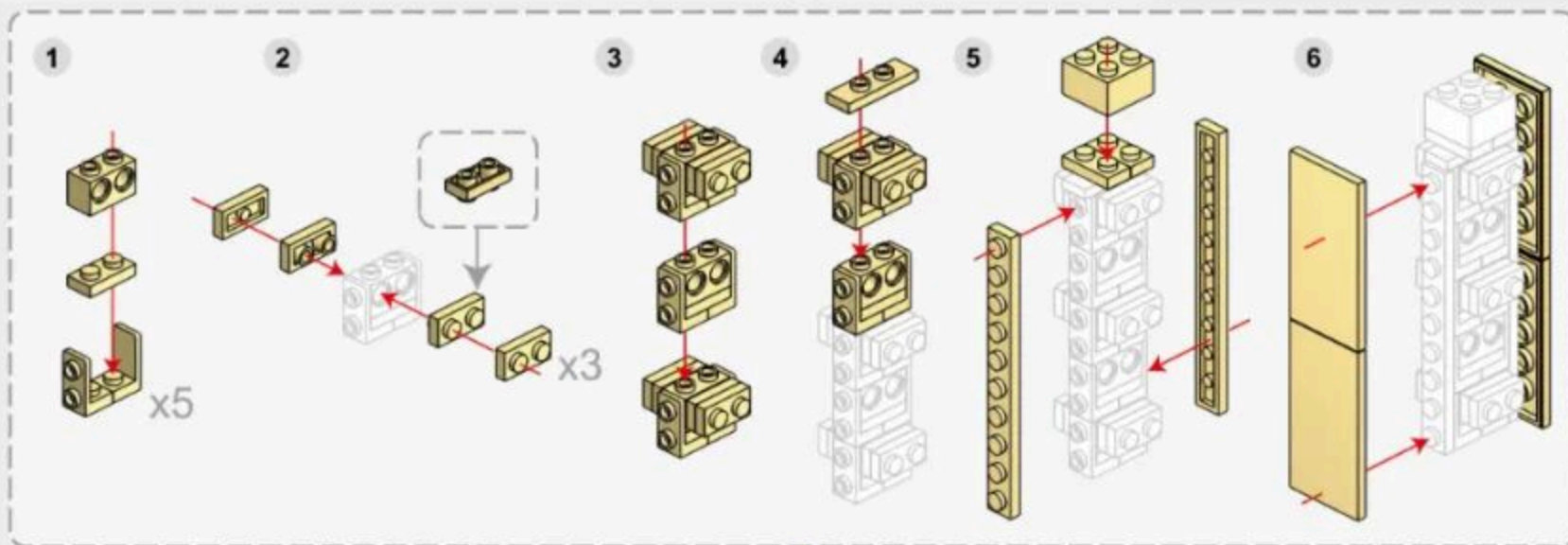



221 PCS

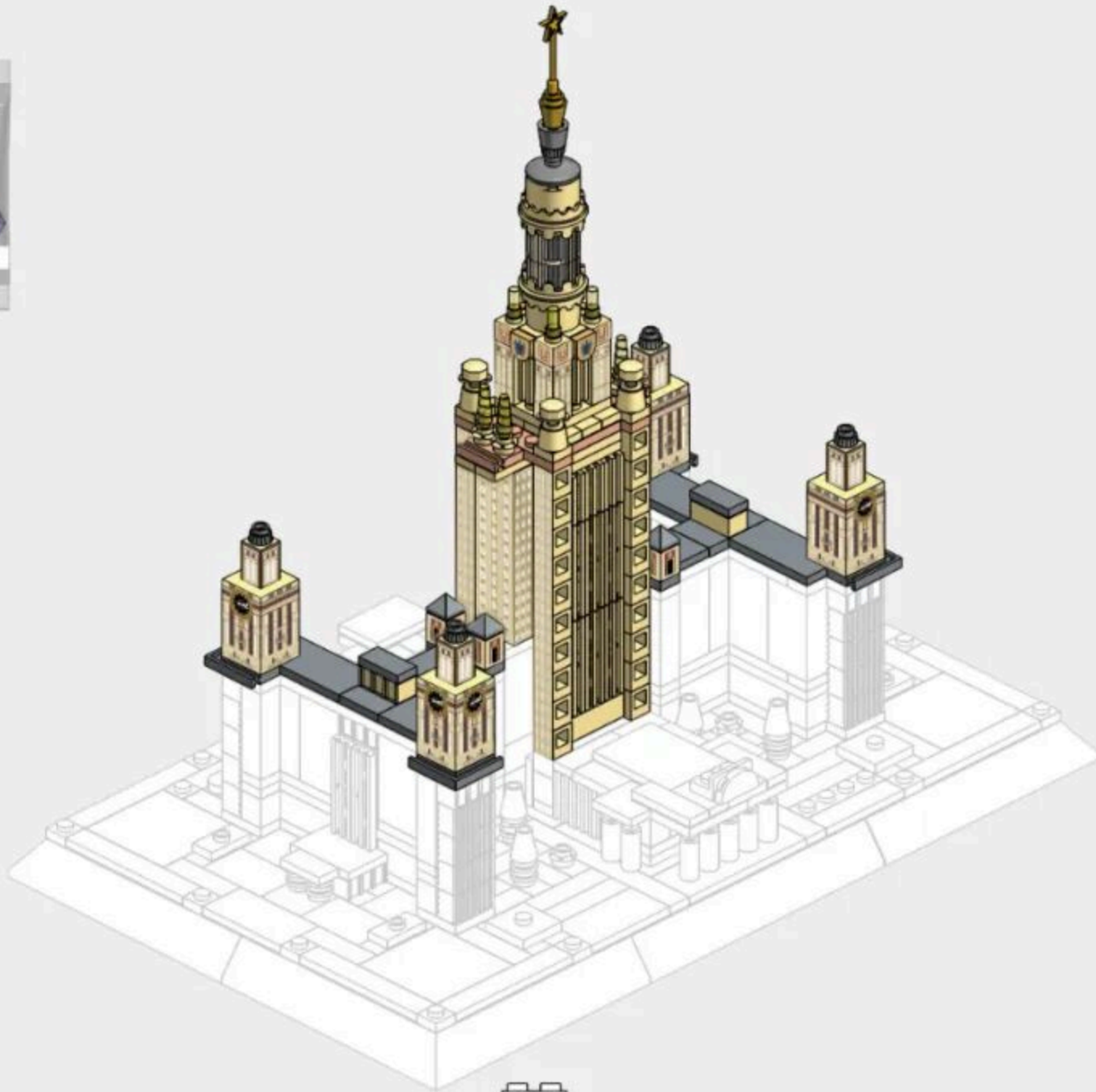





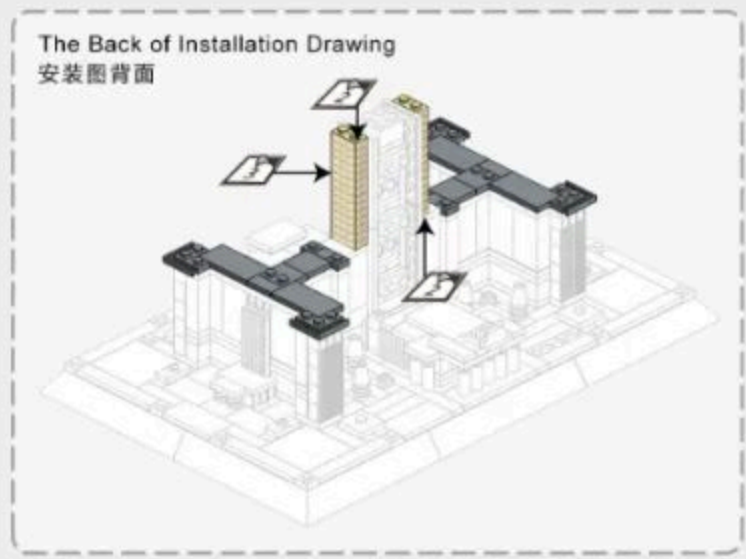
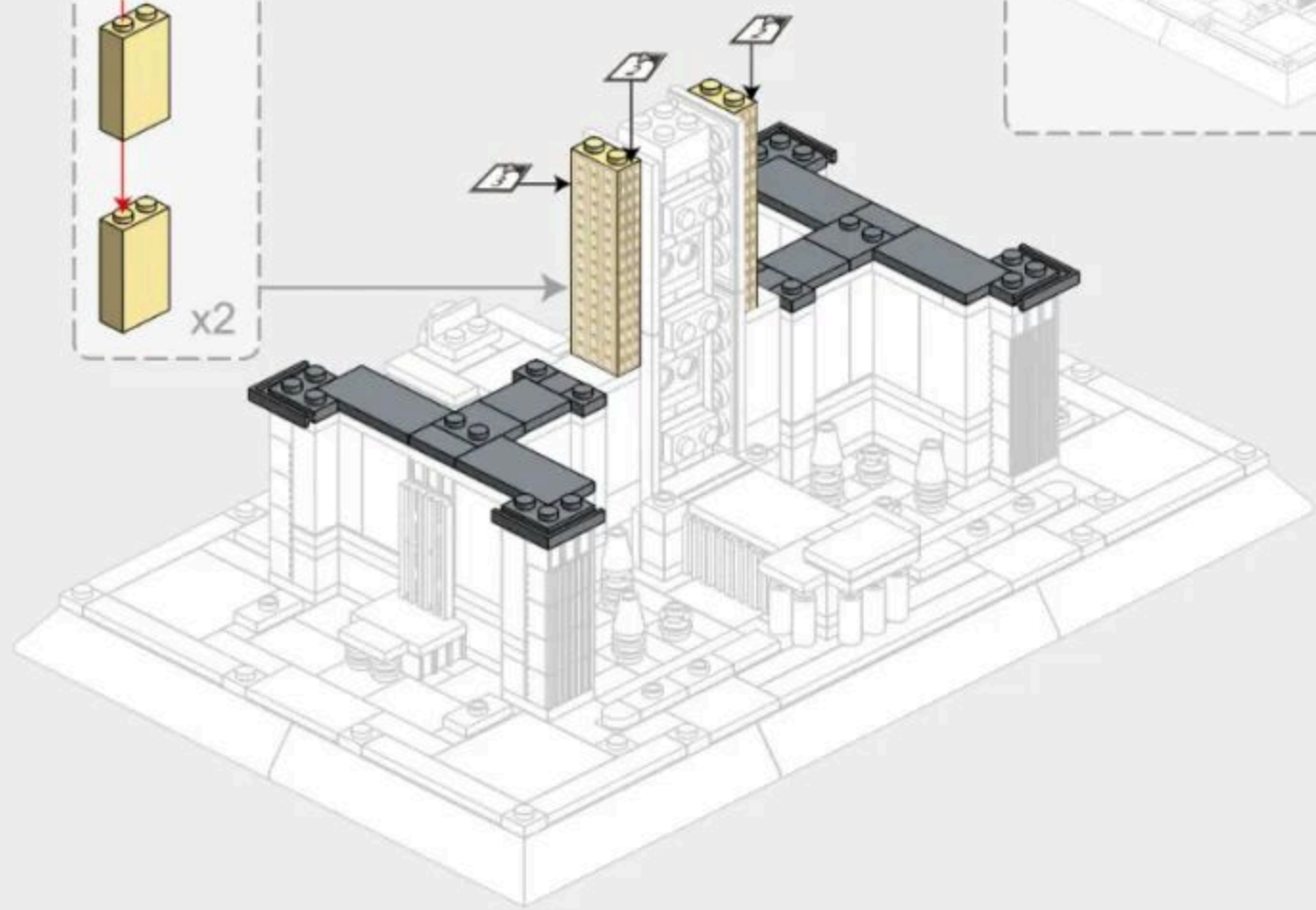
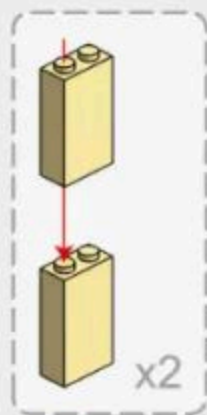
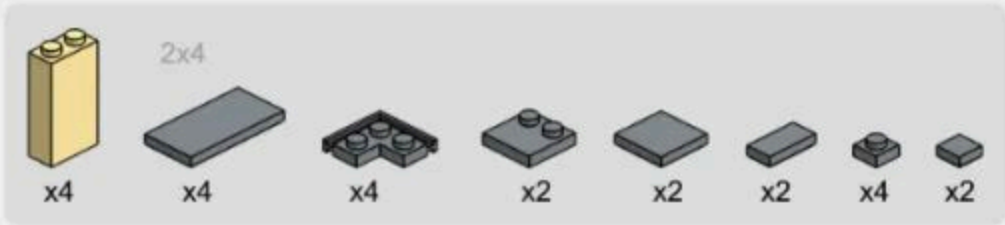



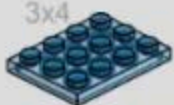
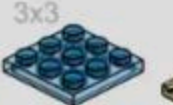

40





# 3-1

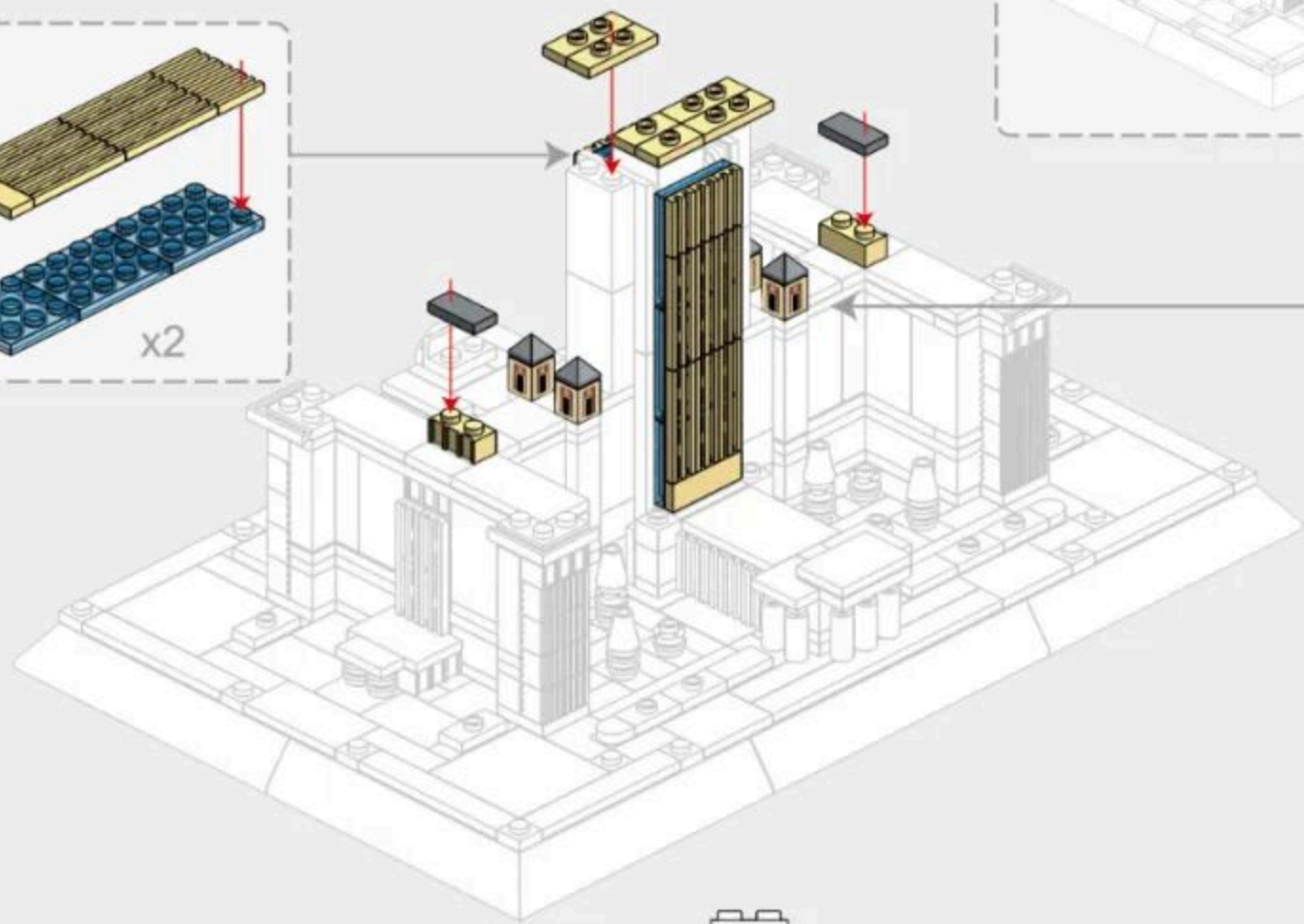
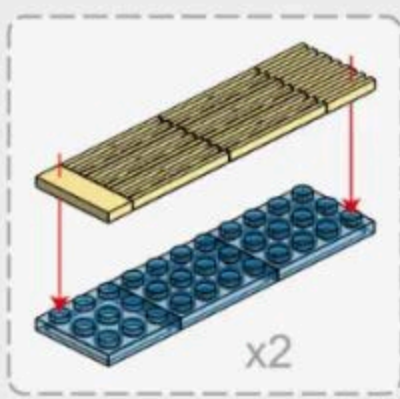
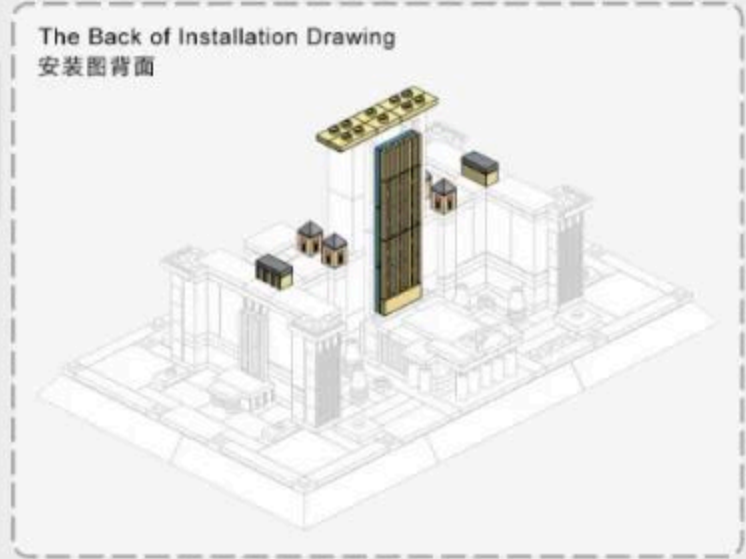

# 3-2

-   
 3x4  
 x4
-   
 3x3  
 x2
-   
 x12
-   
 x4
-   
 1x3  
 x2
-   
 x4
-   
 x2
-   
 x2
-   
 x6
-   
 x2
-   
 x4



- 1
  - 
  -  x4
- 2
  - 
  -  x4

### 3-3

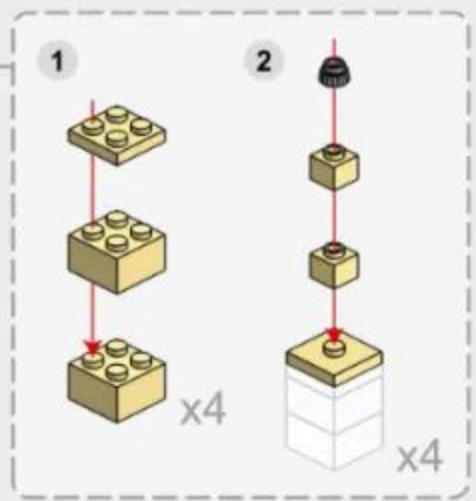
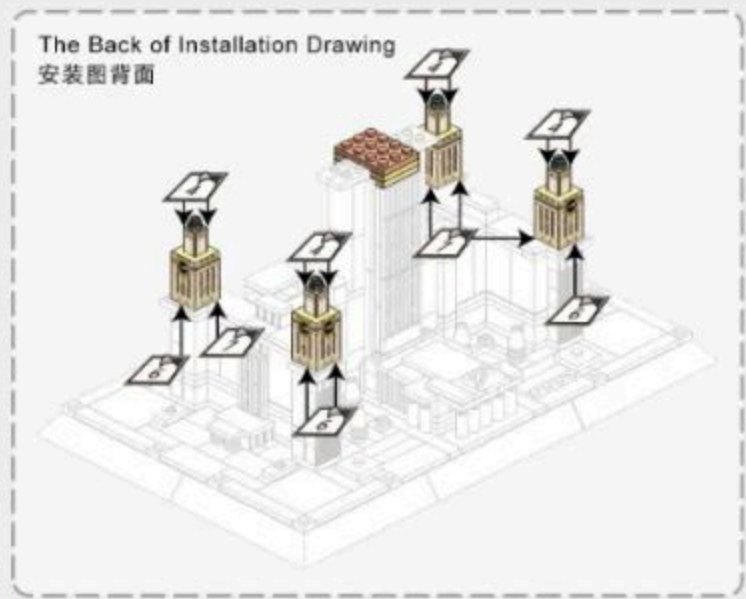
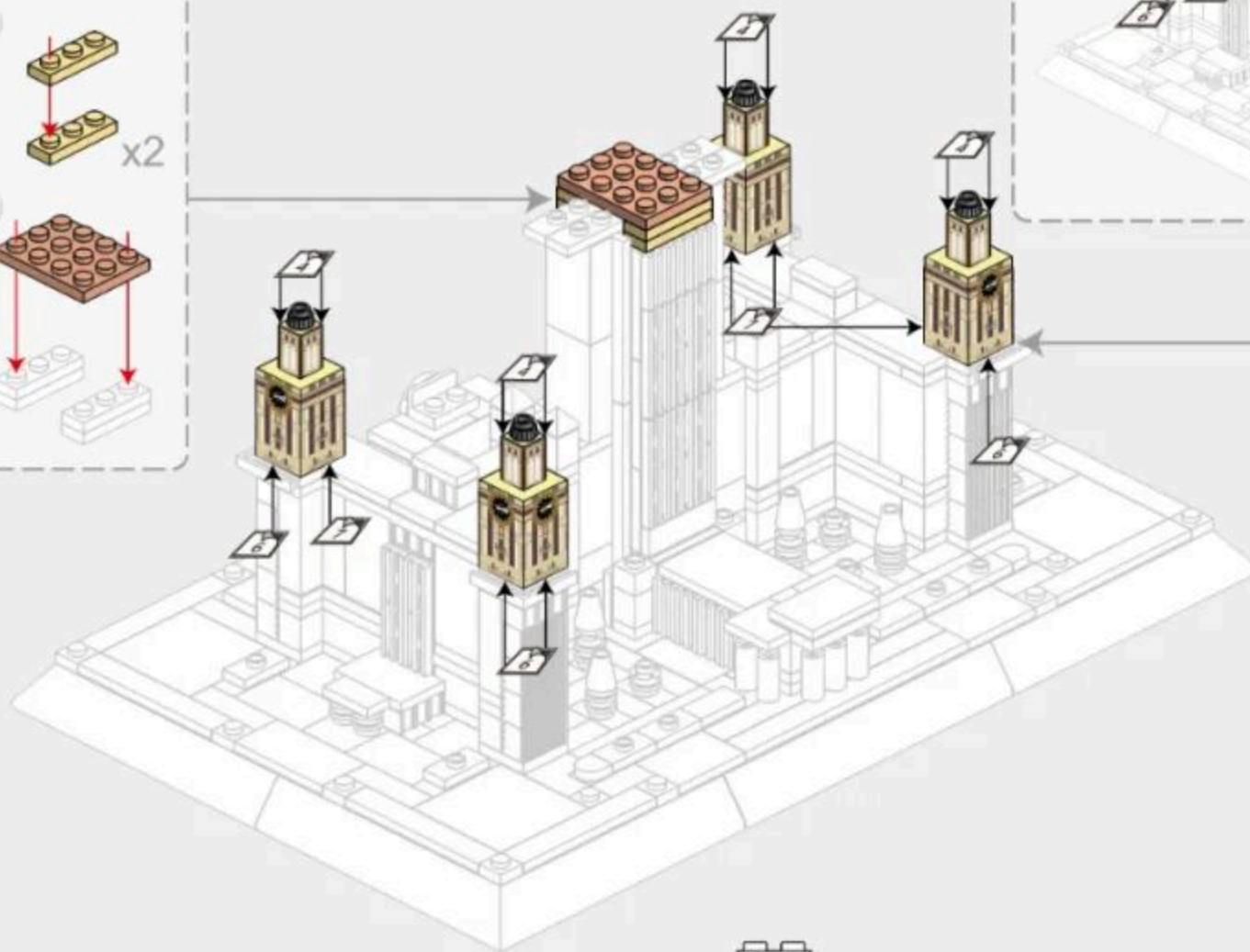
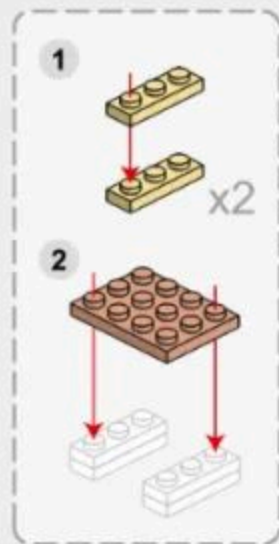

3-4

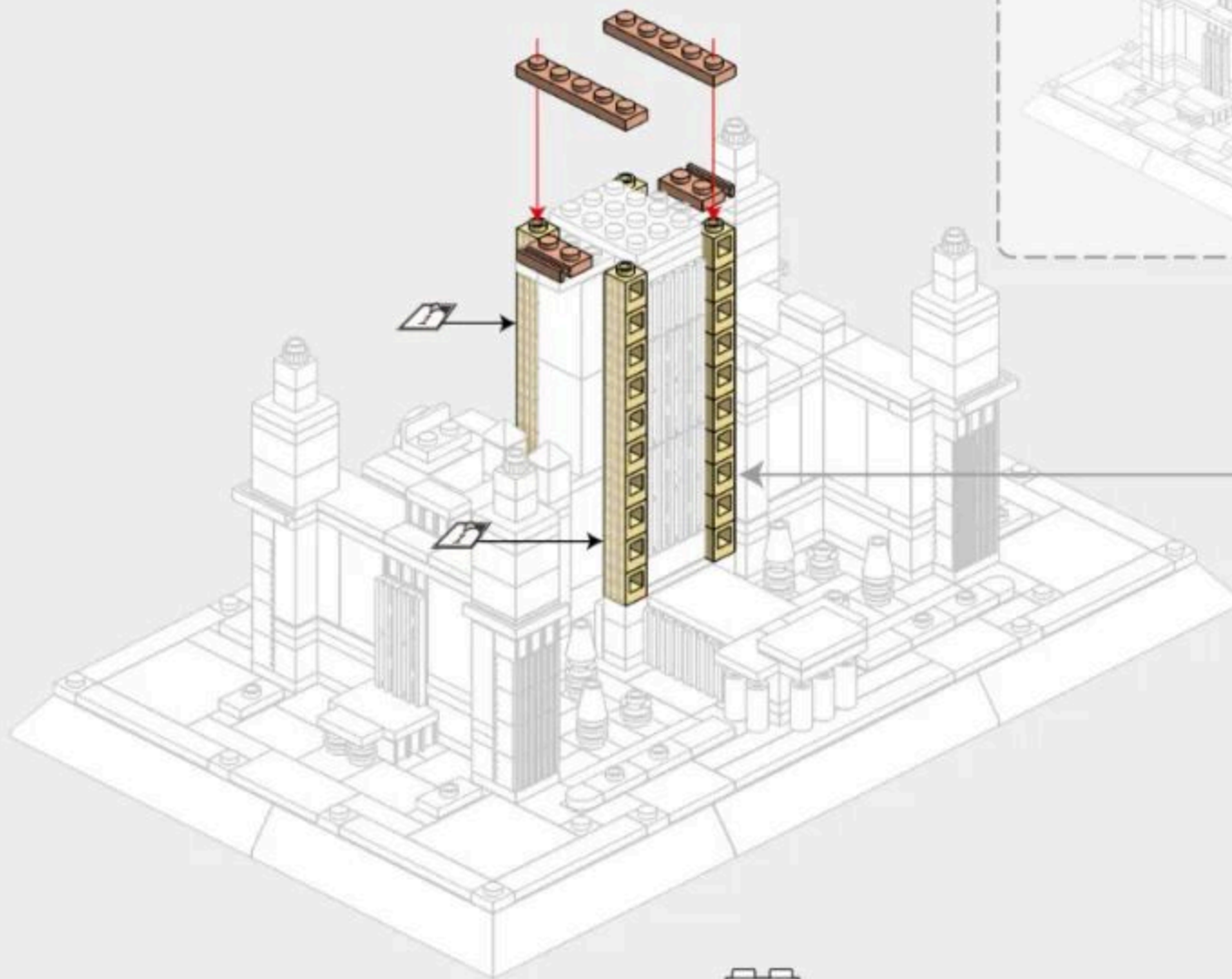

The Back of Installation Drawing  
安装图背面

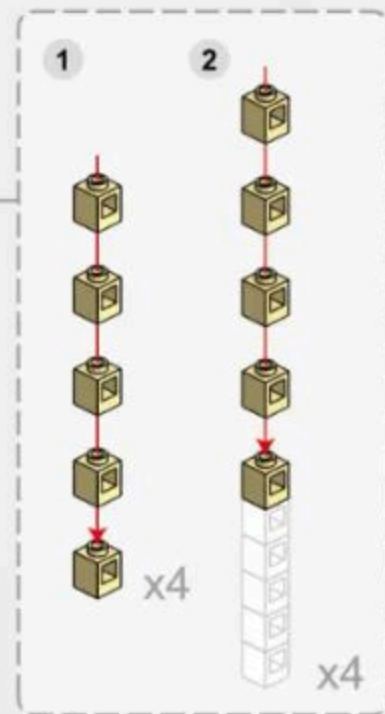
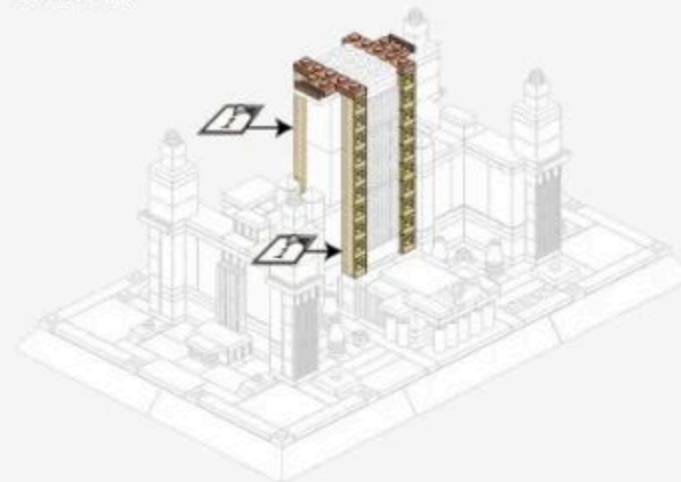

3-5



x4



x6



x4



x4

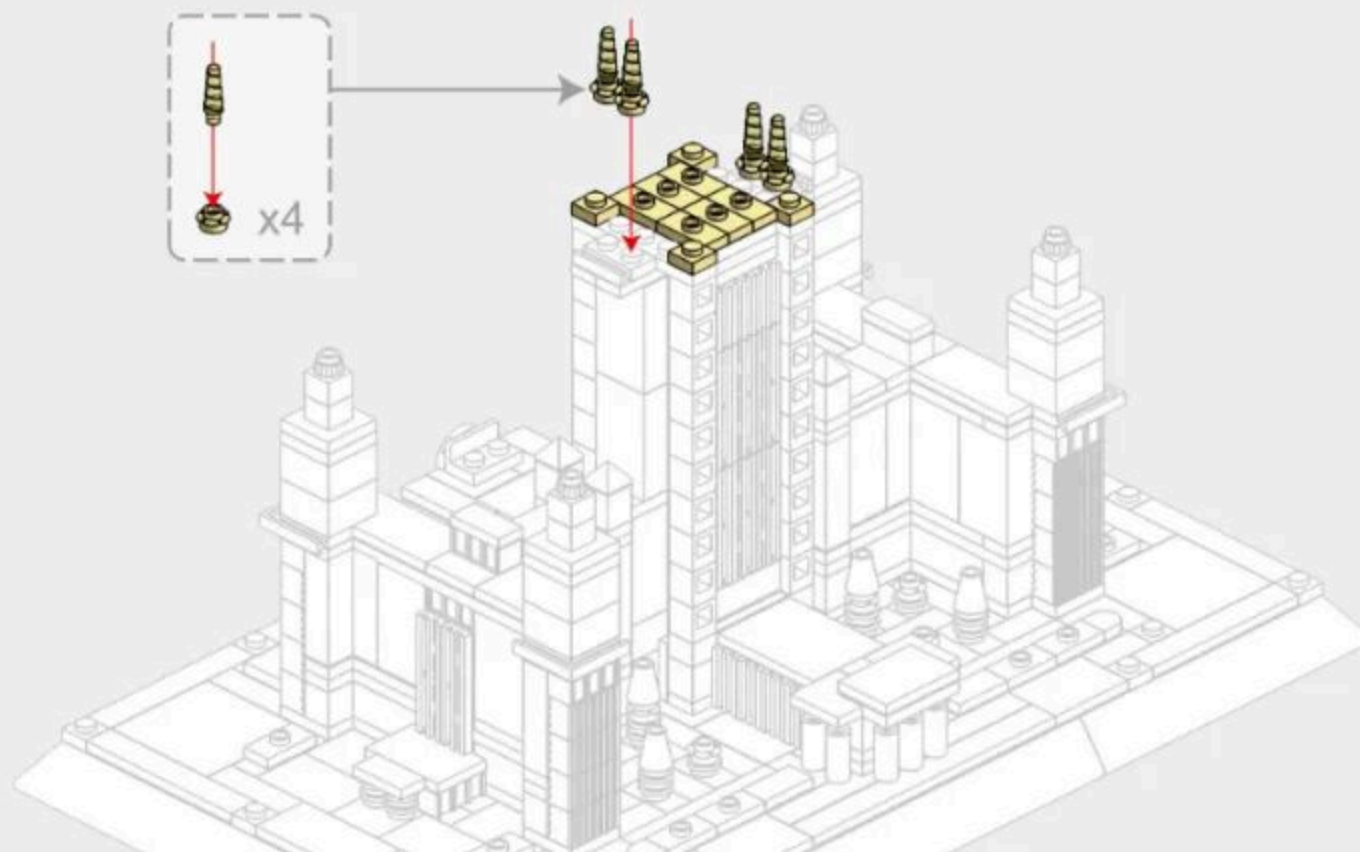

# 3-6

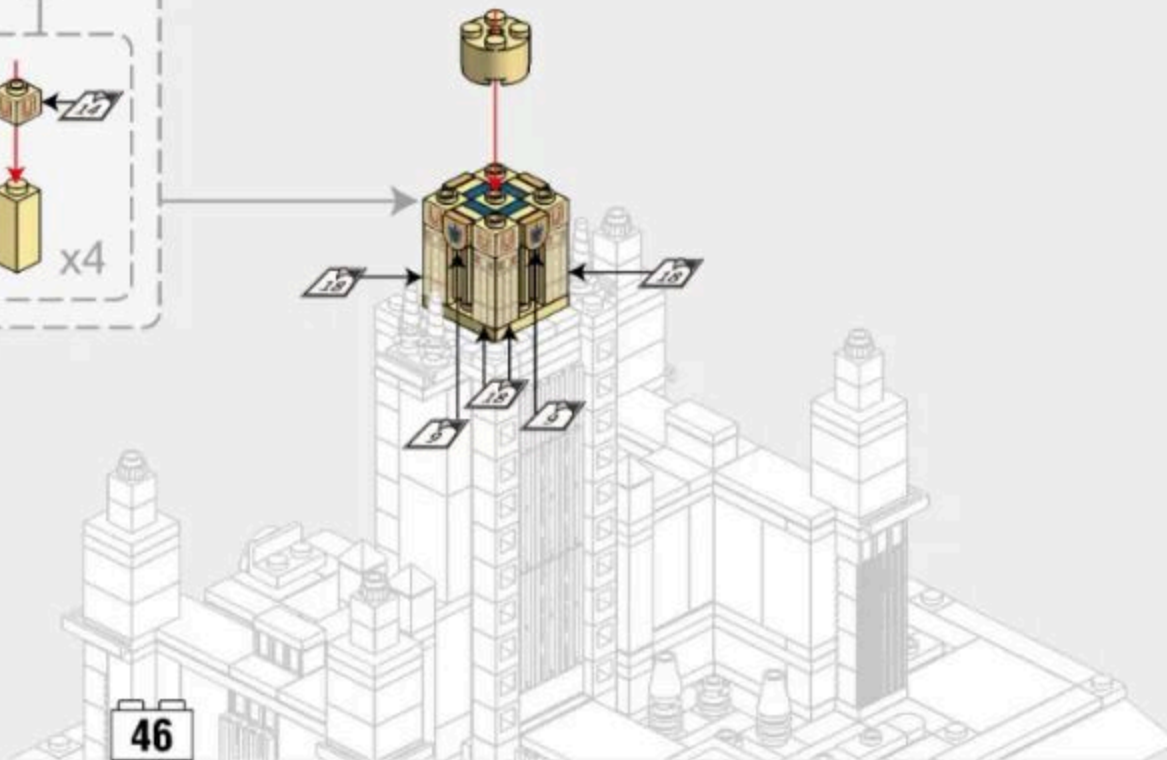
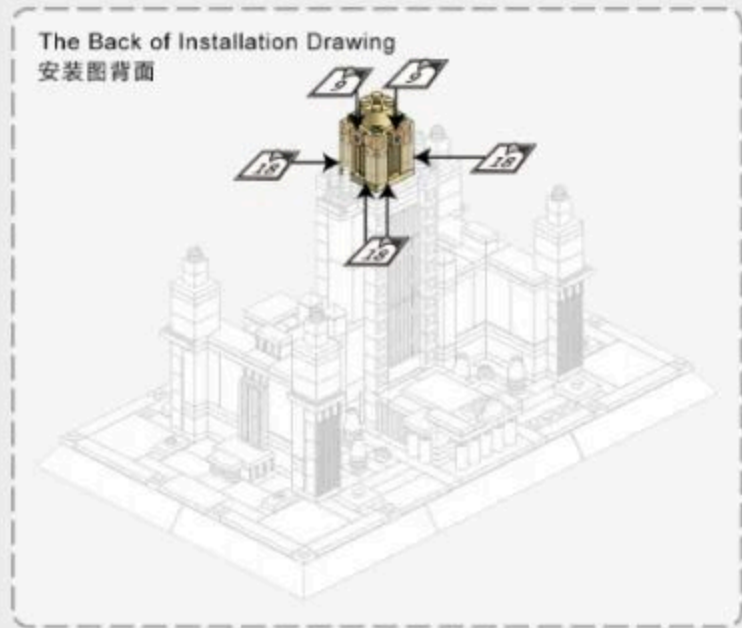
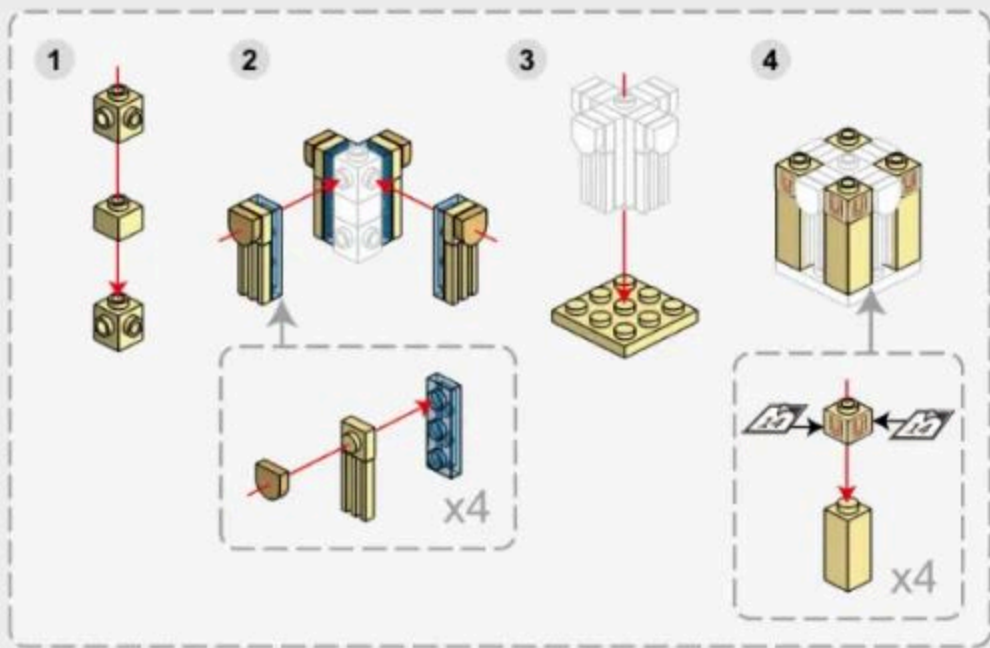

3-7



x4



x4



x4



x4

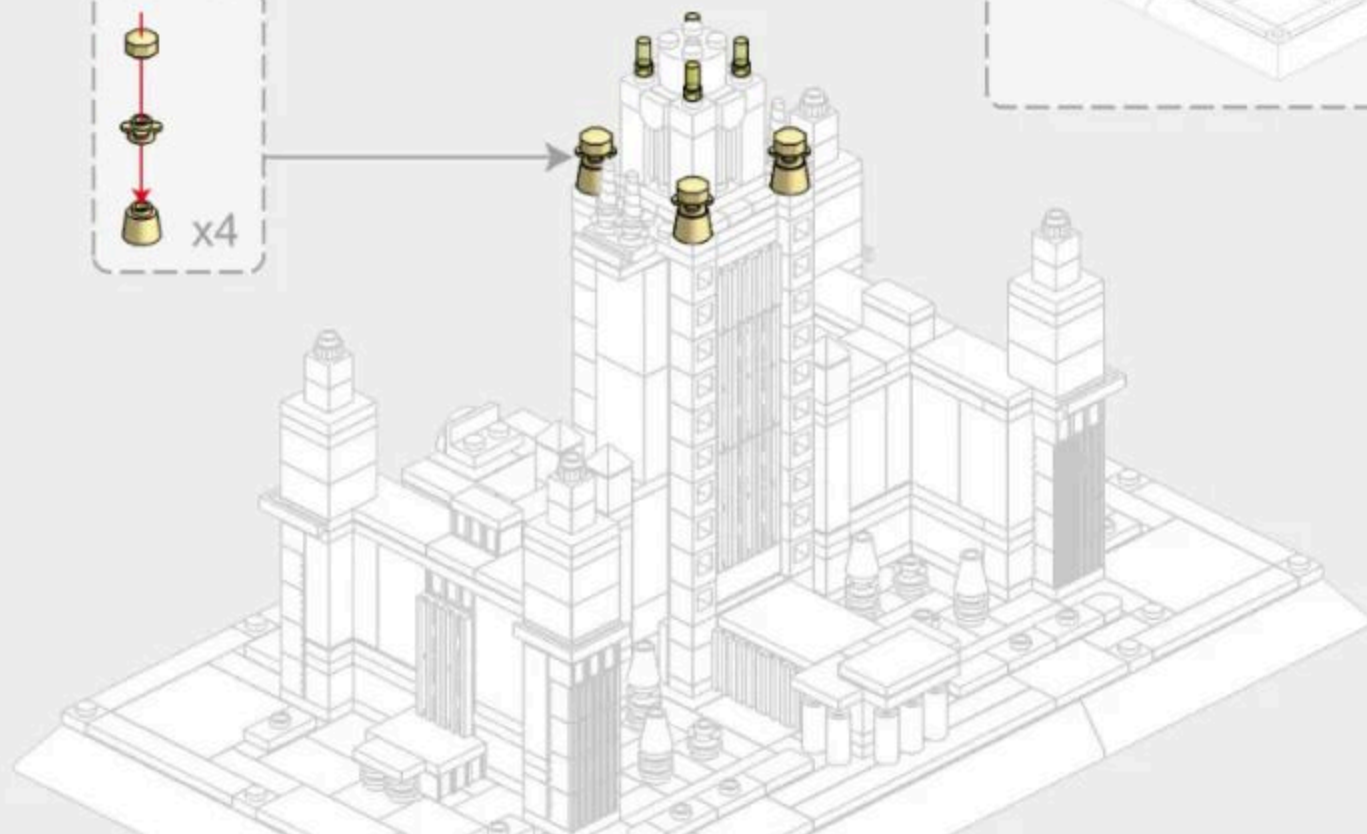
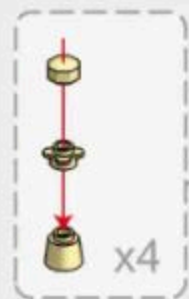

The Back of Installation Drawing  
安装图背面



3-8

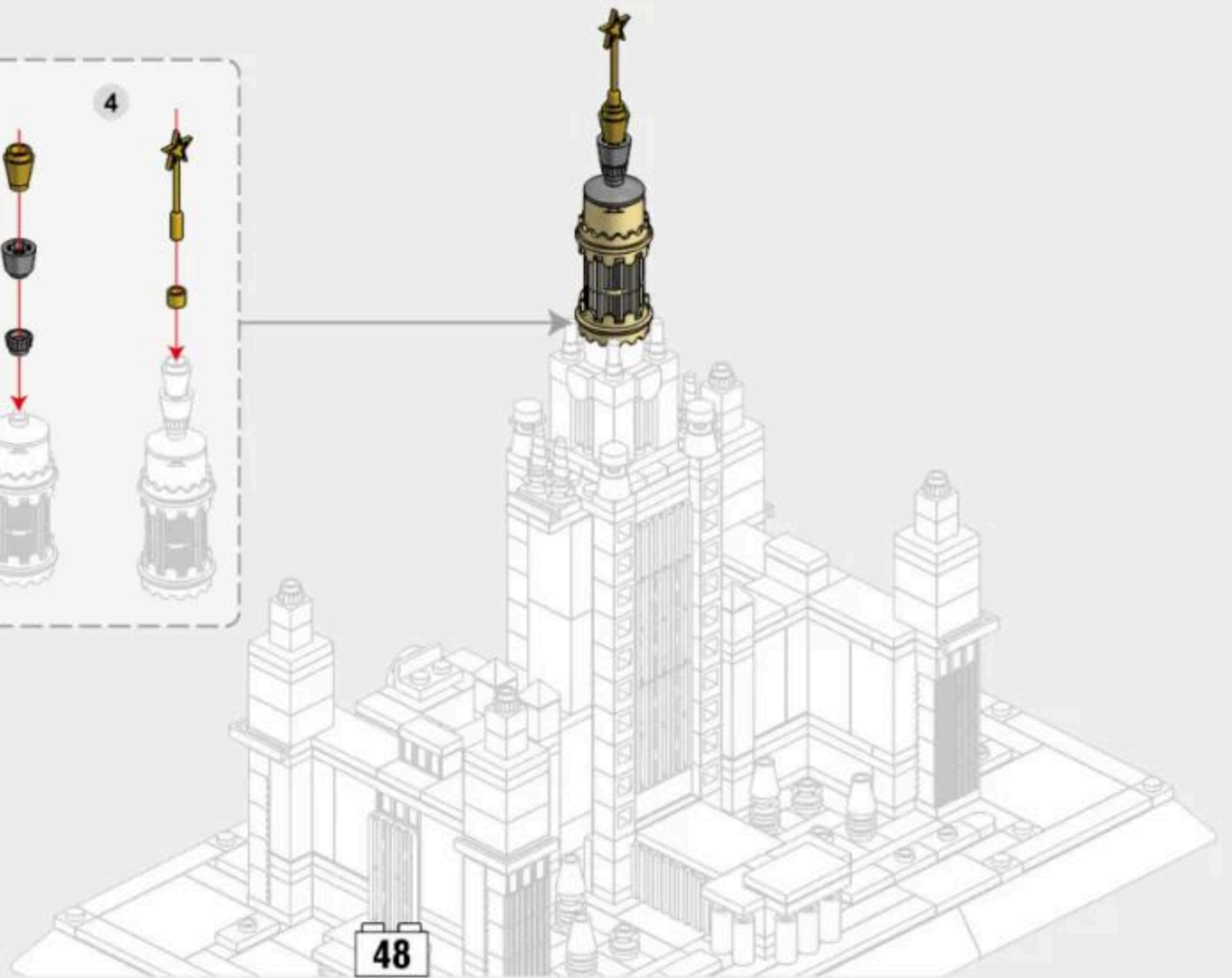
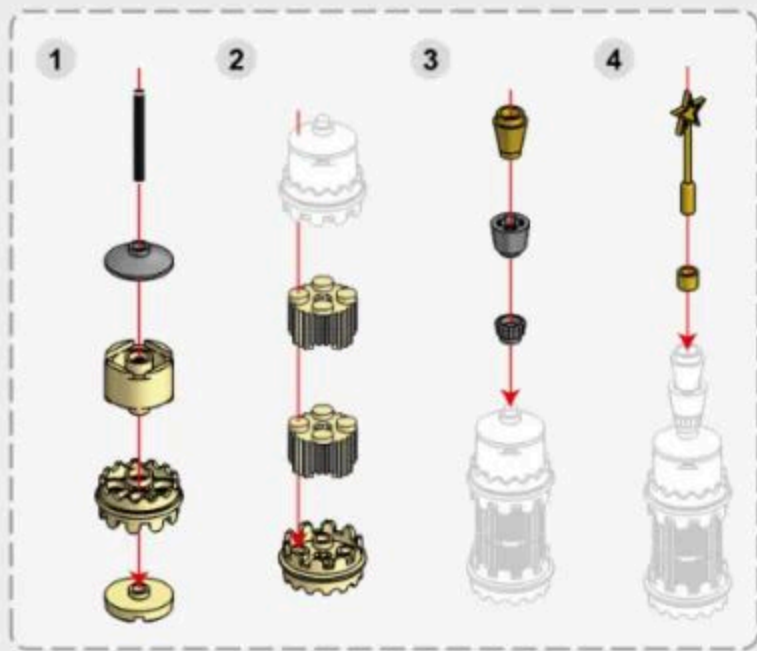



107PCS

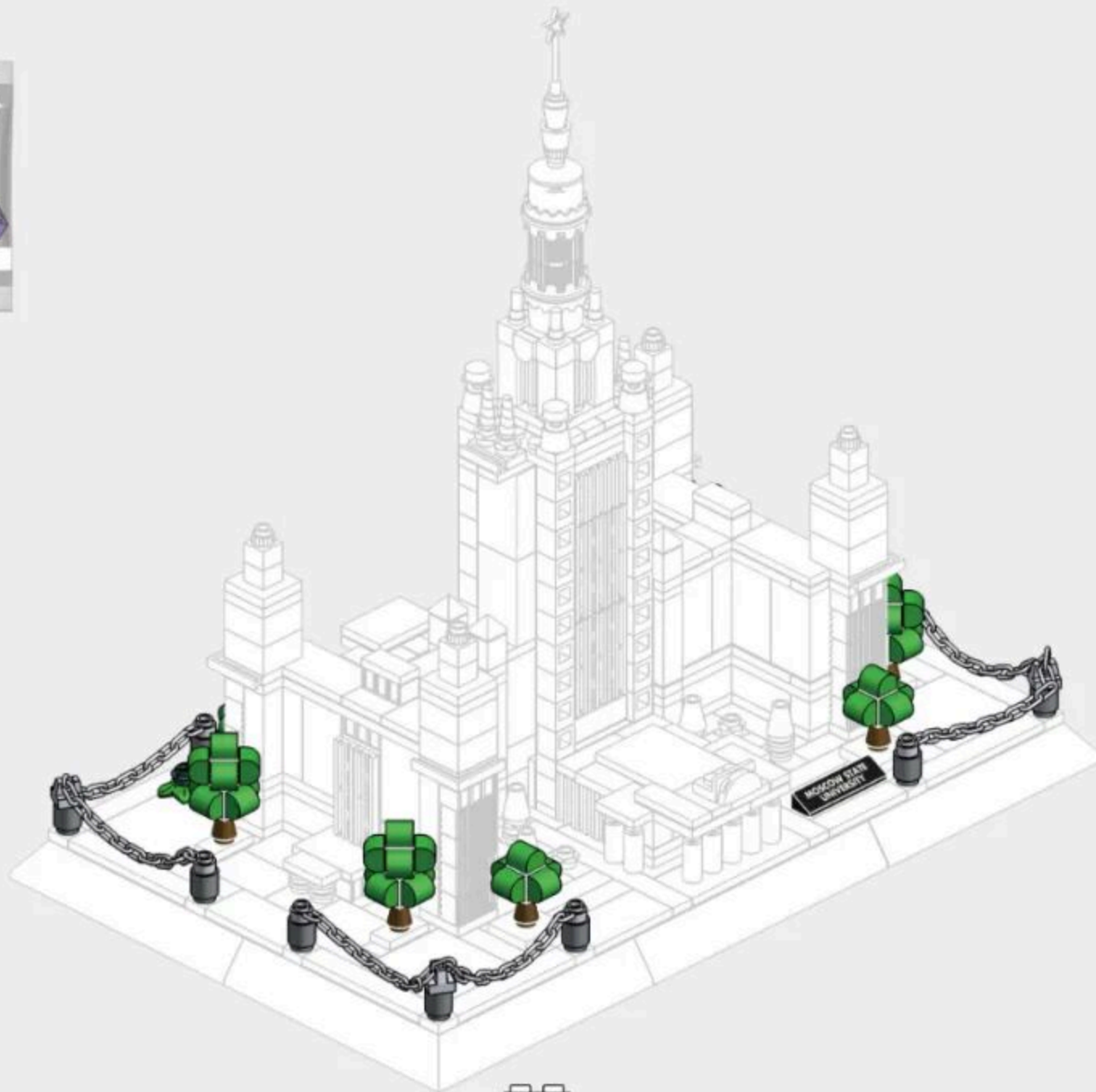

49

4-1

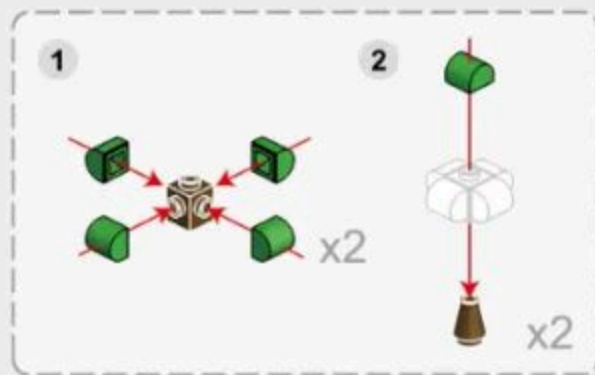
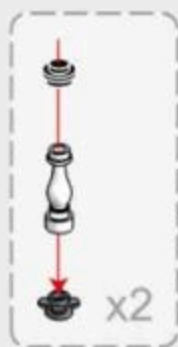

4-2



x4



x2



x18

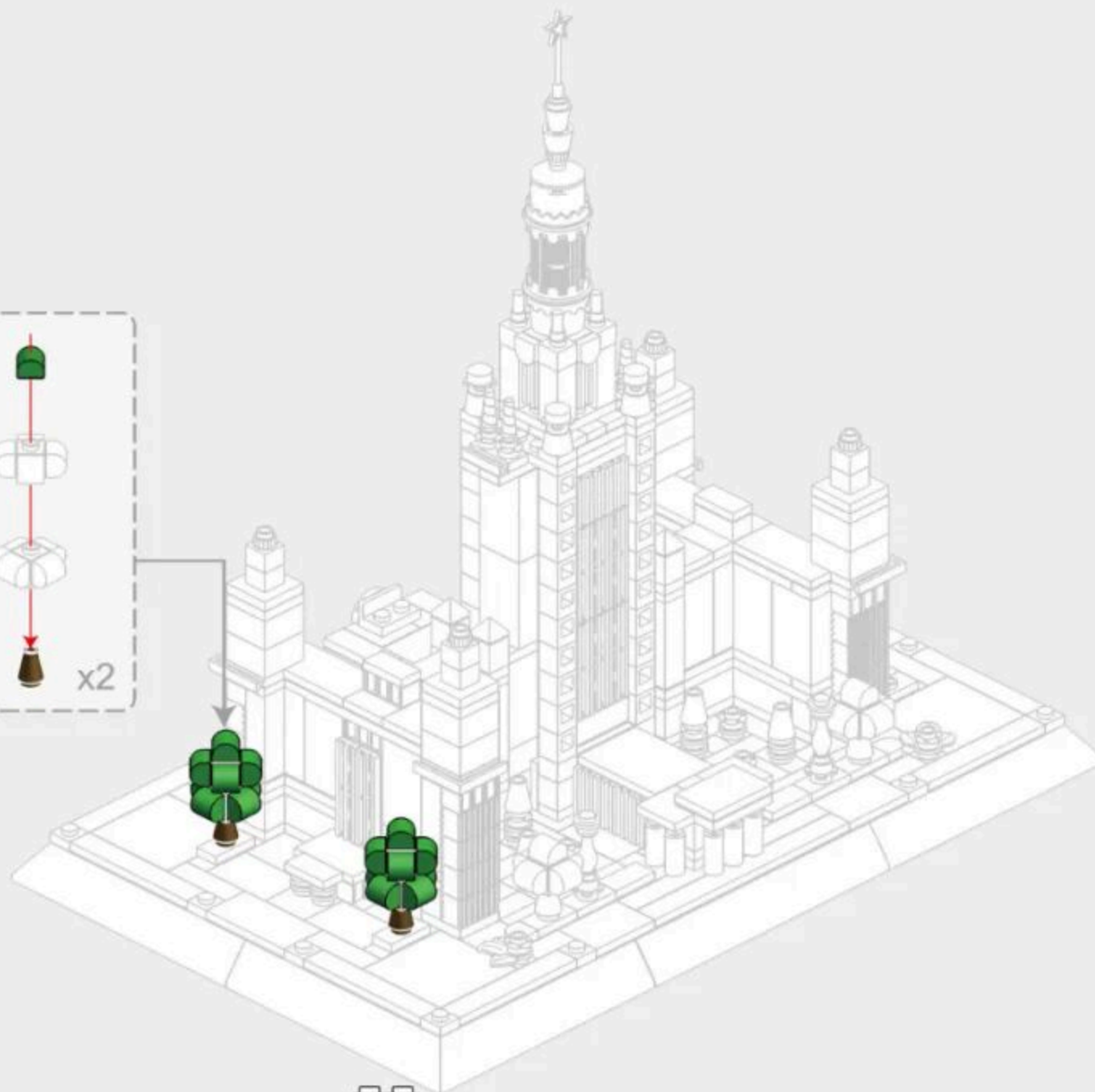
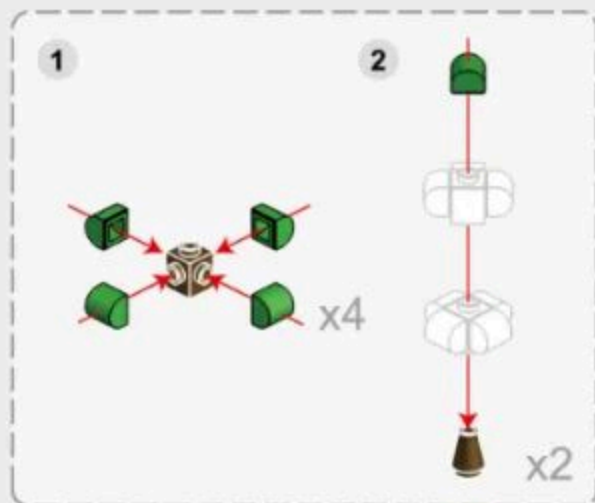

4-3

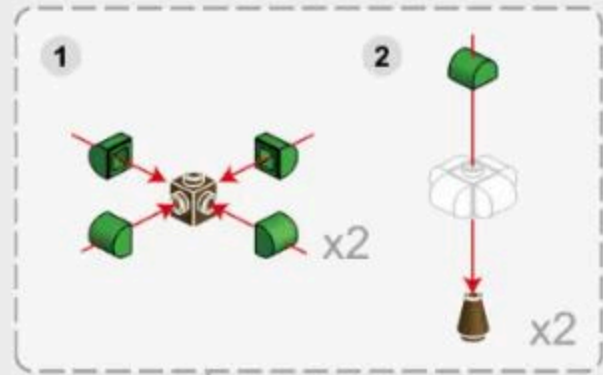
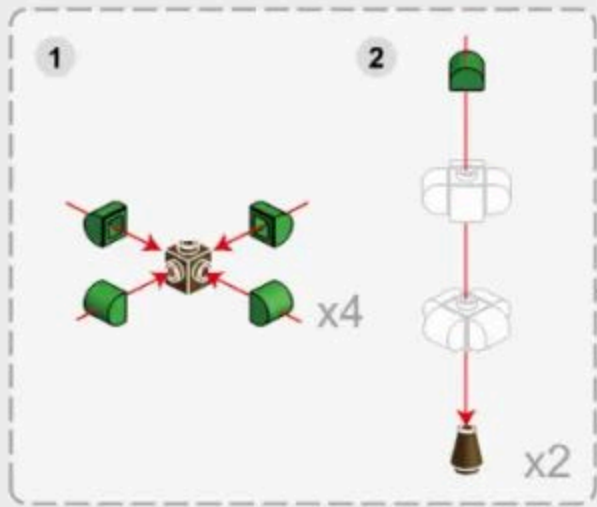

4-4



Vertical View of Installation Drawing  
安装图顶面

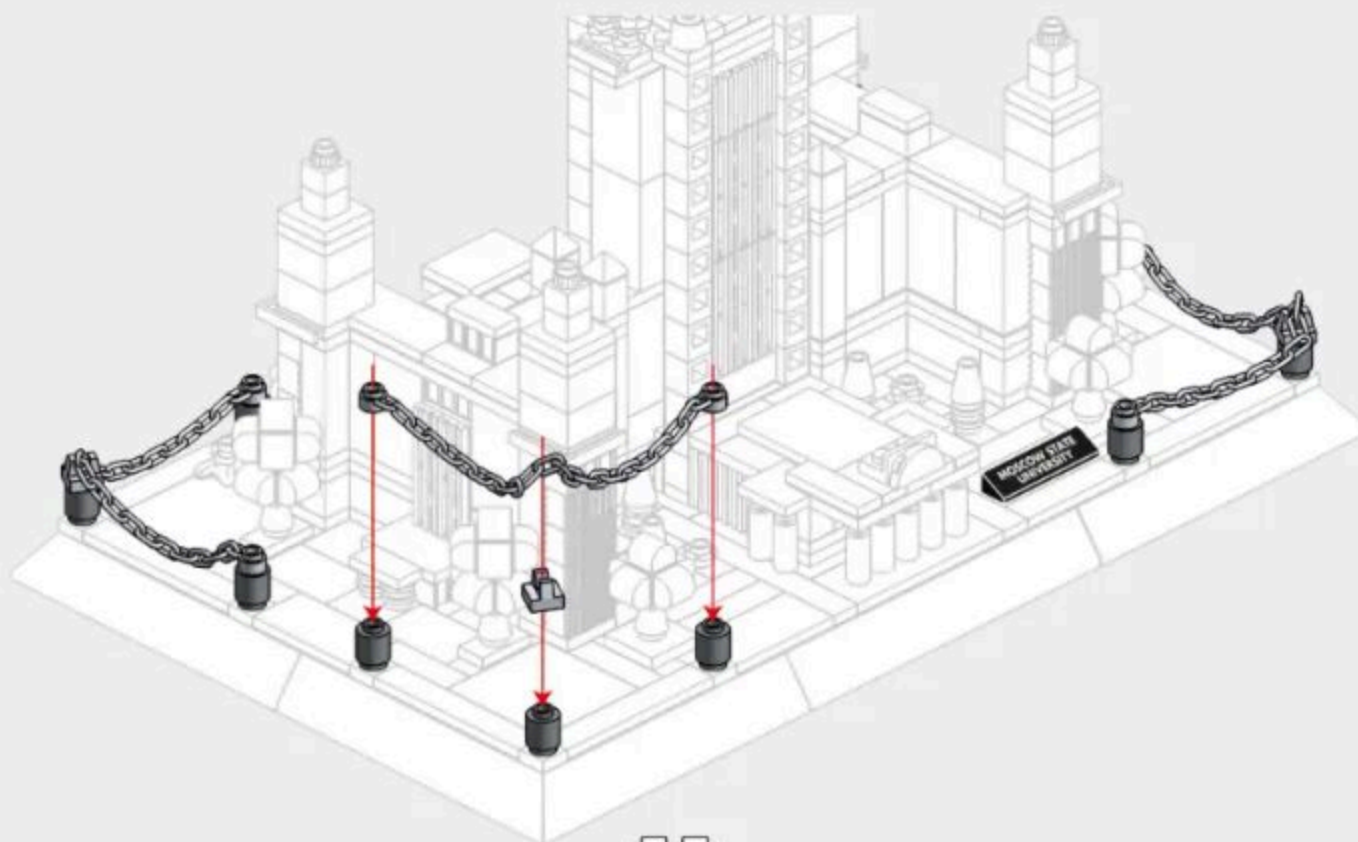
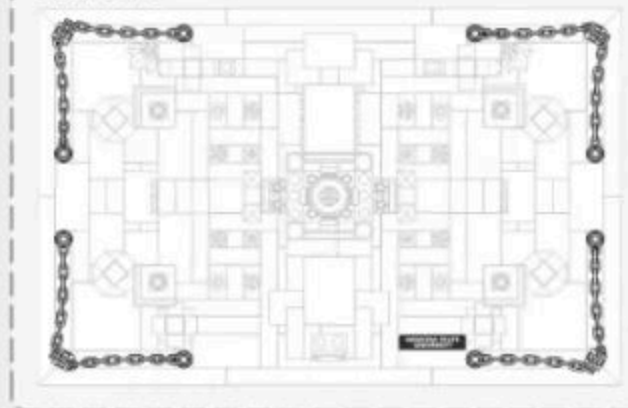



# ARCHITECTURE

The World's great architecture



Shaping Skills



Imagination  
& Curiosity



Mathematical



Self Discovery  
& Perception



Parent-Child  
Interaction



Problem Solving



Creativity



**6224** 英国伦敦白金汉宫  
BLICKINGHAM PALACE, LONDON, ENGLAND



**5225** 意大利罗马斗兽场  
COLOSSEUM, ROME, ITALY



**5226** 日本东京帝国饭店  
IMPERIAL HOTEL, TOKYO, JAPAN



**5227** 美国纽约自由女神像  
STATUE OF LIBERTY, NEW YORK, AMERICA



**6211** 德国柏林勃兰登堡门  
BRANDENBURG GATE, BERLIN, GERMANY

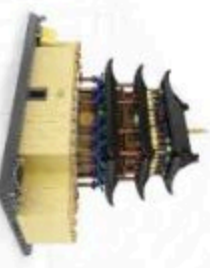

**6222** 中国甘肃长城-嘉峪关  
JIAYU PASS, GANSU, CHINA



**6212** 日本京都清水寺仁王门  
NINON GATE OF KIYOMIZU-dera, KYOTO, JAPAN



**6213** 俄罗斯莫斯科瓦西里大教堂  
SAINT BASIL'S CATHEDRAL, MOSCOW, RUSSIA



**6214** 中国武汉黄鹤楼  
YELLOW CRANE TOWER, WUHAN, CHINA



**6215** 英国伦敦眼  
LONDON EYE, LONDON, ENGLAND



**6221** 中国北京故宫-太和殿  
HALL OF SUPREME HARMONY, BEIJING, CHINA

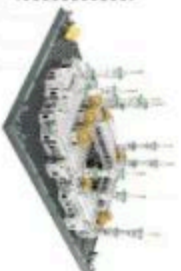

**6220** 沙特阿拉伯麦加大清真寺  
GREAT MOSQUE OF MECCA, SAUDI ARABIA



**6219** 美国纽约联合国大厦  
UNITED NATIONS SECRETARIAT BUILDING, NEW YORK, AMERICA



**4214** 美国华盛顿白宫  
WHITE HOUSE, WASHINGTON D.C., AMERICA



**4212** 意大利罗马许愿池  
TREVI FOUNTAIN, ROME, ITALY



**4213** 法国巴黎卢浮宫  
MUSEE DU LOUVRE, PARIS, FRANCE



**4218** 新加坡-鱼尾狮  
MERLION, SINGAPORE



**4219** 英国伦敦双子塔桥  
TOWER BRIDGE, LONDON, ENGLAND



**4216** 美国华盛顿林肯纪念馆  
LINCOLN MEMORIAL, WASHINGTON D.C., AMERICA



**4217** 新加坡-金沙酒店  
MARINA BAY SANDS, SINGAPORE



**4210** 埃及开罗吉萨金字塔  
GREAT PYRAMID OF GIZA, CAIRO, EGYPT



**4221** 加拿大渥太华国会山庄  
PARLIAMENT BUILDINGS, OTTAWA, CANADA



**4211** 英国伦敦伊丽莎白塔  
ELIZABETH TOWER, ENGLAND



**4215** 加拿大多伦多电视塔  
THE CN TOWER, CANADA



**4220** 美国纽约熨斗大厦  
FLATIRON BUILDING, NEW YORK, AMERICA



4222 阿联酋迪拜哈利法塔 5224 中国上海东方明珠广播电视塔  
THEIR MORNHAUS TOMER-KO BUALE ORIENTAL PEARL TOWER-SHANGHAI CHINA



5212 美国纽约帝国大厦  
EMPER STATE BUILDING-NEW YORK AMERICA



5213 马来西亚吉隆坡石油双塔  
PETRONAS TWIN TOWERS-KUALUMPUR MALAYSIA



5214 意大利托斯卡纳比萨斜塔 5216 英国伦敦伊丽莎白塔  
LEANING TOWER OF PISA-ITALY BZESTON BILDON ENGLAND



5219 俄罗斯莫斯科克里姆林宫塔楼  
SPASSAYA TOWER-MOSCOW, RUSSIA



5220 阿联酋迪拜卓美亚酒店  
BURJ AL ARAB-HOTEL-DUBAI UAE

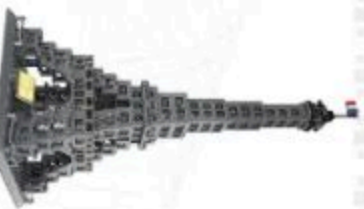

5217 法国巴黎埃菲尔铁塔  
EIFFEL TOWER-PARIS, FRANCE



5221 中国台北101大楼  
TAIPEI 101-TAIPEI CHINA



5228 美国芝加哥威利斯大厦  
WILLIS TOWER-CHICAGO AMERICA



5231 巴西里约热内卢救世基督像  
CRISTO REDENTOR-ARDO DE JANEIRO BRAZIL



6223 中国武汉长江大桥  
WUHAN YANGTZE RIVER BRIDGE



5210 法国巴黎圣母院大教堂  
CATHEDRALE NOTRE DAME DE PARIS-PARIS, FRANCE



5211 印度阿格拉泰姬陵  
TAJ MAHAL-AGRA, INDIA



5223 法国巴黎凯旋门  
ARC DE TRIOMPHE-PARIS, FRANCE



5215 英国伦敦双子塔桥  
TOWER BRIDGE-LONDON, ENGLAND

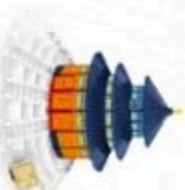

5222 中国北京天坛祈年殿  
HALL OF PRAYER FOR GOOD HARVESTS-TEMPLE, CHINA



6210 美国旧金山金门大桥  
GOLDEN GATE BRIDGE-SAN FRANCISCO, AMERICA



6216 中国北京万里长城 (八达岭)  
THE GREAT WALL-BEIJING, CHINA



5218 中国北京天安门  
TIANANMEN TOWER-BEIJING, CHINA



6217 中国西藏布达拉宫  
POTALA PALACE-TIBET, CHINA



6218 芬兰罗瓦涅米圣诞老人办公室  
SANTA CLAUS OFFICE-ROVANIEMI, FINLAND



6225 墨西哥库库尔坎玛雅金字塔  
EL CASTILLO-KULIKULCAN, MEXICO



6226 德国巴伐利亚新天鹅堡  
SCHLOSS NEUSCHWANSTEIN-BAVARIA, GERMANY



5229 土耳其伊斯坦布尔少女塔  
MAIDEN TOWER-ISTANBUL, TURKEY



5230 中国南京长善桥塔  
LONGSHOU PAGODA-NANJING, CHINA



**7210** 中国上海世博会中国馆  
CHINA PAVILION AT EXPO-SHANGHAI, CHINA



**5232** 美国宾夕法尼亚州流水别墅  
PALLADIUM AT PENNSYLVANIA, AMERICA



**5233** 美国芝加哥范斯沃斯住宅  
FARNSWORTH HOUSE, CHICAGO, AMERICA



**5234** 美国华盛顿唐人街  
CHINA TOWN, WASHINGTON, D.C., AMERICA



**3210** 美国纽约自由女神像  
STATE OF LIBERTY, NEW YORK, AMERICA



**4223** 中国北京清华园  
TSINGHUA CAMPUS, BEIJING, CHINA



**7211** 中国湖南岳阳楼  
YIYANG TOWER, HUNAN, CHINA



**8210** 澳大利亚悉尼歌剧院  
SYDNEY OPERA HOUSE, SYDNEY, AUSTRALIA



**7212** 中国江西南昌滕王阁  
PALACE OF PRINCE TENG, JIANGXI, CHINA



**6227** 中国河南郑州嵩山少林寺  
SHAOLIN TEMPLE, HENAN, CHINA



**7213** 中国重庆洪崖洞  
HONGYADONG, CHONGQING, CHINA



**5235** 美国华盛顿国会大厦  
UNITED STATES CAPITOL, WASHINGTON, D.C., AMERICA



**5236** 中国安徽滁州醉翁亭  
ZUIWENG PAVILION, ANHUI, CHINA



**6228** 中国陕西西安钟楼  
YAN HELL TOWER, SHANXI, CHINA



**5238** 美国西雅图太空针塔  
SPACE NEEDLE, SEATTLE, AMERICA



**5237** 法国巴黎萨伏伊别墅  
VILLA SAVOIE, PARIS, FRANCE



**6229** 中国山西运城鹳雀楼  
STORK TOWER, SHANXI, CHINA



**6230** 希腊爱琴海圣托里尼岛  
SANTORINI, ISLAND GREECE



**6231** 中国上海海关大楼  
SHANGHAI CUSTOMS HOUSE, SHANGHAI, CHINA



**5239** 中国北京紫禁城角楼  
TOWER OF PALACE, BEIJING, CHINA



**5240** 韩国首尔崇礼门  
NAMDEONGMUN, SEOUL, KOREA



**5241** 中国江苏南京夫子庙  
CONFUCIUS TEMPLE, JIANGSU, CHINA



**5242** 美国纽约古根海姆博物馆  
GUGENHEIM MUSEUM, NEW YORK, AMERICA



**6232** 中国江苏南京秦淮河画舫  
QINHUAI RIVER PAINTED BOAT, JIANGSU, CHINA



**6233** 法国诺曼底圣米歇尔山  
SAINT MICHAEL'S MOUNT, NORMANDY, FRANCE

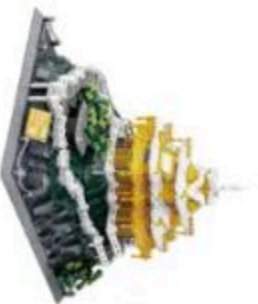

**6234** 中国河南洛阳栾川老君山  
THE LAOJUN MOUNTAIN-HENAN, CHINA



**5243** 耶路撒冷岩石圆顶  
DOME OF THE ROCK-JERUSALEM



**6235** 中国江苏苏州寒山寺 (普明宝塔)  
HANSHAN TEMPLE-JIANGSU, CHINA



**4224** 英国威尔特郡巨石阵  
STONEHENGE-WILTSHIRE, ENGLAND



**4225** 中国内蒙古自治区蒙古包  
MONGOLIAN YURT-INNER MONGOLIA, CHINA



**8211** 中国福建土楼(承启楼)  
CHENQI EARTH BUILDING-FUJIAN, CHINA



**4226** 沙特阿拉伯麦加大清真寺(克尔白)  
KERBAL GREAT MOSQUE OF MECCA, SAUDI ARABIA



**5244** 俄罗斯圣彼得堡冬宫  
WINTER PALACE-ST. PETERSBURG, RUSSIA



**7214** 中国陕西西安鼓楼  
XI'AN DRUM TOWER-SHAANXI, CHINA



**5245** 中国重庆李子坝站  
LIZIBA STATION-CHONGQING, CHINA



**4227** 俄罗斯莫斯科国立大学  
MOSCOW STATE UNIVERSITY-MOSCOW, RUSSIA



**4228** 沙特阿拉伯麦地那先知清真寺  
PROPHET'S MOSQUE-MEDINA, SAUDI ARABIA

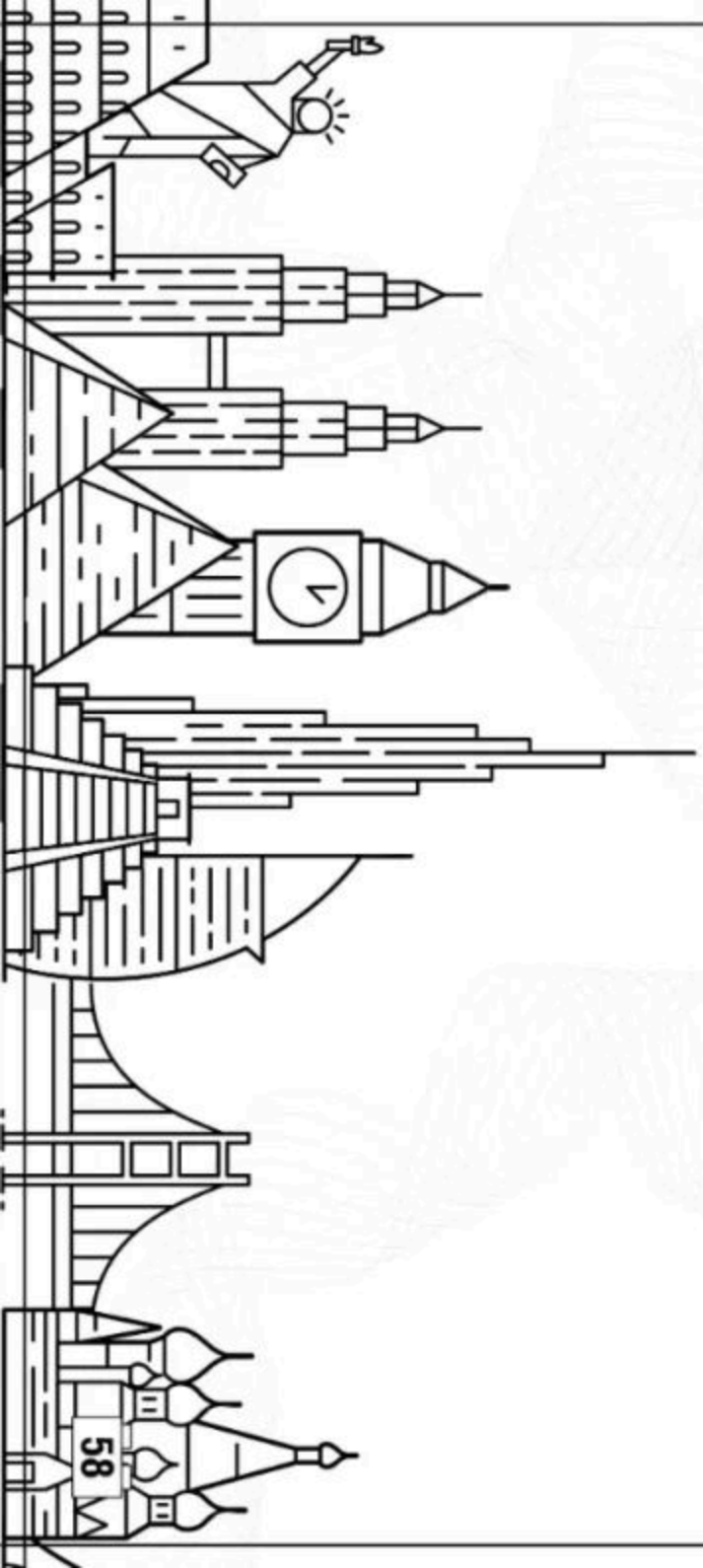

# MOSCOW STATE UNIVERSITY

COUNTRY: Russia

CITY: Moscow



Ver. 4227/20240824