

# MILITARY EQUIPMENT

T-34-85

Building blocks model

Perfect shape, high simulation, classic collection



6+ / 4514 / 604 PCS  
Suitable Age / Product Number / Parts Total

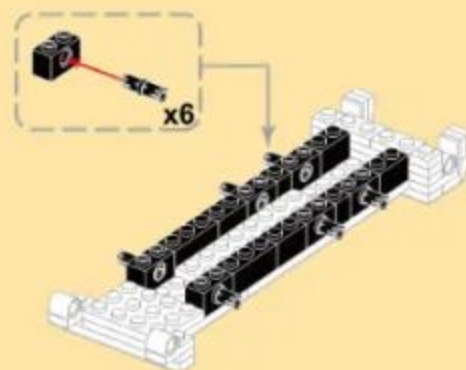
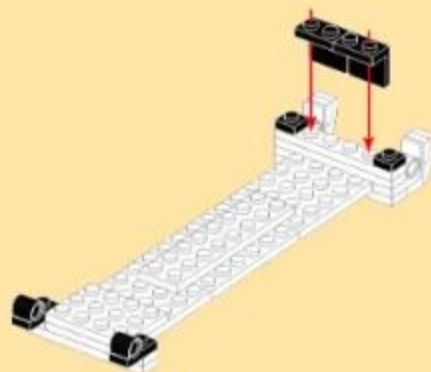
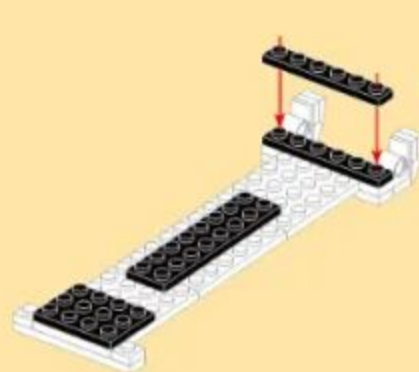
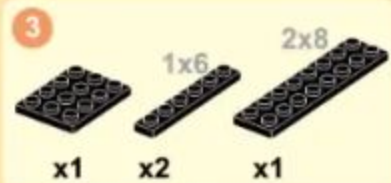
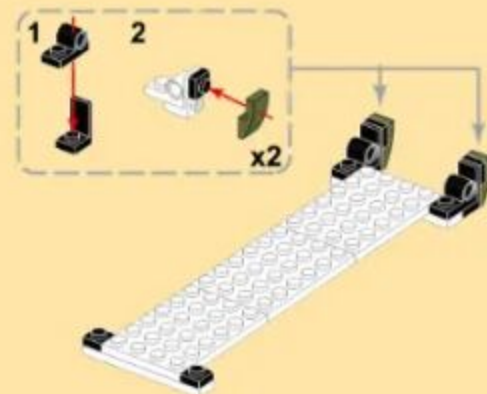
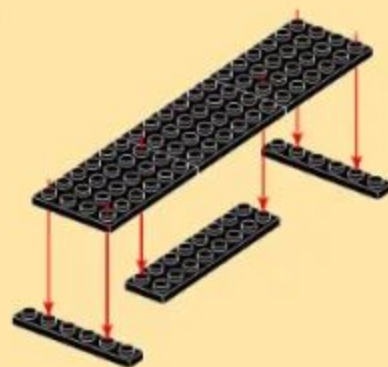
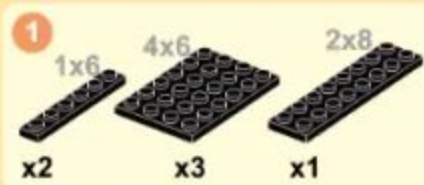
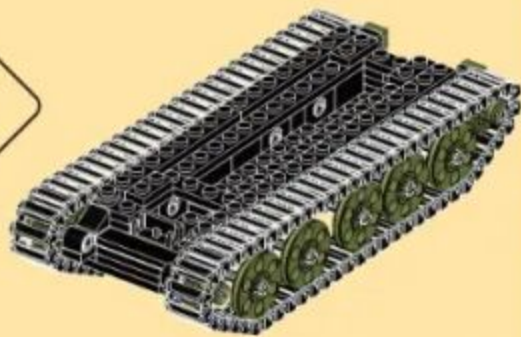

6

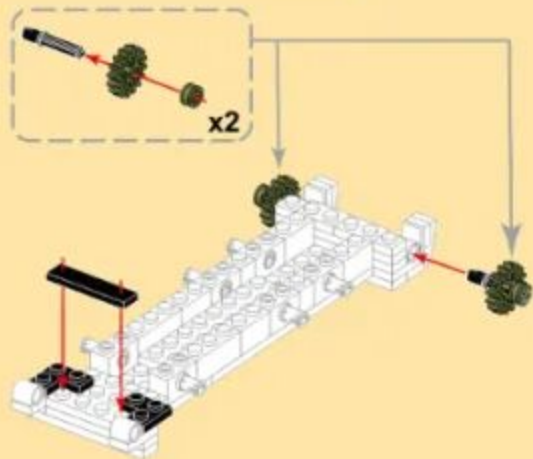

7

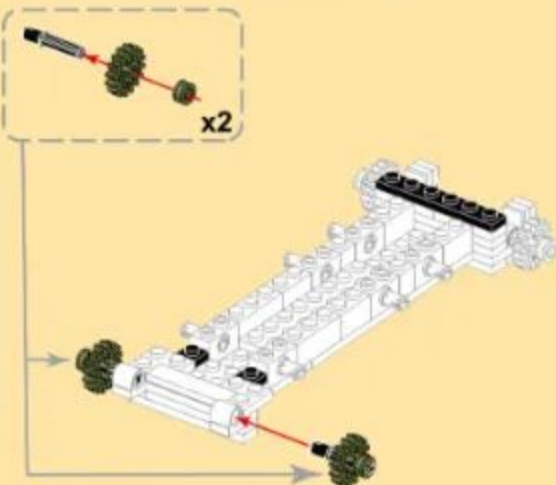

8

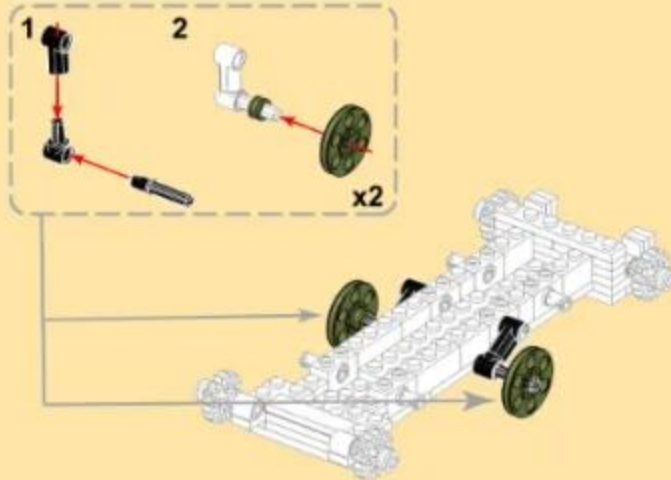

9

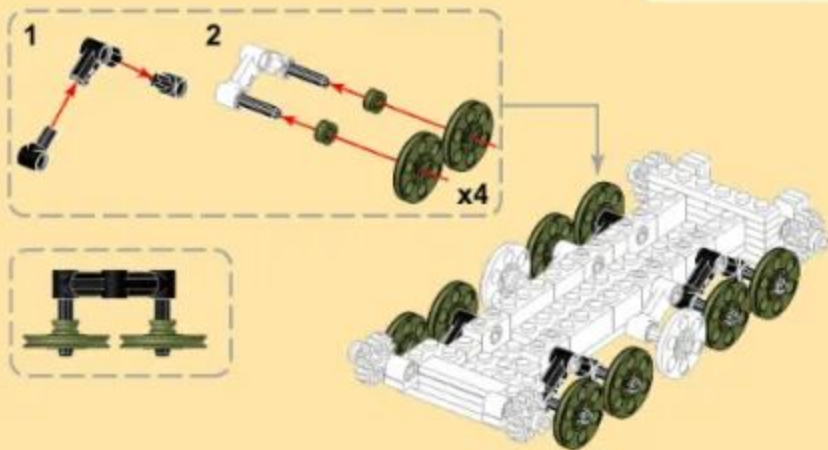

10

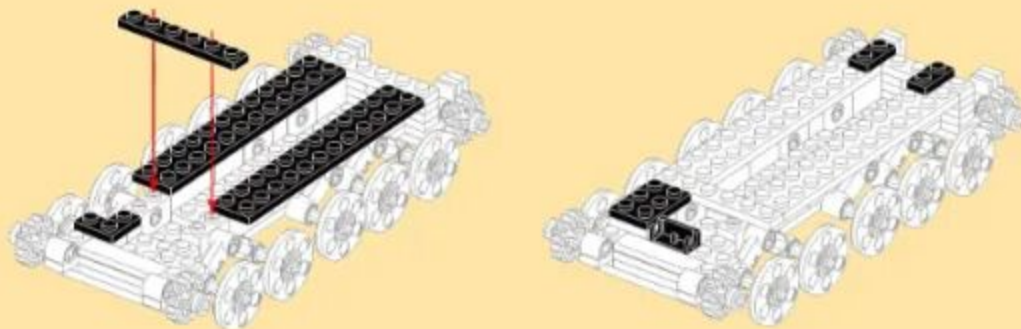
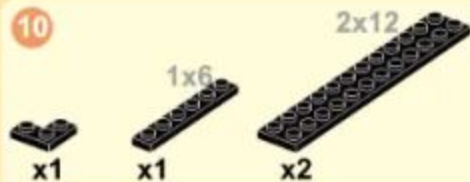

11



12

x1 x1 x1 x2

1x8

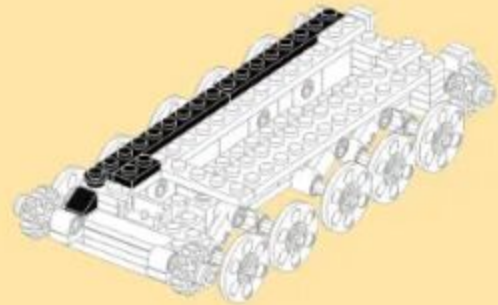

13

x1 x1 x1 x1 x2

1x8

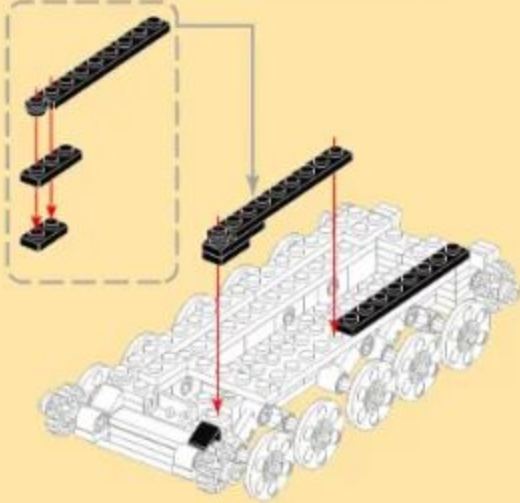

14

x114

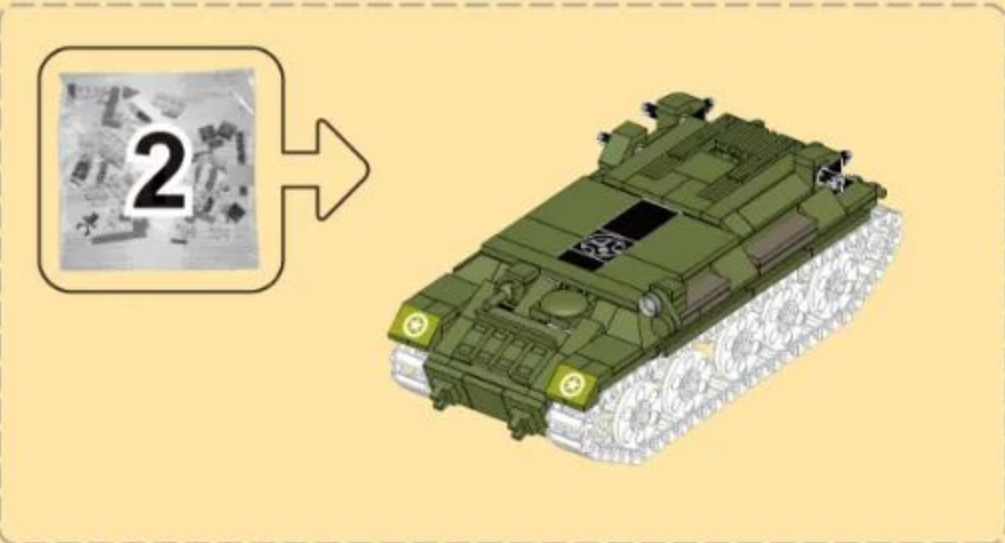
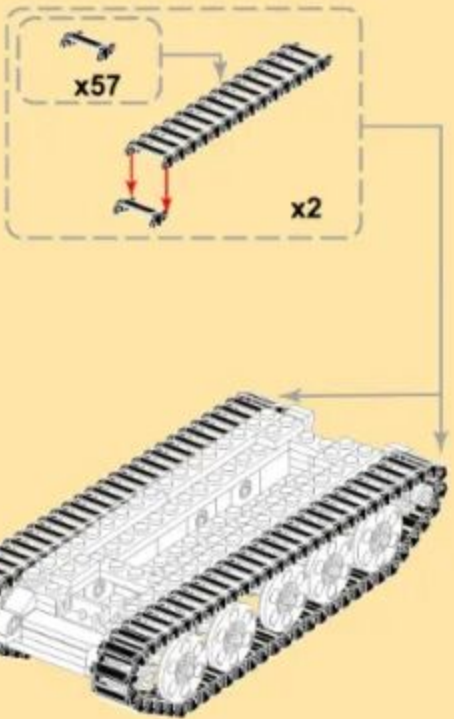

15

x2 x2 x1 x1 x1 x1

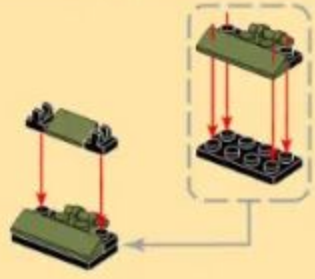

3



20



21

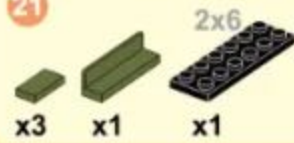

22

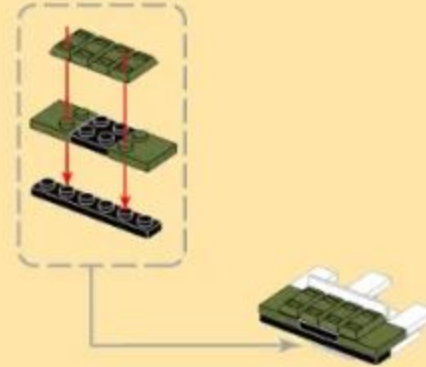

23

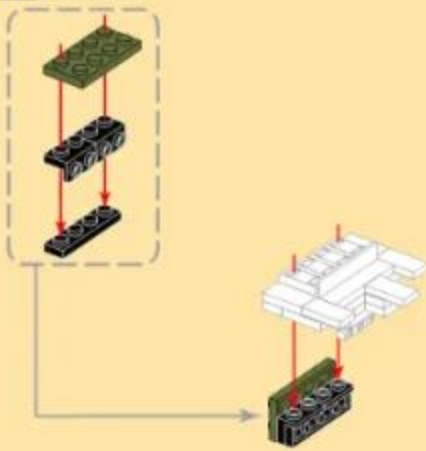

24

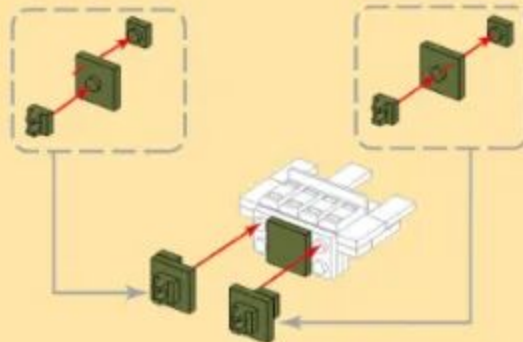

25

19 + 24

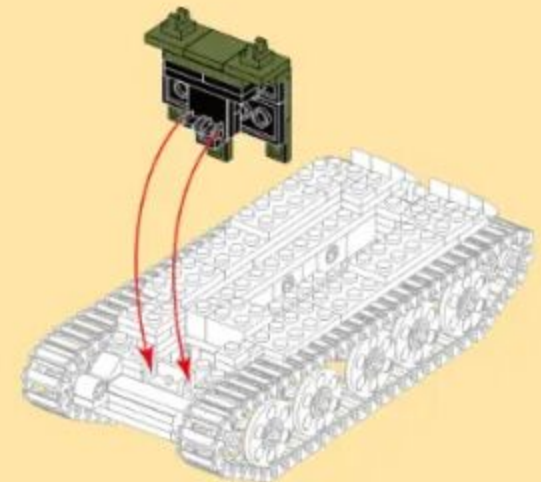

26



27

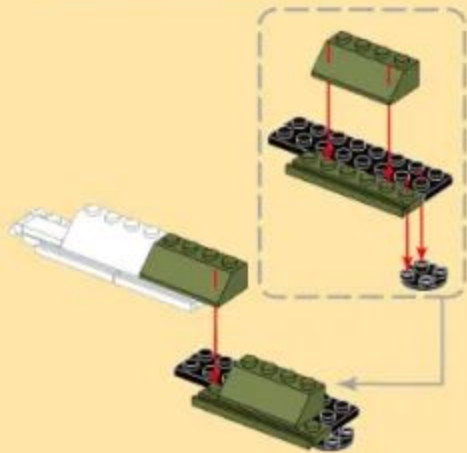
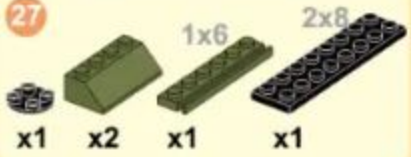

28

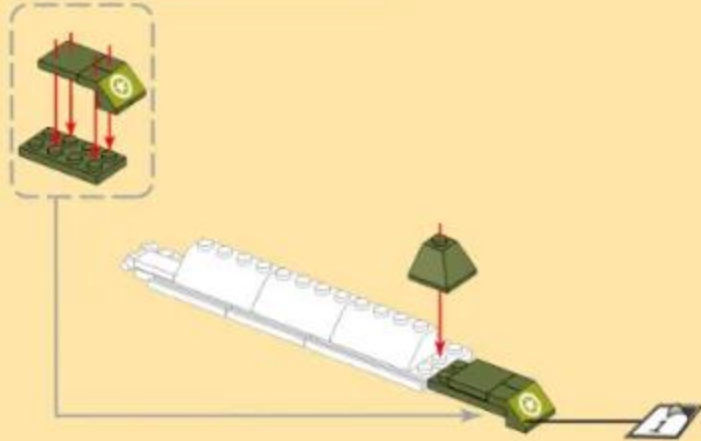

29

25 + 28

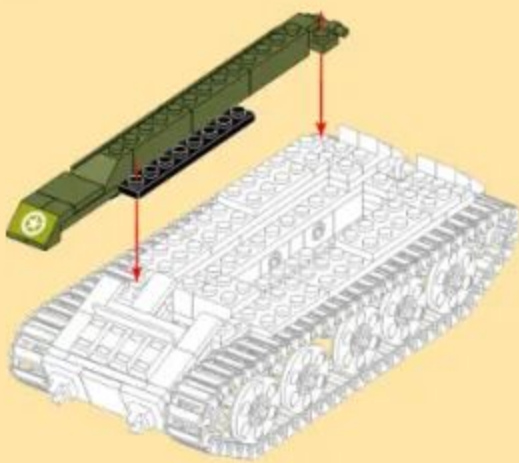

30



31

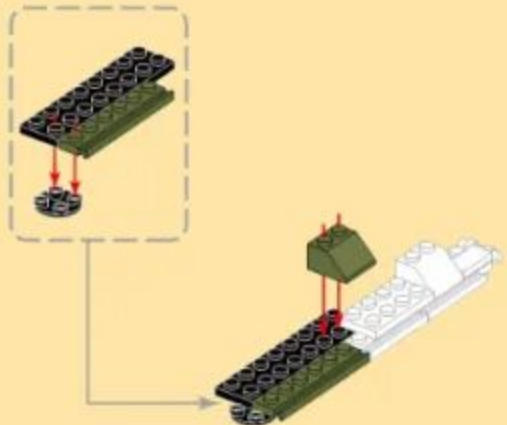
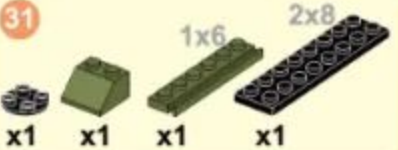

32

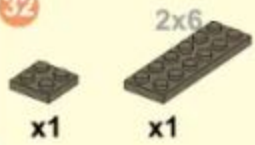

33

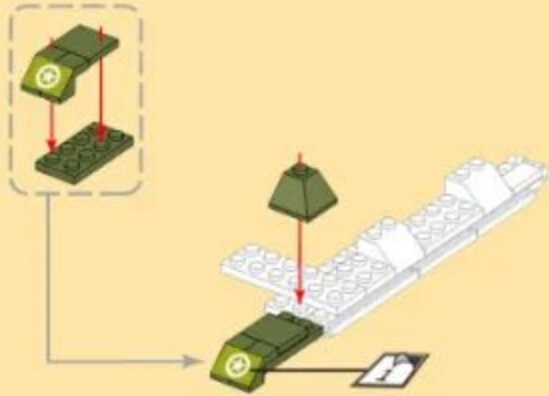

34

29 + 33



35

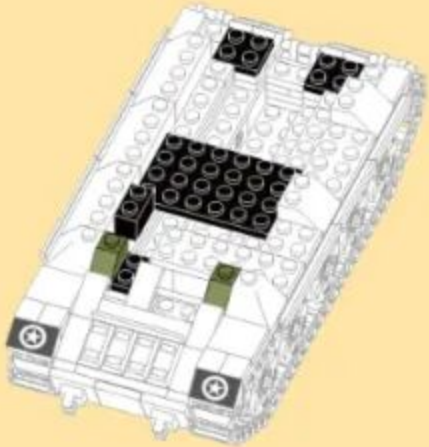
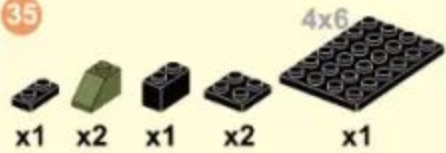

36

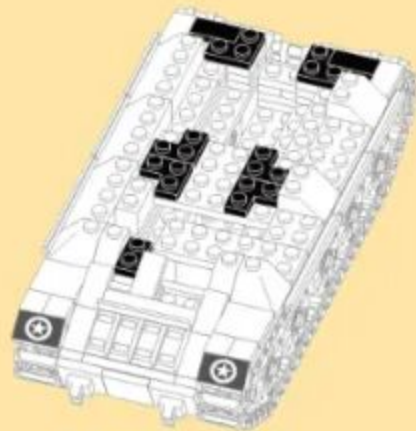

37

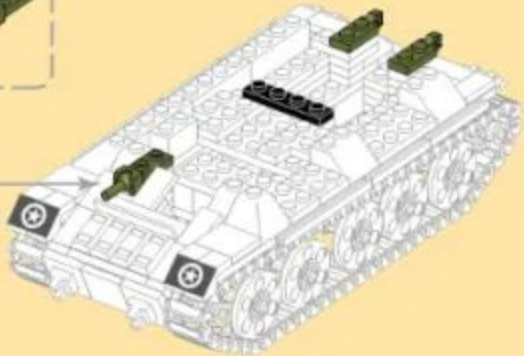

38

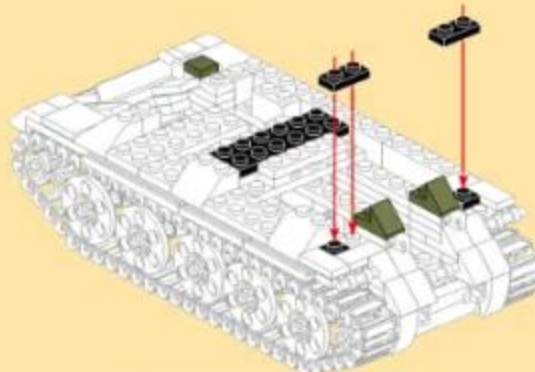

39

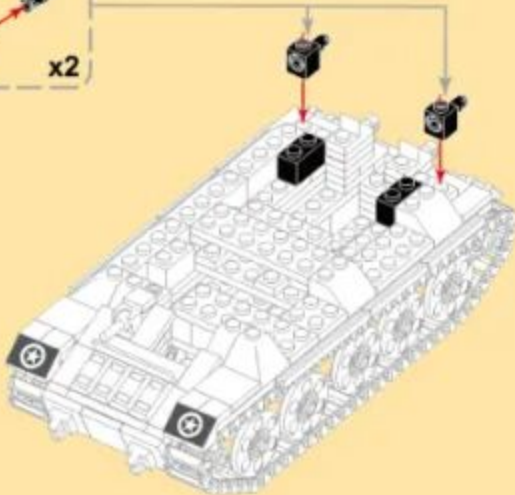

40

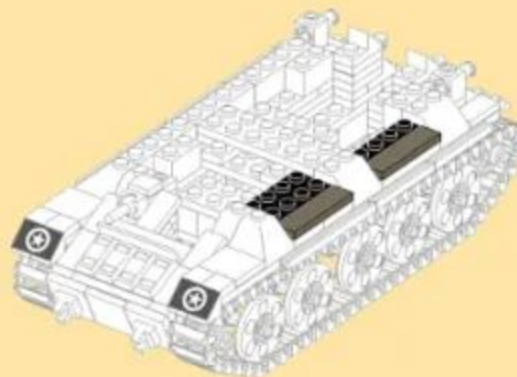

41

x2 x1 x2 x2 x2

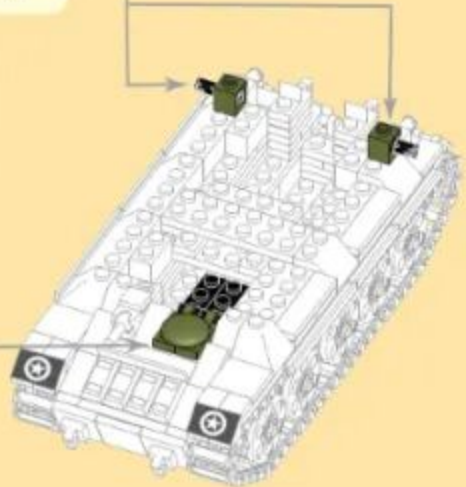

42

x1 x1 x2 x1 x1 x1

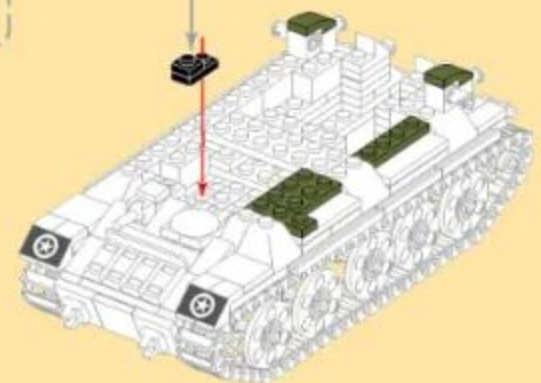

43

x1 x1 x1 x1

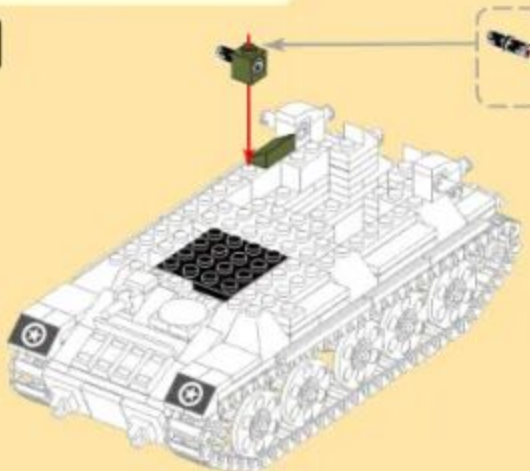
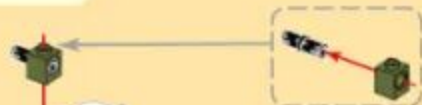

44

x1 x2 x2 x1

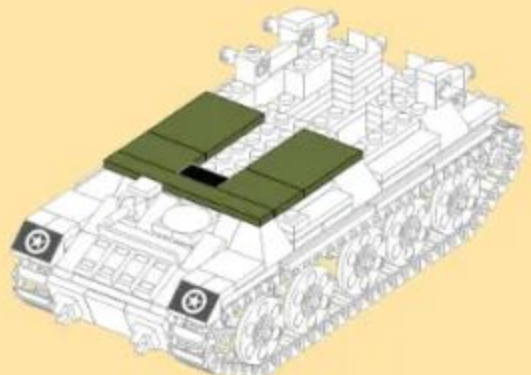
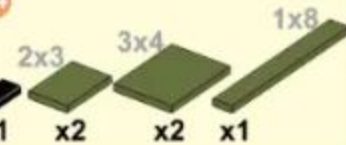

- 45
- x1
  - x1
  - x1
  - x1
  - 2x3
  - x1
  - x1

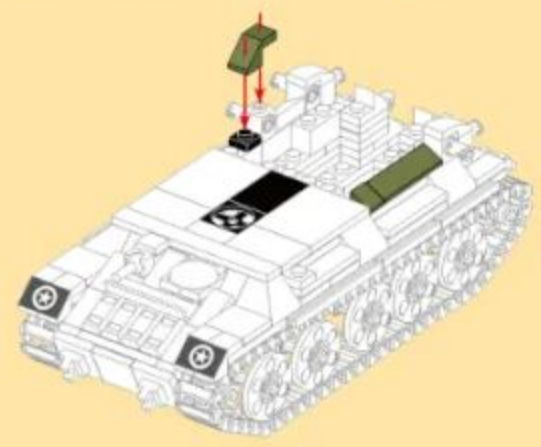

- 46
- x1
  - x1
  - x1
  - x1
  - x1
  - x1

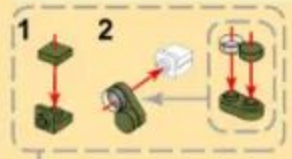

- 47
- x1
  - x2
  - x1
  - x1
  - x1
  - x1

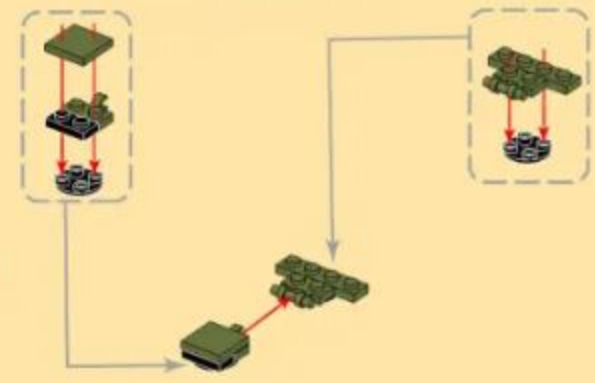

- 48
- x4
  - x2
  - 2x6
  - x2

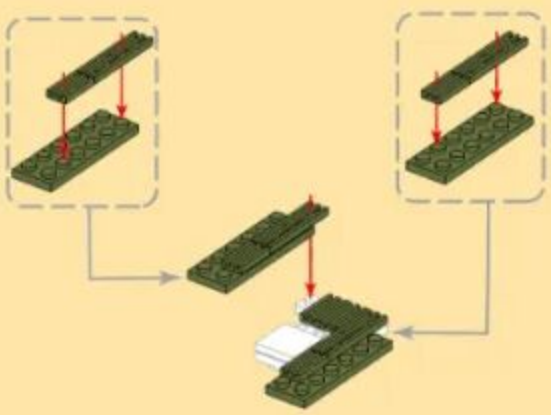

- 49
- x1
  - x2
  - x2
  - 1x6

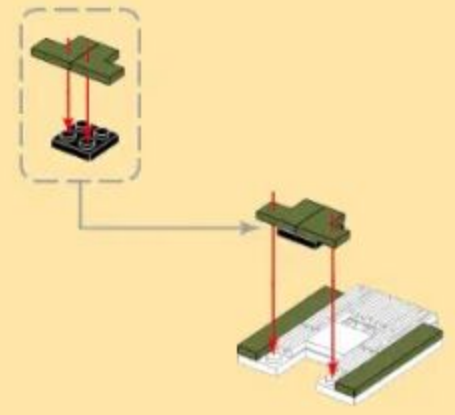

- 50
- 46 + 49

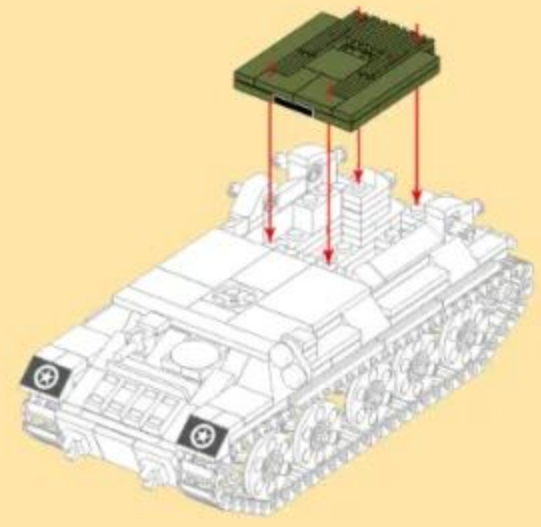

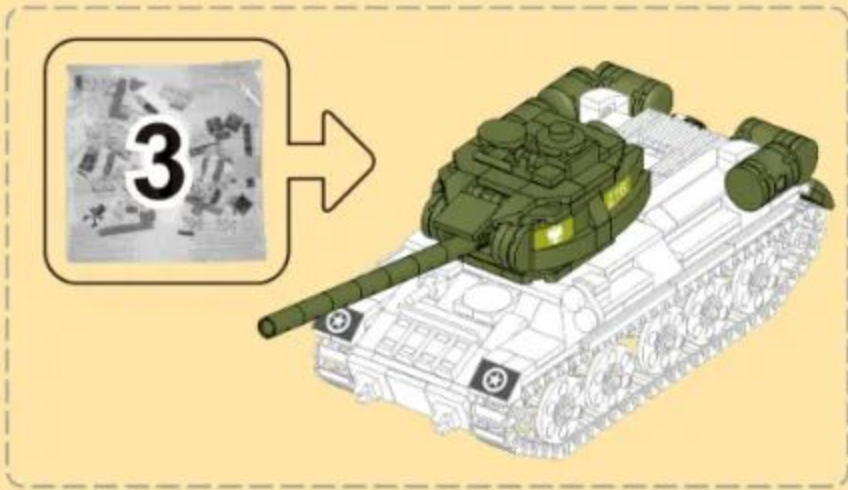

- 51
- x2
  - x2
  - x2

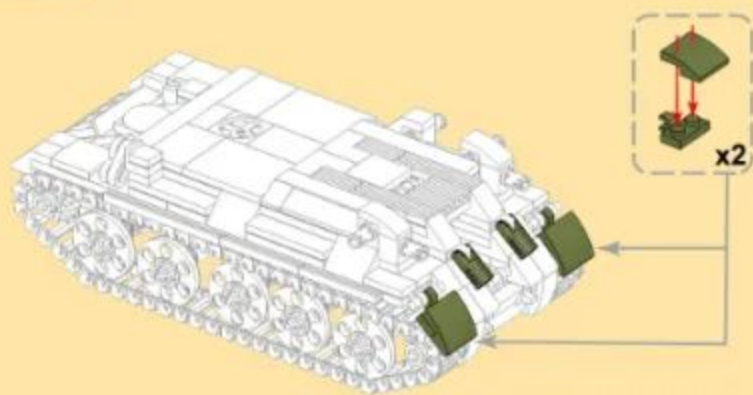

- 52
- x1
  - x1
  - x1
  - x1

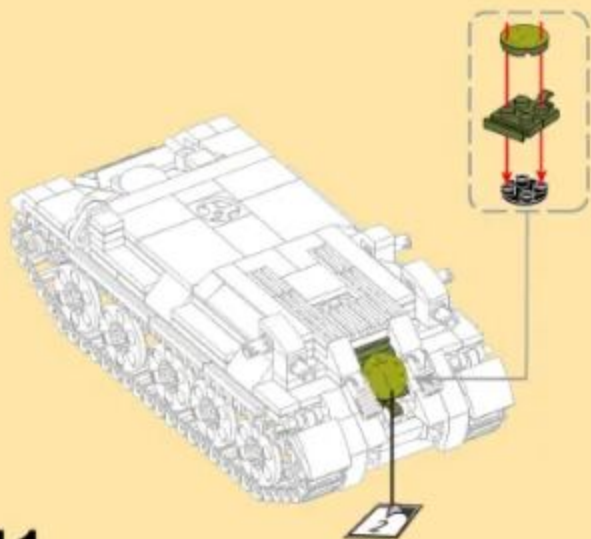

- 53
- x2
  - x2
  - x6
  - x2

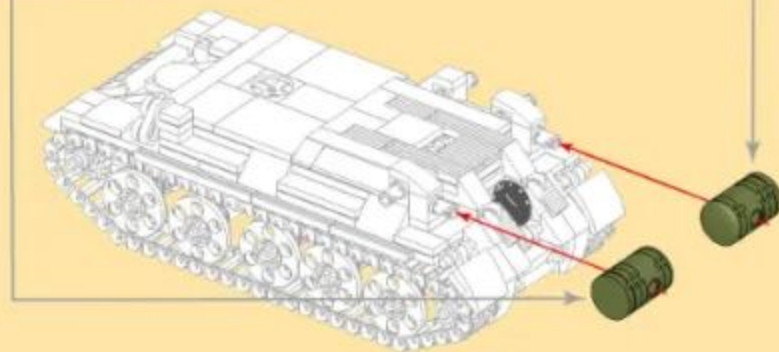
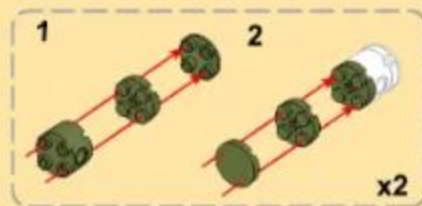

54

- x2
- x2
- x3
- x2

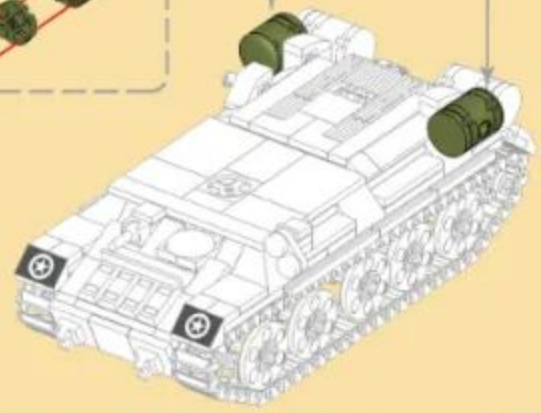
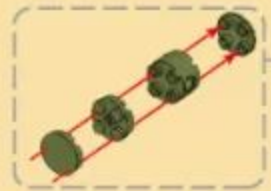
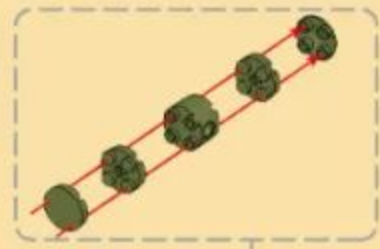

55

- x1
- x1
- x3
- x1

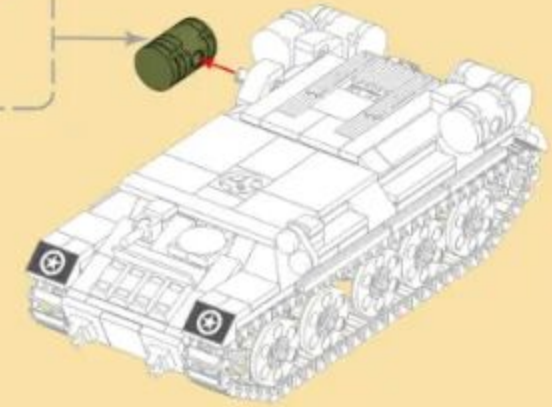
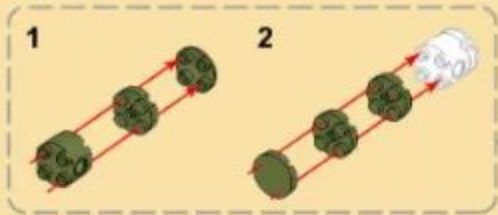

56

- x4
- x2
- x2
- x1
- x1



57

- x2
- x2
- x1
- x3



58

- x4
- x1
- x2

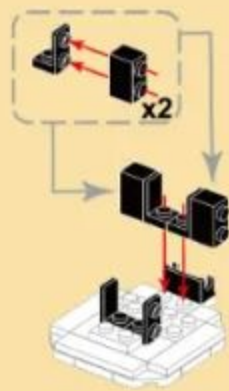

59

- x2
- x1
- x1
- x1

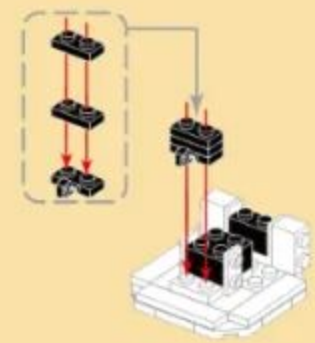

60

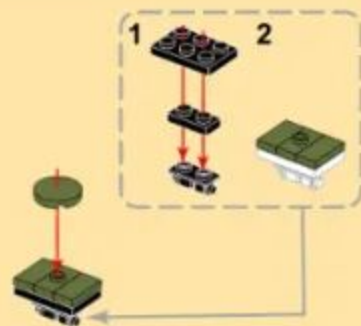

61

59 + 60



62



63



64

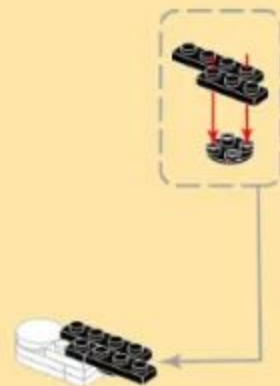

65

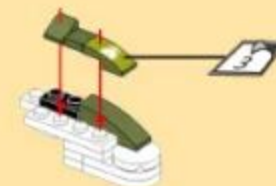

66

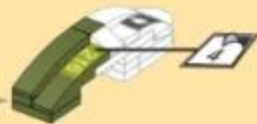

67

62 + 66

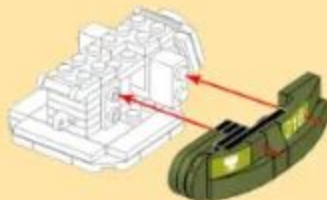

68



69

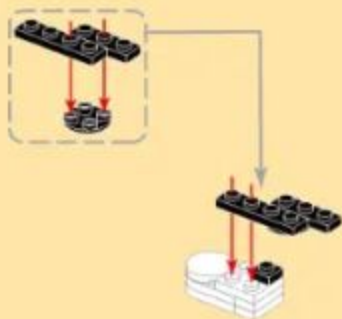

70

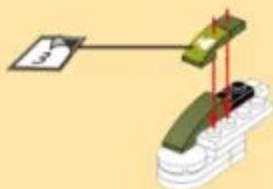

71

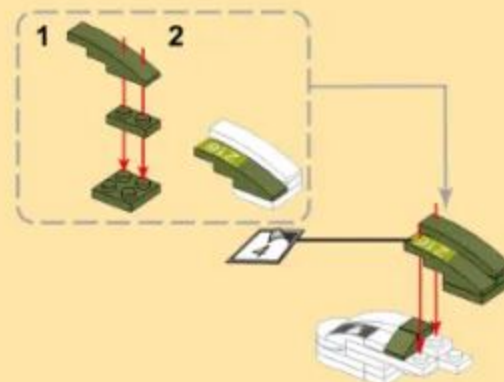

72

67 + 71

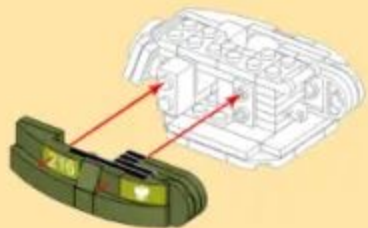

73

x1 x6 x1 x6

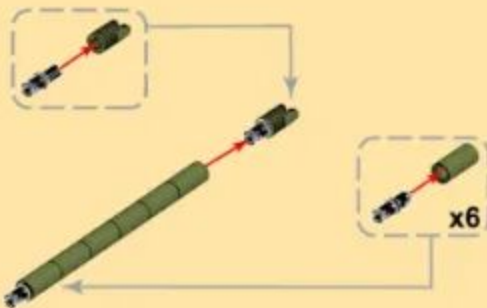

74

x1



75

72 + 74



76

x1 x1 x1 x1

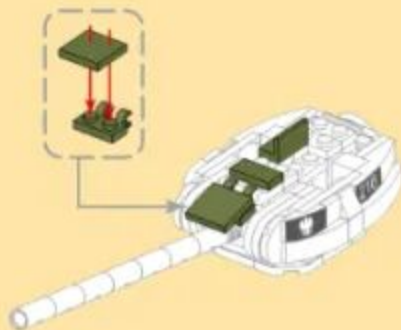

77

x1 x1 x1 x1 1x4

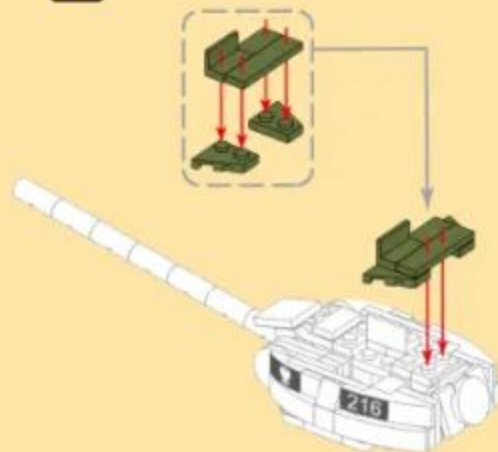

78

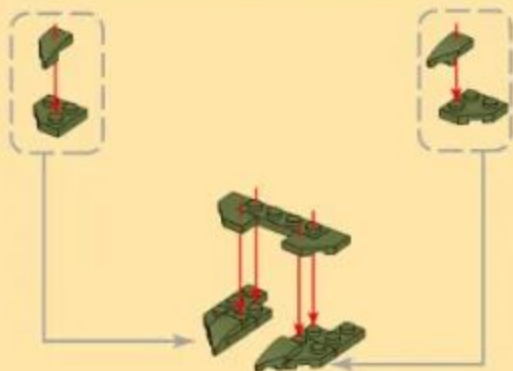

79

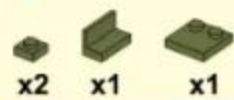

80



81

77 + 80

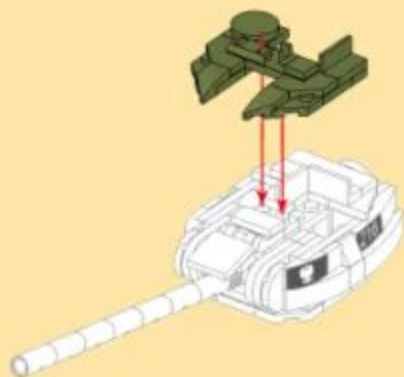

82



83

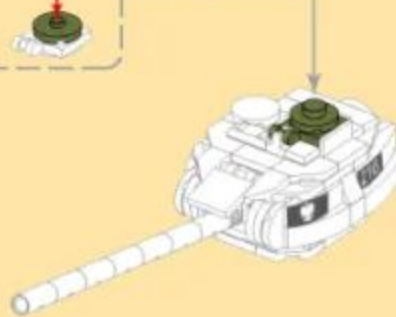

84

55 + 83

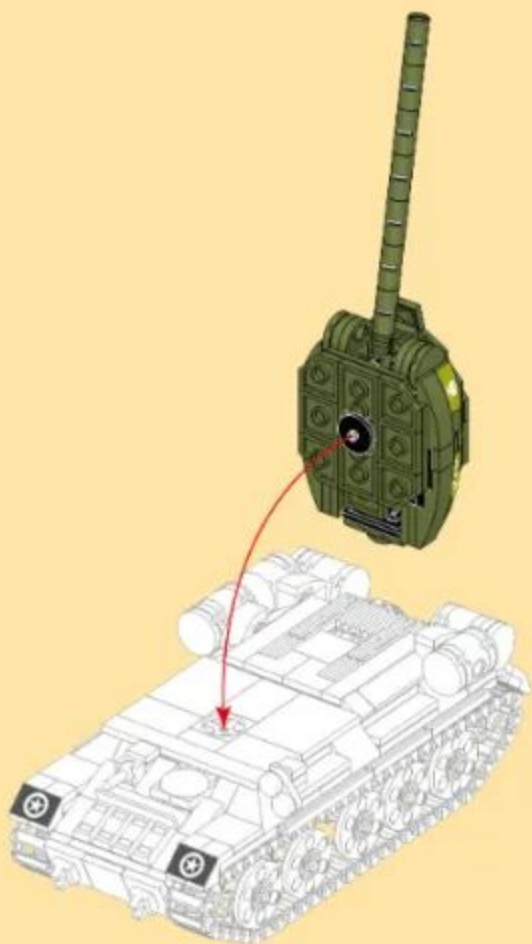



# MILITARY EQUIPMENT

Building blocks model

Perfect shape,high simulation,classic collection

4510



M35 2½-TON CARGO TRUCK  
AND M198 HOWITZER

4511



ANTI-AIRCRAFT MISSILE

4512



ANTI-AIRCRAFT MISSILE TRANSPORT VEHICLE

4513



M1151 ENHANCED ARMAMENT CARRIER

4514



T-34-85

4515



NEUBAUFahrZEUG

4516



DICKER MAX

4517



PANTHER TANK



Ver.451420240511