

MILITARY EQUIPMENT

DICKER MAX

Building blocks model

Perfect shape, high simulation, classic collection



6+ / 4516 / 632 PCS
Suitable Age / Product Number / Parts Total

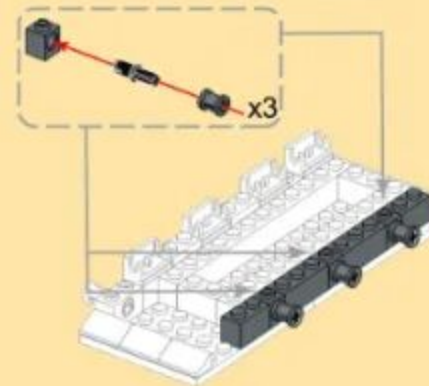
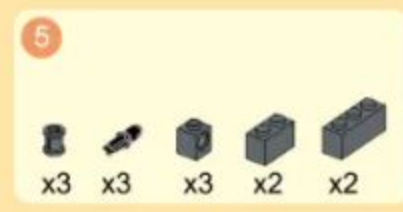
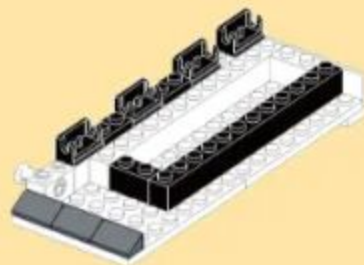
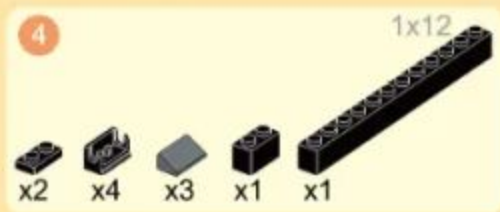
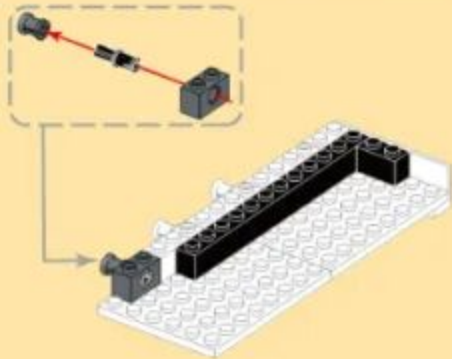
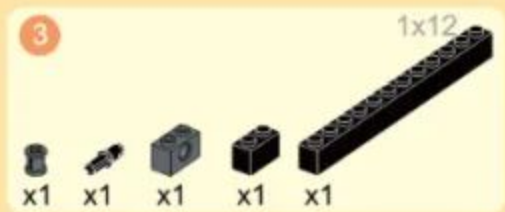
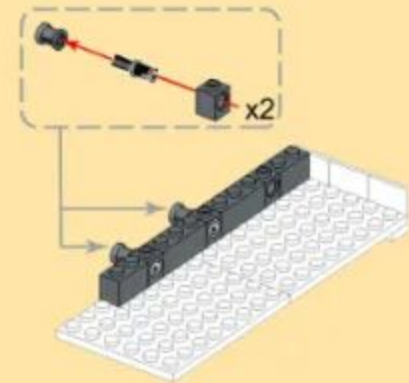
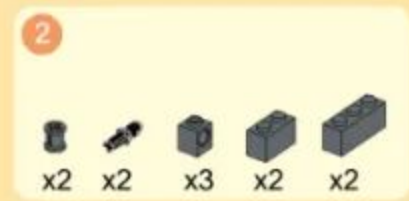
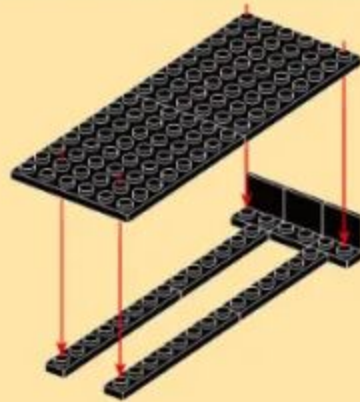
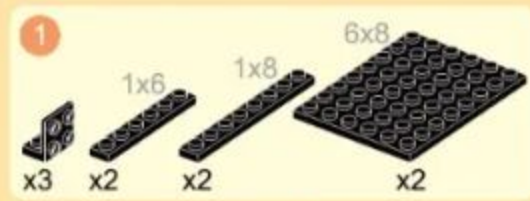
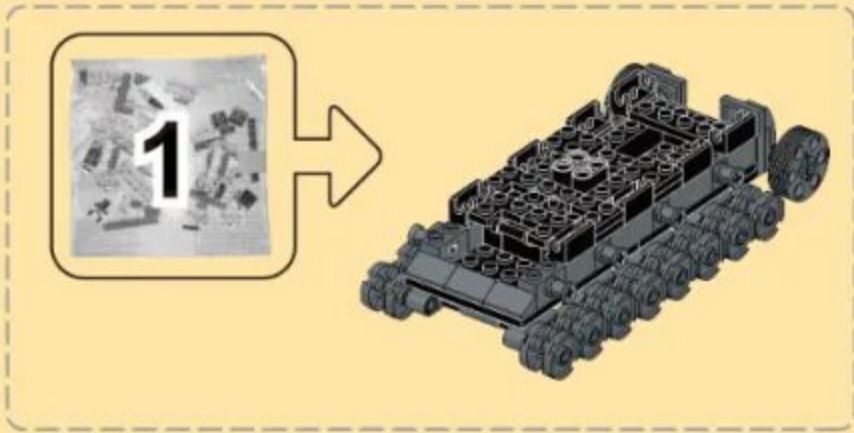

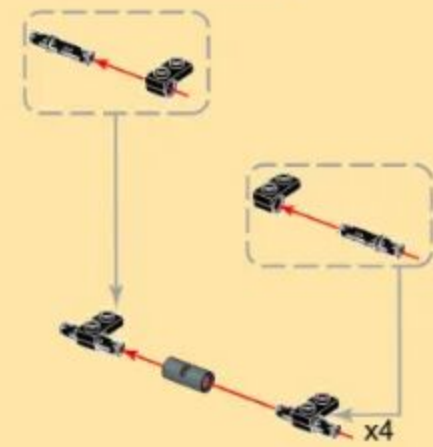
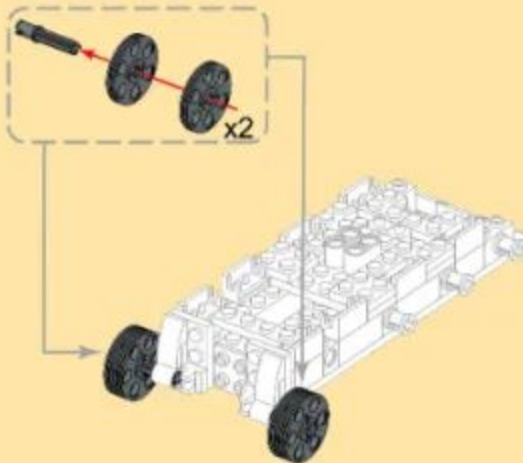
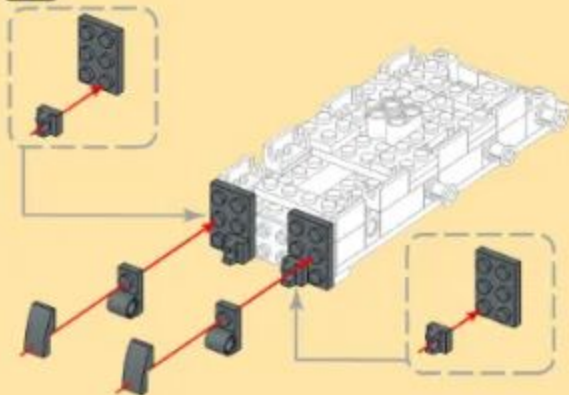
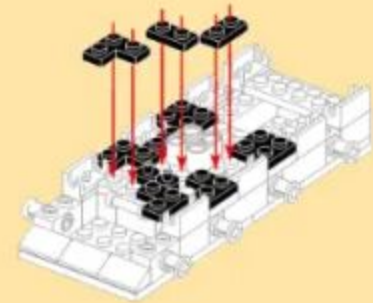
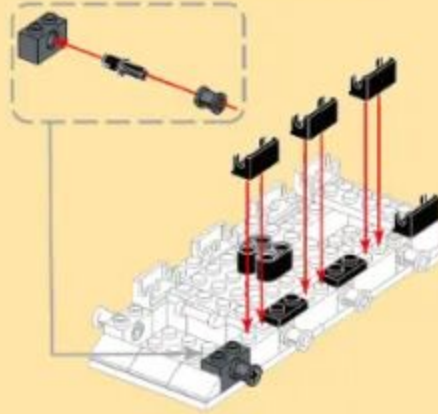
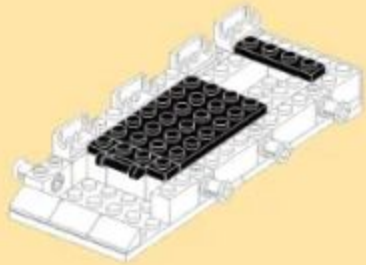
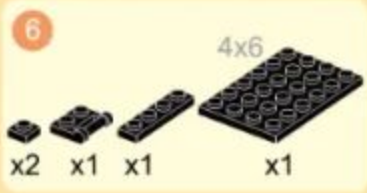

12

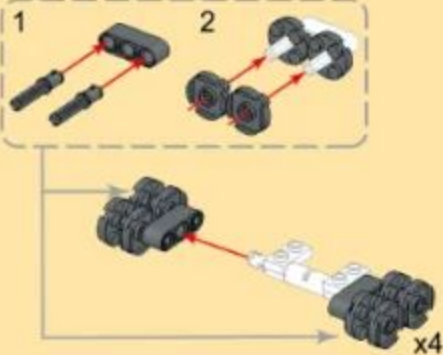

13

10 + 12

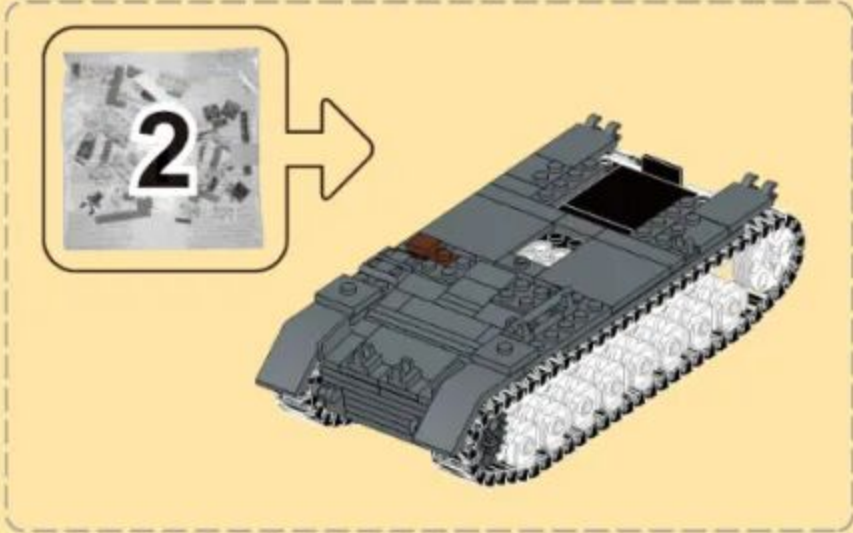
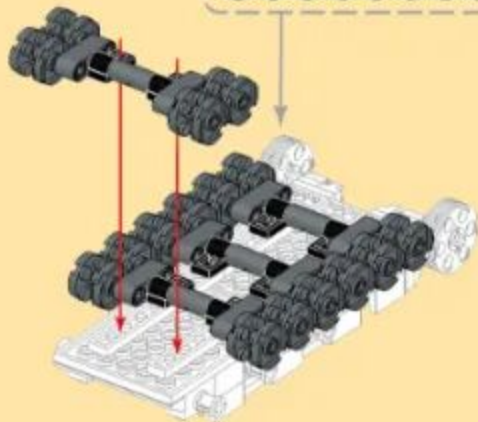

14

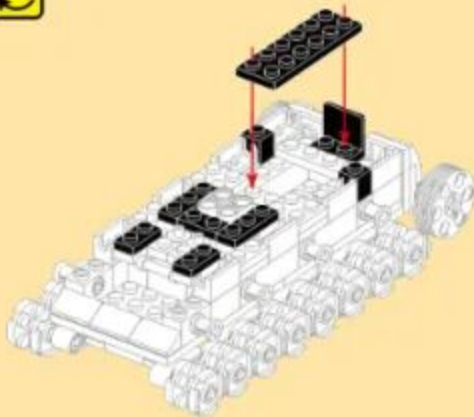

15

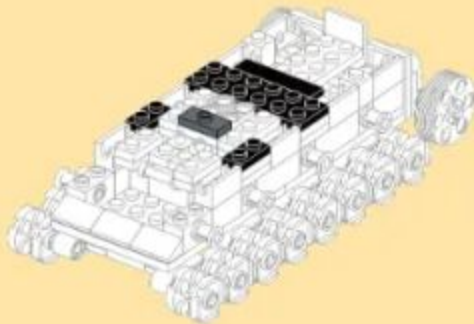
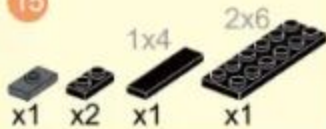

16

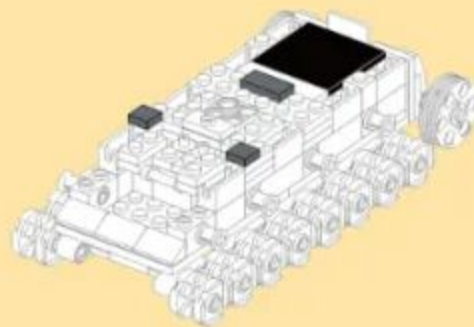
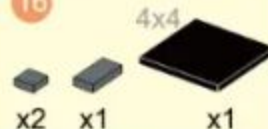

3

17

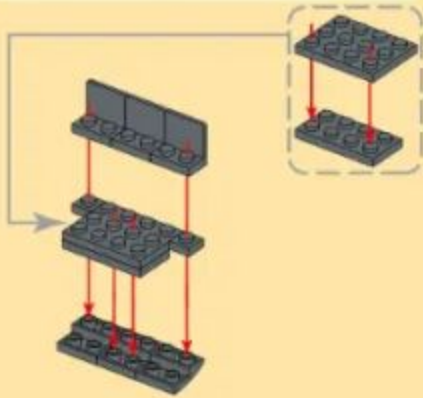

18

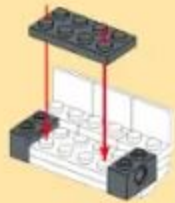

19

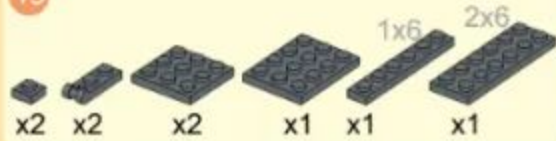

20

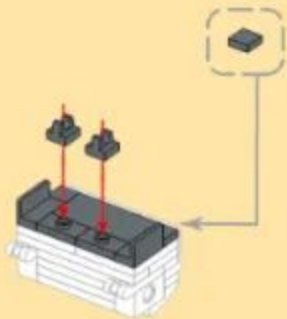

21

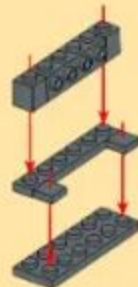

22

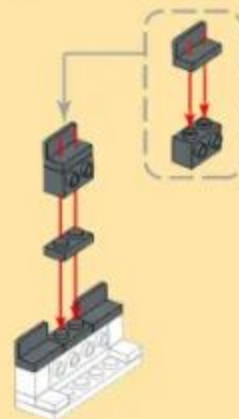

23
20 + 22

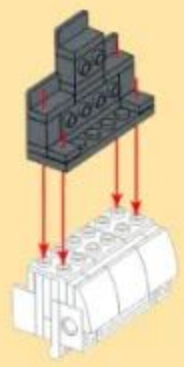

24
x2 x2 x1 x2

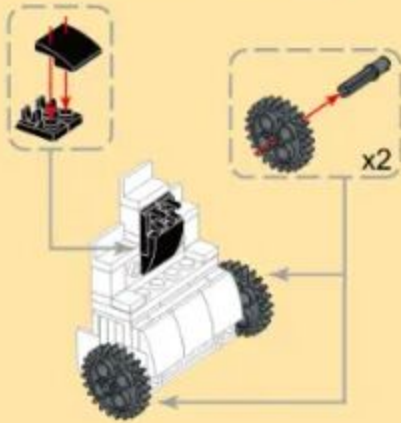

25
16 + 24

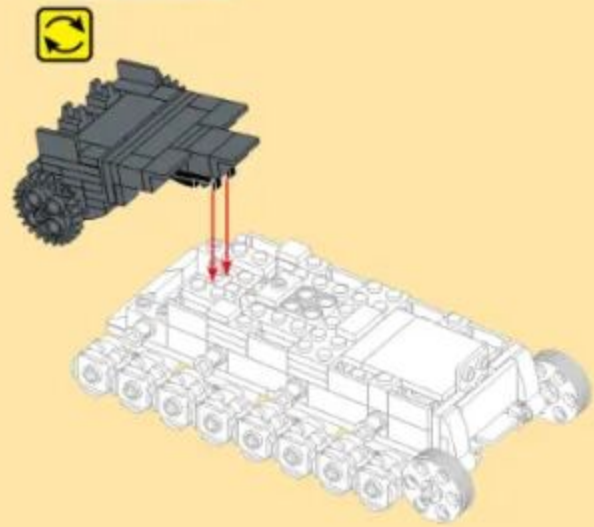

26
x122

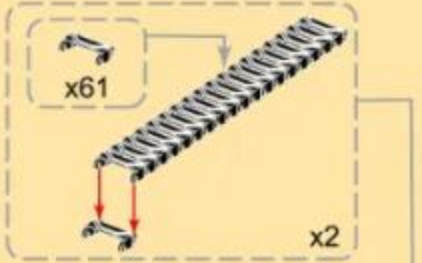

27
x1 x2 x1 x1 x1 x1 1x12



28
1x4 4x4 2x6
x1 x1 x1

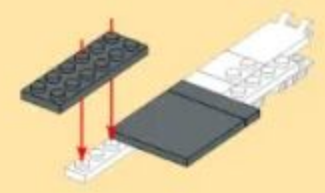
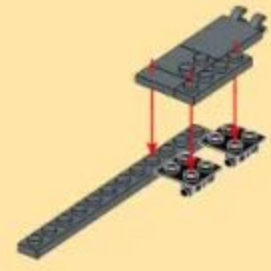
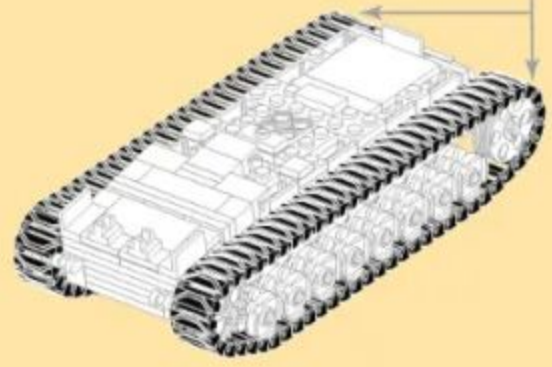
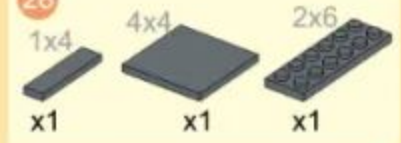

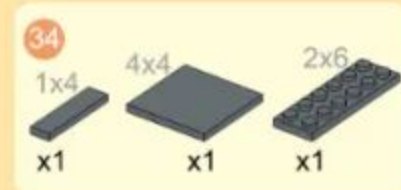
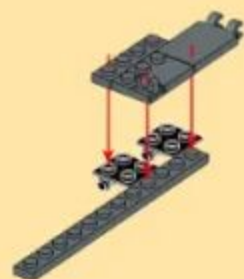
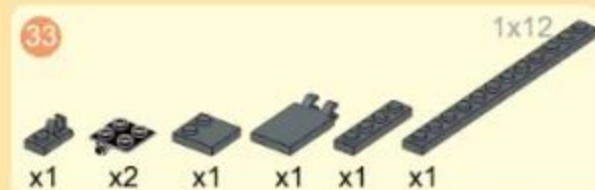
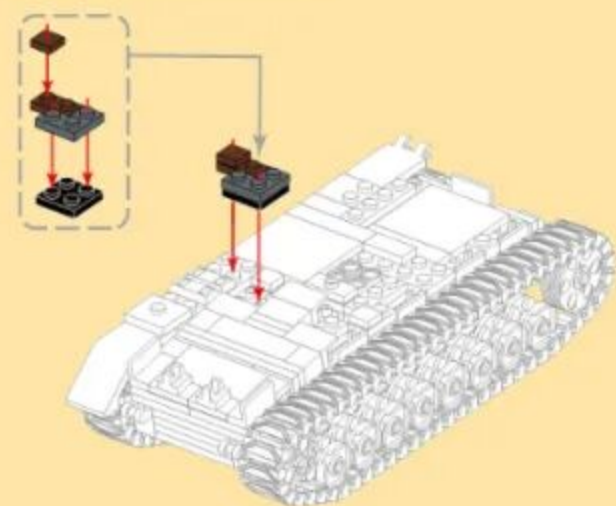
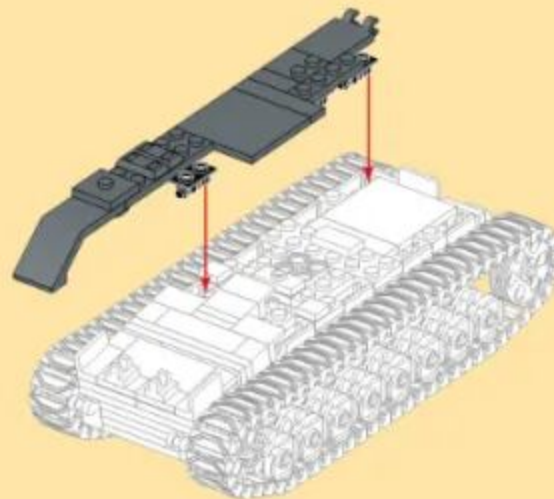
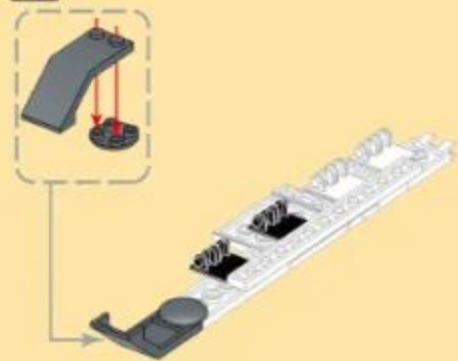
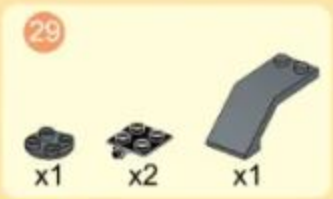

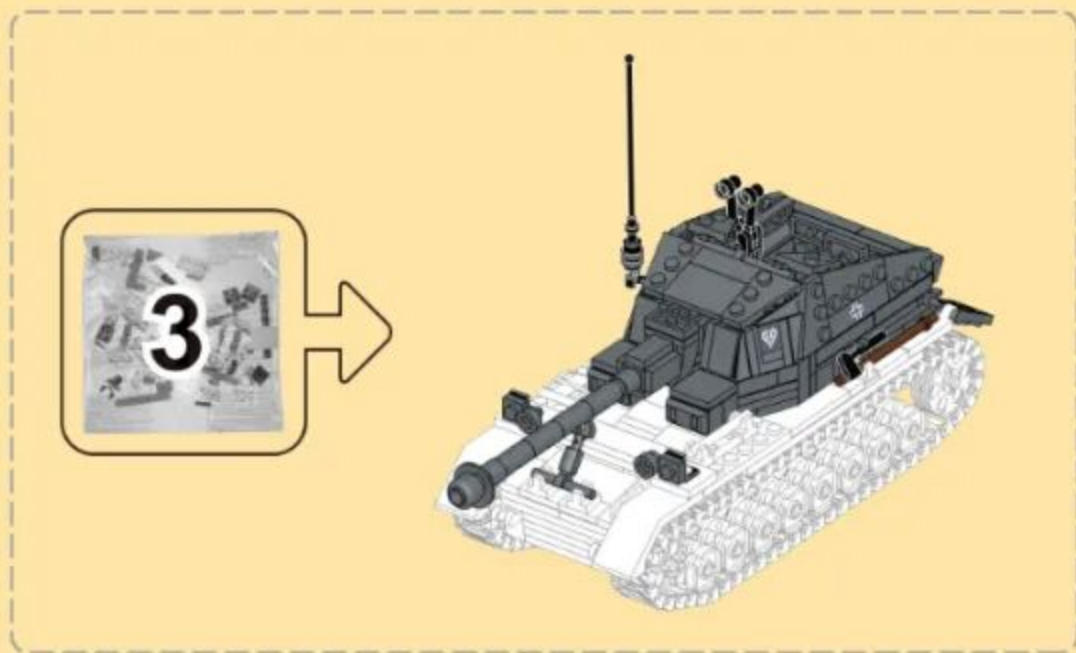
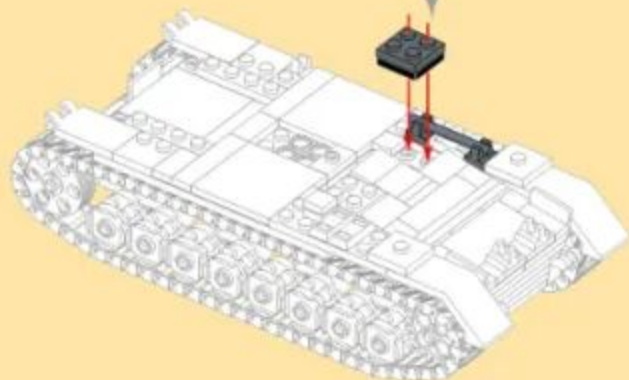
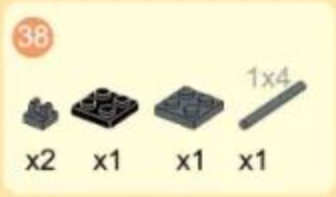
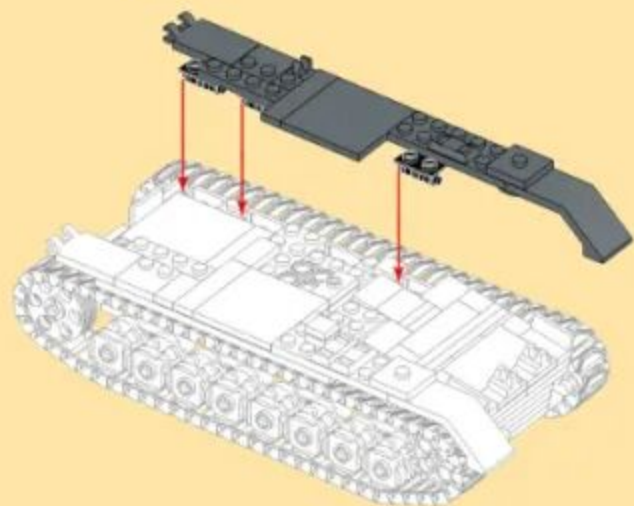
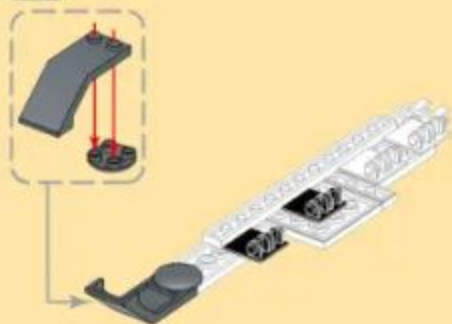
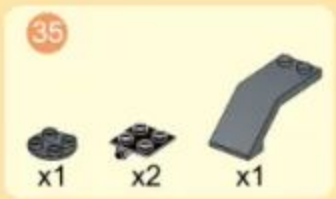

- 39
- x1
 - x1
 - x4
 - 1x3

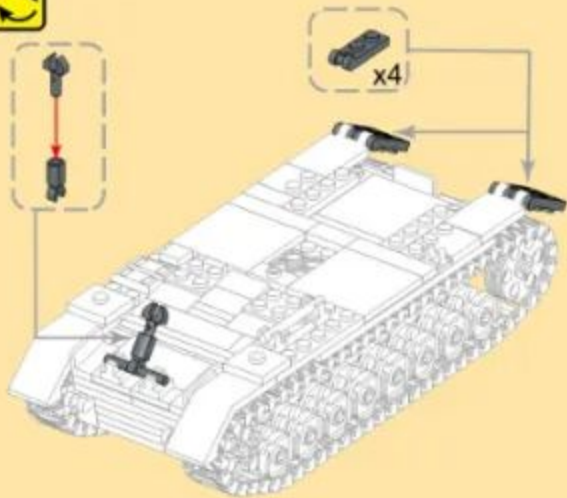

- 40
- x2
 - x2
 - x2

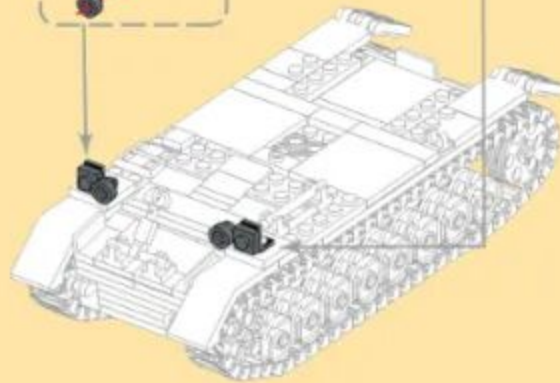
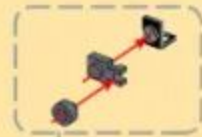
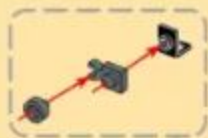

- 41
- x2
 - x2
 - x1
 - 1x6
 - 2x6

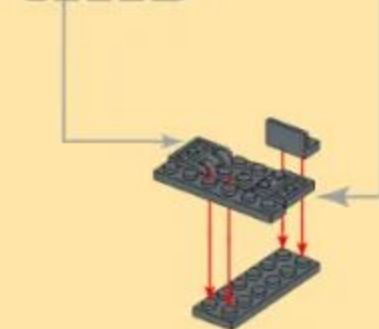
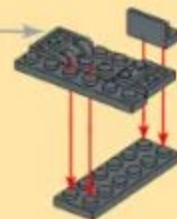
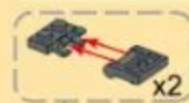

- 42
- x1
 - x1
 - x2
 - 2x4



- 43
- 40 + 42

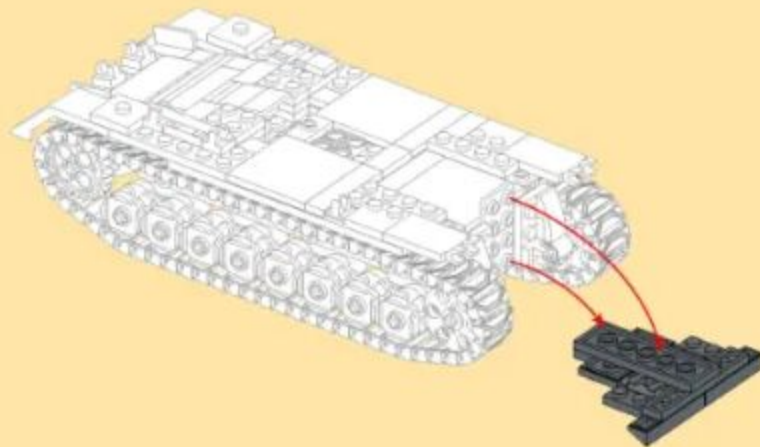

- 44
- x1
 - x1
 - x1

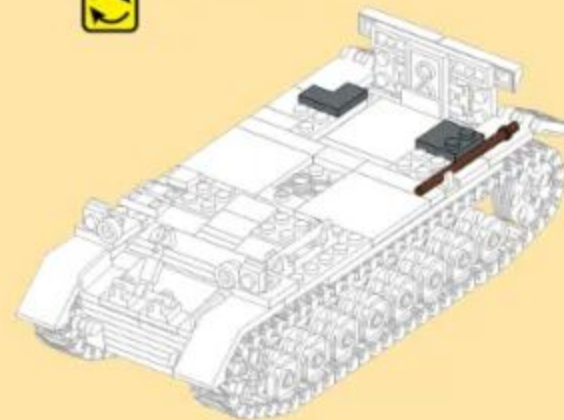

45

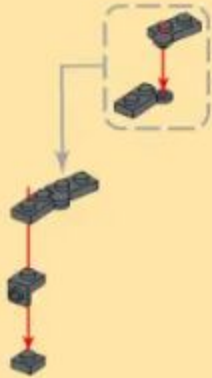

46



47

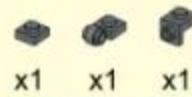

48



49

44 + 48



50

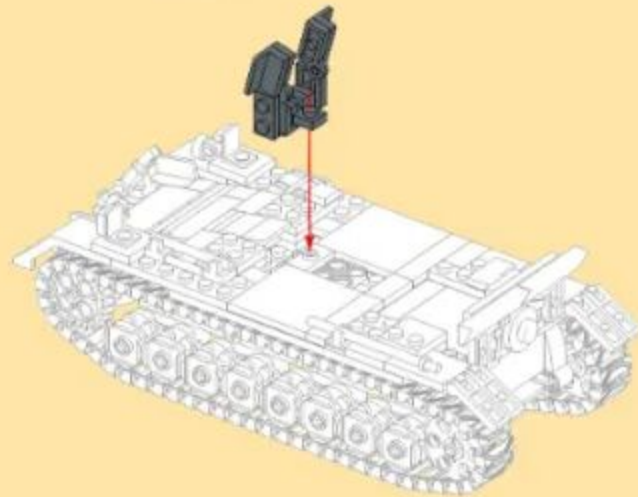

51



52

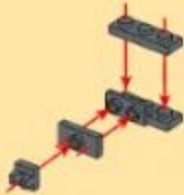

53



54



55



56

51 + 53 + 55

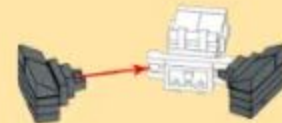

57

49 + 56



58



59

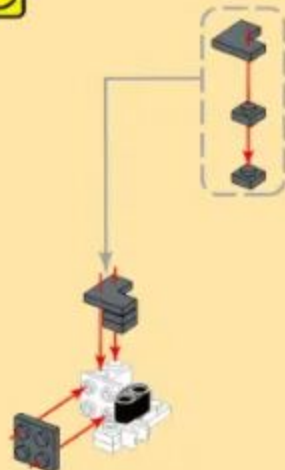
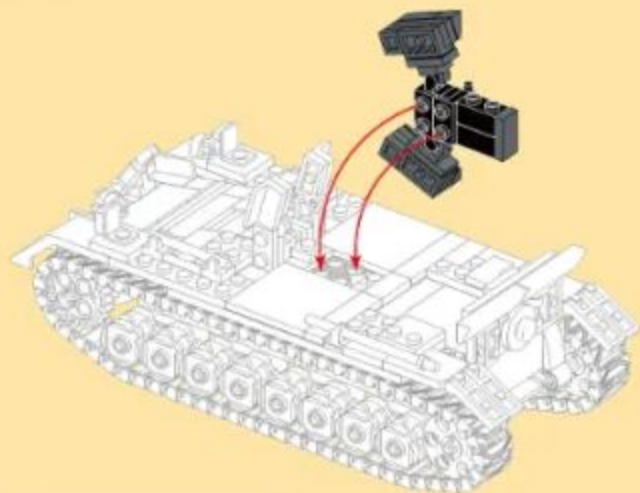

60



61



62



63

60 + 62



66

x1 x1 x1 x1



64

x1 x1 x1 x1 x1



67

x3 x1 x1 x1 x1 x1 x1

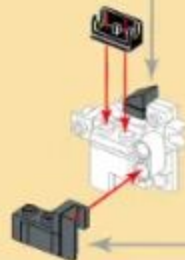
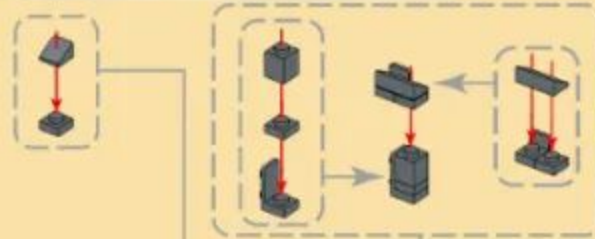

65

x2 x1 x1 x1

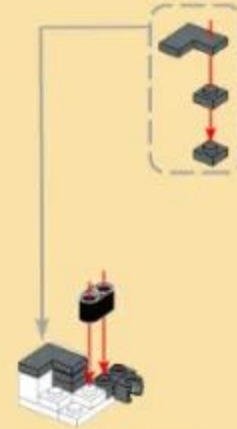

68

57 + 63 + 67

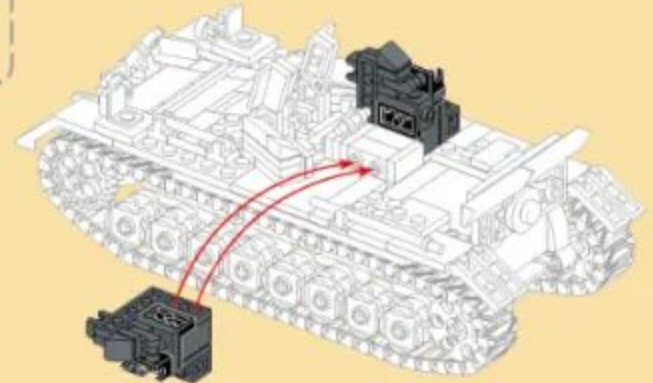

69



70



71

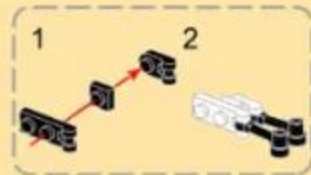
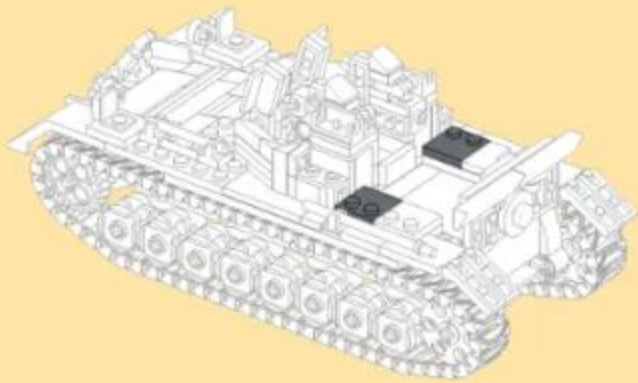

72

69 + 71



73



74

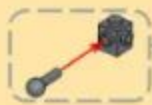
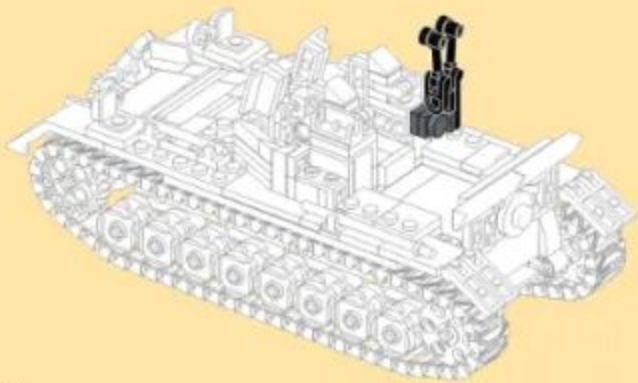

75

x1 x1



78

x1 x1

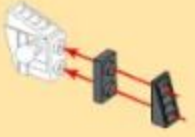

76

x1 x1 x1 x1

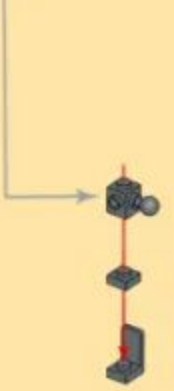
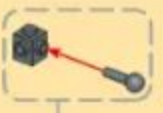

77

x1 x2



79

72 + 75 + 78

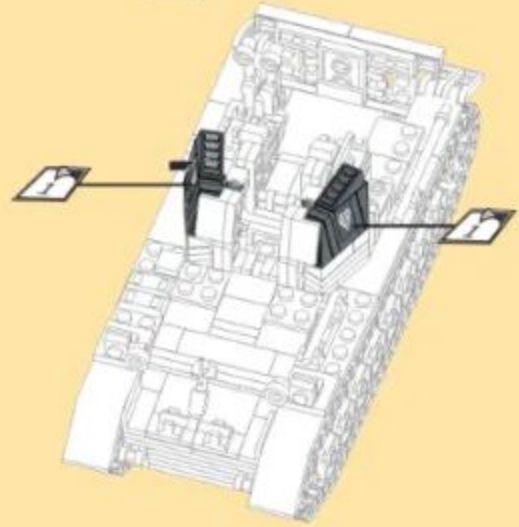

80

x2 x1 x1

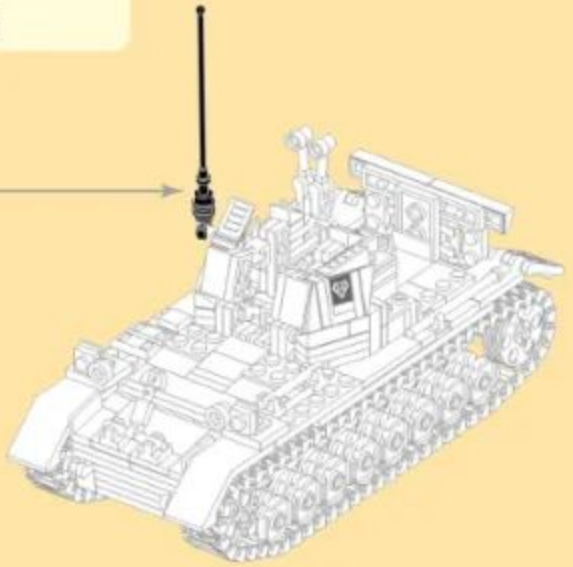

81

x2 x1 x1 x1 1x6



82

x1 x2



83

80 + 82

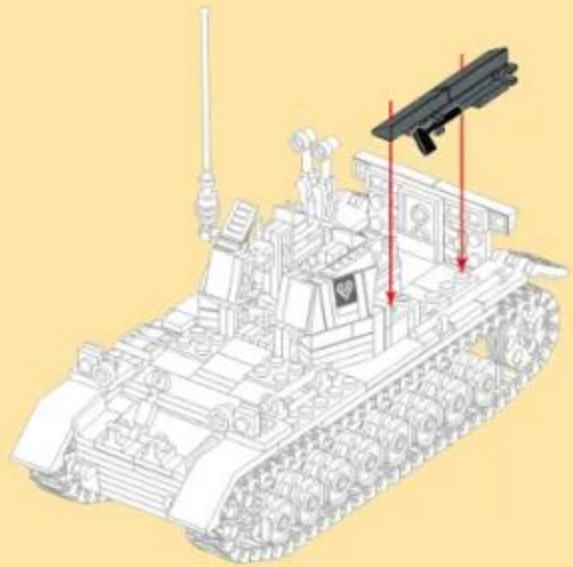

84

x1 x1 x1



85



86

83 + 85

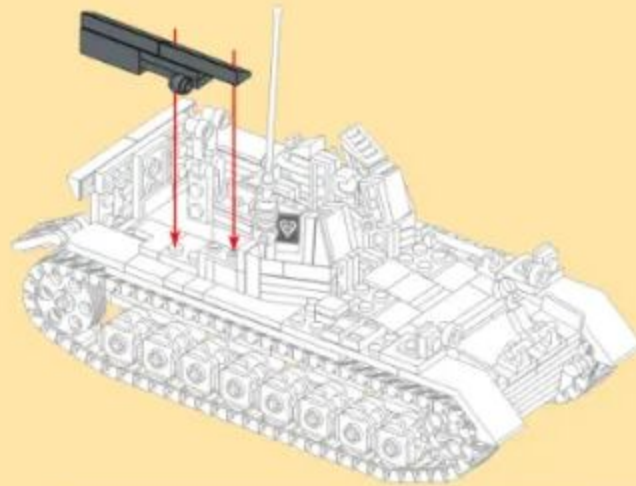

87

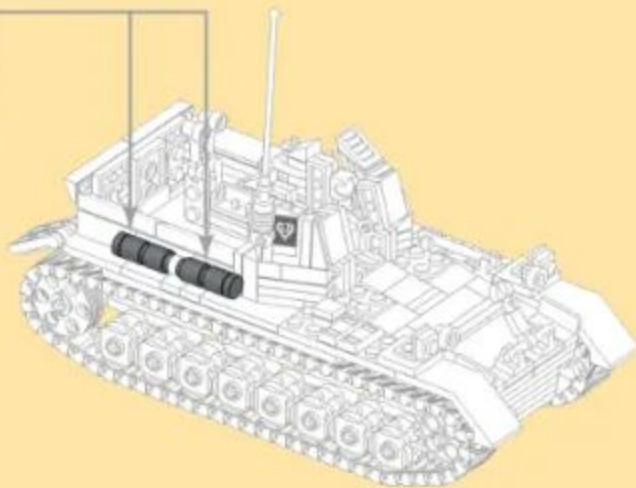

88

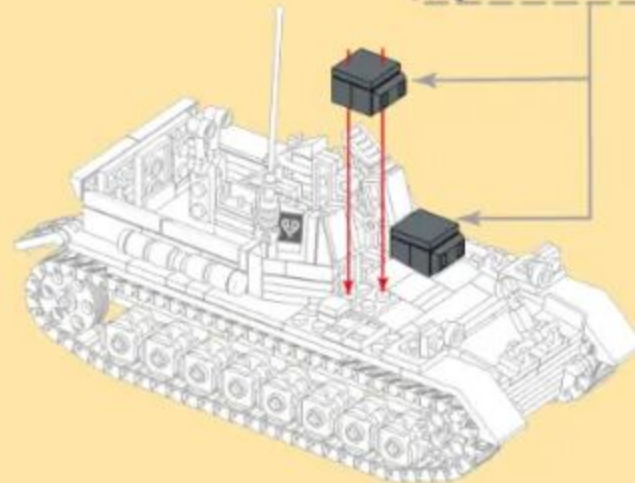
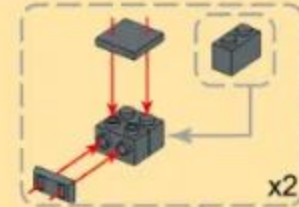

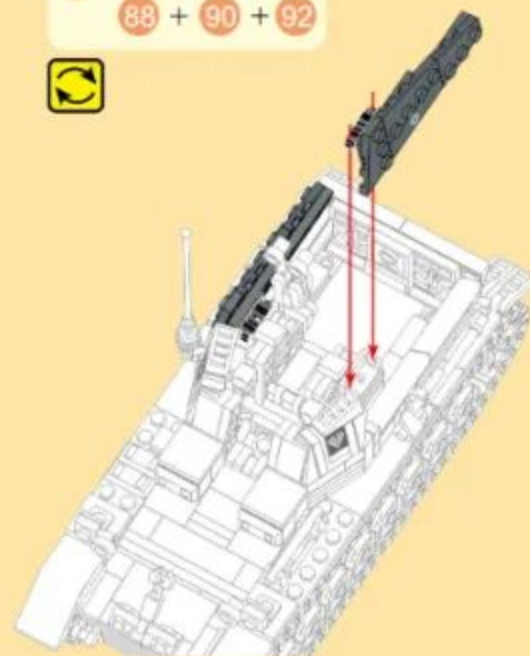
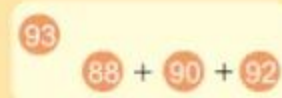
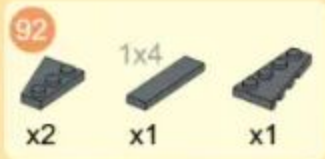
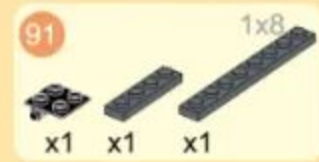
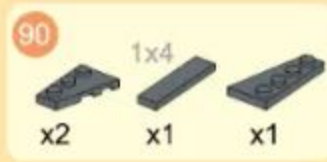
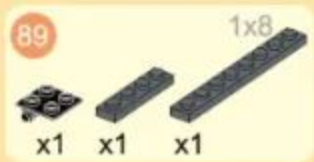

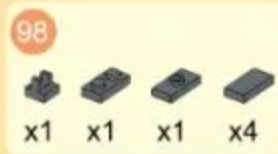
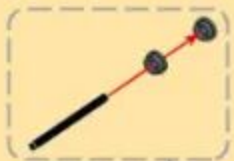
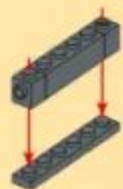
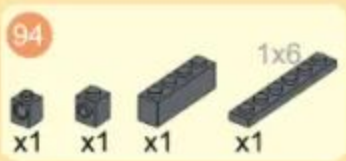

100

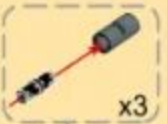
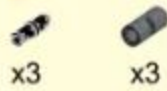

101

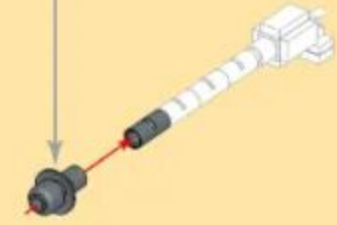
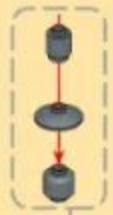

102

96 + 101



103

93 + 102

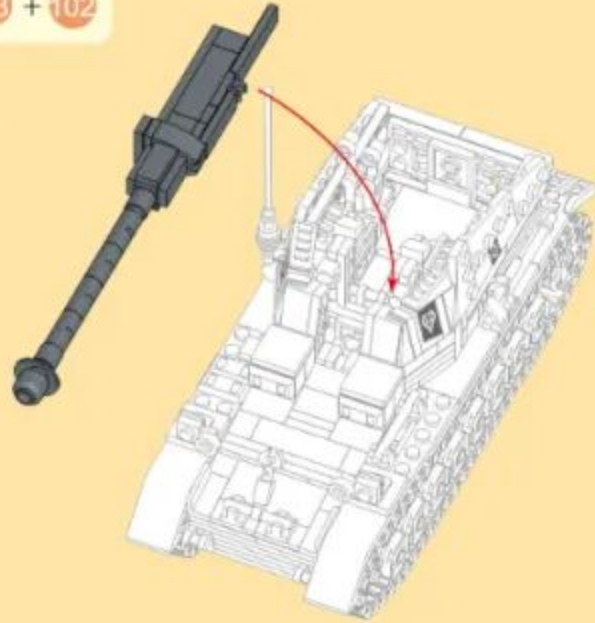

104

1x5

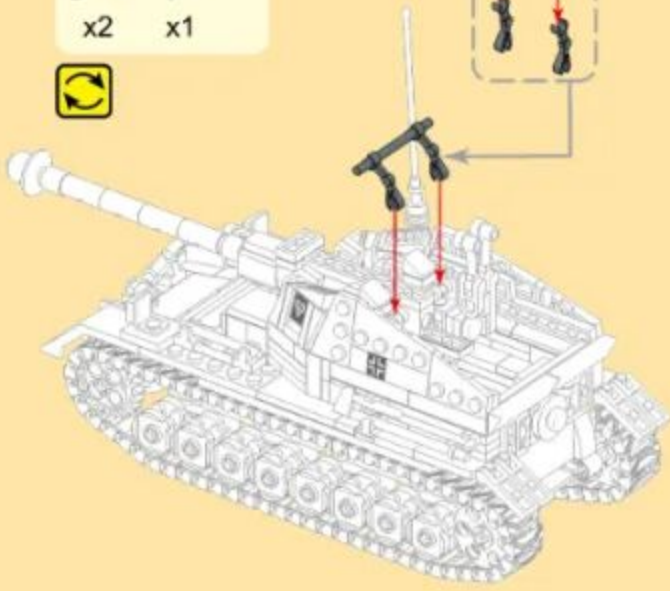
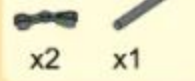

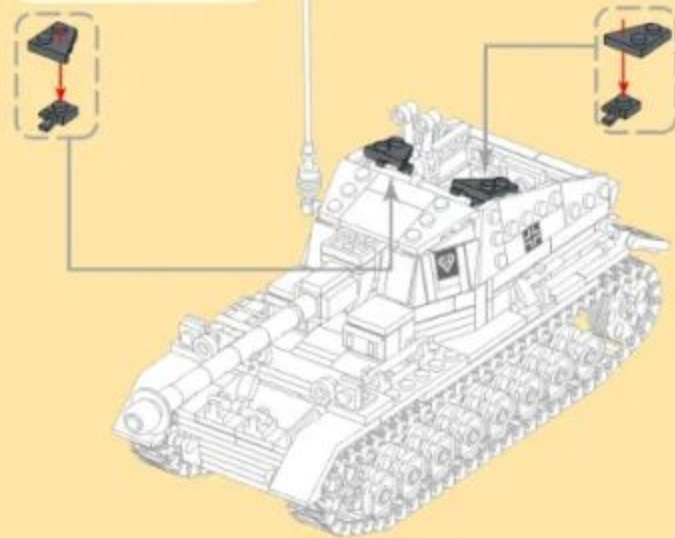
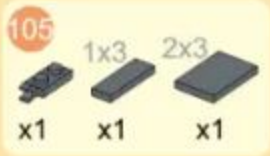



MILITARY EQUIPMENT

Building blocks model

Perfect shape,high simulation,classic collection

4510



M35 2½-TON CARGO TRUCK
AND M198 HOWITZER

4511



ANTI-AIRCRAFT MISSILE

4512



ANTI-AIRCRAFT MISSILE TRANSPORT VEHICLE

4513



M1151 ENHANCED ARMAMENT CARRIER

4514



T-34-85

4515



NEUBAUFahrZEUG

4516



DICKER MAX

4517



PANTHER TANK



Ver.451620240511