



# EMPIRE STATE BUILDING

EL EMPIRE STATE BUILDING

New York, America

The world's great architecture



Creative Ability	Family Interaction	Observation Ability	Thinking Ability	Practical Ability

6+ / 5212 / 1559 PCS  
Suitable Age / Product Number / Parts Total



# Architecture

It will be a city...

这将构成一座城市...

# ABOUT THE PRODUCT

关于产品

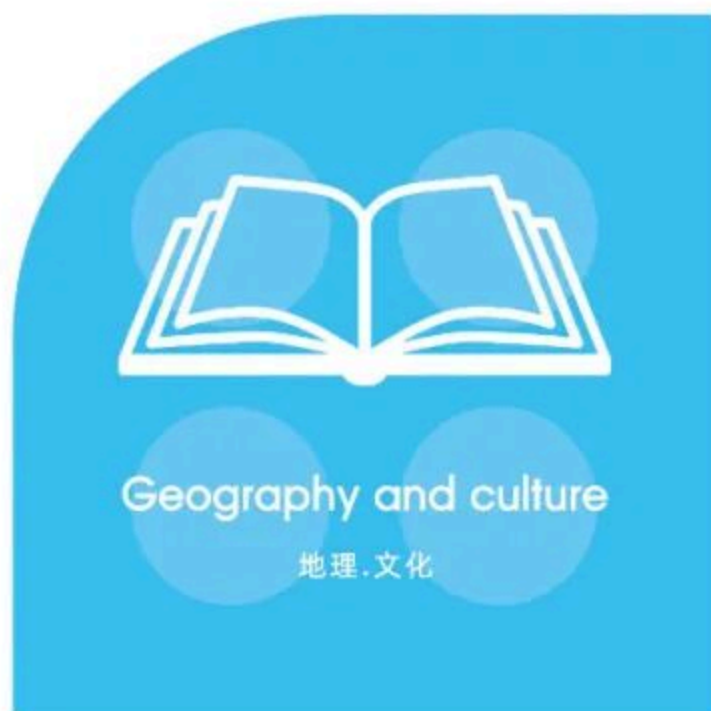

## ARCHITECTURE

WANGE The world's great architect since 1991

Shantou Wange Educational Material Sci-Tech Co., Ltd.  
©2014 Wange / Dubie. All Rights Reserved

# Empire State Building



The Empire State Building is located on the west side of Fifth Avenue in Manhattan, between 33rd Street to the south and 34th Street to the north.

# Empire State Building



Geography and culture

地理·文化



The Empire State Building is a 102-story Art Deco skyscraper in Midtown Manhattan in New York City, United States.



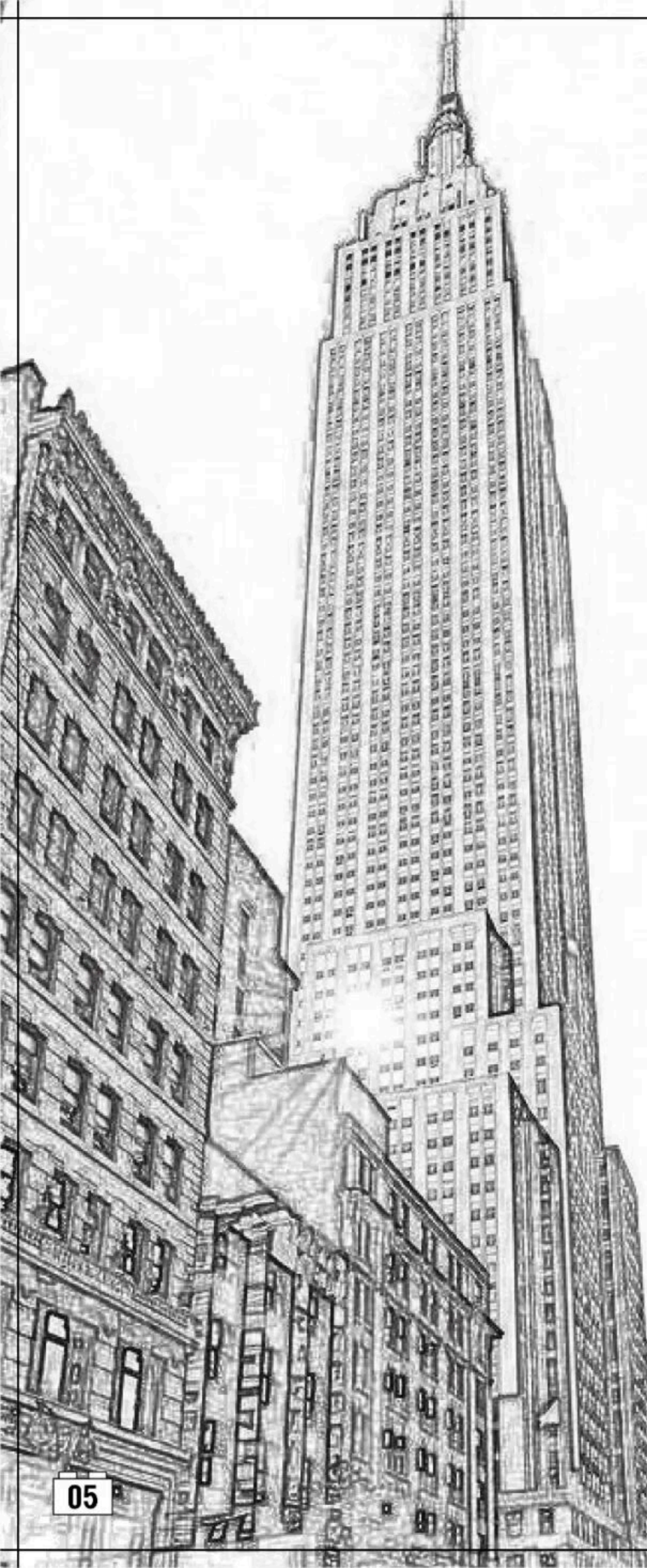

El Empire State Building

# Empire ■ State Building

America

The contents of this chapter refer to the Wikipedia website.

本章内容参考维基百科网站，  
更多资讯可自行查阅。

The world's great architecture

# Buildings and layout

■ 建筑物和布局



The Empire State Building is a 102-story[c] Art Deco skyscraper in Midtown Manhattan in New York City, United States. The site of the Empire State Building, in Midtown South on the west side of Fifth Avenue between West 33rd and 34th Streets, was developed in 1893 as the Waldorf–Astoria Hotel. Its name is derived from "Empire State", the nickname of the state of New York. The building's size has become the global standard of reference to describe the height and length of other structures. A symbol of New York City, the building has been named as one of the Seven Wonders of the Modern World by the American Society of Civil Engineers.

Actualmente, el Empire State es de los rascacielos más emblemáticos e icónicos del mundo por su historia y su gran altura destacable en el siglo pasado. Incluyendo la antena, su altura es de 1453 pies (443 m) convirtiéndolo en el tercer edificio más alto de la ciudad de Nueva York por detrás del One World Trade Center y Central Park Tower. El Empire State Building ha sido nombrado por la Sociedad Estadounidense de Ingenieros Civiles como una de las Siete Maravillas del Mundo Moderno. El edificio y su interior son catalogados como monumentos de la Comisión para la Preservación de Monumentos Históricos de Nueva York, y confirmado por la Junta de Estimación de la Ciudad de Nueva York.



## Architecture

The longest world record held by the Empire State Building was for the tallest skyscraper (to structural height), which it held for 42 years until it was surpassed by the North Tower of the World Trade Center in October 1970. The Empire State Building was also the tallest man-made structure in the world before it was surpassed by the Griffin Television Tower Oklahoma (KWTV Mast) in 1954, and the tallest freestanding structure in the world until the completion of the Ostankino Tower in 1967.

El Empire State Building se eleva hasta los 381 metros (1250 pies) a nivel del piso 102, e incluyendo los 62 metros (203 pies) del pináculo, su altura total llega a los 443 metros o 1453 pies y 8 pulgadas. Fue el primer edificio en tener más de 100 pisos. Tiene 6500 ventanas y 73 ascensores, y hay 1860 pasos desde el nivel de la calle hasta el piso 102. Tiene una superficie total de 257 211 m<sup>2</sup>; la base del Empire State tiene unos 8094 m<sup>2</sup>.



## History

According to The New York Times, builders and real estate speculators predicted that the 1,250-foot-tall (380 m) Empire State Building would be the world's tallest building "for many years", thus ending the great New York City skyscraper rivalry. At the time, most engineers agreed that it would be difficult to build a building taller than 1,200 feet (370 m), even with the hardy Manhattan bedrock as a foundation. Technically, it was believed possible to build a tower of up to 2,000 feet (610 m), but it was deemed uneconomical to do so, especially during the Great Depression. As the tallest building in the world, at that time, and the first one to exceed 100 floors, the Empire State Building became an icon of the city and, ultimately, of the nation.

El Empire State Building fue diseñado por William F. Lamb, socio de la empresa de arquitectura Shreve, Lamb y Harmon, quienes realizaron los dibujos del edificio en tan solo dos semanas, utilizando como base anteriores diseños, como el Edificio Reynolds en Winston-Salem, Carolina del Norte y la Torre Carew de Cincinnati, Ohio, diseñada ésta por el arquitecto Walter W. Ahlschlager. La excavación del emplazamiento se inició el 22 de enero de 1930, y la construcción del propio edificio comenzó simbólicamente el 17 de marzo (día de San Patricio). En el proyecto participaron 3400 trabajadores, en su mayoría inmigrantes procedentes de Europa, junto con cientos de trabajadores Mohawk expertos en hierro, muchos de ellos de la reserva de Kahnawake, cerca de Montreal. Los nietos del gobernador Smith cortaron la cinta el 1 de mayo de 1931.

# Force Balance

受力平衡

$$F = G \frac{m_1 m_2}{d^2}$$

Physical operations

物理运算

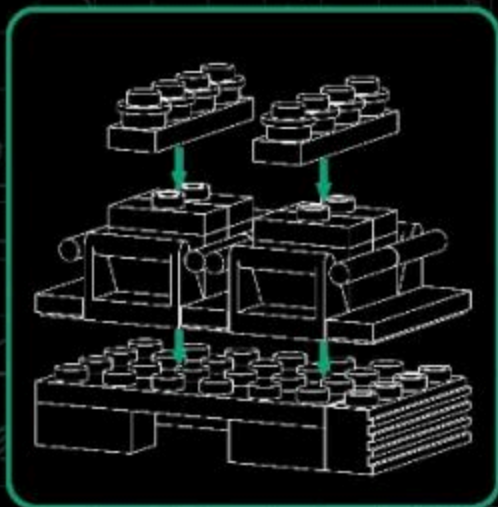
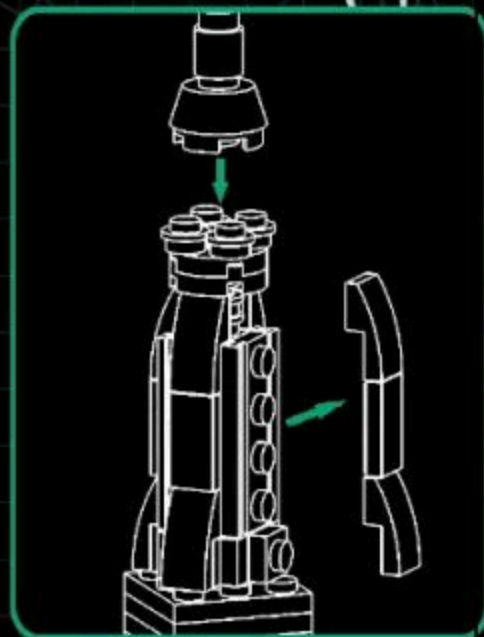

Creation and thinking

创作·思考

# Special parts

特殊零件的开发利用

$$S=4\pi \cdot r^2$$

$$a^2+b^2=c^2$$



**WG1321**  
2倍平双线



**WG1410**  
4倍高1孔



**WG0465**  
加高1孔



**WG1300**  
高长5孔

$$\sin^2 a + \cos^2 a = 1$$



features and functions

特点.功能

# Main Color Matching

配色方案



Pantone 7500C



Pantone 7509C



Pantone 1575C



Pantone Cool Gray 8C



Pantone 431C



Pantone Cool Gray 6C



Pantone Black 6C

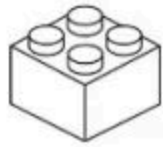

White



Pantone 285C



Pantone 2300C



Pantone 348C



## Color matching

Adopting 3 main colors, cream-colored, silver and gray as the main color, the more reasonable and Green color matching on the original building, making the product more atmospheric and the whole design is more reasonable.

# Empire State Building

帝国大厦



Front

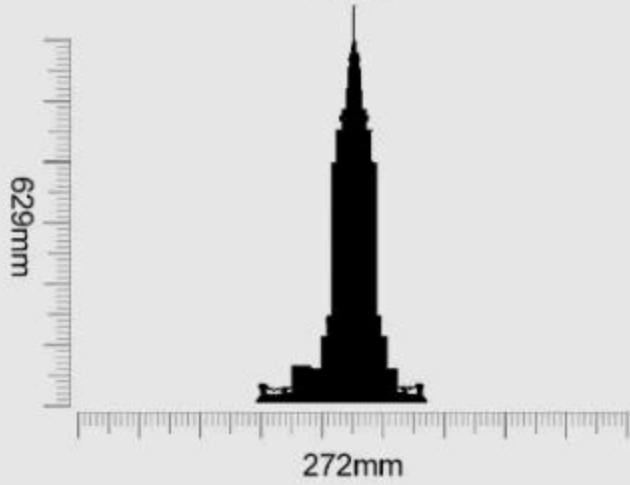

Left

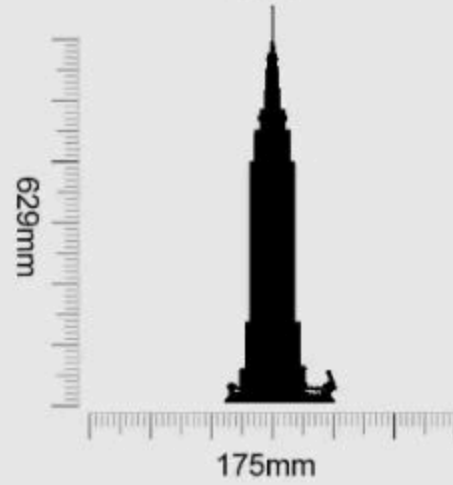

Back

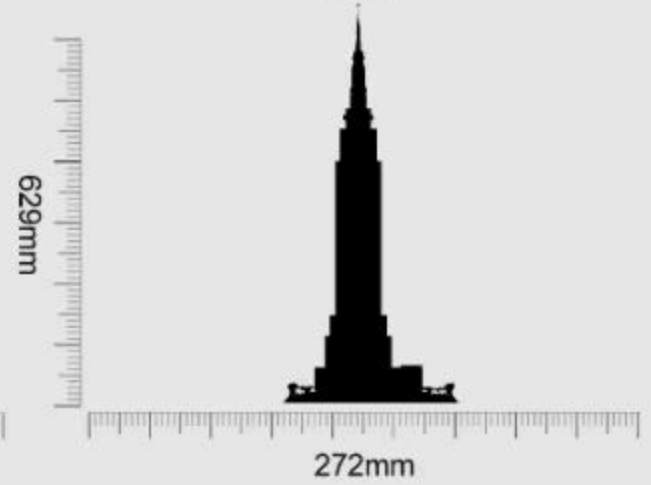

Product Size:272X175X629mm





■ First open the product packaging according to the instructions.

按指导用正确方式拆解产品外包装。



■ Summarize all parts to count the number of familiar accessories.

对照说明书清单确认积木包数量与积木数量。



■ Arranging all accessories by color helps to quickly install the product.

把确认好的积木以类型、颜色进行分类排好以便安装。



■ Carefully install the product and learn about building.

按说明书步骤拼装并完成你的积木模型。



# Instructions For Use

积木起件器使用说明  
Brickseparator

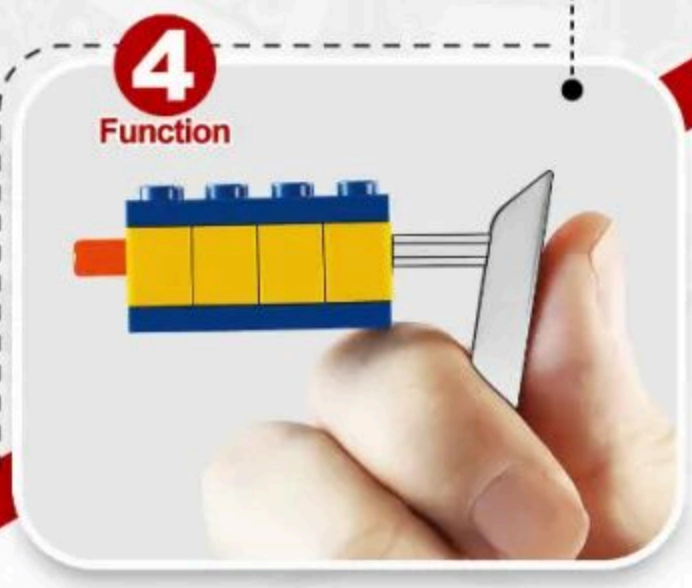
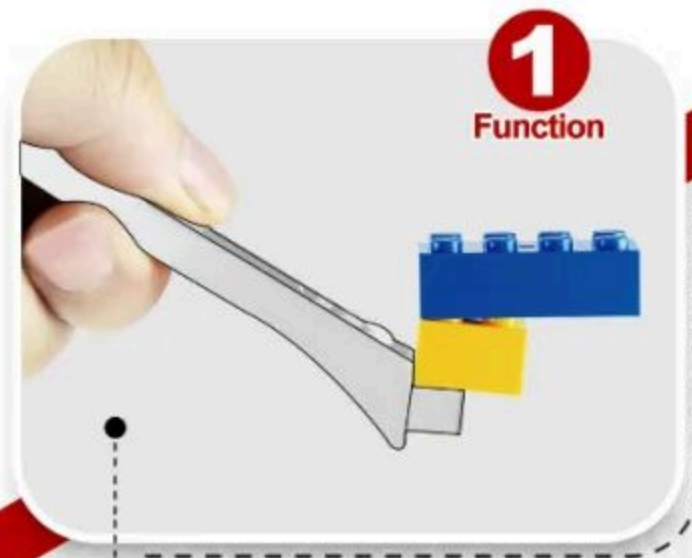

4 ways to make installation easier  
让安装更简单

# 1:1 Physical Reference Table

十字棒配件1:1尺寸参照表



Instructions For Use

让安装更简单



**2** (1x2)=2



**3** (1x3)=3



**4** (1x4)=4



**5** (1x5)=5



**6** (1x6)=6



**7** (1x7)=7



**8** (1x8)=8



**9** (1x9)=9

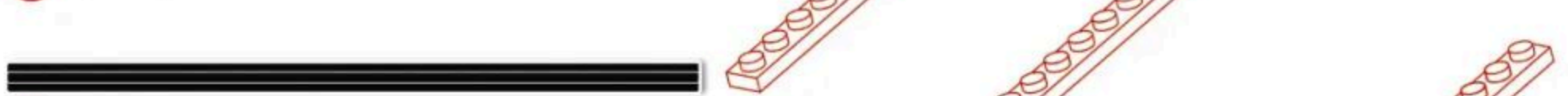

**10** (1x10)=10



**12** (1x12)=12



**16** (1x16)=16



# PARTS LIST

配件清单



x4



x18



x28



x1



x6



x2



x4



x7



x19

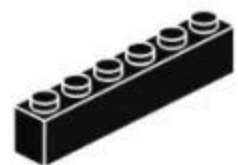

x1



x16



x5



x2



x2



x2



x14



x6



x4



x8



x12



x3



x10



x28



x16



x32



x1



x8



x1



x1



x4



x8



x4



x8



x10



x2



x56



x2



x22



x3



x8



x22



x50



x19



x10



x14



x2

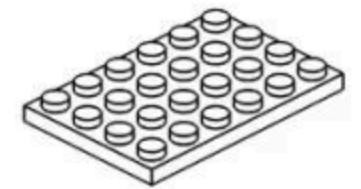

x1



x3



x4



x4



x4













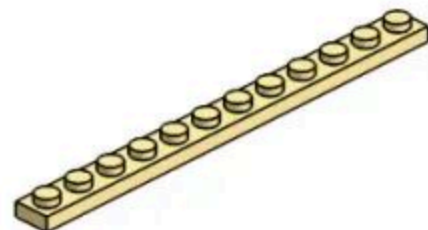
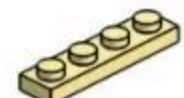



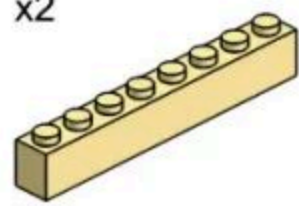



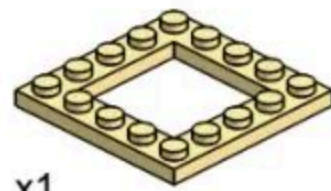

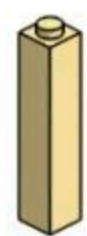

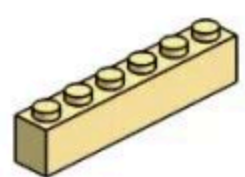
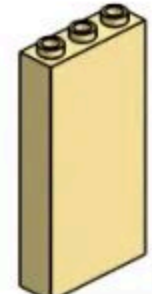

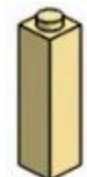
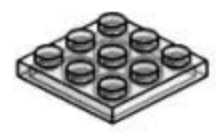
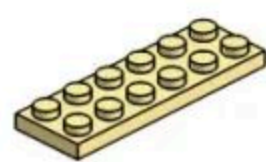

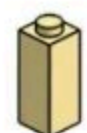

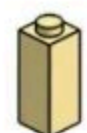
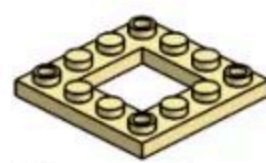

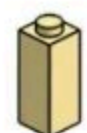

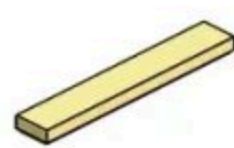



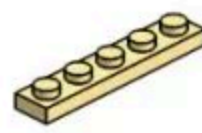



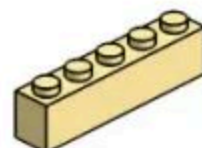
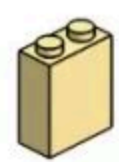

x1

产品有增补件请以实物为准

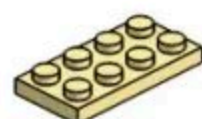
If product has additional parts, please in kind prevail.

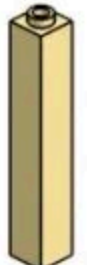
# PARTS LIST

配件清单

				
x2	x4	x40	x2	x59
				
x2	x10	x4	x38	x12
				
x1	x4	x4	x30	x4
				
x3	x14	x8	x6	x2
				
x2	x28			x4
				
x4	x10	x4	x44	x2
				
x8	x14	x22	x8	x10
				
x4	x40	x4		x1
				
x4	x128	x2	x8	x172
				
x4	x24	x6	x4	x76
				
			x12	x4

产品有增补件请以实物为准

If product has additional parts, please in kind prevail.

# PARTS LIST

配件清单



x4



x1

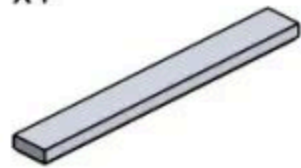

x6



x6

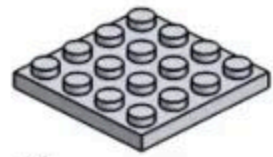

x1



x4

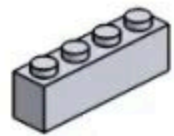

x1

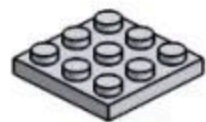

x2



x2



x2



x3



x4



x6



x1



x1



x4



x8



x1



x2

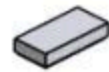

x4



x4



x4



x1



x2



x4



x8



x4

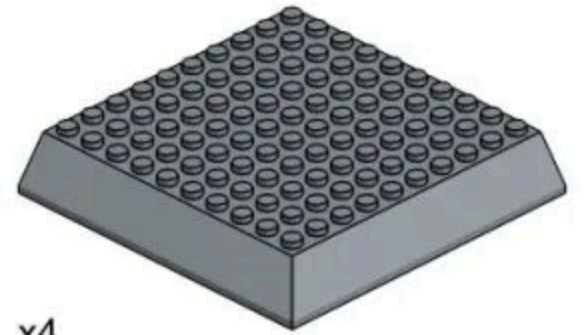

x4

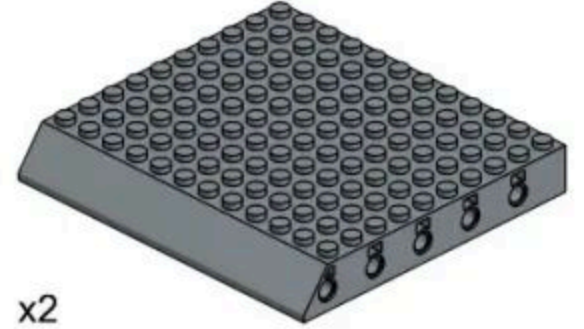

x2



x1



x4



x2



x6



x2



x2



x12



x8



**266PCS**

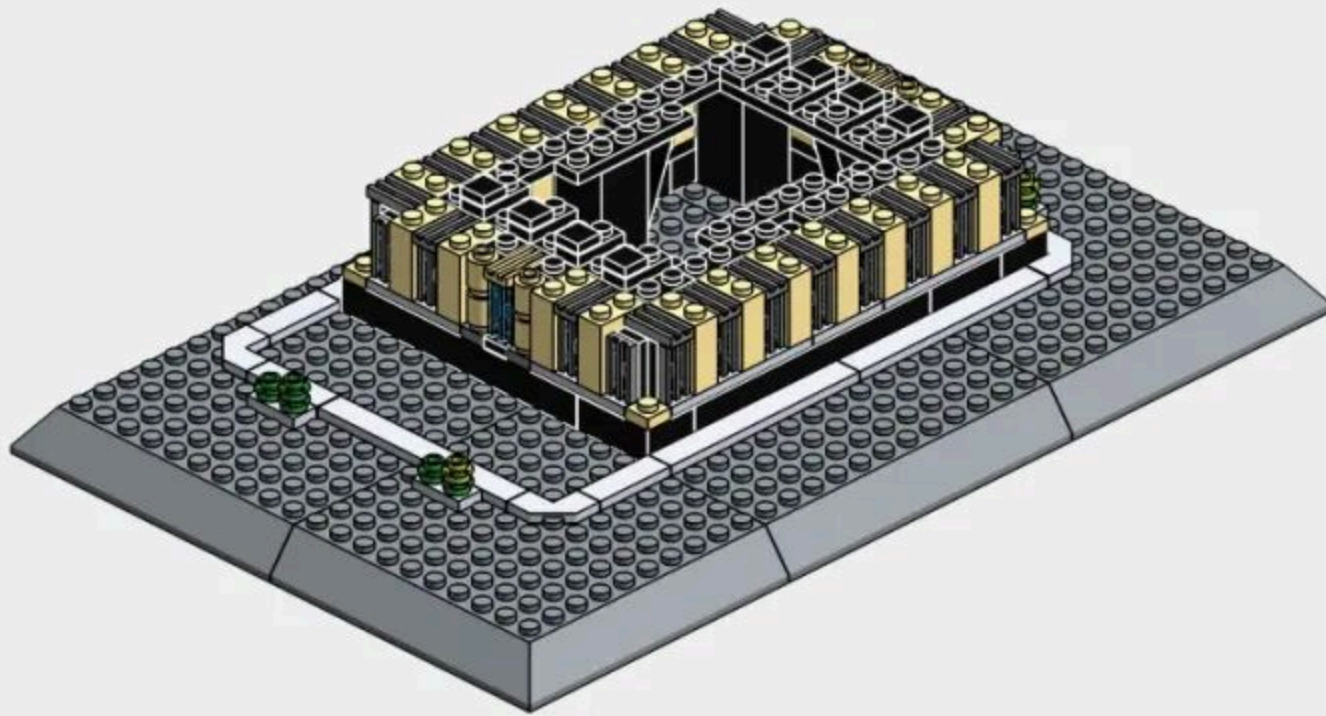

1-1

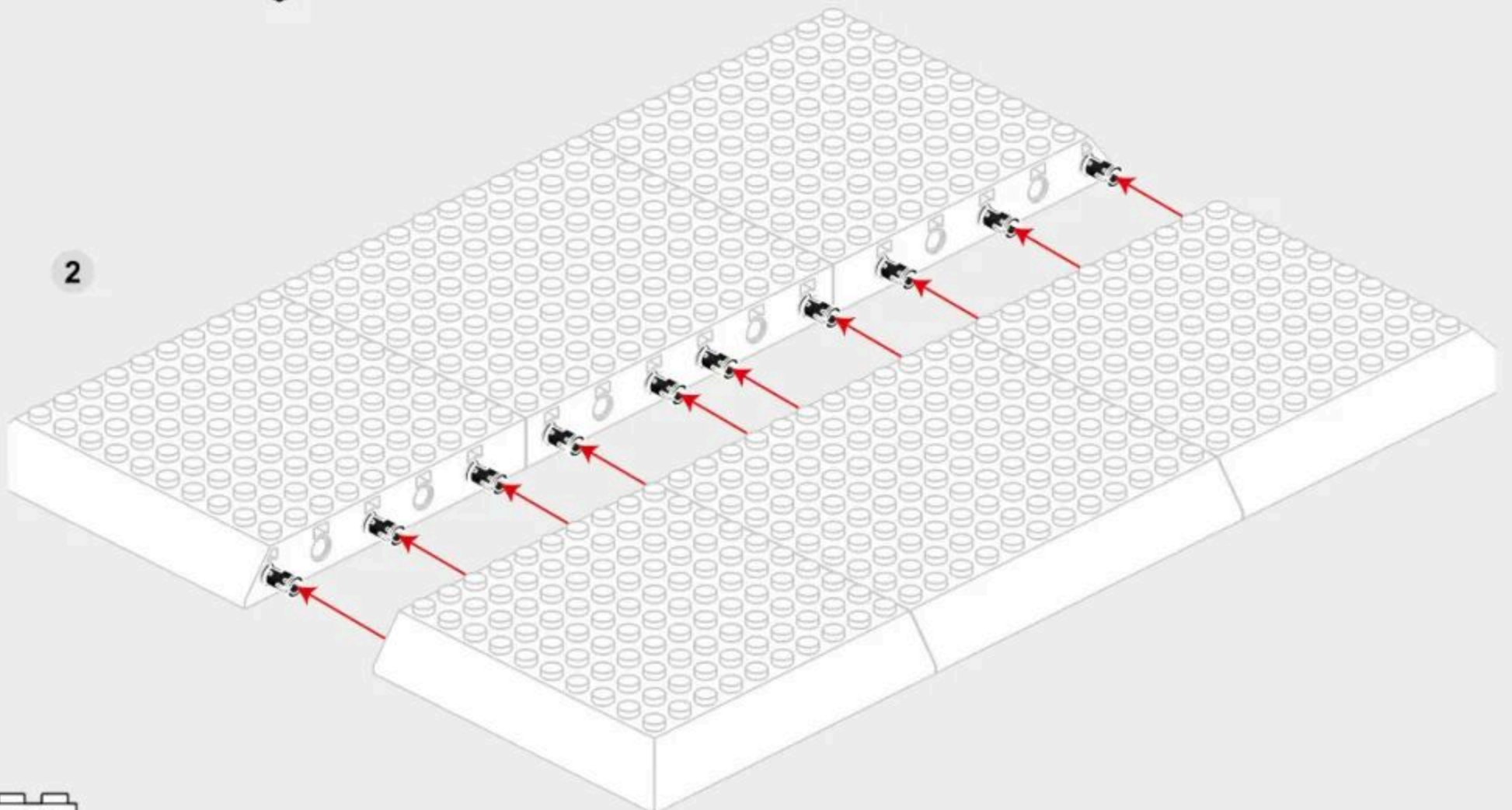
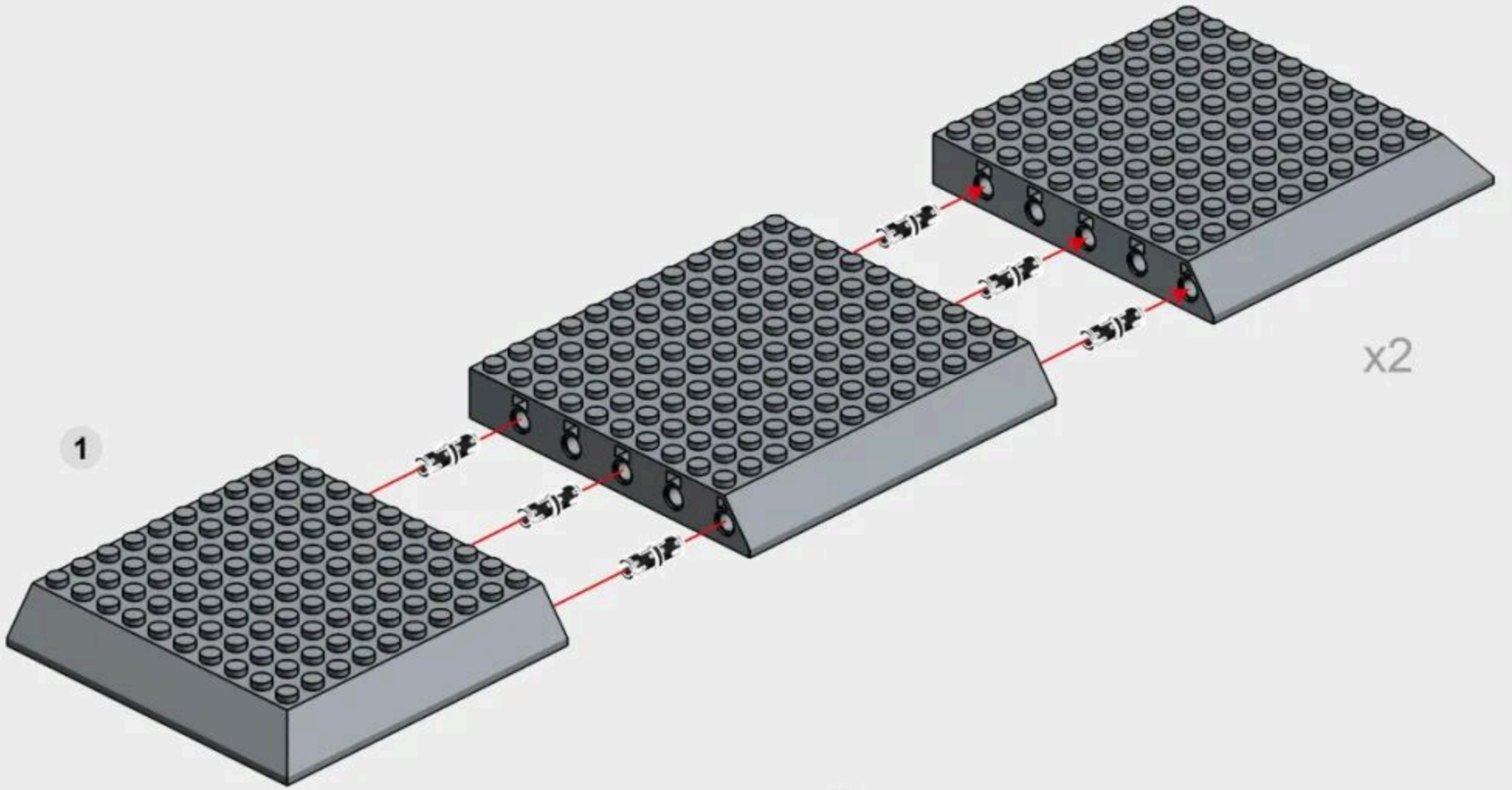
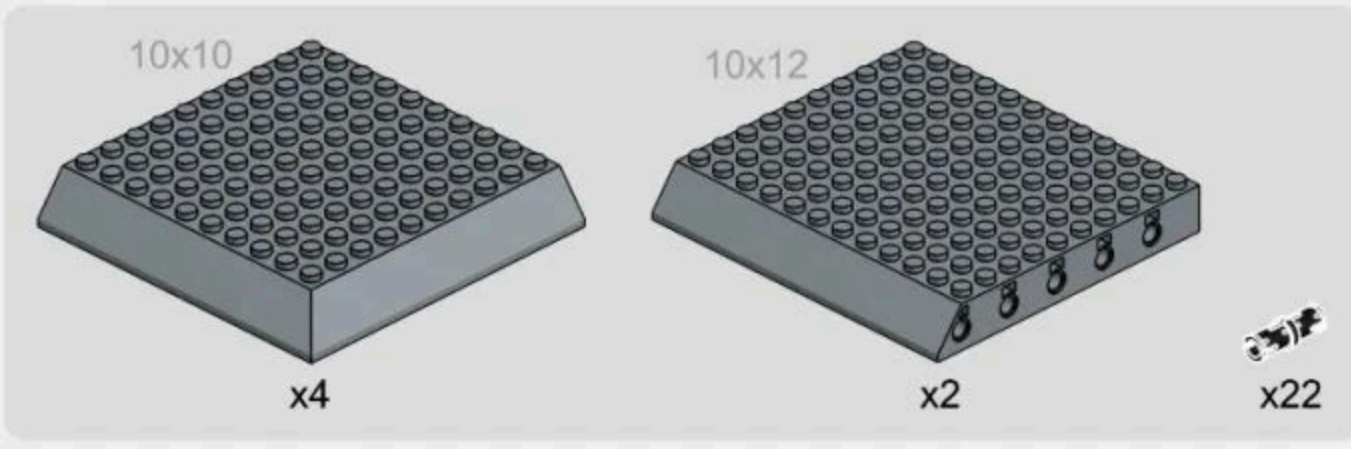

1-2

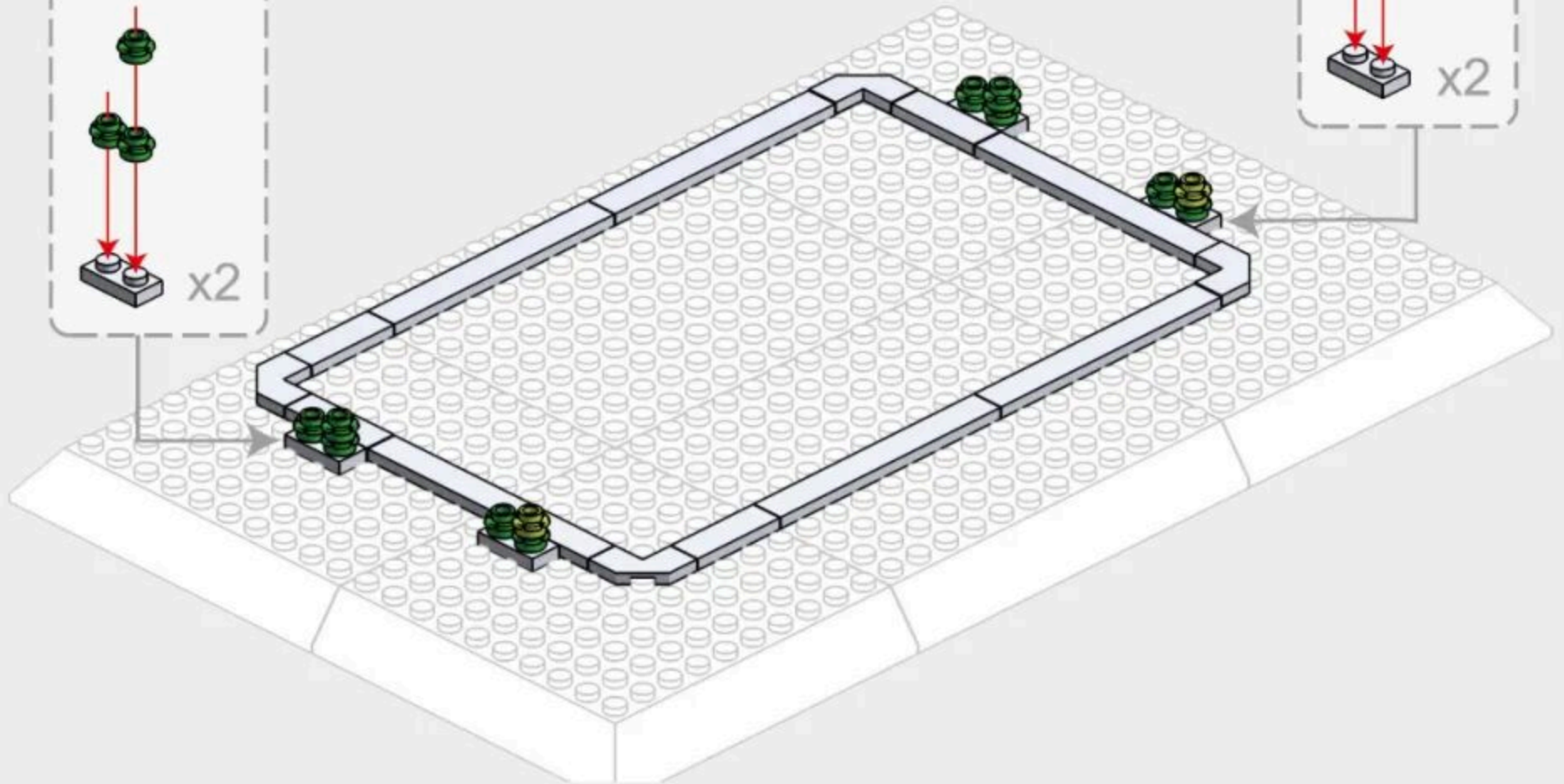
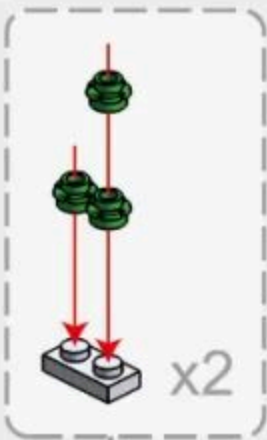
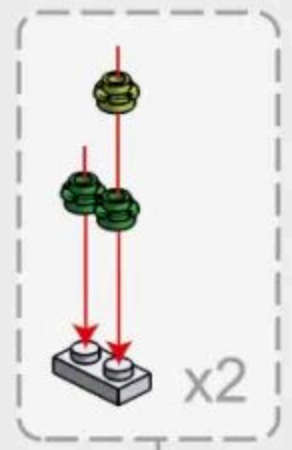
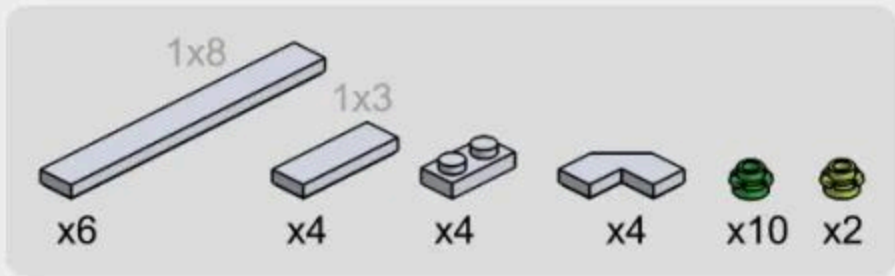

1-3

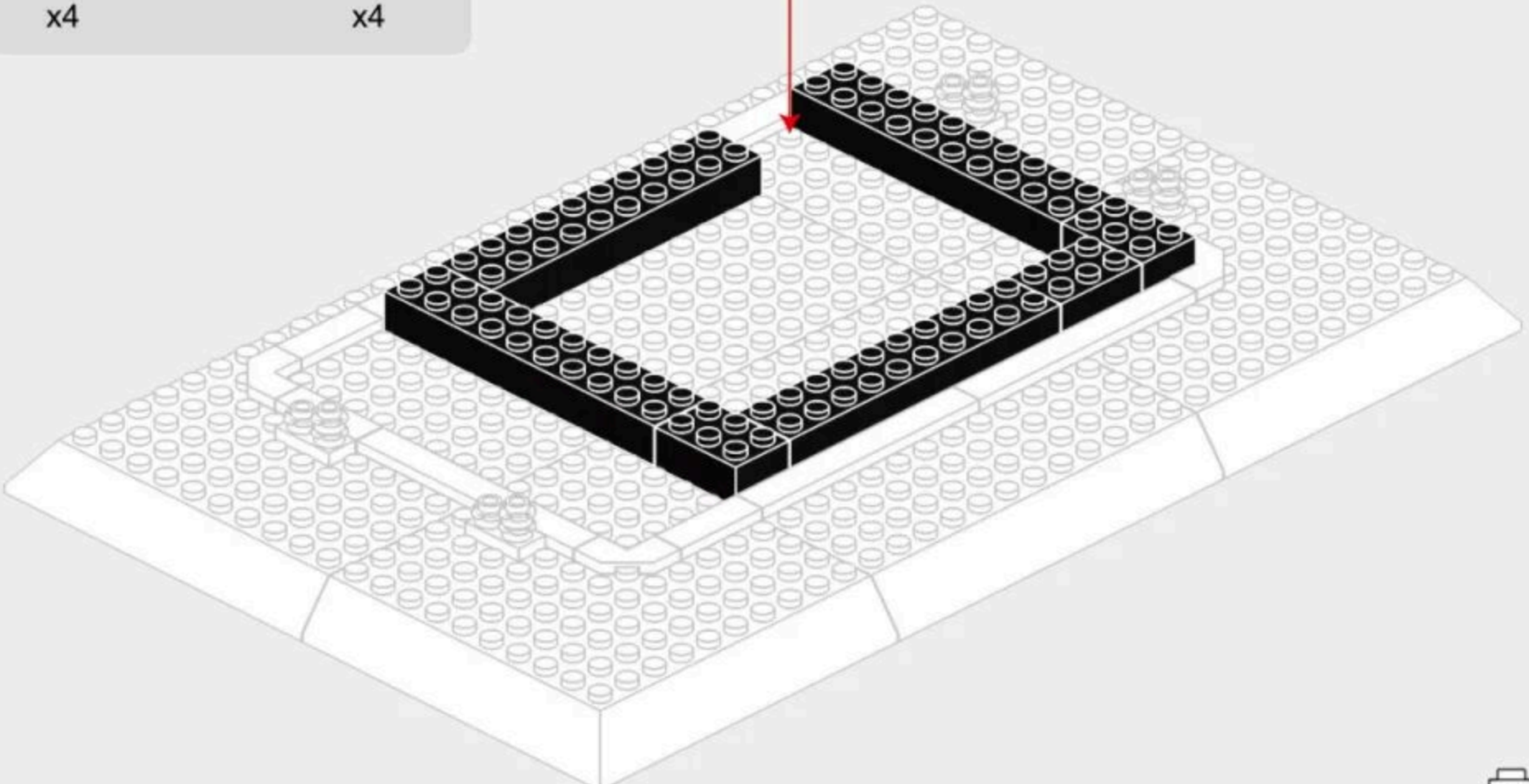
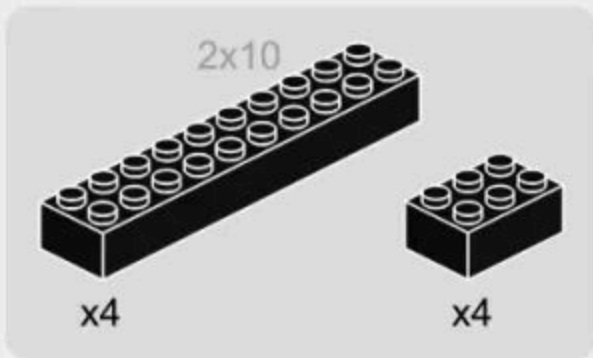

# 1-4

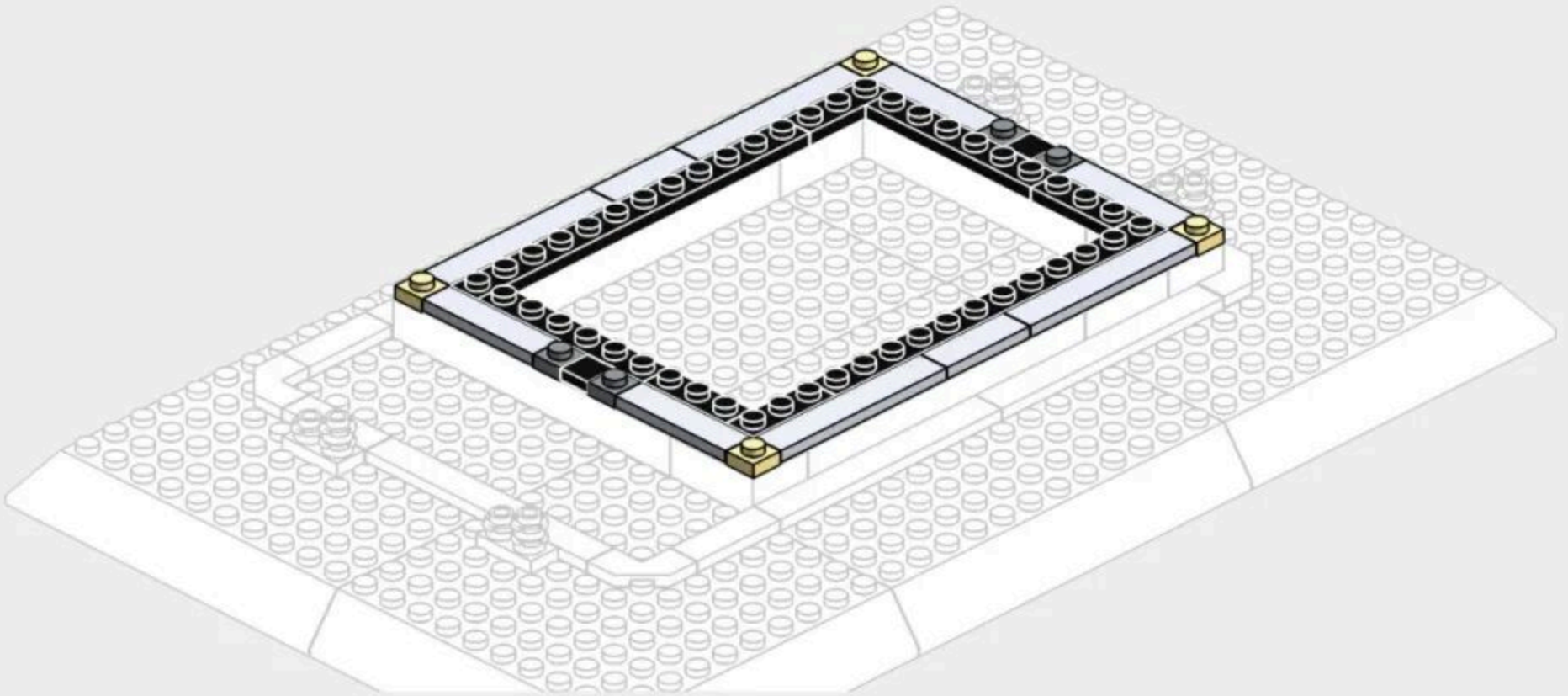
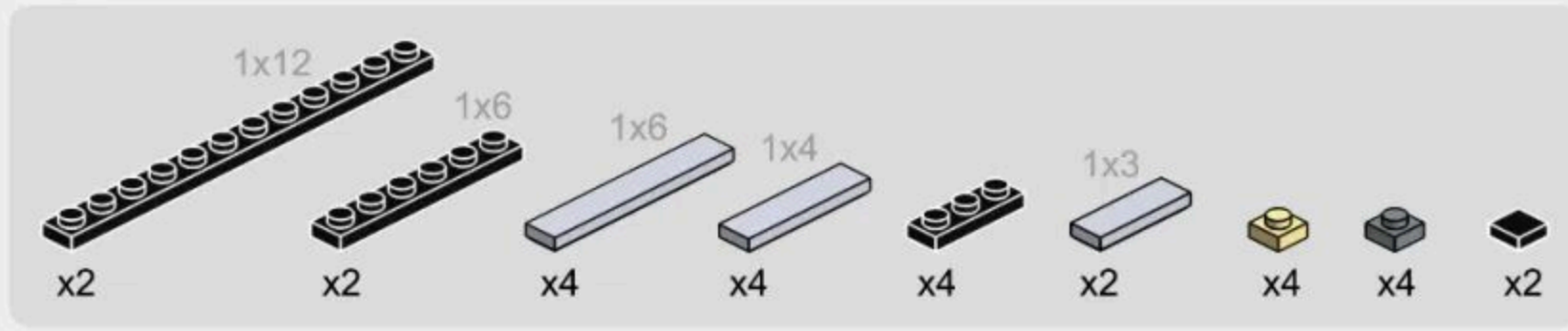

# 1-5

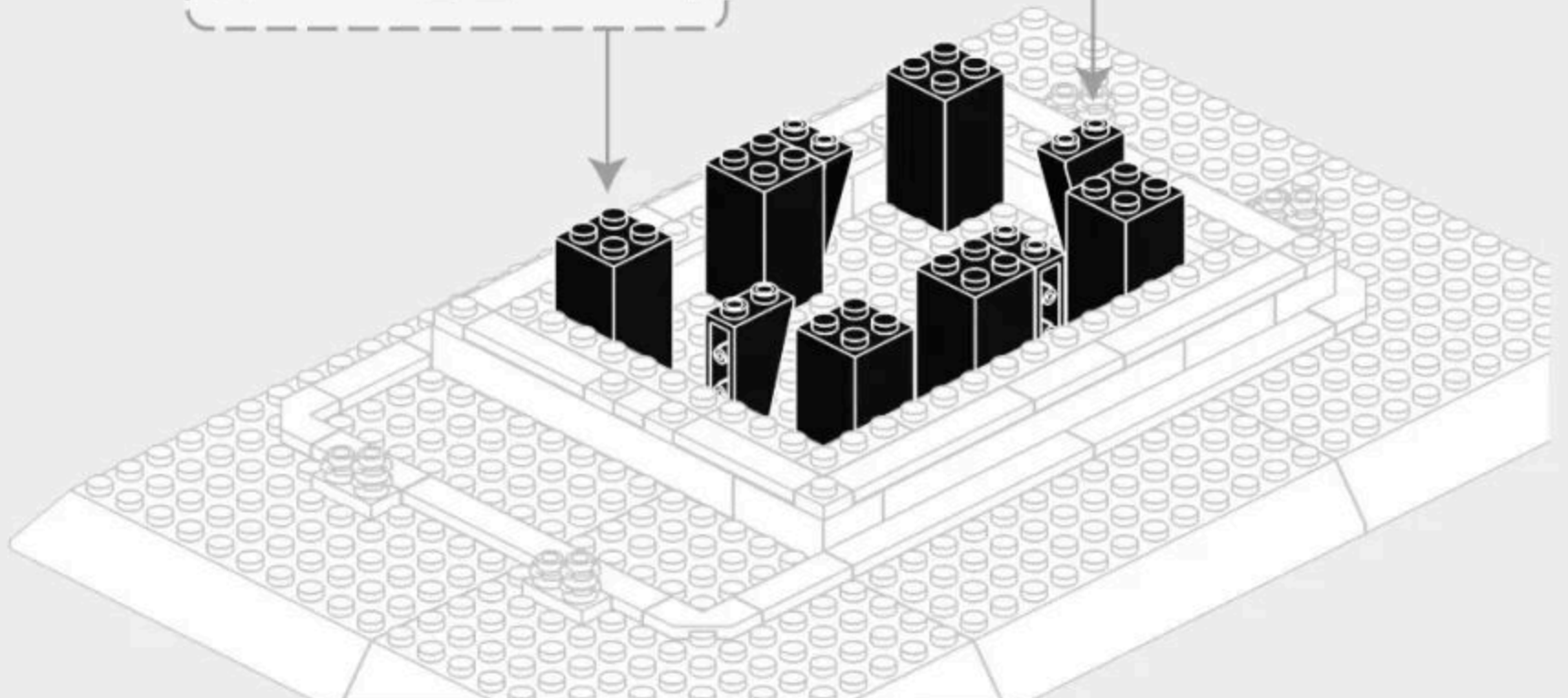
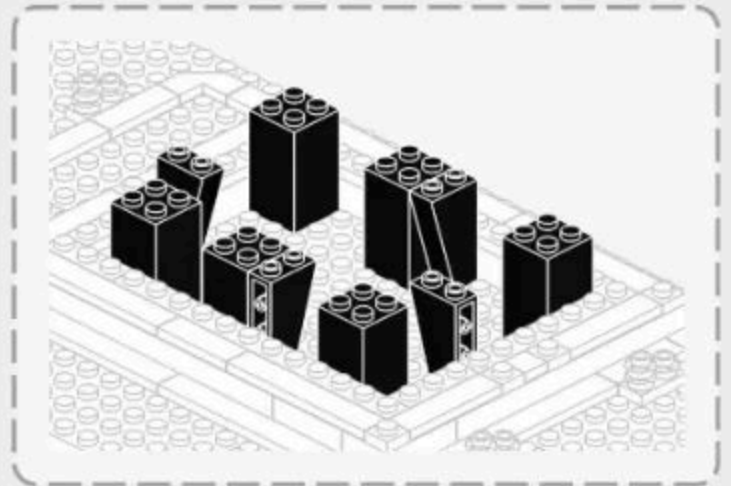
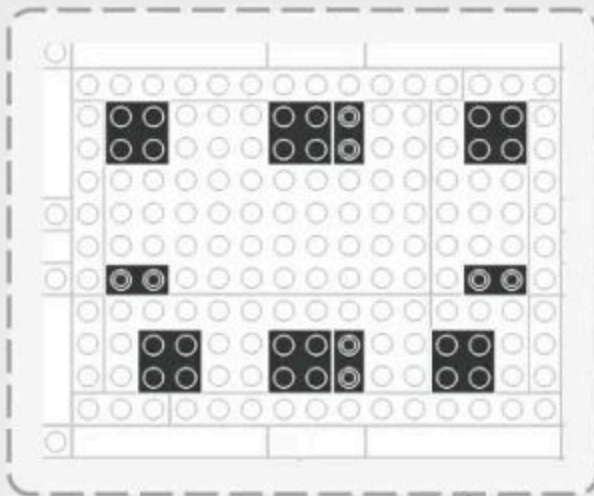
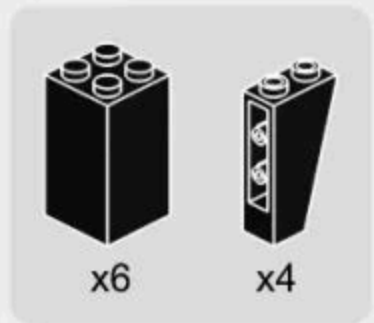

# 1-6

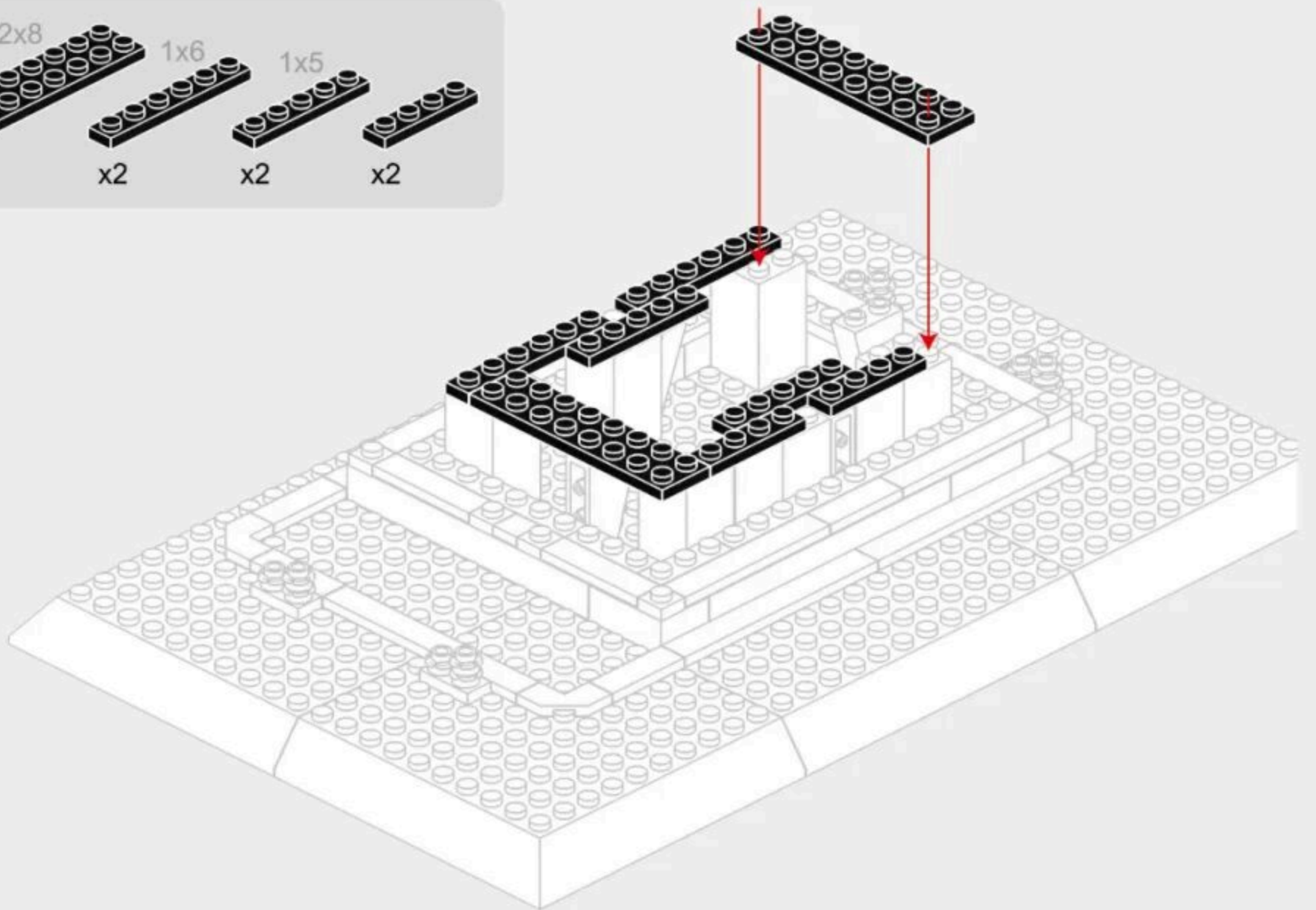
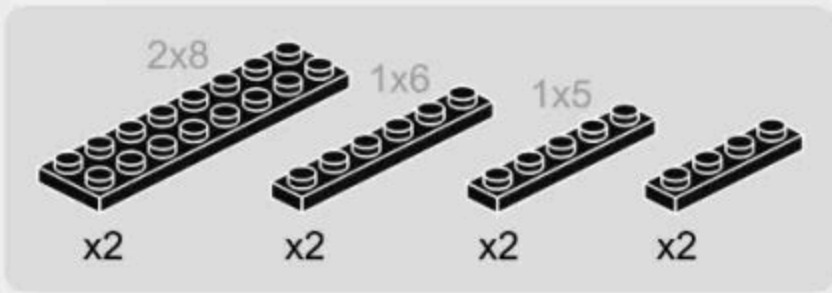

# 1-7

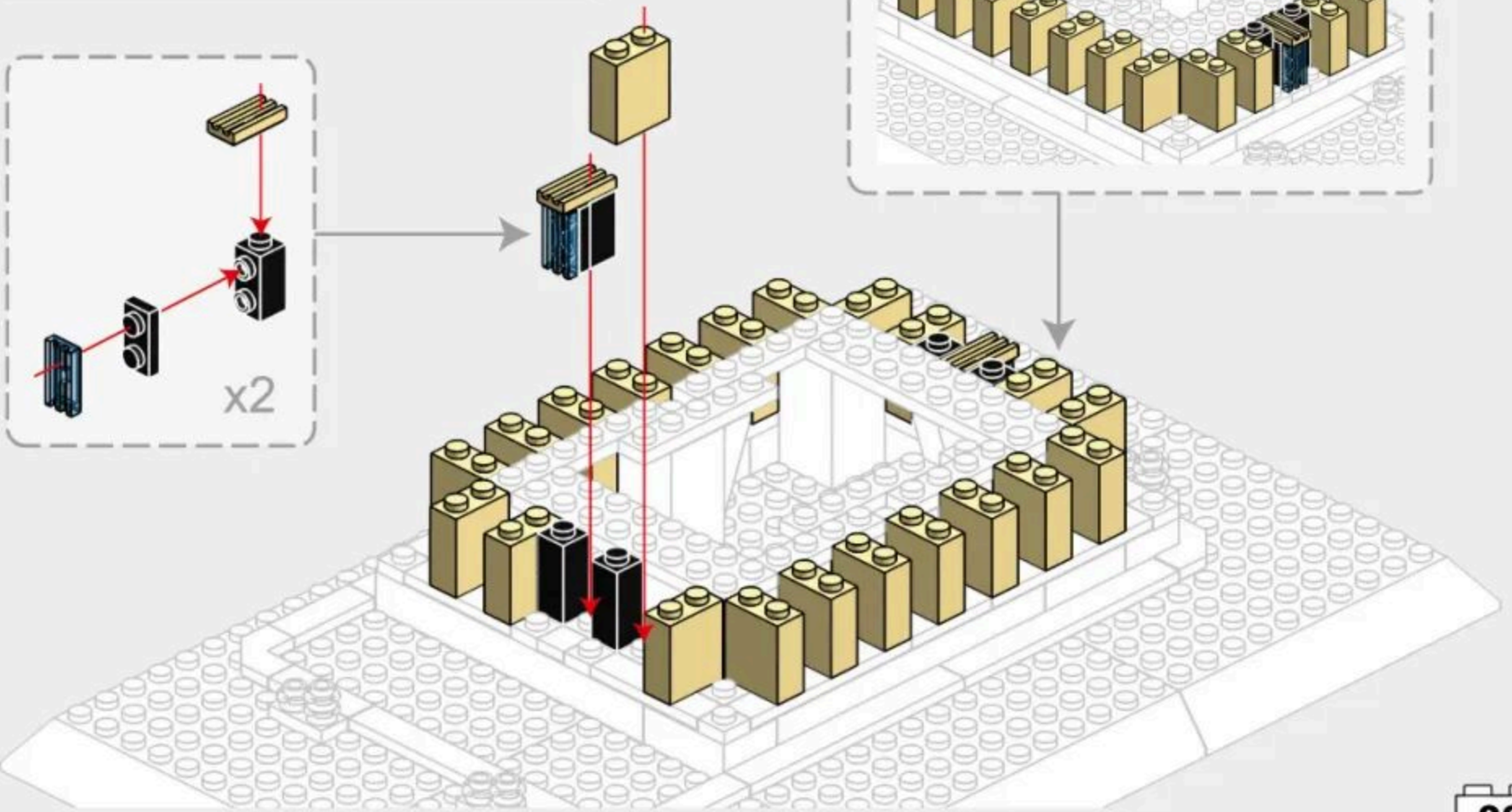

1-8

1x2

x16 x8 x4 x32 x44 x8 x8

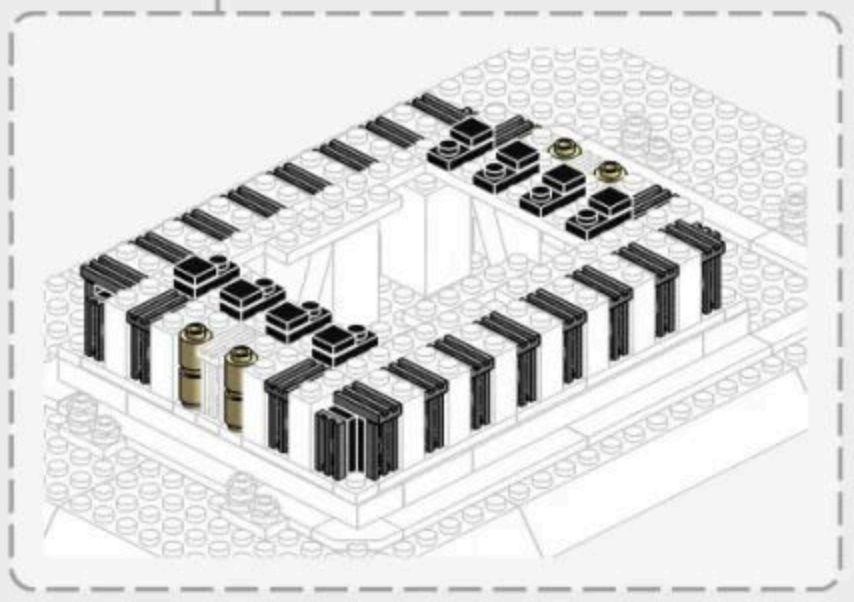
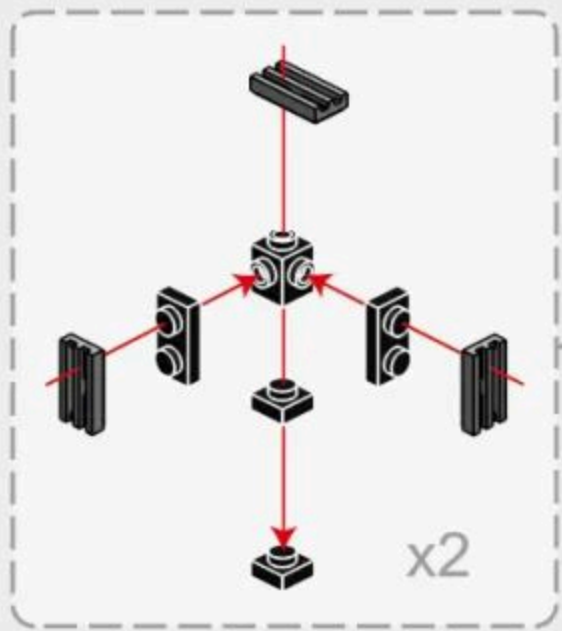
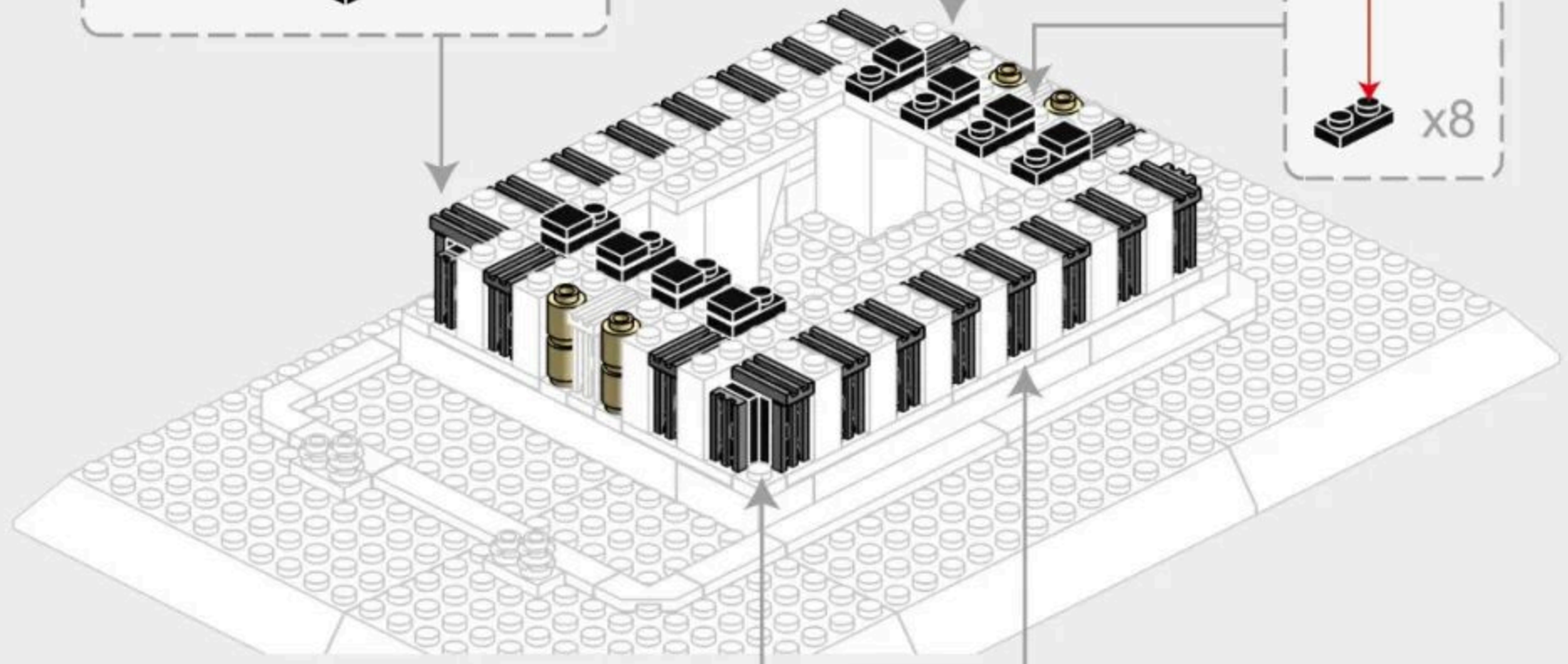
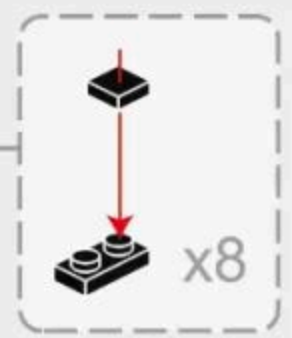
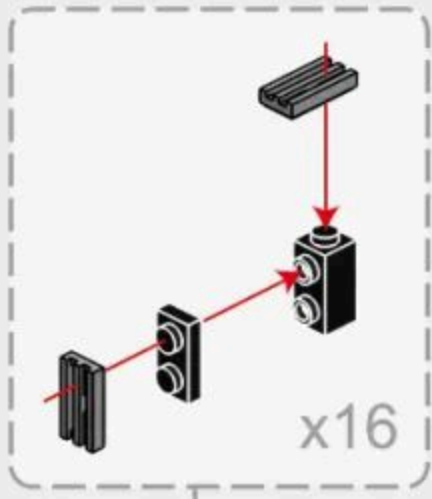
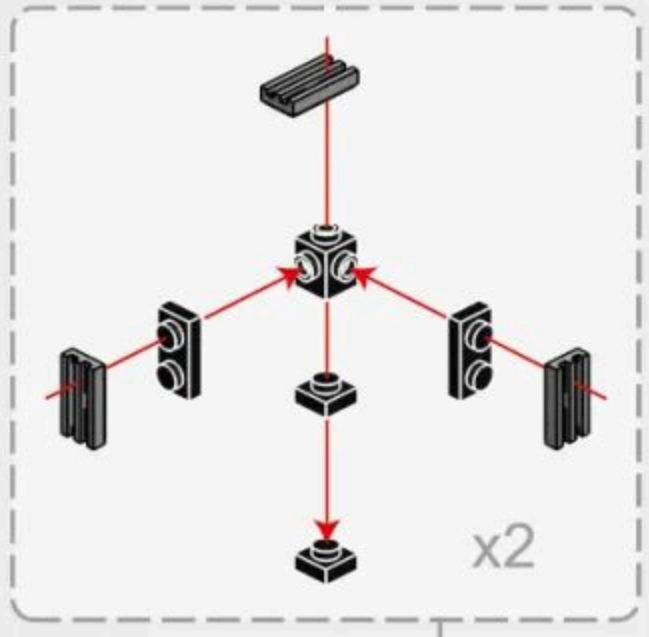



262PCS

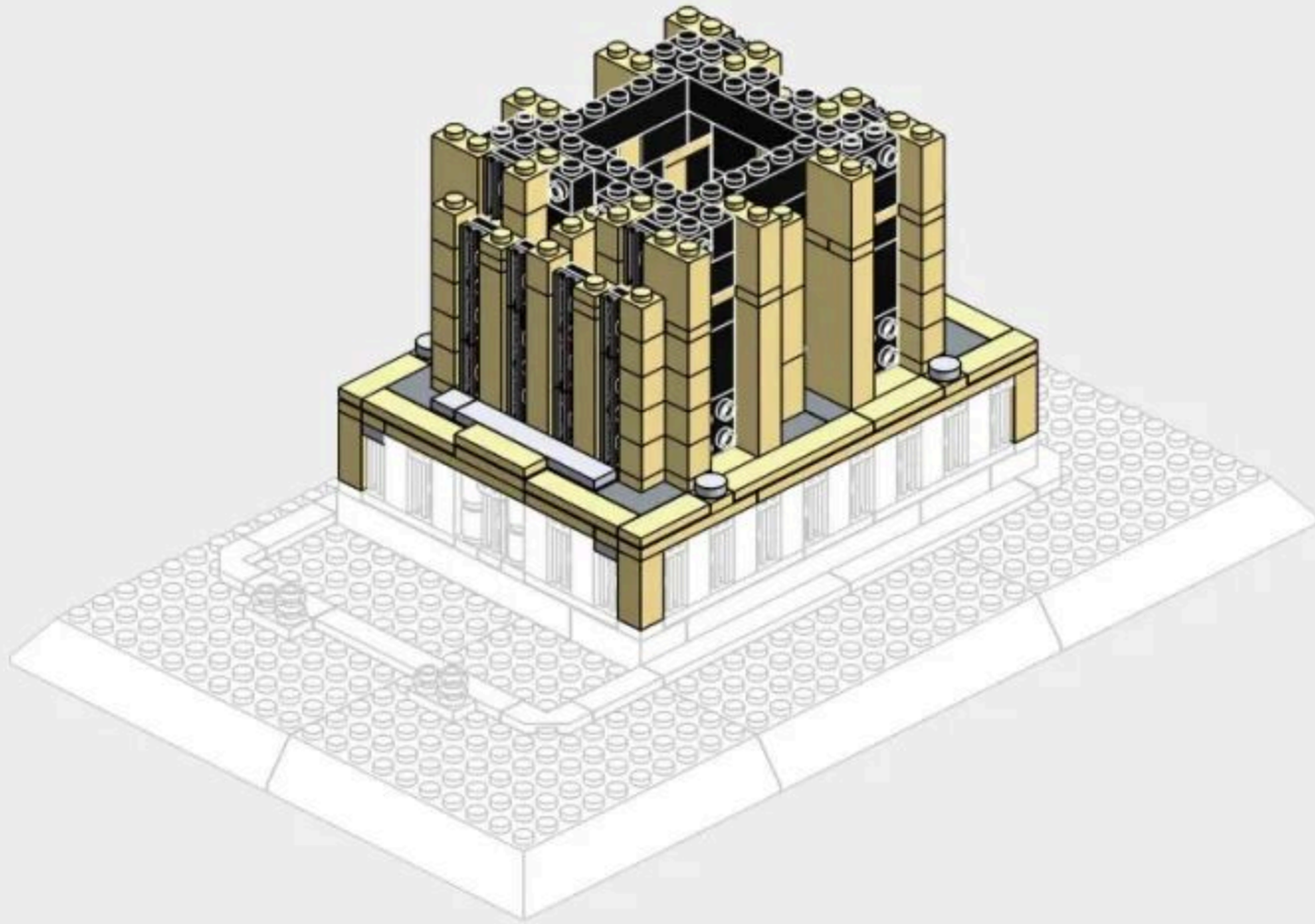

## 2-1

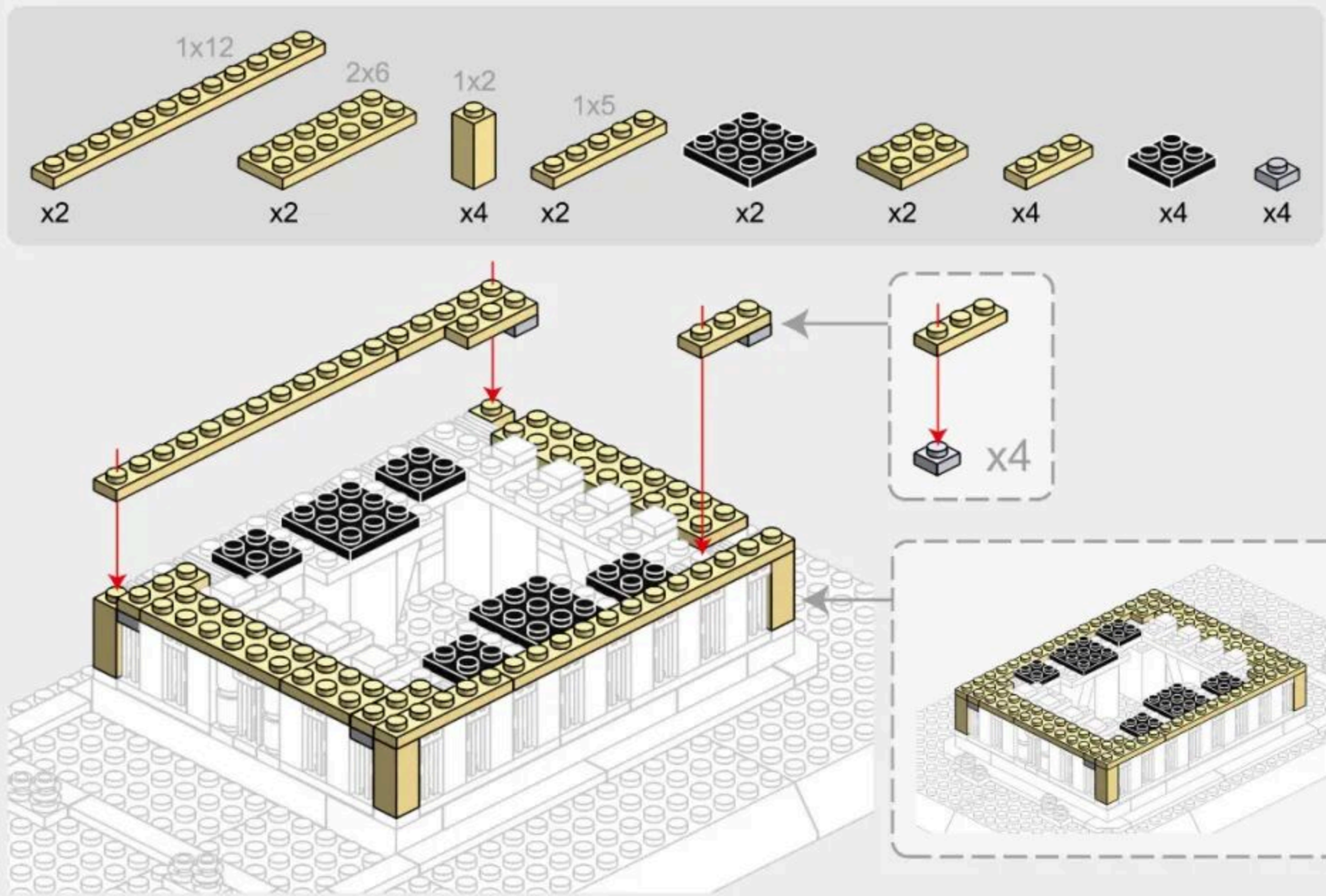

## 2-2

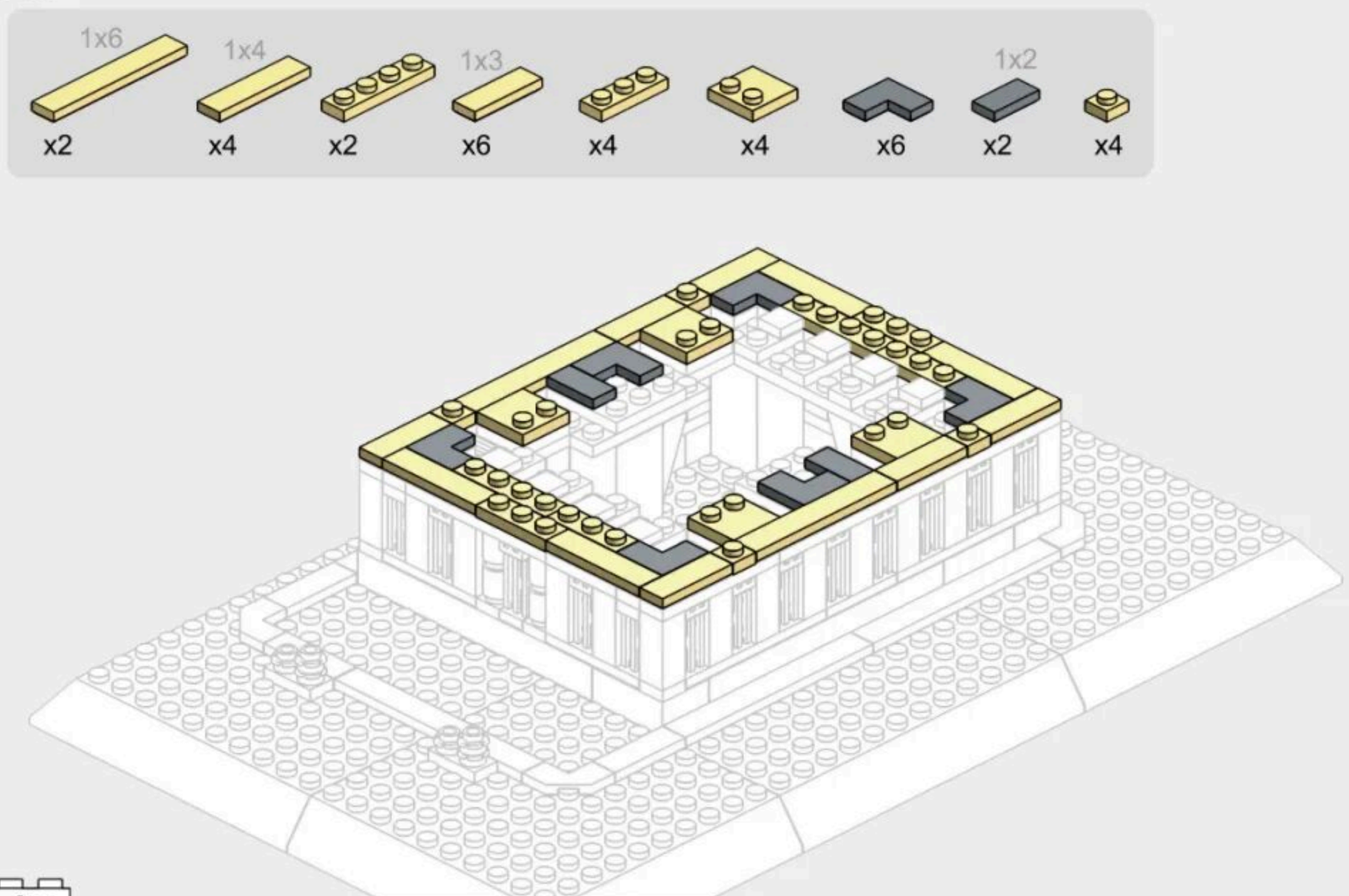

2-3

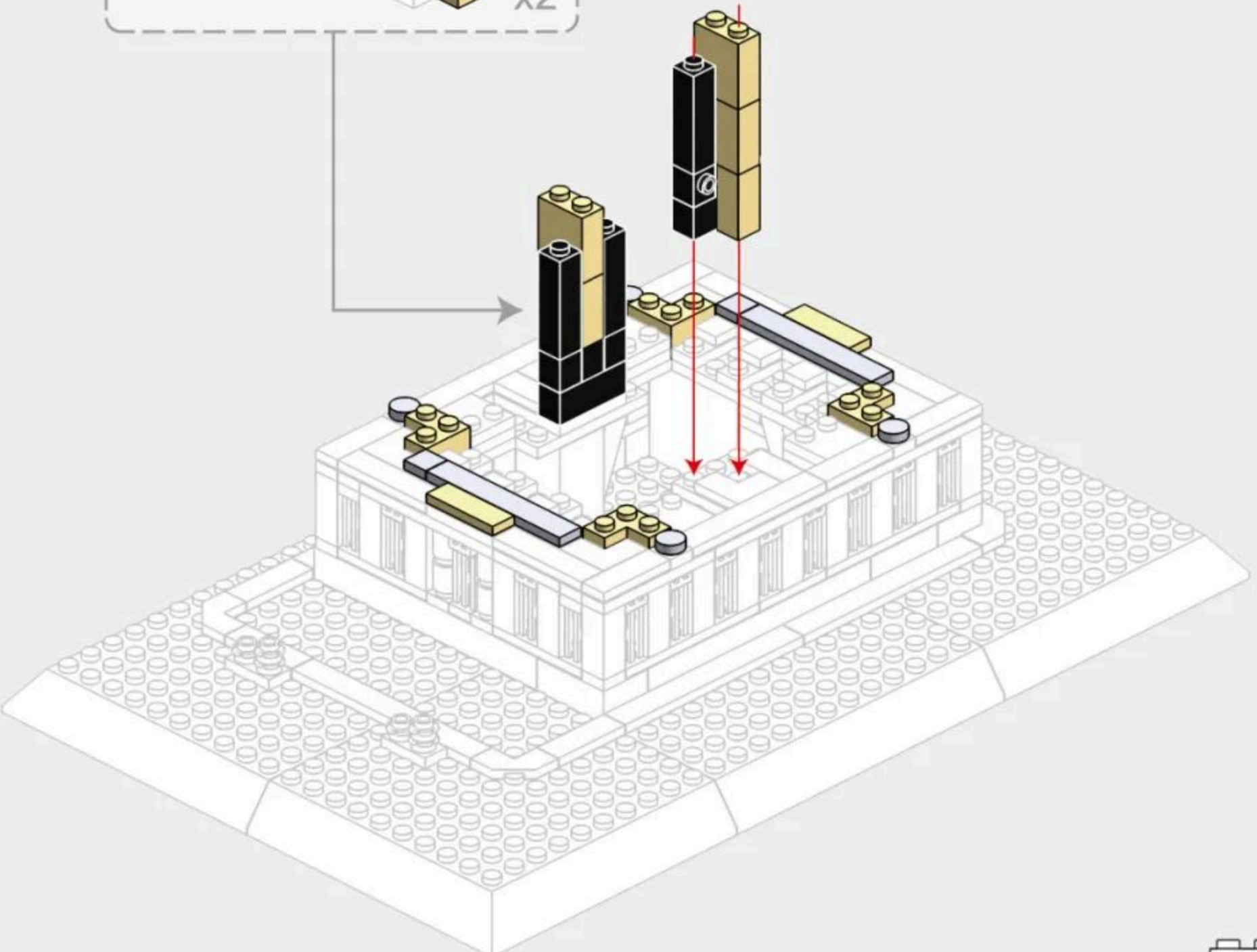
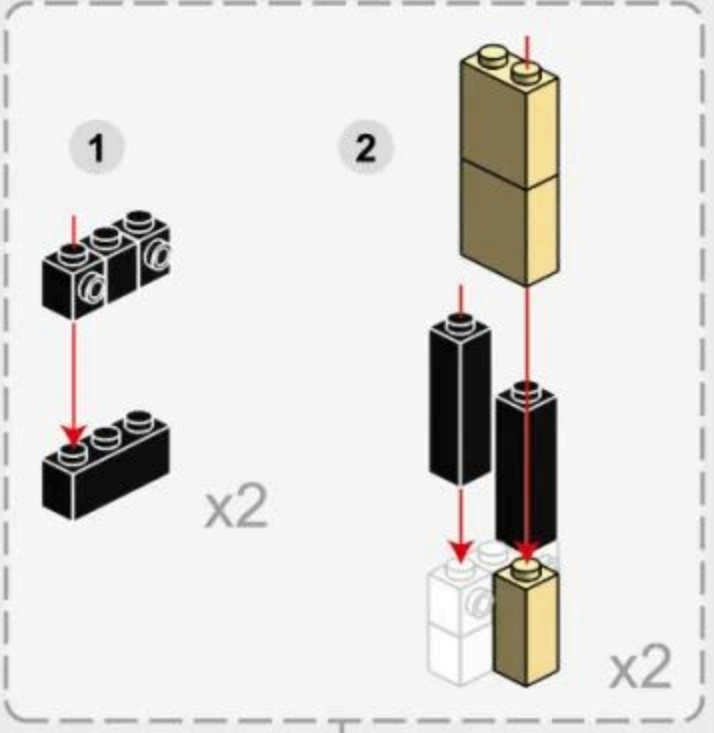

2-4

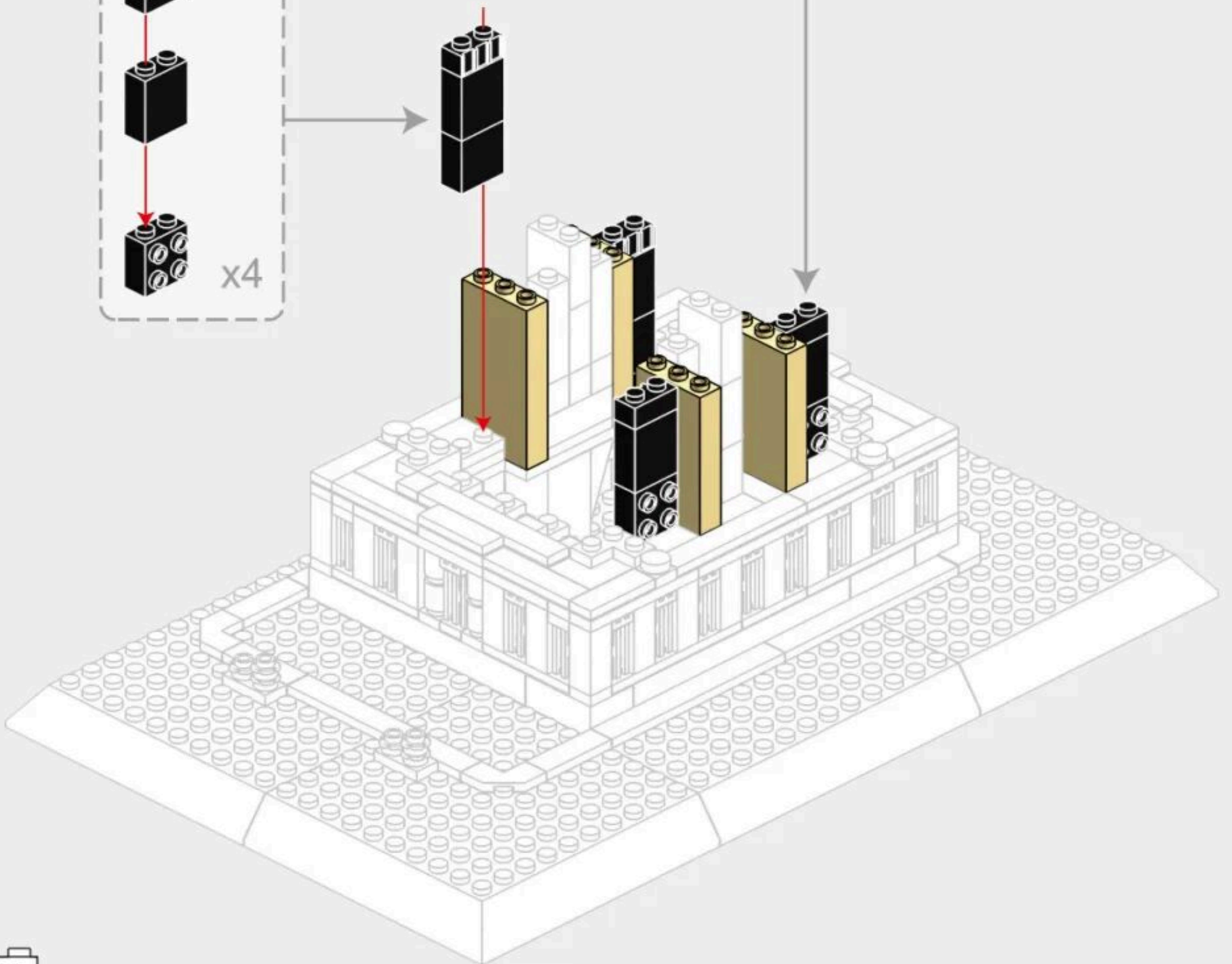
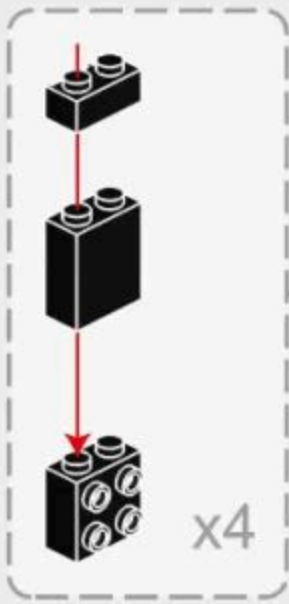
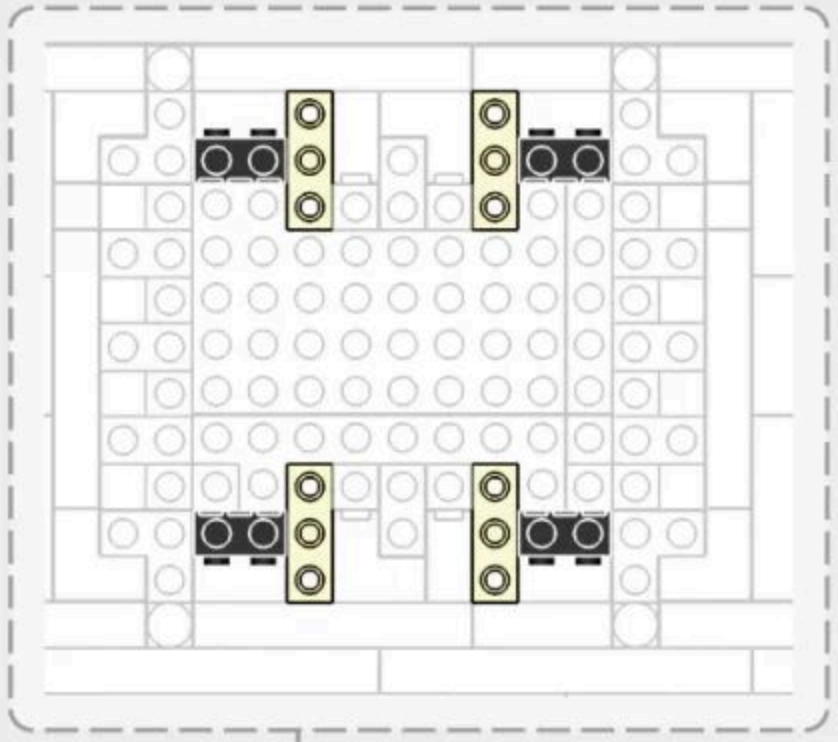
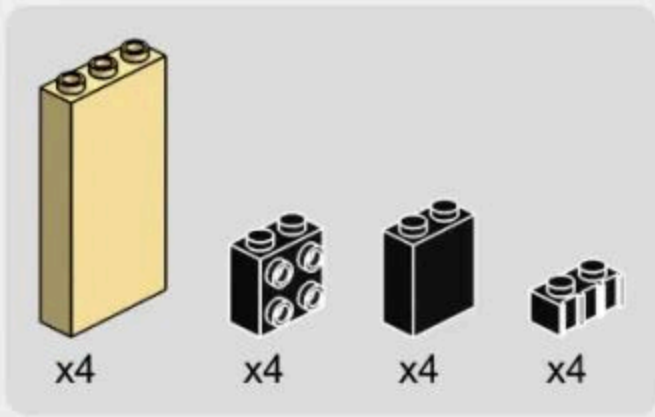

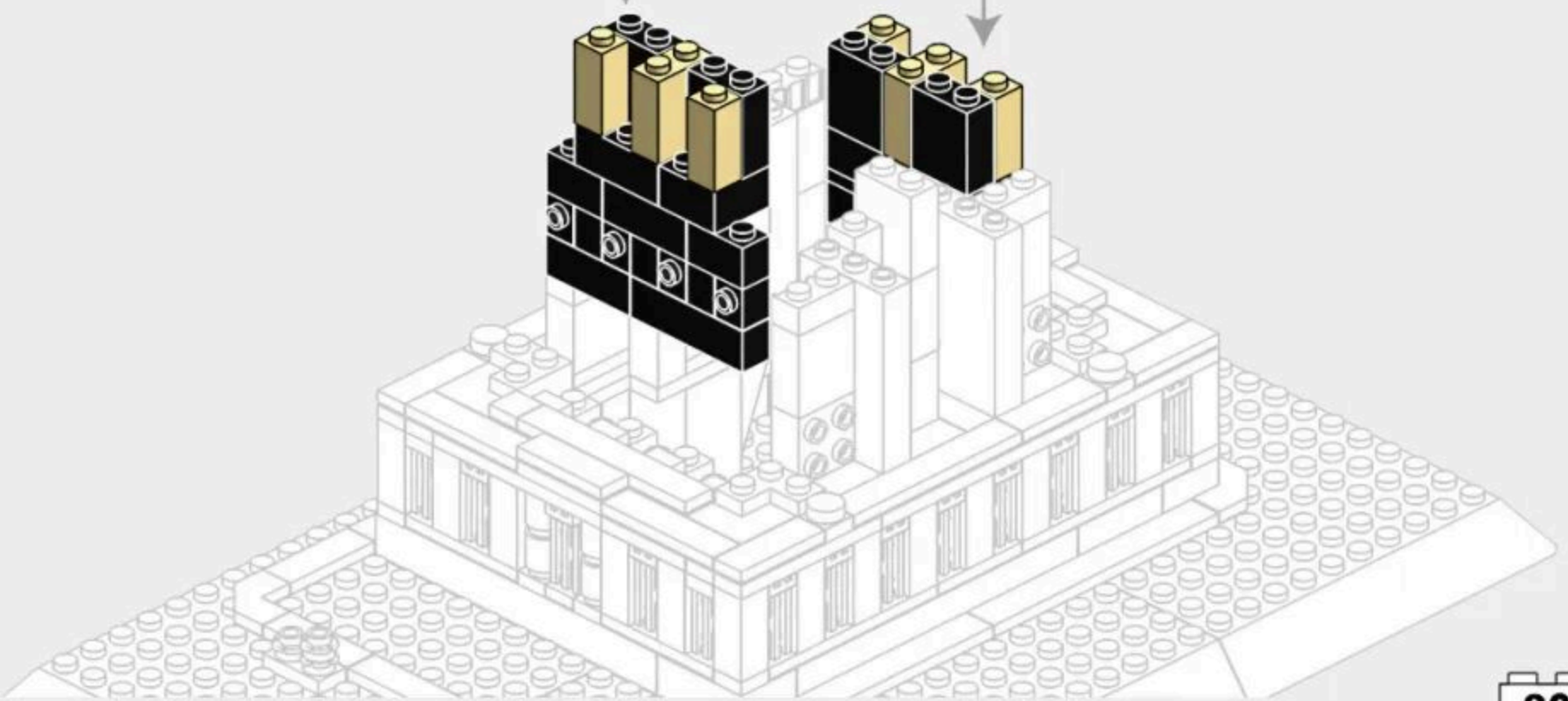
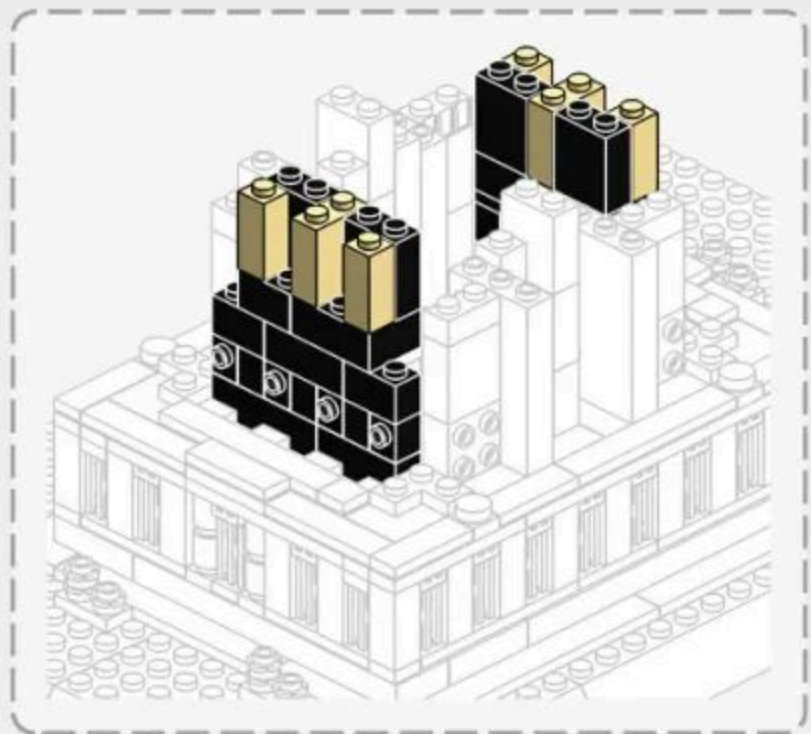
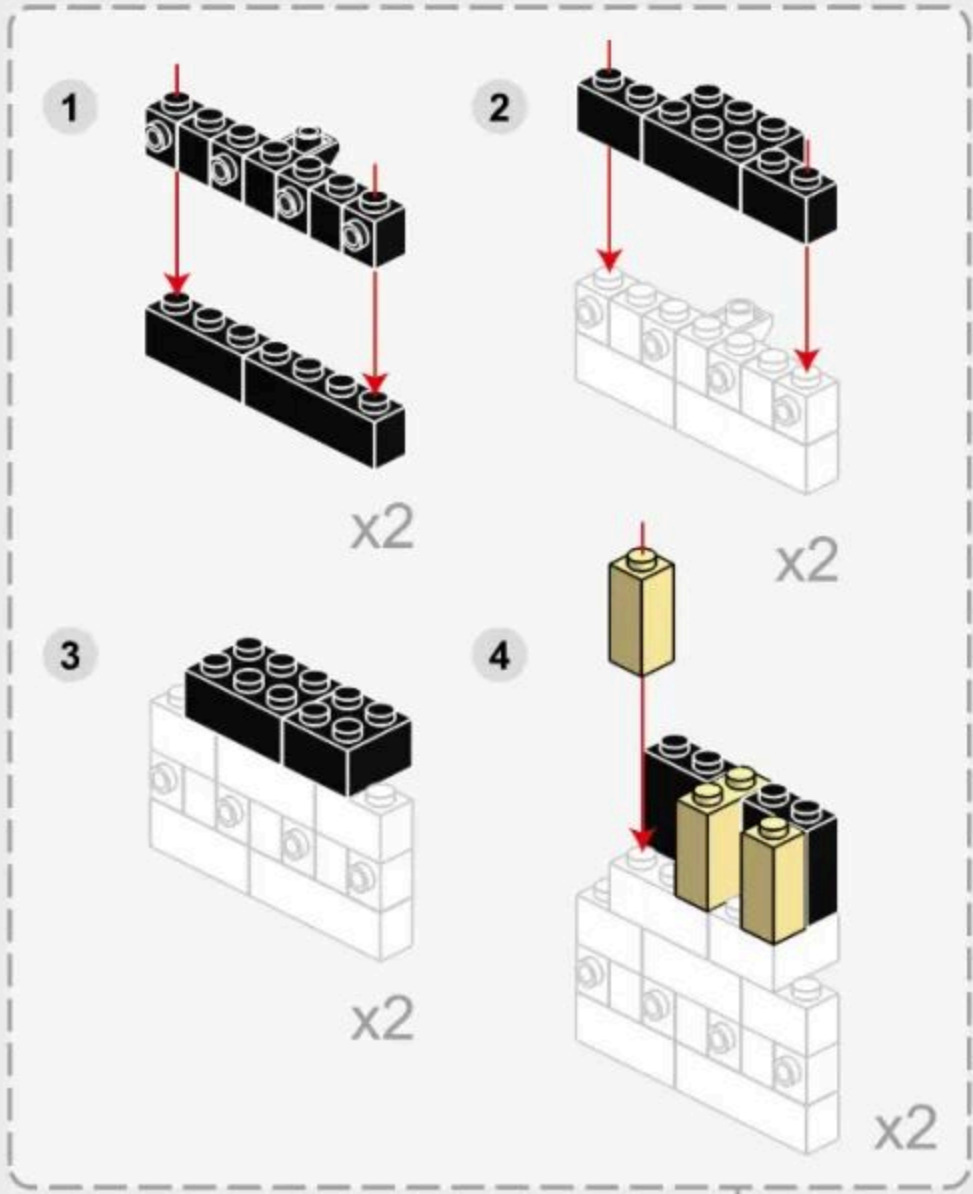

2-6

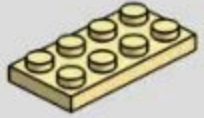

x4



x16



x8

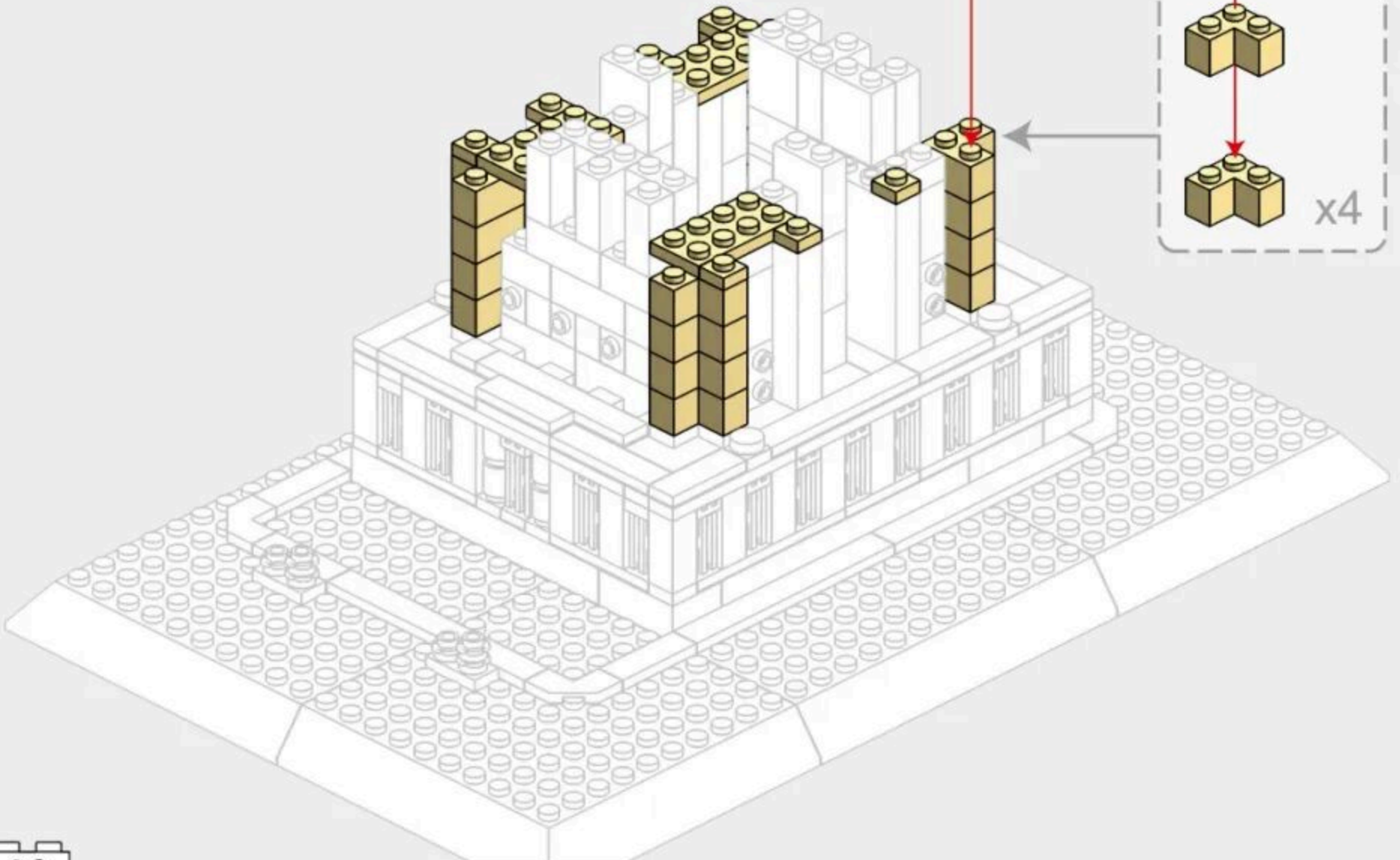
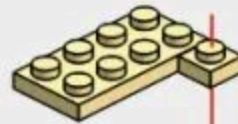
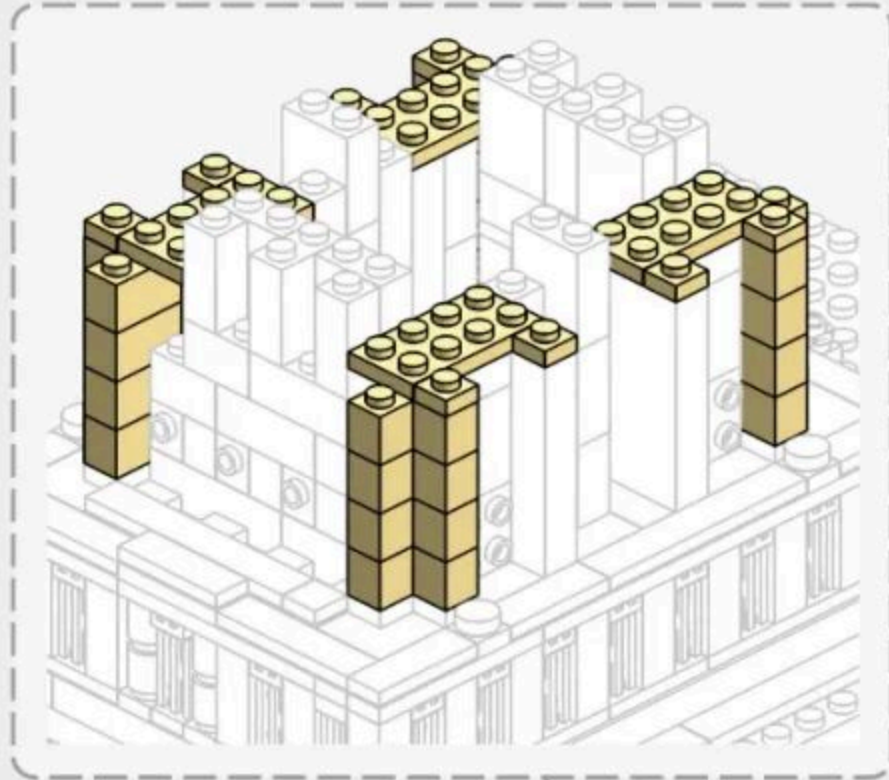

2-7

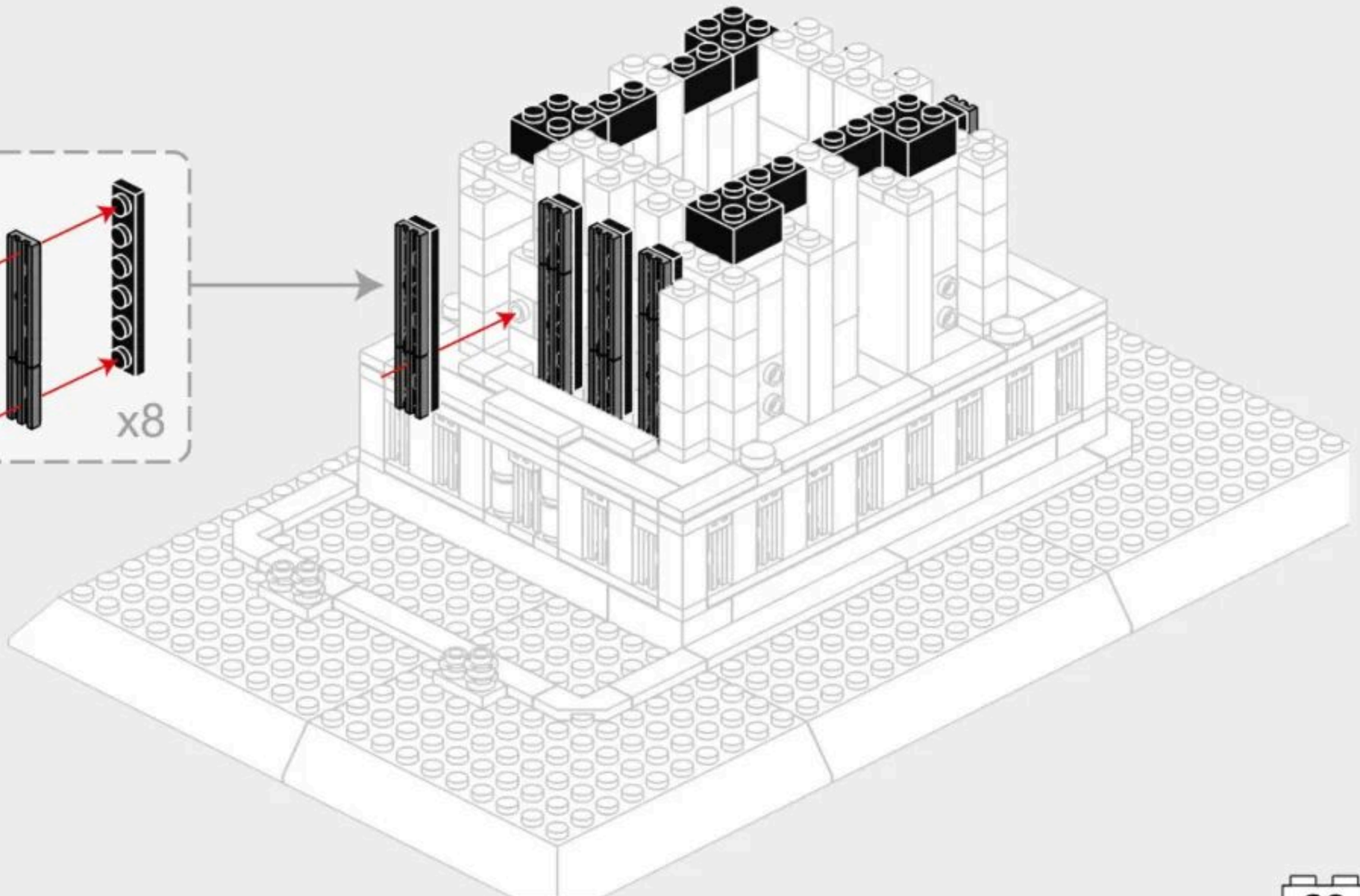
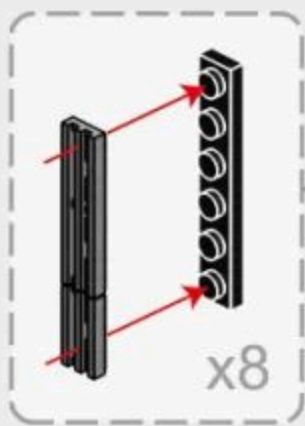
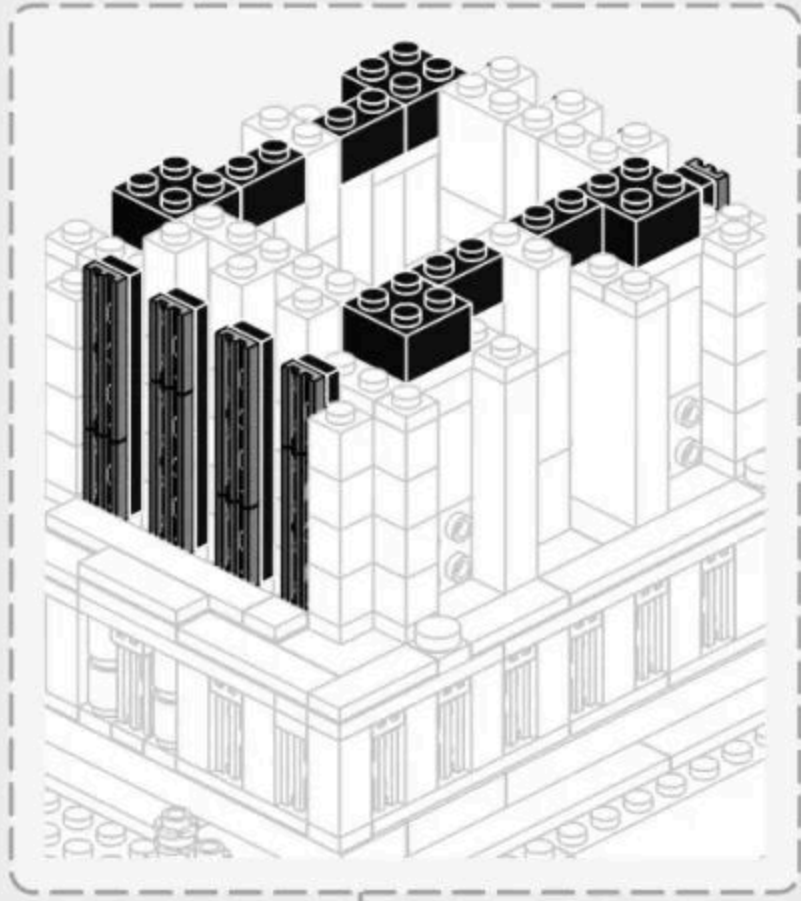
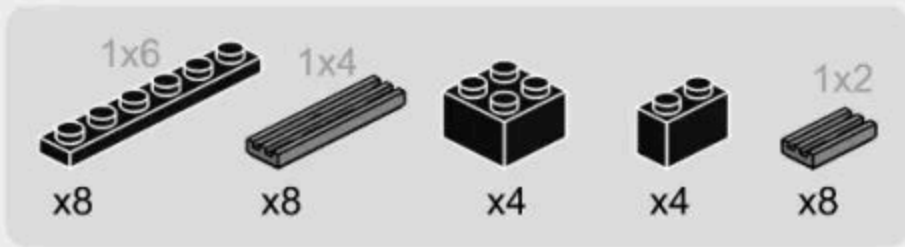



2-9

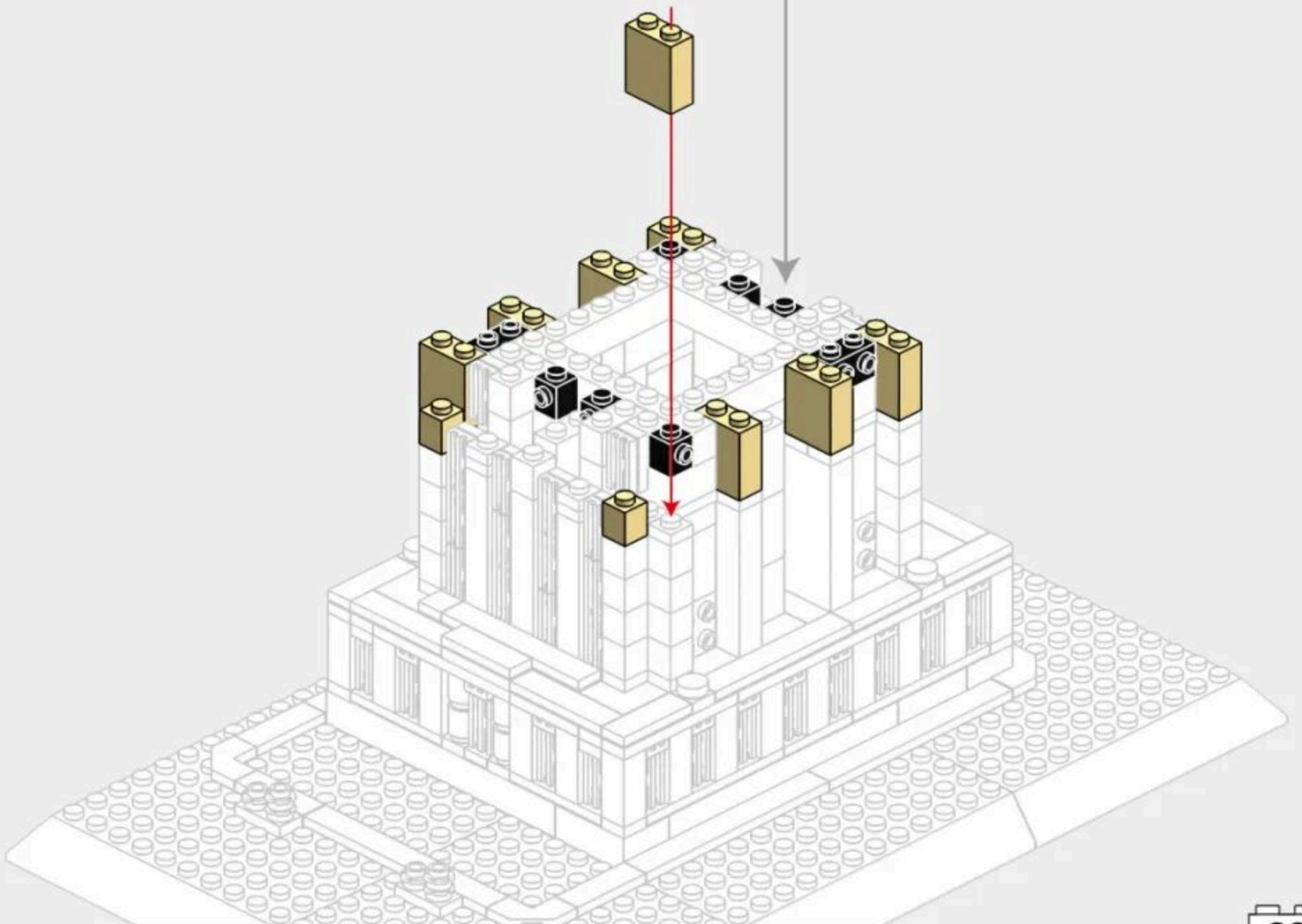
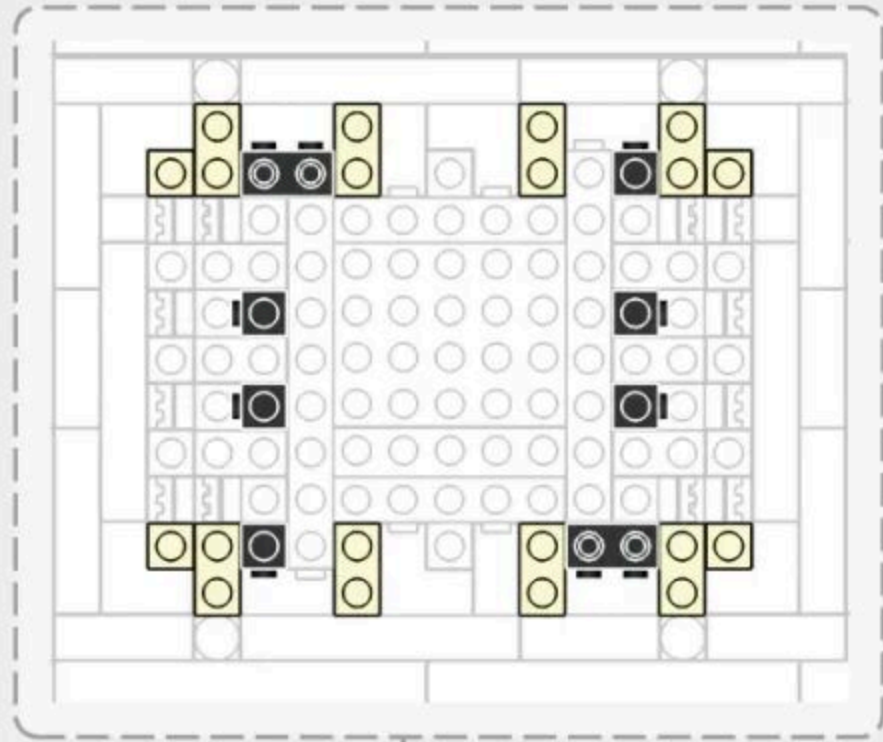
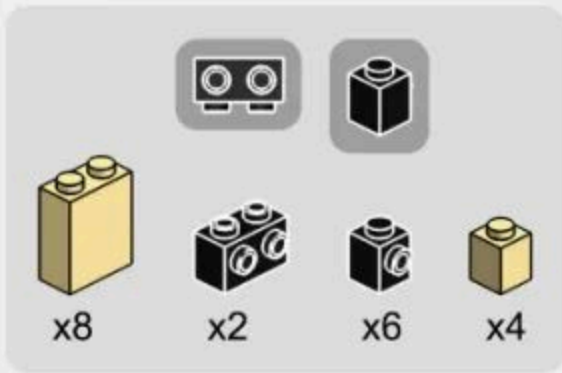



**264PCS**

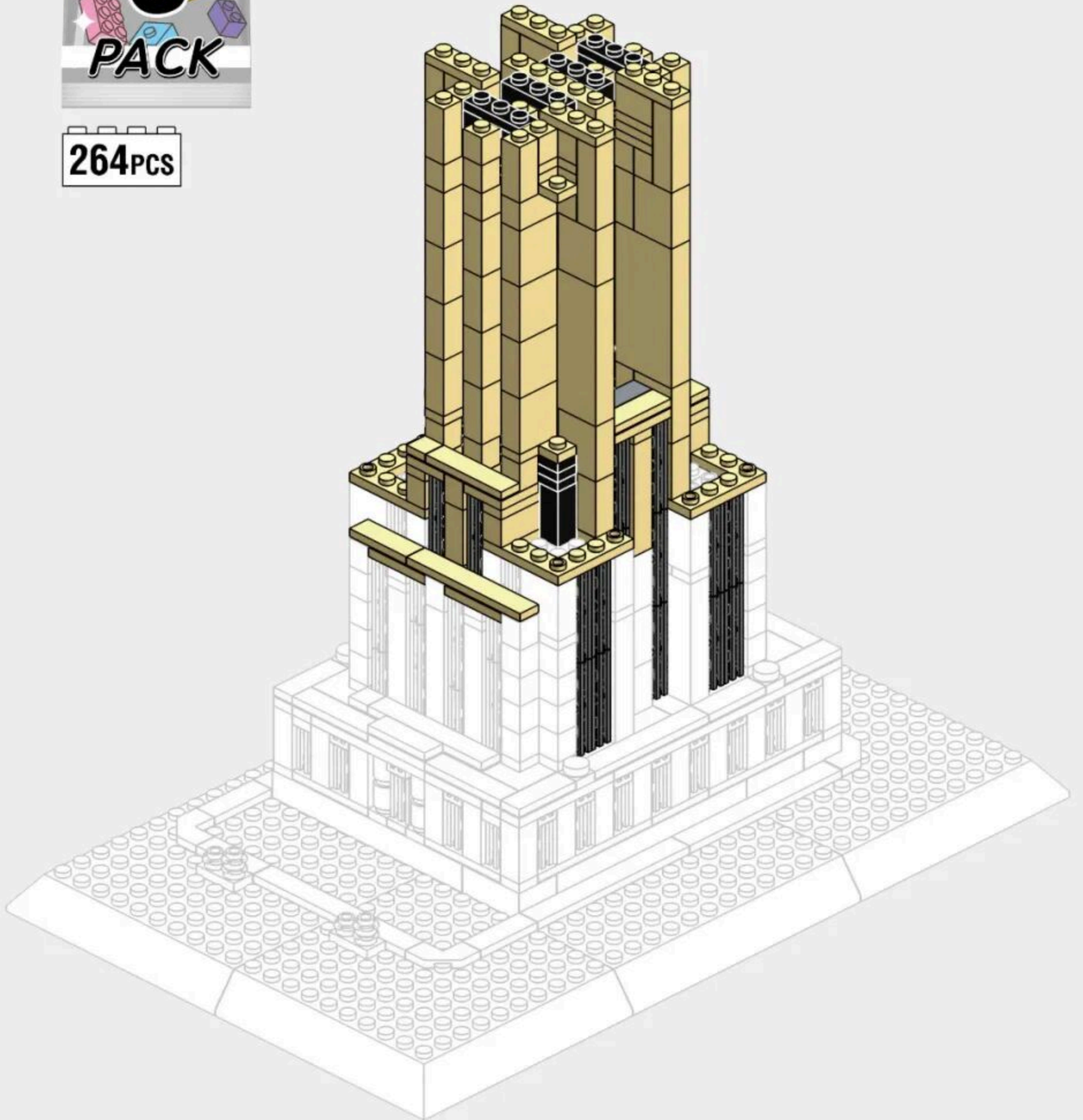

3-1

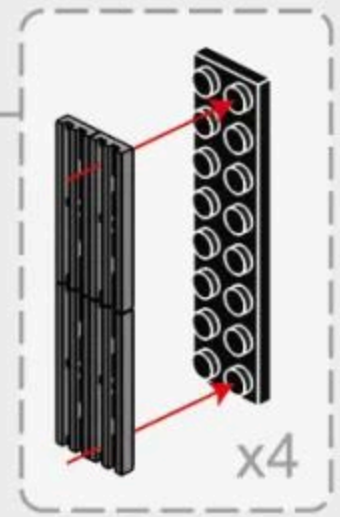
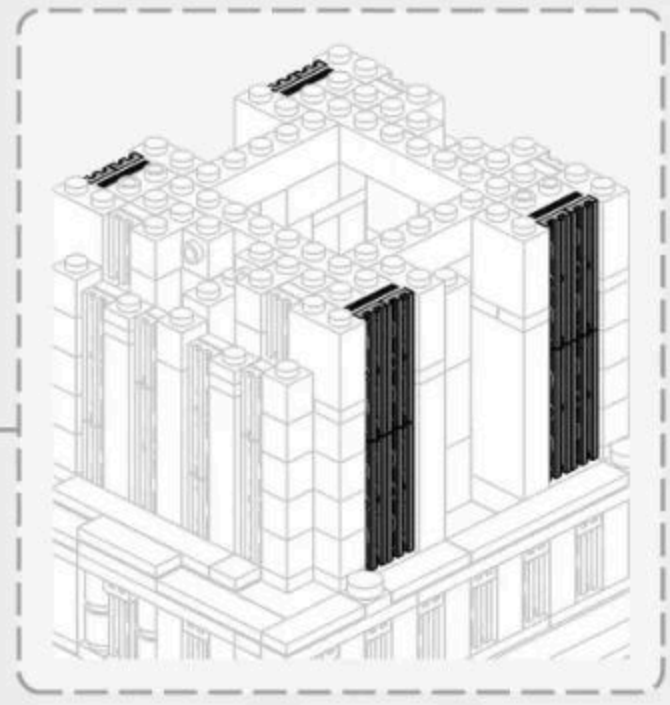
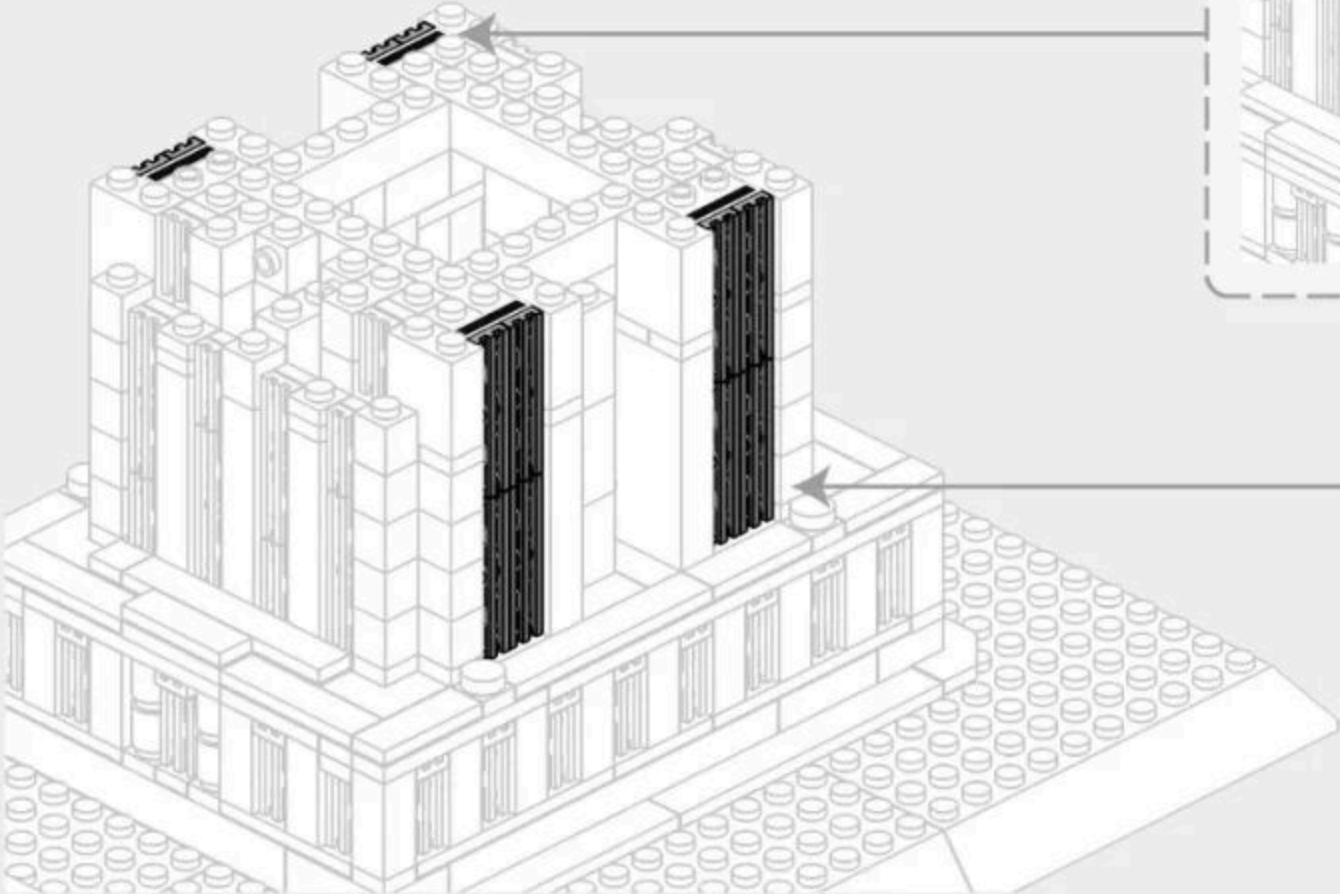
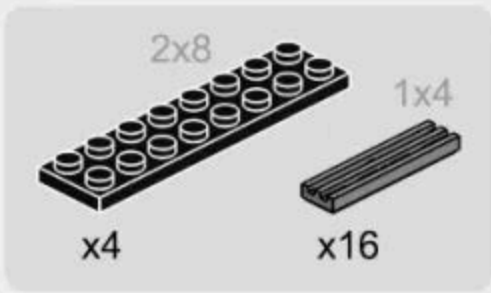

3-2

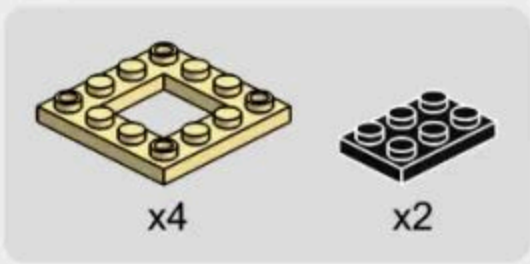

### 3-3

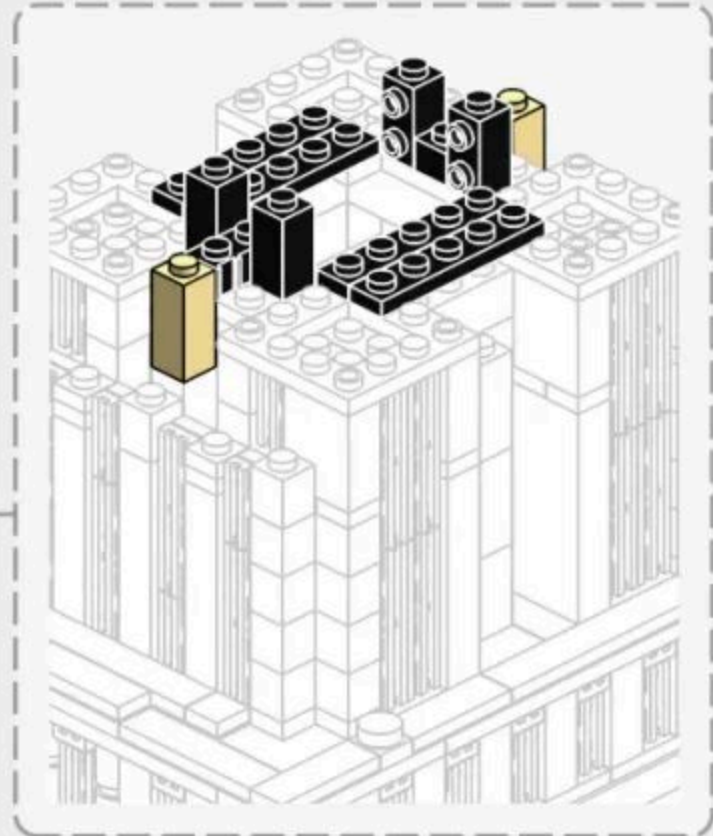
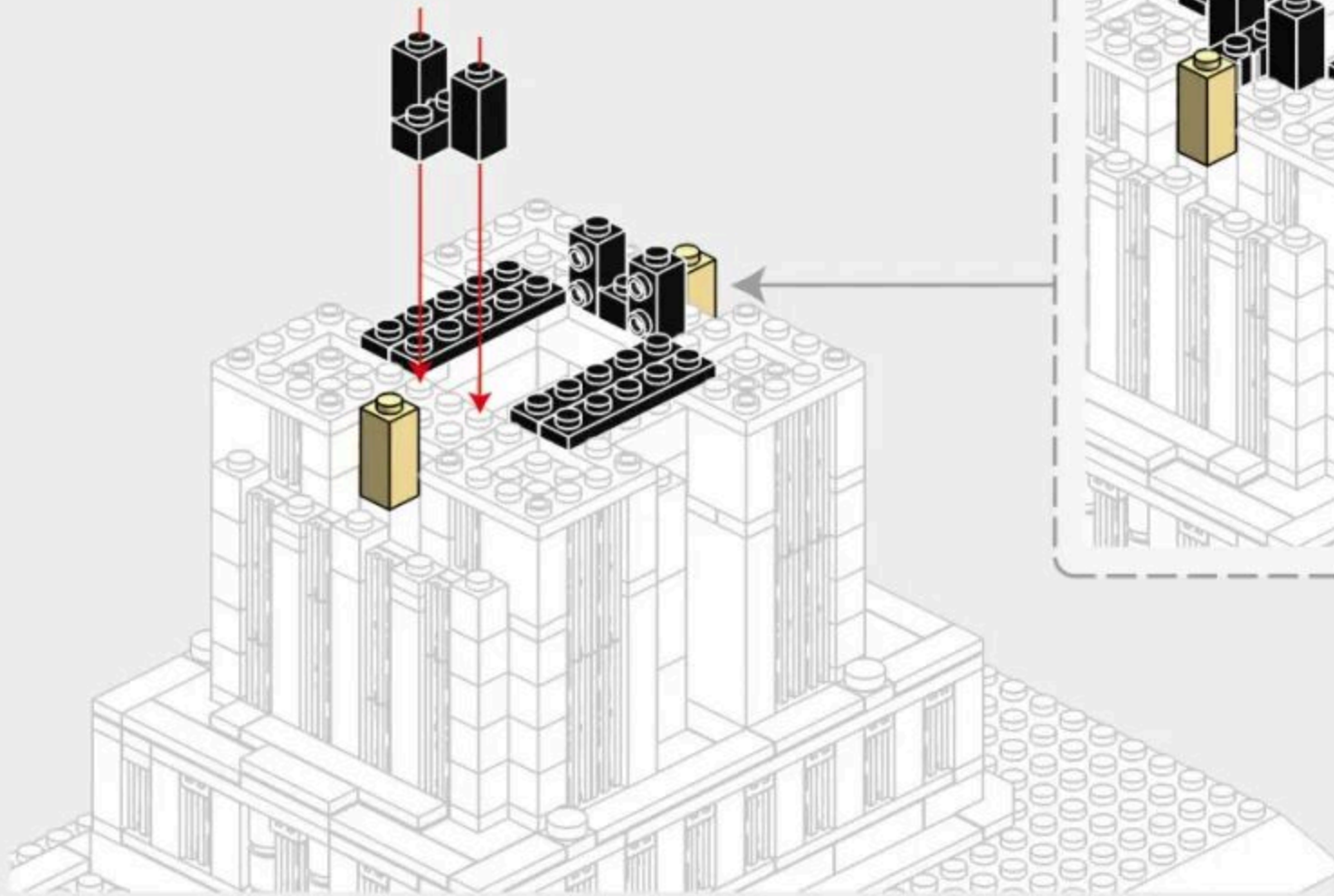
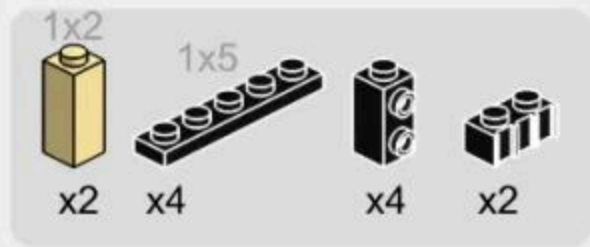

### 3-4

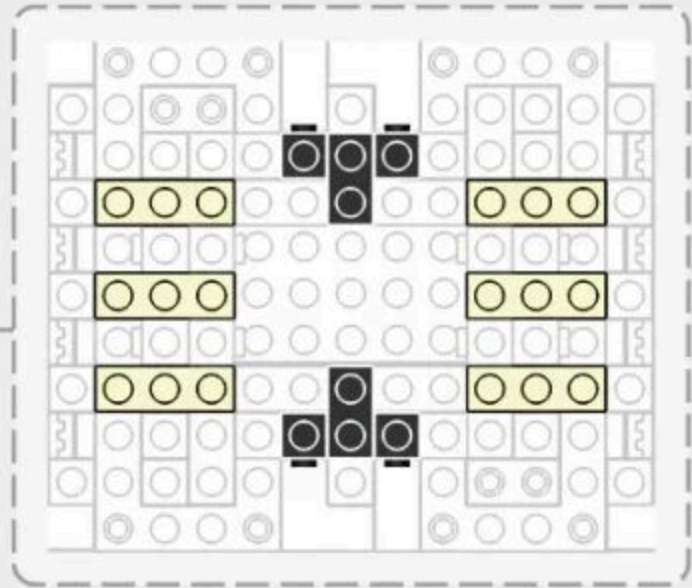
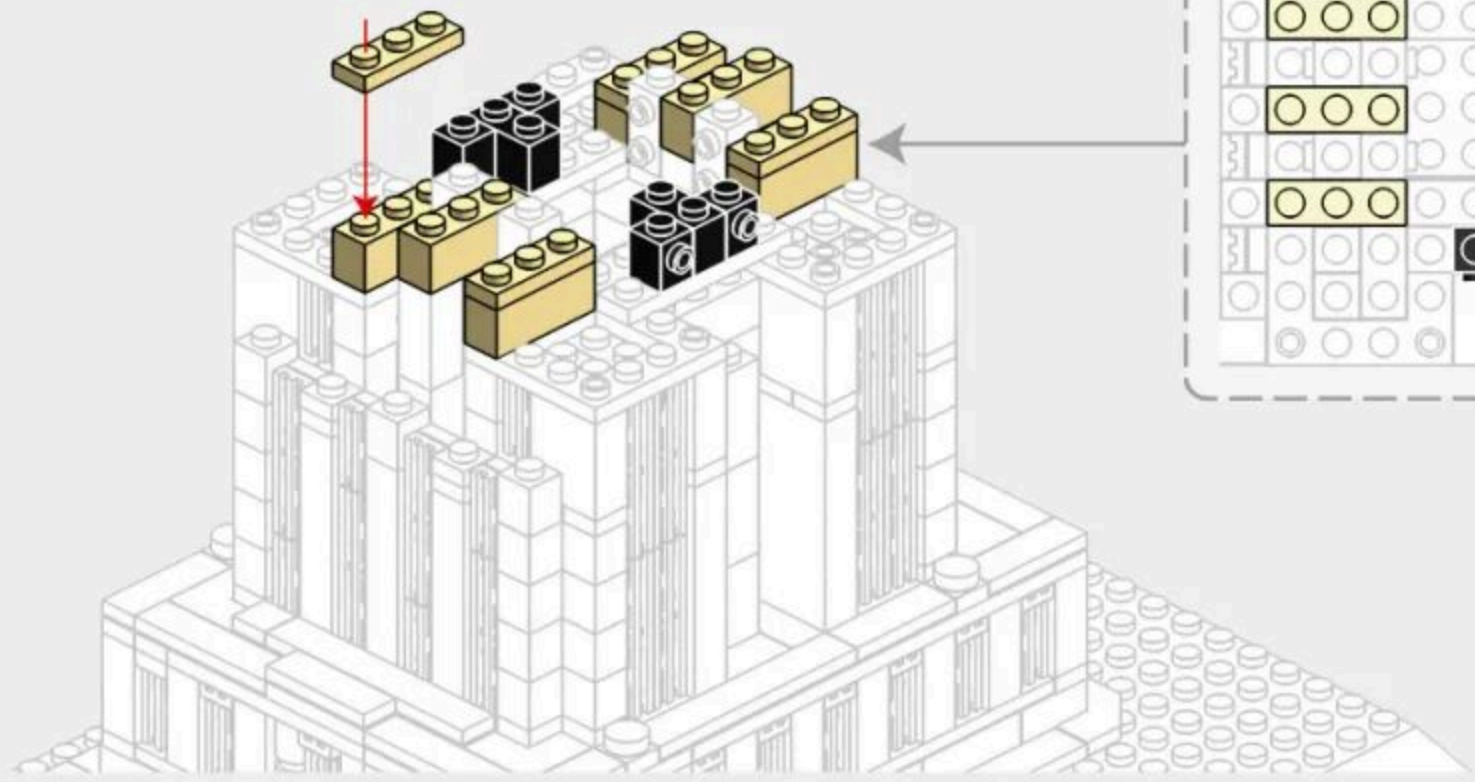
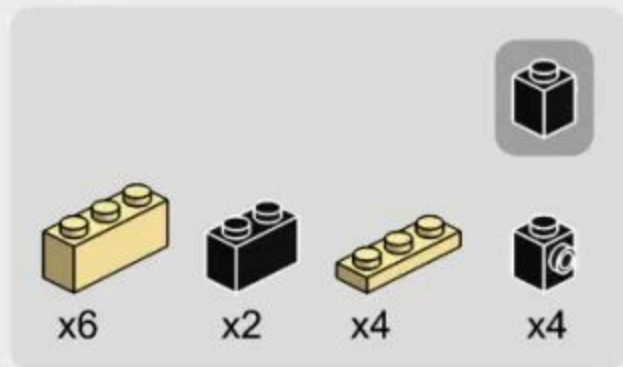

3-5

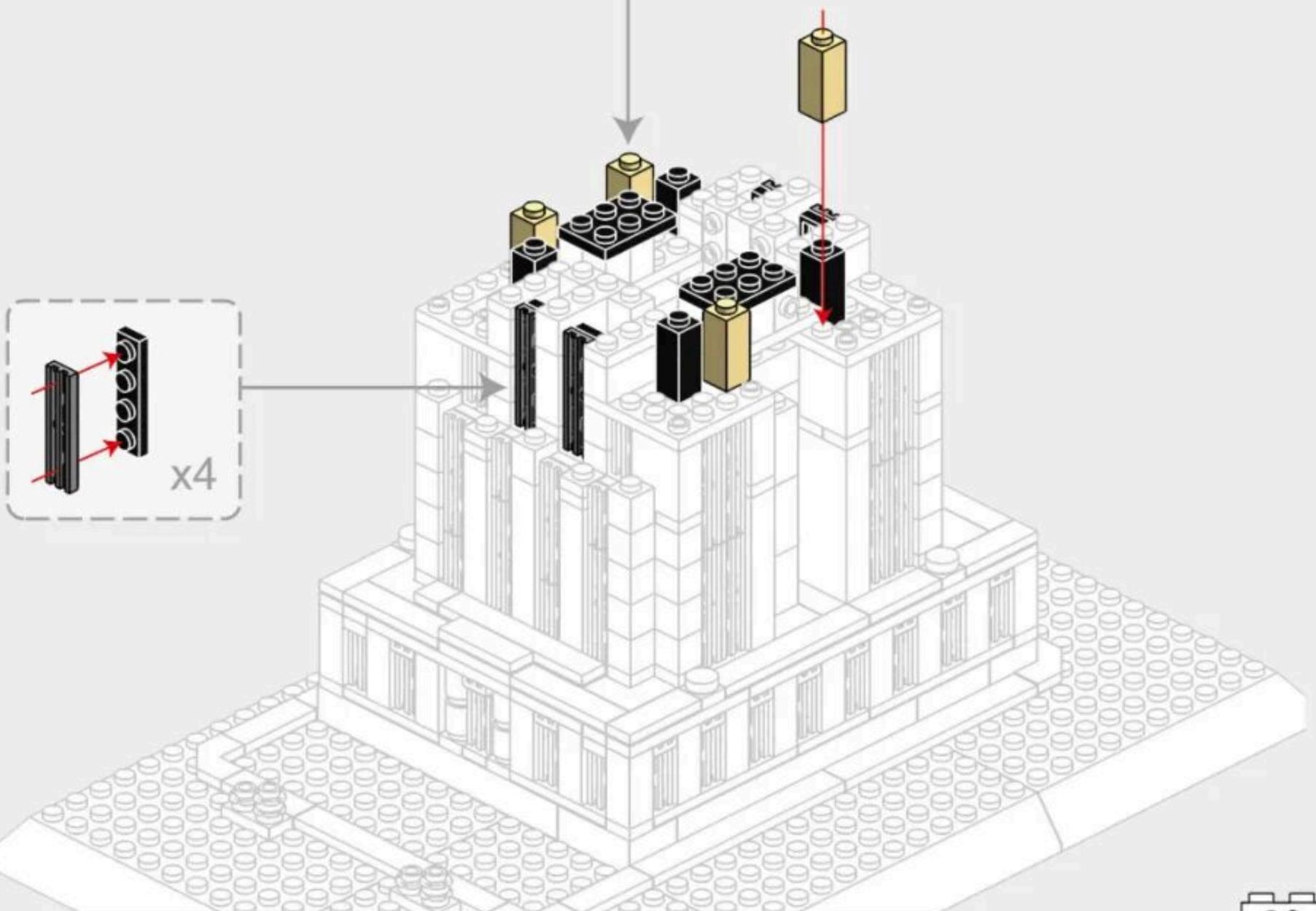
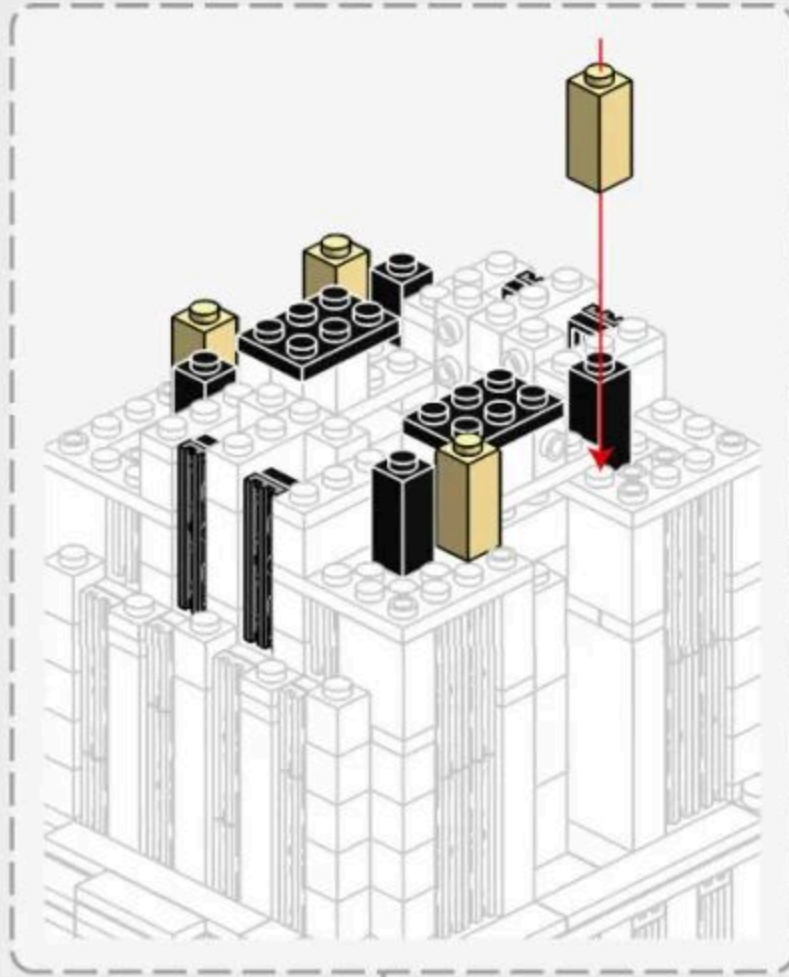
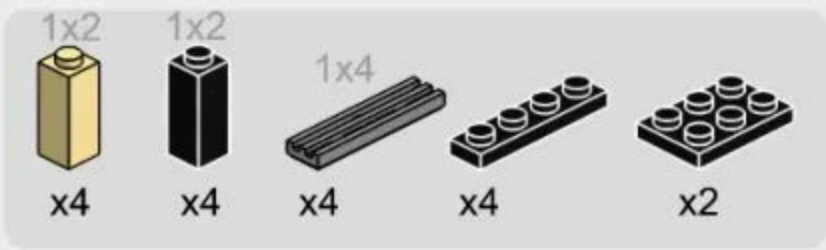



### 3-7

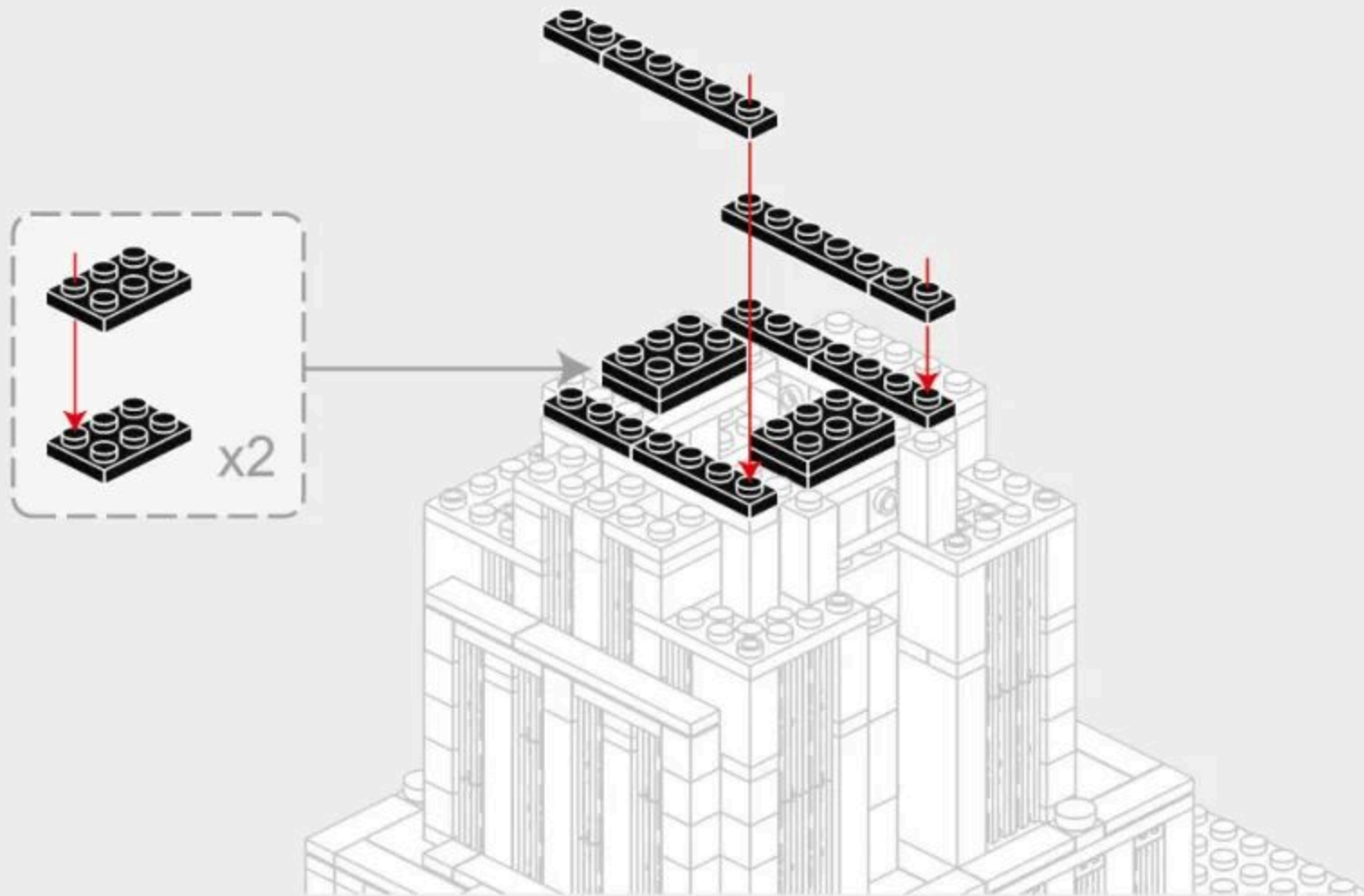

### 3-8

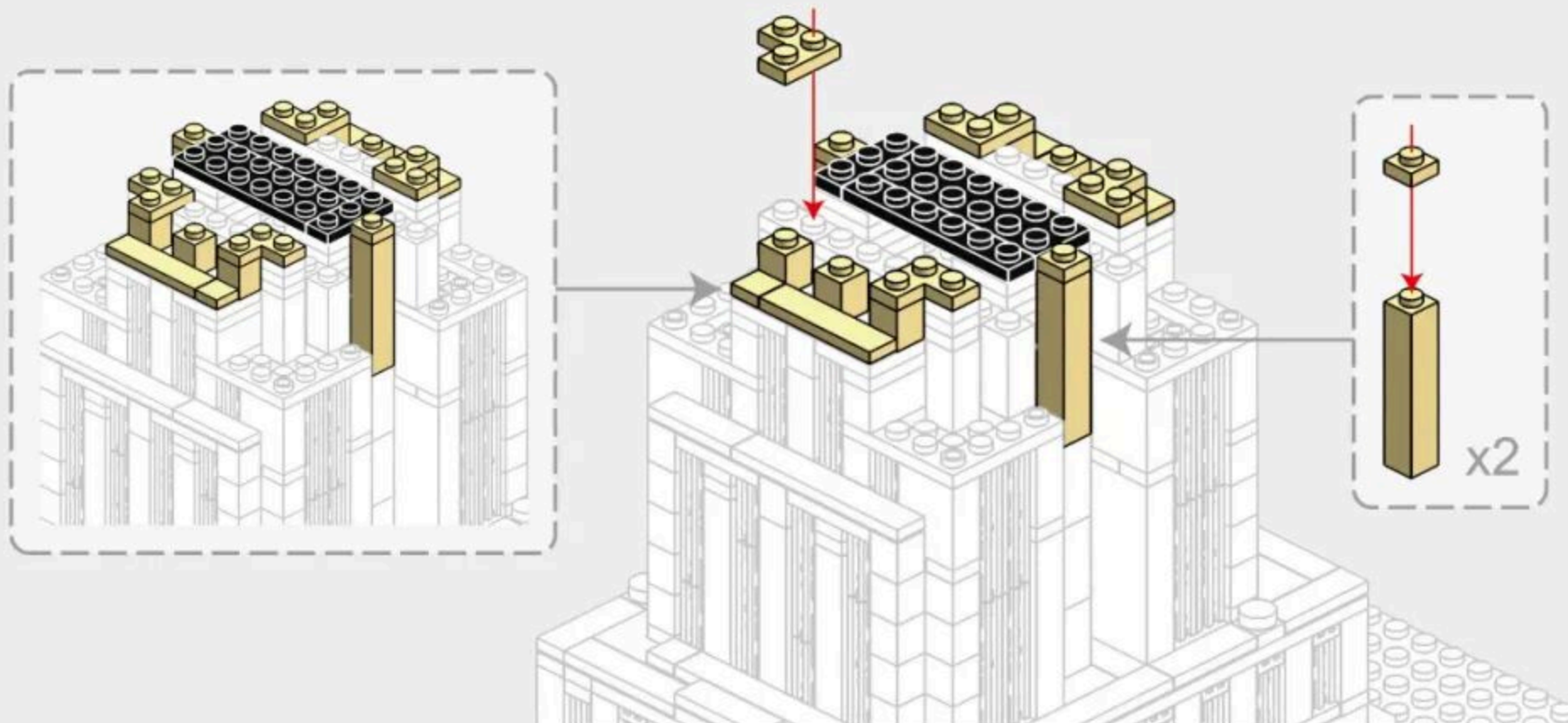
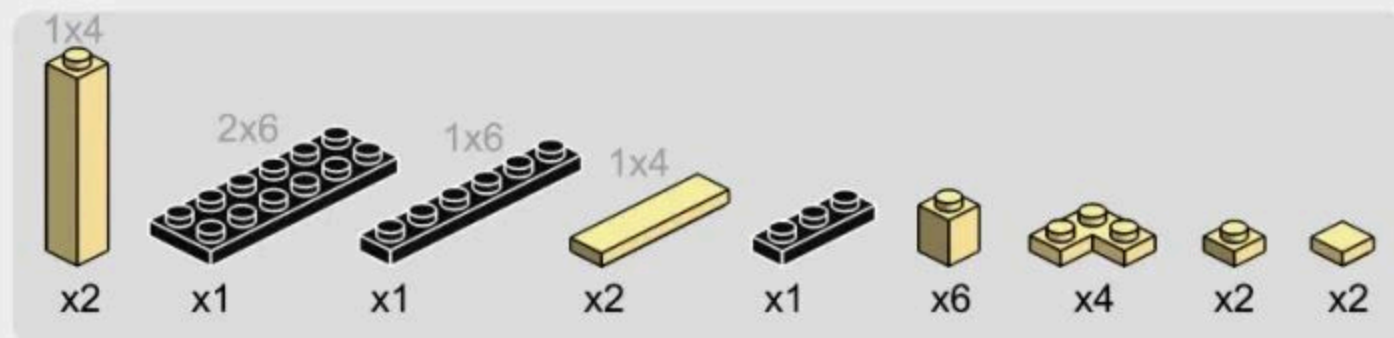

3-9

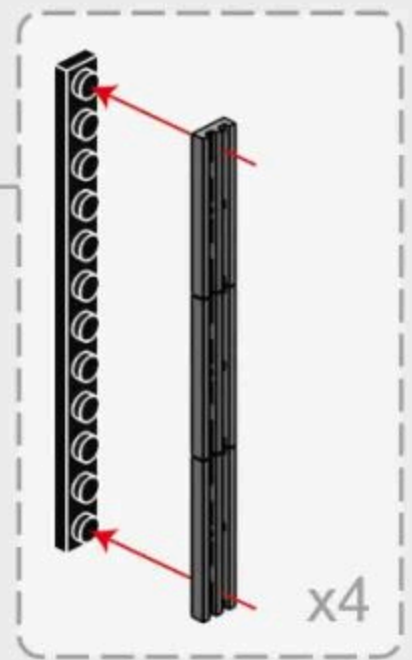
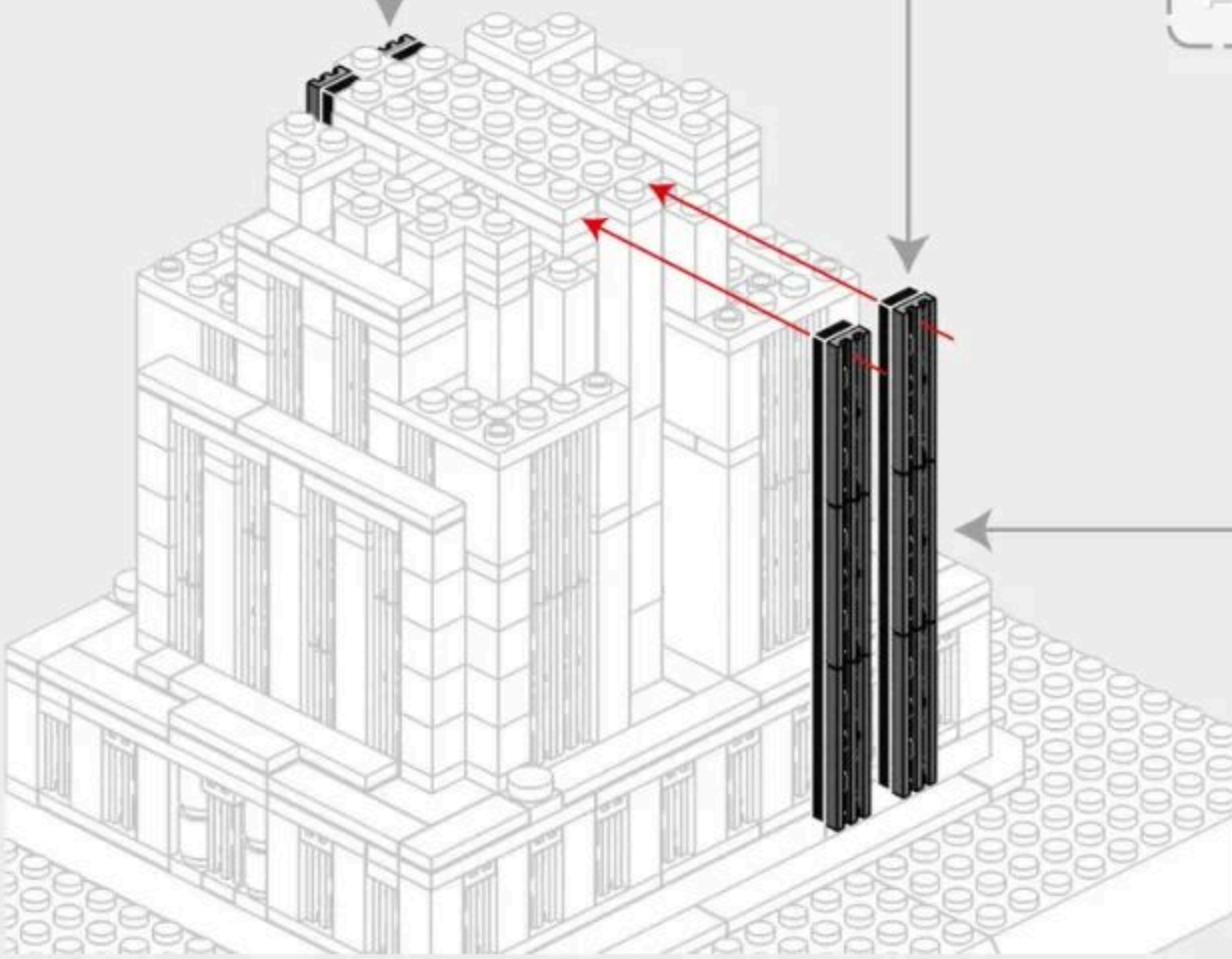
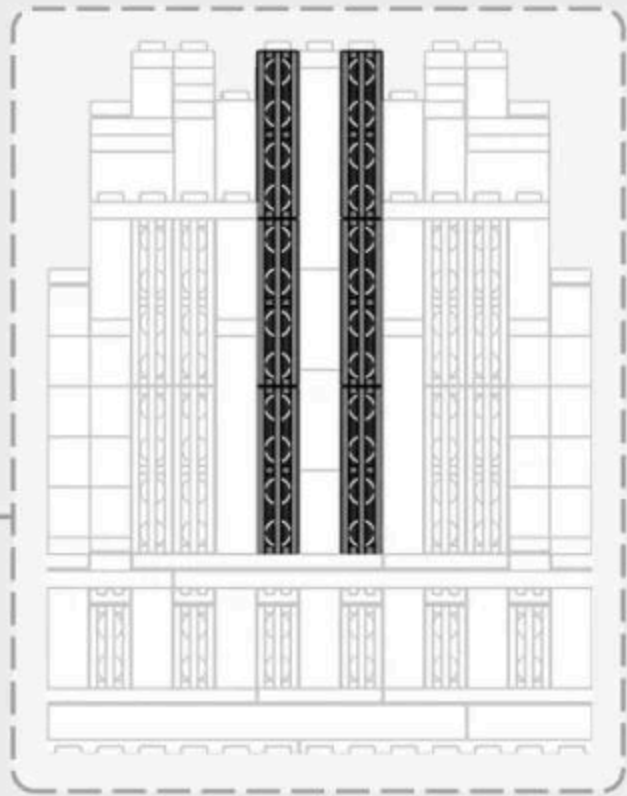
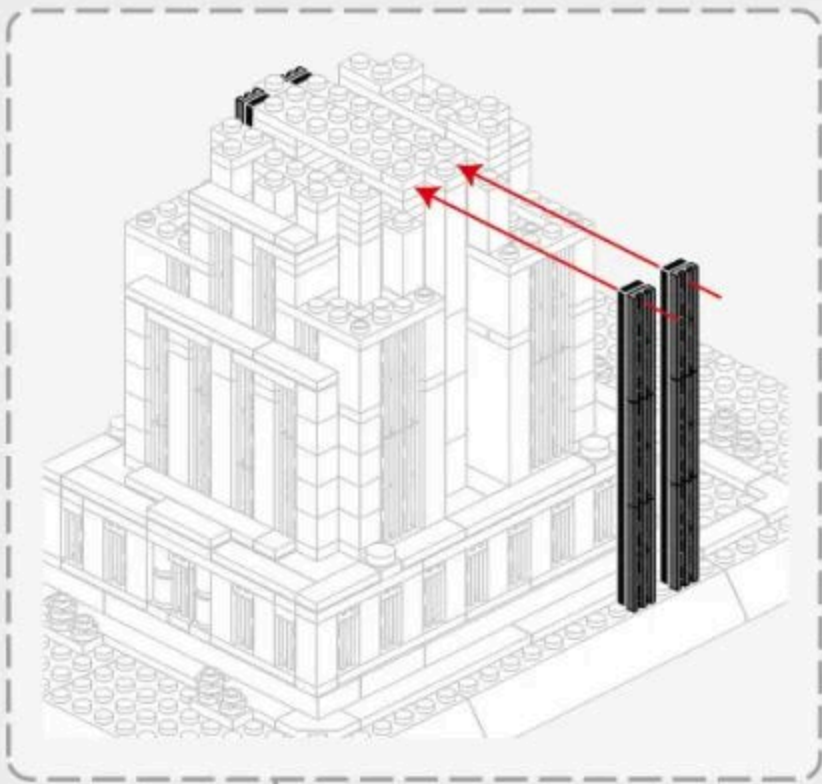
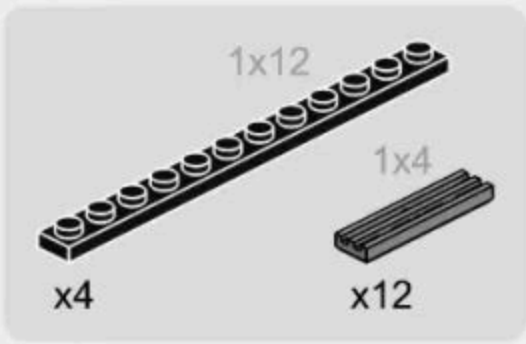

3-10

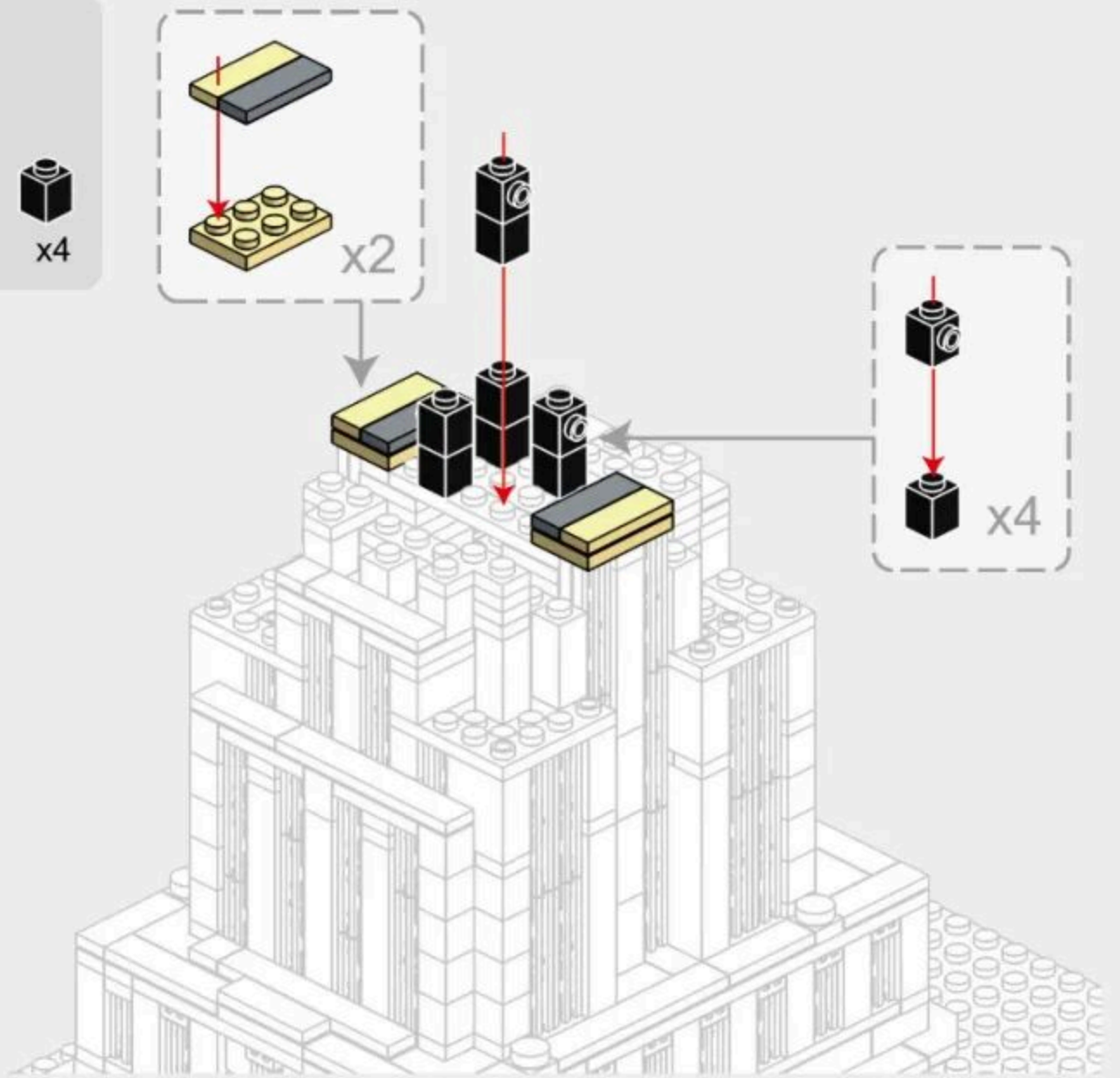
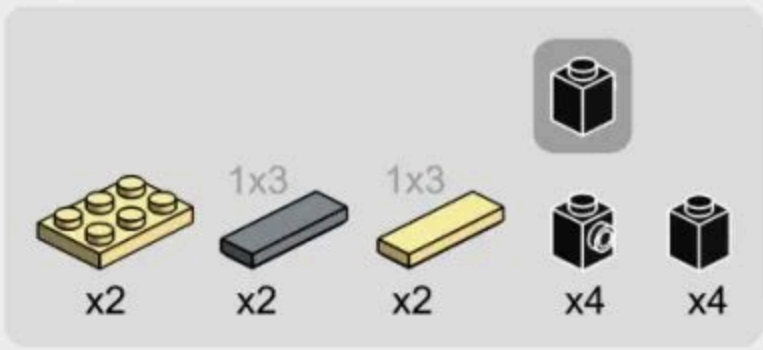

3-11

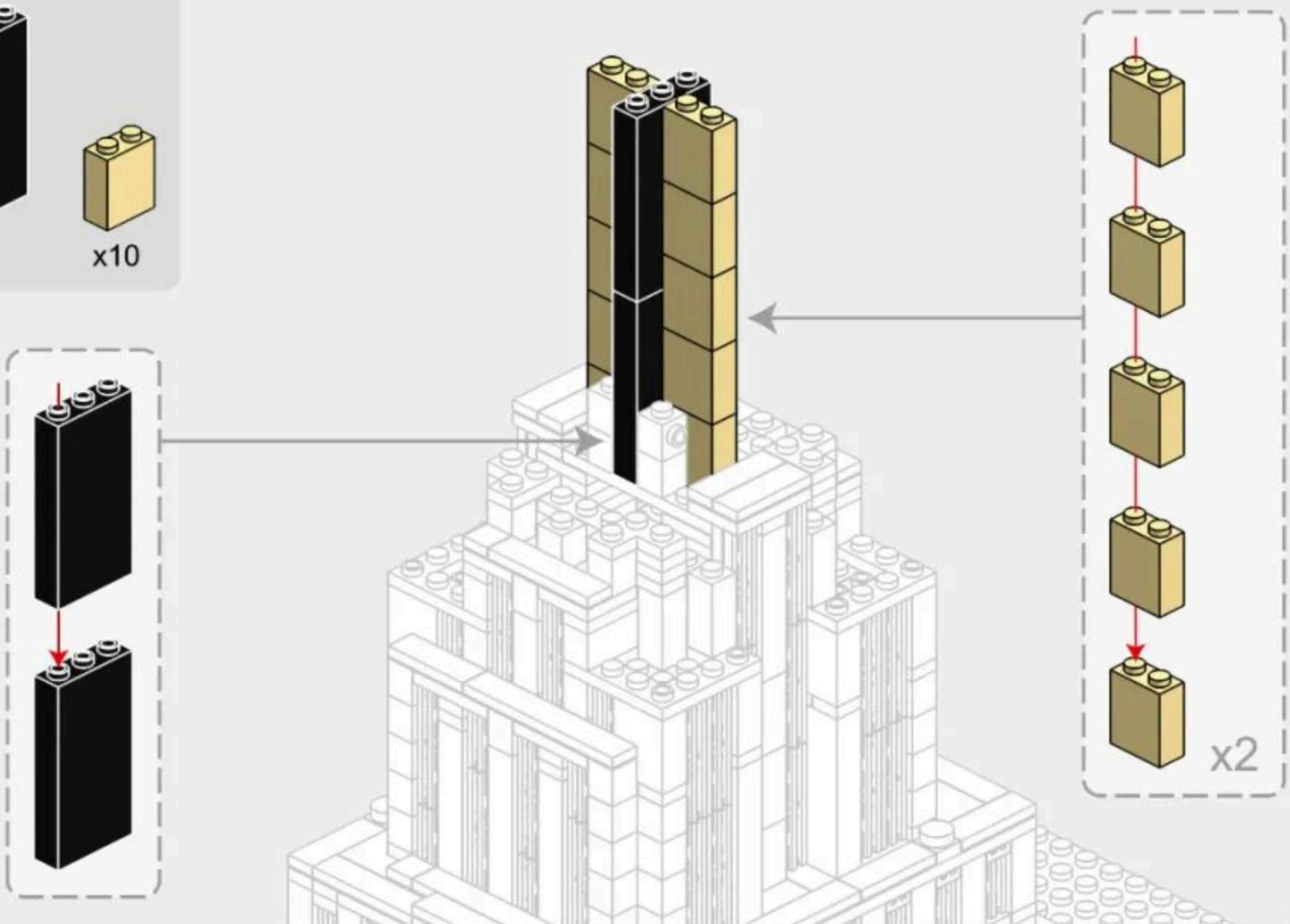
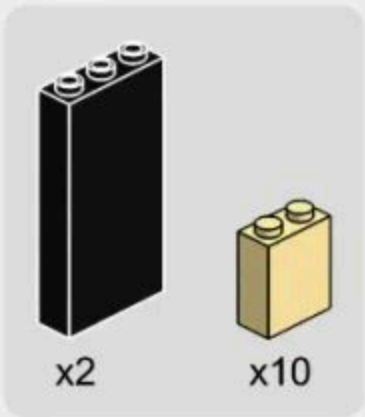

3-12

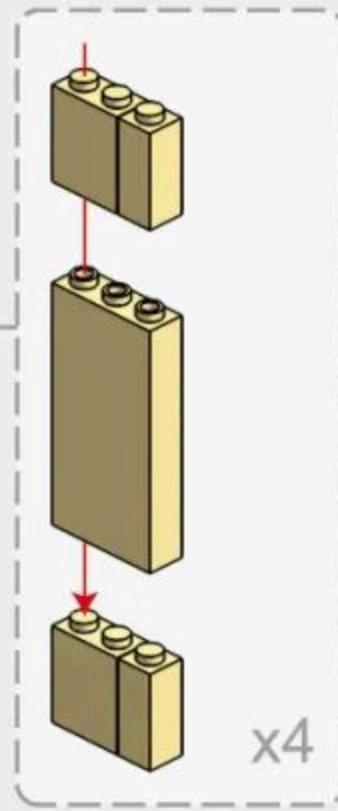
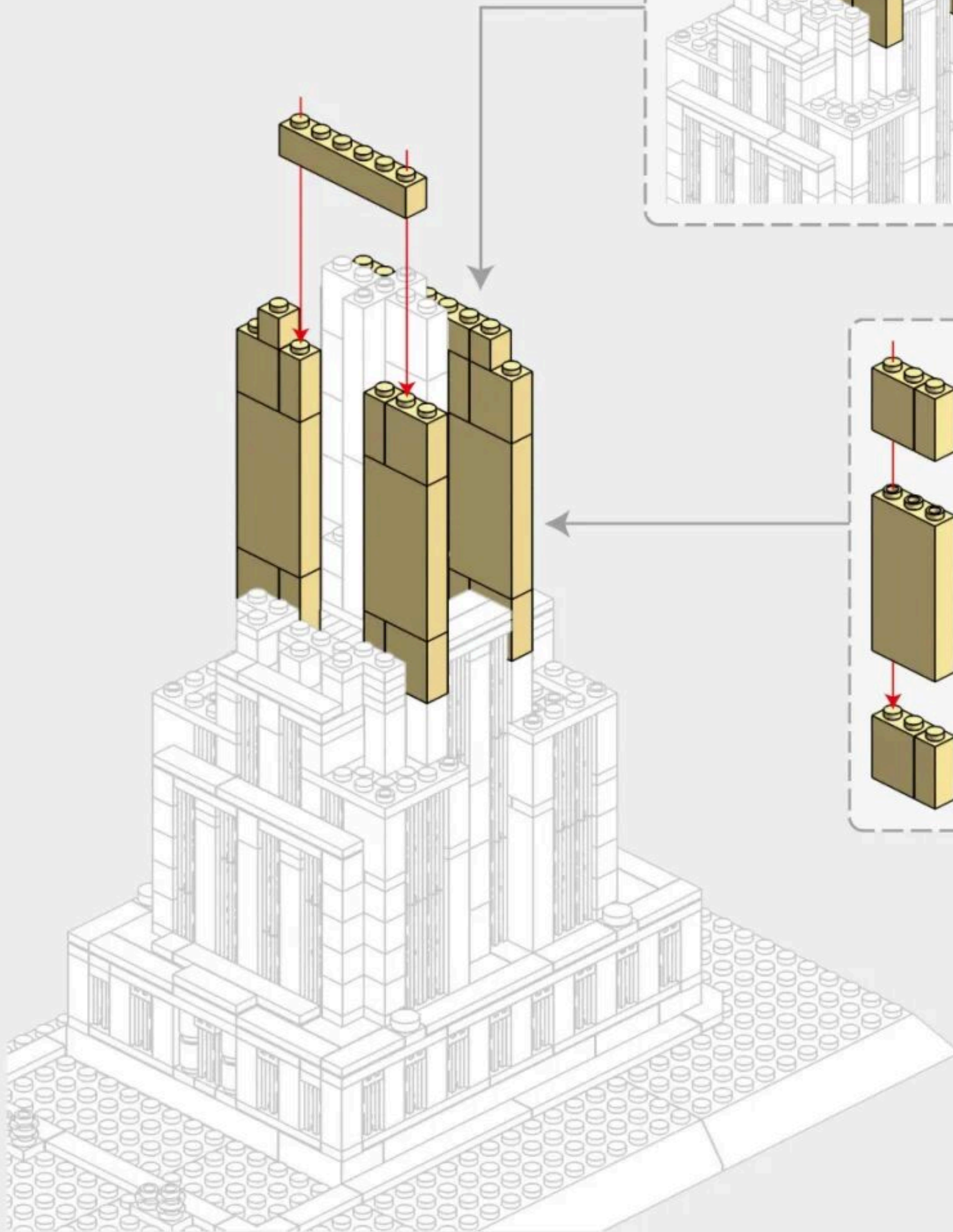
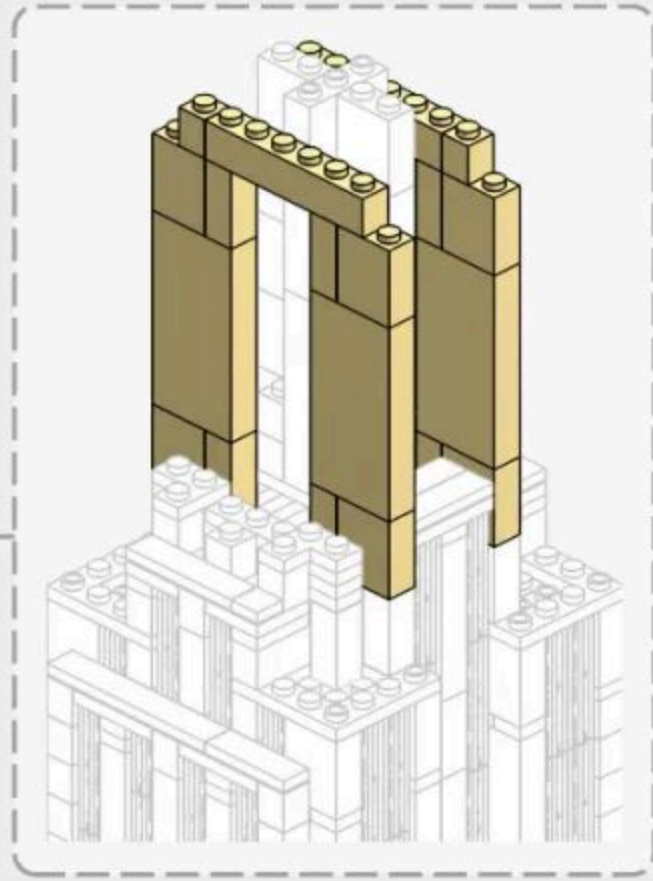
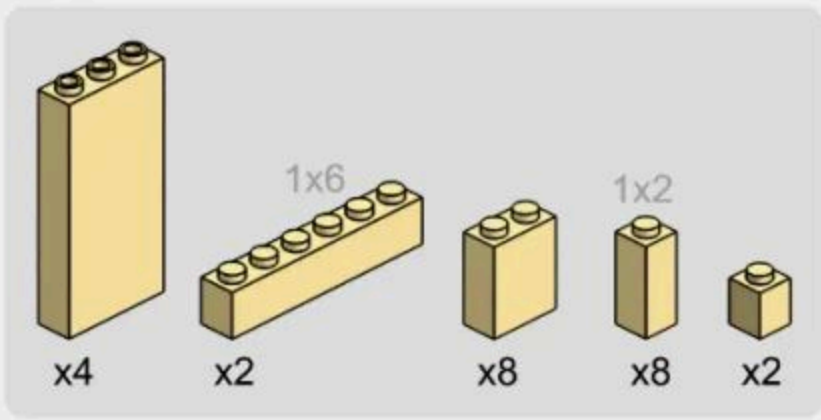

3-13

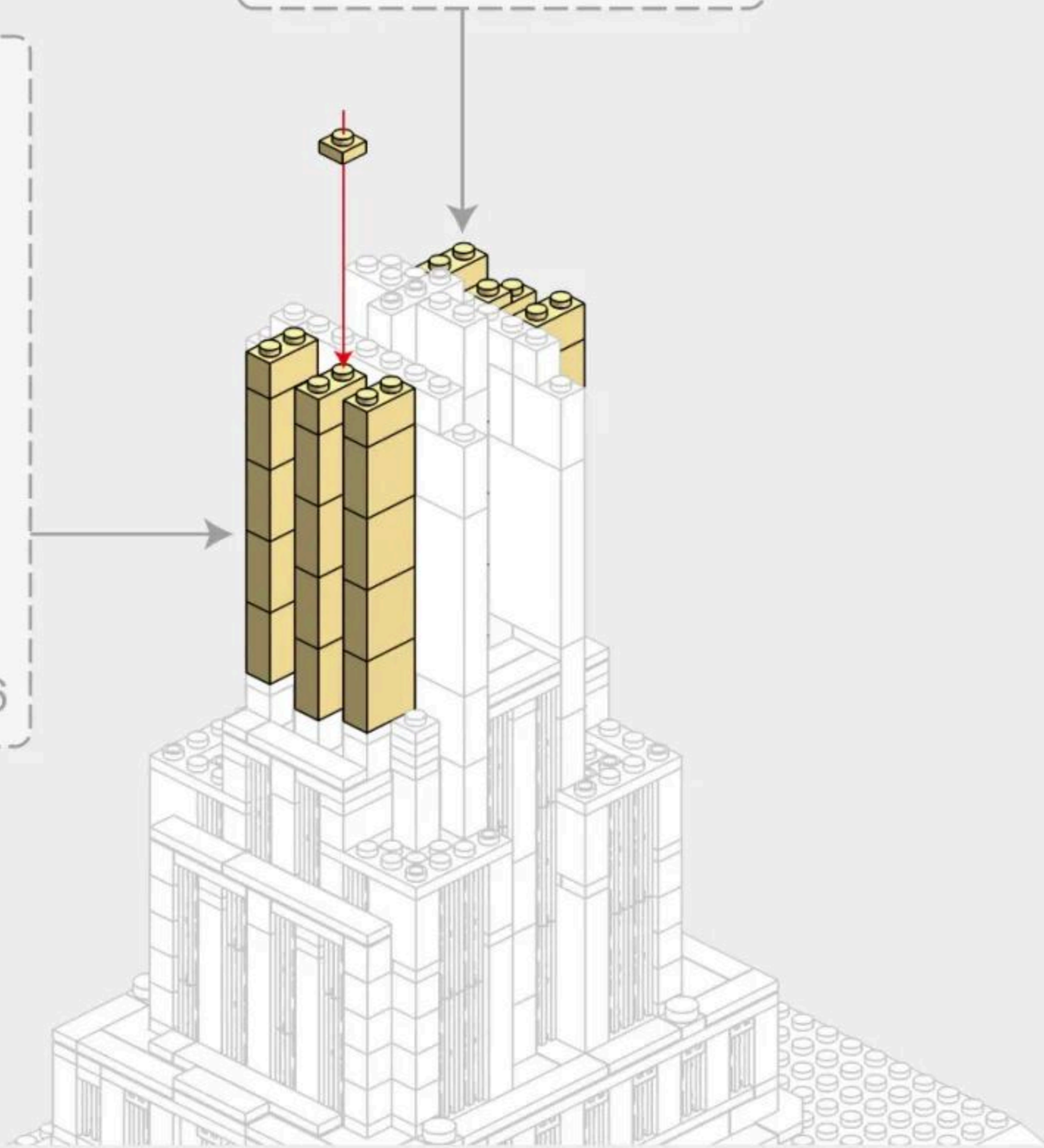
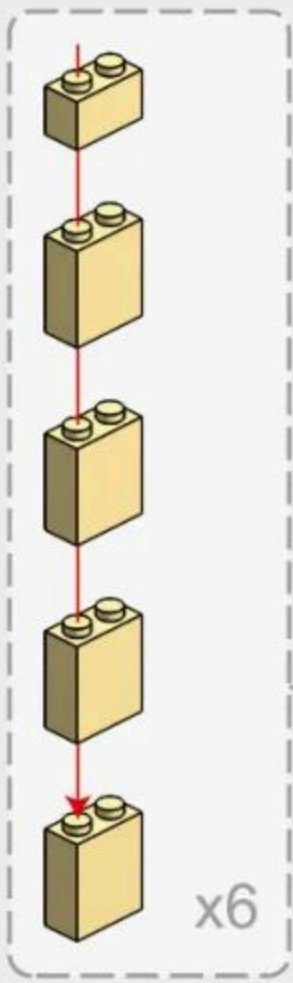
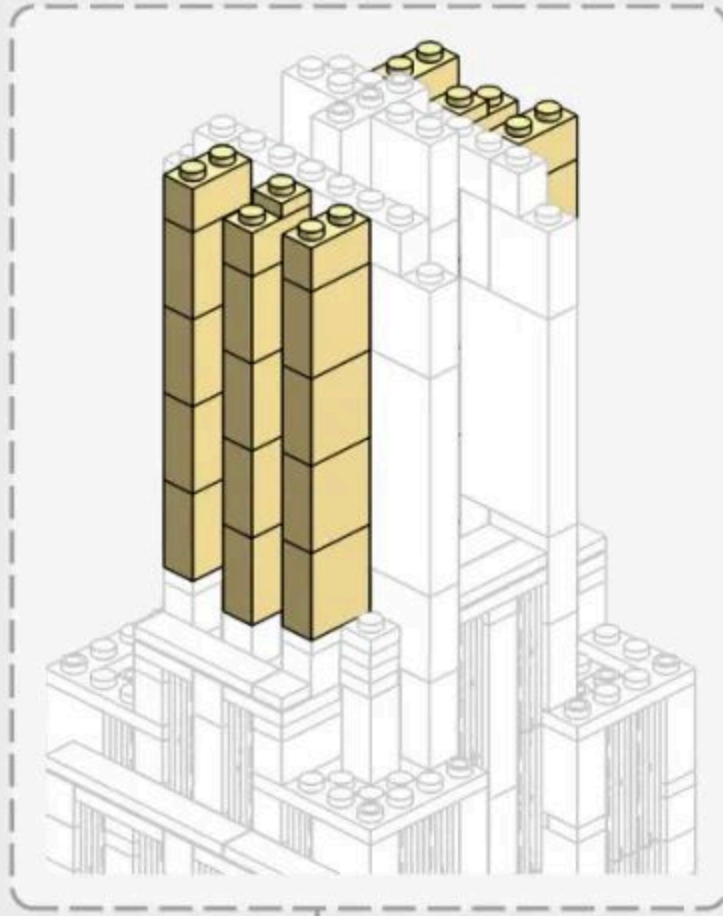
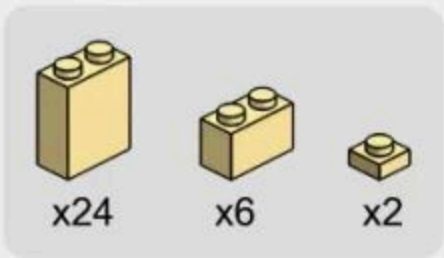

### 3-14

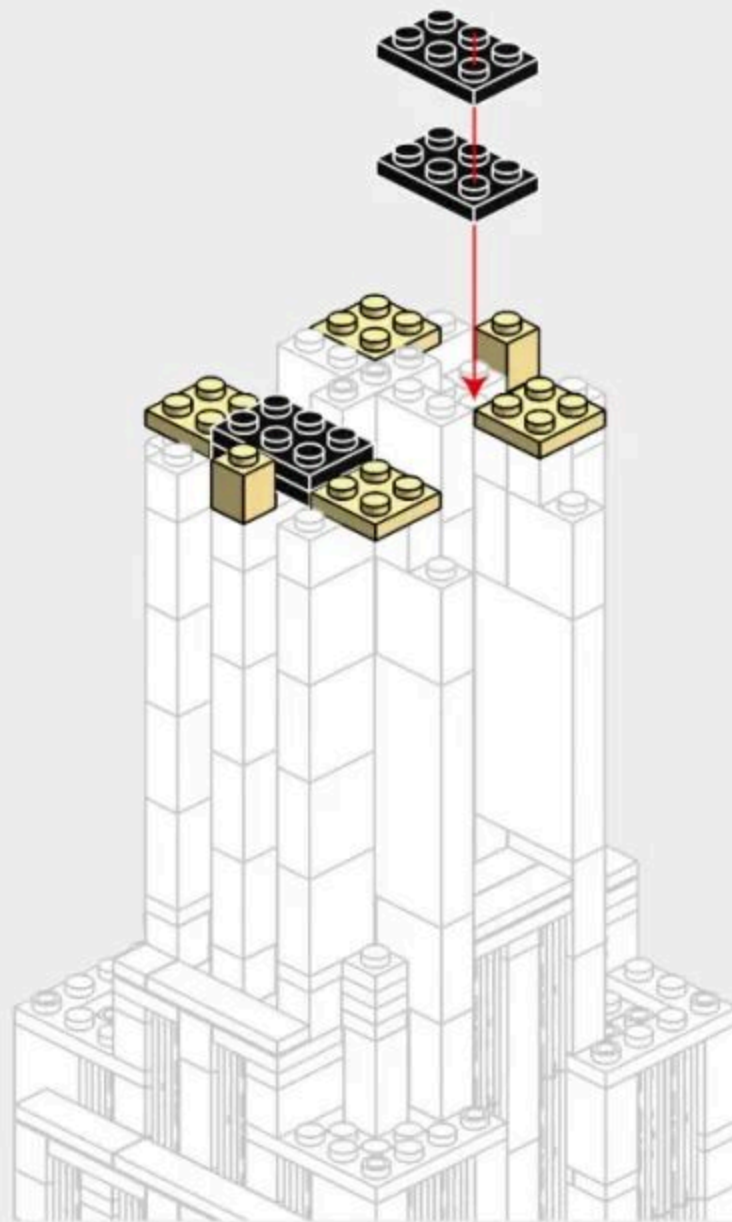

### 3-15

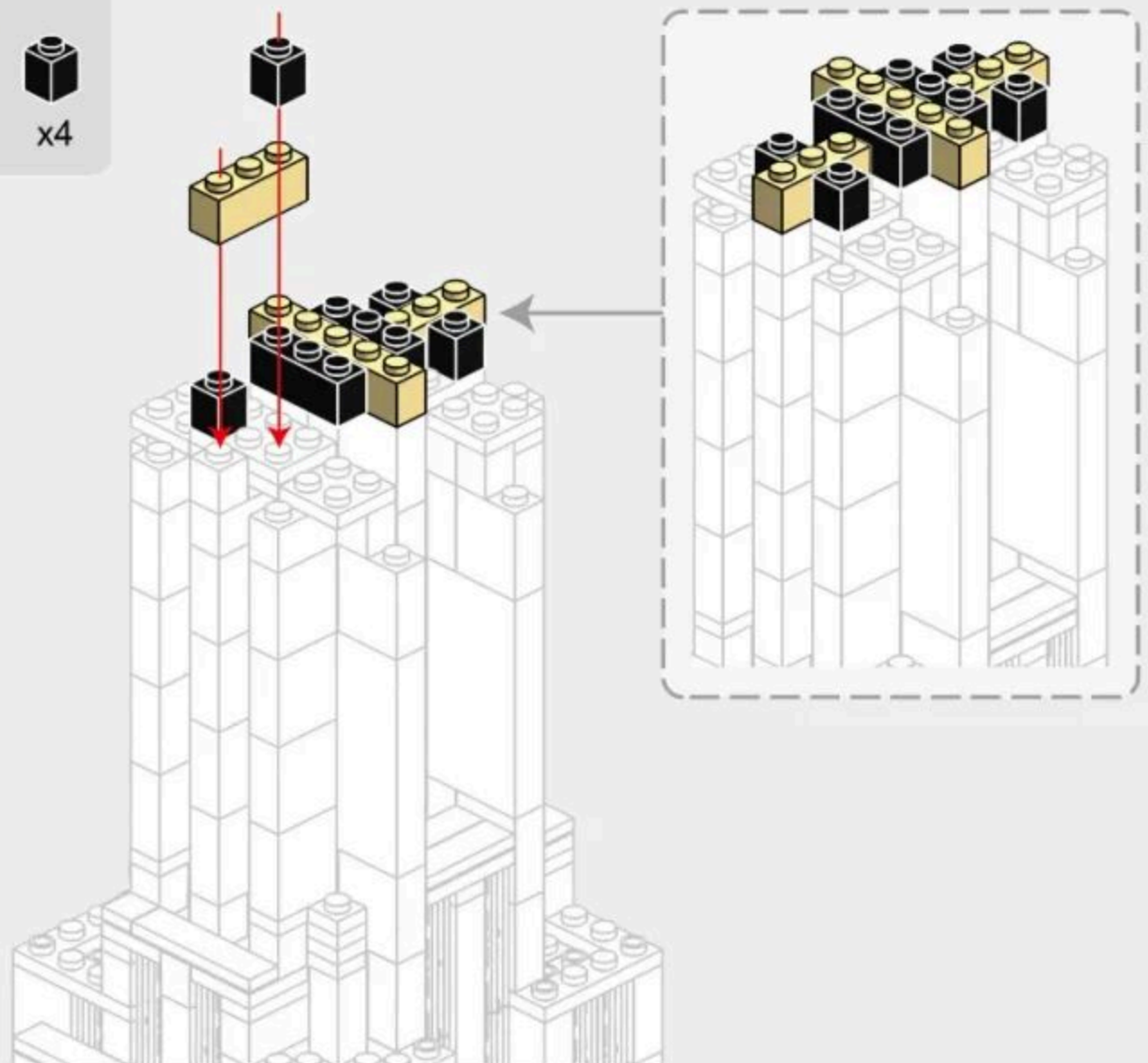
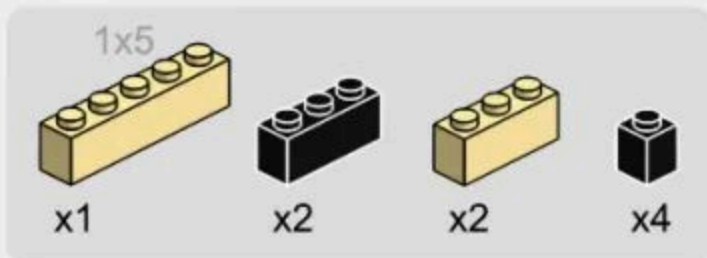

### 3-16

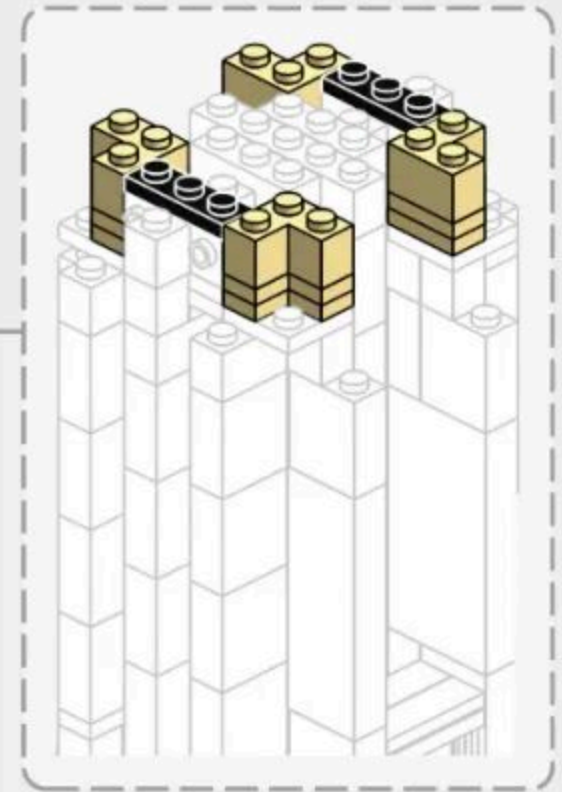
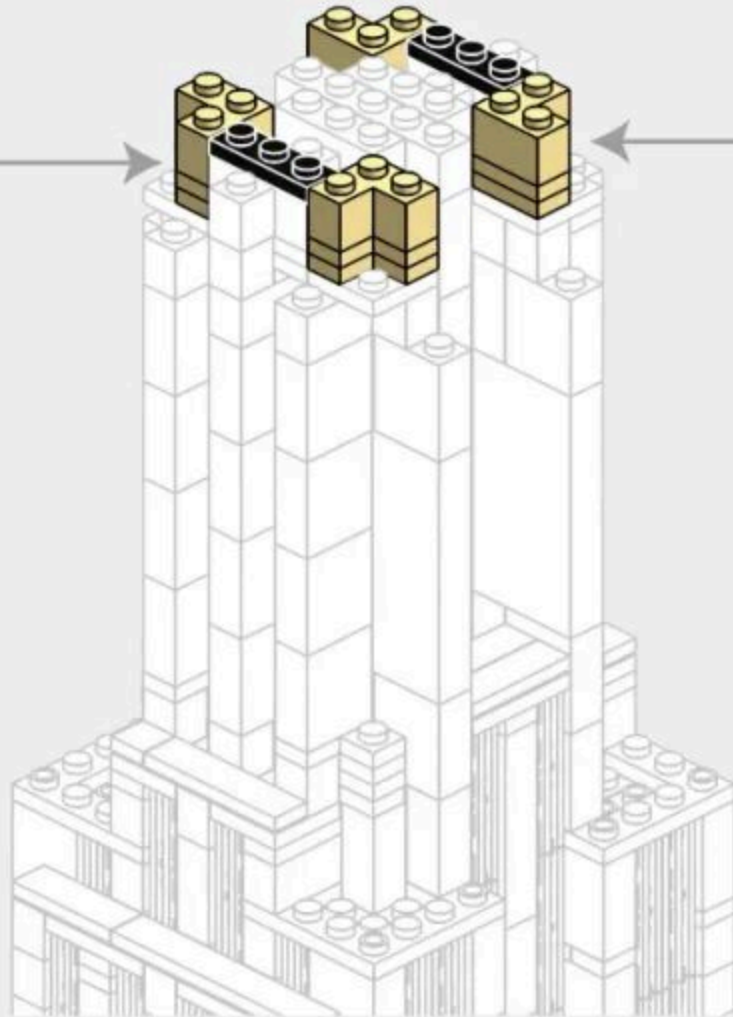
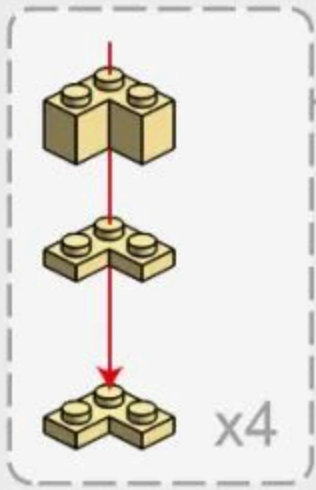

### 3-17

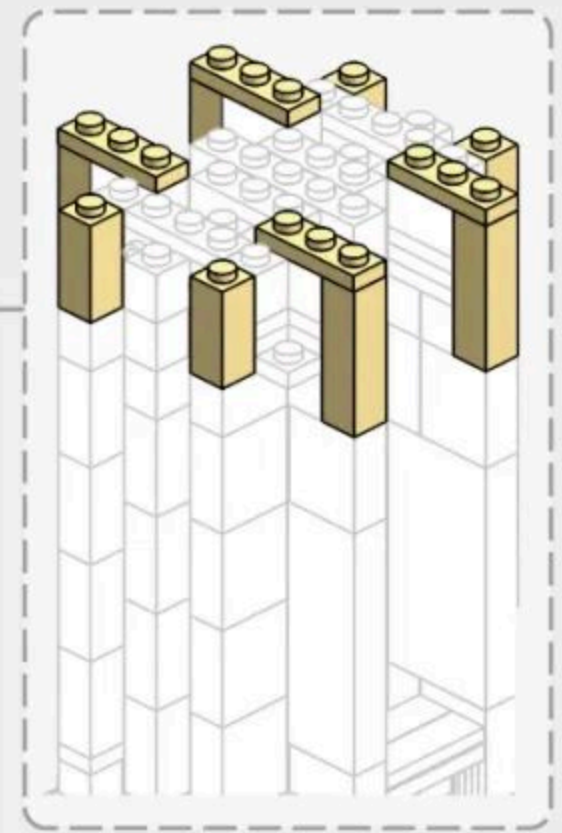
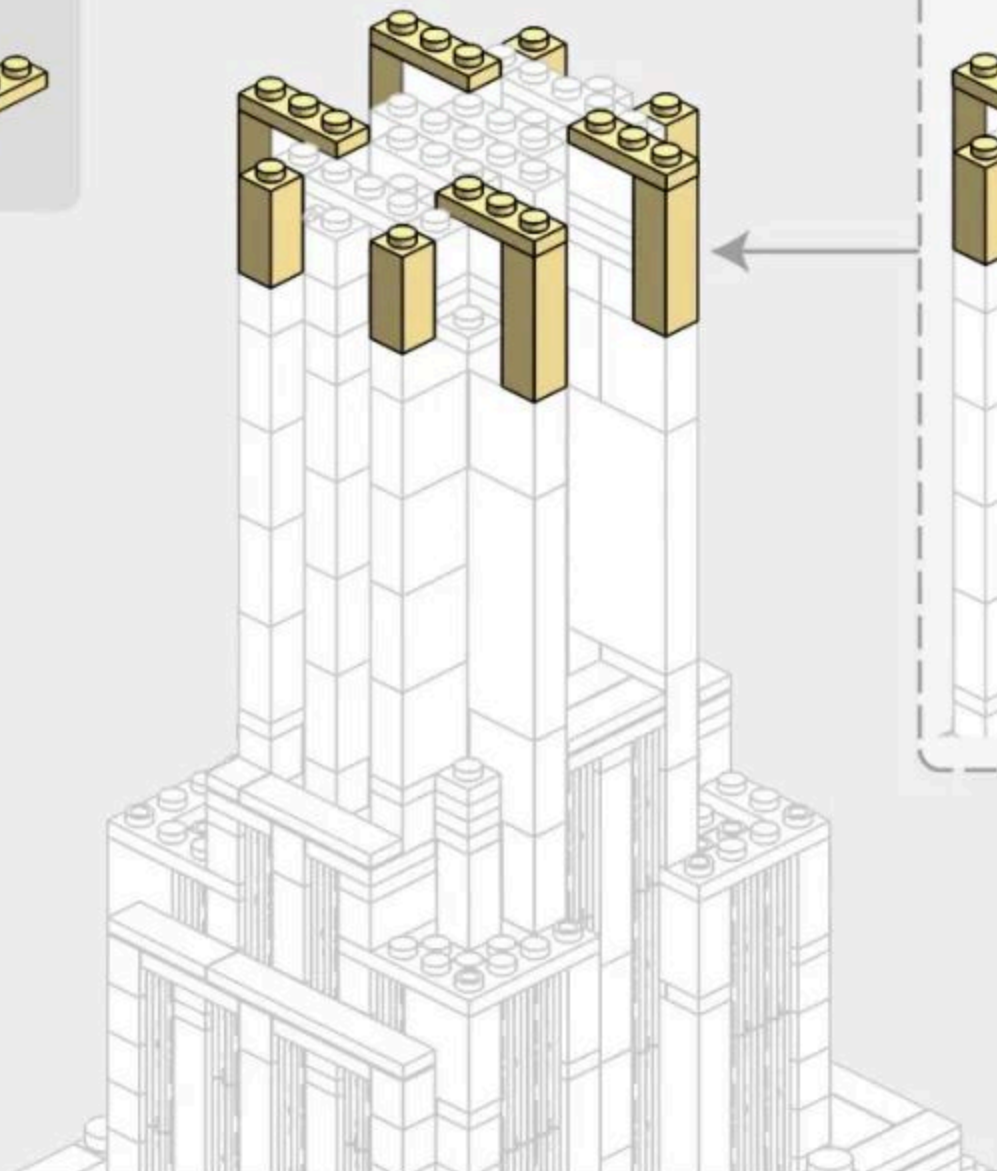
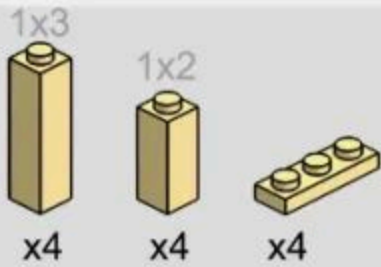



242PCS

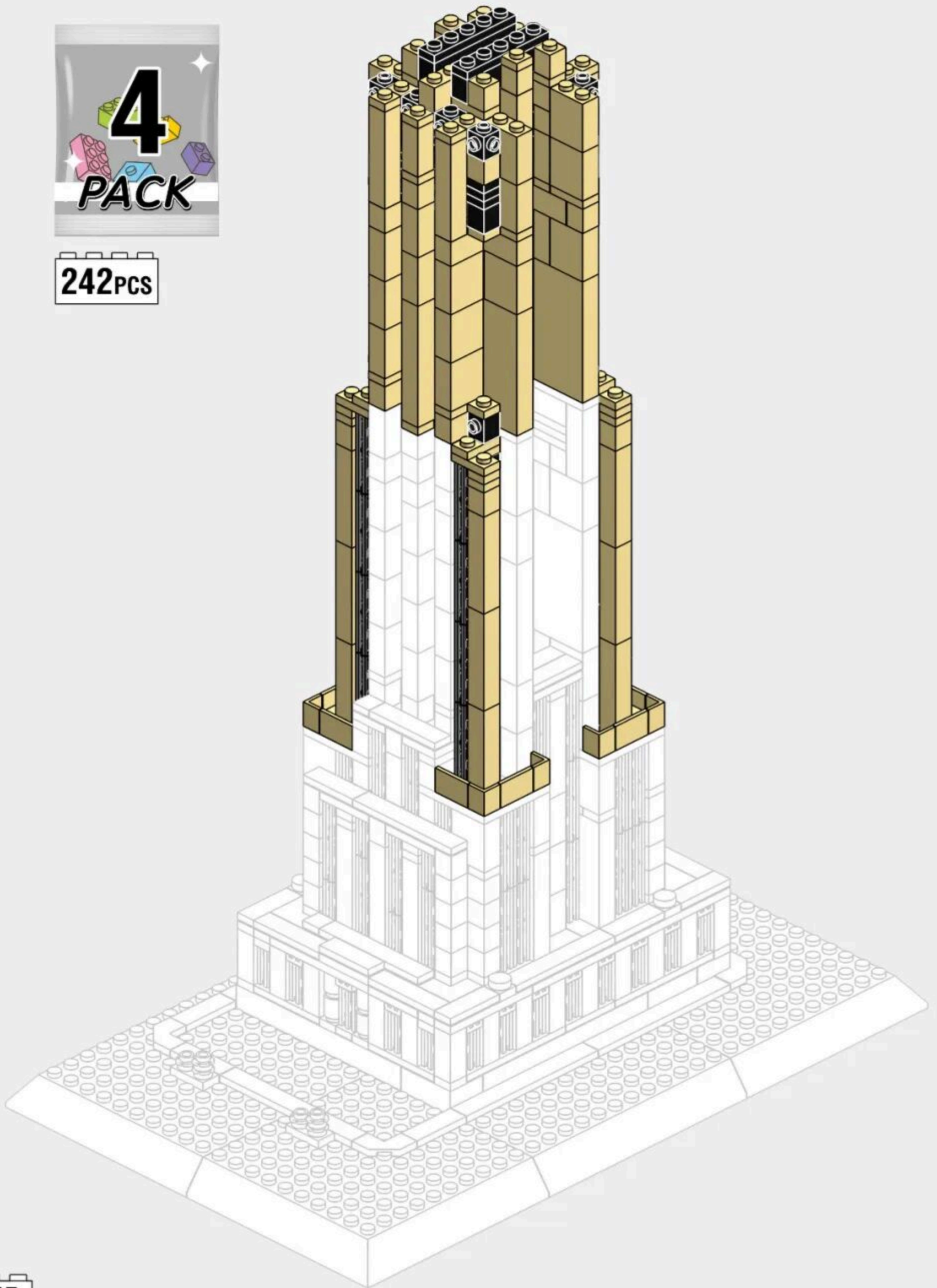

4-1

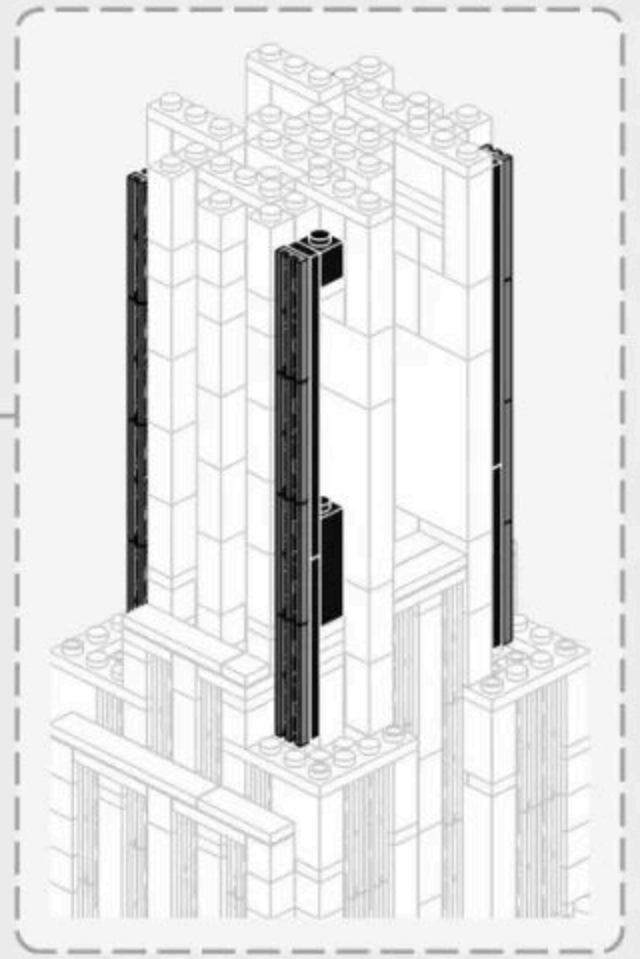
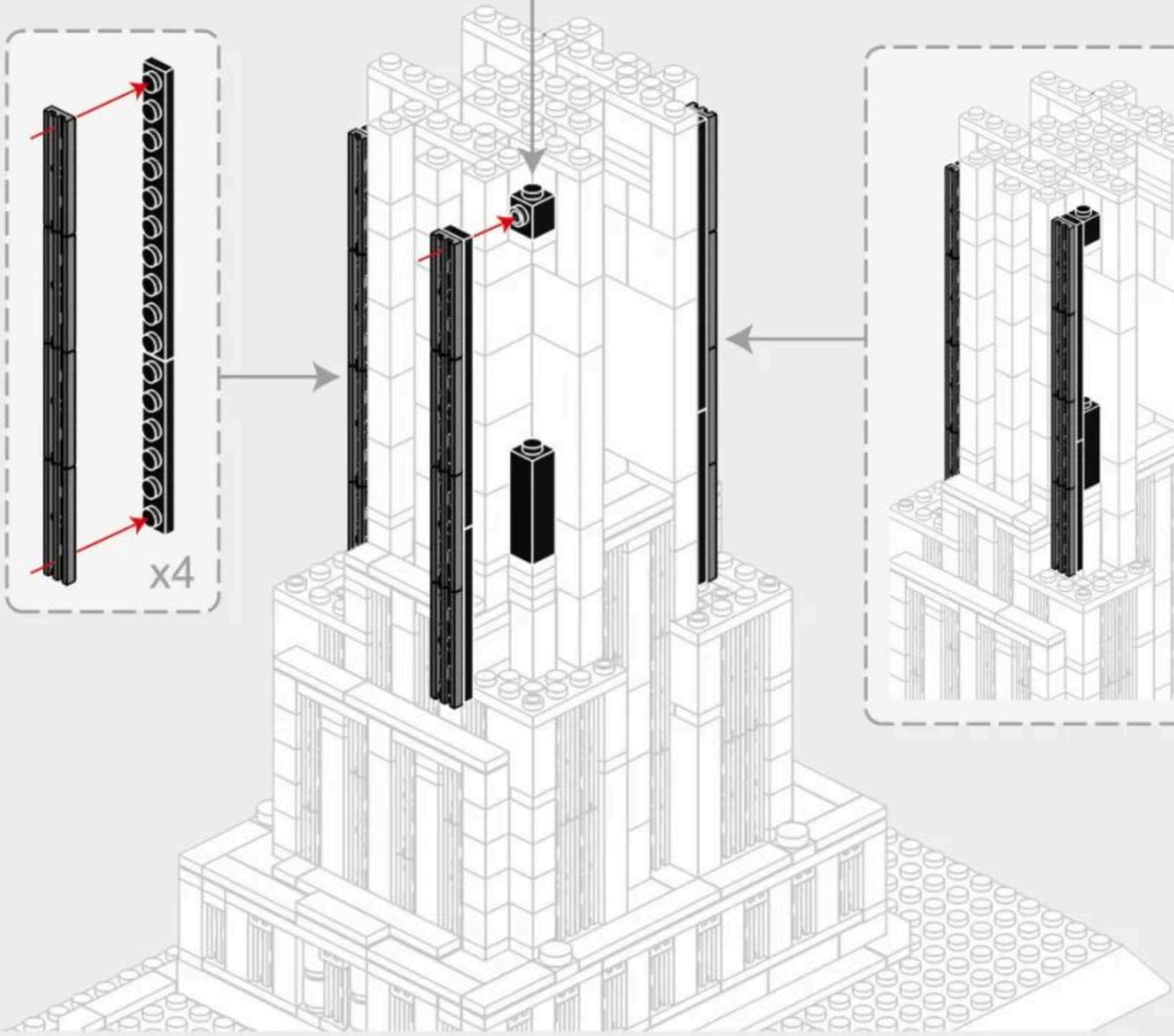
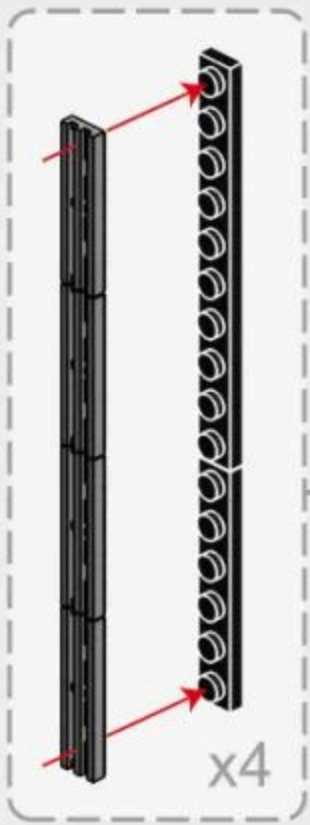
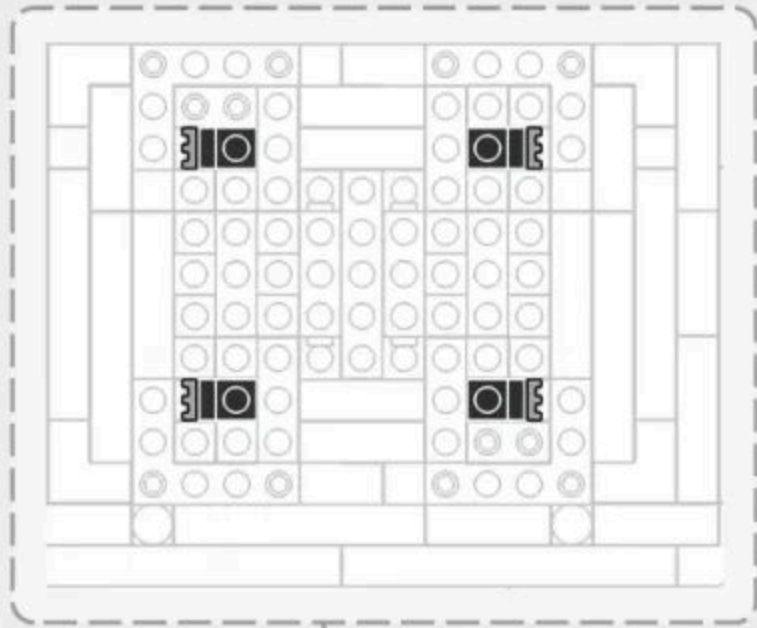
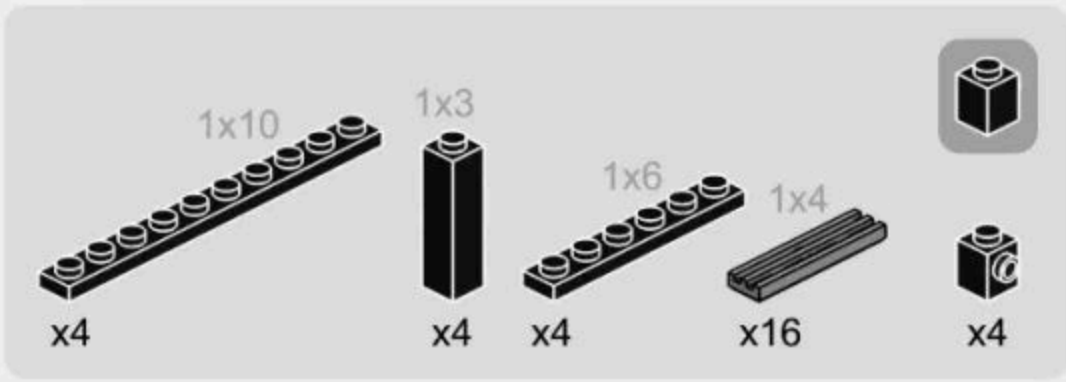

4-2

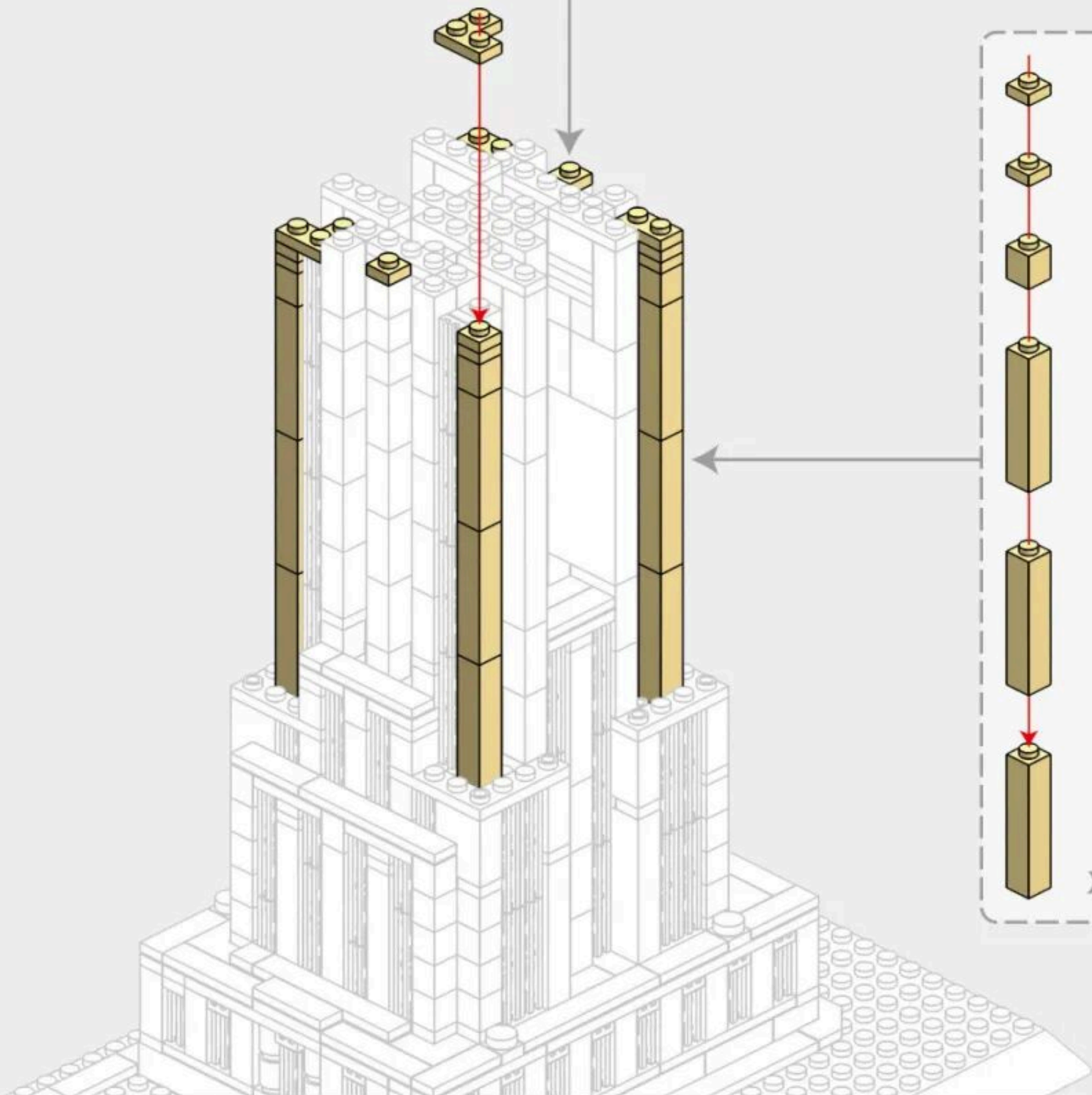
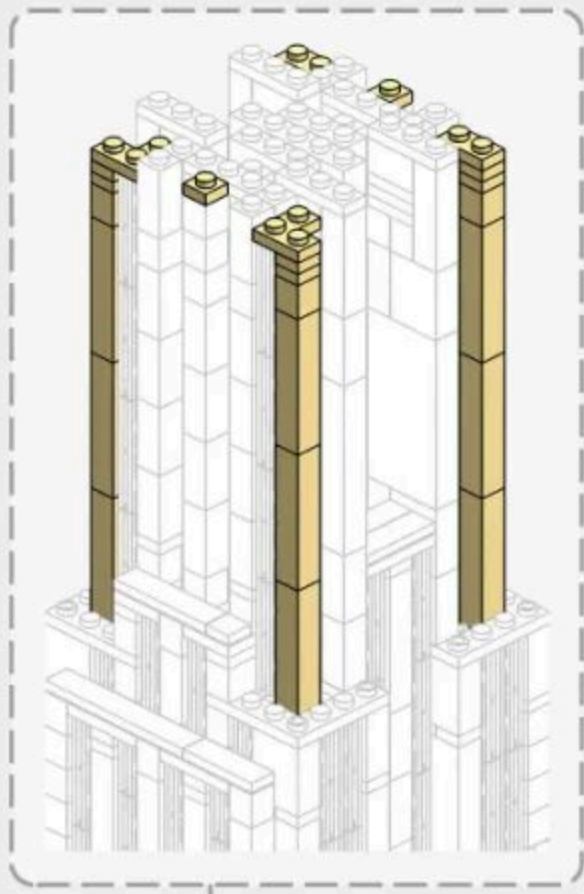
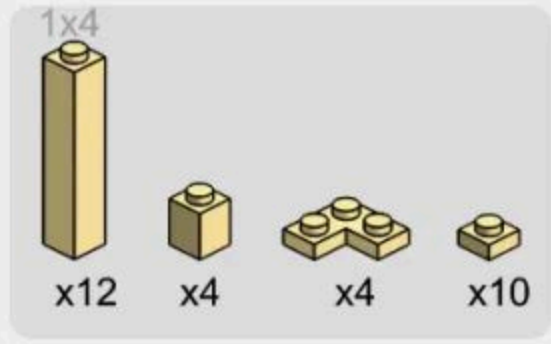

4-3



4-4

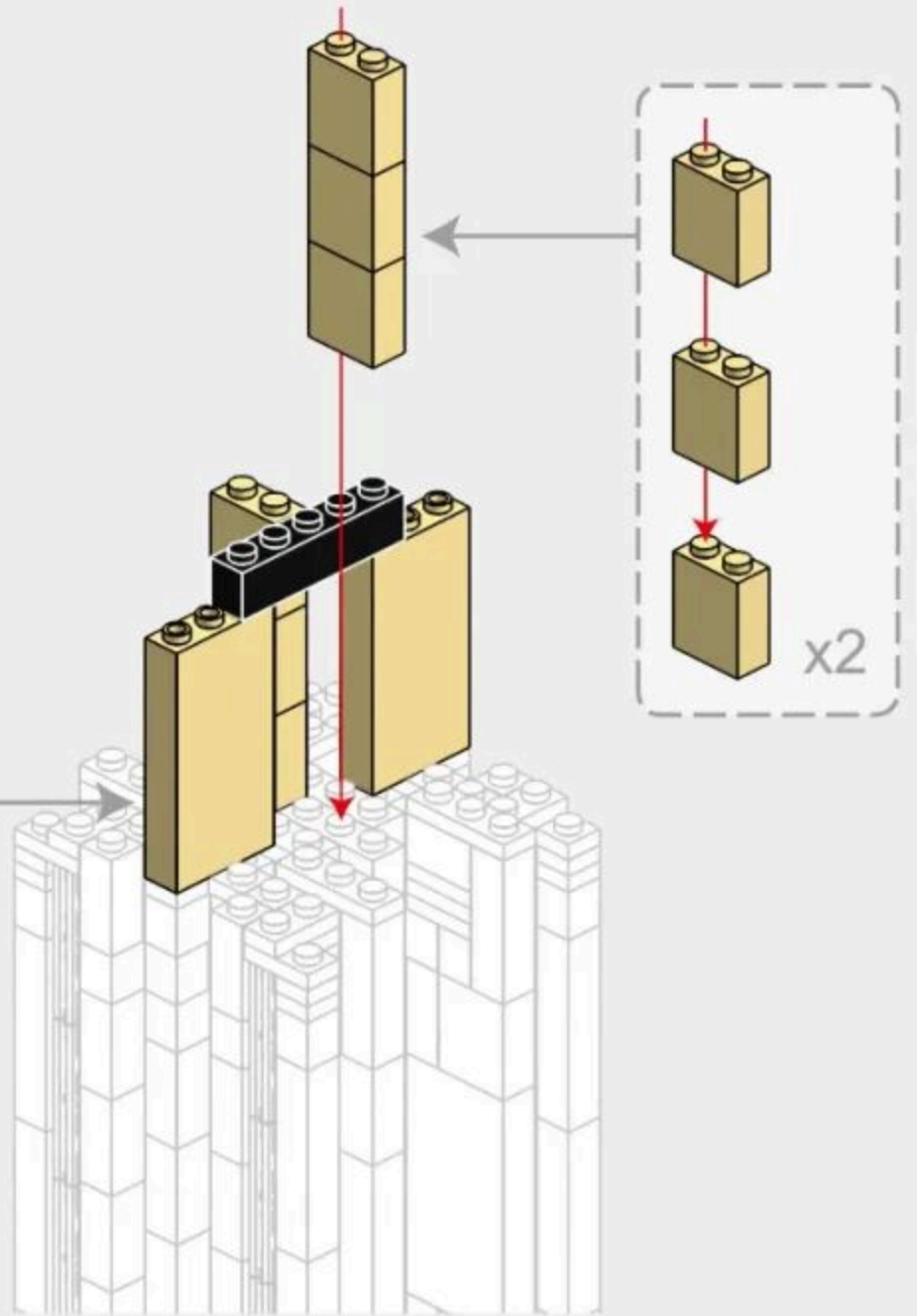
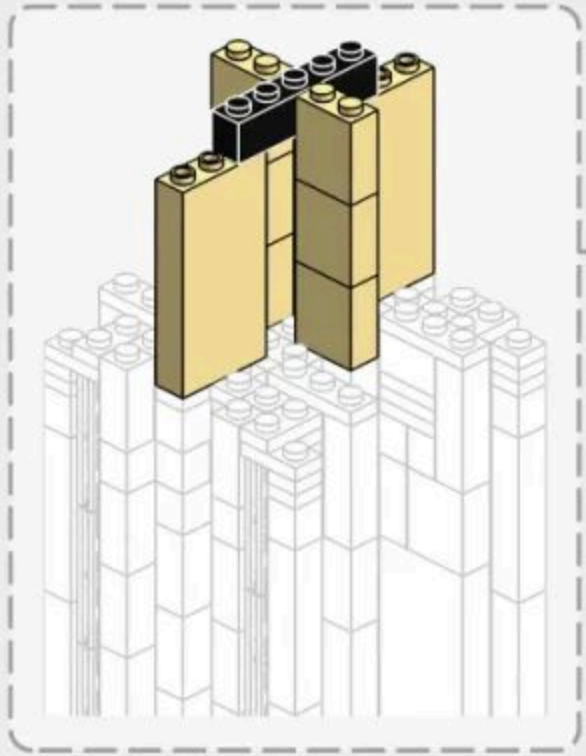
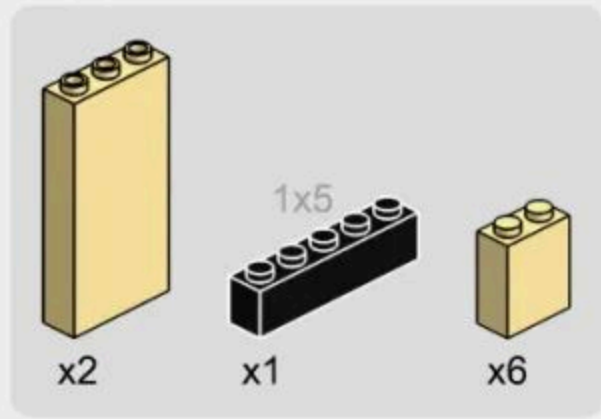

4-5

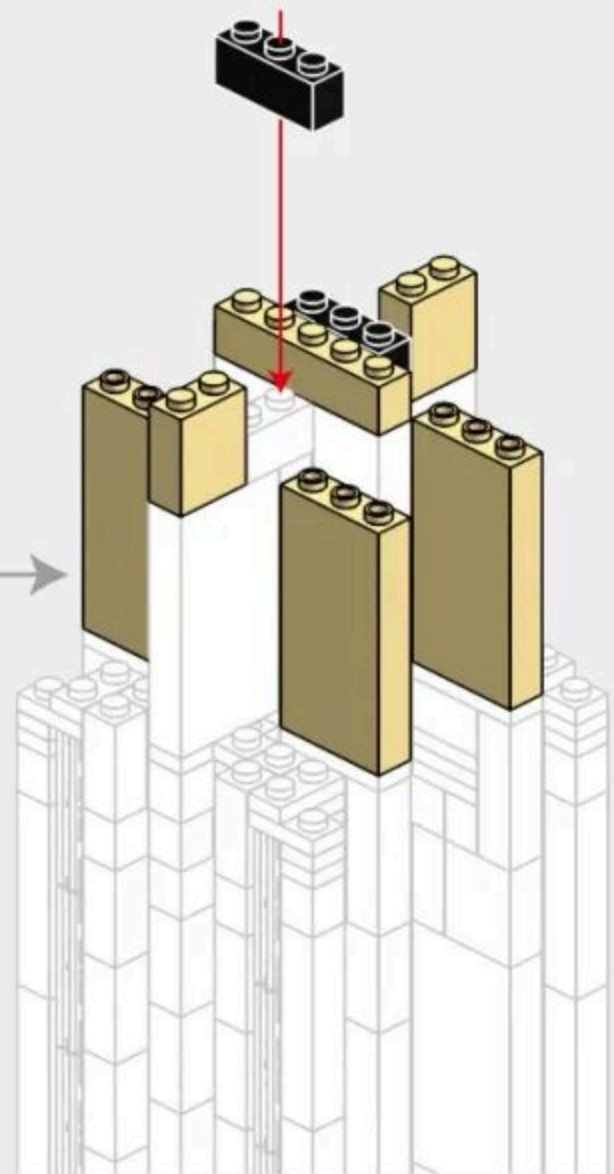
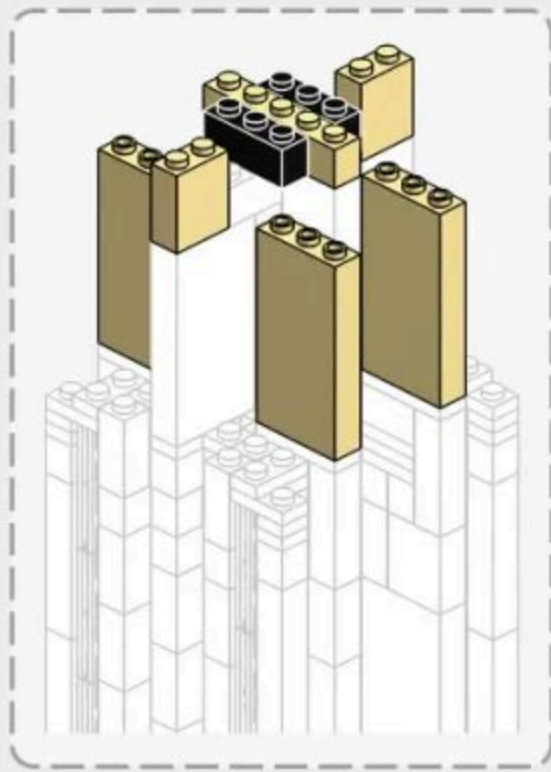
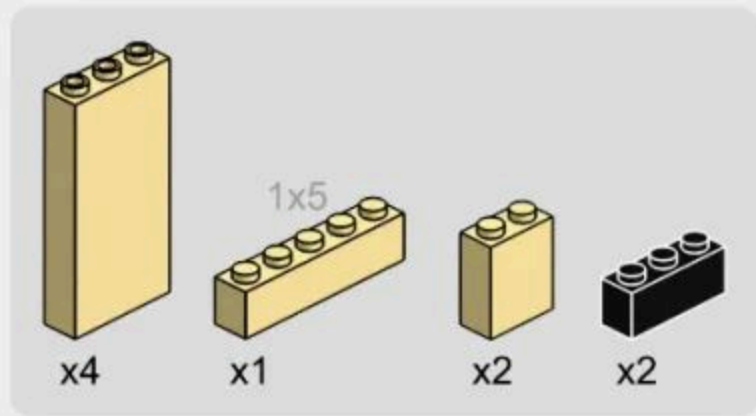

4-6

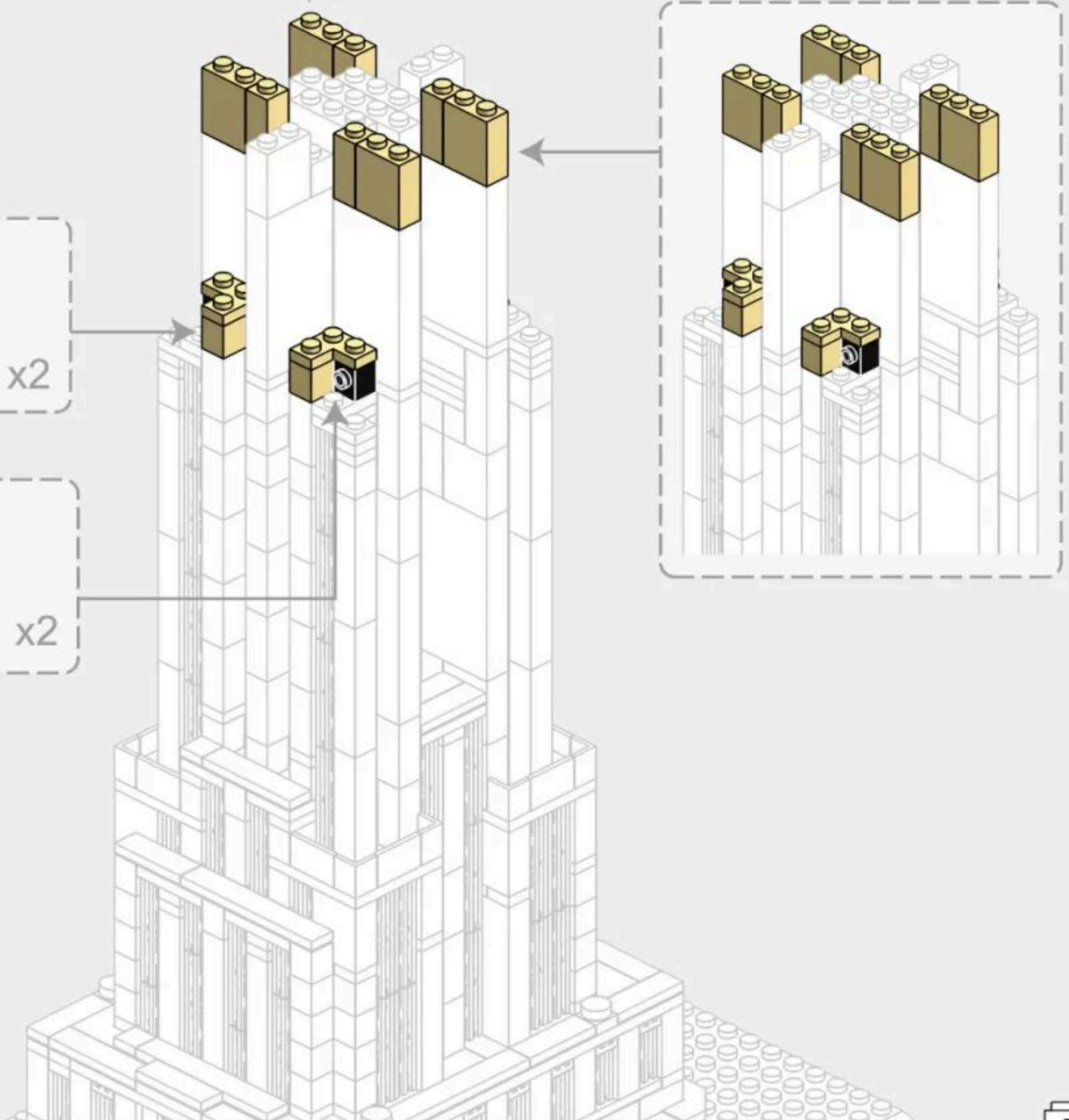
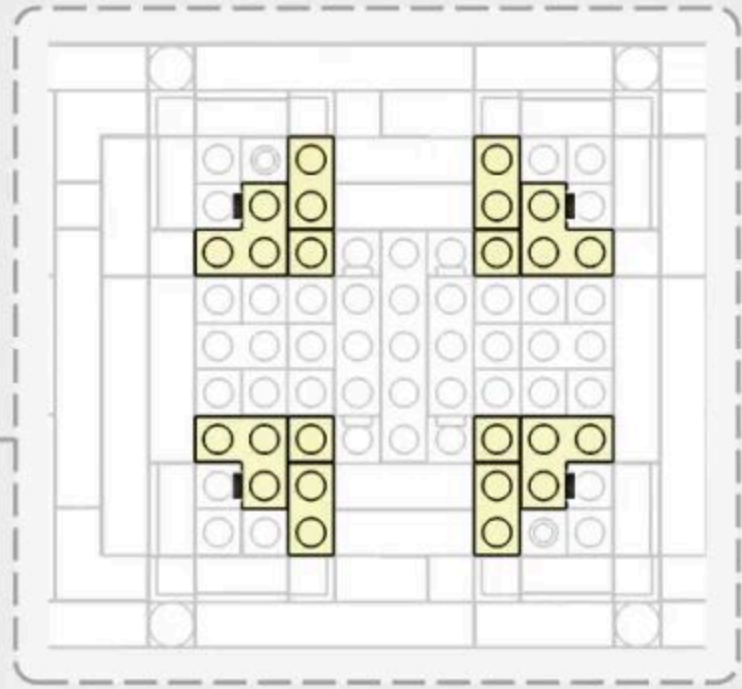
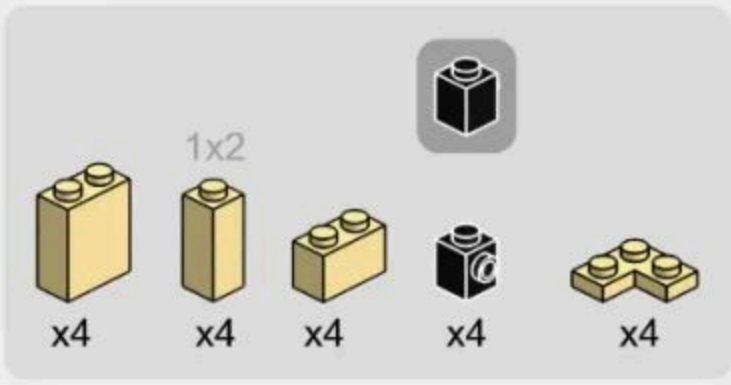

4-7

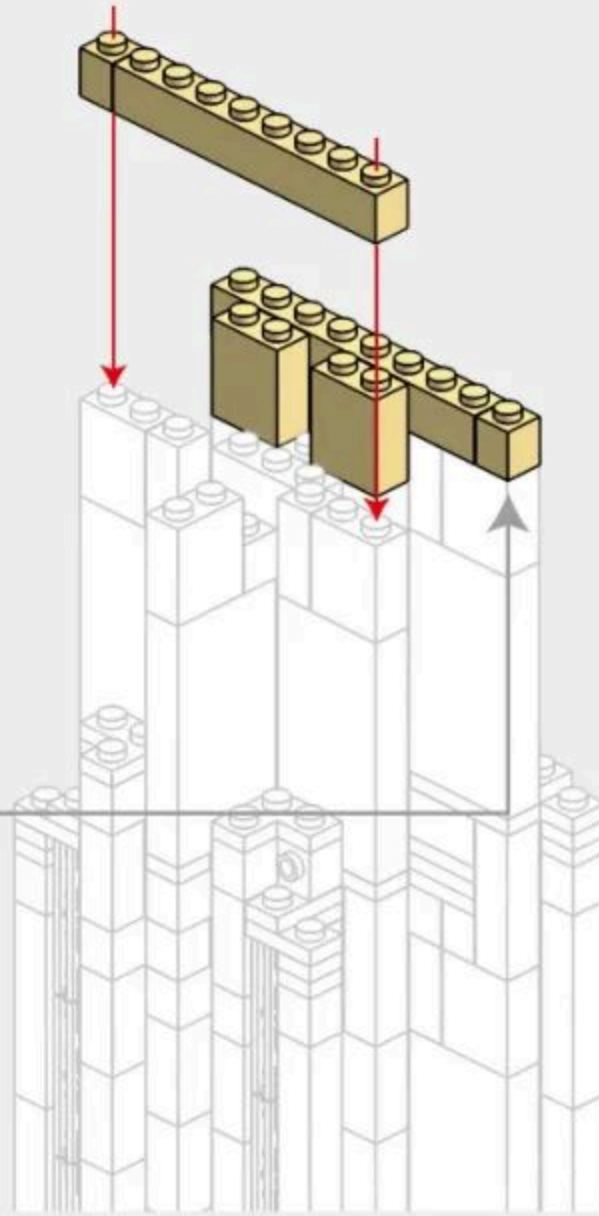
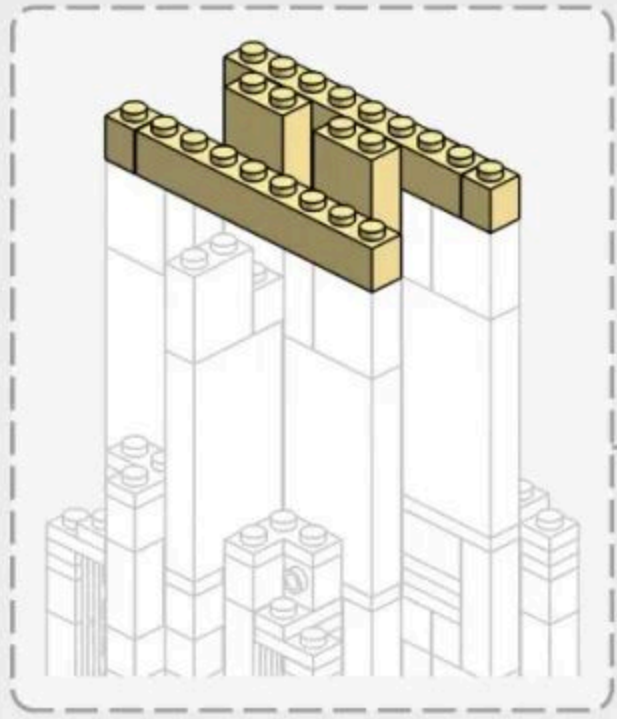
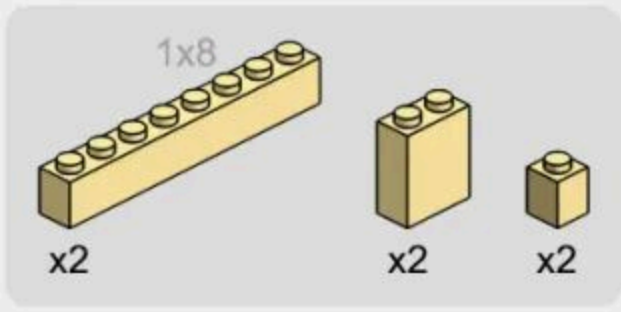

4-8

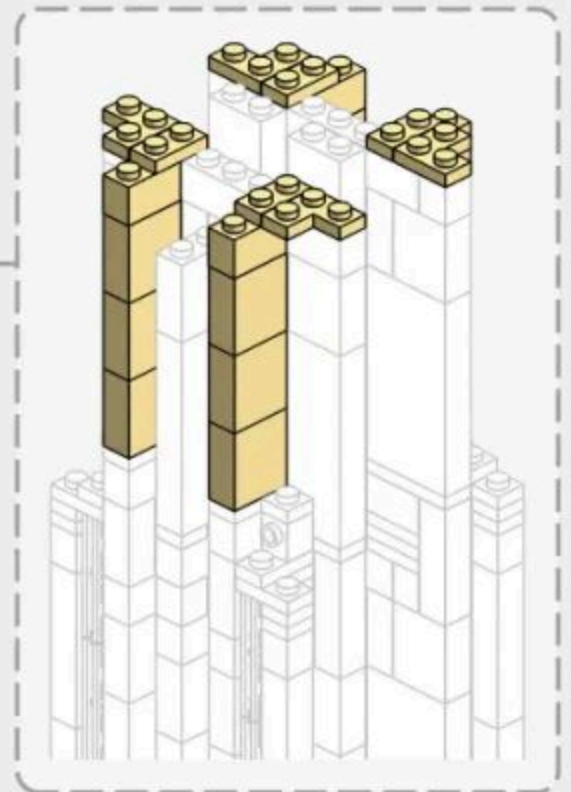
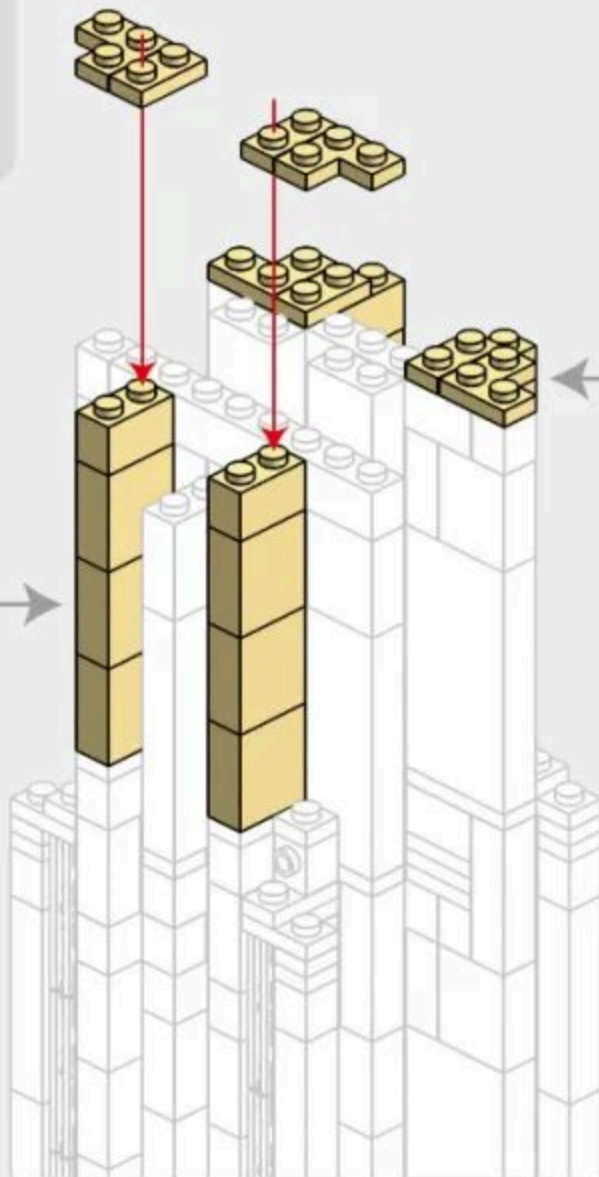
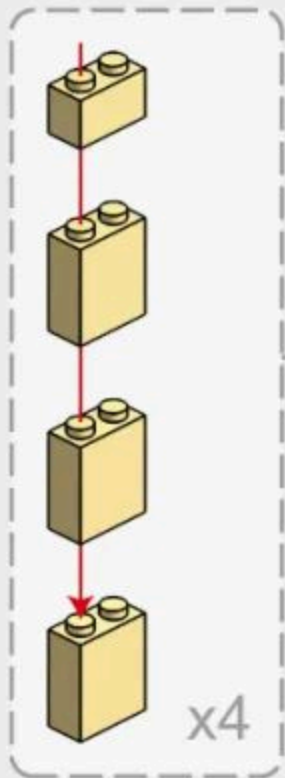
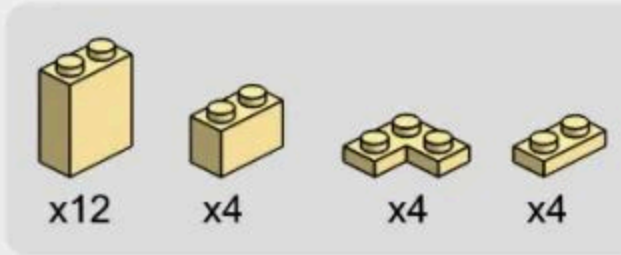

4-9

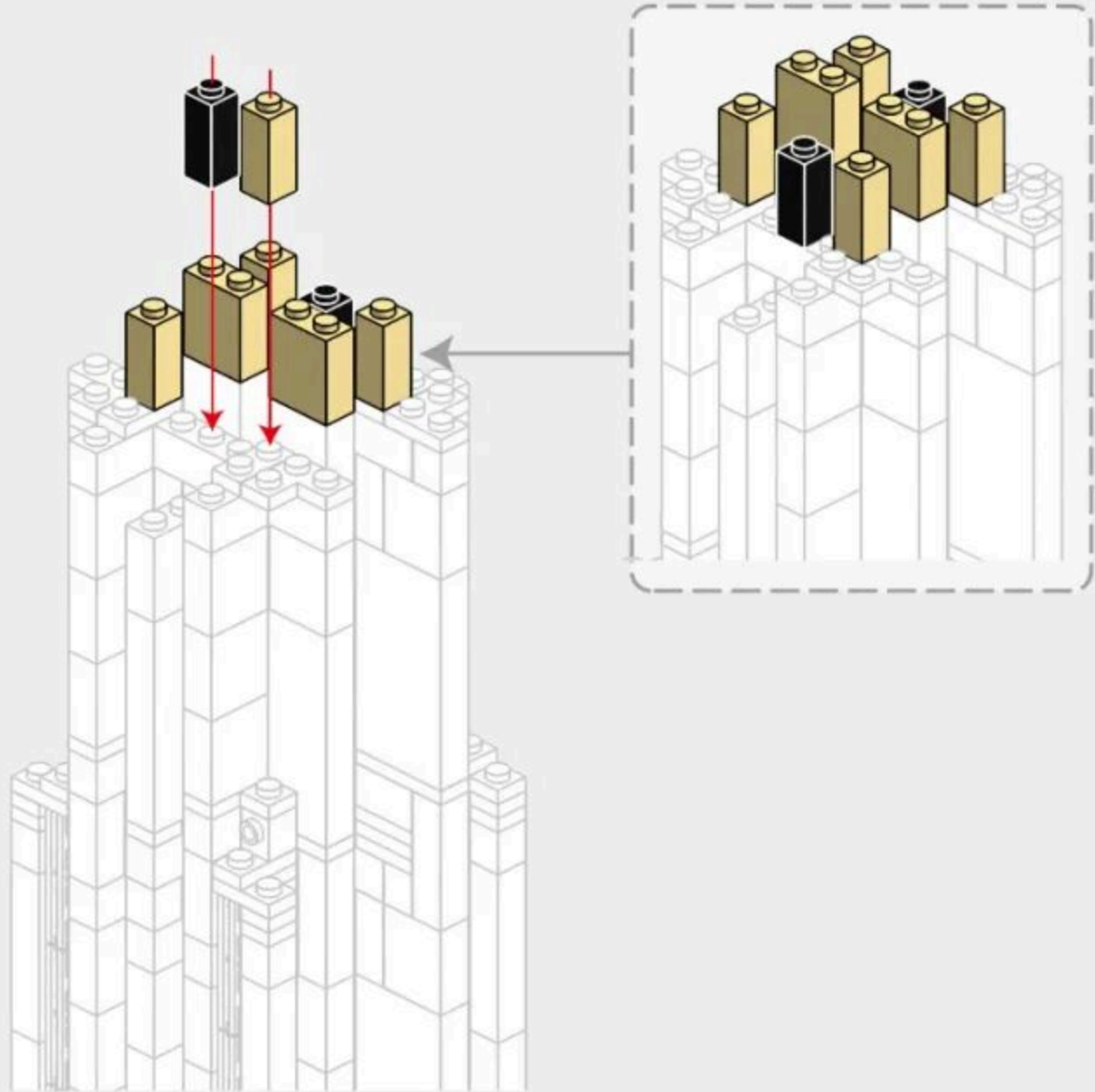
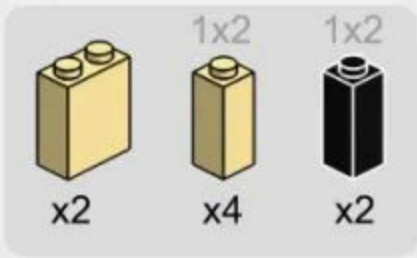

4-10

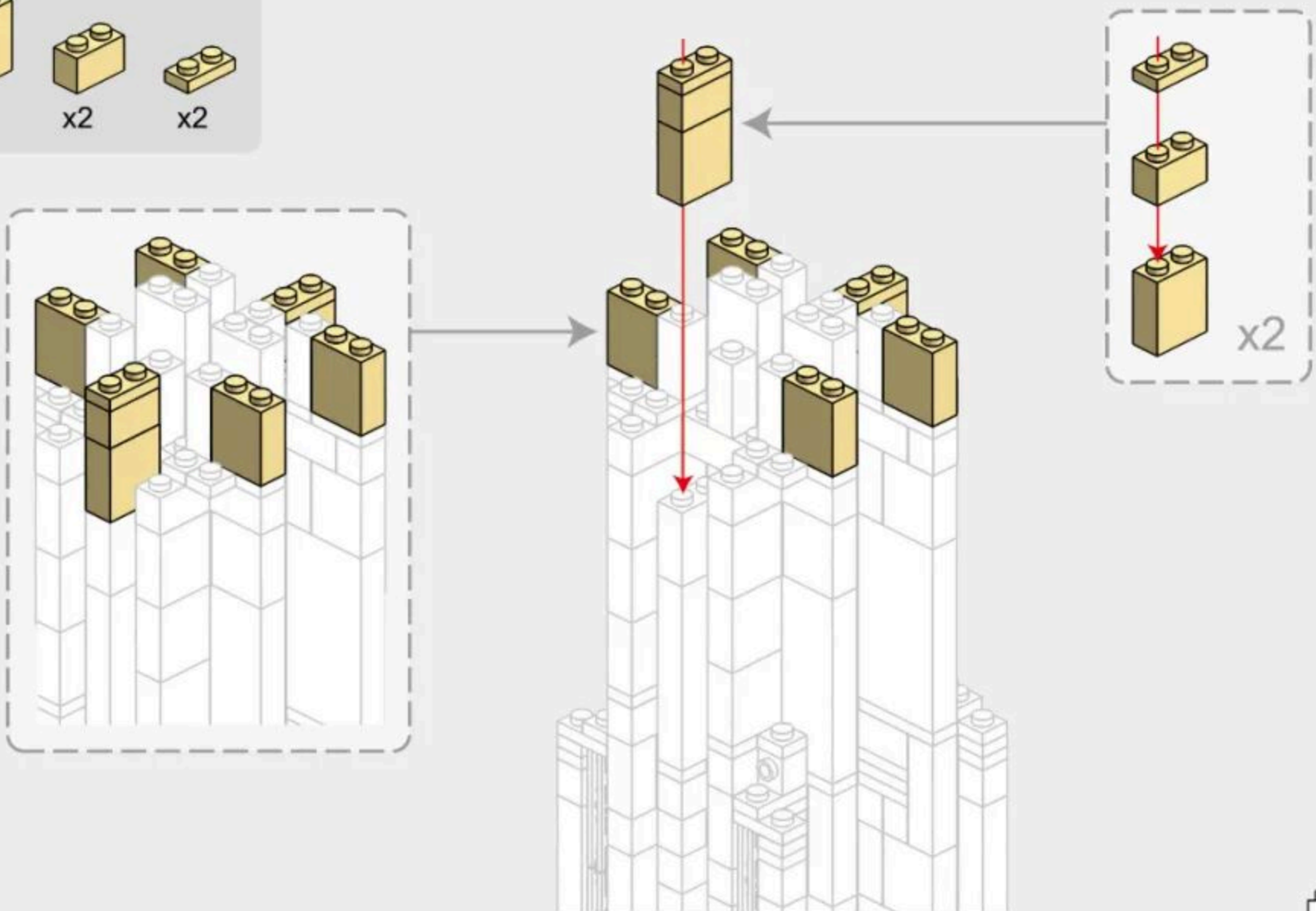
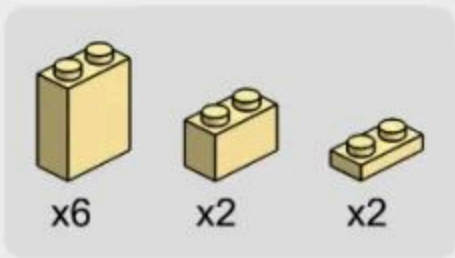

# 4-11

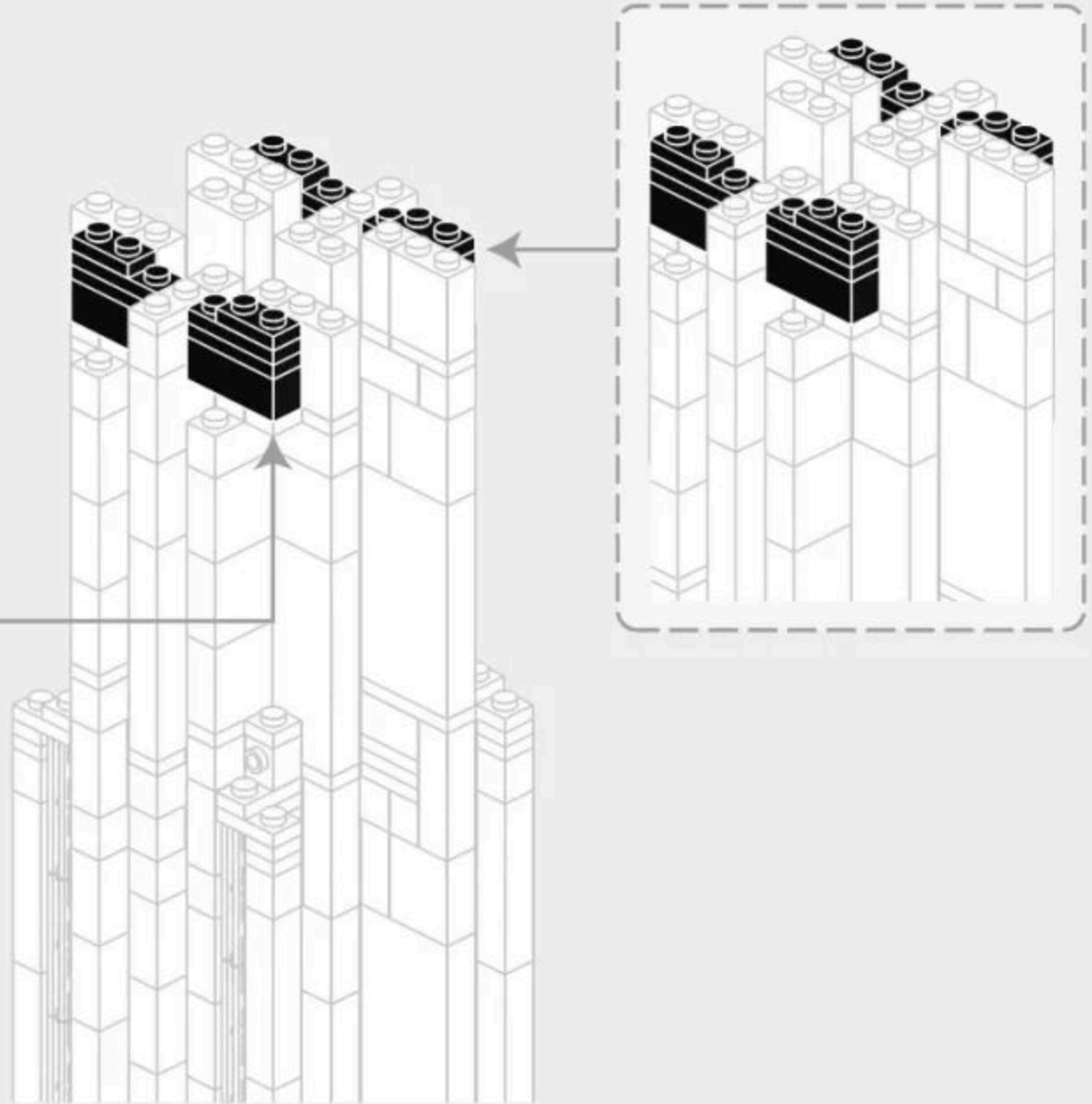
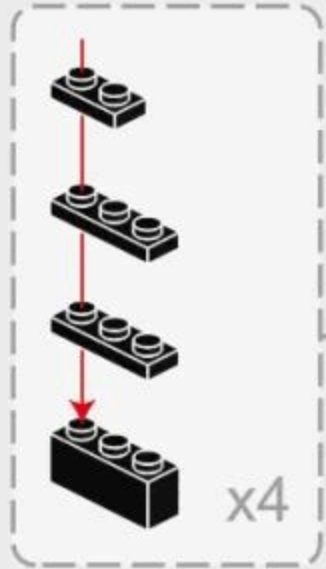
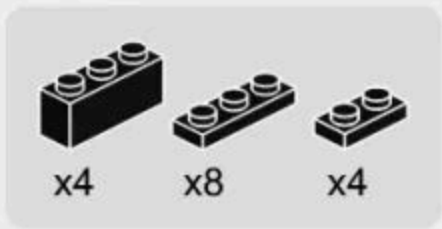

# 4-12

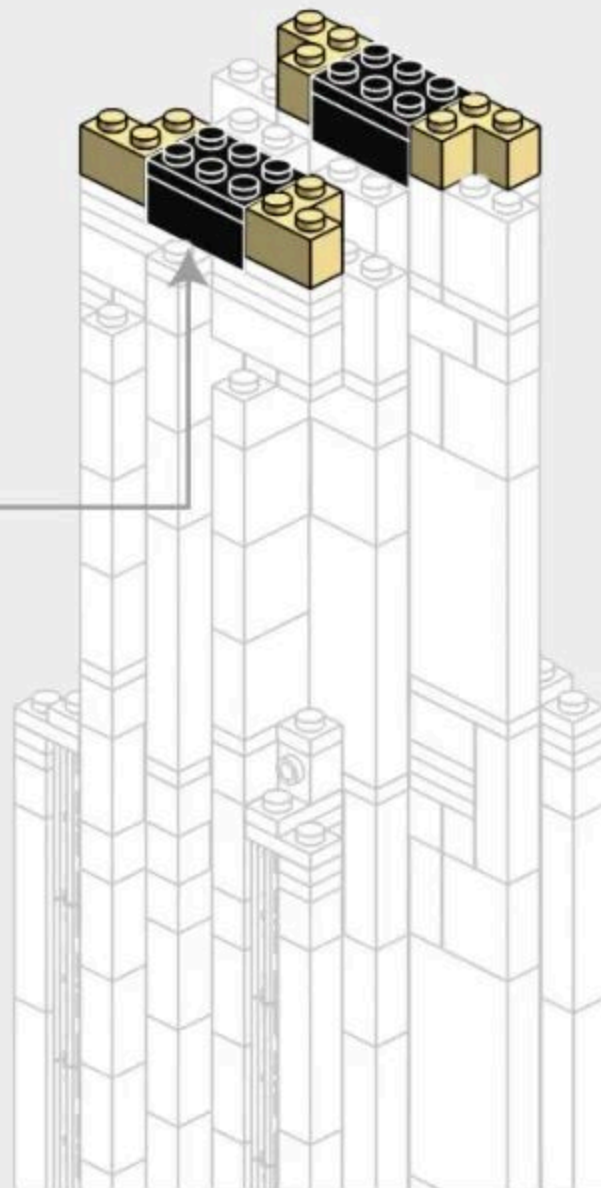
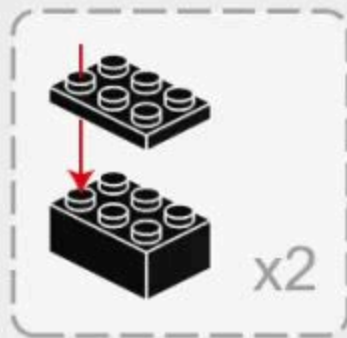

# 4-13

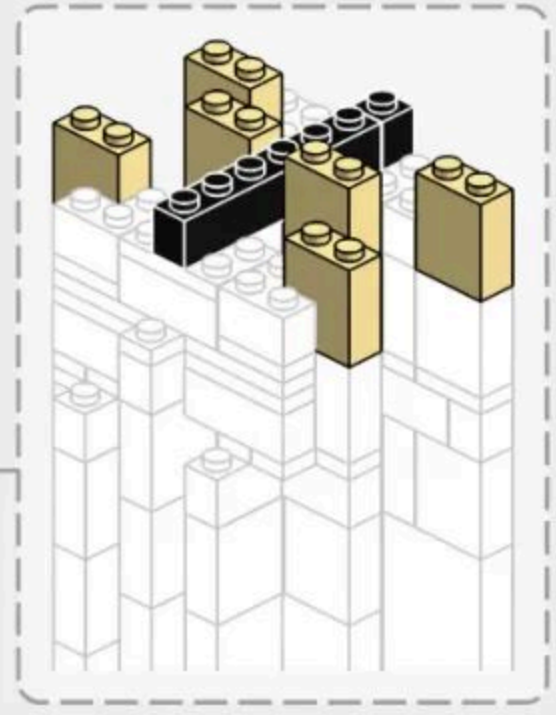
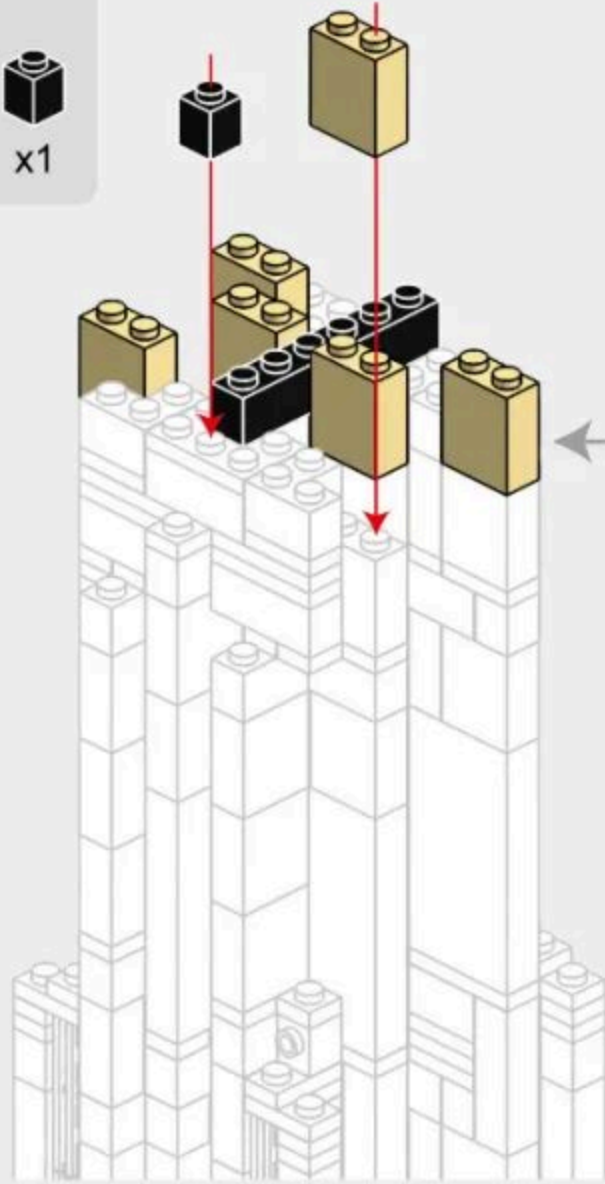
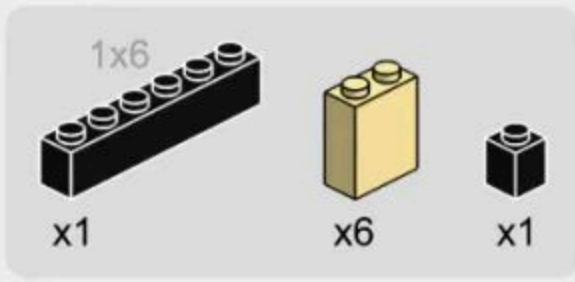

# 4-14

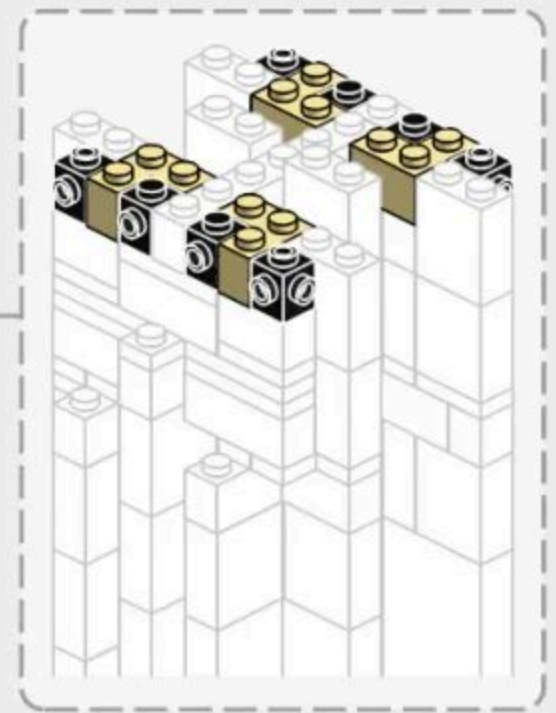
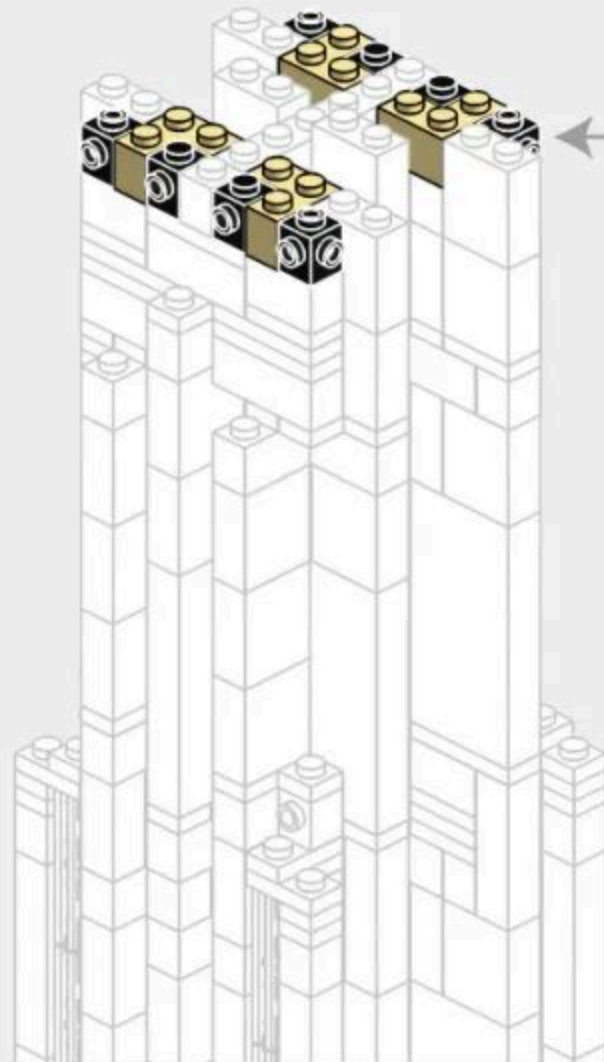

# 4-15

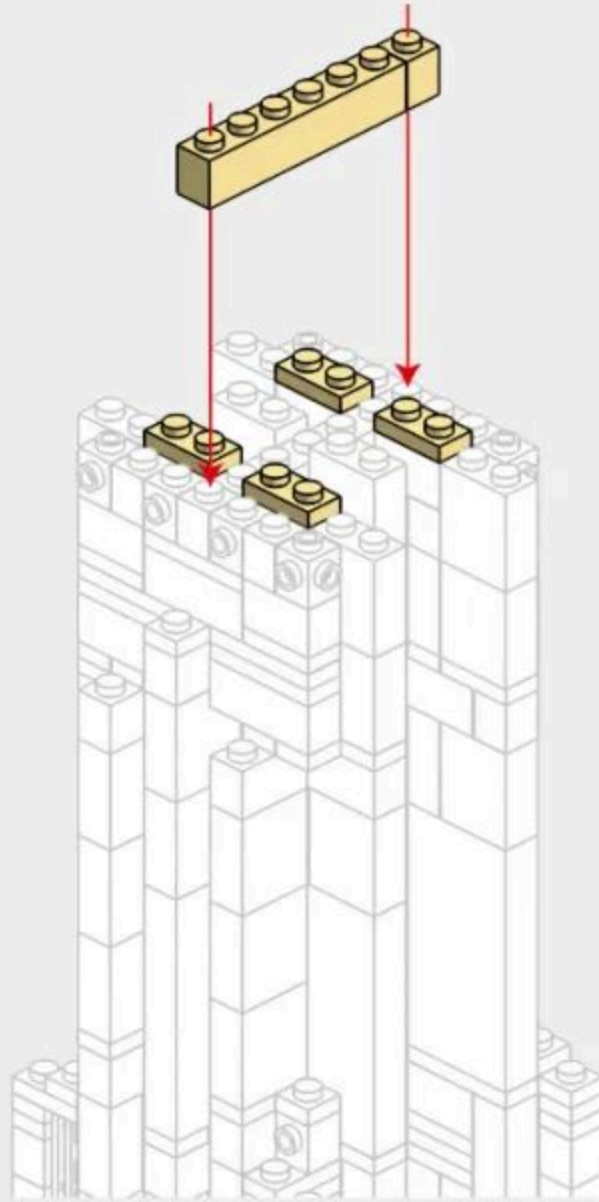
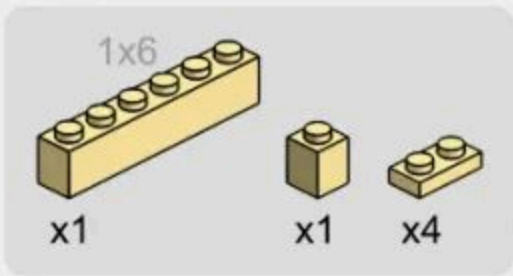

# 4-16

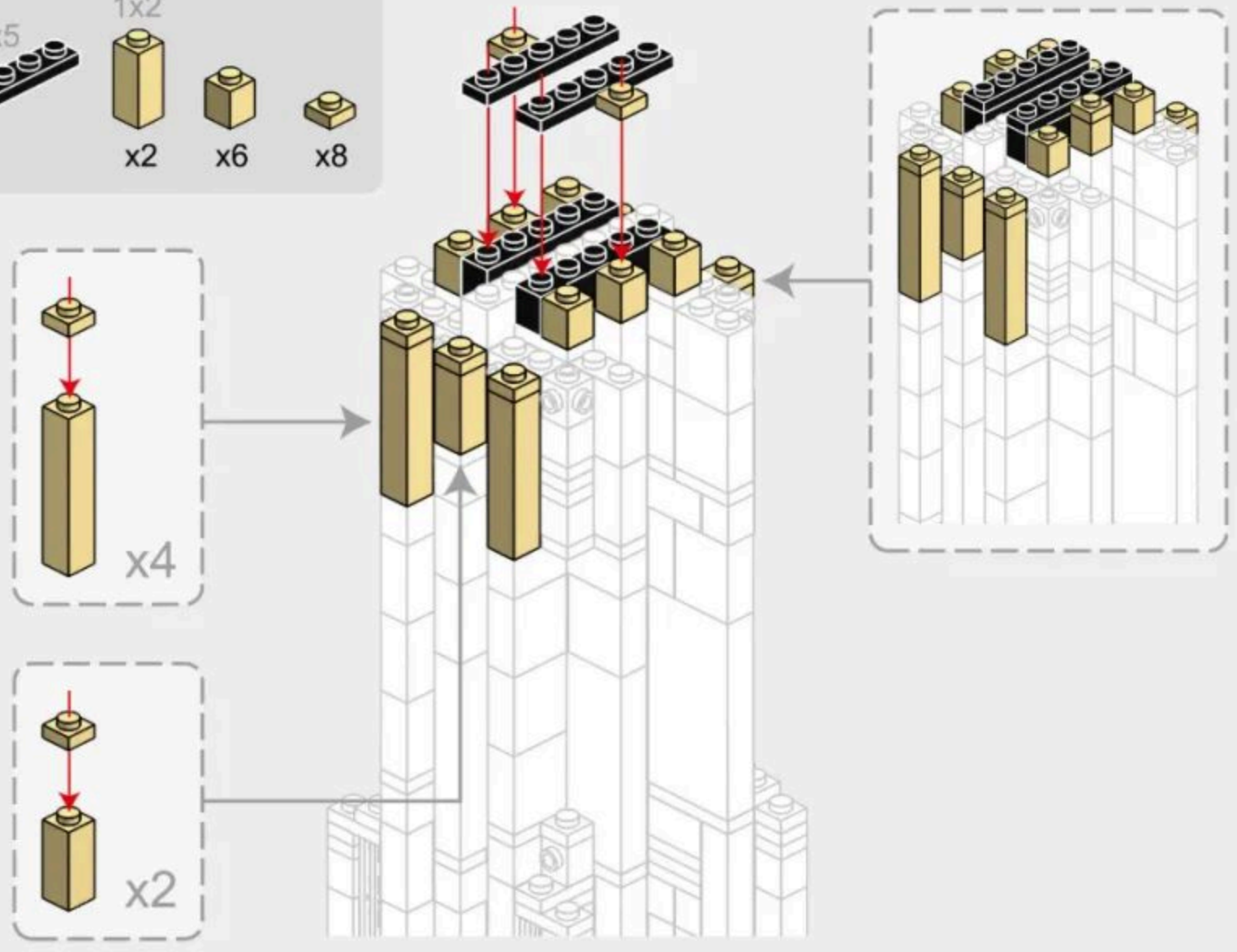
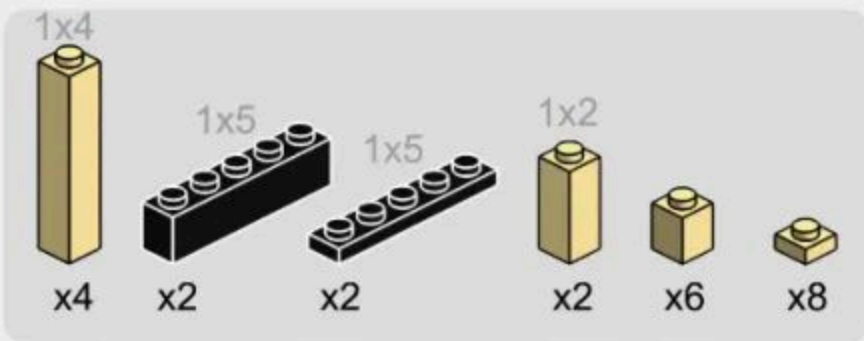



273PCS

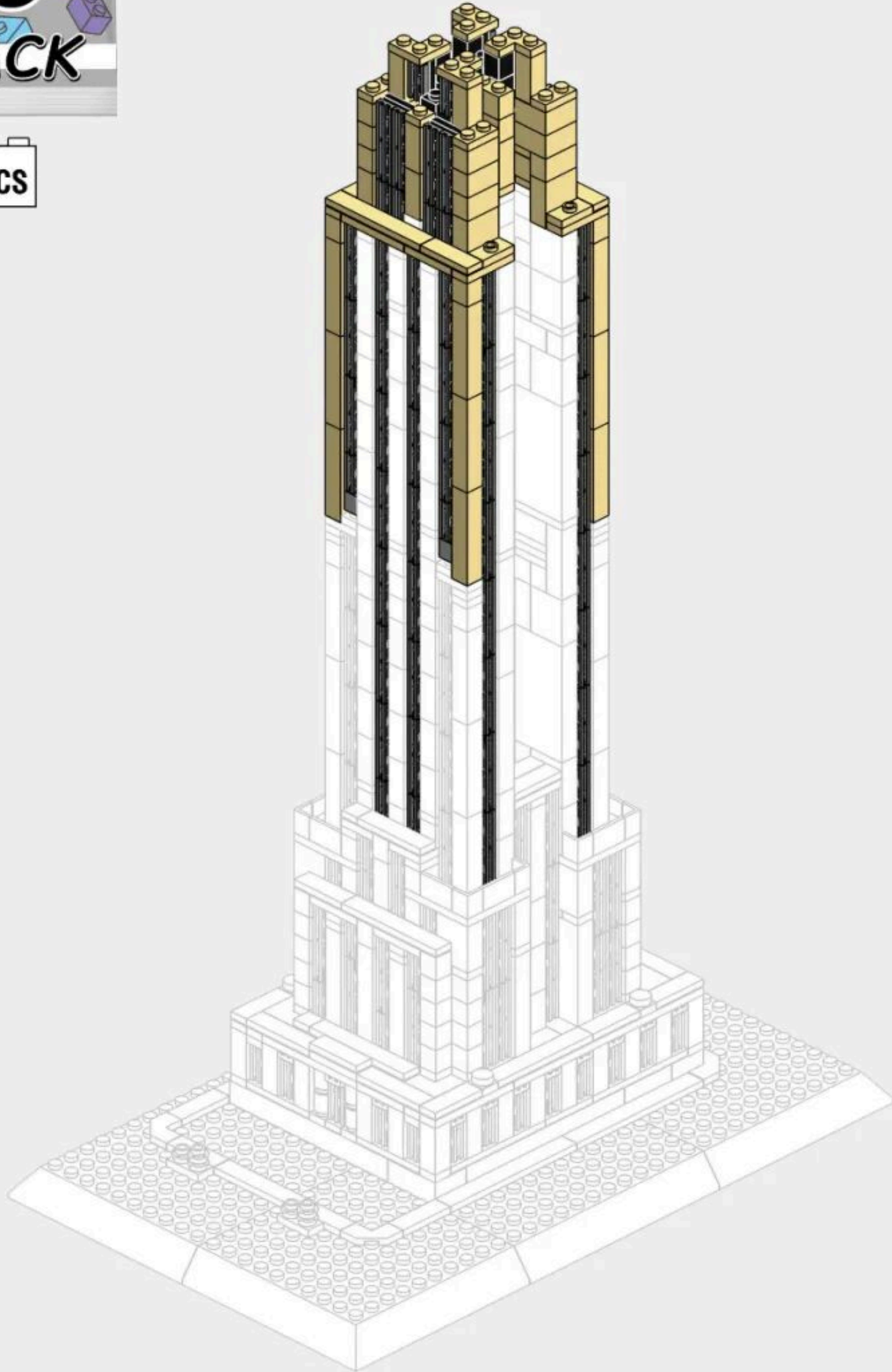

5-1

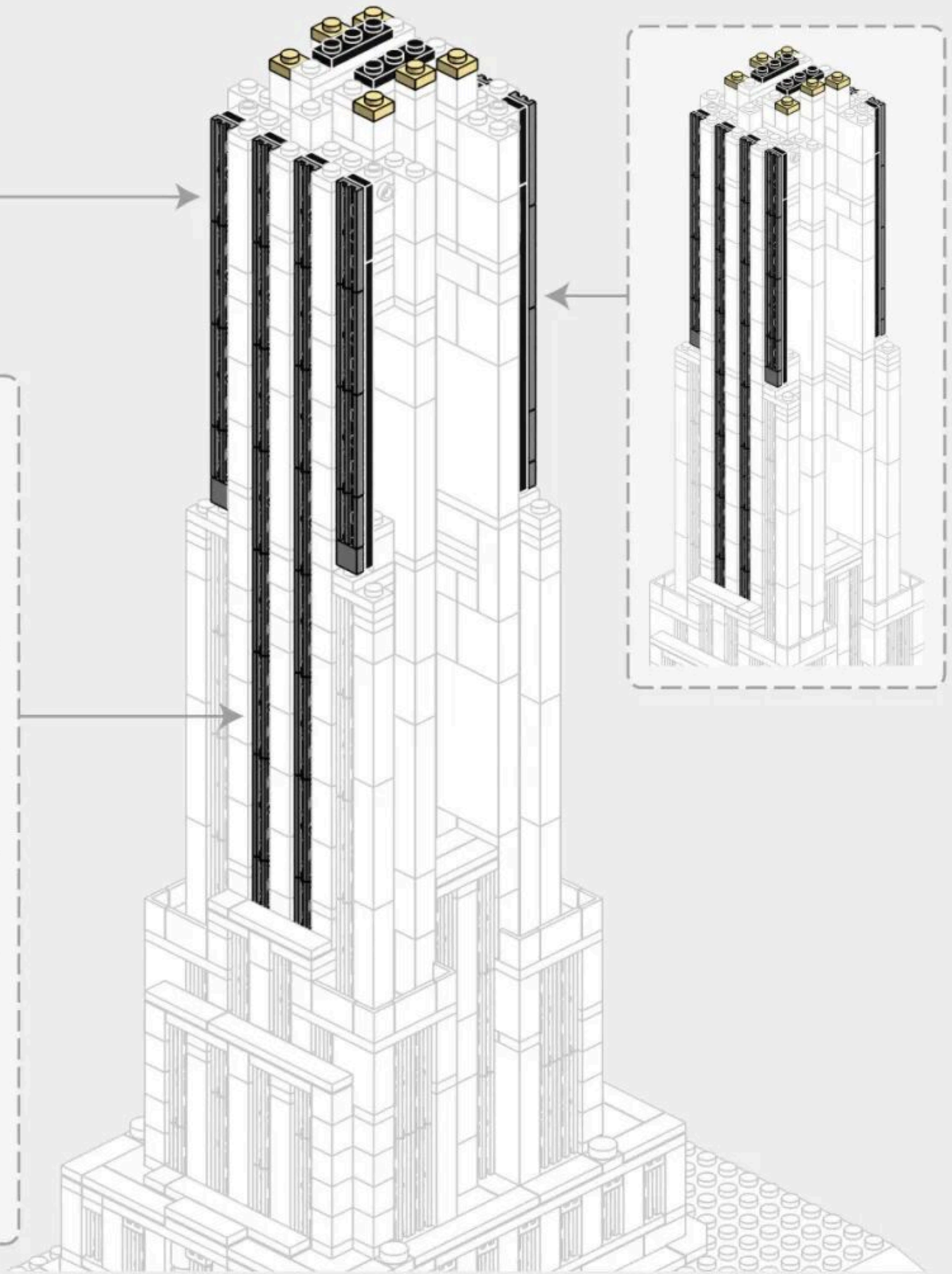
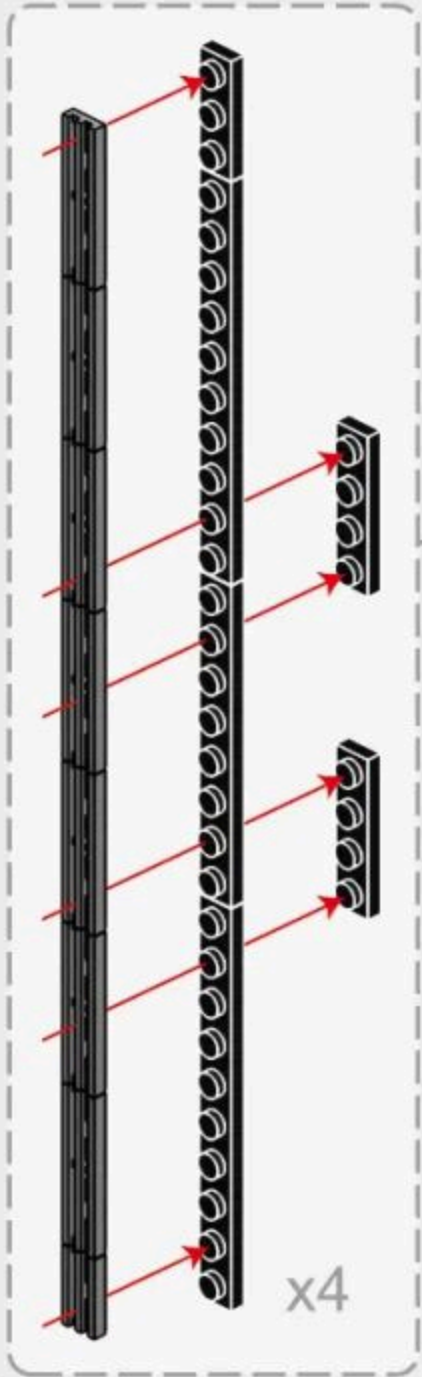
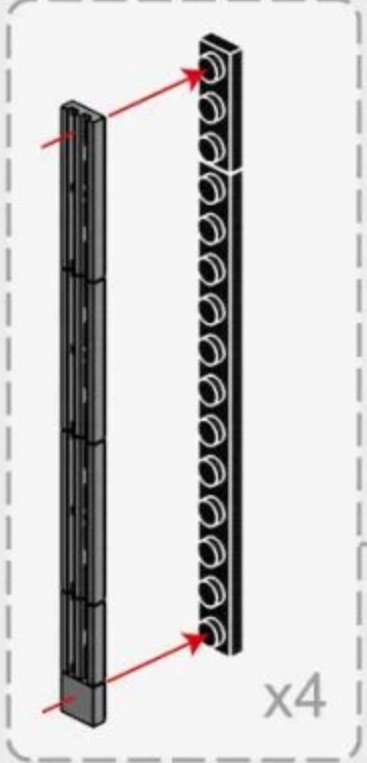
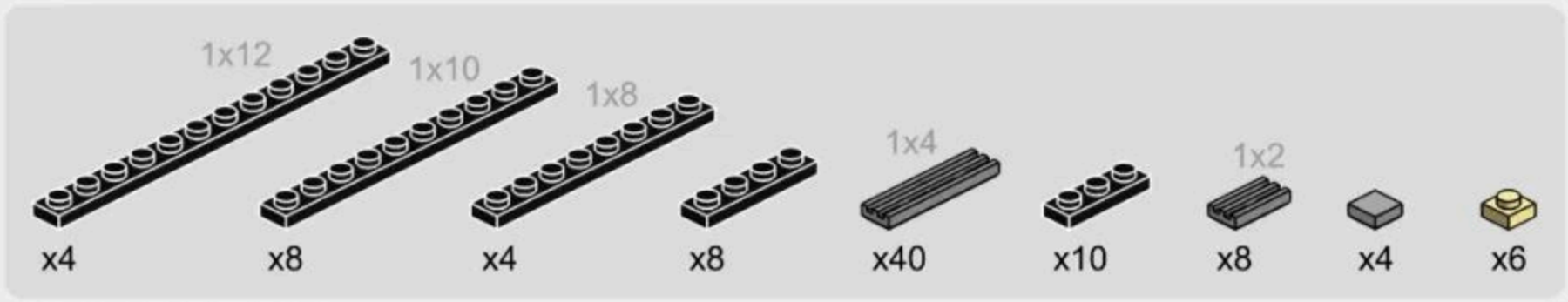

5-2

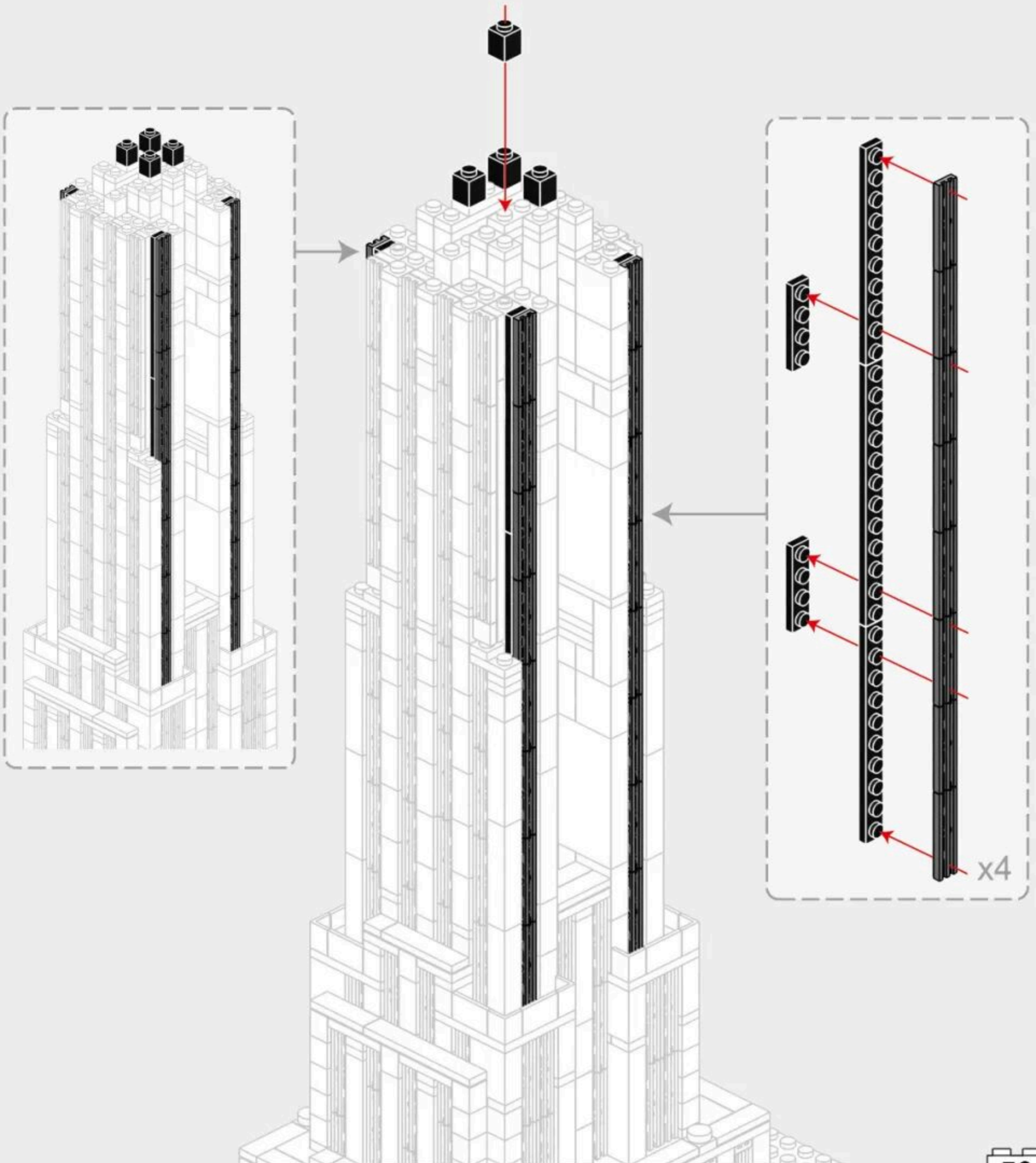
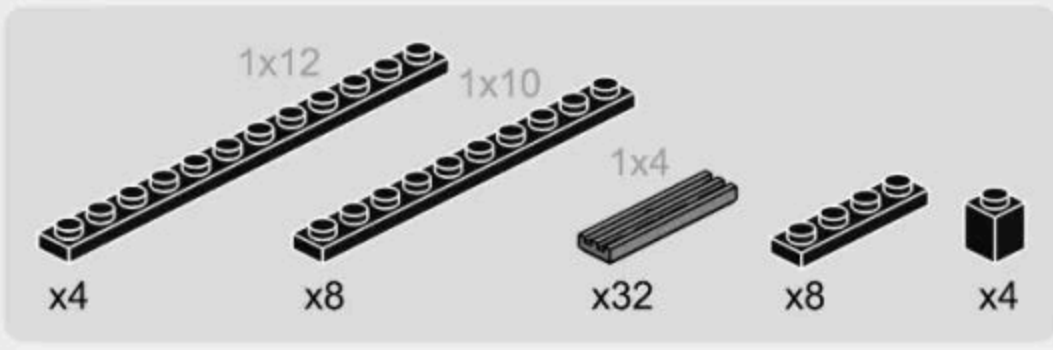

5-3

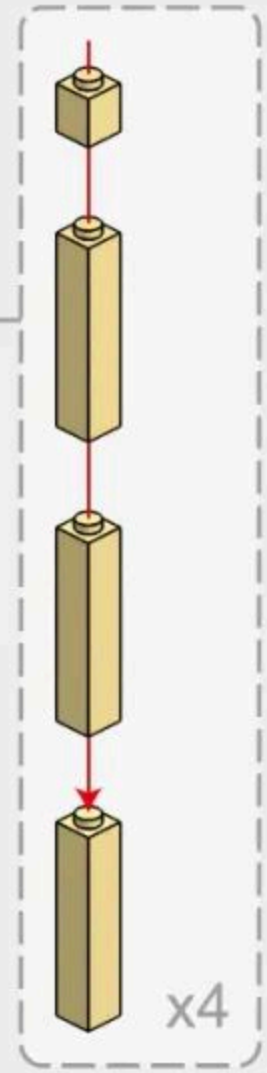
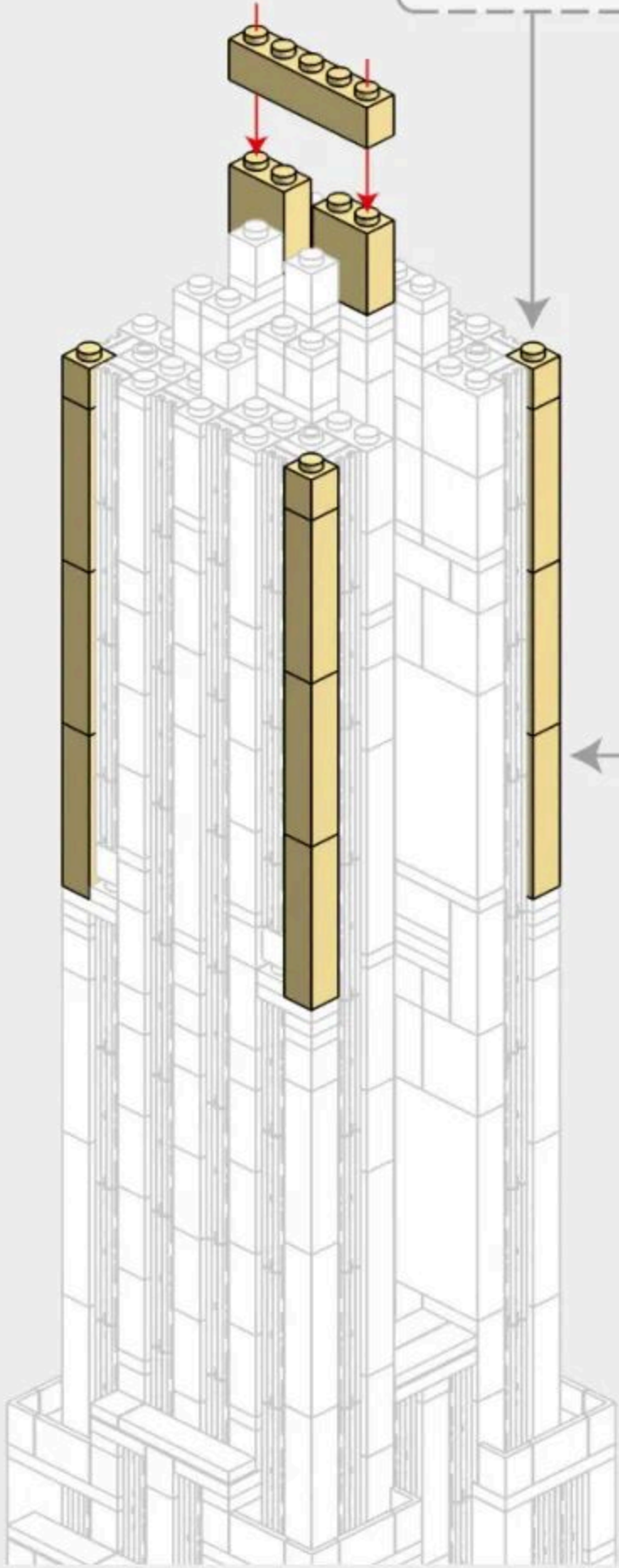
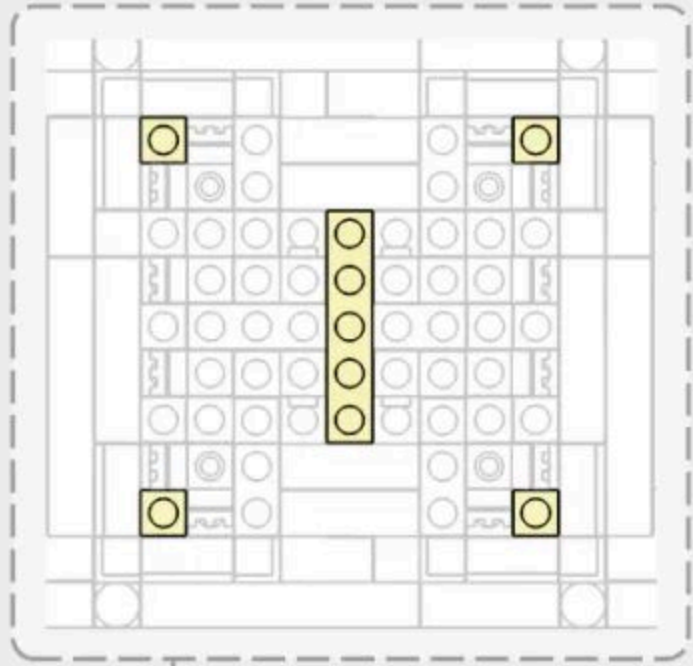
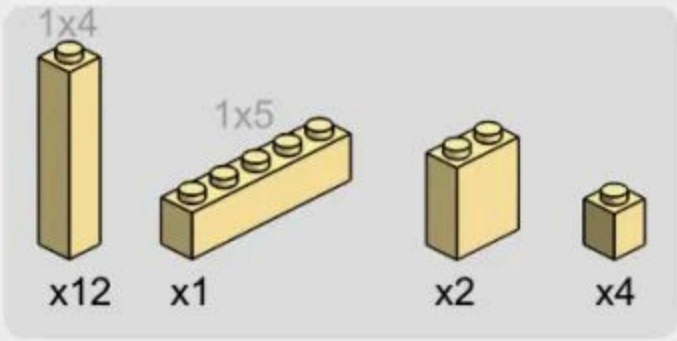

# 5-4

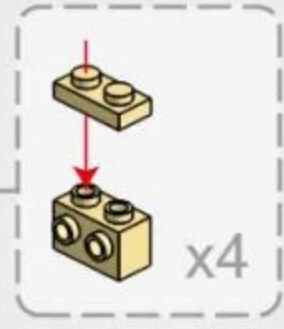
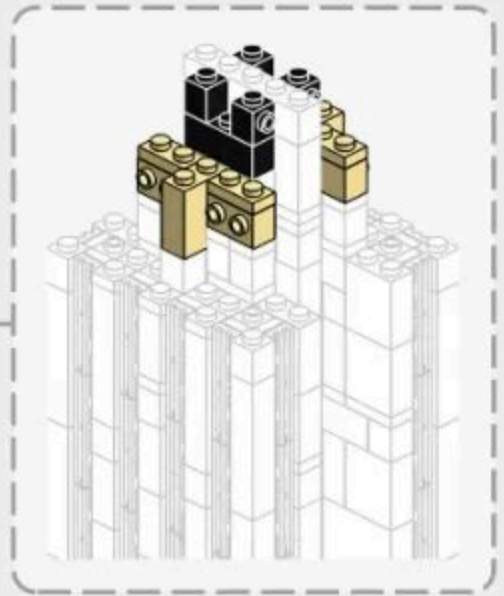
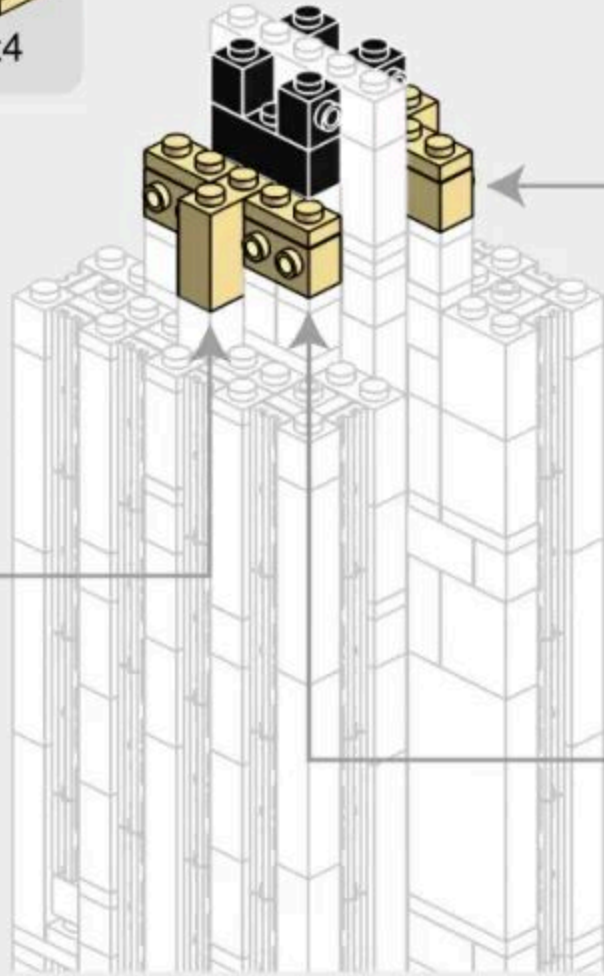
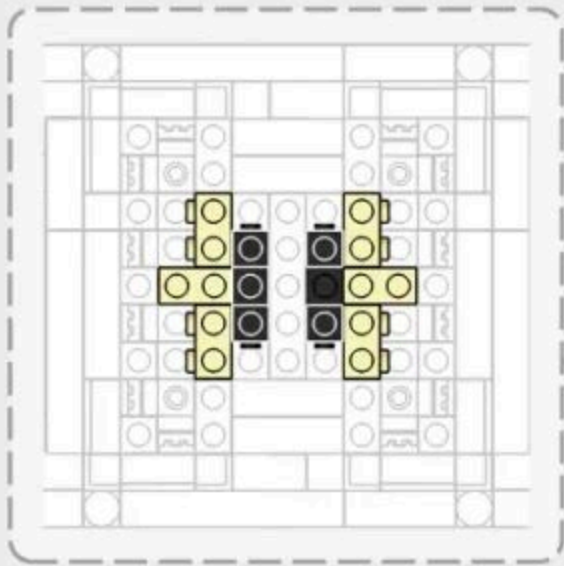
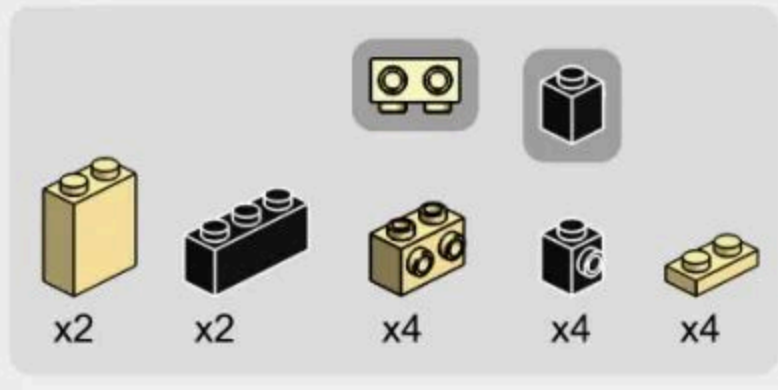

# 5-5

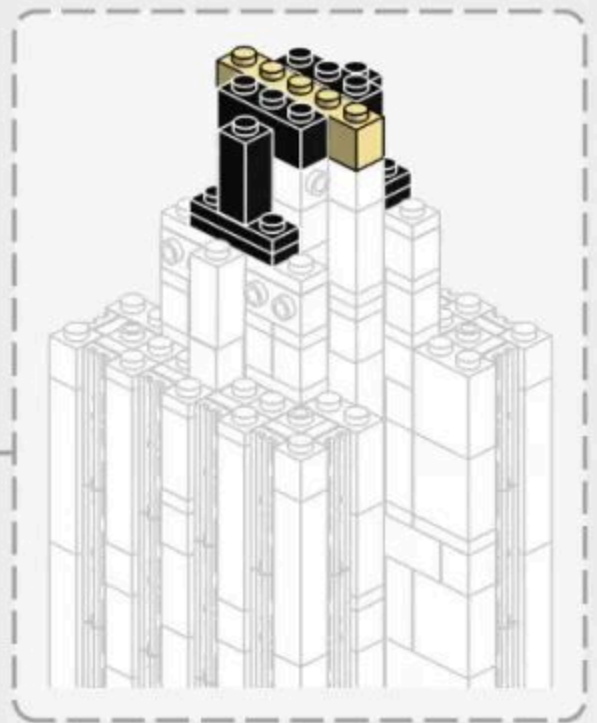
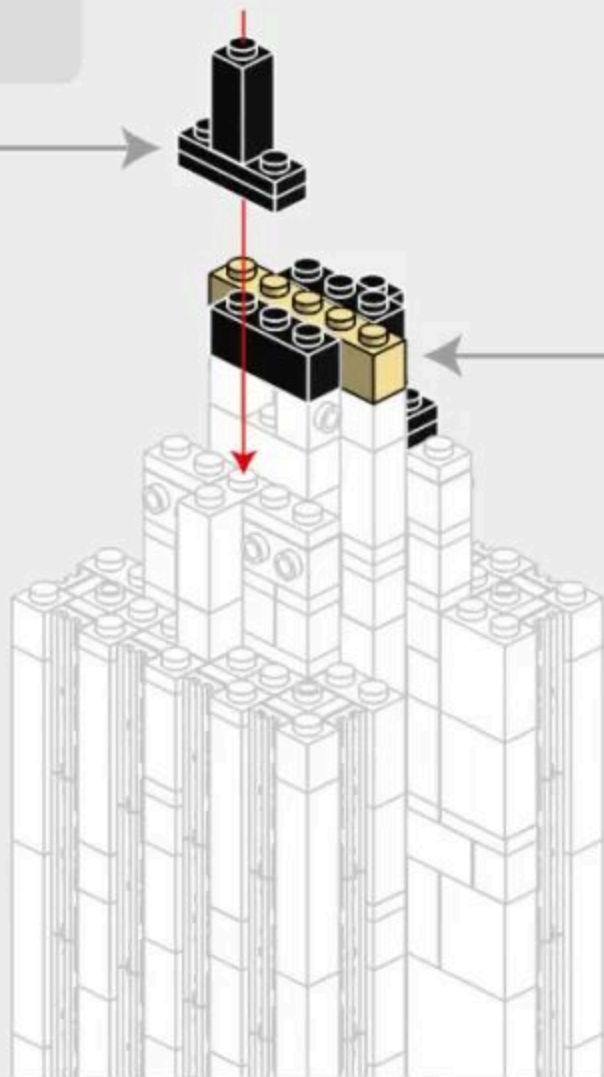
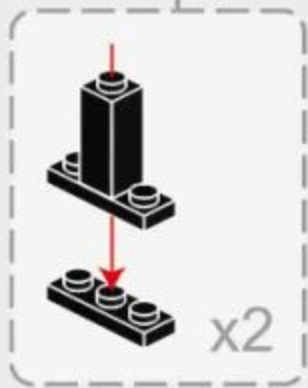

5-6

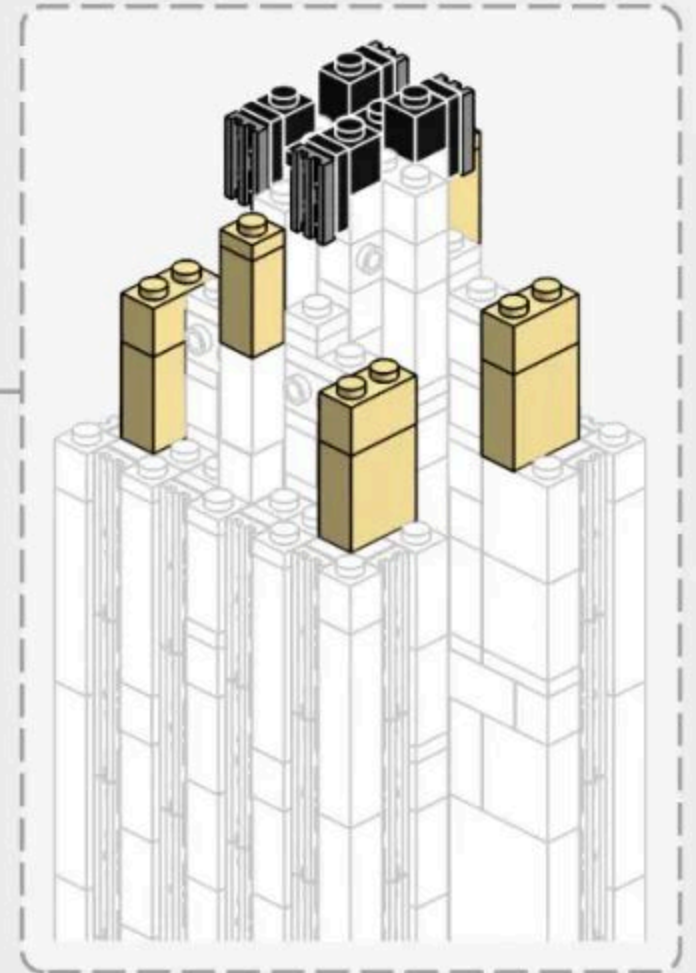
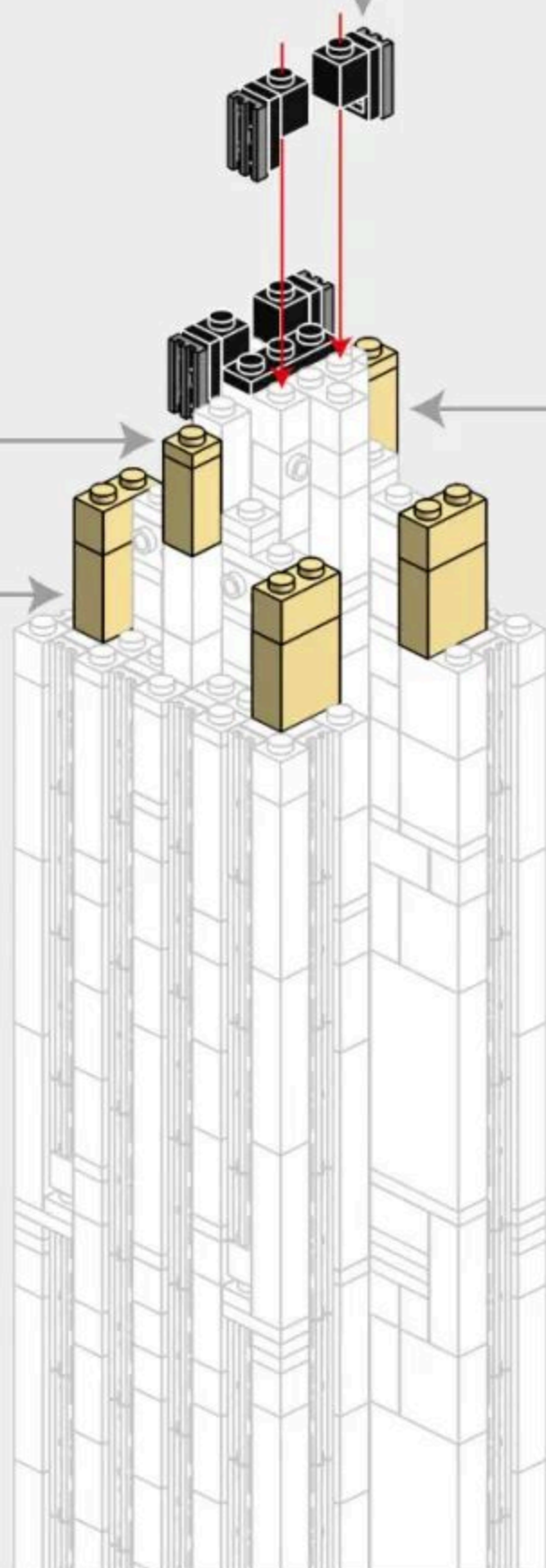
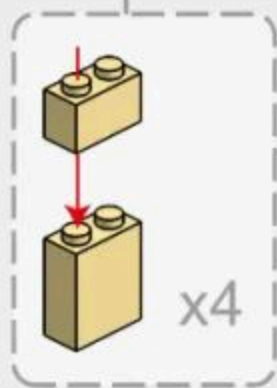
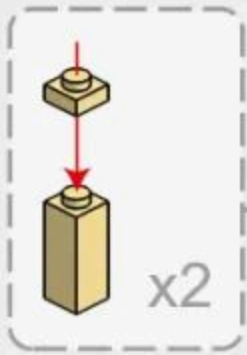
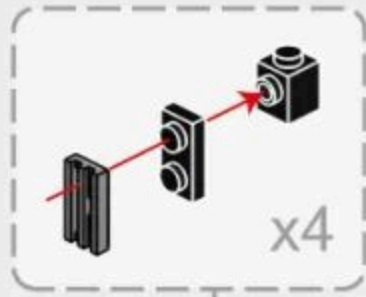
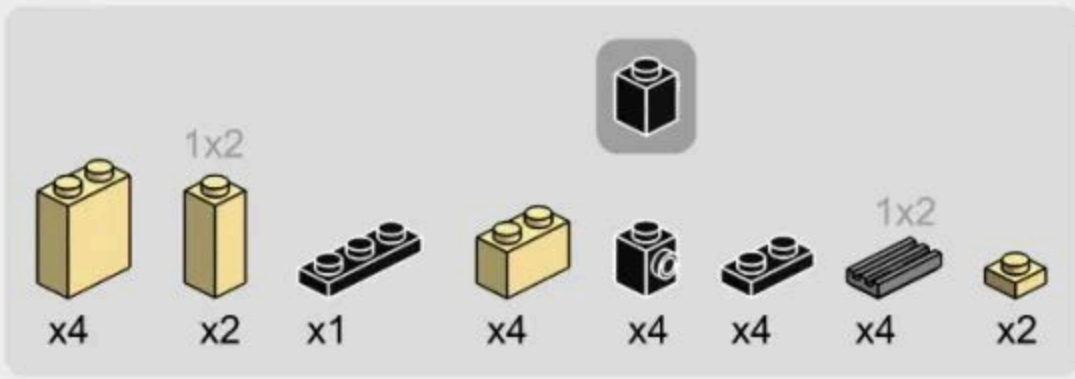

5-7

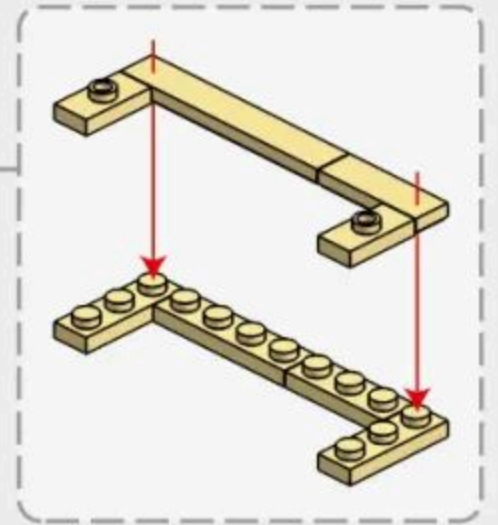
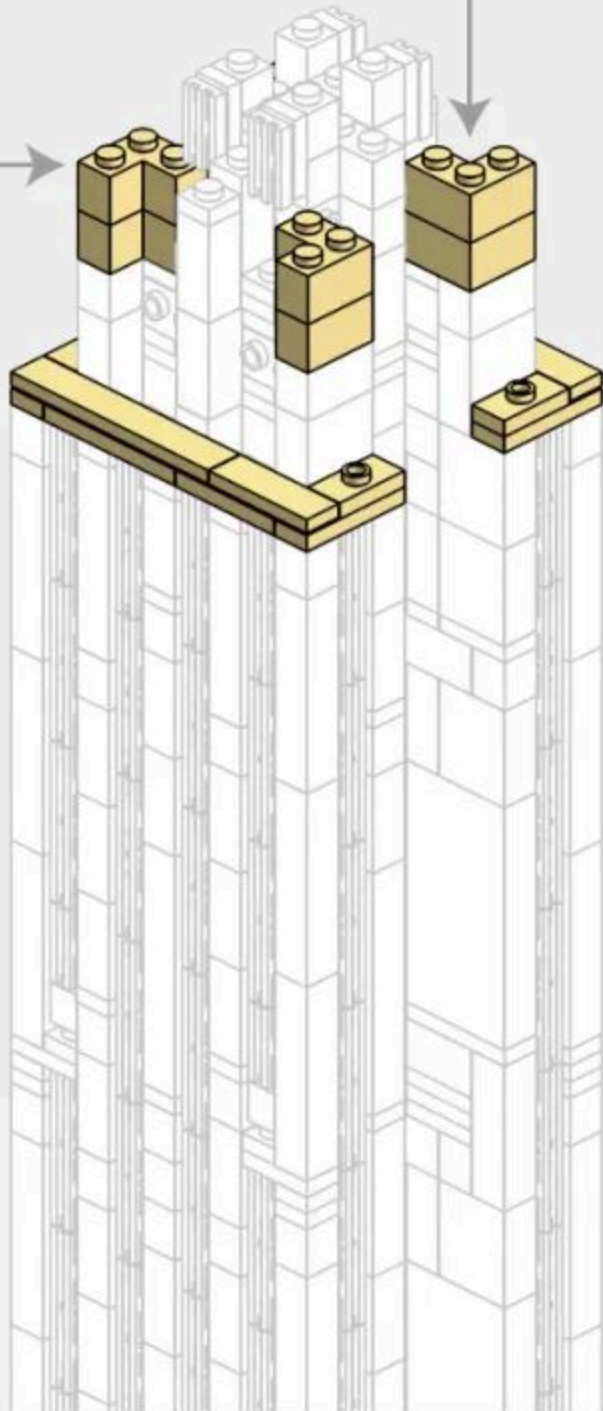
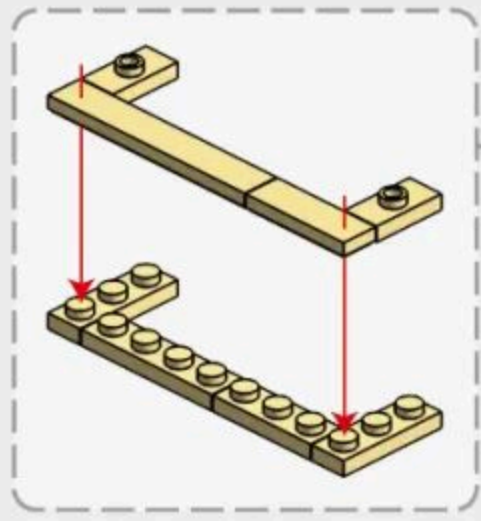
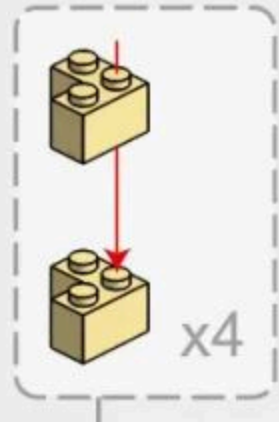
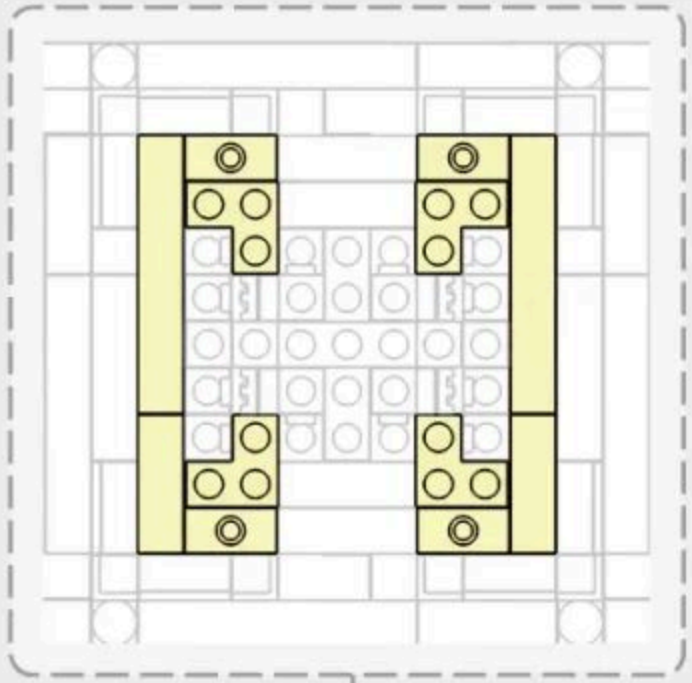

5-8

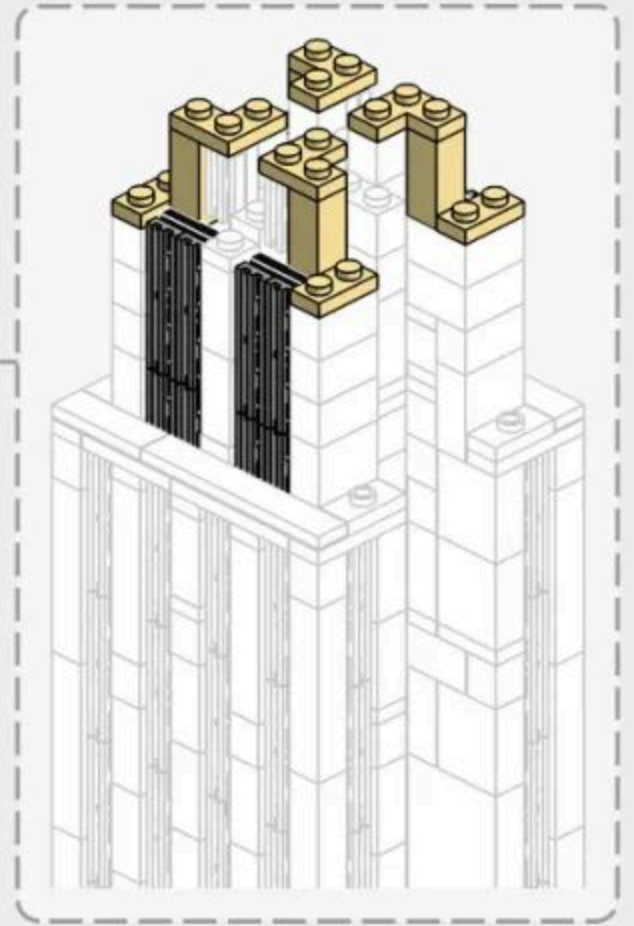
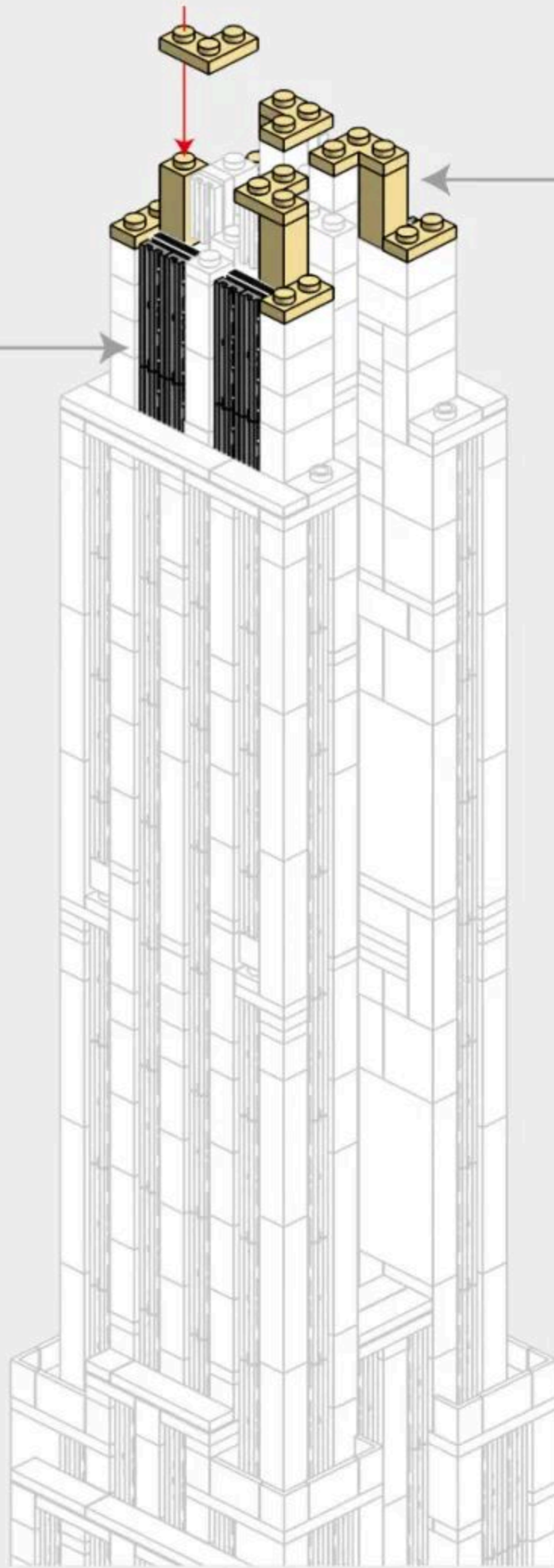
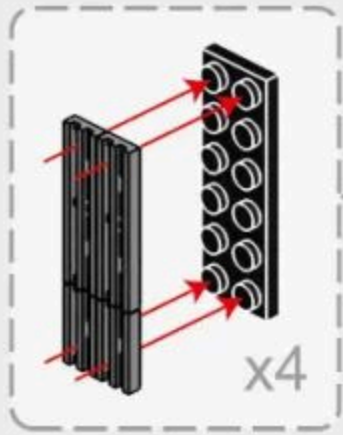
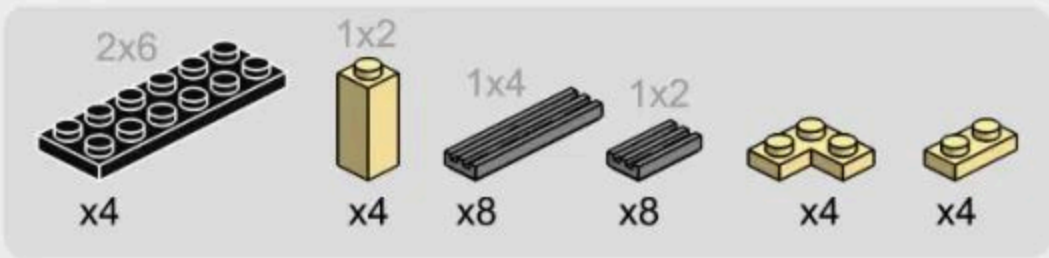



252PCS



6-1

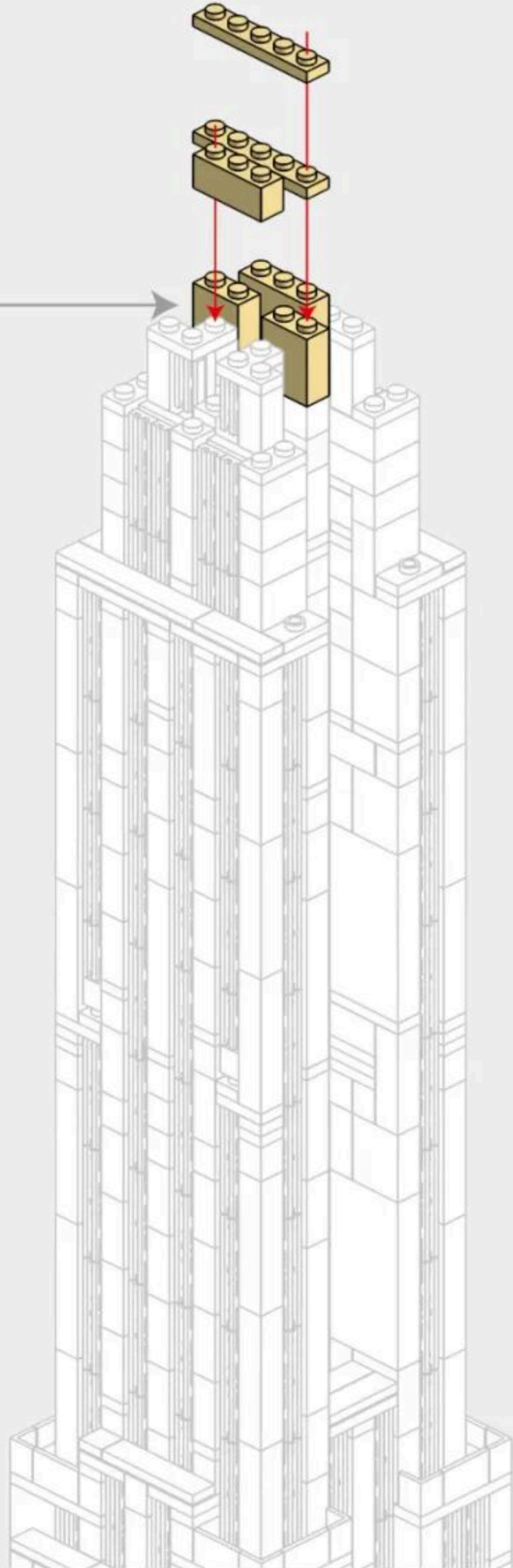
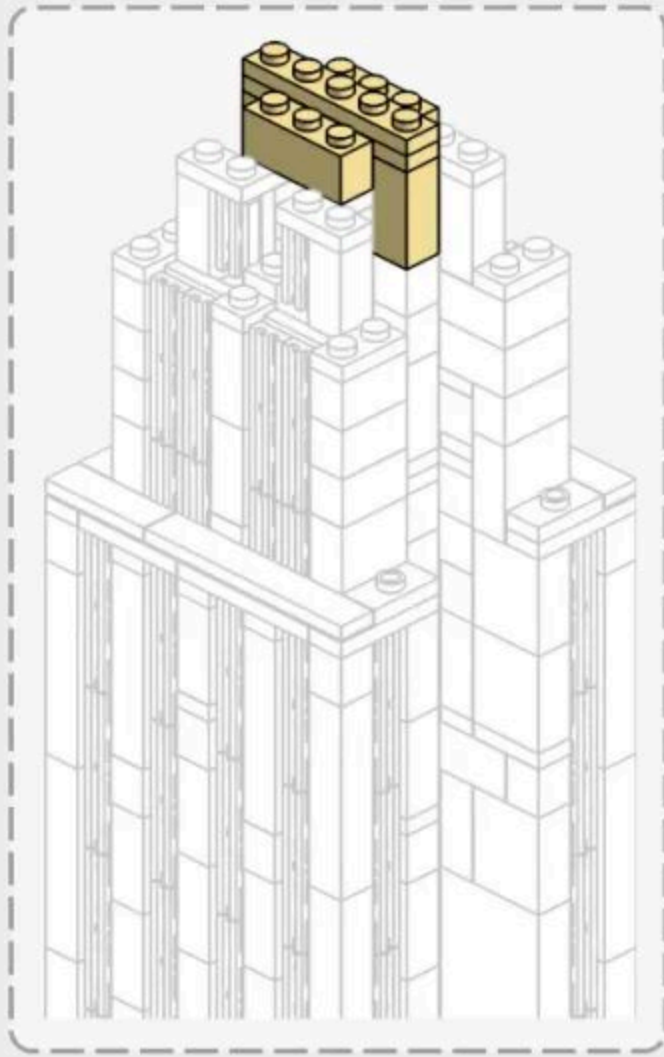
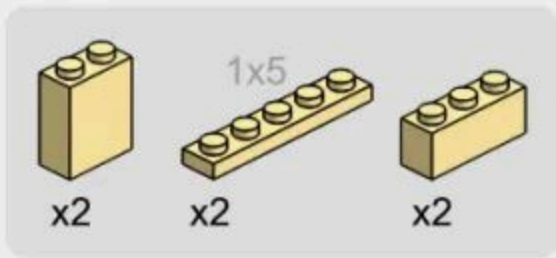

6-2

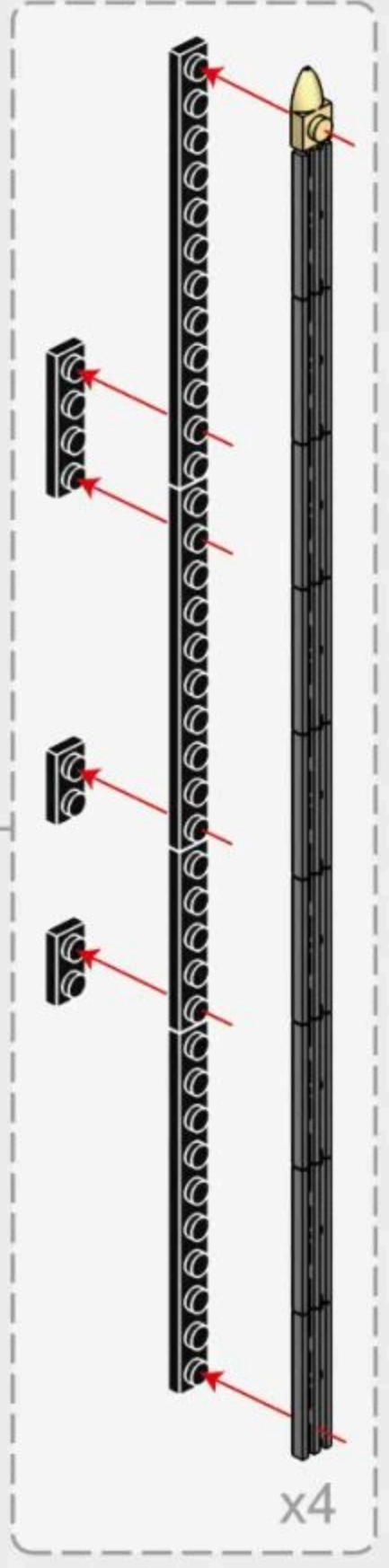
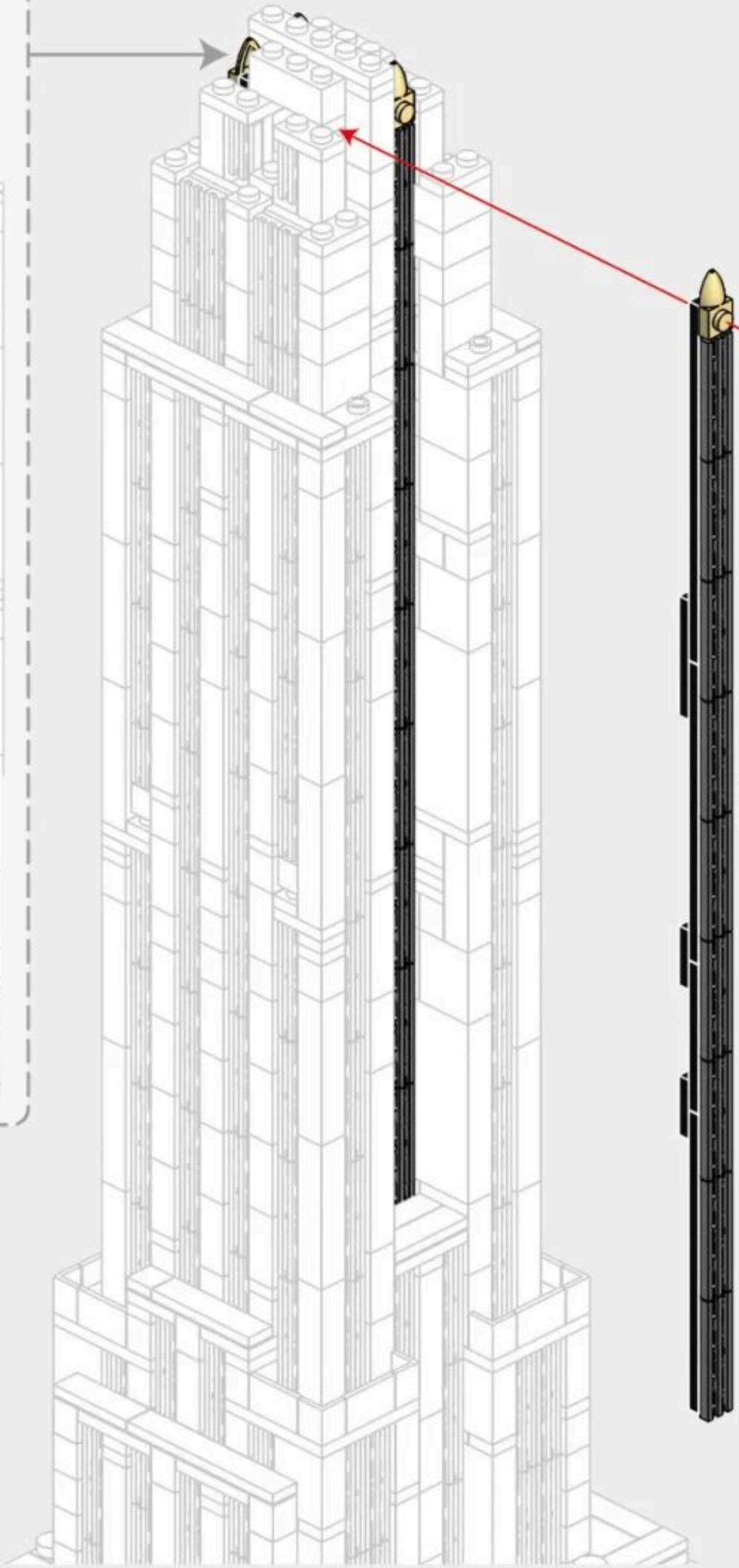
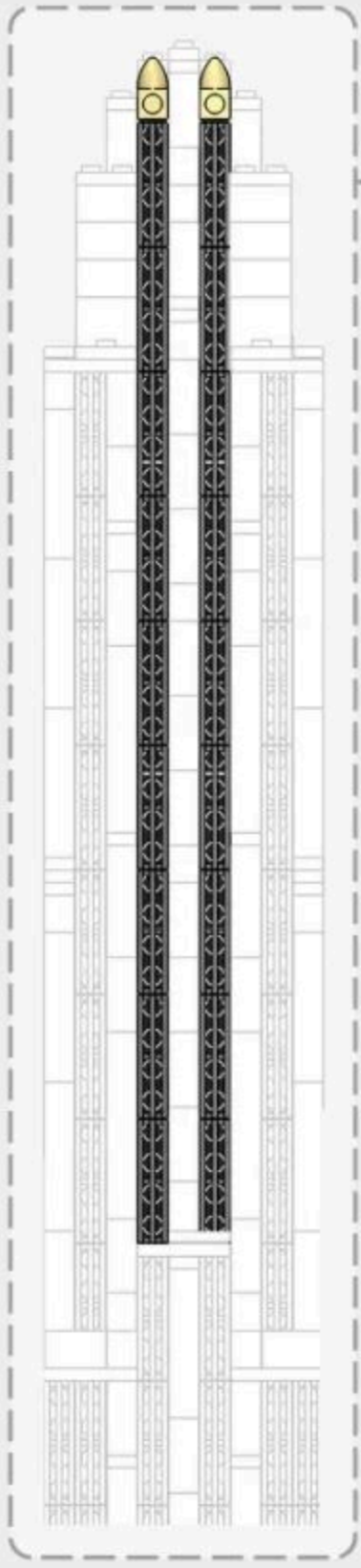
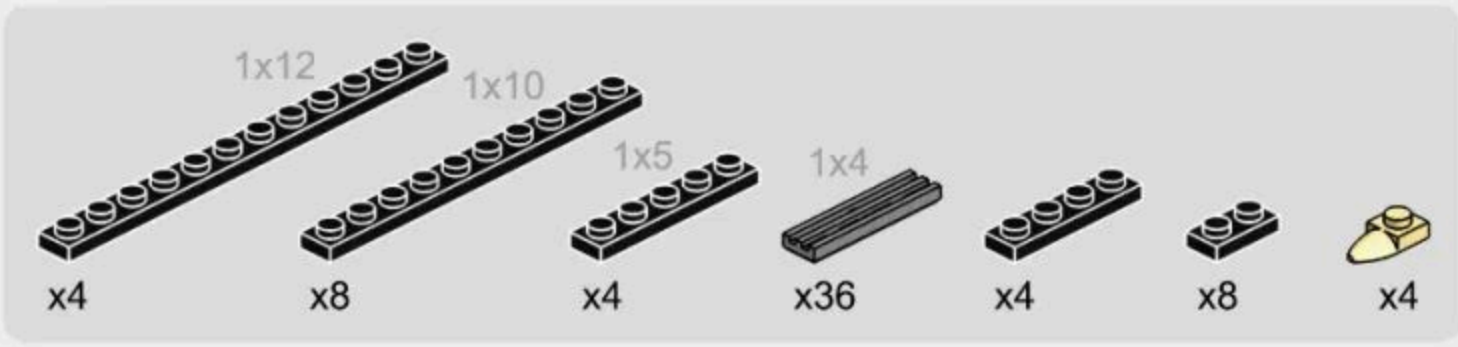

# 6-3

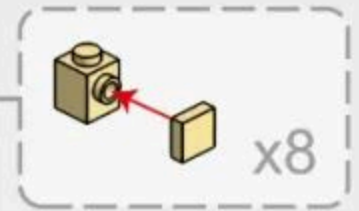
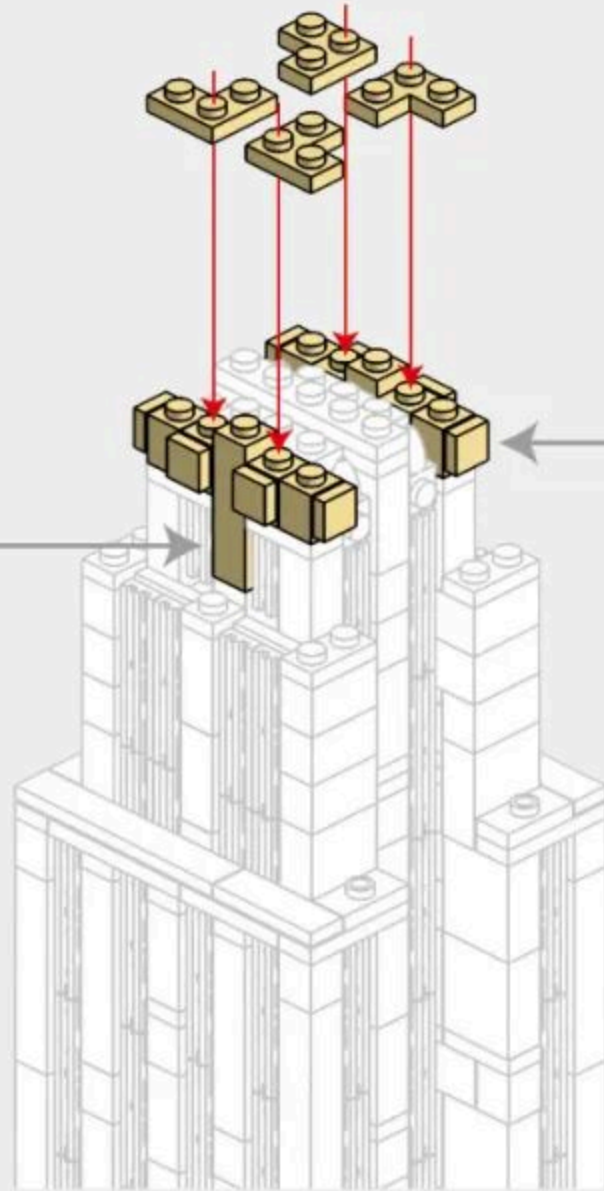
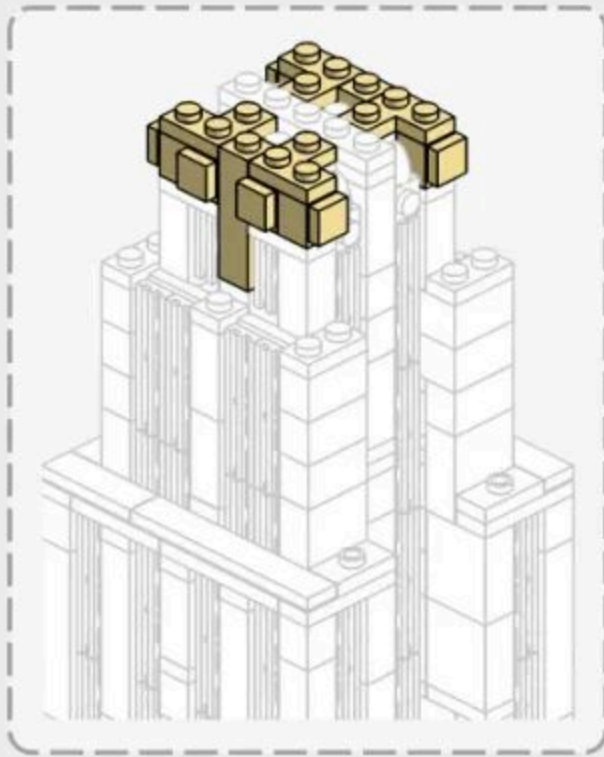
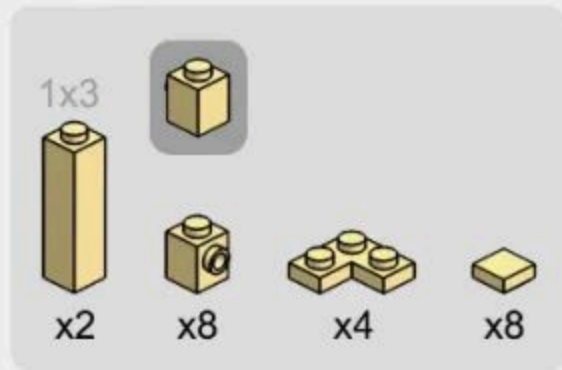

# 6-4

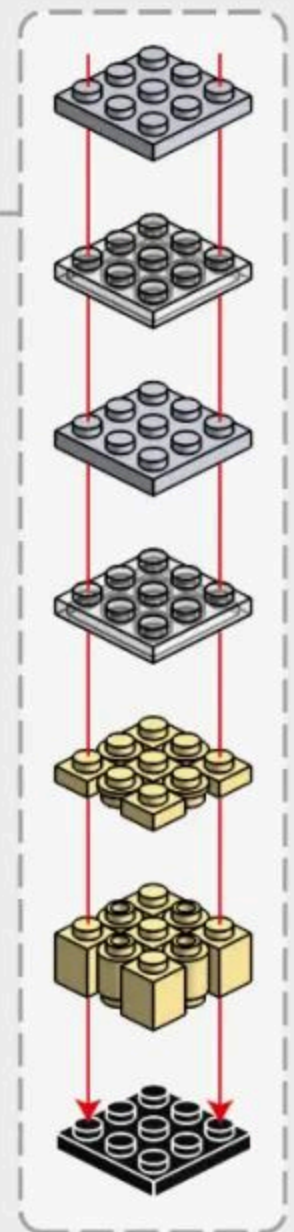
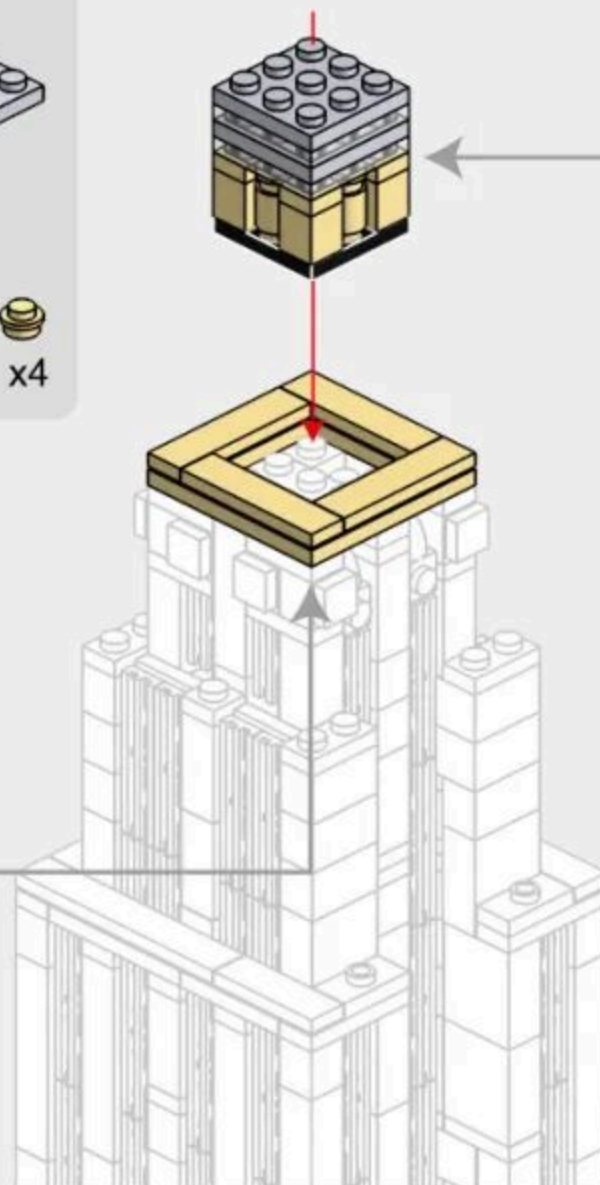
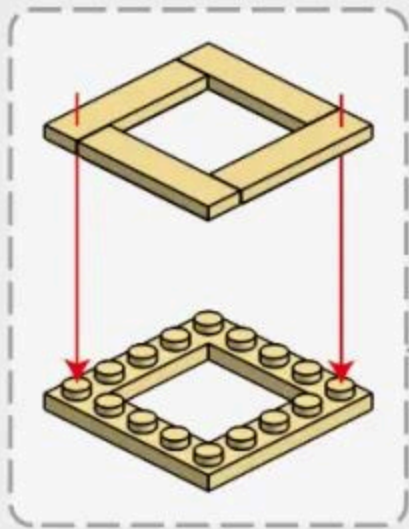
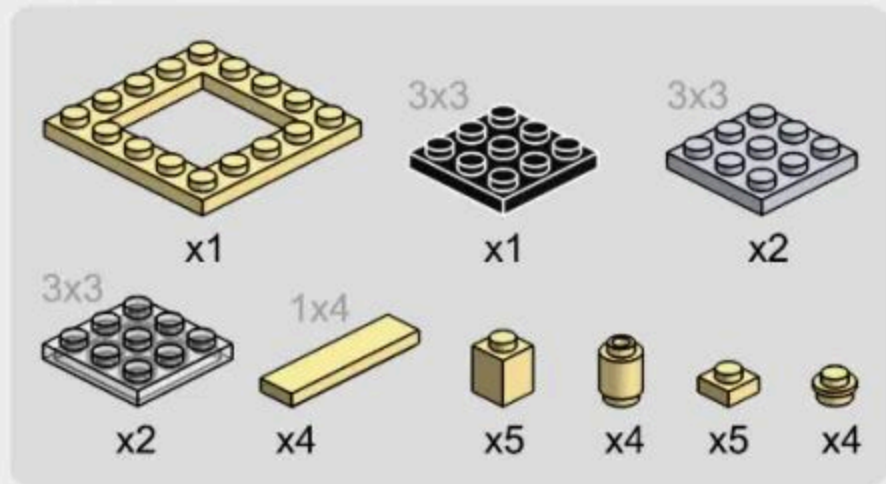

6-5

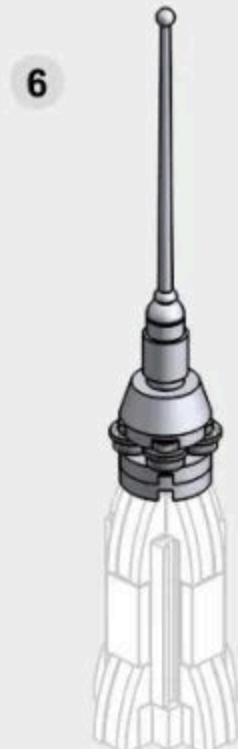
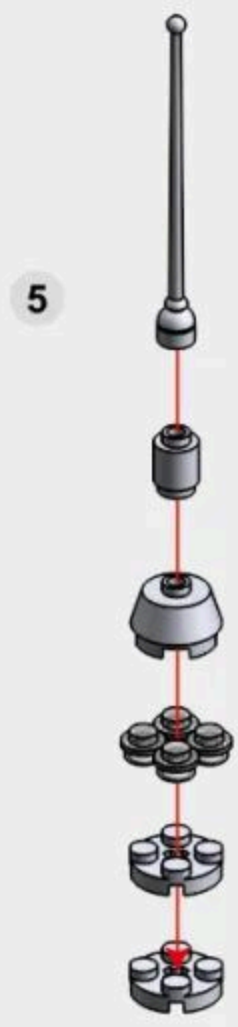
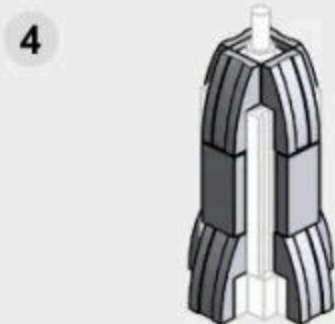
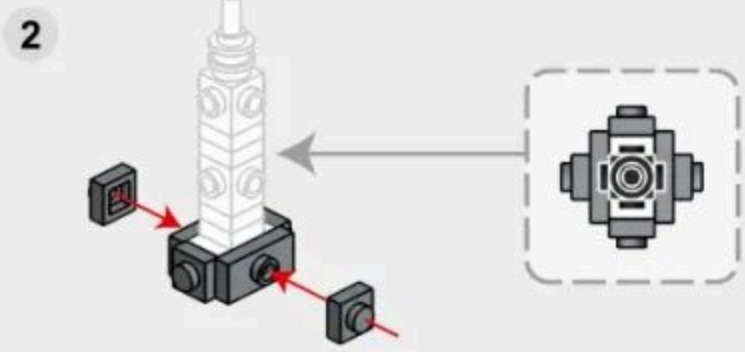
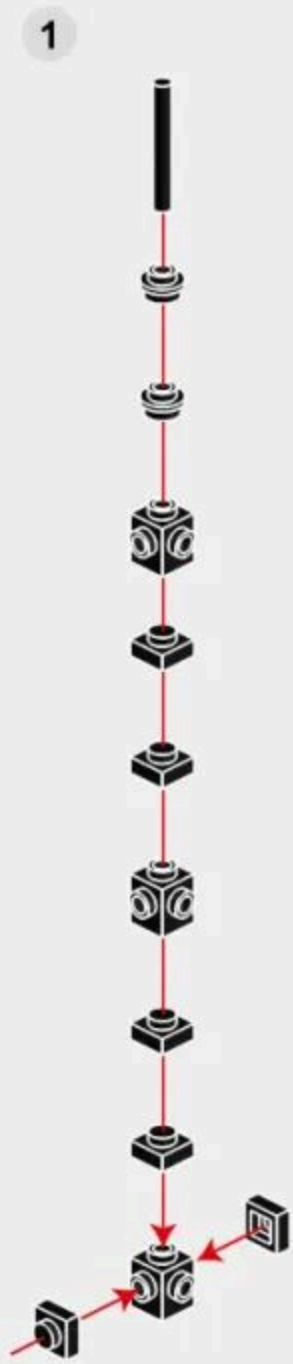

6-6

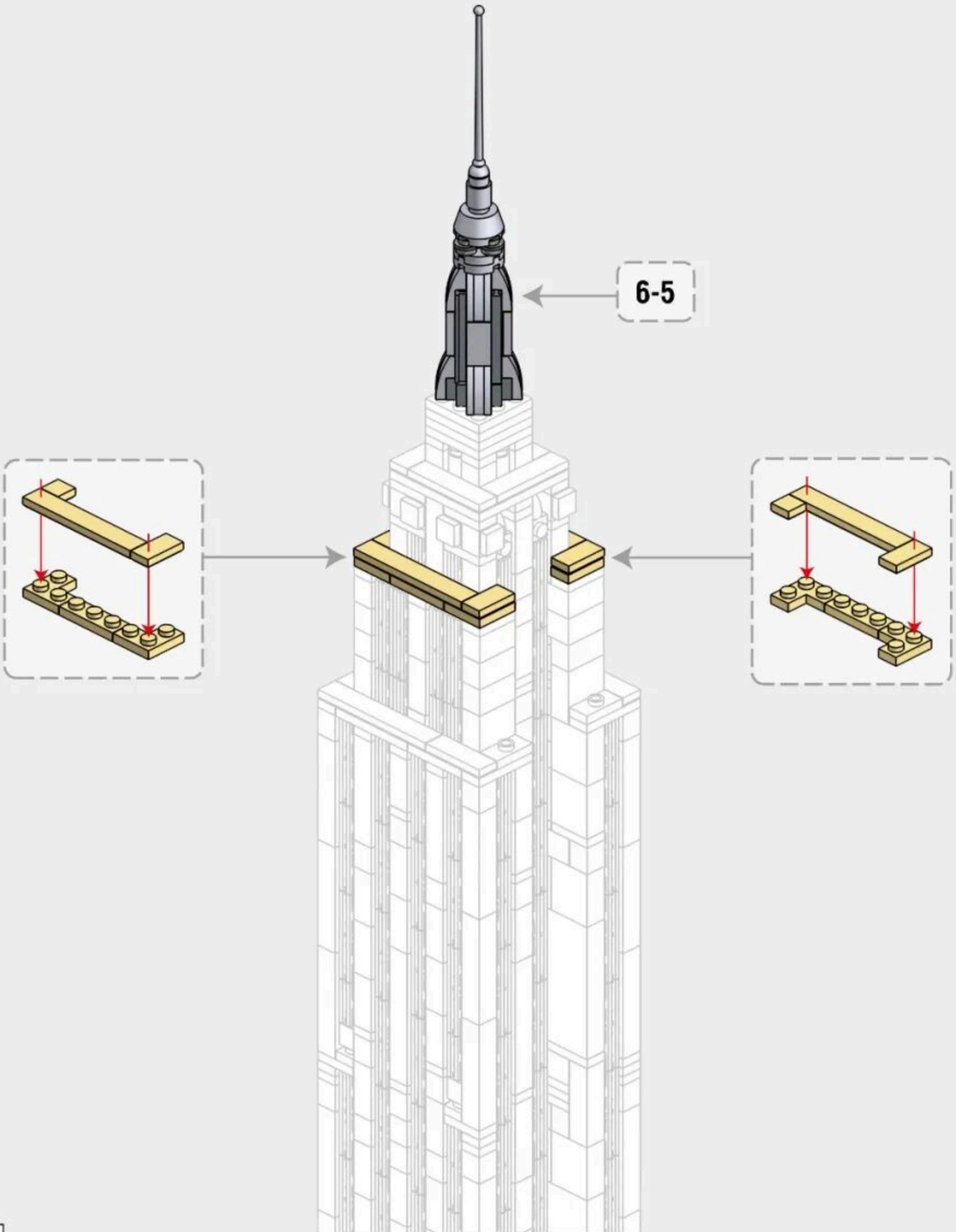
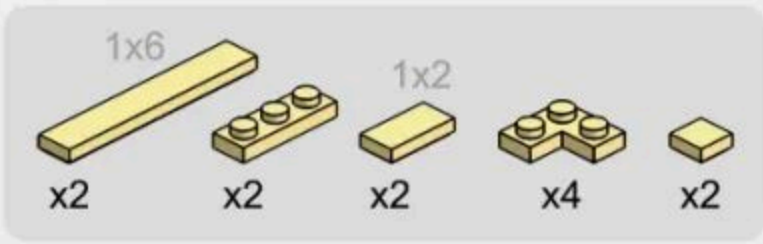

6-7

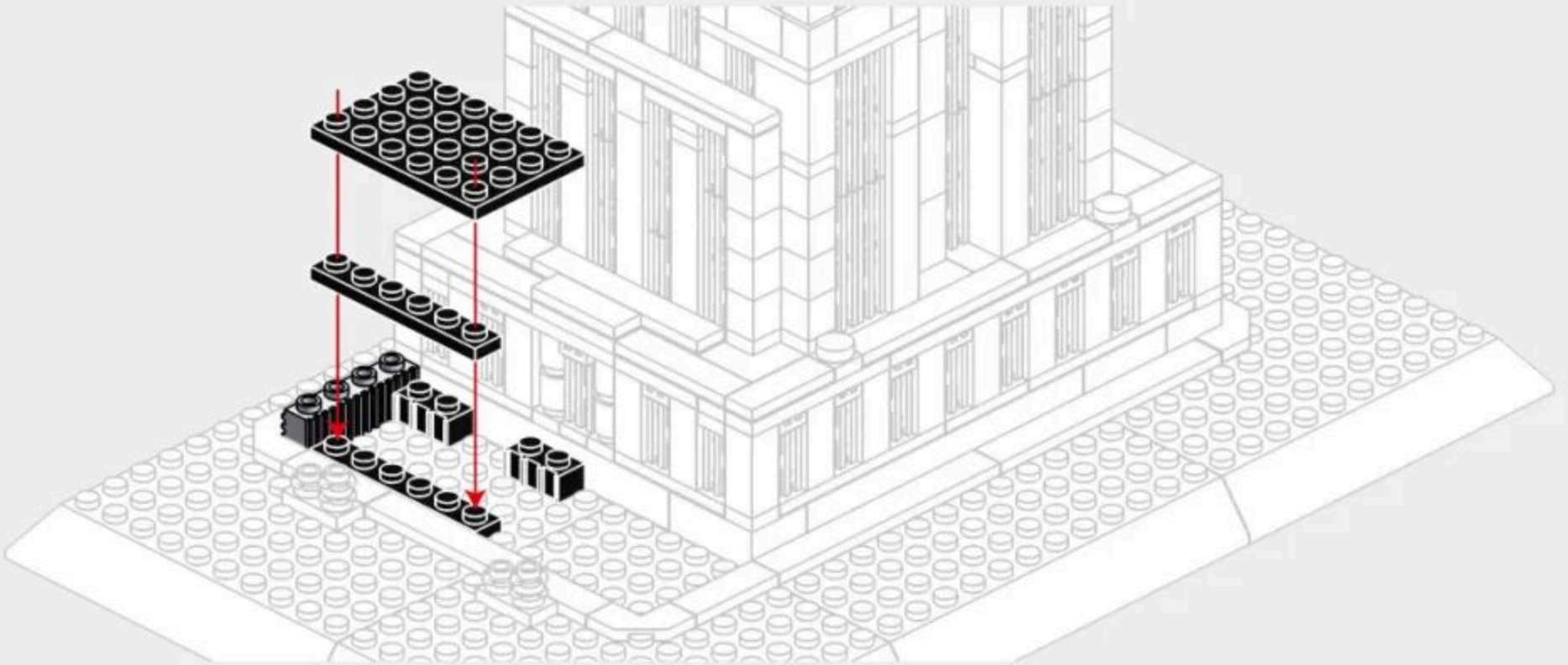
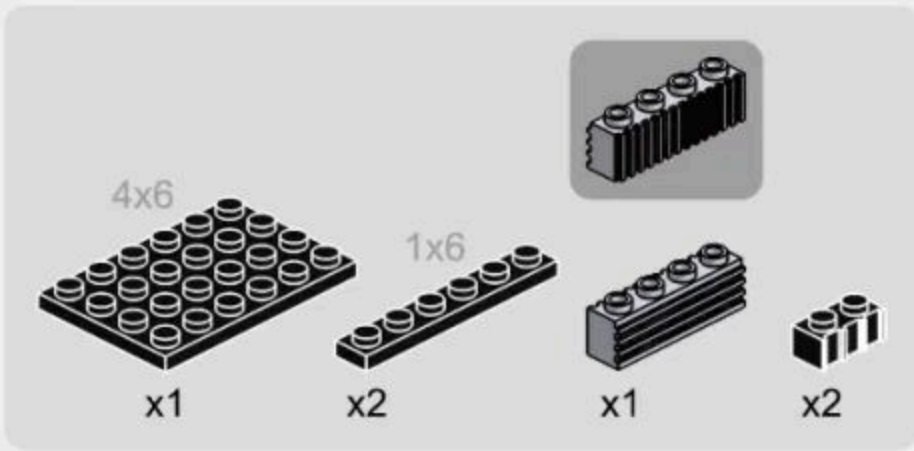

6-8

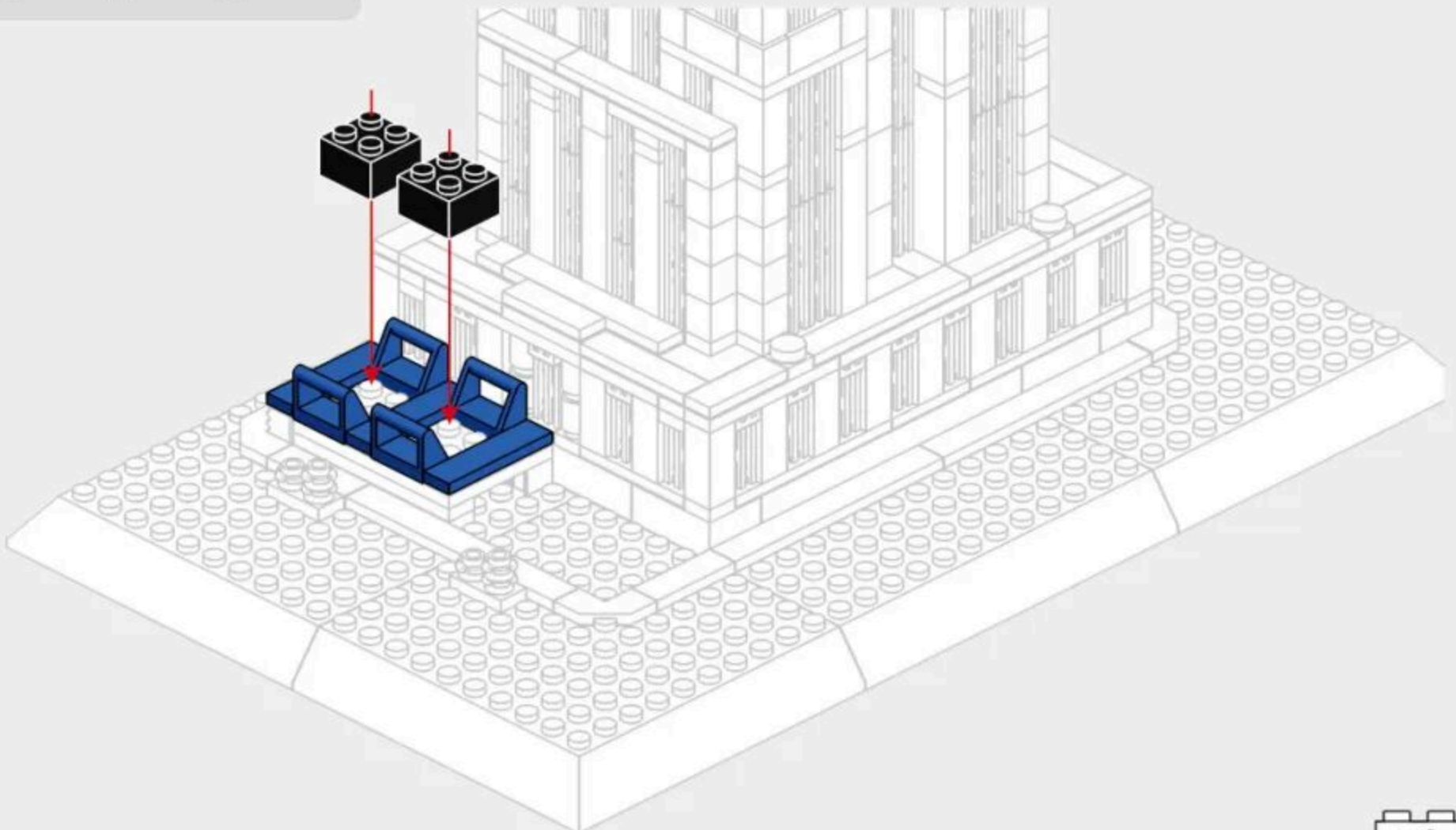
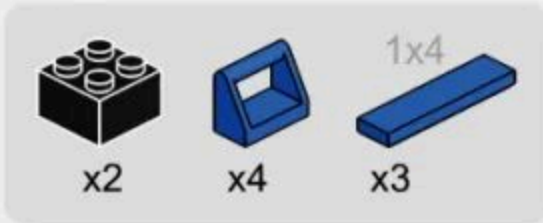

6-9

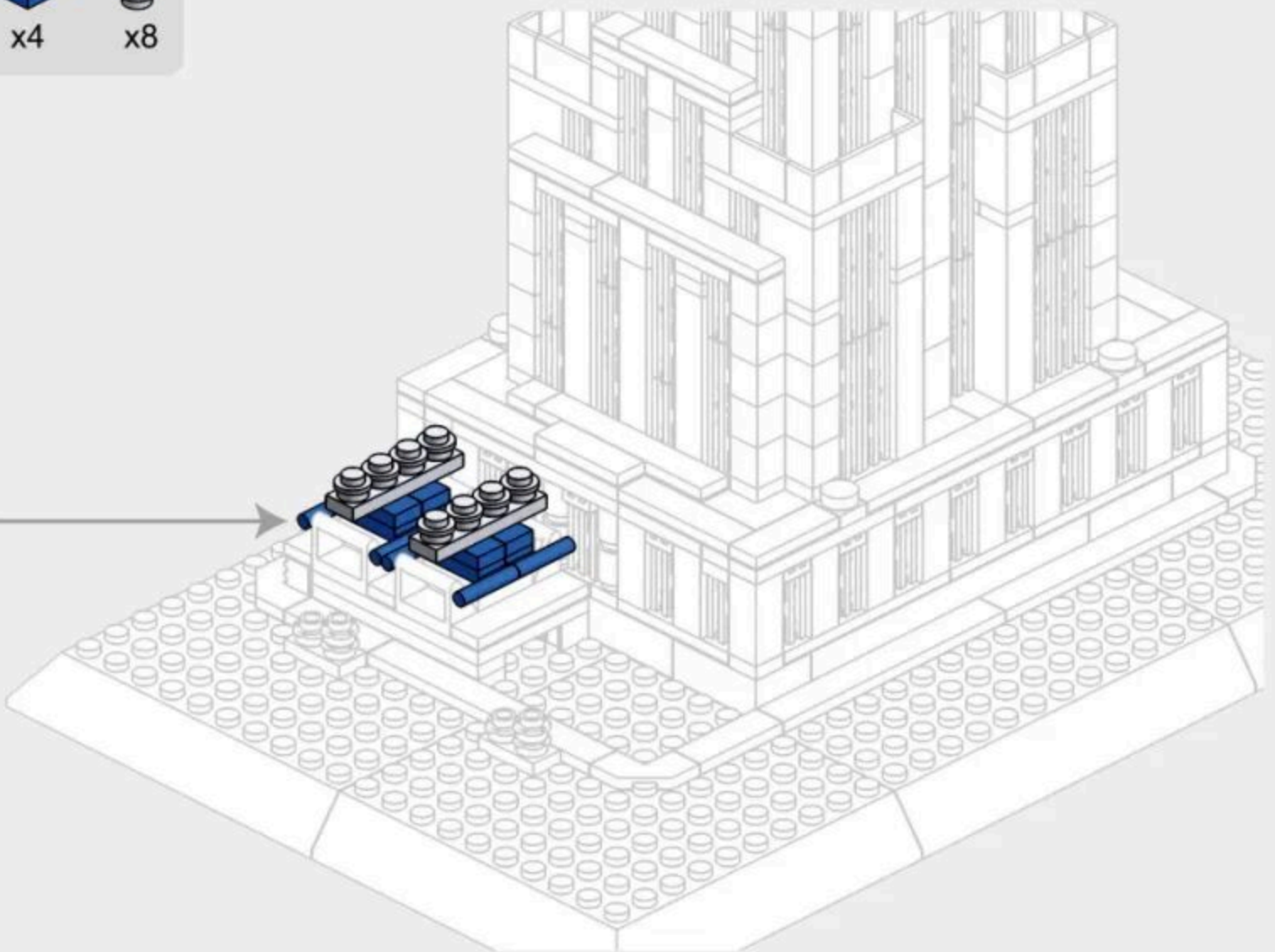
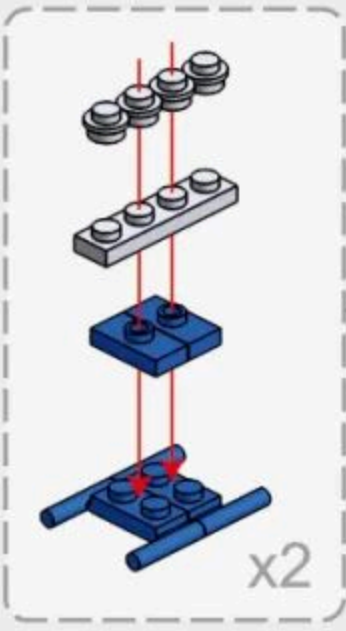

6-10

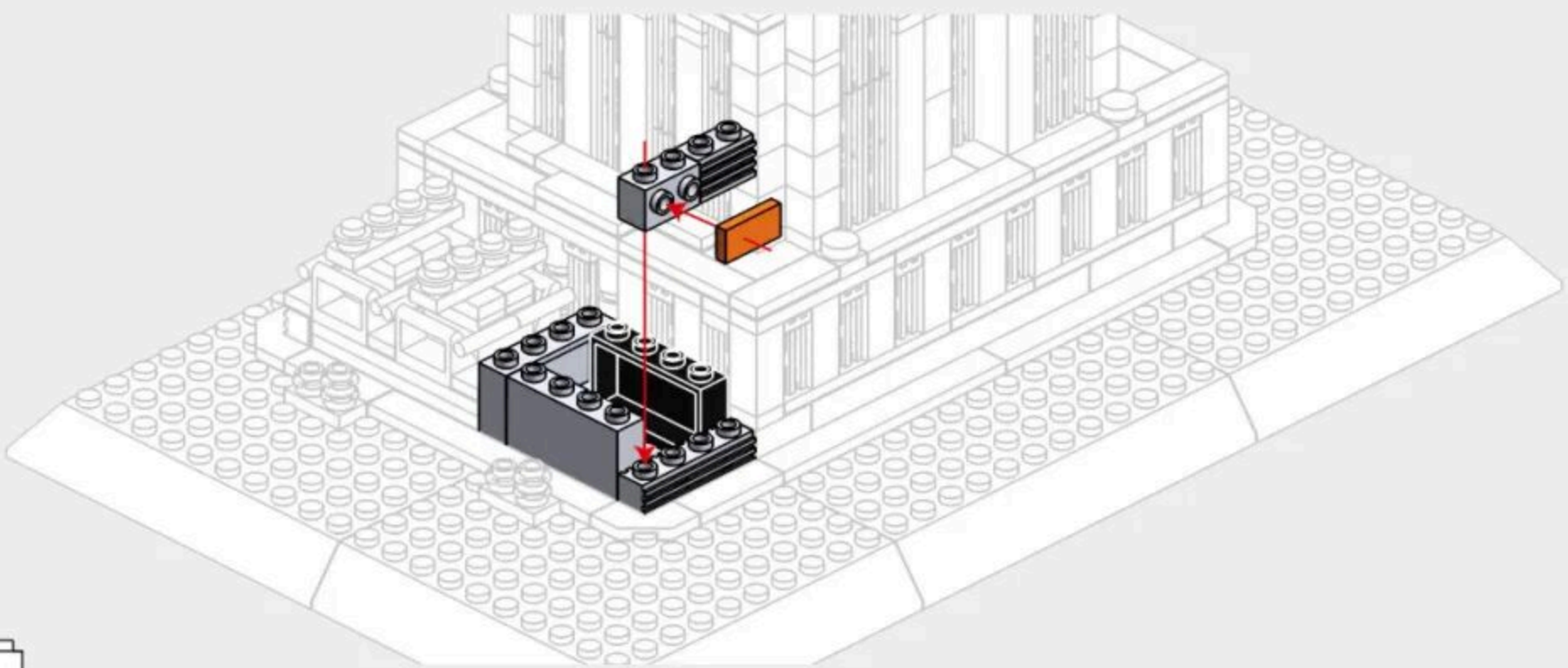
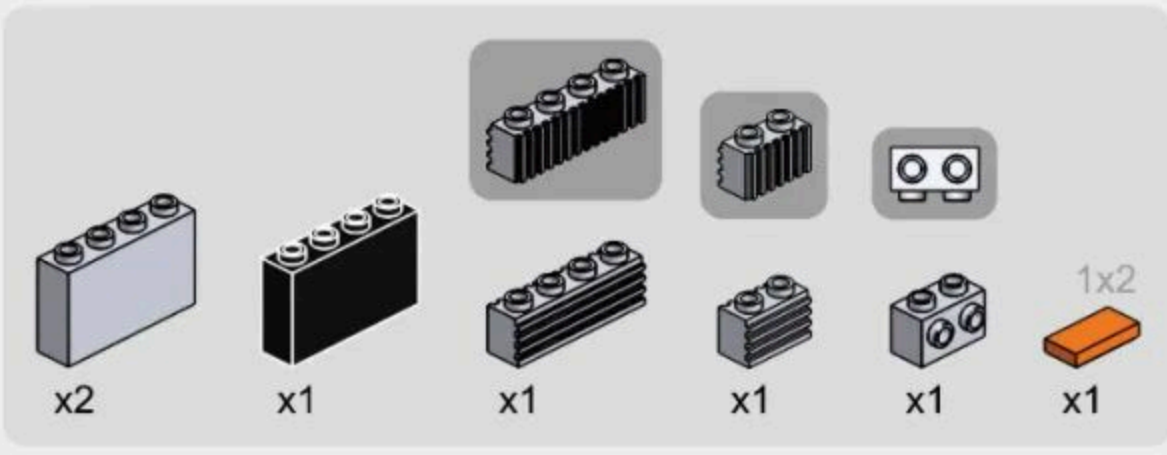

6-11

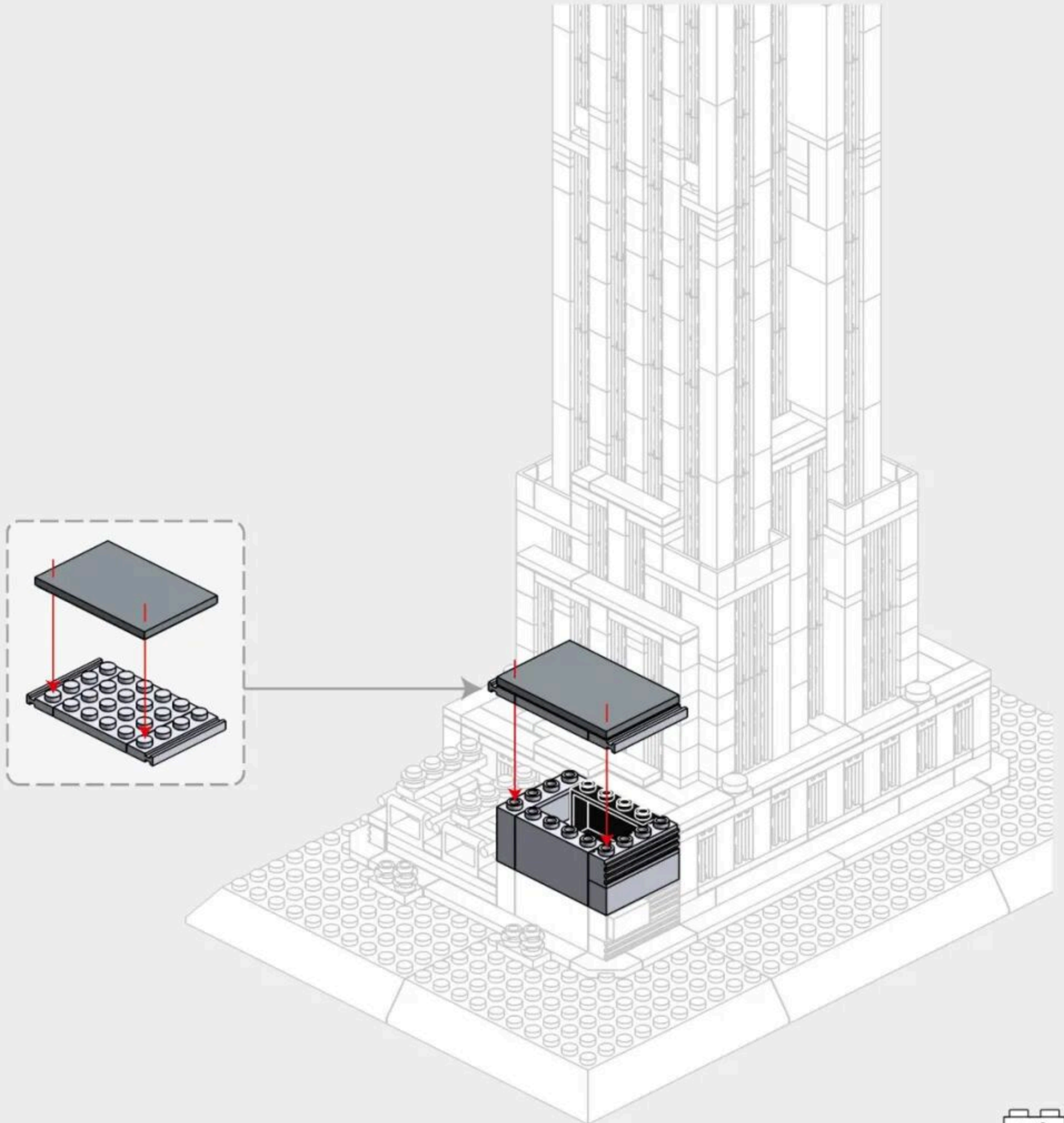
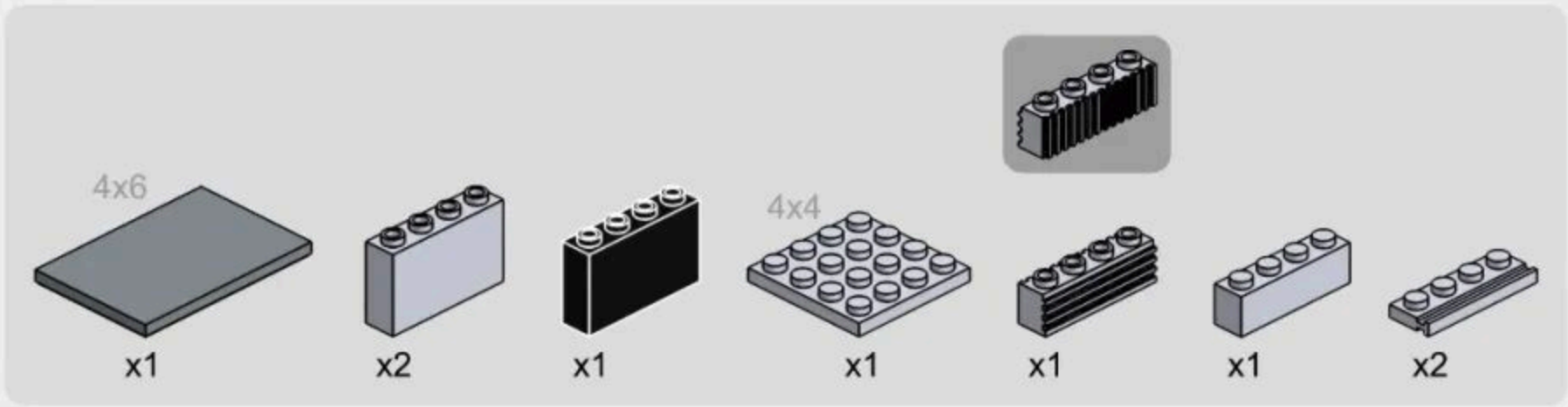

6-12

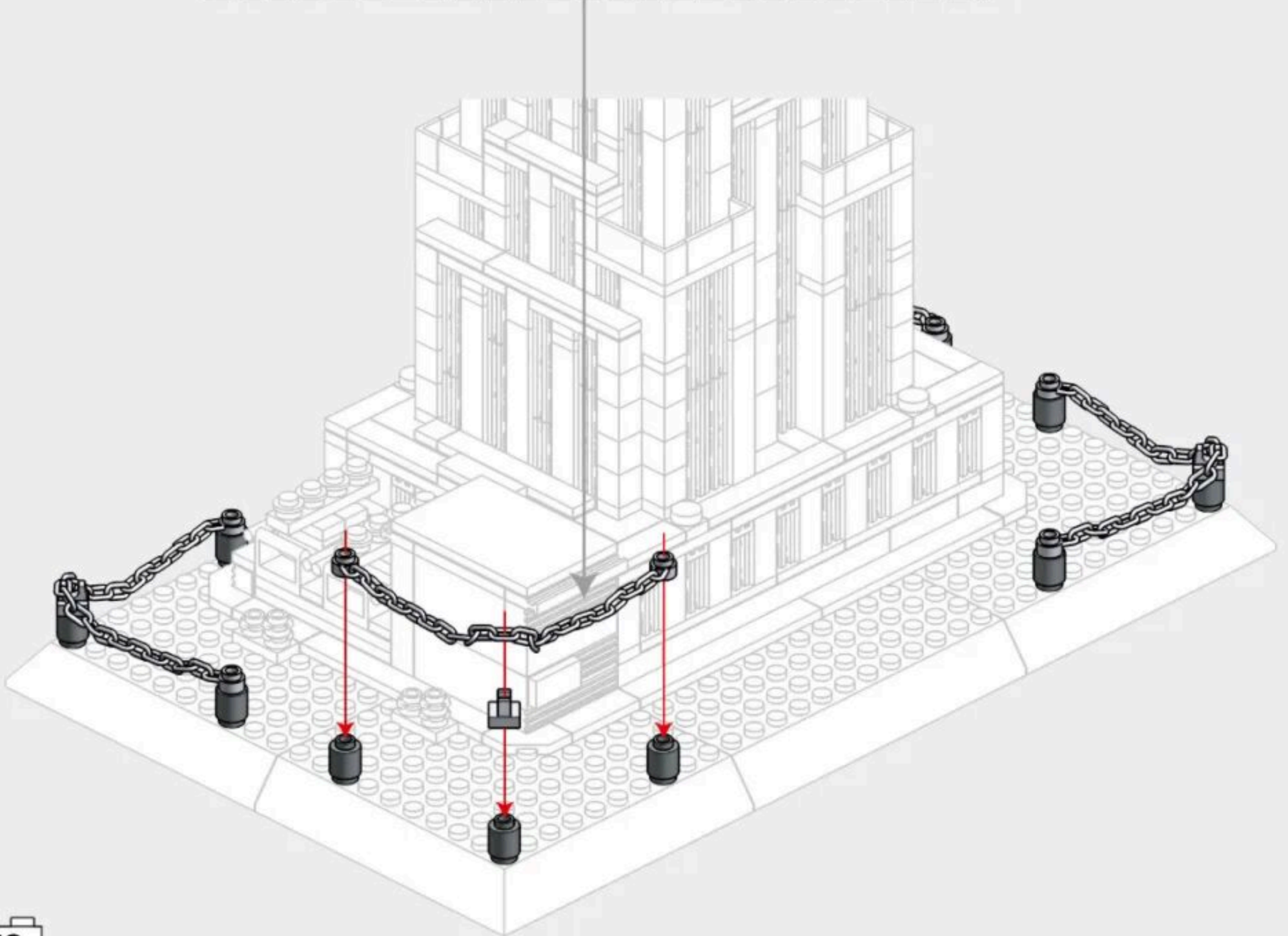
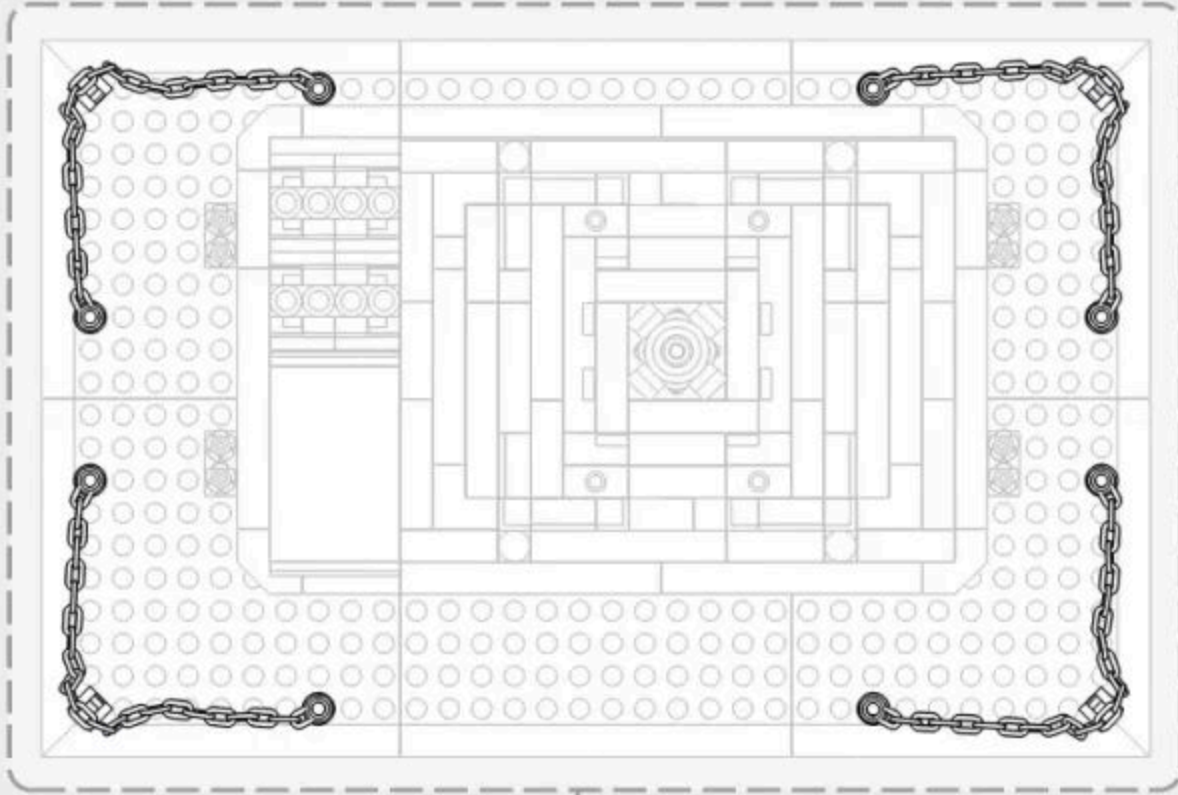
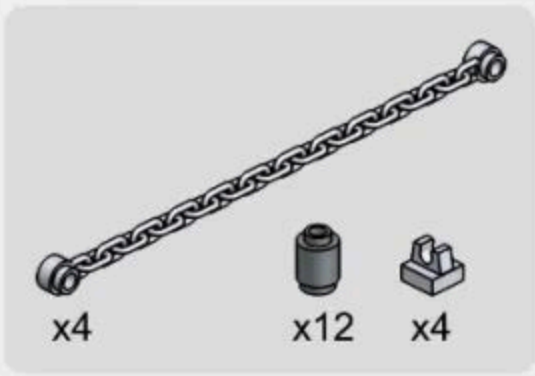

6-13

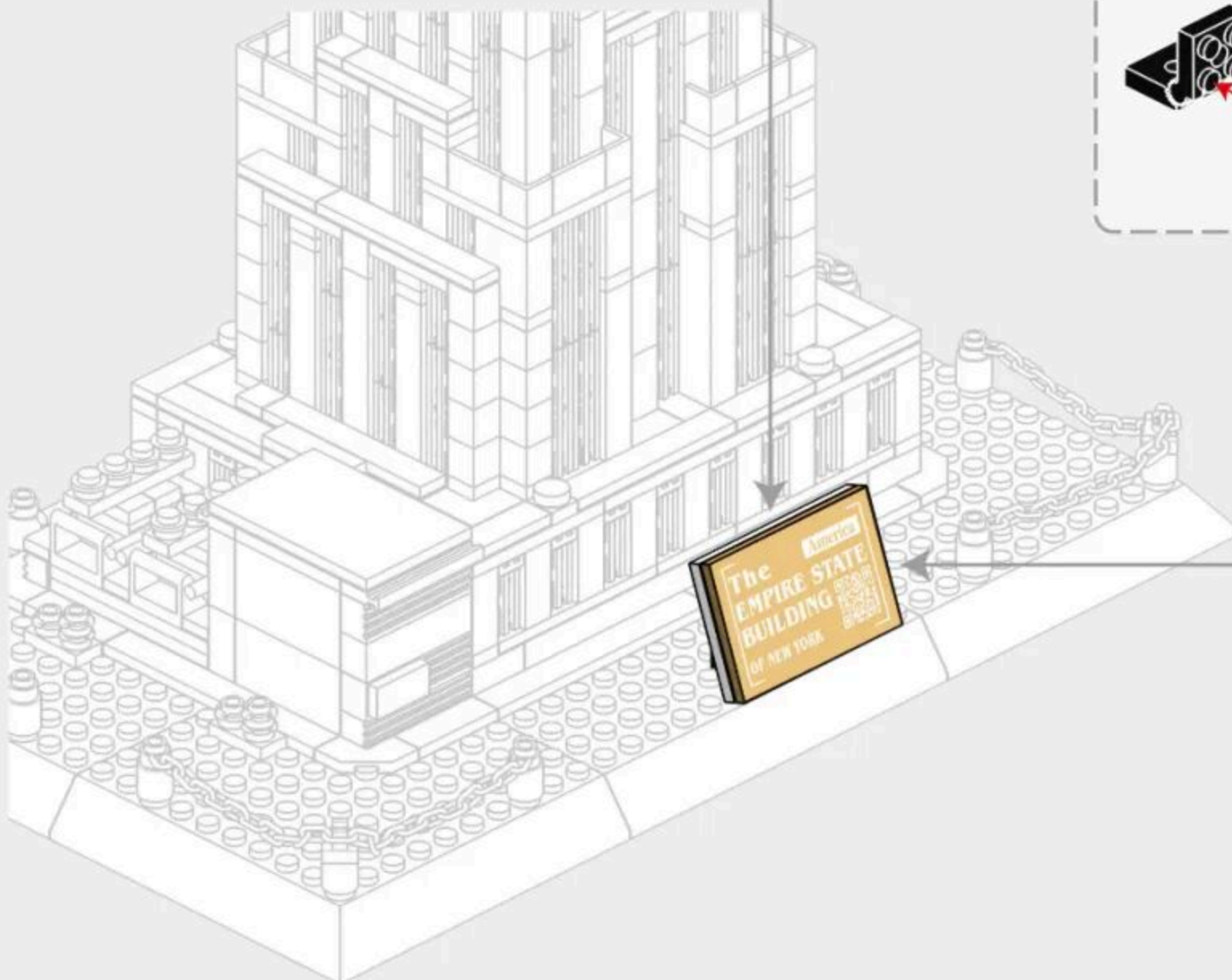
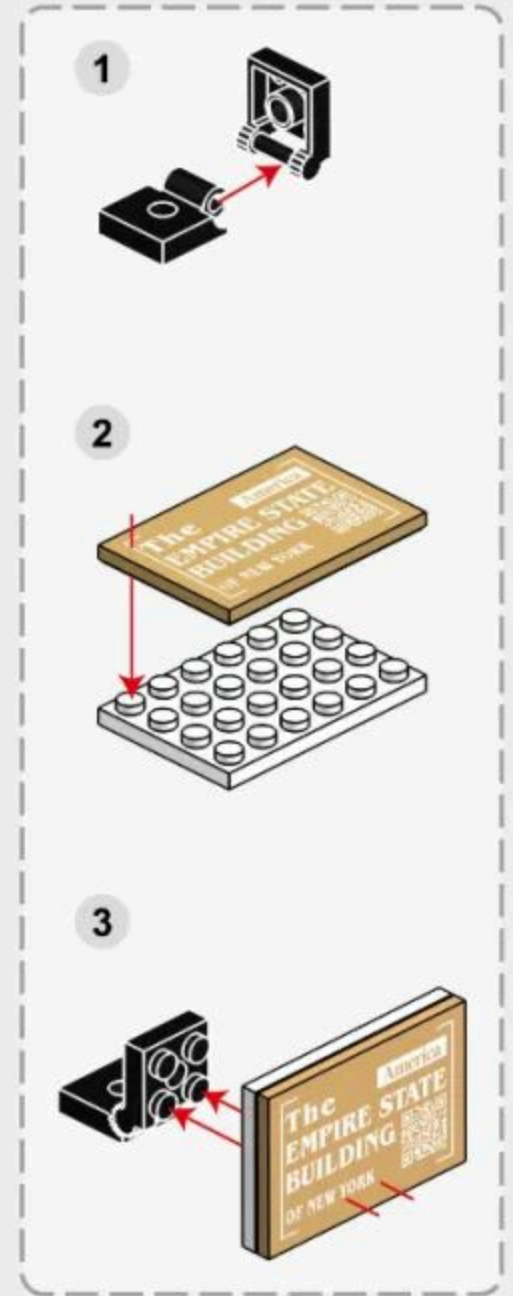
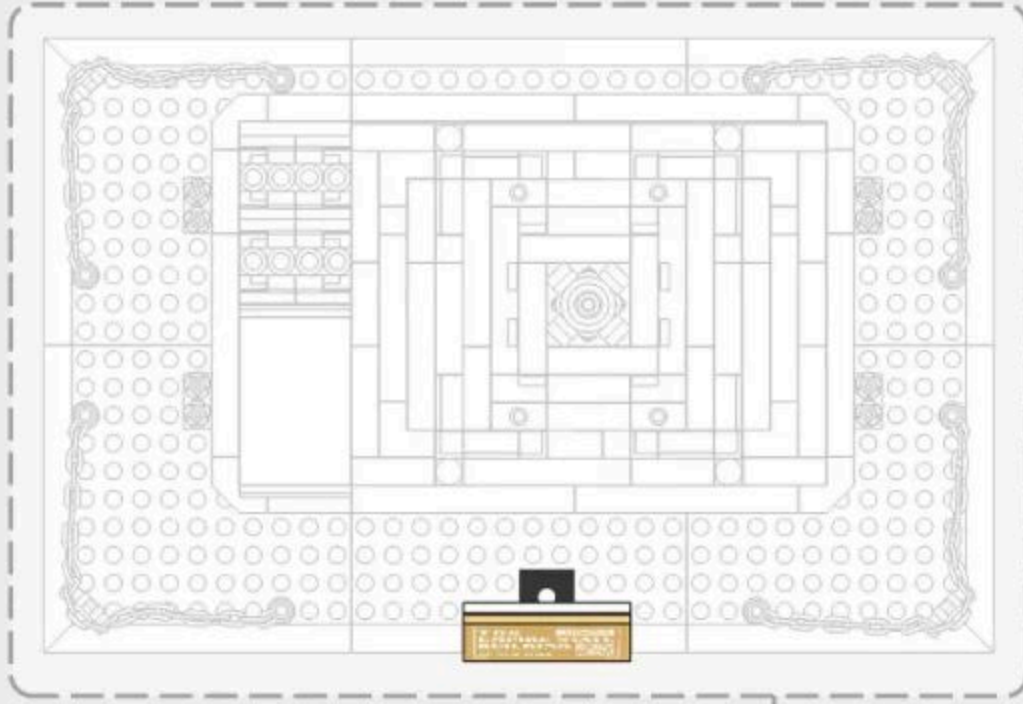
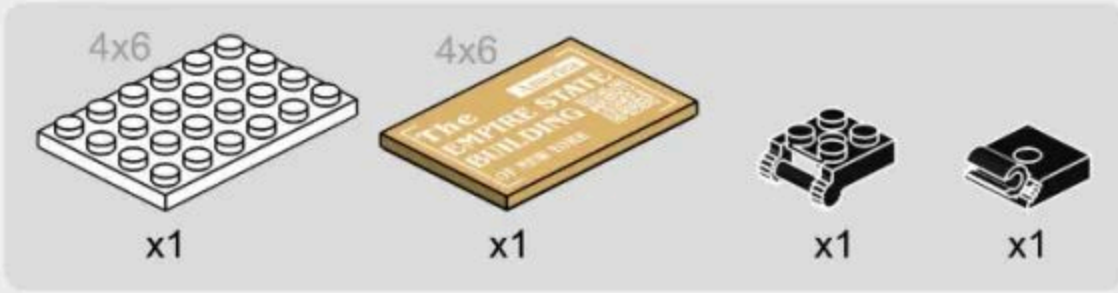

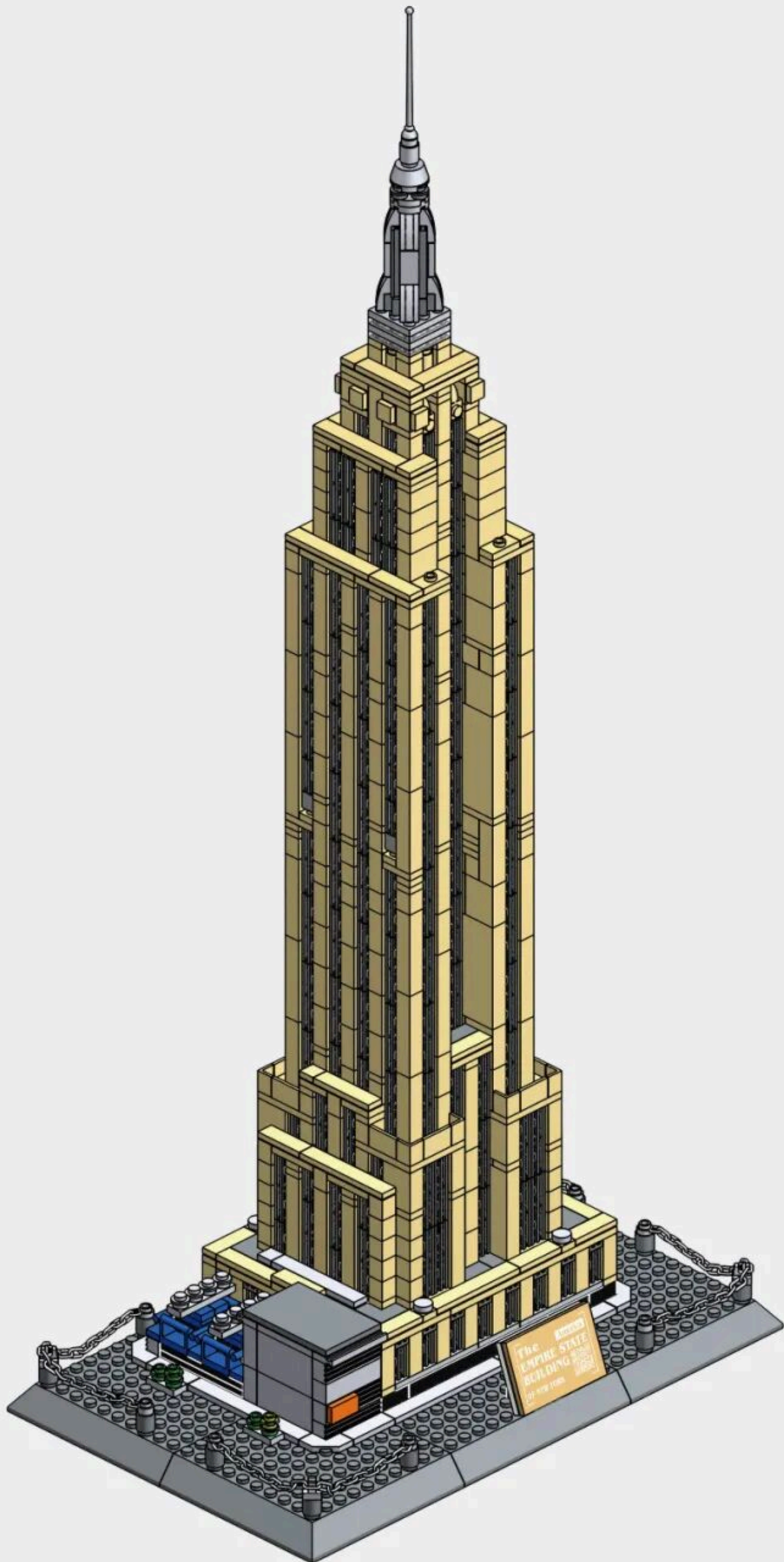

# ARCHITECTURE

The World's great architecture



Shaping Skills



Imagination  
& Curiosity



Mathematical



Self Discovery  
& Perception



Parent-Child  
Interaction



Problem Solving



Creativity



**6224** 英国伦敦白金汉宫  
BUCKINGHAM PALACE-LONDON,ENGLAND

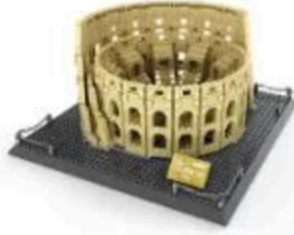

**5225** 意大利罗马斗兽场  
COLOSSEUM-ROME,ITALY



**5226** 日本东京帝国饭店  
IMPERIAL HOTEL-TOKYO,JAPAN



**6211** 德国柏林勃兰登堡门  
BRANDENBURG GATE-BERLIN, GERMANY



**6222** 中国甘肃长城-嘉峪关  
JIAYU PASS-GANSU,CHINA



**6212** 日本京都清水寺仁王门  
NIOMON GATE OF KIYOMIZU-DERA-KYOTO,JAPAN



**6214** 中国武汉黄鹤楼  
YELLOW CRANE TOWER-WUHAN,CHINA



**6215** 英国伦敦眼  
LONDON EYE-LONDON,ENGLAND



**6221** 中国北京故宫-太和殿  
HALL OF SUPREME HARMONY-BEIJING,CHINA



**6213** 俄罗斯莫斯科瓦西里大教堂  
SAINT BASILS CATHEDRAL-MOSCOW,RUSSIA



**6220** 沙特阿拉伯麦加大清真寺  
GREAT MOSQUE OF MECCA,SAUDI ARABIA



**6219** 美国纽约联合国大厦  
UNITED NATIONS HEADQUARTERS-NEW YORK,AMERICA



**4214** 美国华盛顿白宫  
WHITE HOUSE-WASHINGTON D.C.,AMERICA



**4212** 意大利罗马许愿池  
TREVI FOUNTAIN-ROME,ITALY



**4213** 法国巴黎卢浮宫  
MUSÉE DU LOUVRE-PARIS,FRANCE



**4218** 新加坡-鱼尾狮  
MERLION,SINGAPORE



**4210** 埃及开罗吉萨金字塔  
GREAT PYRAMID OF GIZA-CAIRO,EGYPT



**4219** 英国伦敦双子塔桥  
TOWER BRIDGE-LONDON,ENGLAND



**4216** 美国华盛顿林肯纪念堂  
LINCOLN MEMORIAL-WASHINGTON D.C.,AMERICA



**4217** 新加坡-金沙酒店  
MARINA BAY SANDS,SINGAPORE



**7210 中国上海世博会中国馆**  
CHINA PAVILION AT EXPO-SHANGHAI, CHINA



**4221 加拿大渥太华国会山庄**  
PARLIAMENT BUILDINGS-OTTAWA, CANADA



**4211 英国伦敦伊丽莎白塔**  
ELIZABETH TOWER-ENGLAND



**4220 美国纽约熨斗大厦**  
FLATIRON BUILDING-NEW YORK, AMERICA



**5227 美国纽约自由女神像**  
STATUE OF LIBERTY-NEW YORK, AMERICA



**4215 加拿大多伦多电视塔**  
THE CN TOWER-CANADA



**4222 阿联酋迪拜哈利法塔**  
THE BURJ KHALIFA TOWER-DUBAI, UAE



**5224 中国上海东方明珠广播电视塔**  
ORIENTAL PEARL TOWER-SHANGHAI, CHINA



**5212 美国纽约帝国大厦**  
EMPIRE STATE BUILDING-NEW YORK, AMERICA



**5213 马来西亚吉隆坡石油双塔**  
PETRONAS TWIN TOWERS-KUALA LUMPUR, MALAYSIA



**5214 意大利托斯卡纳比萨斜塔**  
LEANING TOWER OF PISA-TUSCANY, ITALY



**5216 英国伦敦伊丽莎白塔**  
ELIZABETH TOWER-LONDON, ENGLAND



**5219 俄罗斯莫斯科克里姆林宫钟楼**  
SPASSKAYA TOWER-MOSCOW, RUSSIA



**5220 阿联酋迪拜卓美亚帆船酒店**  
BURJ AL ARAB HOTEL-DUBAI, UAE



**5217 法国巴黎埃菲尔铁塔**  
EIFFEL TOWER-PARIS, FRANCE



**5221 中国台北101大楼**  
TAIPEI 101-TAIPEI, CHINA



**6223 中国武汉长江大桥**  
WUHAN YANGTZE RIVER BRIDGE



**5210 法国巴黎圣母院大教堂**  
CATHÉDRALE NOTRE DAME DE PARIS-PARIS, FRANCE



**5223 法国巴黎凯旋门**  
ARC DE TRIOMPHE-PARIS, FRANCE



**5211 印度阿格拉泰姬陵**  
TAJ MAHAL-AGRA, INDIA



5215 英国伦敦双子塔桥  
TOWER BRIDGE-LONDON,ENGLAND



5222 中国北京天坛祈年殿  
HALL OF PRAYER FOR GOOD HARVESTS-BEIJING,CHINA



6210 美国旧金山金门大桥  
GOLDEN GATE BRIDGE-SAN FRANCISCO,AMERICA



6216 中国北京万里长城（八达岭）  
THE GREAT WALL-BEIJING,CHINA



5218 中国北京天安门  
TIAN'ANMEN TOWER-BEIJING,CHINA



6217 中国西藏布达拉宫  
POTALA PALACE-TIBET,CHINA



6218 芬兰罗瓦涅米圣诞老人办公室  
SANTA CLAUS OFFICE-ROVANIEMI,FINLAND



6225 墨西哥库库尔坎玛雅金字塔  
EL CASTILLO-KUKULKAN,MEXICO



6226 德国巴伐利亚新天鹅堡  
SCHLOSS NEUSCHWANSTEIN-BAYERN, DEUTSCHLAND



5228 美国芝加哥威利斯大厦  
WILLIS TOWER-CHICAGO, AMERICA



5229 土耳其伊斯坦布尔其少女塔  
MAIDEN TOWER-ISTANBUL,TURKEY



5230 中国湖南长沙爱晚亭  
AIWAN TING PAVILION-HUNAN,CHINA



5231 巴西里约热内卢救世基督像  
CRISTO REDENTOR-RIO DE JANEIRO, BRASIL



5232 美国宾夕法尼亚州流水别墅  
FALLINGWATER-PENNSYLVANIA, AMERICA



5233 美国芝加哥范斯沃斯住宅  
FARNSWORTH HOUSE-CHICAGO, AMERICA



5234 美国华盛顿唐人街  
CHINA TOWN-WASHINGTON, D.C., AMERICA



3210 美国纽约自由女神像  
STATUE OF LIBERTY-NEW YORK,AMERICA



4223 中国北京清华园  
TSINGHUA CAMPUS-CHINA,BEIJING



7211 中国湖南岳阳楼  
YUEYANG TOWER-CHINA,HUNAN



8210 澳大利亚悉尼歌剧院  
SYDNEY OPERA HOUSE-AUSTRALIA,BENNELONG POINT



# EMPIRE STATE BUILDING

COUNTRY: America  
CITY: New York

