

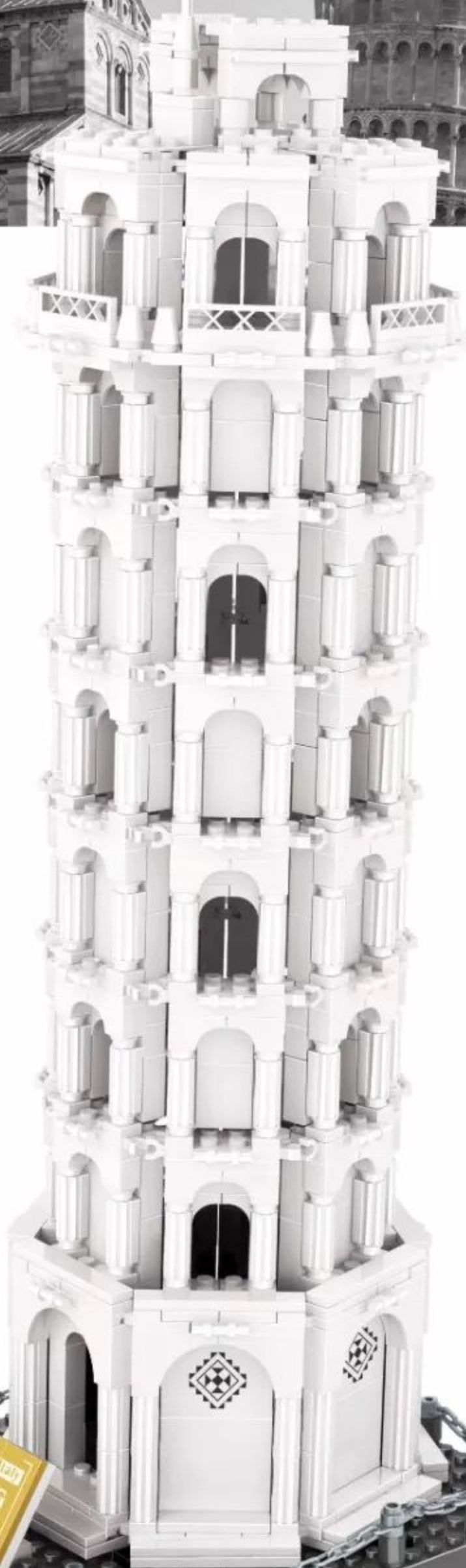

THE LEANING TOWER OF PISA

Italy
The world's great architecture

Ages
6+



Creative Ability

Family Interaction

Observation Ability

Think Ability



NO.5214

1334 PCS

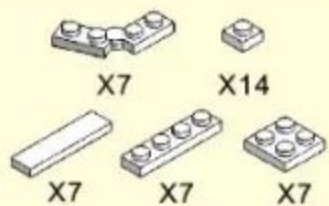

1

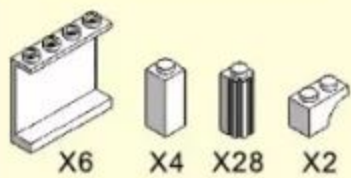
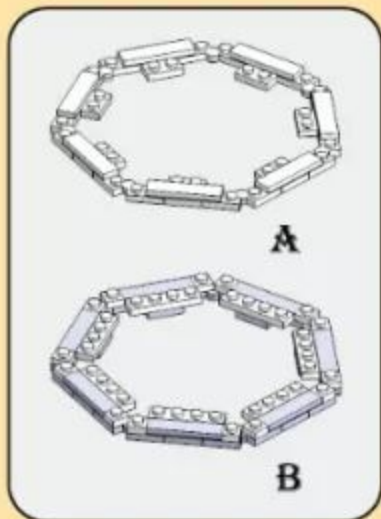

2

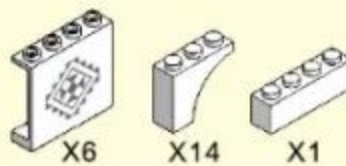
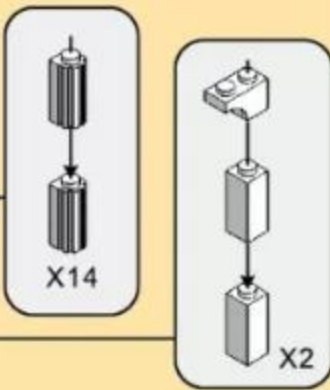
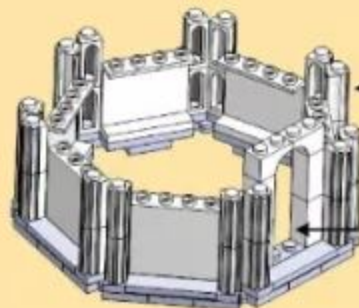

3

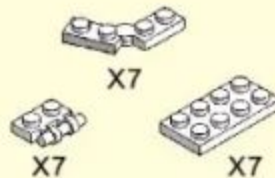
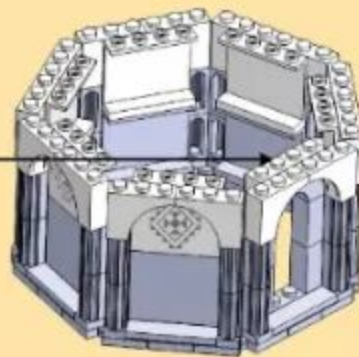
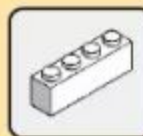

4

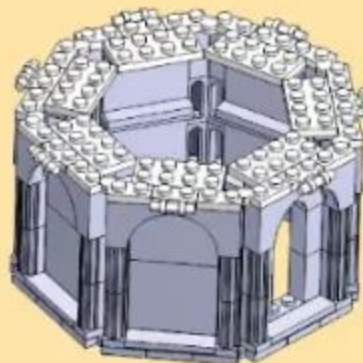

1

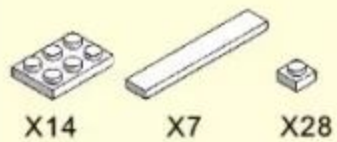

5

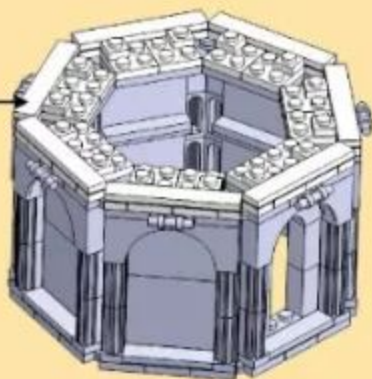
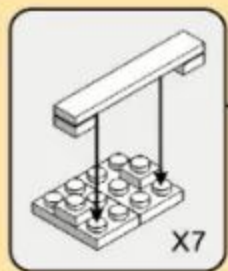

6

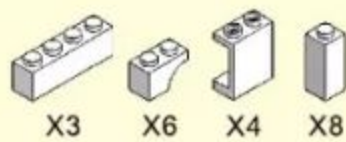
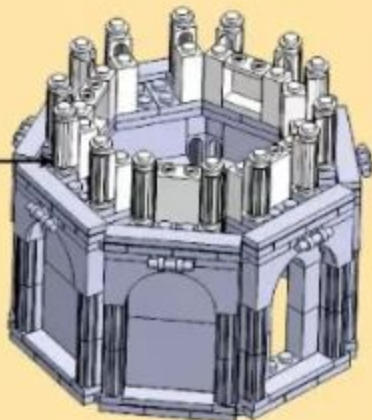

7

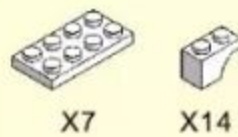
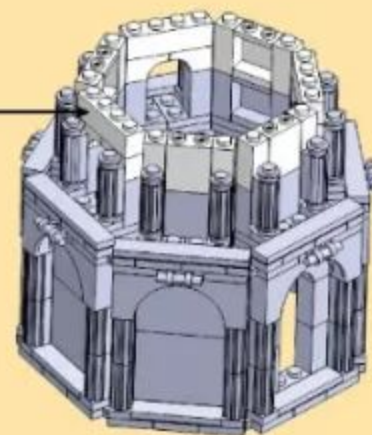
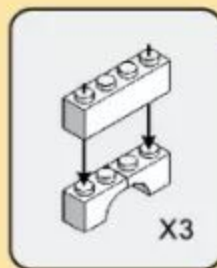

8

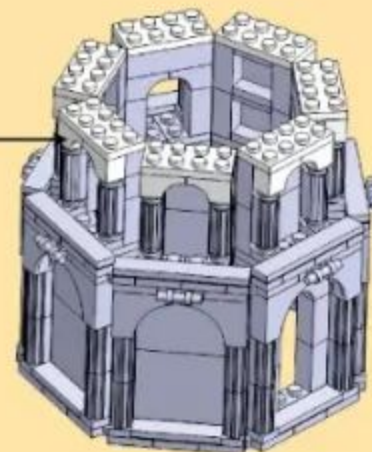
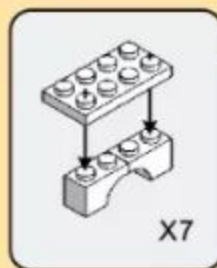



X14 X7 X7



X7 X7

9

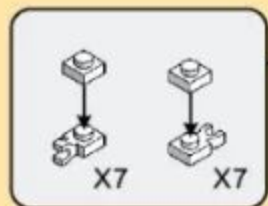

X7 X7

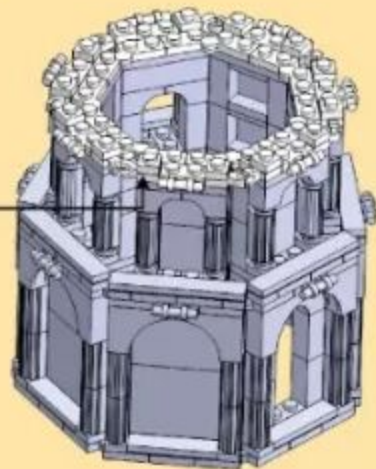

X4 X8 X3 X6

11

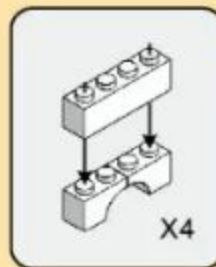

X4

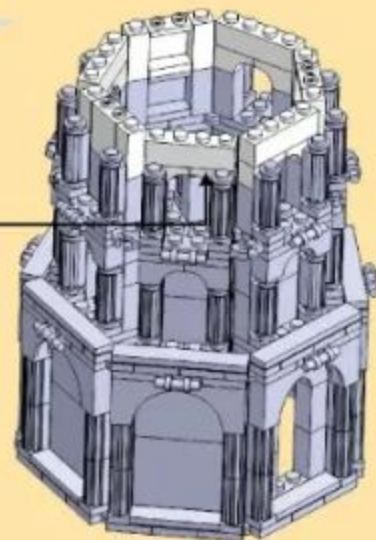

X3 X14 X14 X28

10



X14

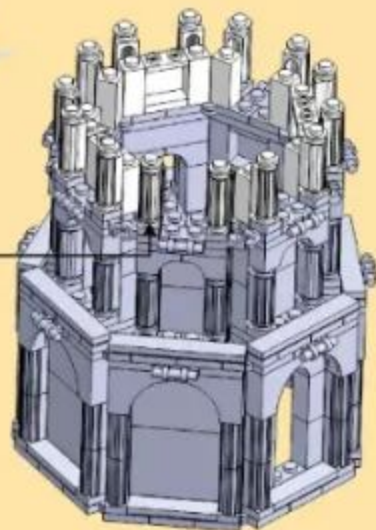

X7 X14

12

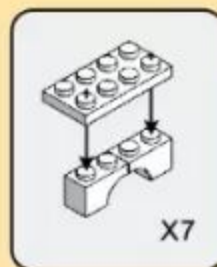

X7

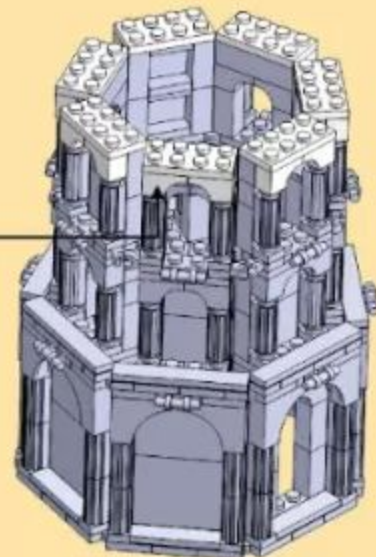

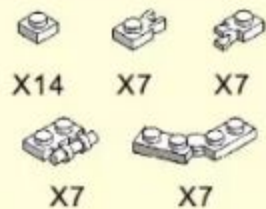

13



14

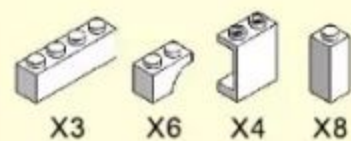

15

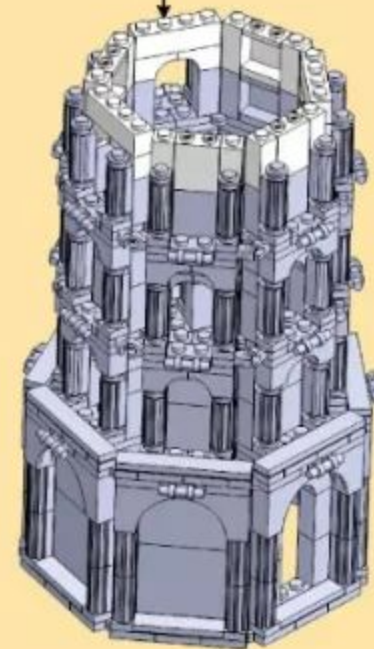
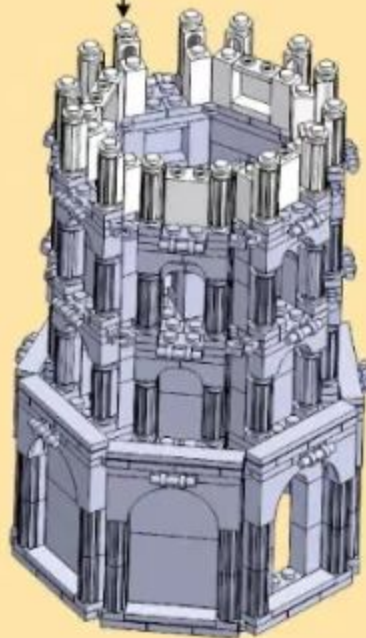
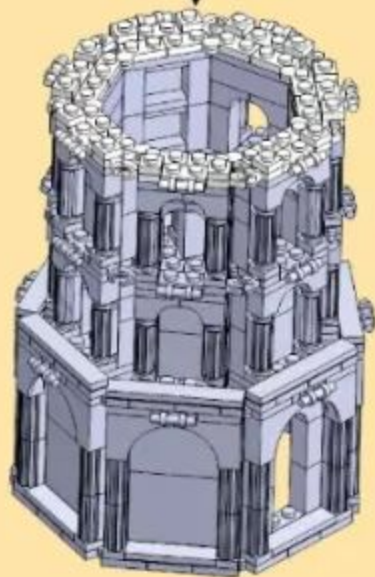
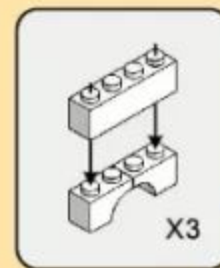
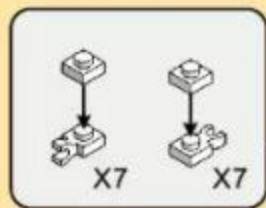

4



X7

X14

16



X14

X7

X7



X7

X7

17



X3



X14



X14



X28

18

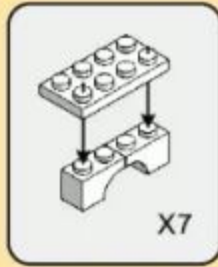

X7

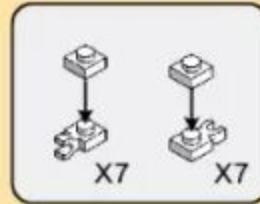

X7

X7



X14

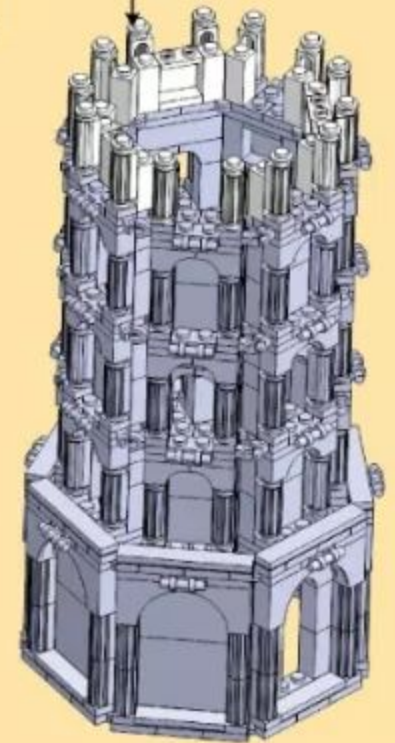
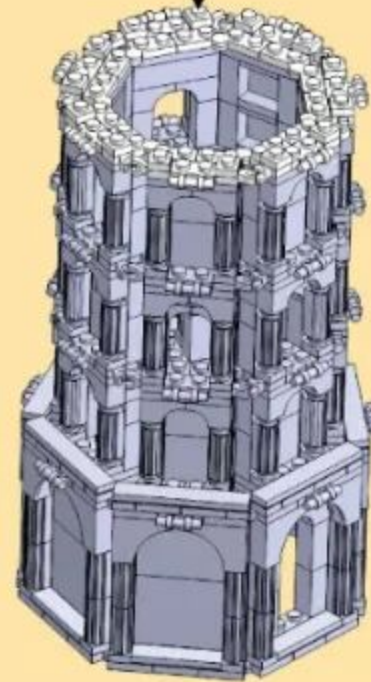
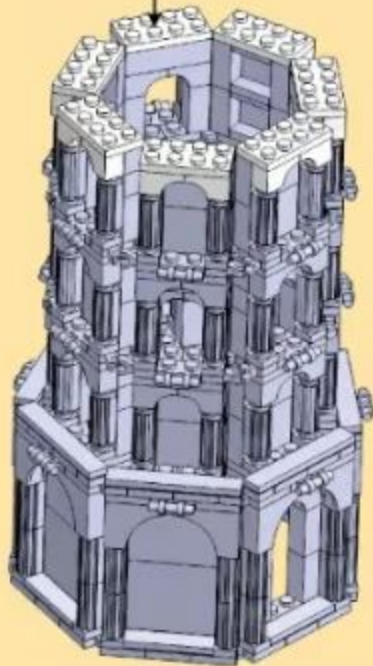

5

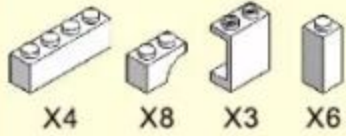

19

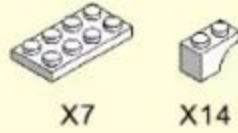

20

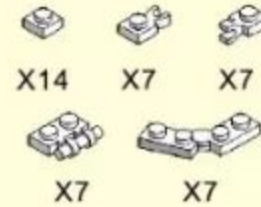

21

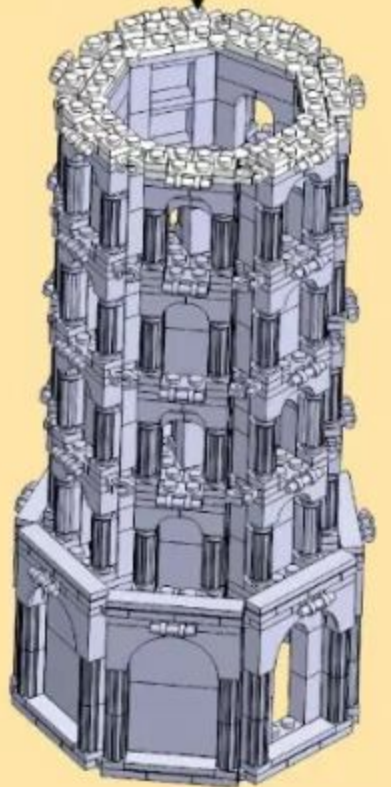
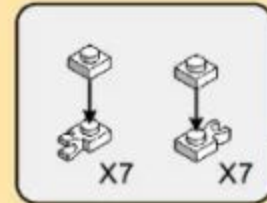
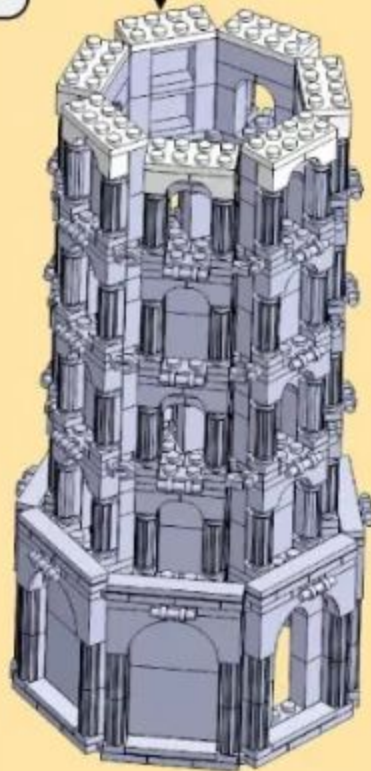
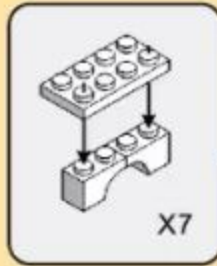
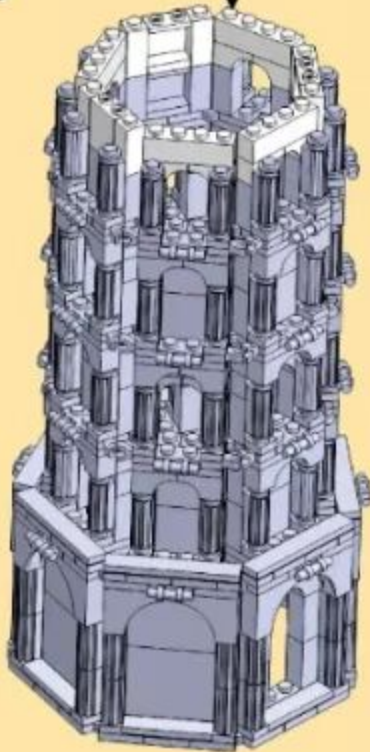
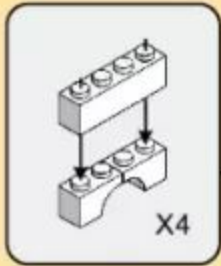

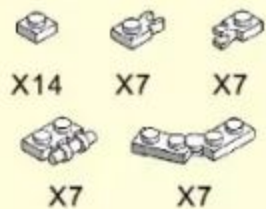

25



26

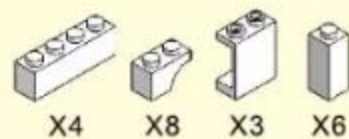

27

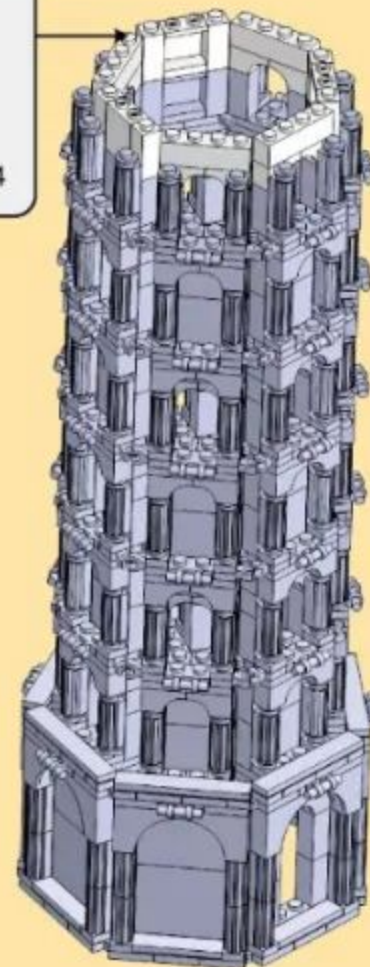
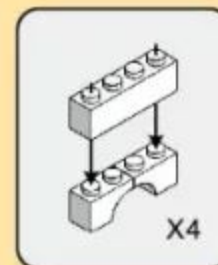
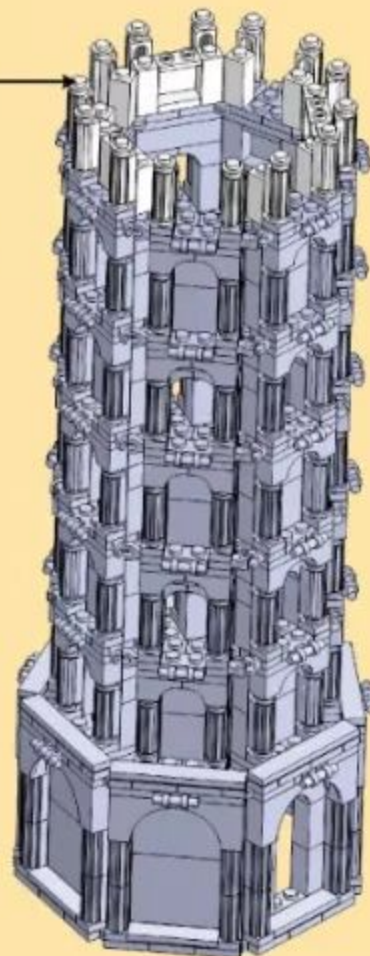
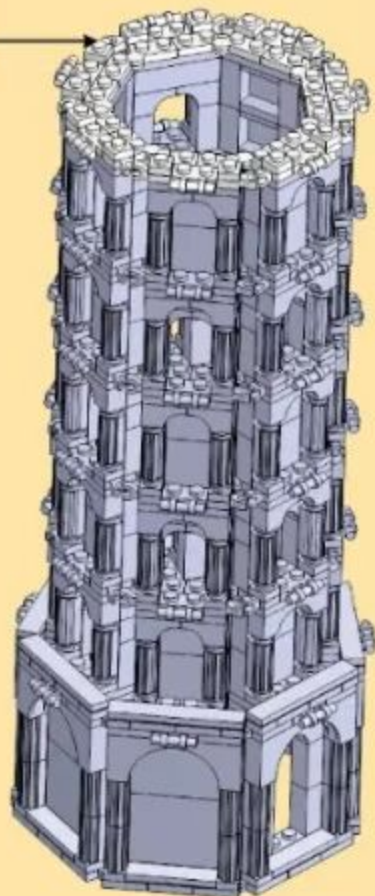
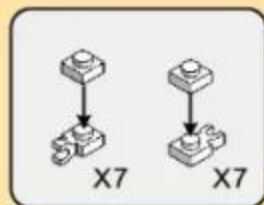



X7 X14 X7

28



X7 X7



X7 X7

29

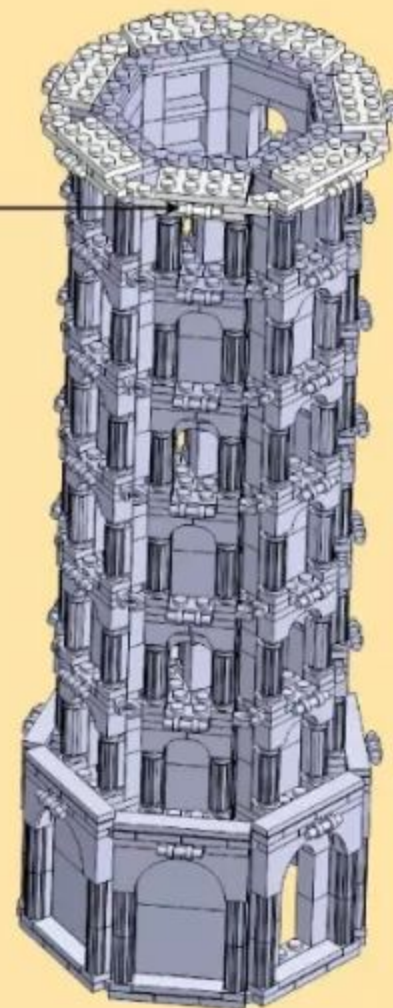
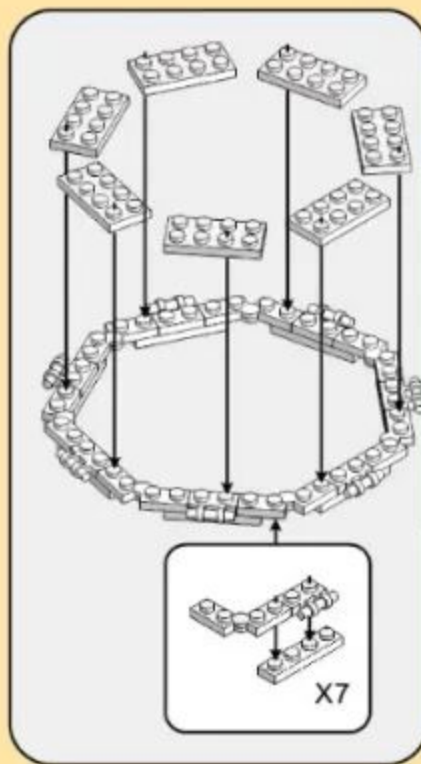
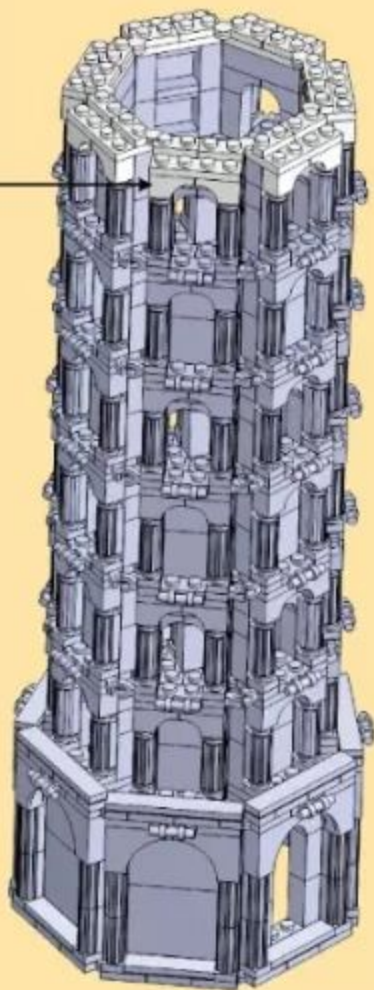
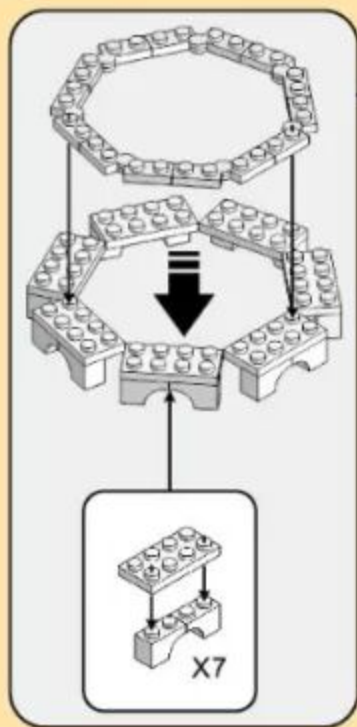



X7



X14



X14

30



X28



X14



X14



X14

31

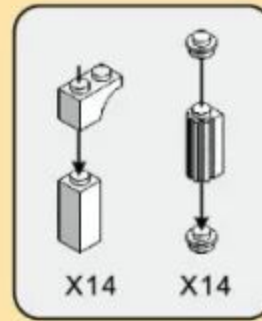
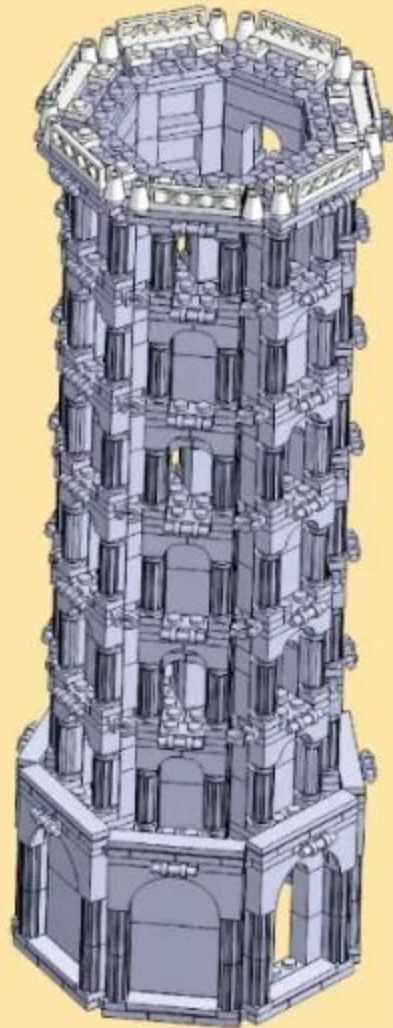

X14

X14

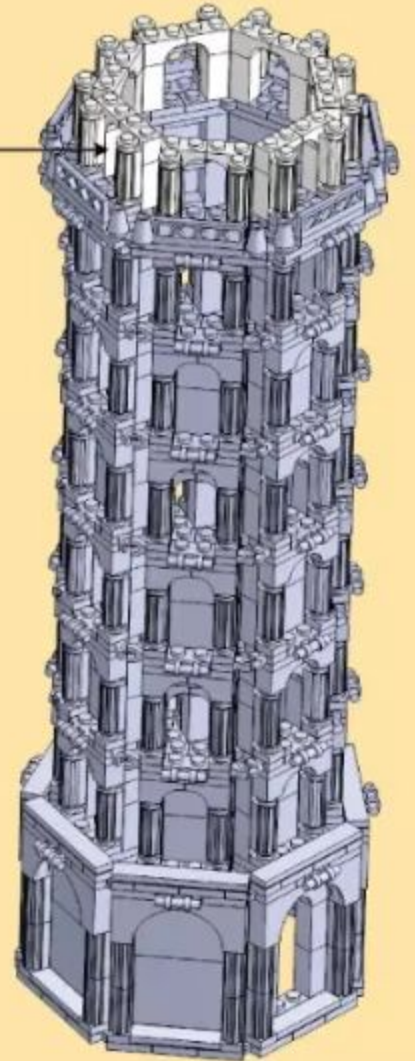



X14



X14

32



X7



X7



X14

33



X7



X7



X7

34

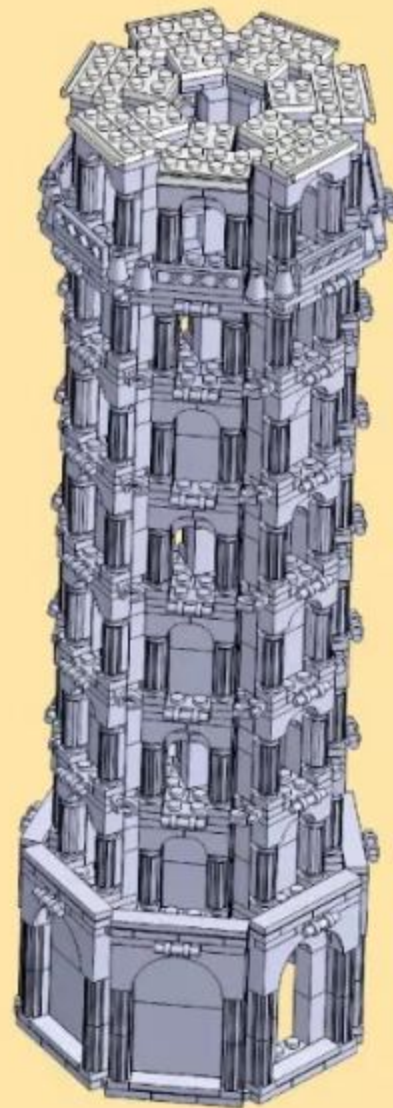
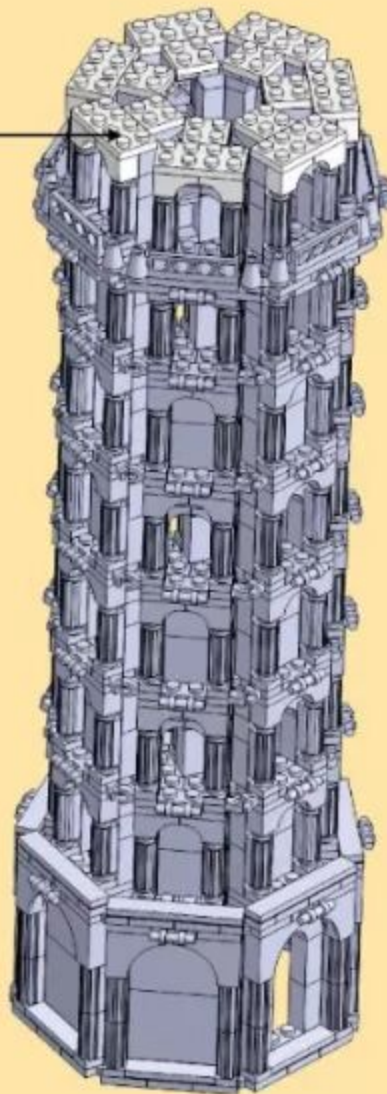
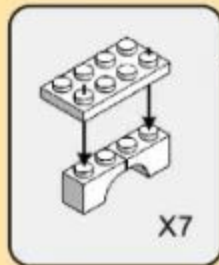
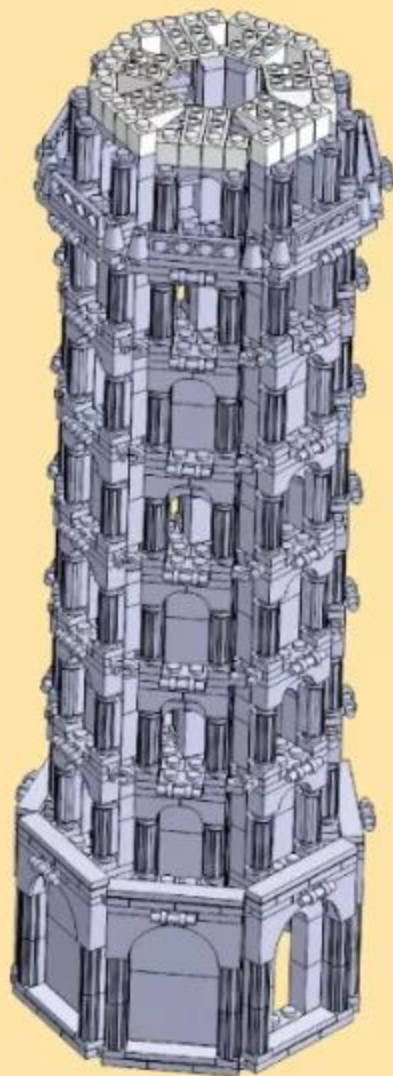



35

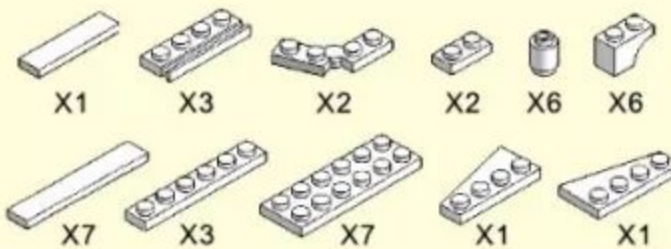
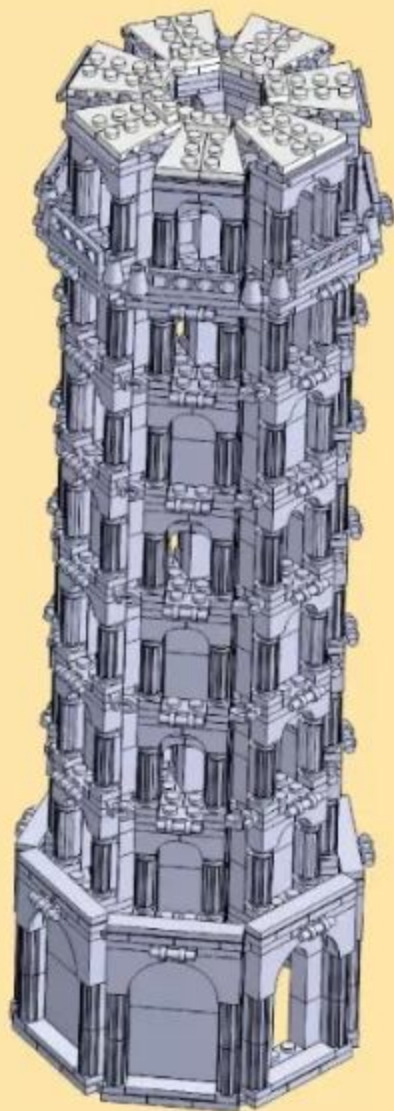

36

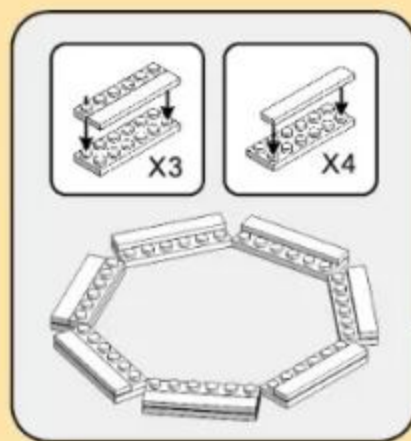
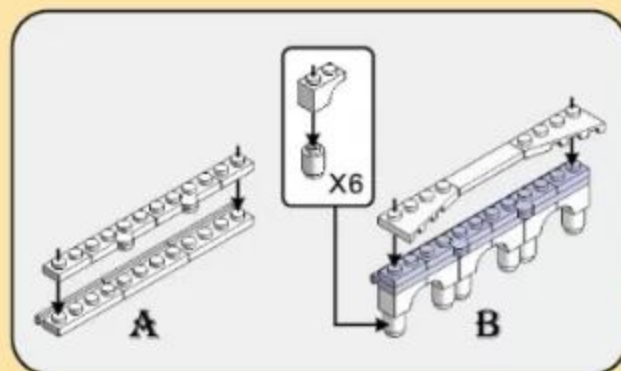
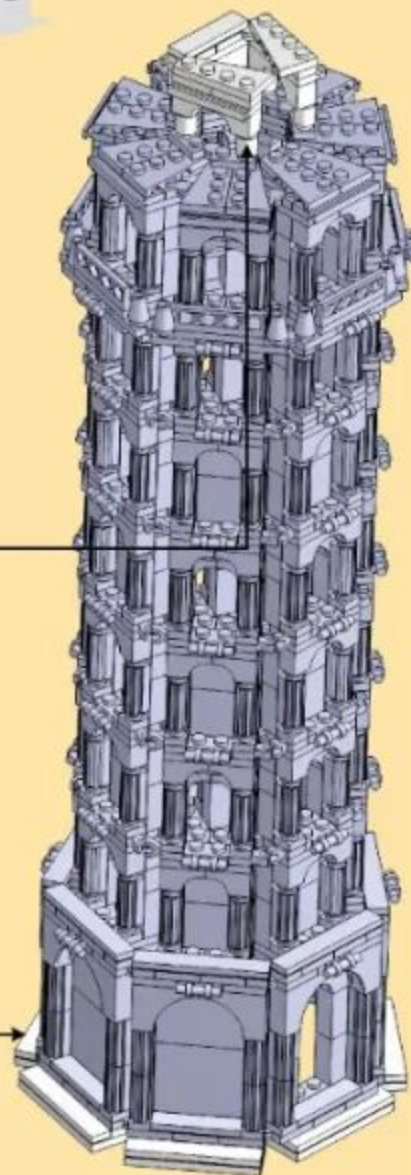



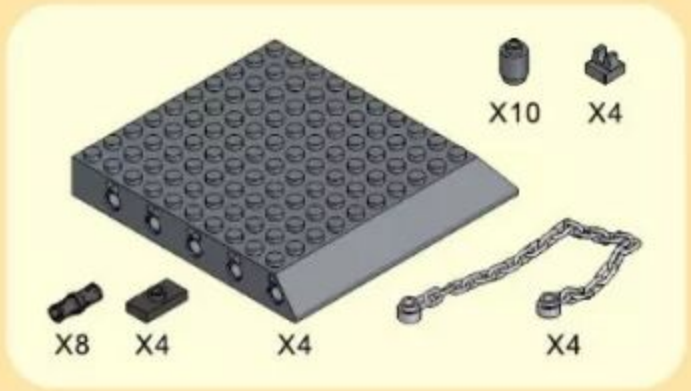

12

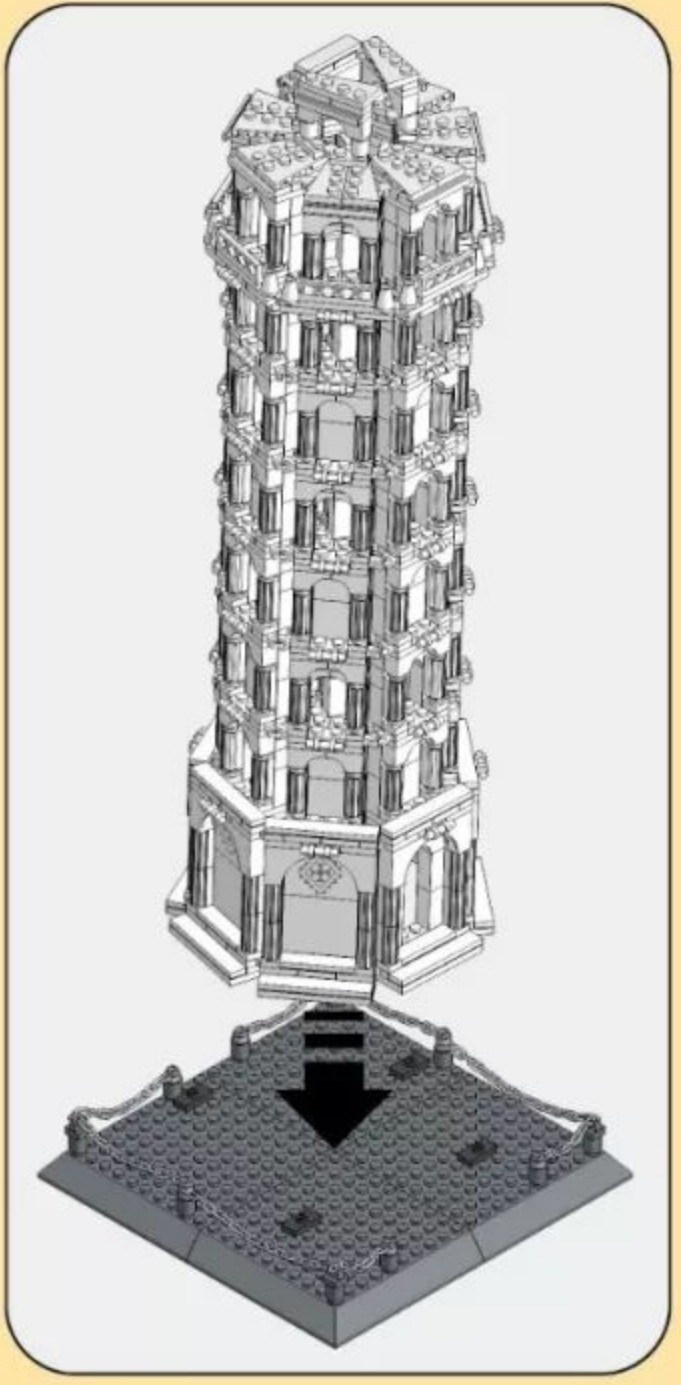
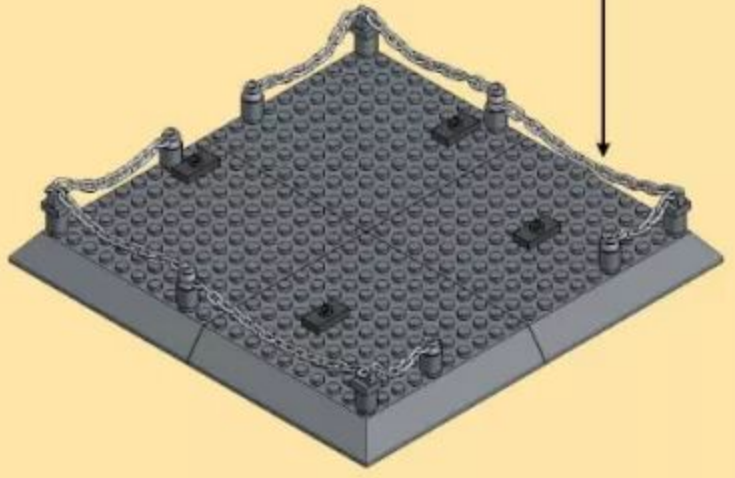
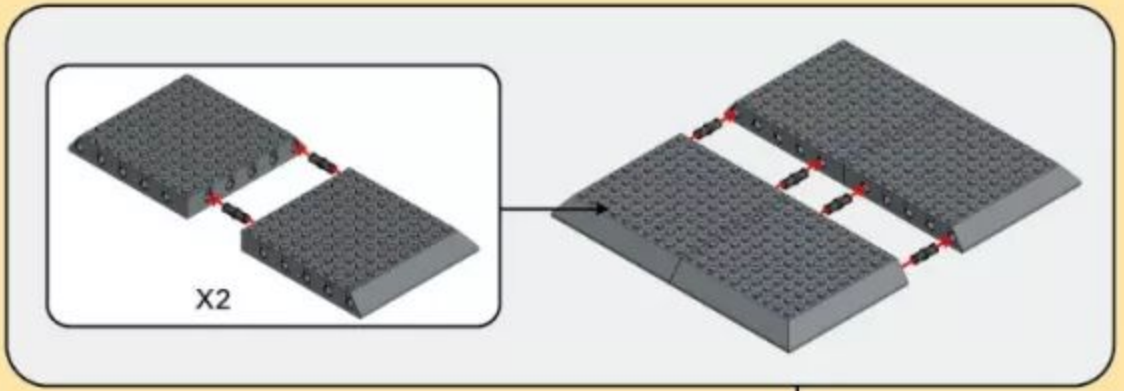

37

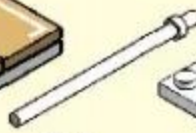

-  X1
-  X1
-  X1
-  X2
-  X1
-  X1
-  X1

-  X1
-  X1
-  X1
-  X1
-  X1
-  X1

38

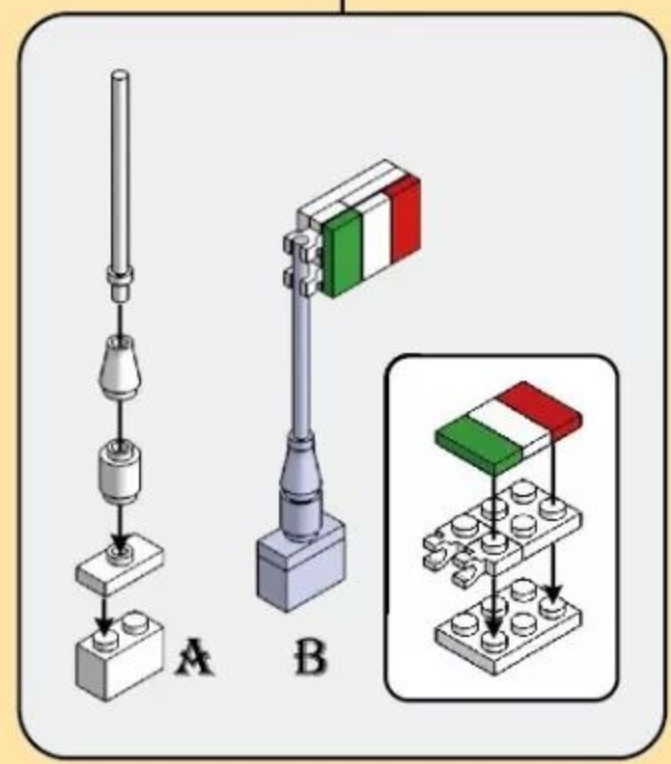
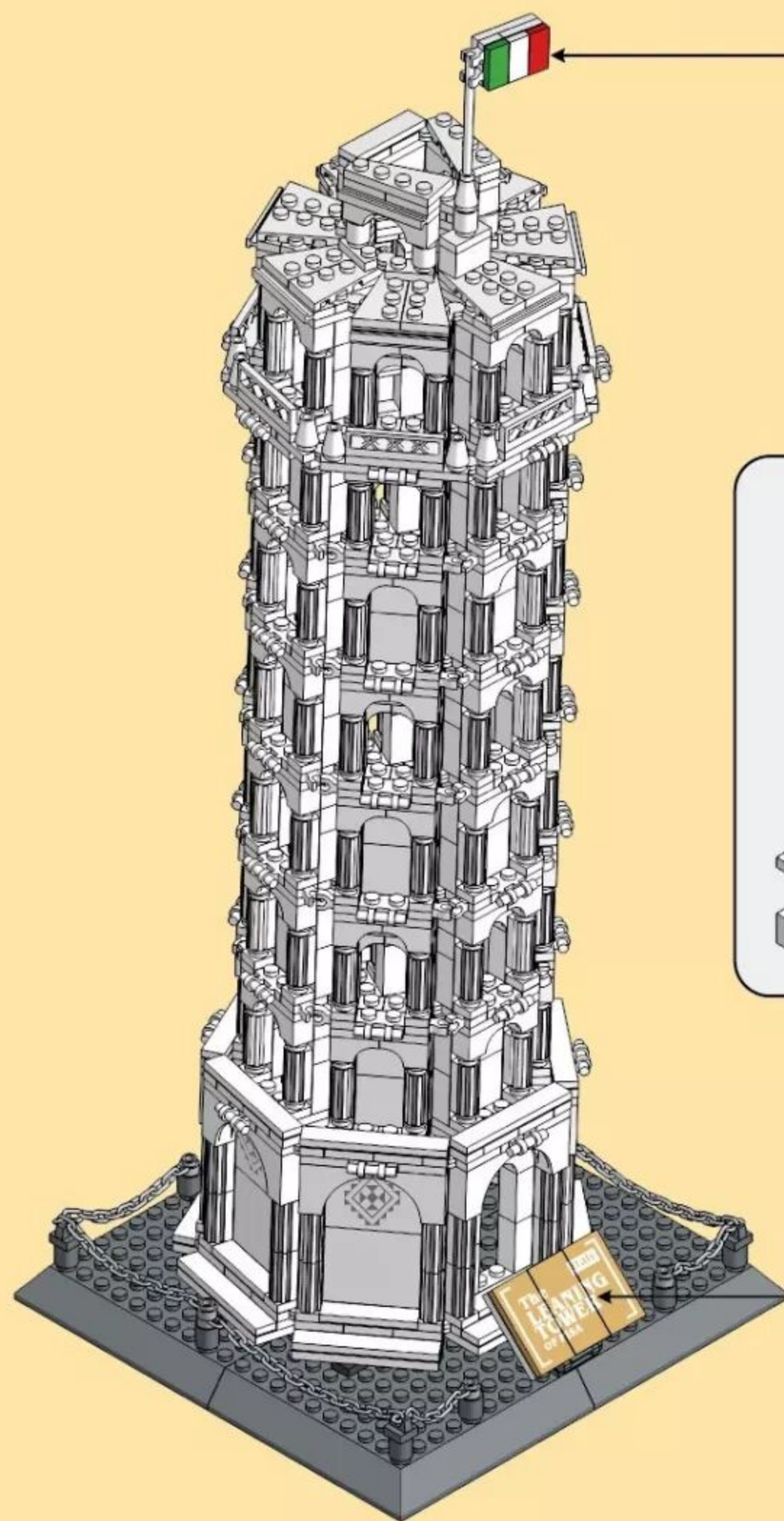



THE LEANING TOWER OF PISA

INTRODUCTION

The leaning Tower of Pisa in Italy is famous simply because it leans. It is the bell tower of the cathedral of the Italian city of Pisa. It is situated behind the Cathedral and is the third oldest structure in Pisa's Cathedral Square after the Cathedral and the Baptistery. The first stage was the building of the first three floors; this began in 1173 and stopped in 1178, when Pisa was at war. Construction began again in 1275 under an architect called Giovanni di Simone. He built the next three floors, and again work was halted until 1319. The final two floors were added between 1319 and 1350.

The tower was initially designed to be vertical. However, only 5 years after work on the building began, it was leaning noticeably to the north. The lean was first noticed during construction of the third floor. It leans because the tower is built on unsuitable ground and soft foundation for such a heavy and tall building. Prior to restoration work performed between 1990 and 2001, the tower leaned at an angle of 5.5 degrees. The tower now leans at about 3.99 degrees from where it would be if the structure were perfectly vertical. The height of the tower is 183.27 ft (55.86m) from the ground on the low side and 186.02 ft (56.70 m) on the high side.

