



TIANANMEN TOWER

中国北京天安门

Beijing, China

The world's great architecture



6+ / 5218 / 820 PCS
Suitable Age Product Number Parts Total



Architecture

It will be a city...

这将构成一座城市...

ABOUT THE PRODUCT

关于产品

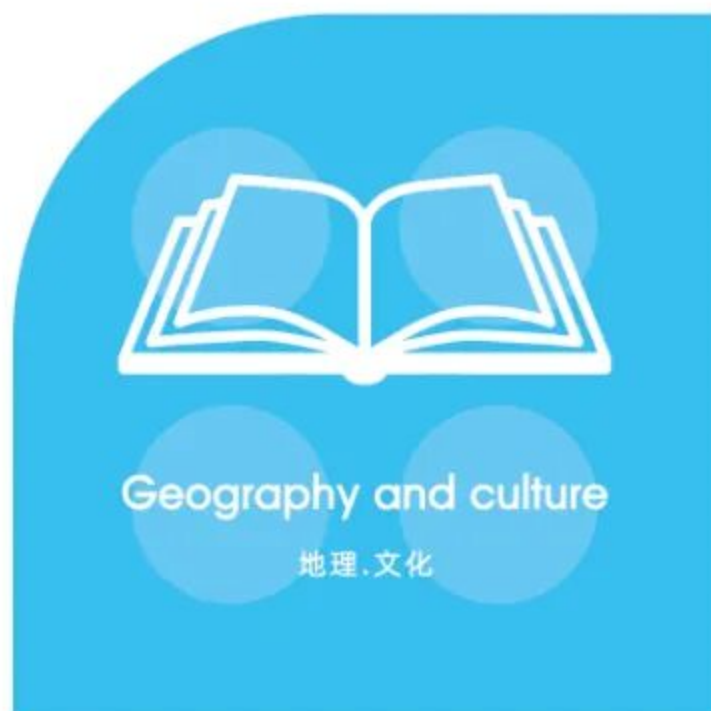

ARCHITECTURE

WANGE The world's great architect since 1991

Tiananmen Tower



The Tiananmen Tower is a monumental gate in the city center of Beijing, China and the front gate of the Imperial City of Beijing, located near the city's Central Business District, and widely used as a national symbol.

Tiananmen Tower



Geography and culture

地理.文化



First built during the Ming dynasty in 1417, Tiananmen Tower was the entrance to the Imperial City, within which the Forbidden City was located.

Tiananmen Tower is located to the north of Tiananmen Square, and is separated from the plaza by Chang'an Avenue.





中国北京天安门

Tiananmen ■ Tower China

The contents of this chapter refer to the Wikipedia website.

本章内容参考维基百科网站，更多资讯可自行查阅。

The world's great architecture

Buildings and layout

■ 建筑物和布局



天安门是明清两代北京皇城的正门，始建于明朝永乐十五年(1417年)，最初名“承天门”，寓“承天启运、受命于天”之意。设计者为明代御用建筑匠师蒯祥。清朝顺治八年(1651年)更名为天安门。由城台和城楼两部分组成，造型威严庄重，气势宏大，有汉白玉石的须弥座，总高34.7米。天安门城楼长66米、宽37米。城台下有券门五阙，中间的券门最大，位于北京皇城中轴线上。明清时，天安门是皇城的正门。正中门洞上方悬挂着毛泽东画像，两边分别是“中华人民共和国万岁”和“世界人民大团结万岁”的大幅标语。

Tiananmen Tower is the main gate of the imperial city in the Ming and Qing Dynasties. It was first built in the year of 1417 in the Ming Dynasty. It was originally named "Cheng tian gate", meaning of "Accepting Heavenly Mandate". The designer is Kuai Xiang, the imperial architect of Ming Dynasty. In 1651, it was renamed Tiananmen. The building is 66 meters (217 ft) long, 37 meters (121 ft) wide and 32 meters (105 ft) high. It has five gates. The largest one in the middle is located on the central axis of Beijing's imperial city. In the past, only the emperor could get in and out of it. Above the archway hangs a large portrait of Maozedong, on the east and west sides of which are two giant slogans, the left one reading: "Long Live the People's Republic of China" while the right one reading: "Long Live the Great Unity of the World's Peoples."



Symbolism

天安门城楼为中国传统的重檐歇山顶建筑，即由四个倾斜的顶面、一条正脊、四条垂脊、四条戗脊(垂脊下端折向的一条)和两侧倾斜层面上部转折成垂直的三角形墙面组成，形成两坡和四坡屋顶的混合形式。故有“八檐九脊”之称。城楼为木结构建筑，大殿飞檐下是排列有序的斗拱和梁枋。斗拱为中国传统木构架体系中独有，是斗形木弓形横木组成的具有翘、昂、拱特点的木制构件。梁枋又分额枋、檐枋，斗拱下面是额枋，上面彩画和金龙图案，柱子之间的构件叫檐枋，会有金龙和玺图案。

Tian'anmen Tower is a traditional Chinese double eaves Xieshan building, which is composed of four sloping top surfaces, one main ridge, four vertical ridges, four berm ridges (the one at the lower end of the vertical ridge) and the upper part of the inclined layers on both sides turning into vertical triangular walls, forming a mixed form of two slope and four slope roof. Therefore, it is called "eight eaves and nine ridges". The tower is a wooden structure, and under the eaves of the main hall are arranged orderly with brackets and beams.



Design and construction

城楼的主体建筑分为上下两层。上层是重檐歇山式，黄琉璃瓦顶的巍峨城楼，东西面阔九楹，南北进深五间，取“九五”之数，象征皇帝的尊严。正面上有36扇菱花格式的门窗。城楼内所用木材大部分是楠木，大殿内有60根直径为92厘米的红漆木柱，承受着屋顶建筑大部分重力。排列整齐，柱顶上有藻井与梁枋，绘着金龙吉祥彩画和团龙图案。正面的36扇门窗为中国传统的菱花格式，屋顶上的天花藻井画的是团龙图案，在殿厅堂纵横交错的梁枋上绘的是金龙和玺彩绘；17盏古雅的大型宫灯，最大的那盏称为主灯，有8个面，全高6米，直径2.8米，重约450公斤；其余16盏为6个面的辅灯，每个高6米，直径2.2米，重约350公斤。每盏灯上的角各有一盏伞形小灯。地面铺的全是金砖，面积约2000平方米。

屋顶的正脊与垂脊上装饰着螭吻、仙人、走兽。下层是高13米的朱红色城台，四周环绕琉璃瓦封顶的矮墙，下部是1.59米高的雕刻精美的汉白玉须弥座台基，座上为高10多米的红色墩台，以每块重达43千克的大砖砌成。城楼基座周围有汉白玉栏杆、栏板，雕刻着莲花宝瓶图案。

The main building of the tower is divided into two floors. The upper layer is a tower with double eaves and a yellow glazed tile roof. There are nine rooms in the East and West and five rooms in the north and south. The nine-room-wide and five-room-long gate tower was made to reflect the highly-exalted status of the emperor. There are 36 doors and windows on the front. Most of the timber used in the tower is Phoebe. There are 60 red painted wooden columns with a diameter of 92 cm in the main hall, which bear most of the gravity of the roof building. The floor is covered with gold bricks, covering an area of about 2000 square meters.

Creation and thinking

创作·思考

Drawing Design

手绘设计



Guangdong Baoge Educational Material Sci-Tech Co., Ltd.
©2014 Wange / Dubie. All Rights Reserved

Force Balance

受力平衡

Physical operations

物理运算

$$F = G \frac{m_1 m_2}{d^2}$$

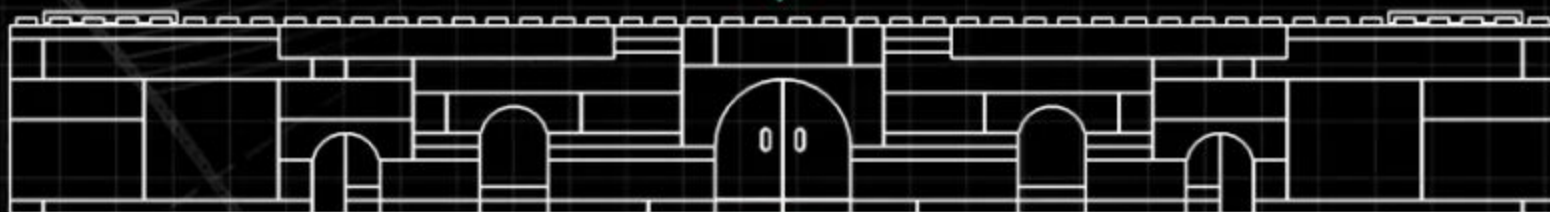
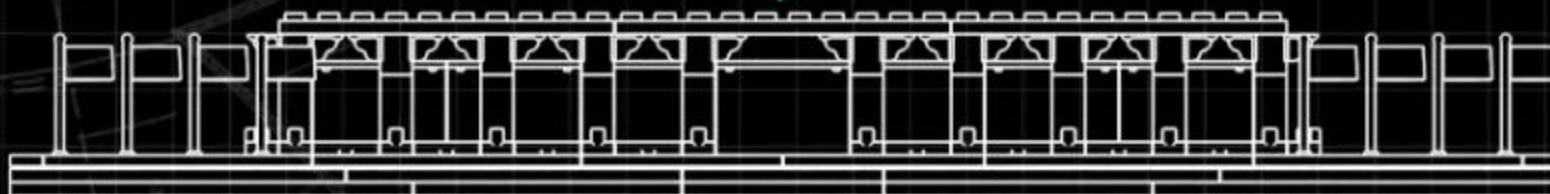
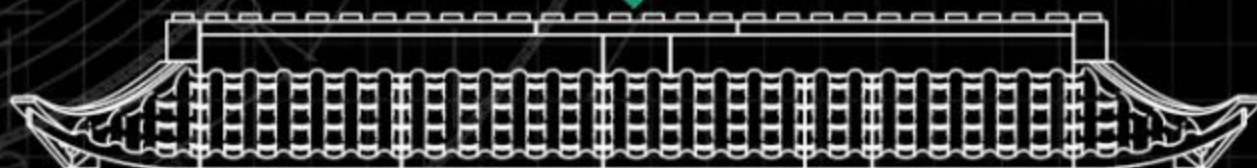
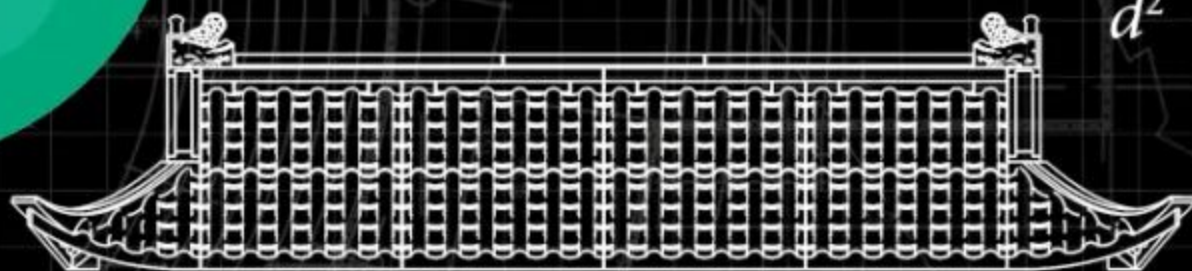

Creation and thinking

创作·思考

Special parts

特殊零件的开发利用



$$a^2 + b^2 = c^2$$

WG1274

1孔栏杆

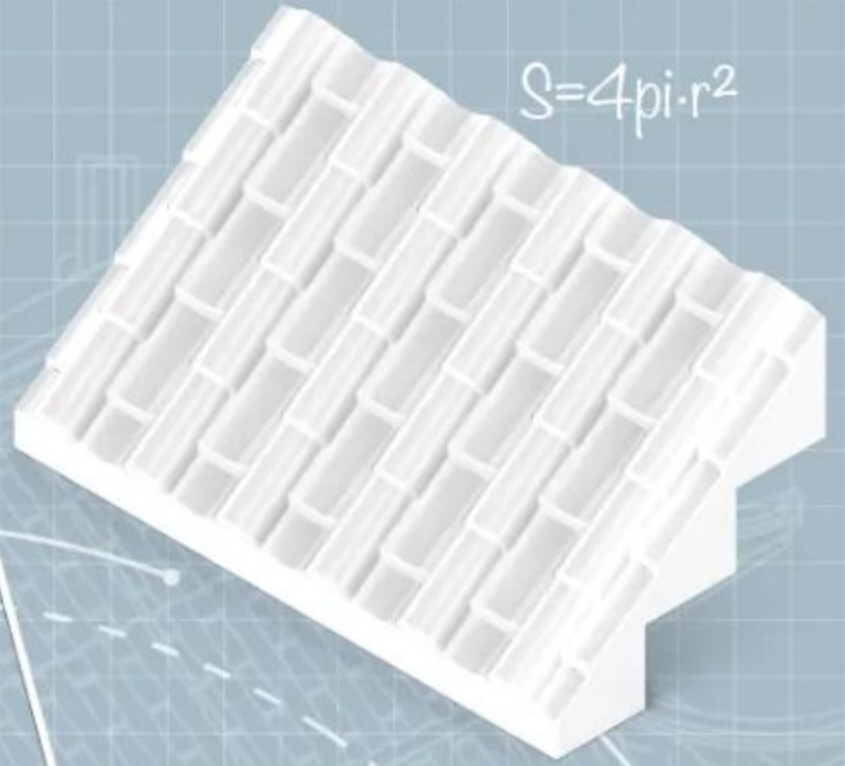

$$S = 4\pi \cdot r^2$$

WG0534

直瓦片6孔



WG1289

雀替柱



WG1290

雀替



WG1291

2倍雀替



WG0532

直瓦片

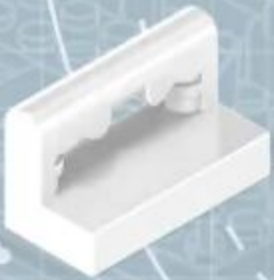

WG1275

2孔栏杆



WG1284

2孔龙头砖



$$\sin^2 a + \cos^2 a = 1$$

WG0533

角瓦片



features and function

特点.功能

Main Color Matching

配色方案



Pantone Black 6C



Pantone 431C



Pantone 347C



Pantone 285C



Pantone 1575C



Pantone 123C



Pantone 7620C



Pantone 189C



Pantone 7509C

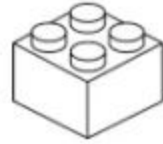

White



Pantone Cool Gray 6C



Color matching

Adopting 3 main colors, White, Orange and Red as the main color, the more reasonable and bold color matching on the original building, making the product more atmospheric and the whole design is more reasonable.

Tiananmen Tower

中国北京天安门



Front

Left

Back

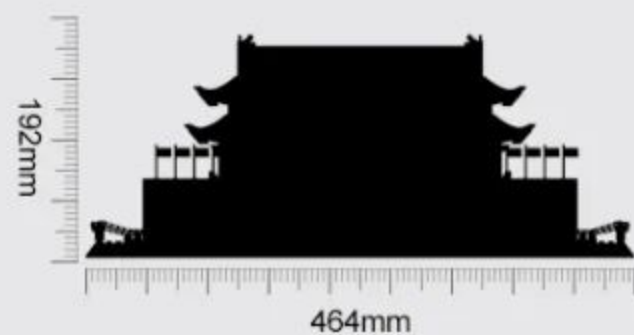
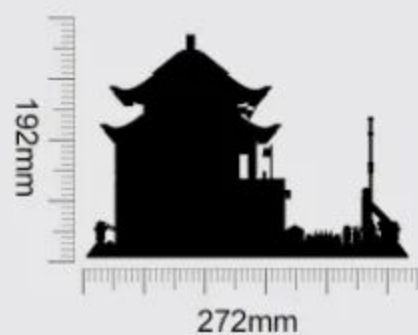
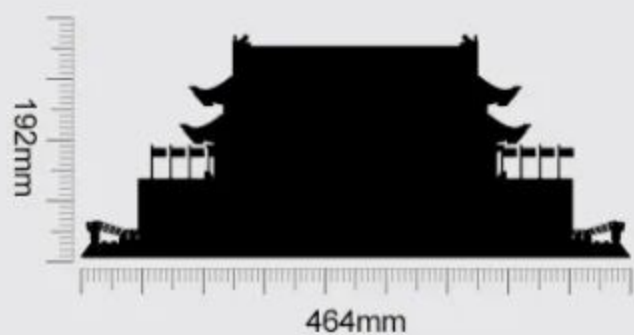

Product Size:464X272X192mm



Instructions For Use

积木起件器使用说明
Brickseparator

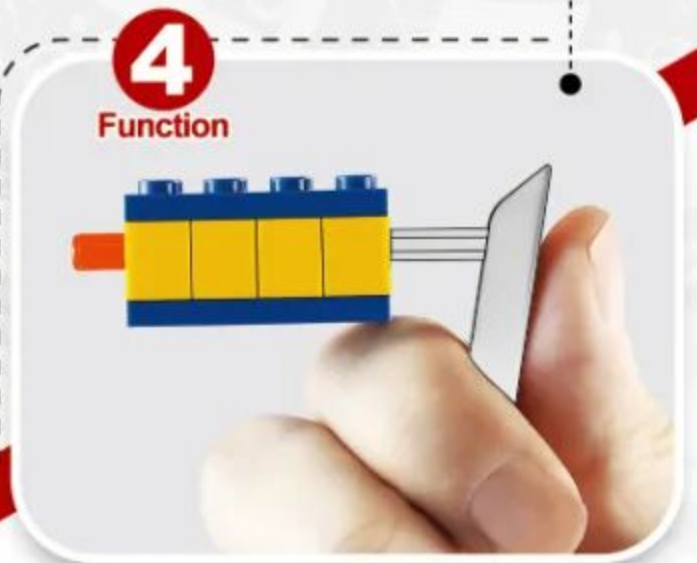
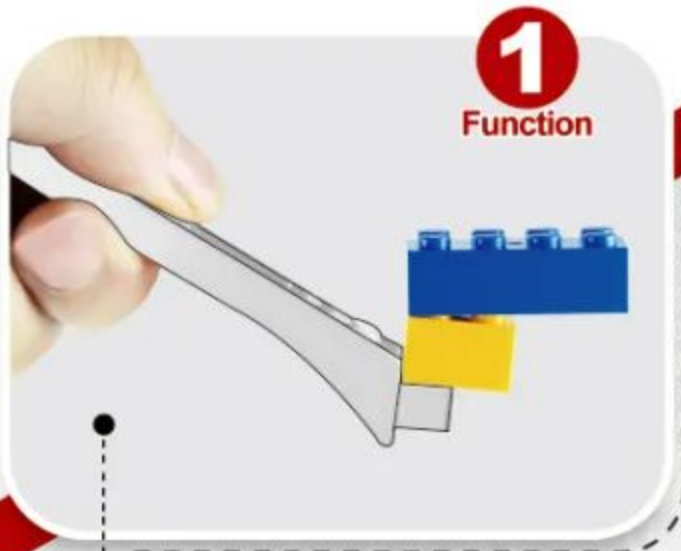

4 ways to make installation easier
让安装更简单



- First open the product packaging according to the instructions.

按指导用正确方式拆解产品外包装。



- Summarize all parts to count the number of familiar accessories.

对照说明书清单确认积木包数量与积木数量。



- Arranging all accessories by color helps to quickly install the product.

把确认好的积木以类型、颜色进行分类排好以便安装。



- Carefully install the product and learn about building.

按说明书步骤拼装并完成你的积木模型。



1:1 Physical Reference Table

十字棒配件1:1尺寸参照表



Instructions For Use

让安装更简单



2 $(1 \times 2) = 2$



3 $(1 \times 3) = 3$



4 $(1 \times 4) = 4$



5 $(1 \times 5) = 5$



6 $(1 \times 6) = 6$



7 $(1 \times 7) = 7$



8 $(1 \times 8) = 8$



9 $(1 \times 9) = 9$



10 $(1 \times 10) = 10$



12 $(1 \times 12) = 12$



16 $(1 \times 16) = 16$



PARTS LIST

配件清单

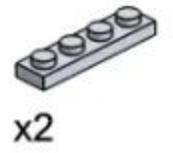
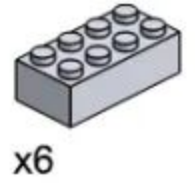
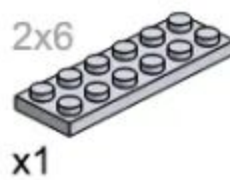
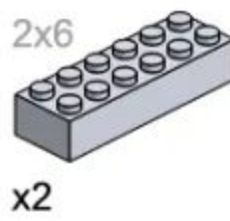
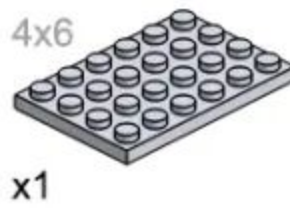
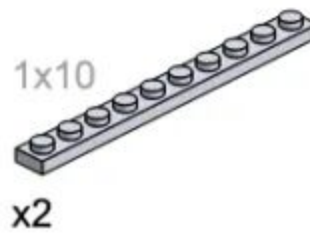
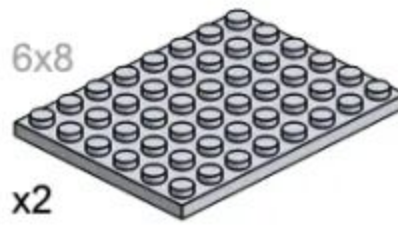
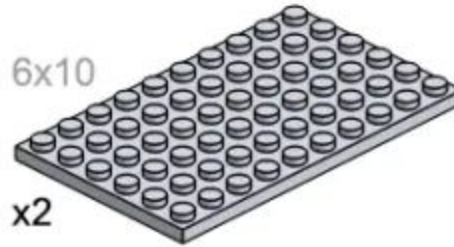
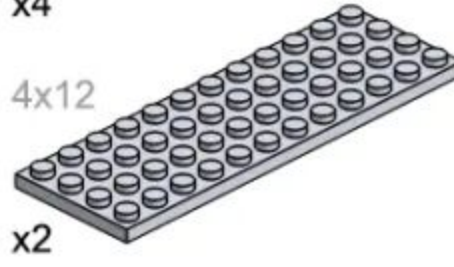
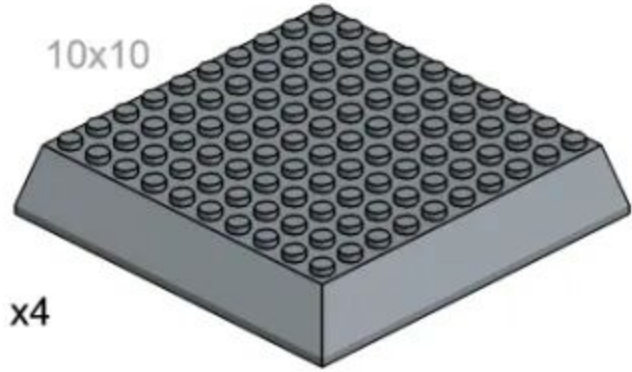
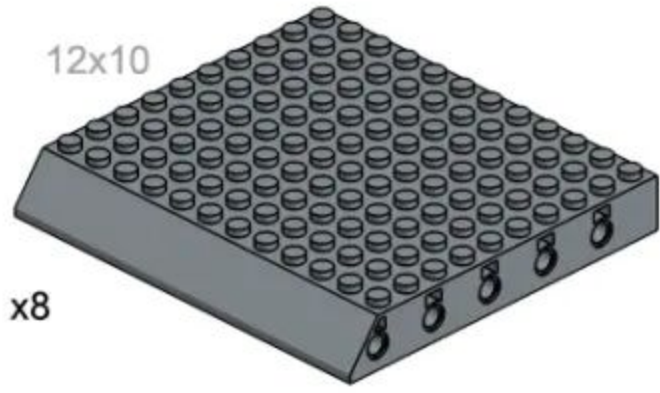

产品有增补件请以实物为准
If product has additional parts, please in kind prevail.

PARTS LIST

配件清单

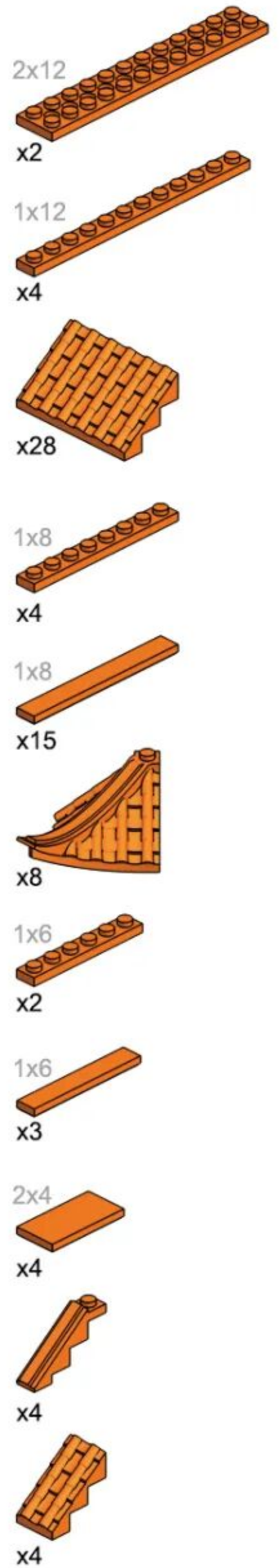
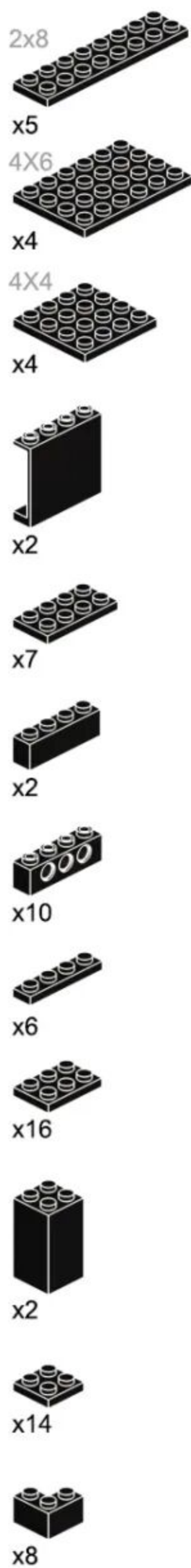
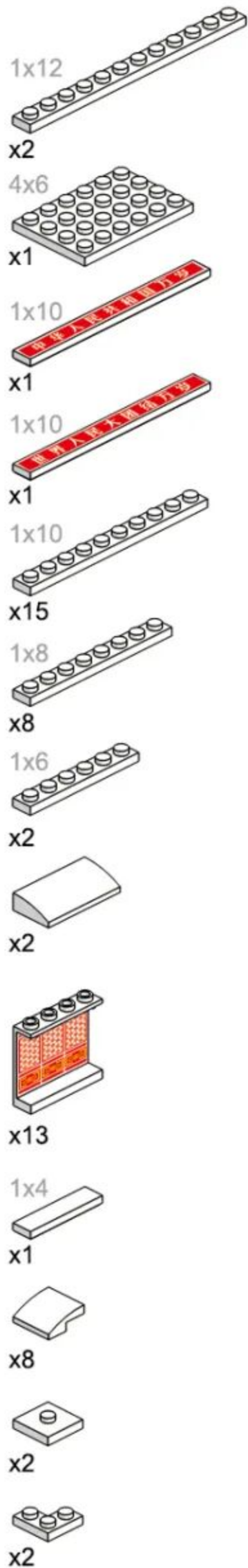

















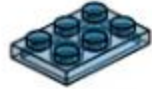







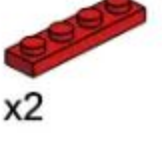

产品有增补件请以实物为准

If product has additional parts, please in kind prevail.

PARTS LIST

配件清单

1x16 x4	1x5 x2	 x1	1x12 x7	1x10 x2
1x16 x2	1x5 x2	 x1	1x10 x3	1x8 x2
1x12 x3	 x2	 x4	1x10 x7	1x6 x2
1x12 x4	 x28	 x4	1x8 x4	2x10 x2
1x10 x2	 x2	 x2	1x8 x2	 x2
1x8 x4	1x5 x5	 x4	1x8 x2	 x2
1x8 x4	 x4	 x14	1x6 x2	 x1
1x6 x4	 x2	 x2	 x2	 x6
1x6 x5	 x2	 x10	 x4	 x6
1x6 x2	 x1	 x6	 x20	
	 x4	 x10		

产品有增补件请以实物为准
If product has additional parts, please in kind prevail.



73PCS

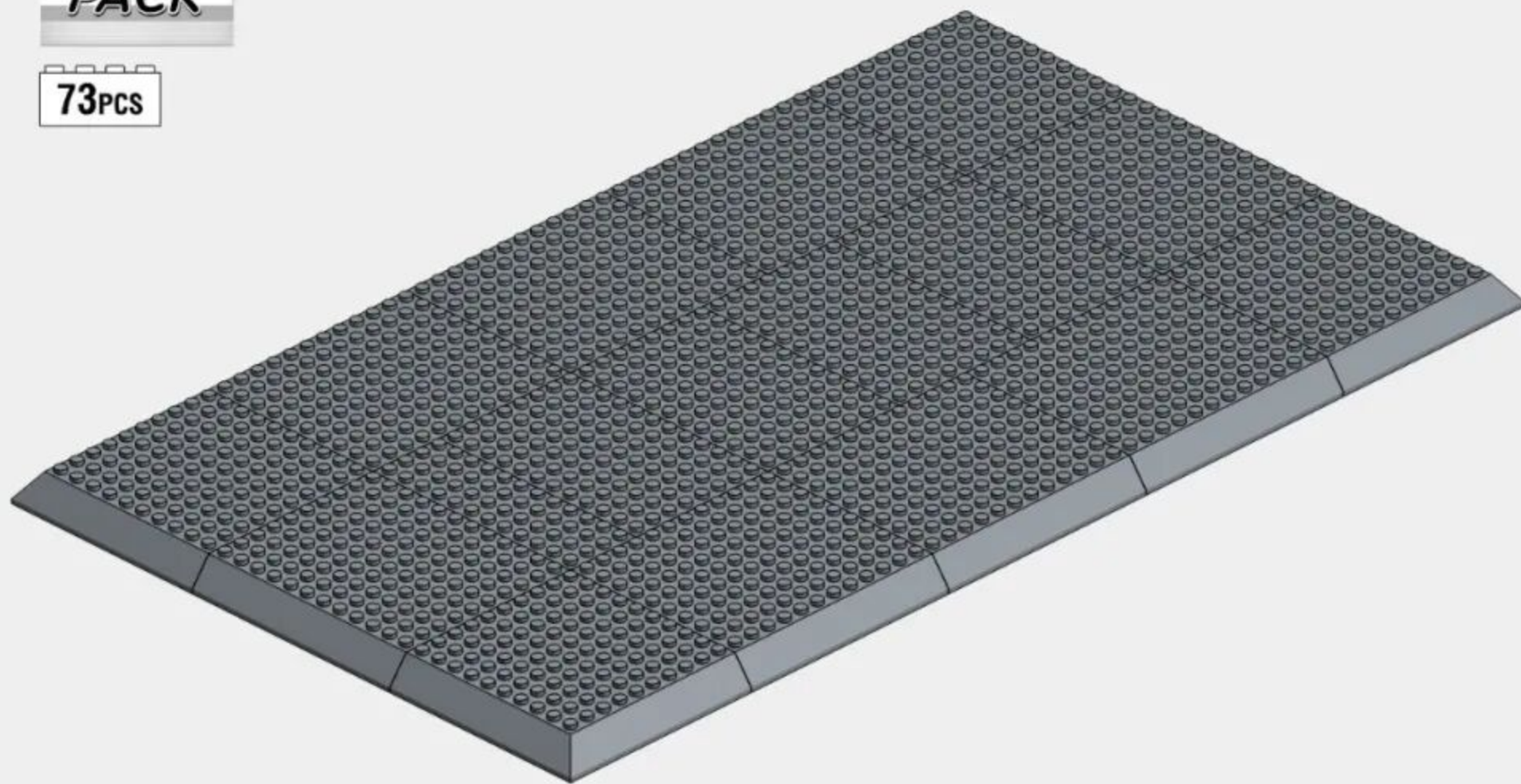

1-1



微信扫一扫
补件更简单

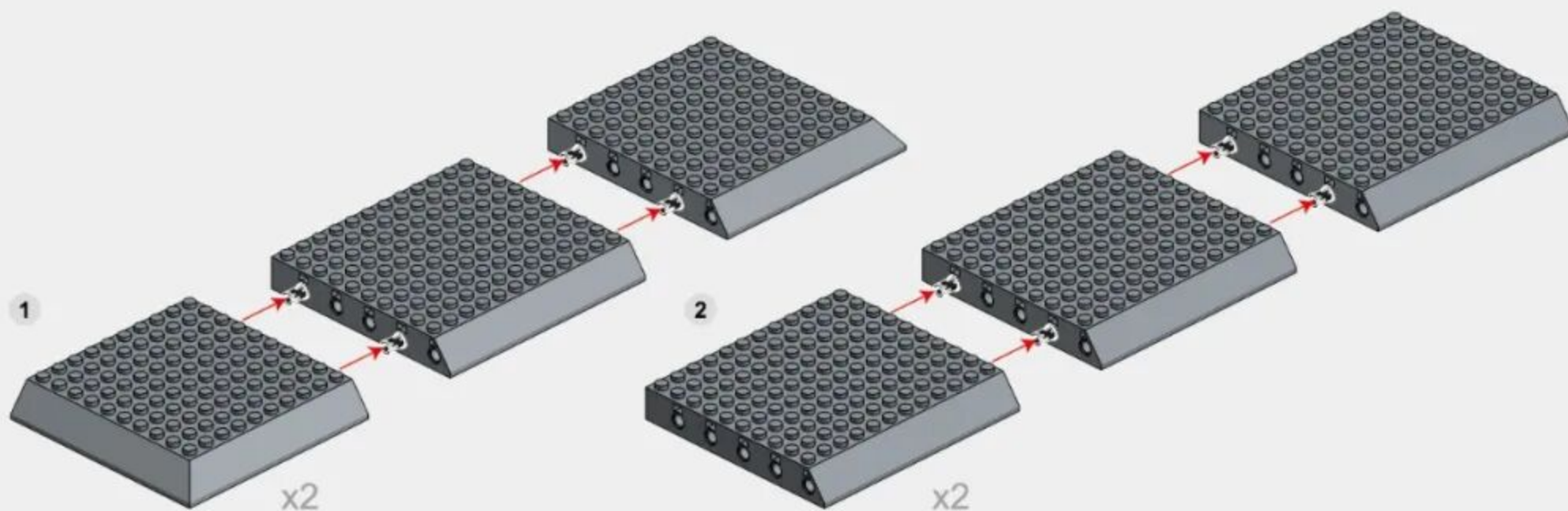
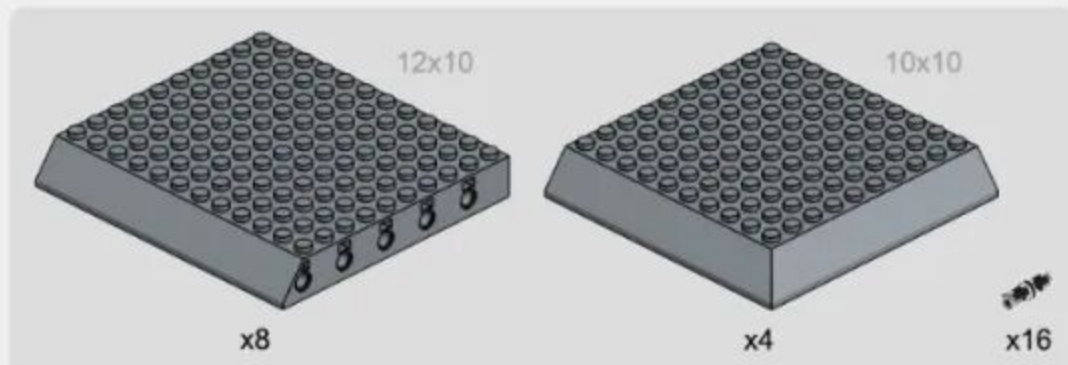

Vertical View of Installation Drawing
安装图顶面

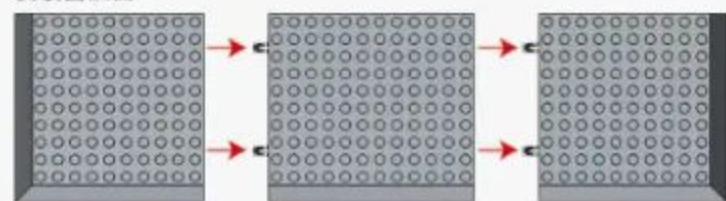

Vertical View of Installation Drawing
安装图顶面

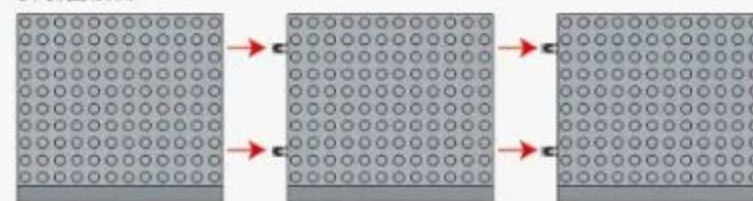

1-2

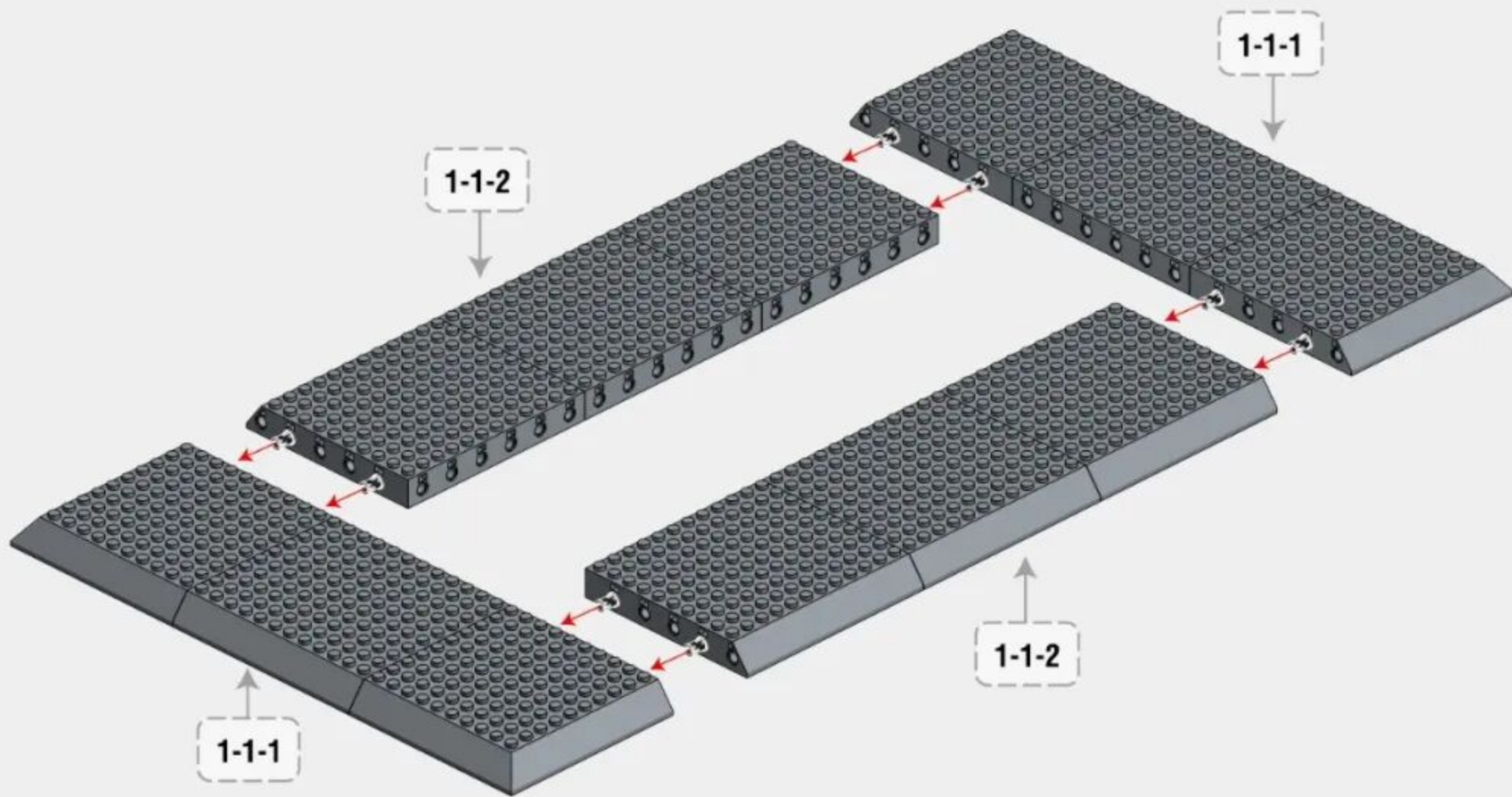

1-3

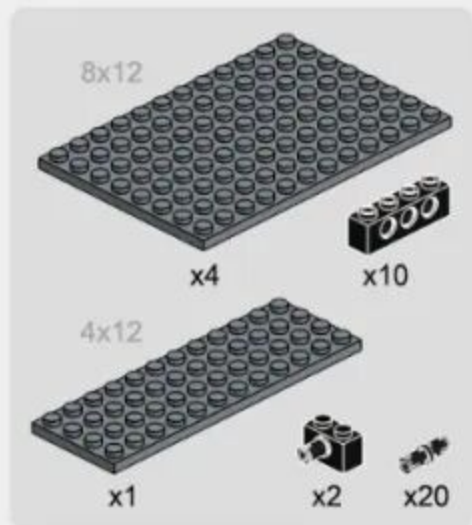

8x12

x4

4x12

x1



x2



x20

x10

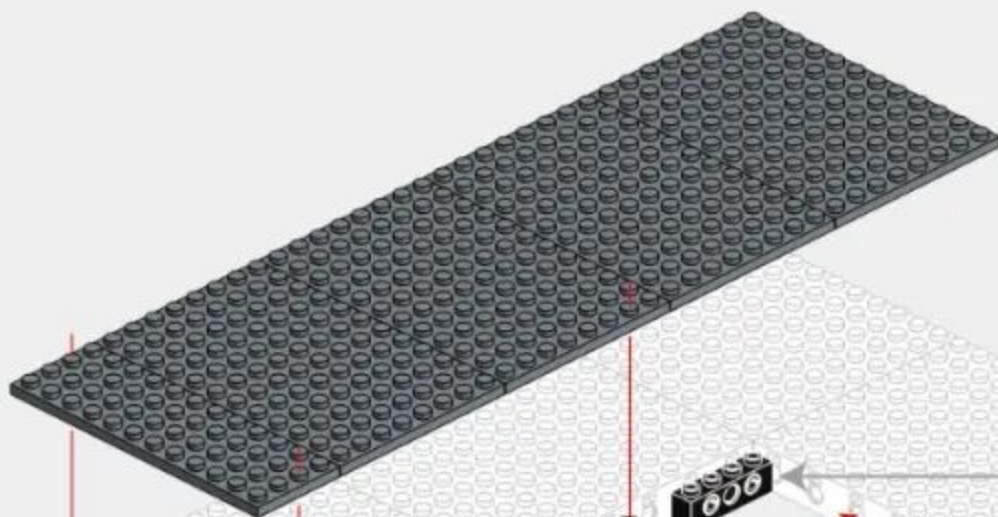

x10

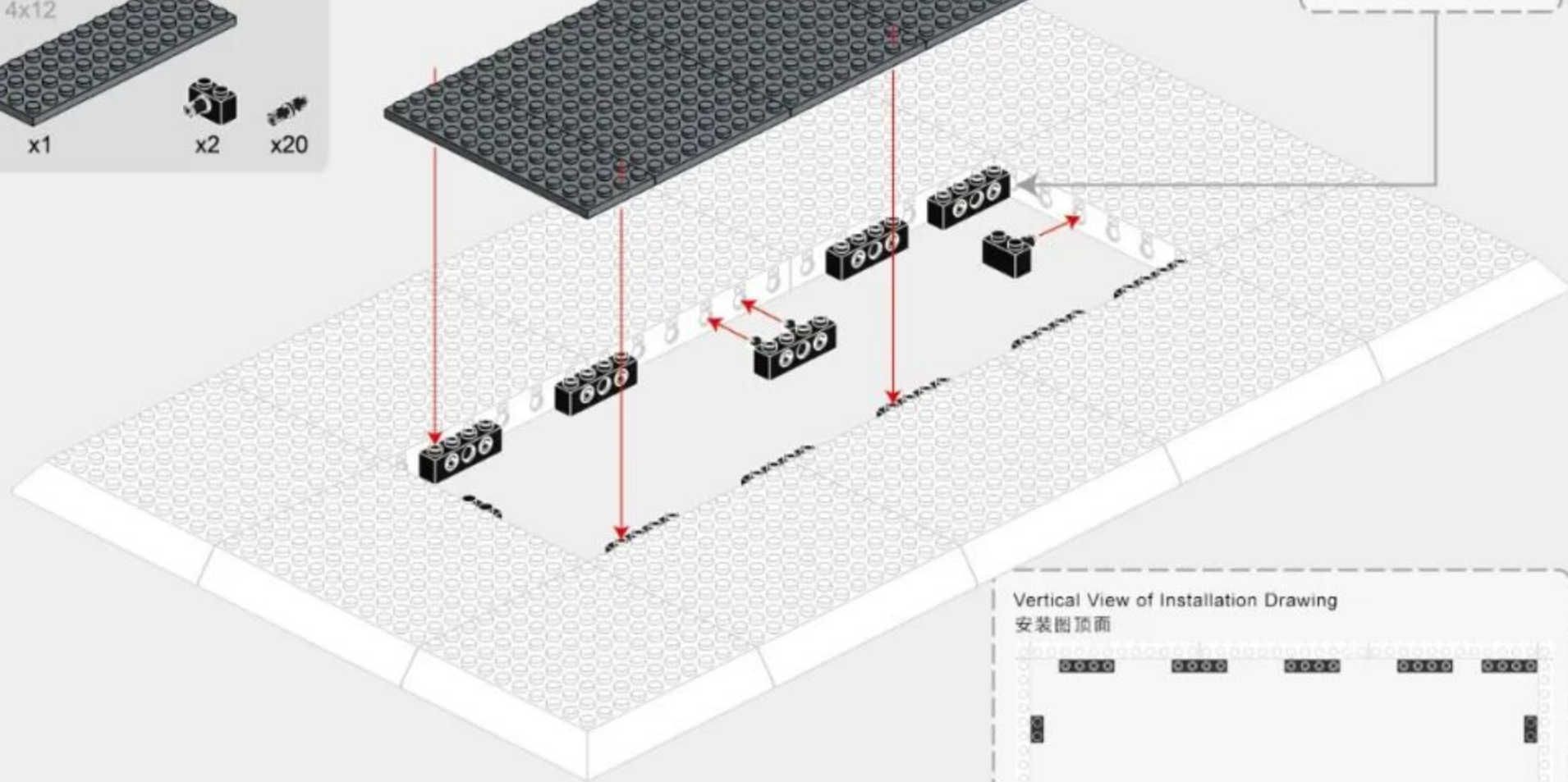

Vertical View of Installation Drawing
安装图顶面





181 PCS

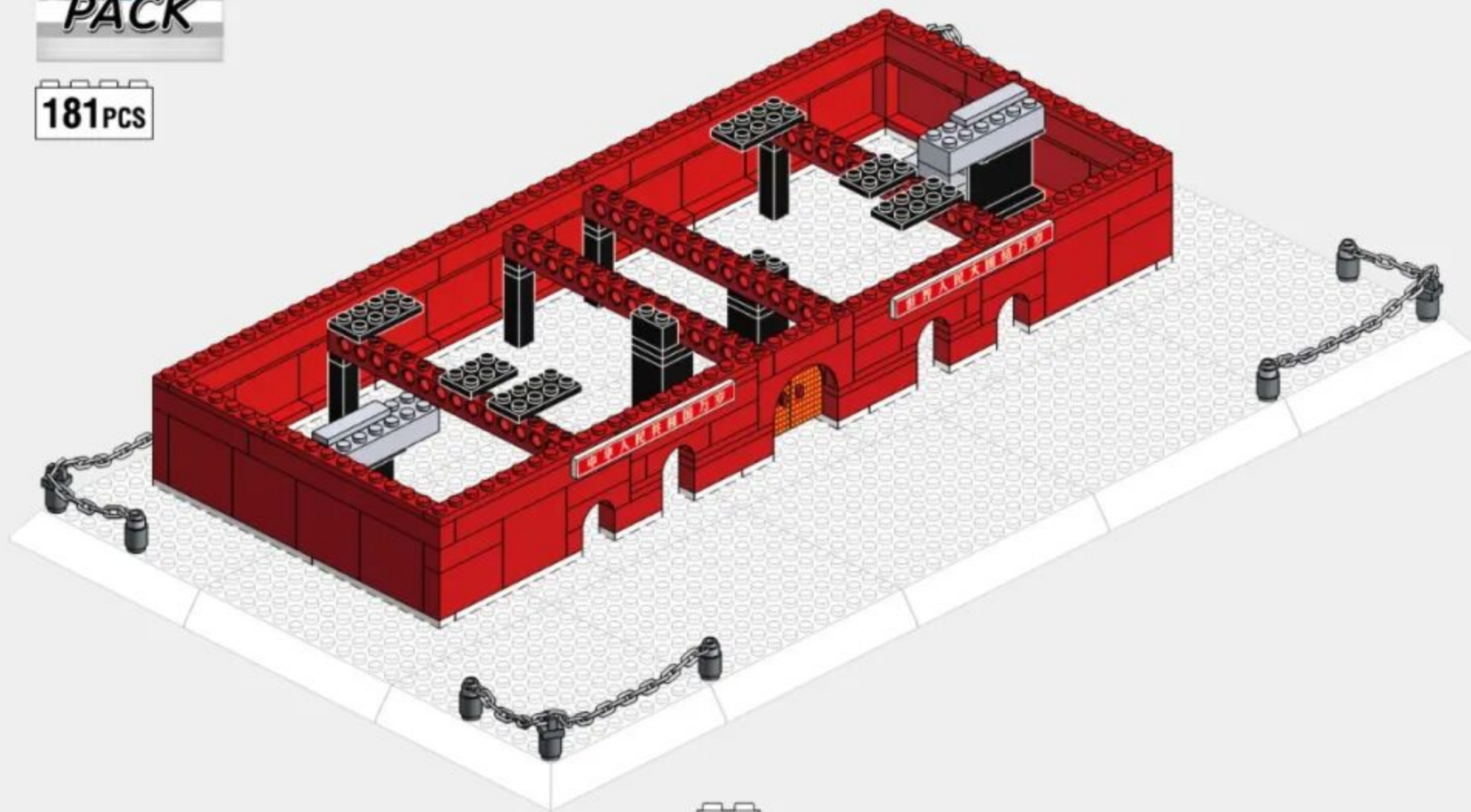

23

2-3

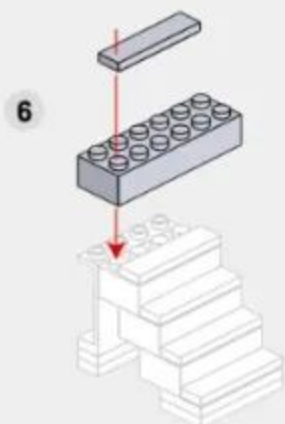
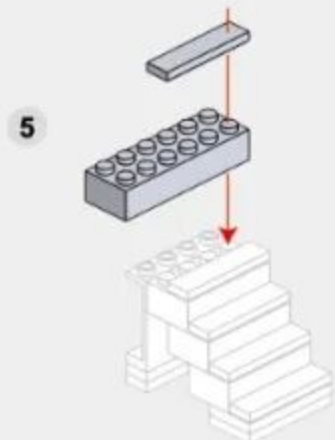
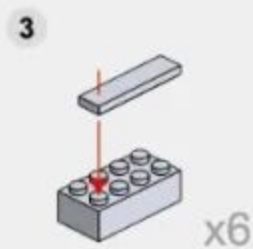
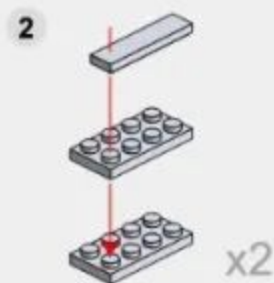
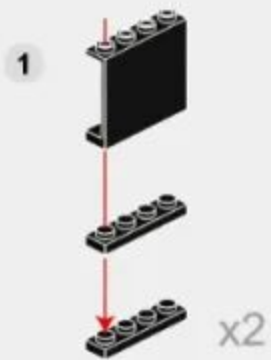
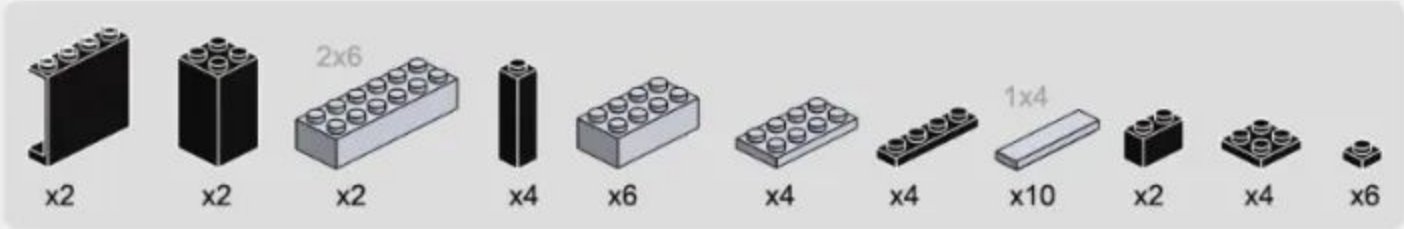

2-4

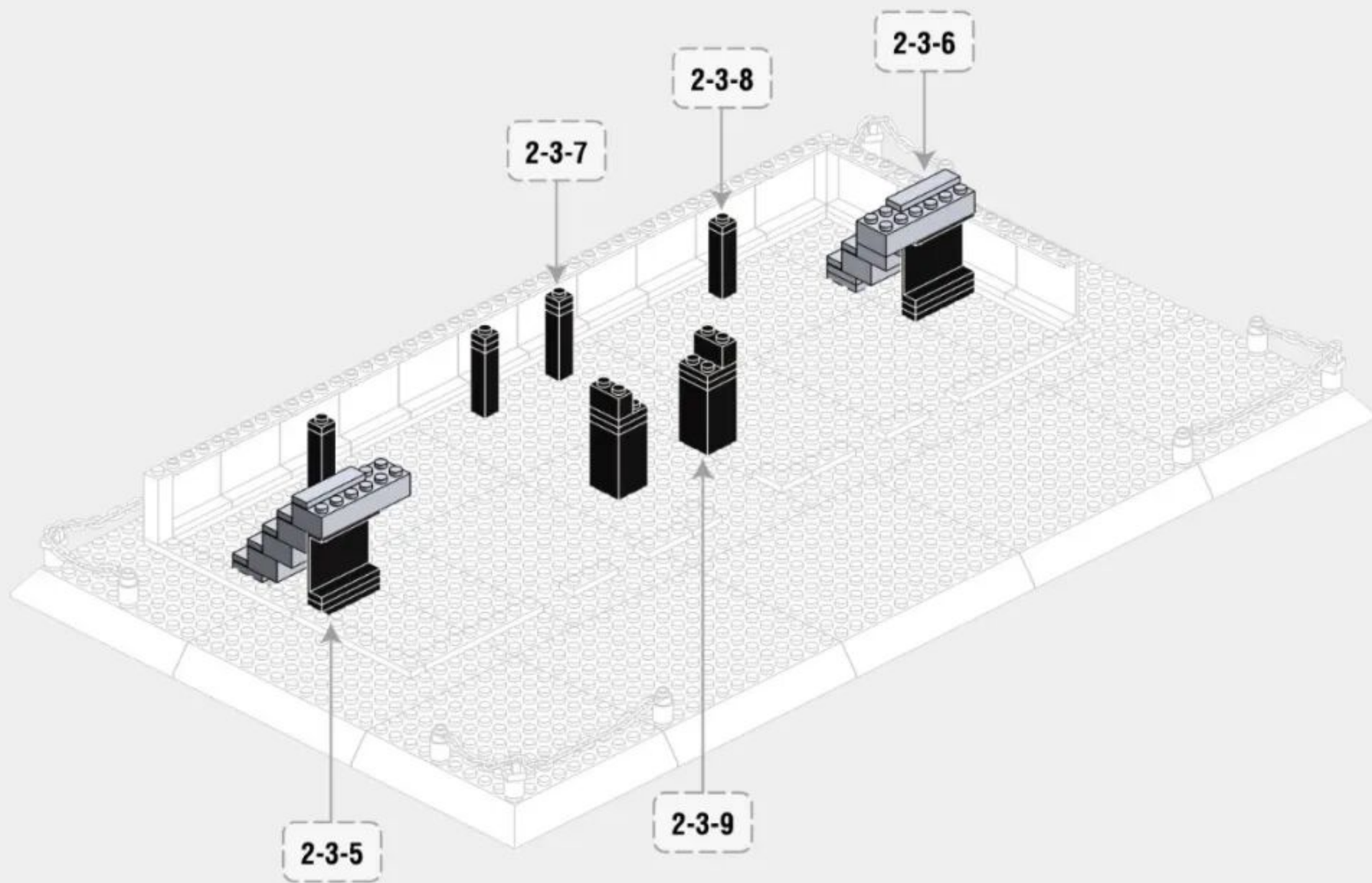

2-5

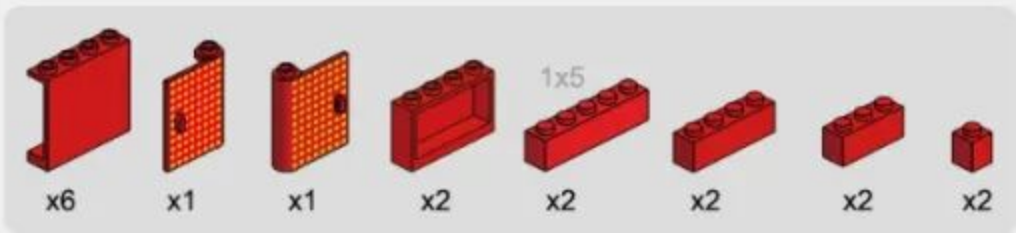

2-6

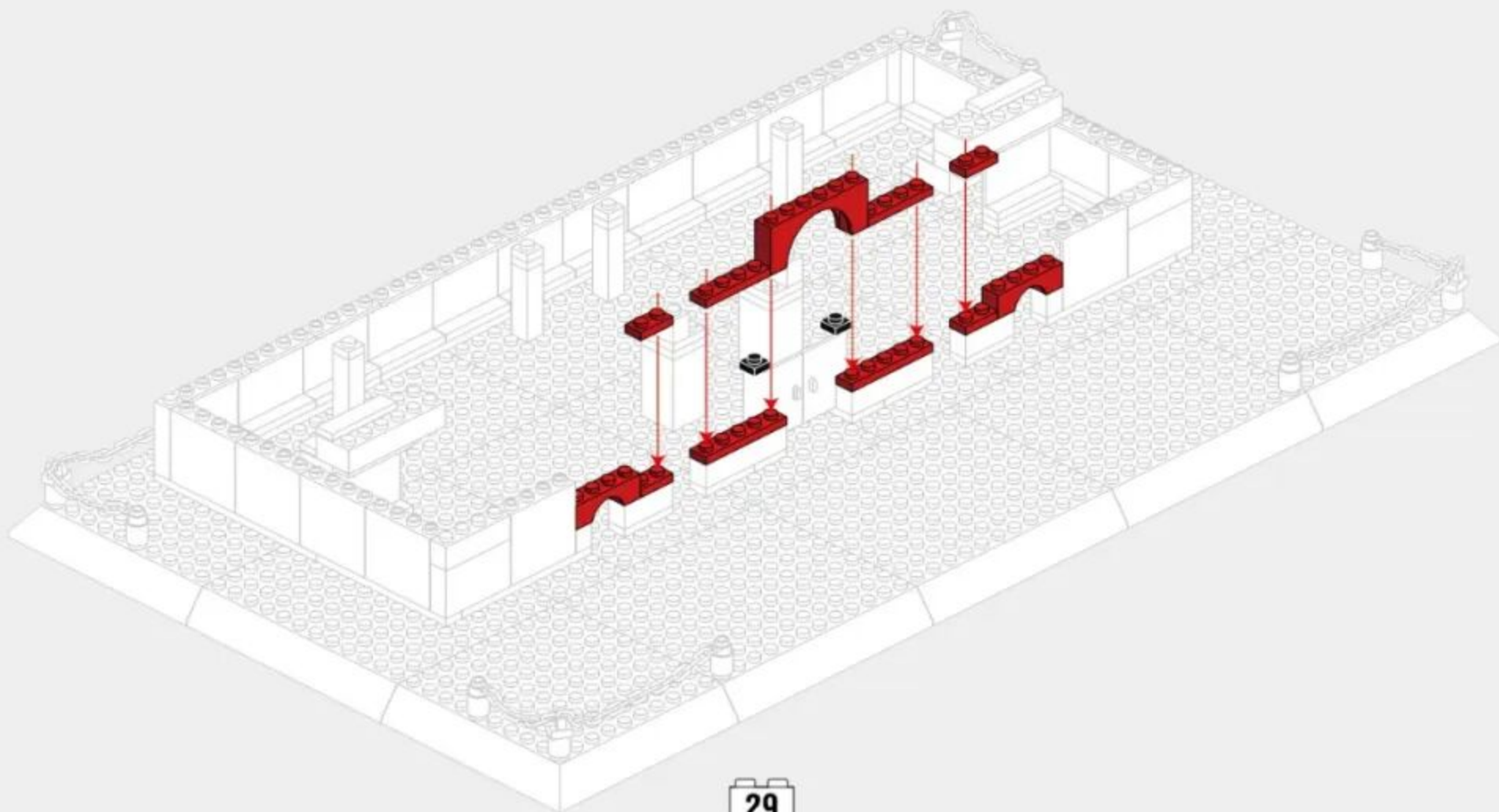
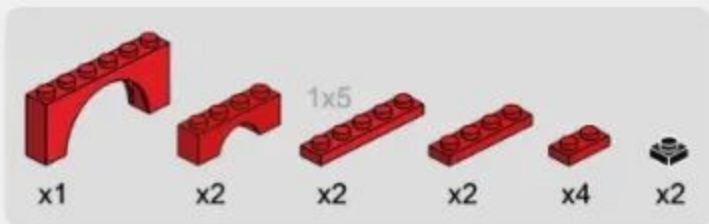

2-7

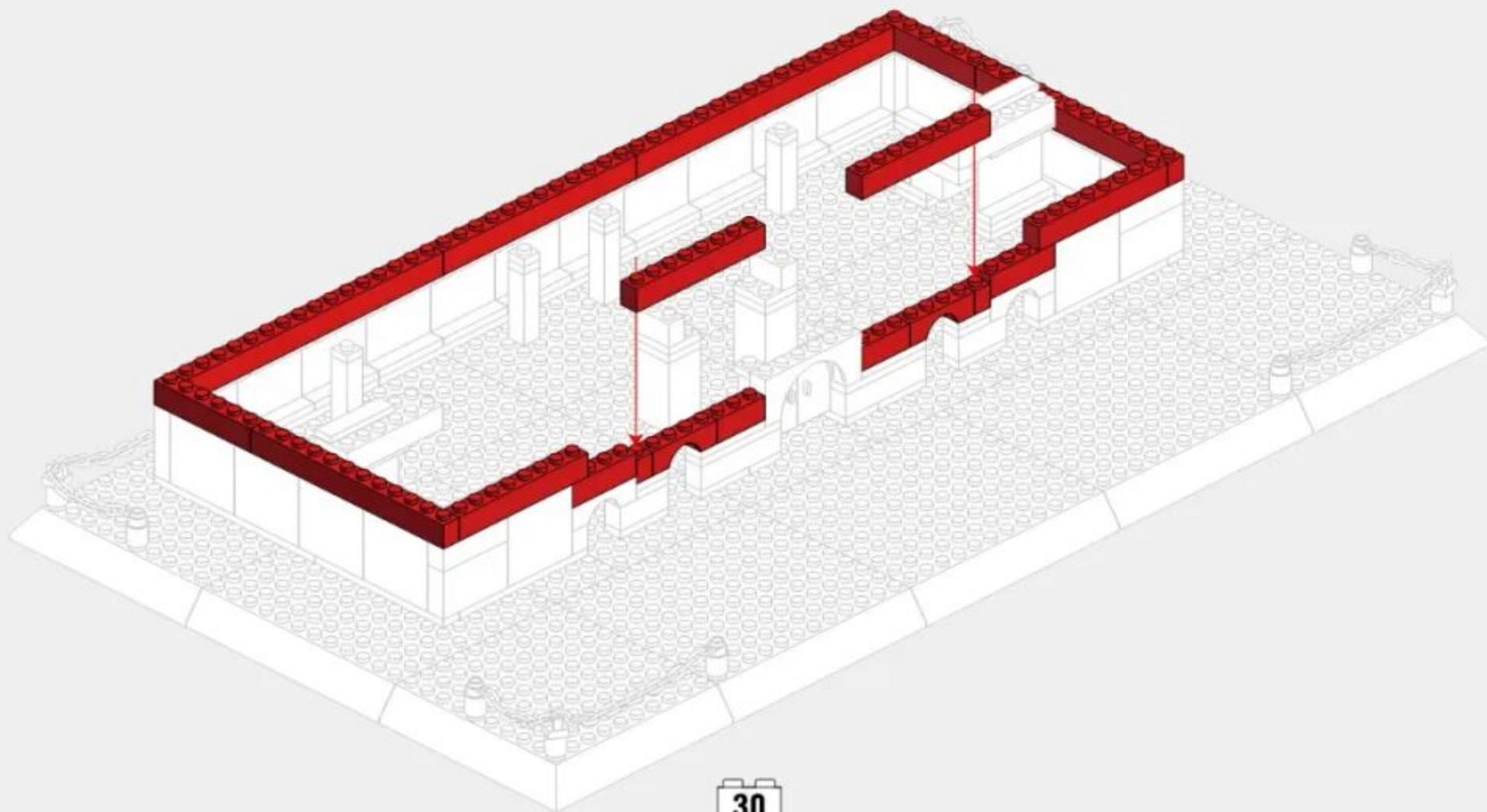
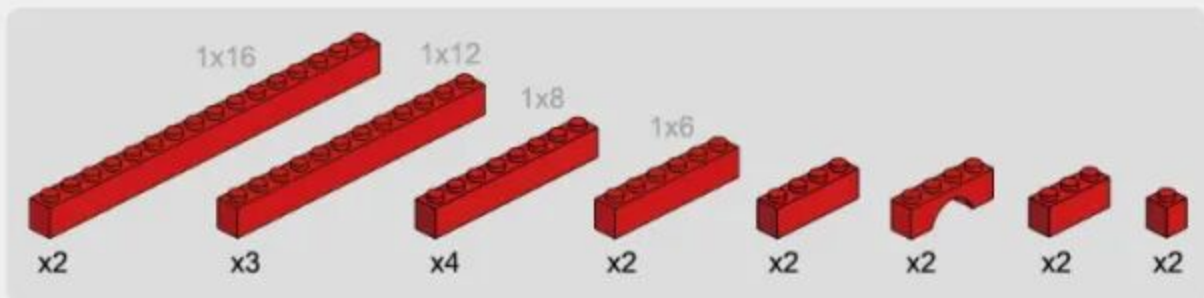

2-8

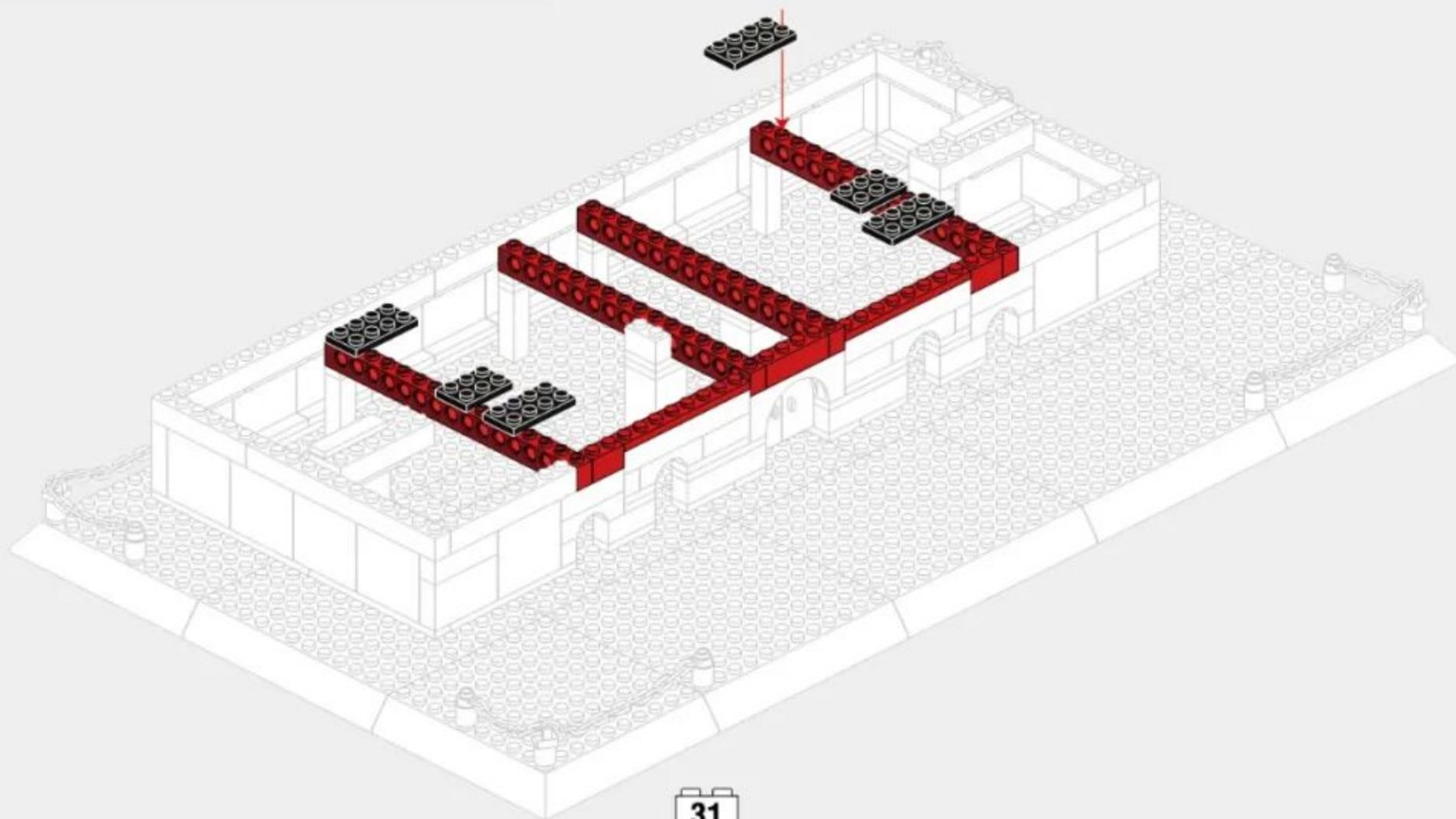
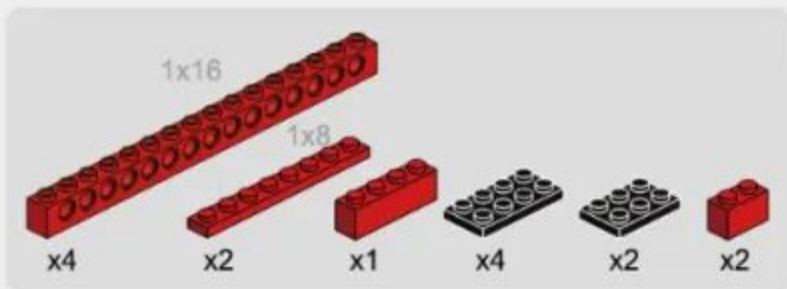

2-9

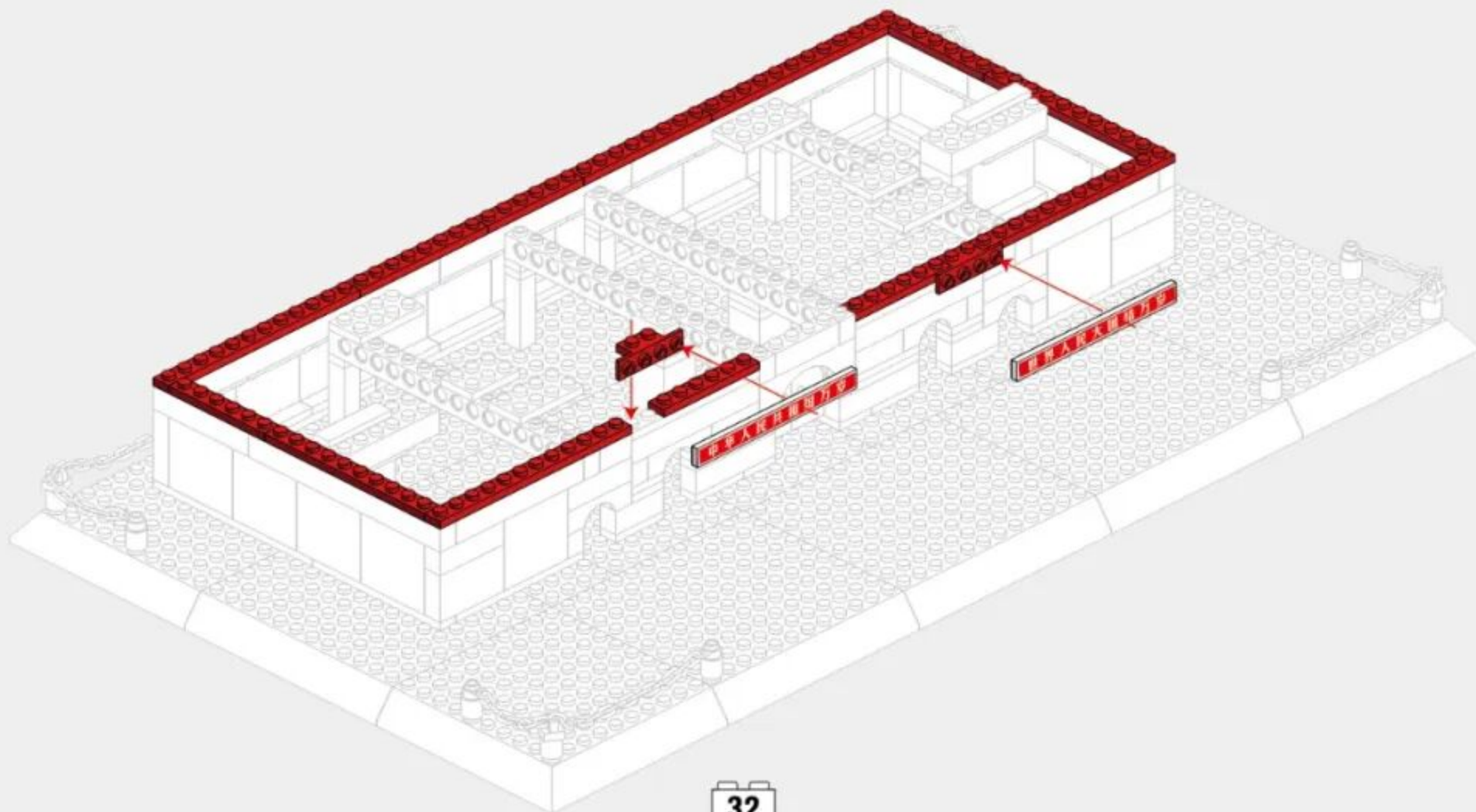
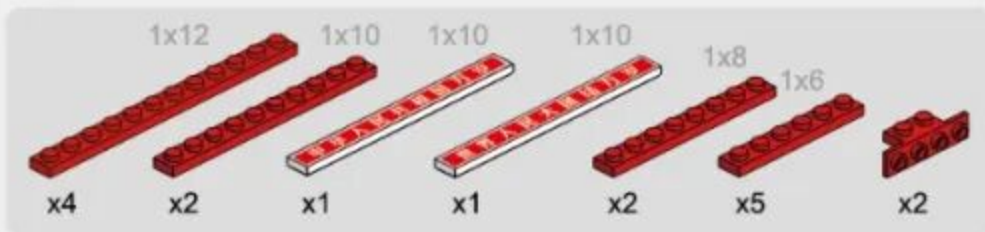



182PCS

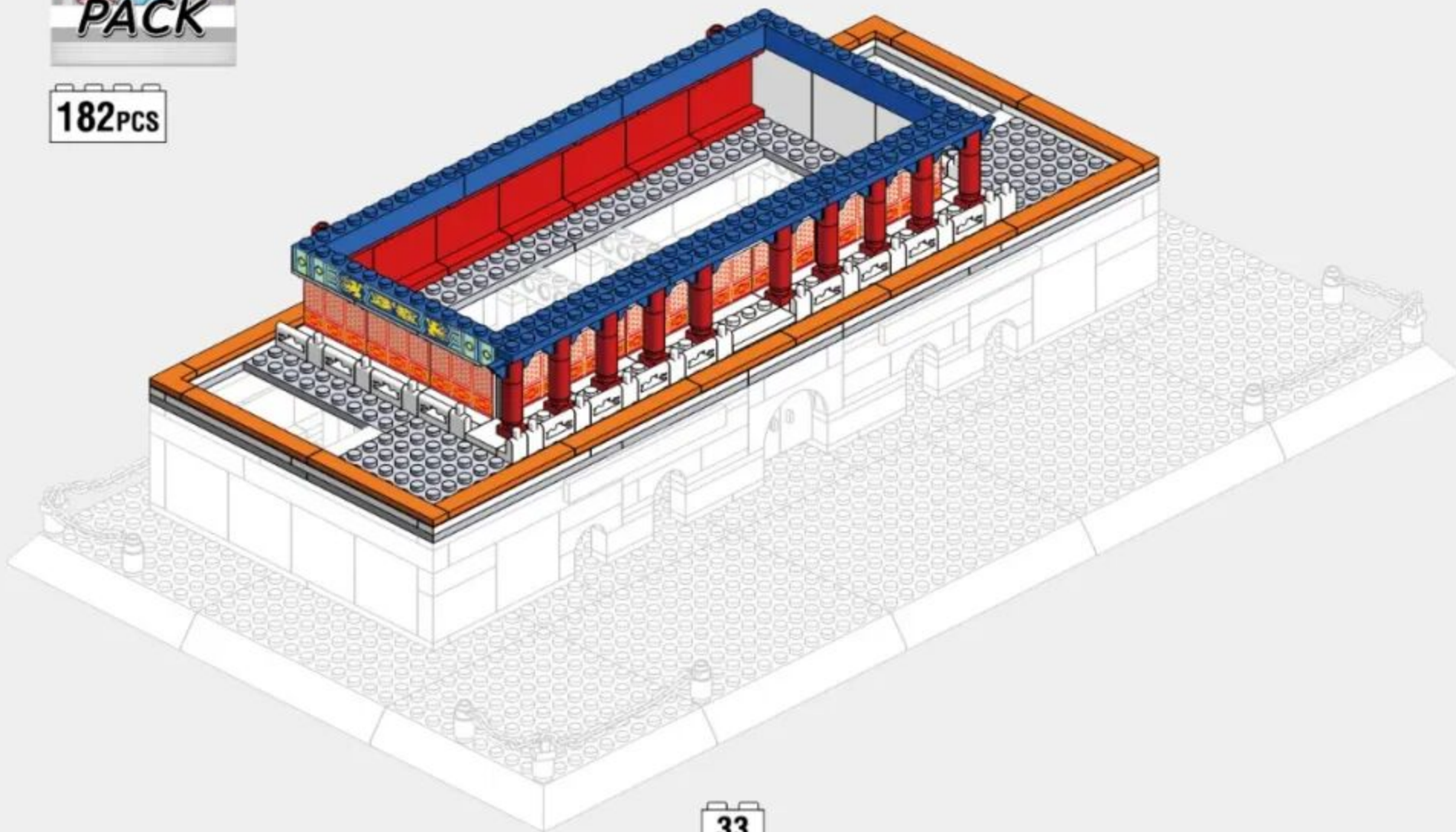

3-1

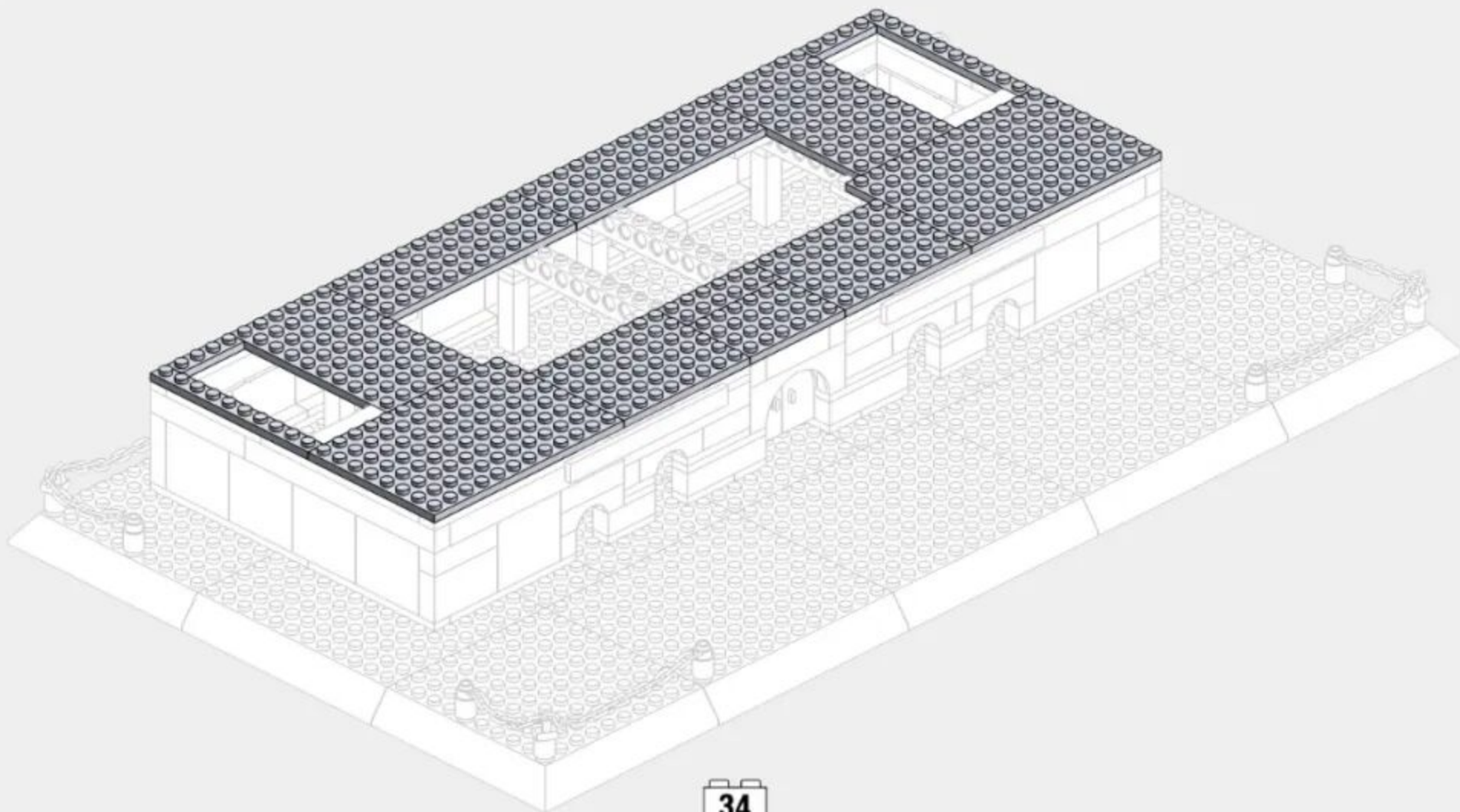
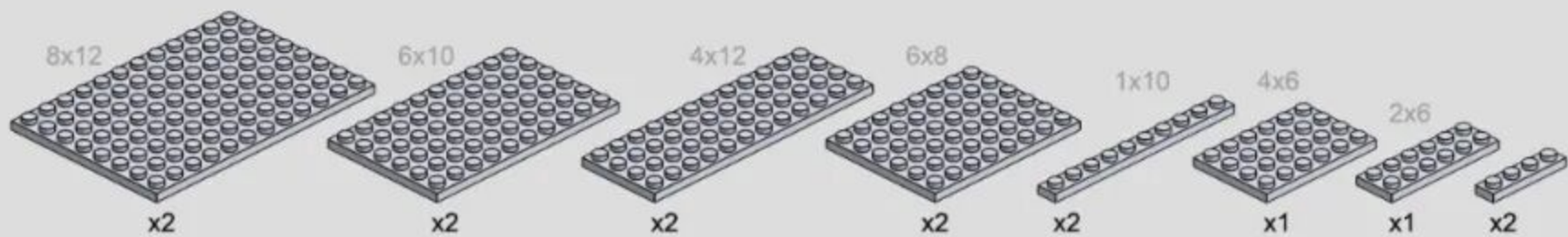

3-2

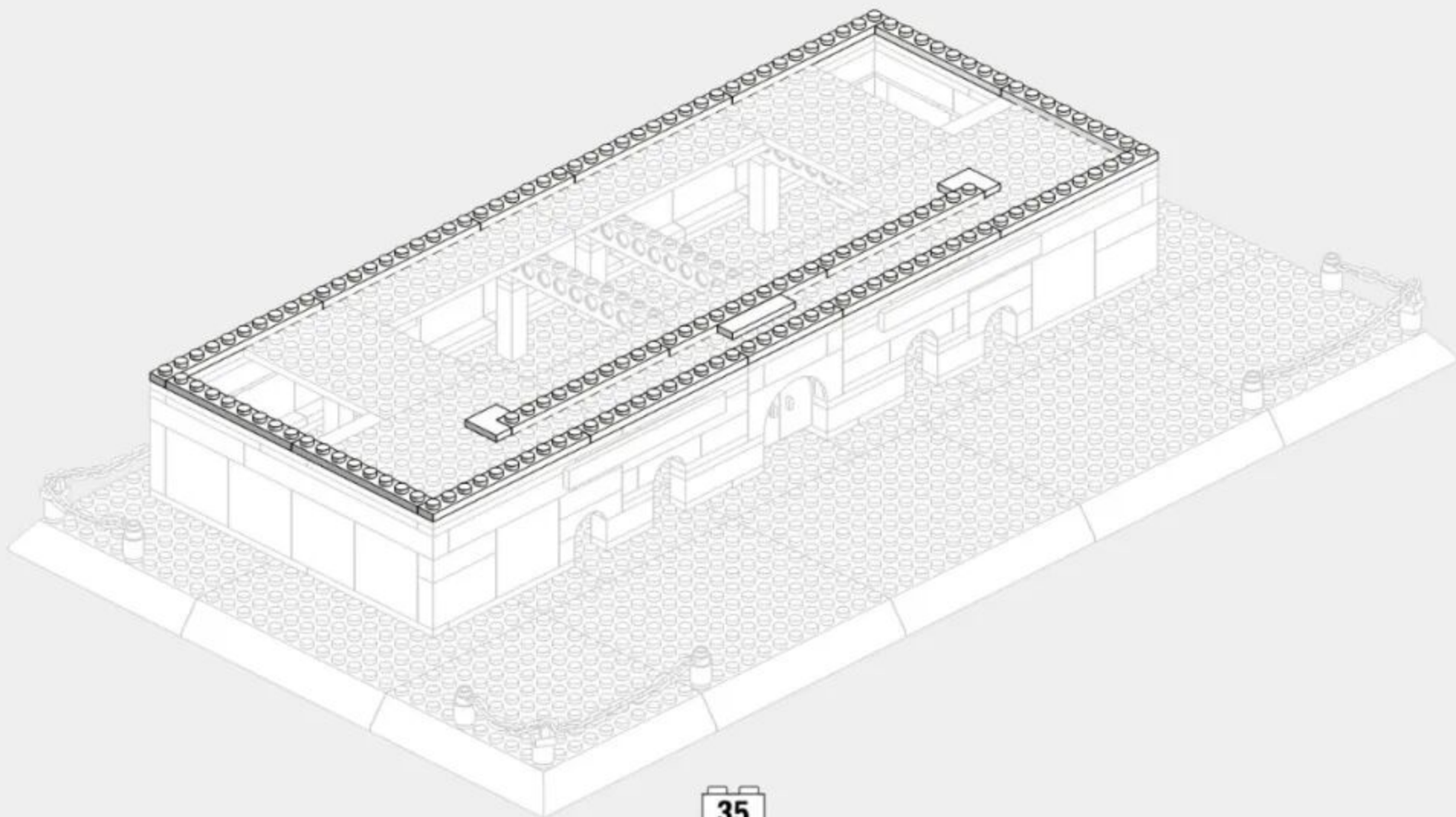
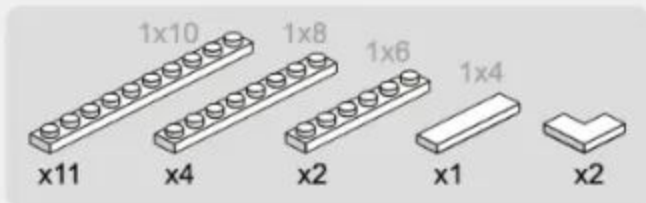

3-3

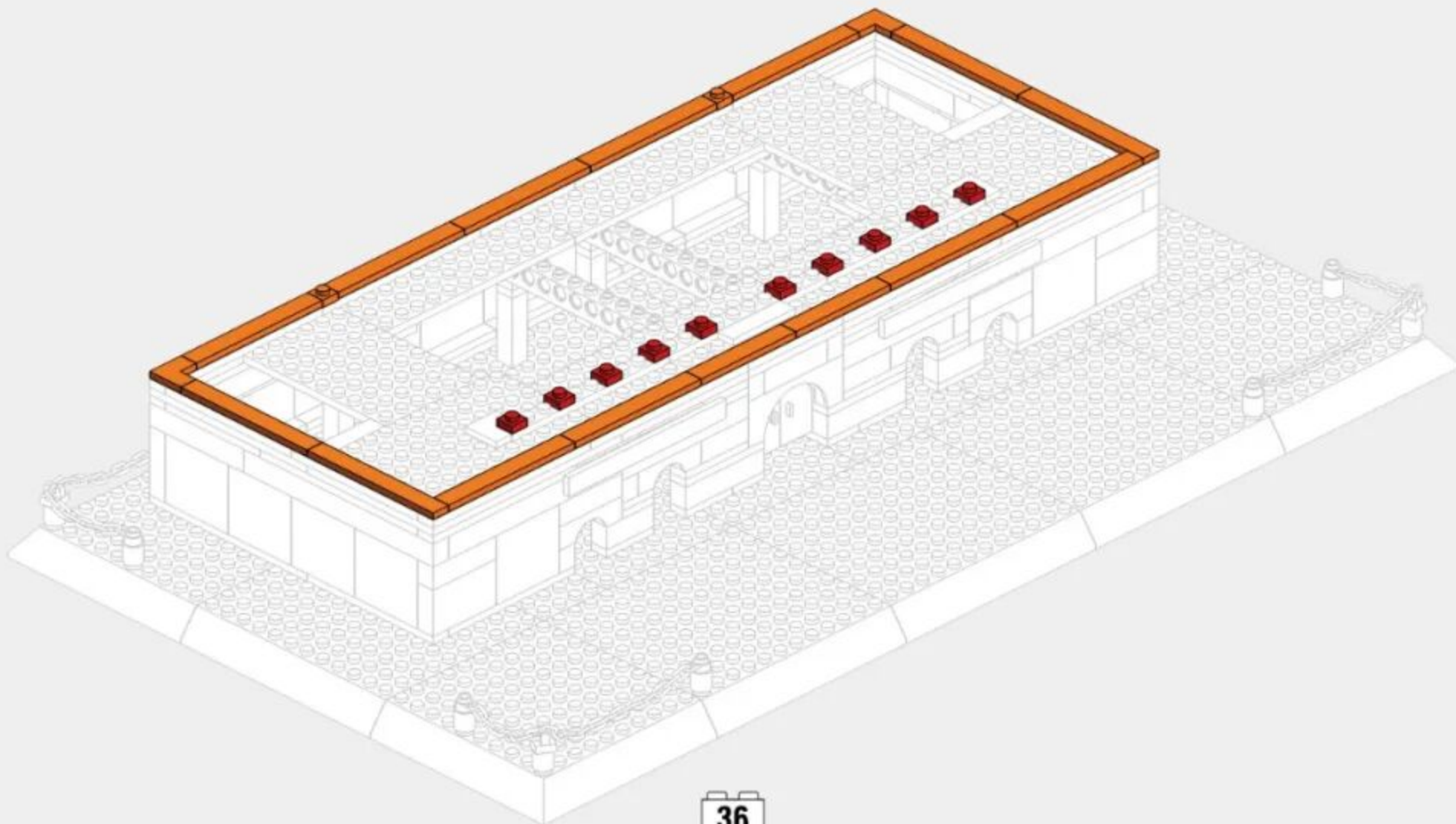
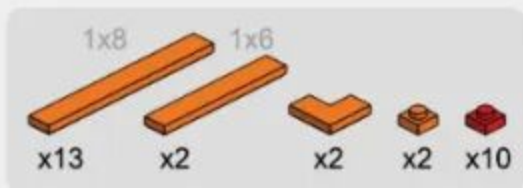

3-4



x2



x16



x20

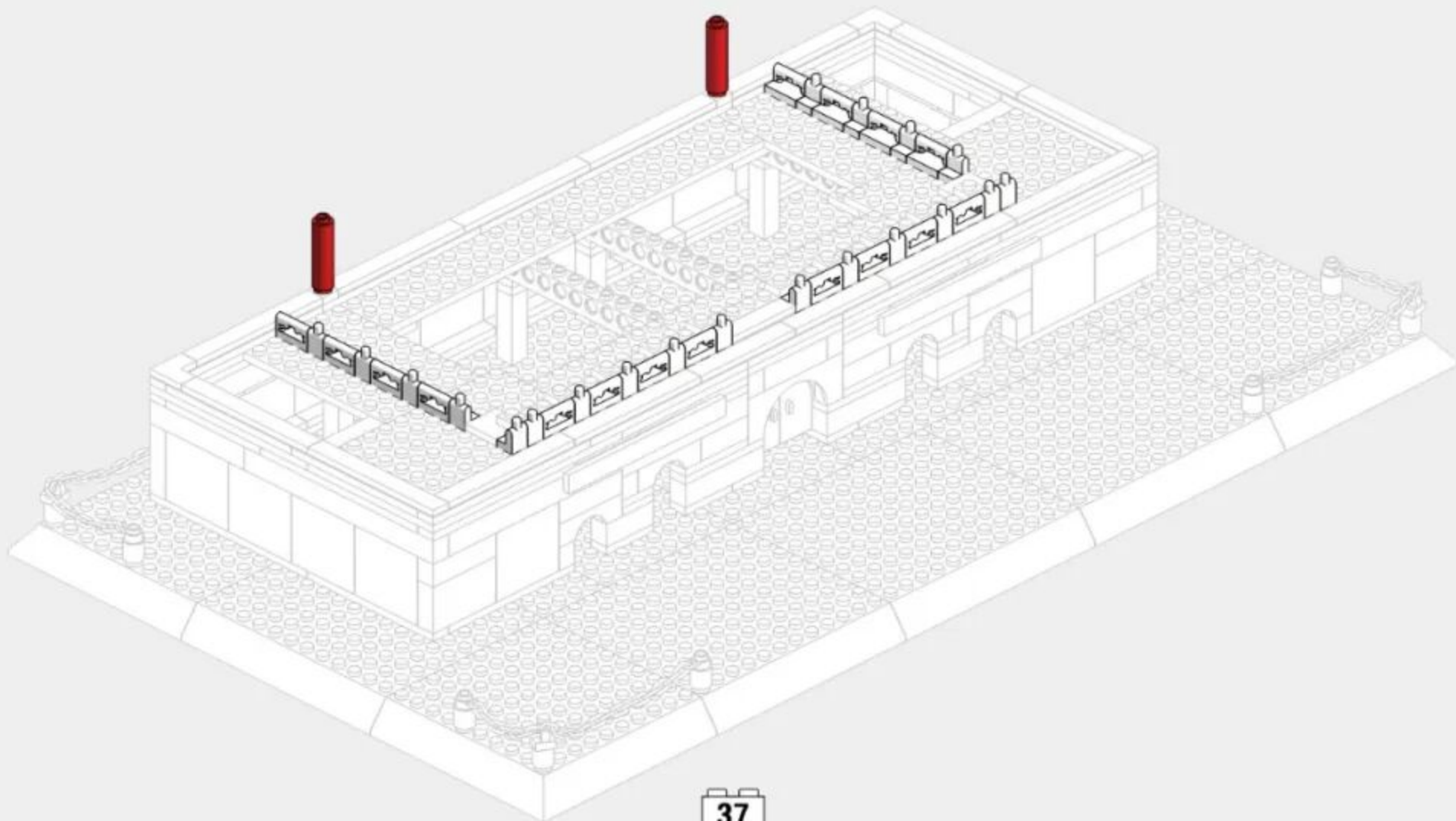

3-5

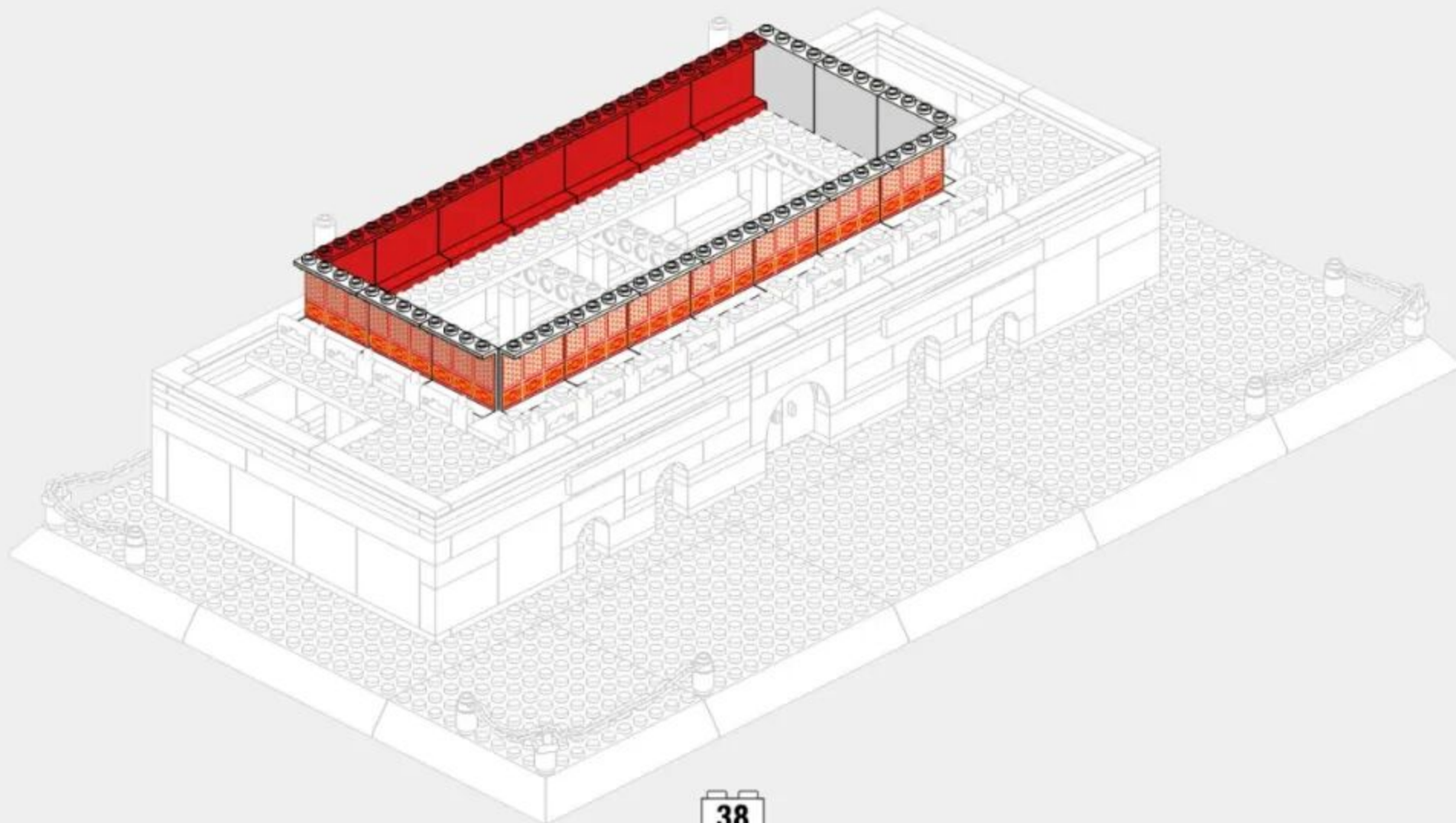

3-6

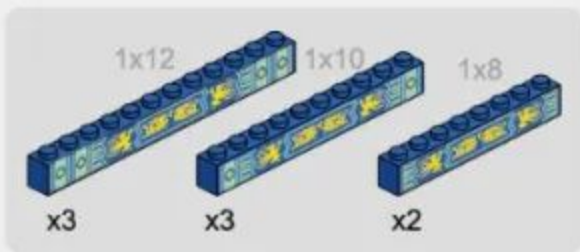

3-7

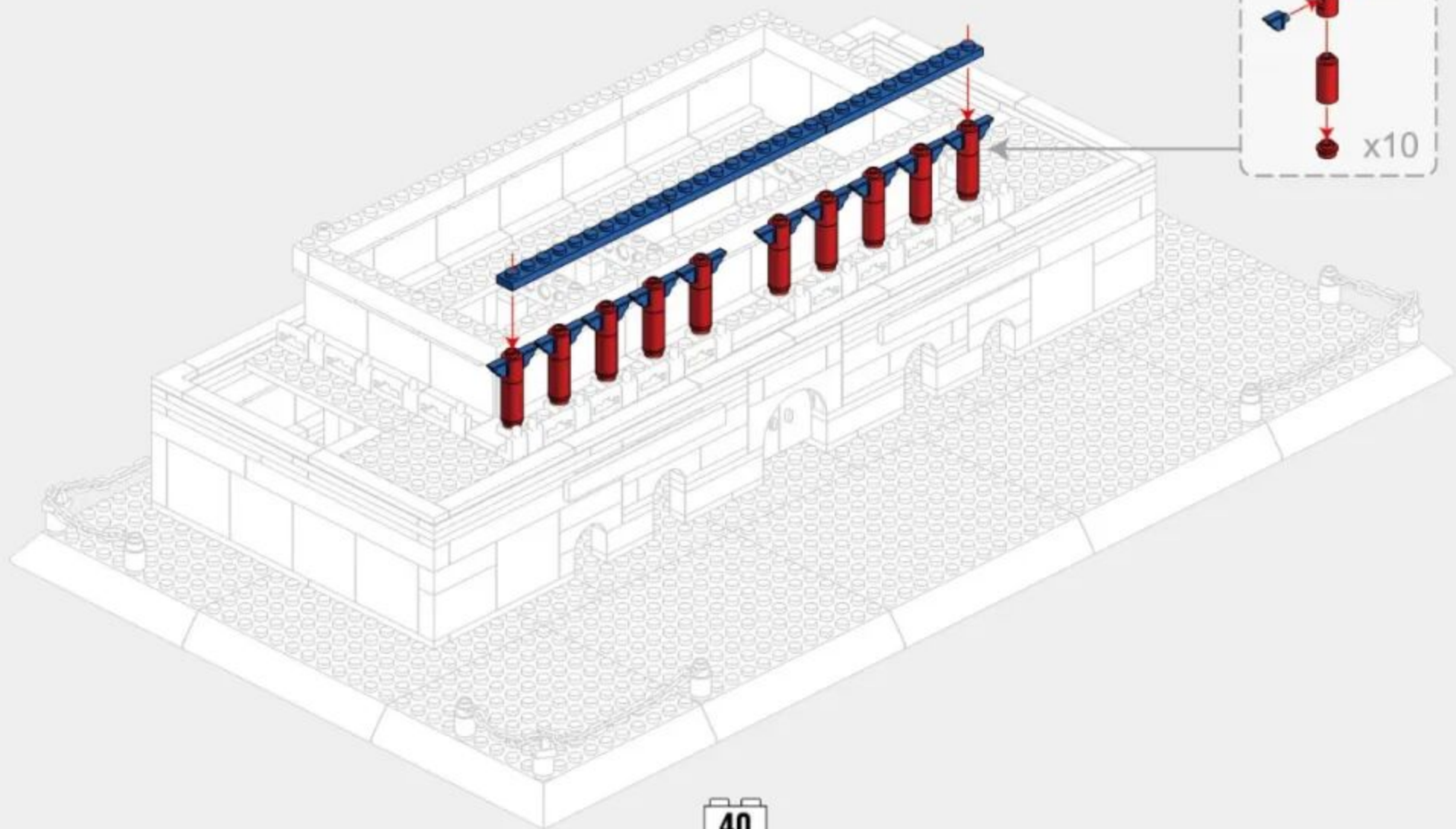



94PCS

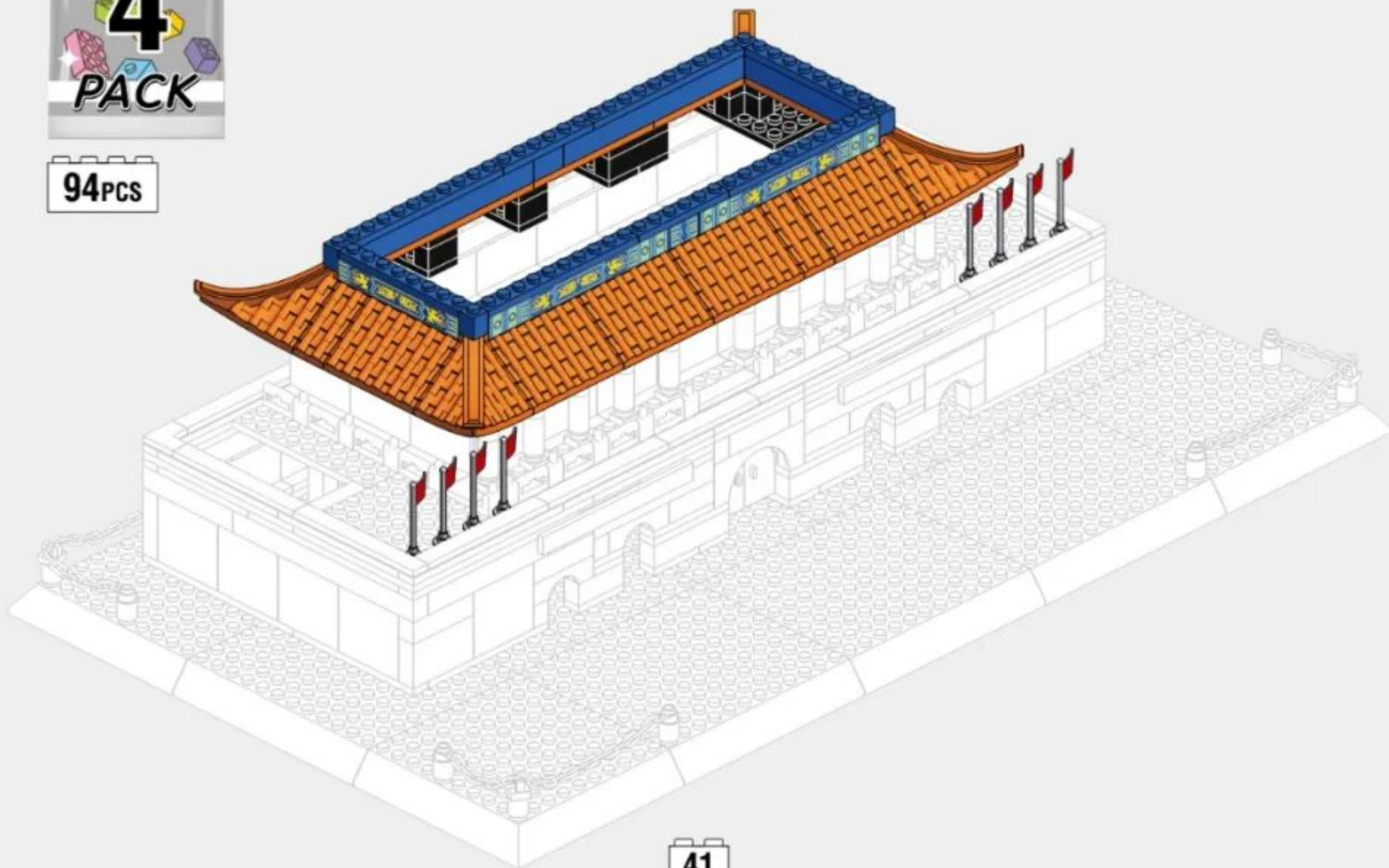

4-1

4x6

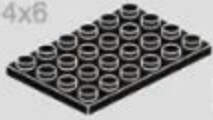

x4



x2



x4



x2



x8



x4



x4



x4

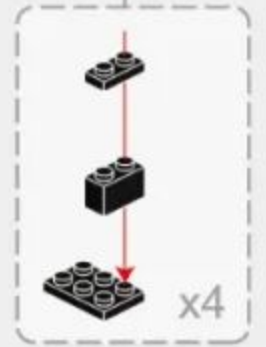
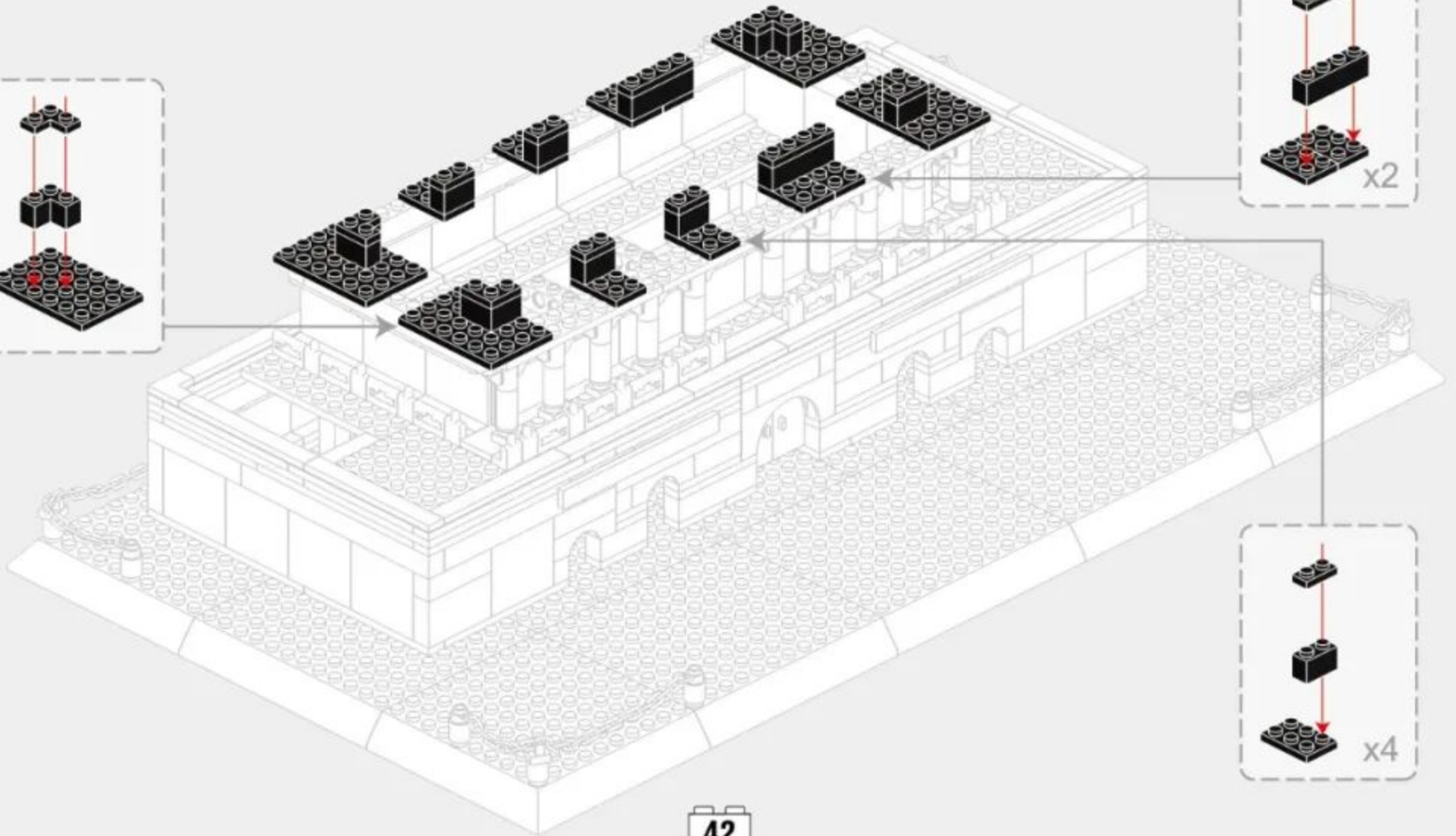
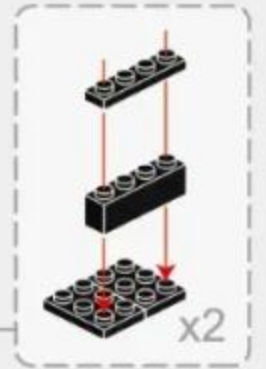
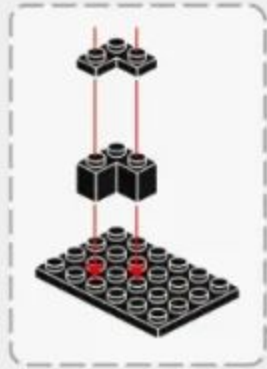

4-2

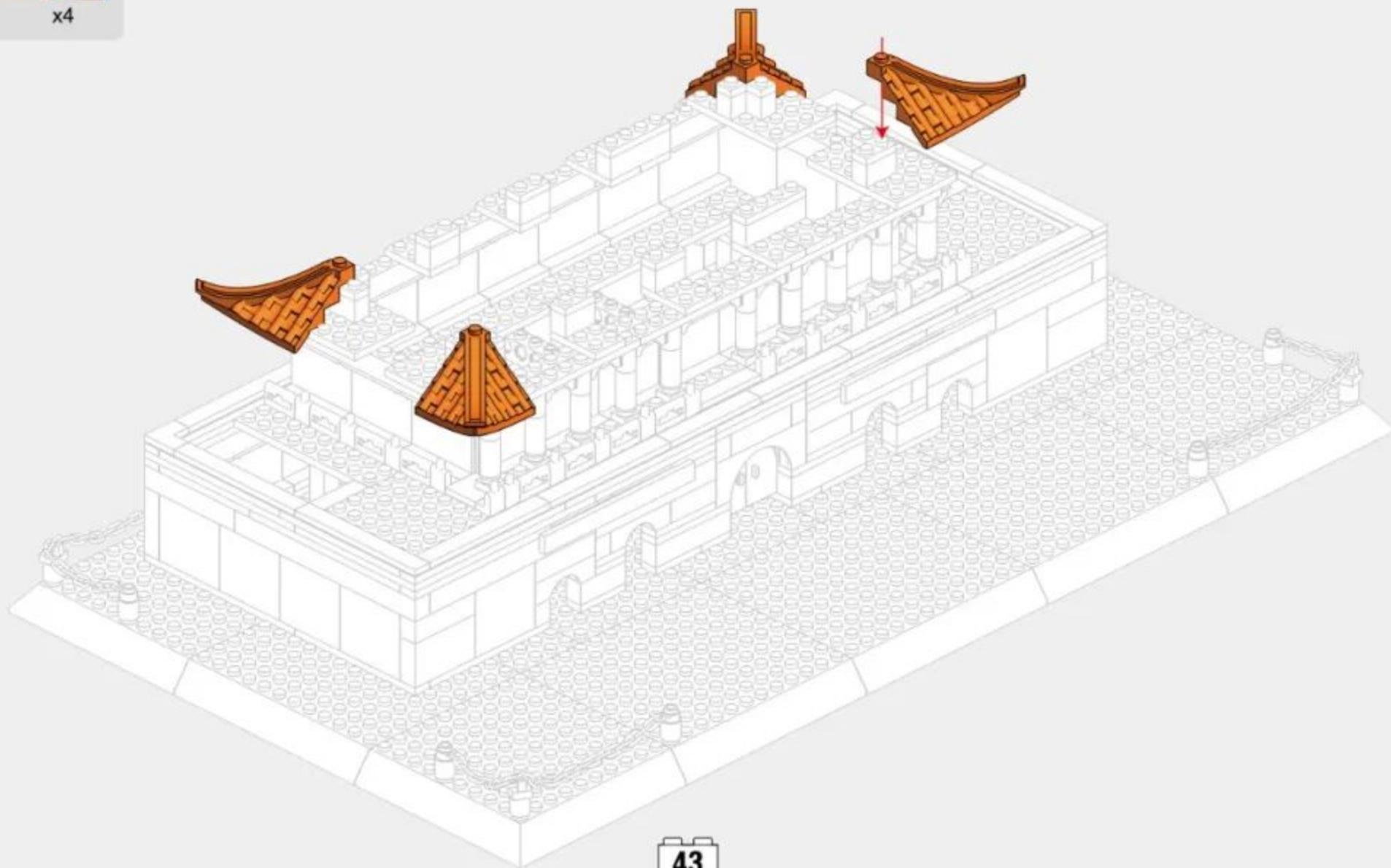

4-3

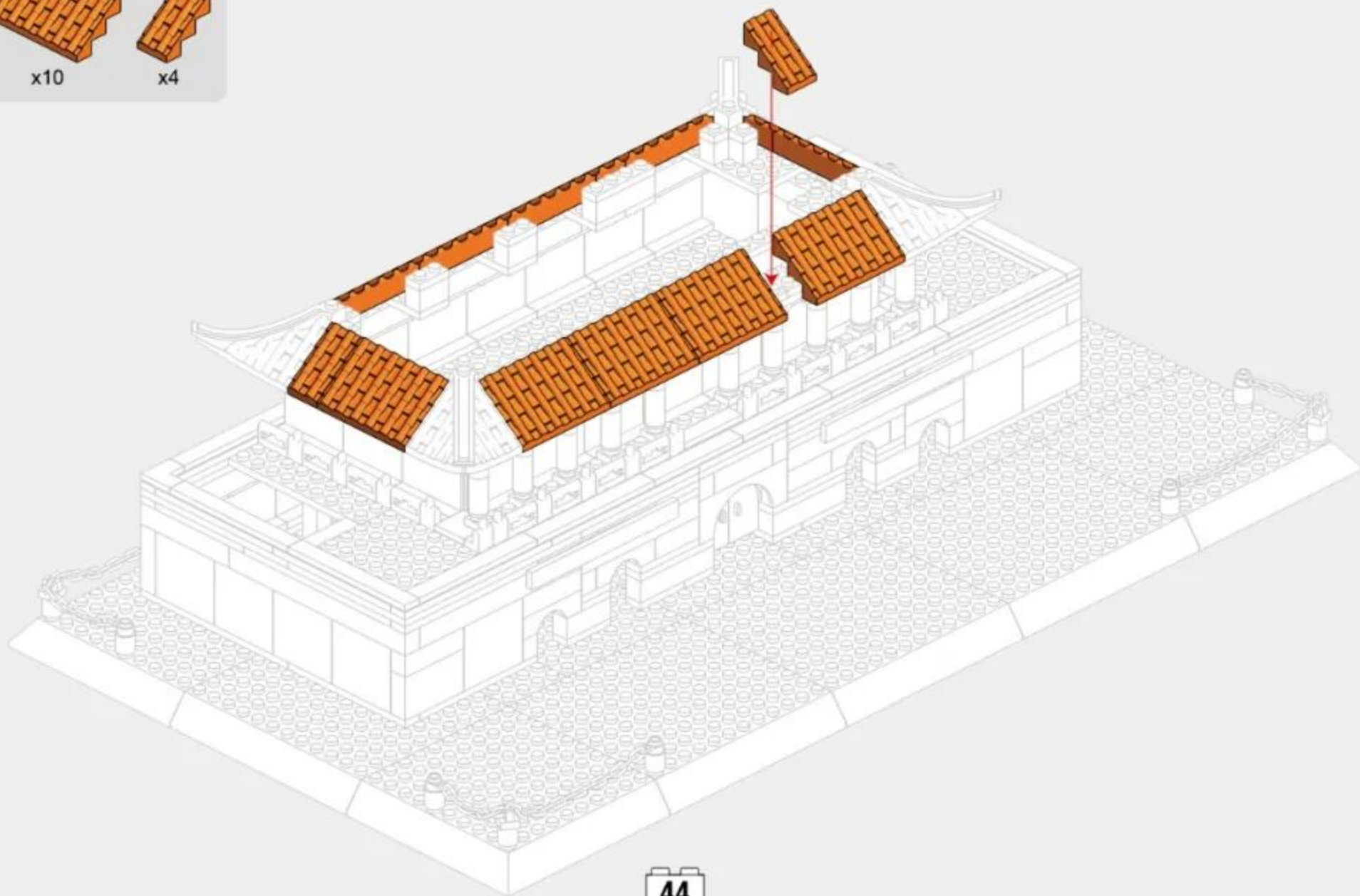

4-4

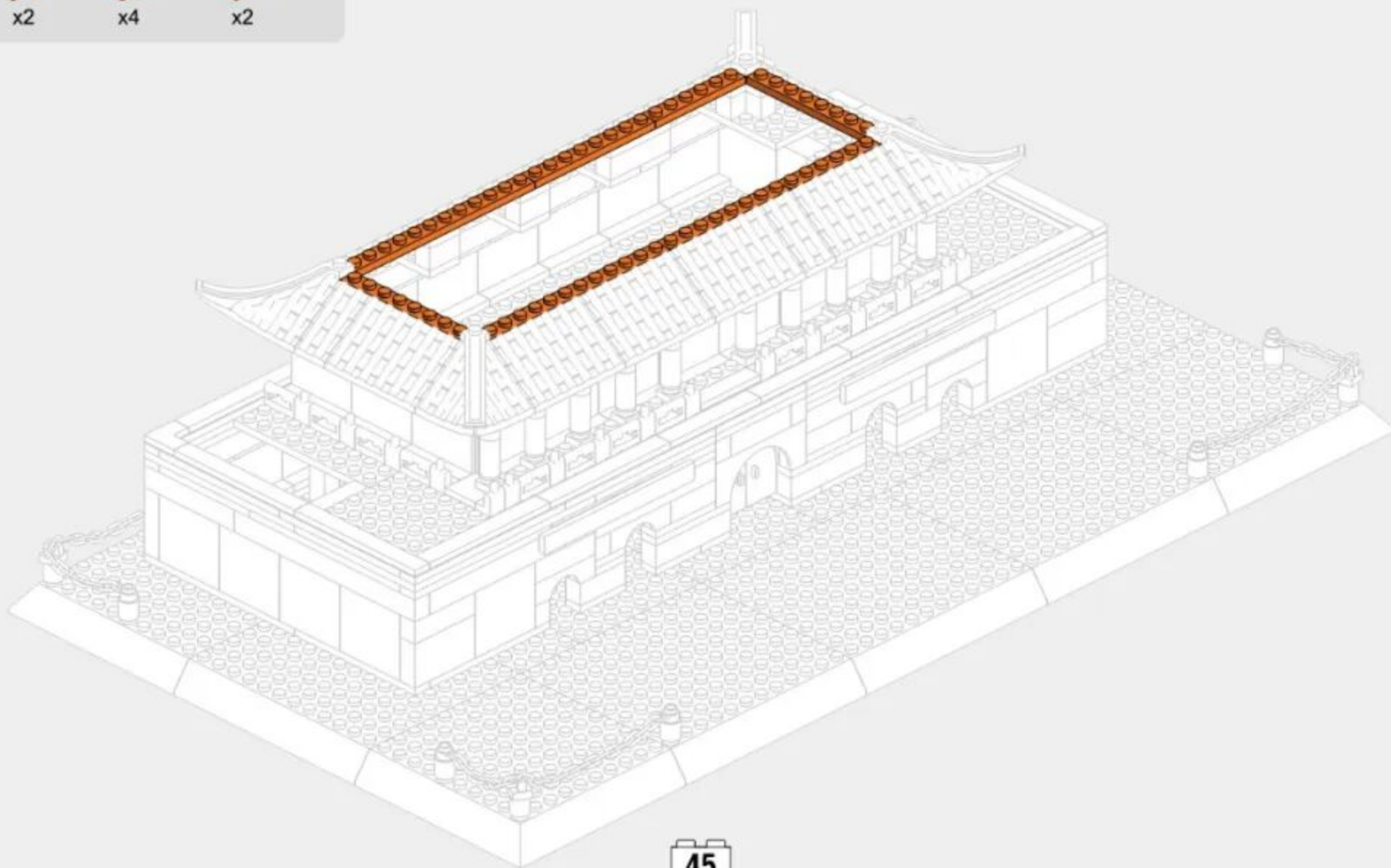
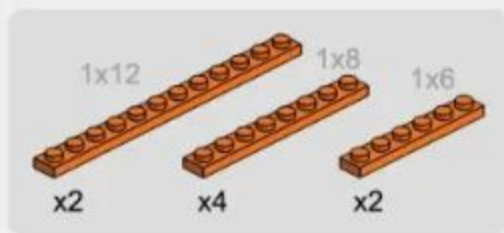

4-5

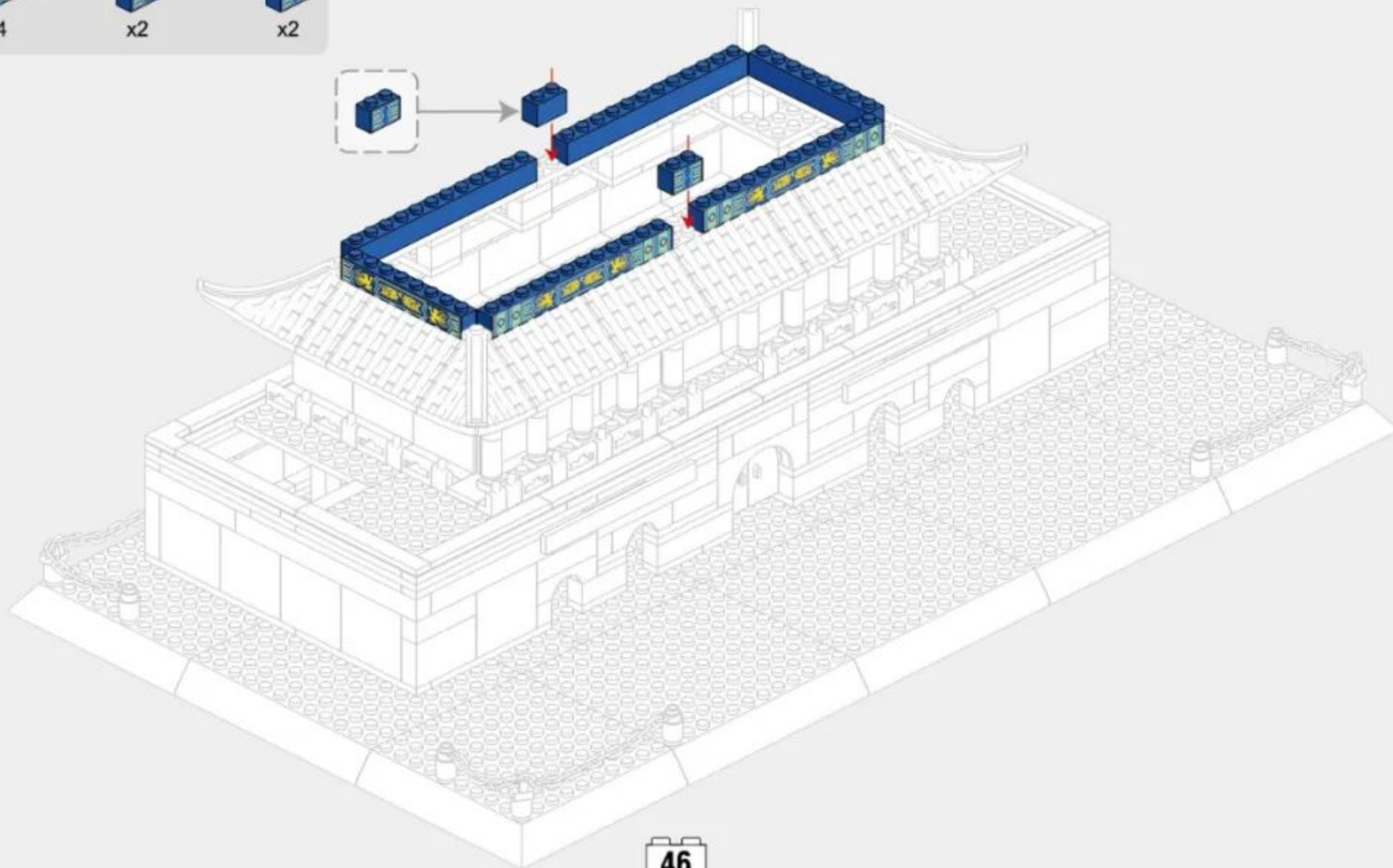
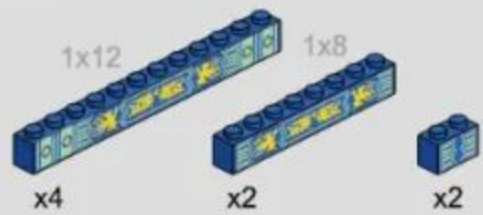

4-6

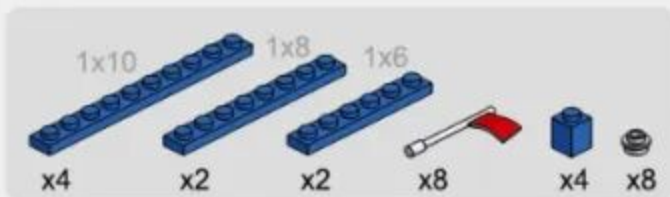

Vertical View of Installation Drawing

安装图顶面

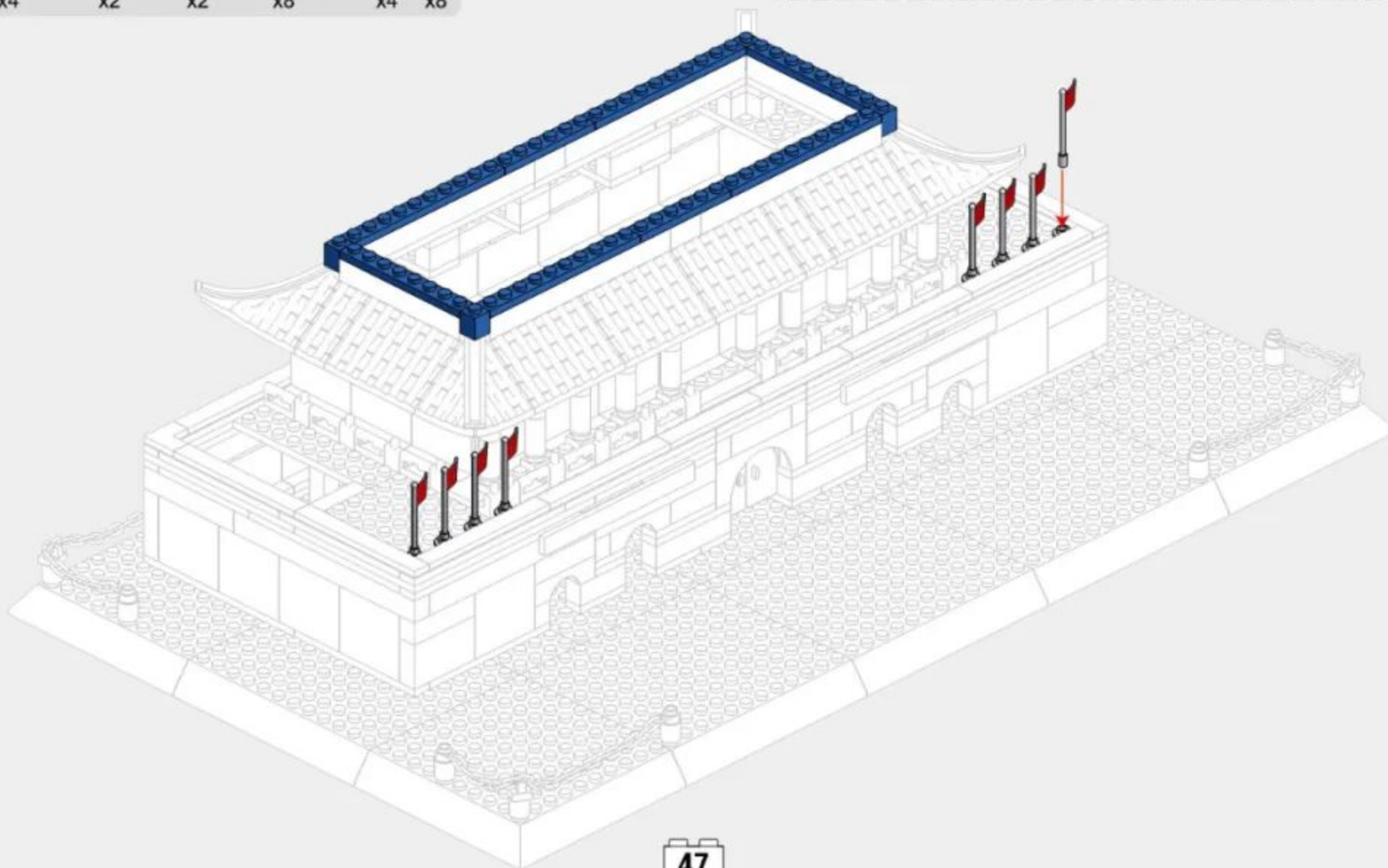



103PCS

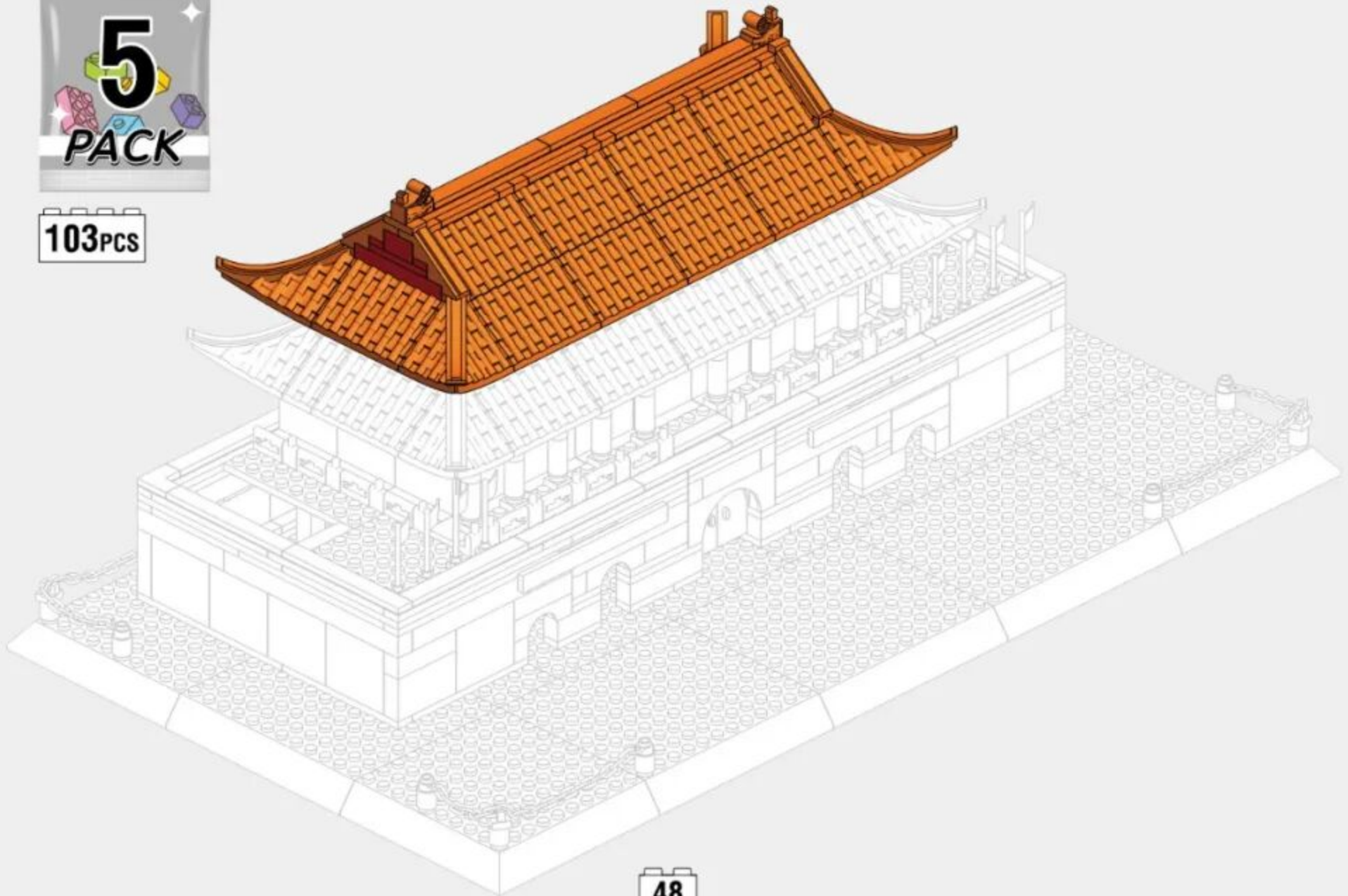

48

5-1

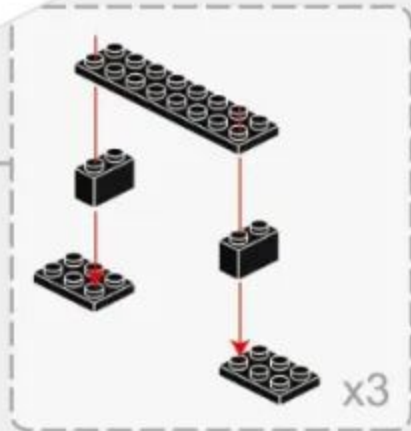
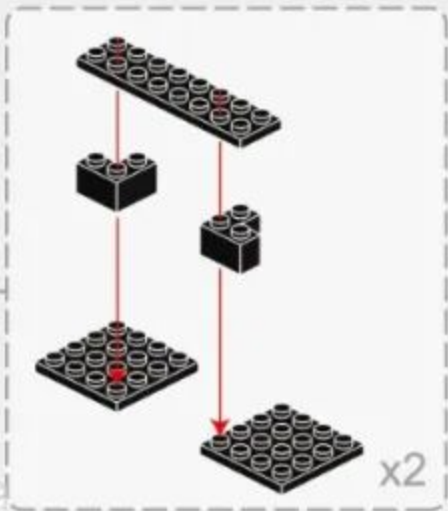
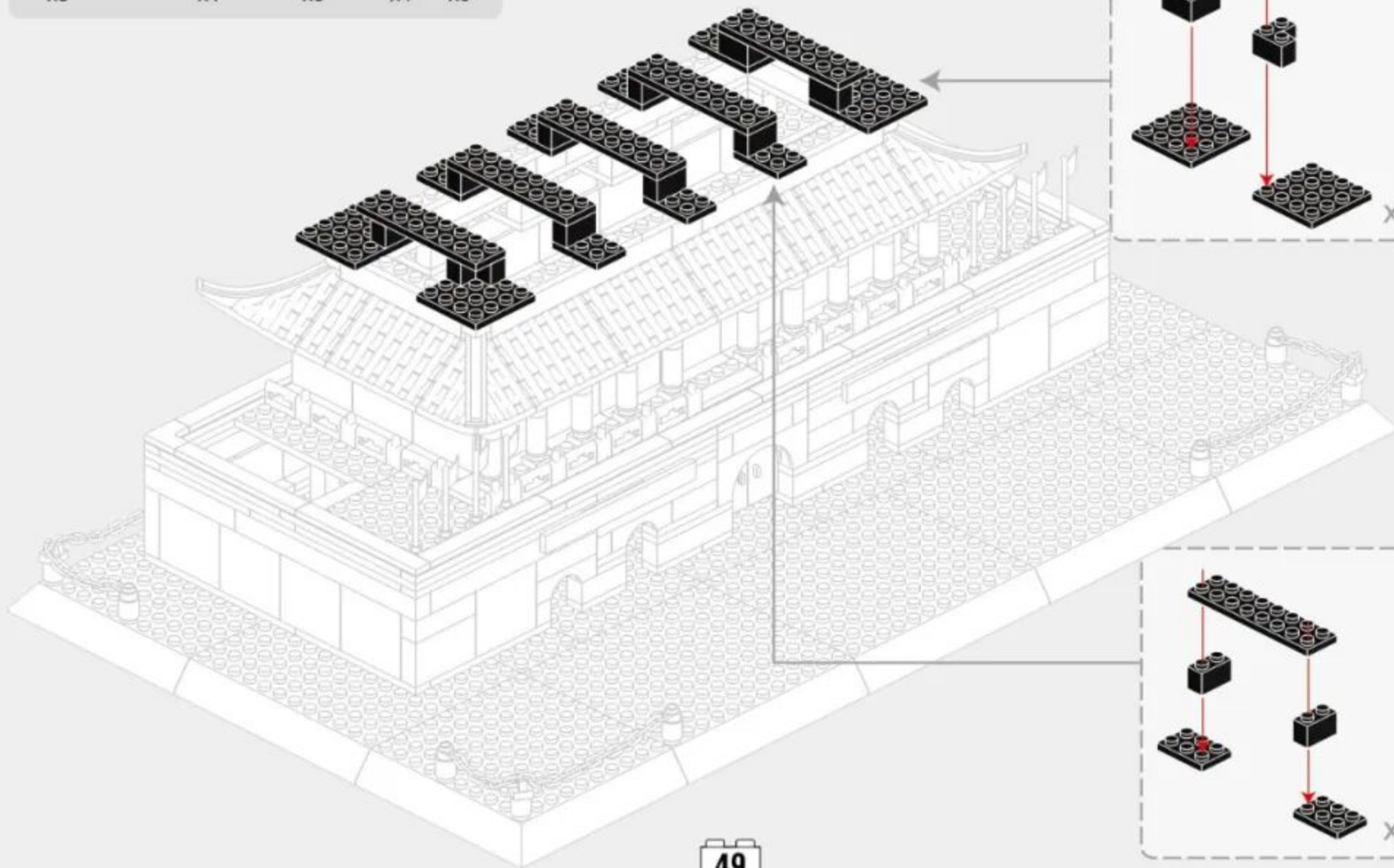
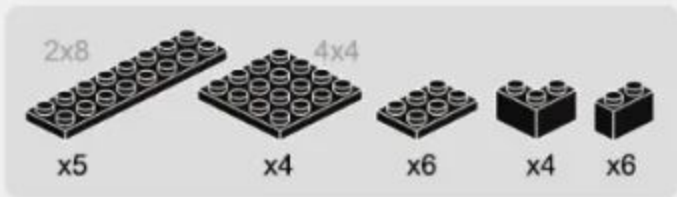

5-2

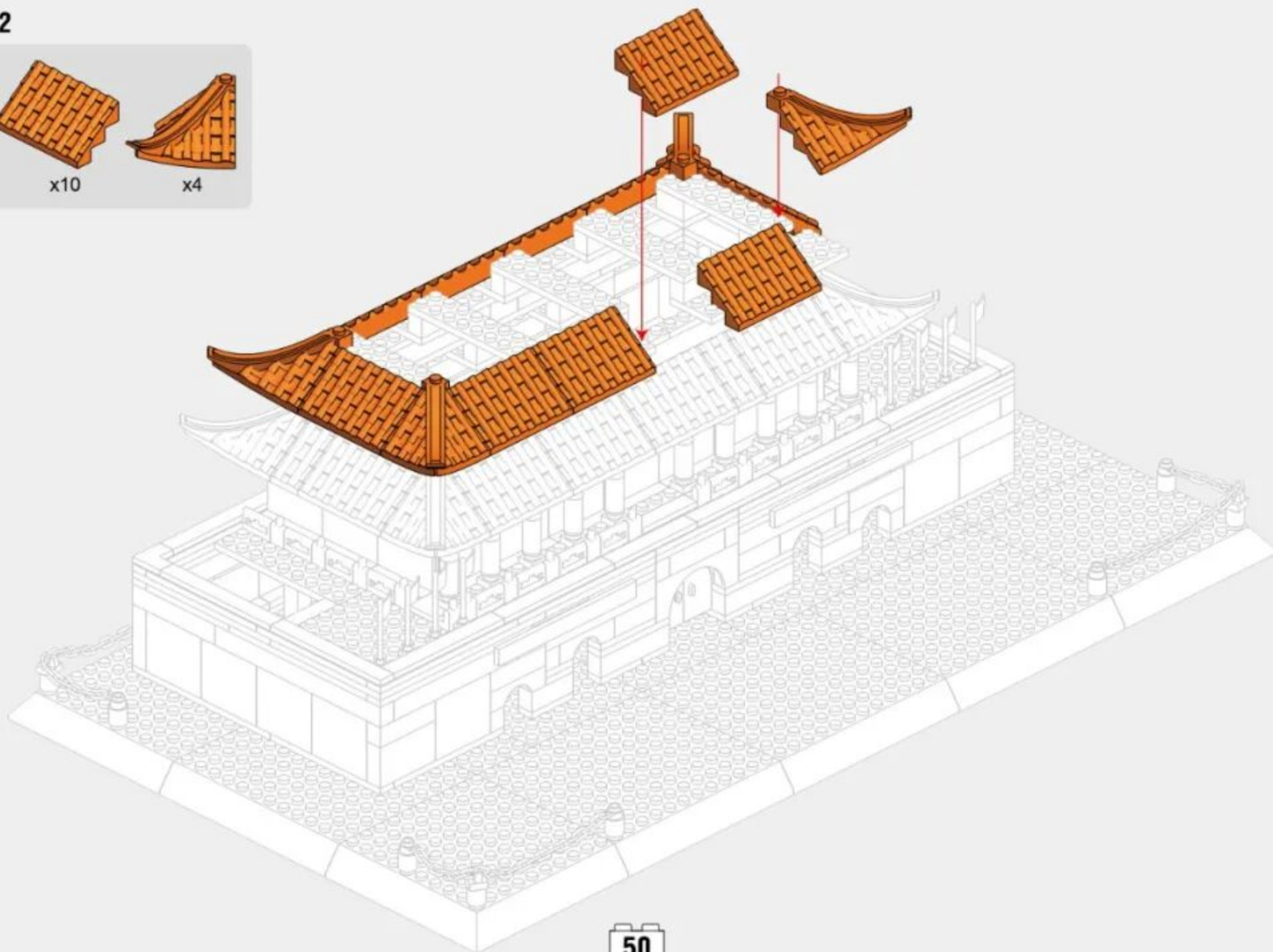
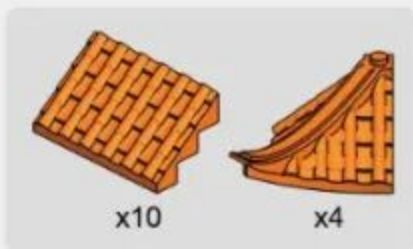

5-3

1x6

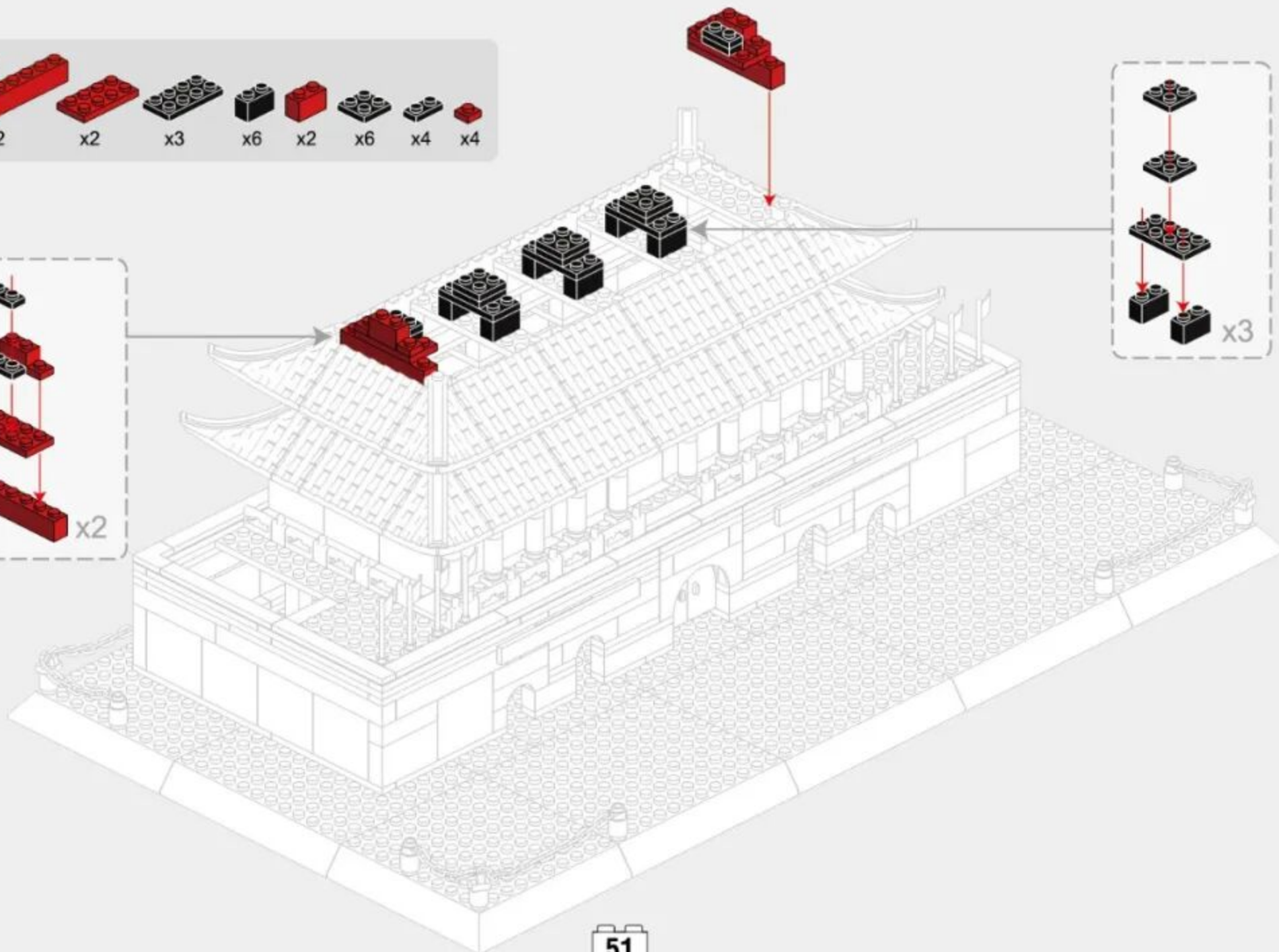
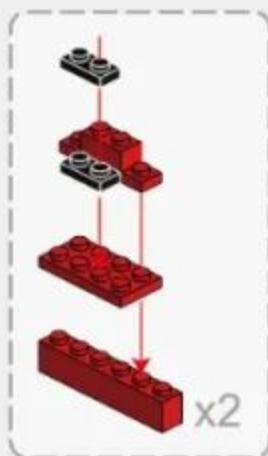
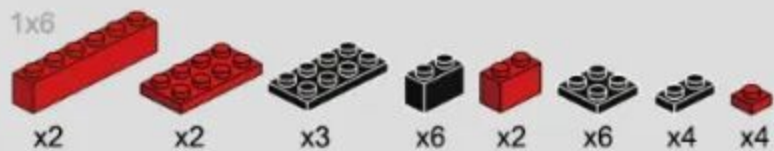

5-4

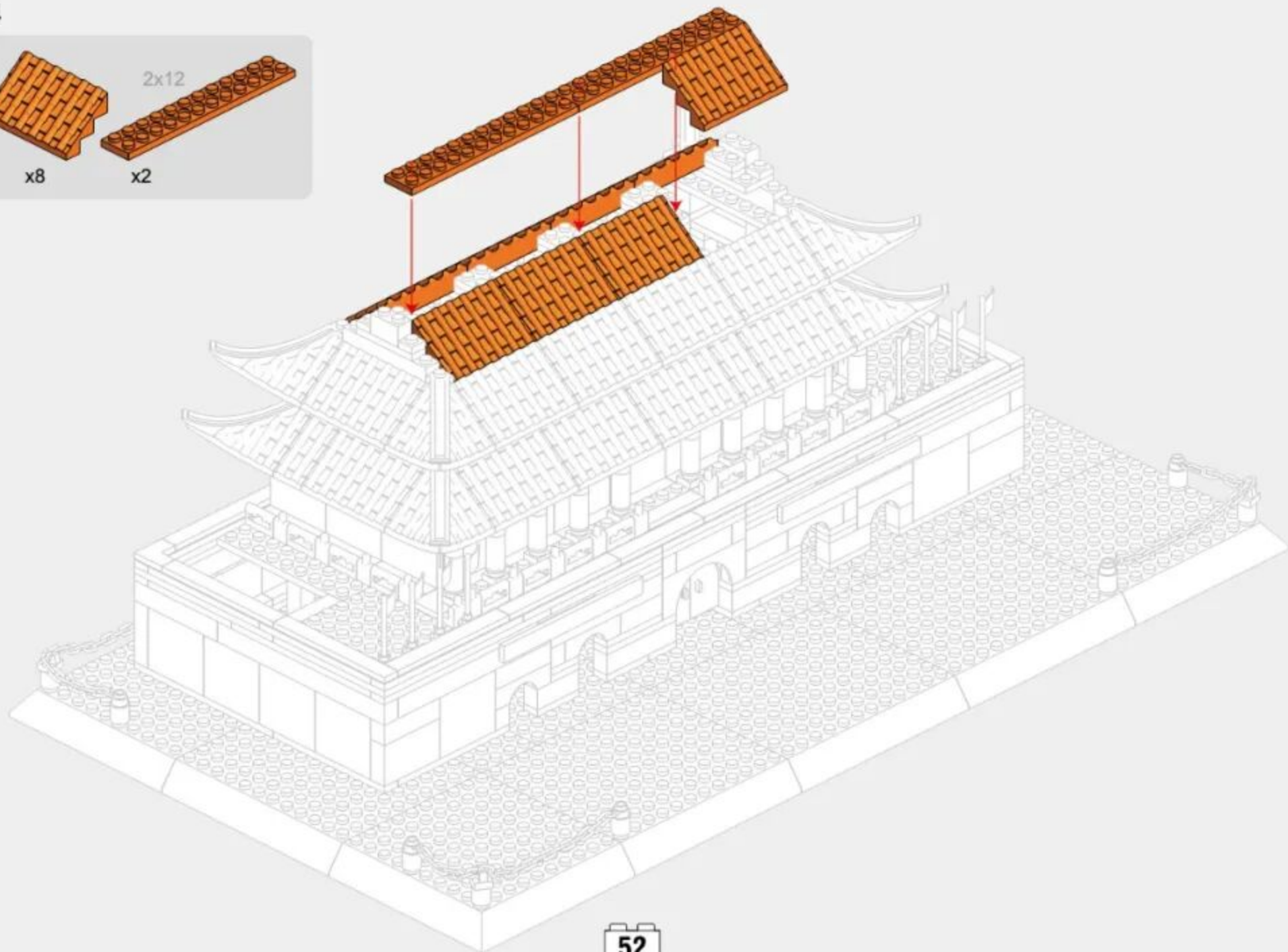
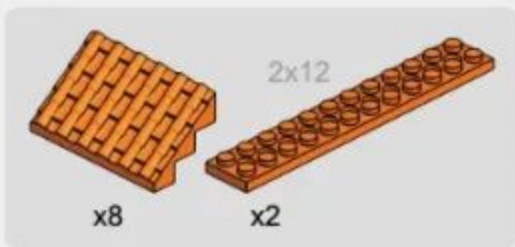

5-5

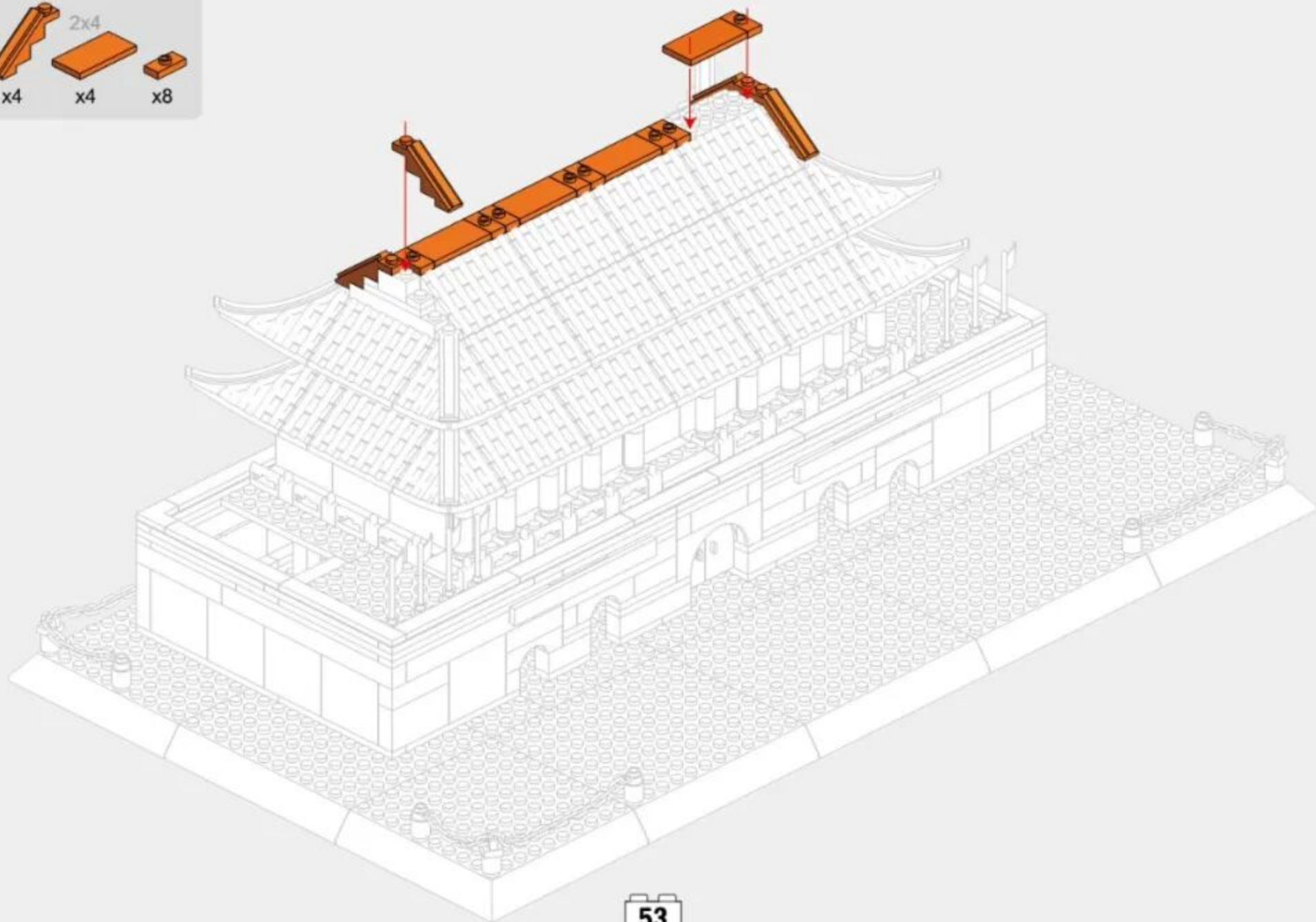

5-6

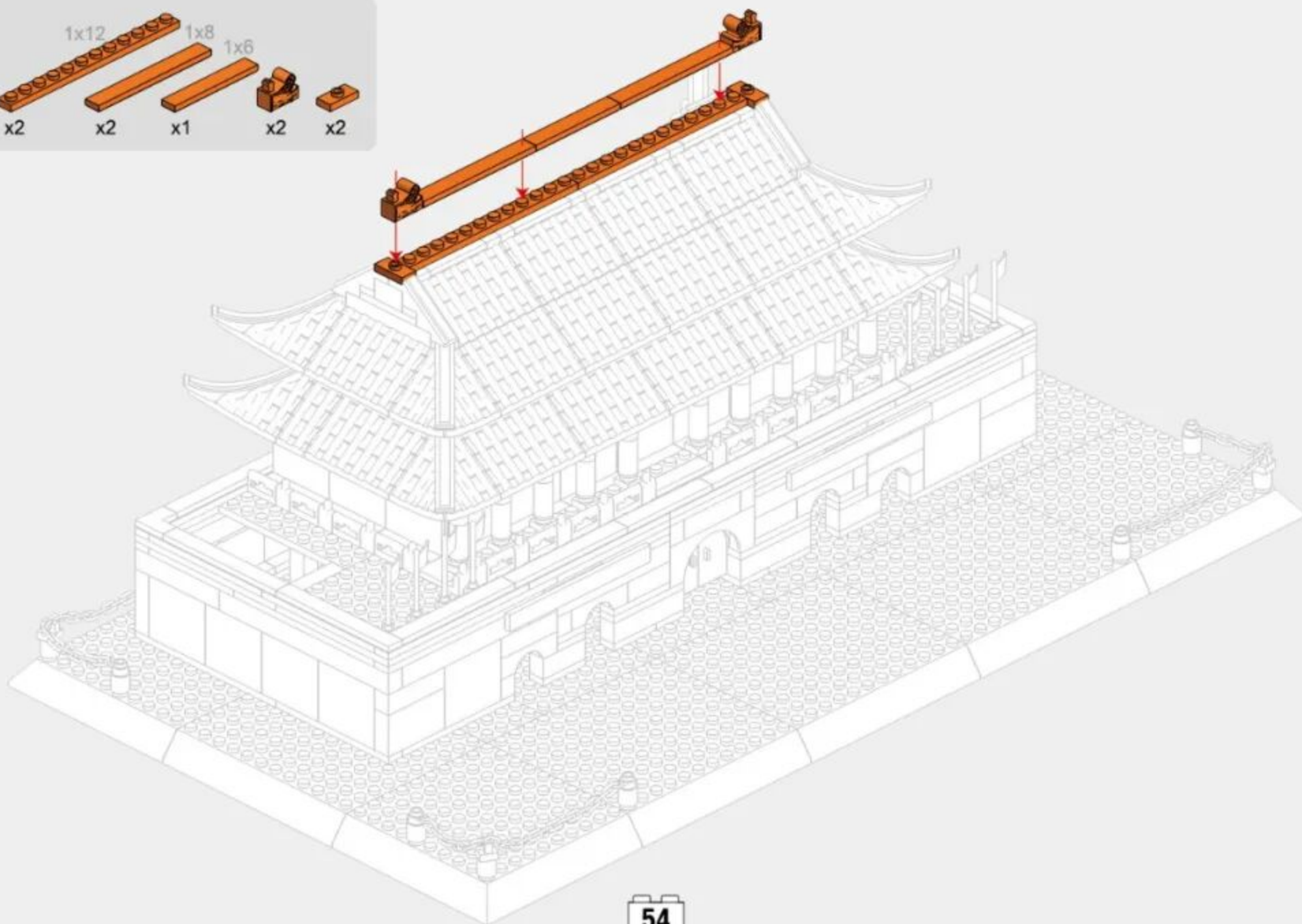
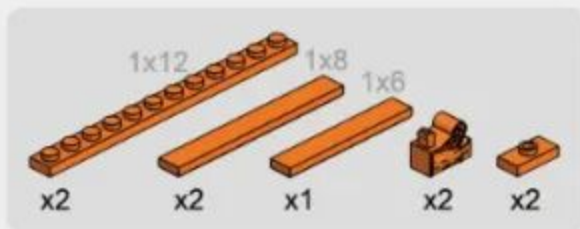



187PCS



55

6-1

2x10
x2

1x10
x2

1x8
x2

1x6
x2

1x6
x2

1x6
x2

x4

x4

x1

x20

x2

x4

x4

x4

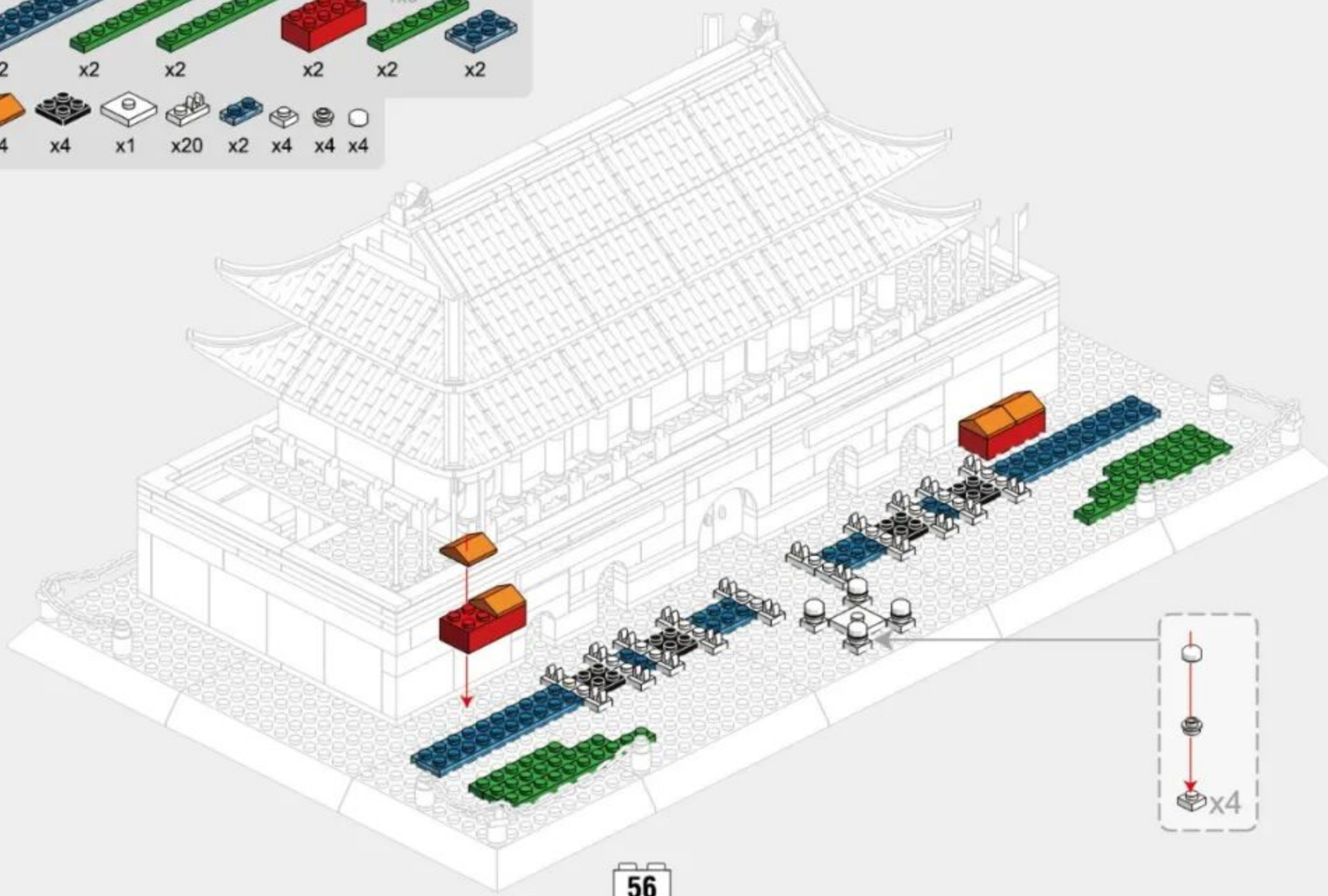

6-2

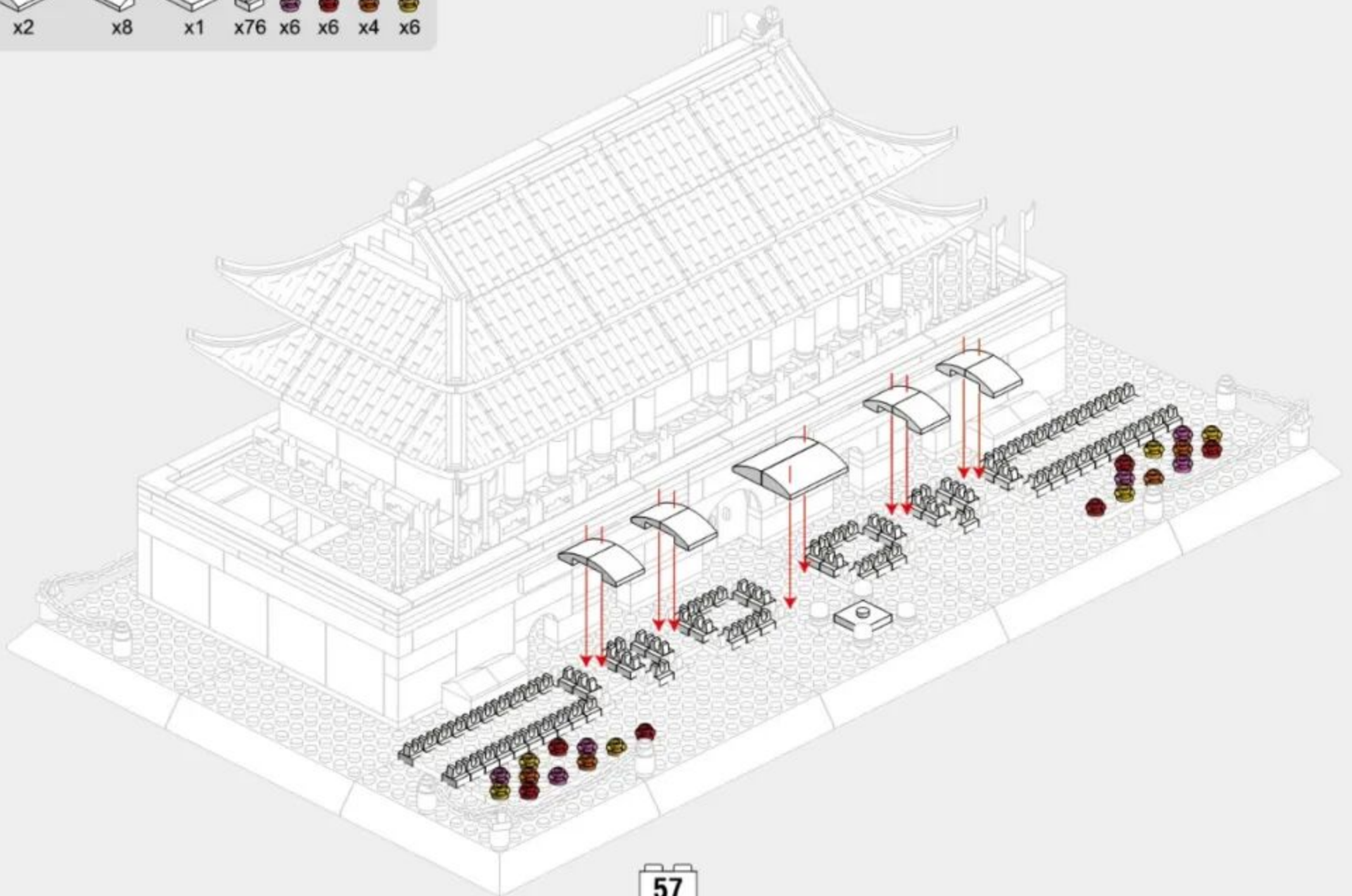

6-3

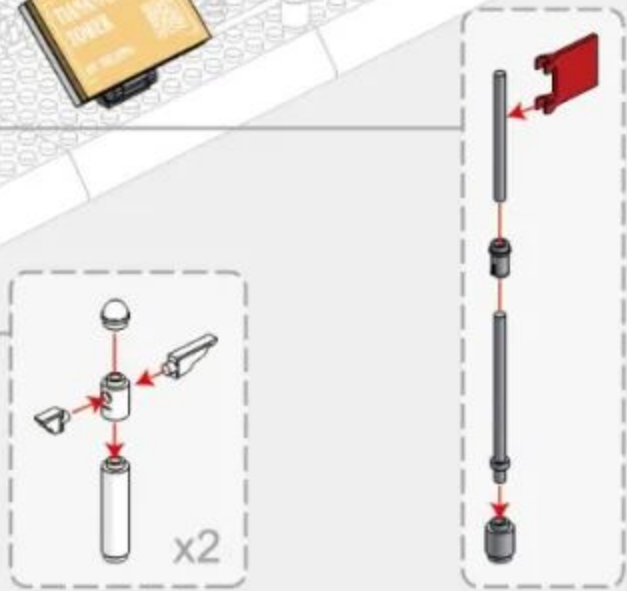
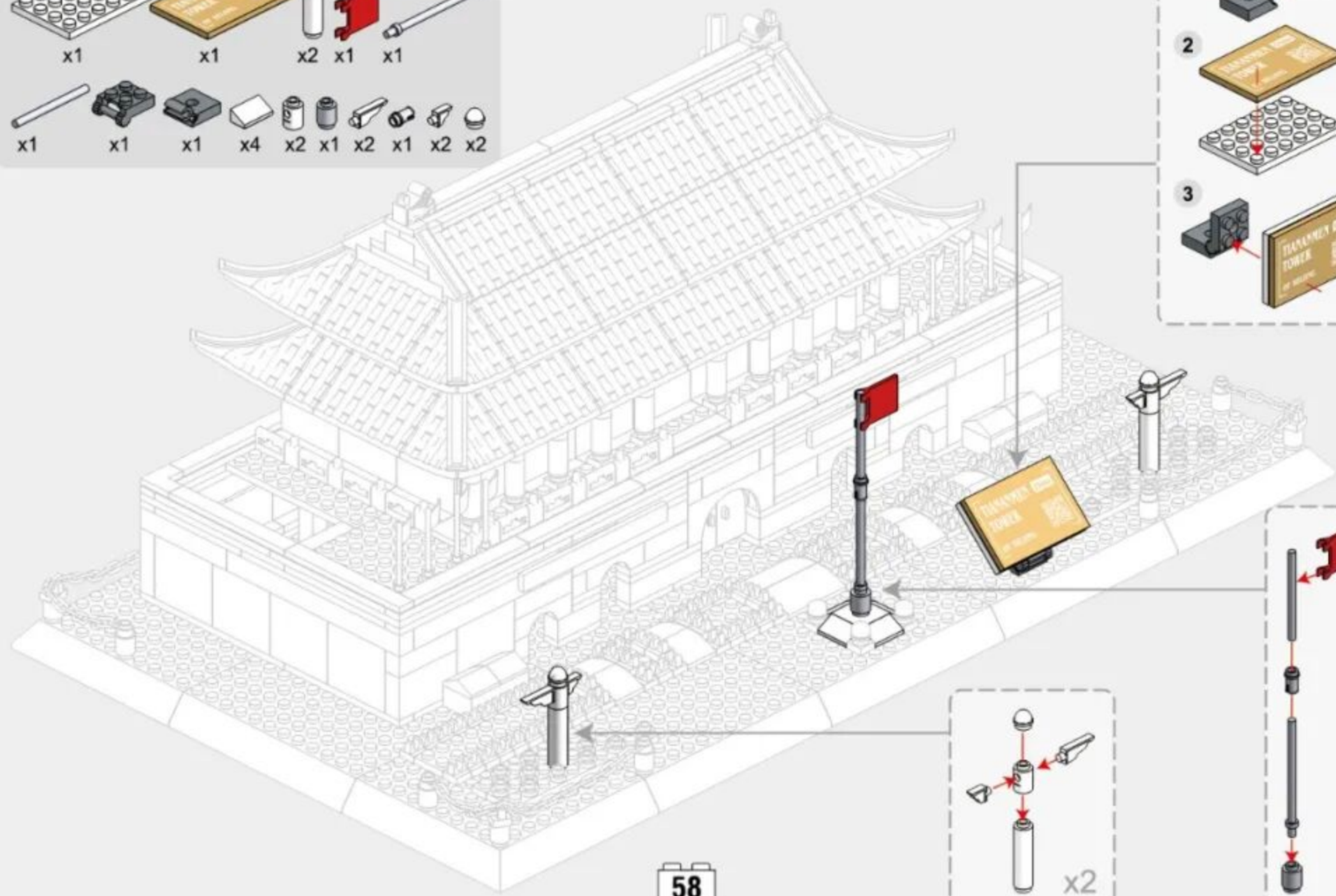
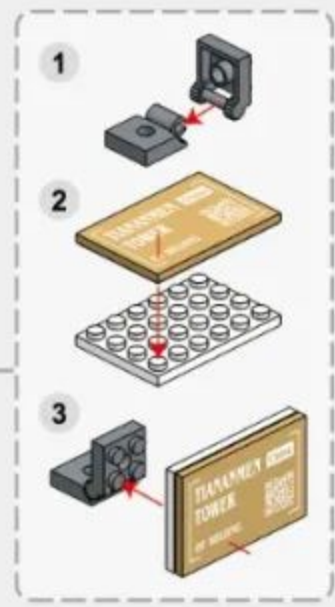
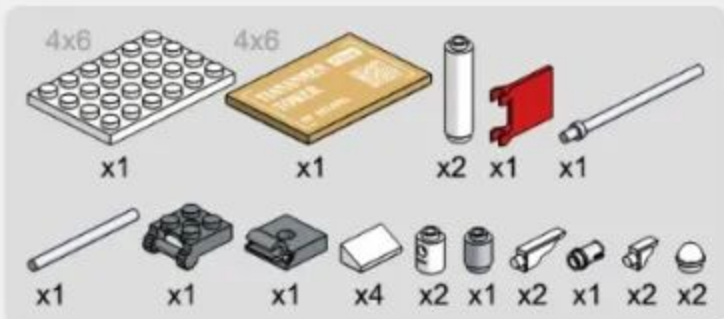



TIANANMEN TOWER

COUNTRY: China

CITY: Beijing

