



THE TAIPEI 101 OF TAIWAN

China
The world's great architecture

Ages
6+



Creative Ability

Family Interaction

Observation Ability



NO:5221

1512 PCS

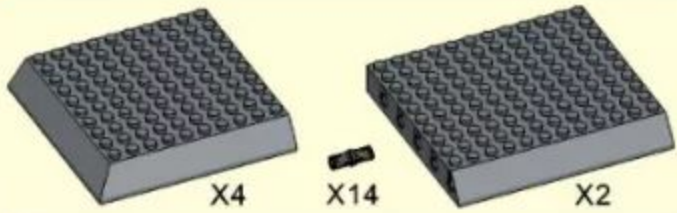

1

X10 X4 X12

2

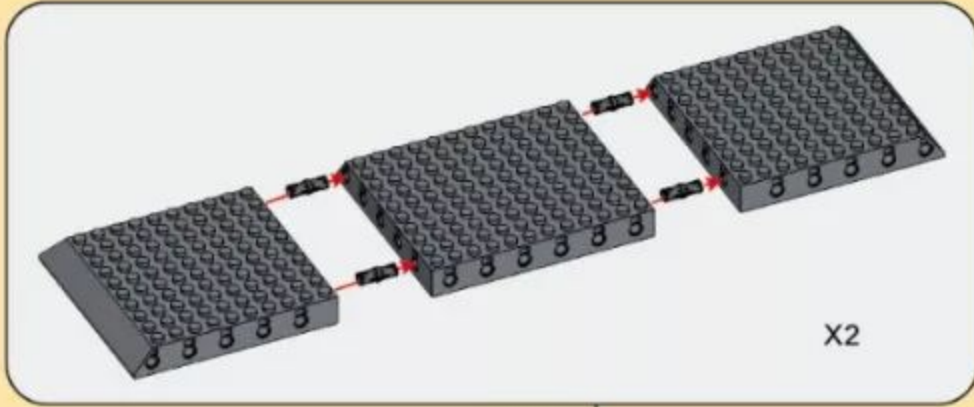
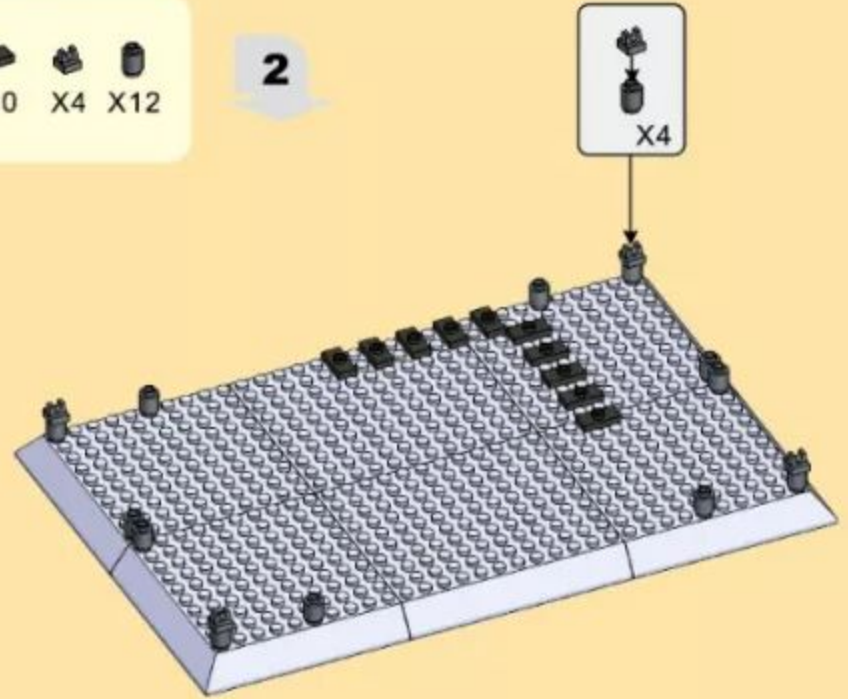

X2

X2 X2 X4
X2 X4 X2

3

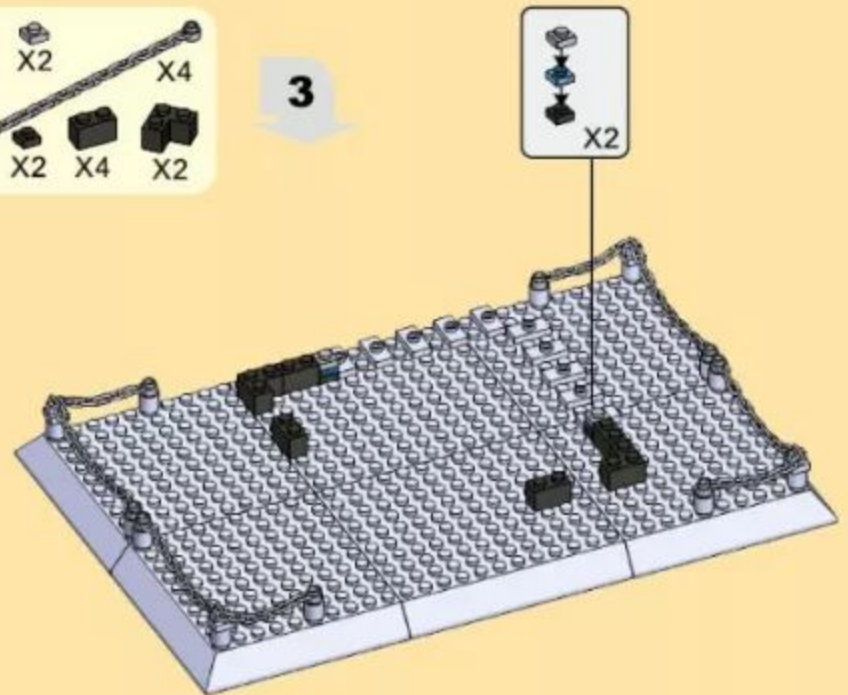

1

- X2
- X10
- X28
- X4
- X24

4

- X4
- X10
- X4

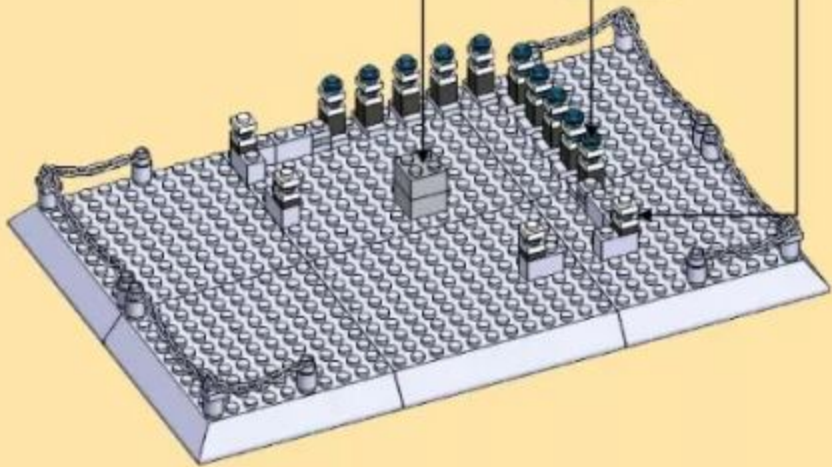

- X8
- X4
- X2
- X1
- X9
- X1
- X4

6

- X2
- X2

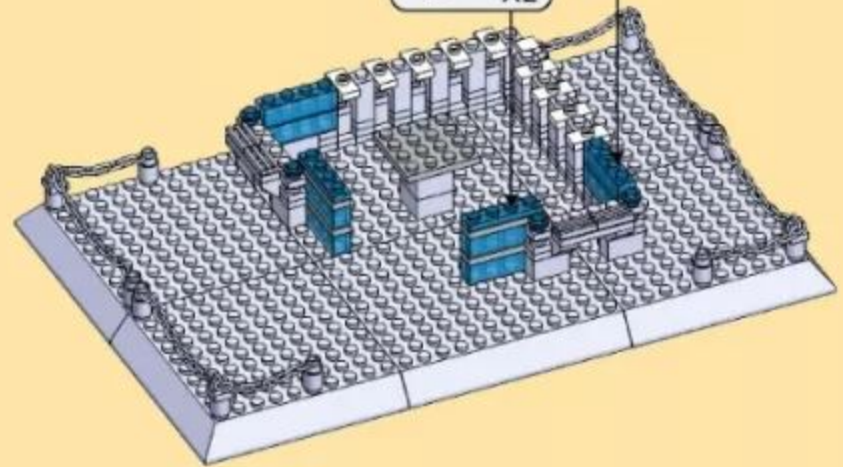

- X9
- X2
- X9
- X9
- X2
- X4
- X4
- X9

5

- X9
- X2

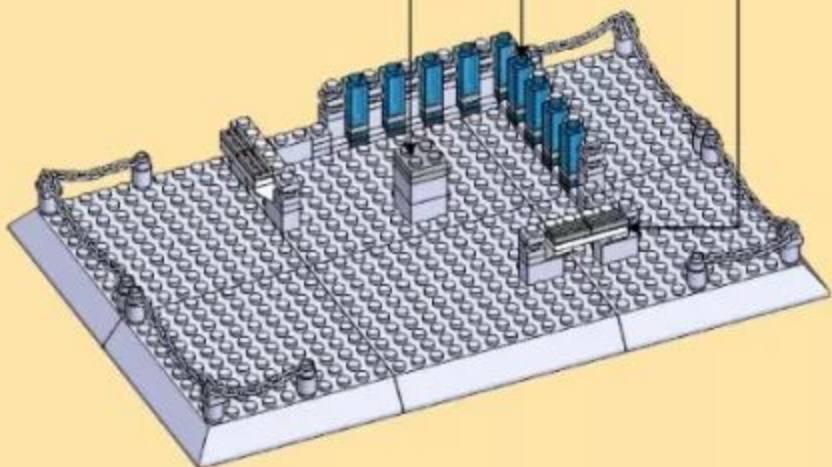

- X2
- X1
- X1
- X2
- X1
- X4
- X4

7

- X4

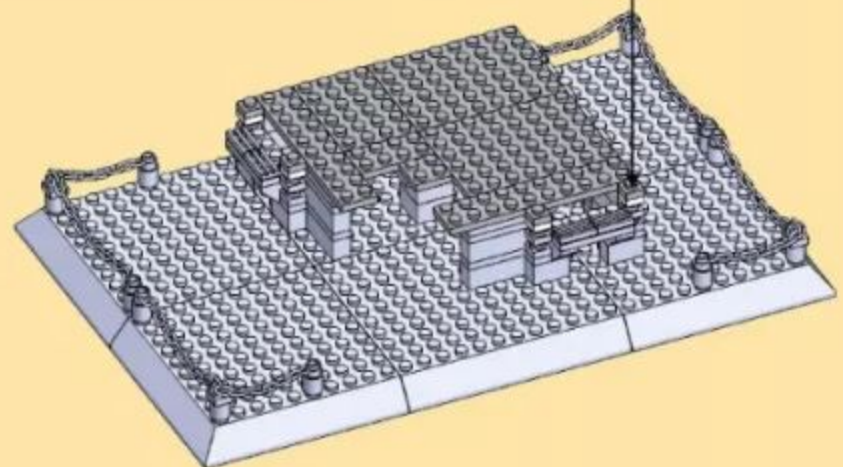

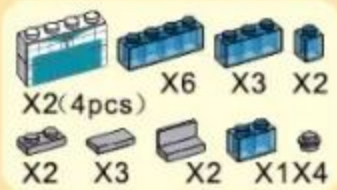

8

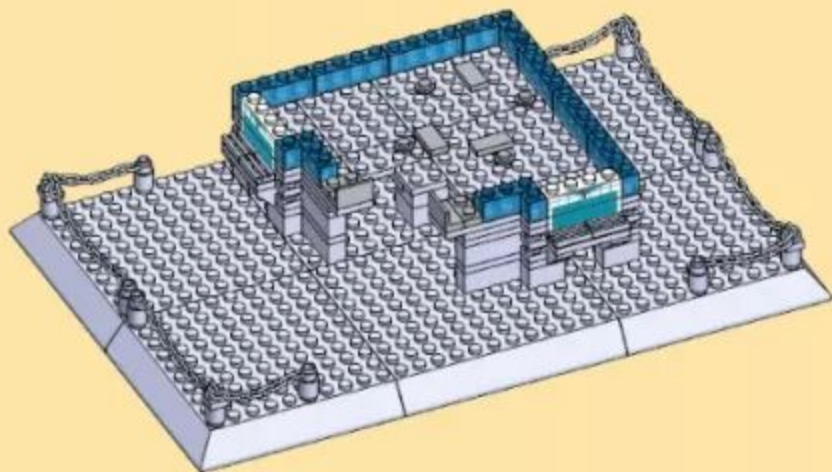

X61

10

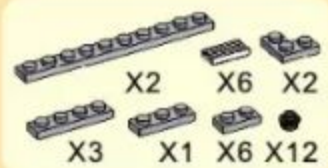
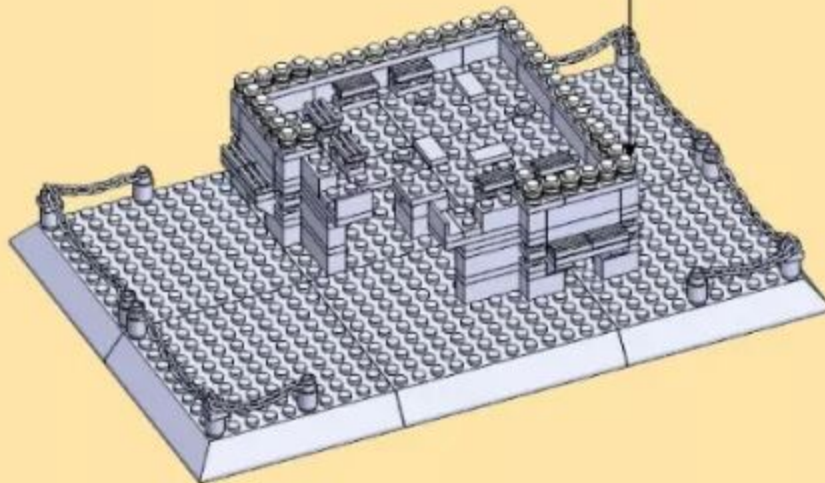

9

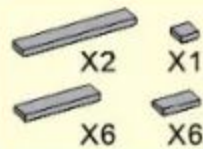
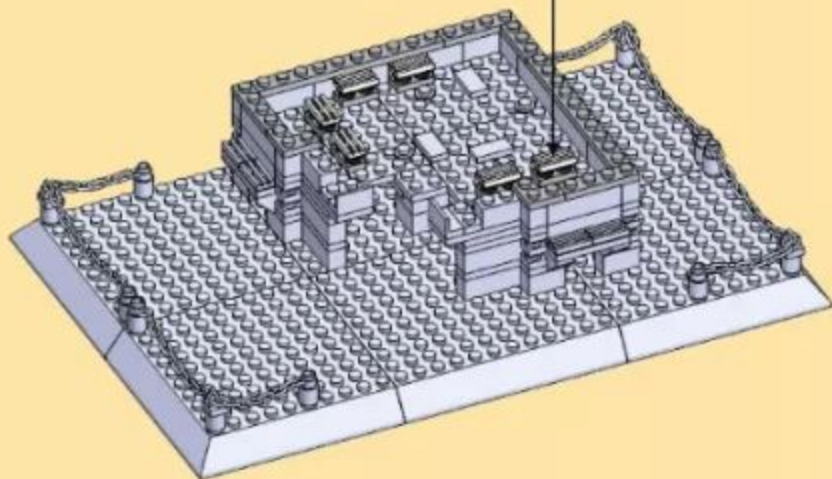

11

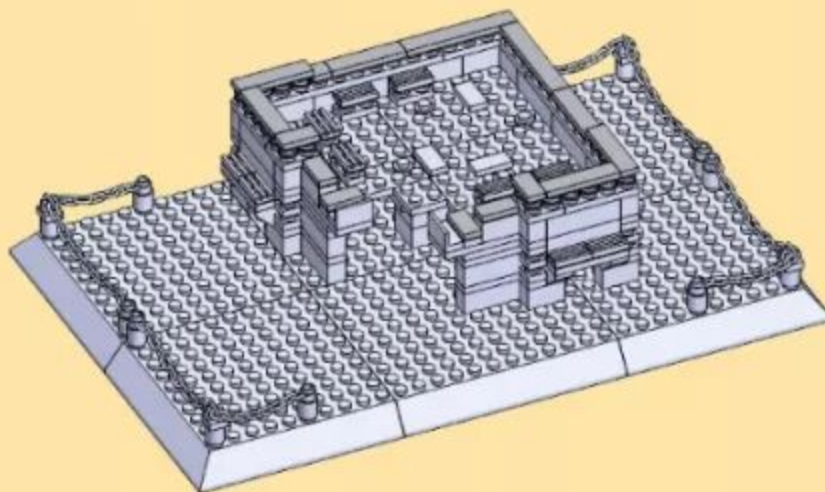

3

- X1 (2pcs)
- X1
- X1
- X2
- X2
- X1
- X2
- X1
- X3
- X2
- X2
- X2
- X2
- X4
- X2
- X2
- X2
- X2
- X4
- X2
- X2
- X2
- X4
- X4
- X3
- X1
- X2

12

- X2
- X10
- X2 (4pcs)
- X2
- X4
- X4
- X1
- X1
- X1
- X2
- X2
- X6
- X14
- X7
- X4

13

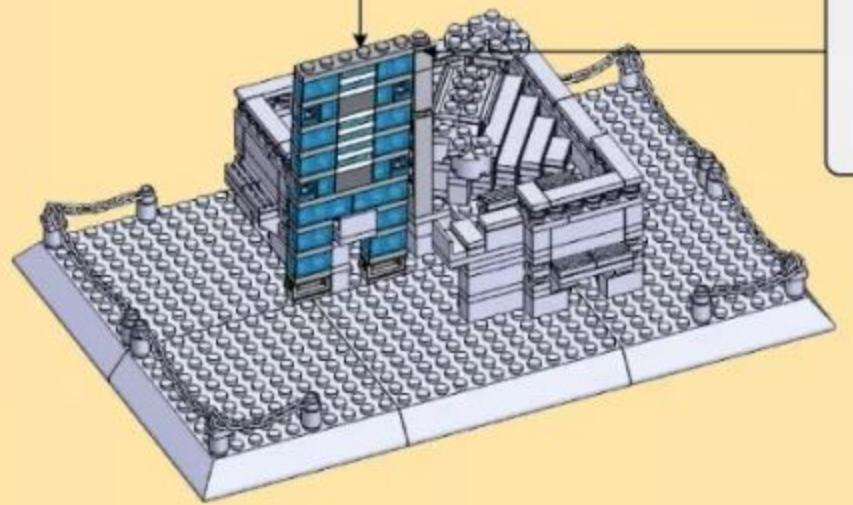
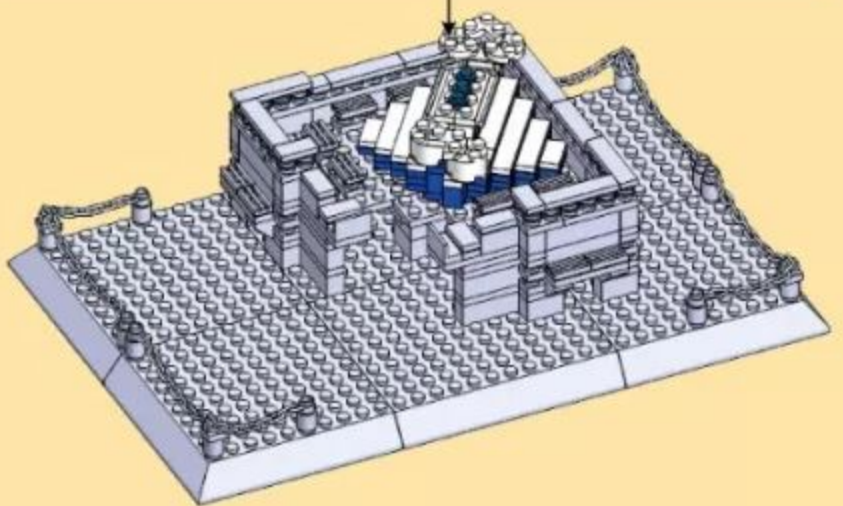
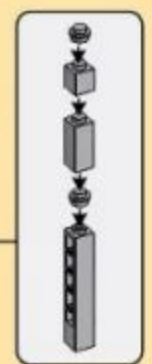
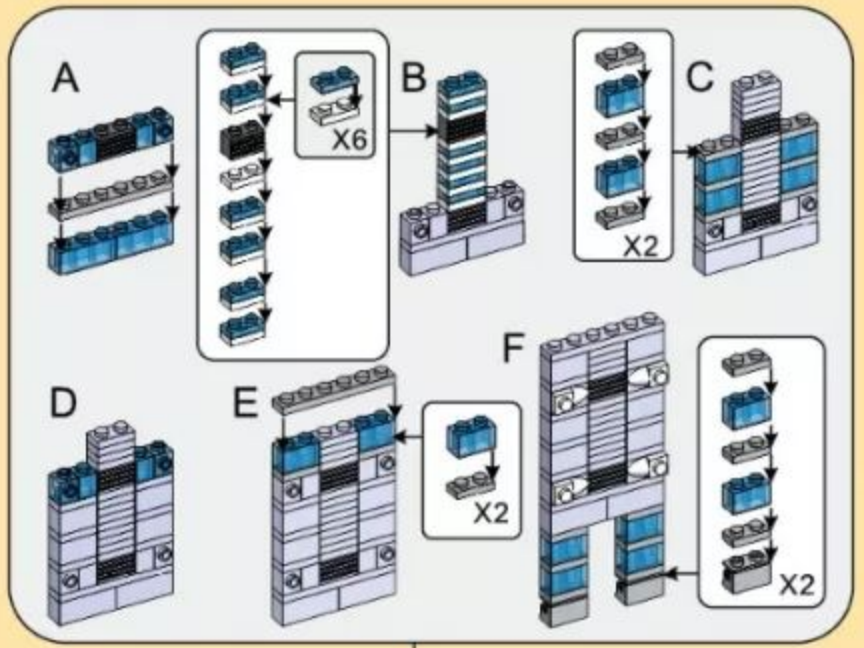
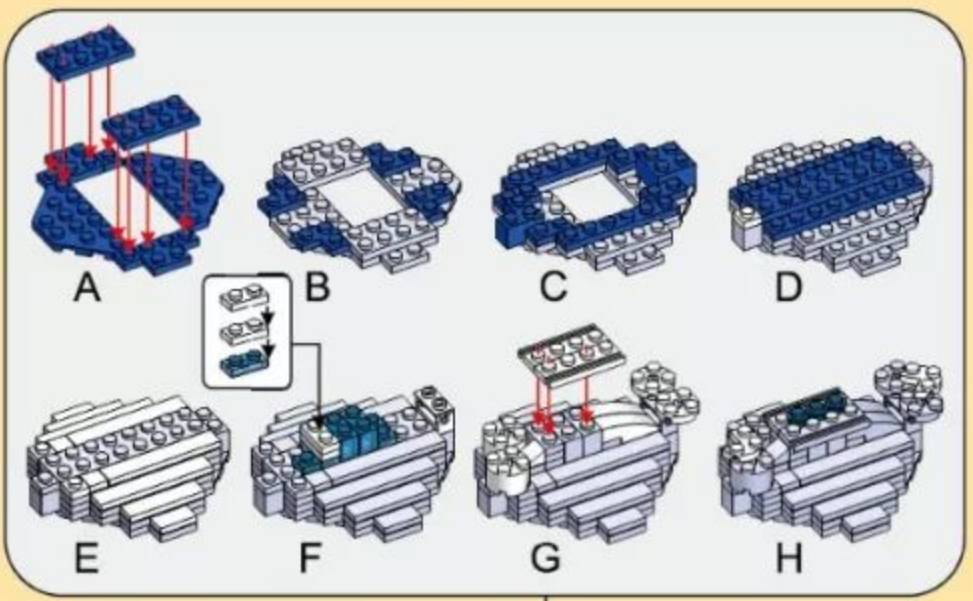

4

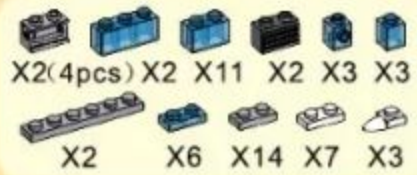

 X2(4pcs) X2 X11 X2 X3 X3
 X2 X6 X14 X7 X3

14

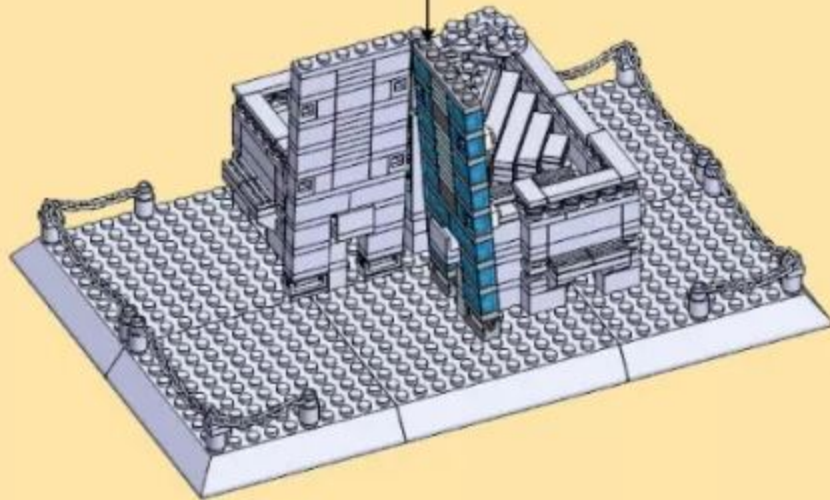
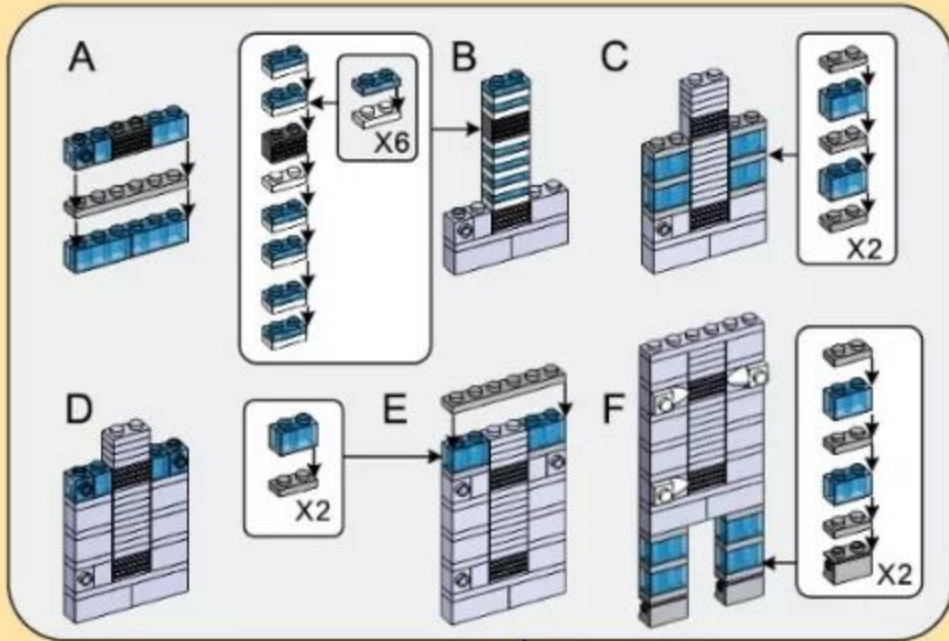

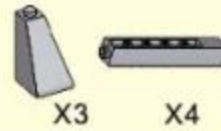

 X3 X4

15

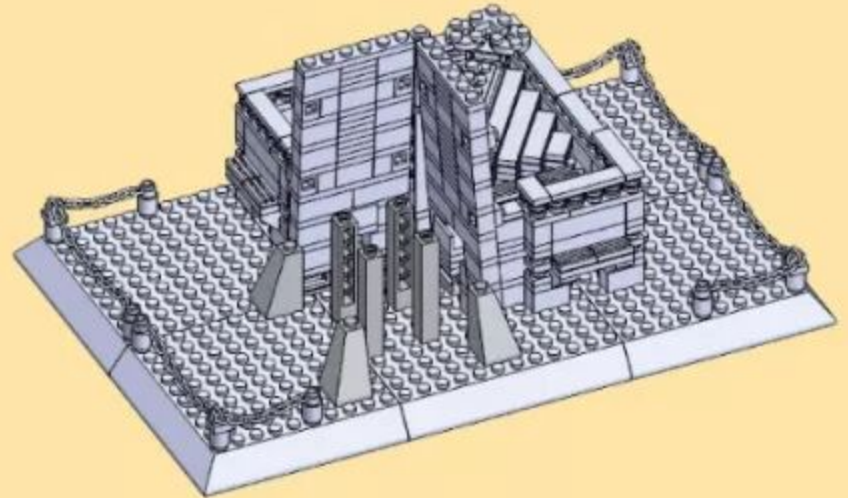



 X1 X3

16

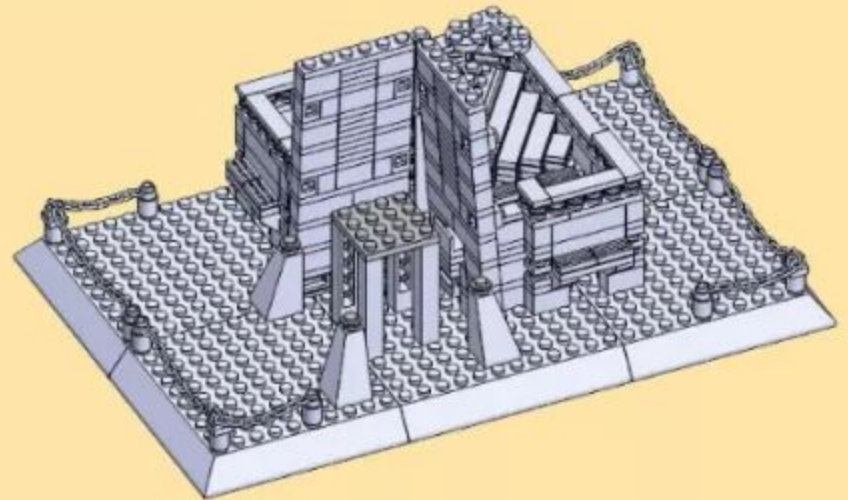

5



17

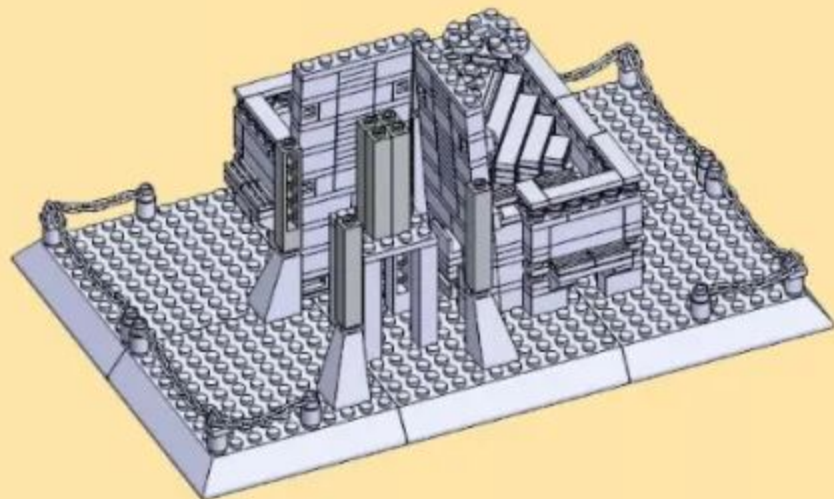

19

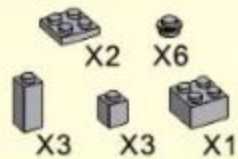
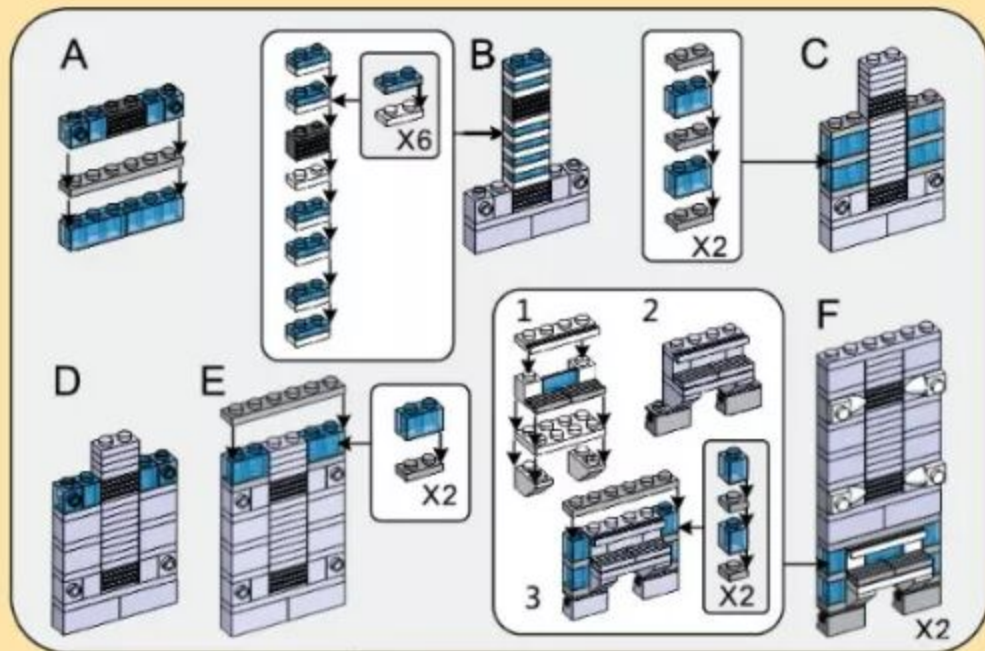

18

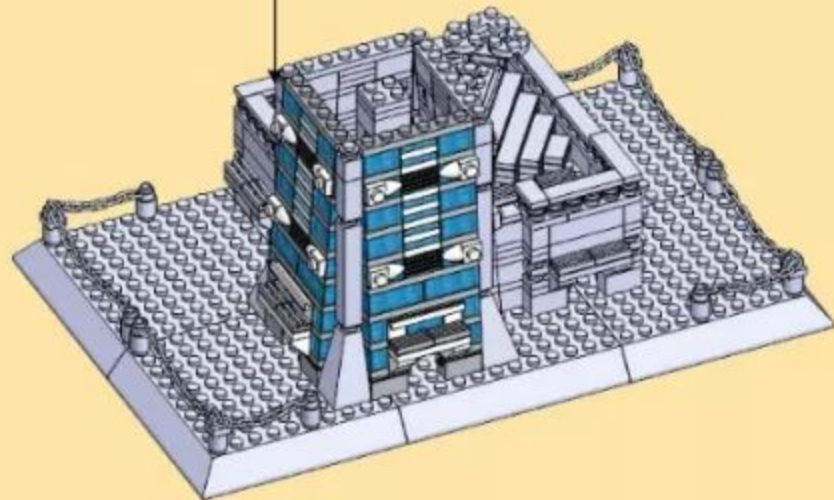
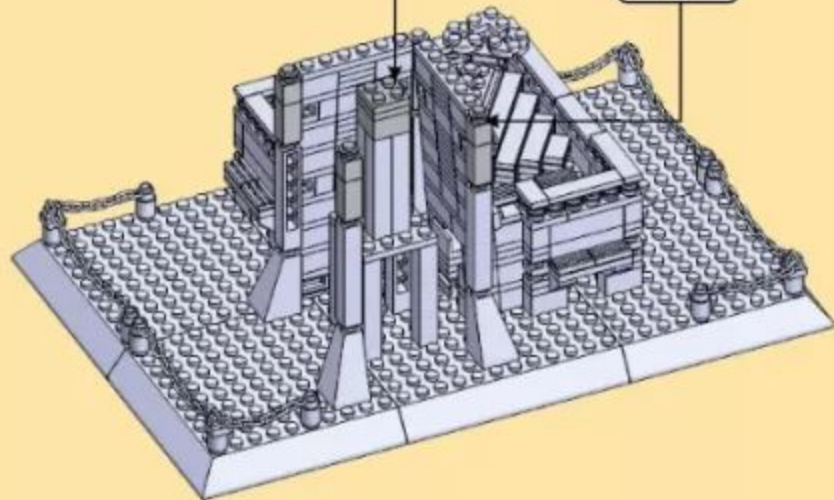
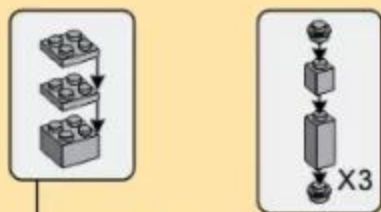

- X4
- X2
- X2
- X2
- X2
- X2

20

- X2

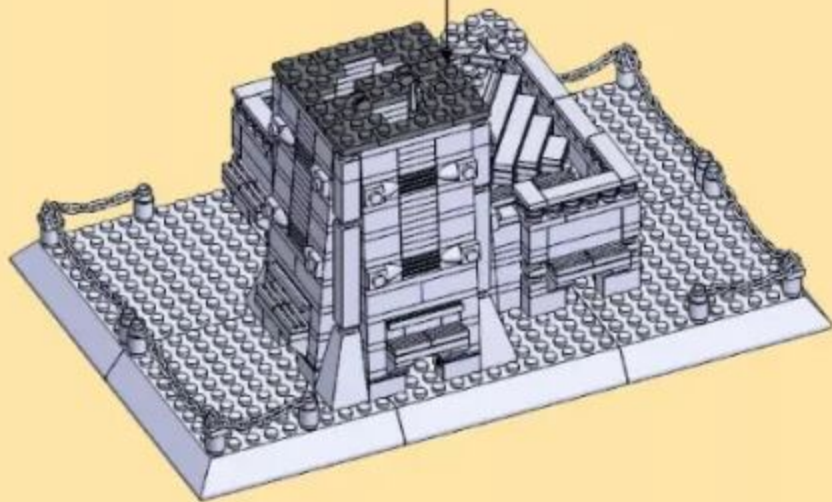

- X8
- X4
- X4
- X4
- X4

22

- X4

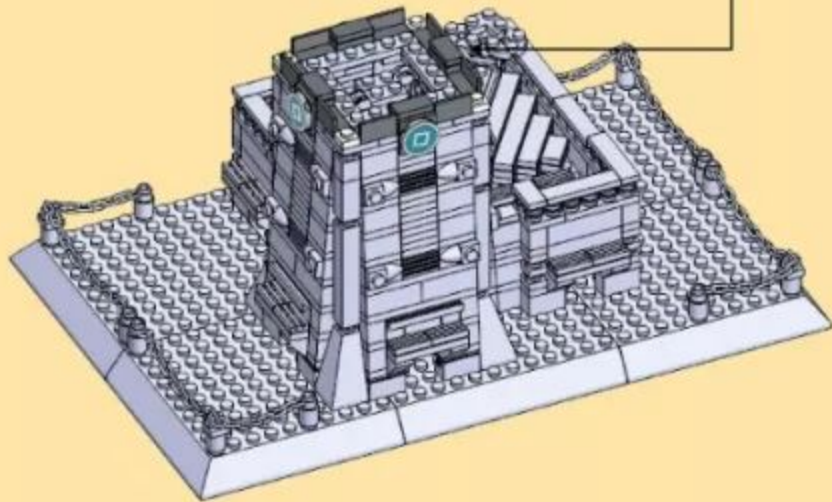

- X2
- X2
- X4

21

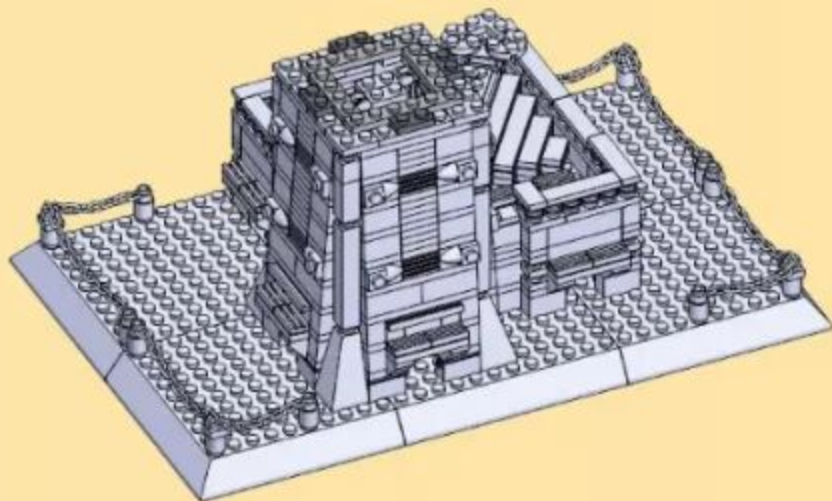

- X4
- X4

23

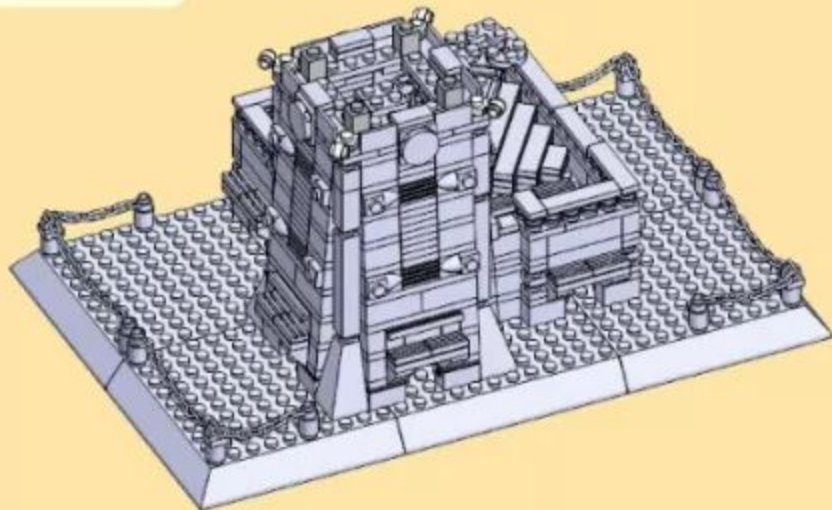



X4



X4

24



X8



X8

(16 pcs)



X4



X4



X4



X4



X8



X4



X4



X4



X8

25

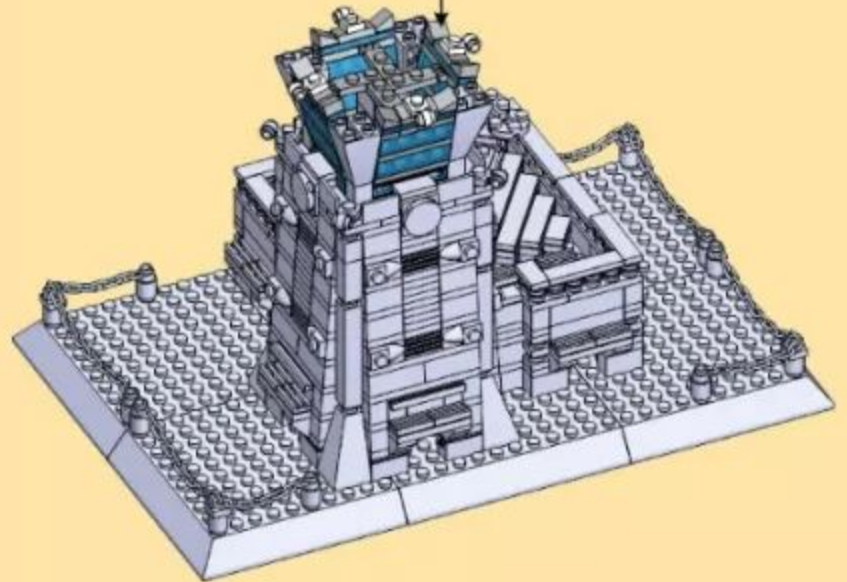
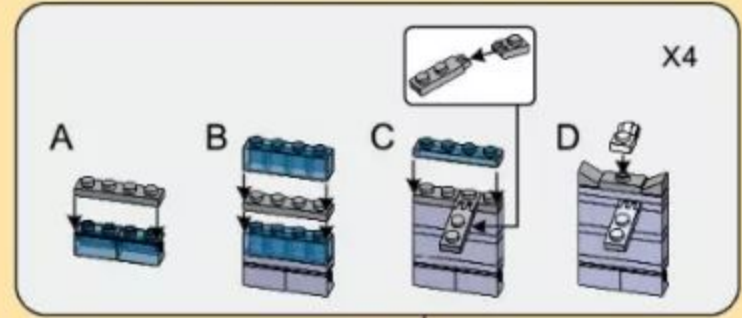
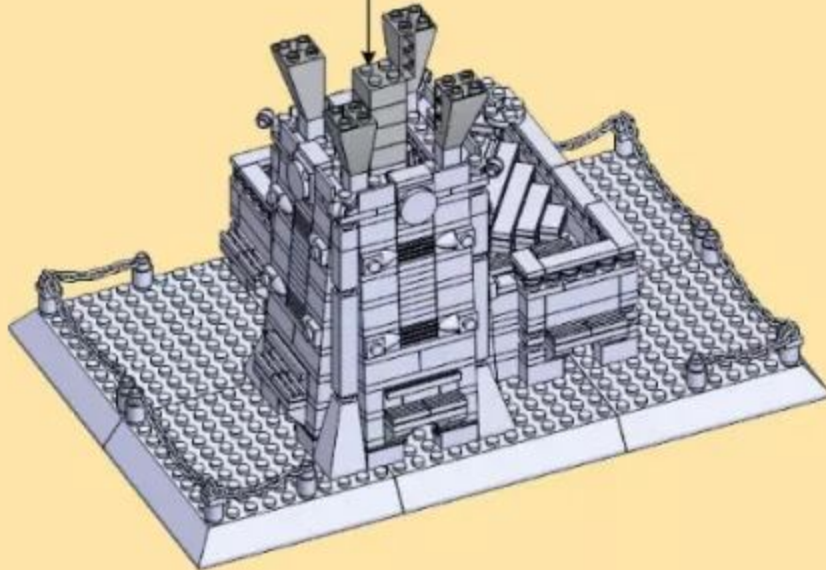
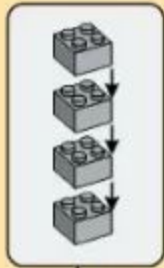

X2
X2 X4

26

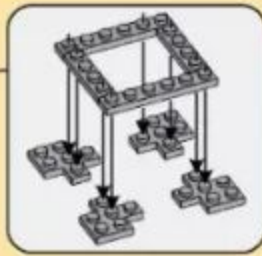
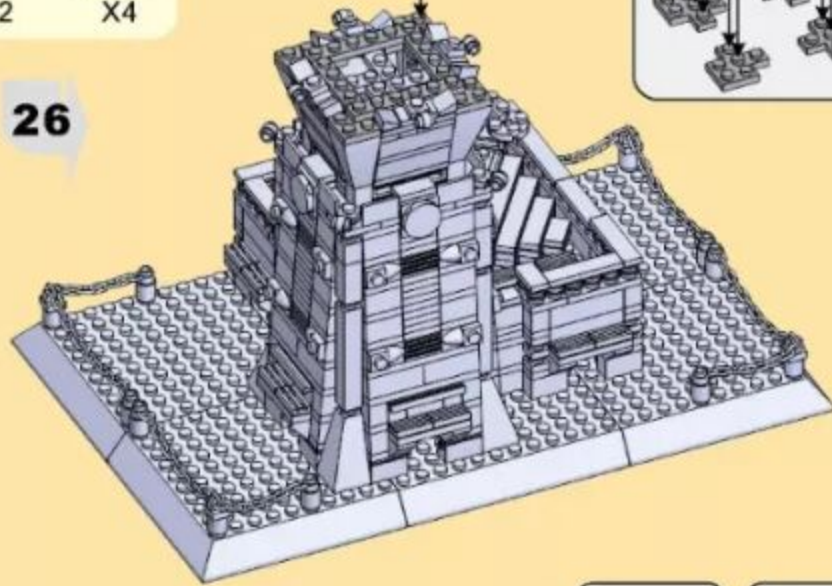

X8 X8 (16pcs) X4 X4 X4
X4 X8 X4 X4 X4 X8

28

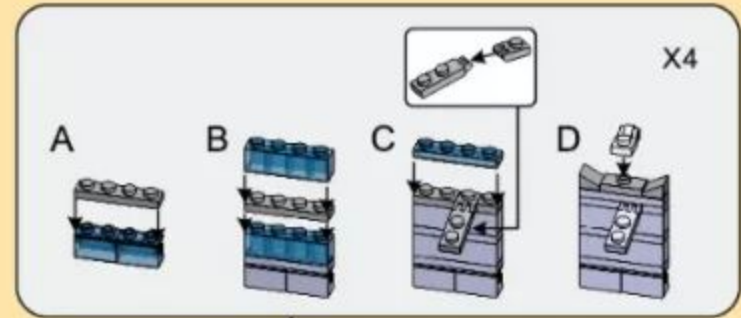

X4
X1 X4 X4

27

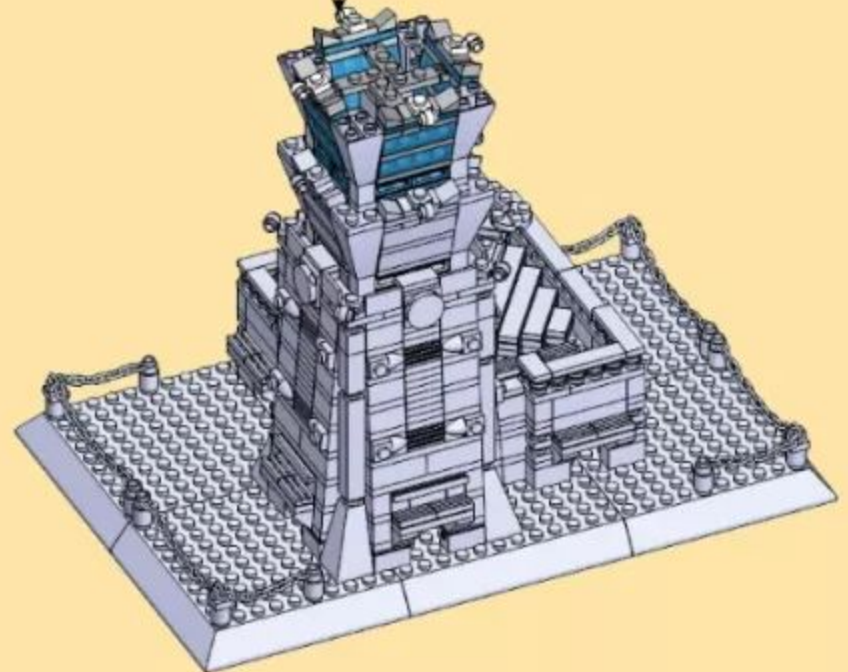
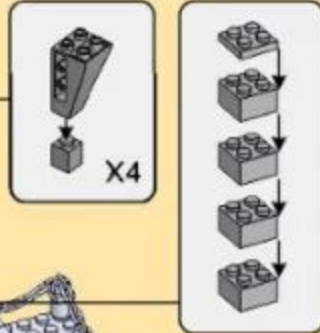
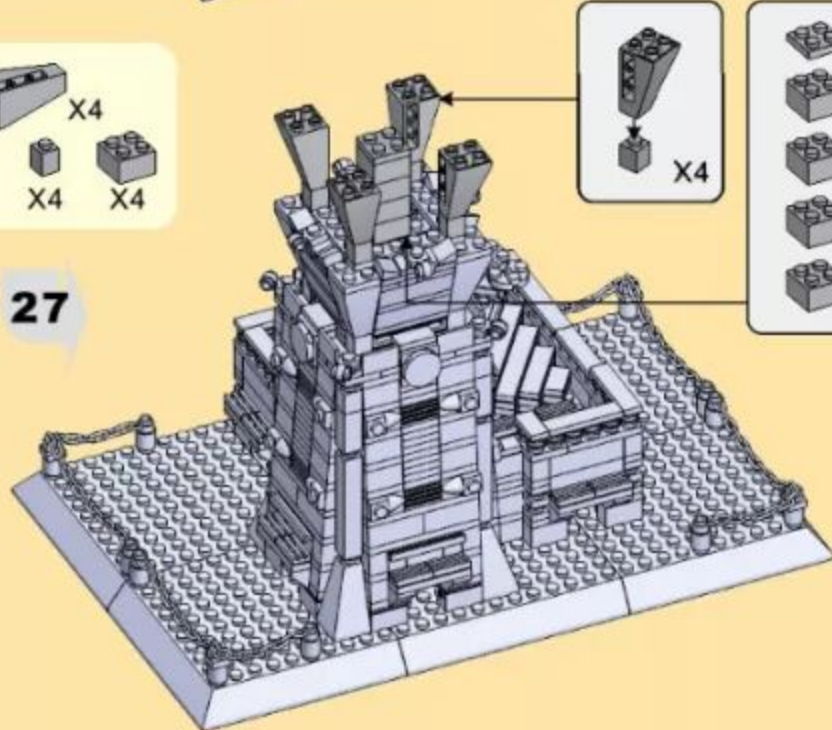

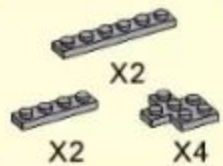

29

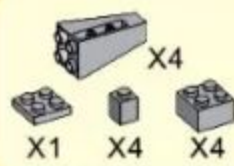
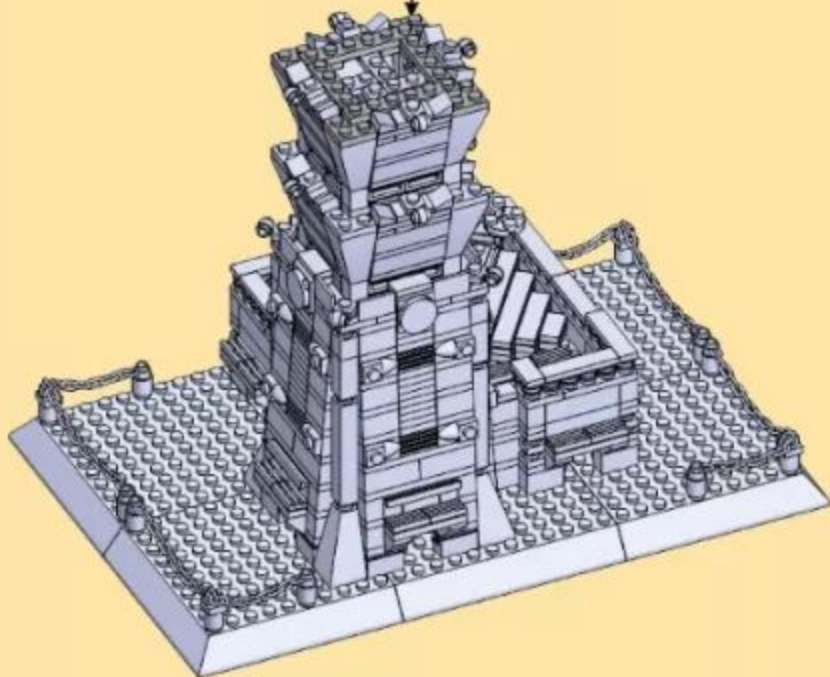
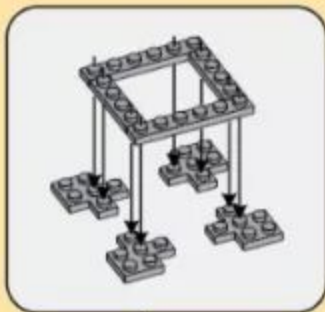

30

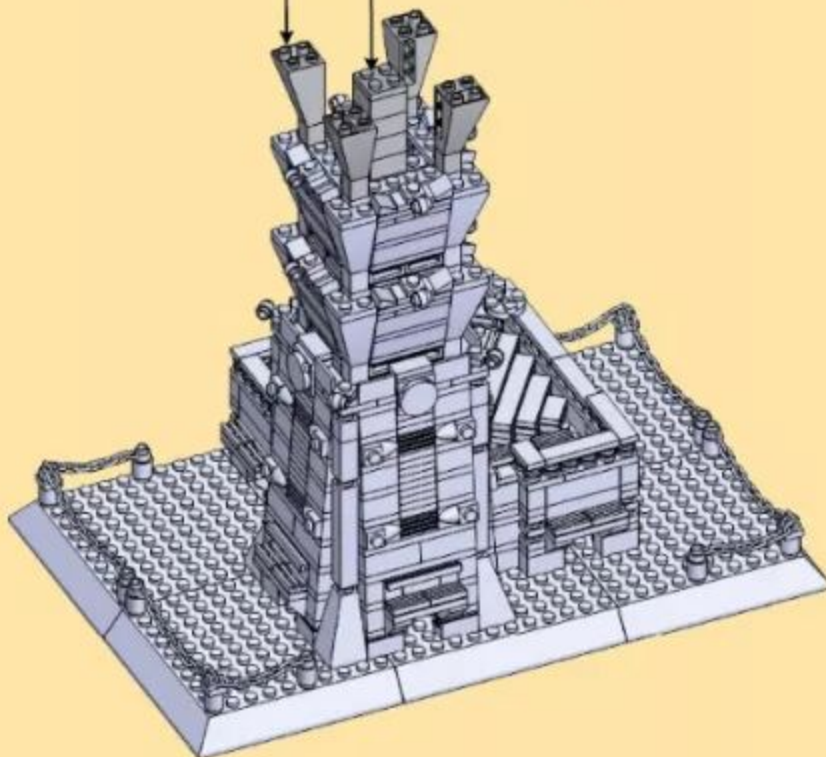
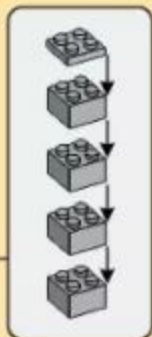



31

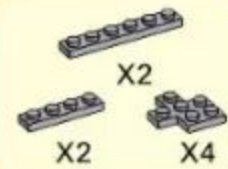

32

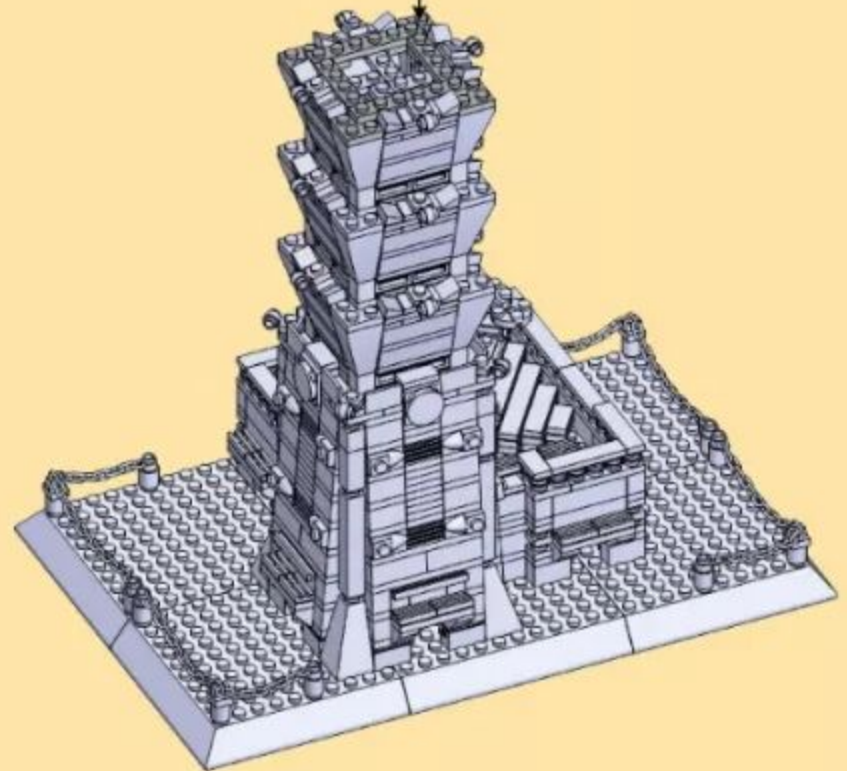
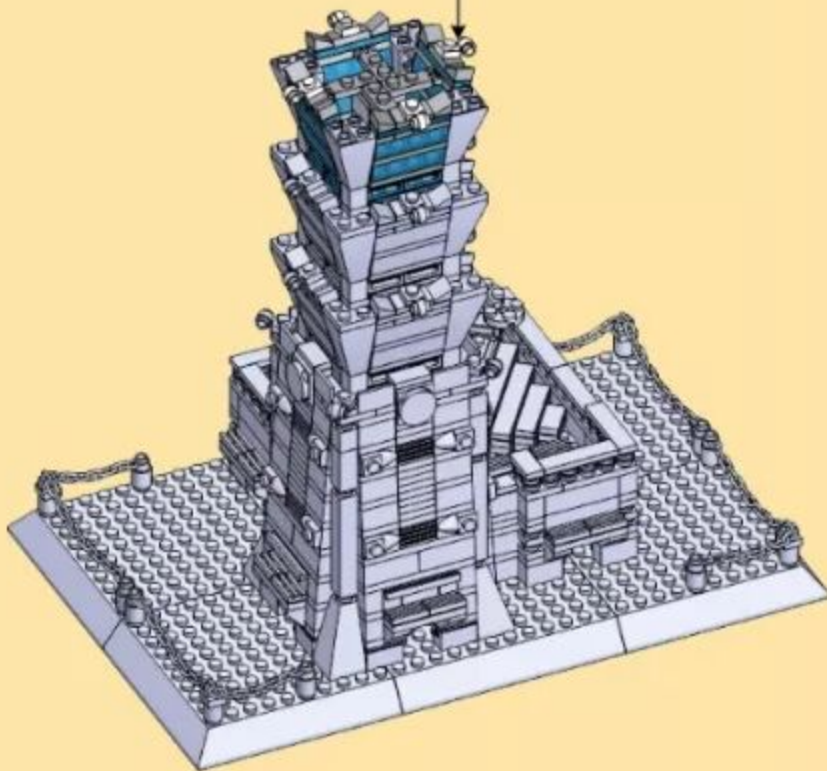
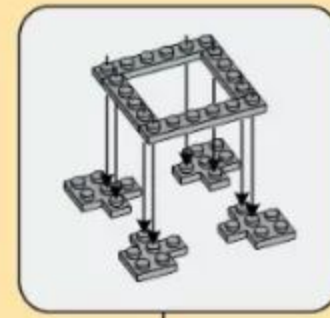
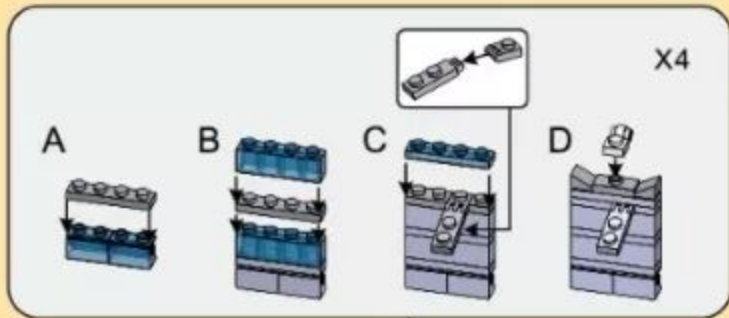

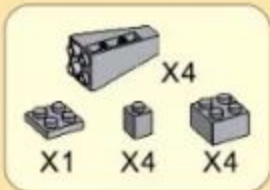

33



34

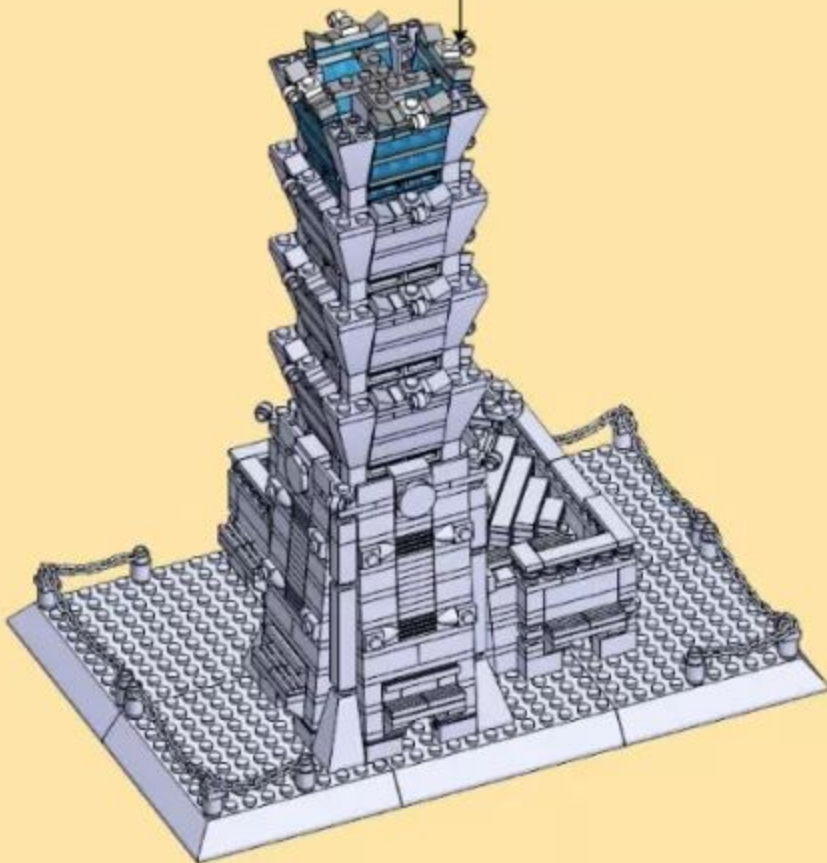
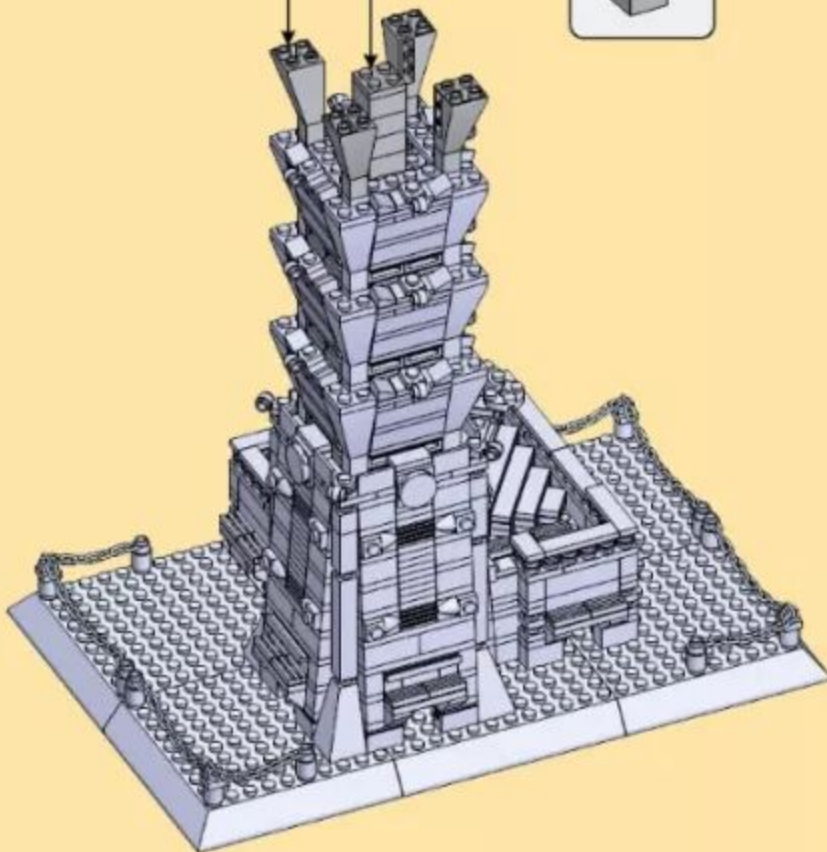
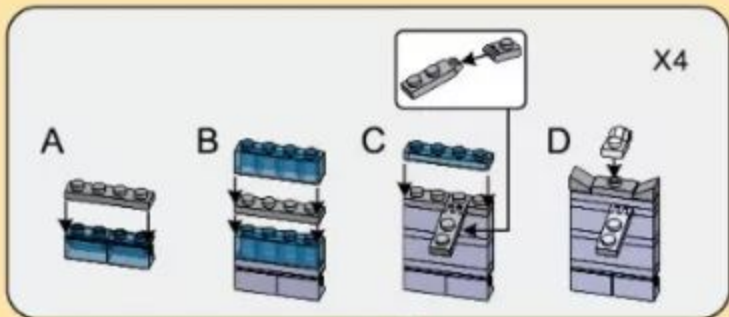
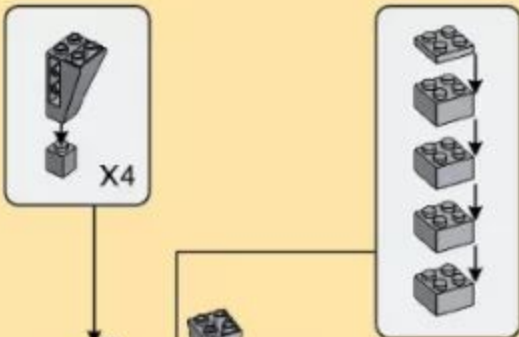

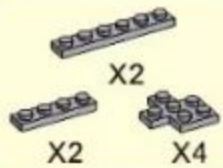

35

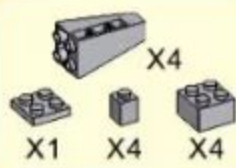
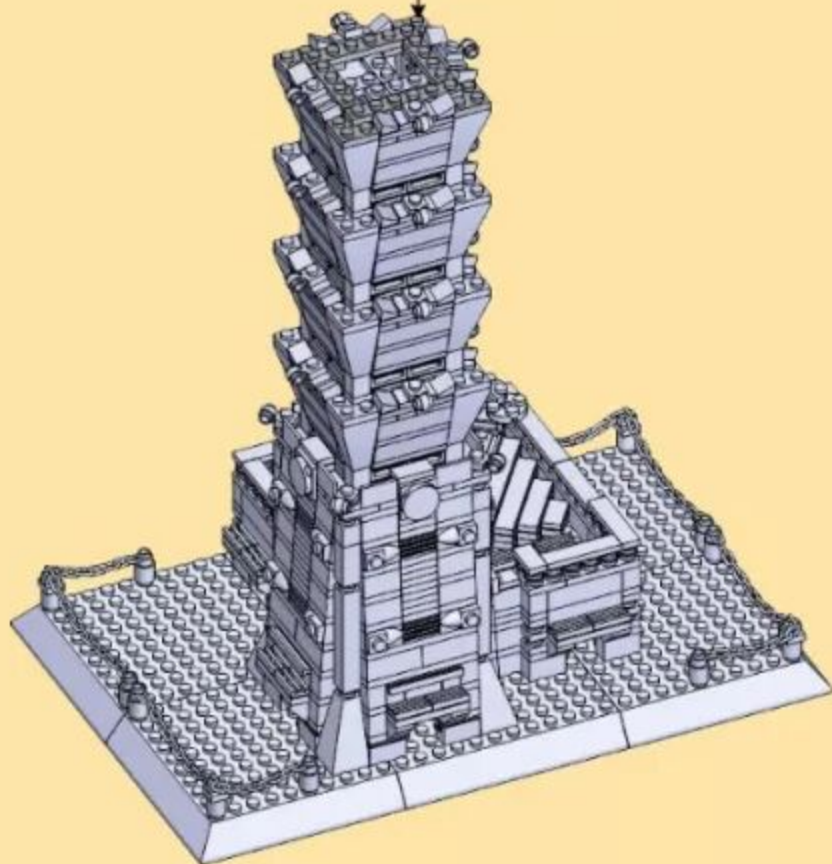
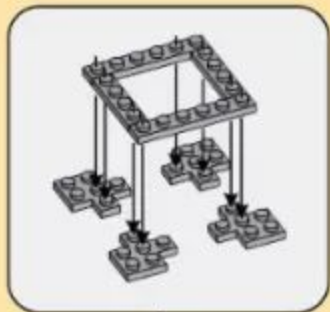

36

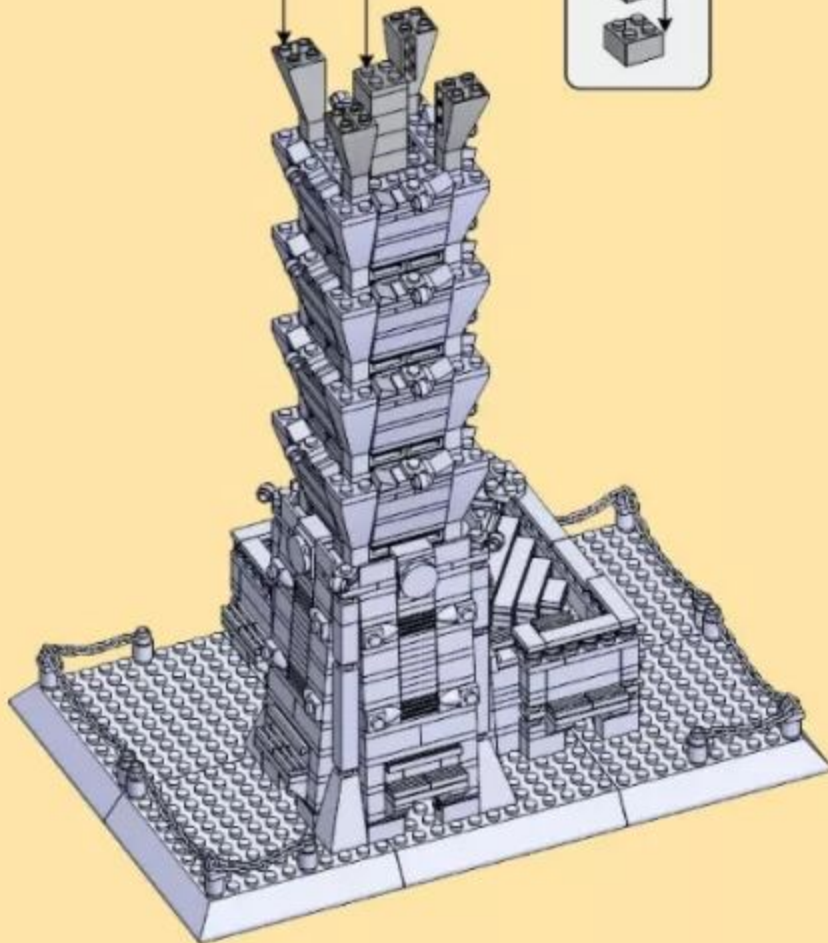
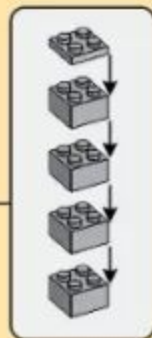



37

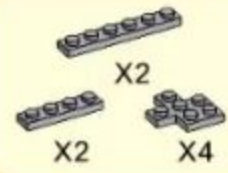

38

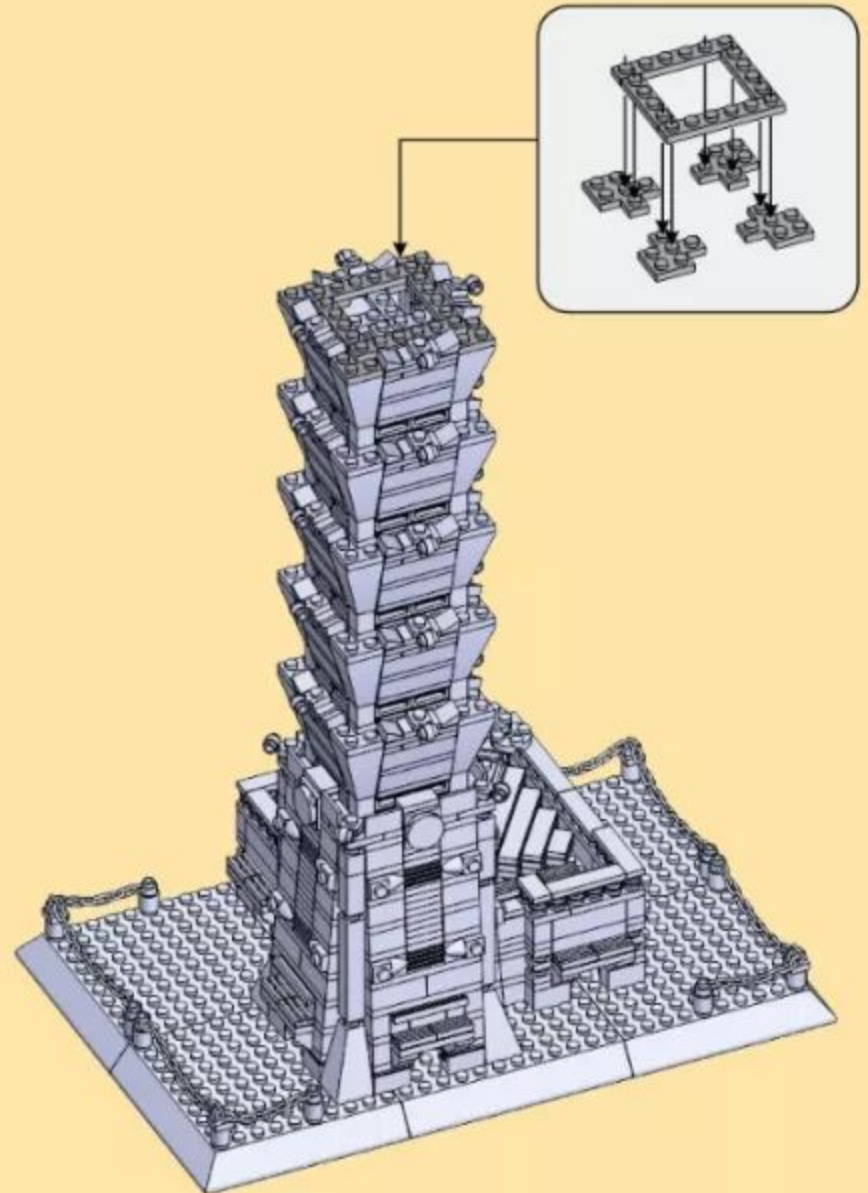
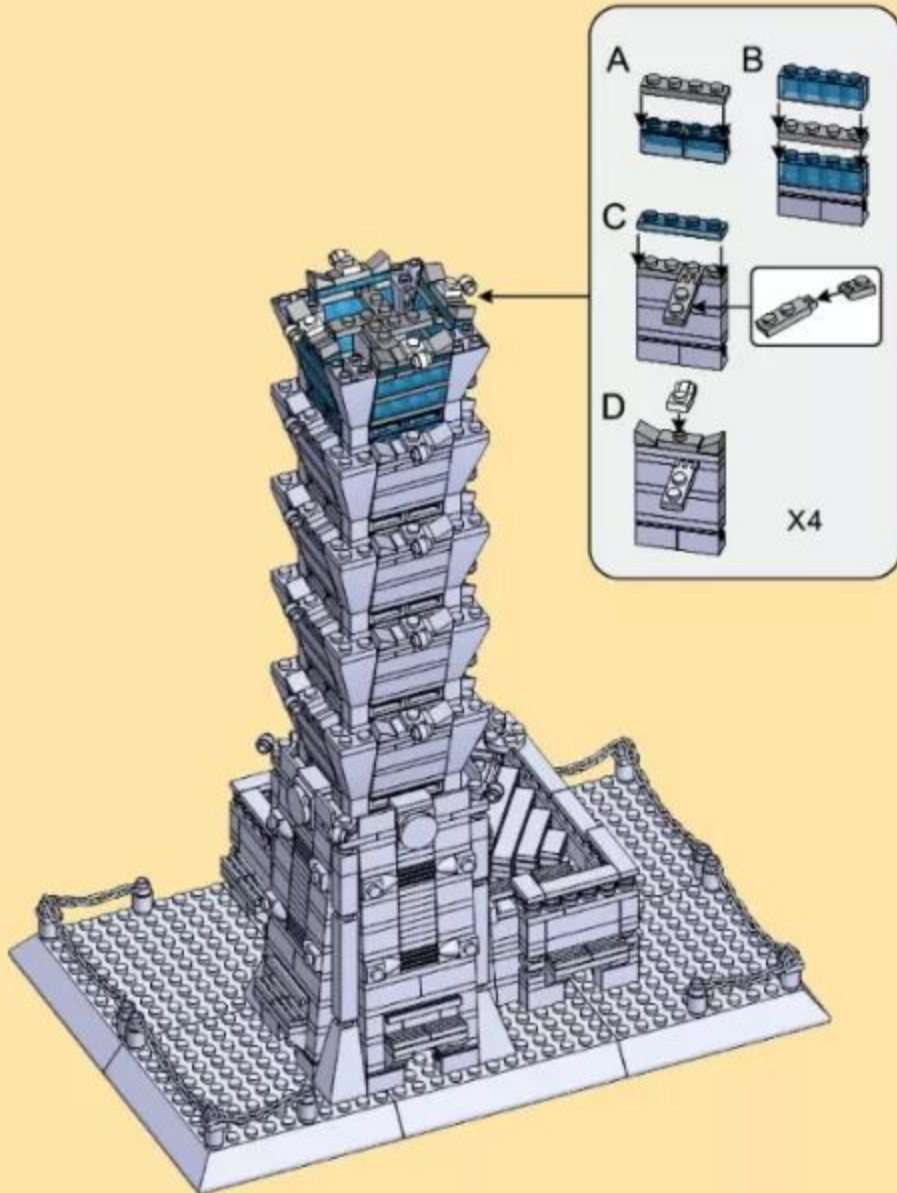

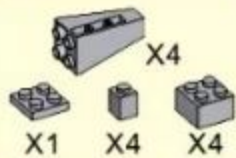

39

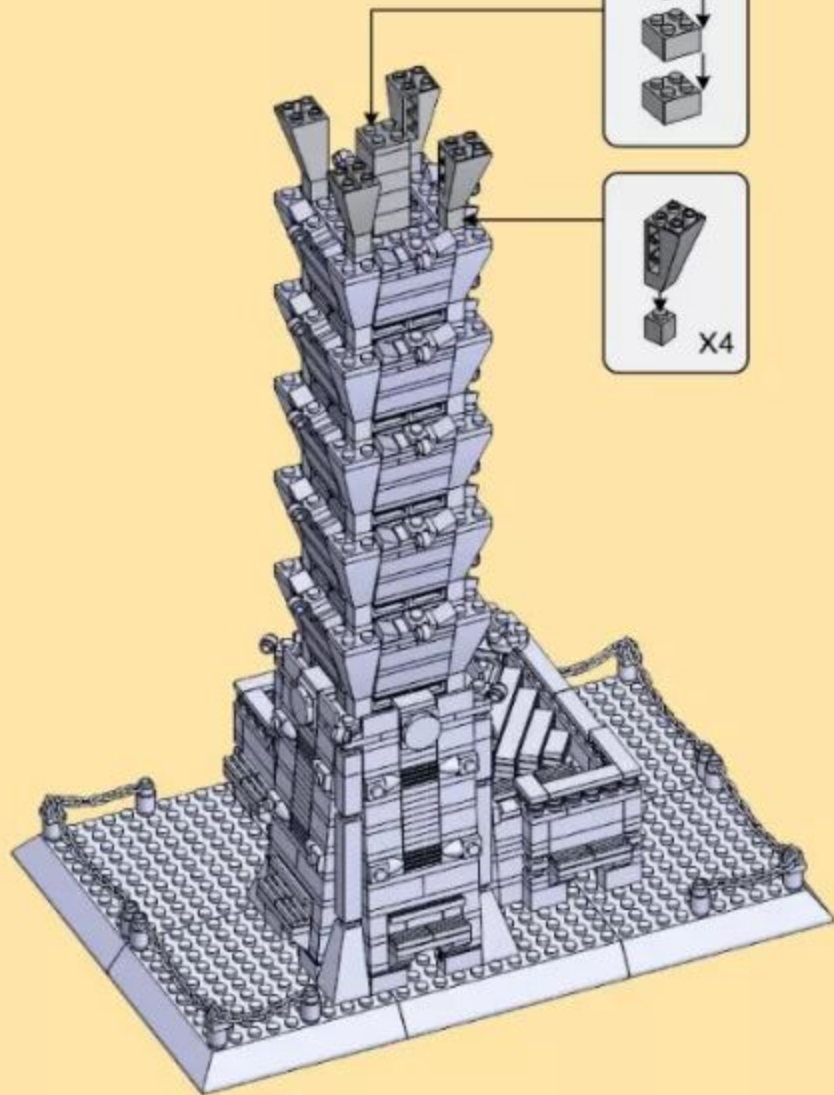

40

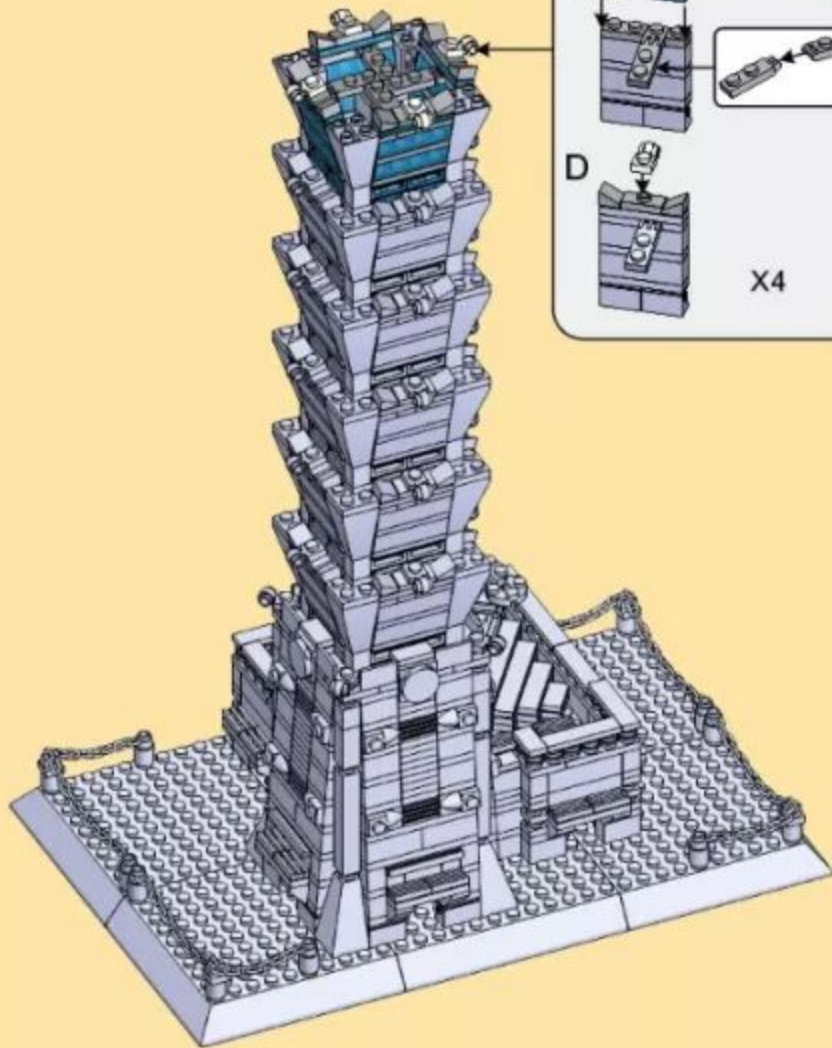
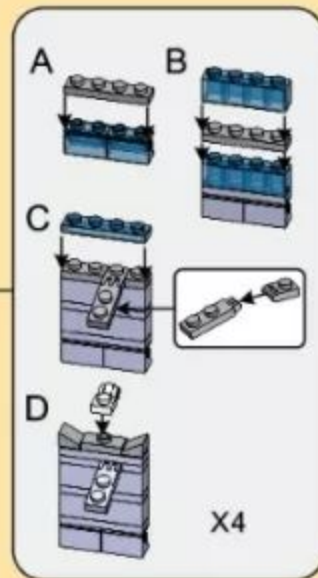

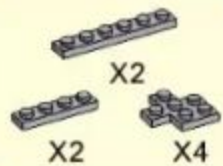

41

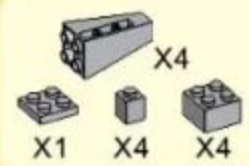
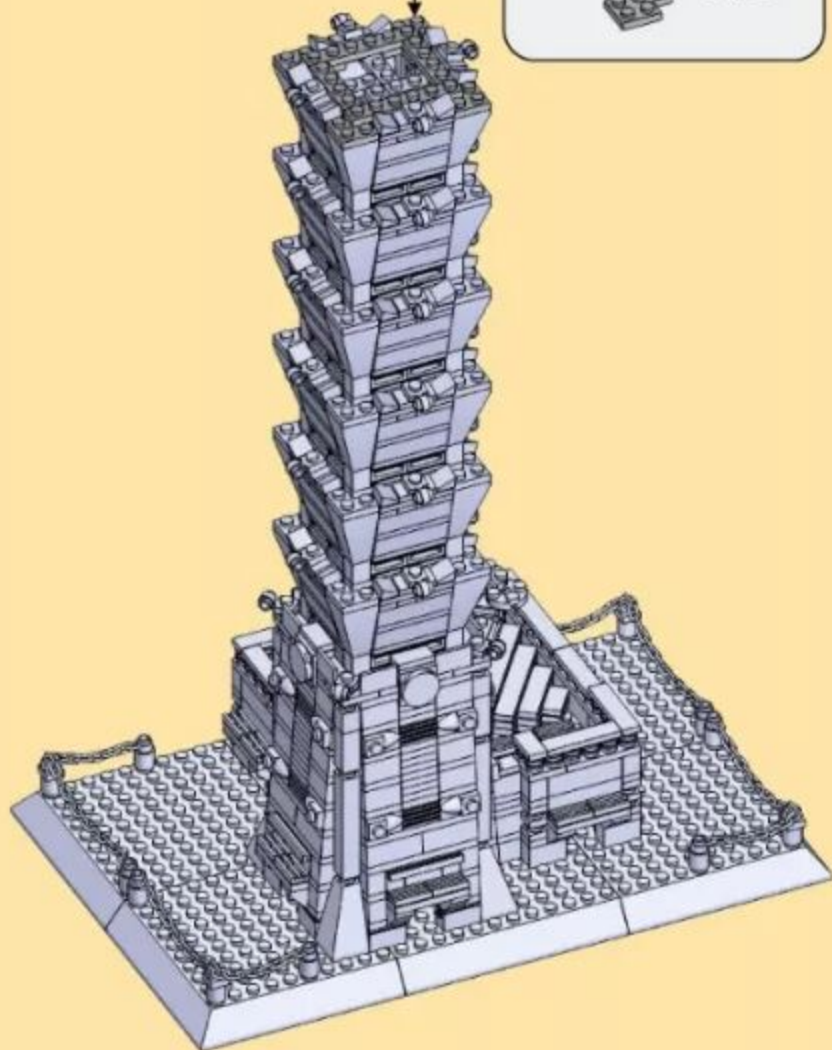
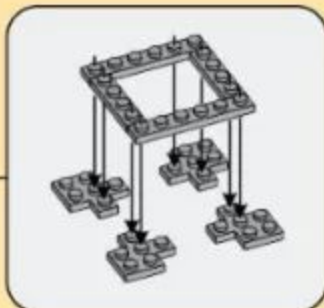

42

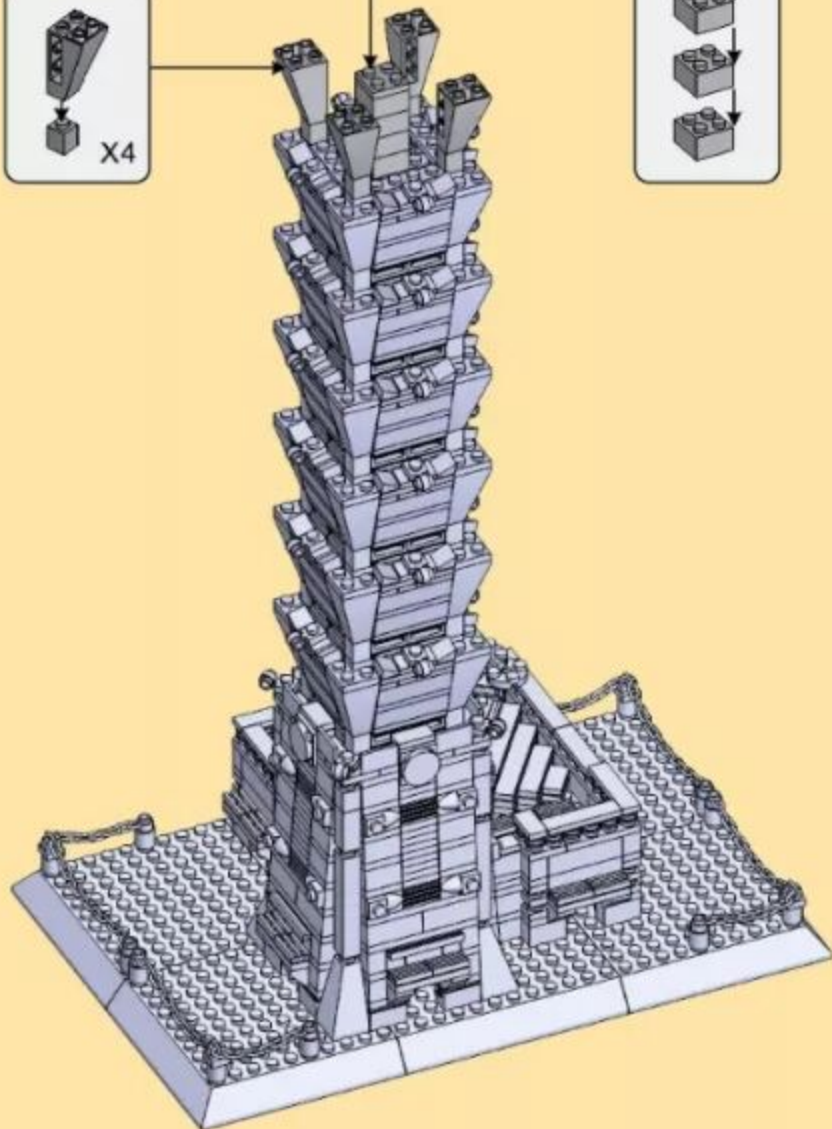
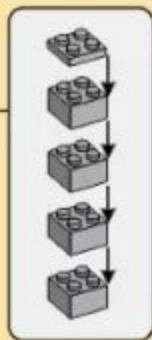

- X8
- X8 (16pcs)
- X4
- X4
- X4
- X4
- X8
- X4
- X4
- X4
- X4
- X8

43

- X2
- X2
- X4

44

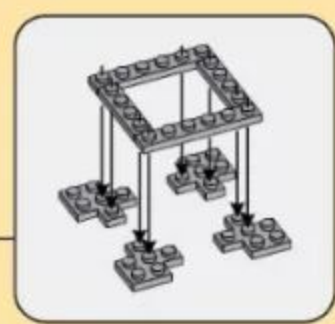
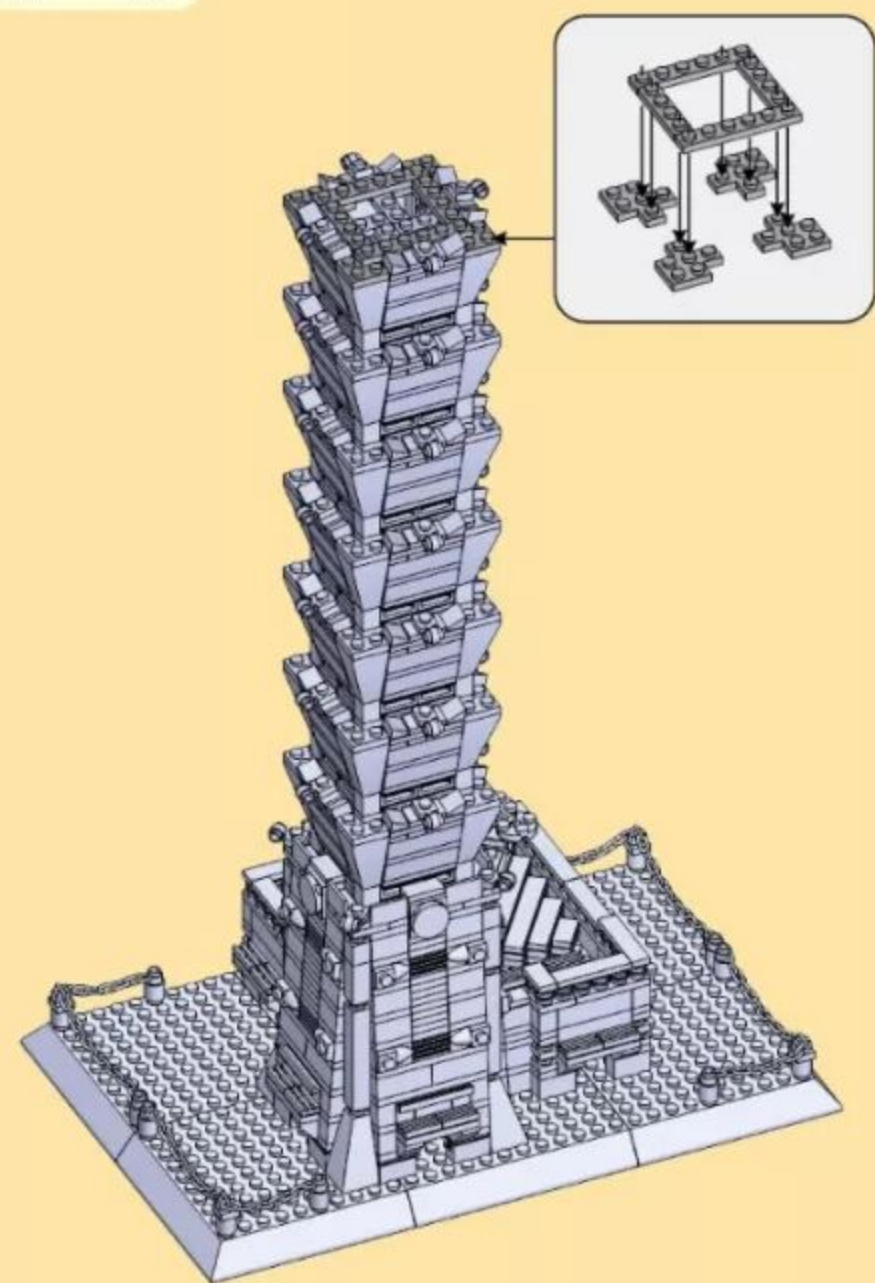
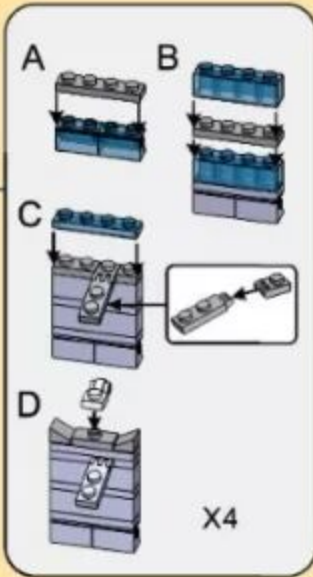
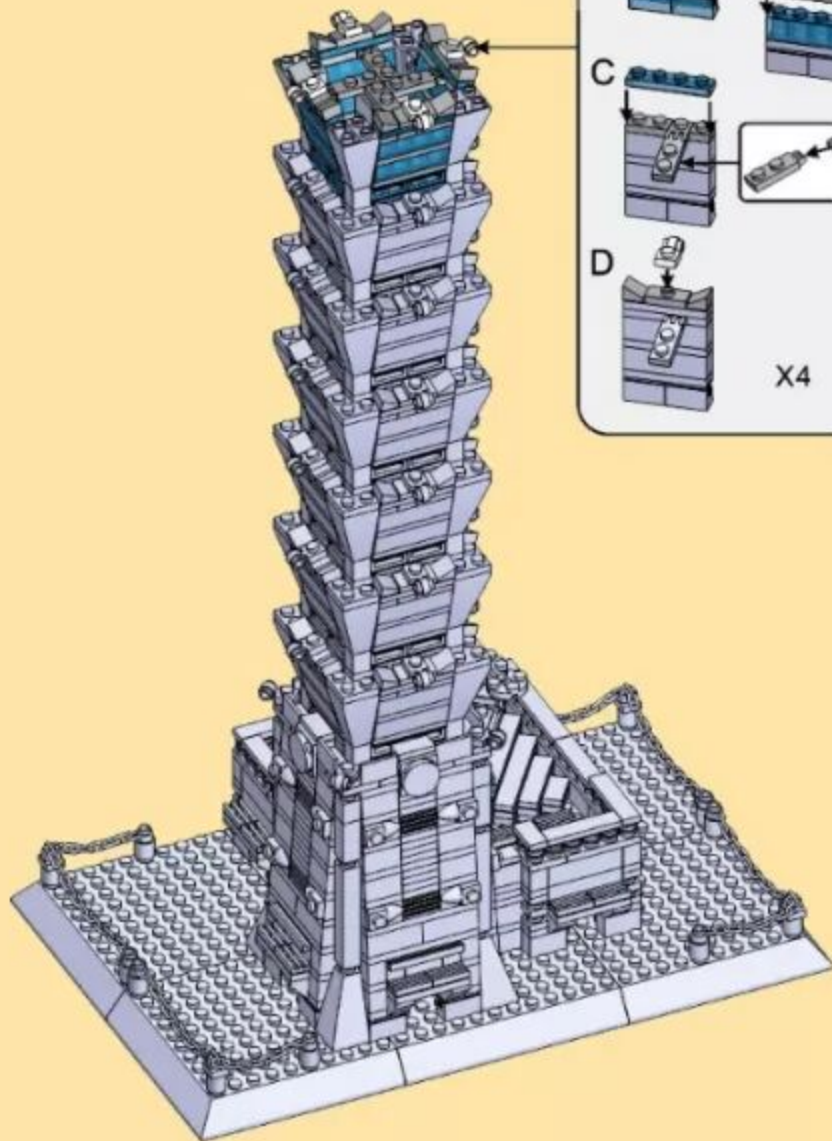

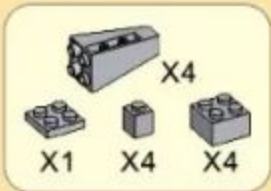

45

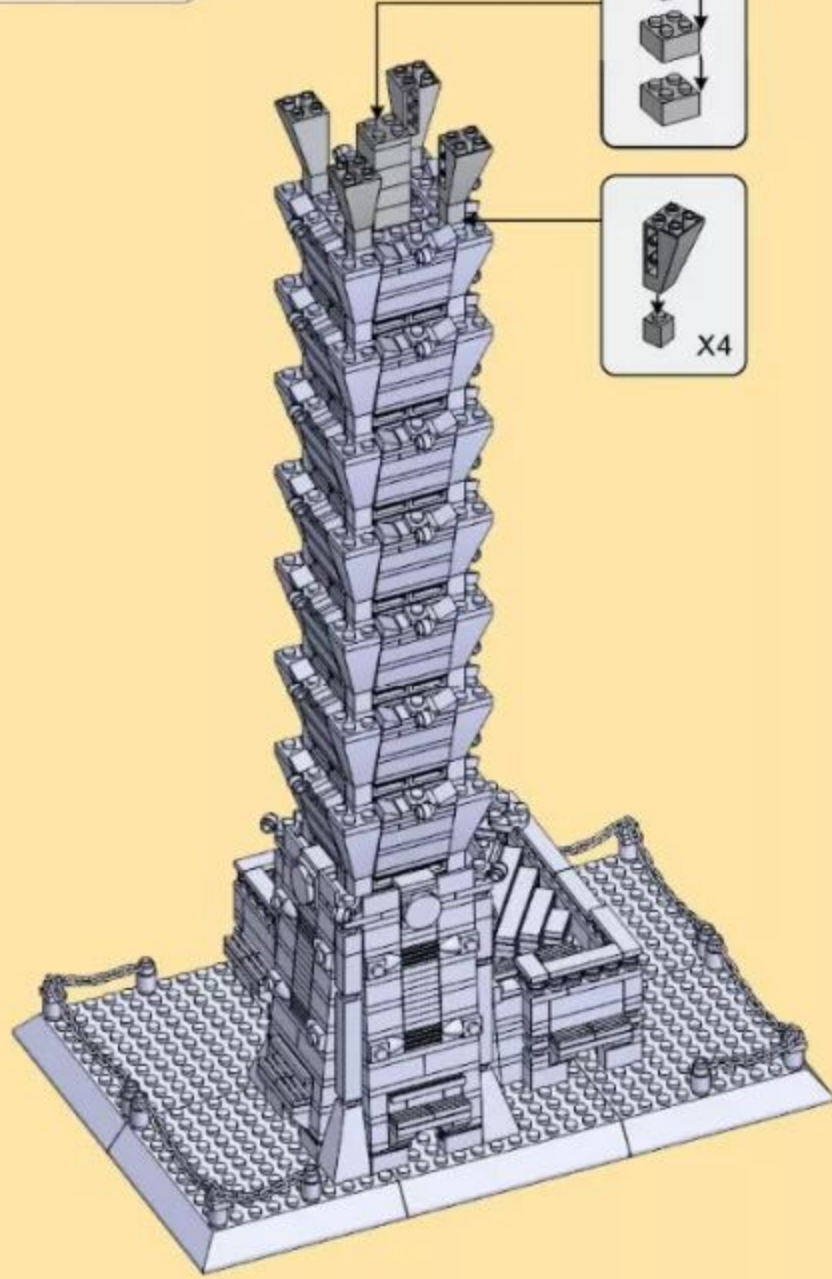
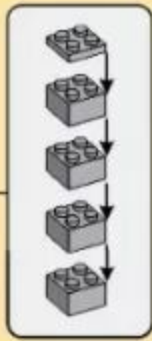

46

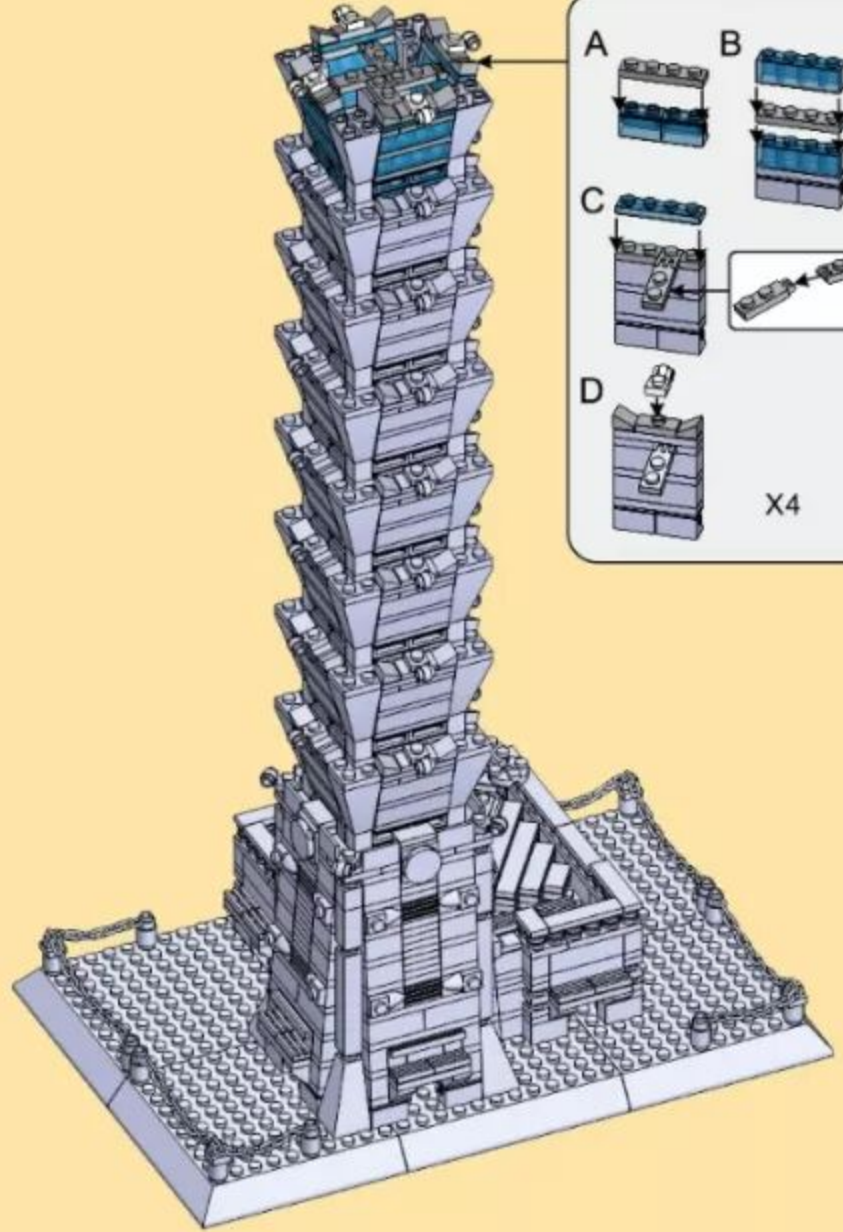
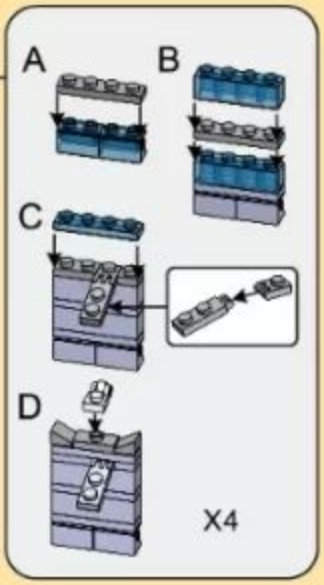

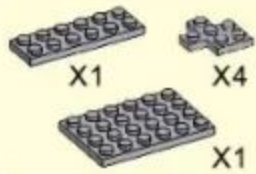

47

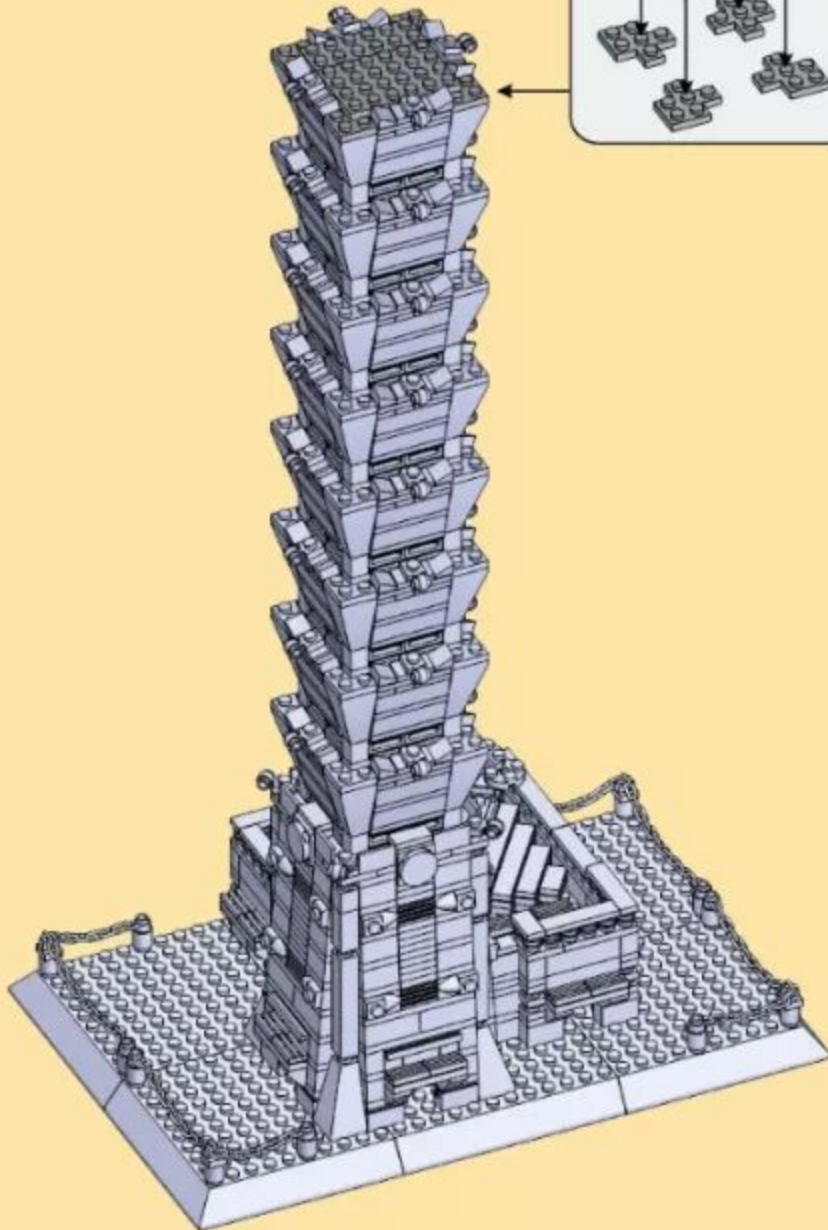

48

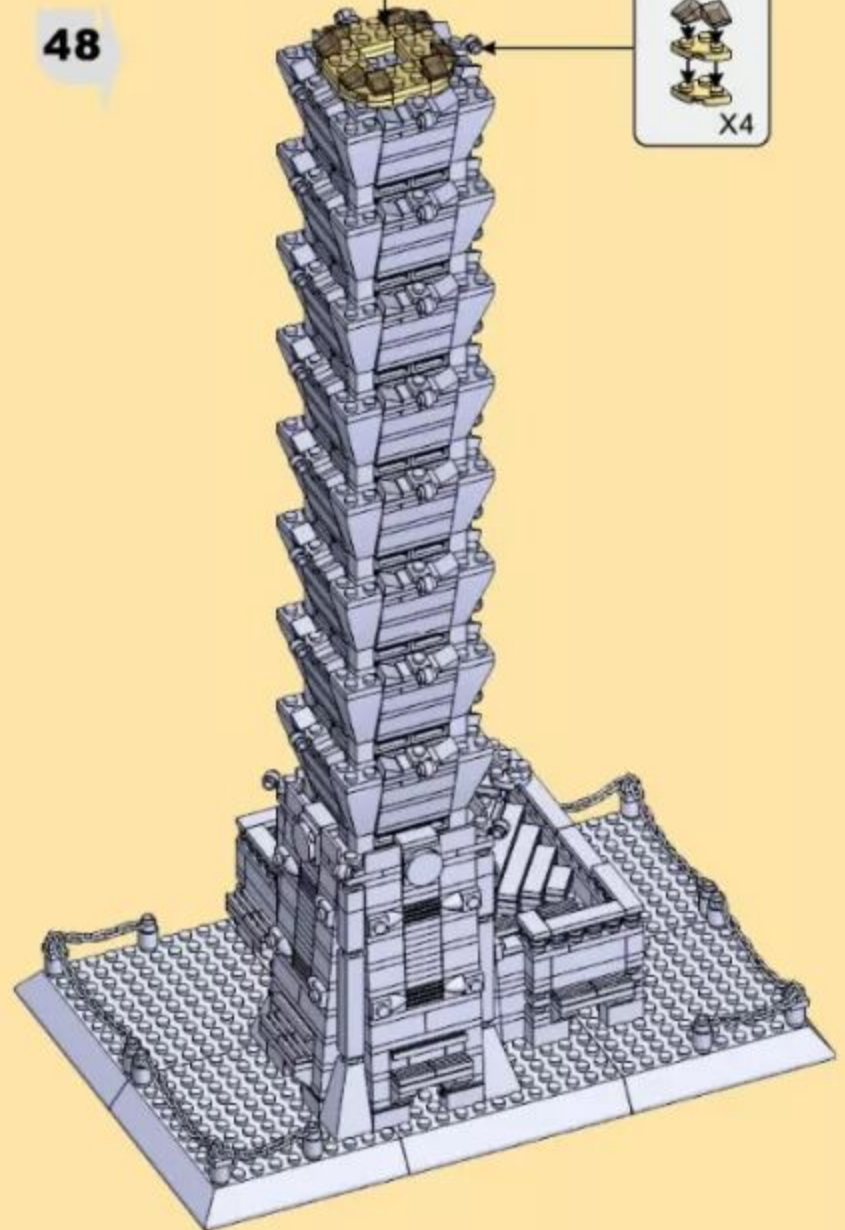



X4

49

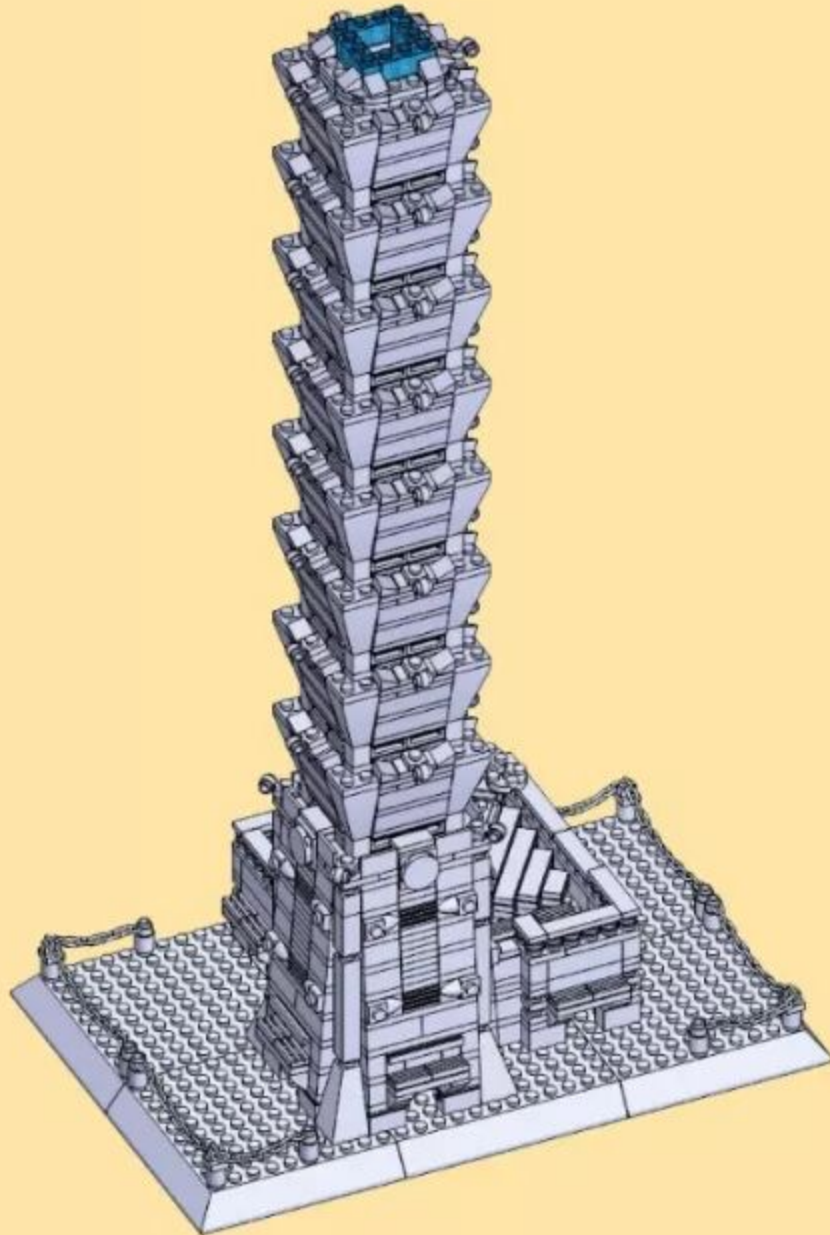

X1

50

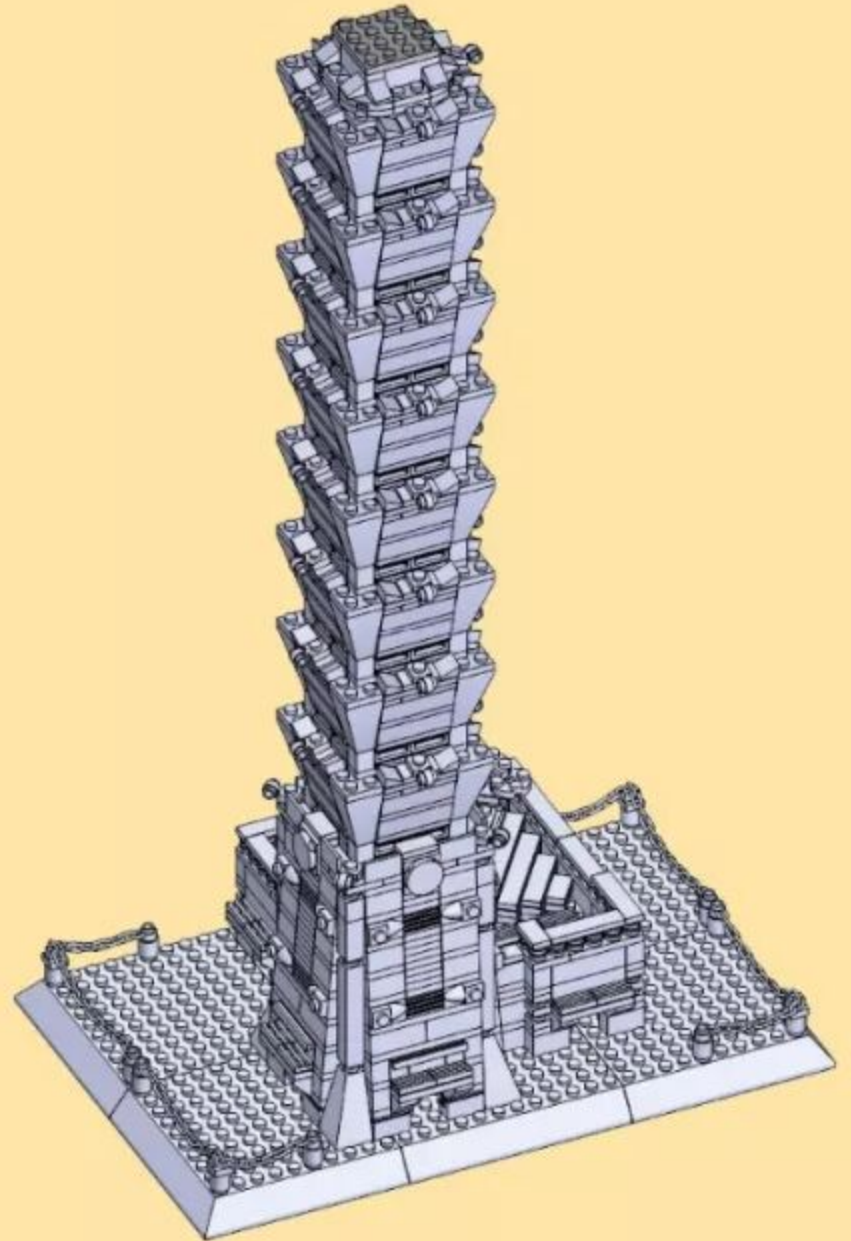

20

X4 X4

51

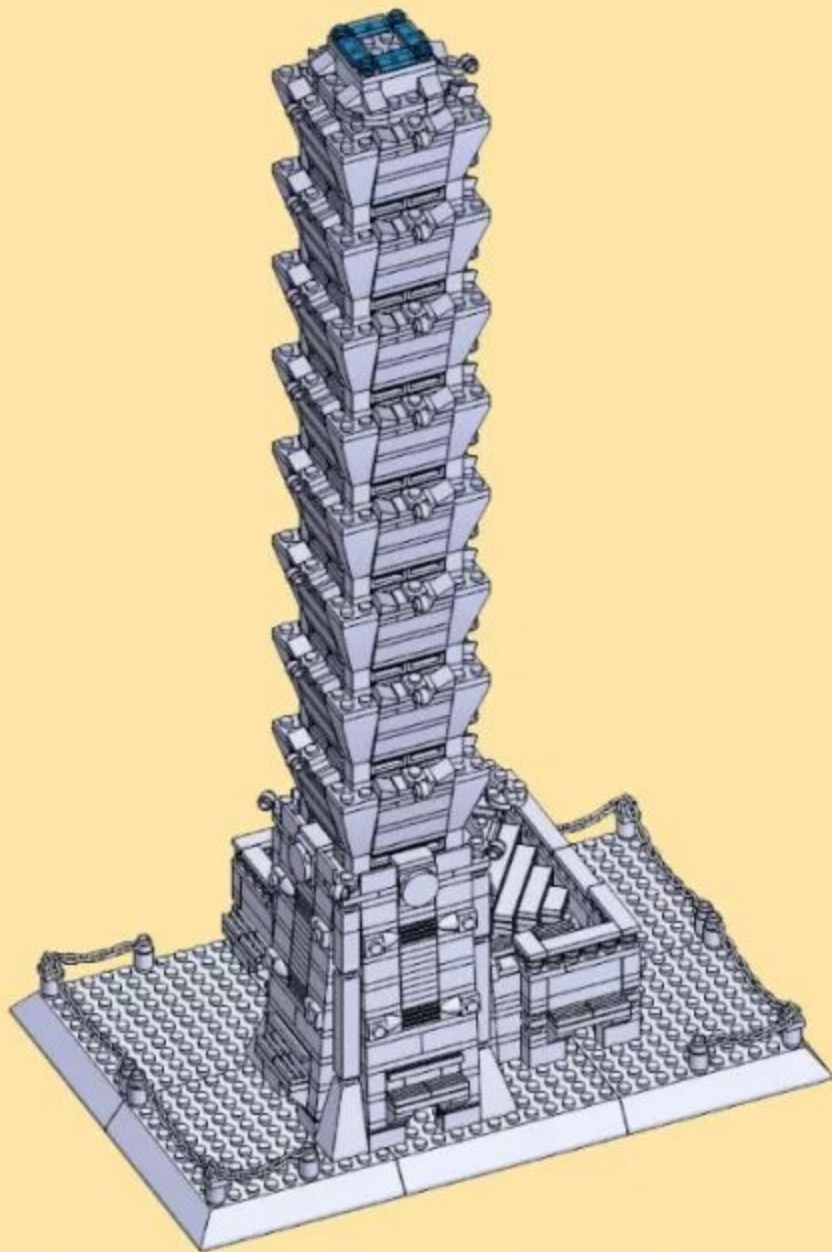

X1(4pcs) X1
X1 X1 X1 X1

52

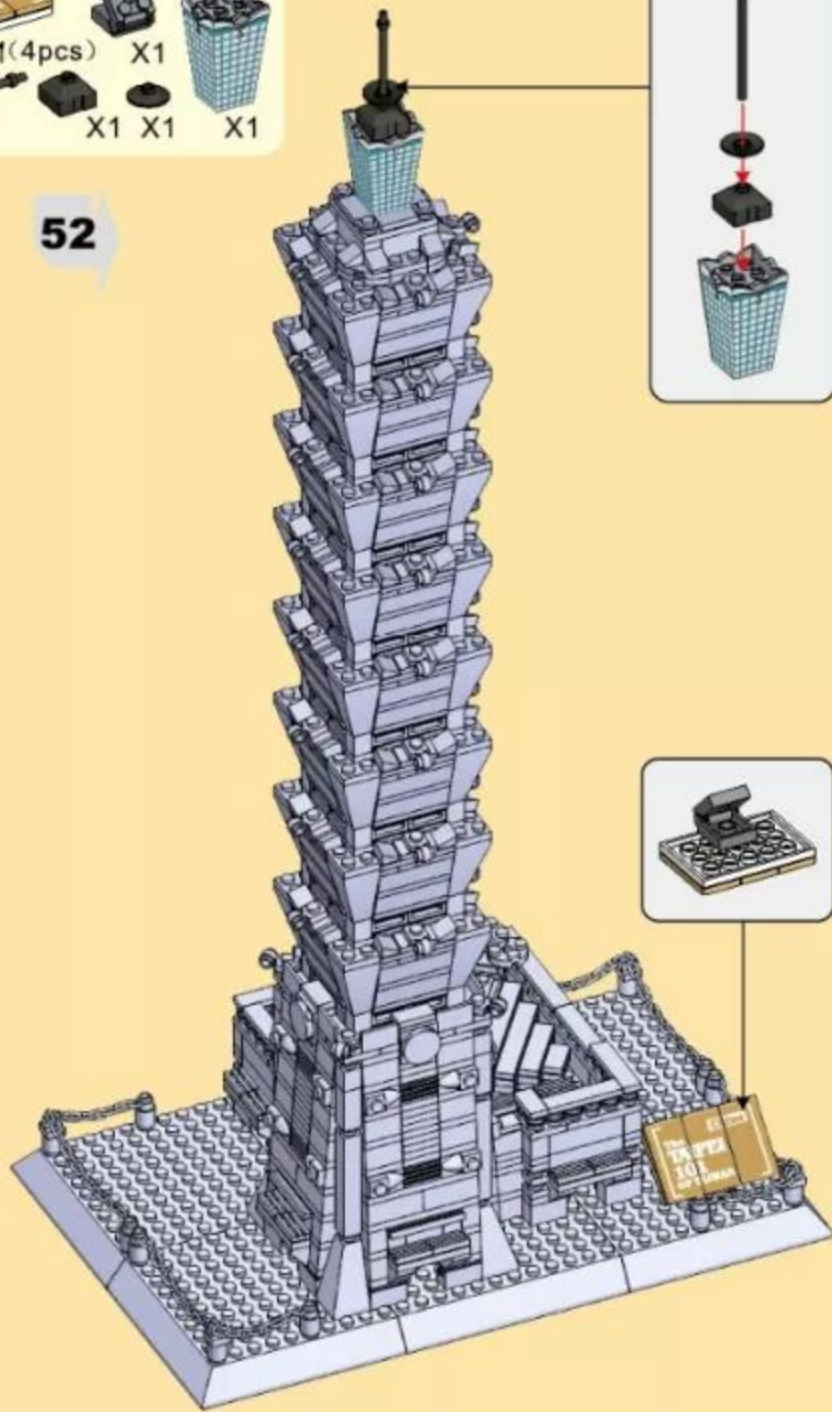

21





THE TAIPEI 101 OF TAIWAN

INTRODUCTION

TAIPEI 101 IS LOCATED IN XINYI DISTRICT, TAIPEI TAIWAN, A SKYSCRAPER, THE WORLD'S TALLEST SKYSCRAPER AND CURRENTLY THE WORLD'S SECOND HIGHEST BUILDING, FORMERLY KNOWN AS THE TAIPEI INTERNATIONAL FINANCIAL CENTER.

89 FLOOR. TAIPEI 101 OBSERVATION DECK FOR THE INTERIOR, 91 FLOOR FOR THE OUTDOOR VIEWING PLATFORM. OBSERVATION DECK TICKET OFFICE. LOCATED ON THE 5TH FLOOR ELEVATOR ENTRANCE, A TOTAL OF 2 LIFTS CAN REACH THE VIEWING PLATFORM, IS THE GUINNESS WORLD RECORD FOR THE MOST RAPID ELEVATOR, THE MAXIMUM UPLINK SPEEDS OF UP TO 1010 METERS PER MINUTE. 9-84, TAIPEI 101 OFFICE BUILDING FOR RENTAL, WHICH 35, 59, 60 HOUSE "AIR HALL", THE WHOLE BUILDING IS DIVIDED INTO LOW, MEDIUM AND HIGH-RISE SECTION OF THE THREE REGIONS. THE HALL FLOOR TO PROVIDE CONVENIENCE STORE POST OFFICE MANAGEMENT OFFICE AND OTHER FACILITIES. FLOOR, THERE ARE 36 INTERNATIONAL CONFERENCE CENTER, CONFERENCE SERVICES, 84 FLOOR OF THE GATHERING A MULTI-FUNCTIONAL VENUE.

TAIPEI 101 NIGHT-LIGHT CHOICE RAINBOW SEVEN COLORS, ONE COLOR EACH DAY. AS MONDAY IS RED. TUESDAY IS ORANGE. YELLOW WEDNESDAY, THE DAILY START TIME OF THE SUNSET LIGHT UP TO 10 PM.

