



THE ORIENTAL PEARL TOWER

中国上海东方明珠广播电视塔
Shanghai, China

The world's great architecture



Creative Ability

Family Interaction

Observation Ability

Thinking Ability

Practical Ability



6+
Suitable Age

5224
Product Number

834 PCS
Parts Total



Architecture

It will be a city...

这将构成一座城市...

ABOUT THE PRODUCT

关于产品

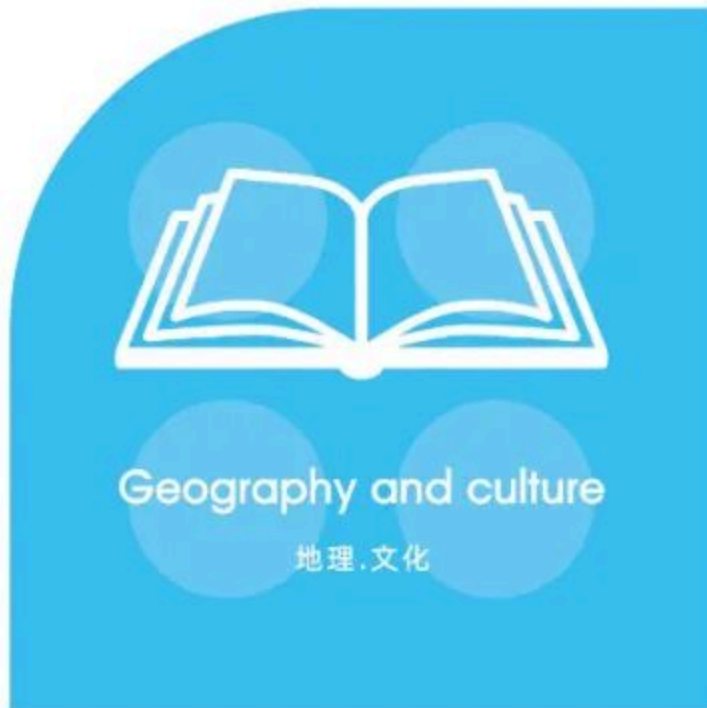

ARCHITECTURE

WANGE The world's great architect since 1991

The Oriental Pearl Tower



The Oriental Pearl Radio & Television Tower is a TV tower in Shanghai. Its location at the tip of Lujiazui in the Pudong New Area by the side of Huangpu River, opposite The Bund, makes it a distinct landmark in the area.

The Oriental Pearl Tower



Geography and culture

地理·文化



The Oriental Pearl Tower was constructed on July 30, 1991 and completed and put into use on October 1, 1994. It is one of the landmark buildings in Shanghai. As of 2019, it is the sixth tallest tower in Asia and the ninth tallest tower in the world.



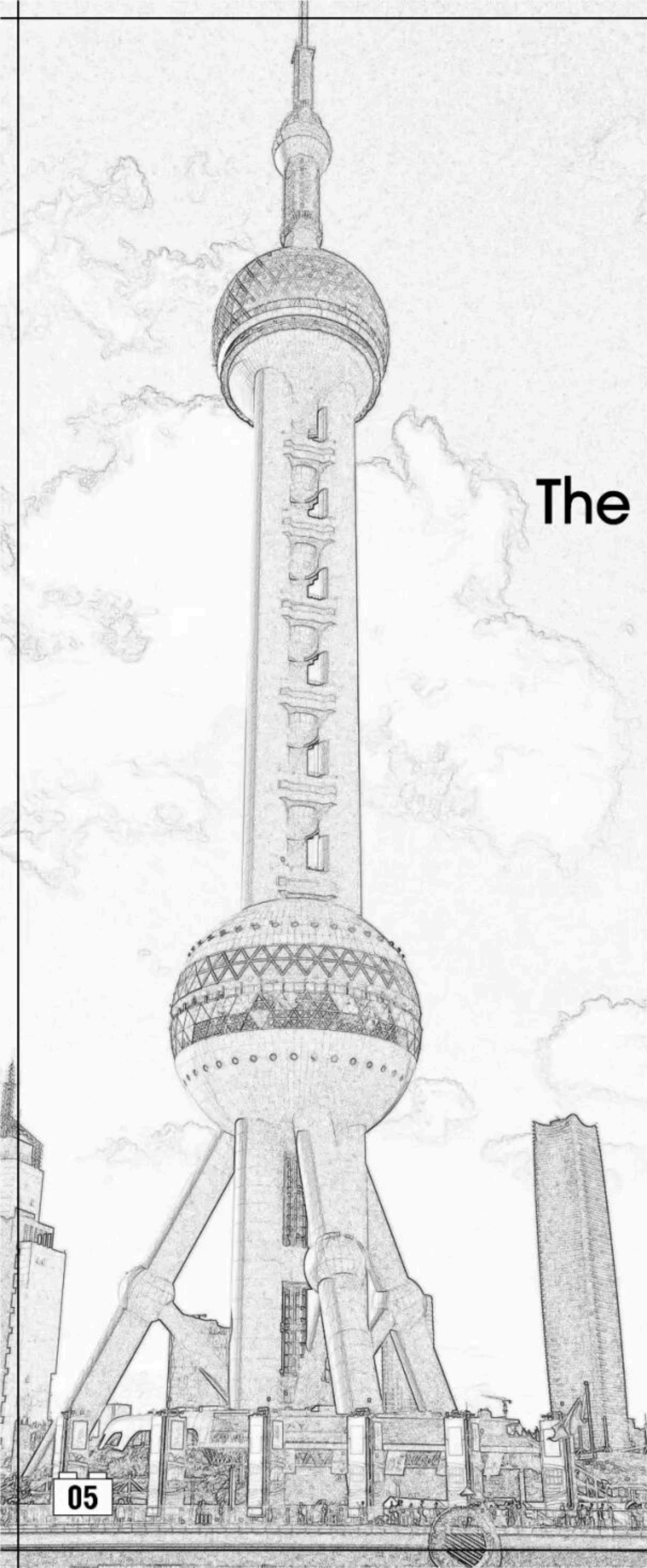

中国上海东方明珠广播电视塔

The Oriental Pearl Tower

China

The contents of this chapter refer to the Wikipedia website.

本章内容参考维基百科网站，更多资讯可自行查阅。

The world's great architecture

Buildings and layout

■ 建筑物和布局



东方明珠广播电视塔位于上海市浦东新区陆家嘴世纪大道1号，地处黄浦江畔，背拥陆家嘴地区现代化建筑楼群，与隔江的外滩万国建筑博览群交相辉映，1991年7月30日动工建造，1994年10月1日建成投入使用，是集都市观光、时尚餐饮、购物娱乐、历史陈列、浦江游览、会展演出、广播电视发射等多功能于一体的上海市标志性建筑之一。1995年，东方明珠广播电视塔被评为上海十大新景观之一。1999年，东方明珠广播电视塔获上海市优秀勘察设计一等奖、中国土木工程詹天佑奖。2007年5月8日，东方明珠广播电视塔被中华人民共和国国家旅游局批准为国家AAAAA级旅游景区。

The Oriental Pearl Radio & Television Tower, Its location at the tip of Lujiazui in the Pudong New Area by the side of Huangpu River, opposite The Bund, makes it a distinct landmark in the area. Construction began on July 30, 1991, and the tower was completed on October 1, 1994, and put into use on May 1, 1995. In 1999, the Oriental Pearl Radio and Television Tower won the first prize of Shanghai Excellent Survey and Design Award and the China Civil Engineering Zhan Tianyou Award. On May 8, 2007, the Oriental Pearl TV Tower was approved by the National Tourism Administration of the People's Republic of China as a national AAAAA-level tourist attraction.



Value Significance

东方明珠广播电视塔选用东方民族喜爱的圆体作为基本建筑线条，具有鲜明的海派建筑特色，使现代科技与东方文化结合统一。东方明珠广播电视塔具有发射9套电视和10套调频广播节目的能力，可覆盖整个上海市及邻近省份80公里半径范围内的地区，改善了临近地区收听收视质量。同时，东方明珠广播电视塔是浦东开发开放后第一个重点工程，集都市观光、时尚餐饮、购物娱乐、历史陈列、浦江游览、会展演出等多功能于一体，是上海市对外宣传的重要窗口之一。

The Oriental Pearl Tower uses the sphere, a shape beloved by Eastern cultures, as its basic architectural line, embodying a distinct Haipai architectural style and unifying modern technology with Eastern culture. The Oriental Pearl Tower has the capability to broadcast 9 TV and 10 FM radio programs, covering the entire city of Shanghai and neighboring provinces within an 80-kilometer radius, improving the quality of radio and television reception in nearby areas.



Design and construction

东方明珠广播电视塔建造过程中创造性的使用了许多施工新工艺，如地下20米深基础施工、350米高直筒体施工、93米高的斜筒体施工、竖向307米长预应力钢绞线张拉、350米混凝土泵送、塔身垂直度偏差控制、高垂直运输起重、钢结构球体吊装施工和450吨钢桅杆天线就位安装等。塔体采用了内筒外挂整体式自动提升钢平台体系，450吨重的钢天线桅杆安装采用了倒装法拼装、整体提升一次到位的施工方法，同步控制技术和液压提升工艺属国际先进水平。主体为多筒结构，由3根斜撑、3根立柱及广场、塔座、下球体、5个小球体、上球体、太空舱、发射天线桅杆等构成，主体结构高350米，总高468米，总建筑面积达10万平方米。东方明珠广播电视塔内共有5个观光层，主要由高90米、直径50米的下球体室外观光廊和高272.5米、直径45米的上球体观光层组成，是鸟瞰上海全市的最佳场所之一。

During the construction of the Oriental Pearl Tower, many innovative construction techniques were creatively used. The main body is a multi-tube structure, composed of 3 braces, 3 columns, and a square, tower base, lower sphere, 5 small spheres, upper sphere, space capsule, transmission antenna mast, etc. The main structure is 350 meters high, the total height is 468 meters, and the total building area is 100,000 square meters. The Oriental Pearl Tower has a total of 5 sightseeing floors, mainly composed of a 90-meter high, 50-meter diameter lower sphere outdoor sightseeing corridor and a 272.5-meter high, 45-meter diameter upper sphere sightseeing floor, making it one of the best places to overlook the entire city of Shanghai.

Force Balance

受力平衡

Physical operations

物理运算

$$F = G \frac{m_1 m_2}{d^2}$$

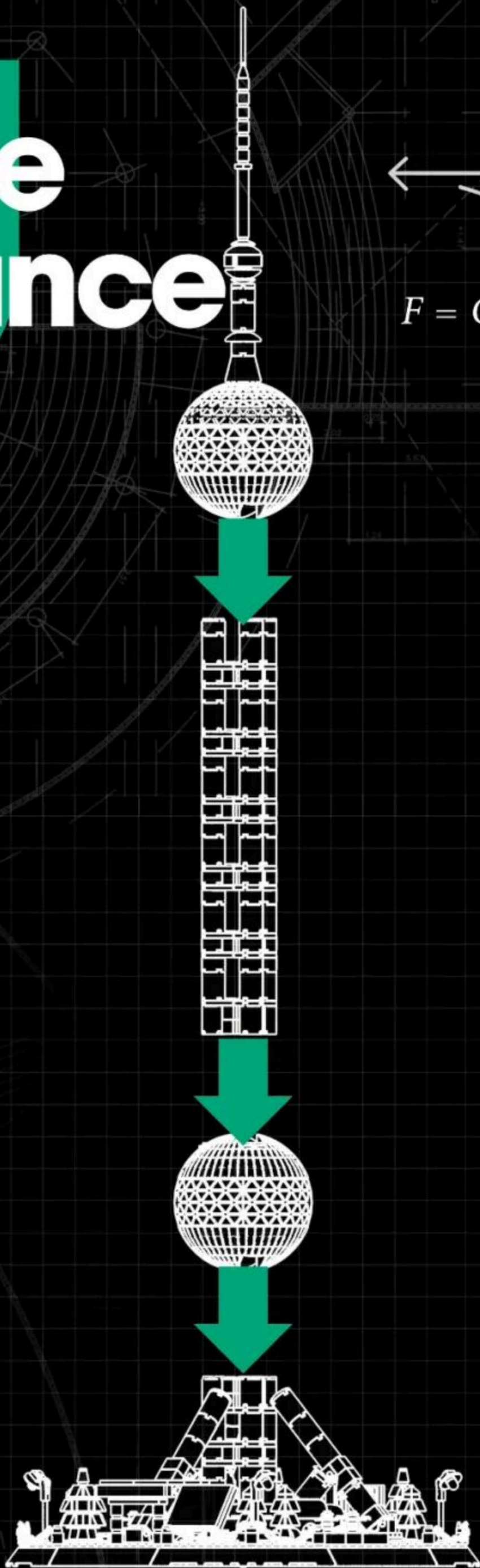

Creation and thinking

创作·思考

08

Special parts

特殊零件的开发利用

$$S=4\pi \cdot r^2$$



$$a^2+b^2=c^2$$

WG1101

弧4孔



WG1678

东方明珠四分菱纹件



WG1626

四方双面凸司四孔



WG1345

竖纹2倍2孔



WG1676

方圆2X3孔带十字孔

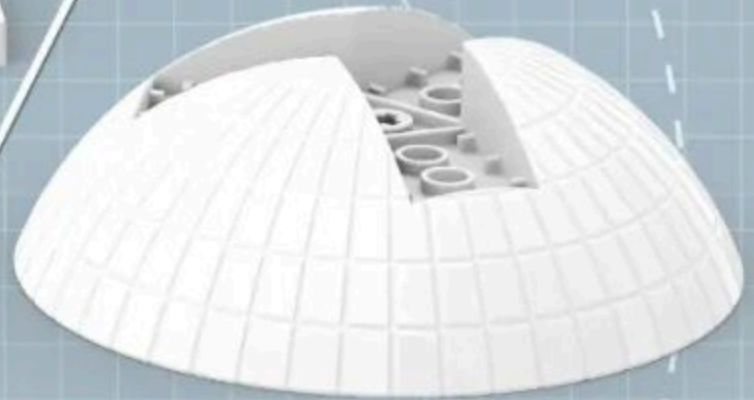

WG1677

东方明珠条纹圆盖11X11孔



WG1217

2高圆4孔



WG1405

4倍柱珠



$$\sin^2 a + \cos^2 a = 1$$

WG1679

东方明珠菱纹圆盖11X11孔



features and functions

特点.功能

Main Color Matching

配色方案



Pantone Black 6C



Pantone 431C



Pantone Cool Gray 6C

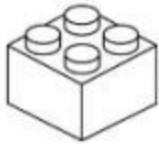

White



Pantone 3435C



Pantone 383C



Pantone 348C



Pantone 477C



Pantone 7620C



Pantone 1575C



Pantone 7509C



Pantone 7500C



Color matching

Adopting 3 main colors, Red, Tan and White as the main color, the more reasonable and bold color matching on the original building, making the product more atmospheric and the whole design is more reasonable.

The Oriental Pearl Tower

中国上海东方明珠广播电视塔

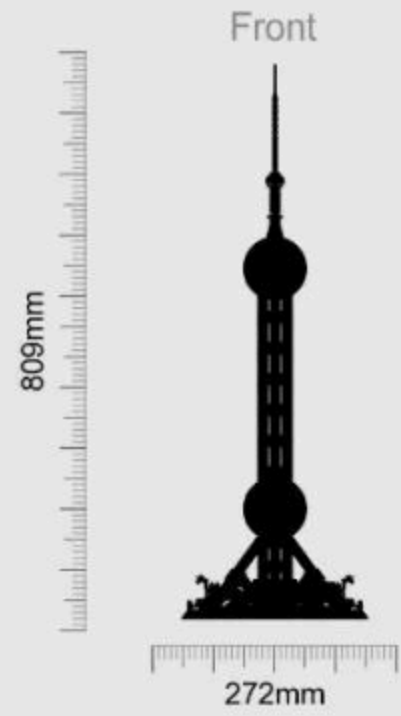
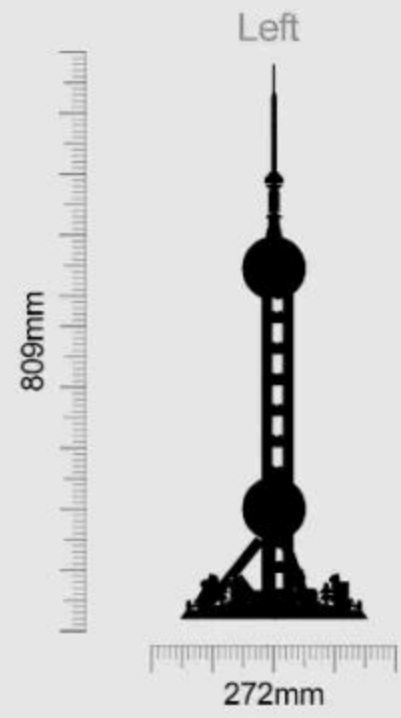
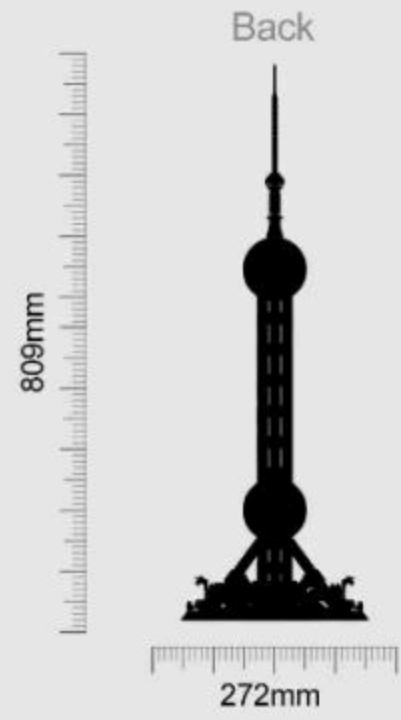

Product Size: 272X272x809mm



Instructions For Use

积木起件器使用说明
Brickseparator

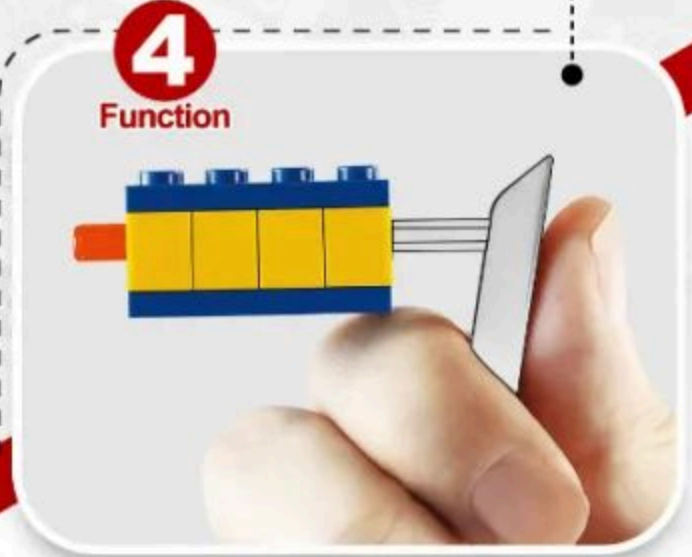
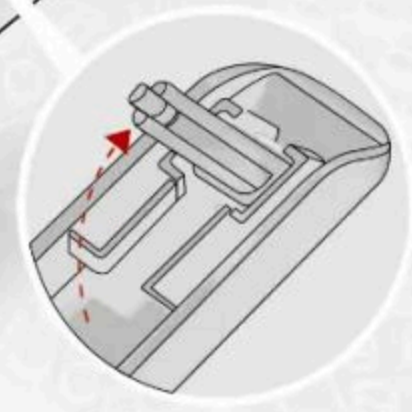
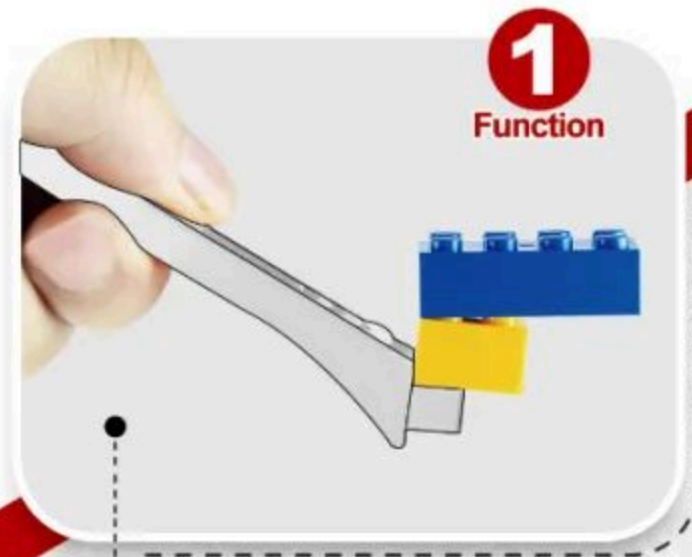

4 ways to make installation easier
让安装更简单

小提示：积木包分为底板包、整版配件包及普通配件包，底板包标识为A/B/C...，普通配件包编码与说明书对应，整版配件包无标识。
 Tip: Building block packs are divided into baseplate packs, runner accessory packs, and standard accessory packs. Baseplate packs are labeled A/B/C..., regular accessory packs have codes that correspond to the instructions, and runner accessory packs have no labels.



- Open the product packaging correctly and classify the building block packs by type.

用正确方式拆解产品外包装,按积木包类型进行分类。



- Confirm the quantity of building block packs and cross-check them with the pack identifiers and the instructions.

确认积木包数量, 对照积木包标识和说明书步骤。



- Open the building block packs according to the pack identifier steps. Sort them in order by type and color for easier assembly.

按积木包标识步骤拆开积木包,按顺序以类型、颜色进行分类以便搭建。



- Assemble your building block model following the steps in the instruction manual.

按说明书步骤拼装并完成你的积木模型。



1:1 Physical Reference Table

十字棒配件1:1尺寸参照表



Instructions For Use

让安装更简单

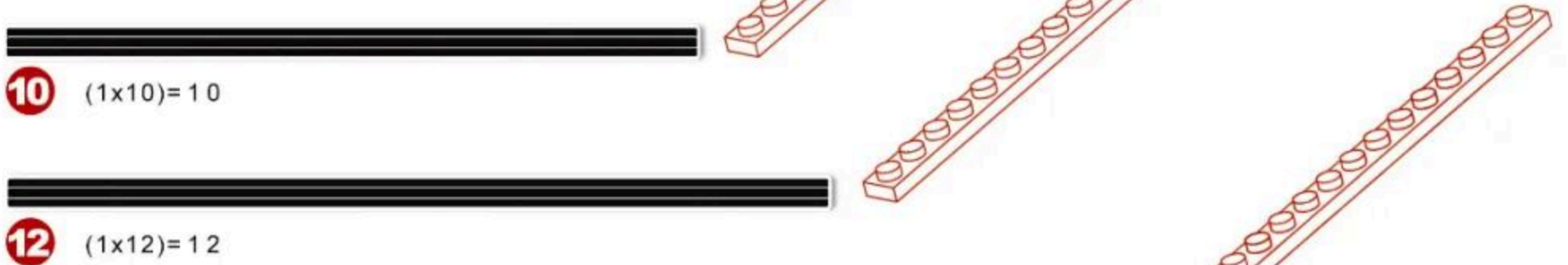
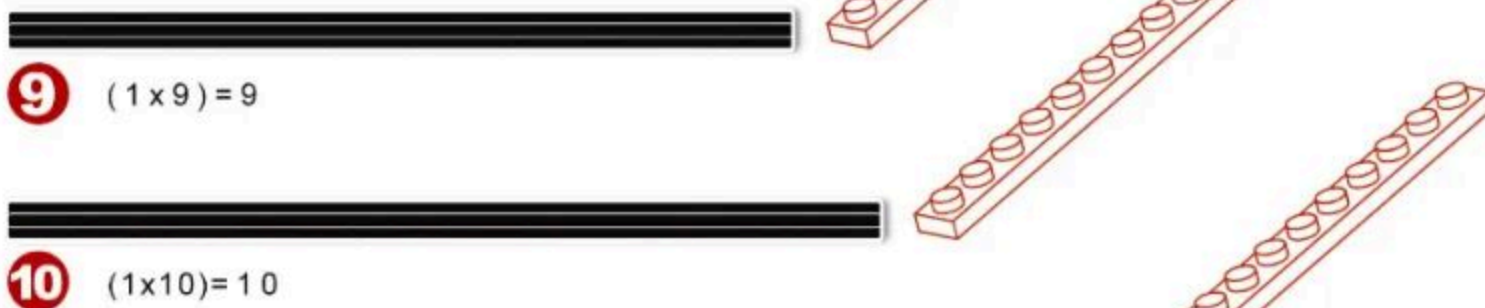
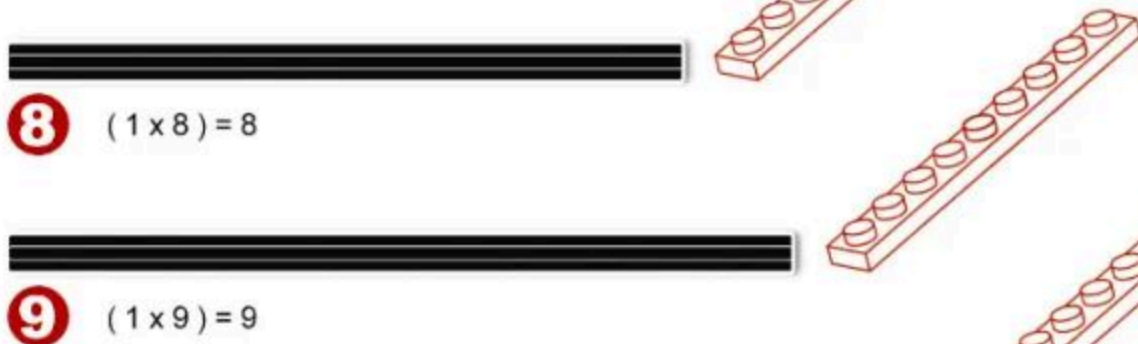
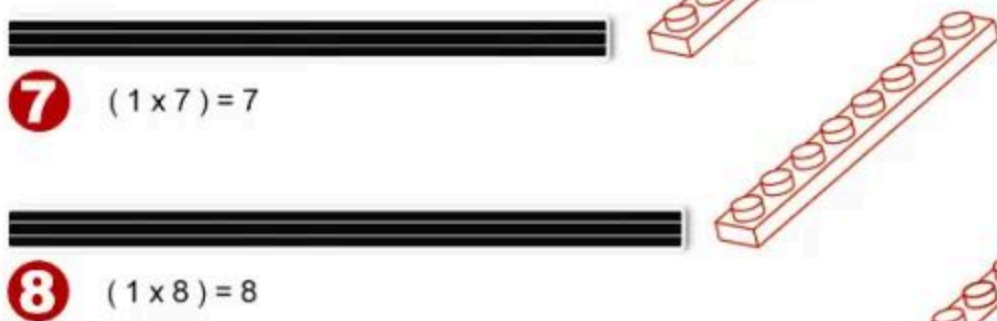
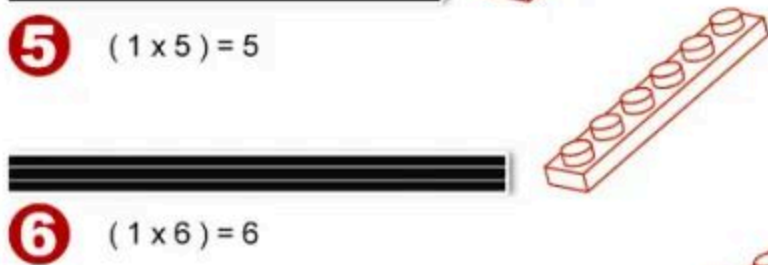
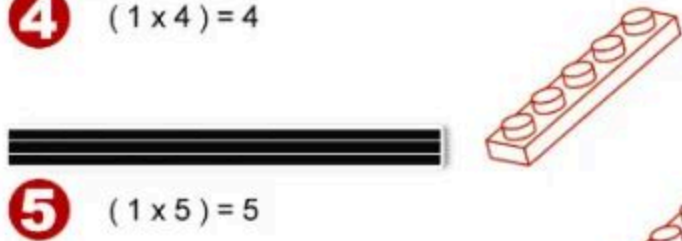
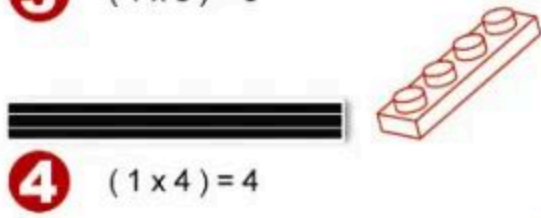
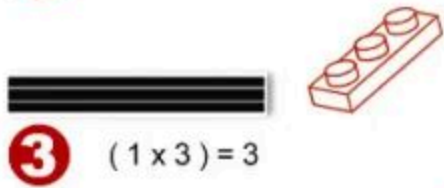
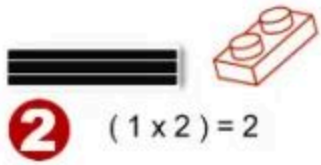

PARTS LIST

配件清单

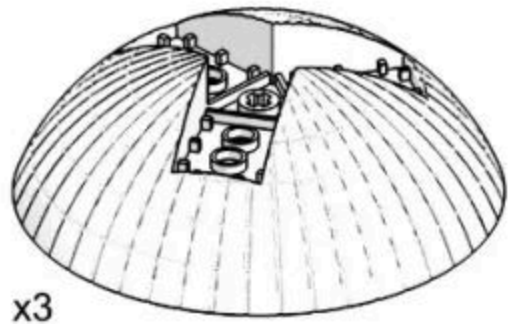

x3



x2



x2



x4

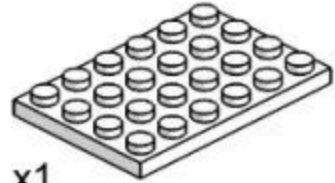

x1



x1



x6



x2

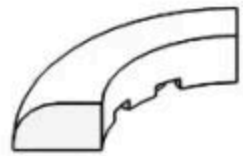

x4



x1



x3



x1

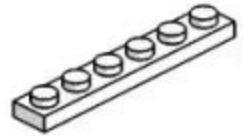

x2



x1



x3

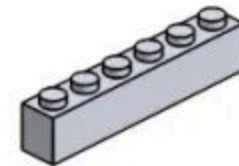

x1

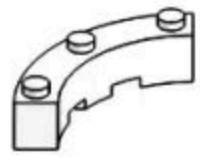

x4



x1



x3



x1

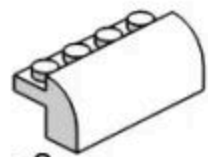

x3



x3



x2



x3

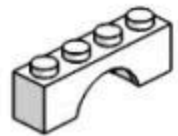

x4



x6



x5

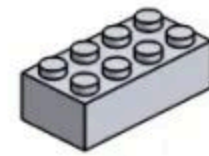

x1

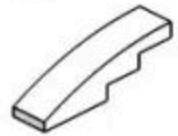

x6

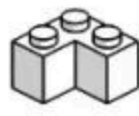

x2



x2

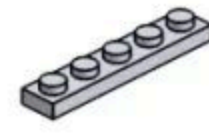

x4



x6



x3



x2

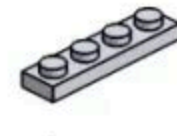

x1

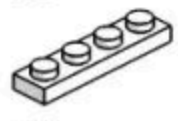

x2



x3



x13



x4



x2



x3



x4

















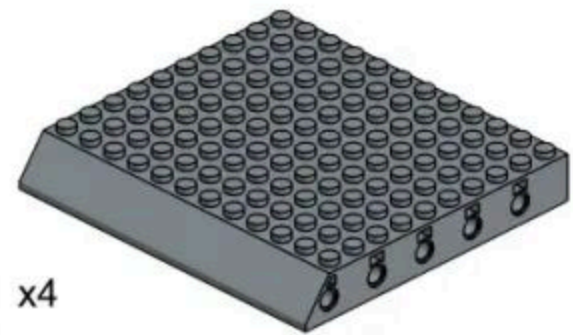













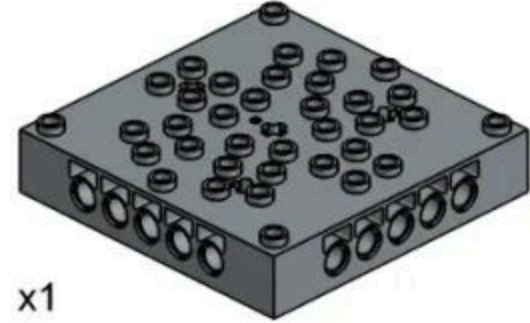













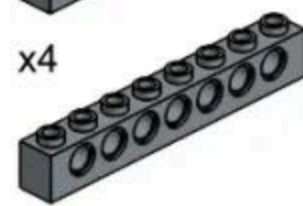











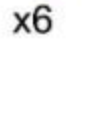

x9

产品有增补件请以实物为准

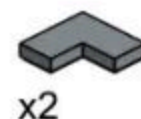
If product has additional parts, please in kind prevail.

PARTS LIST

配件清单

				
x3	x48	x2	x2	
				
x3	x1	x7	x4	x4
				
x2	x1	x1	x1	x4
				
x4	x5	x1	x1	x1
				
x4	x3	x3	x8	
				
x3	x49	x3	x16	x4
				
x4	x48	x2	x4	x4
				
x1	x6	x1	x32	x6
				
x4	x6	x1	x8	x1
				
x4	x6	x1	x1	x4
				
x2	x6	x4	x4	x2
				
			x1	x1
			x9	x12

产品有增补件请以实物为准
If product has additional parts, please in kind prevail.

PARTS LIST

配件清单



x4



x1



x4



x1



x1



x4



x3



x6



x9



x4



x2



x2

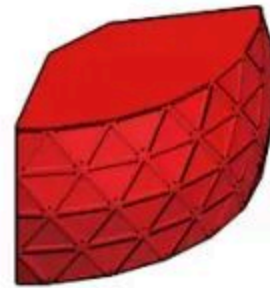

x8



x4



x4



x6



x6



x3

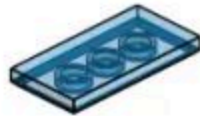

x2



x4



x18



x16



x2



x4



x4



x12



x2



x8



x3



x3



x12



x4



x8



x24



x60



x4



x21



x6



x12



x4



x9



x6



x6

产品有增补件请以实物为准

If product has additional parts, please in kind prevail.



288PCS

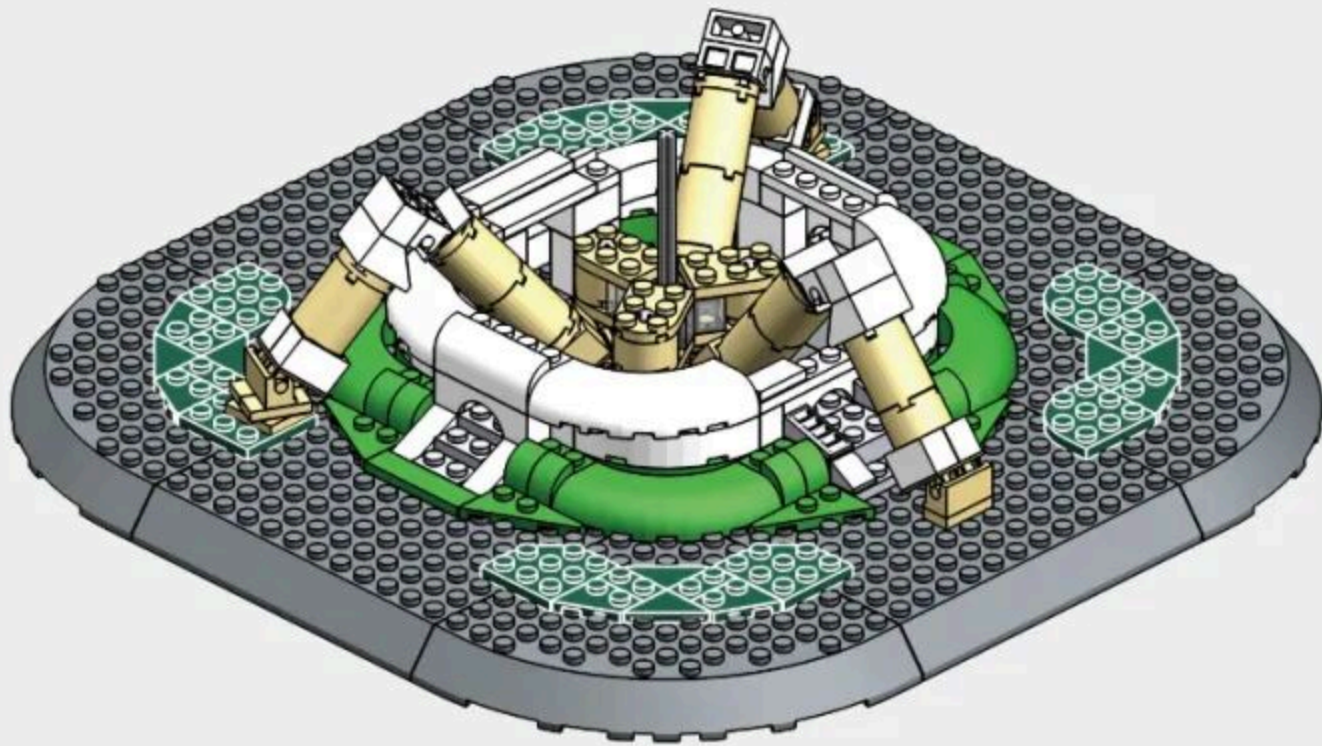

1-1

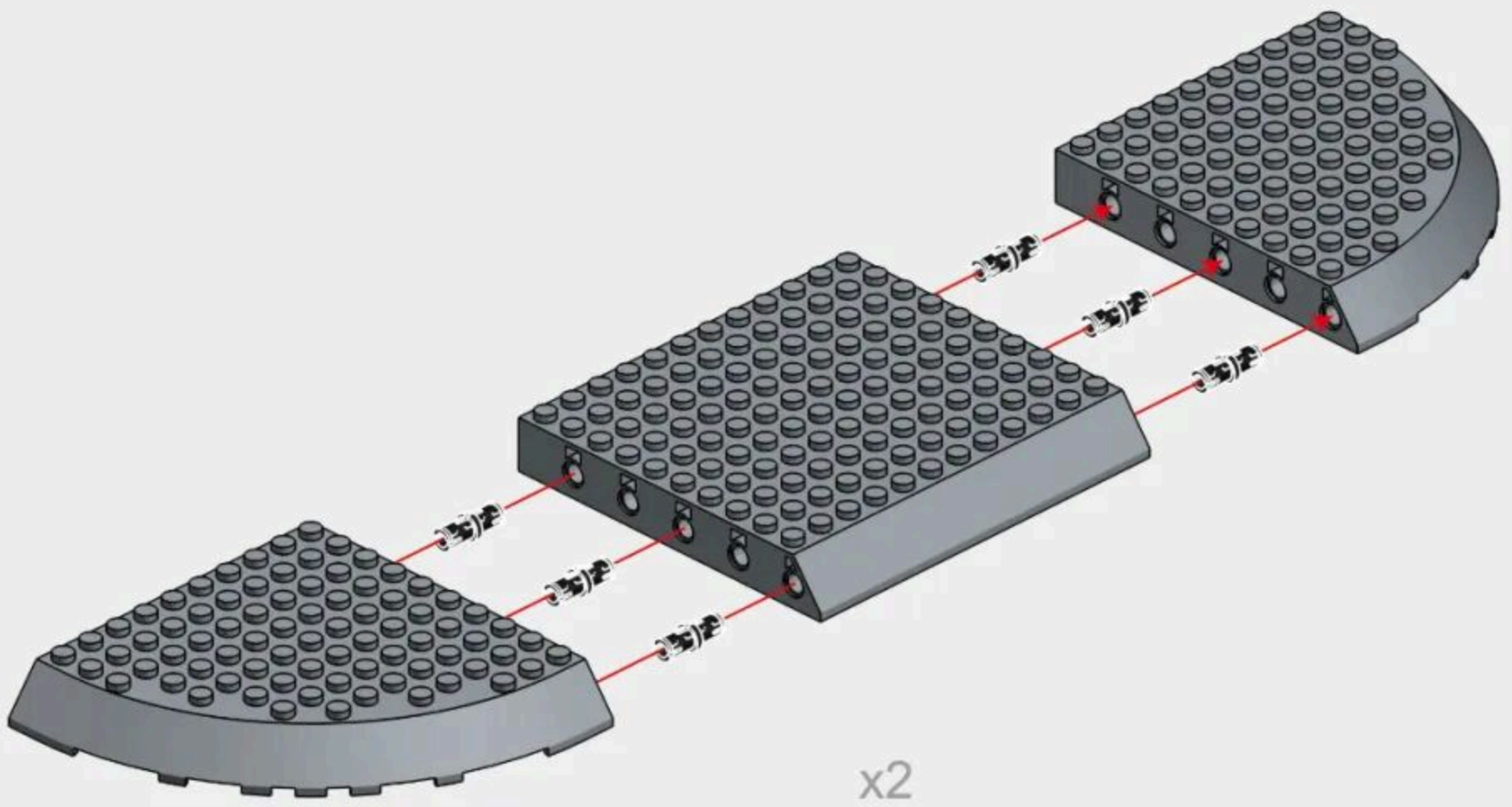
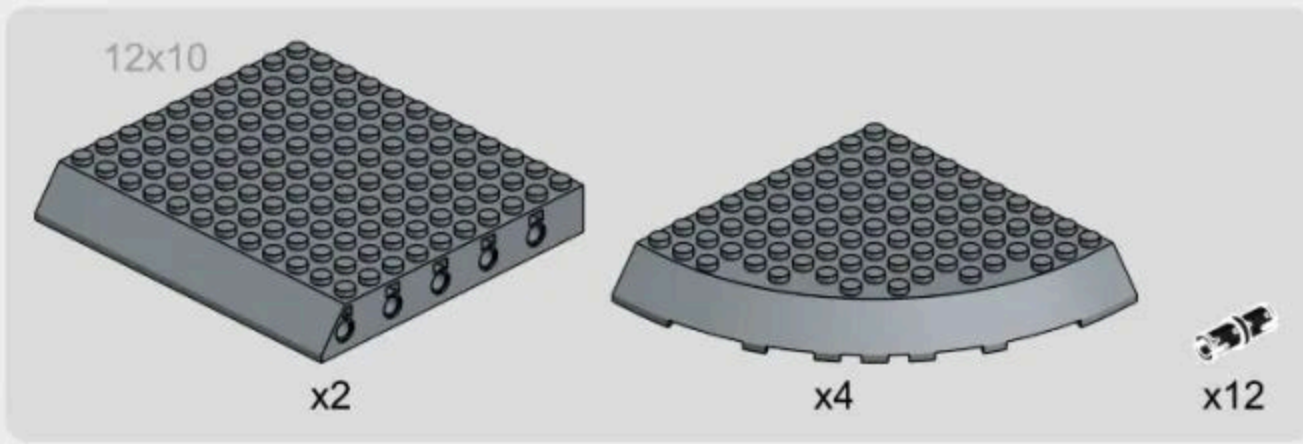

1-2

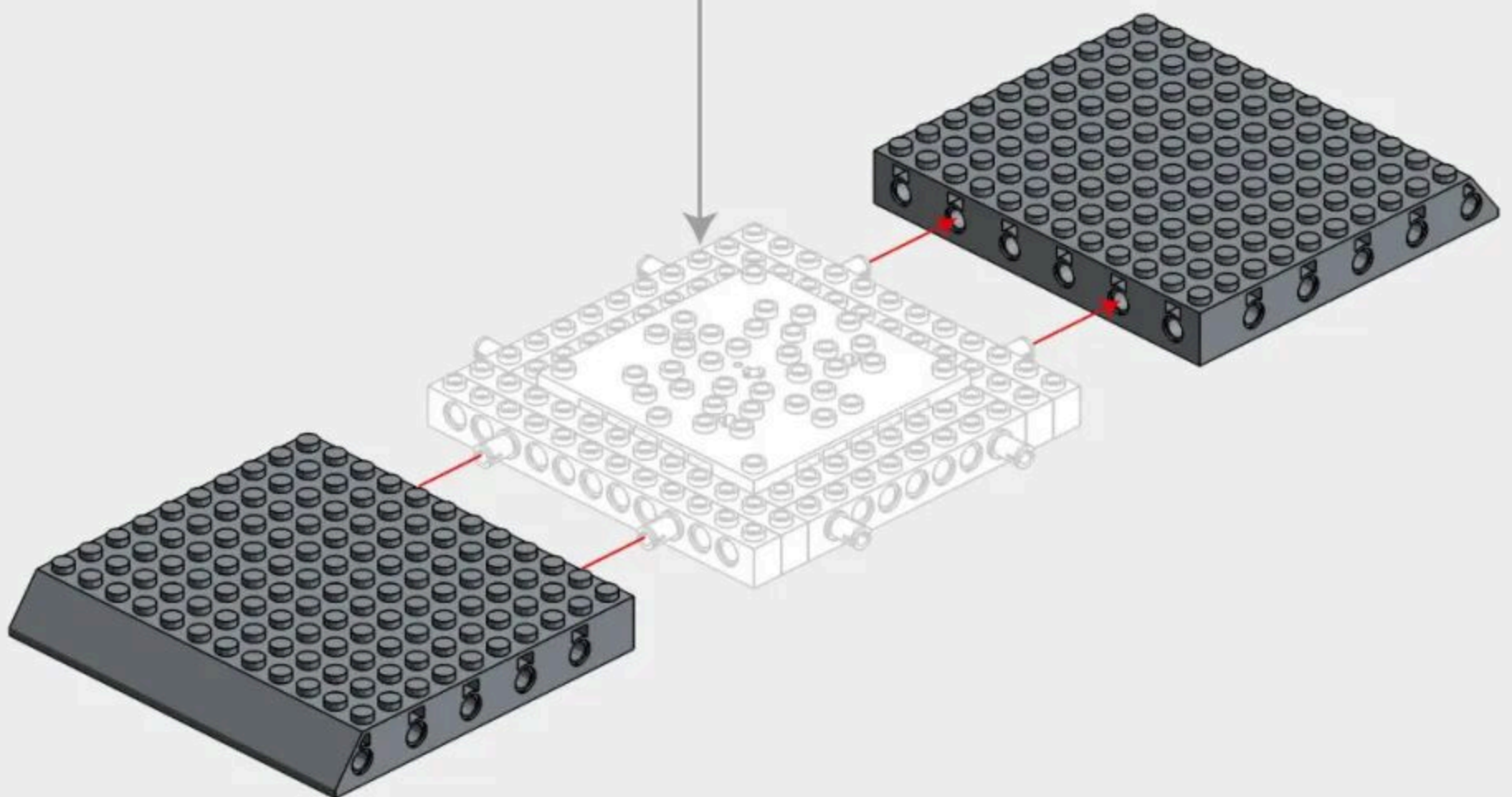
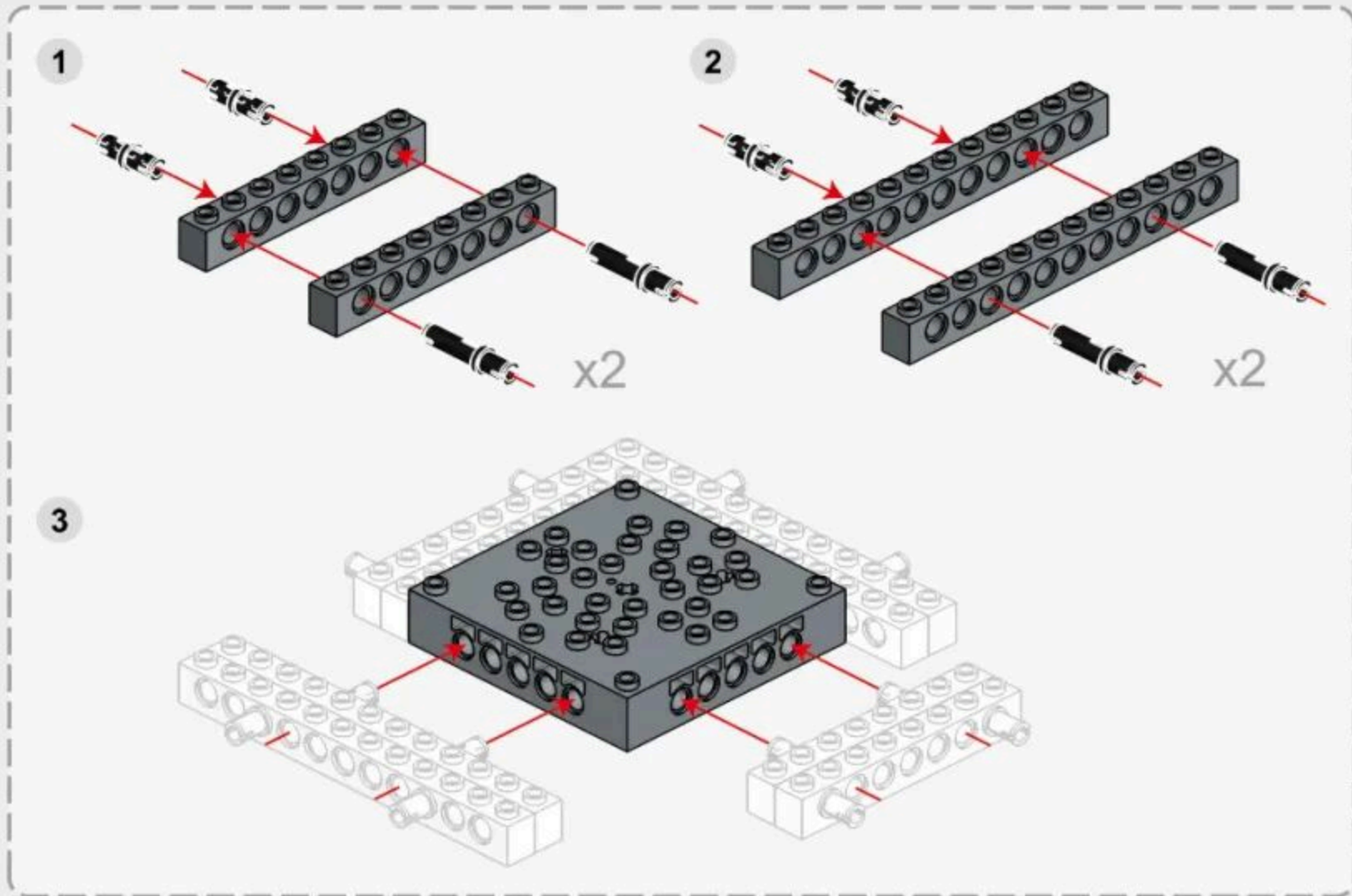
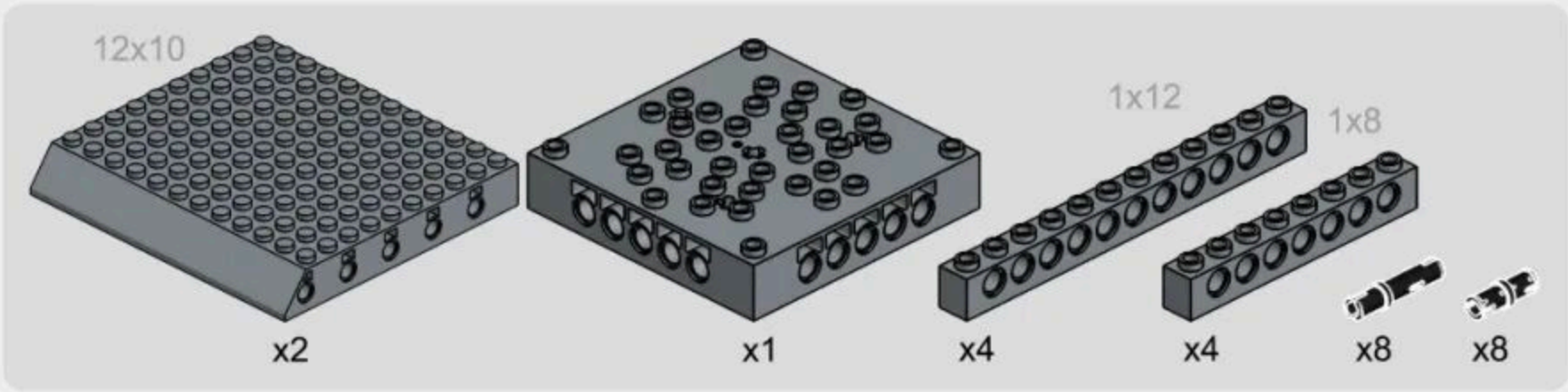

1-3

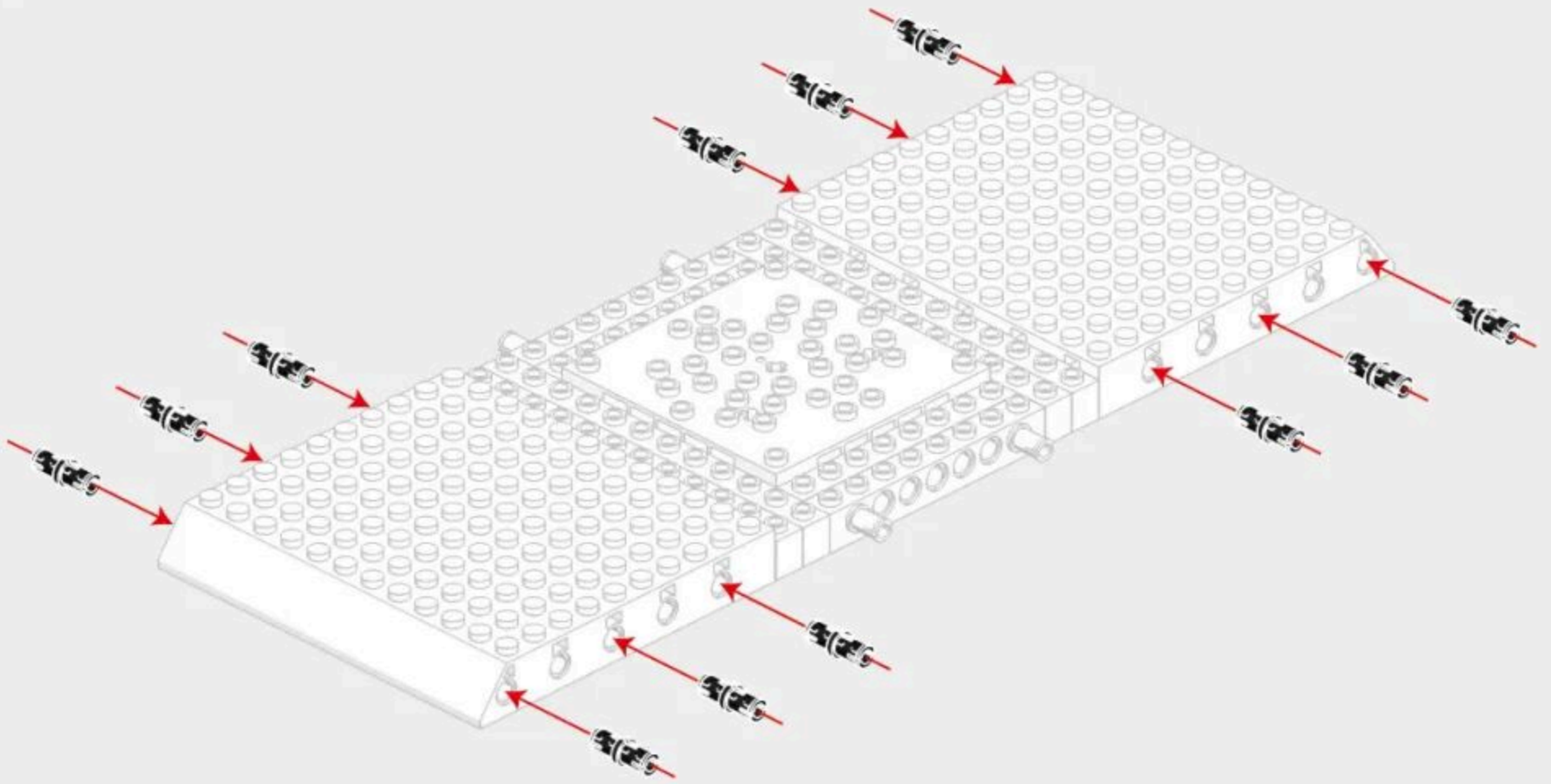

1-4

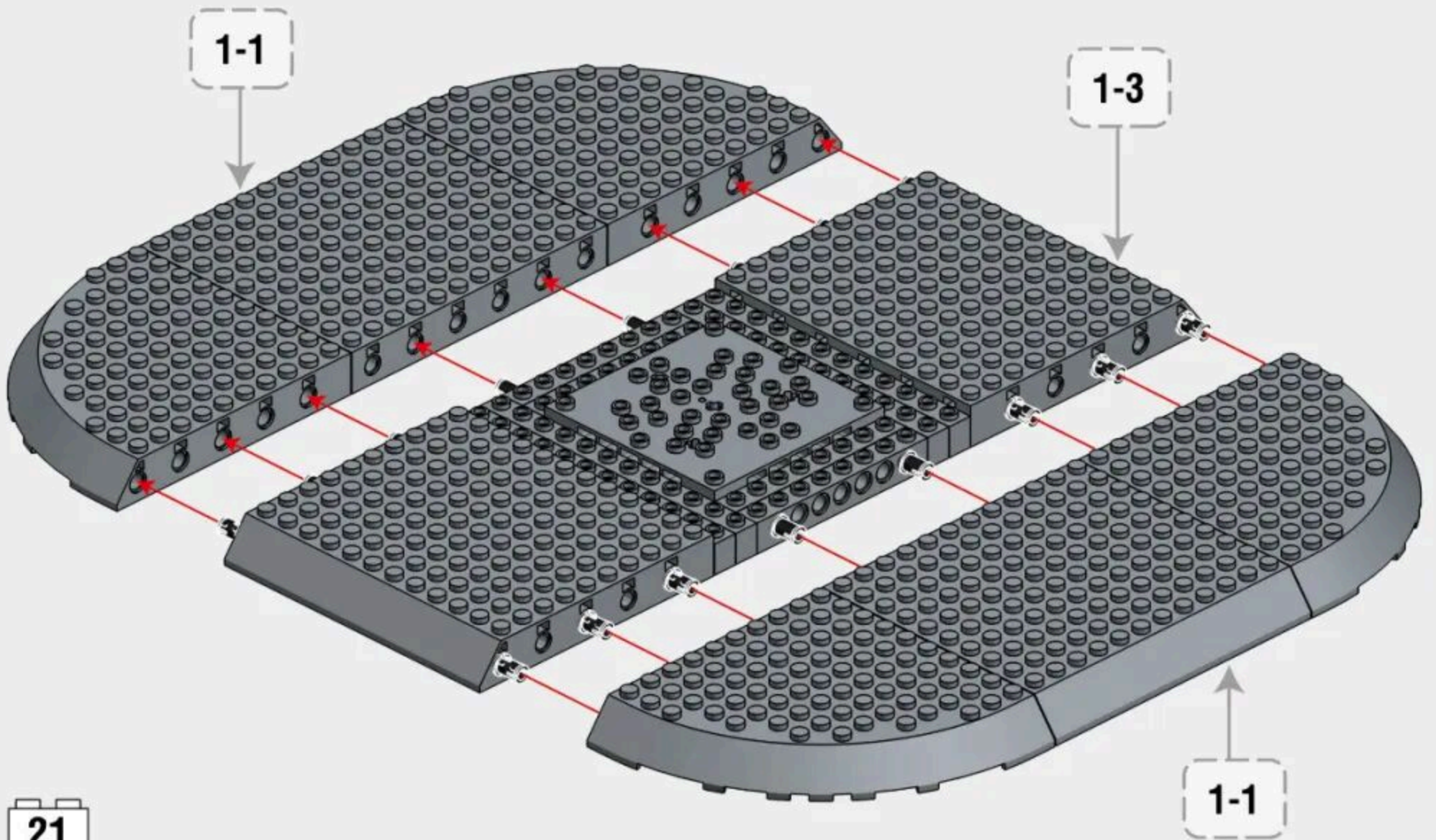

1-6



Vertical View of Installation Drawing
安装图顶面

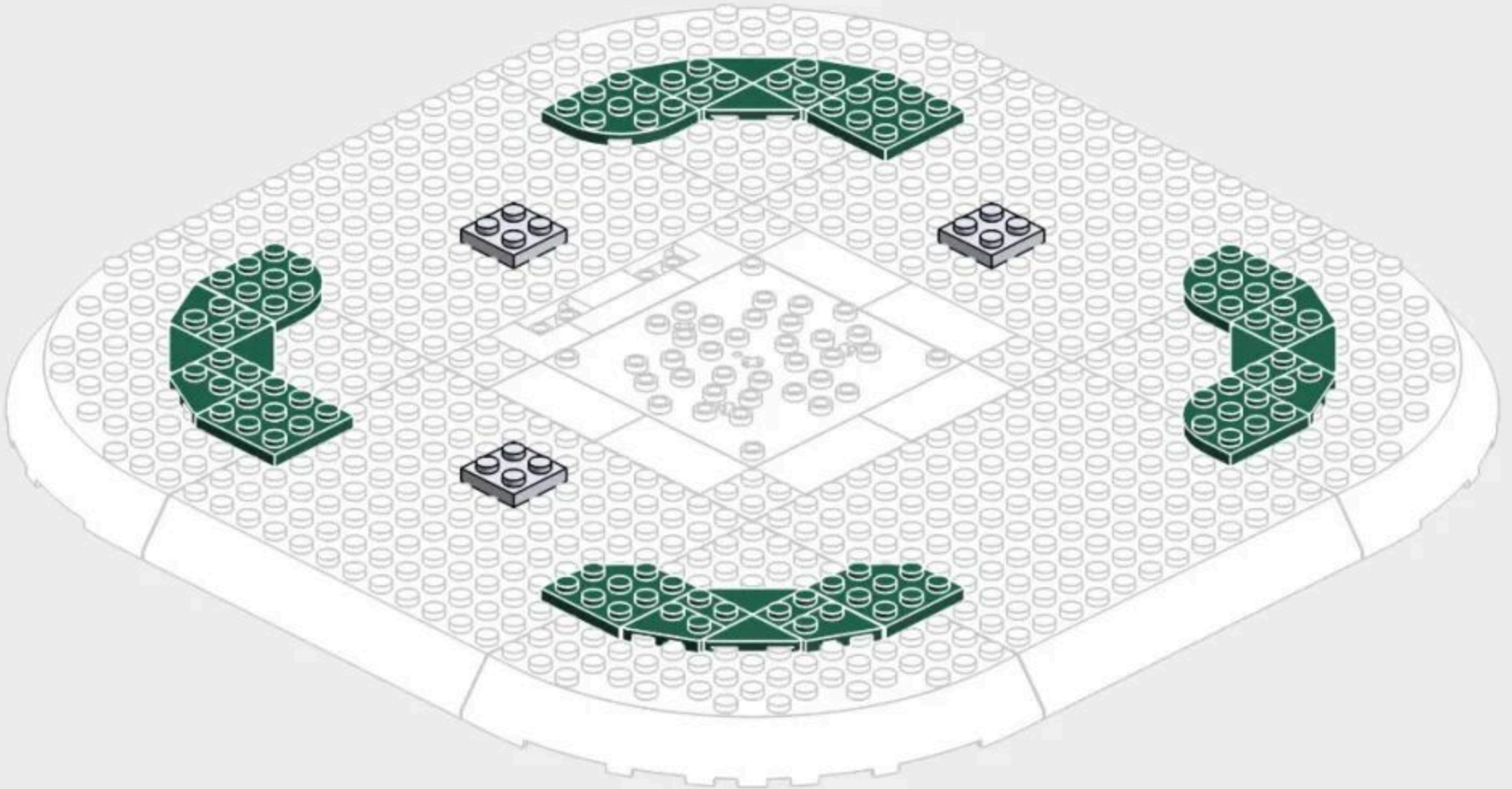
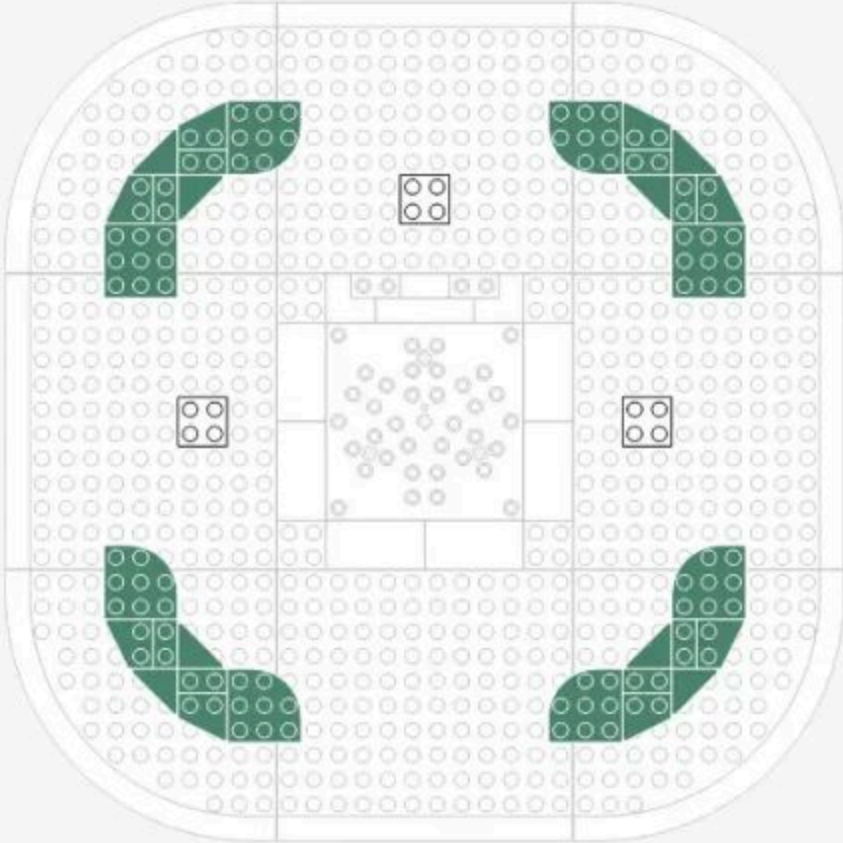

1-7

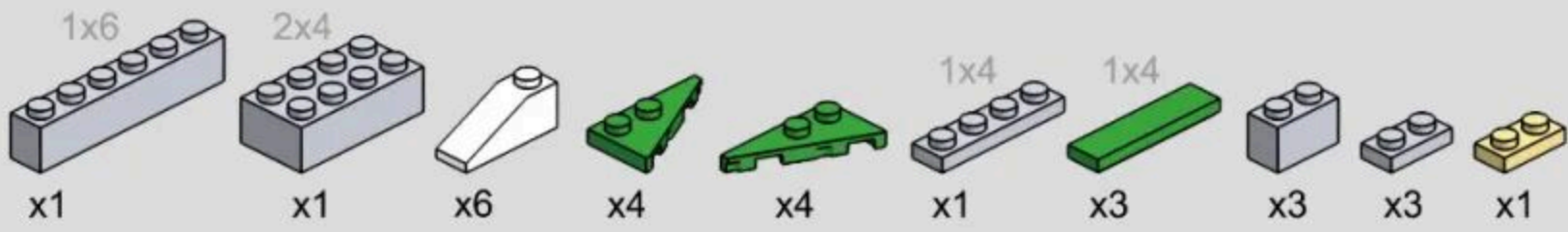

Vertical View of Installation Drawing
安装图顶面

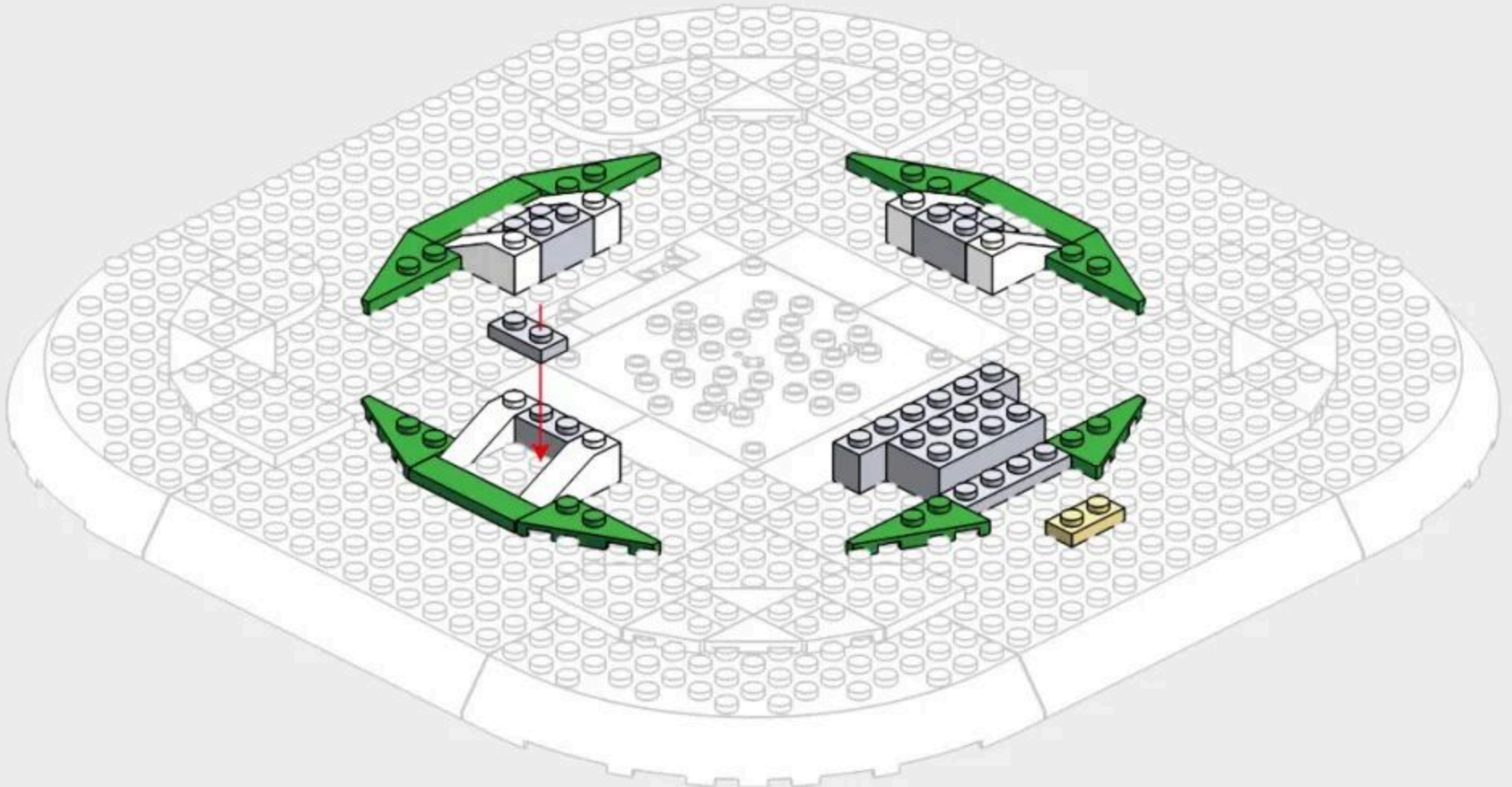
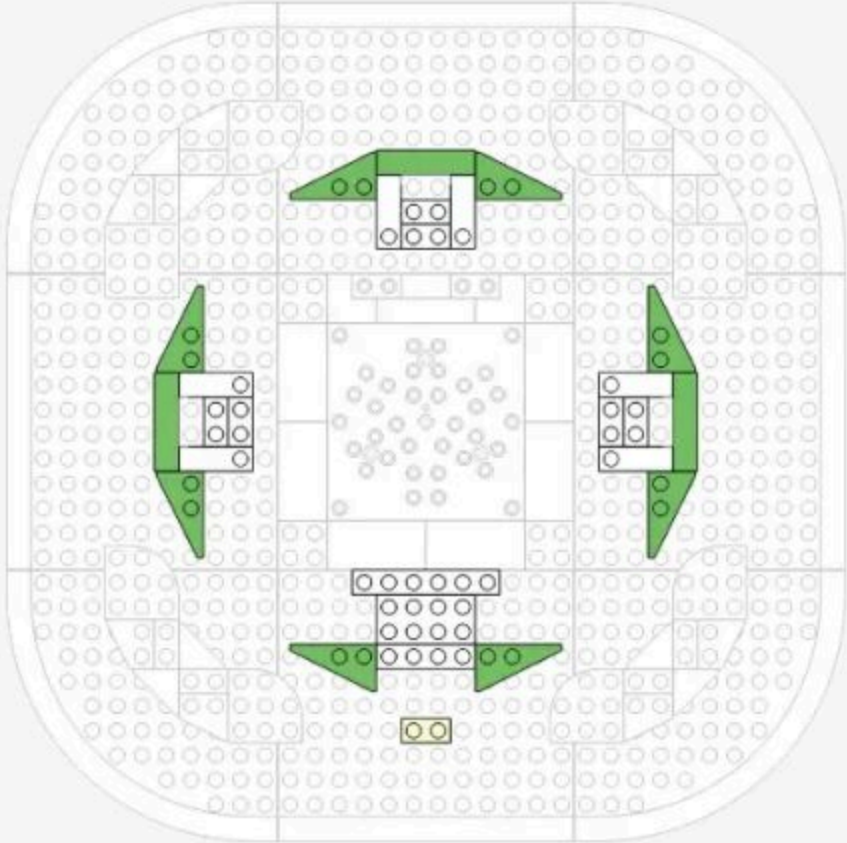

1-8



x4

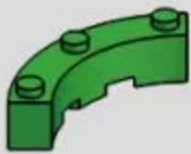

x4



x16



x8



x2

Vertical View of Installation Drawing
安装图顶面

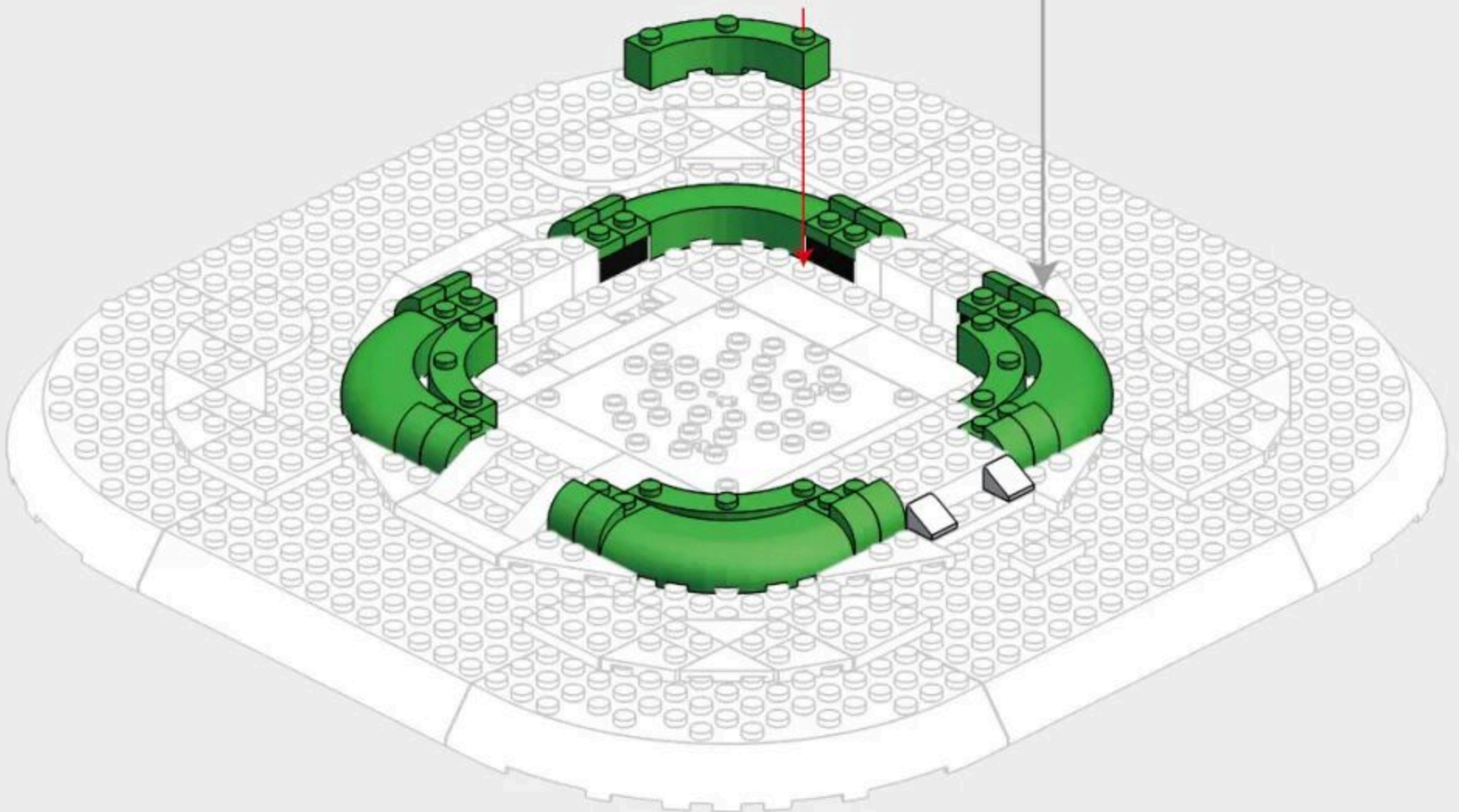
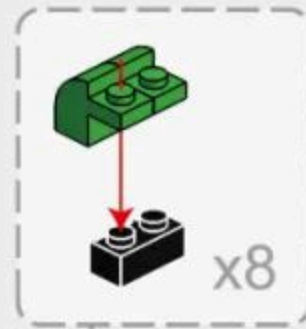
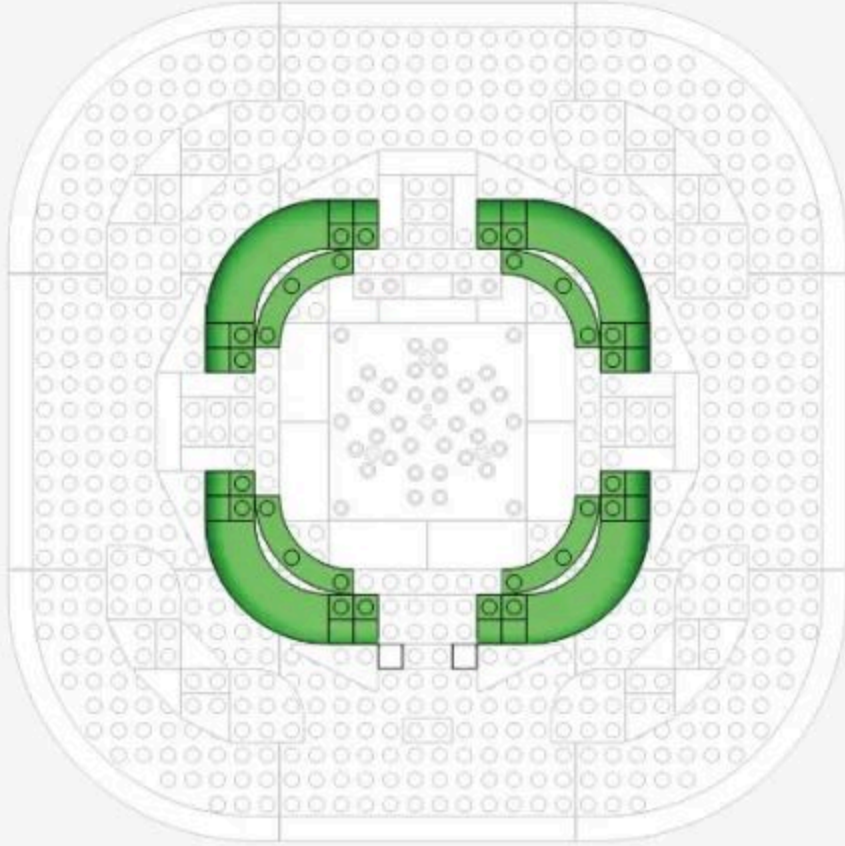

1-9

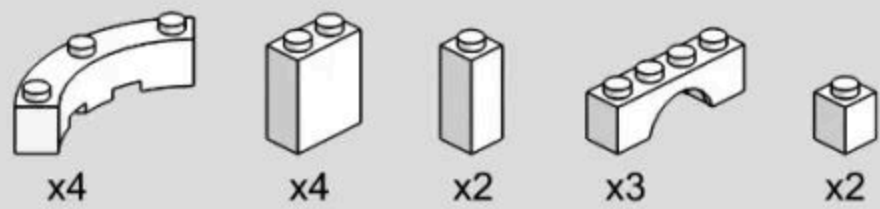

Vertical View of Installation Drawing
安装图顶面

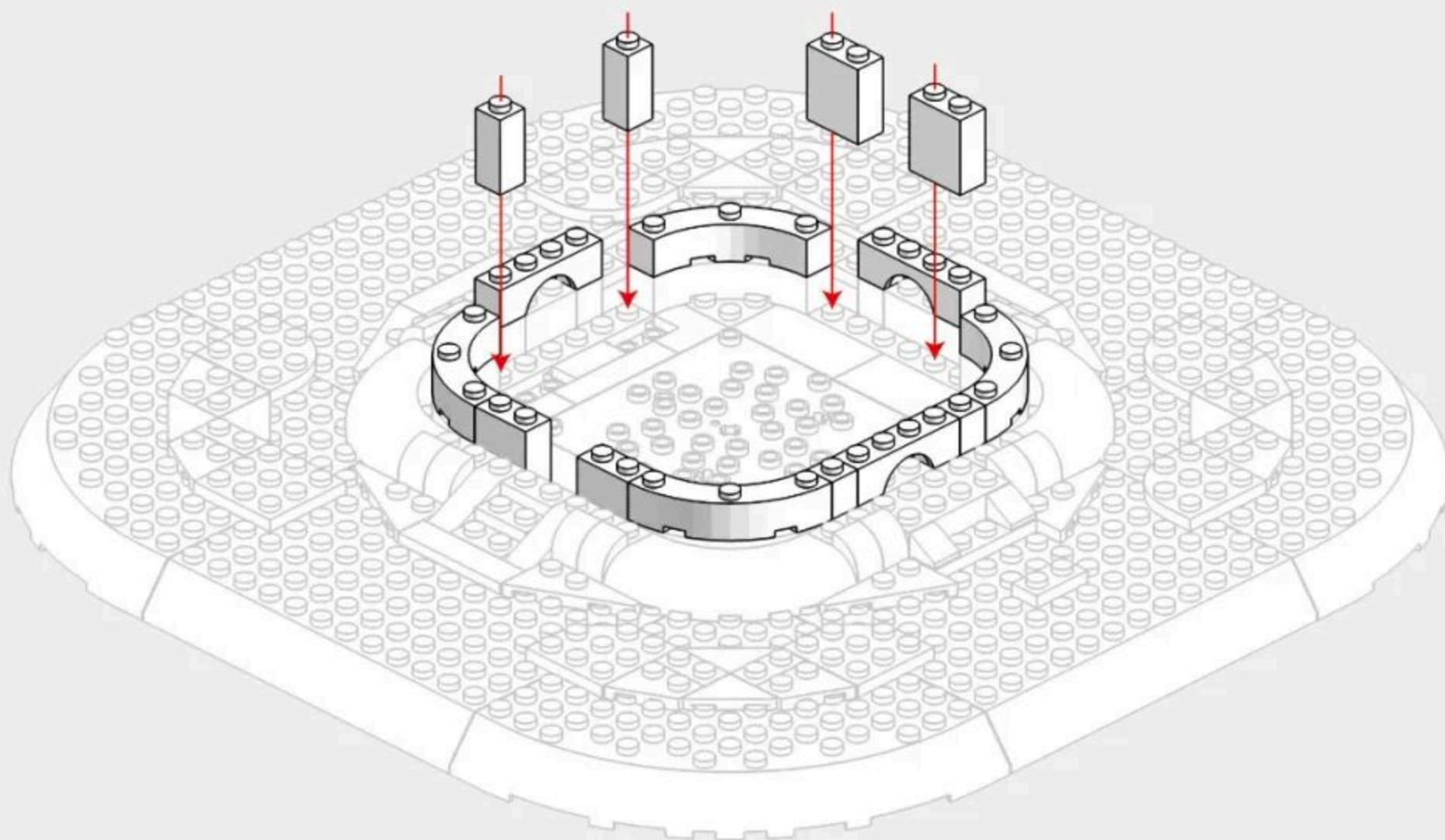
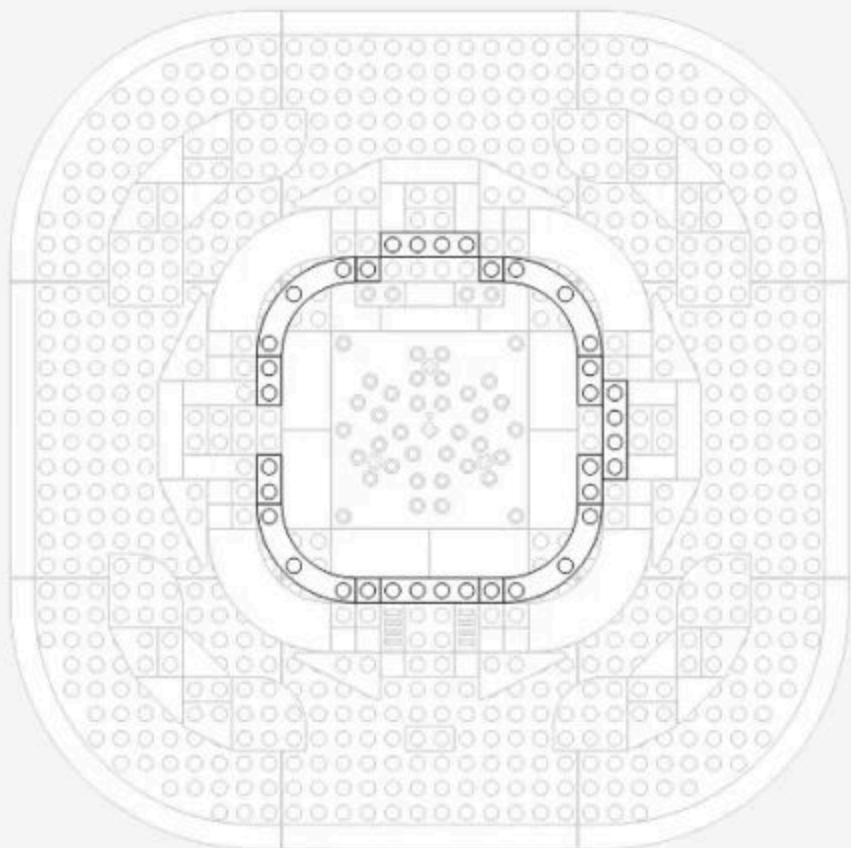

1-10

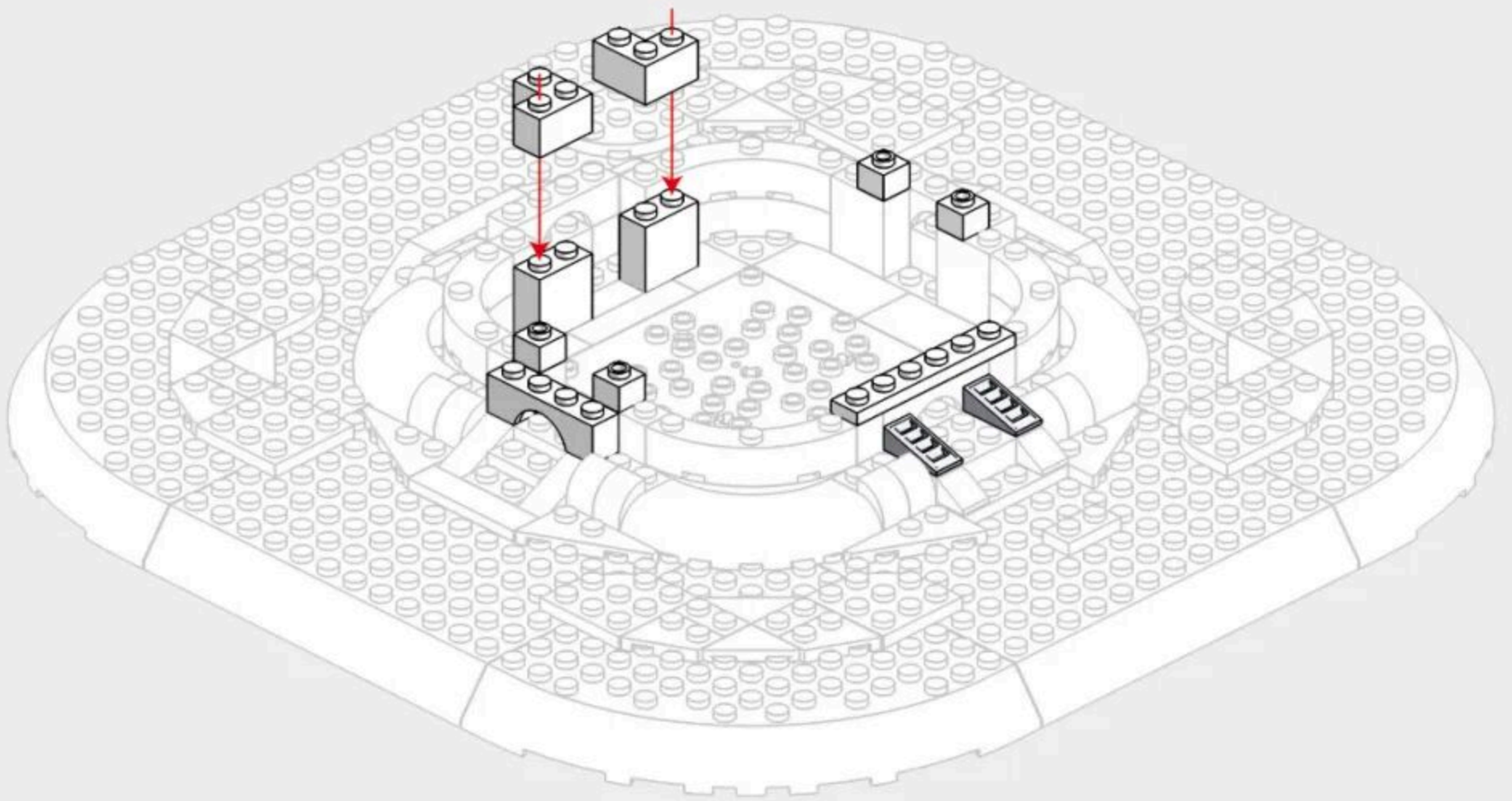
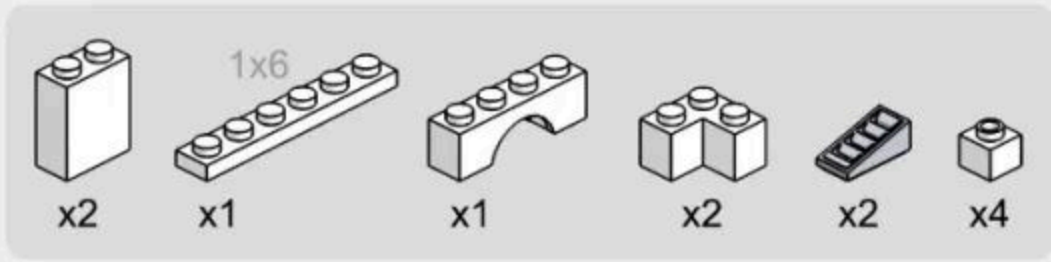

1-11

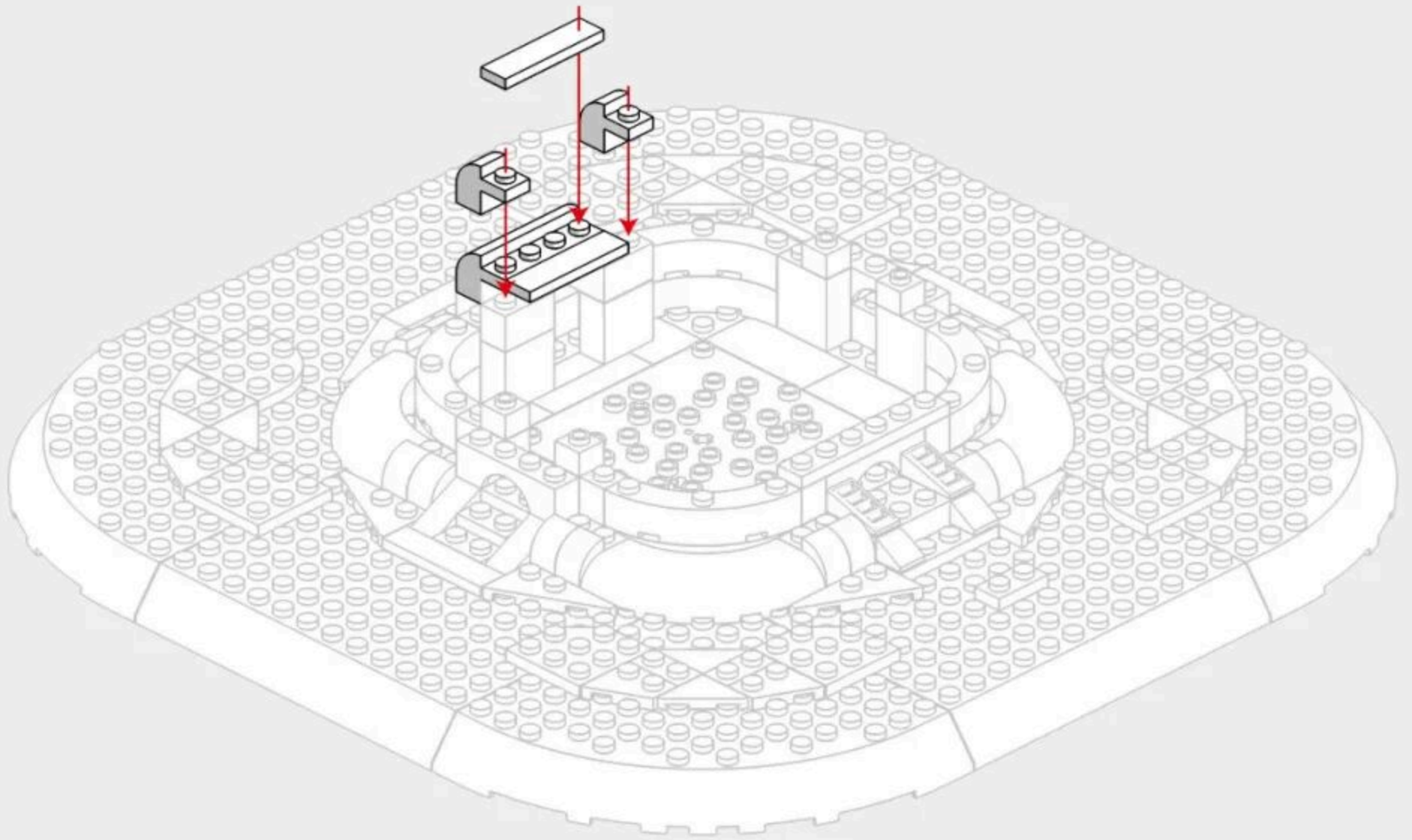
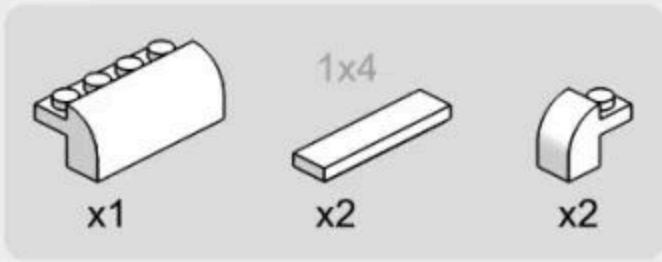

1-12

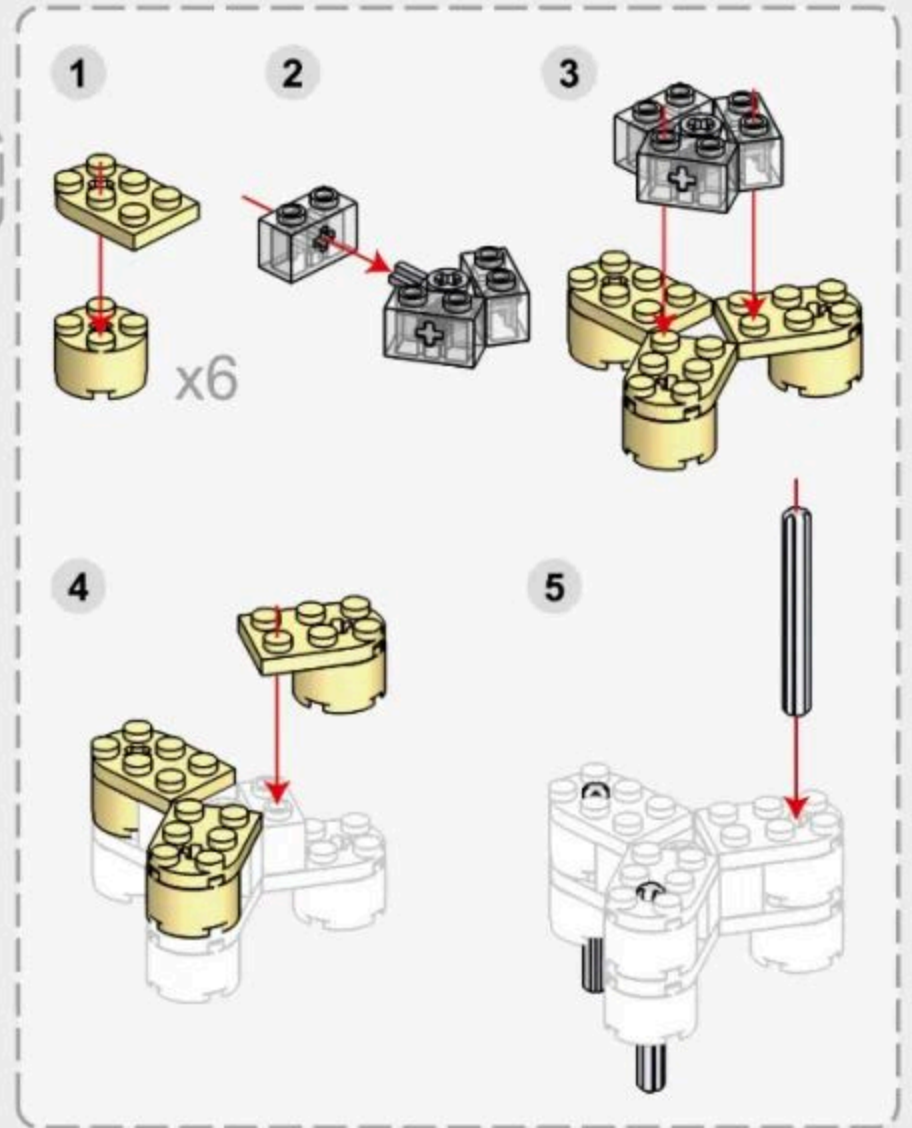
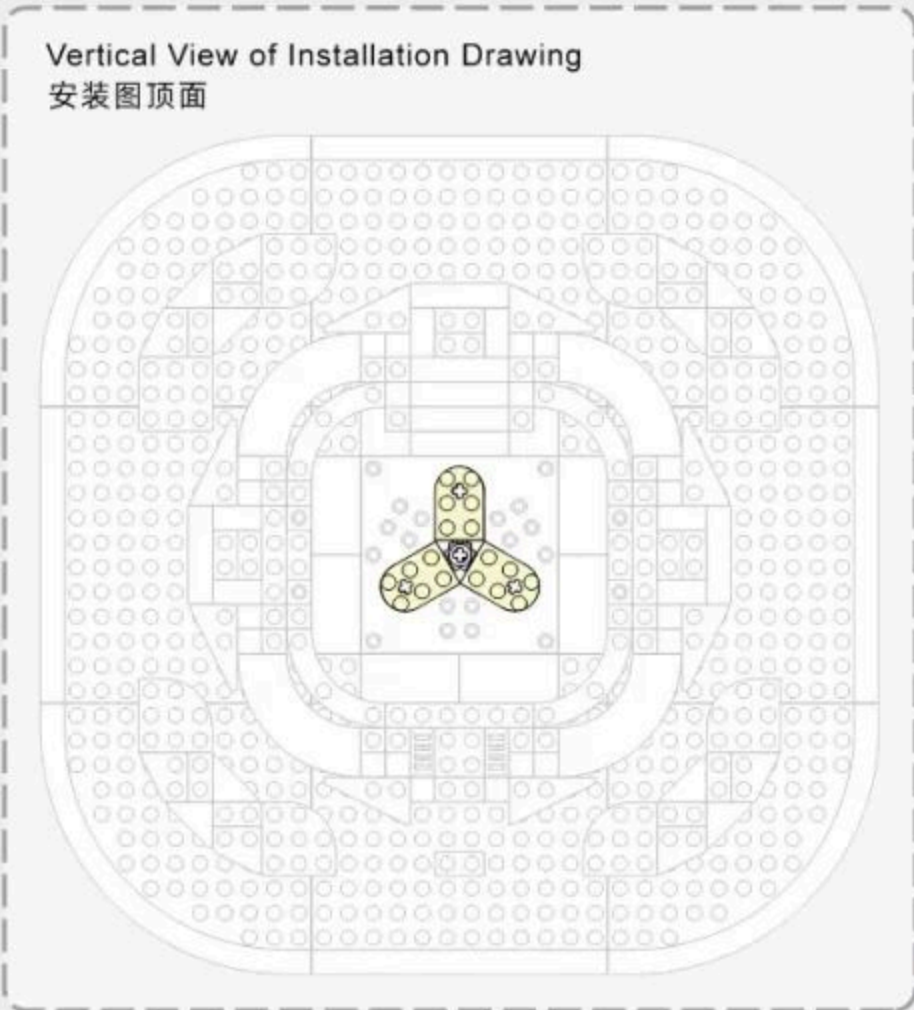
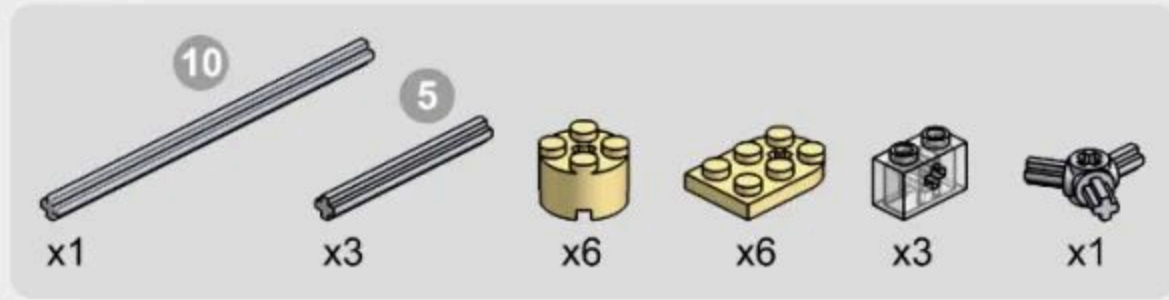

Install according to the direction of the cross hole in the diagram
需按照图中十字孔方向安装

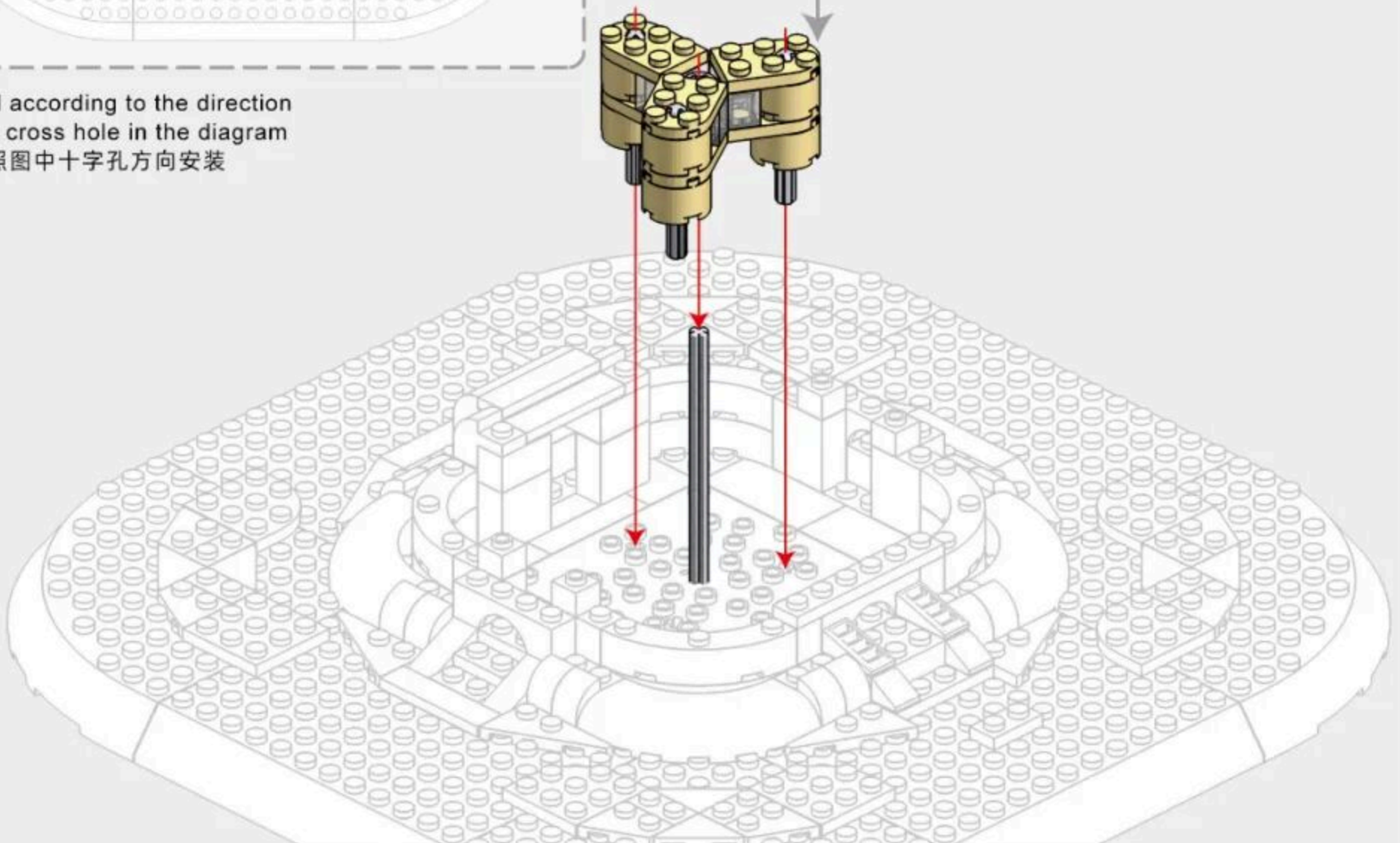

1-13

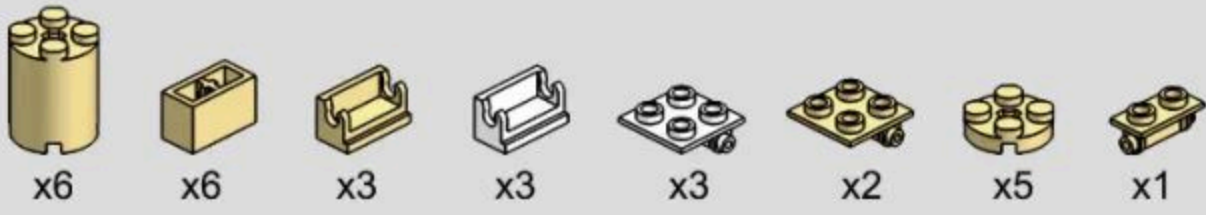

The Back of Installation Drawing
安装图背面

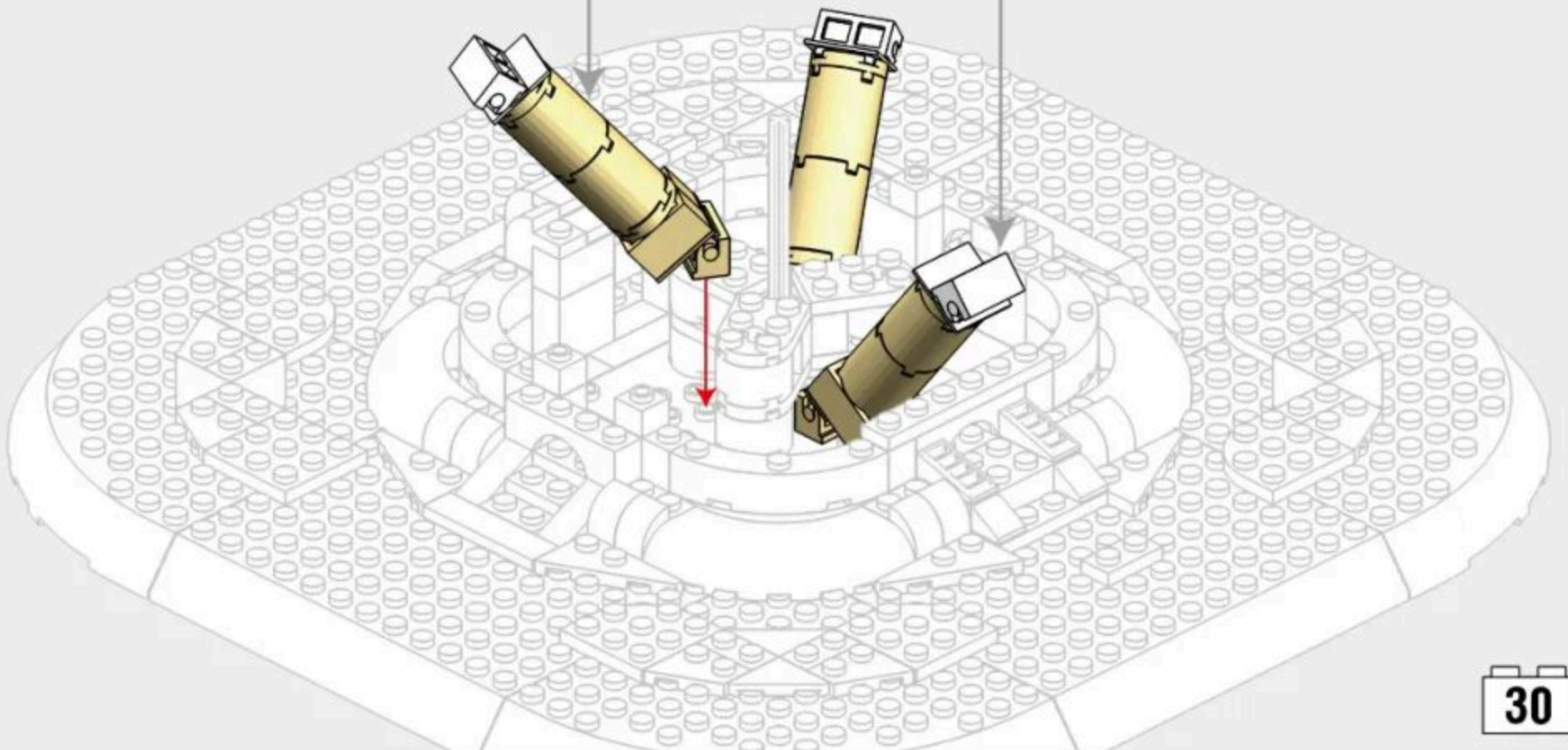
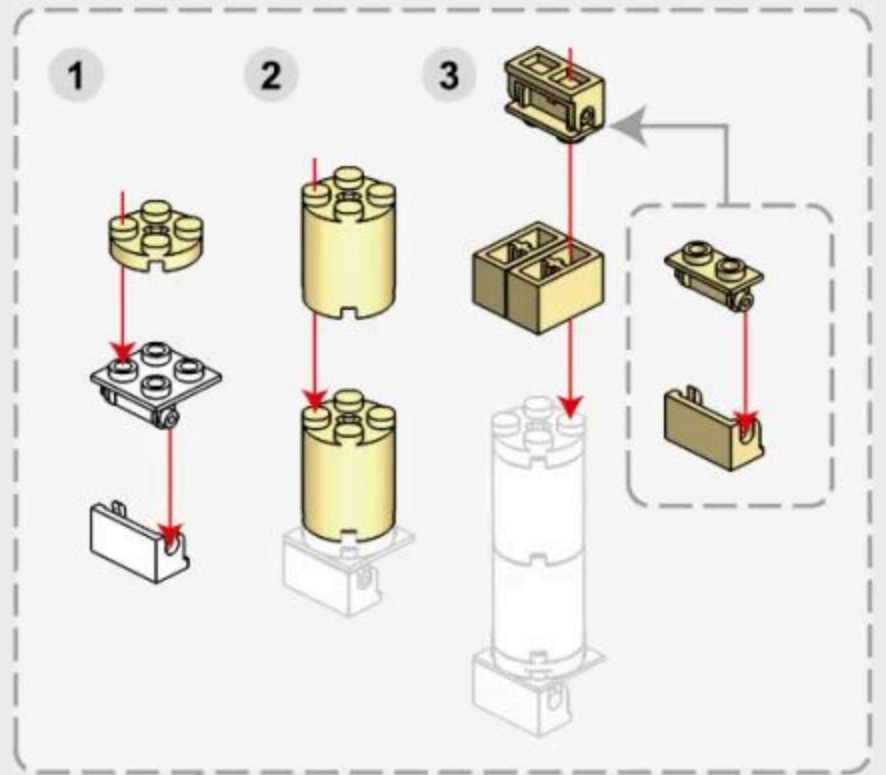
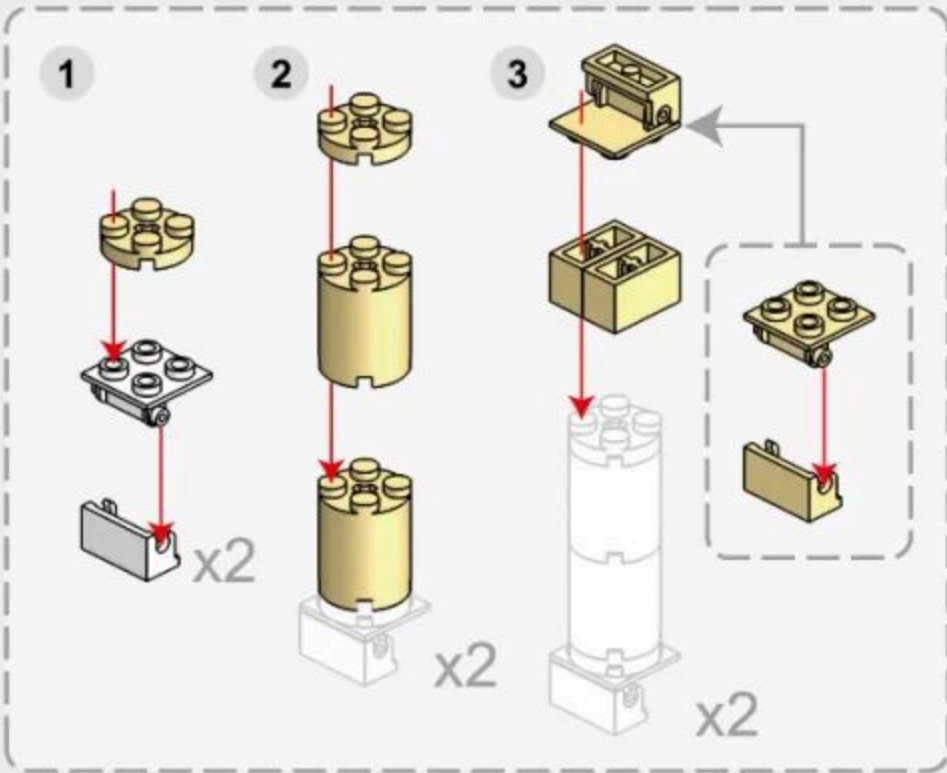
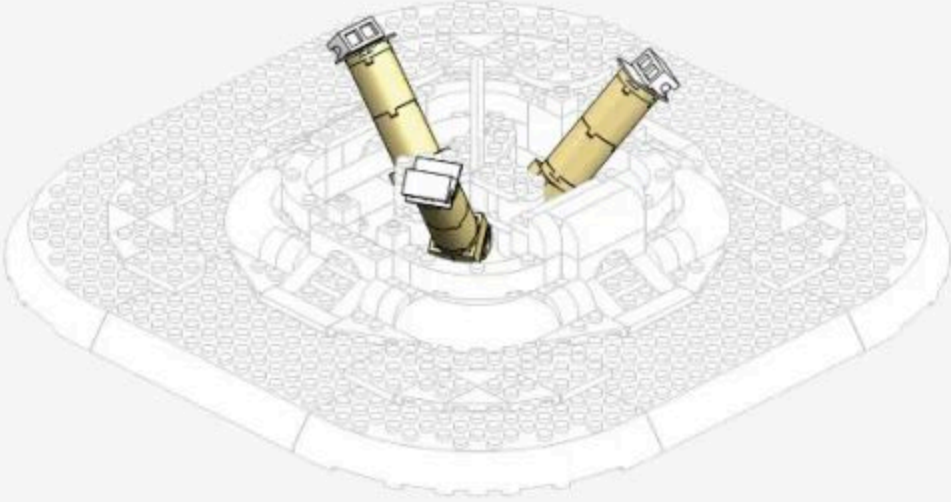

1-14

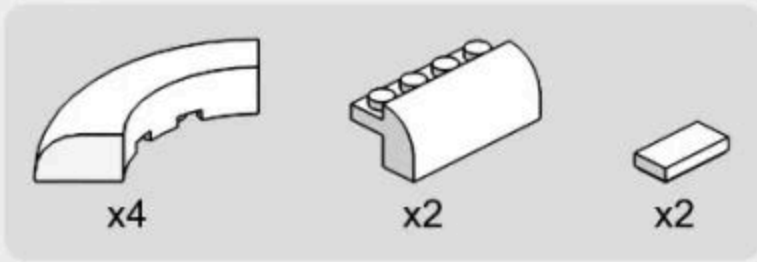

The Back of Installation Drawing
安装图背面

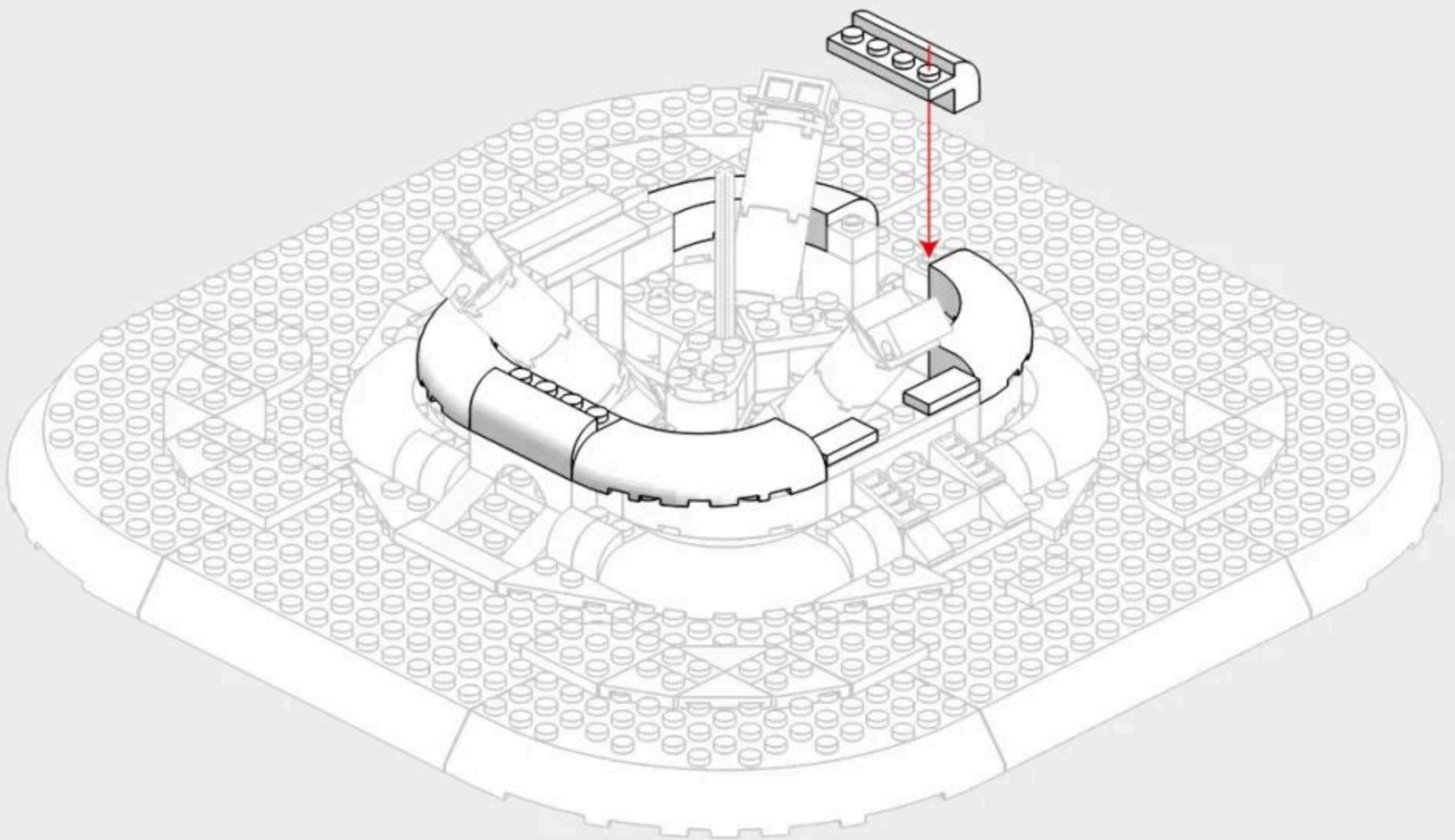
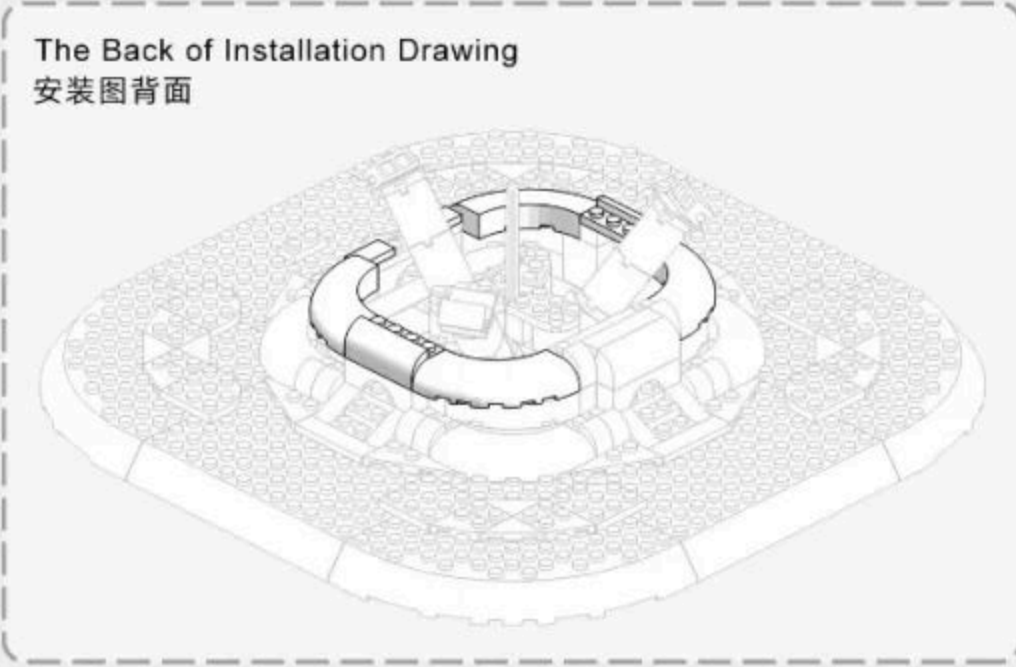

1-15

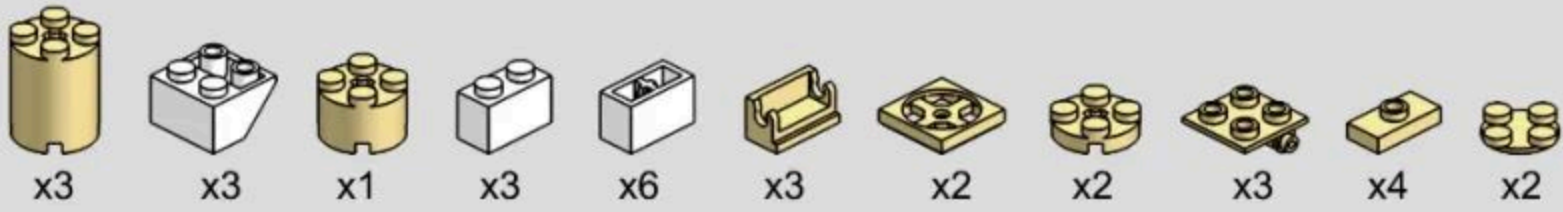

The Back of Installation Drawing
安装图背面

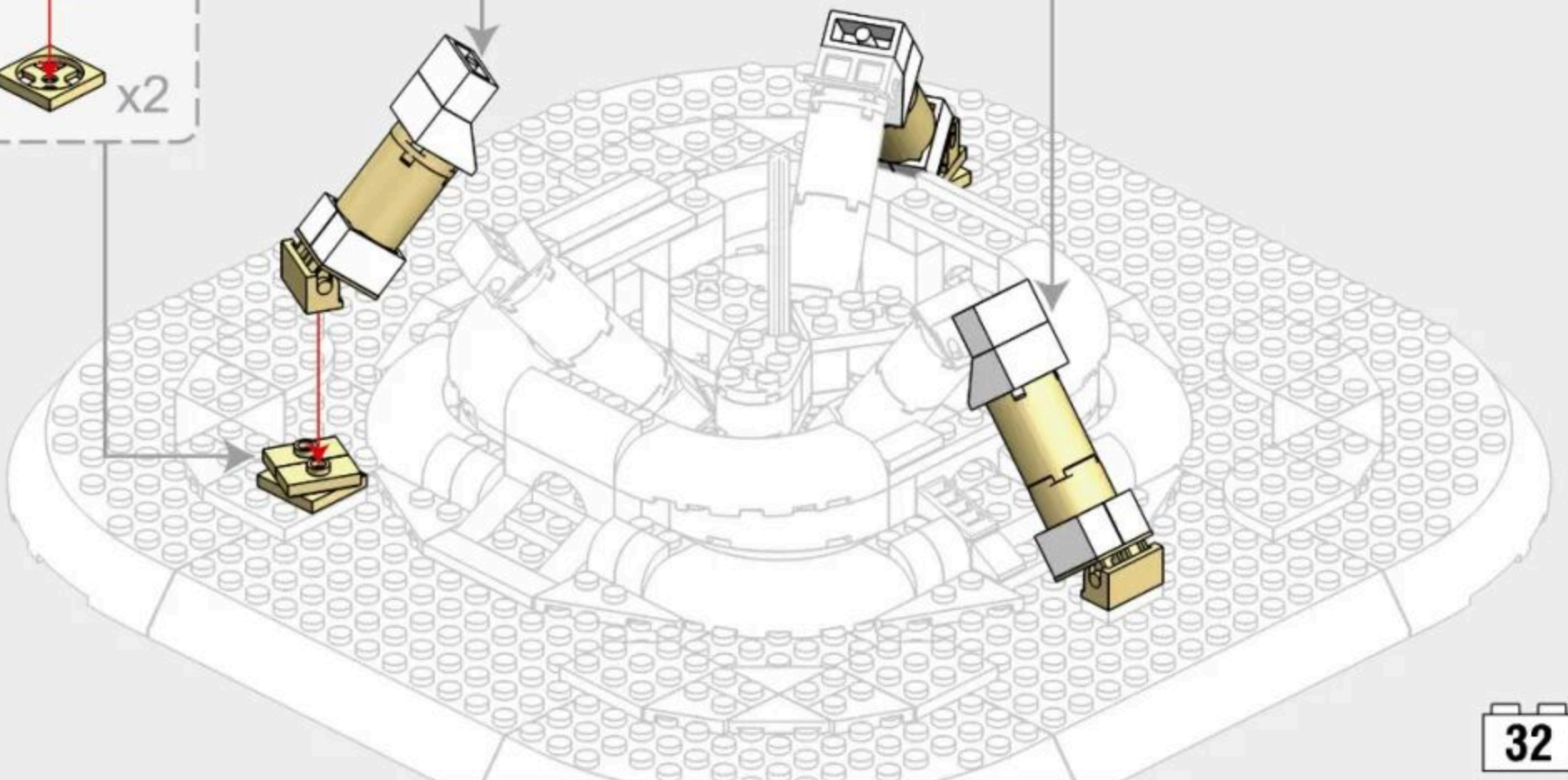
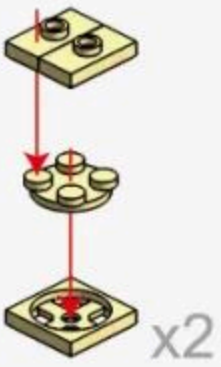
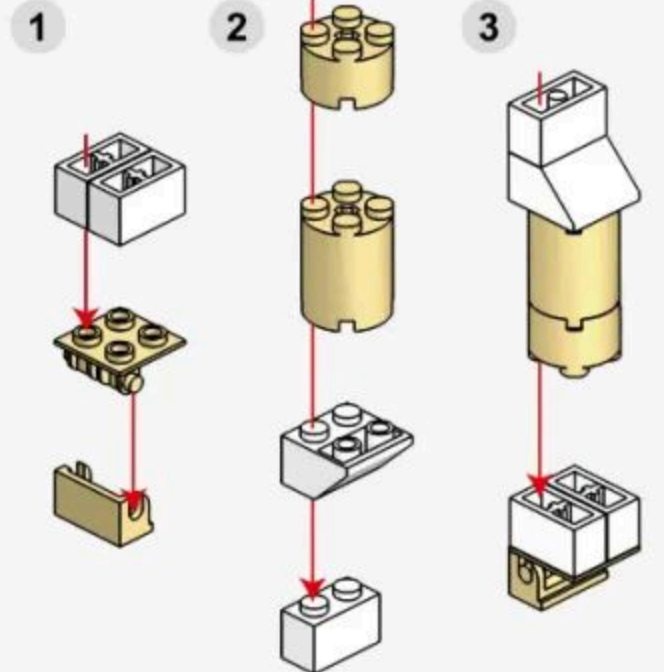
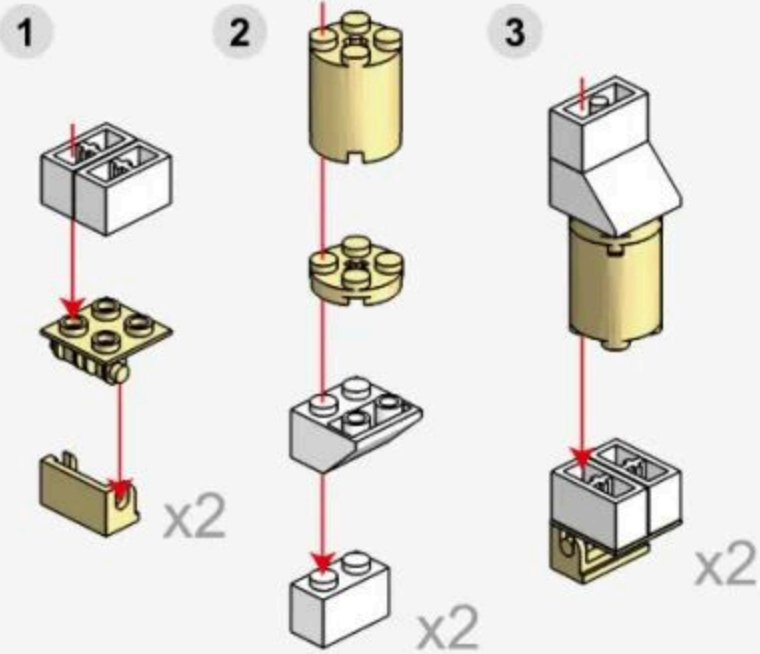
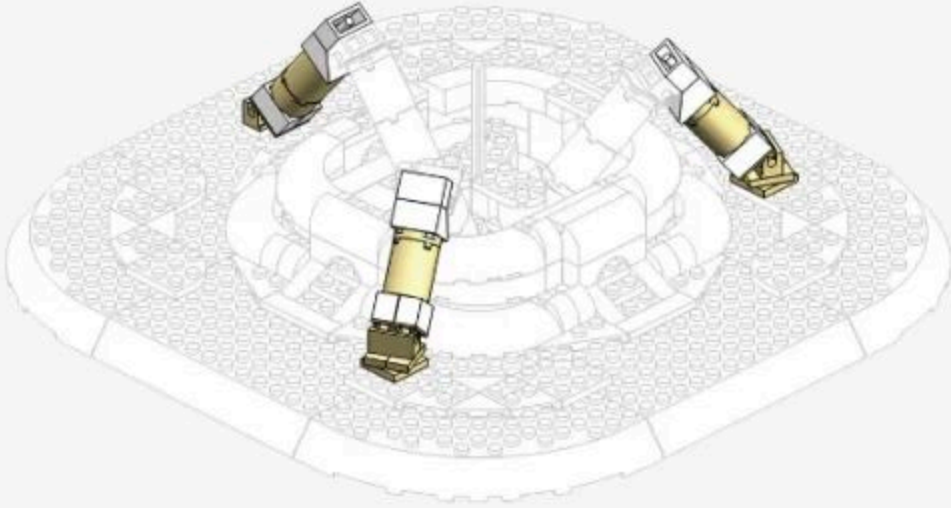



260PCS

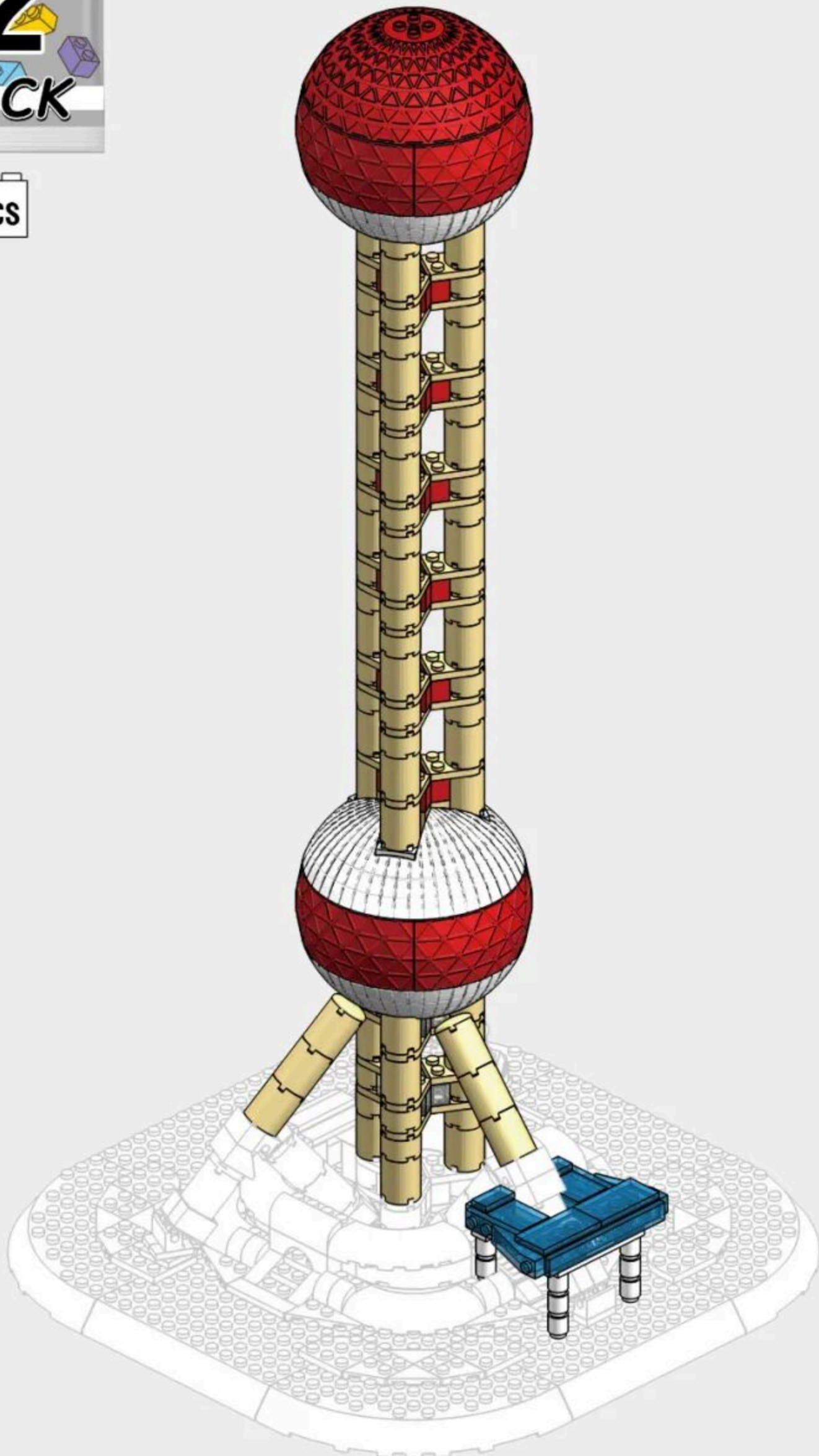

2-1



x9



x3

The Back of Installation Drawing
安装图背面

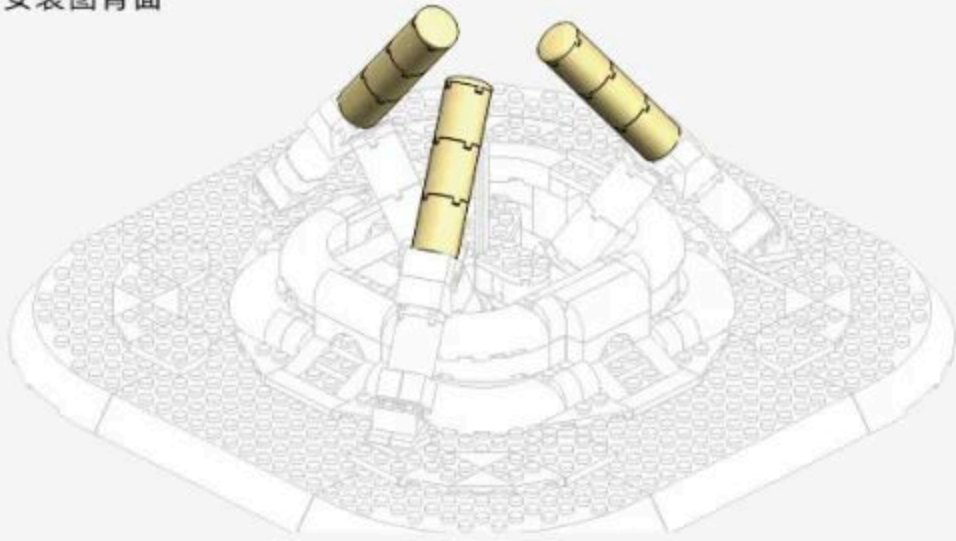

x3

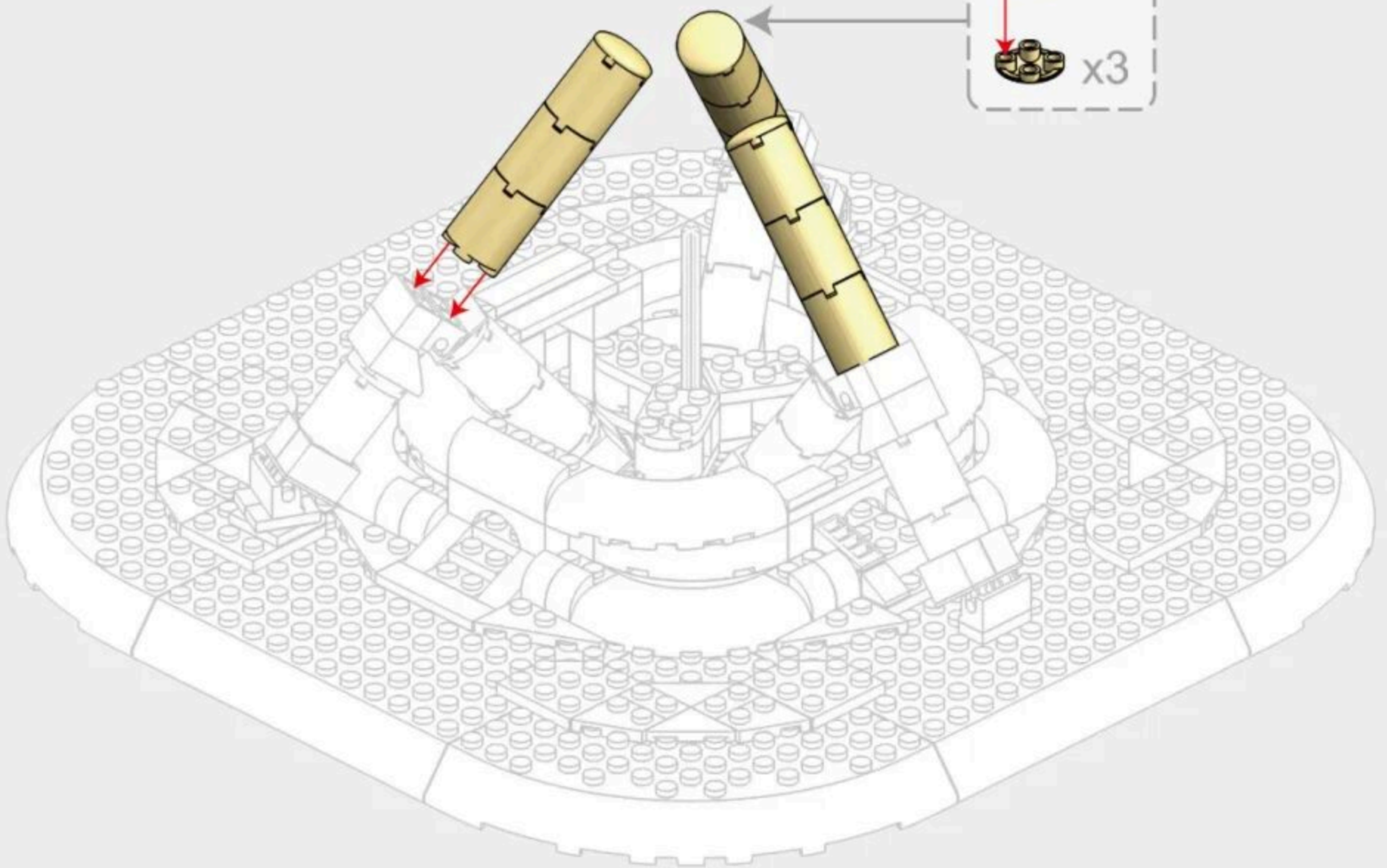

2-2

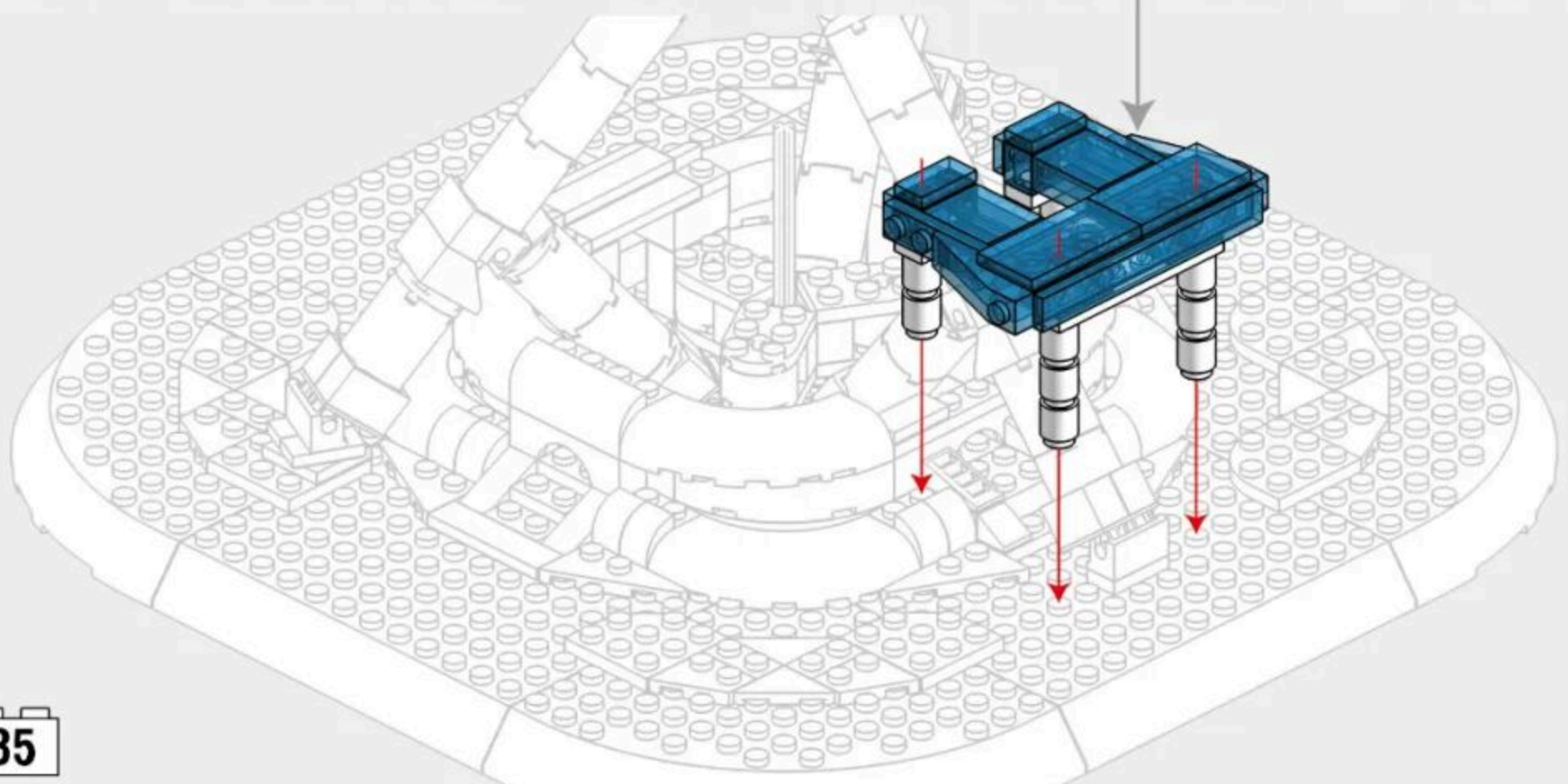
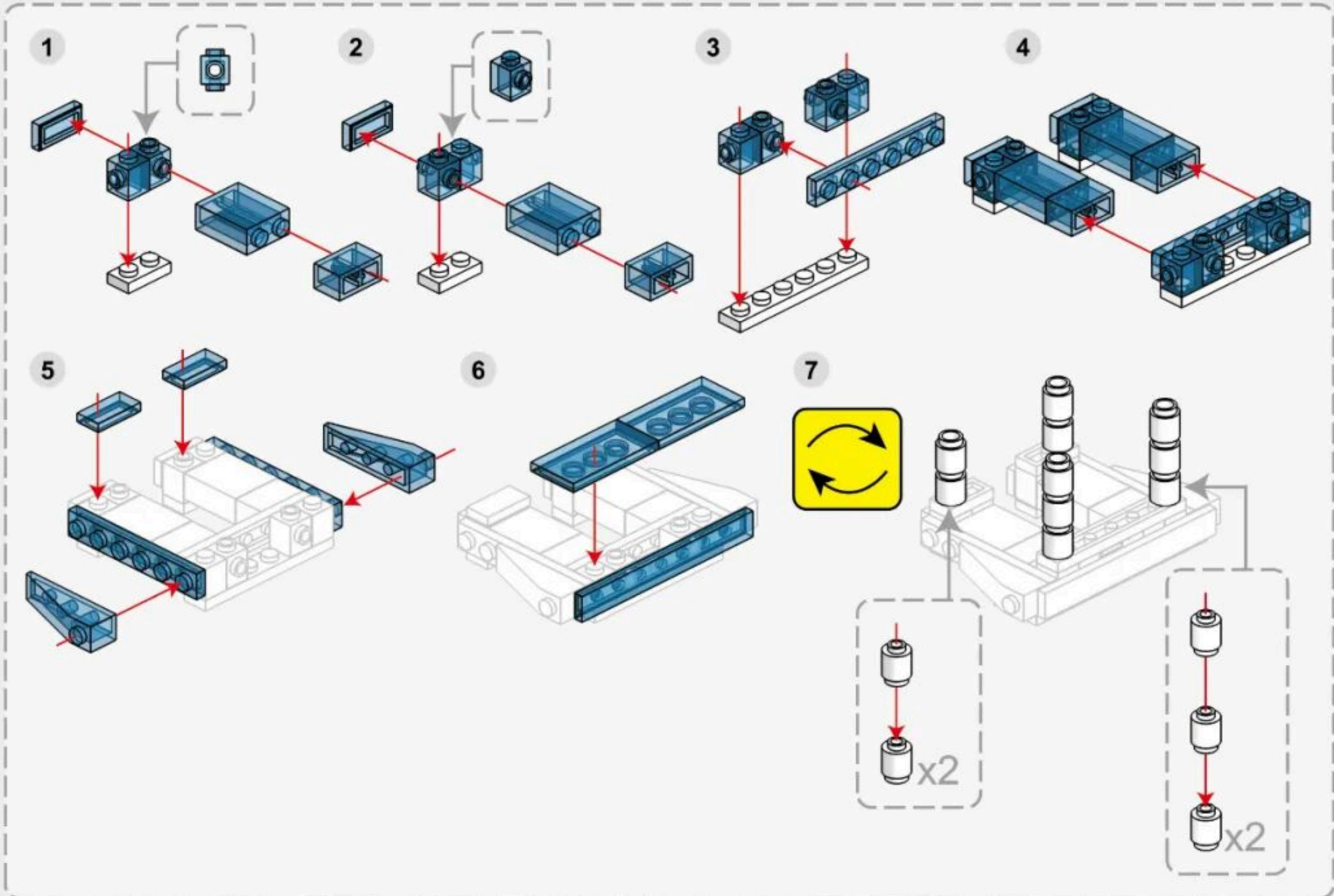
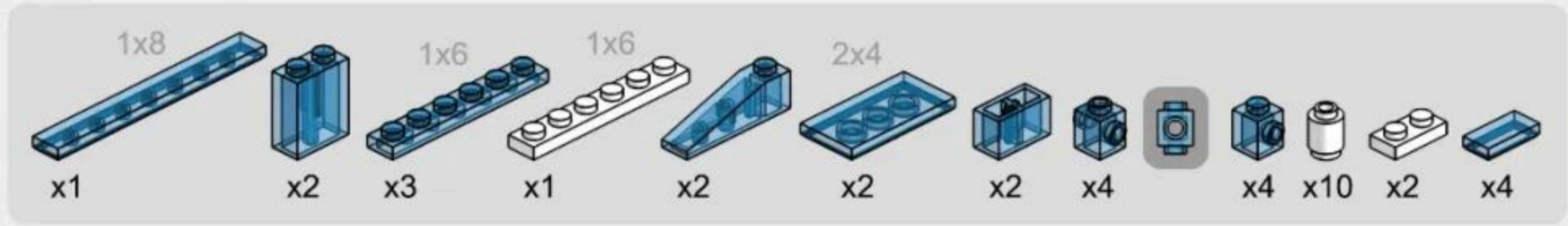

2-3



x3



x6



x3



x6



x1

Vertical View of Installation Drawing
安装图顶面

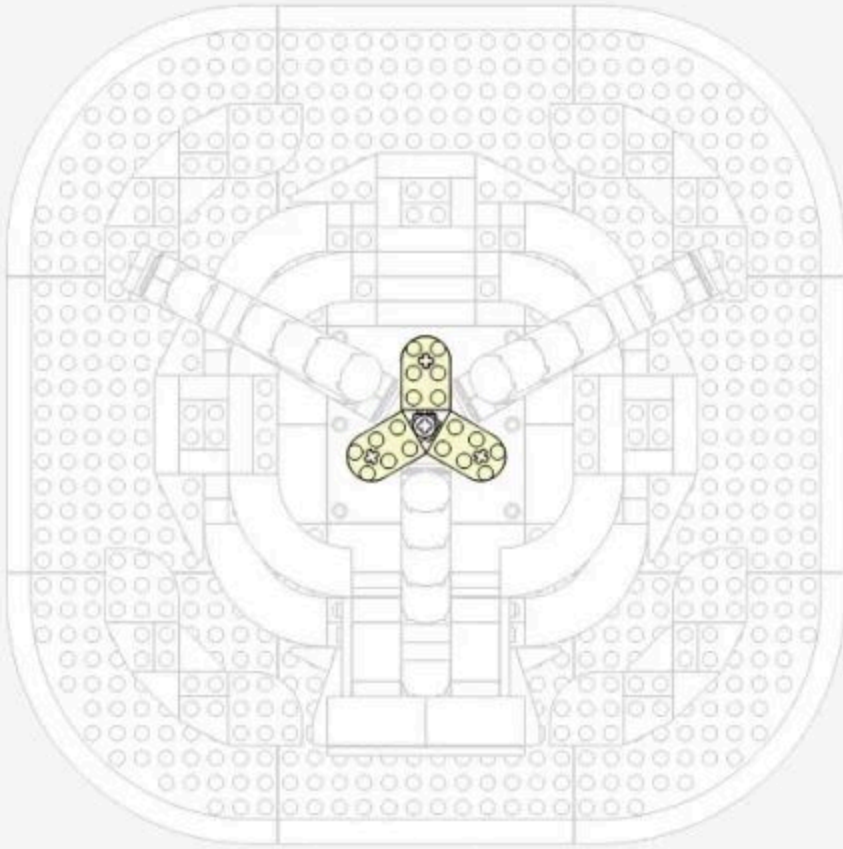

Install according to the direction
of the cross hole in the diagram
需按照图中十字孔方向安装

1



x3

3

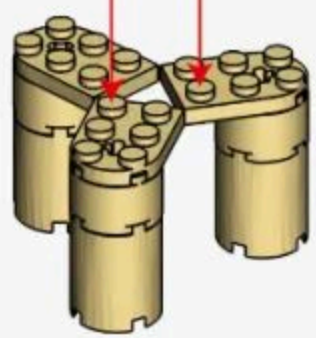

2



4

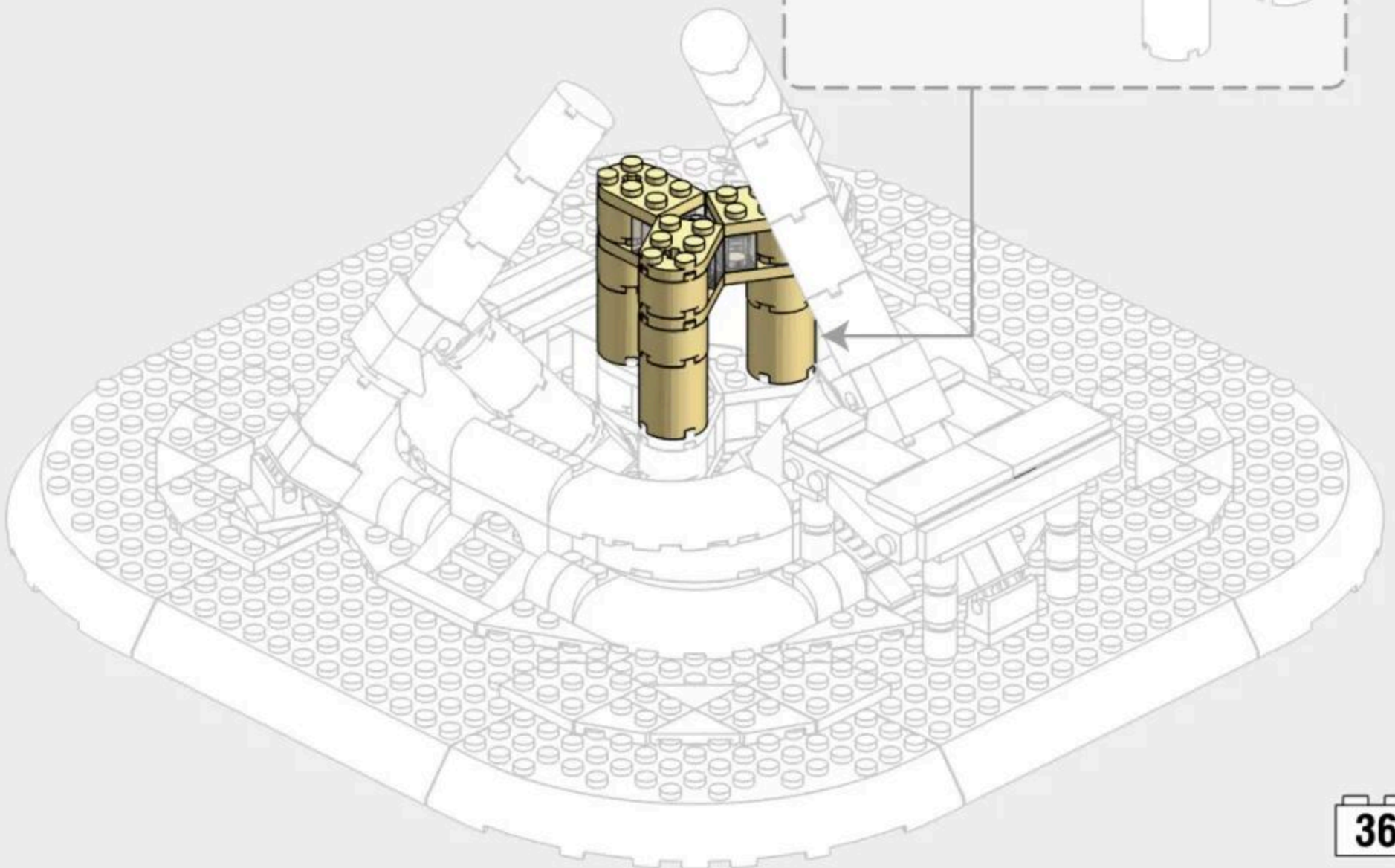
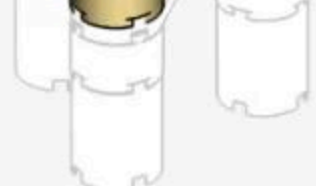
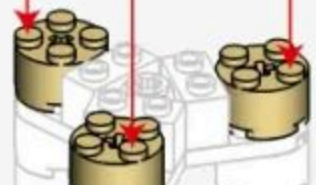

2-4



x6



x3



x3



x3



x1

1

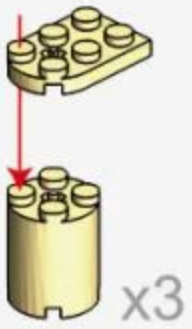

2

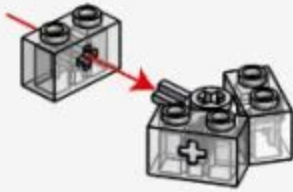

3

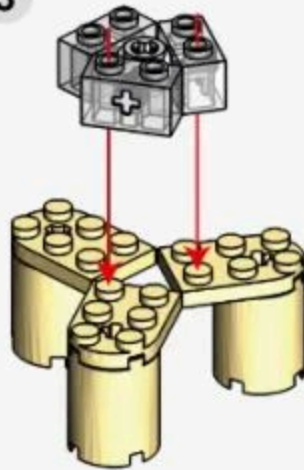

4



5

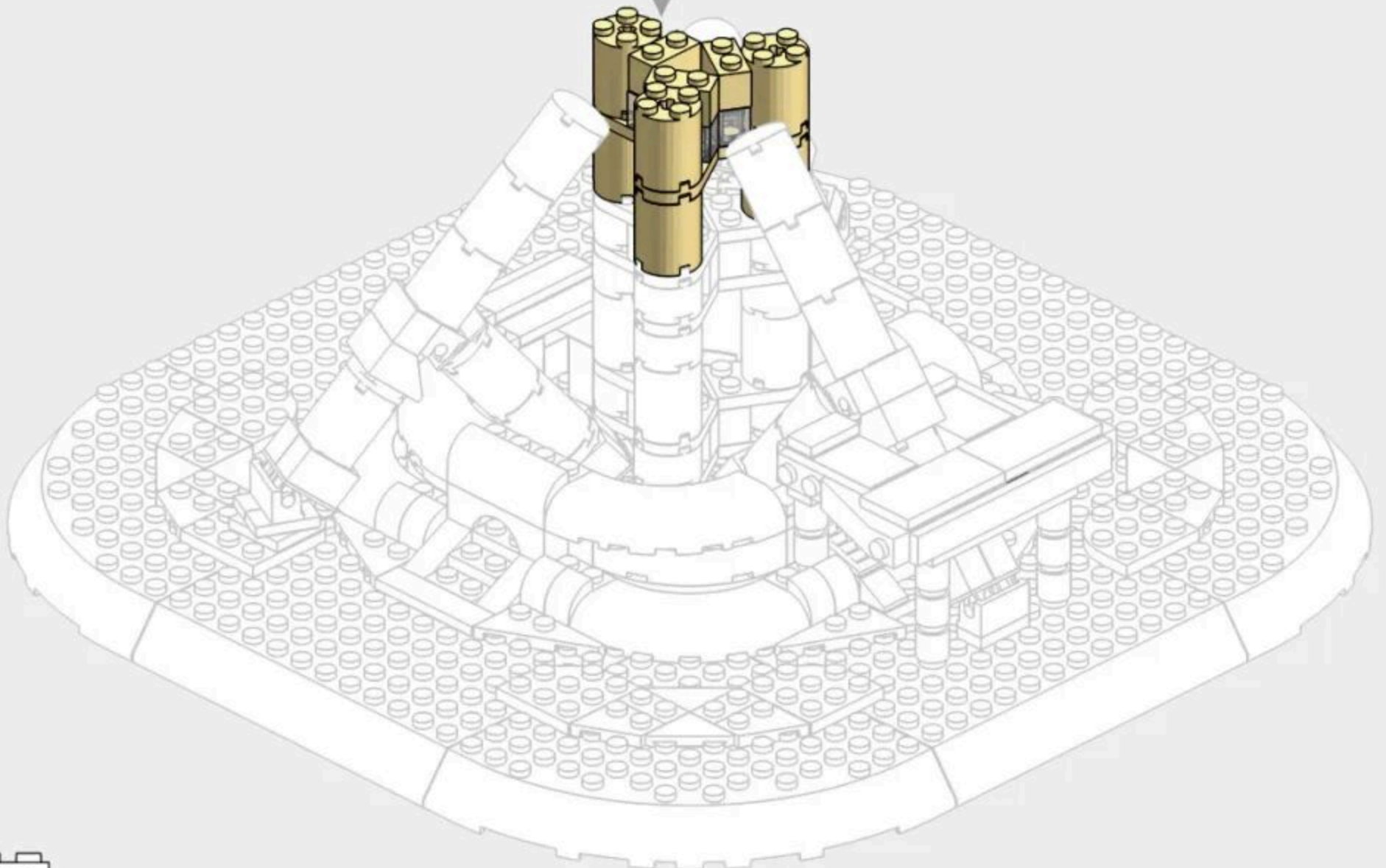
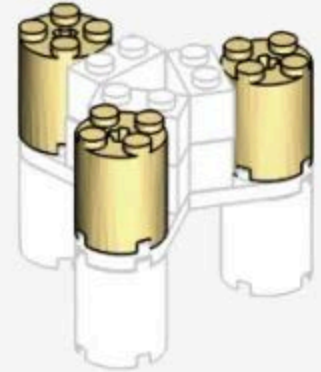

2-5

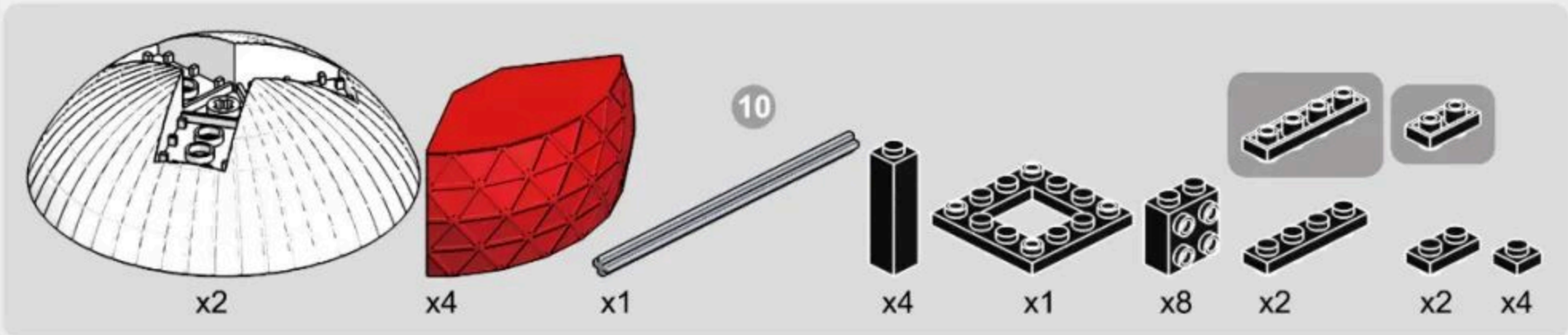

The cross holes of the upper and lower spheres need to be installed in the direction shown in the diagram
 上下球体十字孔需按图示方向安装

Vertical View of Installation Drawing
 安装图顶面

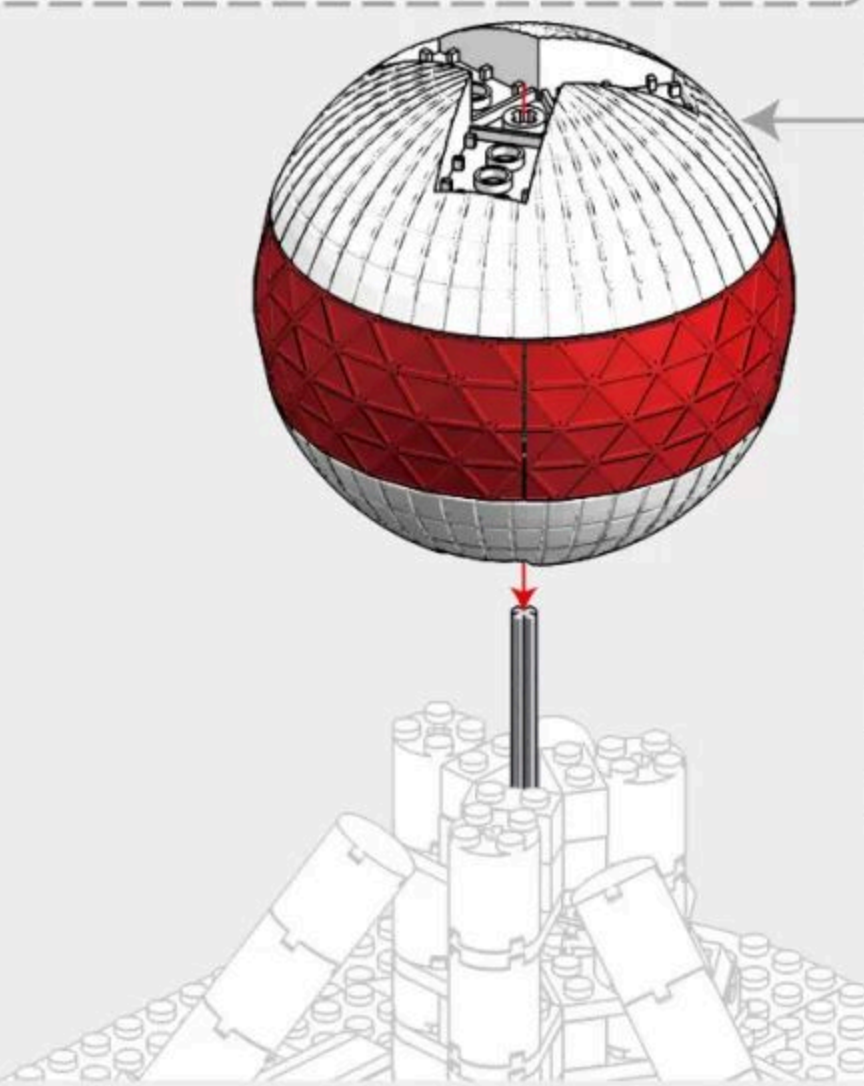
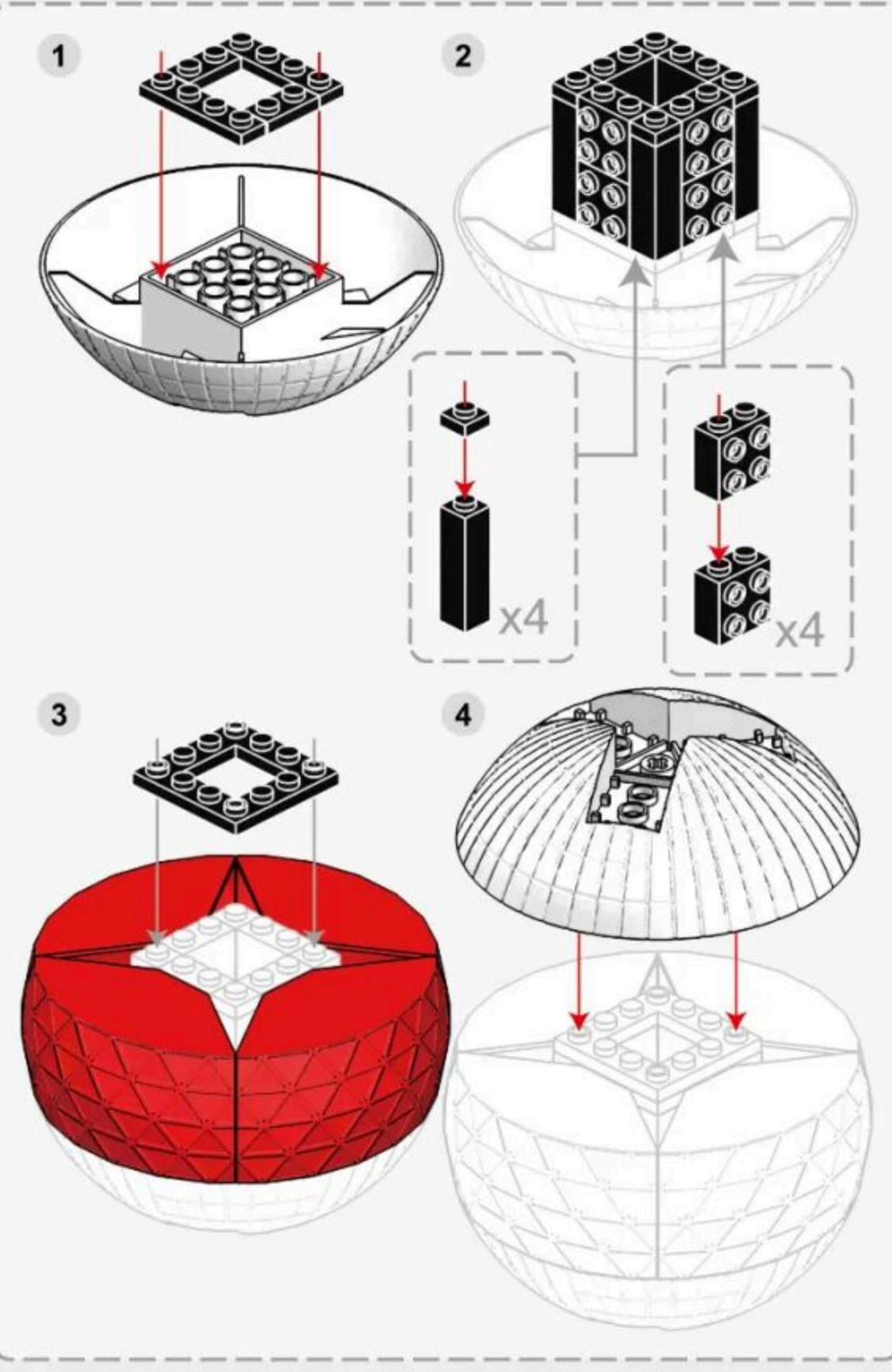
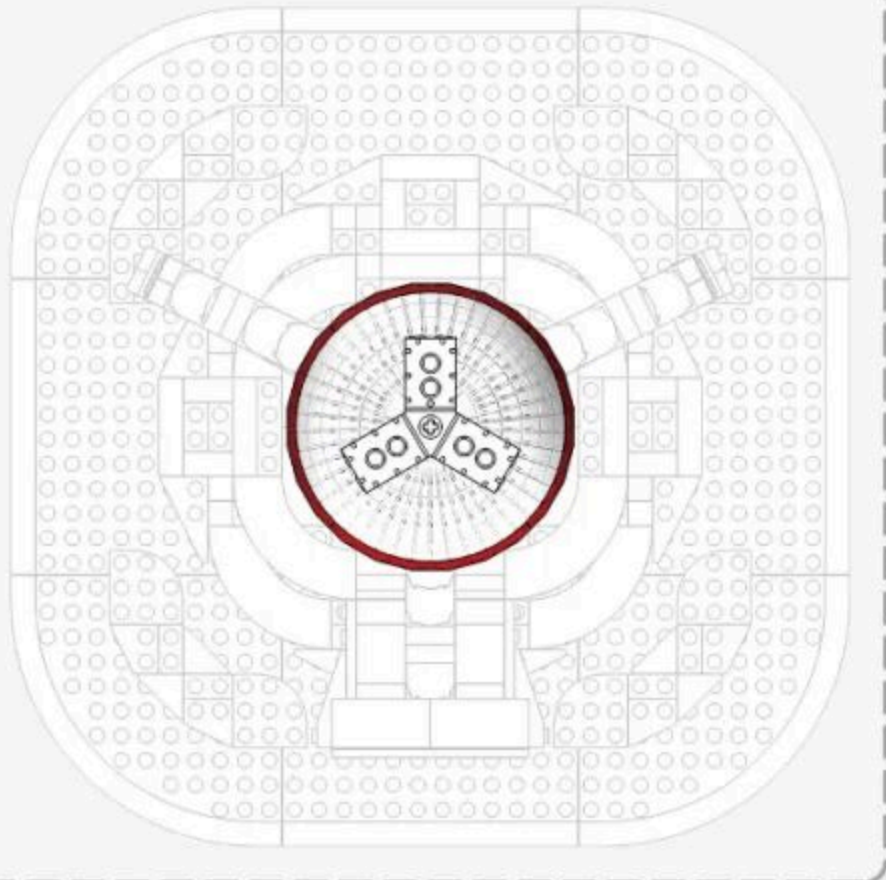

2-6

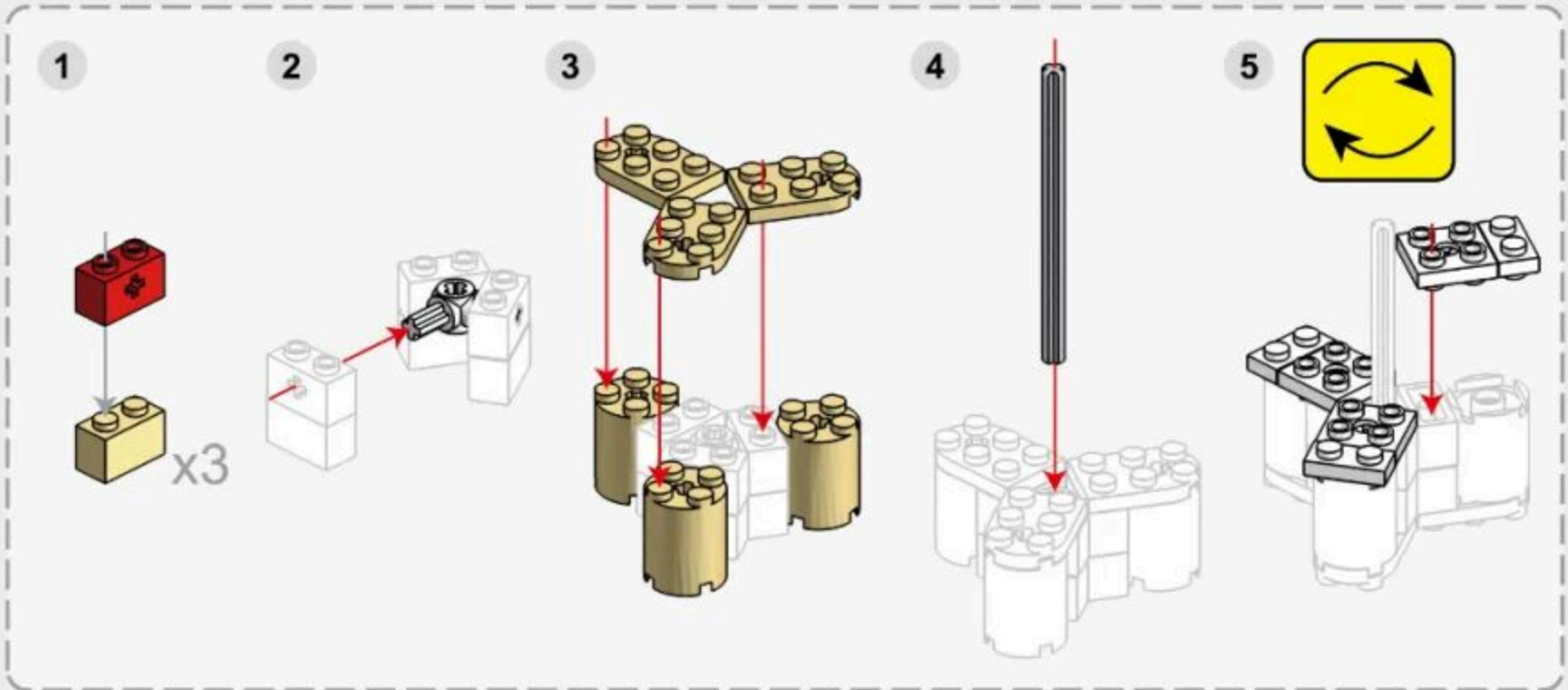
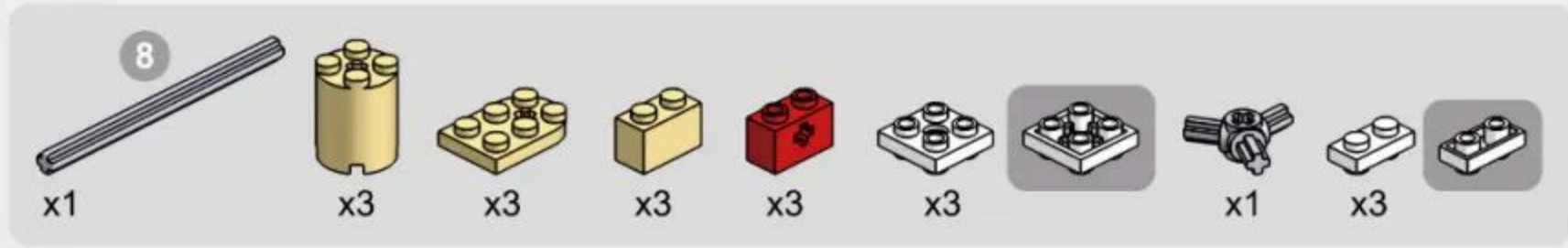

2-7

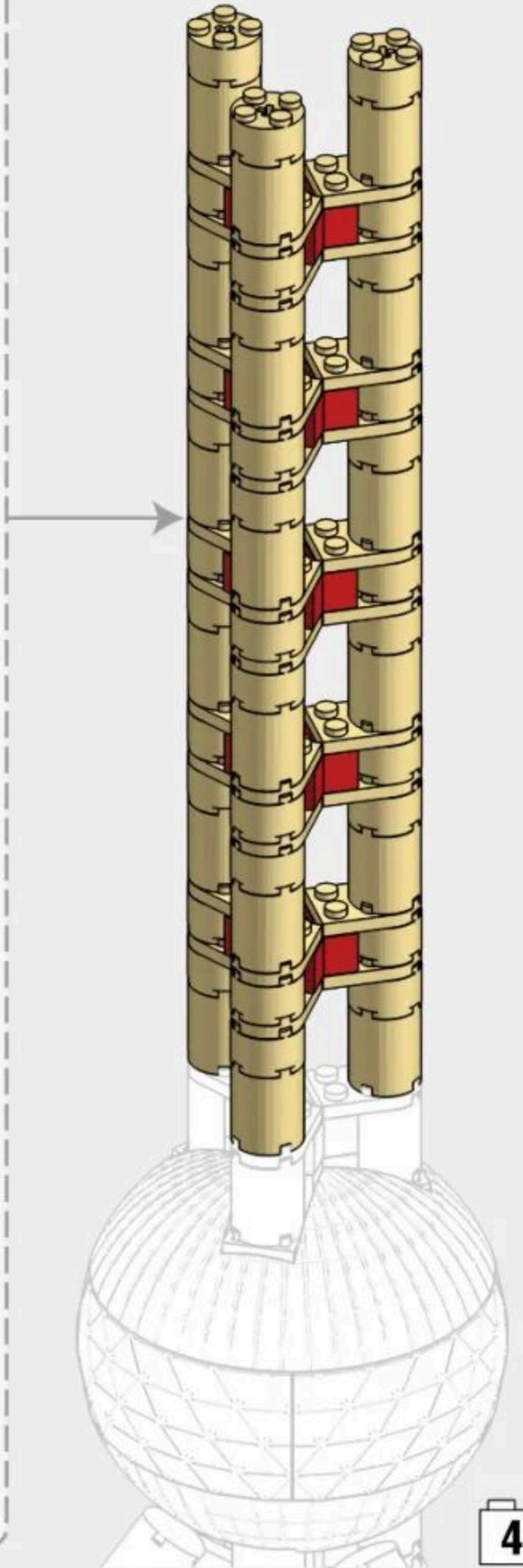
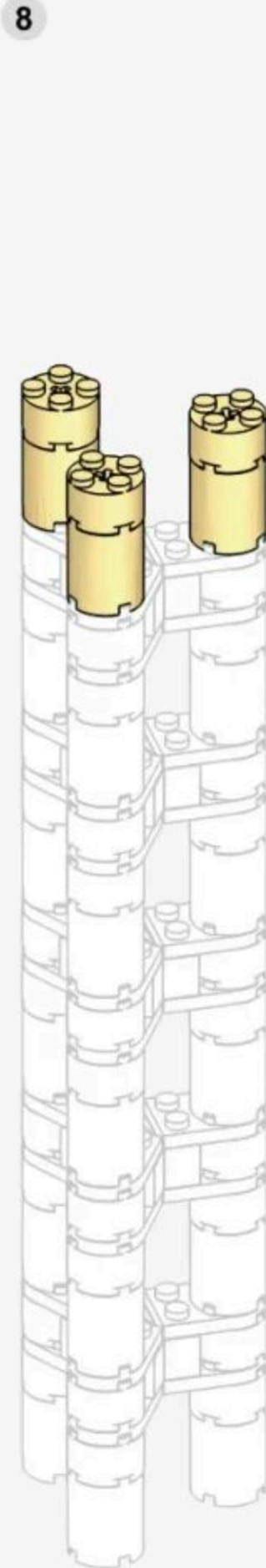
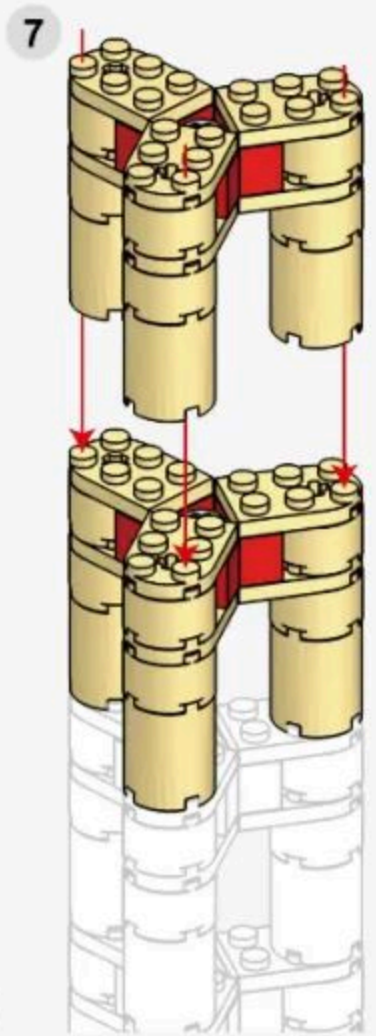
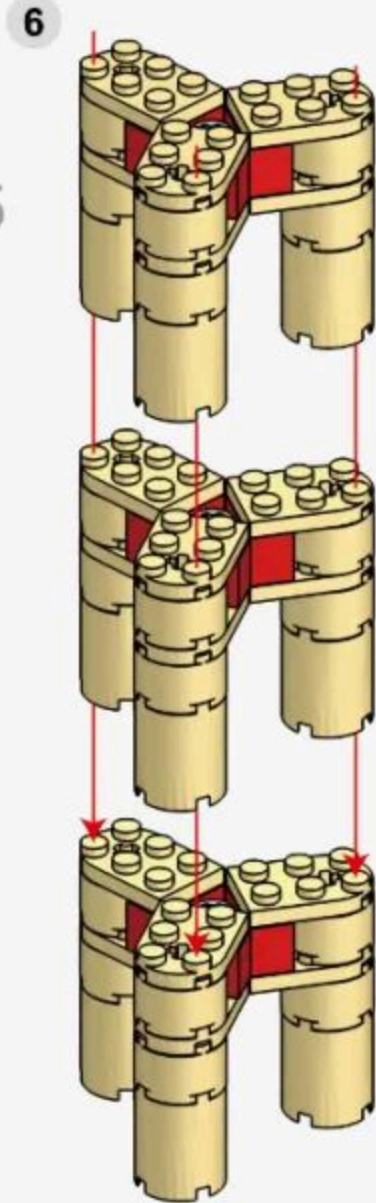
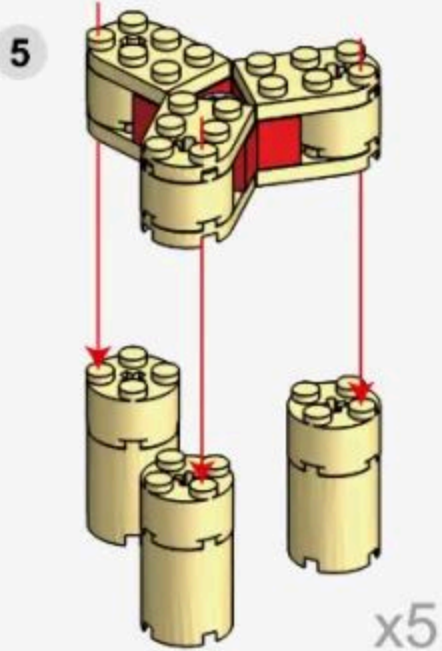
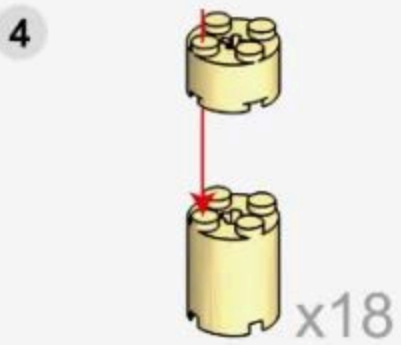
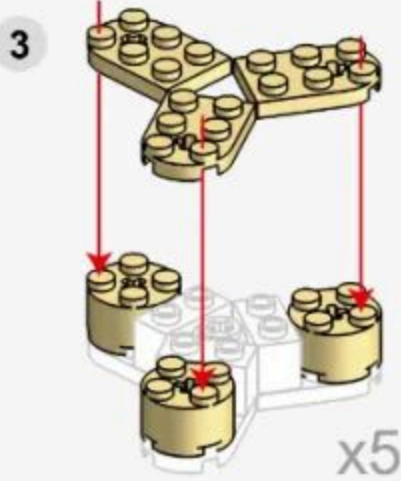
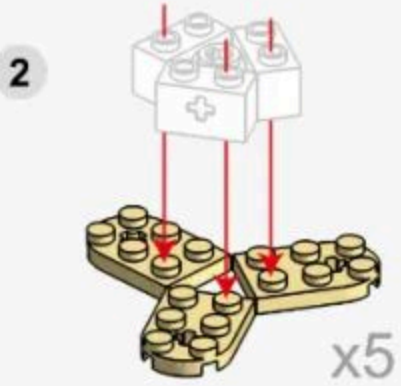
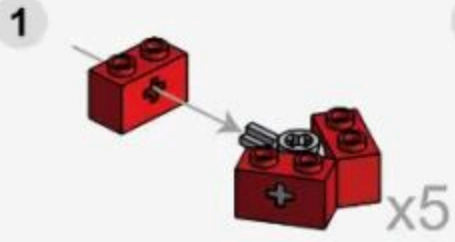

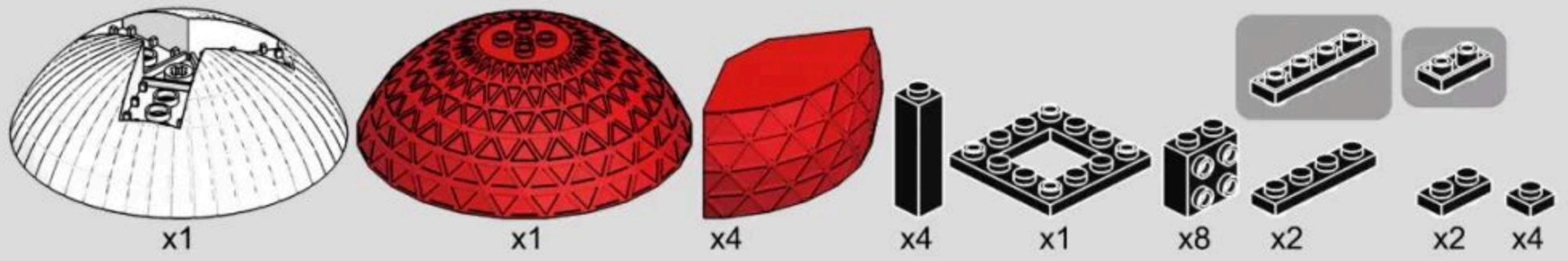

Vertical View of Installation Drawing
安装图顶面

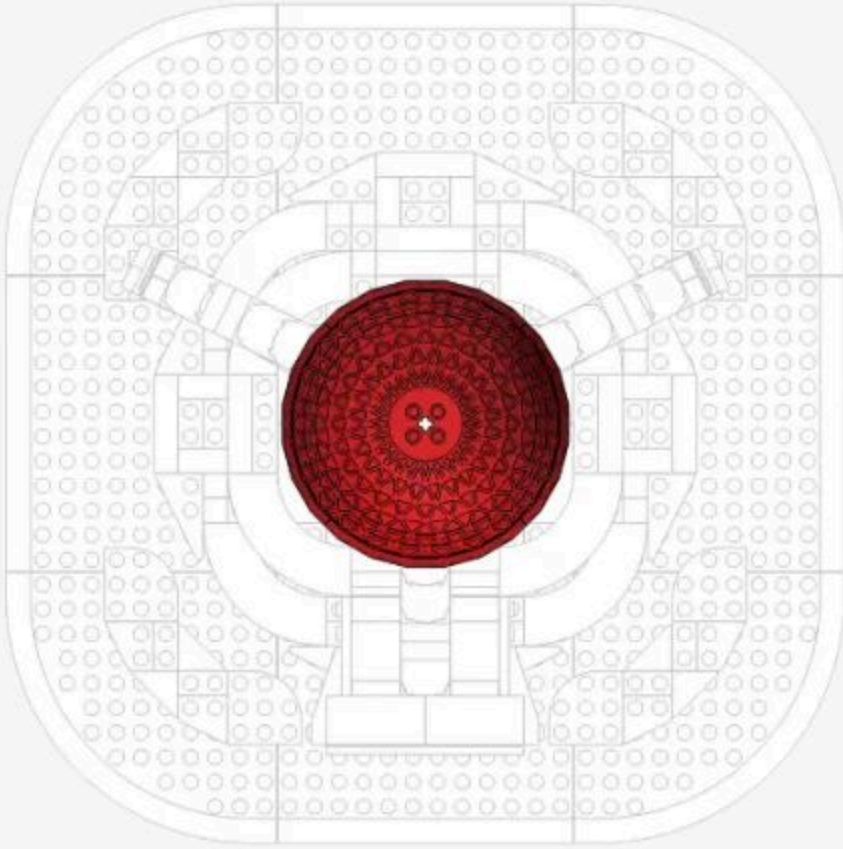

The cross holes of the upper and lower spheres need to be installed in the direction shown in the diagram
上下球体十字孔需按图示方向安装

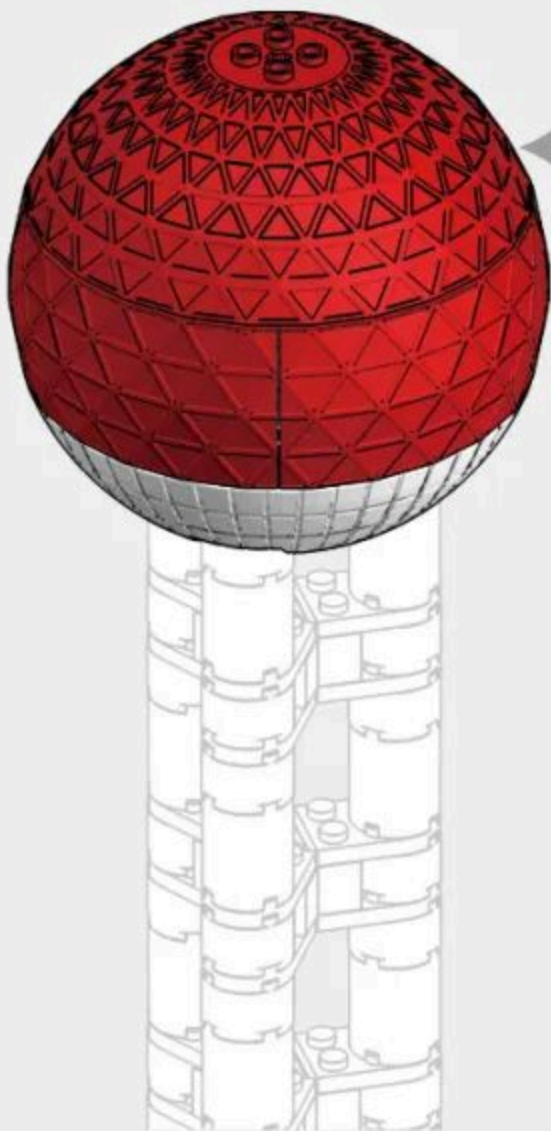
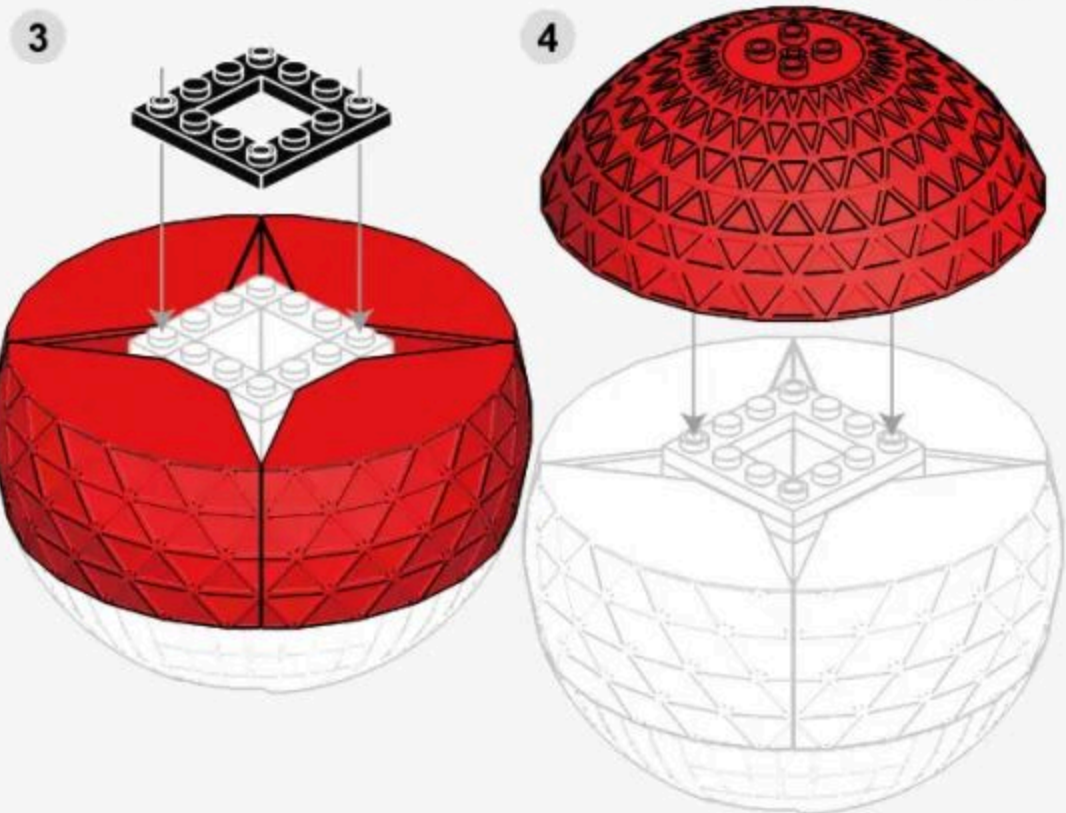
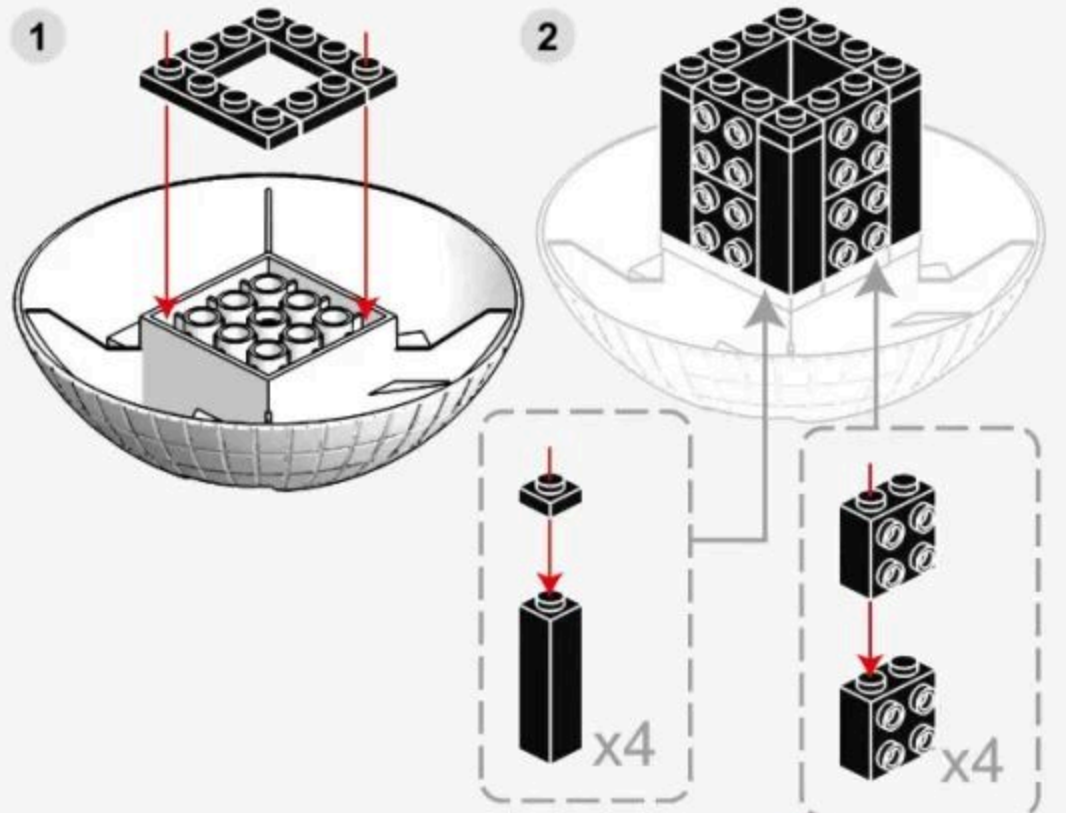



286PCS

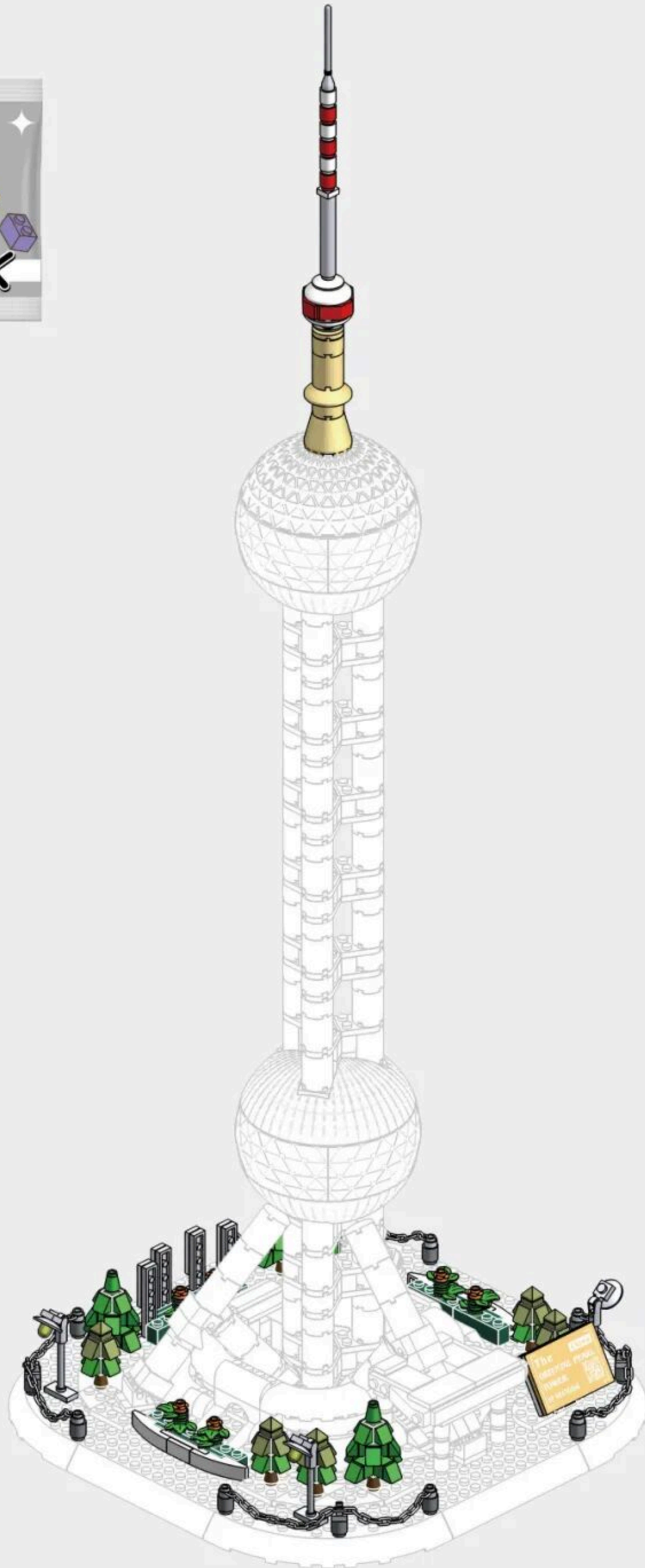

3-1

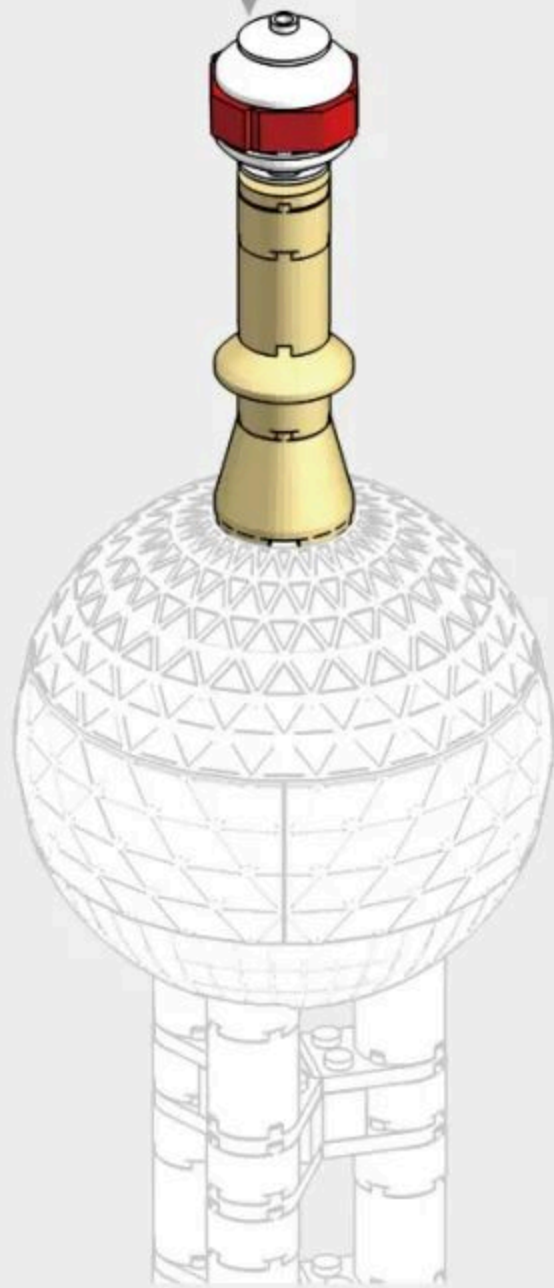
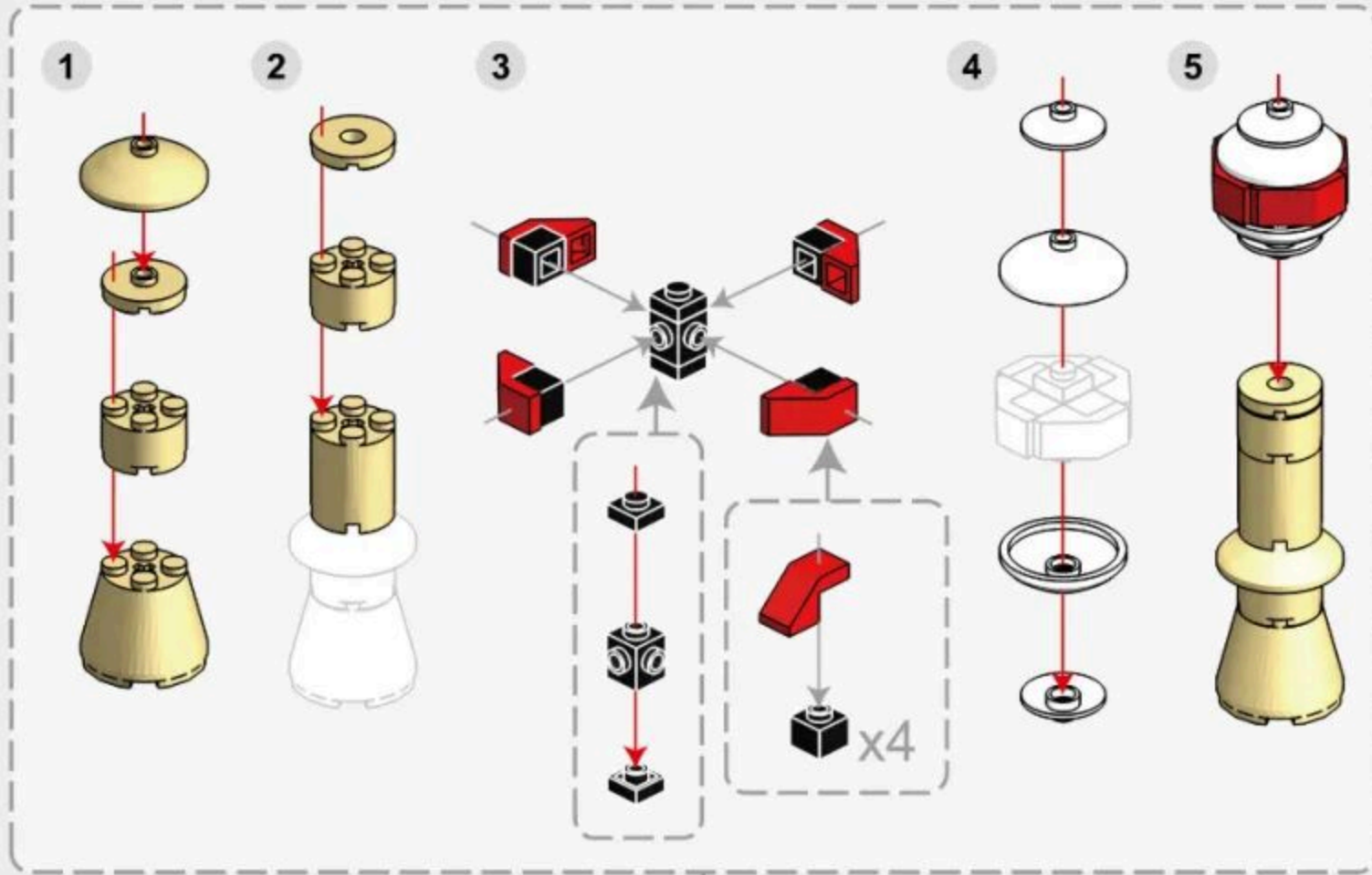

3-2

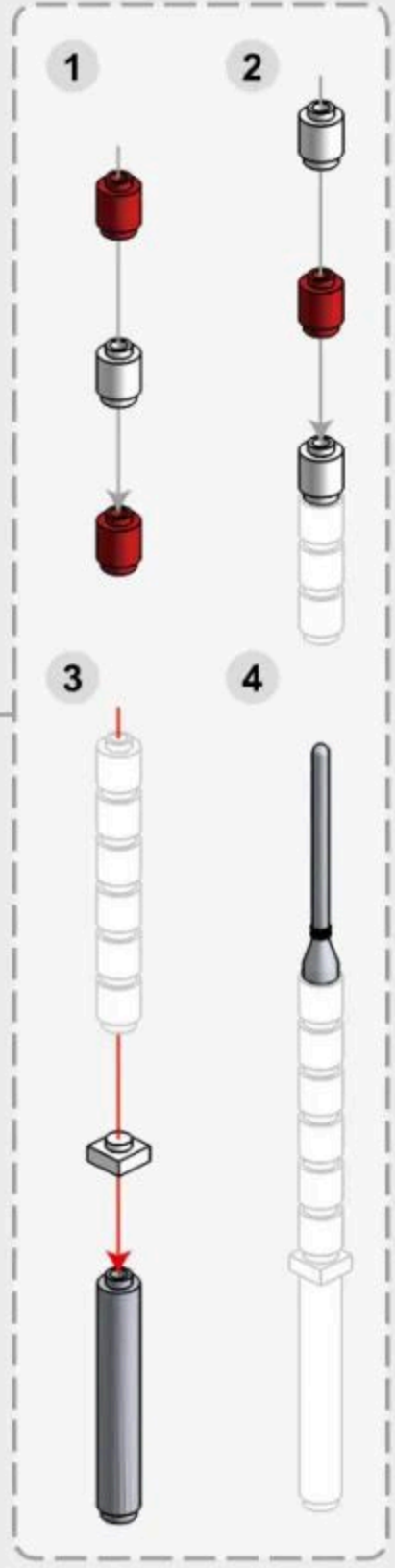
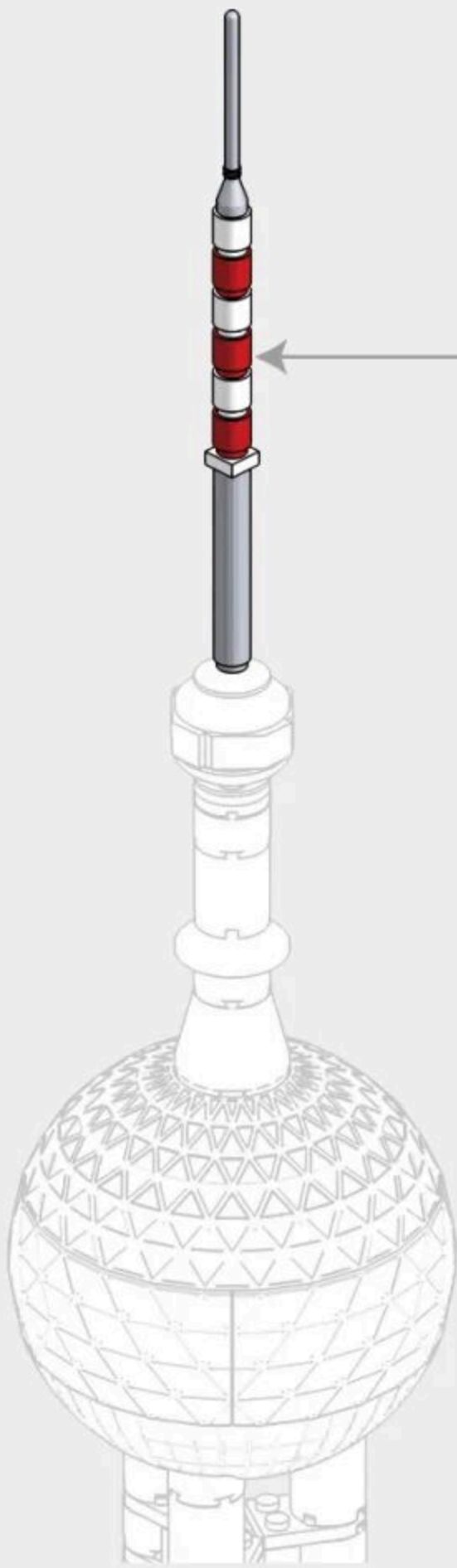
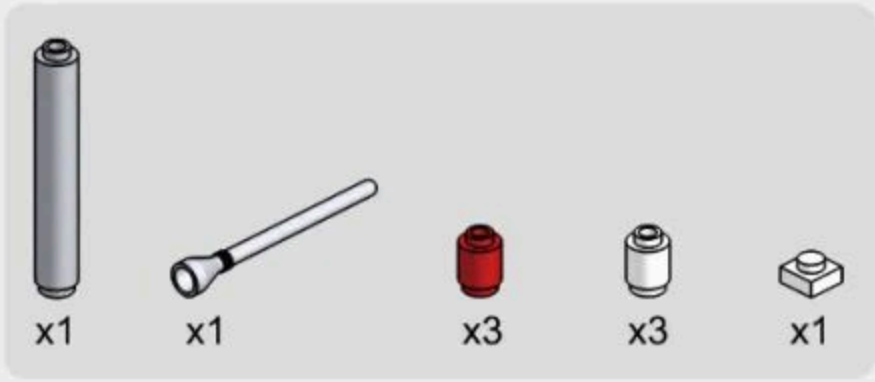

3-3

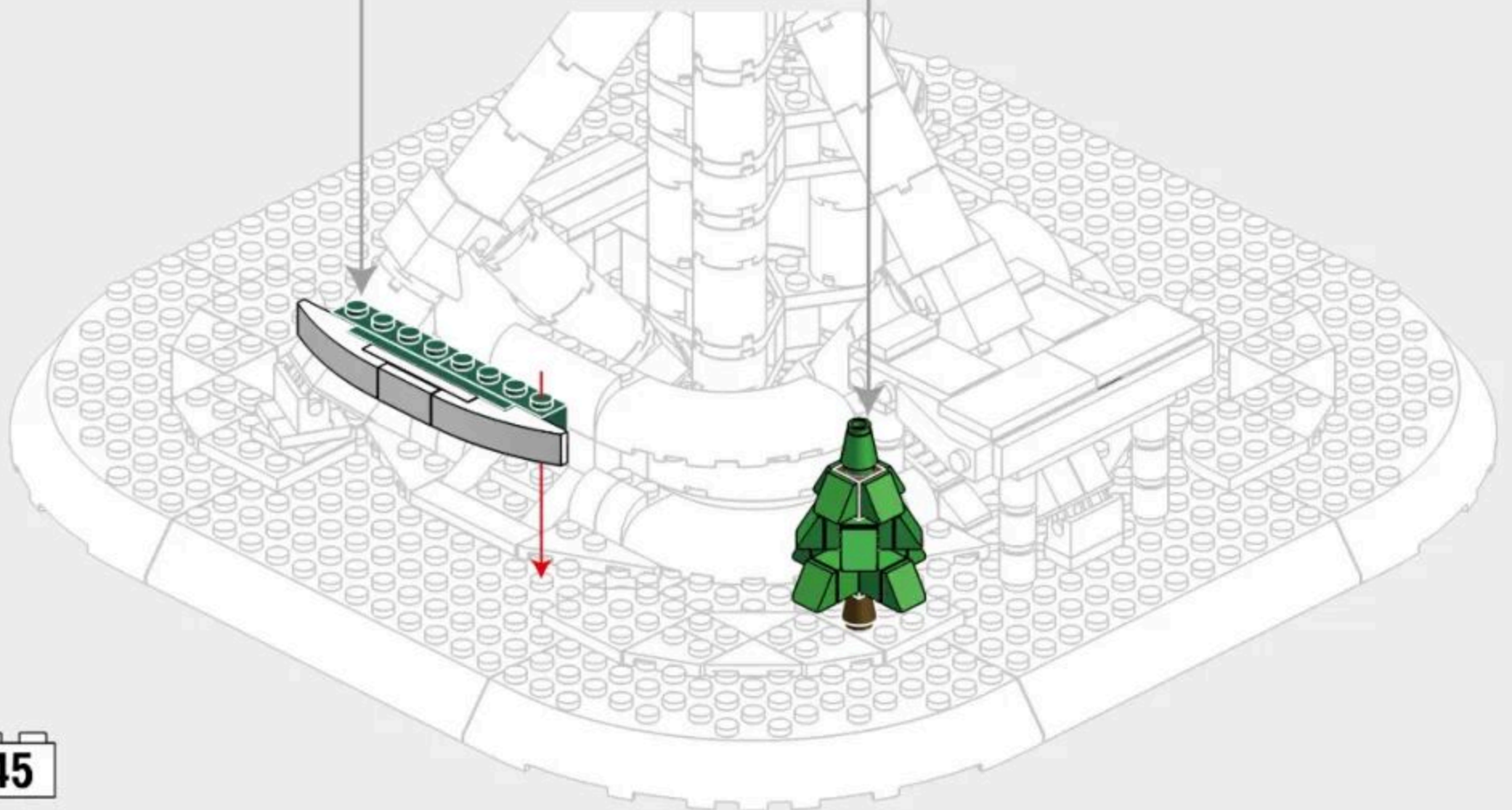
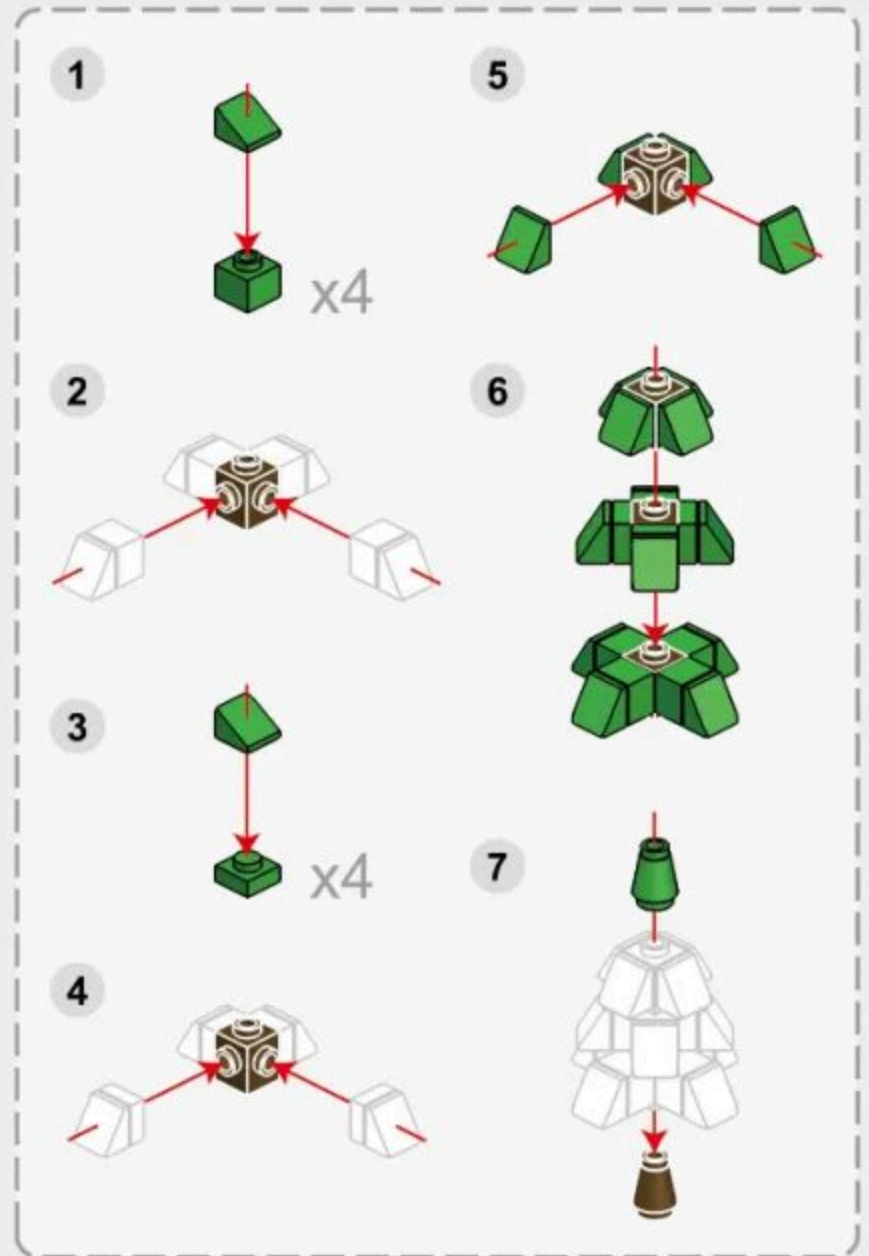
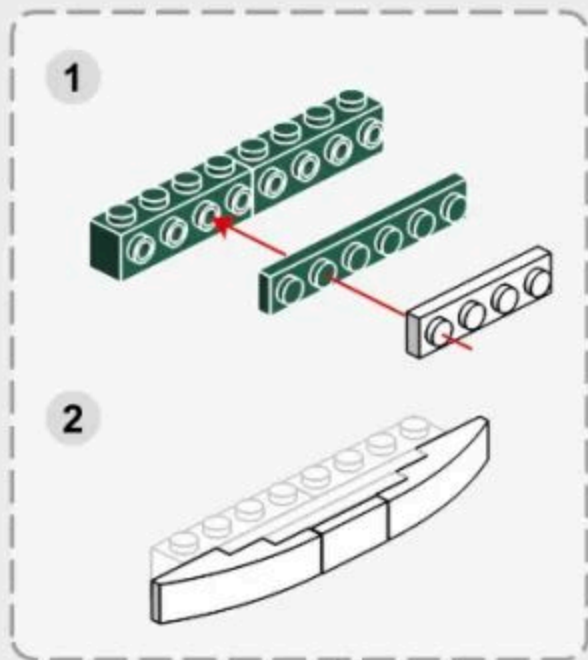

3-4

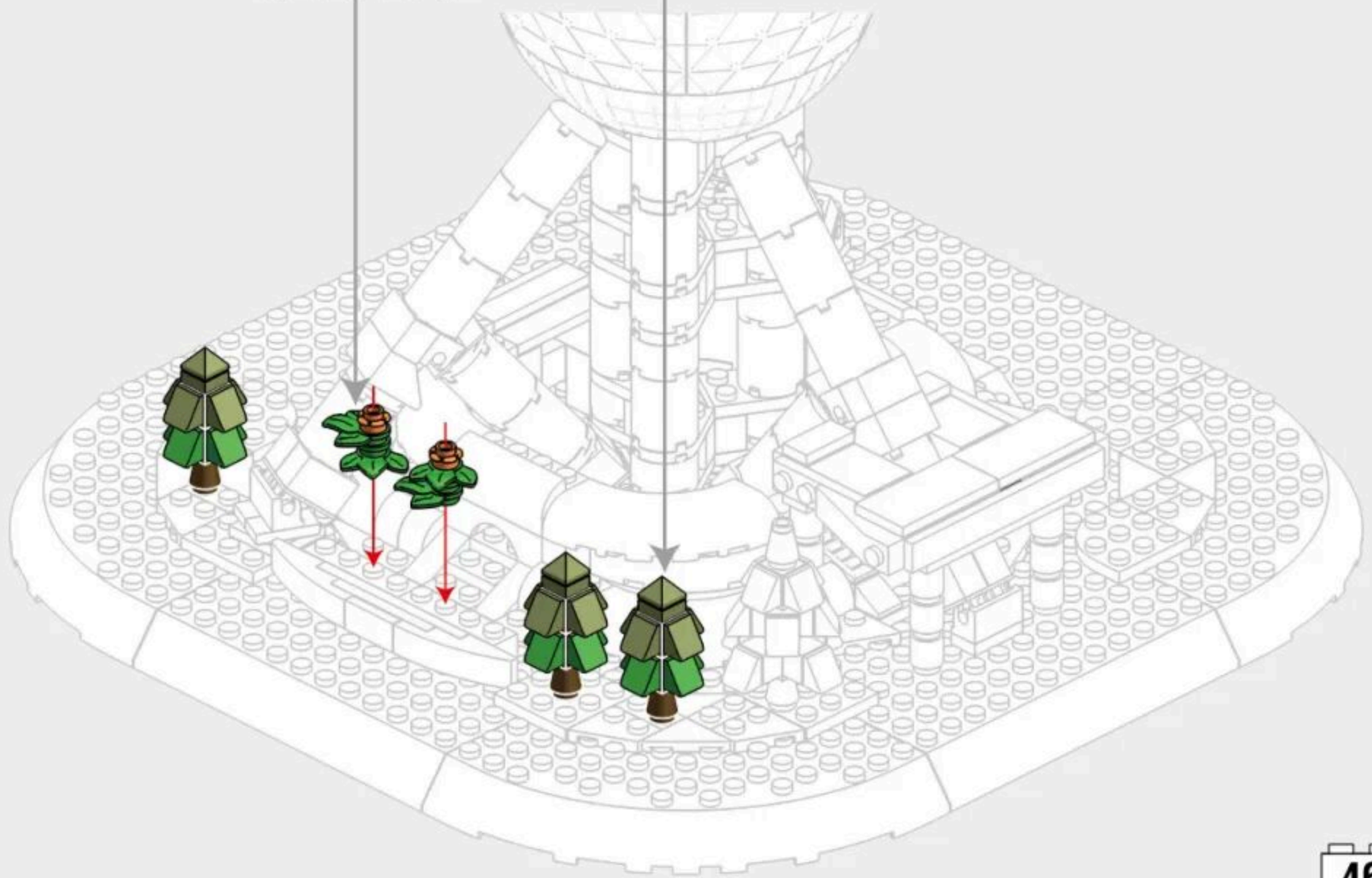
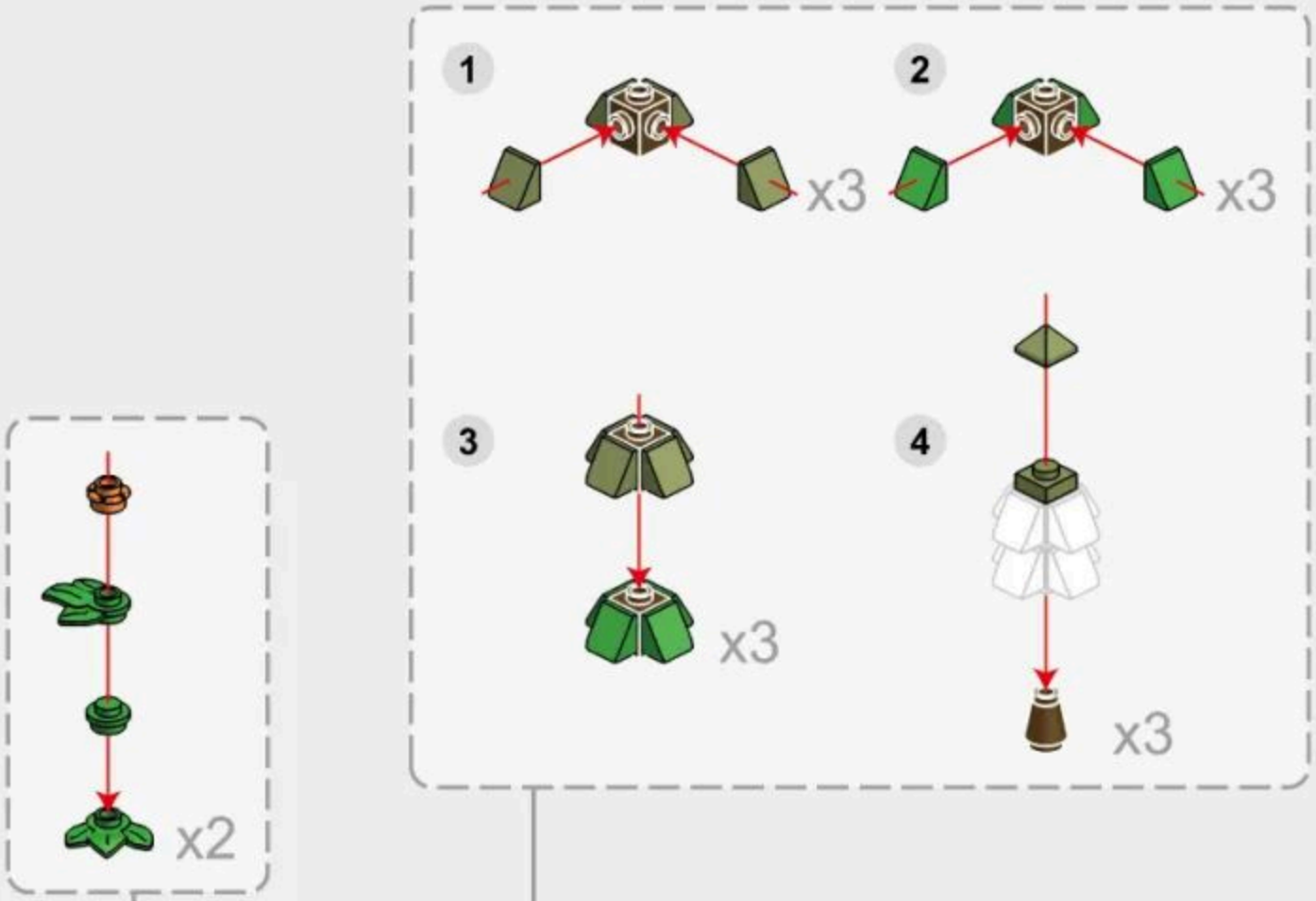

3-5

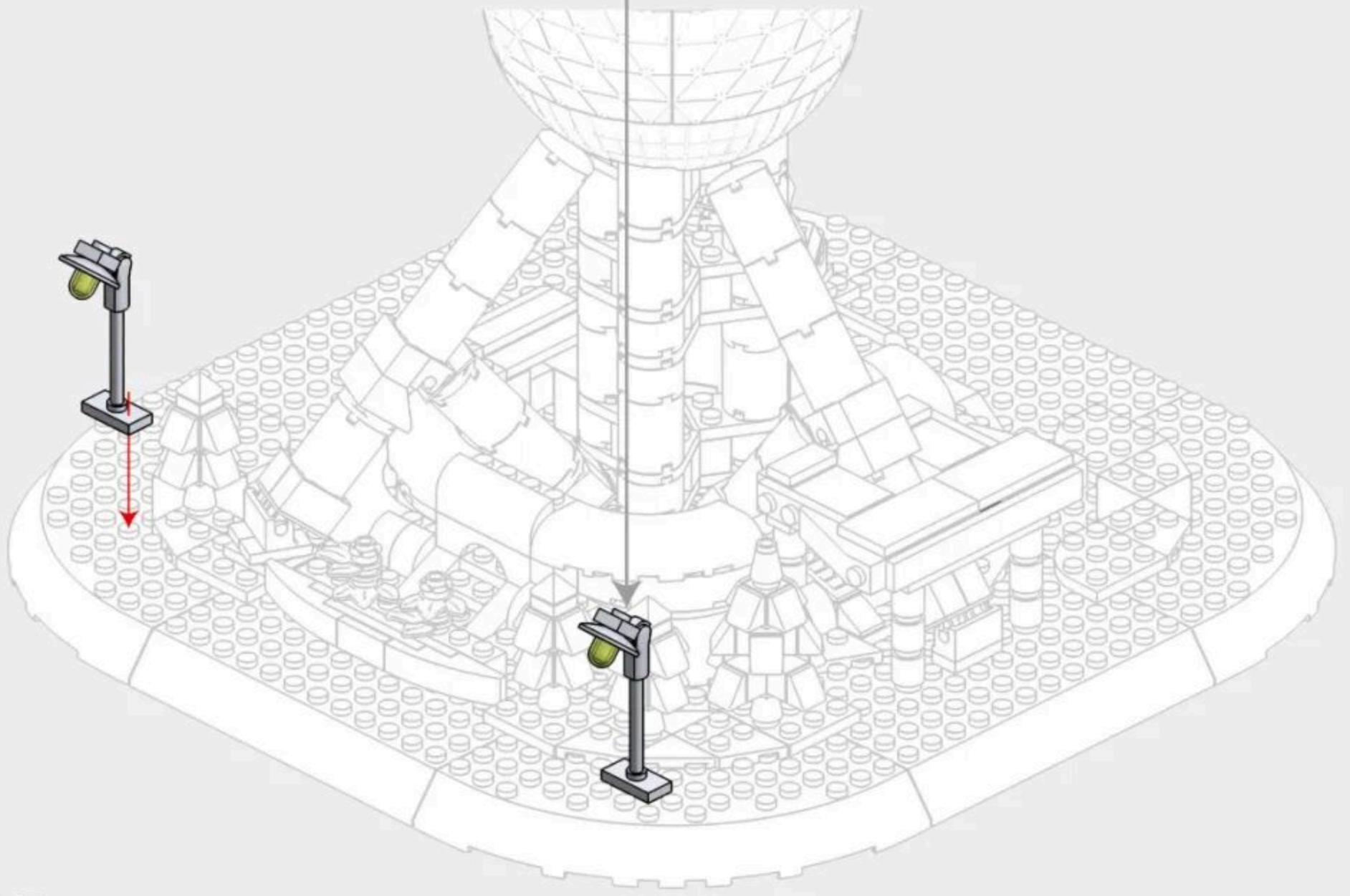
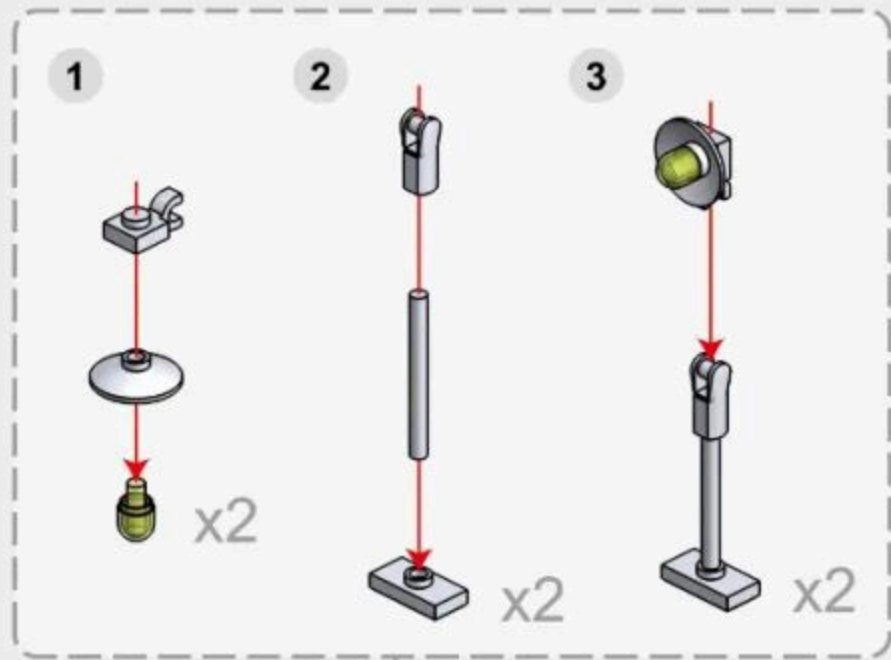

3-6

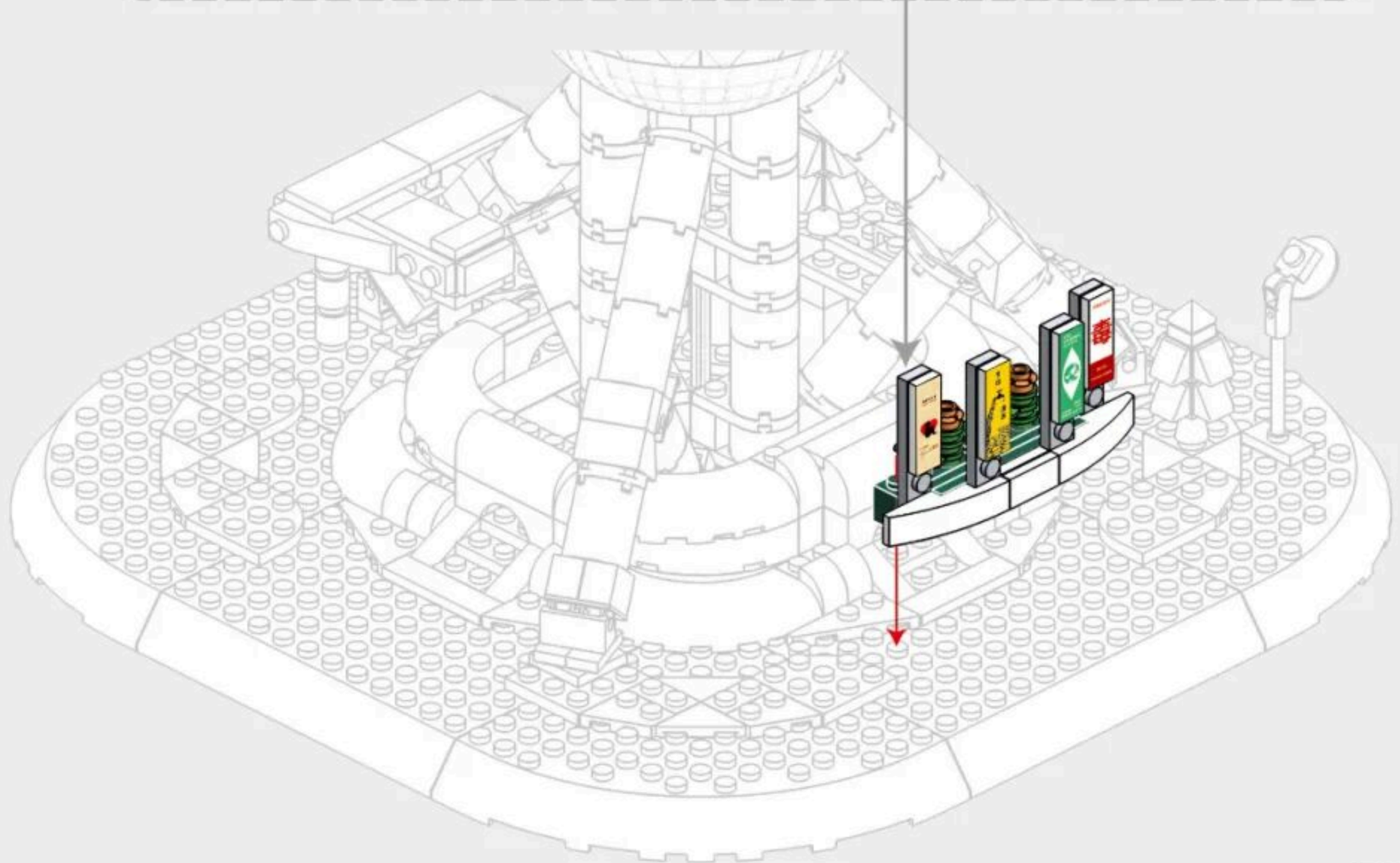
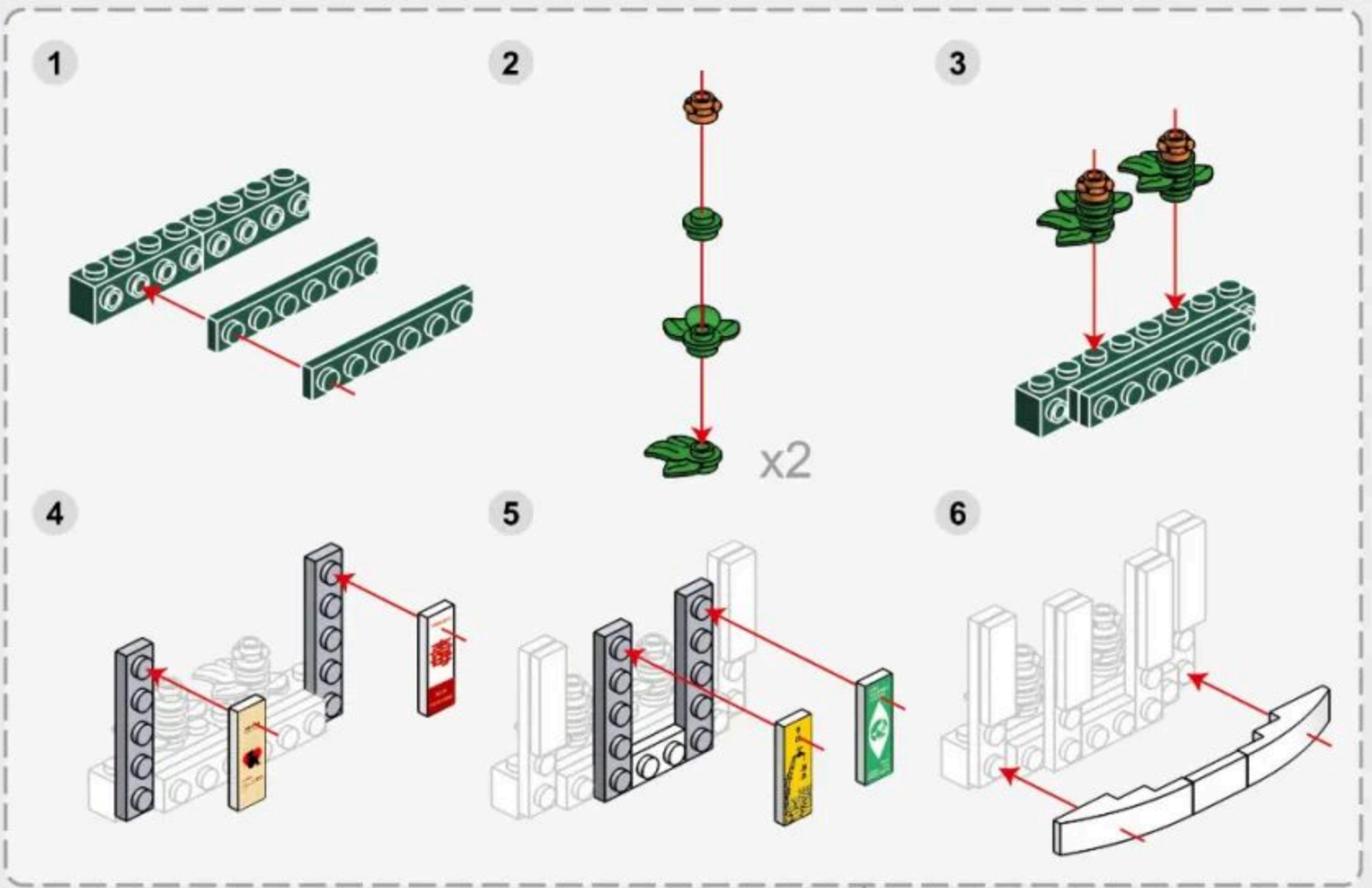
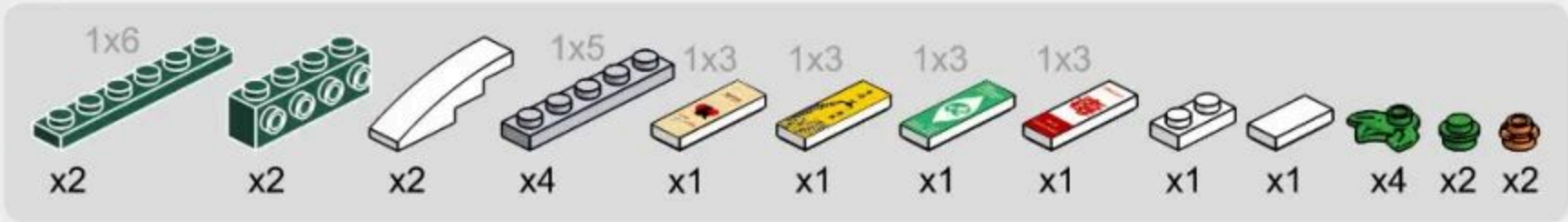

3-7

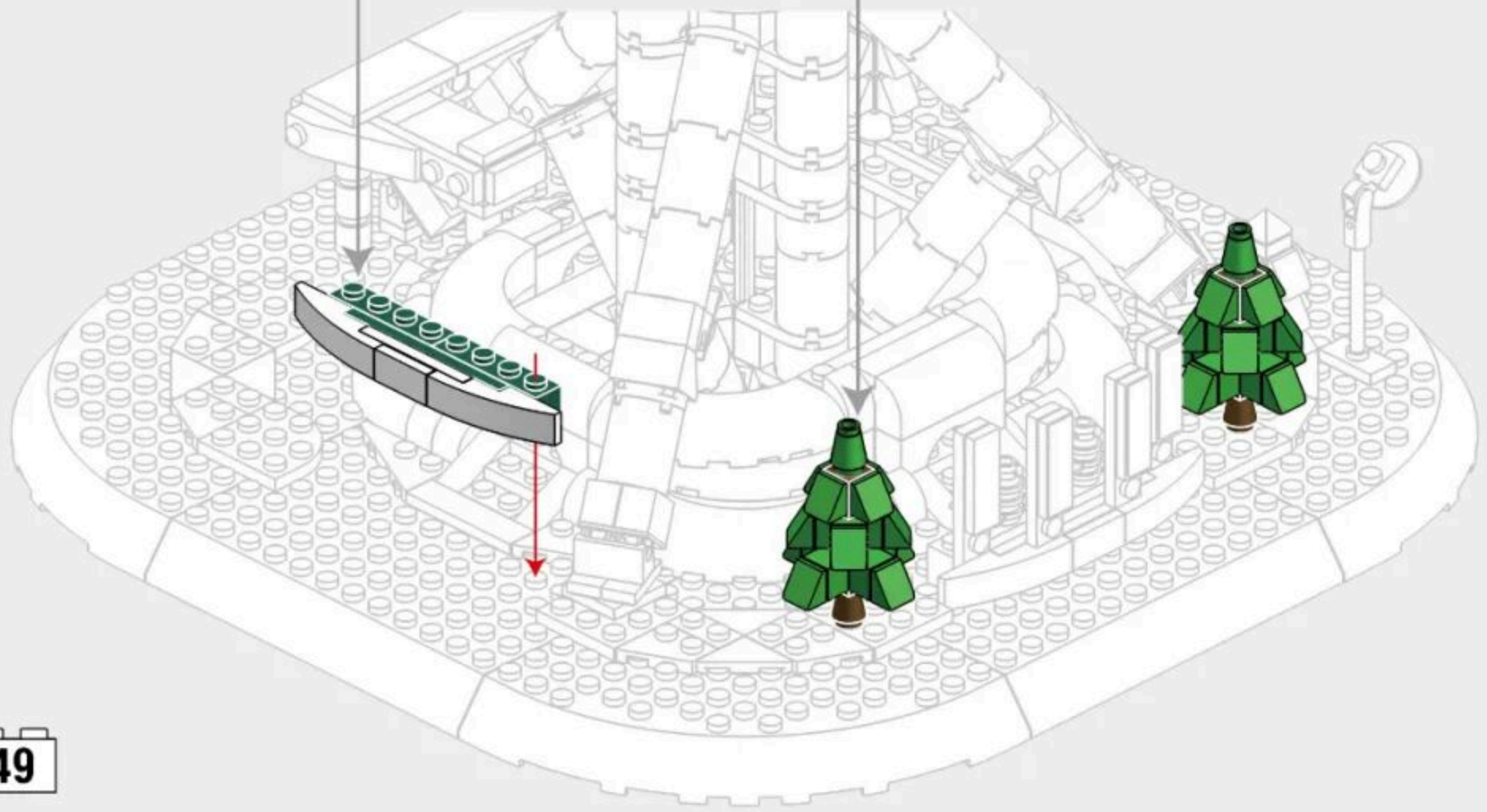
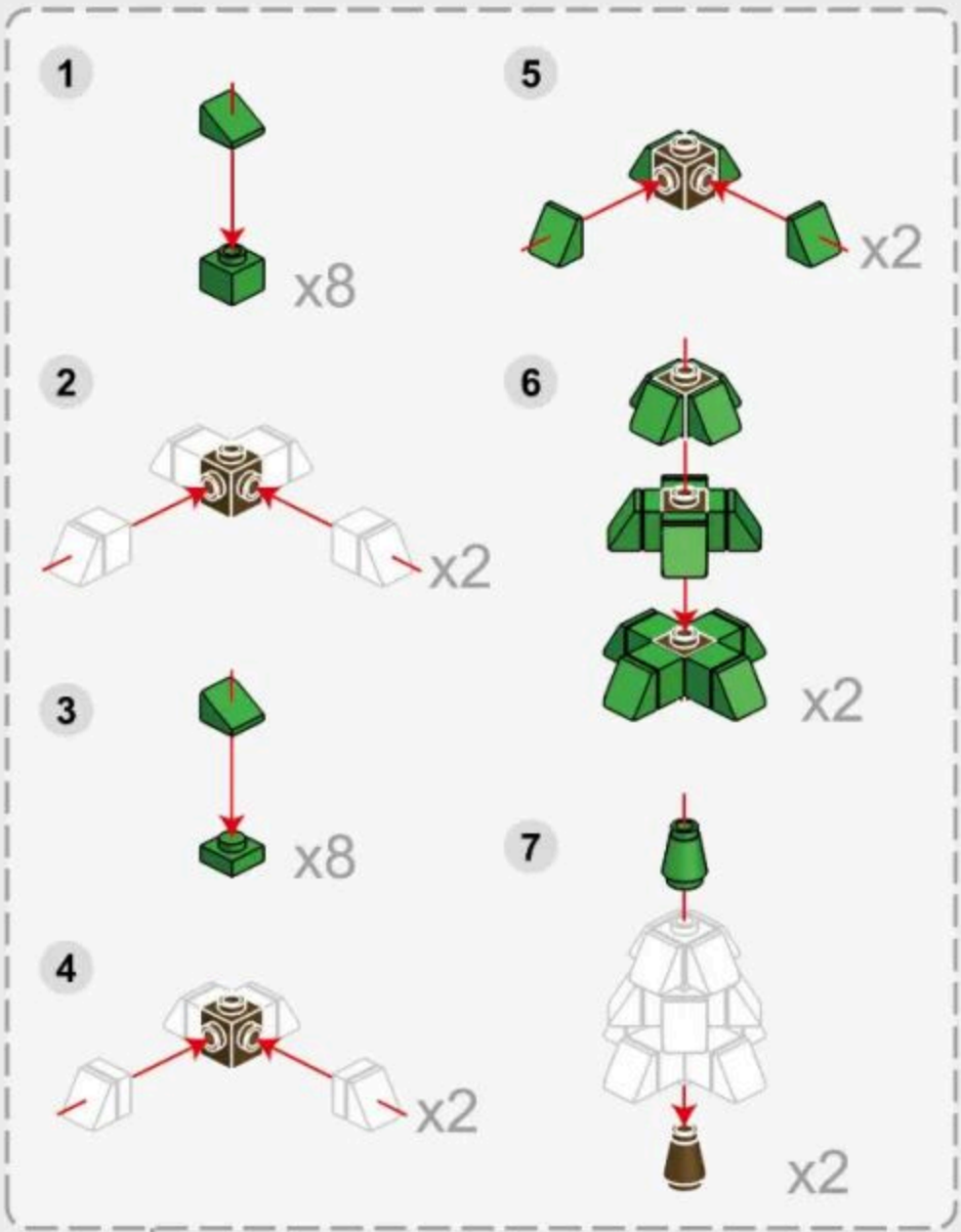
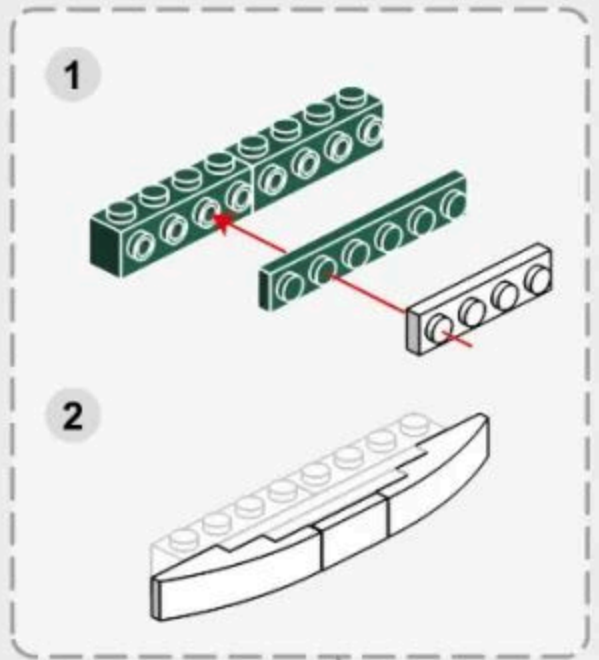

3-8

-  x6
-  x3
-  x3
-  x12
-  x12
-  x4
-  x3
-  x3
-  x2
-  x2

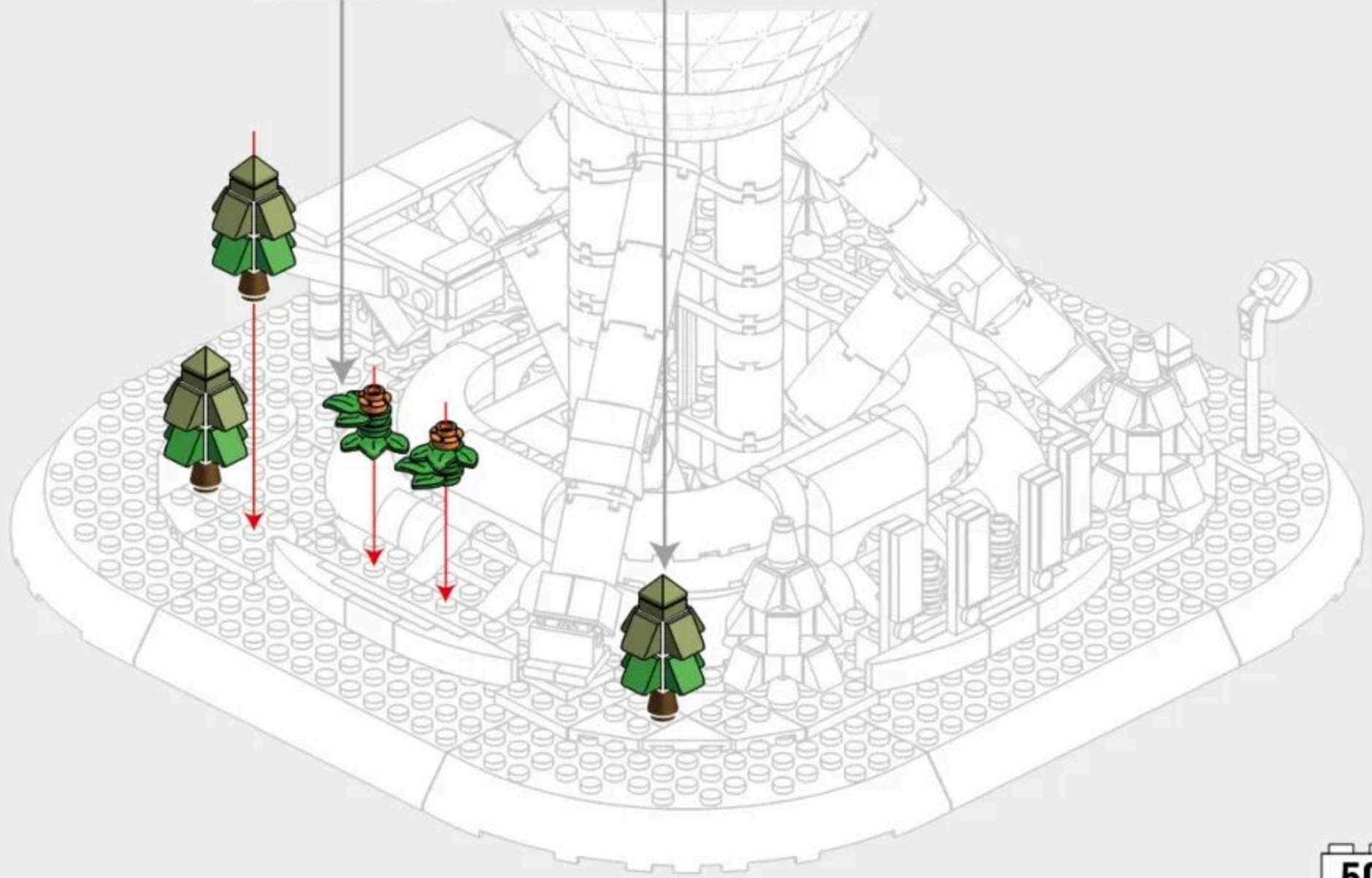
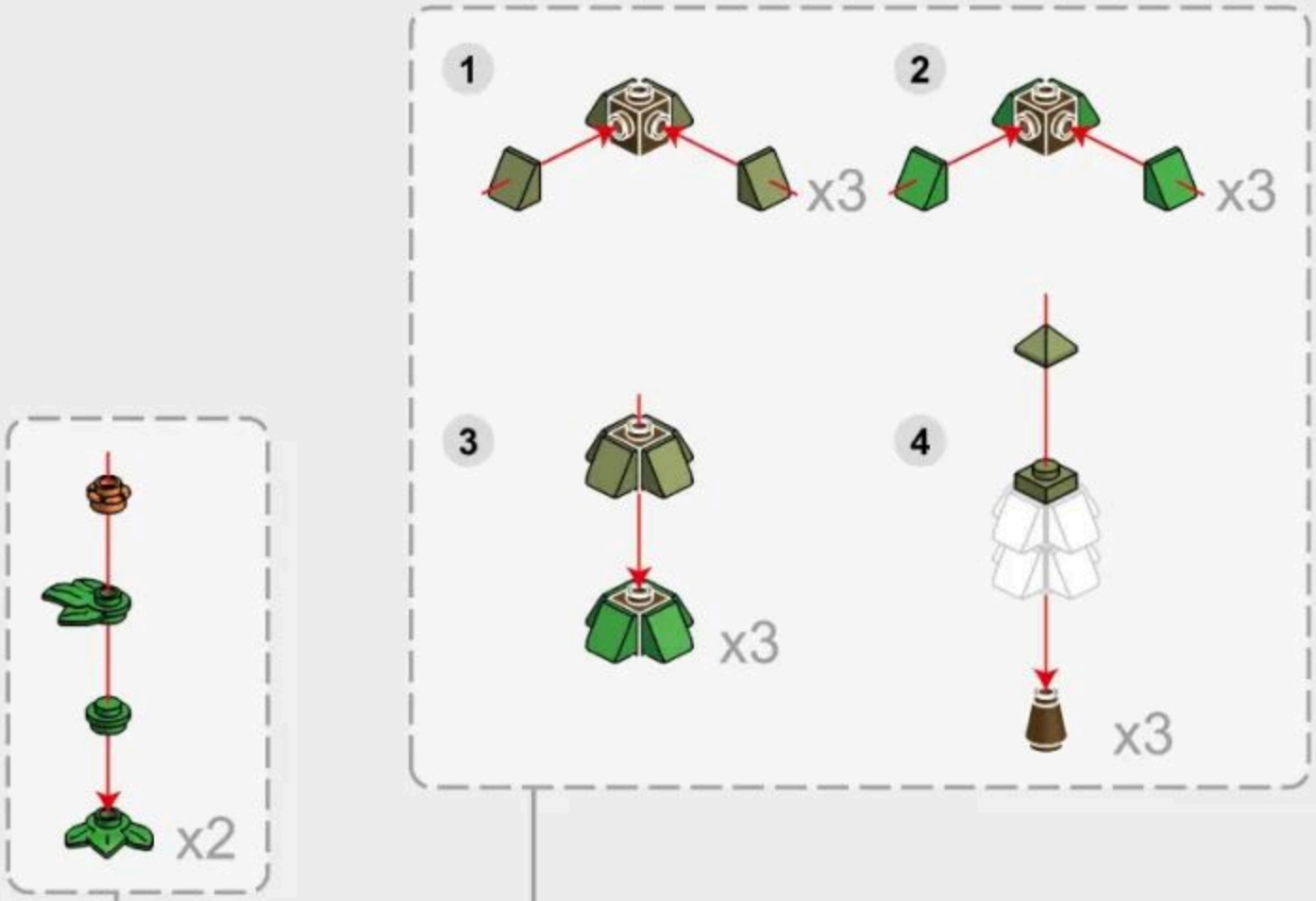

3-9

- 4 x2
- x2
- x2
- x2
- x2
- x2

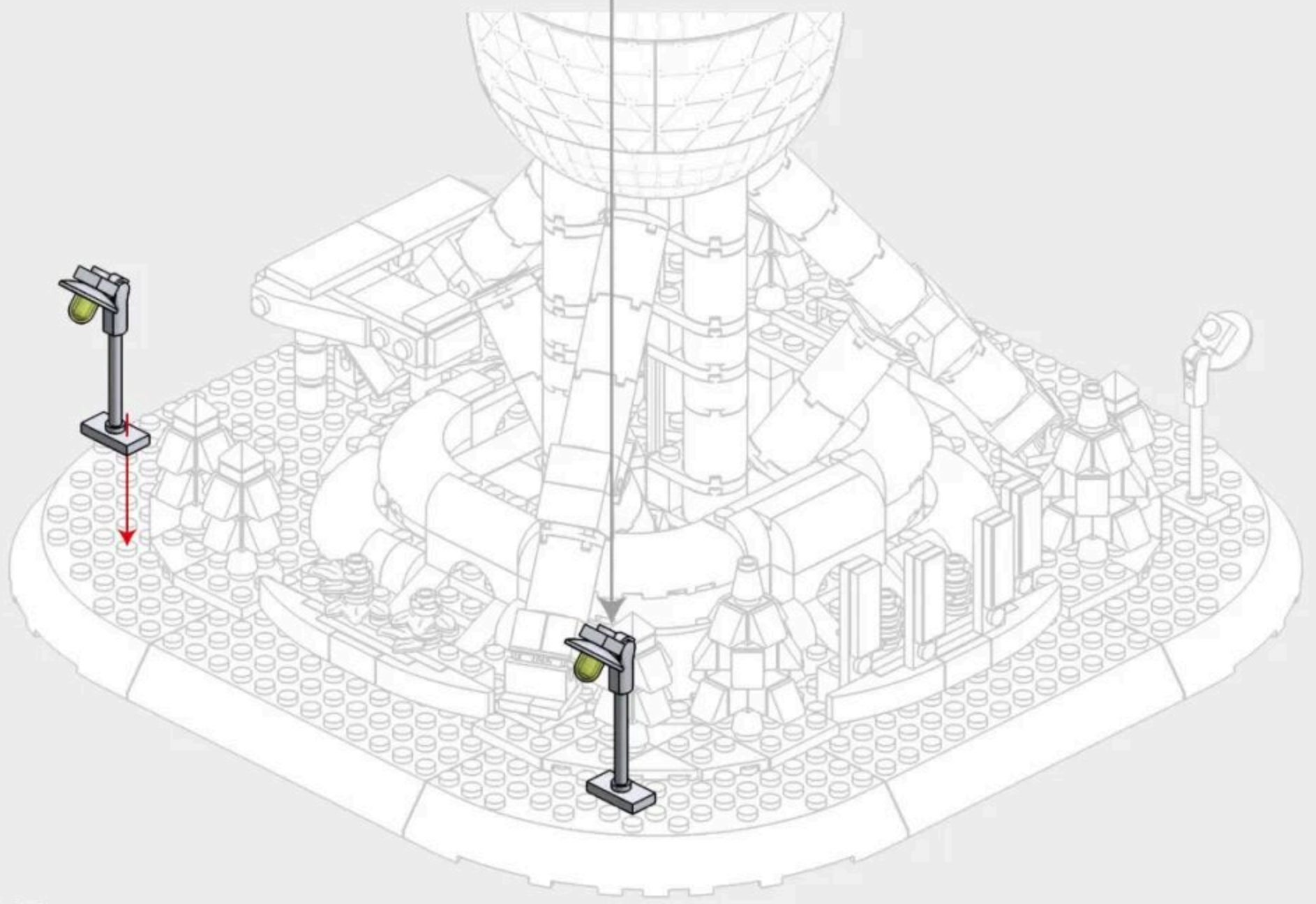
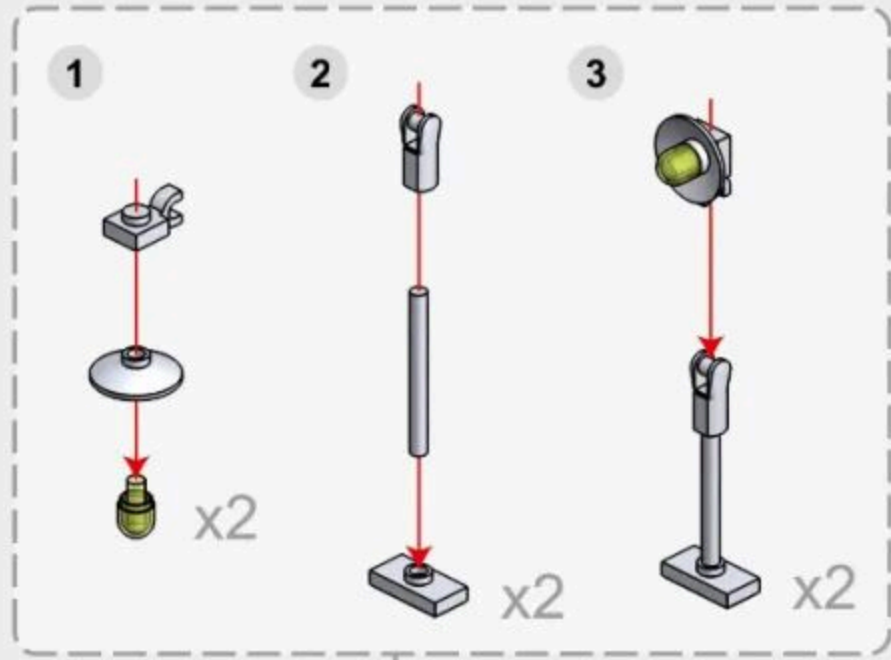

3-10

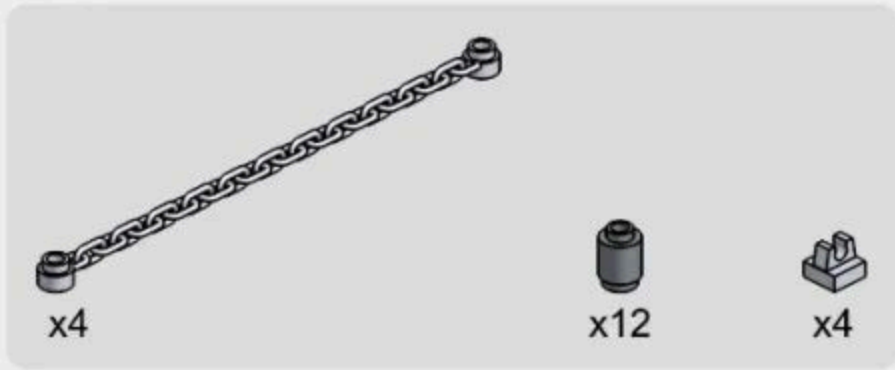

Vertical View of Installation Drawing
安装图顶面

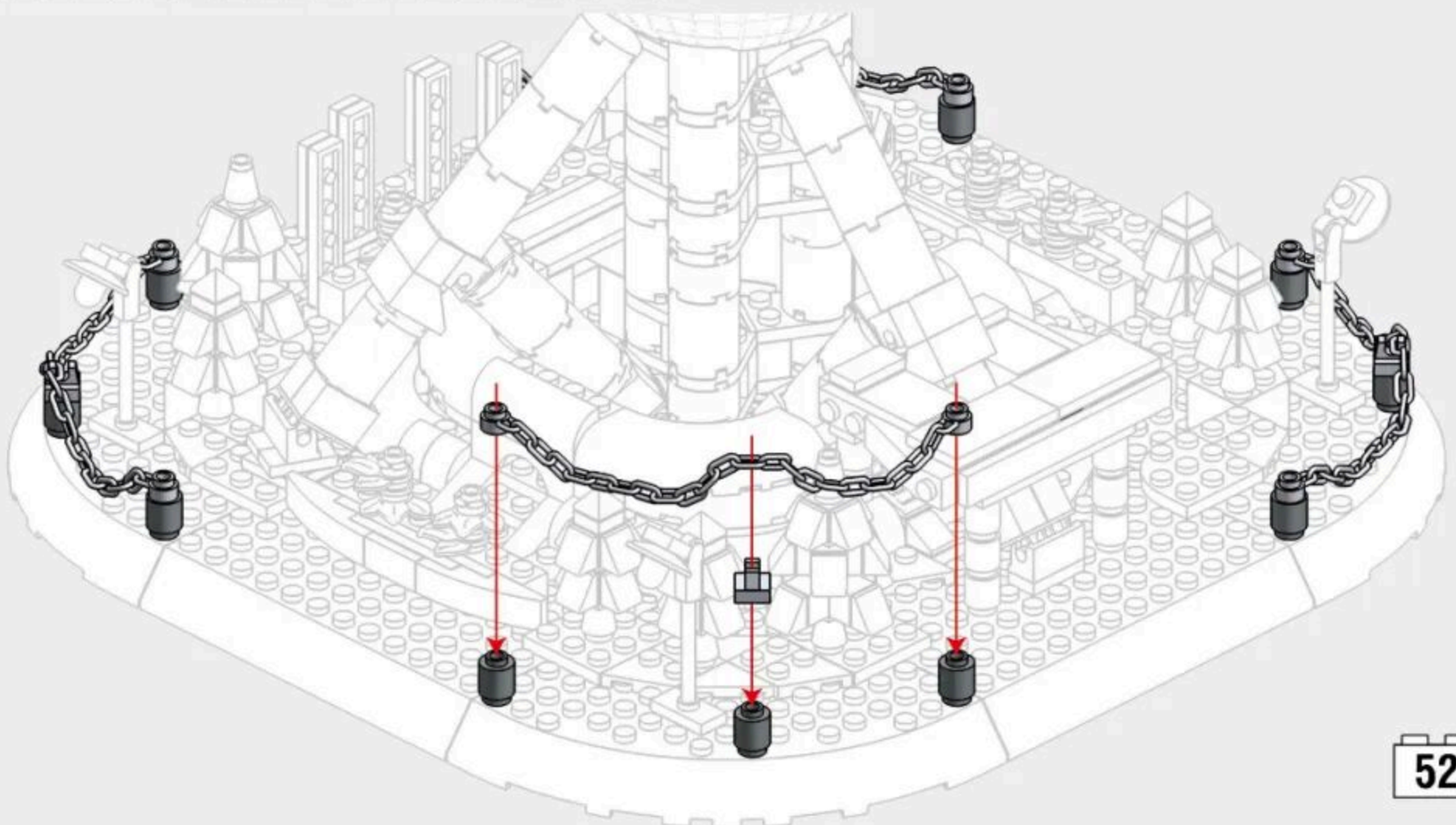

3-11

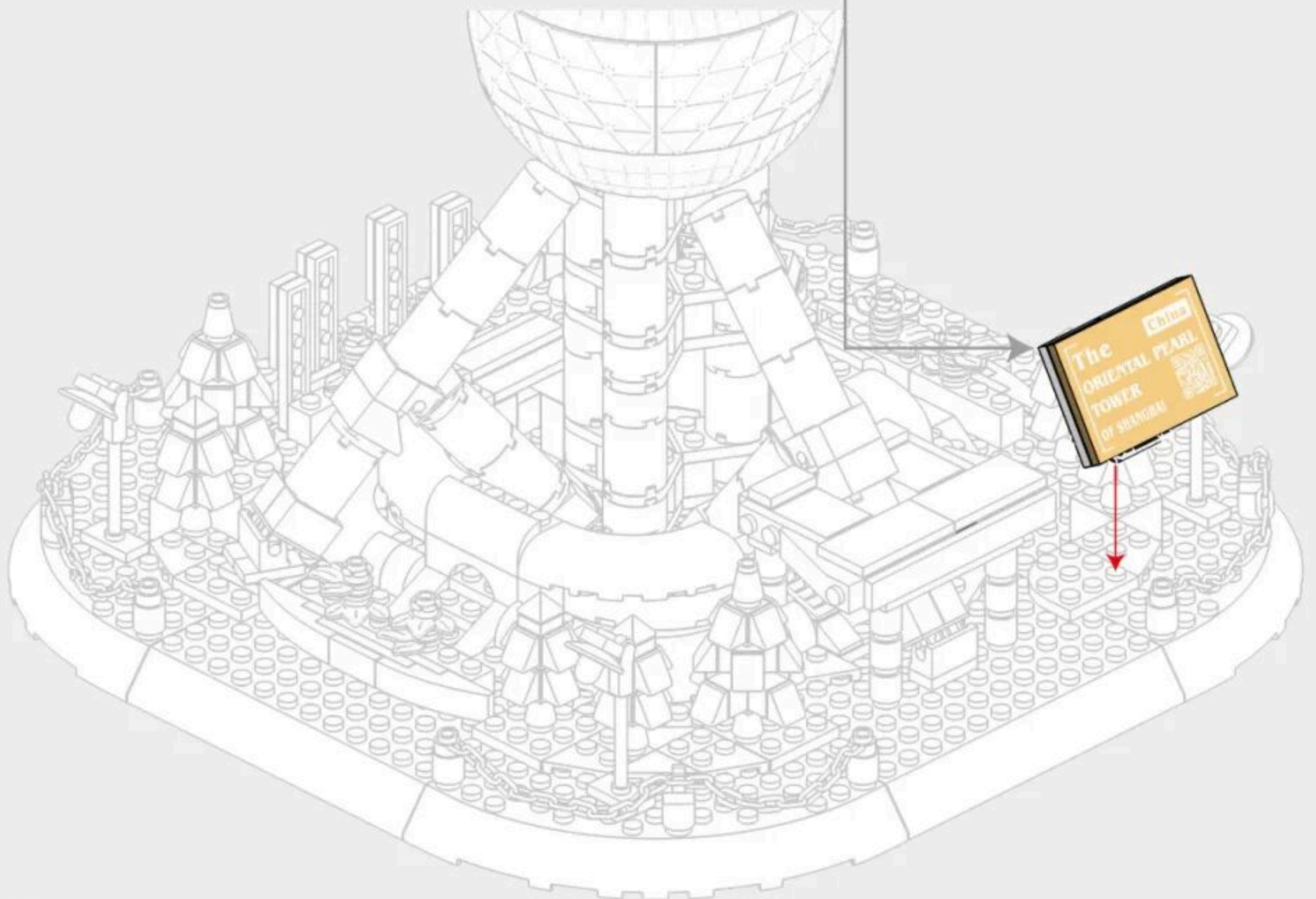
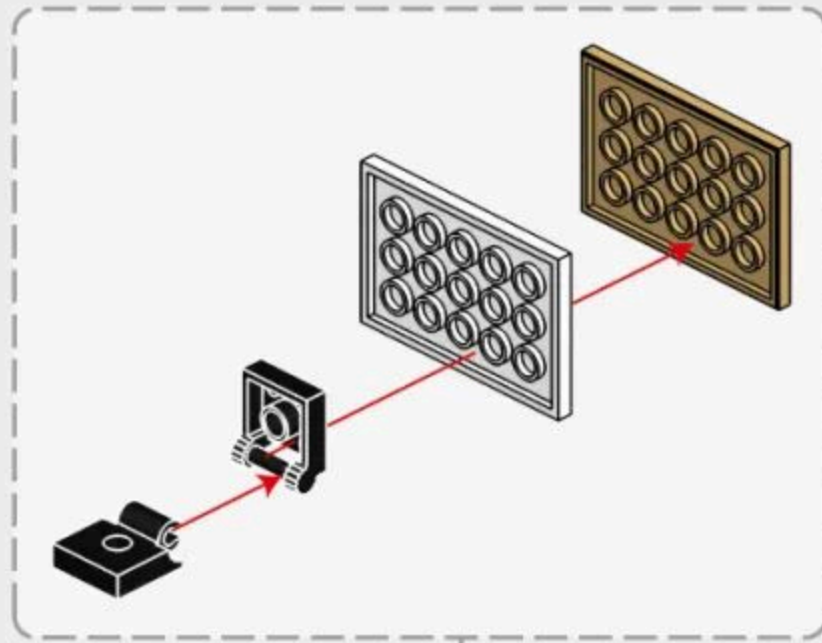
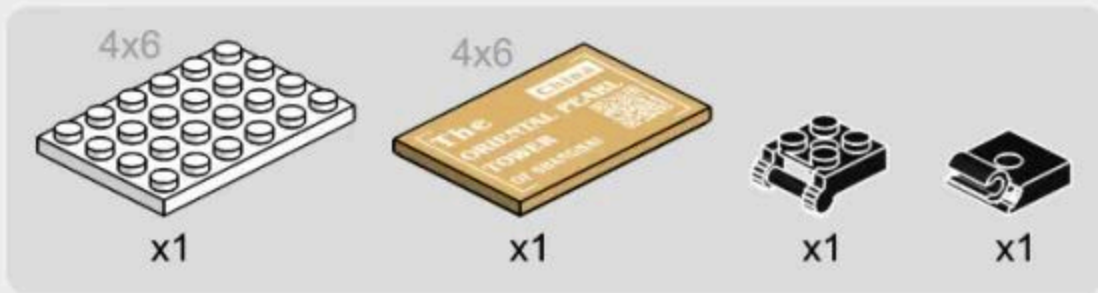

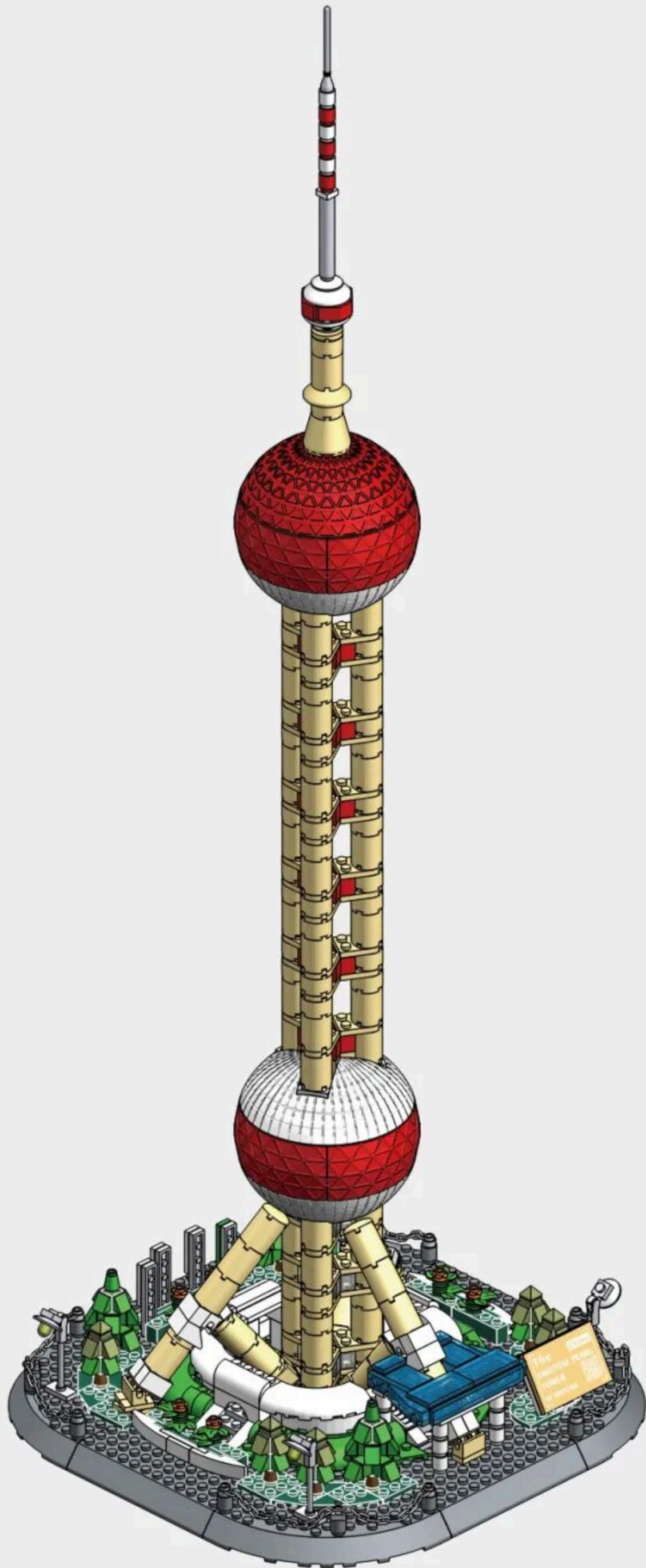

ARCHITECTURE

The World's great architecture

- Shaping Skills
- Imagination & Curiosity
- Mathematical
- Self Discovery & Perception
- Parent-Child Interaction
- Problem Solving
- Creativity



6224 英国伦敦白金汉宫
BUCKINGHAM PALACE-LONDON,ENGLAND



5225 意大利罗马斗兽场
COLOSSEUM-ROME,ITALY



5226 日本东京帝国饭店
IMPERIAL HOTEL-TOKYO,JAPAN



5227 美国纽约自由女神像
STATUE OF LIBERTY-NEW YORK,AMERICA



6211 德国柏林勃兰登堡门
BRANDENBURG GATE-BERLIN, GERMANY



6222 中国甘肃长城-嘉峪关
JIAYU PASS-GANSU,CHINA



6212 日本京都清水寺仁王门
NOMON GATE OF KIYOMIZU-DERA-KYOTO,JAPAN



6213 俄罗斯莫斯科瓦西里大教堂
SAINT BASIL'S CATHEDRAL-MOSCOW,RUSSIA



6214 中国武汉黄鹤楼
YELLOW CRANE TOWER-WUHAN,CHINA



6215 英国伦敦眼
LONDON EYE-LONDON,ENGLAND



6221 中国北京故宫-太和殿
HALL OF SUPREME HARMONY-BEIJING,CHINA



6220 沙特阿拉伯麦加大清真寺
GREAT MOSQUE OF MECCA,SAUDI ARABIA



6219 美国纽约联合国大厦
UNITED NATIONS HEADQUARTERS-NEW YORK,AMERICA



4214 美国华盛顿白宫
WHITE HOUSE-WASHINGTON D.C.,AMERICA



4212 意大利罗马许愿池
TREVI FOUNTAIN-ROME,ITALY



4213 法国巴黎卢浮宫
MUSÉE DU LOUVRE-PARIS,FRANCE

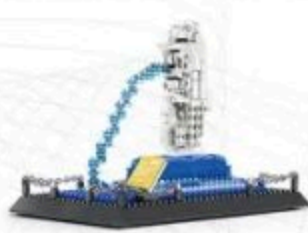

4218 新加坡-鱼尾狮
MERLION,SINGAPORE



4219 英国伦敦双子塔桥
TOWER BRIDGE-LONDON,ENGLAND



4216 美国华盛顿林肯纪念堂
LINCOLN MEMORIAL-WASHINGTON D.C.,AMERICA



4217 新加坡-金沙酒店
MARINA BAY SANDS,SINGAPORE



4210 埃及开罗吉萨金字塔
GREAT PYRAMID OF GIZA-CAIRO,EGYPT



4221 加拿大渥太华国会山庄
PARLIAMENT BUILDINGS-OTTAWA,CANADA



4211 英国伦敦伊丽莎白塔
ELIZABETH TOWER-ENGLAND



4215 加拿大多伦多电视塔
THE CN TOWER-CANADA



4220 美国纽约熨斗大厦
FLATIRON BUILDING-NEW YORK,AMERICA



4222 阿联酋迪拜哈利法塔 THE BURJ KHALIFA TOWER-DUBAI, UAE
 5224 中国上海东方明珠广播电视塔 ORIENTAL PEARL TOWER-SHANGHAI, CHINA
 5212 美国纽约帝国大厦 EMPIRE STATE BUILDING-NEW YORK, AMERICA
 5213 马来西亚吉隆坡石油双塔 PETRONAS TWIN TOWERS-KUALA LUMPUR, MALAYSIA
 5214 意大利托斯卡纳比萨斜塔 LEANING TOWER OF PISA-TUSCANY, ITALY
 5216 英国伦敦伊丽莎白塔 ELIZABETH TOWER-LONDON, ENGLAND



5219 俄罗斯莫斯科克里姆林宫钟楼 SPASSKAYA TOWER-MOSCOW, RUSSIA
 5220 阿联酋迪拜卓美亚帆船酒店 BURJ AL ARAB HOTEL-DUBAI, UAE
 5217 法国巴黎埃菲尔铁塔 EIFFEL TOWER-PARIS, FRANCE
 5221 中国台北101大楼 TAIPEI 101-TAIPEI, CHINA
 5228 美国芝加哥威利斯大厦 WILLIS TOWER-CHICAGO, AMERICA
 5231 巴西里约热内卢救世基督像 CRISTO REDENTOR-RIO DE JANEIRO, BRASIL



6223 中国武汉长江大桥 WUHAN YANGTZE RIVER BRIDGE
 5210 法国巴黎圣母院大教堂 CATHEDRALE NOTRE DAME DE PARIS-PARIS, FRANCE
 5211 印度阿格拉泰姬陵 TAJ MAHAL-AGRA, INDIA
 5223 法国巴黎凯旋门 ARC DE TRIOMPHE-PARIS, FRANCE
 5215 英国伦敦双子塔桥 TOWER BRIDGE-LONDON, ENGLAND



5222 中国北京天坛祈年殿 HALL OF PRAYER FOR GOOD HARVESTS-BEIJING, CHINA
 6210 美国旧金山金门大桥 GOLDEN GATE BRIDGE-SAN FRANCISCO, AMERICA
 6216 中国北京万里长城(八达岭) THE GREAT WALL-BEIJING, CHINA
 5218 中国北京天安门 TIANANMEN TOWER-BEIJING, CHINA
 6217 中国西藏布达拉宫 POTALA PALACE-TIBET, CHINA



6218 芬兰罗瓦涅米圣诞老人办公室 SANTA CLAUS OFFICE-ROVANIEMI, FINLAND
 6225 墨西哥库库尔坎玛雅金字塔 EL CASTILLO-KUKULKAN, MEXICO
 6226 德国巴伐利亚新天鹅堡 SCHLOSS NEUSCHWANSTEIN-BAYERN, DEUTSCHLAND
 5229 土耳其伊斯坦布尔少女塔 MAIDEN TOWER-ISTANBUL, TURKEY
 5230 中国湖南长沙爱晚亭 AIWANTING PAVILION-HUNAN, CHINA



7210 中国上海世博会中国馆
CHINA PAVILION AT EXPO-SHANGHAI, CHINA



5232 美国宾夕法尼亚州流水别墅
FALLINGWATER-PENNSYLVANIA, AMERICA



5233 美国芝加哥范斯沃斯住宅
FARNSWORTH HOUSE-CHICAGO, AMERICA



5234 美国华盛顿唐人街
CHINA TOWN-WASHINGTON, D.C., AMERICA



3210 美国纽约自由女神像
STATUE OF LIBERTY-NEW YORK, AMERICA



4223 中国北京清华园
TSINGHUA CAMPUS-BEIJING, CHINA



7211 中国湖南岳阳楼
YUEYANG TOWER-HUNAN, CHINA



8210 澳大利亚悉尼歌剧院
SYDNEY OPERA HOUSE-BENNELONG POINT, AUSTRALIA



7212 中国江西南昌滕王阁
PAVILION OF PRINCE TENG-JIANGXI, CHINA



6227 中国河南郑州嵩山少林寺
SHAOLIN TEMPLE-HENAN, CHINA



7213 中国重庆洪崖洞
HONGYADONG-CHONGQING, CHINA



5235 美国华盛顿国会大厦
UNITED STATES CAPITOL-WASHINGTON, D.C., AMERICA



5236 中国安徽滁州醉翁亭
ZUTONG PAVILION-ANHUI, CHINA



6228 中国陕西西安钟楼
XI'AN BELL TOWER-SHAANXI, CHINA



5238 美国西雅图太空针塔
SPACE NEEDLE-SEATTLE, AMERICA



5237 法国巴黎萨伏伊别墅
VILLA SAVOYE-PARIS, FRANCE



6229 中国山西运城鹳雀楼
STORK TOWER-SHANXI, CHINA



6230 希腊爱情海圣托里尼岛
SANTORINI-FIRA, GREECE



6231 中国上海海关大楼
SHANGHAI CUSTOMS HOUSE-SHANGHAI, CHINA



5239 中国北京紫禁城角楼
TURRET OF PALACE MUSEUM-BEIJING, CHINA



5240 韩国首尔崇礼门
NAMDAEMUN-SEOUL, KOREA



5241 中国江苏南京夫子庙
CONFUCIUS TEMPLE-JIANGSU, CHINA



5242 美国纽约古根海姆博物馆
GUGGENHEIM MUSEUM-NEW YORK, AMERICA



6232 中国江苏南京秦淮河画舫
QINHUAI RIVER PAINTED BOAT-JIANGSU, CHINA



6233 法国诺曼底圣米歇尔山
SAINT MICHAEL'S MOUNT-NORMANDY, FRANCE



6234 中国河南洛阳栾川老君山
THE LAOJUN MOUNTAIN-HENAN, CHINA



5243 耶路撒冷岩石圆顶
DOME OF THE ROCK-JERUSALEM



6235 中国江苏苏州寒山寺 (普明宝塔)
HANSHAN TEMPLE-JIANGSU, CHINA



4224 英国威尔特郡巨石阵
STONEHENGE-WILTSHIRE, ENGLAND



4225 中国内蒙古自治区蒙古包
MONGOLIAN YURT-INNER MONGOLIA, CHINA



8211 中国福建土楼(承启楼)
CHENGQI EARTH BUILDING-FUJIAN, CHINA



4226 沙特阿拉伯麦加大清真寺(克尔白)
KERBAL, GREAT MOSQUE OF MECCA, SAUDI ARABIA



5244 俄罗斯冬宫
WINTER PALACE-ST.PETERSBURG, RUSSIA



7214 中国陕西西安鼓楼
XI'AN DRUM TOWER-SHAANXI, CHINA





THE ORIENTAL PEARL TOWER

COUNTRY: China
CITY: Shanghai



Ver.522420240415