

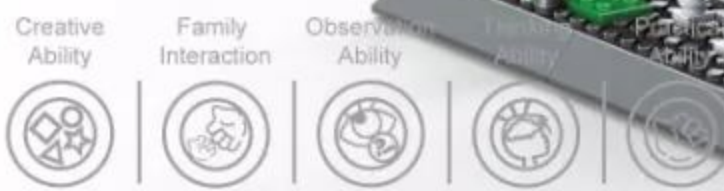

THE ORIENTAL PEARL TOWER OF SHANGHAI

China
The world's great architecture

Ages
6+



NO.5224
1109 PCS

1 10 X 12 10 X 10 1 X 10

x4 x4 x2 x32

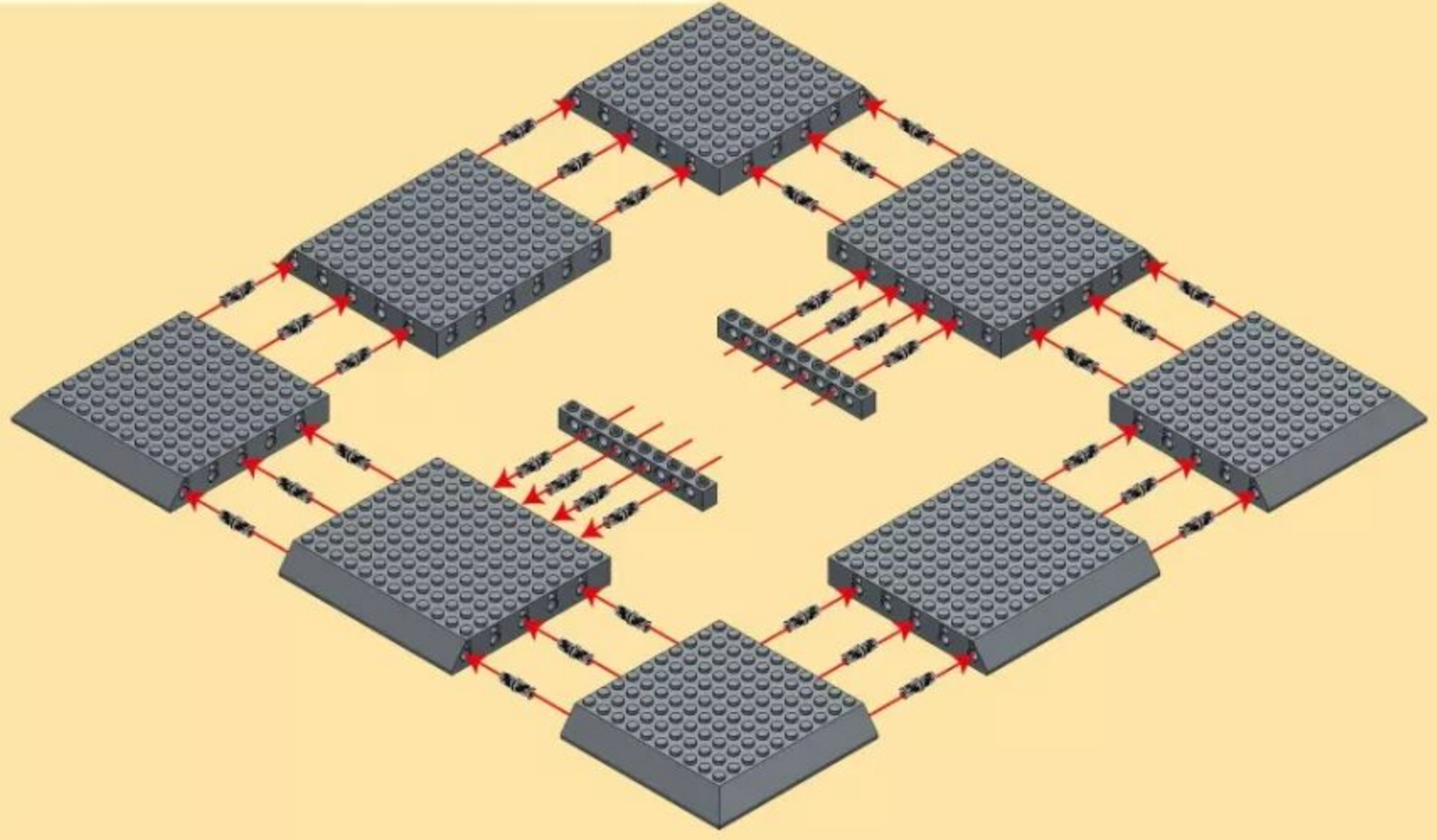

2 8 X 12 4 X 12 2 X 6

x1 x1 x3

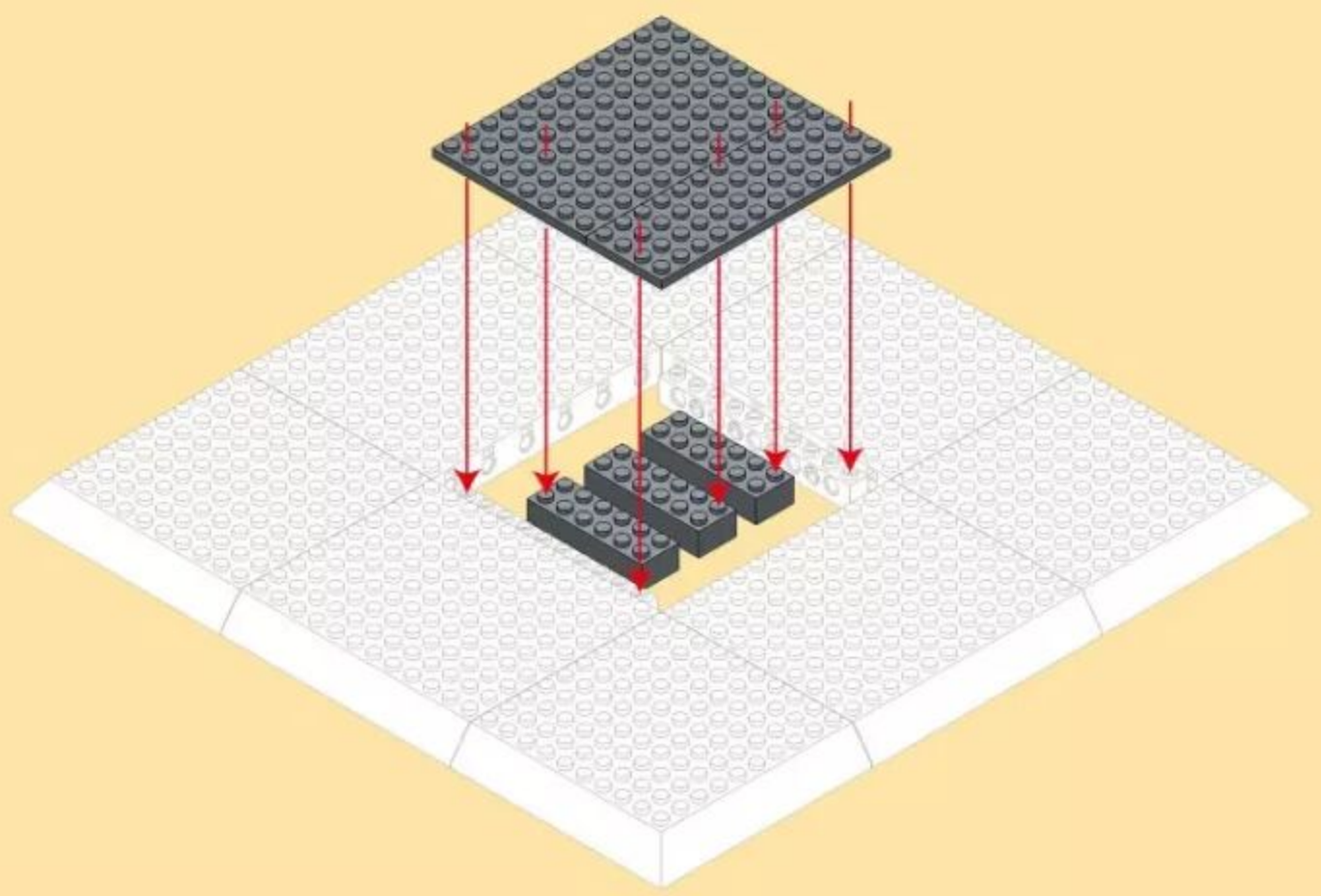

3

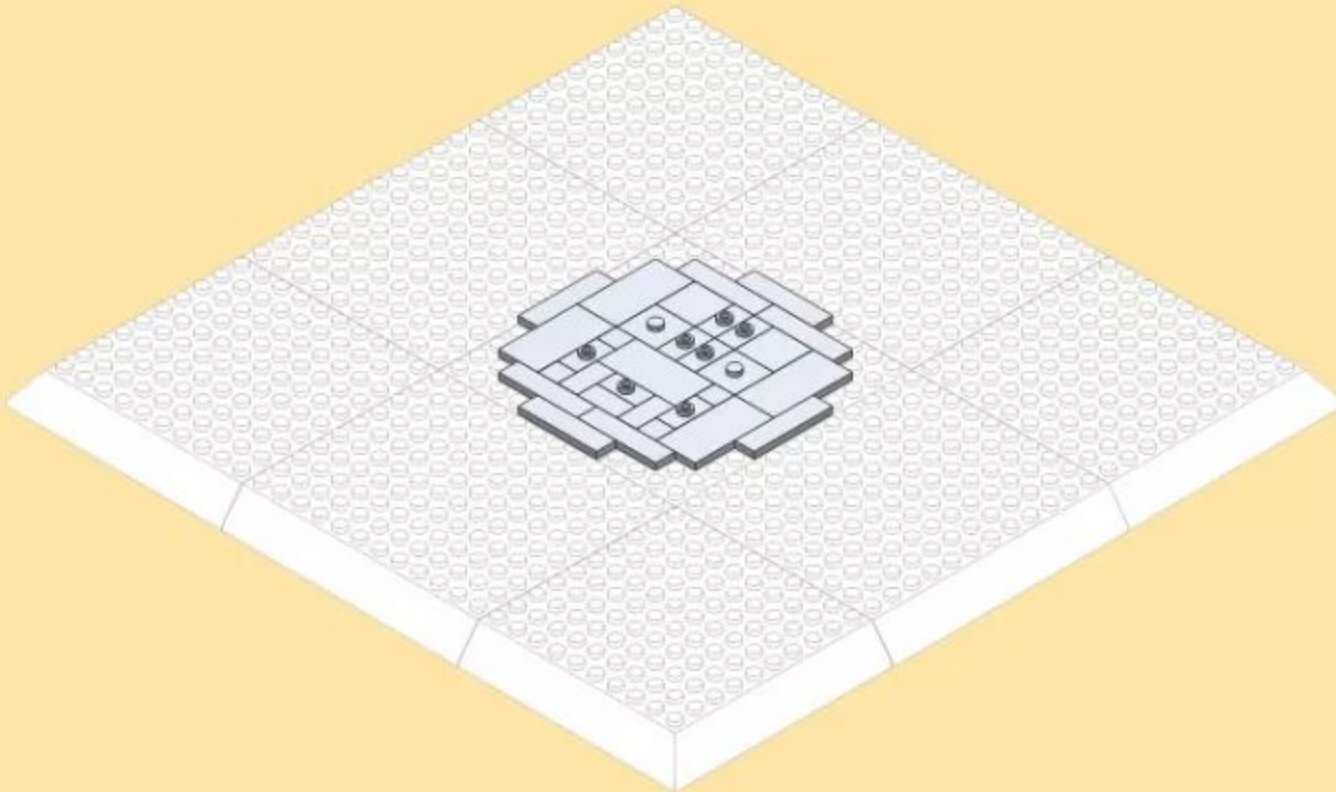
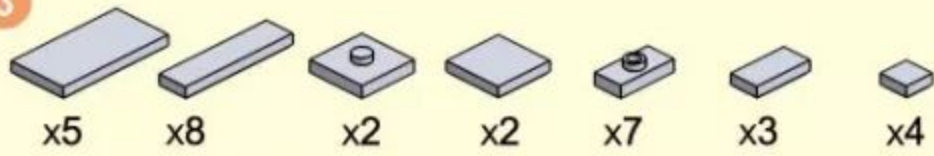

4

2 X 6

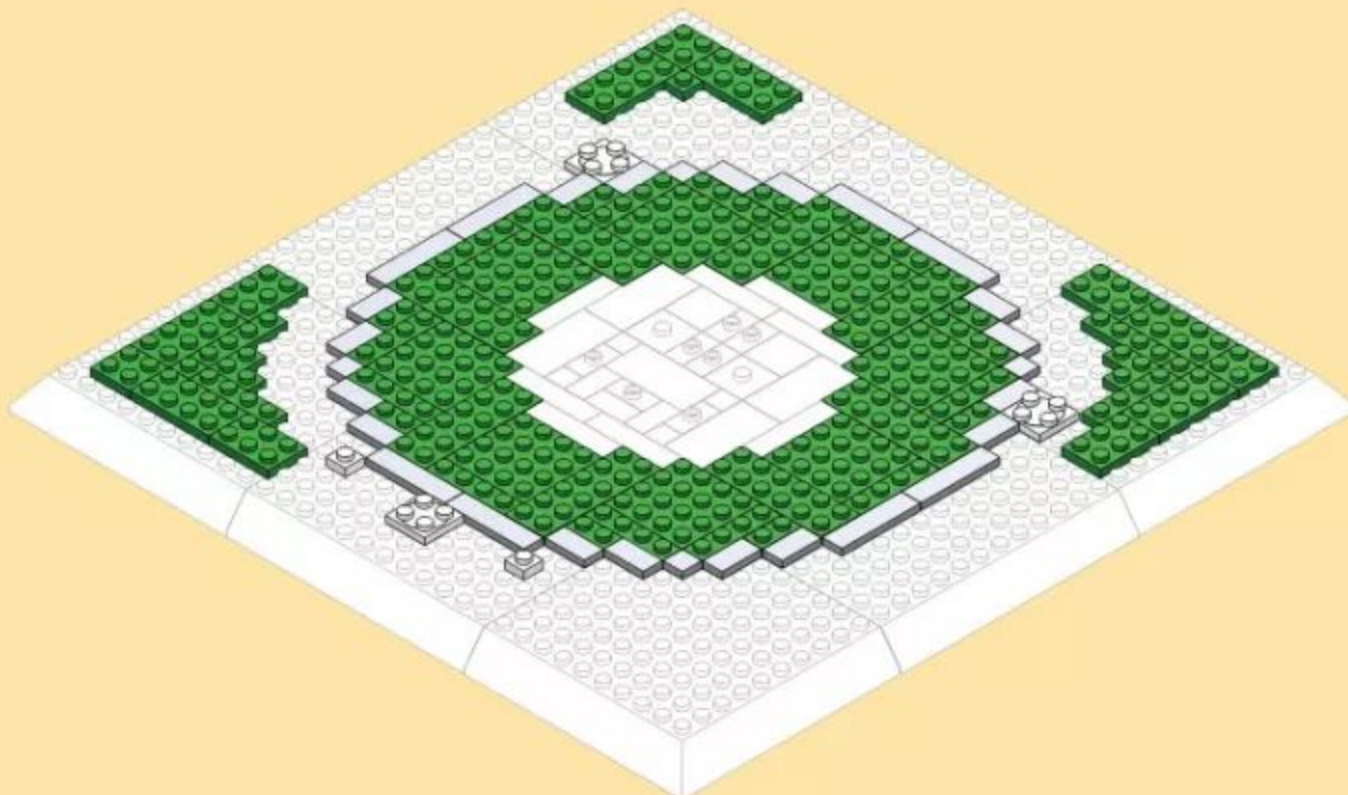
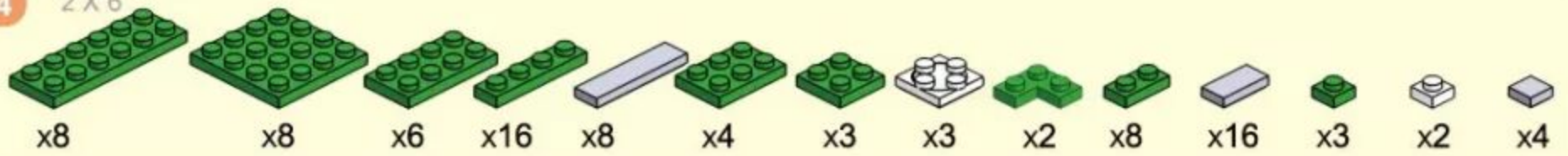

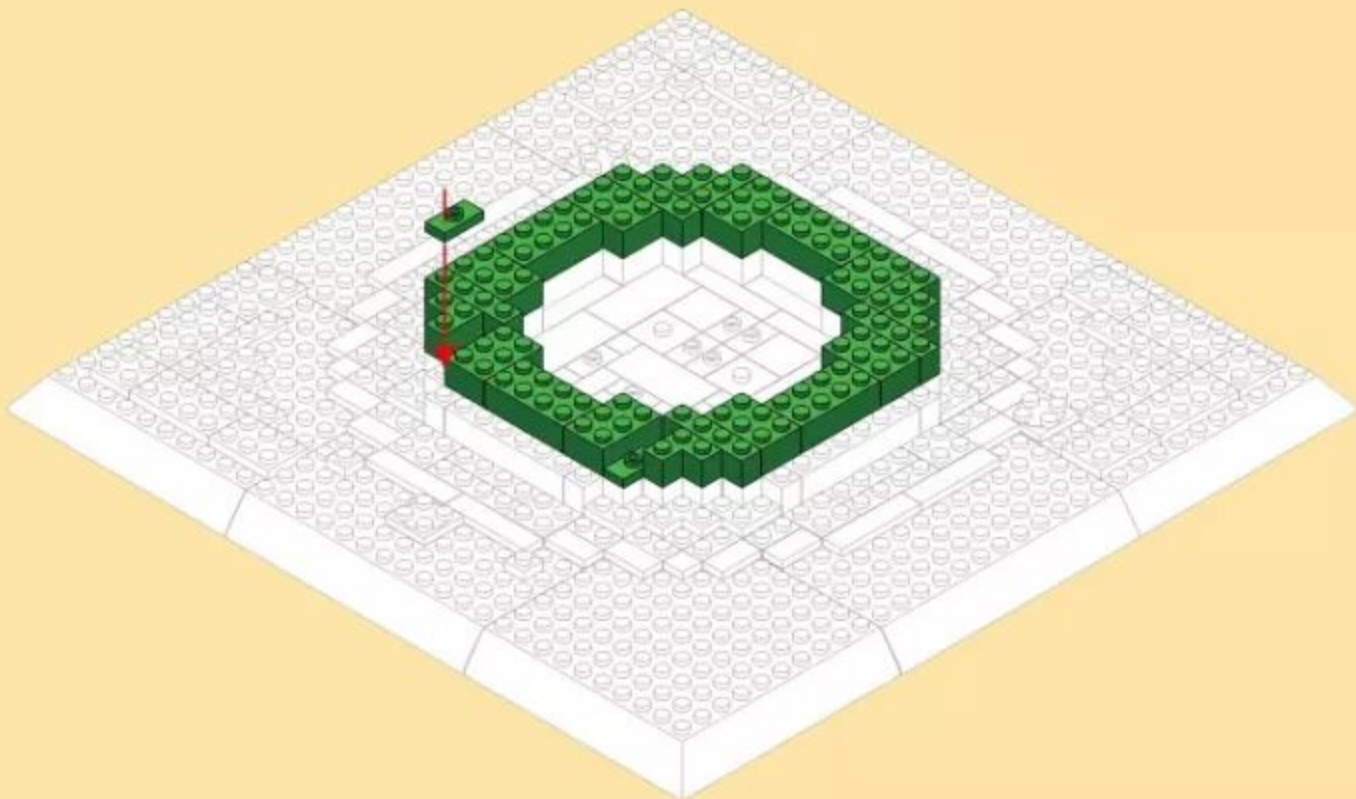
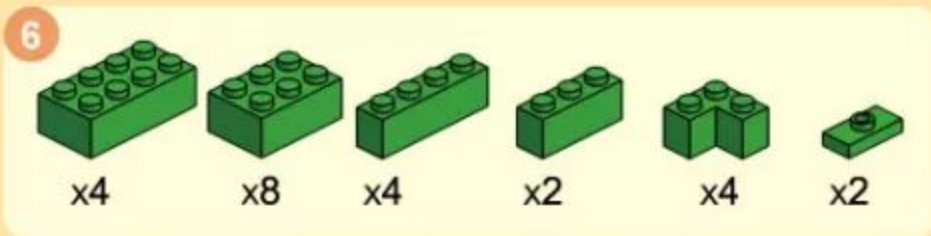
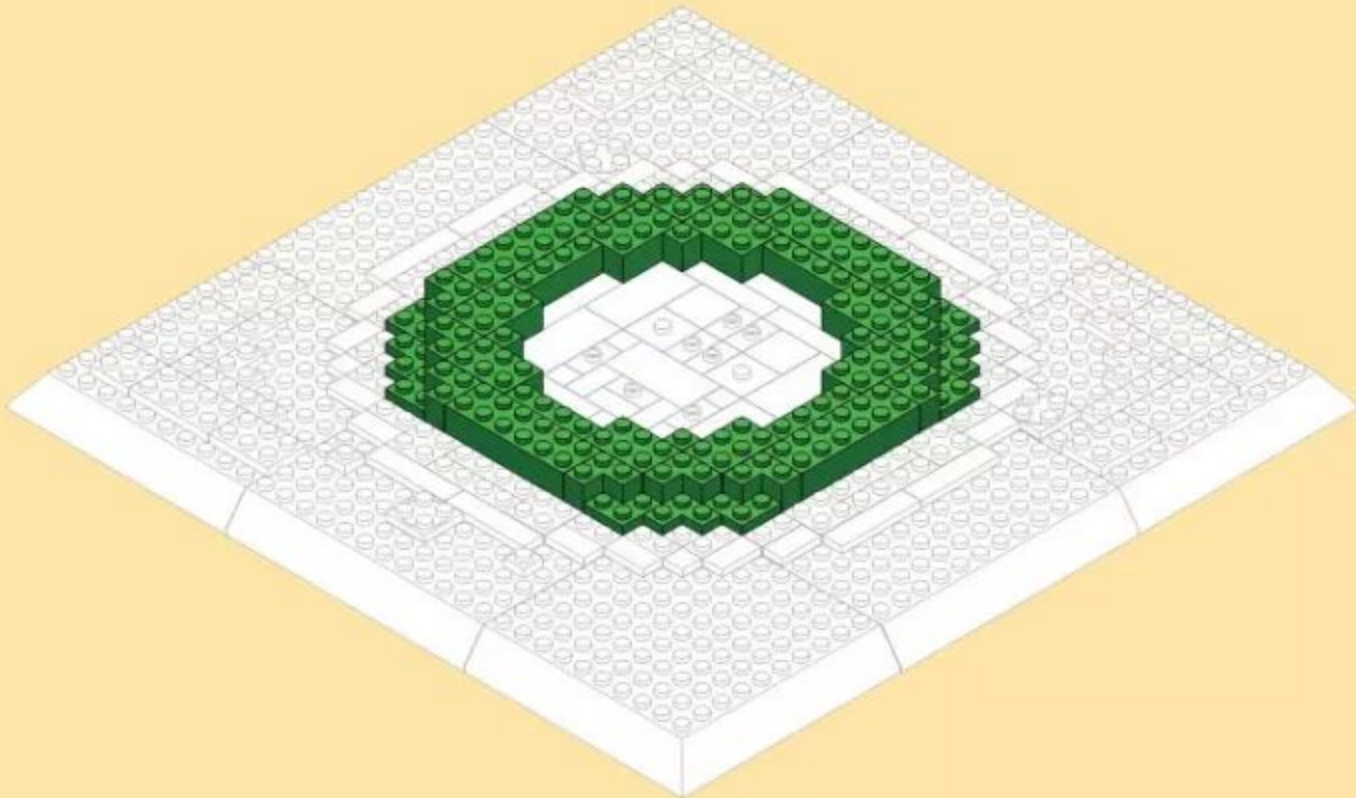
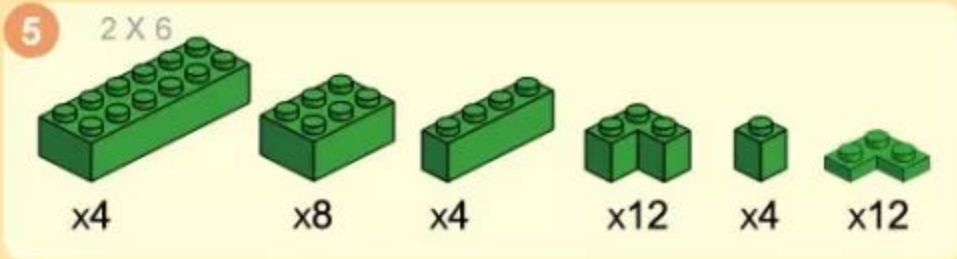

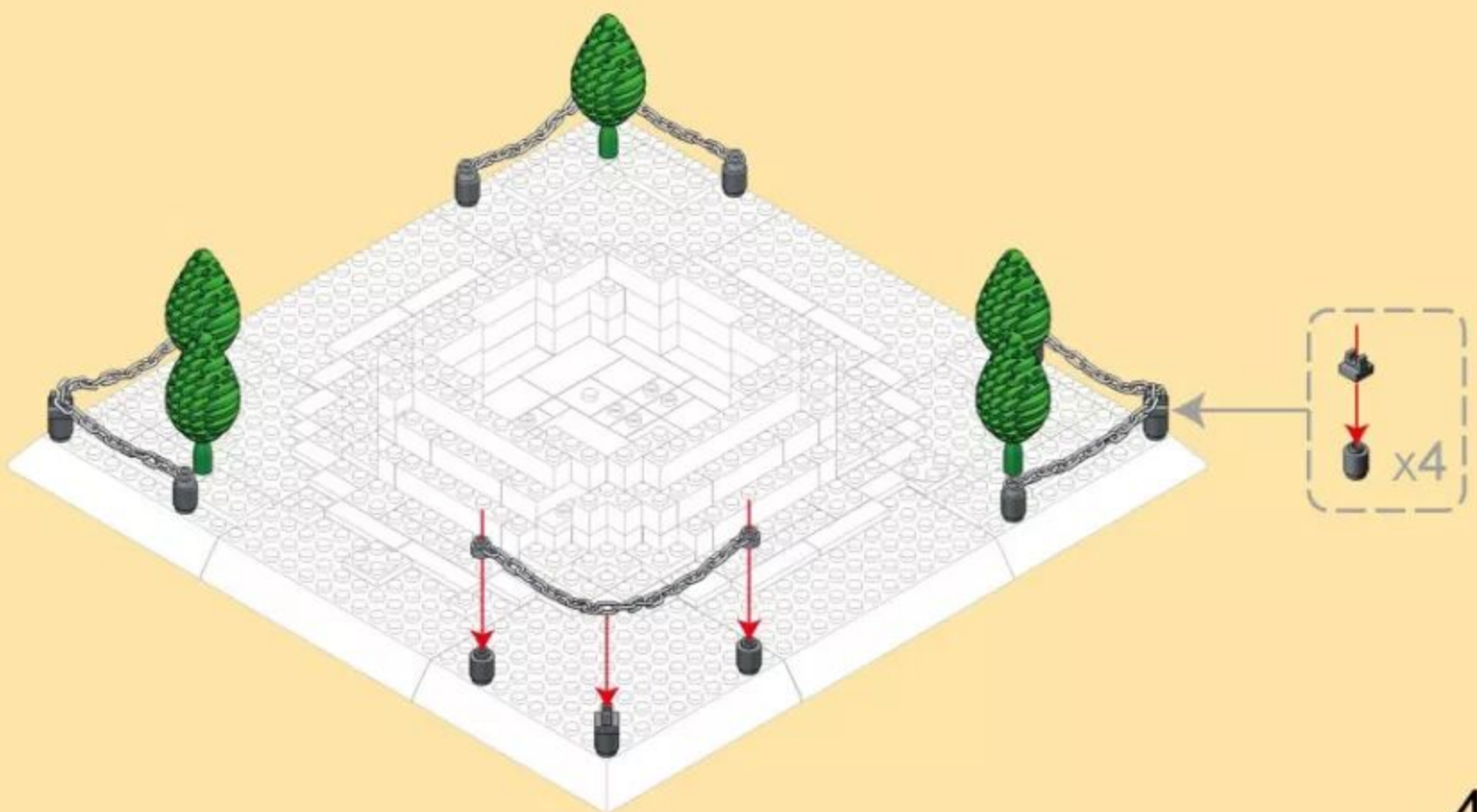
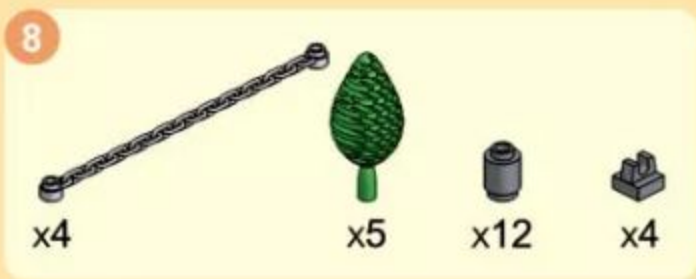
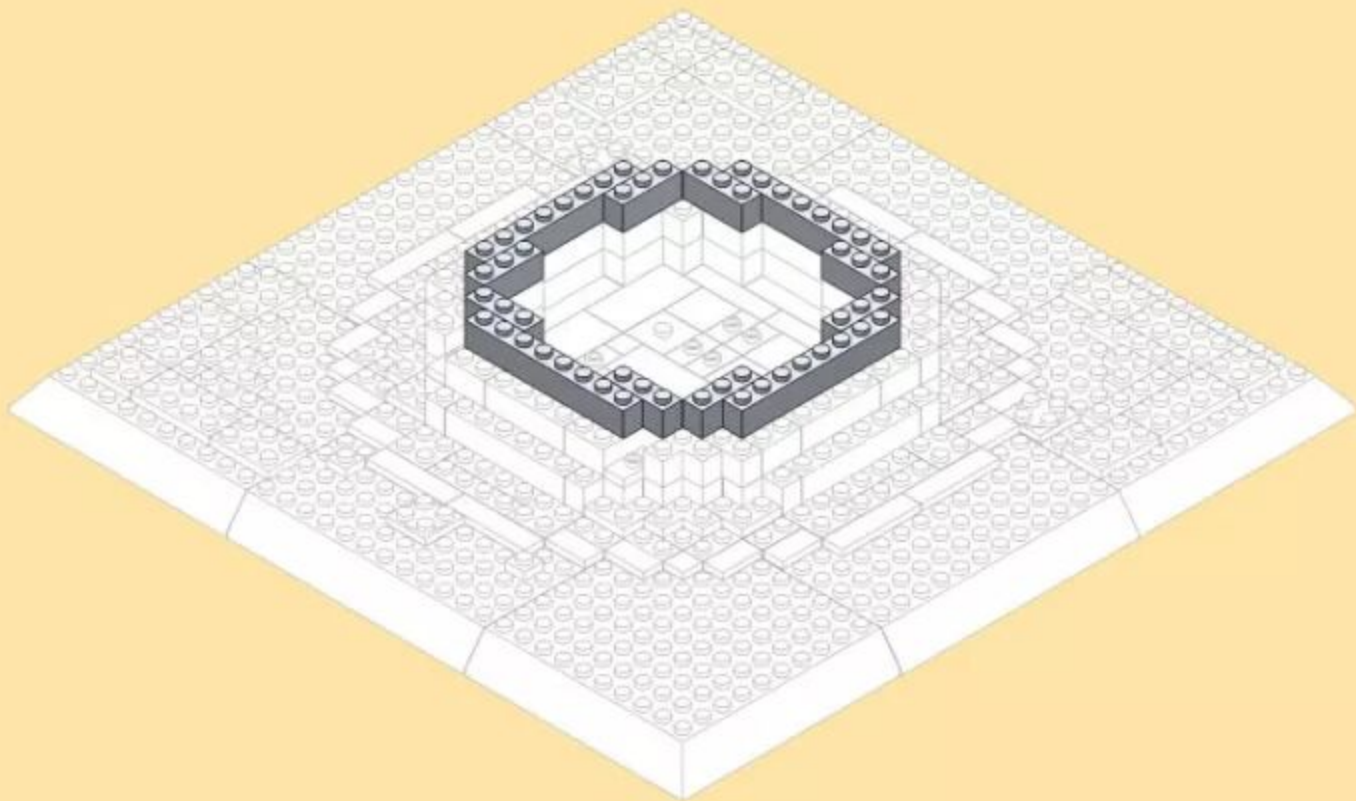
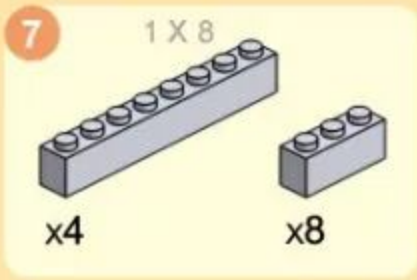

- 9
- 1 X 5 (grey) x3
 - 1 X 5 (grey) x3
 - 1 X 4 (grey) x6
 - 1 X 4 (grey) x6
 - 1 X 4 (grey) x3
 - 1 X 4 (grey) x3
 - 1 X 4 (grey) x3
 - 1 X 4 (grey) x3
 - 1 X 4 (grey) x3
 - 1 X 4 (grey) x3
 - 1 X 4 (grey) x3
 - 1 X 4 (grey) x3
 - 1 X 4 (grey) x3

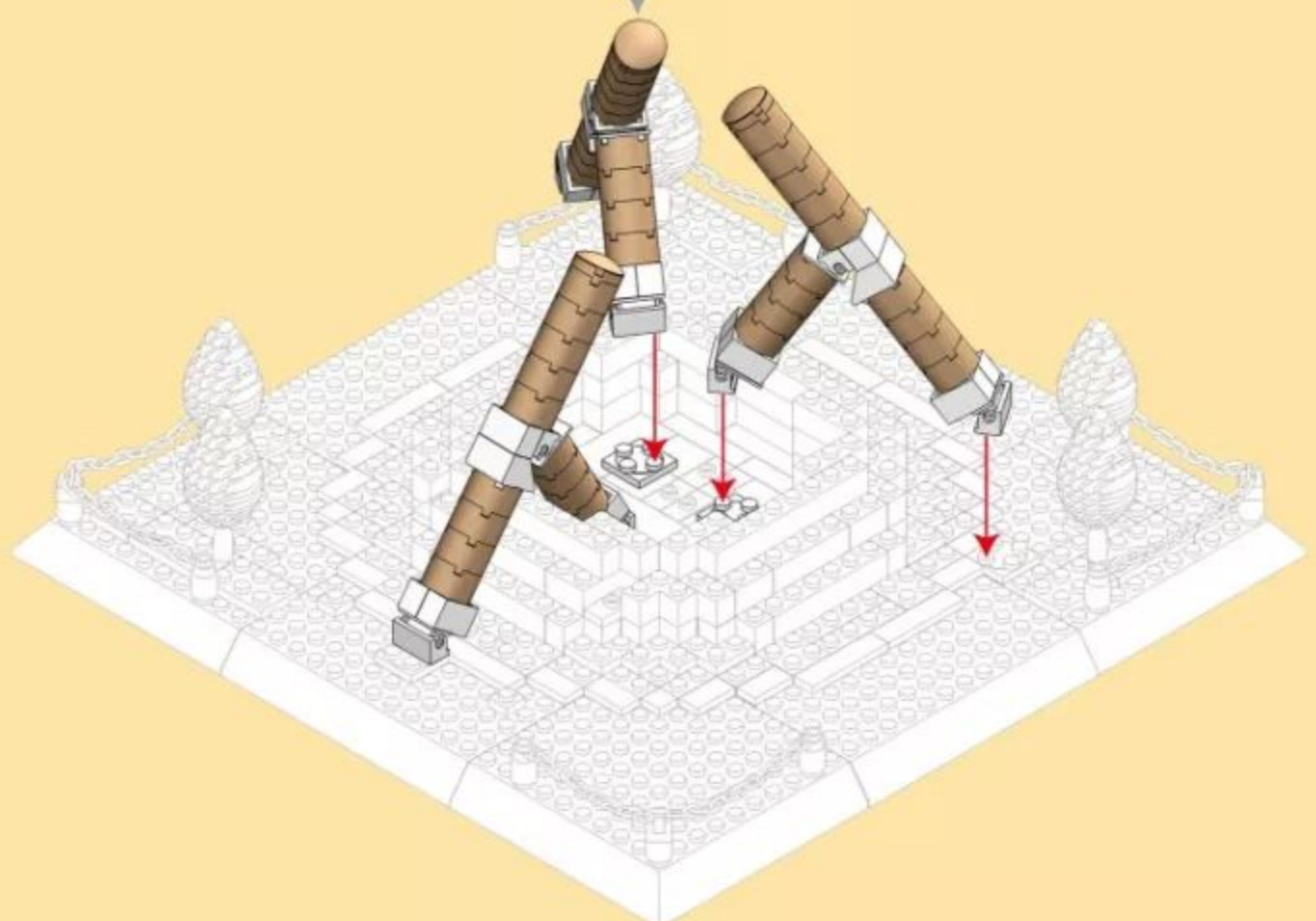
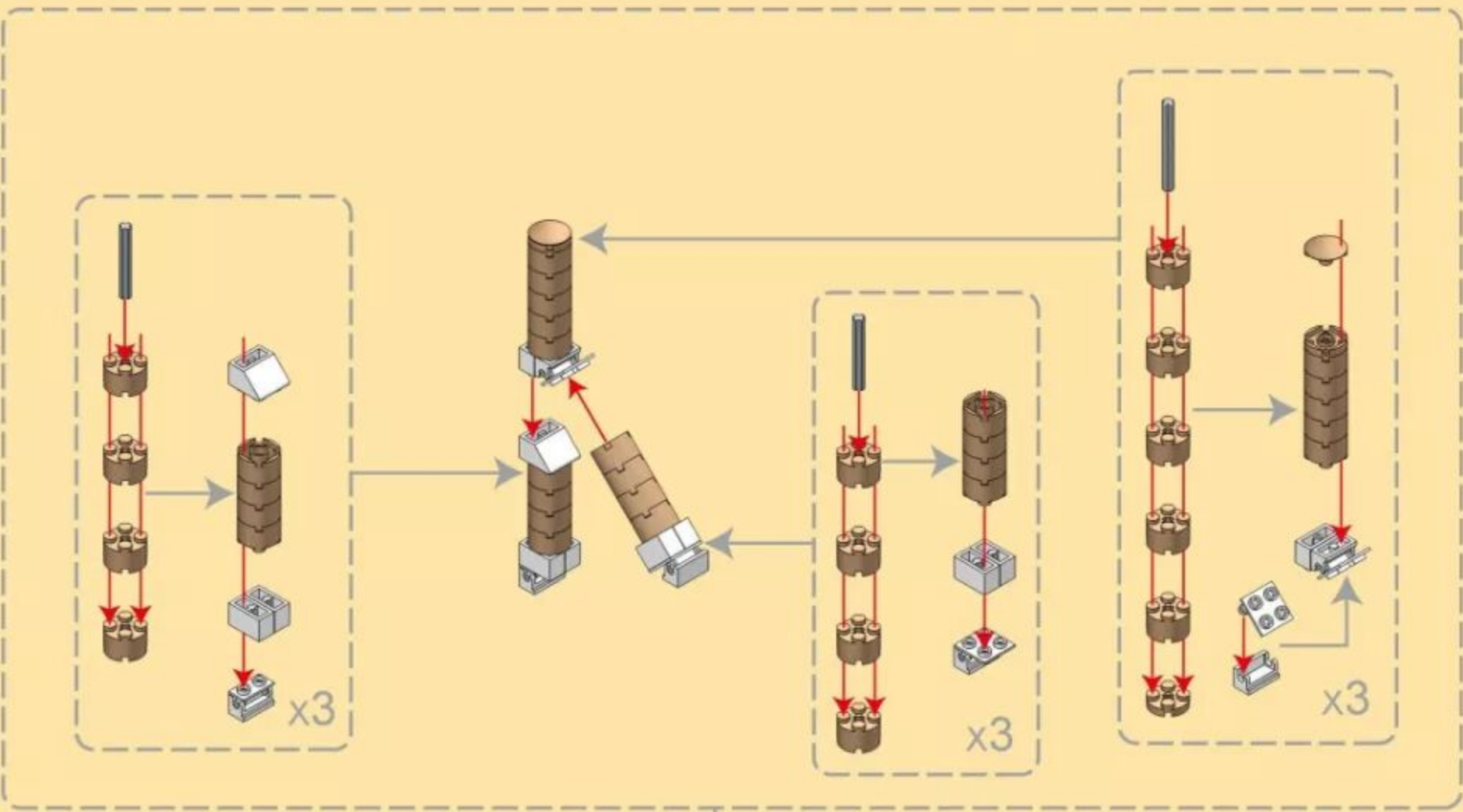

10



x27



x3



x9



x15



x15





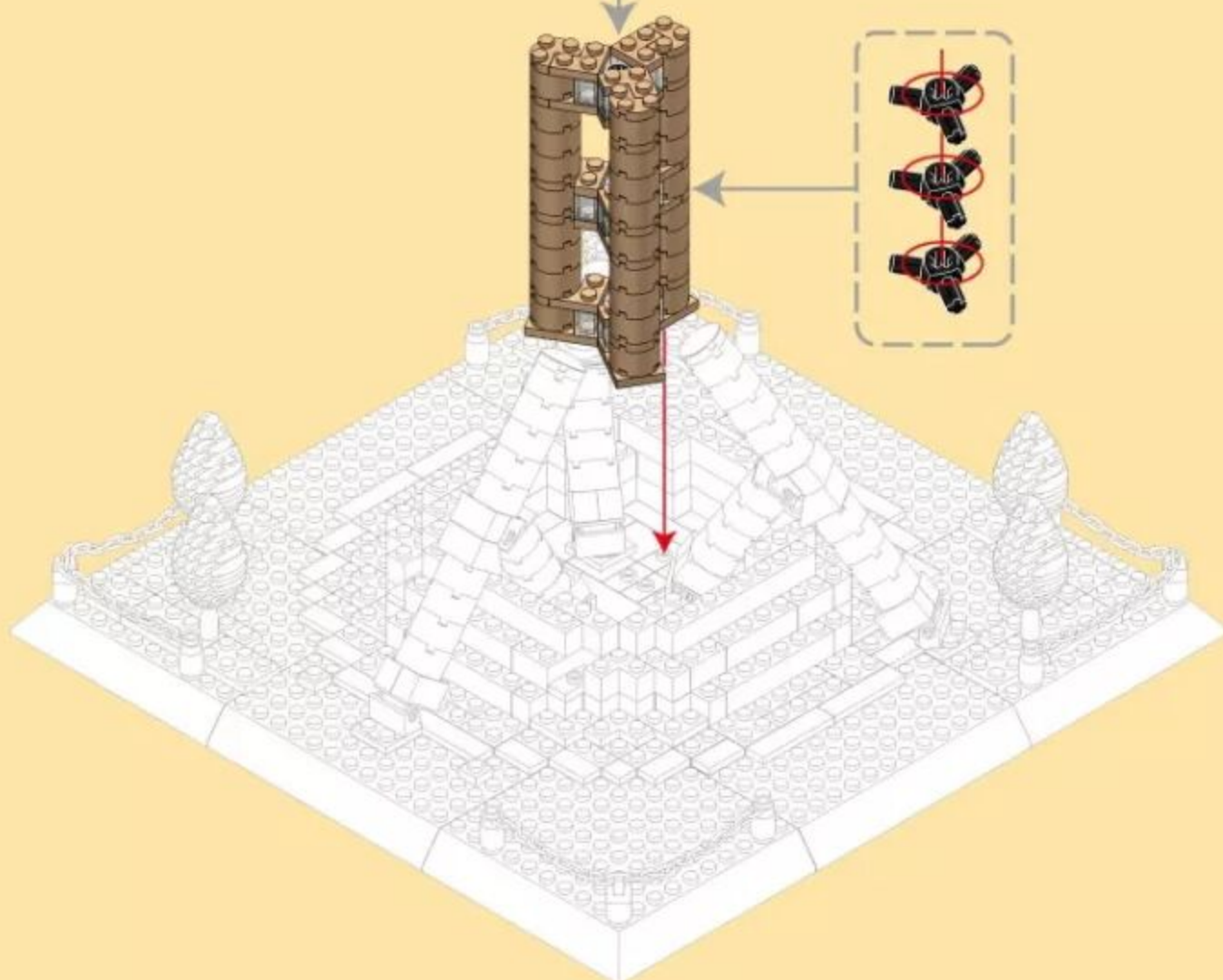
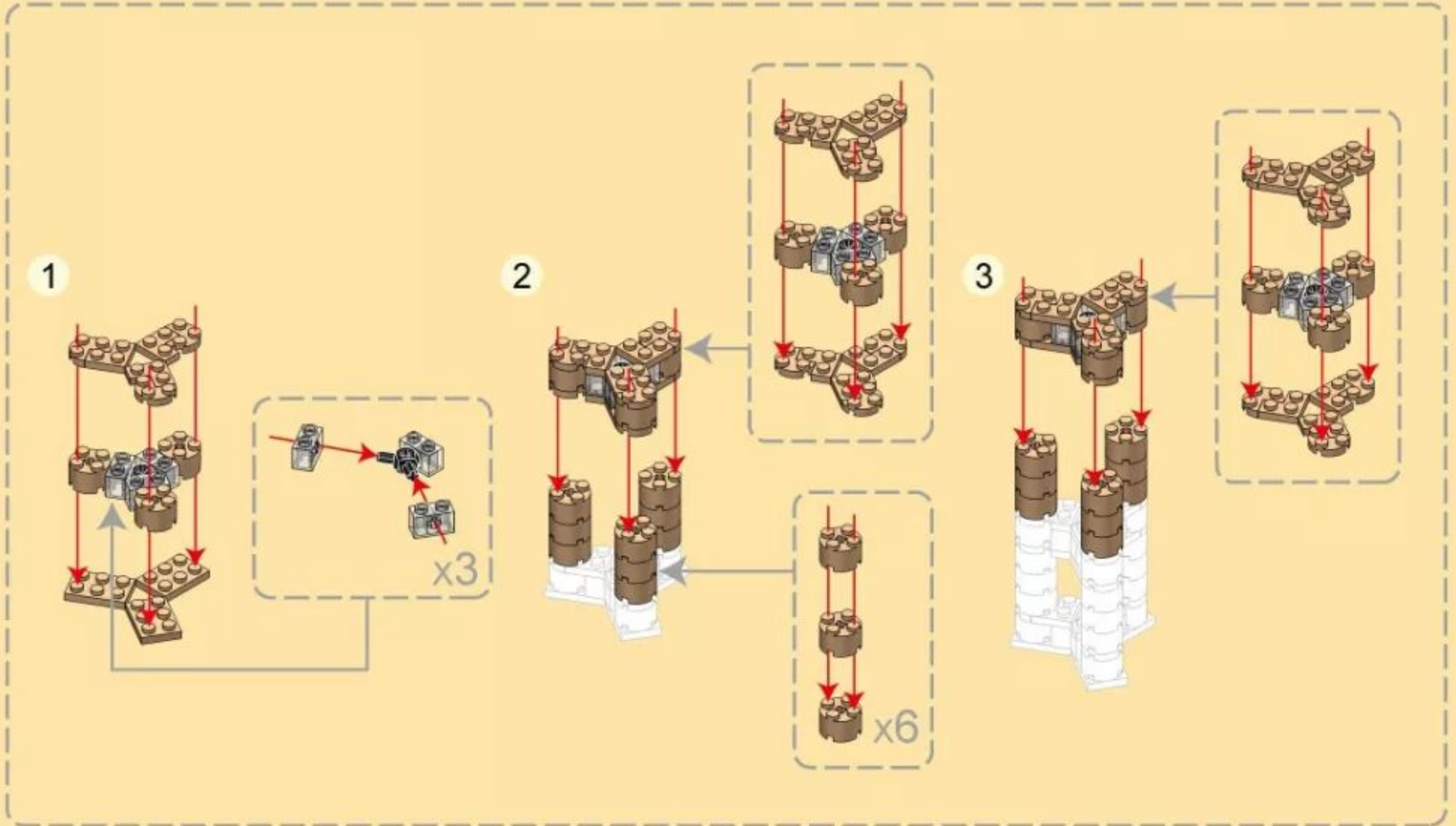









x3



11

1 X 10

-  x1
-  x2
-  x7
-  x4
-  x2
-  x16
-  x2
-  x14
-  x5
-  x6
-  x4
-  x2

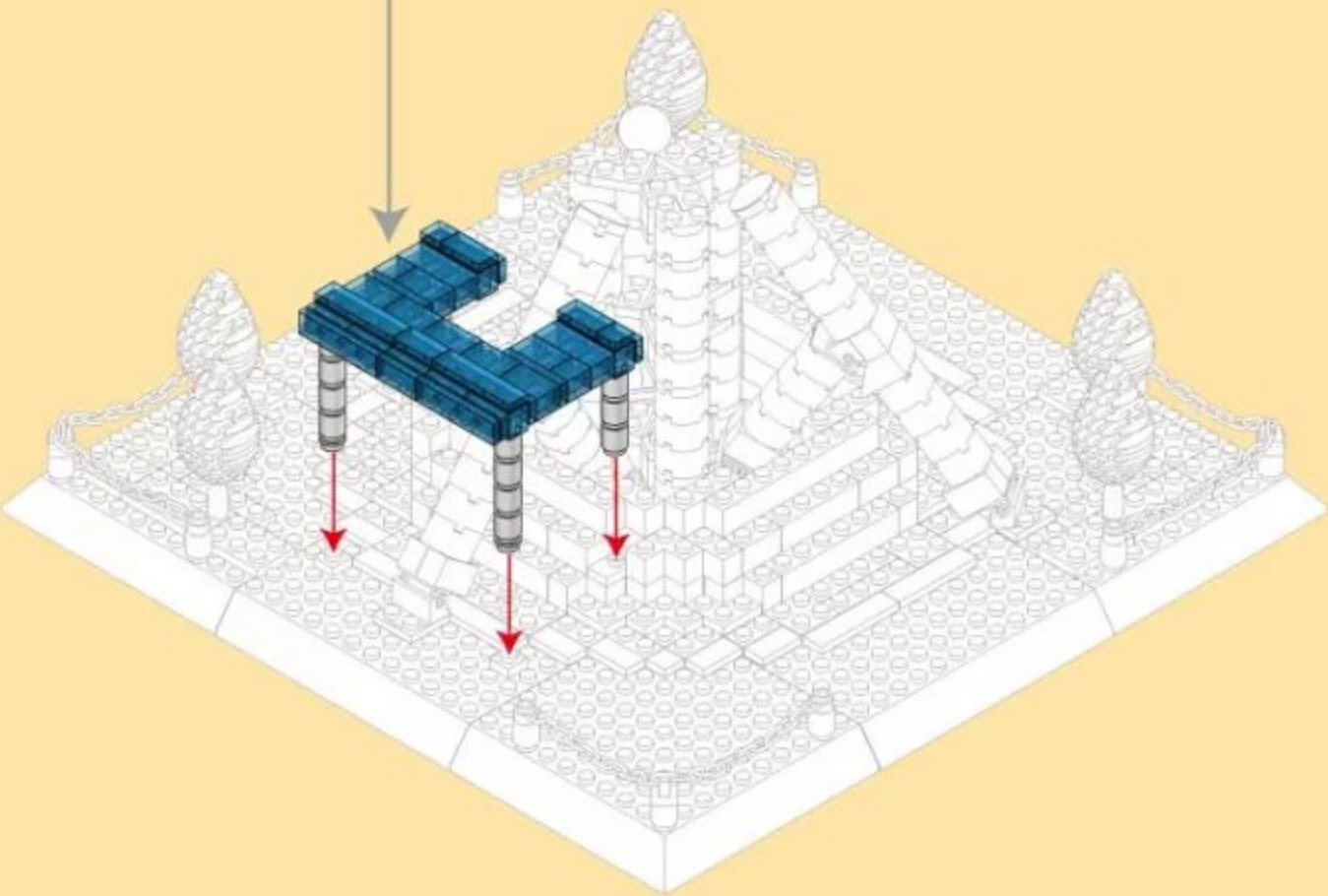
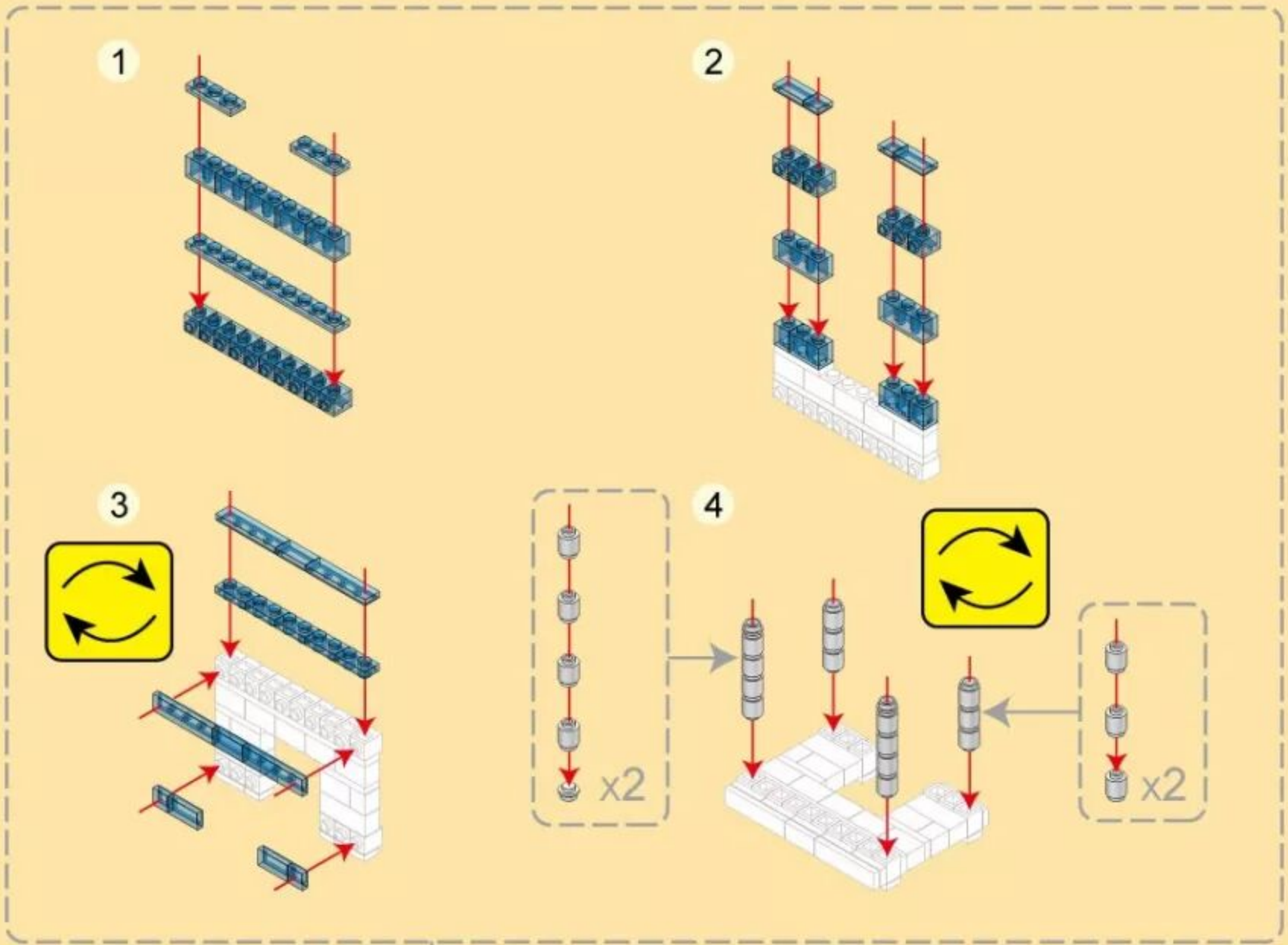

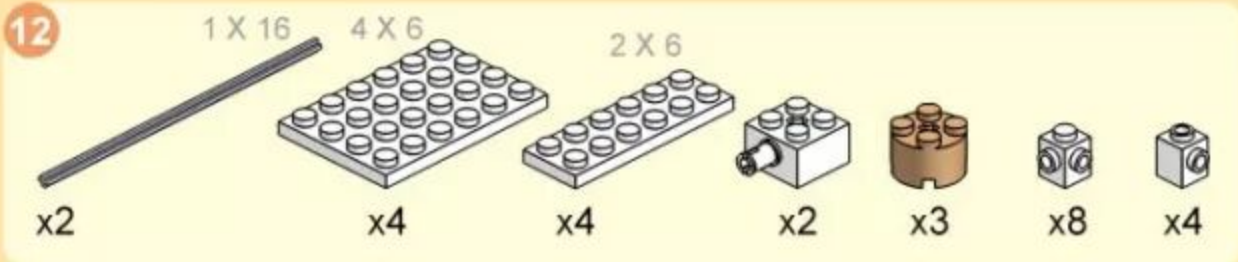

1

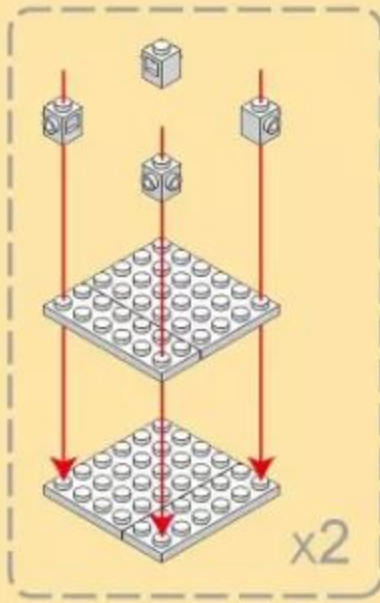
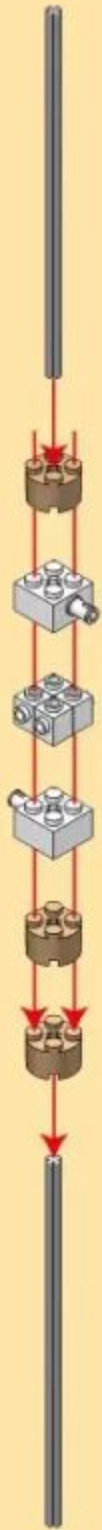

2

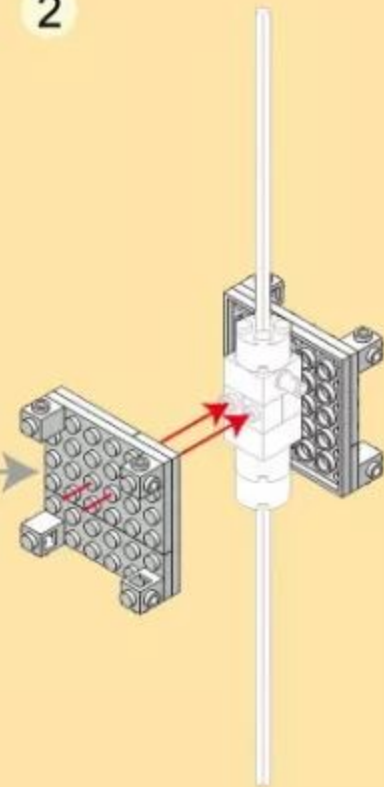

- 13** 2 X 6 2 X 6 1 X 6 1 X 6
- x2 x4 x12 x4 x4 x4 x4 x16 x16 x6 x10 x4 x8
- x4 x16 x8 x8 x8 x16

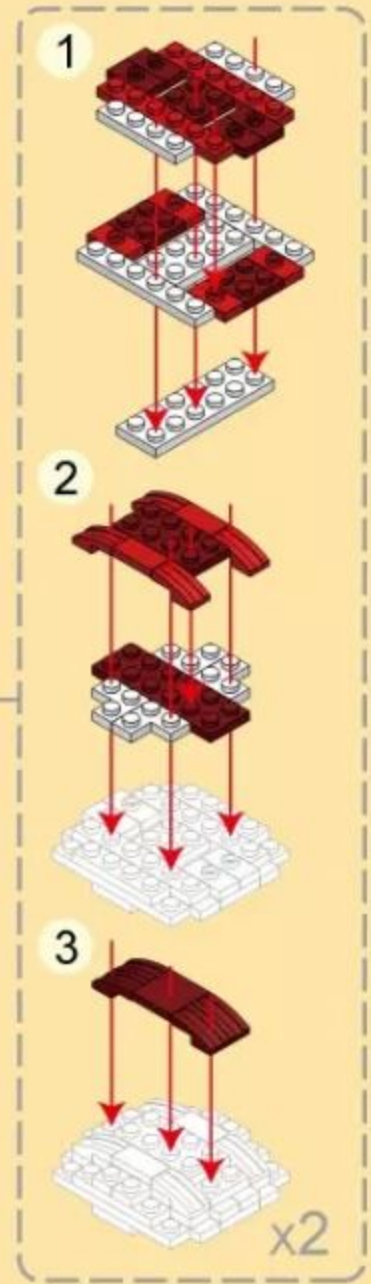
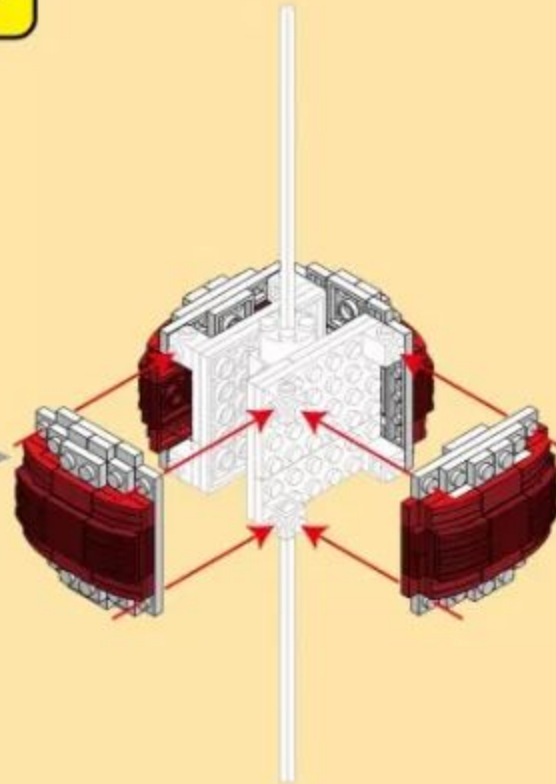
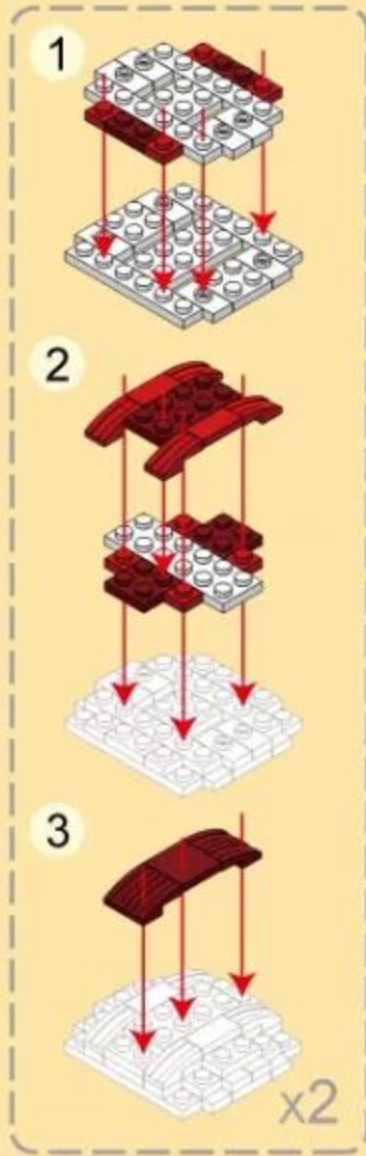

- 14** 1 X 6
- x4 x8 x4 x4 x4 x4 x4

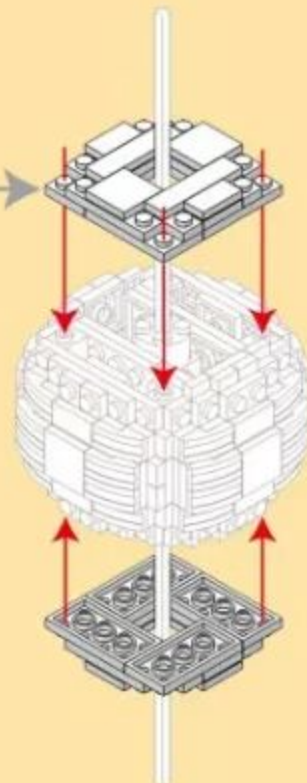
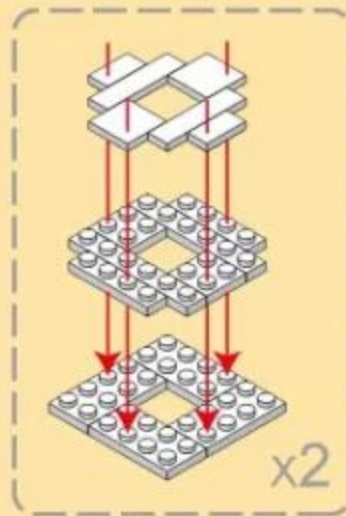

15

11 + 14

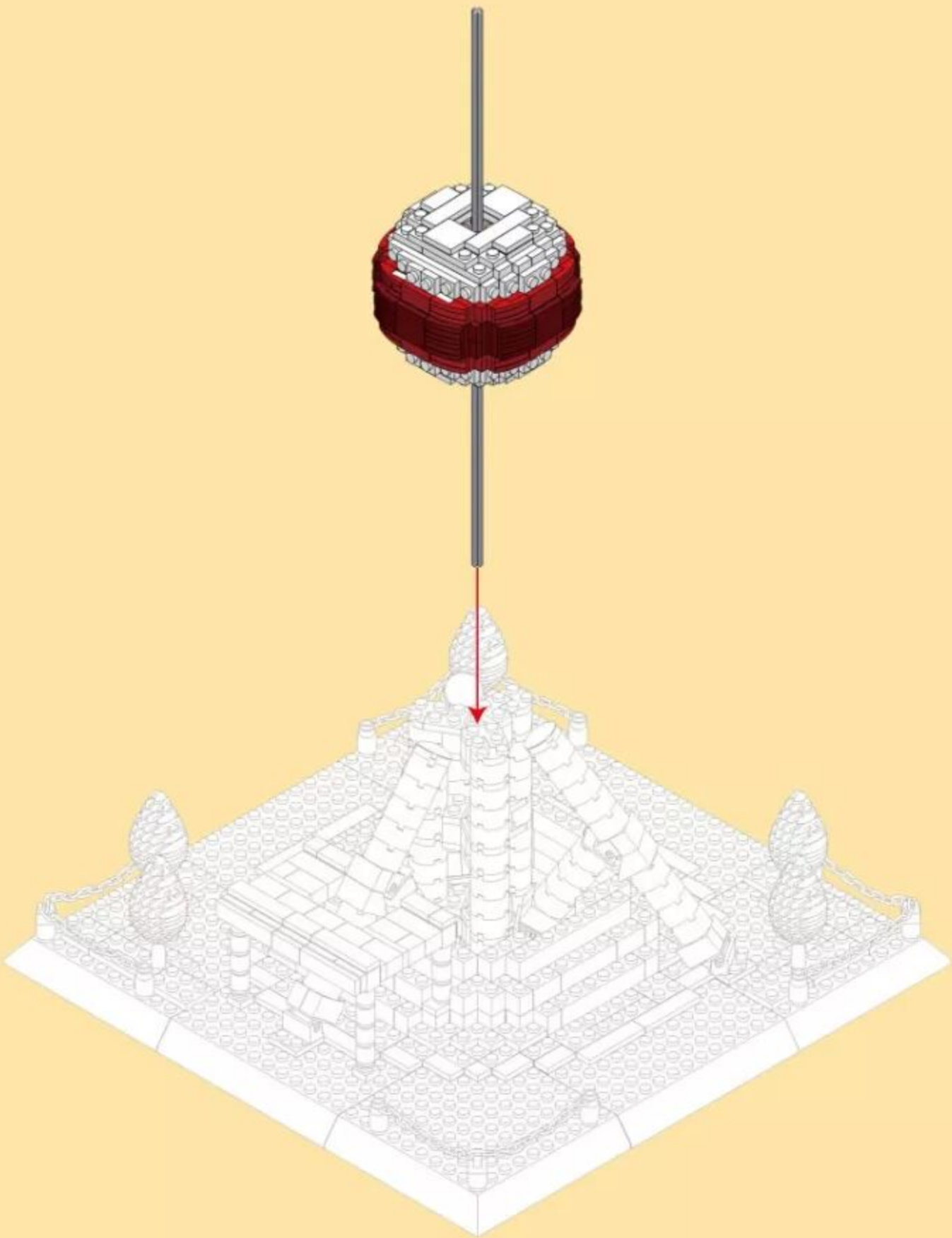

- 16 1 X 6
 x1 x63 x18 x36 x36 x6

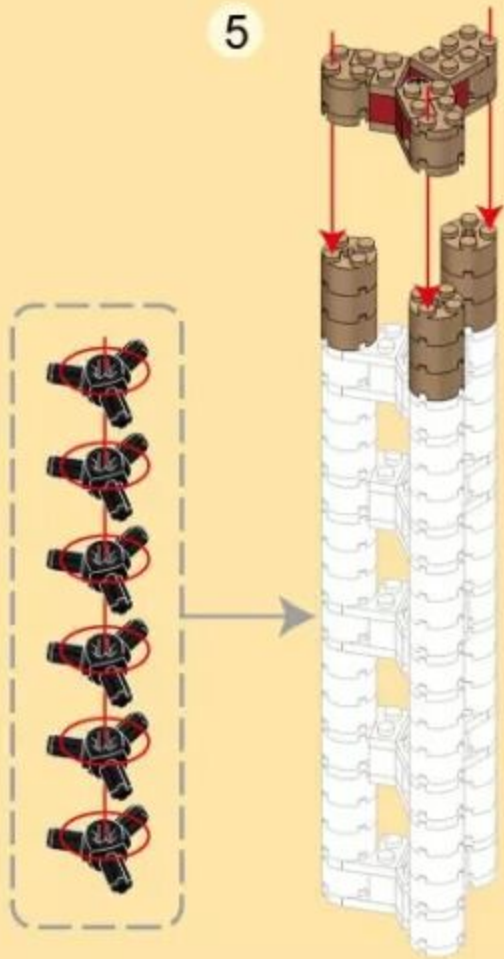
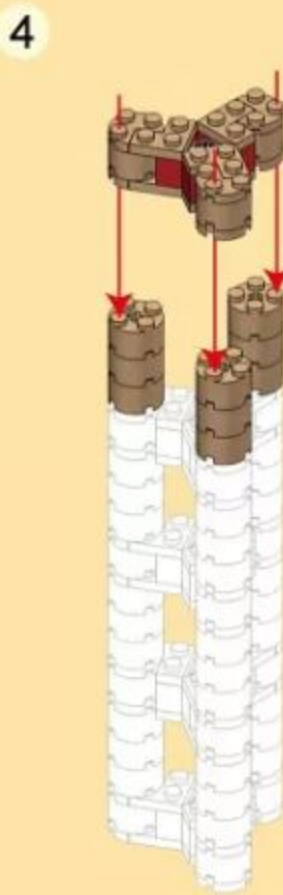
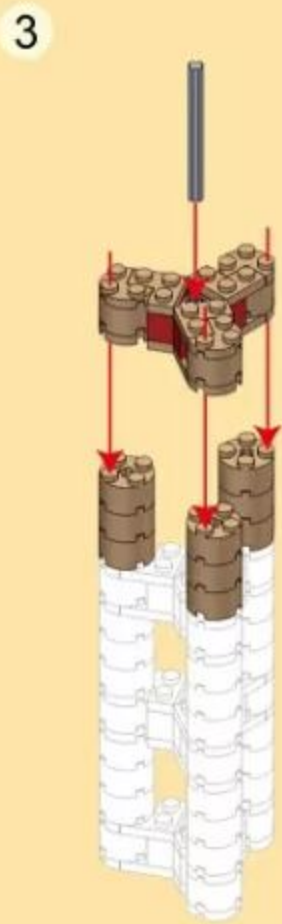
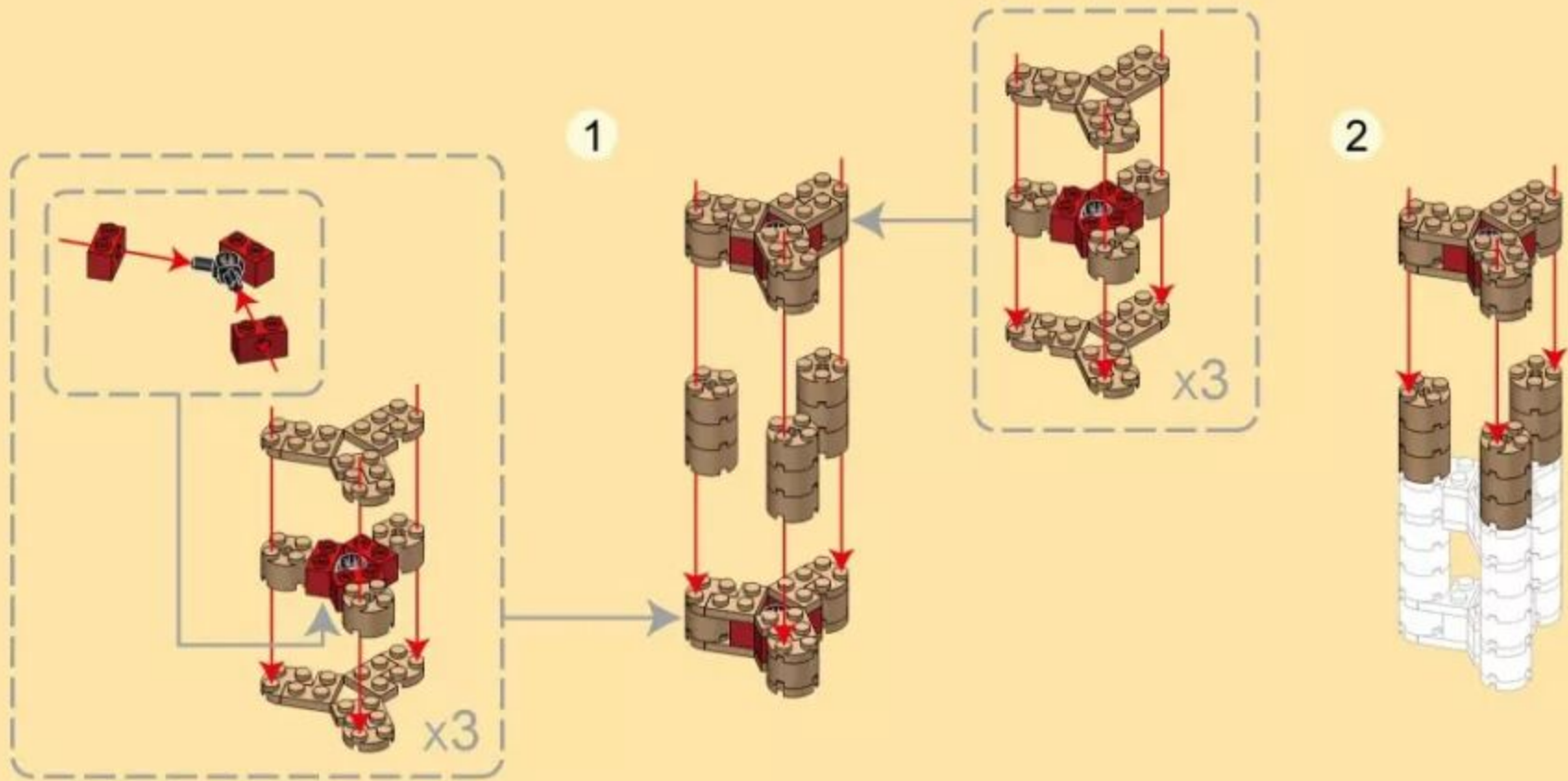

17

15 + 16



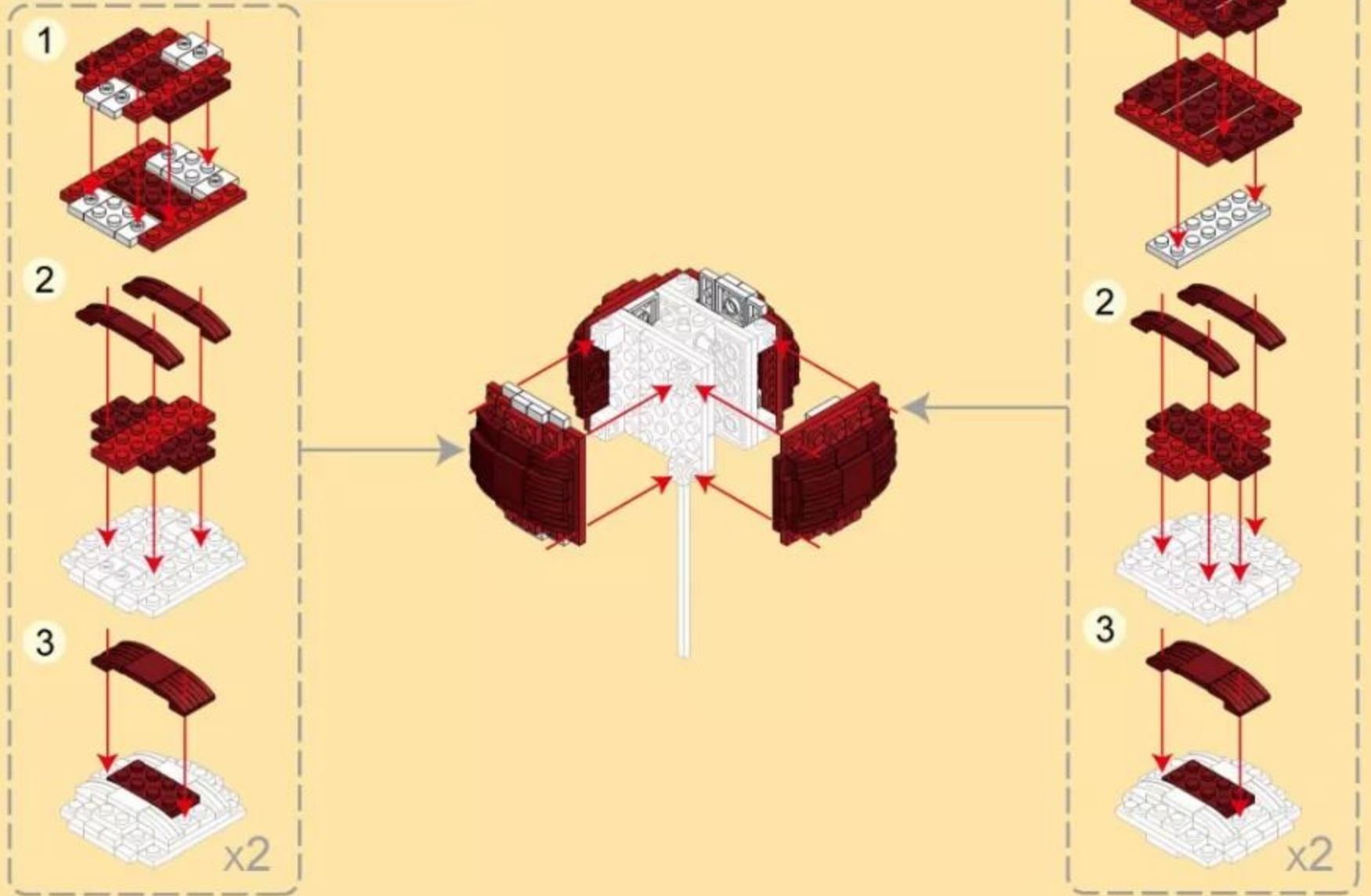
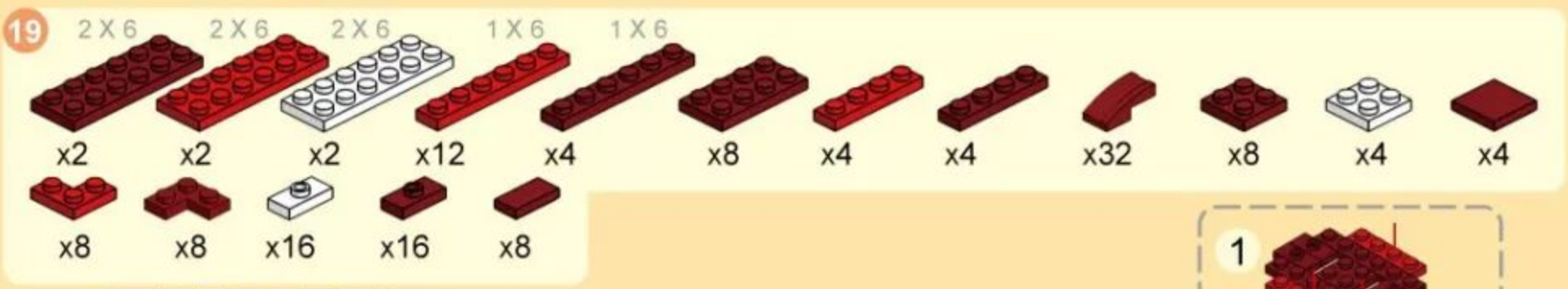
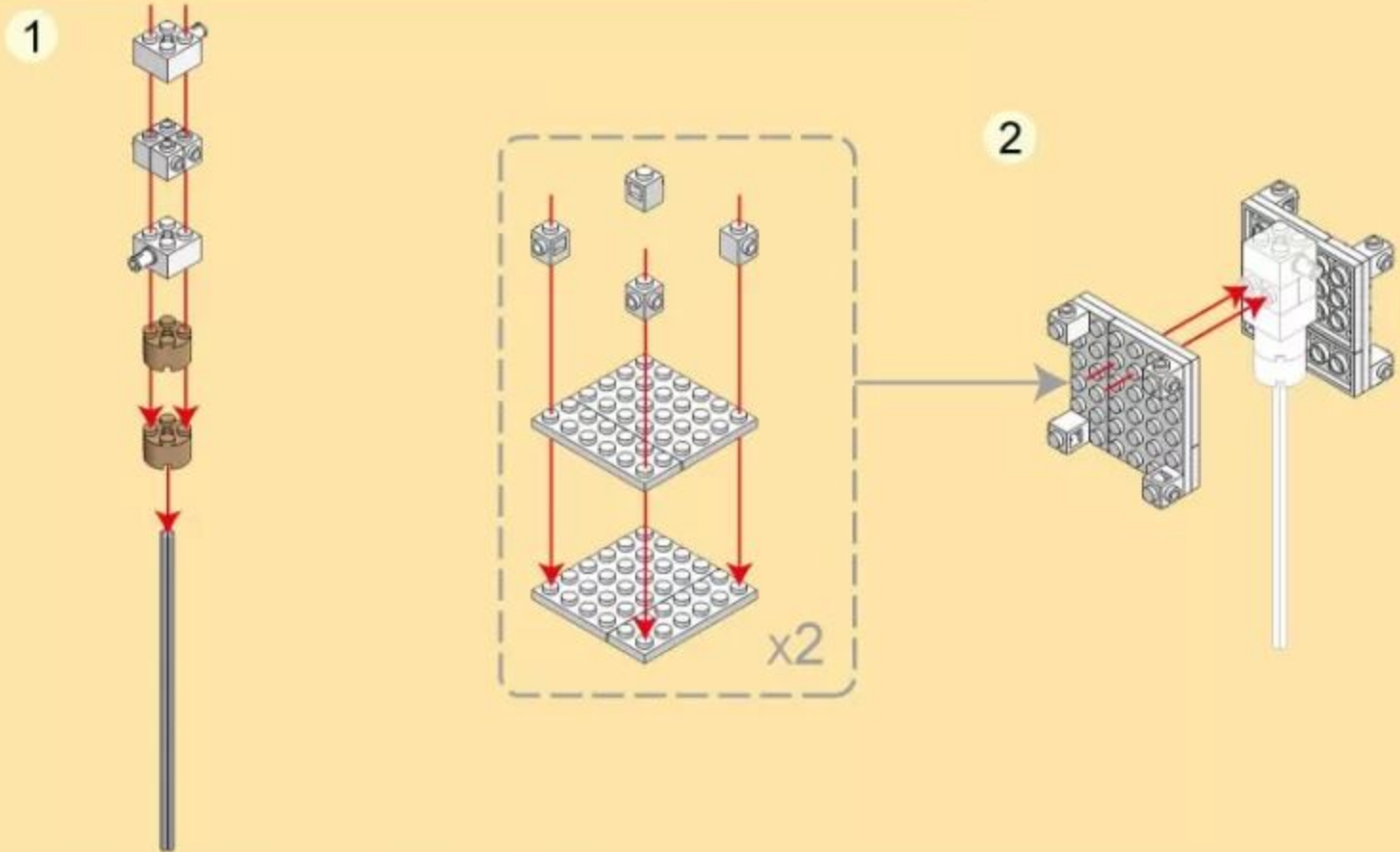
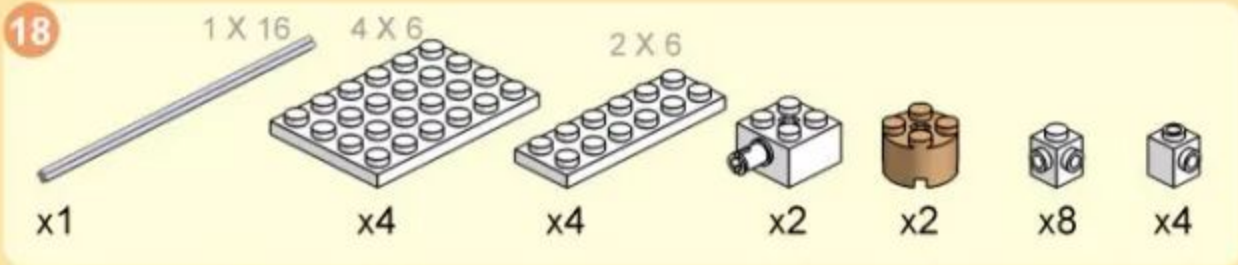

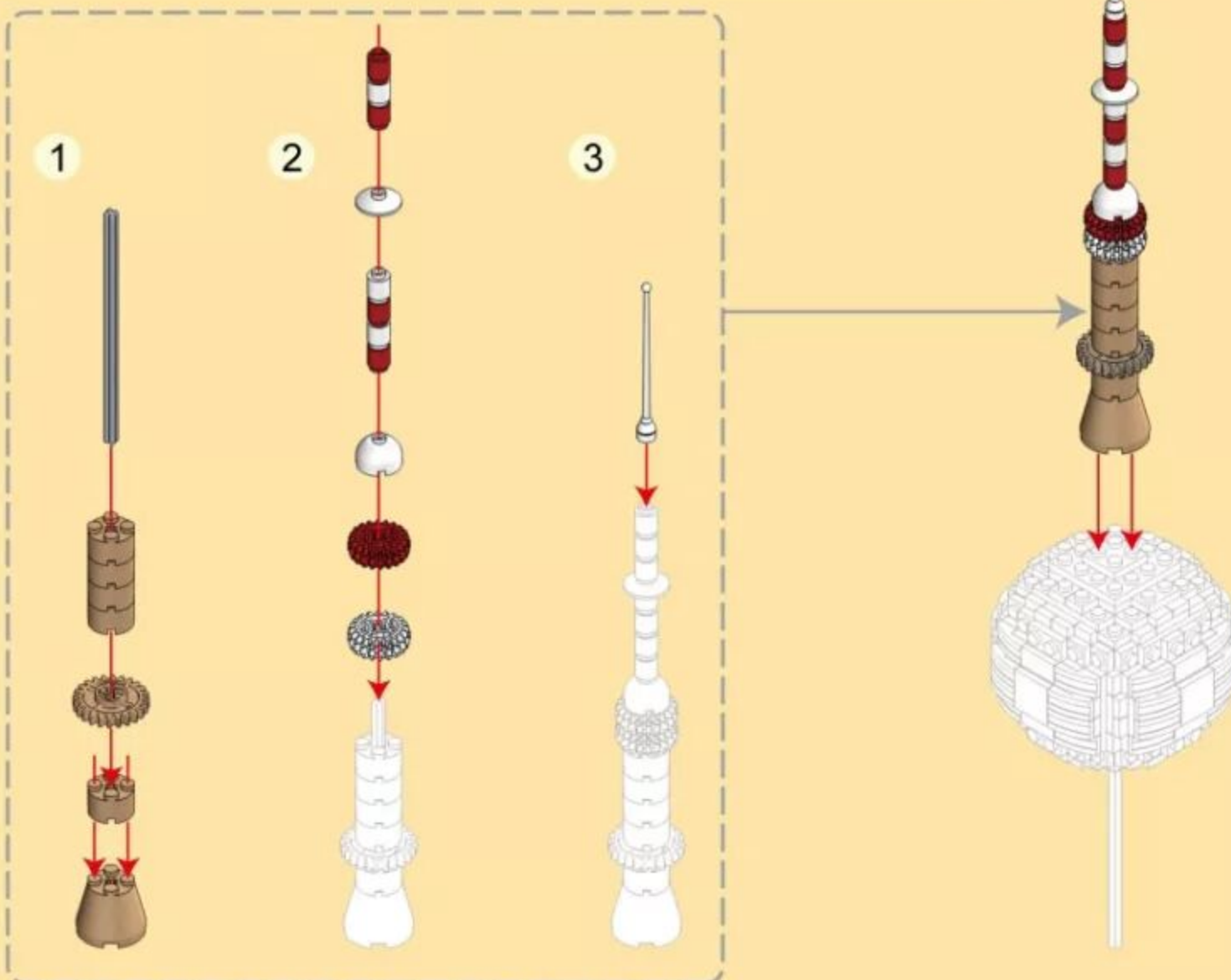
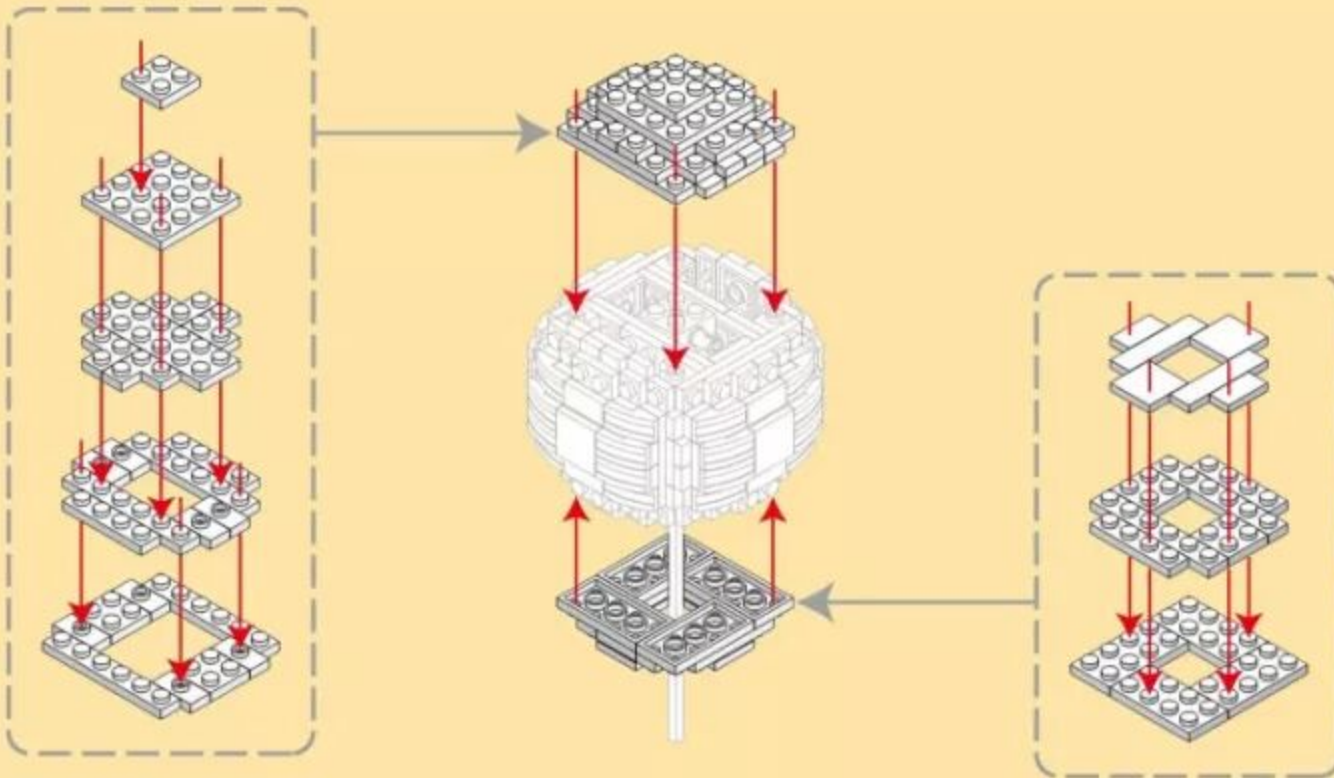
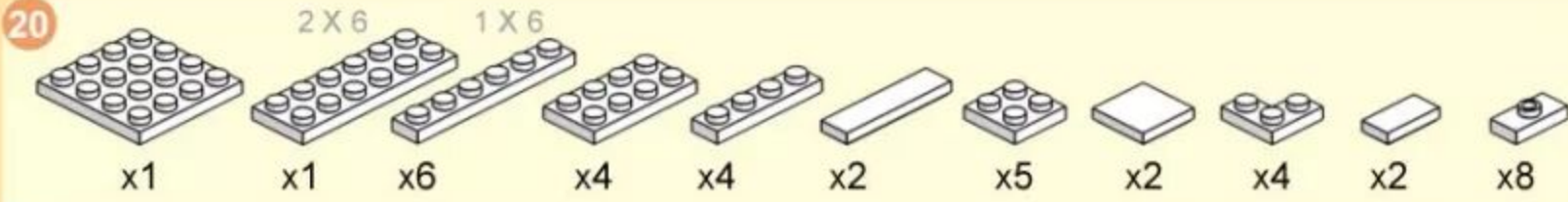

22

17 + 21

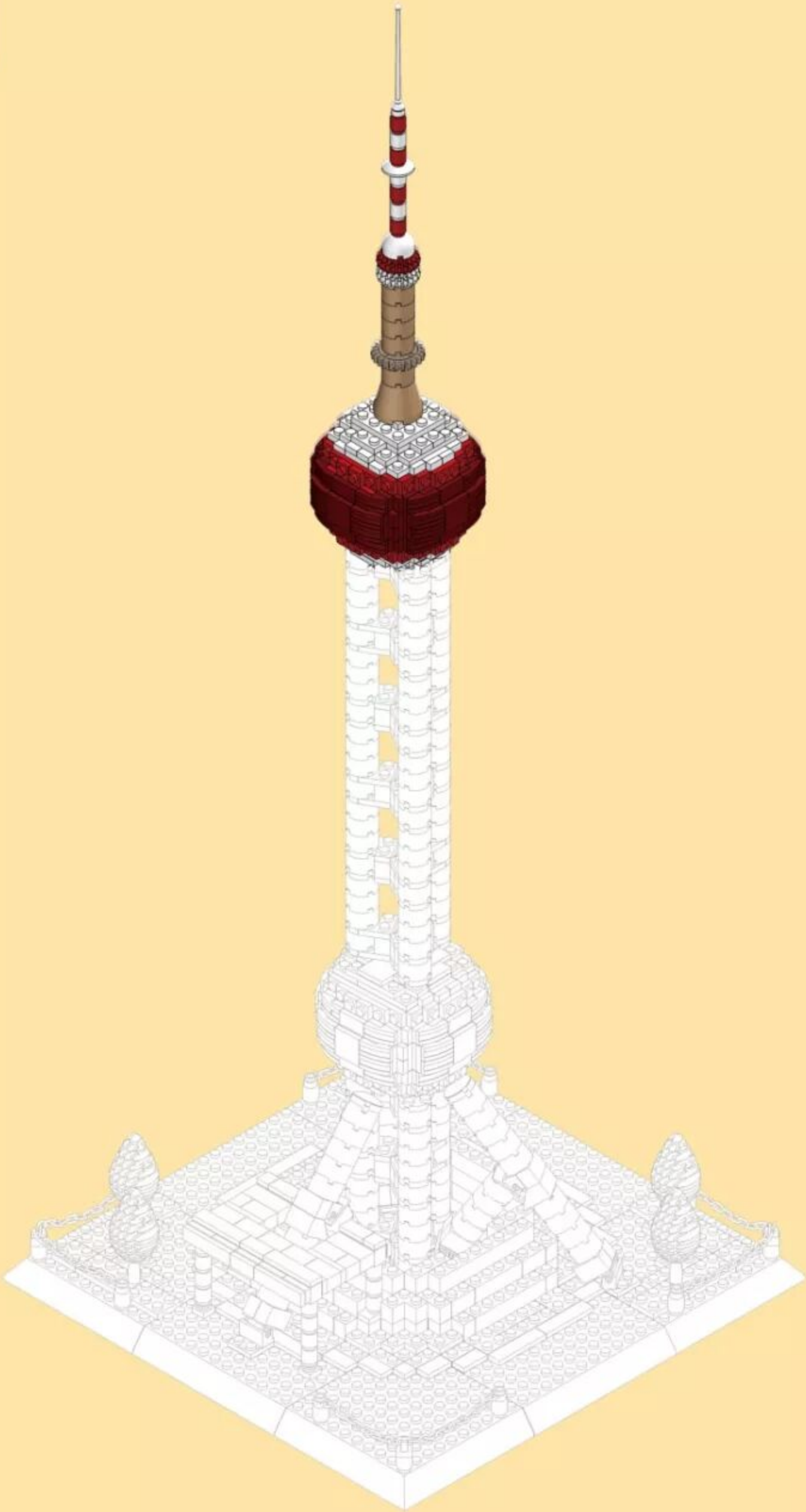

23



x1



x1



x1

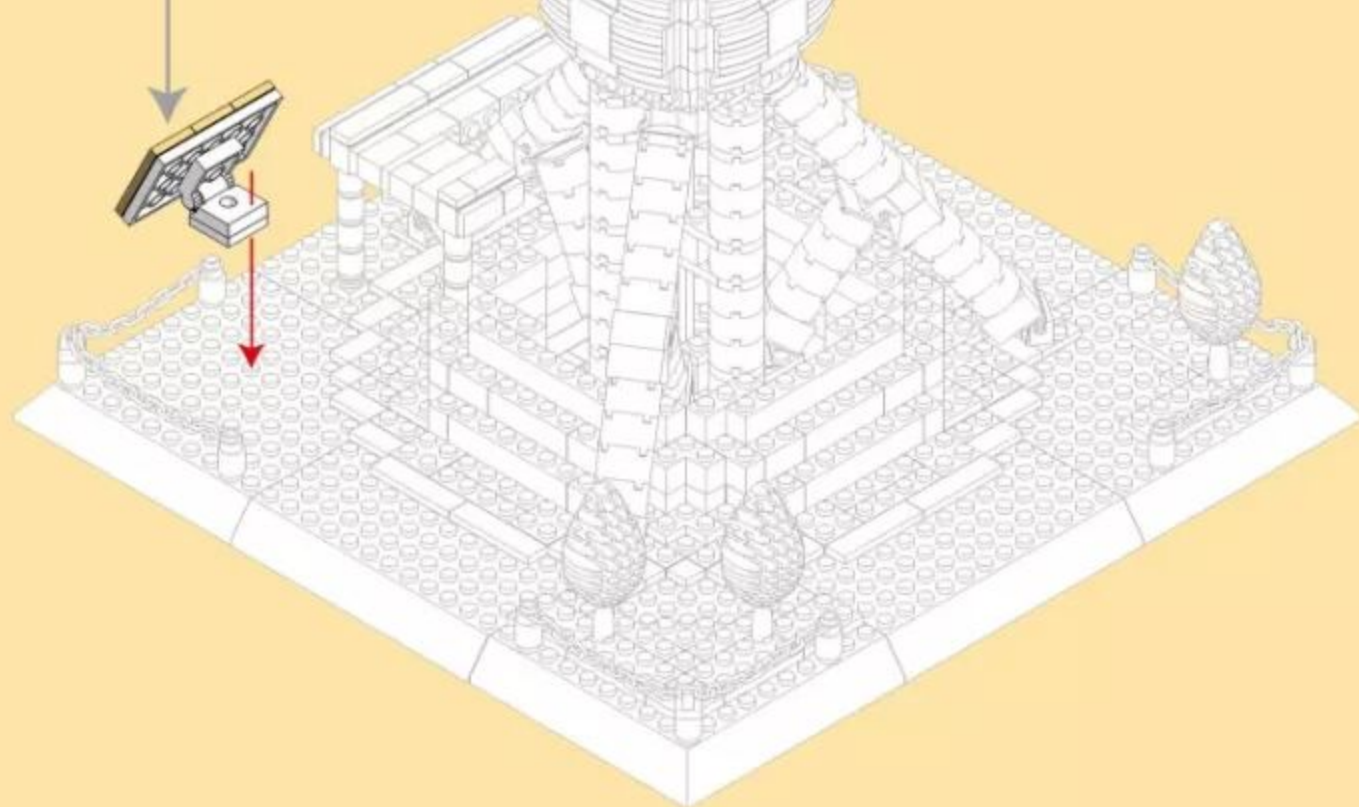
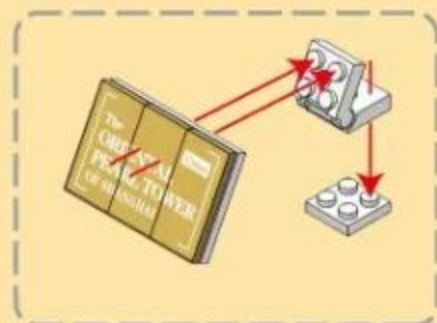



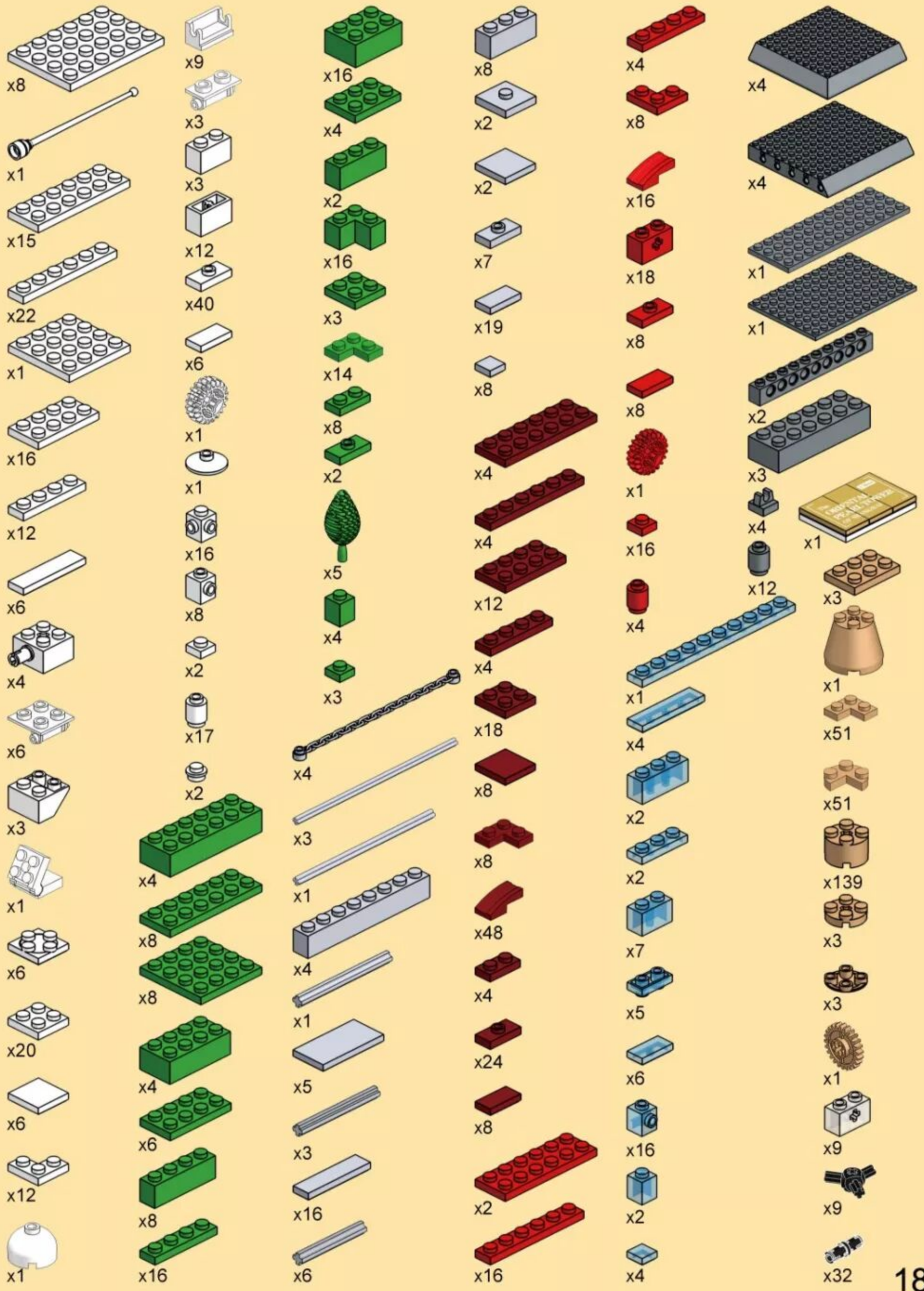



THE ORIENTAL PEARL TOWER OF SHANGHAI

INTRODUCTION

The Oriental Pearl Radio & Television Tower is a TV tower in Shanghai. Its location at the tip of Lujiazui in the Pudong New Area by the side of Huangpu River, opposite The Bund, makes it a distinct landmark in the area. Its principal designers were Jiang Huan Chen, Lin Benlin, and Zhang Xiulin. Construction began in 1991, and the tower was completed in 1994.

At 468 m (1,535 feet) high, it was the tallest structure in China from 1994–2007, when it was surpassed by the Shanghai World Financial Center. It is classified as an AAAAA scenic area by the China National Tourism Administration. The tower is brightly lit in different LED sequences at night. On 7 July 2007, Oriental Pearl Tower was host to the Chinese Live Earth concert.

The tower features 11 spheres, big and small. The two largest spheres, along the length of the tower, have diameters of 50 m (164 ft) for the lower and 45 m (148 ft) for the upper. They are linked by three columns, each 9 m (30 ft) in diameter. The highest sphere is 14 m (46 ft) in diameter.

The entire tower is supported by three enormous columns that start underground.

