



MAIDEN TOWER

Torre de la Doncella
Istanbul, Turkey

The world's great architecture

Ages 6+



6+ / 5229 / 910 PCS
Suitable Age / Product Number / Parts Total



Architecture

It will be a city...

这将构成一座城市...

ABOUT THE PRODUCT

关于产品

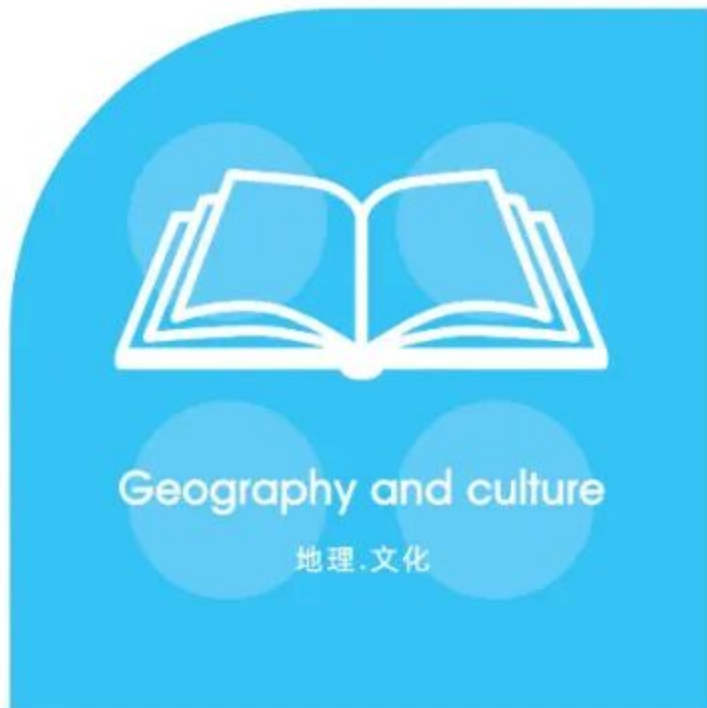

ARCHITECTURE

WANGE The world's great architect since 1991

Maiden's Tower



This article is about the landmark in Istanbul, Turkey.
For other uses, see Maiden's Tower .

Maiden's Tower



Geography and culture

地理·文化



The Maiden's Tower, also known as Leander's Tower since the medieval Byzantine period, is a tower on a small islet at the southern entrance of the Bosphorus strait 200 m from the coast of Uskudar in Istanbul, Turkey.



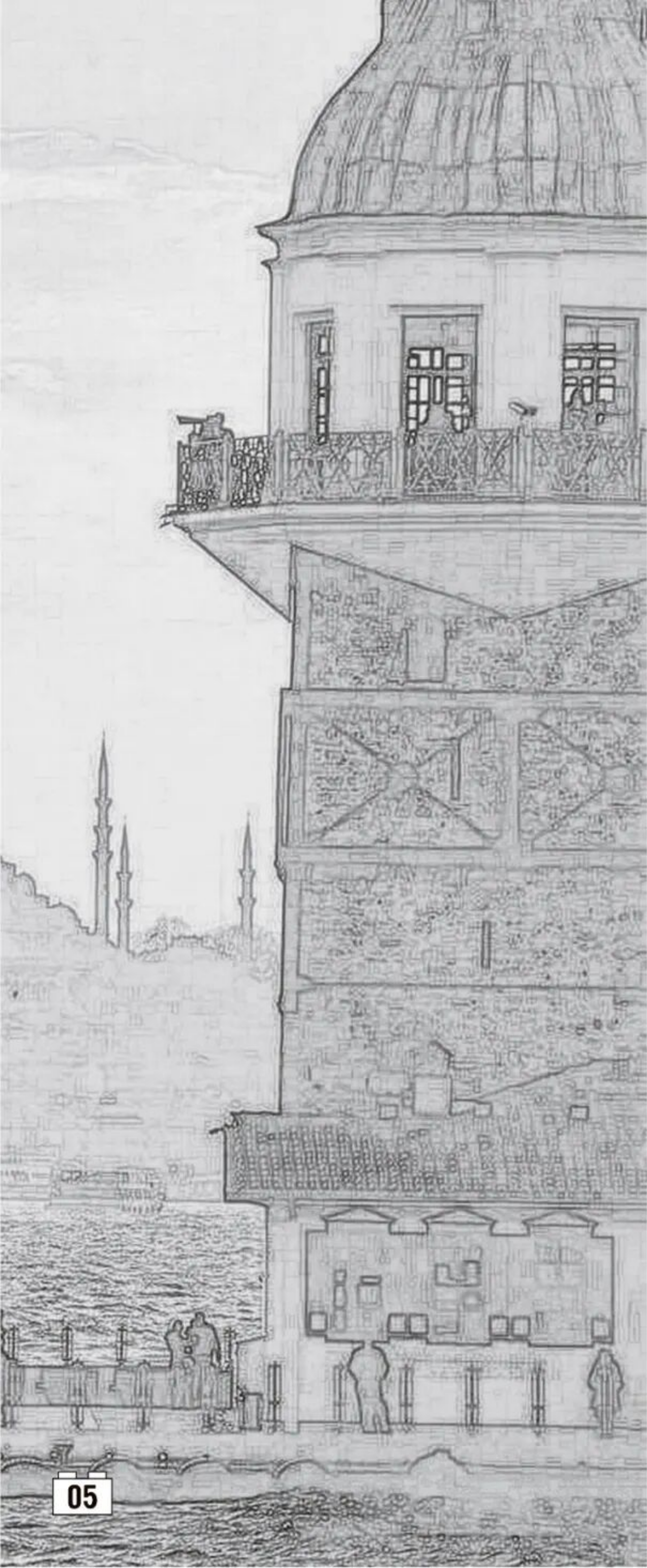

Torre de la Doncella

Maiden's ■

Tower

Turkey

The contents of this chapter refer to the Wikipedia website.

本章内容参考维基百科网站，更多资讯可自行查阅。

The world's great architecture

History and Legend

■ 历史和传奇



The tower, often named Leander's Tower in reference to the legend of Hero and Leander (which took place in the Dardanelles strait, also known as the Hellespont in antiquity), was destroyed during the earthquake of 1509, and burned in 1721. Since then it was used as a lighthouse, and the surrounding walls were repaired in 1731 and 1734, until in 1763 it was erected using stone. From 1829 the tower was used as a quarantine station, and in 1832 was restored by Sultan Mahmud II. Restored again by the harbour authority in 1945, the most recent restoration began in 1998 for the James Bond movie *The World Is Not Enough*, and steel supports were added around the ancient tower as a precaution after the 17 August 1999 earthquake.

The interior of the tower has been converted into a café and restaurant, with views of the former Roman, Byzantine and Ottoman capital. Private boats make trips to the tower several times a day.



History

Tras la victoria naval de Cícico, se cree que el general ateniense Alcibiades construyó una estación aduanera para los barcos que vinieran del Mar Negro en una pequeña roca frente a Chrysopolis (actual Üsküdar). En 1110 el Emperador bizantino Alejo I Comneno construyó una torre de madera protegida por una muralla de piedra. Desde la torre se extendía una cadena de hierro hacia otra torre construida en la costa europea, en el barrio de Mangana de Constantinopla. El islote estaba conectado a la costa asiática mediante una muralla defensiva, cuyos restos subterráneos son todavía visibles. Durante la conquista otomana de Constantinopla de 1453, la torre albergó una guarnición bizantina comandada por el veneciano Gabriele Trevisano. Posteriormente, la torre fue usada como atalaya por los otomanos durante el reinado del Sultán Mehmed II



Legend

Hay muchas leyendas sobre la construcción de la torre y su localización. Según la leyenda turca más popular, un emperador tenía una hija muy querida y un día, un oráculo profetizó que sería asesinada por una serpiente venenosa en su 18º cumpleaños. El emperador, en un esfuerzo por impedir la temprana muerte de su hija colocándola lejos de la tierra para mantenerla alejada de las serpientes, construyó esta torre en medio del Bósforo para proteger a su hija hasta su 18º cumpleaños. La princesa se instaló en la torre, donde era visitada frecuentemente solo por su padre.

En el 18º cumpleaños de la princesa, el emperador le llevó una cesta de frutas exóticas como regalo, contento de que había sido capaz de evitar la profecía. Sin embargo, al coger la cesta, un áspid que se escondía entre la fruta mordió a la joven princesa y esta murió en los brazos de su padre, justo como había predicho el oráculo. De ahí el nombre Torre de la Doncella.

Design Points

结构难点

Angle calculation

角度的计算

$$S=4\pi \cdot r^2$$

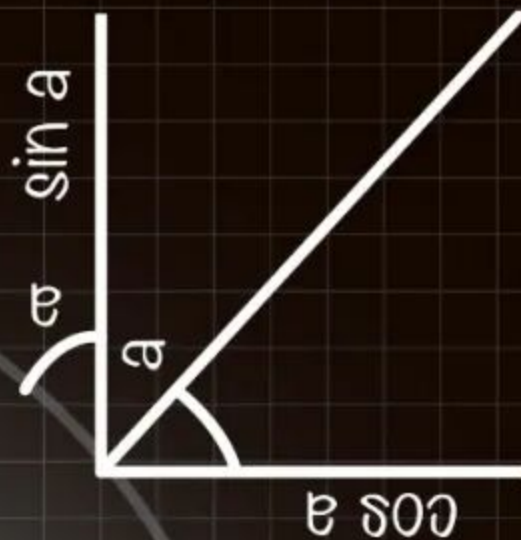

$$a^2+b^2=c^2$$

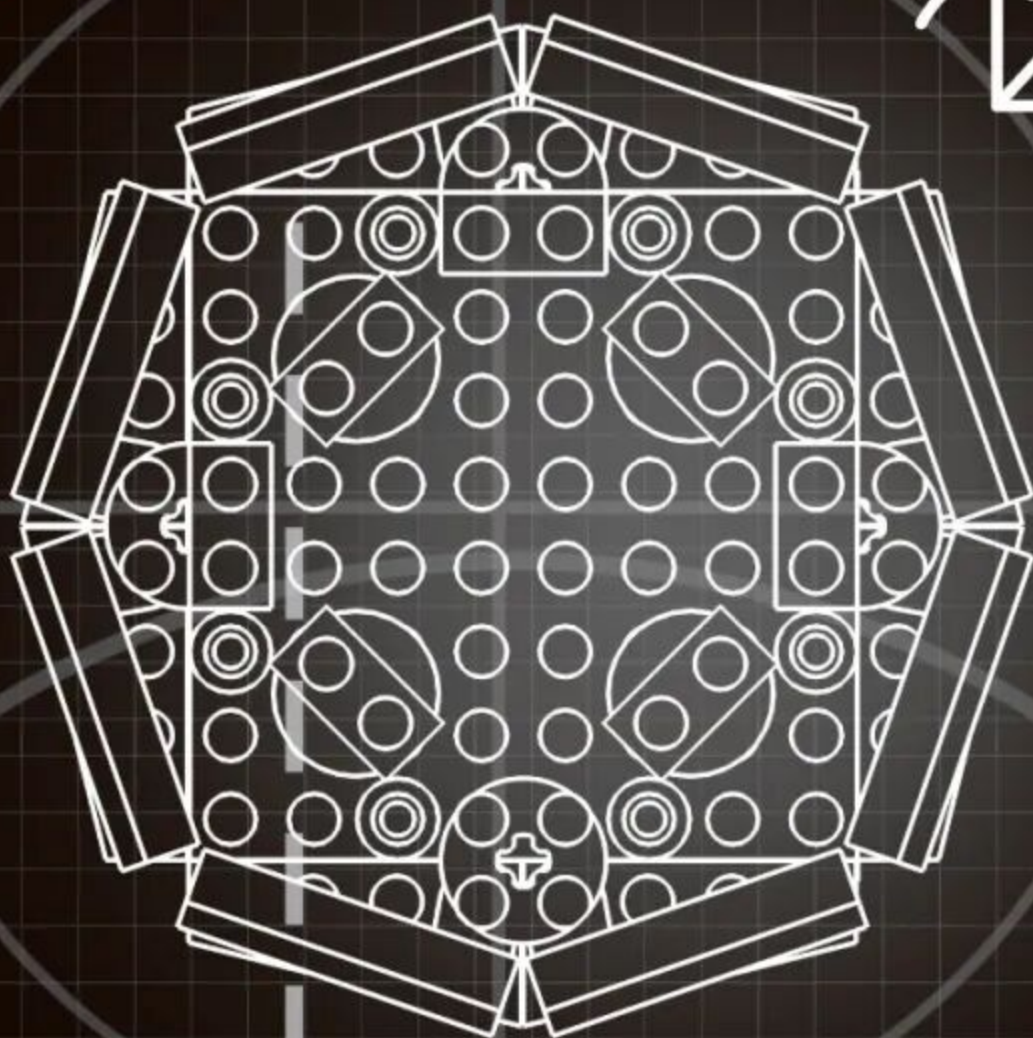

$$\sin^2 a + \cos^2 a = 1$$

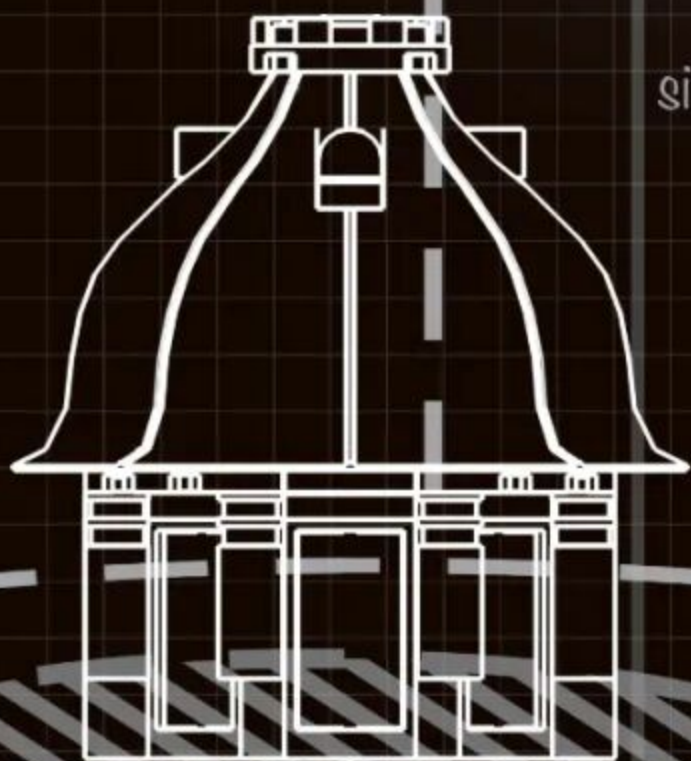

Creation and thinking

创作·思考

08

Special parts

特殊零件的开发利用

$$S=4\pi \cdot r^2$$



WG1378

花型塔顶4孔

$$a^2+b^2=c^2$$



WG1343

3孔米字栏杆



WG1370

角斜3X3孔



WG1317

直角墙砖

$$\sin^2 a + \cos^2 a = 1$$



WG1288

弧形高1孔



features and functions

特点.功能

Main Color Matching

配色方案



Pantone Black 6C



Pantone 431C



Pantone Cool Gray 6C



Pantone 473C



Pantone 472C



Pantone 123C



Pantone 7620C



Pantone 7500C



Pantone 7509C

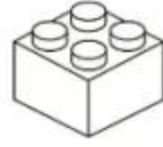

Pantone 4625C



Pantone 2184C



Color matching

Adopting 4 main colors, White, Orange, light grey and Red as the main color, the more reasonable and bold color matching on the original building, making the product more atmospheric and the whole design is more reasonable.

Maiden's Tower

土耳其少女塔



Front

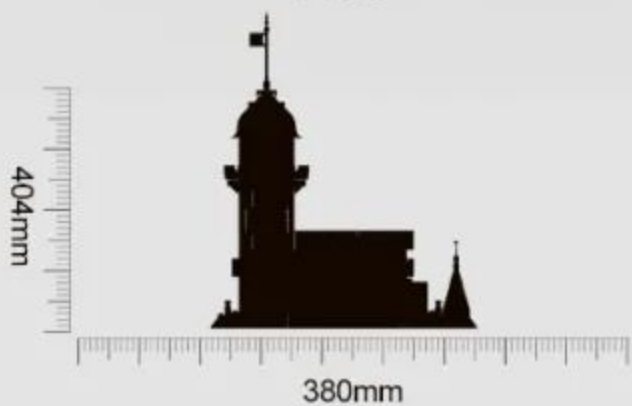

Left

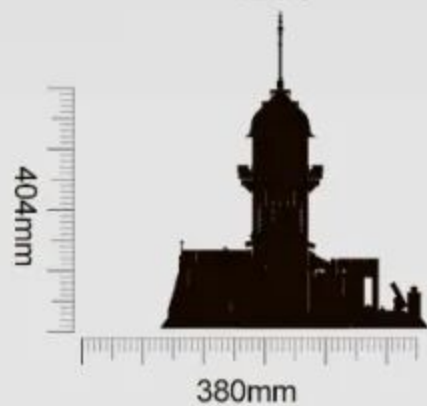

Back

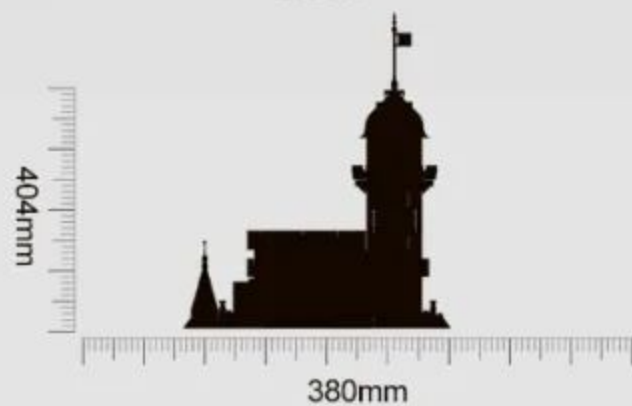

Product Size:404X380X380mm



Instructions For Use

积木起件器使用说明
Brickseparator

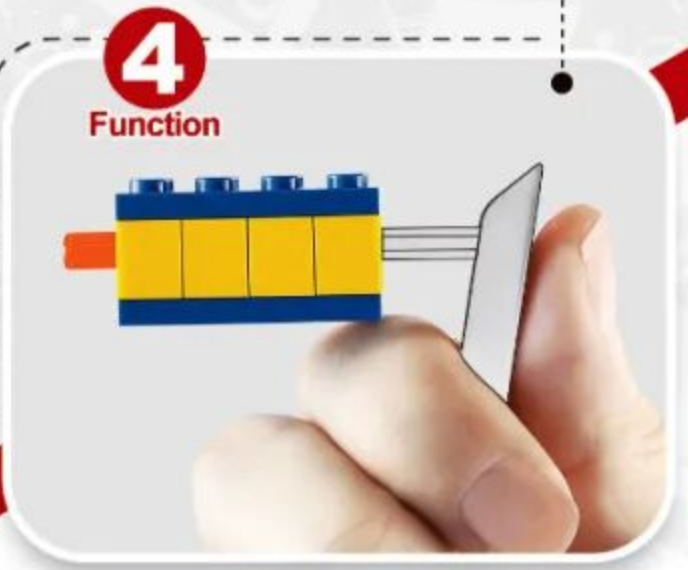
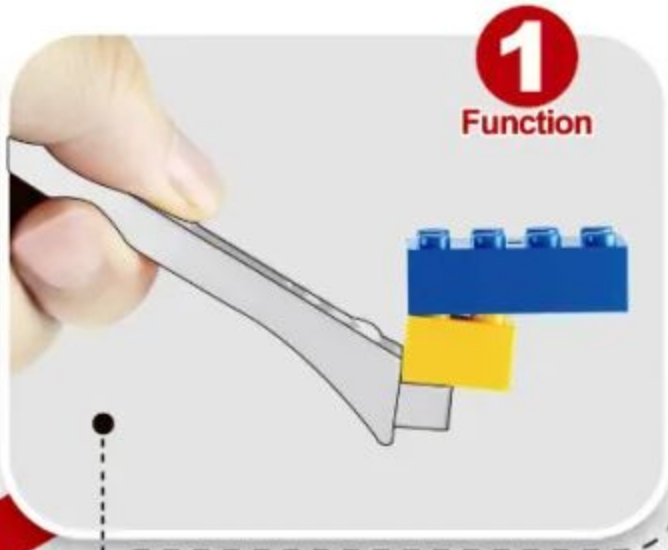

4 ways to make installation easier
让安装更简单



■ First open the product packaging according to the instructions.

按指导用正确方式拆解产品外包装。



■ Summarize all parts to count the number of familiar accessories.

对照说明书清单确认积木包数量与积木数量。



■ Arranging all accessories by color helps to quickly install the product.

把确认好的积木以类型、颜色进行分类排好以便安装。



■ Carefully install the product and learn about building.

按说明书步骤拼装并完成你的积木模型。



1:1 Physical Reference Table

十字棒配件1:1尺寸参照表



Instructions For Use

让安装更简单



2 $(1 \times 2) = 2$

3 $(1 \times 3) = 3$

4 $(1 \times 4) = 4$

5 $(1 \times 5) = 5$

6 $(1 \times 6) = 6$

7 $(1 \times 7) = 7$

8 $(1 \times 8) = 8$

9 $(1 \times 9) = 9$

10 $(1 \times 10) = 10$

12 $(1 \times 12) = 12$

16 $(1 \times 16) = 16$



116PCS

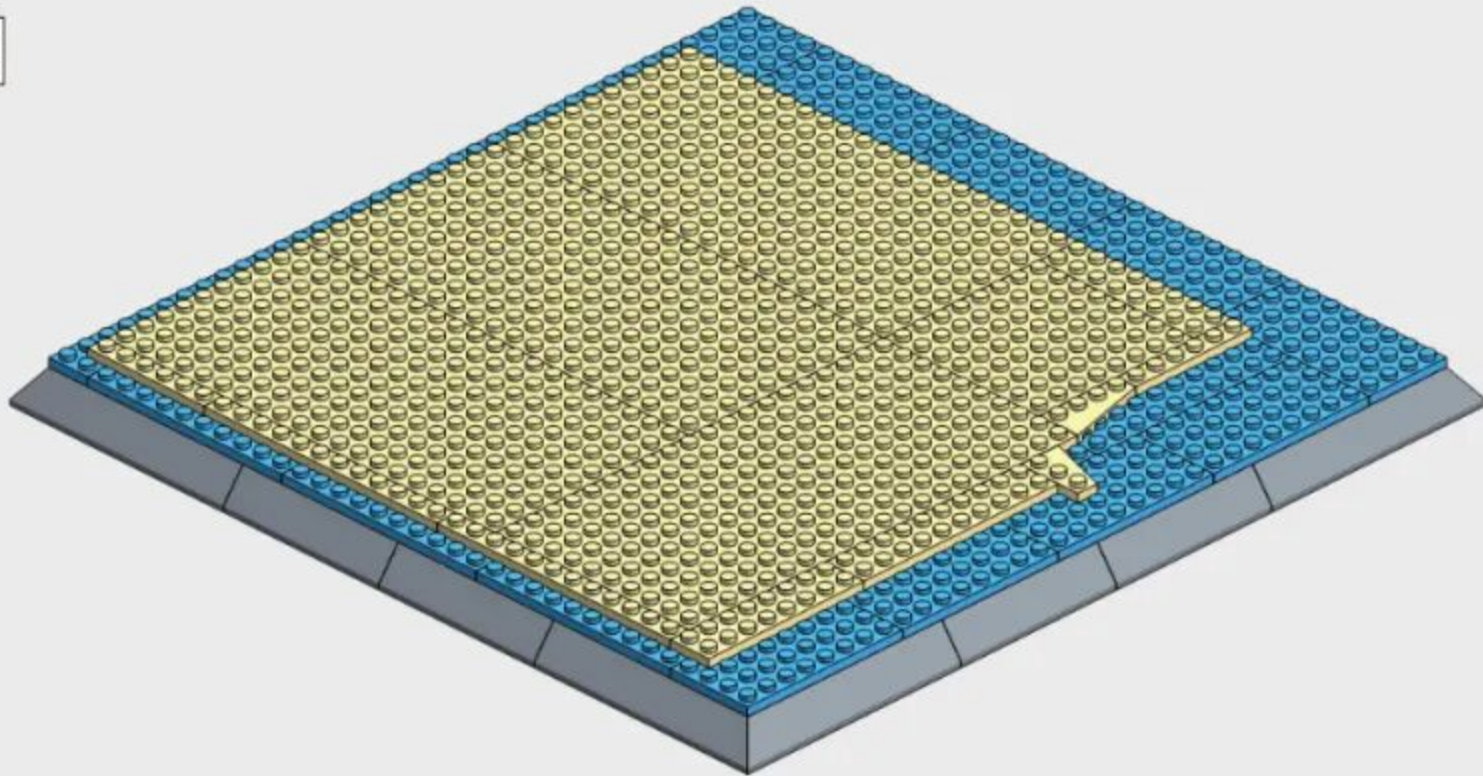

1-1

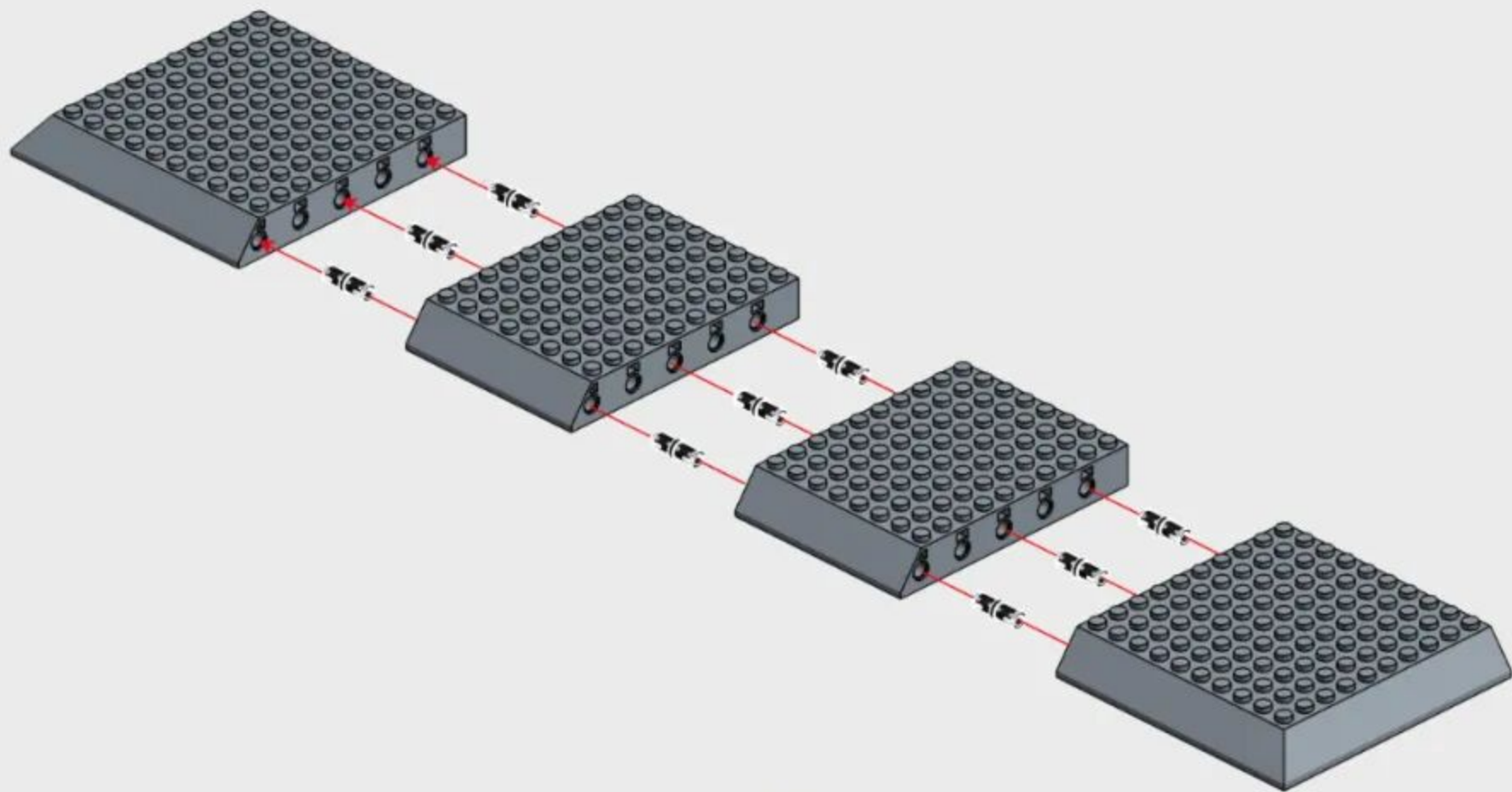
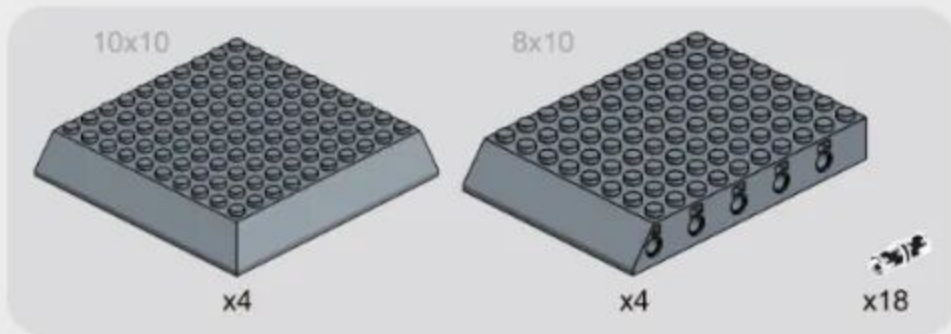

1-2

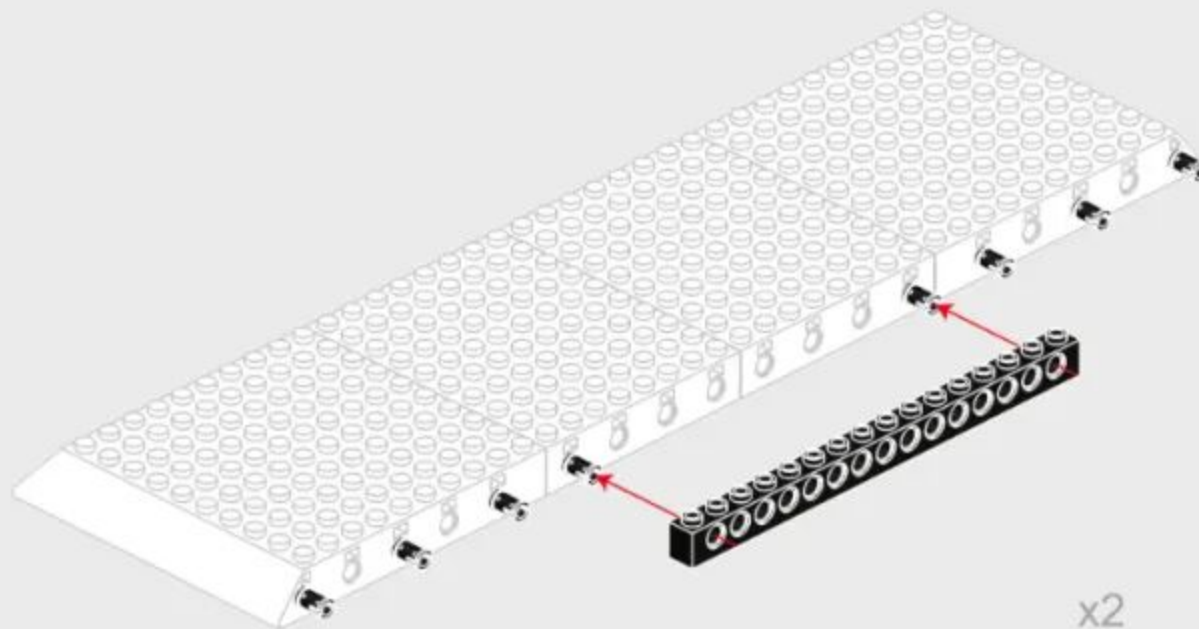
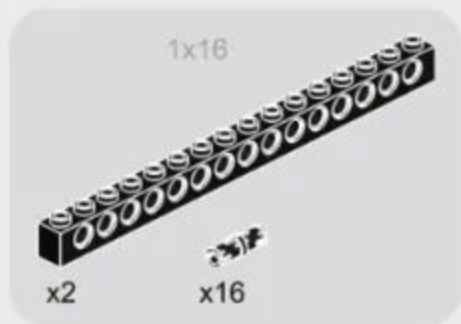

1-3

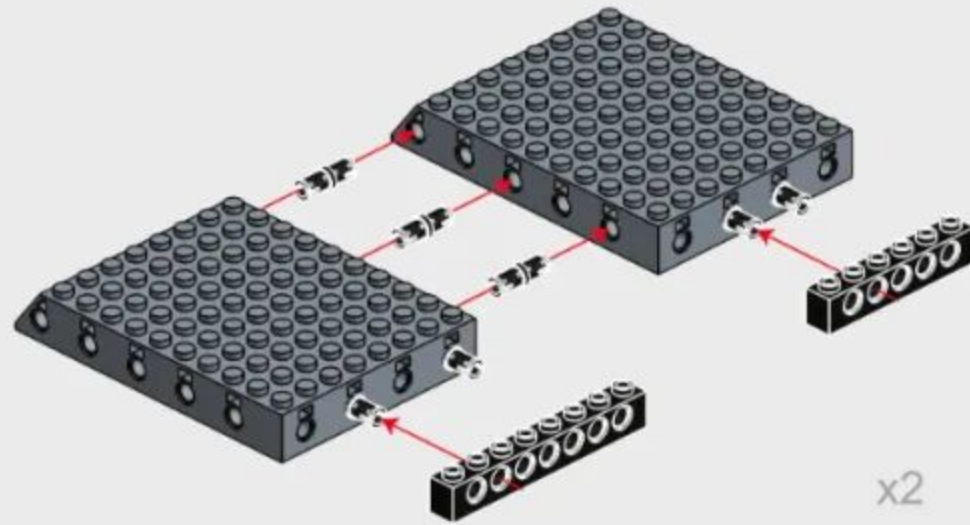
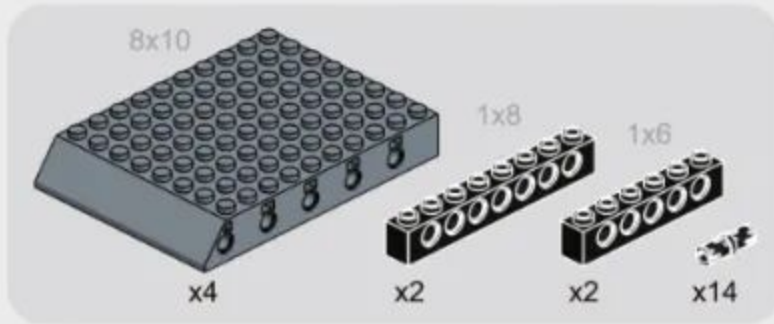

1-4

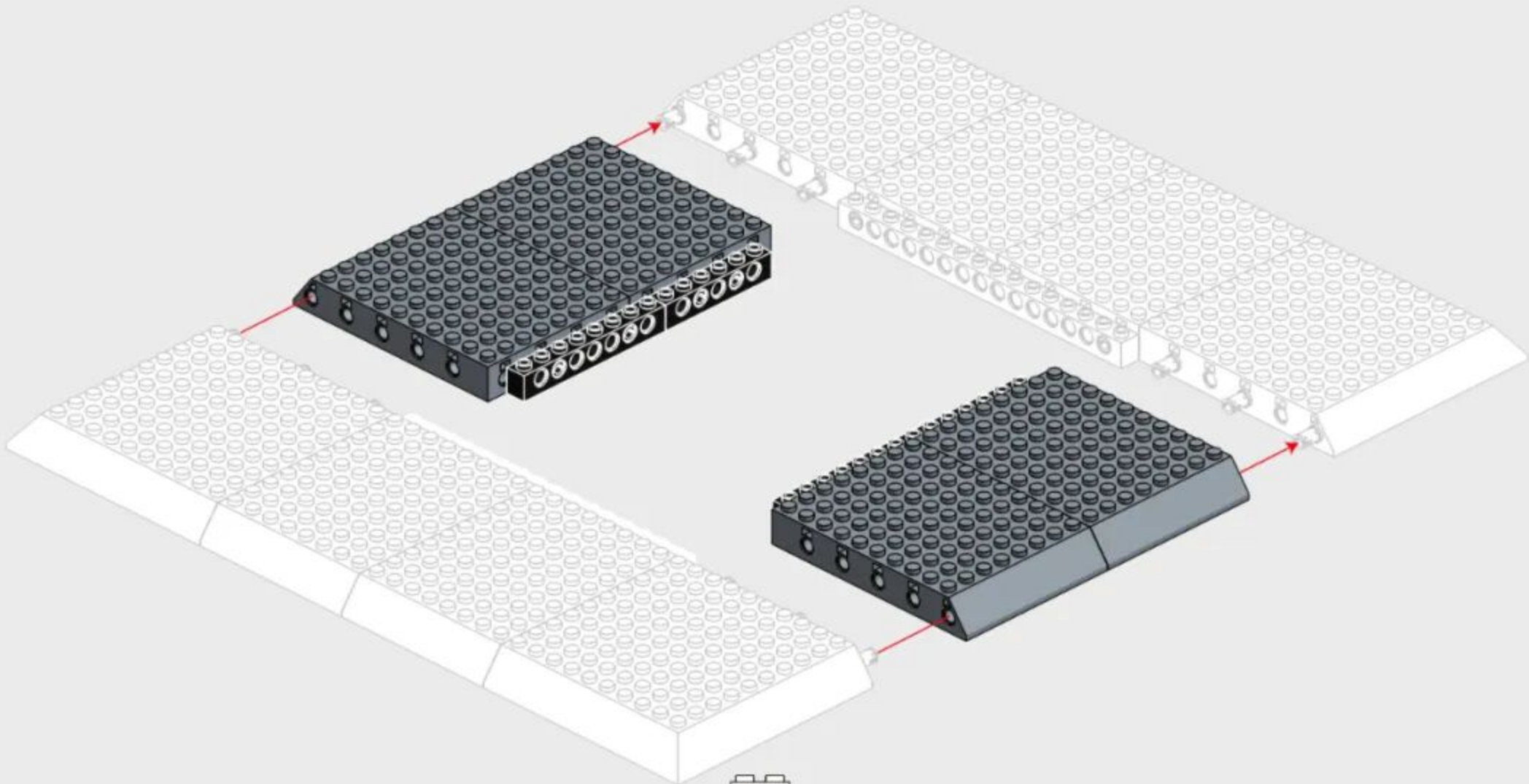

1-5

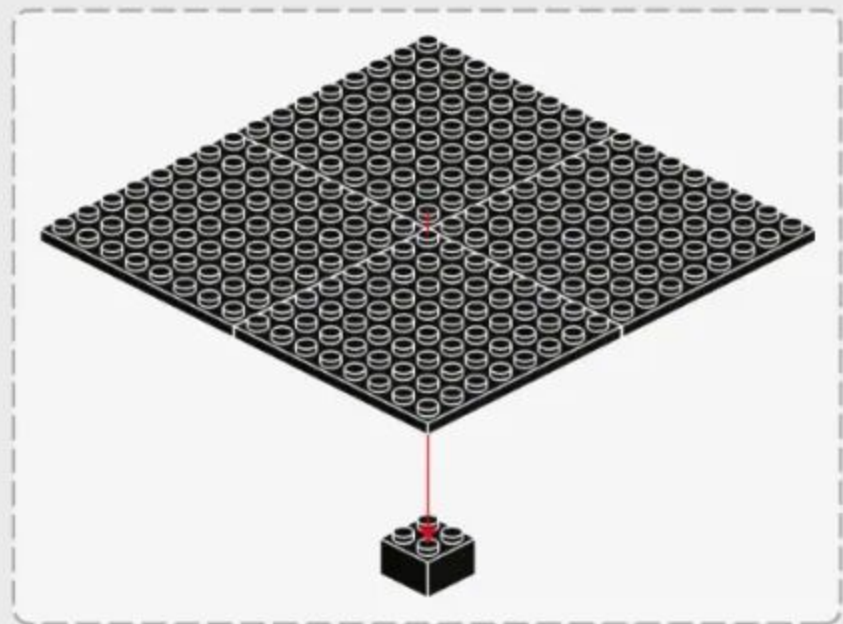
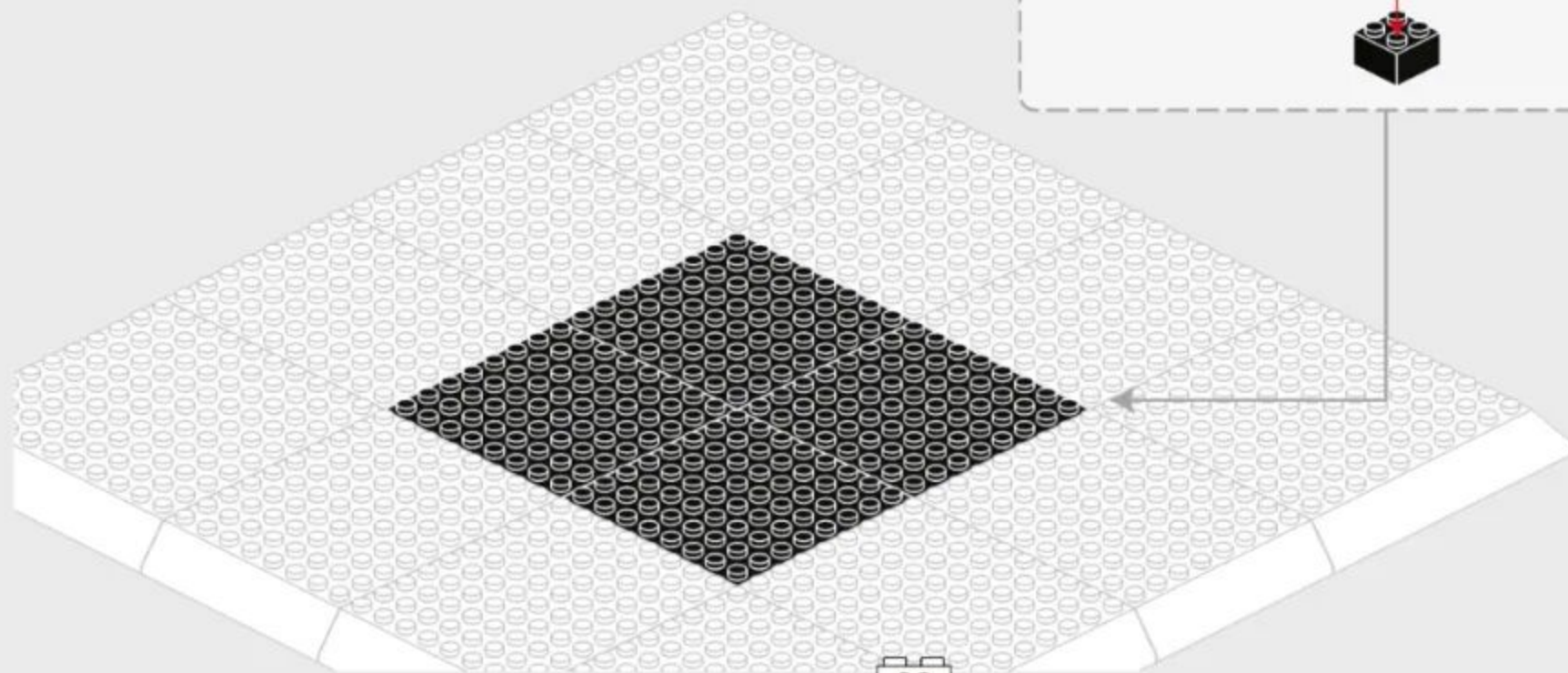
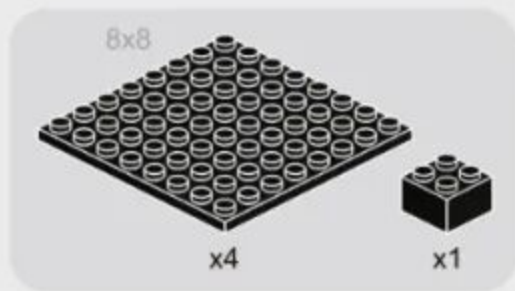

1-6

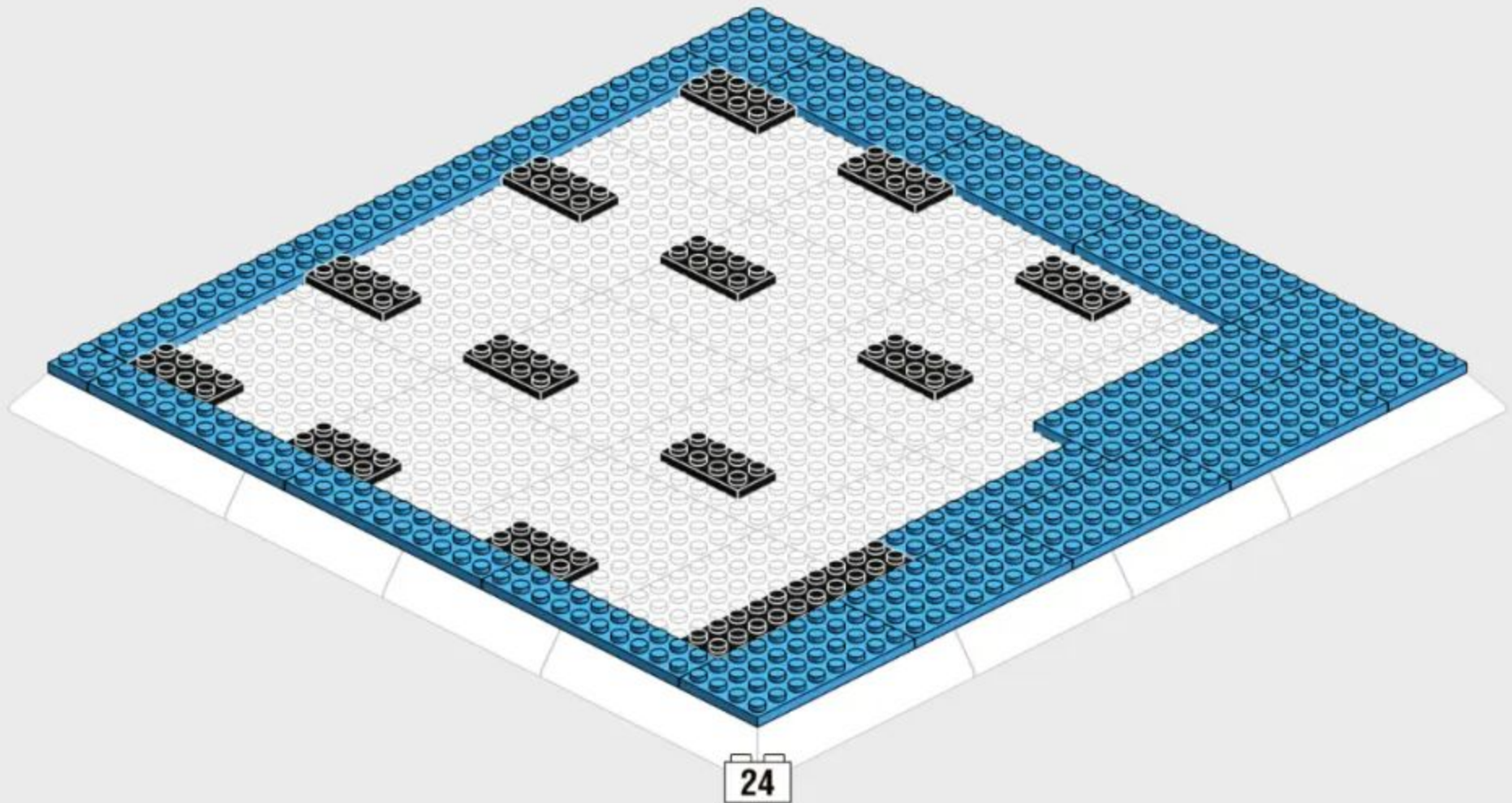
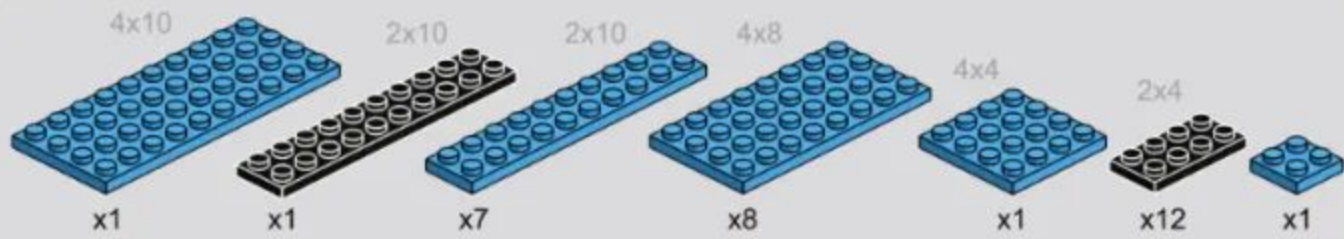

1-7

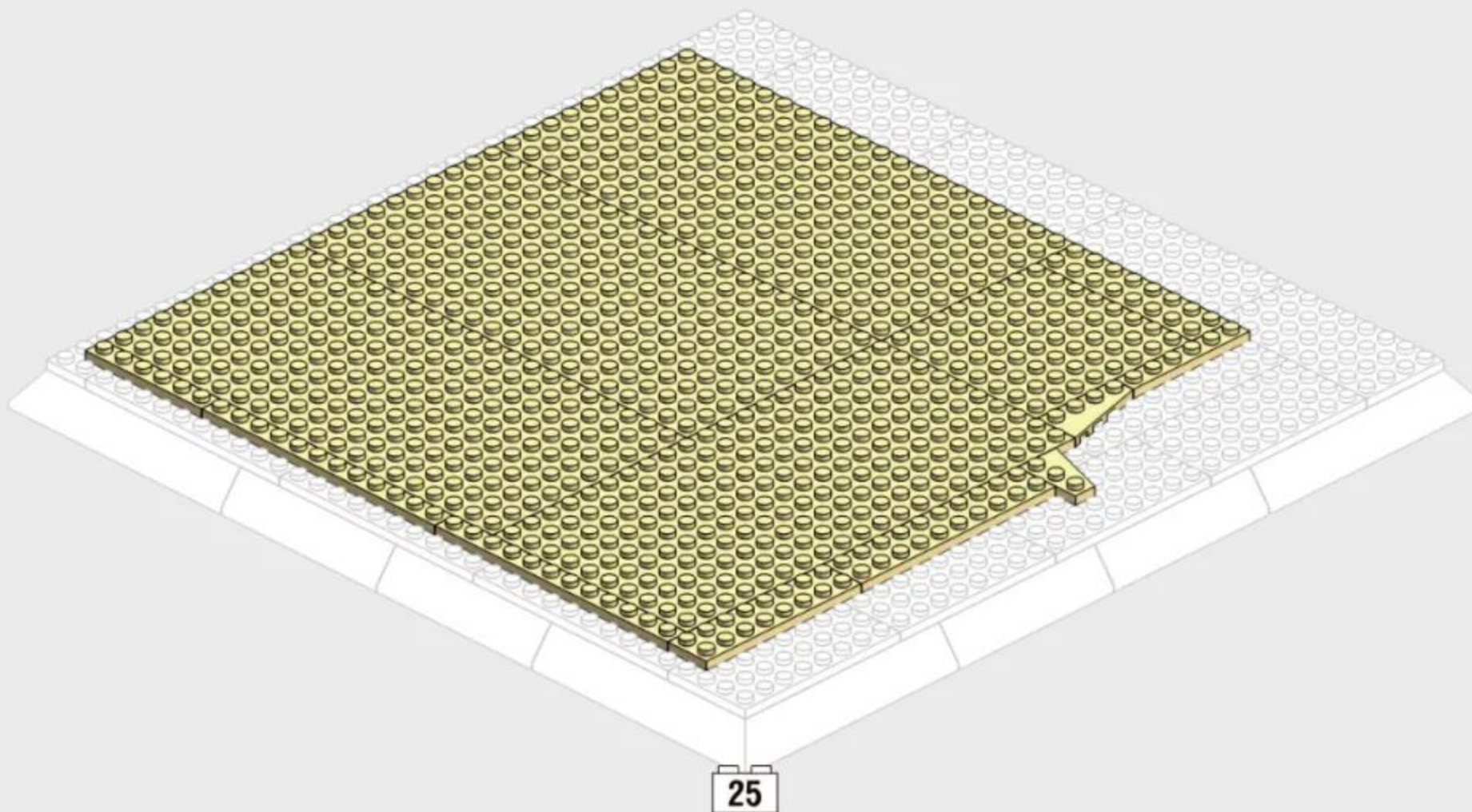
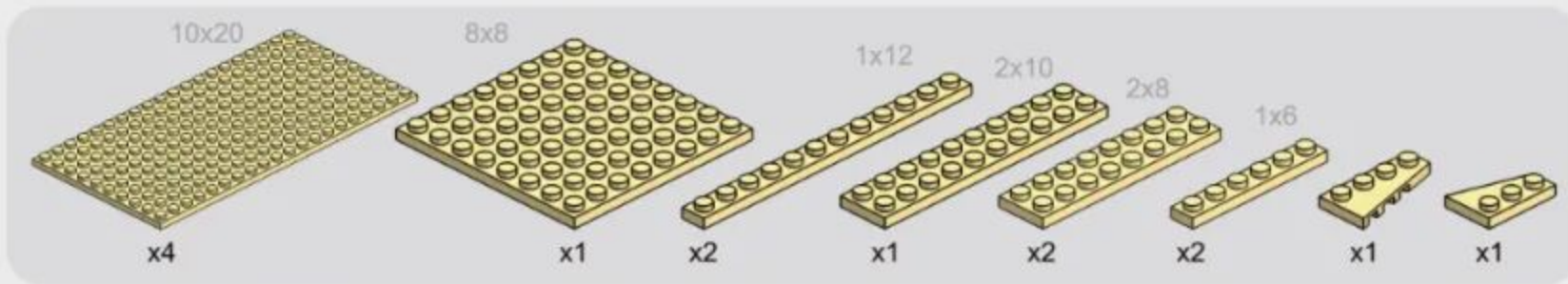



286PCS



2-1

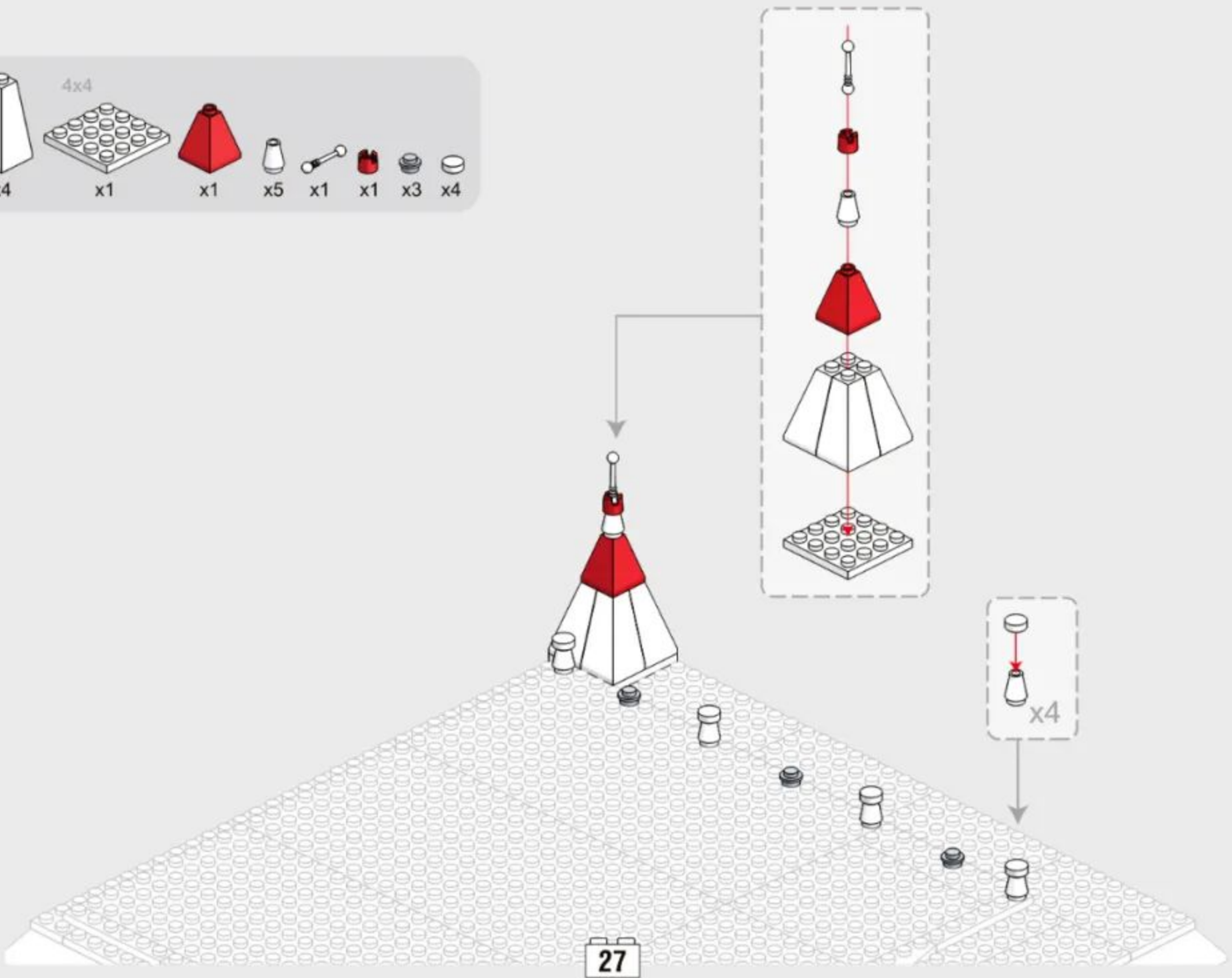

2-2

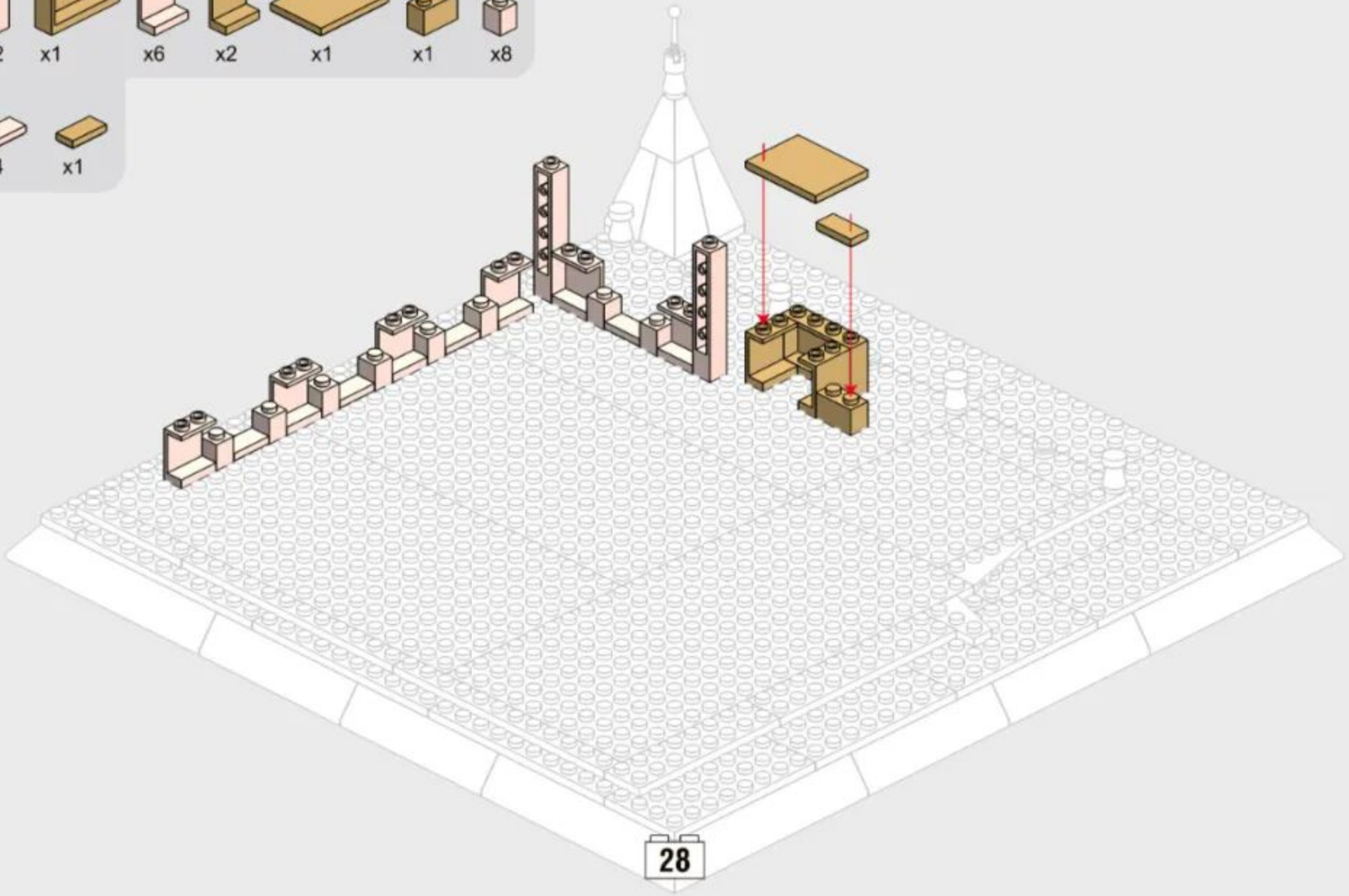
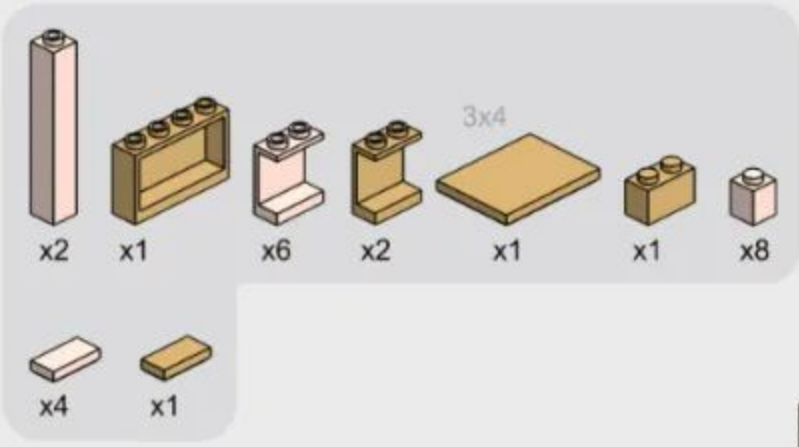

2-3

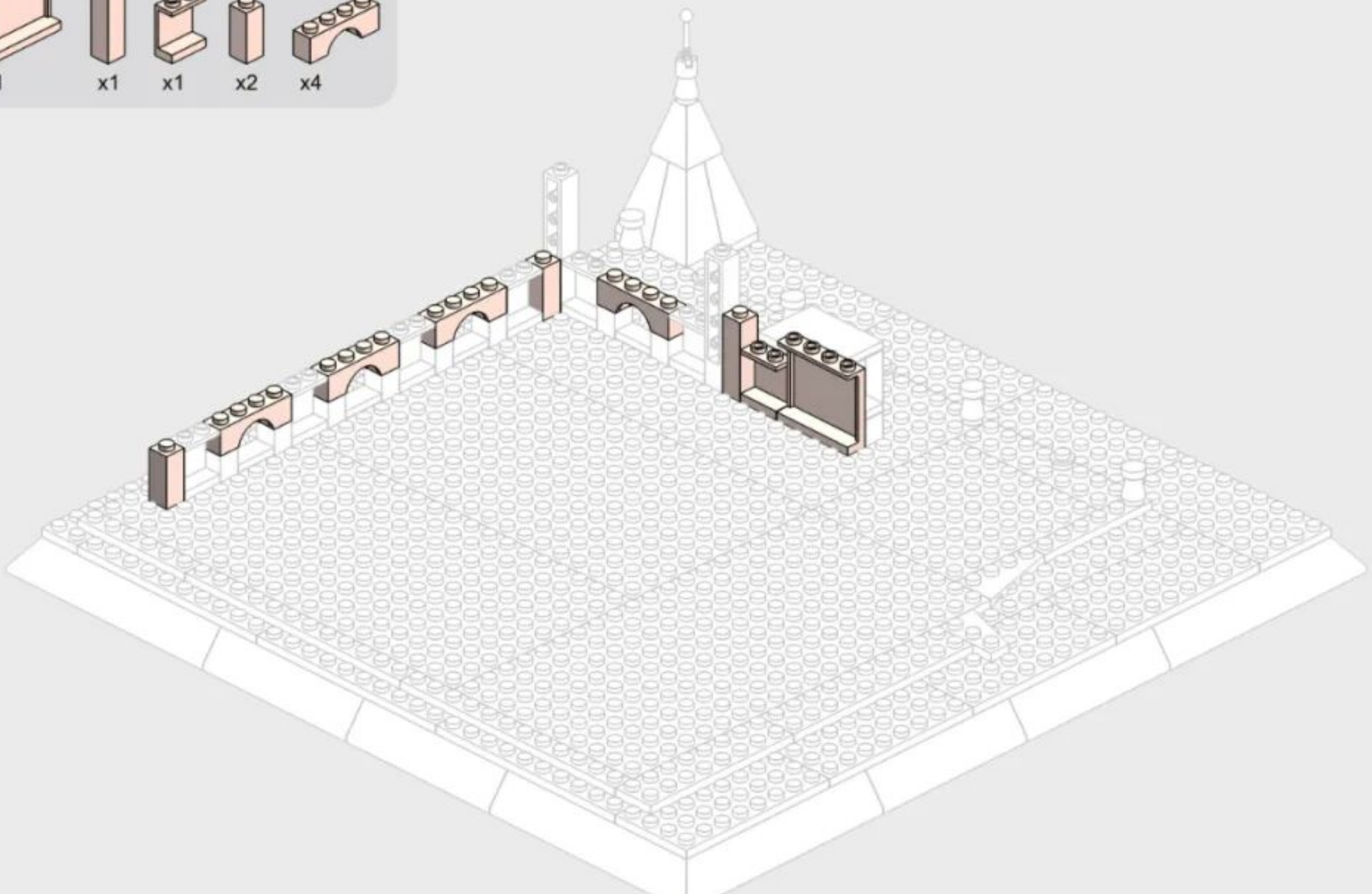
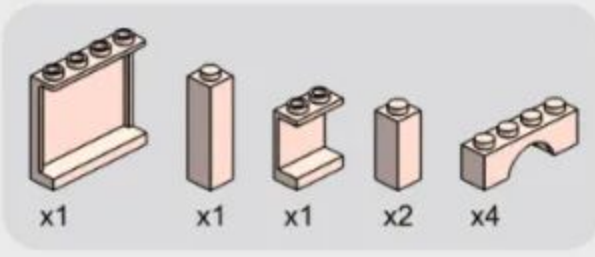

2-4

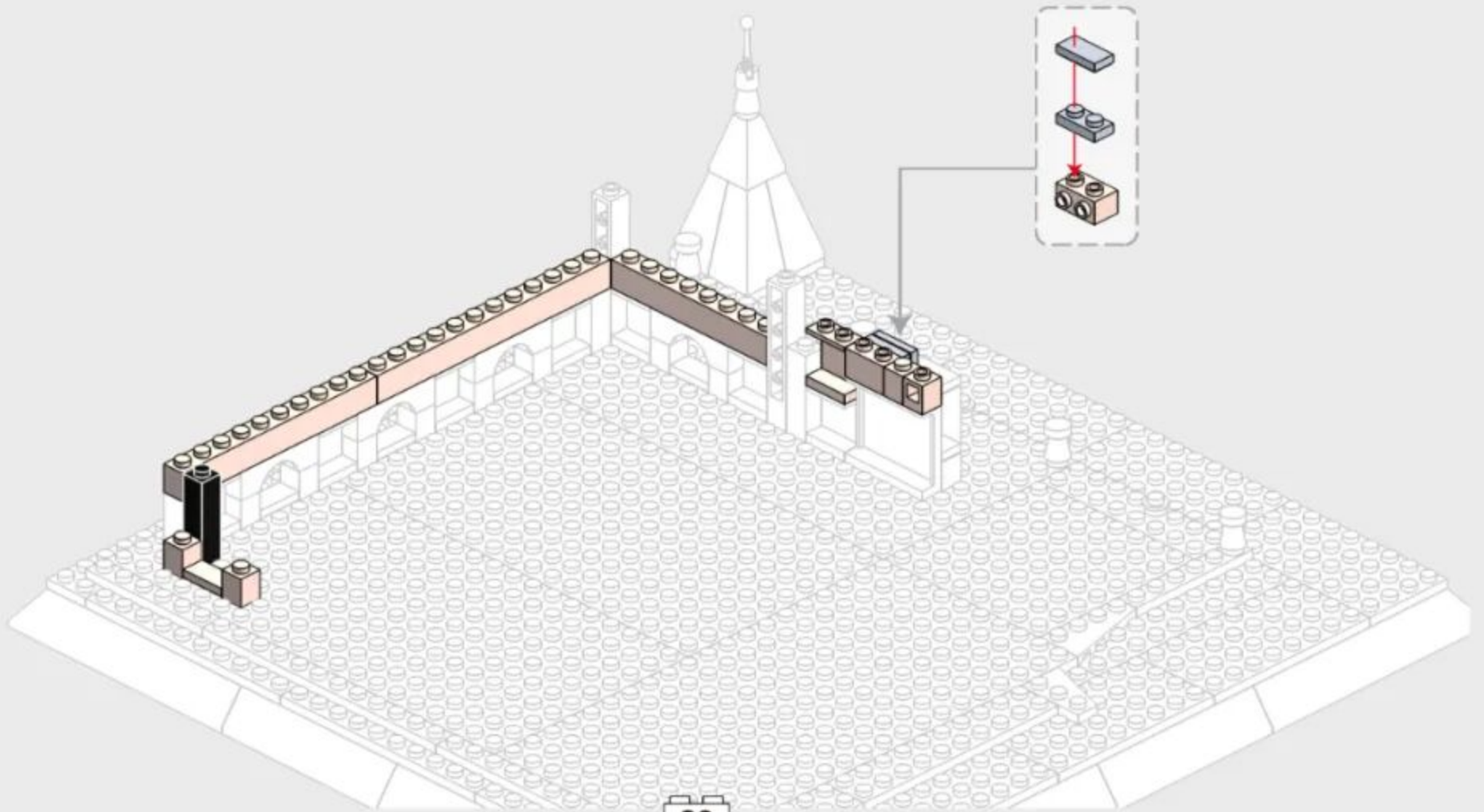
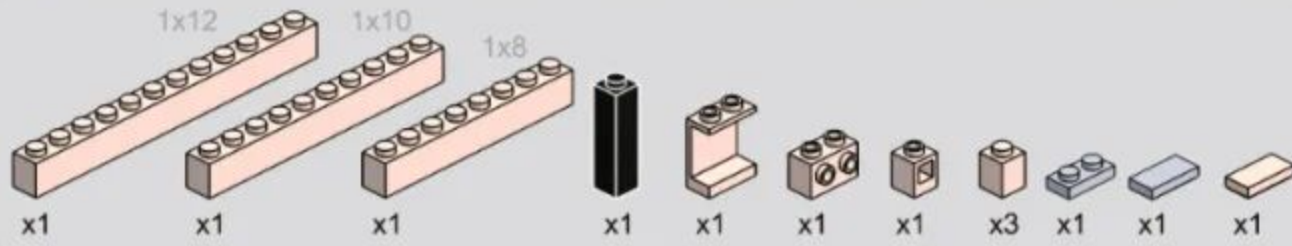

2-5

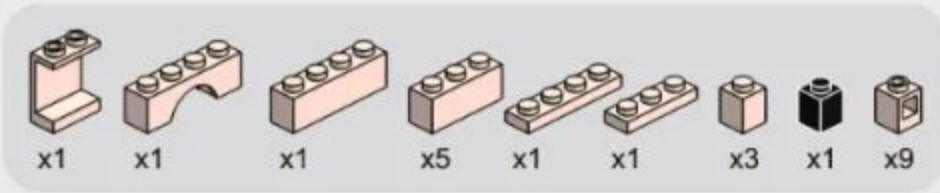

2-7

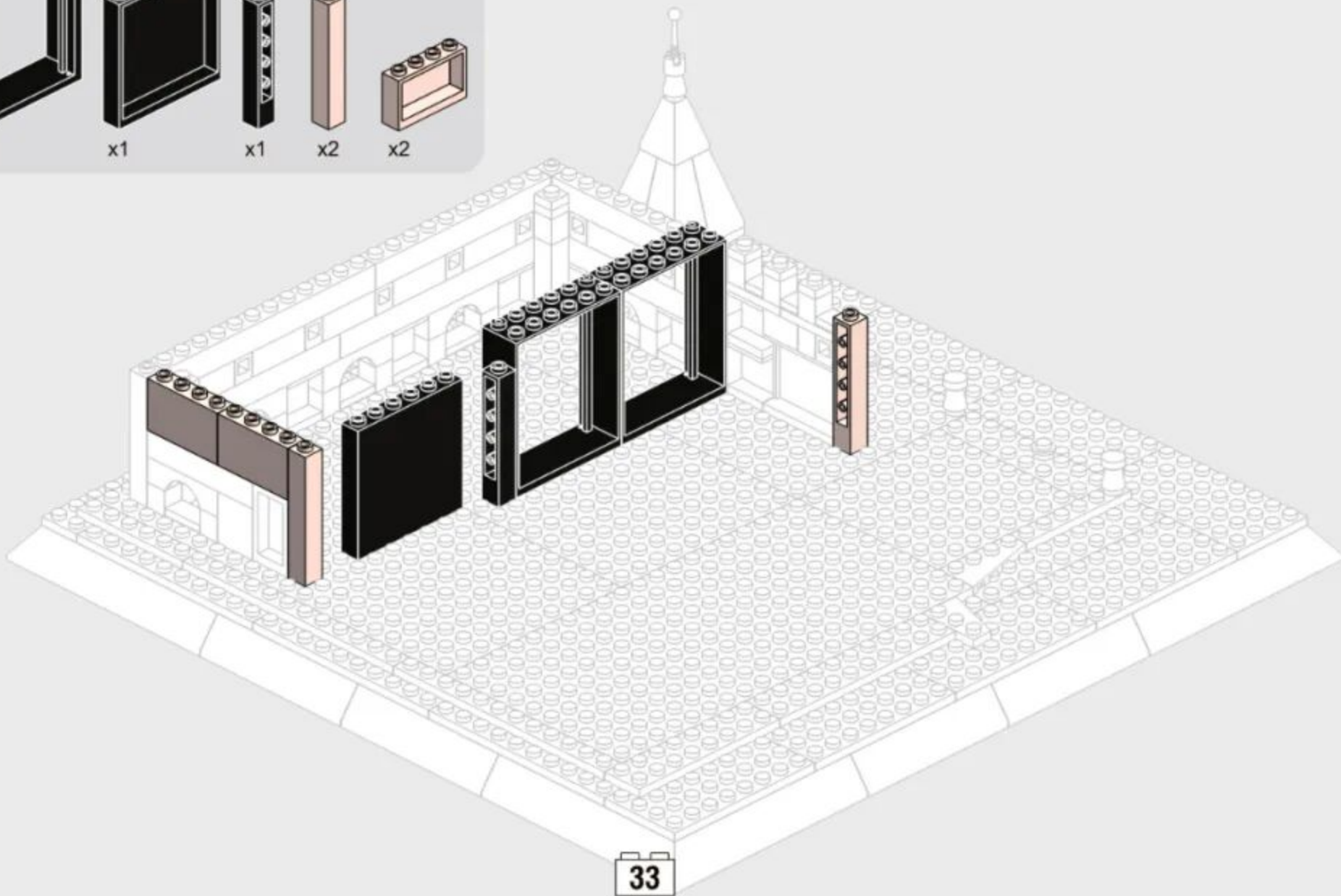
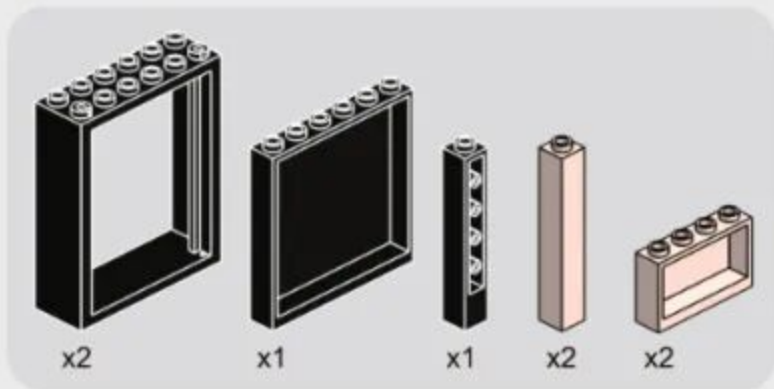

2-8

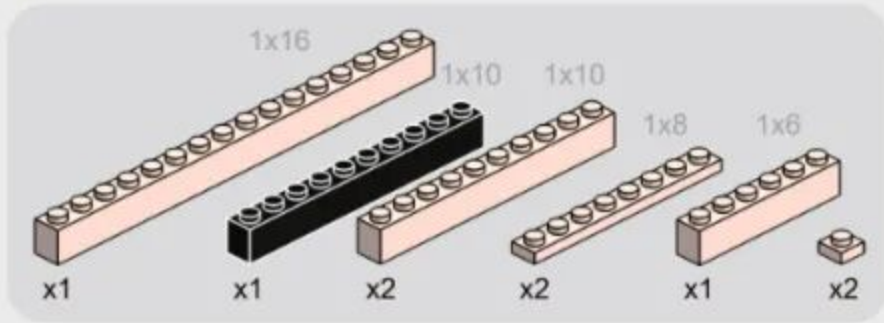

2-9

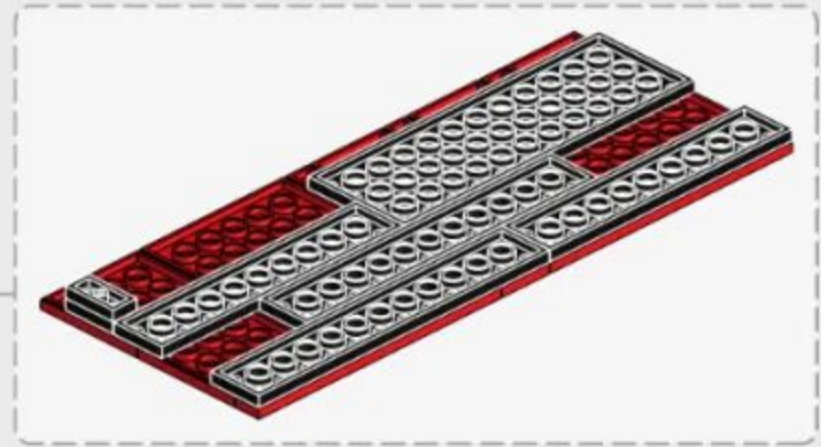
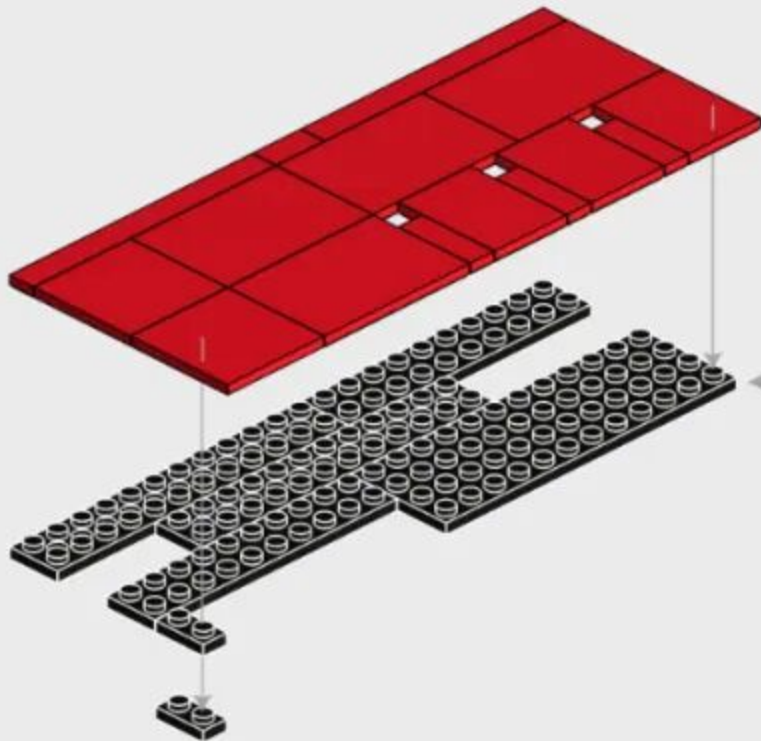
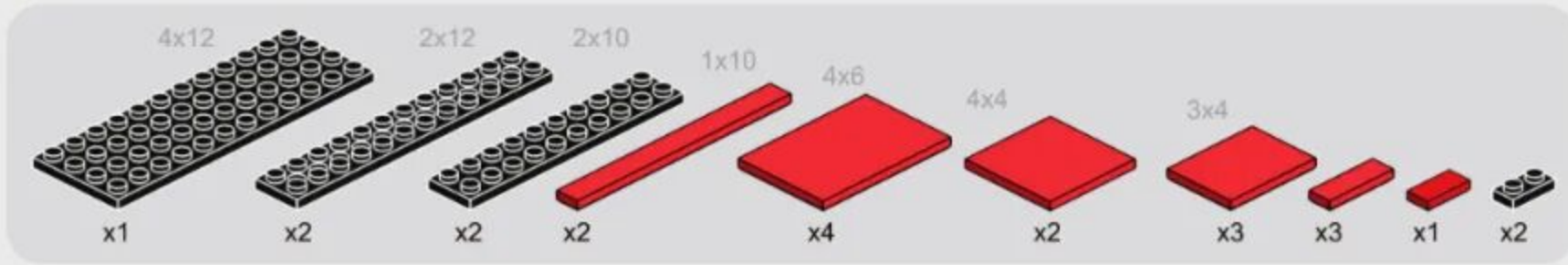

2-10

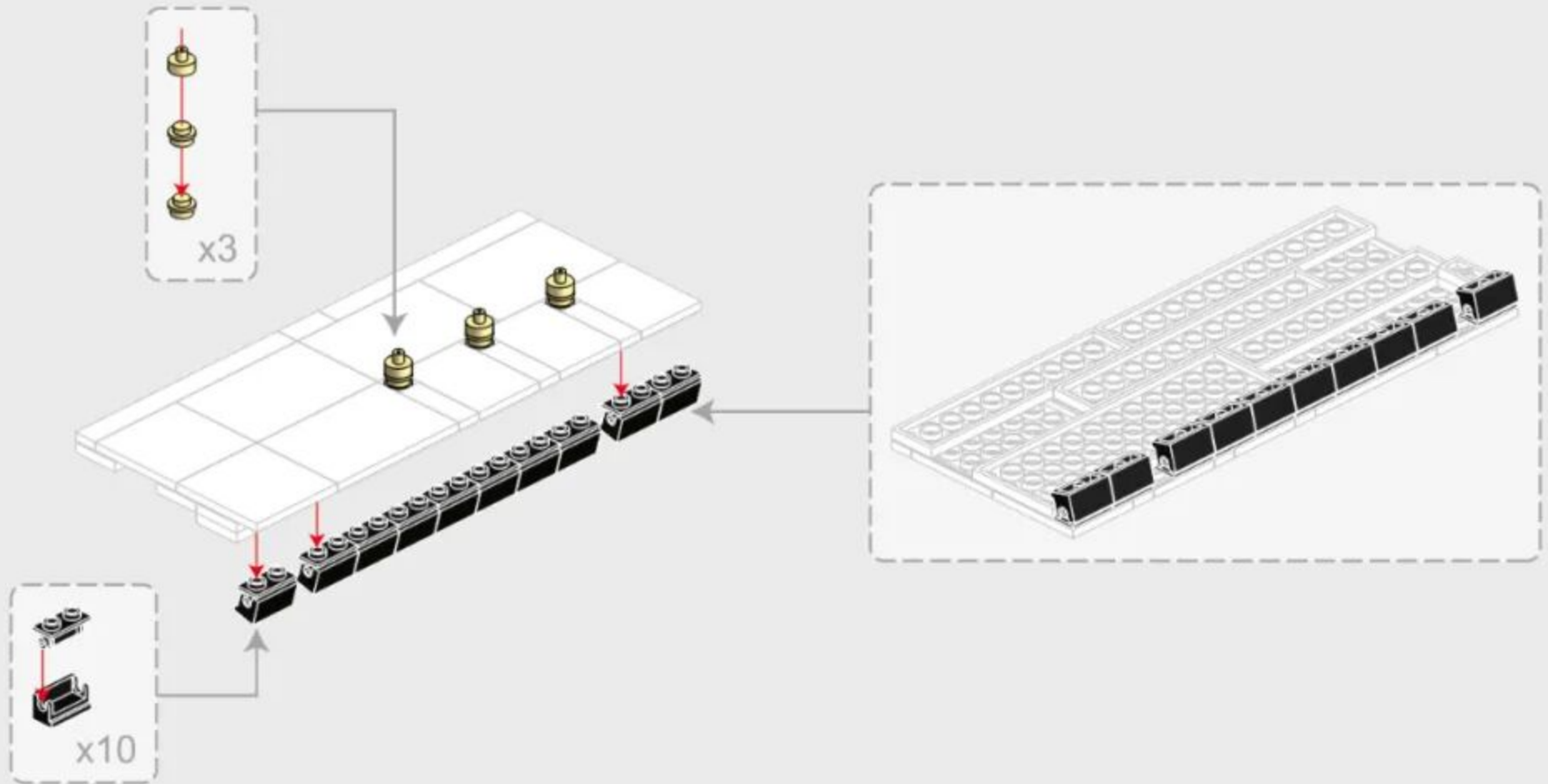

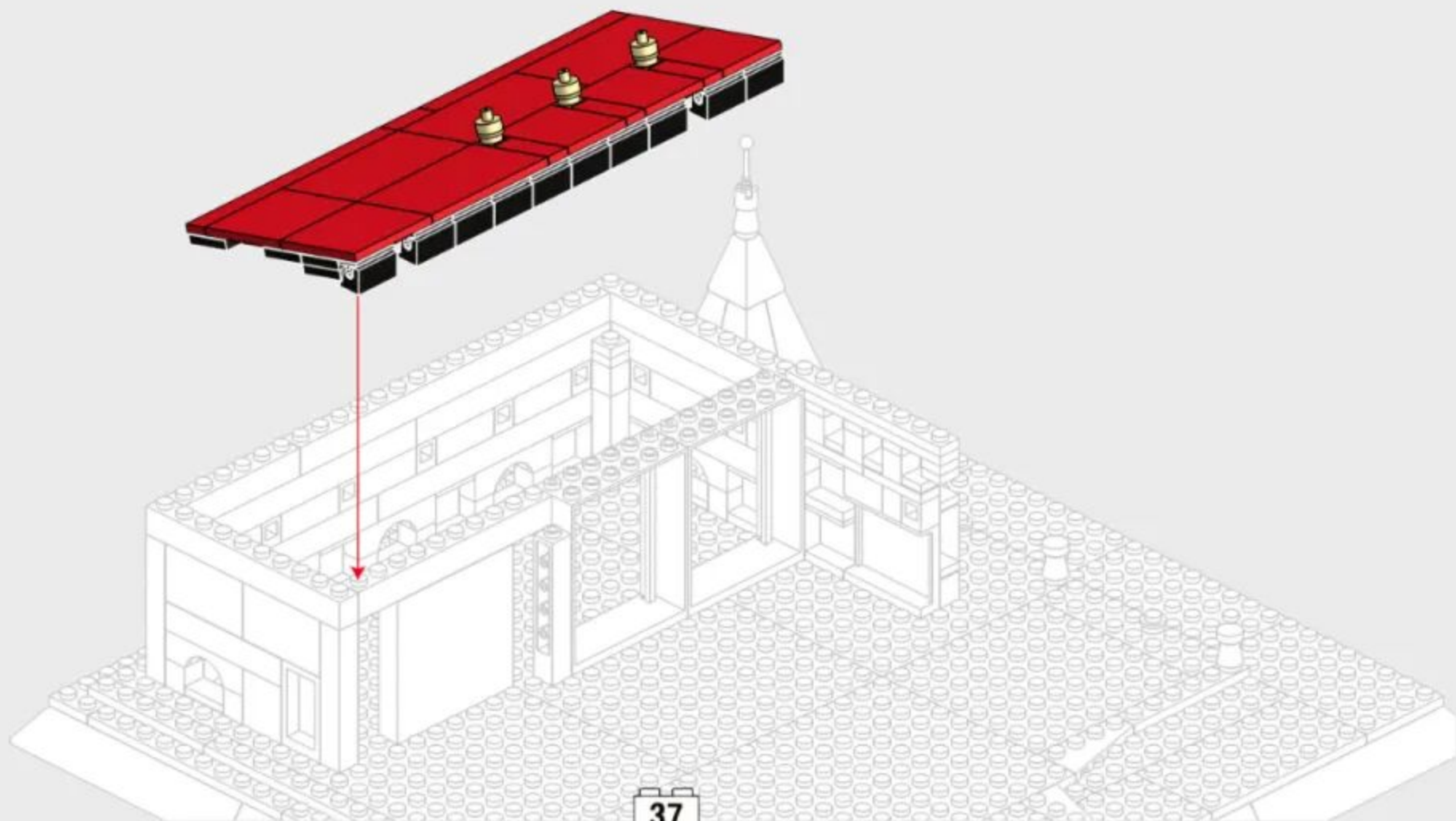

2-15

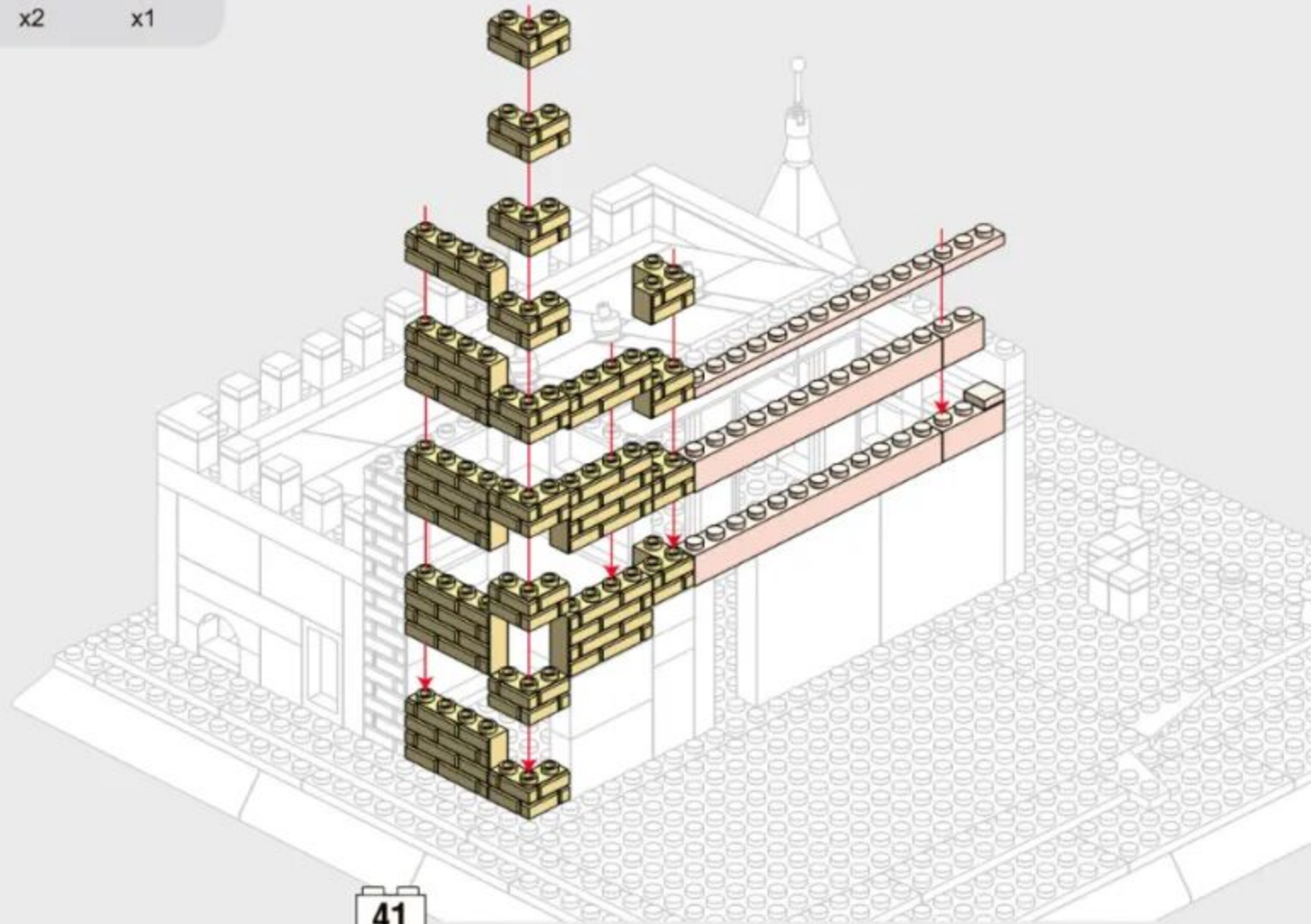
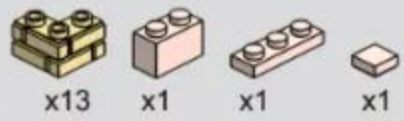
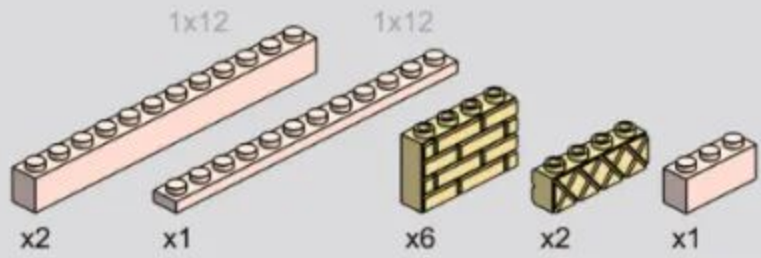



236PCS



42

3-1

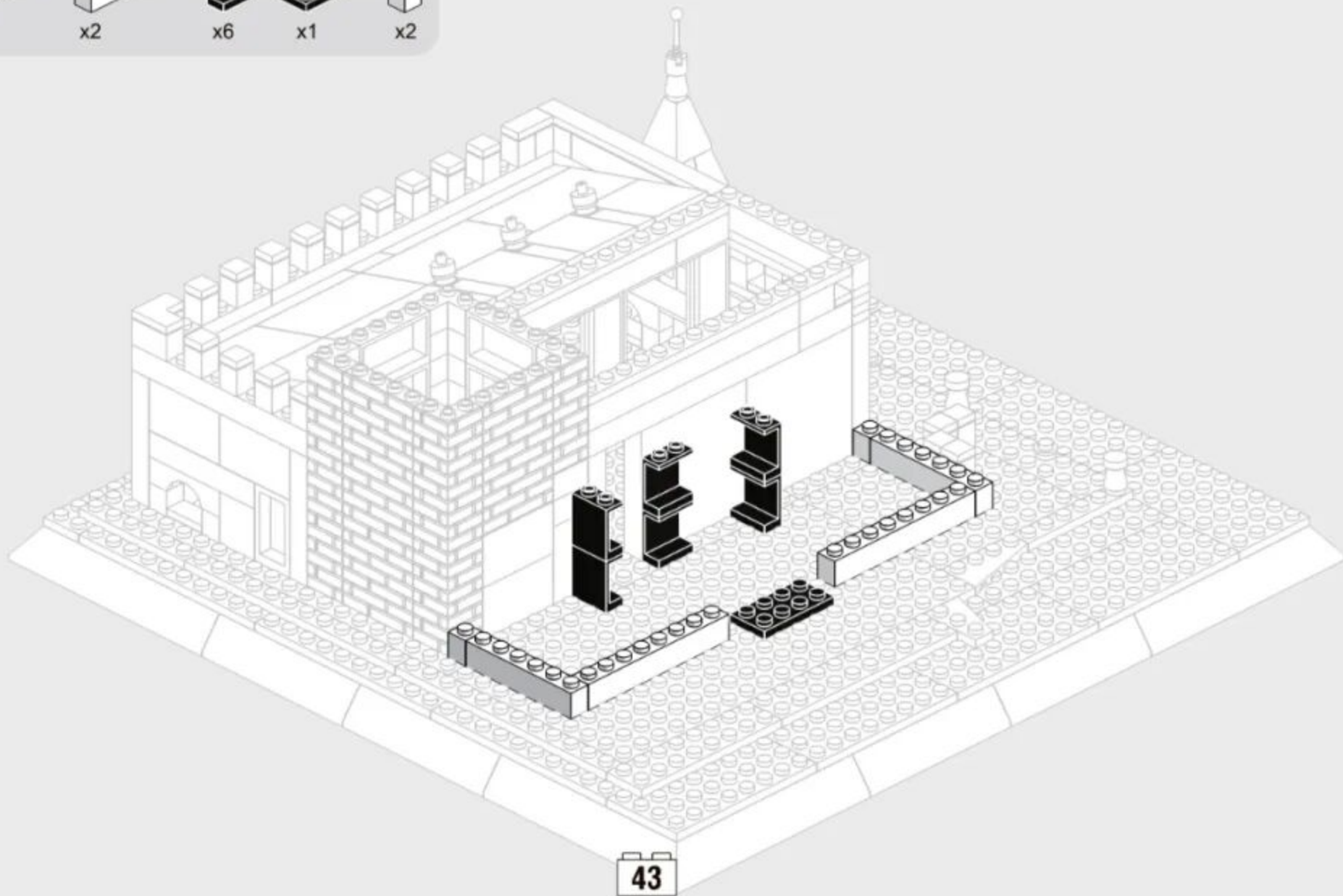
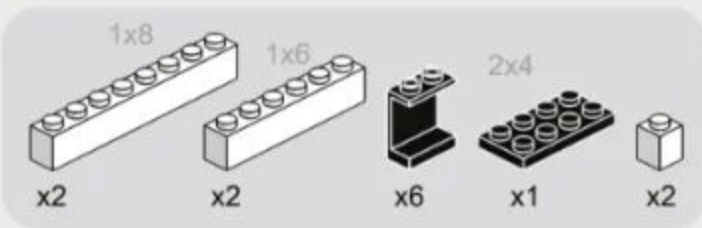

3-3



x1



x2



x8



x2



x4



x8

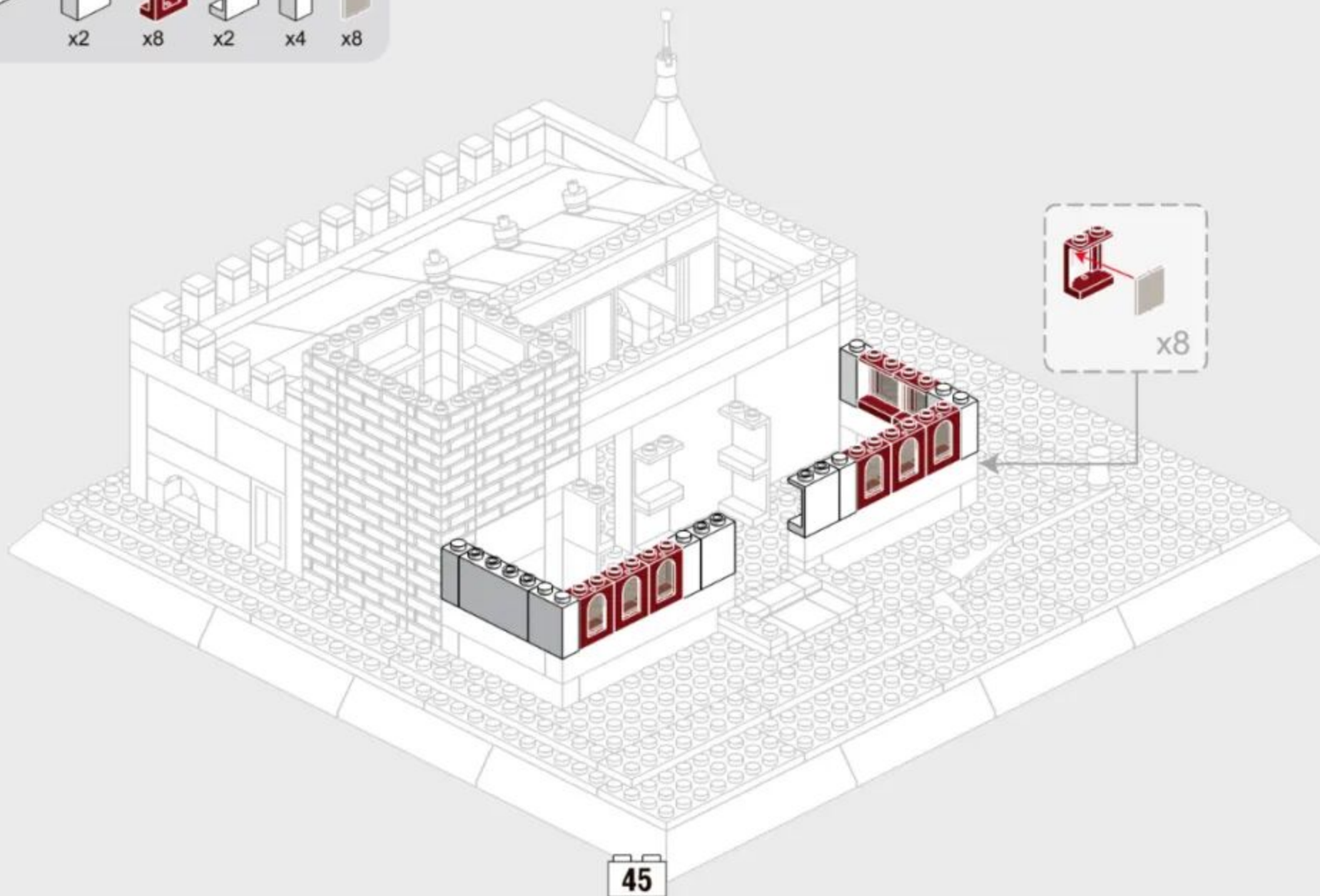

3-4

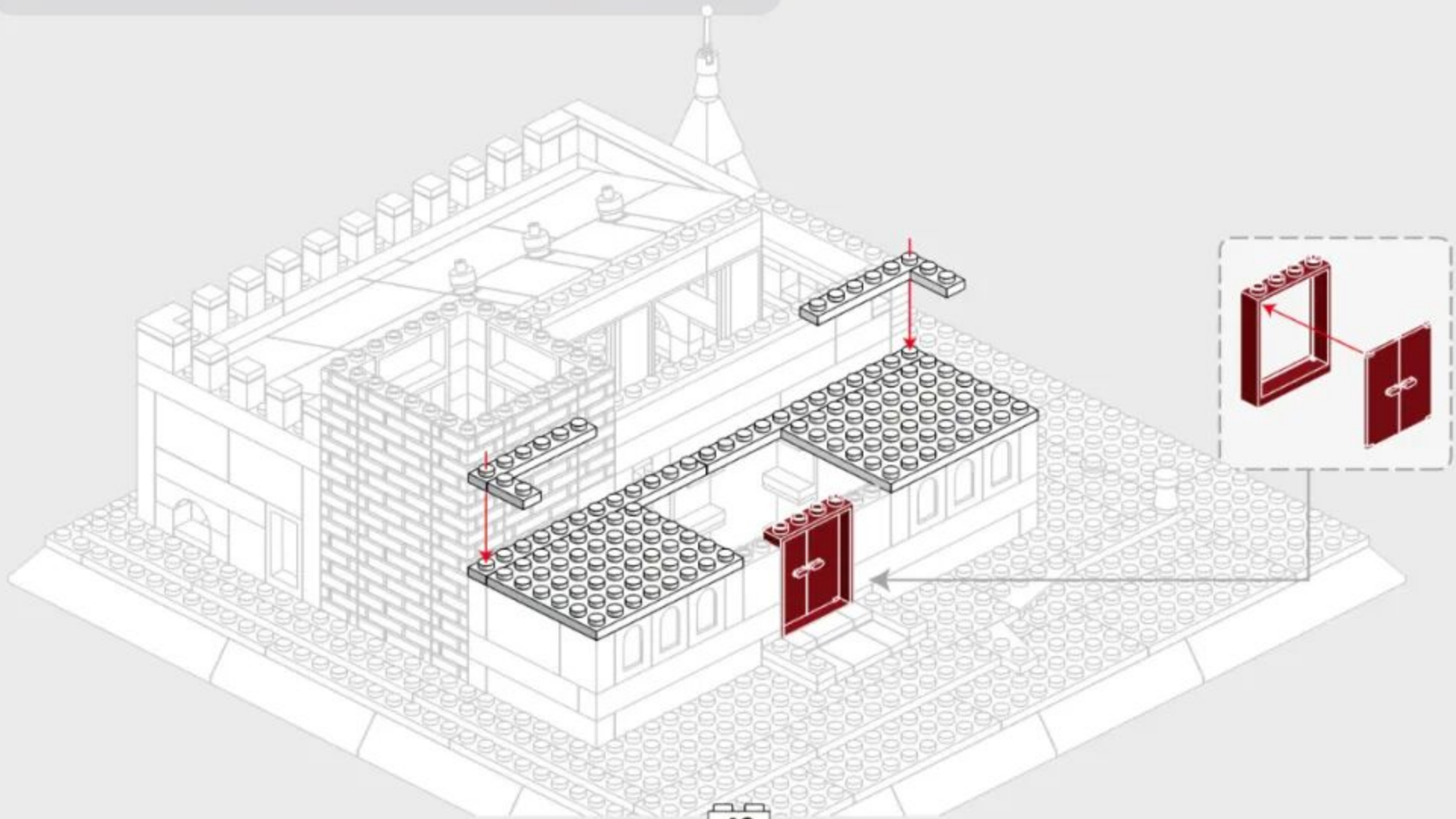
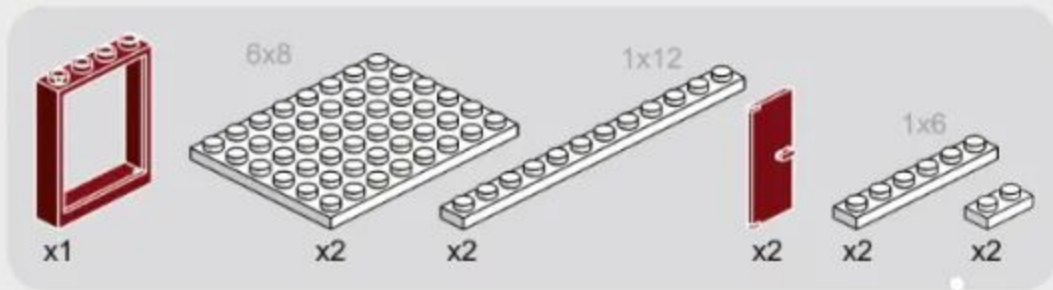

3-5

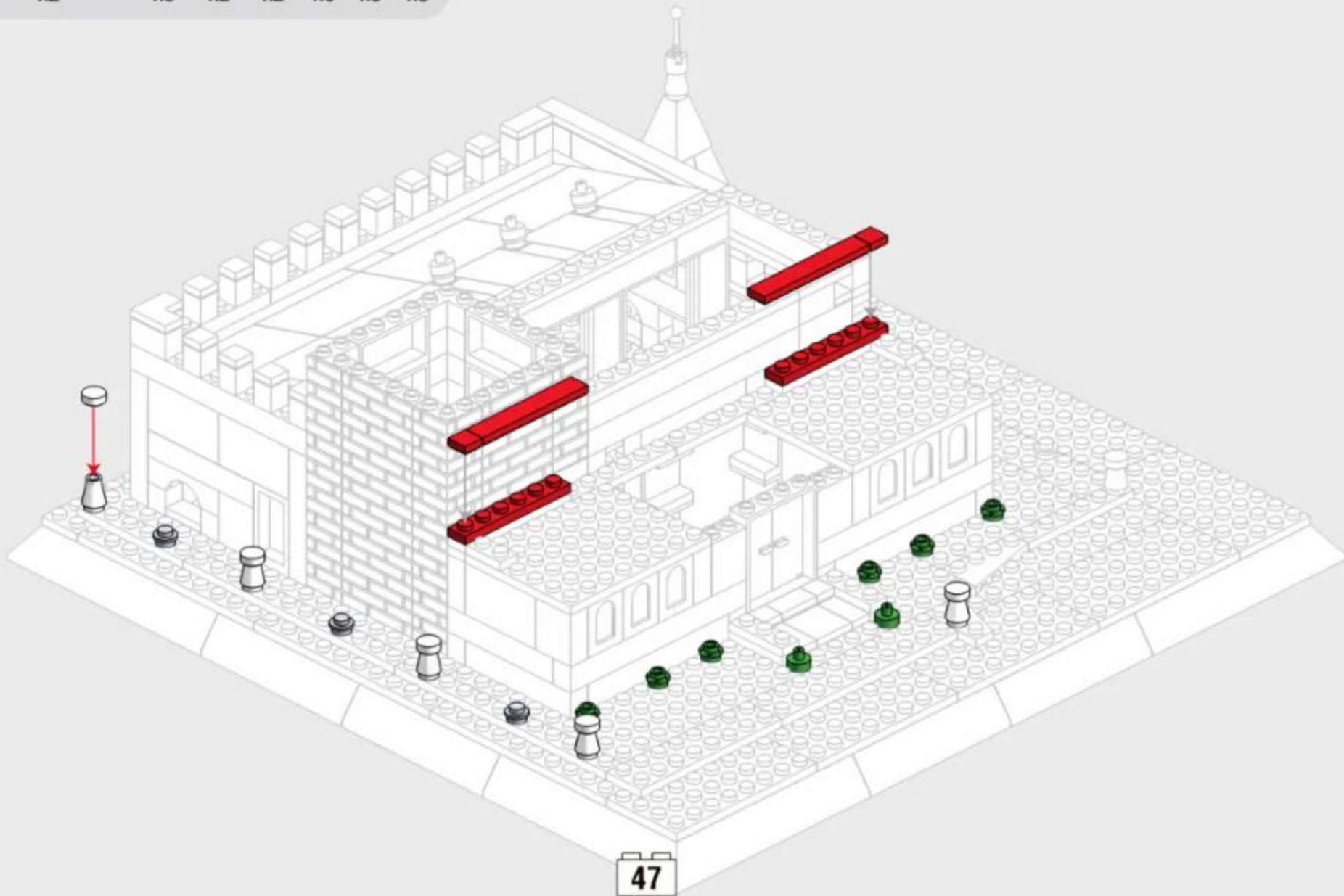

47

3-6

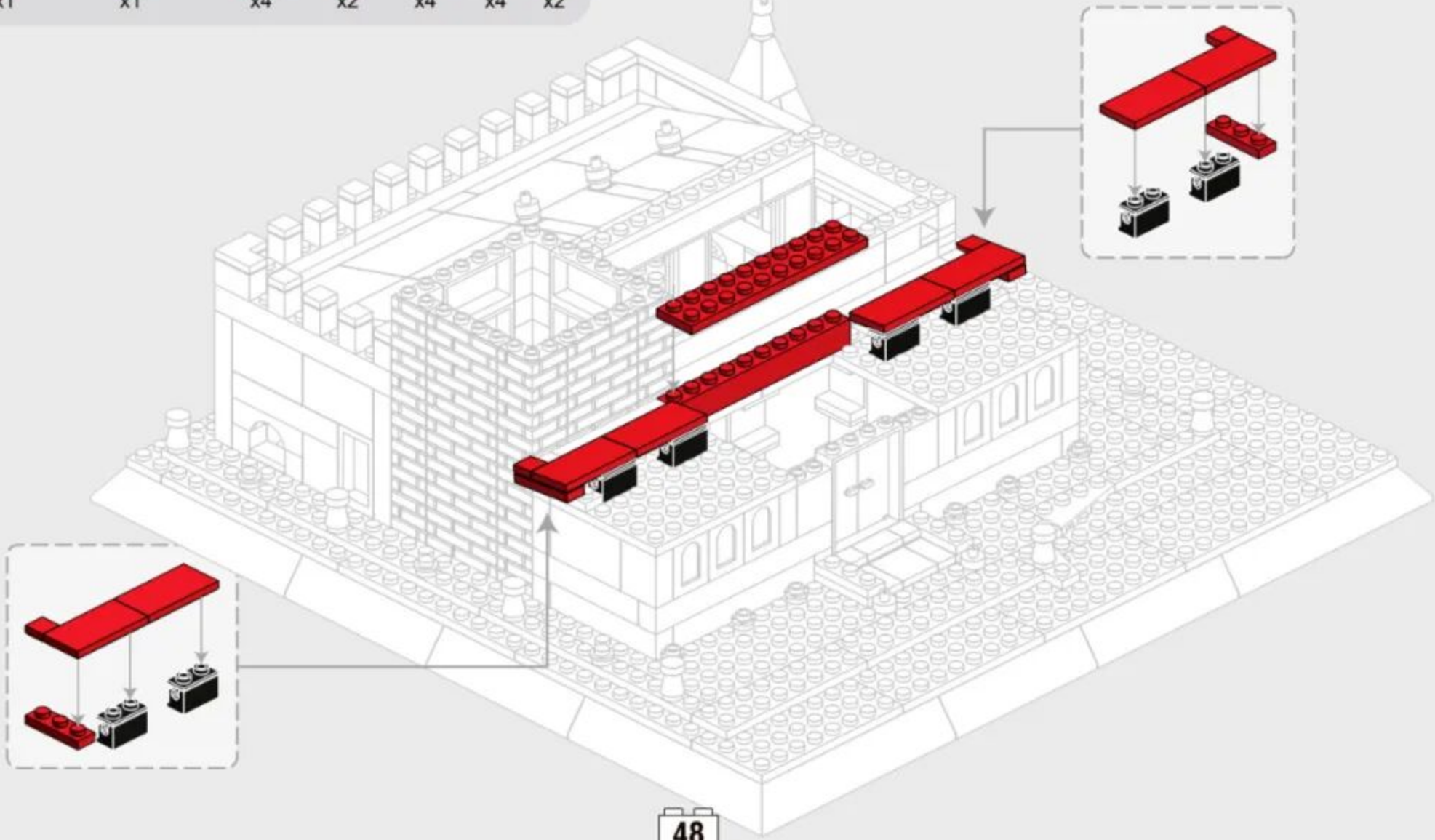
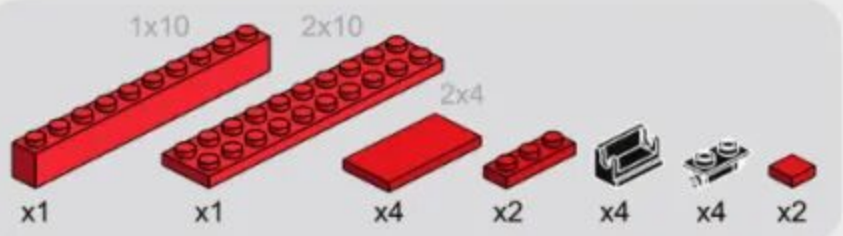

3-7

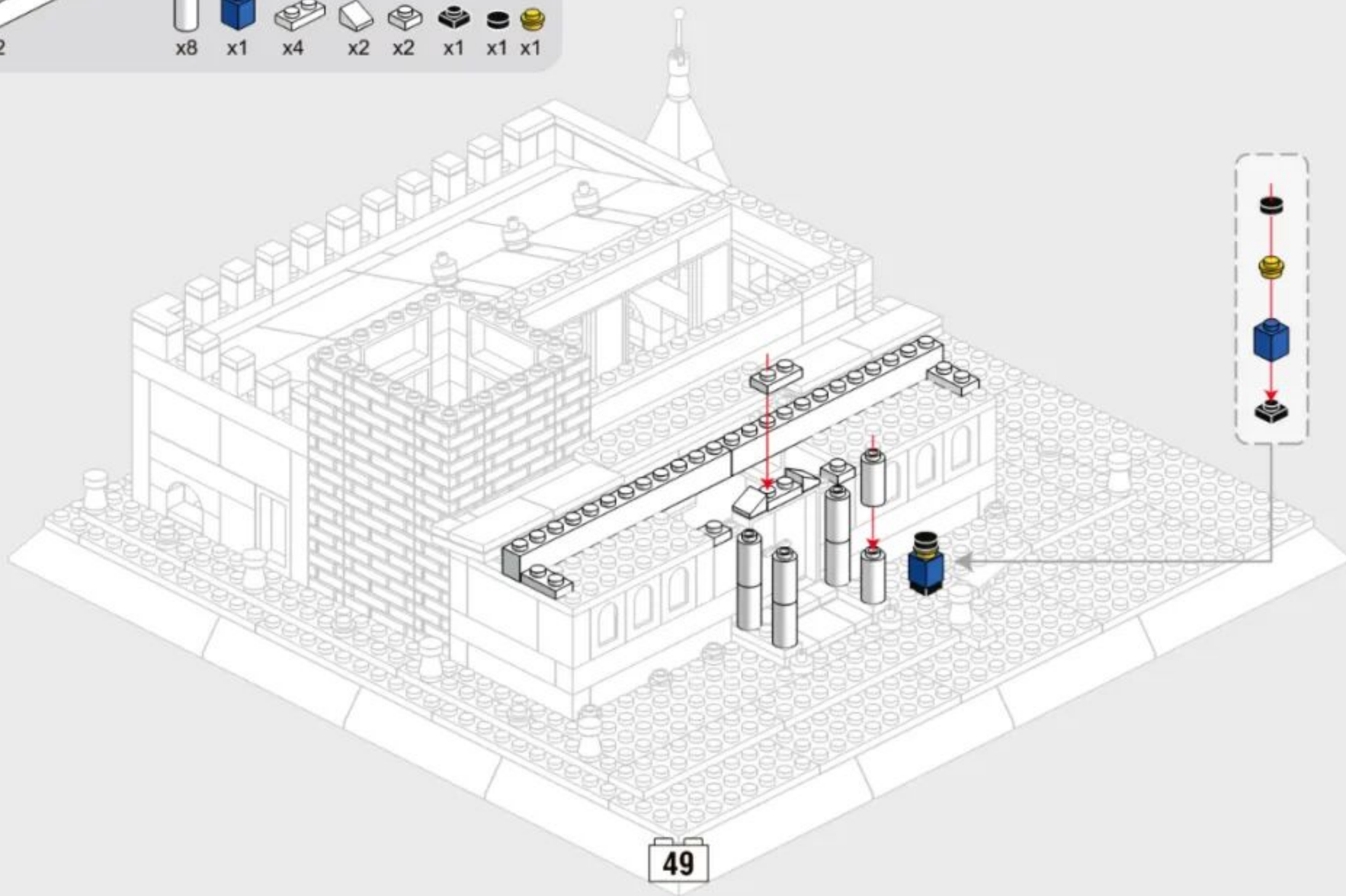
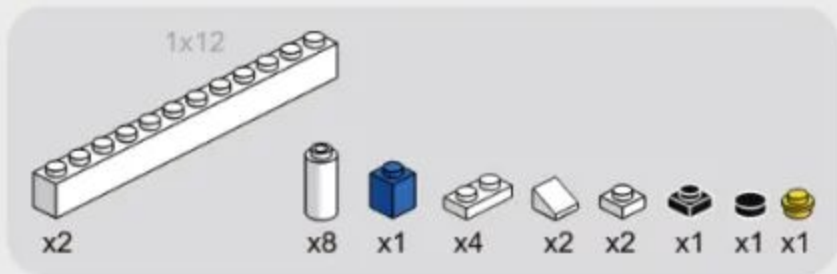

3-8

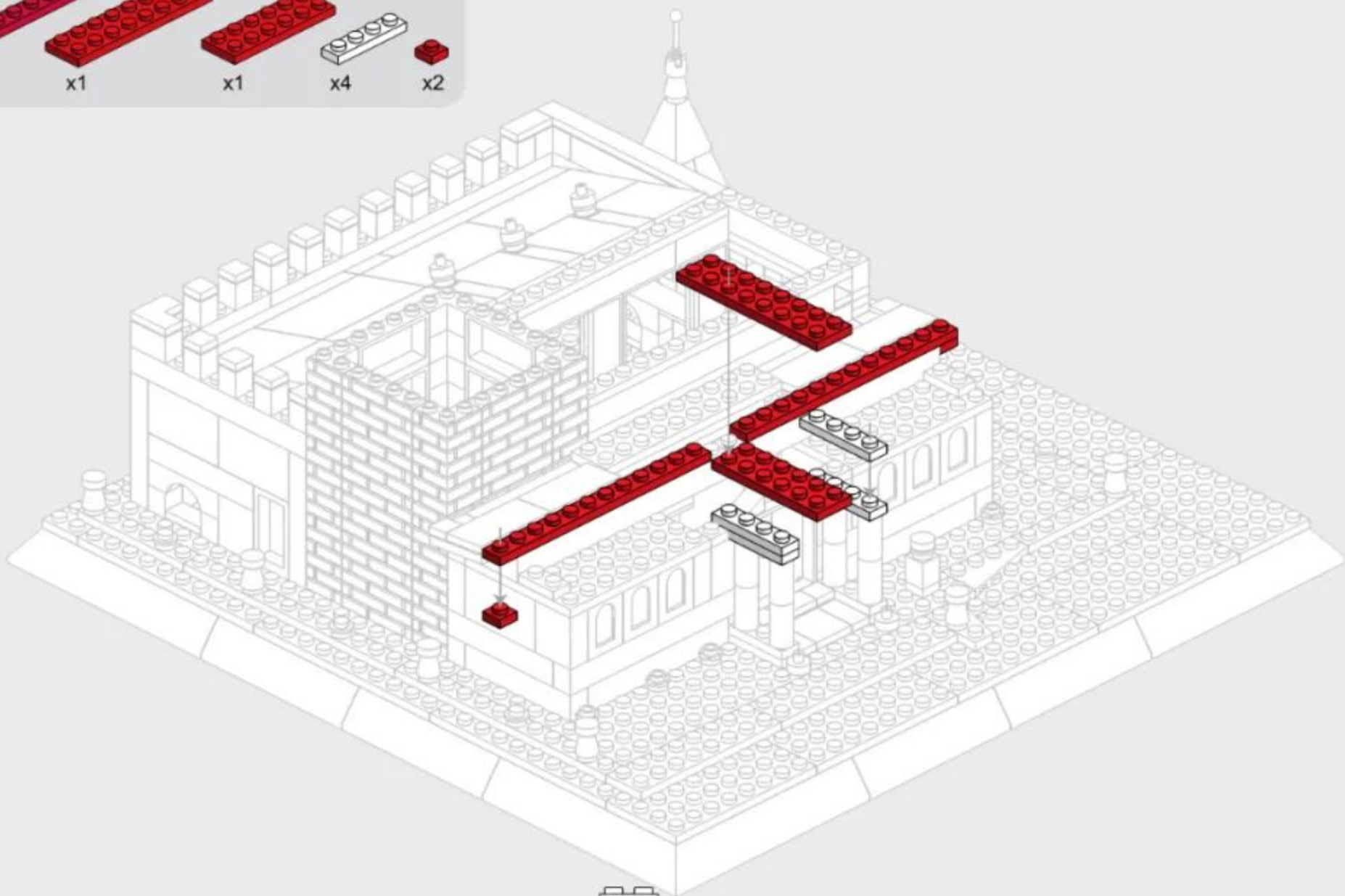
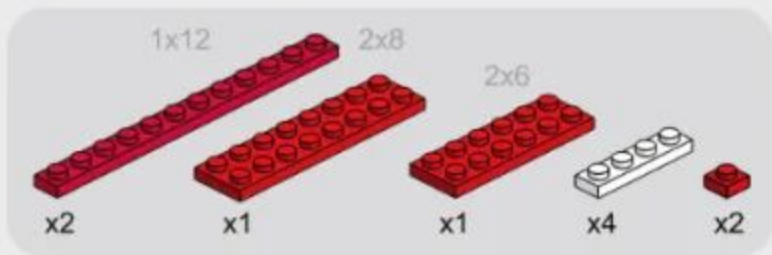

3-10

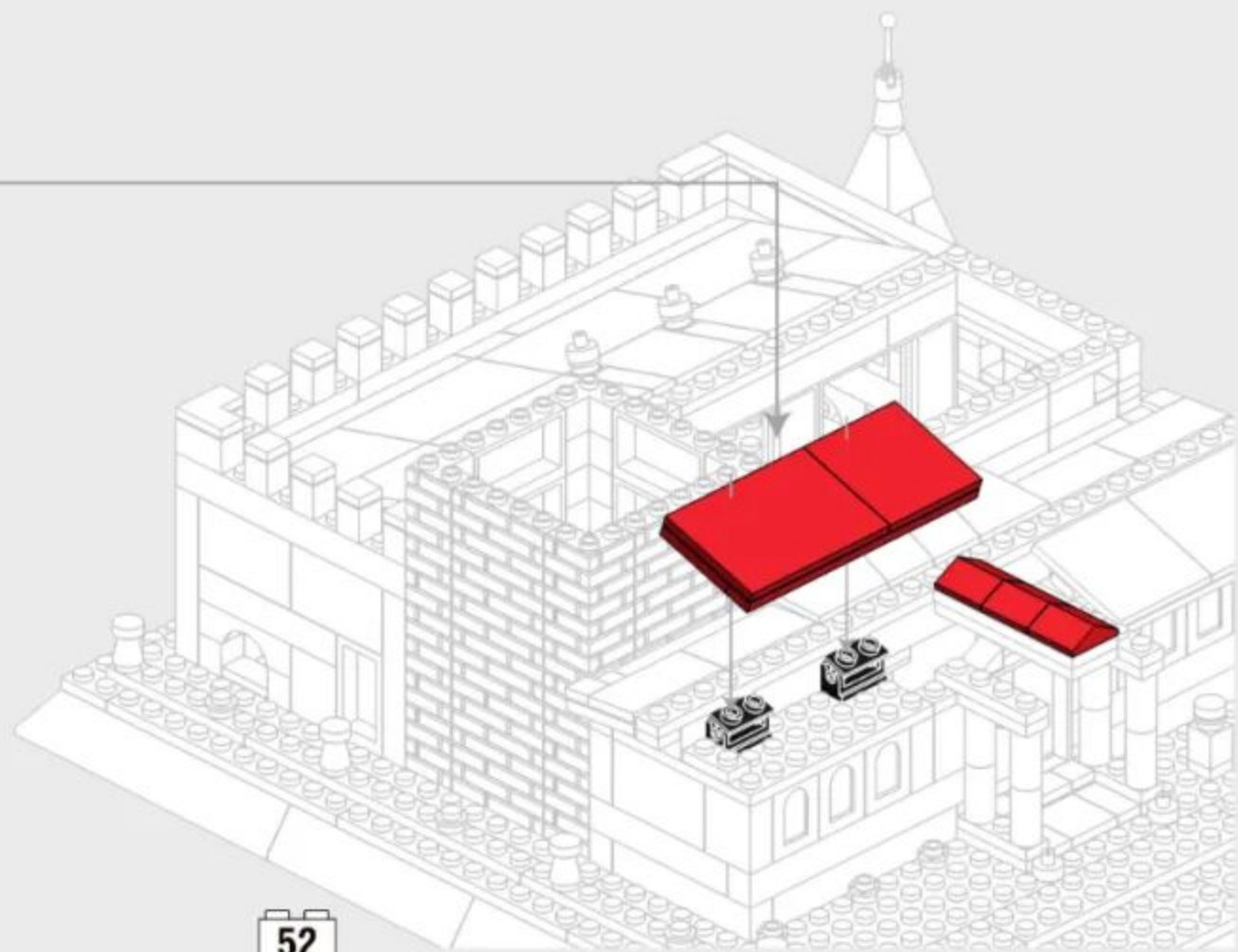
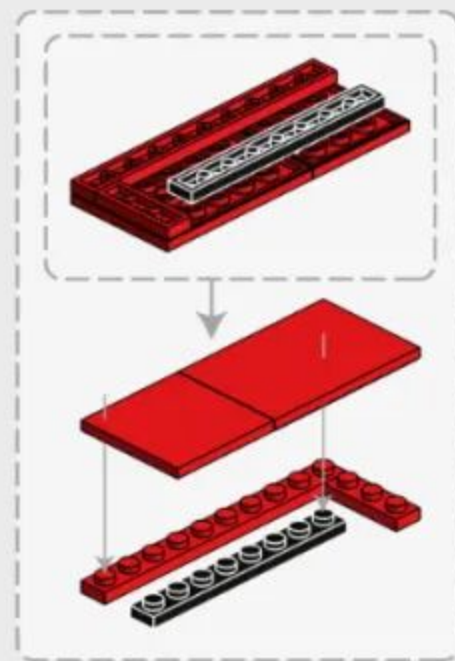
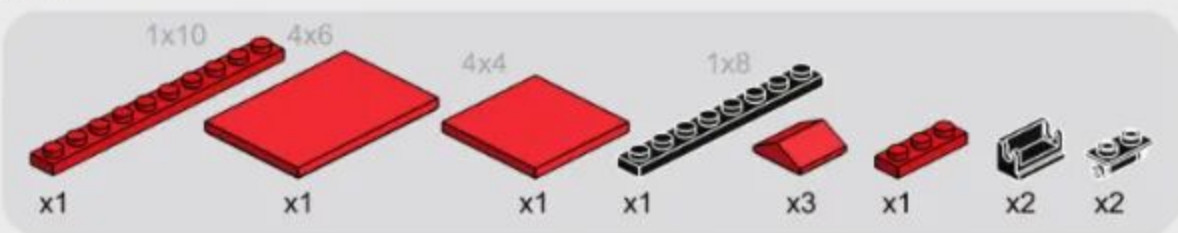

3-12

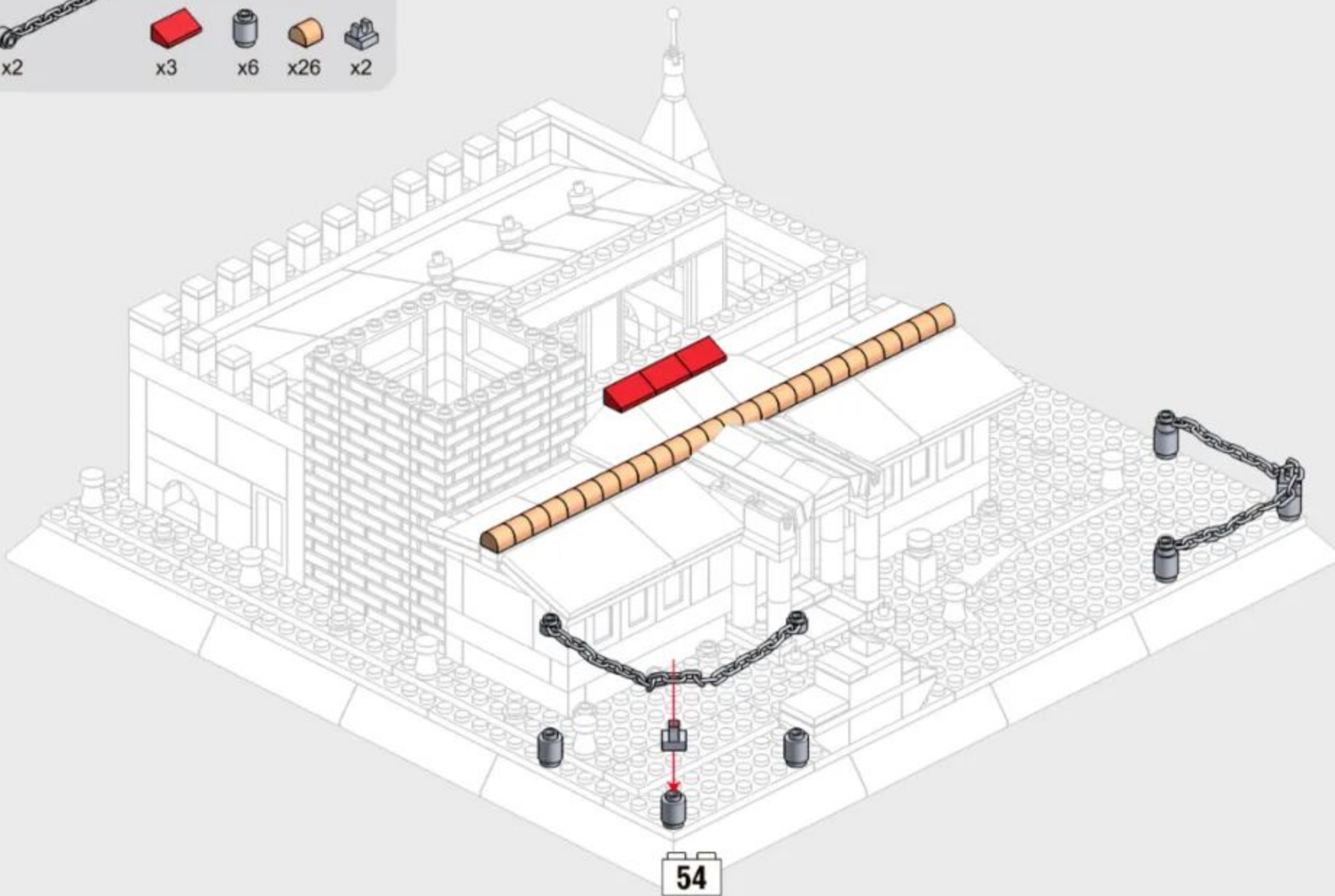



272PCS

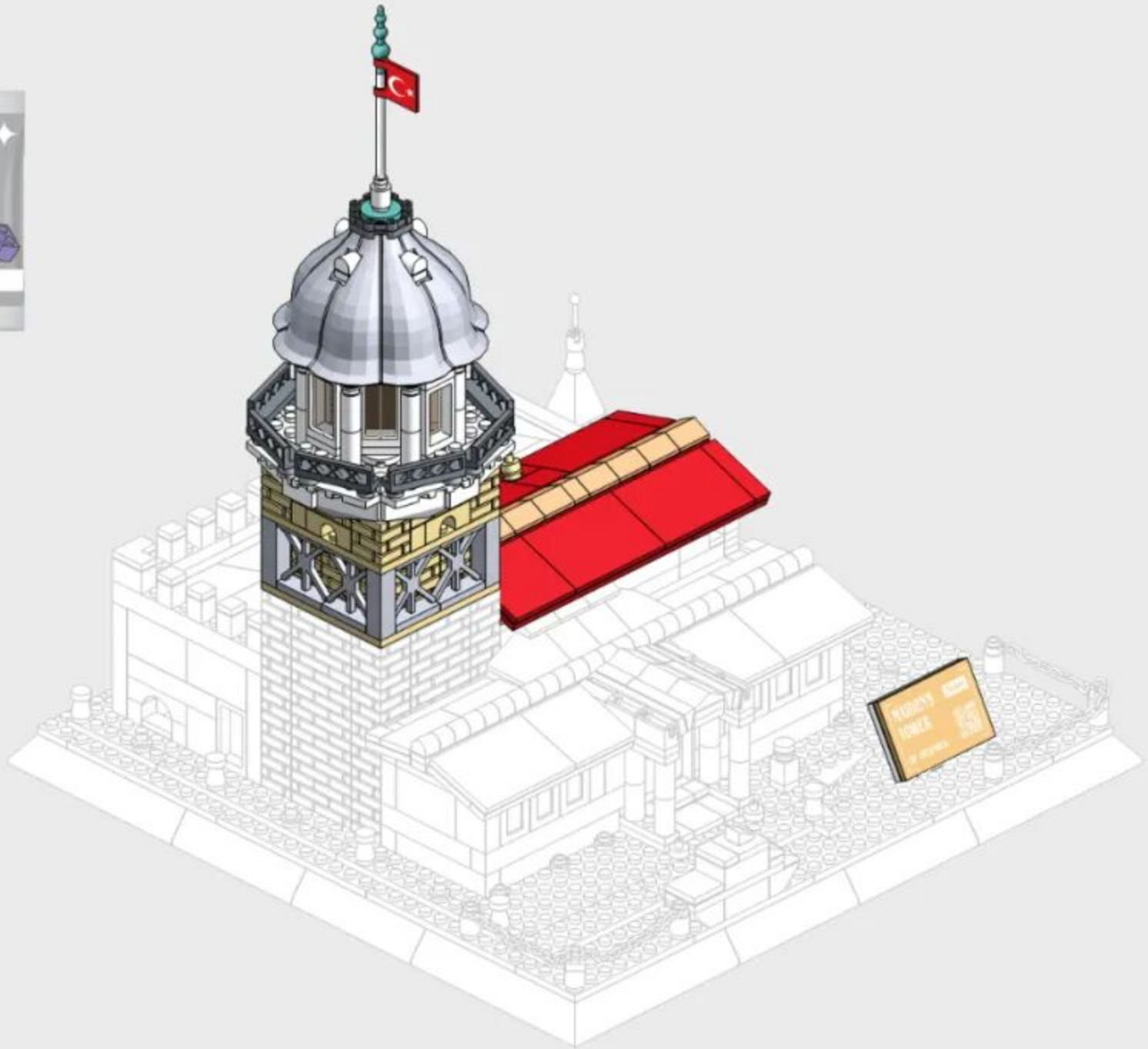

55

4-1

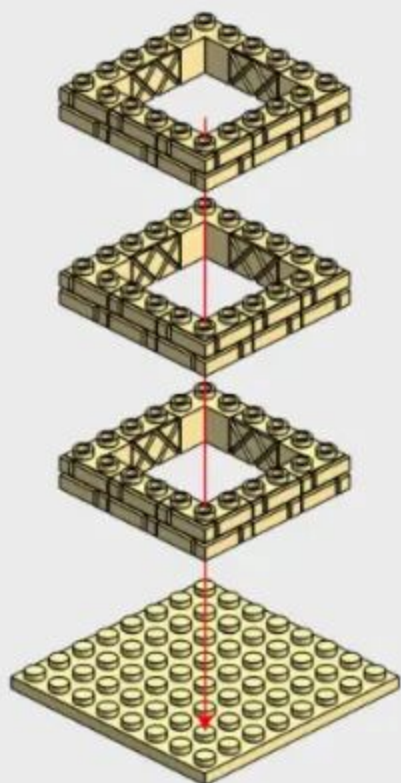
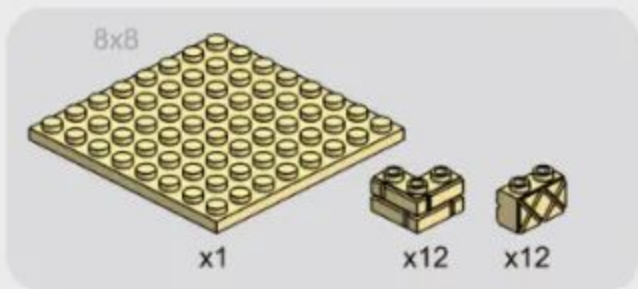

4-2

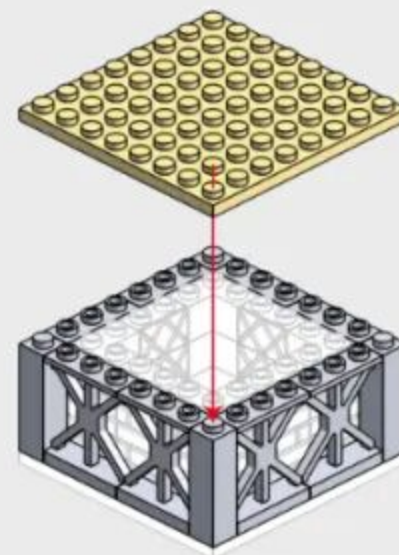
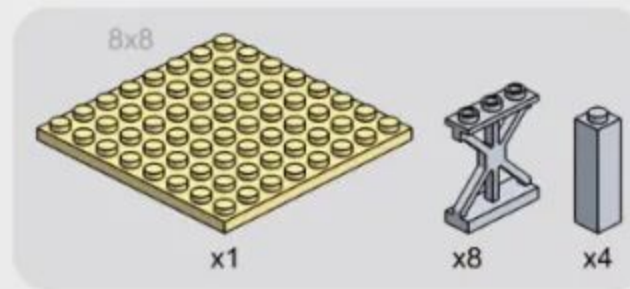

4-3

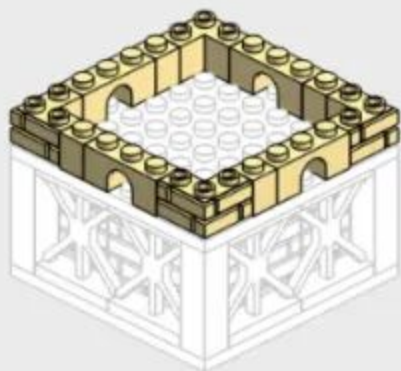

4-4

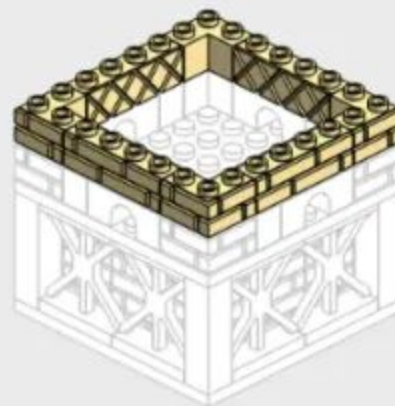

4-5



4-6

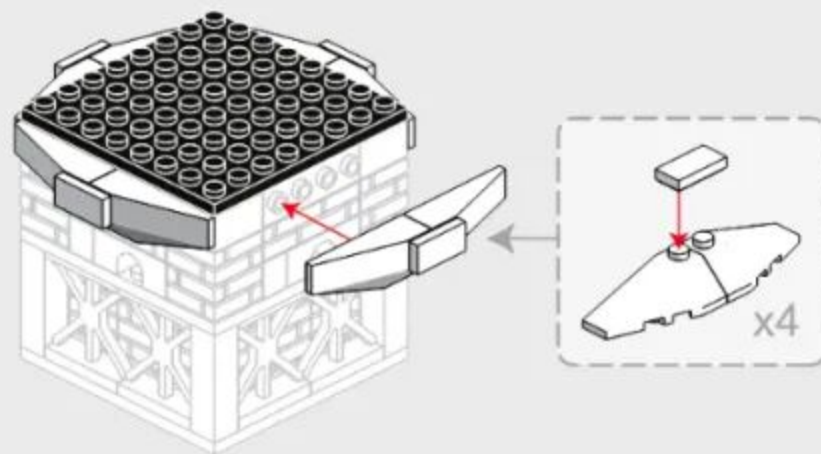
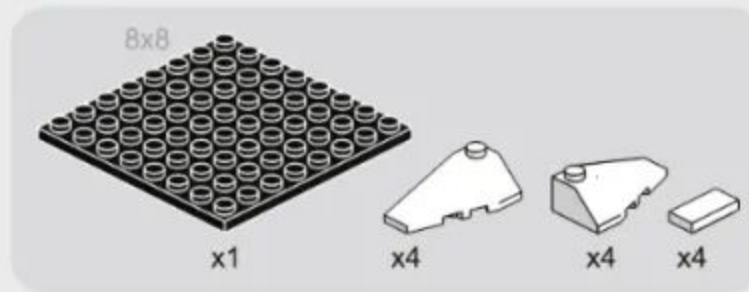

4-7

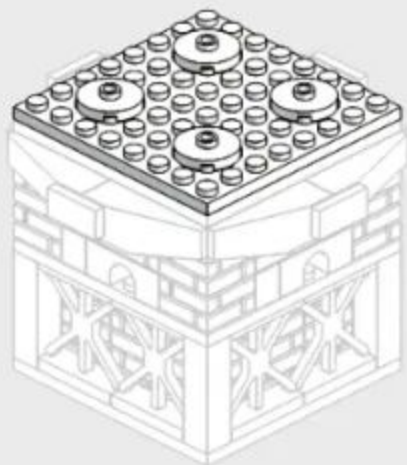
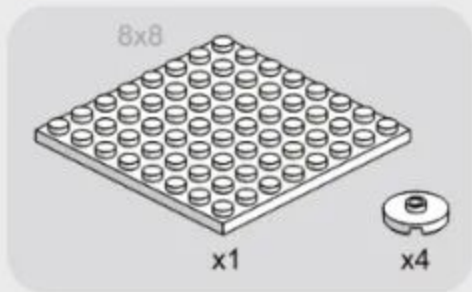

4-8

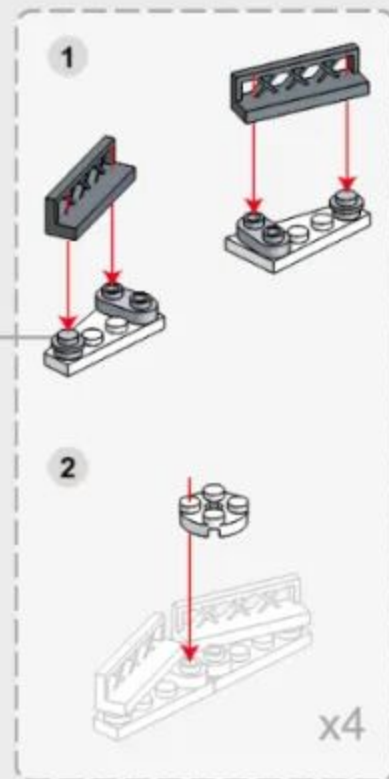
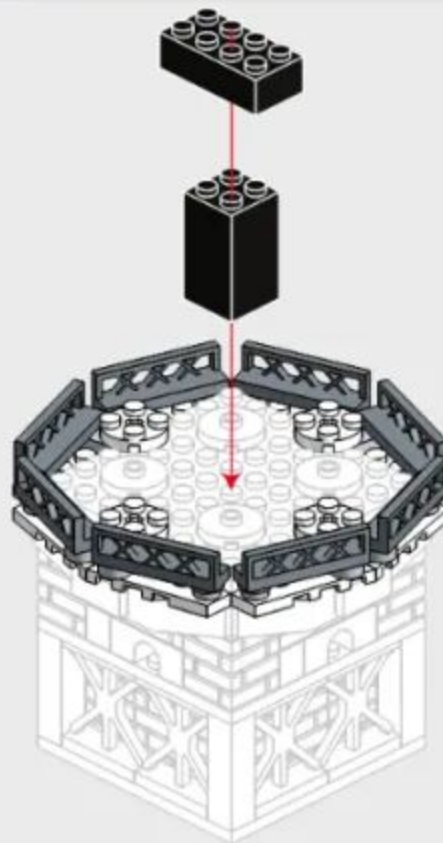
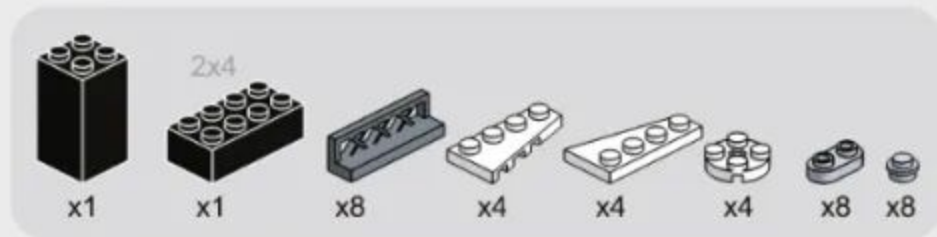

4-9

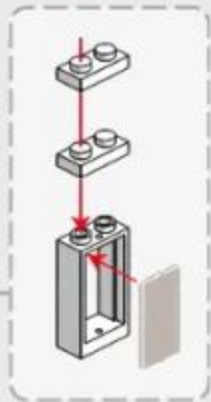
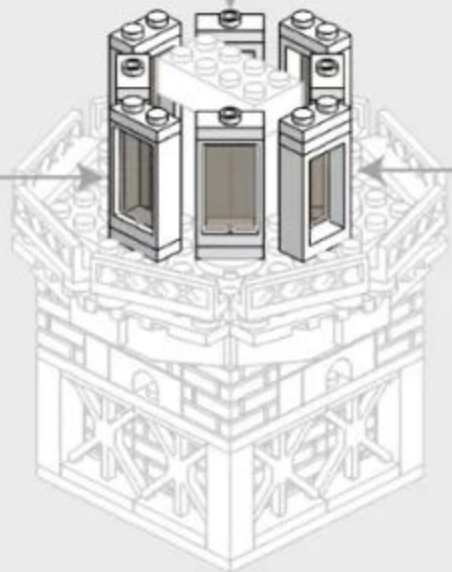
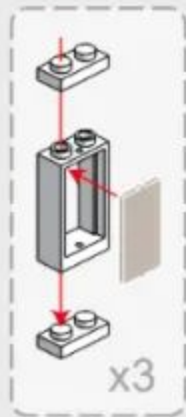
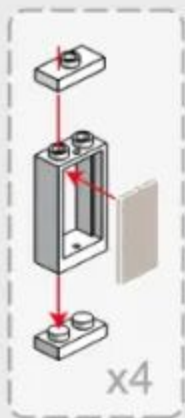
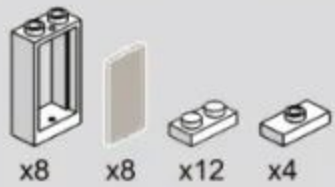

4-10

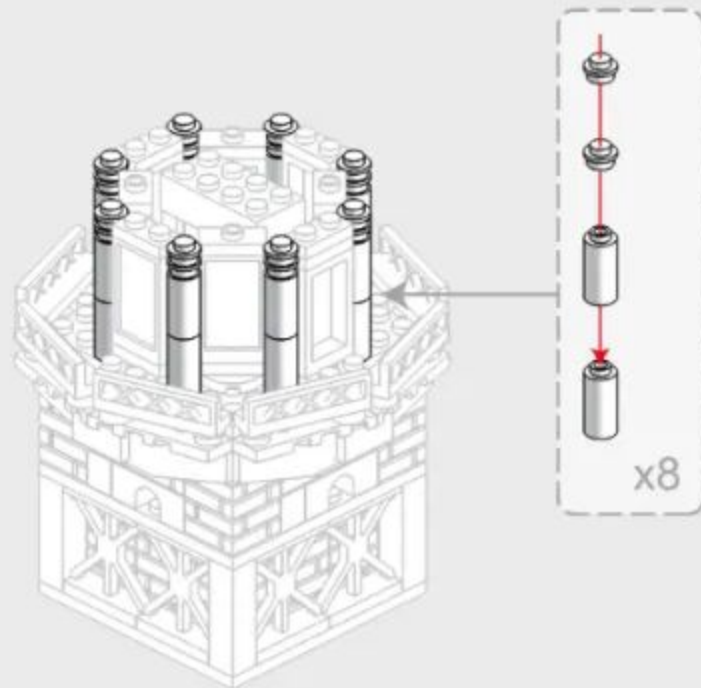

4-11

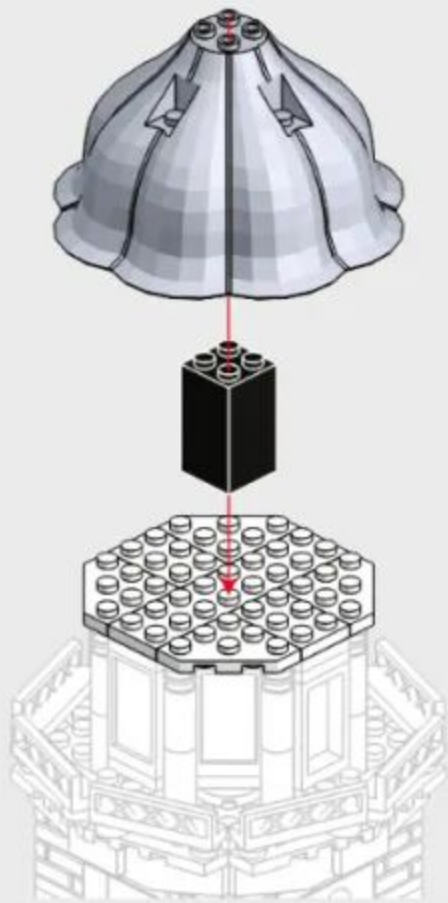
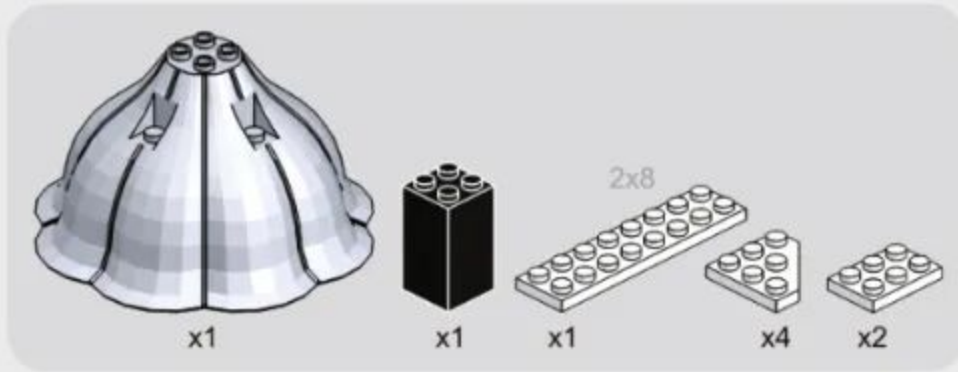

4-12

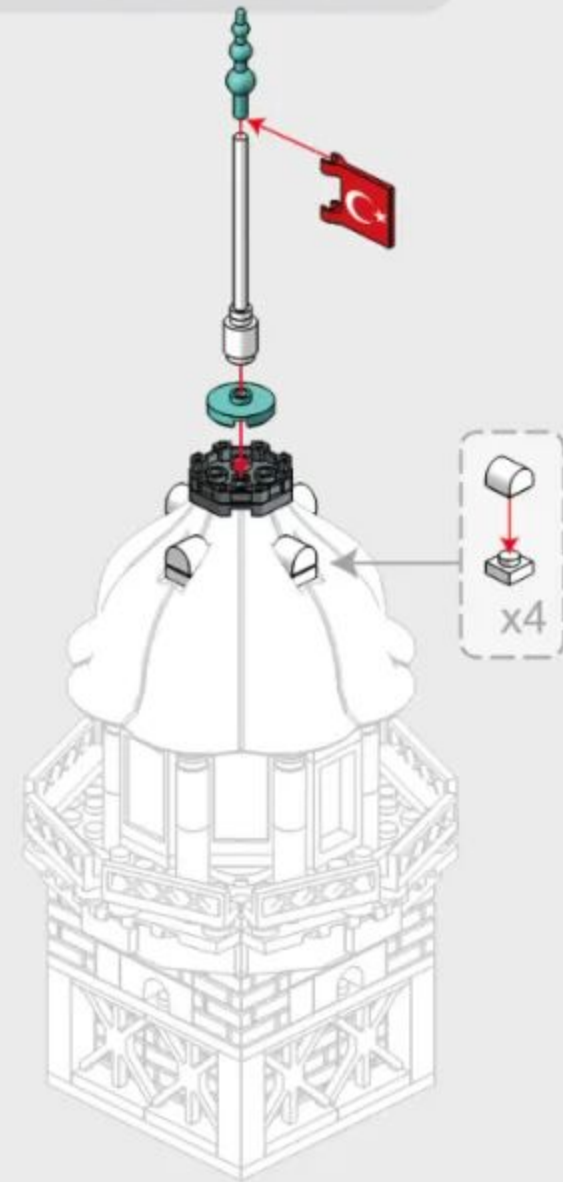

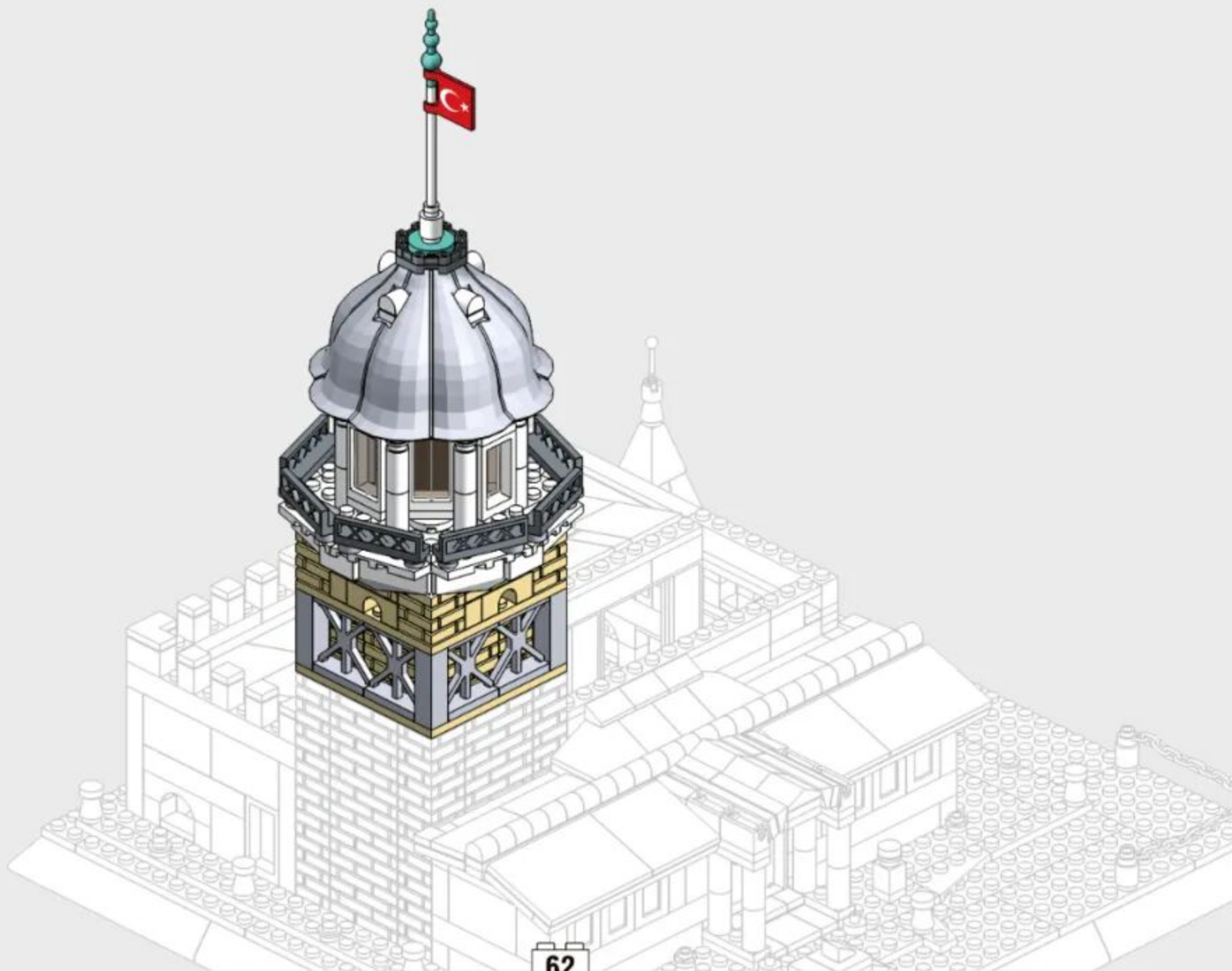

4-14

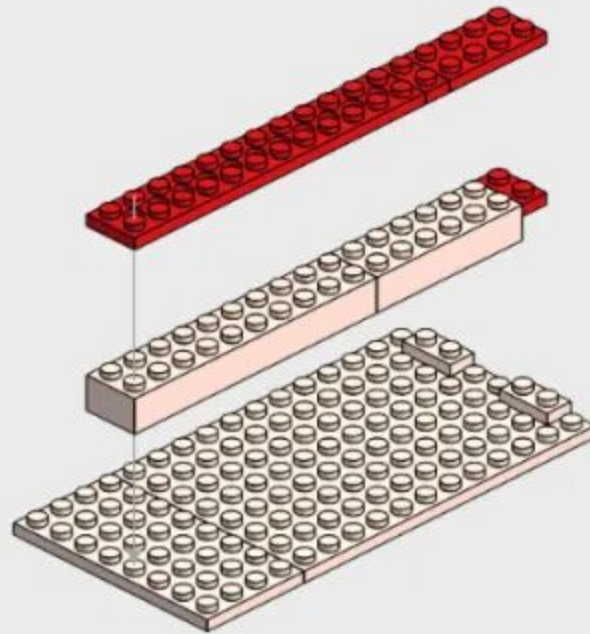
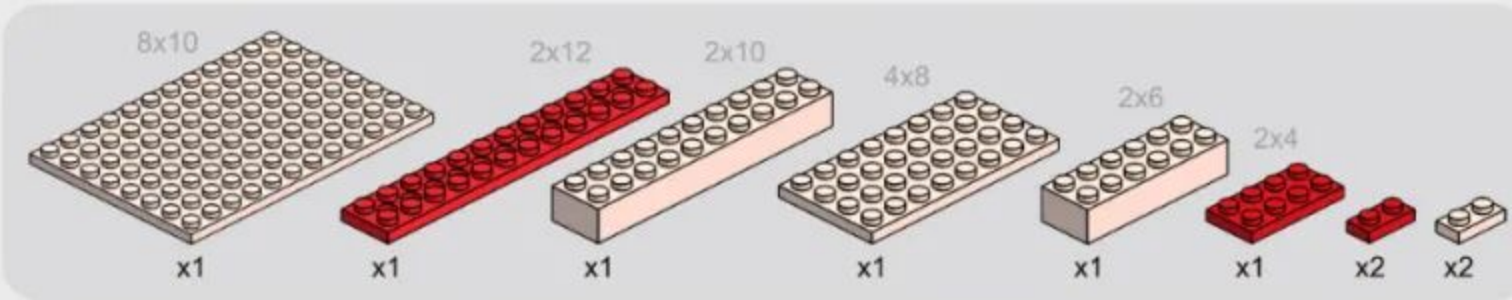

4-15

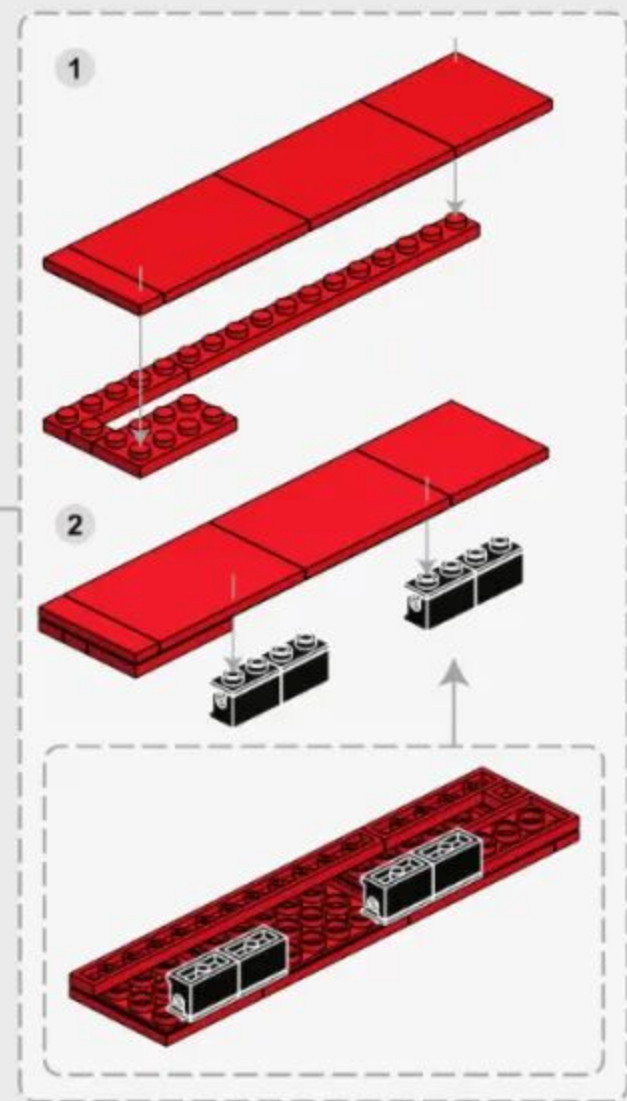
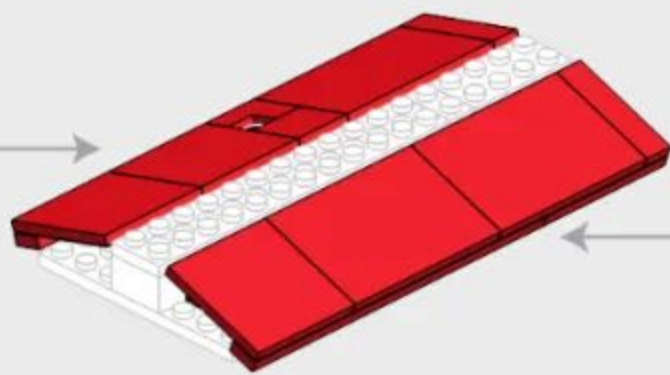
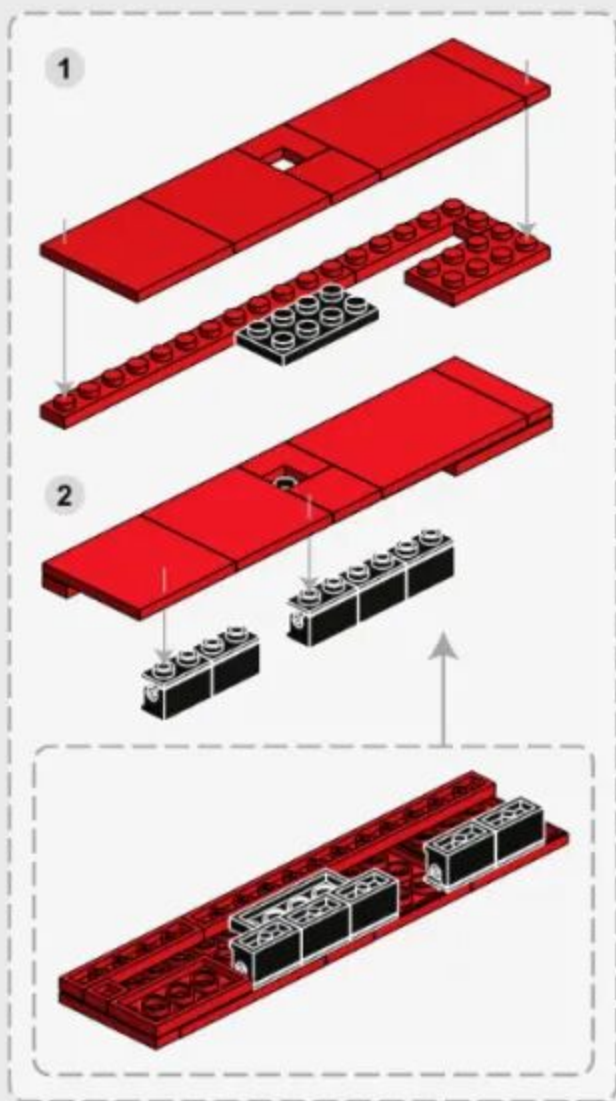
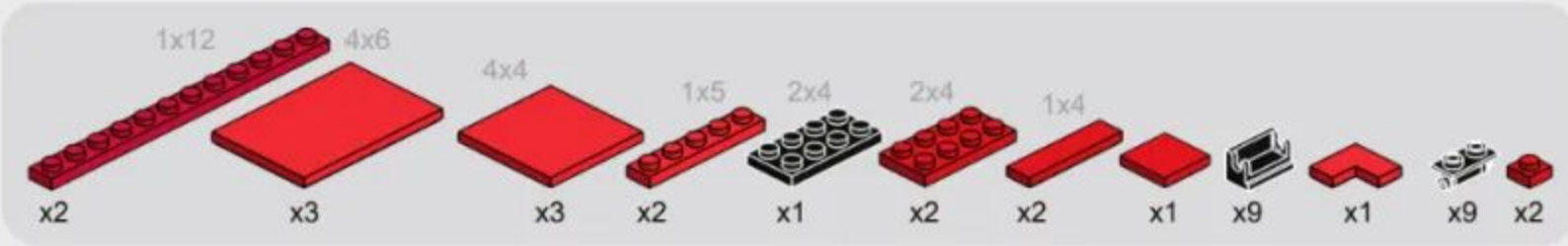

4-16

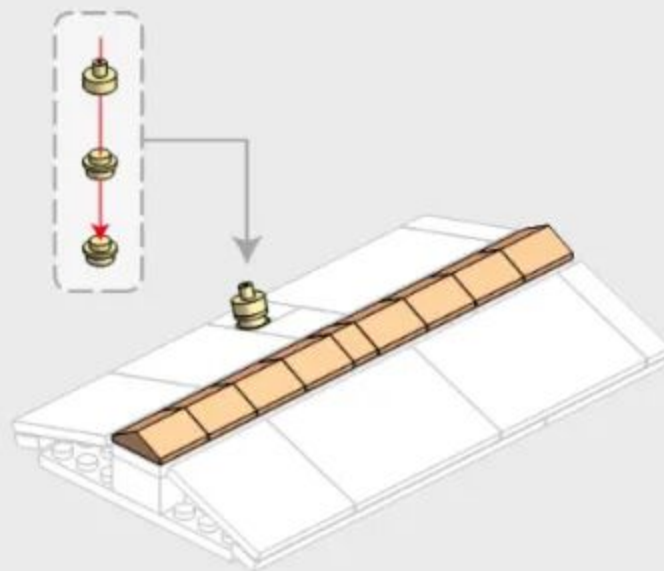

4-17

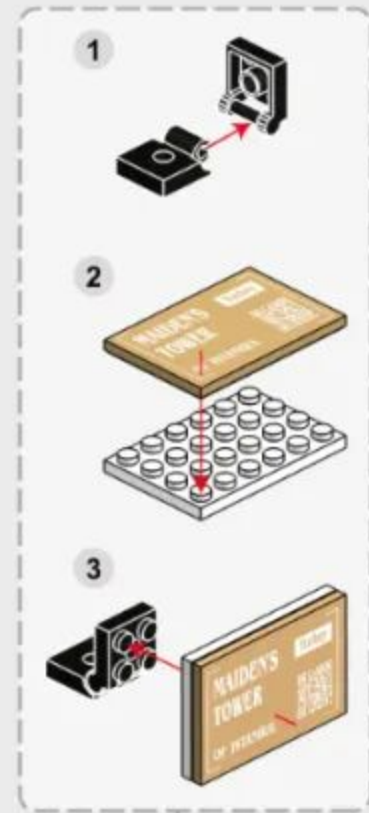
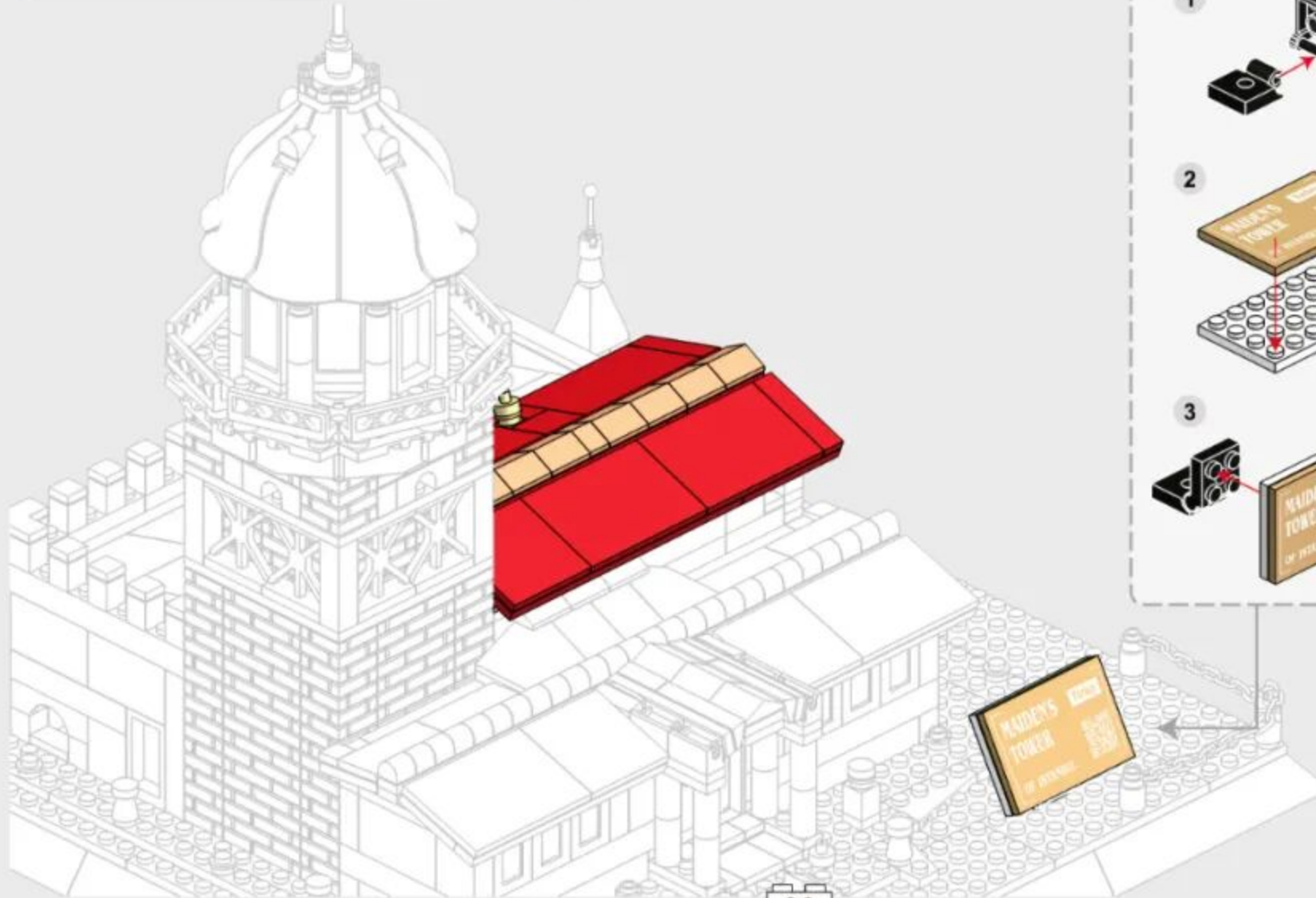
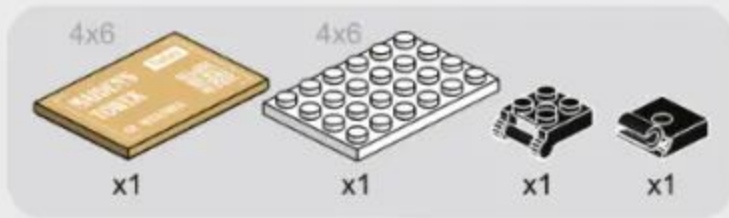

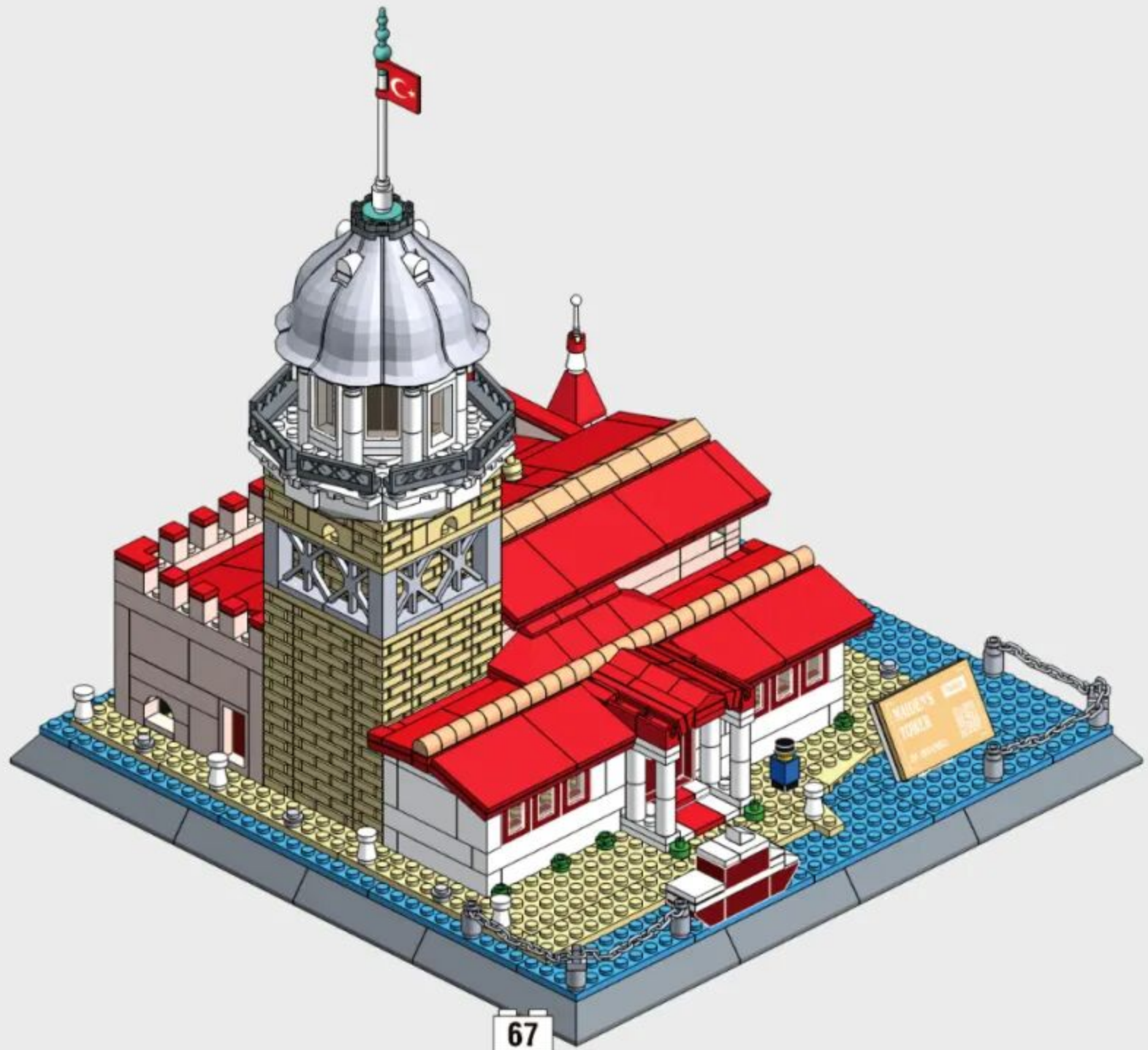

ARCHITECTURE

The World's great architecture



6224 英国伦敦白金汉宫
BUCKINGHAM PALACE-LONDON,ENGLAND



5225 意大利罗马斗兽场
COLOSSEUM-ROME,ITALY



5226 日本东京帝国饭店
IMPERIAL HOTEL-TOKYO,JAPAN



6211 德国柏林勃兰登堡门
BRANDENBURG GATE-BERLIN, GERMANY



6222 中国甘肃长城-嘉峪关
JIAYU PASS-GANSU,CHINA



6212 日本京都清水寺仁王门
NIOMON GATE OF KIYOMIZU-DERA-KYOTO,JAPAN



6214 中国武汉黄鹤楼
YELLOW CRANE TOWER-WUHAN,CHINA



6215 英国伦敦眼
LONDON EYE-LONDON,ENGLAND



6221 中国北京故宫-太和殿
HALL OF SUPREME HARMONY-BEIJING,CHINA



6213 俄罗斯莫斯科瓦西里大教堂
SAINT BASIL'S CATHEDRAL-MOSCOW,RUSSIA



6220 沙特阿拉伯麦加大清真寺
GREAT MOSQUE OF MECCA,SAUDI ARABIA



6219 美国纽约联合国大厦
UNITED NATIONS HEADQUARTERS-NEW YORK,AMERICA



4214 美国华盛顿白宫
WHITE HOUSE-WASHINGTON D.C.,AMERICA



4212 意大利罗马许愿池
TREVI FOUNTAIN-ROME,ITALY



4213 法国巴黎卢浮宫
MUSÉE DU LOUVRE-PARIS,FRANCE



4218 新加坡-鱼尾狮
MERLION,SINGAPORE



4210 埃及开罗吉萨金字塔
GREAT PYRAMID OF GIZA-CAIRO,EGYPT



4219 英国伦敦双子塔桥
TOWER BRIDGE-LONDON,ENGLAND



4216 美国华盛顿林肯纪念堂
LINCOLN MEMORIAL-WASHINGTON D.C.,AMERICA



4217 新加坡-金沙酒店
MARINA BAY SANDS,SINGAPORE



6214 中国武汉黄鹤楼
YELLOW CRANE TOWER-WUHAN,CHINA



4221 加拿大渥太华国会山庄
PARLIAMENT BUILDINGS-OTTAWA,CANADA



4211 英国伦敦伊丽莎白塔
ELIZABETH TOWER-ENGLAND



4220 美国纽约熨斗大厦
FLATIRON BUILDING-NEW YORK,AMERICA



5227 美国纽约自由女神像
STATUE OF LIBERTY-NEW YORK,AMERICA



4215 加拿大多伦多电视塔
THE CN TOWER-CANADA



4222 阿联酋迪拜哈利法塔
THE BURJ KHALIFA TOWER-DUBAI,UAE



5224 中国上海东方明珠广播电视塔
ORIENTAL PEARL TOWER-SHANGHAI,CHINA



5212 美国纽约帝国大厦
EMPIRE STATE BUILDING-NEW YORK,AMERICA



5213 马来西亚吉隆坡石油双塔
PETRONAS TWIN TOWERS-KUALA LUMPUR,MALAYSIA



5214 意大利托斯卡纳比萨斜塔
LEANING TOWER OF PISA-TUSCANY,ITALY



5216 英国伦敦伊丽莎白塔
ELIZABETH TOWER-LONDON,ENGLAND



5219 俄罗斯莫斯科克里姆林宫钟楼
SPASSKAYA TOWER-MOSCOW,RUSSIA



5220 阿联酋迪拜卓美亚帆船酒店
BURJ AL ARAB HOTEL-DUBAI,UAE



5217 法国巴黎埃菲尔铁塔
EIFFEL TOWER-PARIS,FRANCE



5221 中国台北101大楼
TAIPEI 101-TAIPEI,CHINA



6223 中国武汉长江大桥
WUHAN YANGTZE RIVER BRIDGE



5210 法国巴黎圣母院大教堂
CATHÉDRALE NOTRE DAME DE PARIS-PARIS,FRANCE



5223 法国巴黎凯旋门
ARC DE TRIOMPHE-PARIS,FRANCE



5211 印度阿格拉泰姬陵
TAJ MAHAL-AGRA,INDIA



5215 英国伦敦双子塔桥
TOWER BRIDGE-LONDON,ENGLAND



5222 中国北京天坛祈年殿
HALL OF PRAYER FOR GOOD HARVESTS-BEIJING,CHINA



6210 美国旧金山金门大桥
GOLDEN GATE BRIDGE-SAN FRANCISCO,AMERICA



6216 中国北京万里长城（八达岭）
THE GREAT WALL-BEIJING,CHINA



5218 中国北京天安门
TIAN'ANMEN TOWER-BEIJING,CHINA



6217 中国西藏布达拉宫
POTALA PALACE-TIBET,CHINA



6218 芬兰罗瓦涅米圣诞老人办公室
SANTA CLAUS OFFICE-ROVANIEMI,FINLAND



6225 墨西哥库库尔坎玛雅金字塔
EL CASTILLO-KUKULKAN,MEXICO



6226 德国巴伐利亚新天鹅堡
SCHLOSS NEUSCHWANSTEIN-BAYERN, DEUTSCHLAND



5228 美国芝加哥威利斯大厦
WILLIS TOWER-CHICAGO, AMERICA



5229 土耳其少女塔
MAIDEN TOWER-ISTANBUL,TURKEY

MAIDEN TOWER

Torre de la Doncella

Istanbul, Turkey

The world's great architecture



522920210720101