

FARNSWORTH HOUSE

Casa Farnsworth

Chicago, America

The world's great architecture



6+ / 5233 / 661 PCS
Suitable Age / Product Number / Parts Total



Architecture

It will be a city...

这将构成一座城市...

ABOUT THE PRODUCT

关于产品

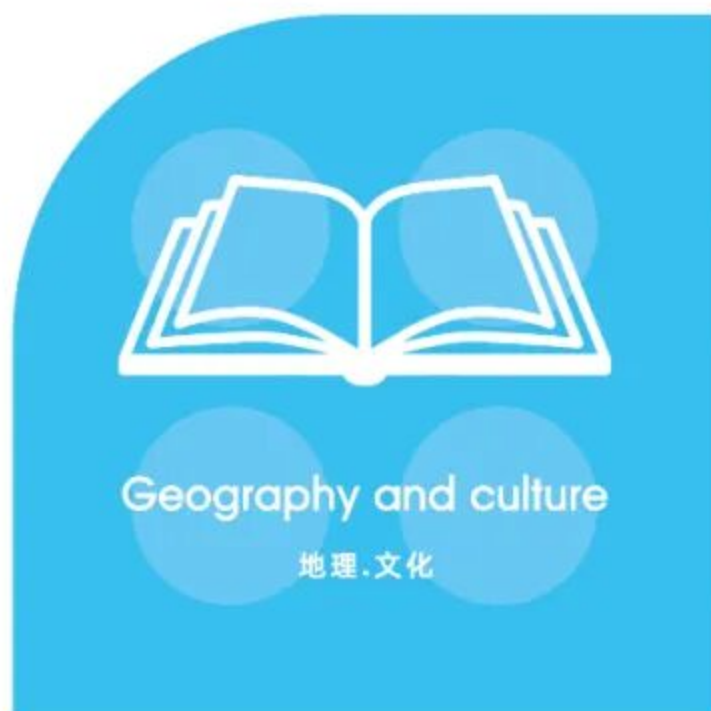

ARCHITECTURE

WANGE The world's great architect since 1991

Farnsworth House

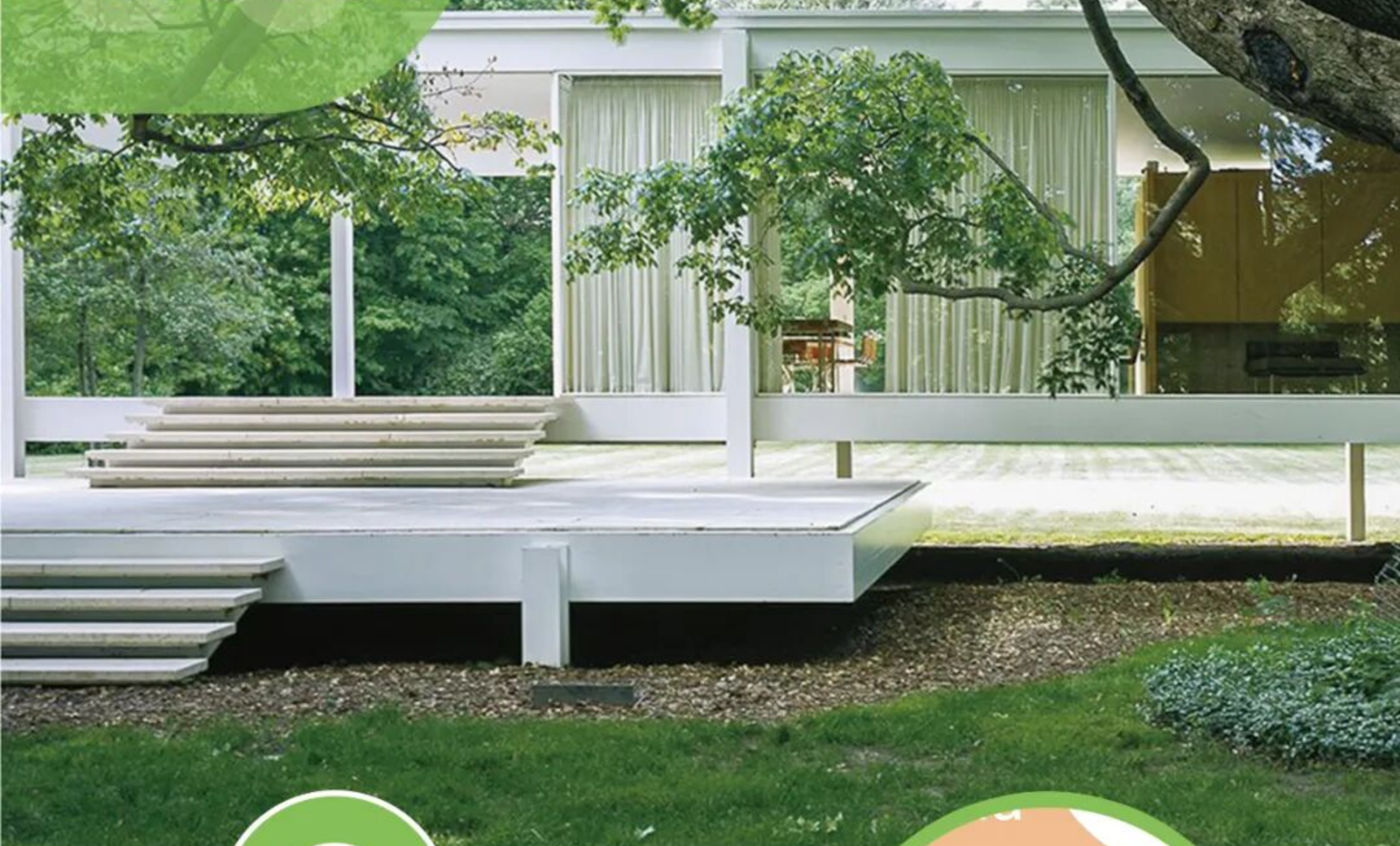

This article is about the Ludwig Mies van der Rohe house in Plano, Illinois. For other uses, see Farnsworth House (disambiguation).

Farnsworth House



Geography and culture

地理·文化



The Farnsworth House is a historical house designed and constructed by Ludwig Mies van der Rohe between 1945 and 1951.

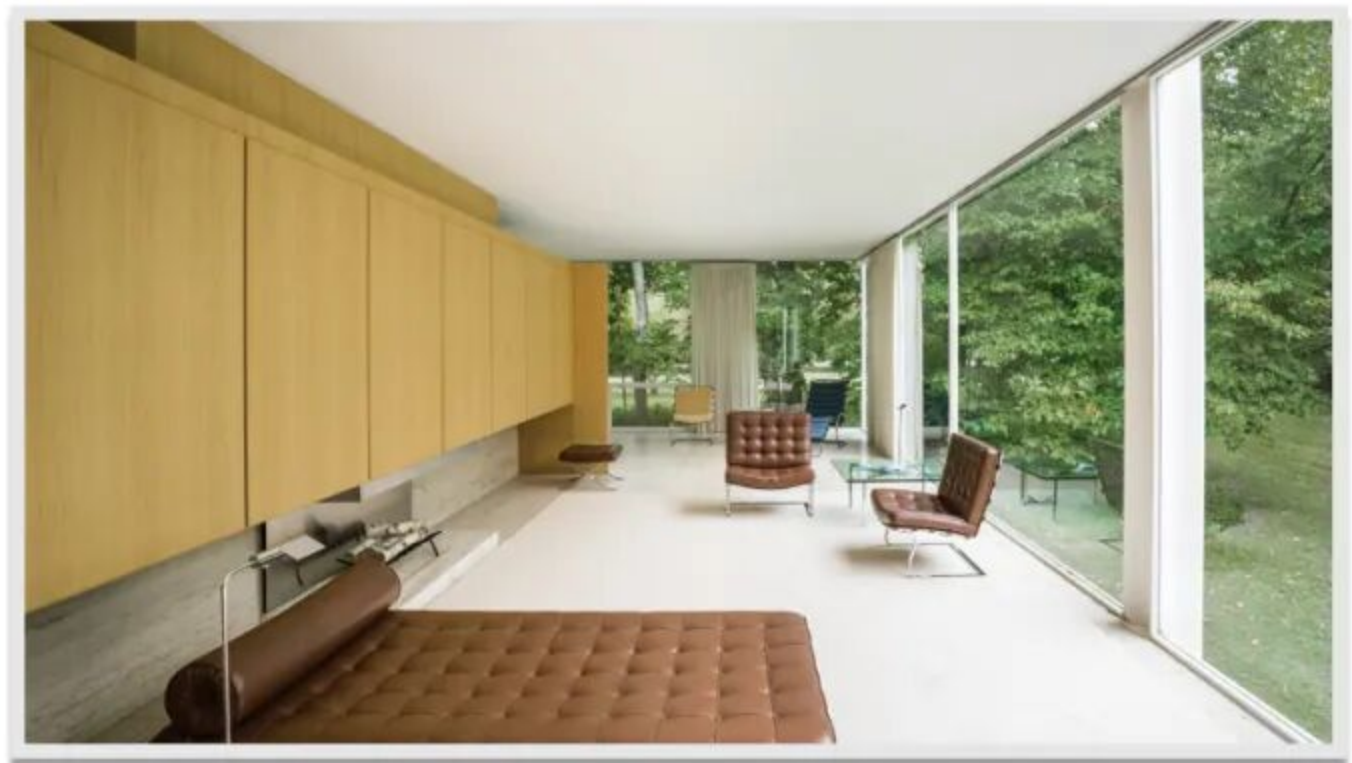



Casa Farnsworth

Farnsworth ■ House American

The contents of this chapter refer to the Wikipedia website.

本章内容参考维基百科网站，更多资讯可自行查阅。

The world's great architecture

Configuration

■ 灵感与设计



The essential characteristics of the house are immediately apparent. The extensive use of clear floor-to-ceiling glass opens the interior to its natural surroundings to an extreme degree. Two distinctly expressed horizontal slabs, which form the roof and the floor, sandwich an open space for living. The slab edges are defined by exposed steel structural members painted pure white. The house is elevated 5 feet 3 inches (1.60 m) above a flood plain by eight wide flange steel columns which are attached to the sides of the floor and ceiling slabs. The slab ends extend beyond the column supports, creating cantilevers. A third floating slab, an attached terrace, acts as a transition between the living area and the ground. The house is accessed by two sets of wide steps connecting ground to terrace and then to porch.



Historia

La casa es el resultado de un encargo de la doctora Edith Farnsworth, en 1945, para construir un lugar de retiro de fin de semana. Las obras comenzaron en 1947, finalizándose en su mayor parte en 1951. Existe una amplia rumorología acerca de una posible relación romántica entre Mies y la Doctora Farnsworth, pero en cualquier caso la relación entre el arquitecto y la cliente desembocó en los tribunales, negándose ella a pagar parte de los costes de la vivienda —estimados originalmente en 58.000\$, y que terminaron alcanzando los 73.000\$—, bajo acusaciones de mala praxis. Mies ganó el juicio, pero el mobiliario de la casa, diseñado también por Mies, fue finalizado sin su supervisión.



Características

El módulo de la vivienda nace de la baldosa de travertino empleada: de 90x60cm. (3x2 pies redondeando). Resultan así las siguientes dimensiones:

Plataforma de acceso: 20x11 baldosas, a las que se suma el perfil metálico que confina el forjado (equivalente al UPN español), resultando aproximadamente 18,20x6,80 metros (123,75 m²).

Plataforma superior (porche y vivienda): 28x14 baldosas, a las que se suma el perfil metálico que confina el forjado, resultando, aproximadamente, 25,40x8,60 metros (218,45 m²).

La cocina y los dos baños se agrupan en una pastilla central con acabados en madera, que aloja las instalaciones y articula la separación entre las distintas zonas de la vivienda, dejando libre circulación en todo el perímetro.

Design Points

结构难点

Angle calculation
角度的计算

$$S=4\pi \cdot r^2$$

$$a^2+b^2=c^2$$

$$\sin^2 a + \cos^2 a = 1$$



Creation and thinking

创作·思考

08

Special parts

特殊零件的开发利用

$$S=4\pi \cdot r^2$$

$$a^2+b^2=c^2$$



WG1354
草枝



WG1326
小树枝



WG1406
七叶花



WG1394
三叶片

$$\sin^2 a + \cos^2 a = 1$$



features and functions

特点.功能

Main Color Matching

配色方案



Pantone 477C



Pantone 123C



Pantone 7500C



Pantone 7620C



Pantone 509C



Pantone 347C

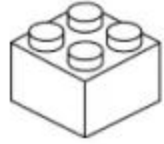

Pantone 4625C



Pantone Cool Gray 6C



Color matching

Adopting 4 main colors, Beige, green, Light gray, white as the main color, the more reasonable and bold color matching on the original building, making the product more atmospheric and the whole design is more reasonable.

Farnsworth House

美国范斯沃斯住宅



Left

Front

Back

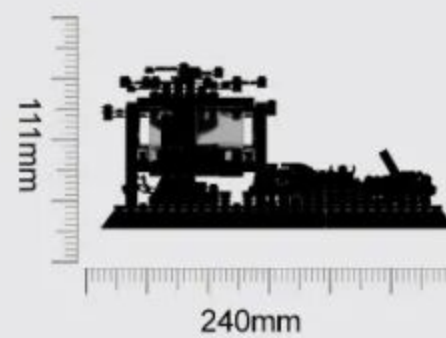
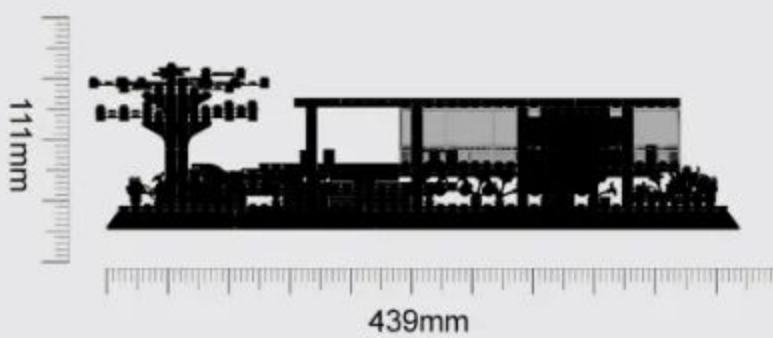
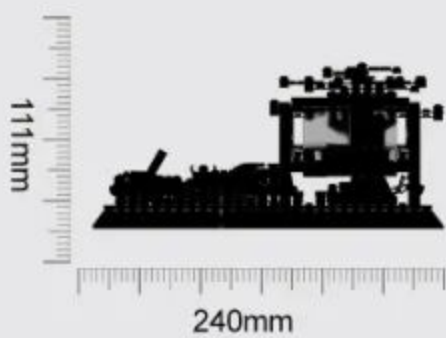

Product Size:439X240X111mm



Instructions For Use

积木起件器使用说明
Brickseparator

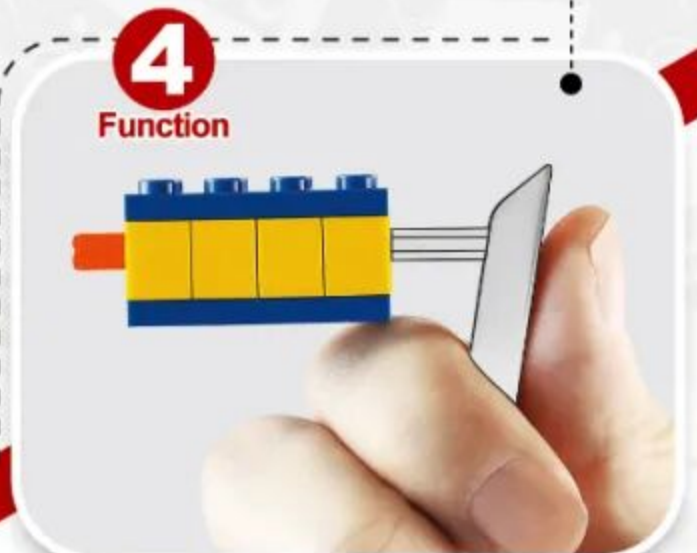
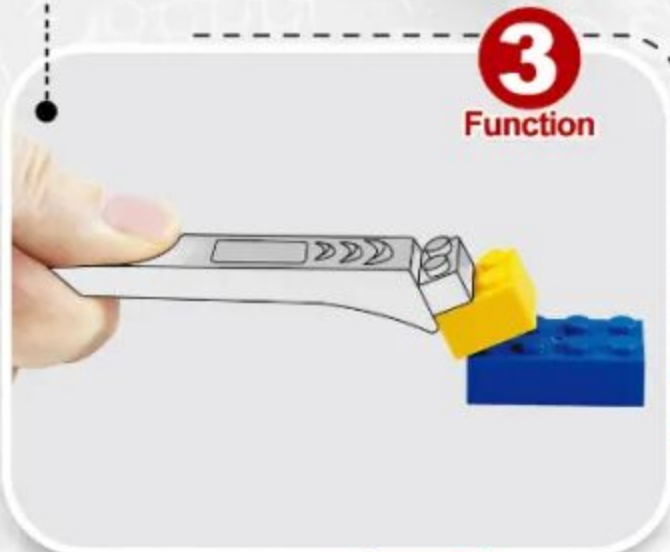
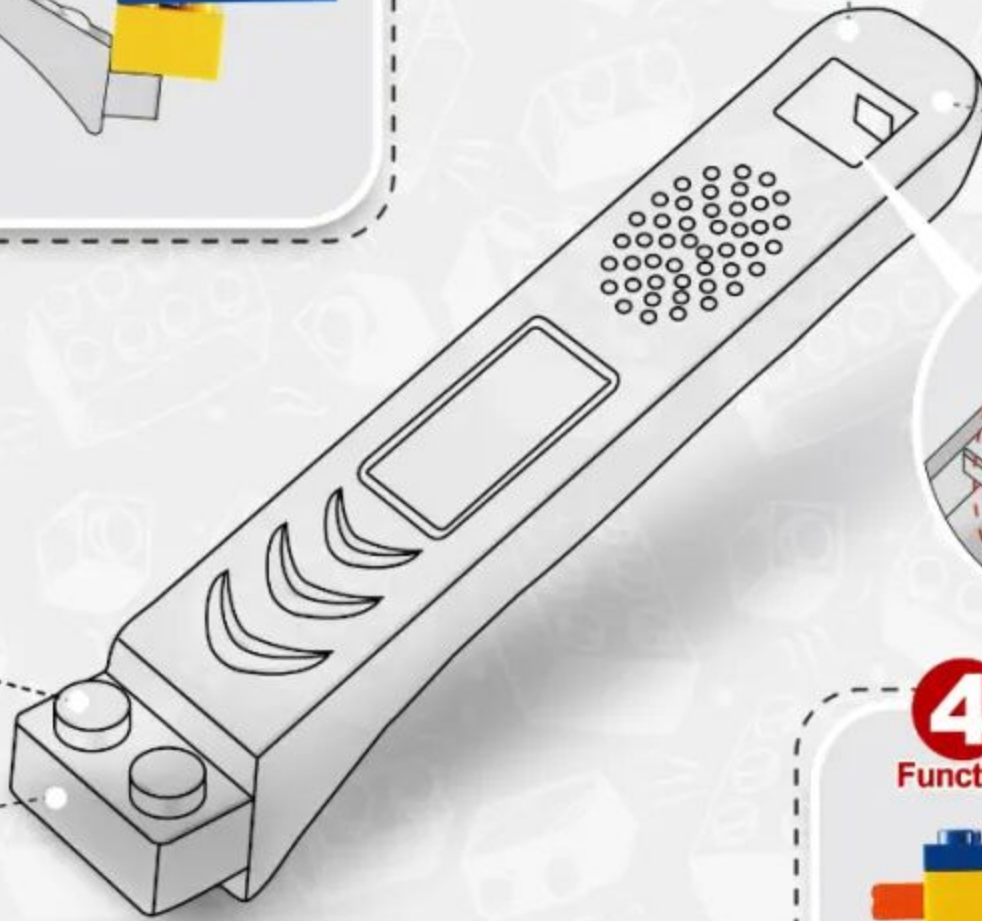
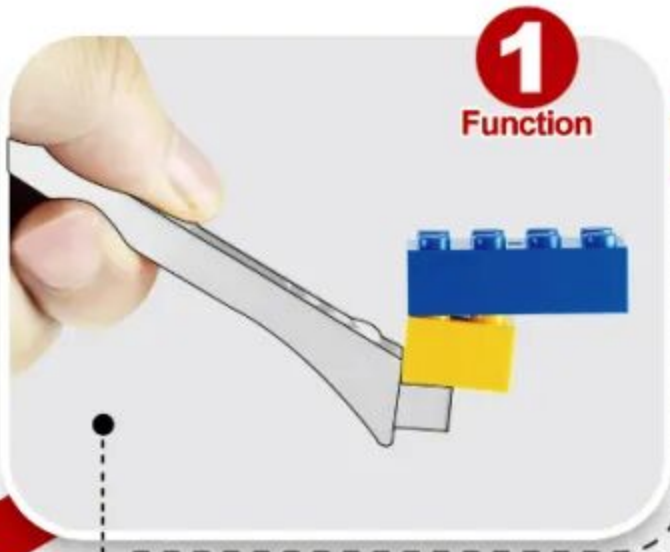

4 ways to make installation easier
让安装更简单



■ First open the product packaging according to the instructions.

按指导用正确方式拆解产品外包装。



■ Summarize all parts to count the number of familiar accessories.

对照说明书清单确认积木包数量与积木数量。



■ Arranging all accessories by color helps to quickly install the product.

把确认好的积木以类型、颜色进行分类排好以便安装。



■ Carefully install the product and learn about building.

按说明书步骤拼装并完成你的积木模型。



1:1 Physical Reference Table

十字棒配件1:1尺寸参照表



Instructions For Use
让安装更简单



2 $(1 \times 2) = 2$

3 $(1 \times 3) = 3$

4 $(1 \times 4) = 4$

5 $(1 \times 5) = 5$

6 $(1 \times 6) = 6$

7 $(1 \times 7) = 7$

8 $(1 \times 8) = 8$

9 $(1 \times 9) = 9$

10 $(1 \times 10) = 10$

12 $(1 \times 12) = 12$

16 $(1 \times 16) = 16$

PARTS LIST

配件清单

x1	x14	x9	x1	x2
x1	x1	x22	x1	x8
x4	x2	x9	x1	x2
x1	x3	x1	x2	x2
x5	x1	x1	x1	x4
x5	x8	x1	x3	x2
x3	x8	x5	x2	x4
x3	x12	x1	x2	x1
x2	x20	x2	x1	x4
x2	x8	x8	x1	x4
x9	x16	x6	x6	x1
x4	x1	x7	x2	x10
x1		x2	x2	x1
x3	x18	x1	x9	x1
x5	x9	x1	x4	x4
	x30	x1		
		x1		
	x12			

产品有增补件请以实物为准

If product has additional parts, please in kind prevail.

PARTS LIST

配件清单



x4

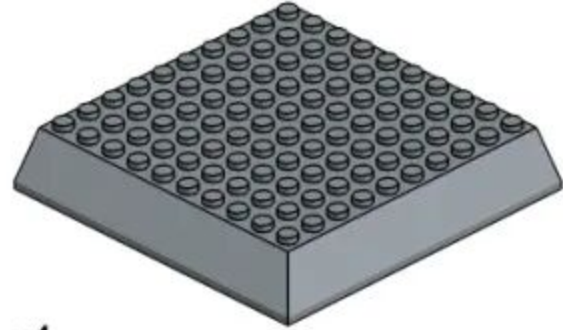

x4



x4

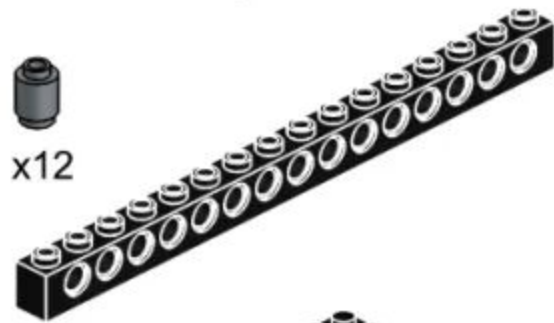

x12

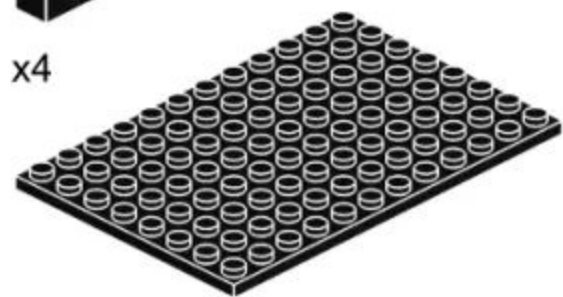

x4

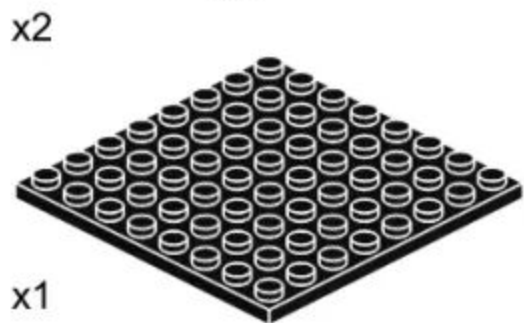

x2

x1



x1



x1



x36

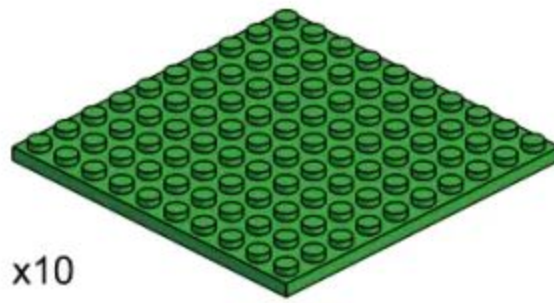

x10

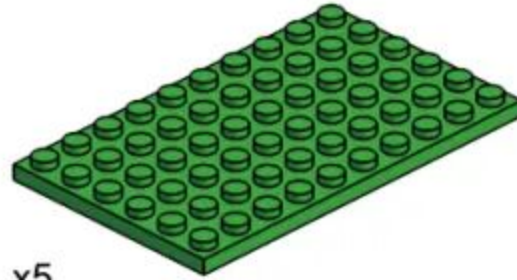

x5



x10



x16



x9



x3



x5



x4



x10



x8



x18



x9



x30



x4

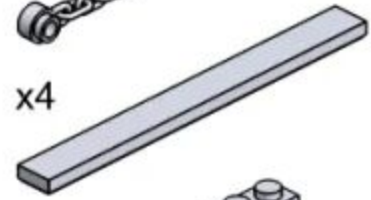

x15

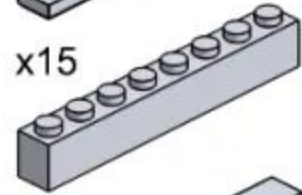

x1



x3

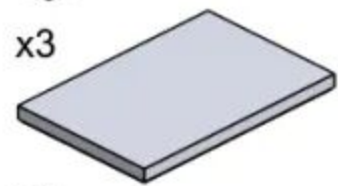

x8



x9



x8



x1



x4



x2



x4



x1



x4



x24



x6

产品有增补件请以实物为准
If product has additional parts, please in kind prevail.

1-1

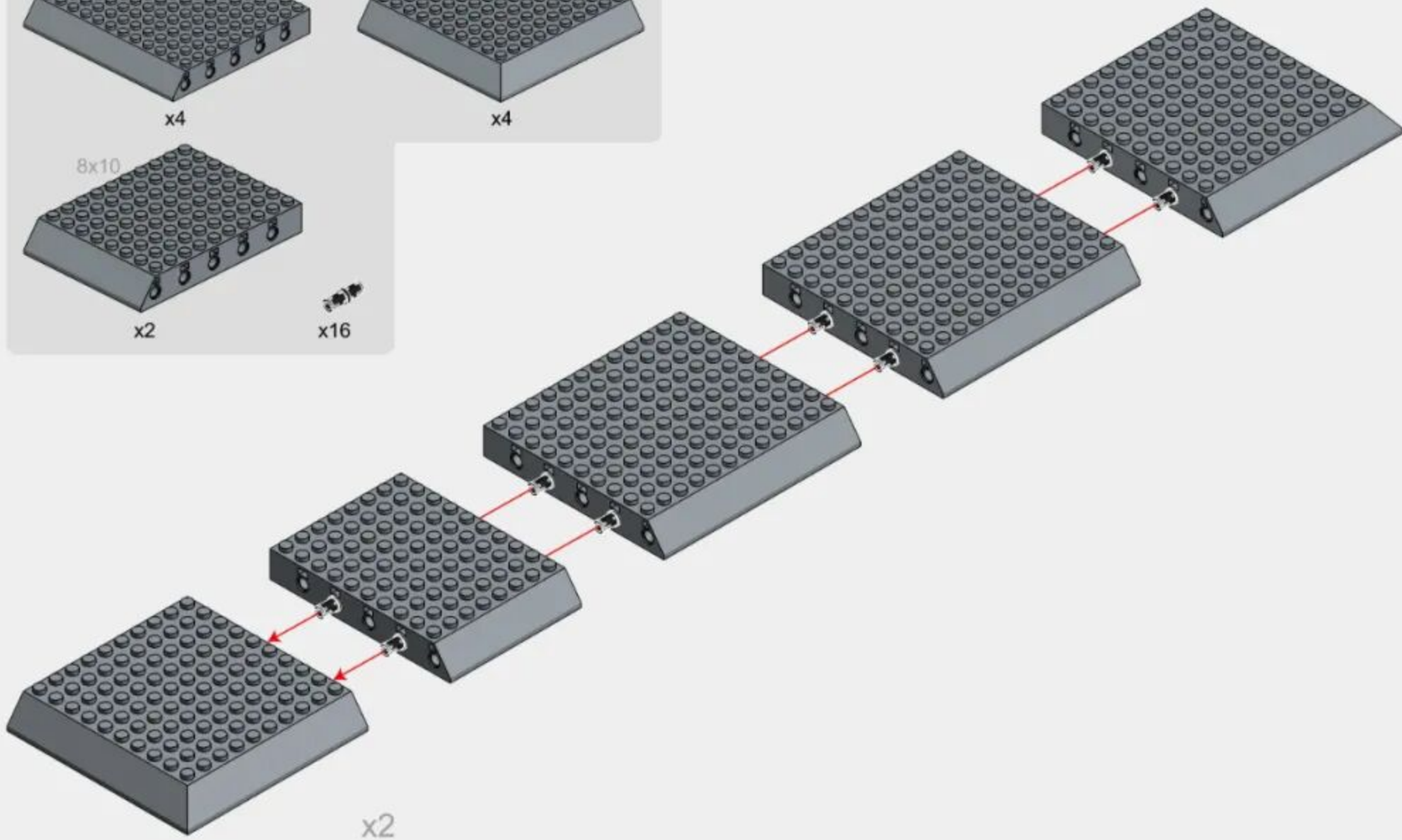
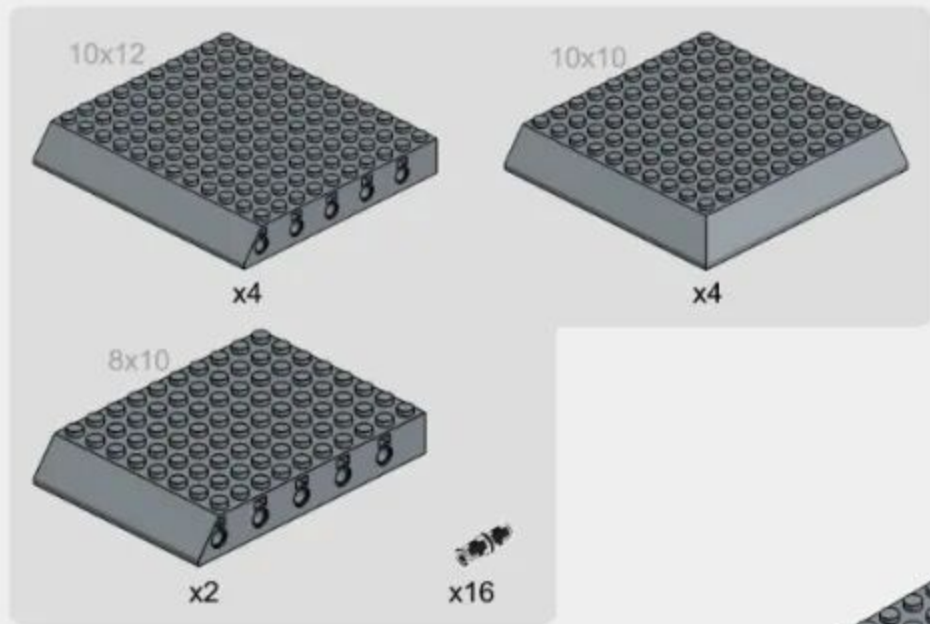

1-2

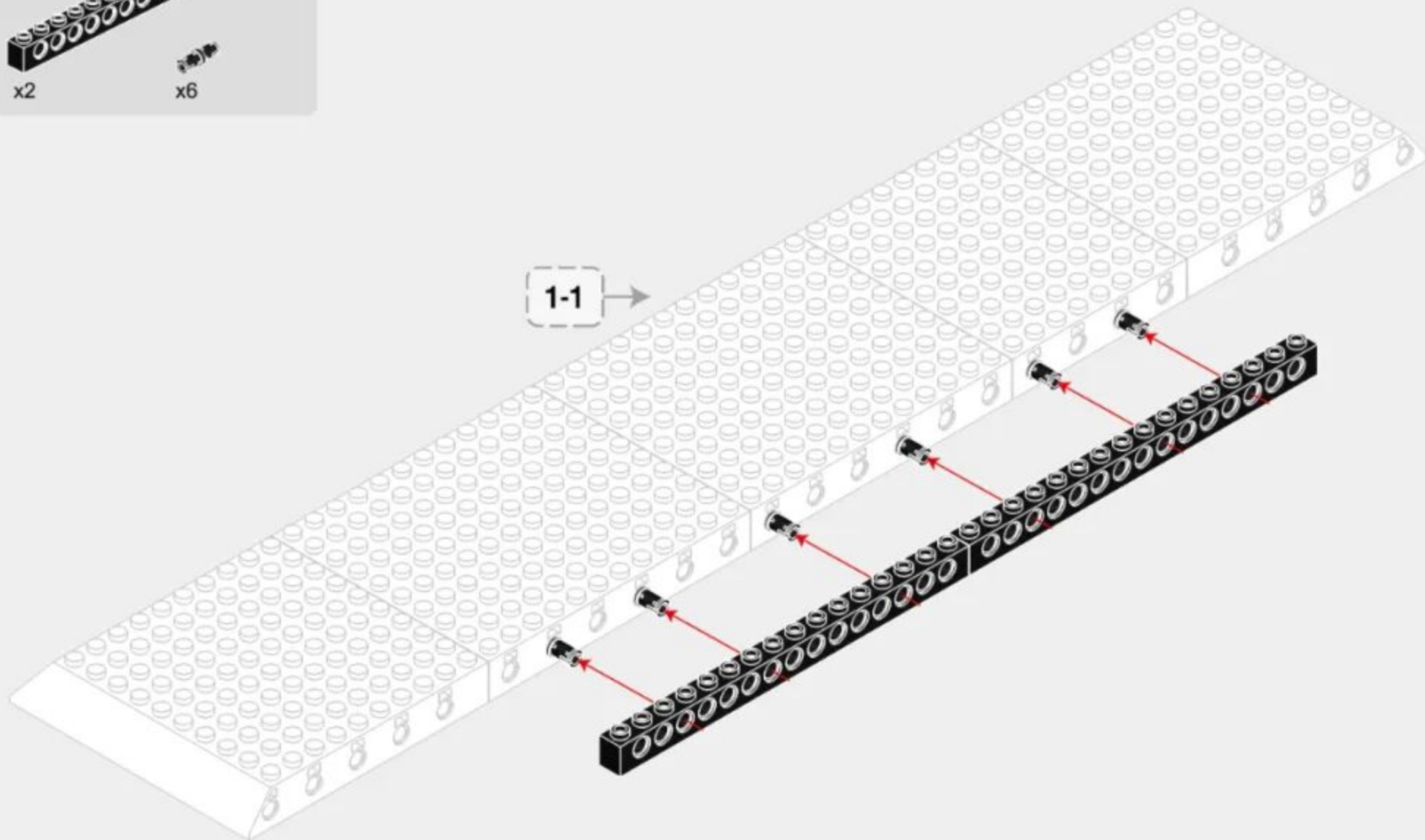
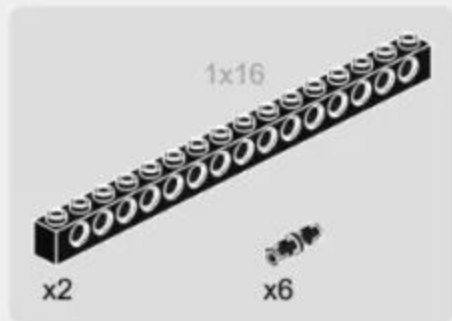

1-3

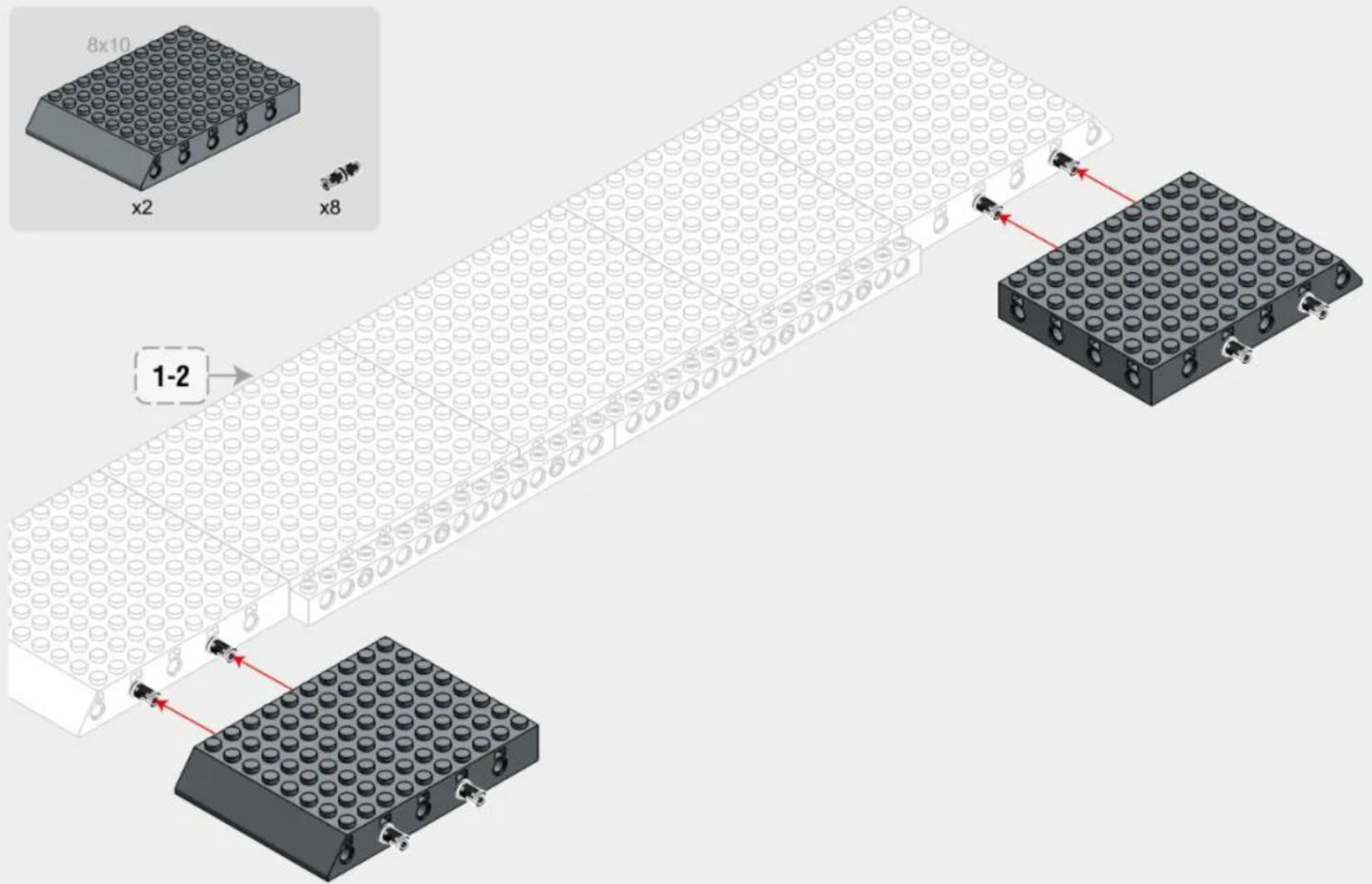
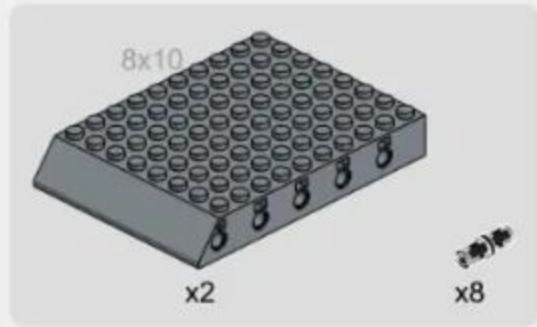

1-4

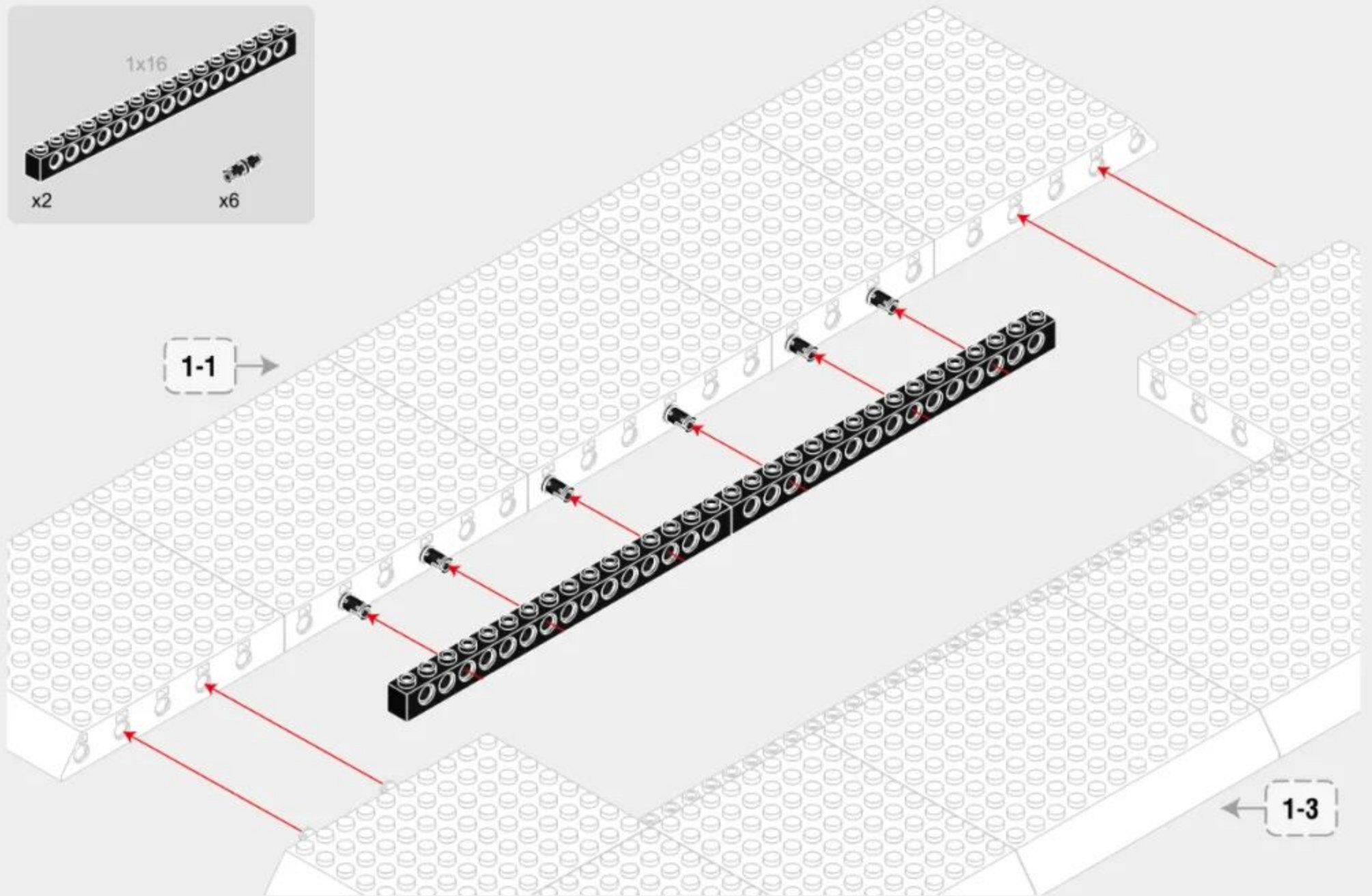
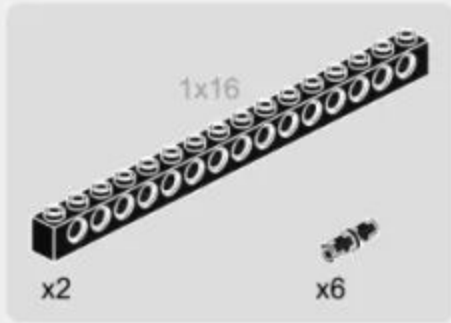

1-5

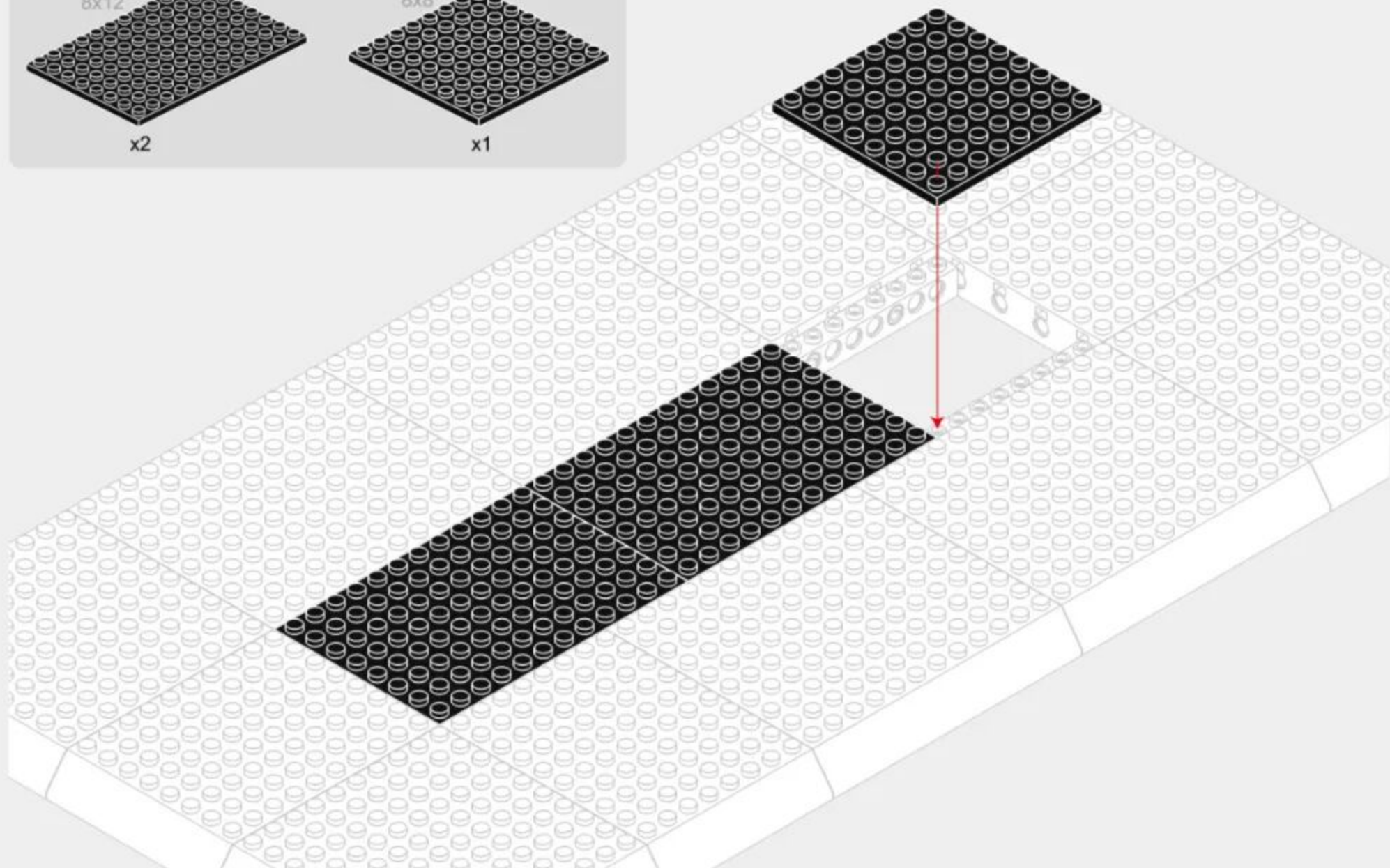
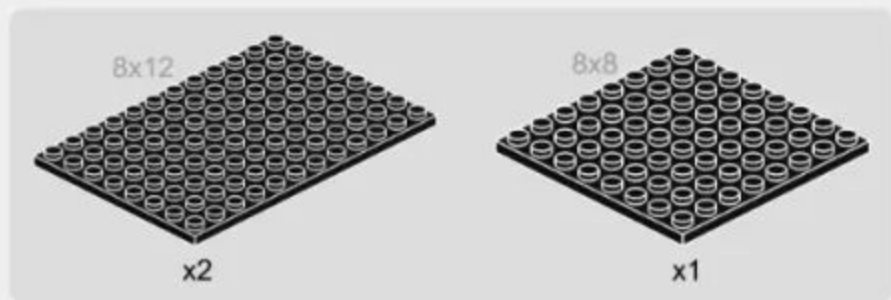

1-6

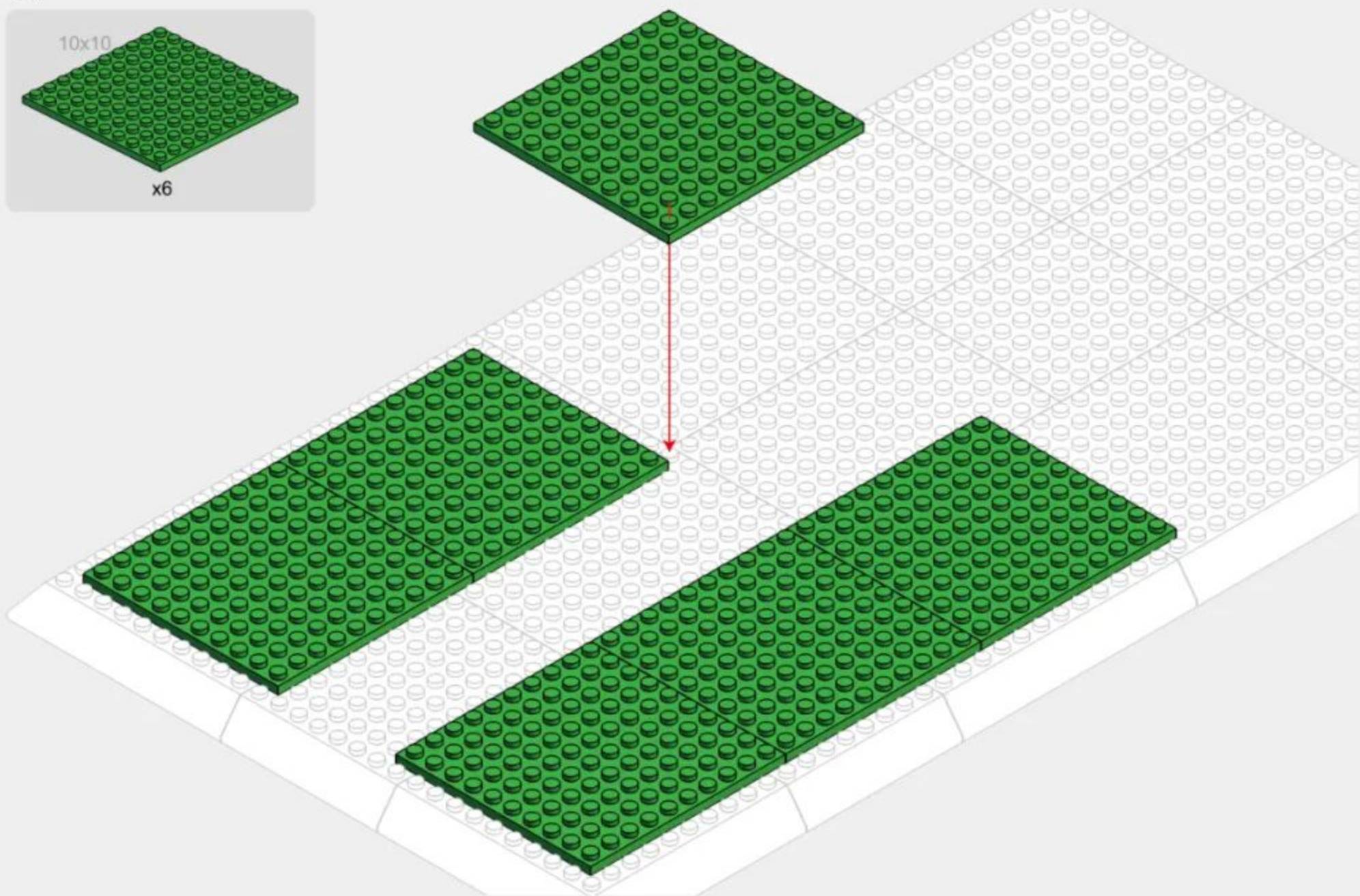
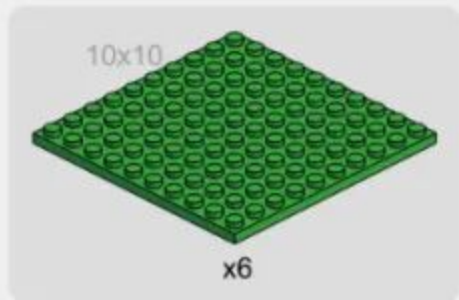

1-7

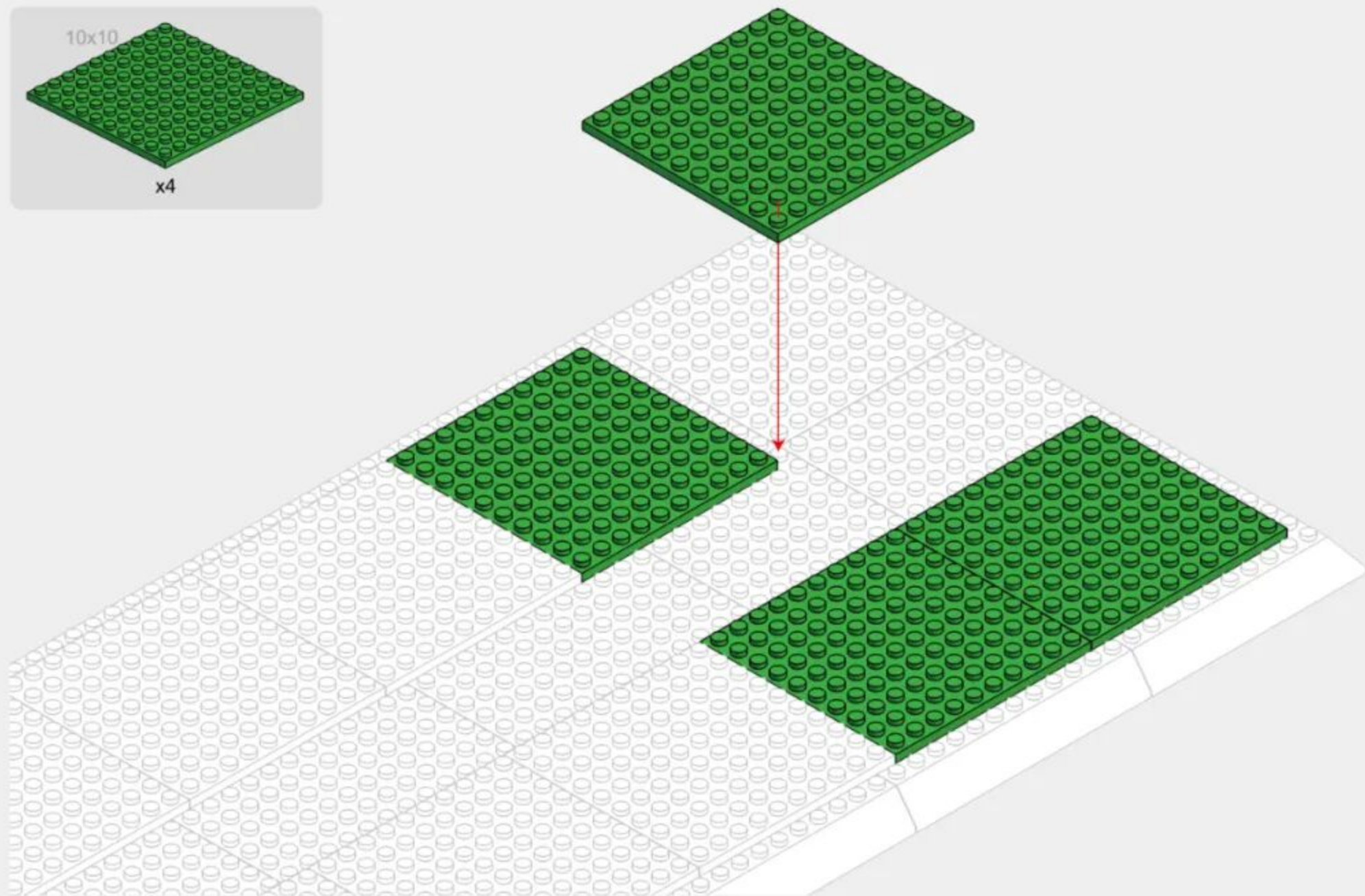
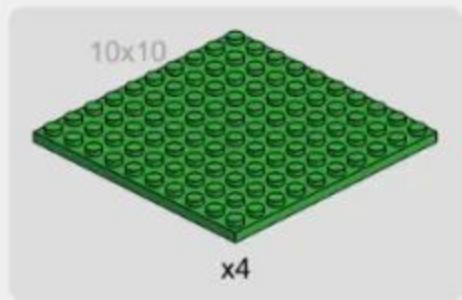

1-8

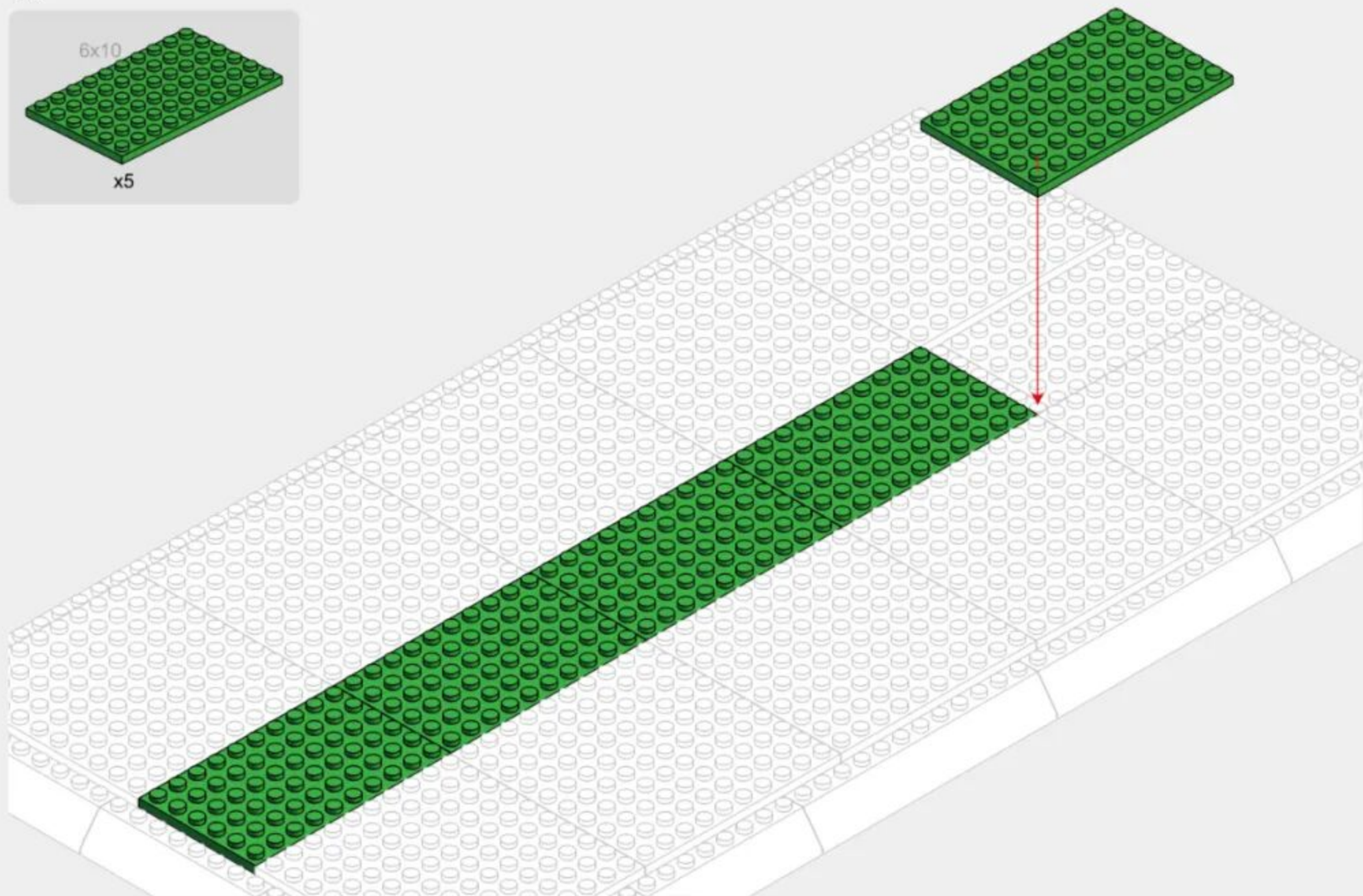
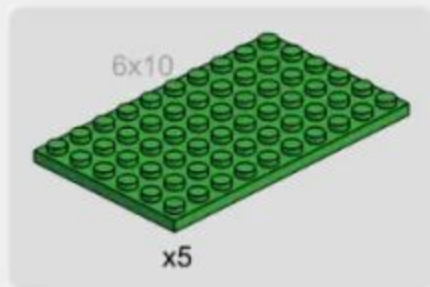

1-9

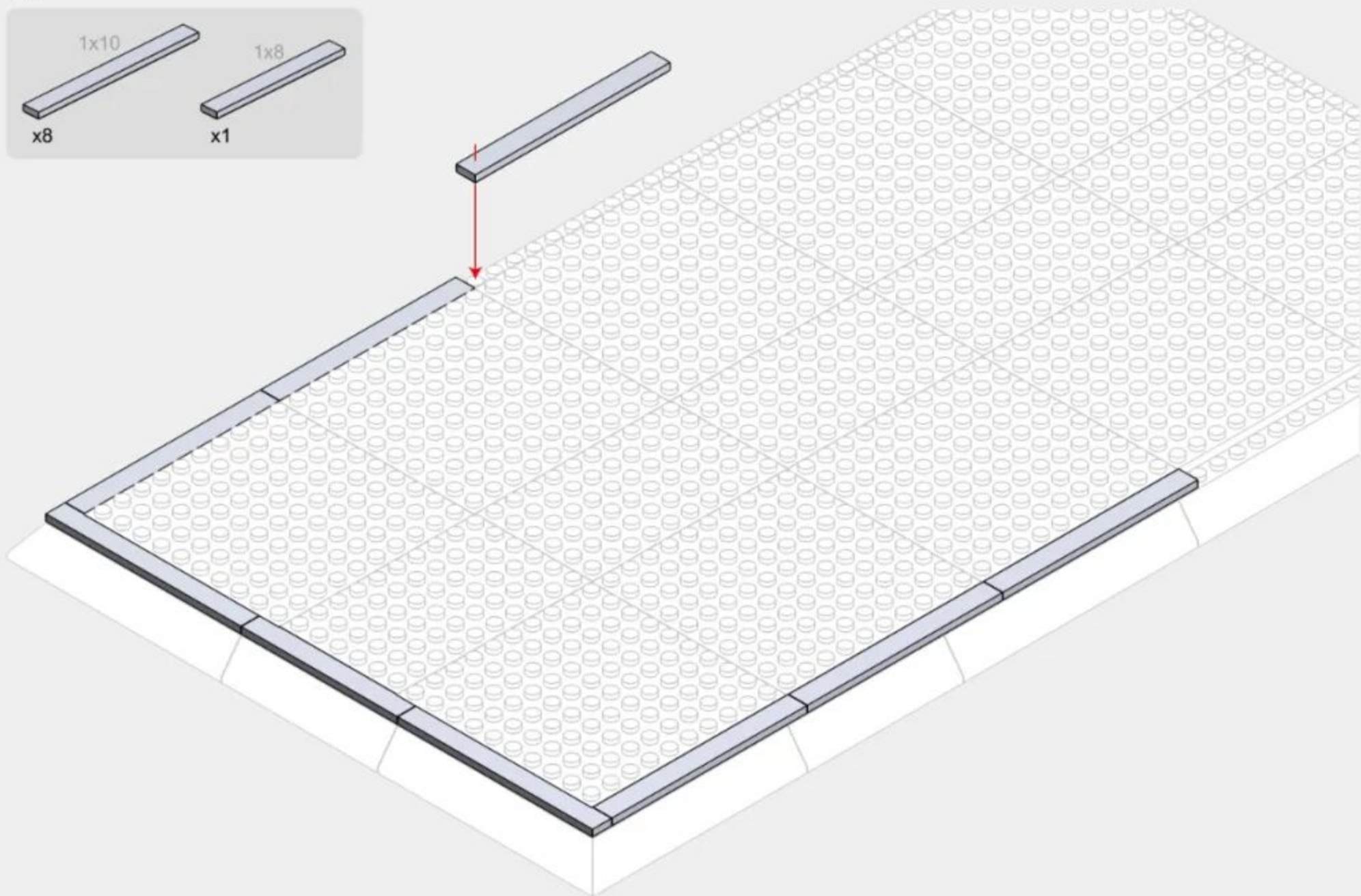
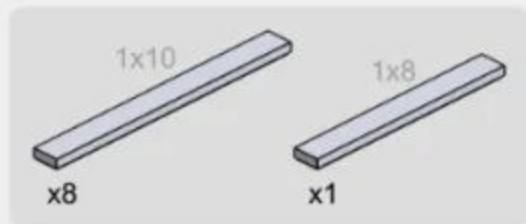

1-10

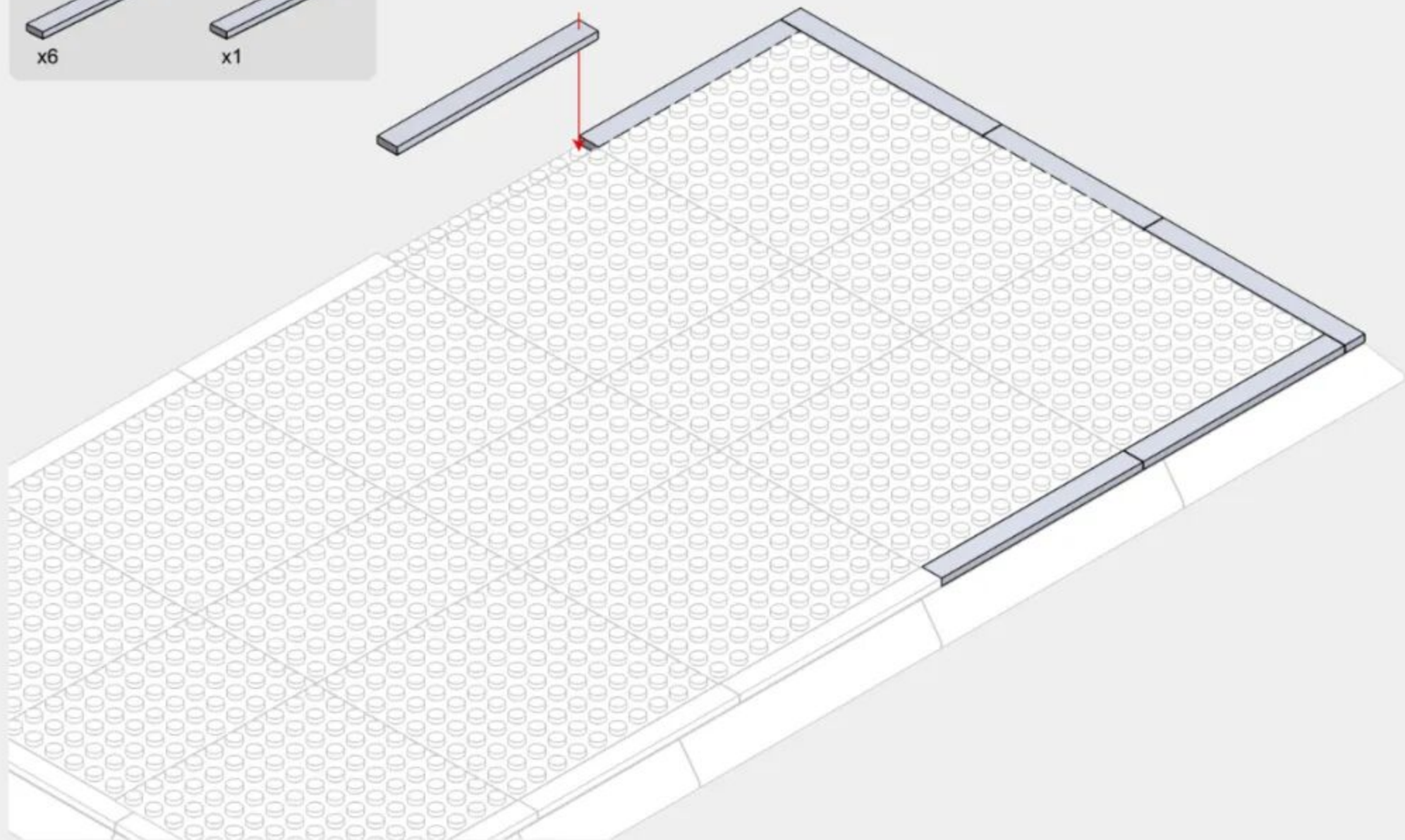
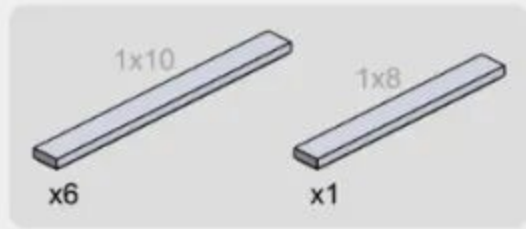

1-11

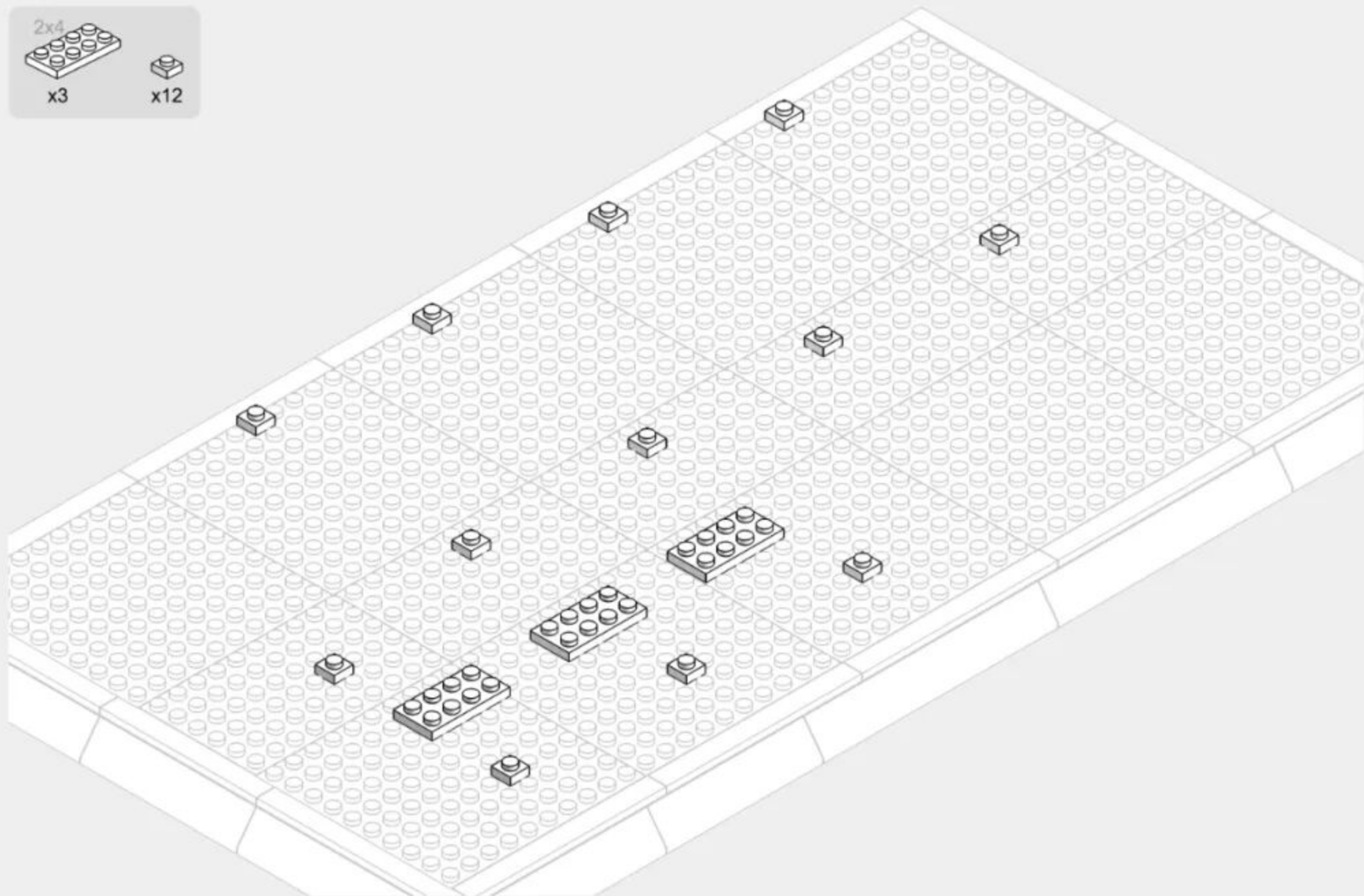

1-12

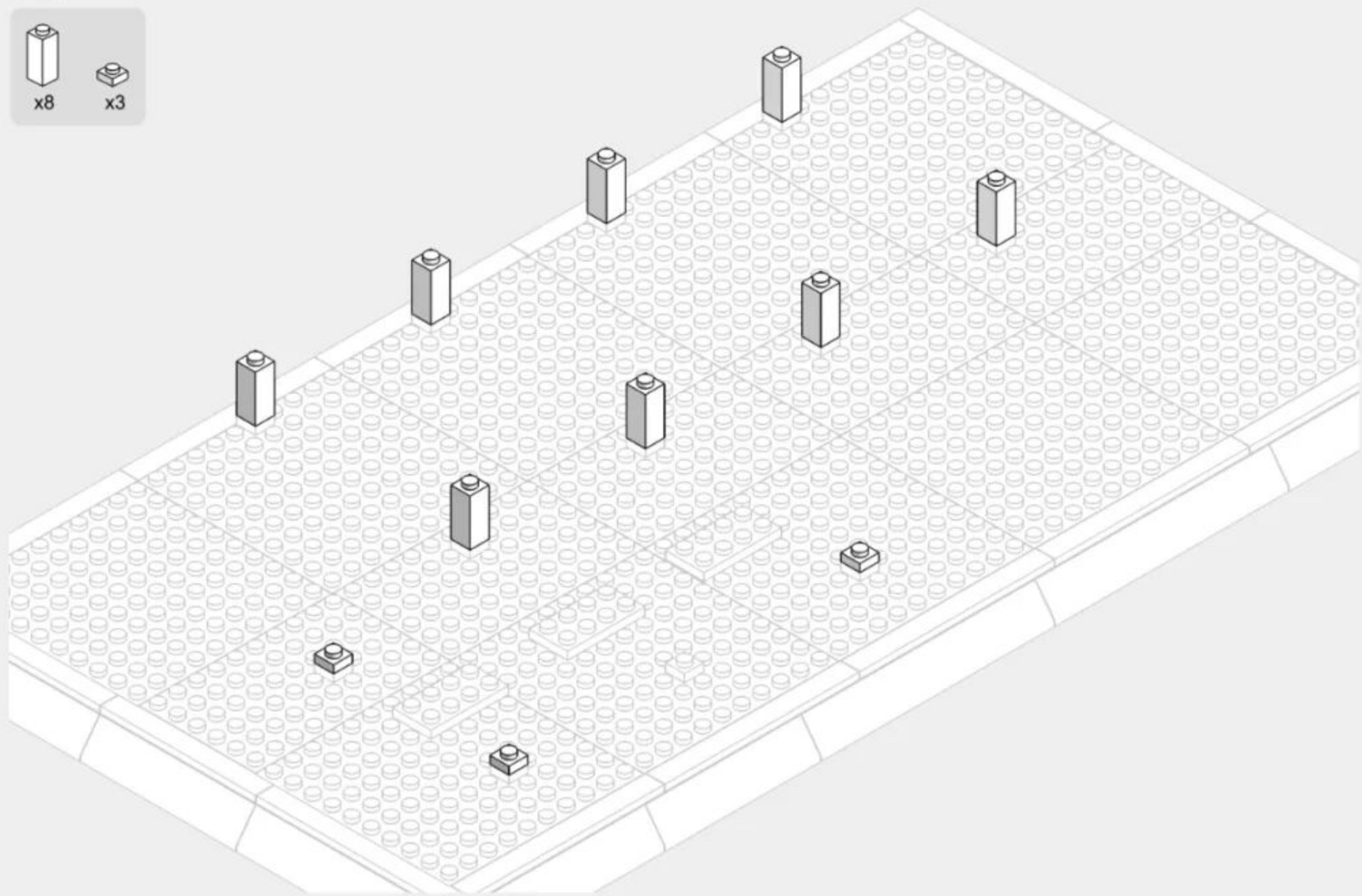
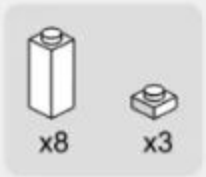

1-13

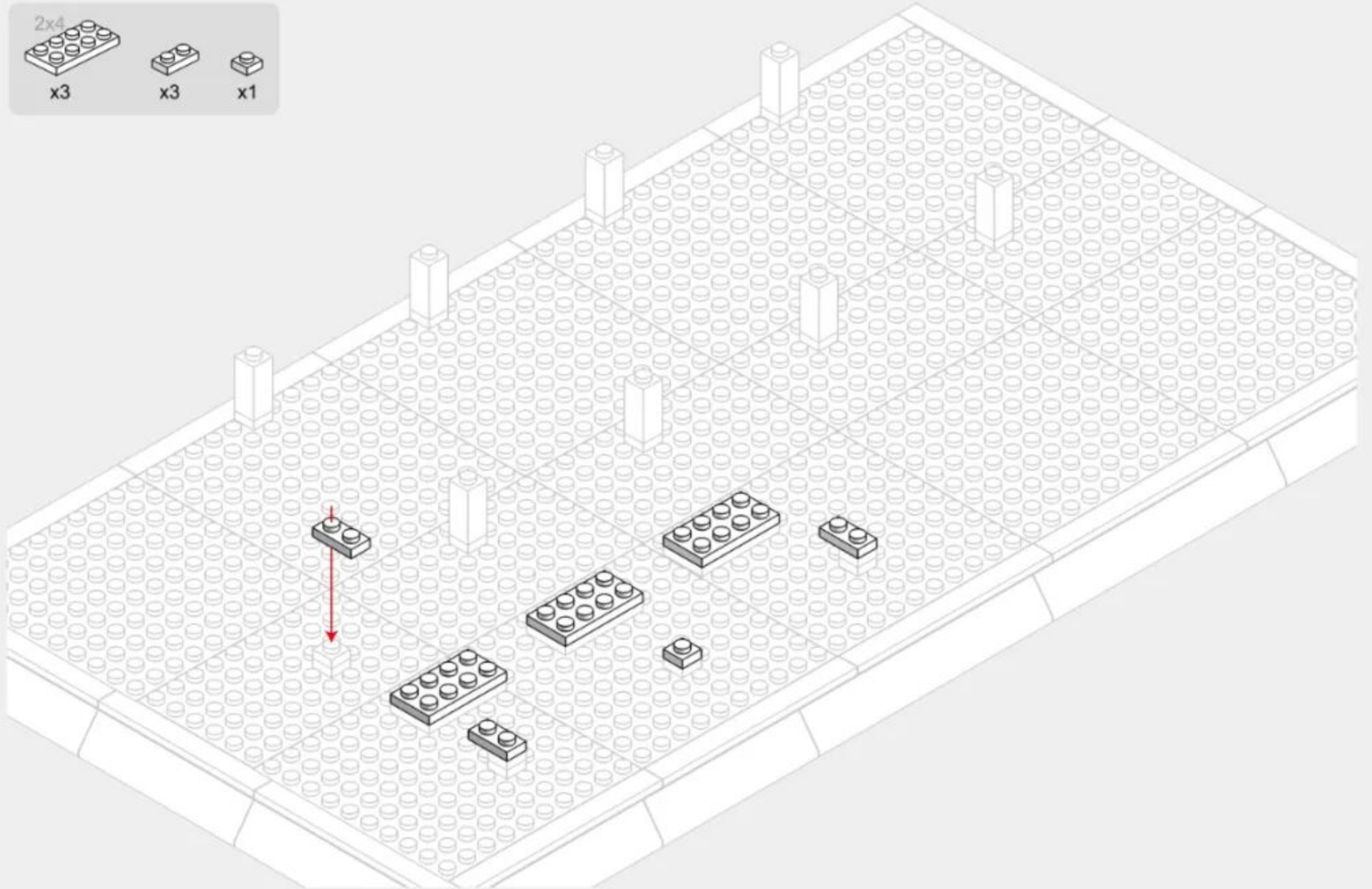
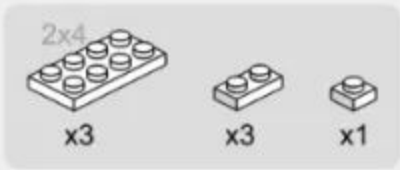

1-14

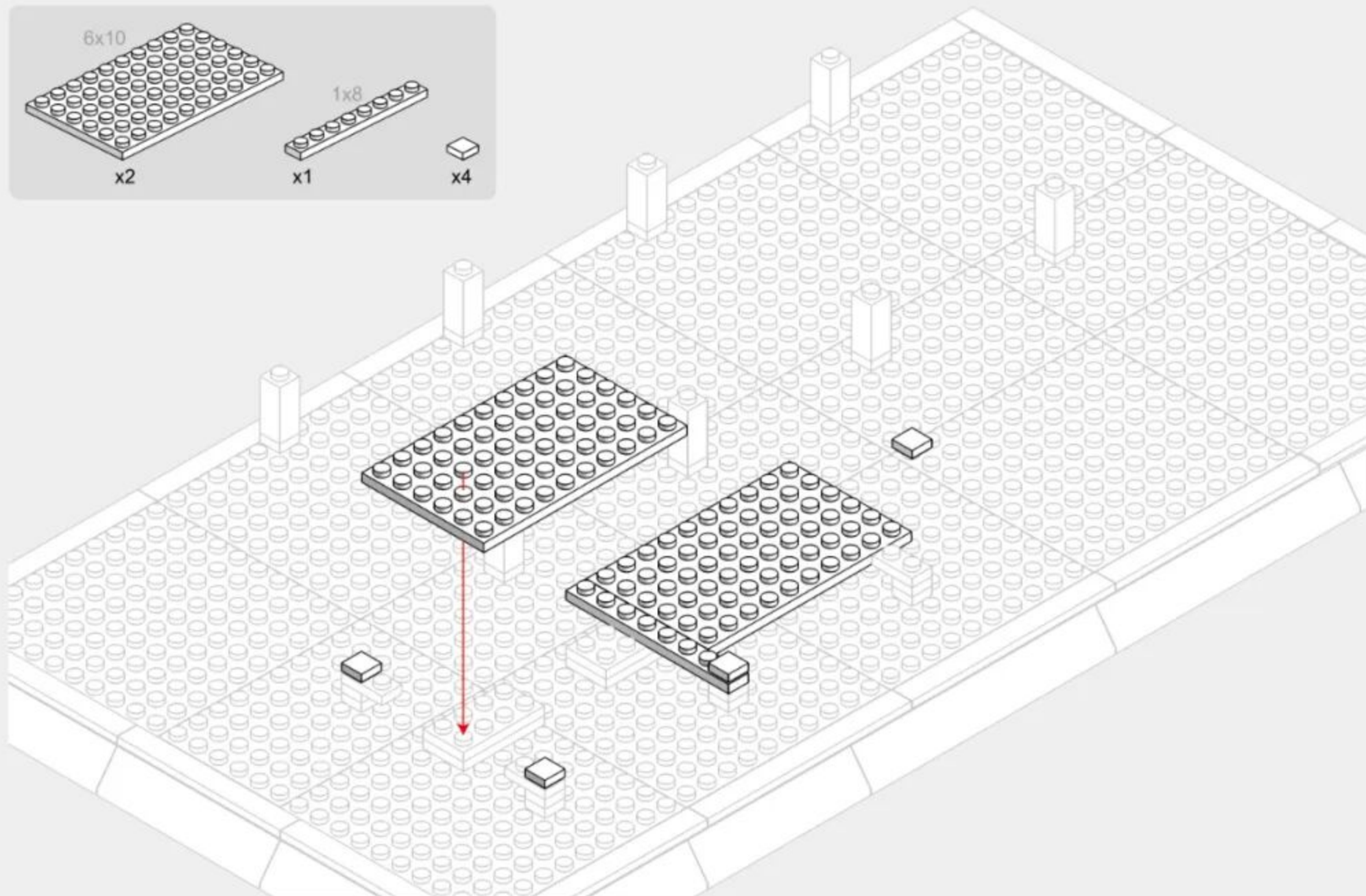
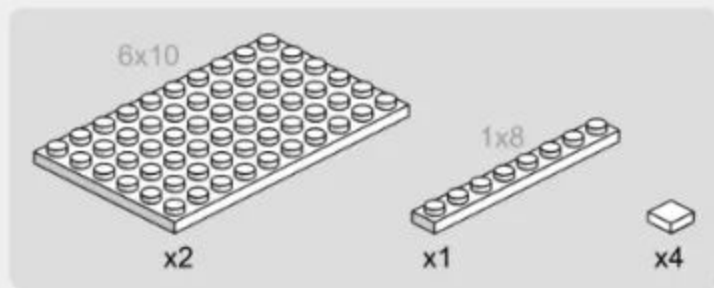

1-15

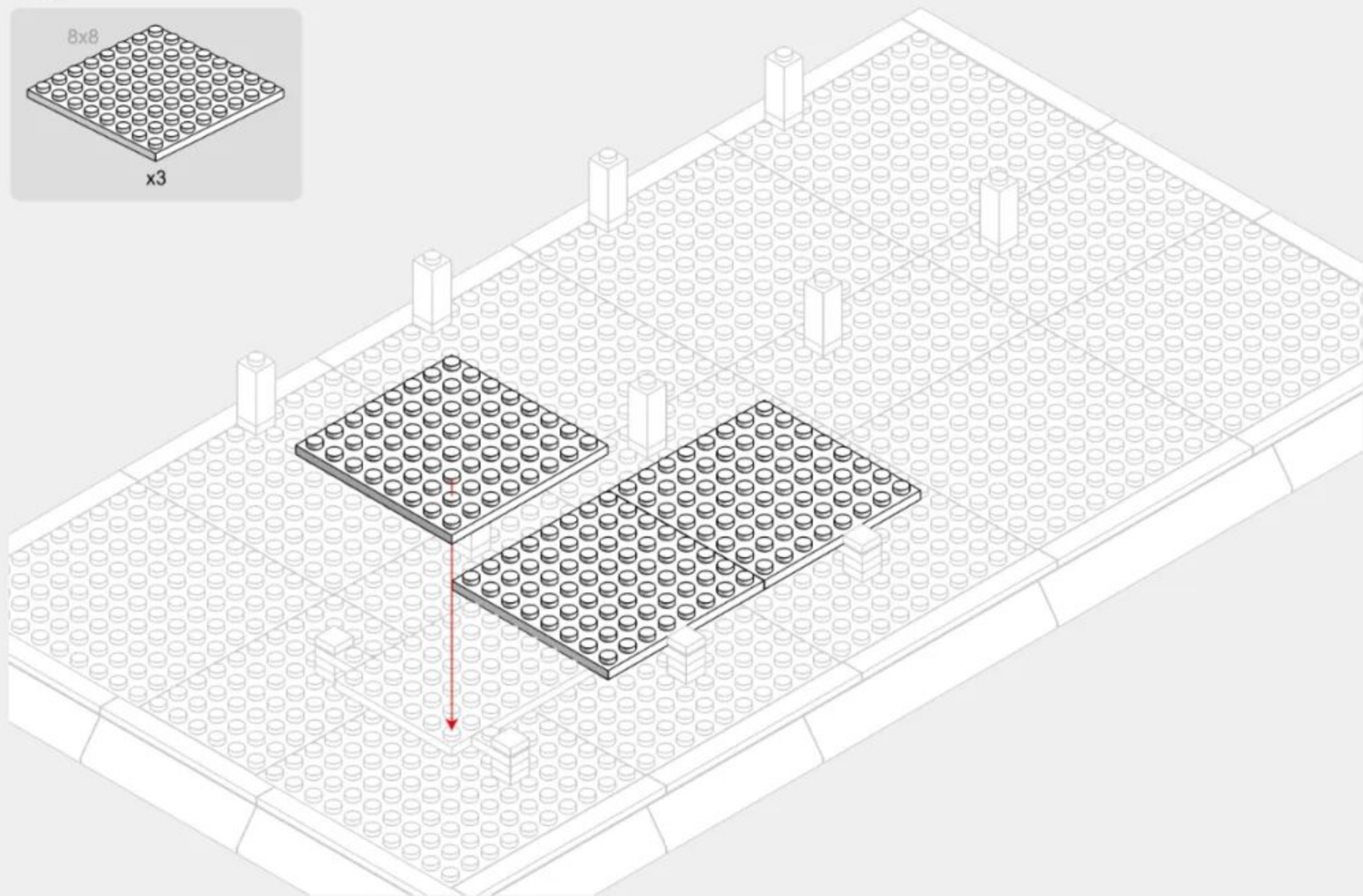
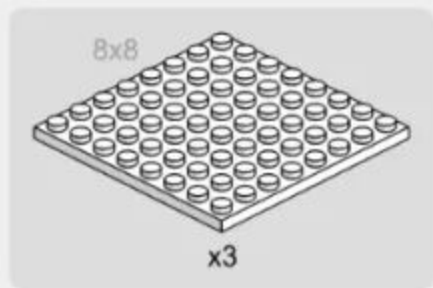

1-16

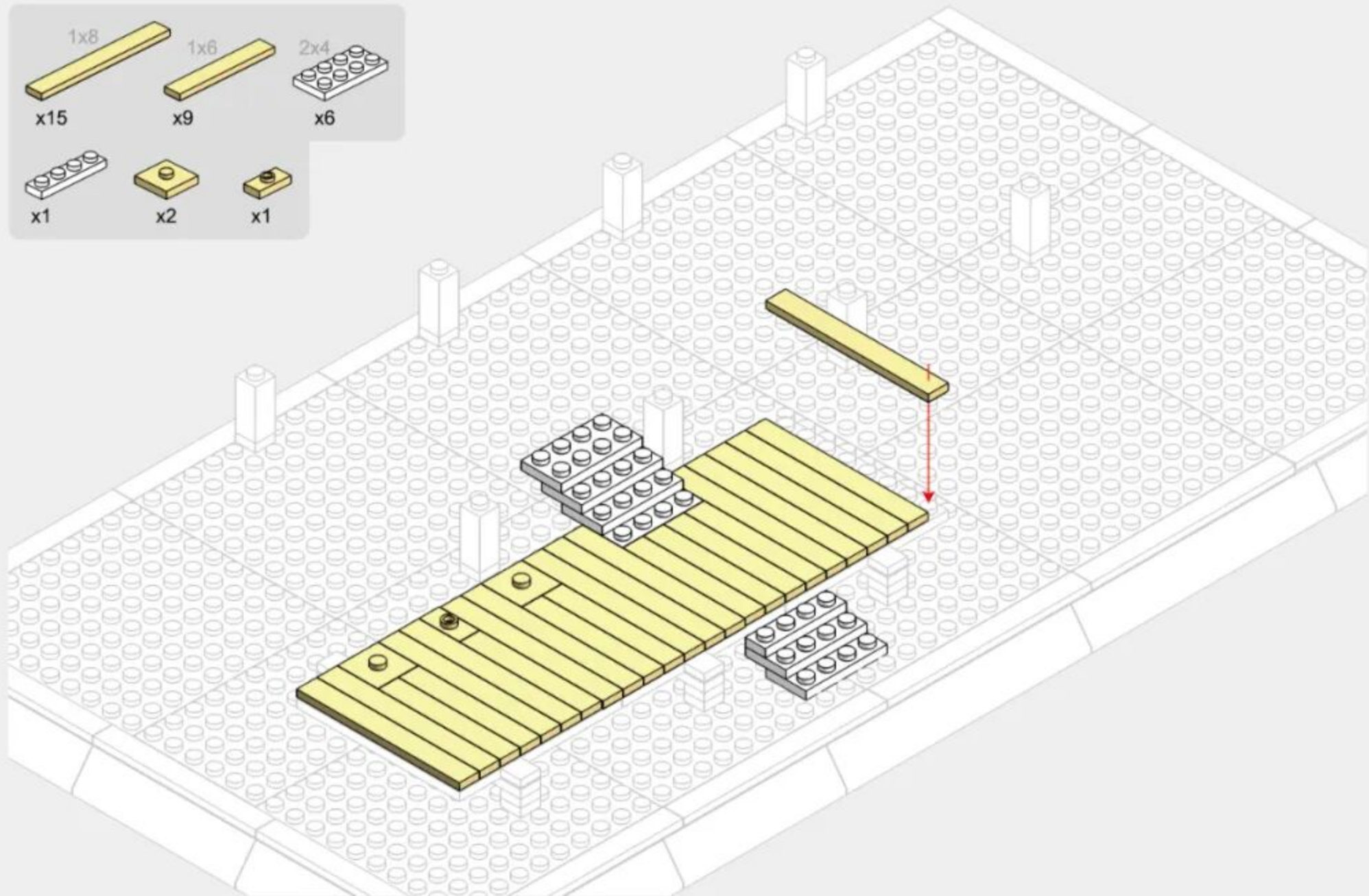
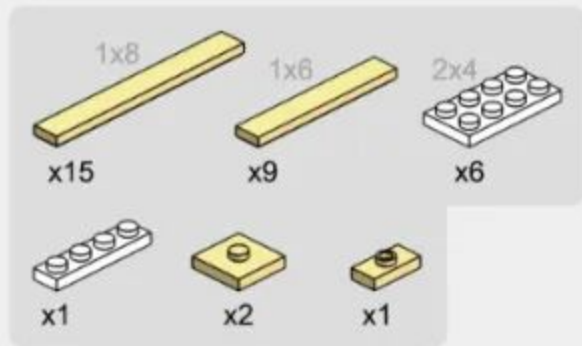

1-17

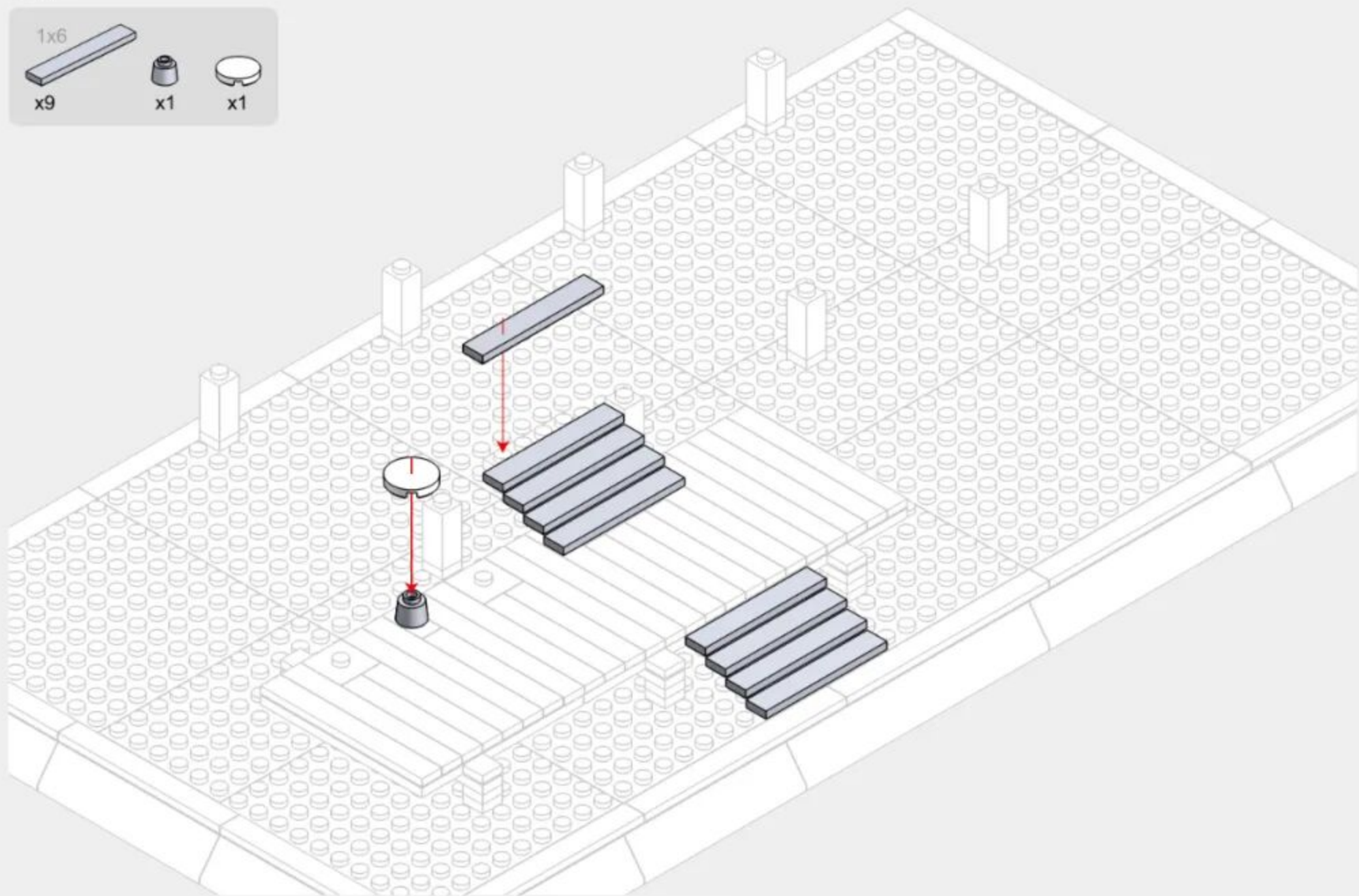

1-18

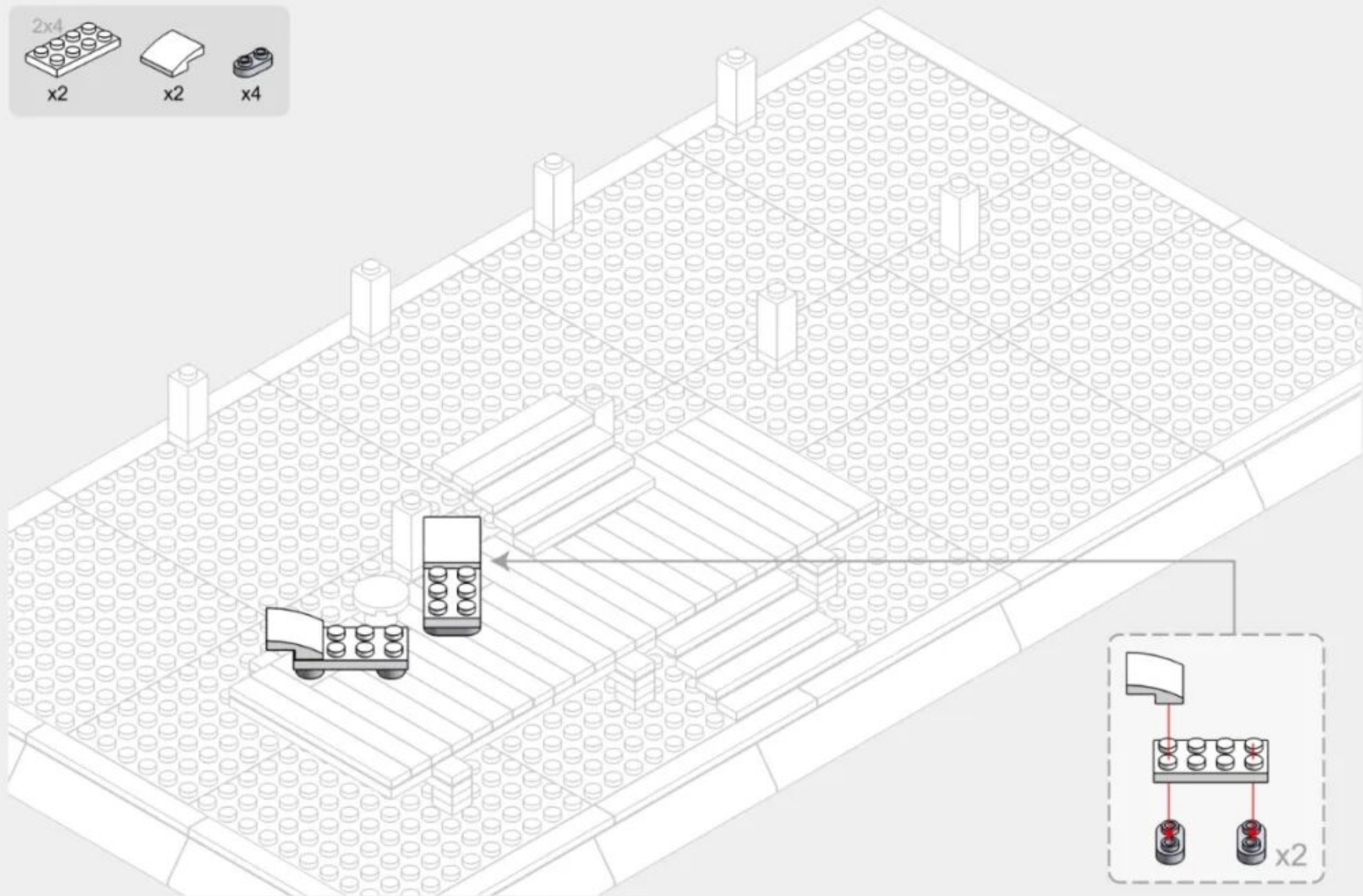
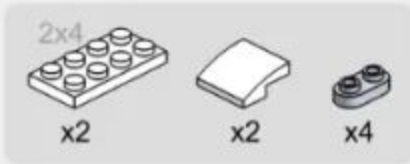



193PCS

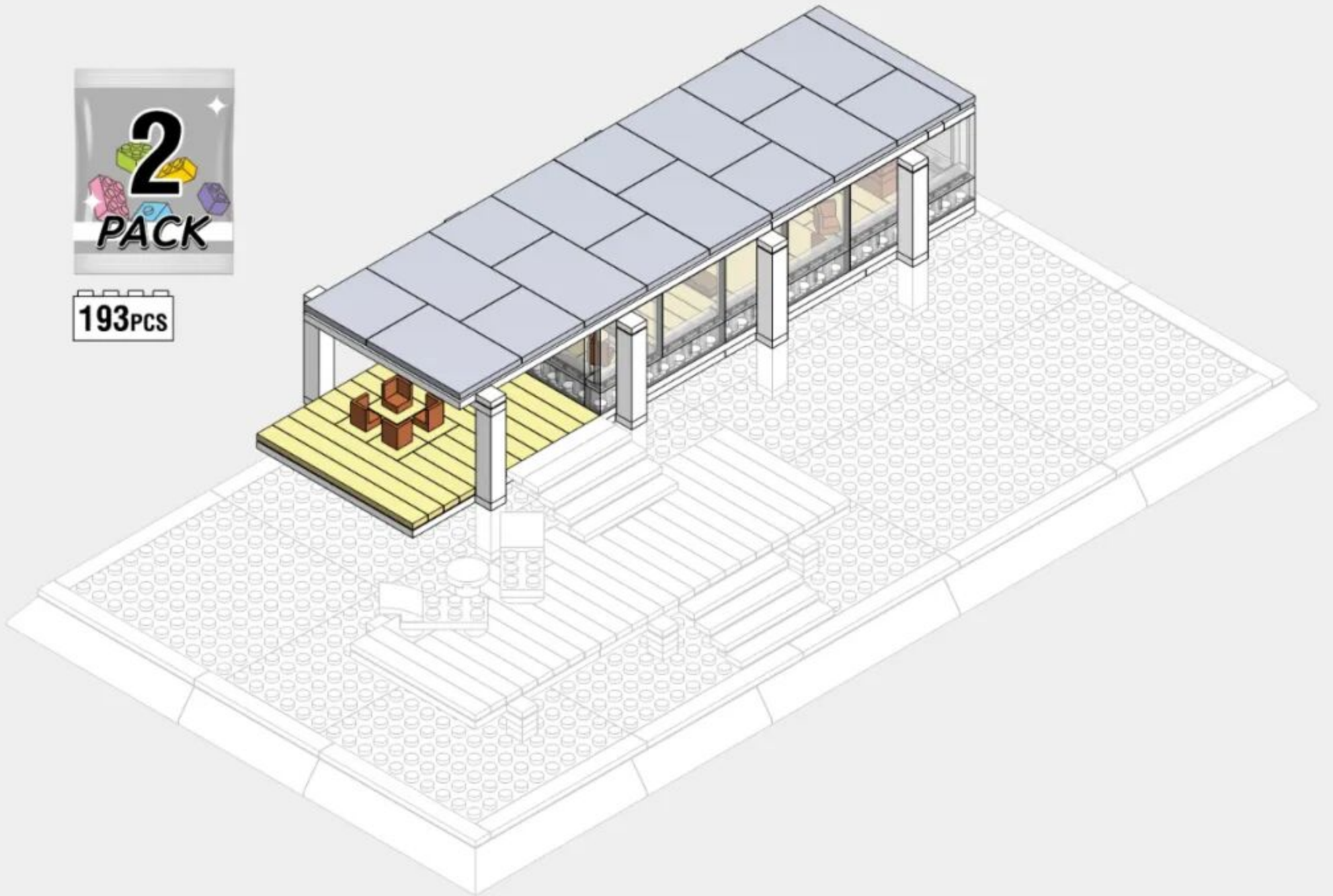

2-1

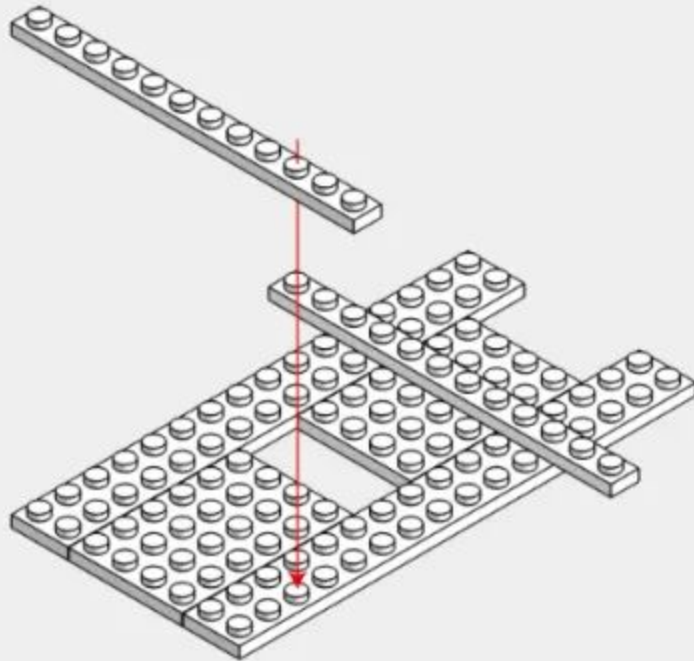
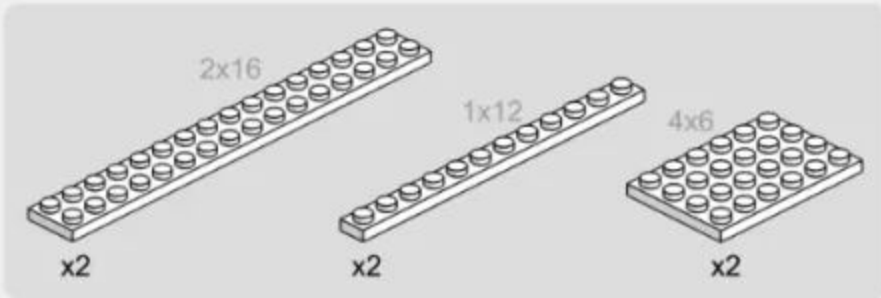

2-2

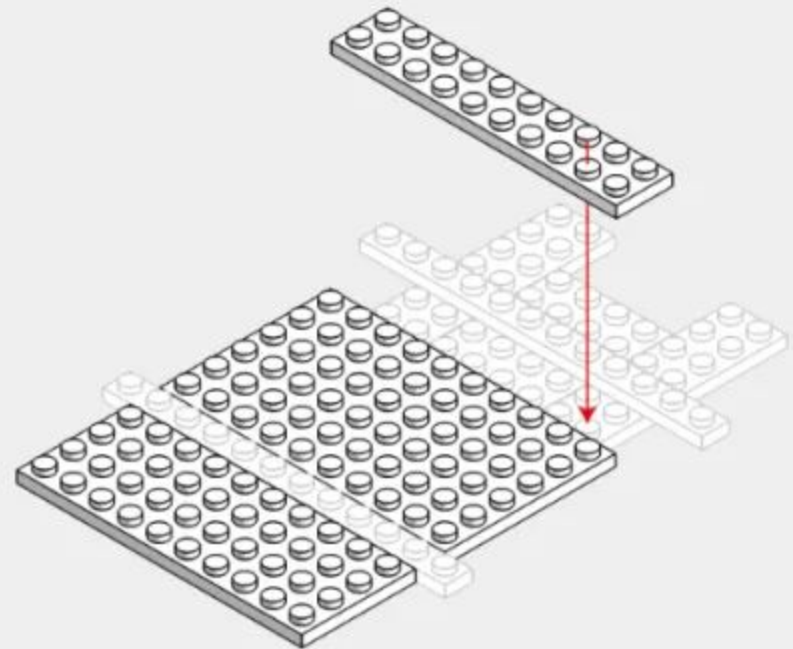
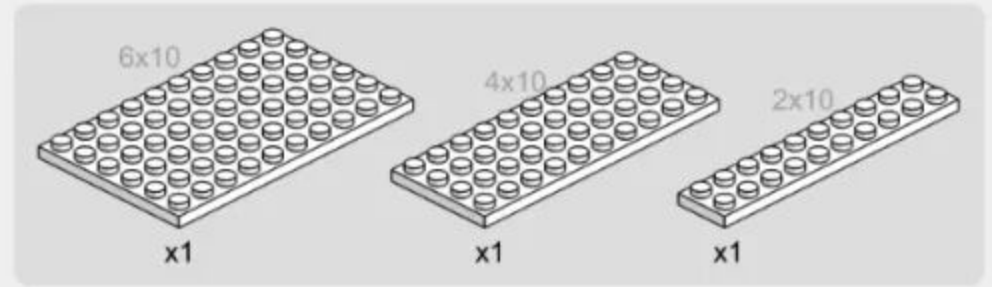

2-3

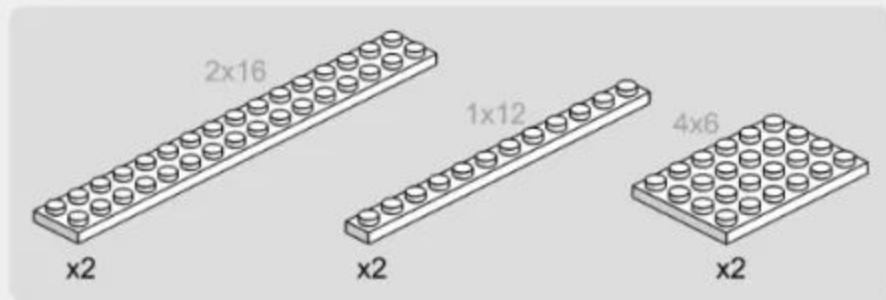

2-4

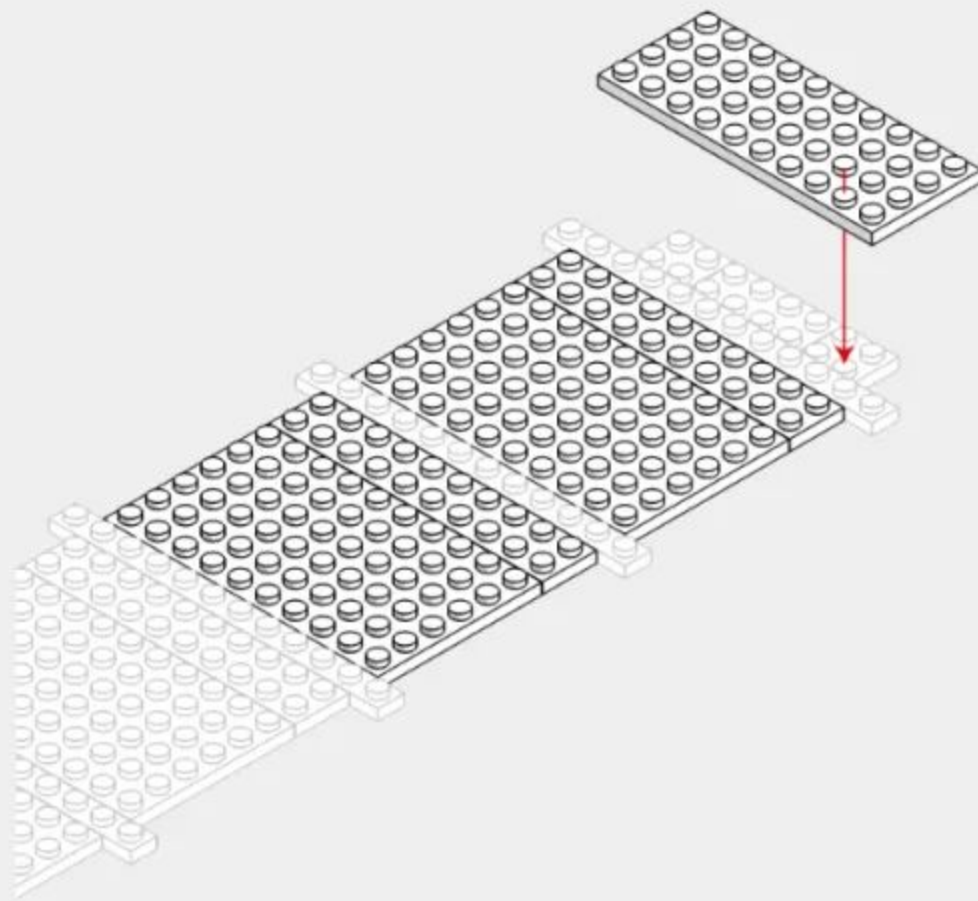
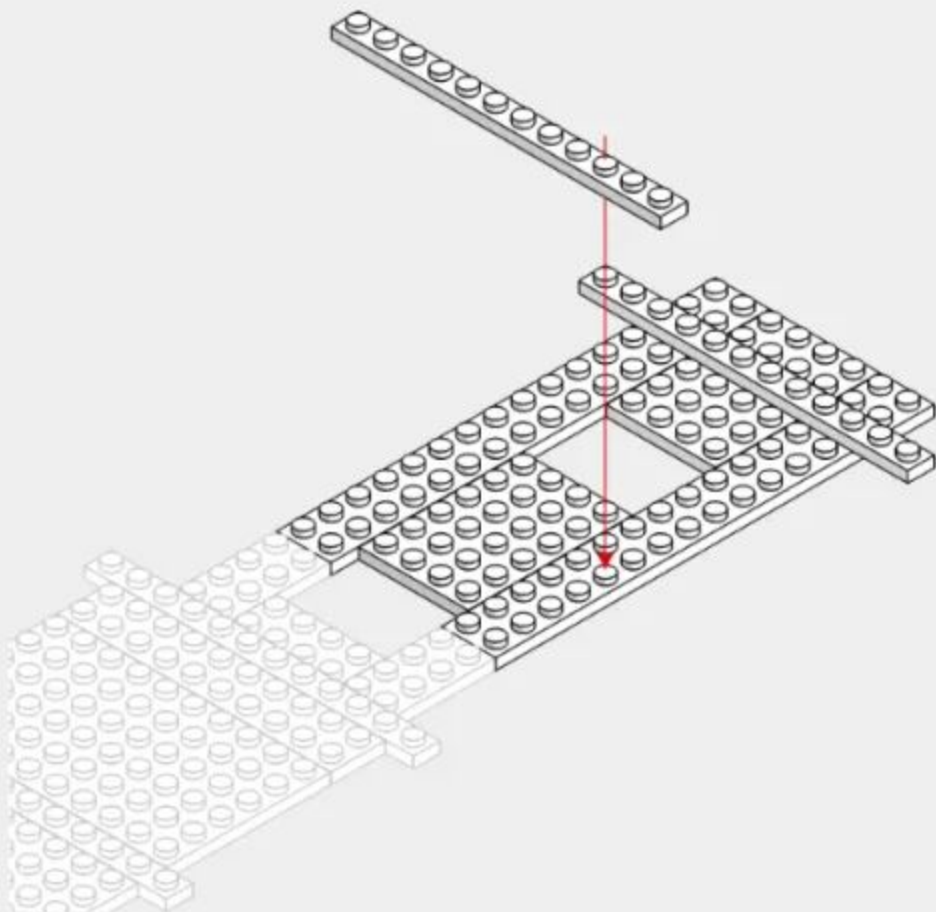
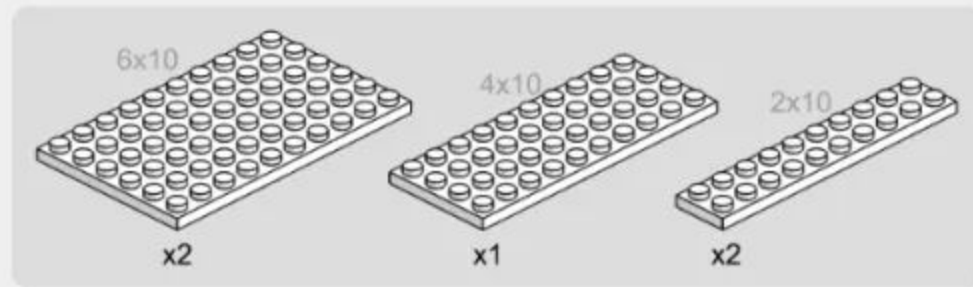

2-5

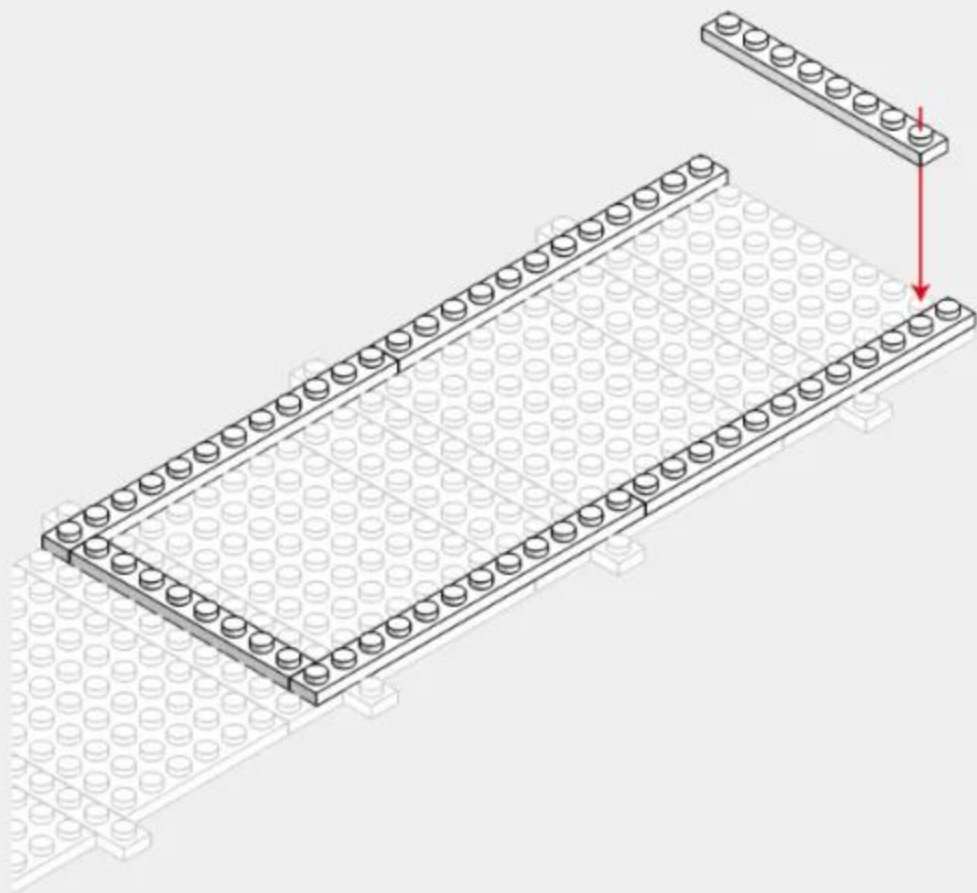
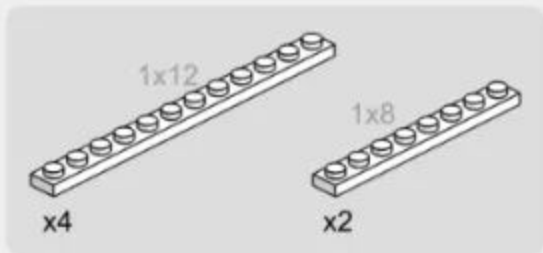

2-6

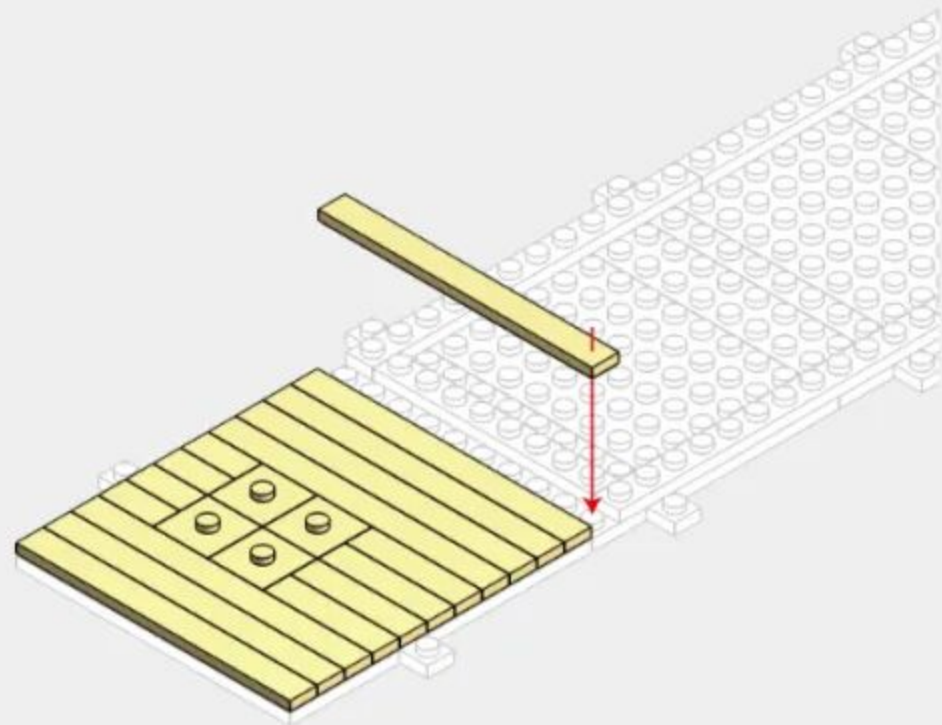
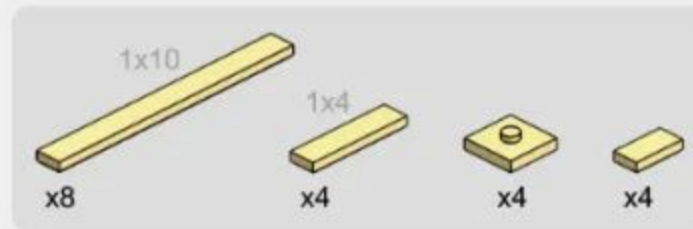

2-7

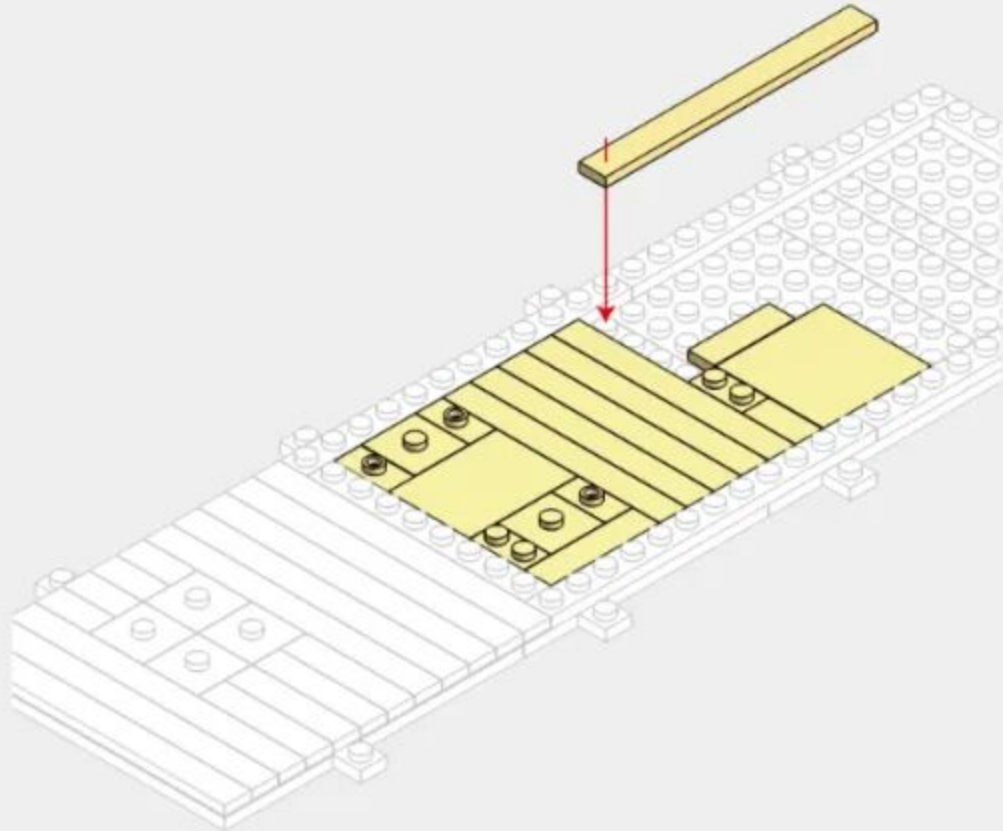
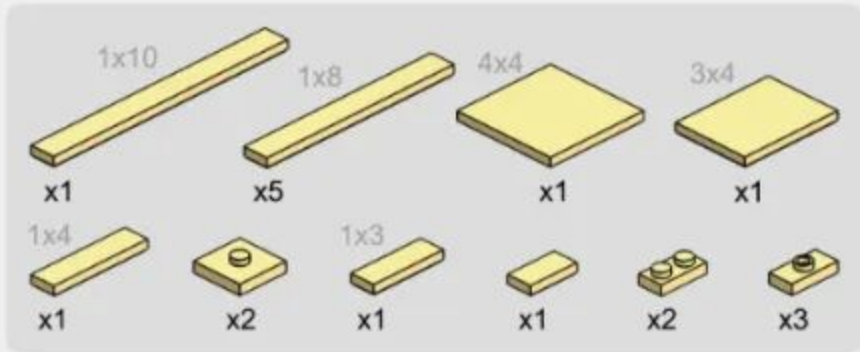

2-8

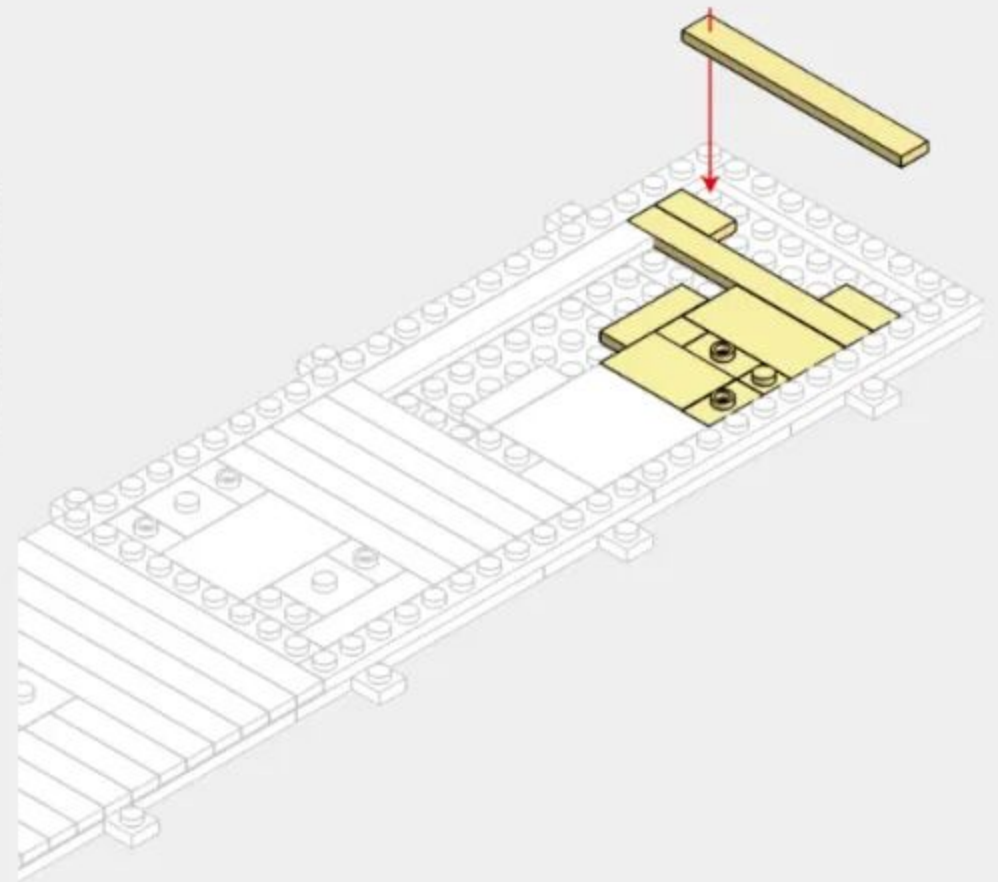
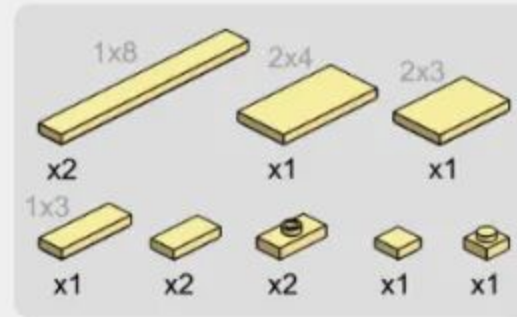

2-9

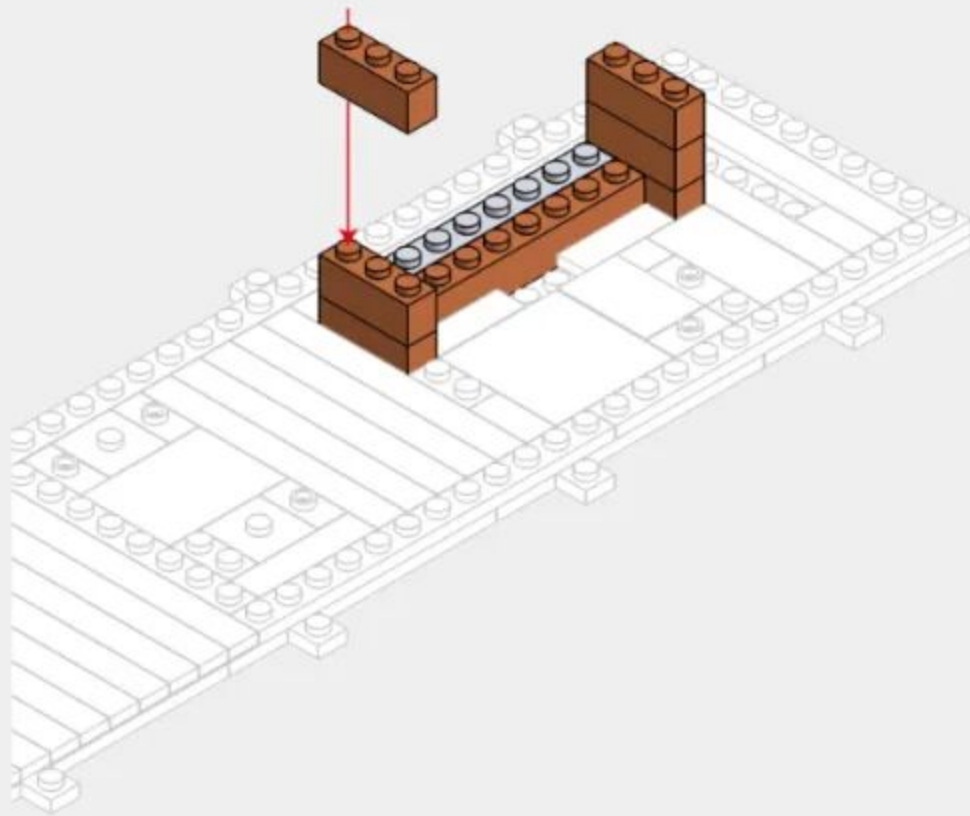
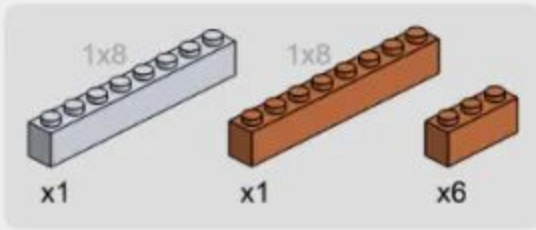

2-10

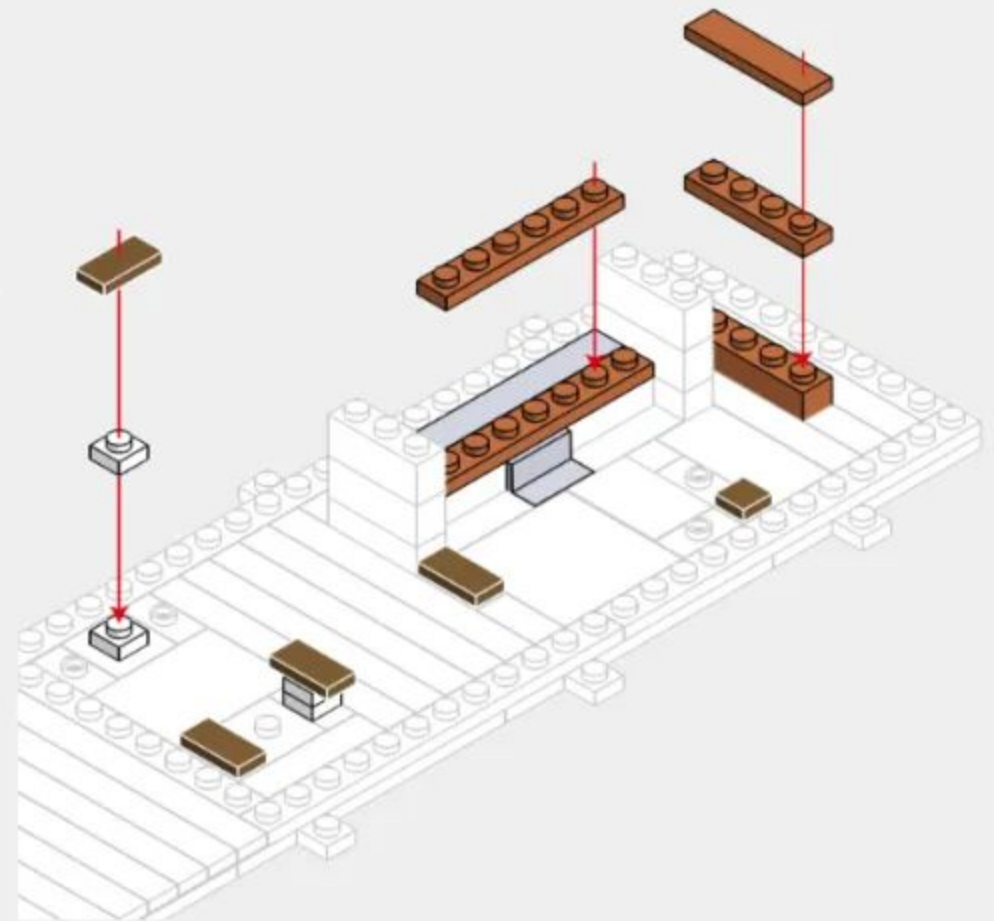
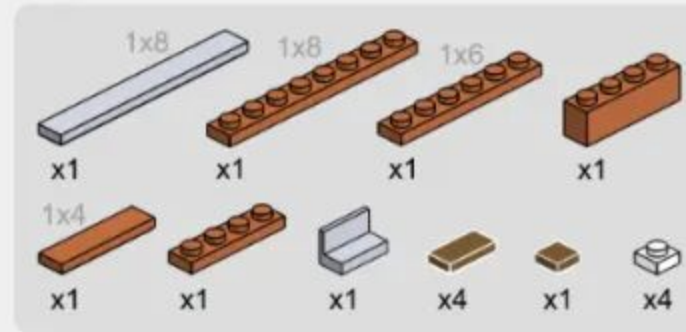

2-11



2-12

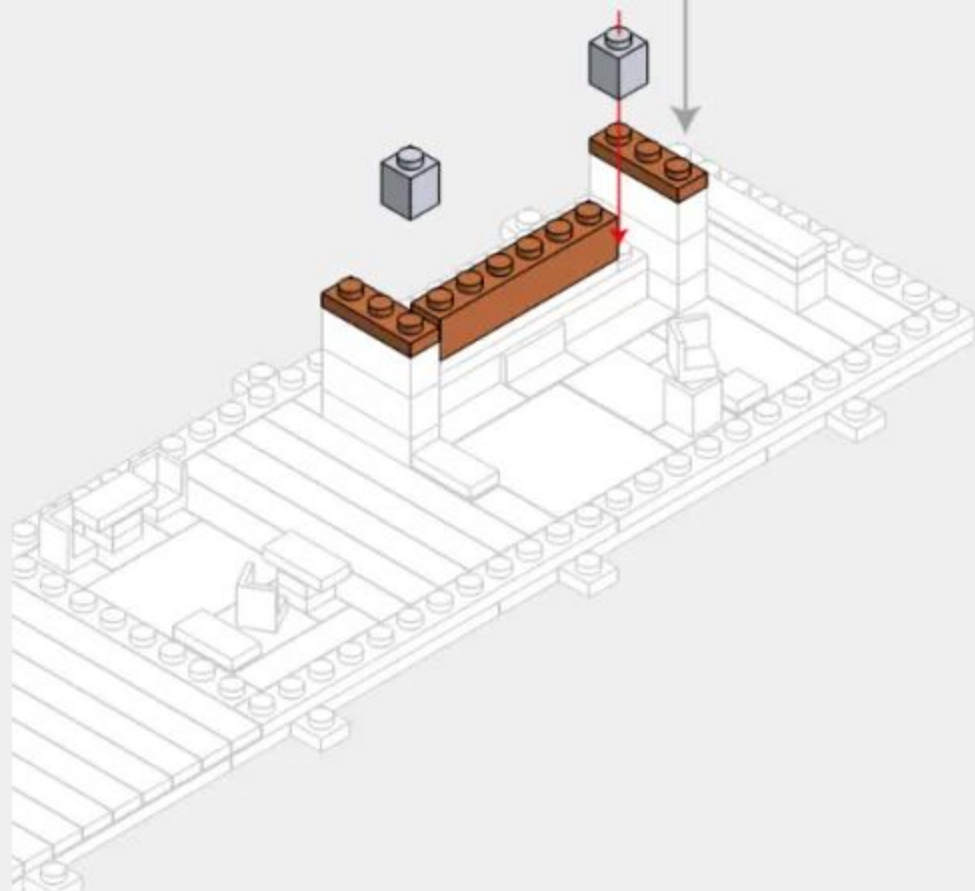
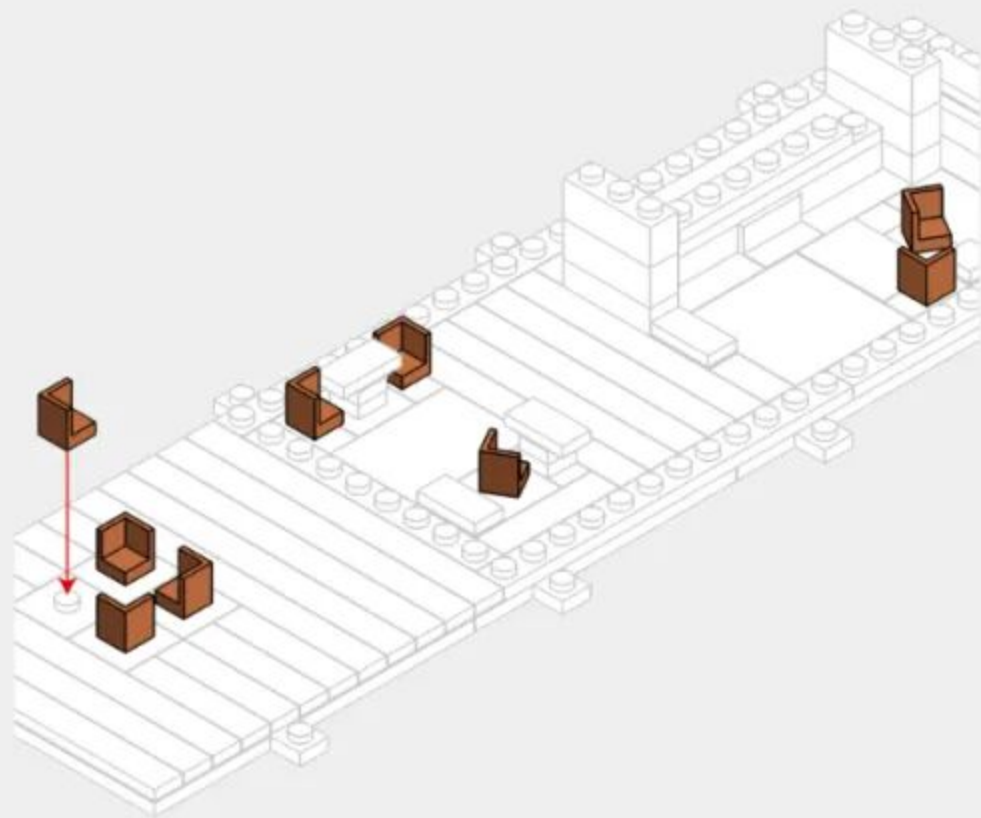
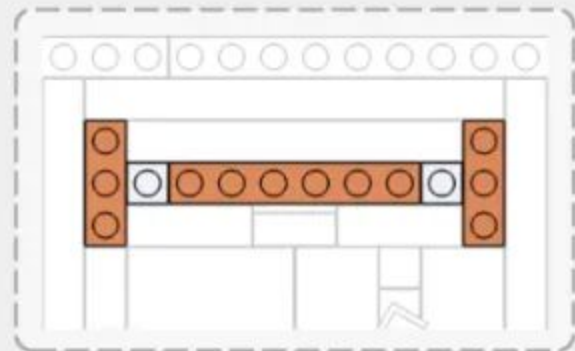
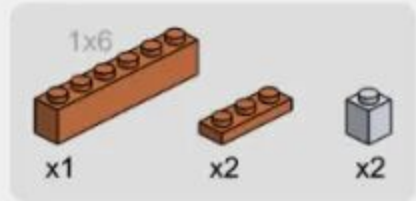

2-13

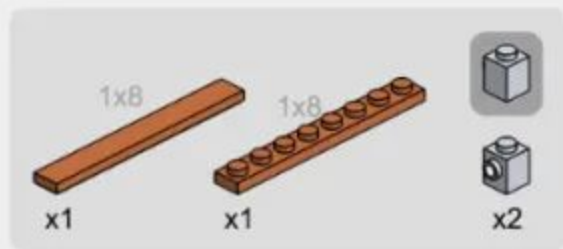

2-14

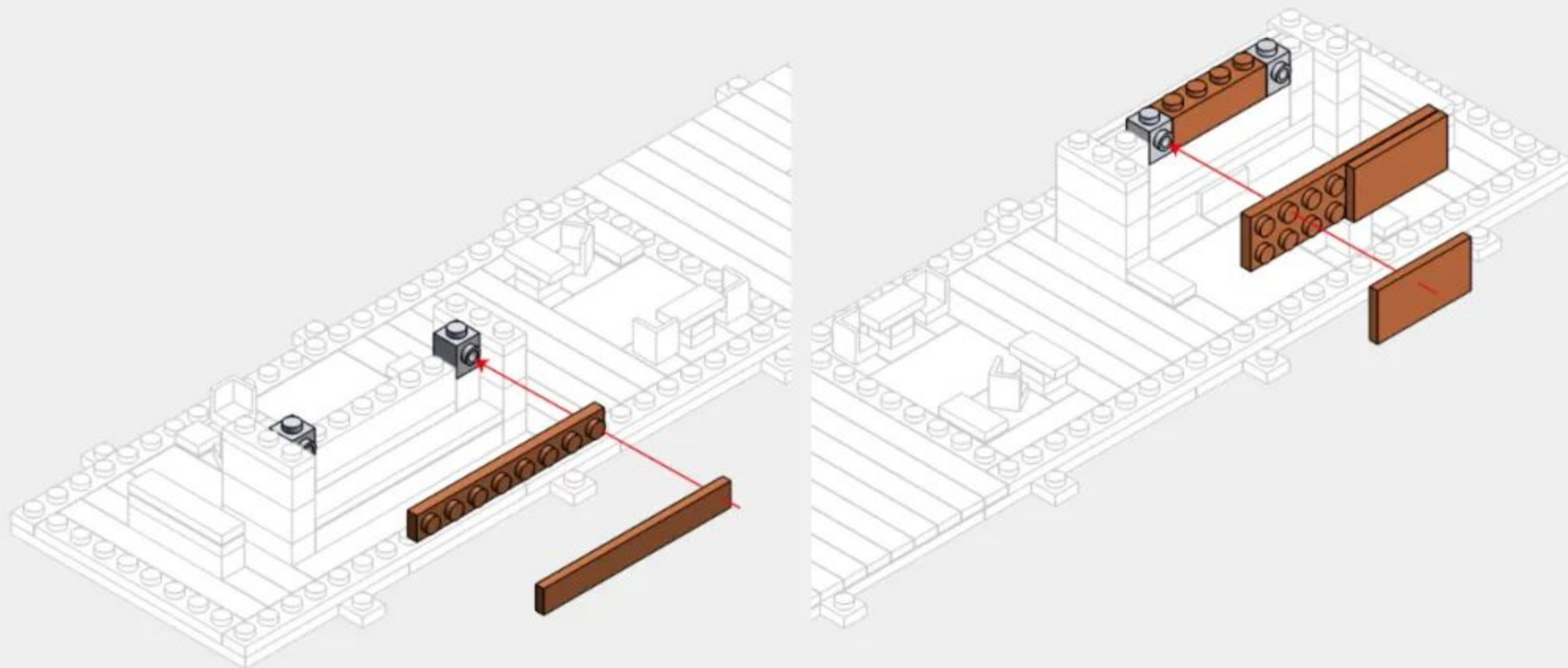
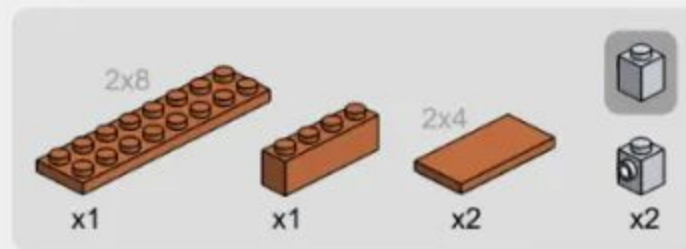

2-15

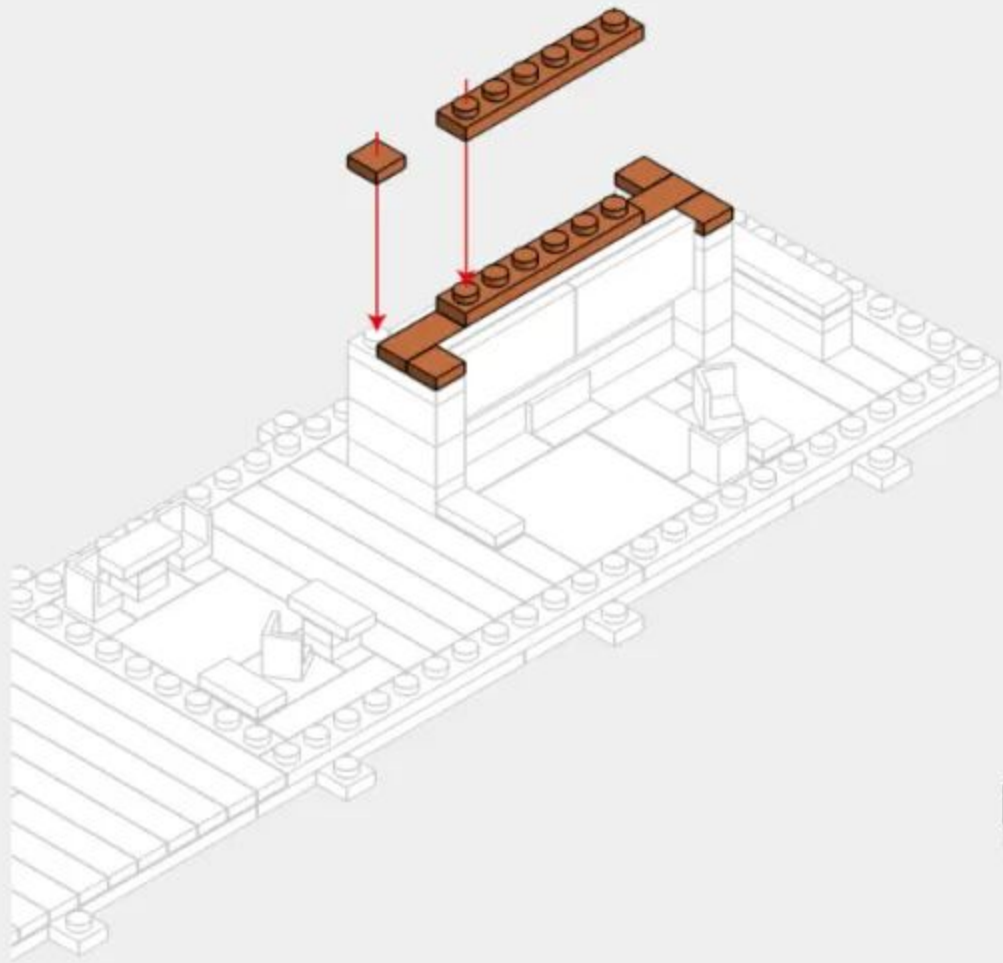
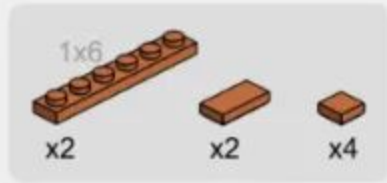

2-16

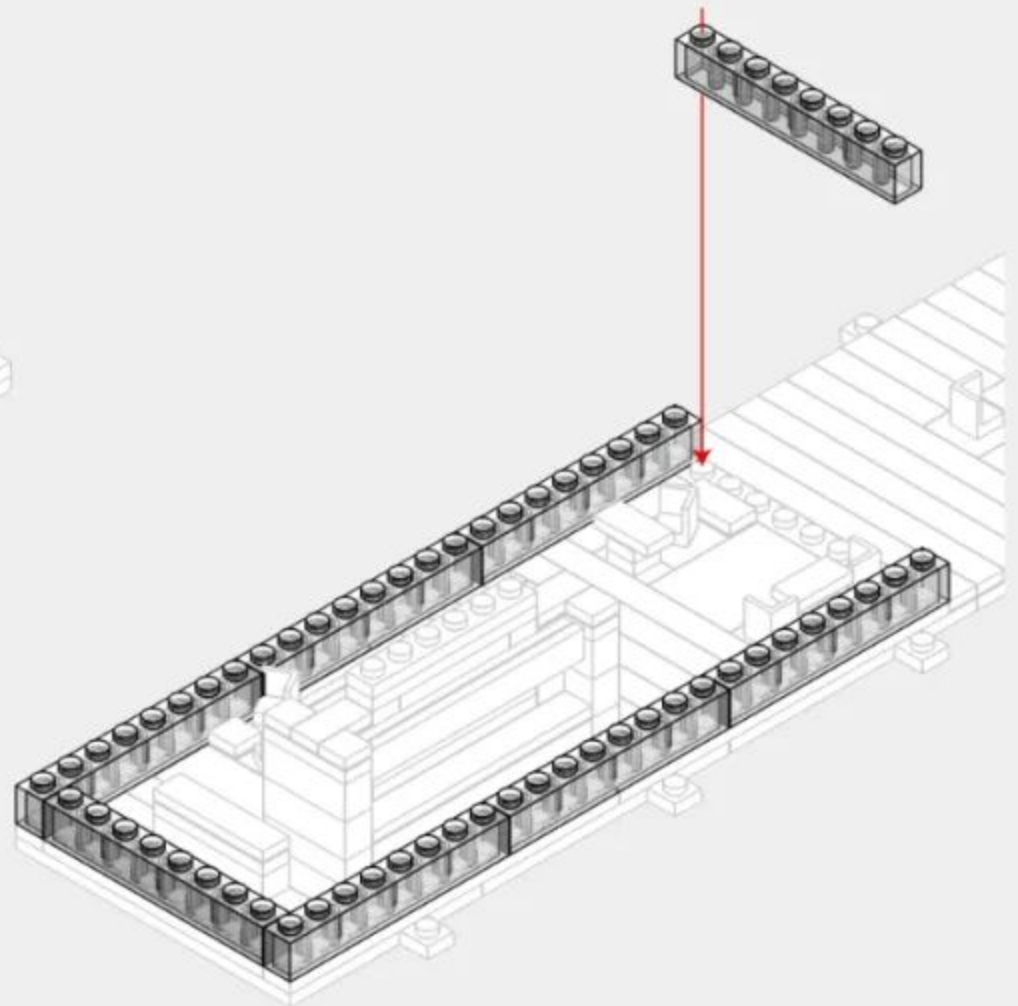
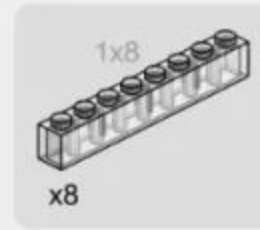

2-17

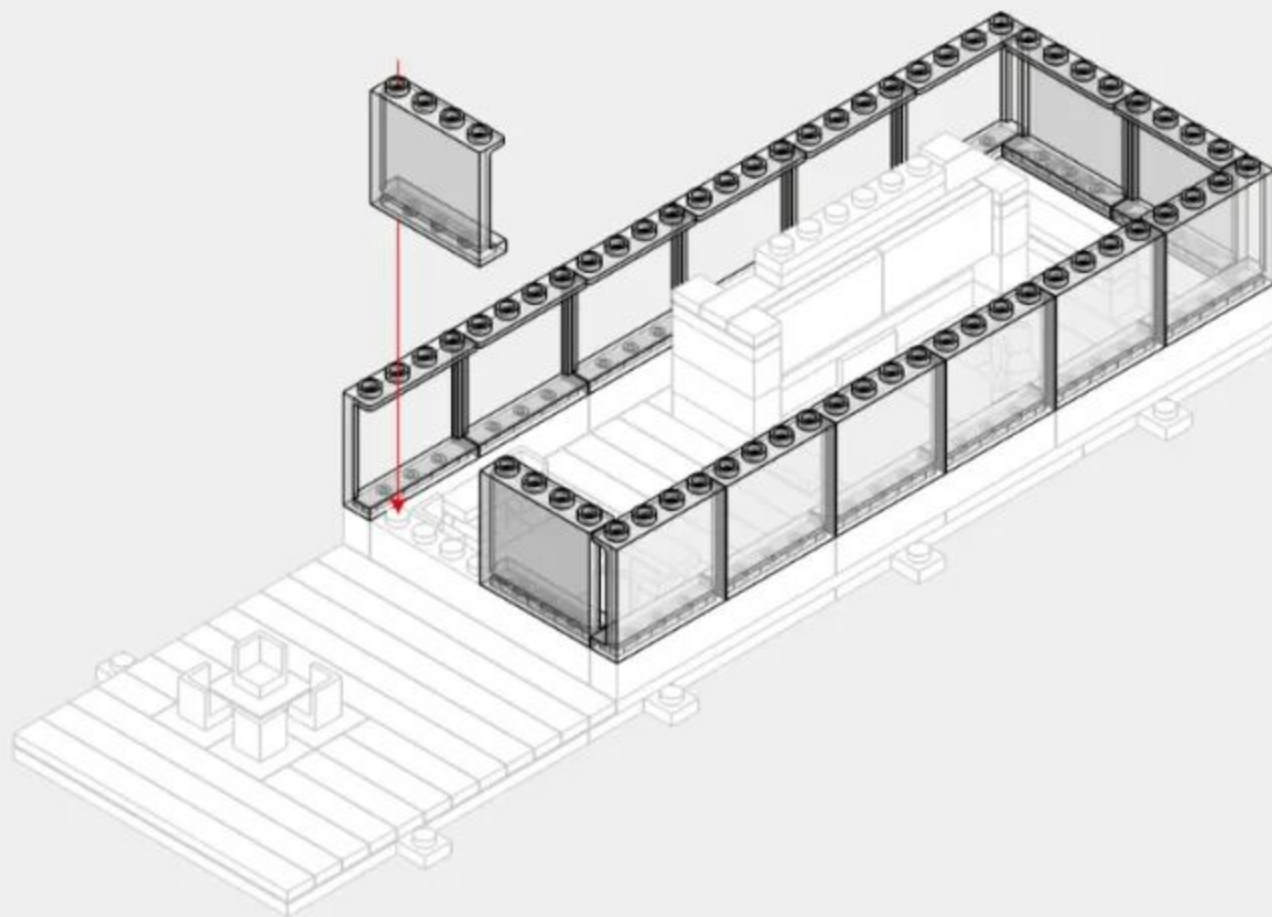

2-18

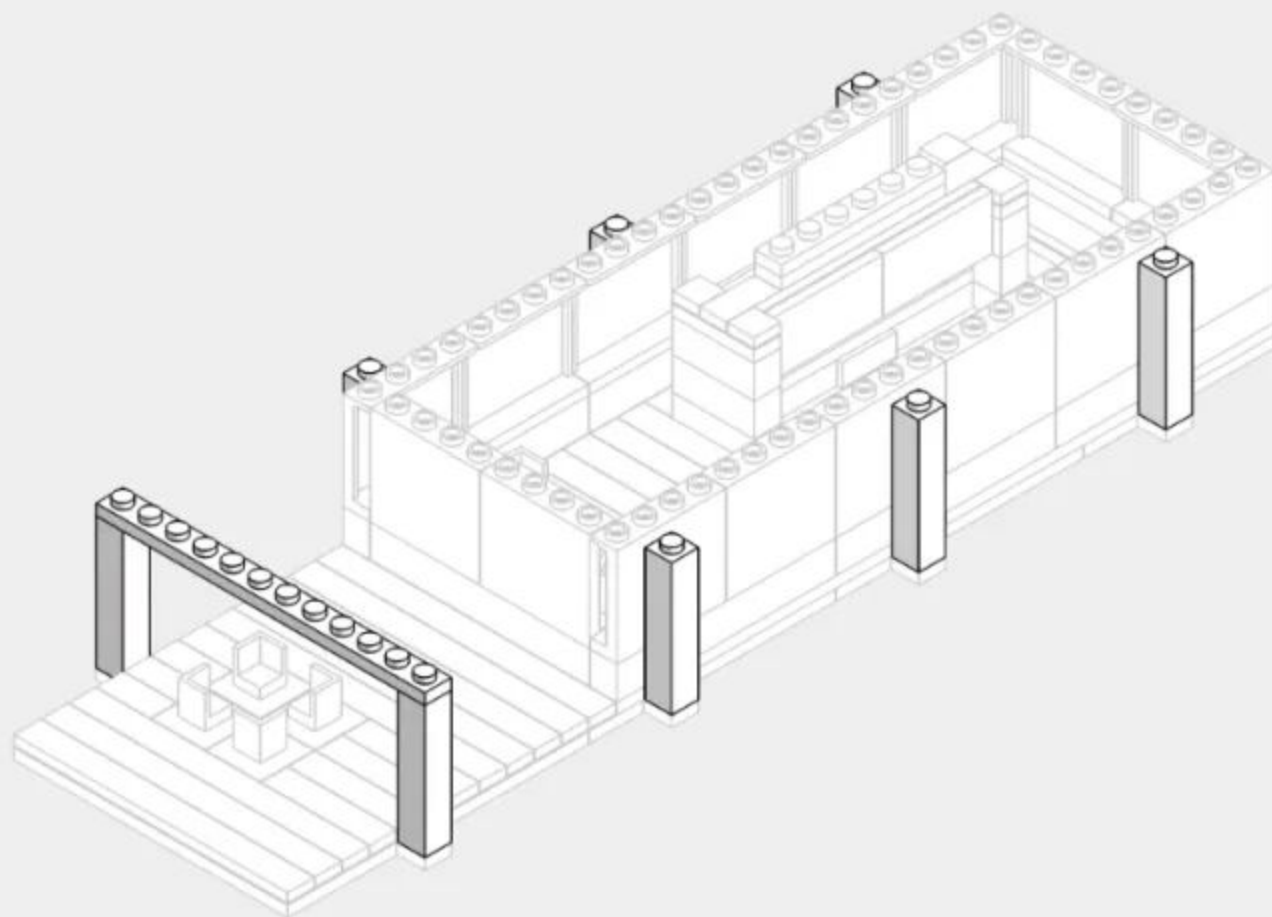
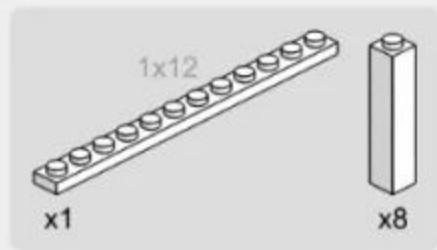

2-19

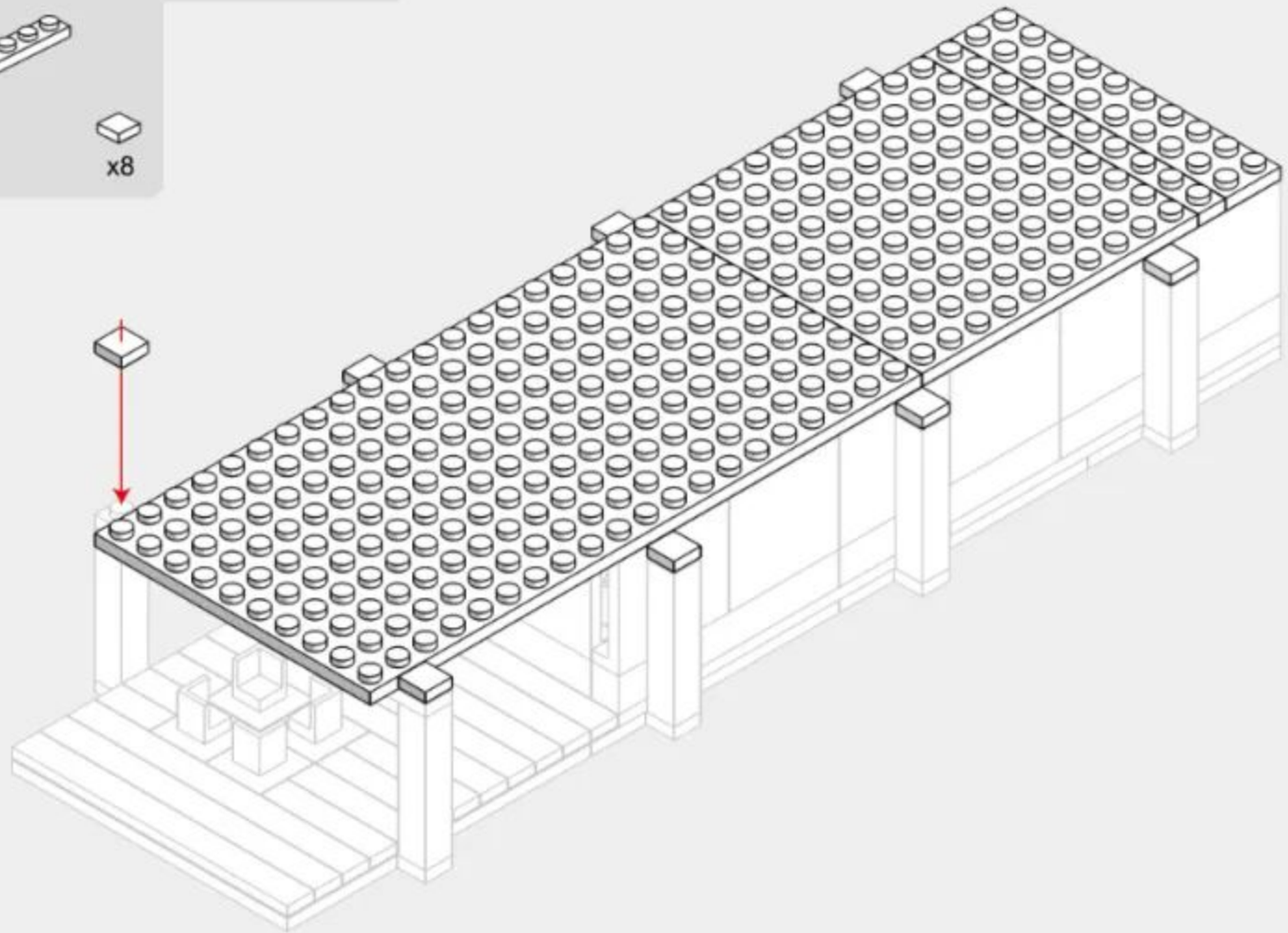
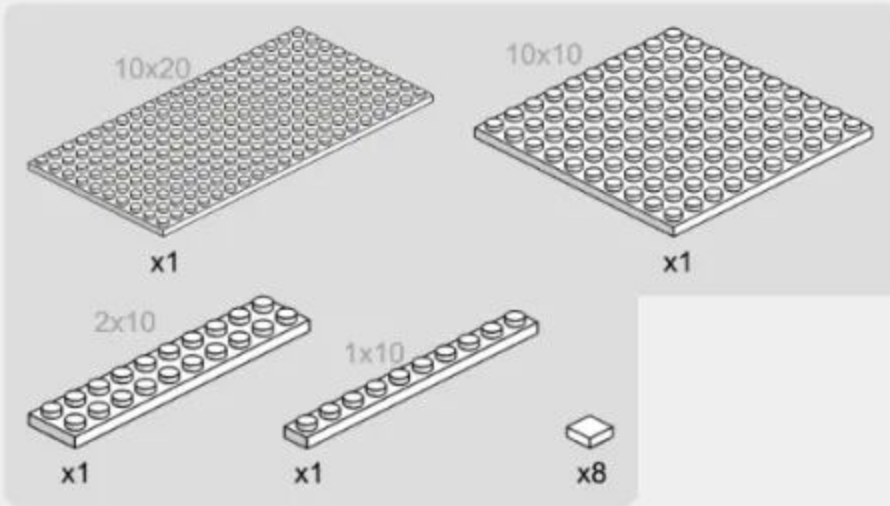

2-20

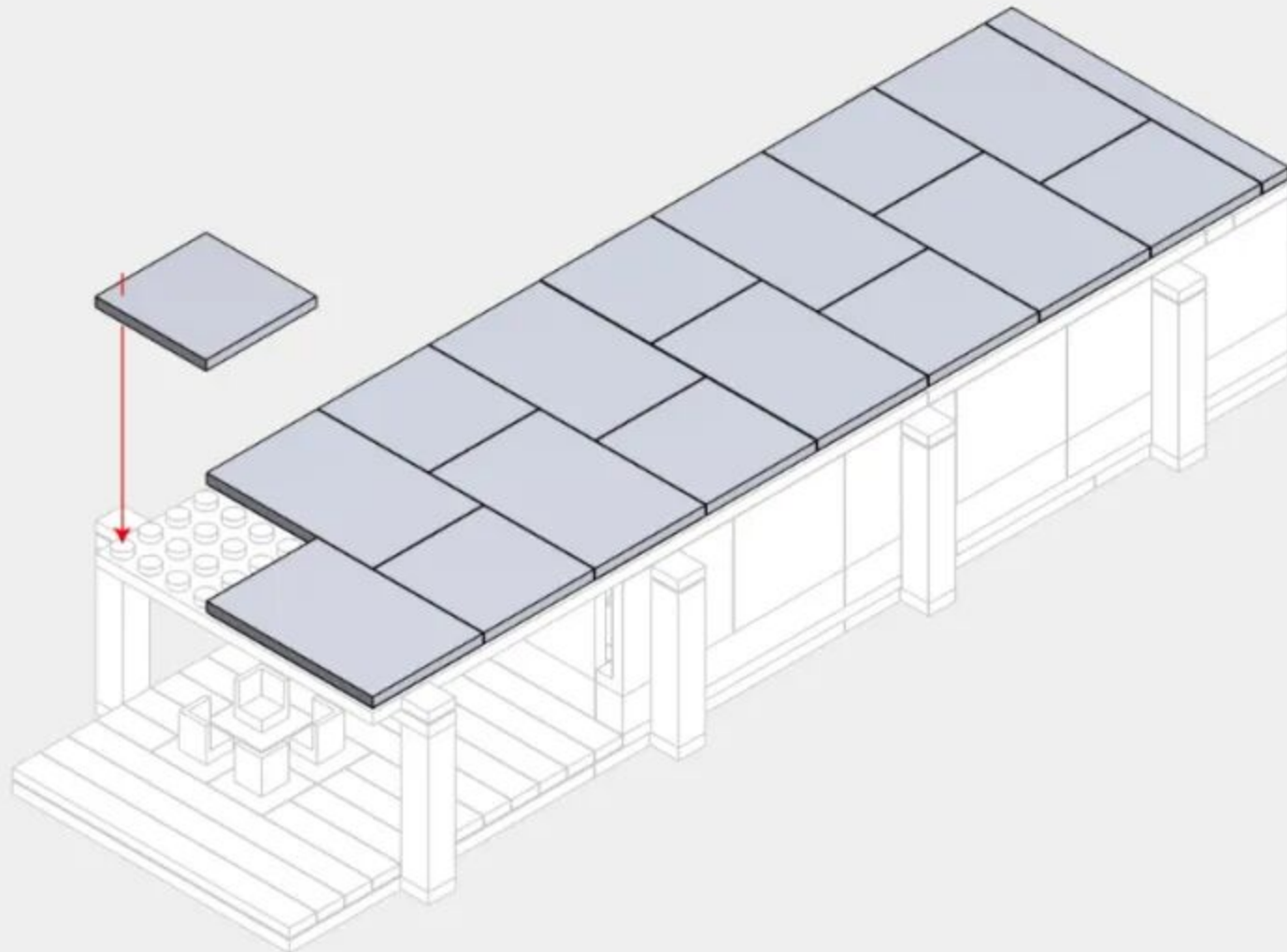
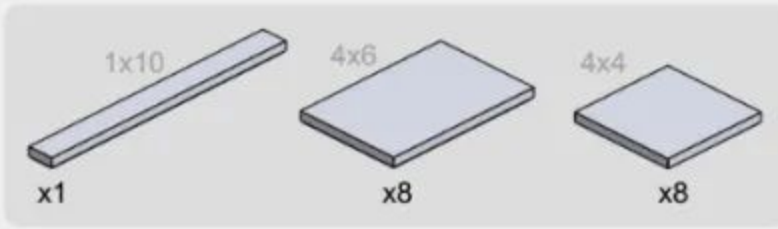

2-21

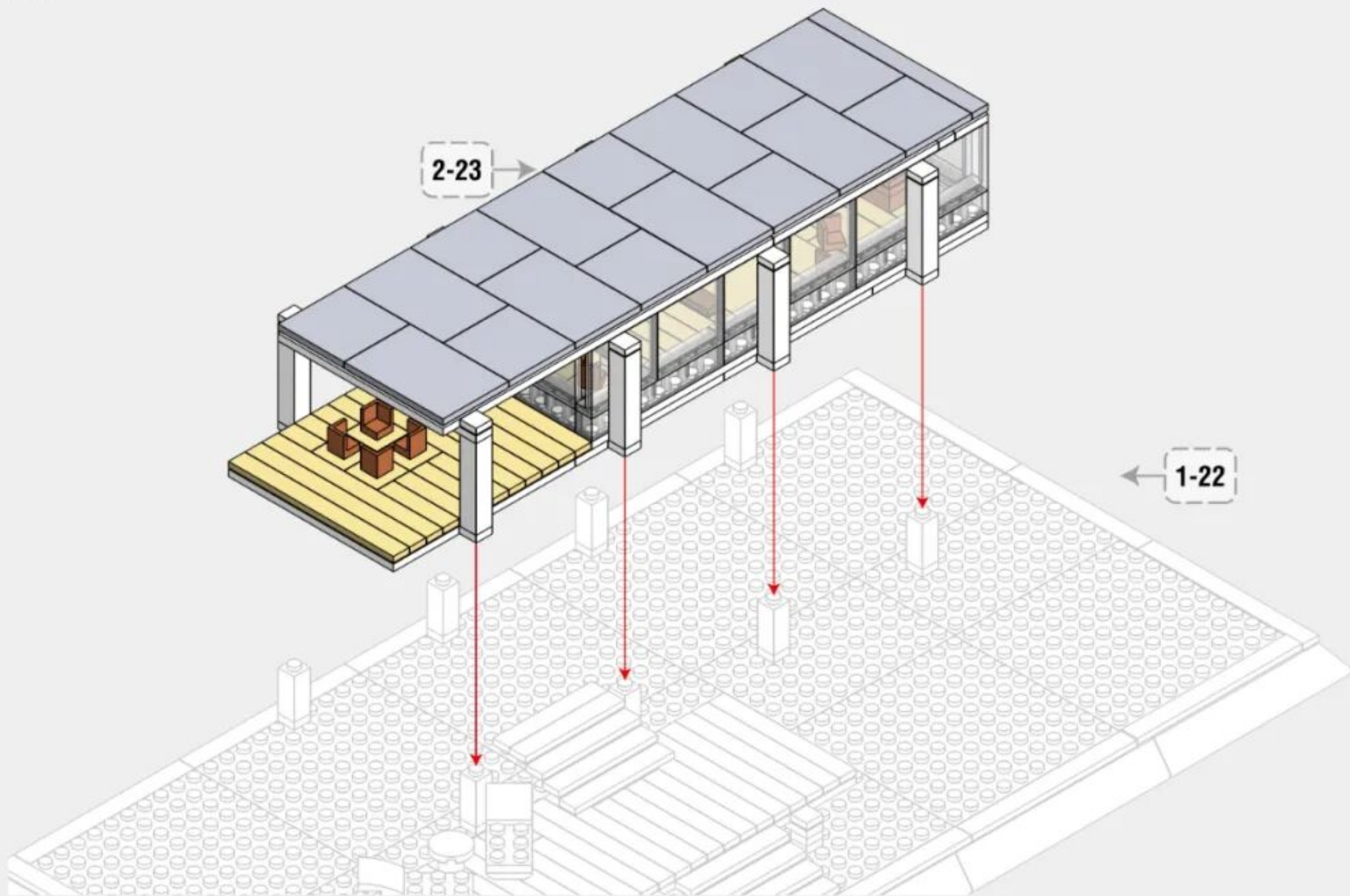



286PCS



50

3-1

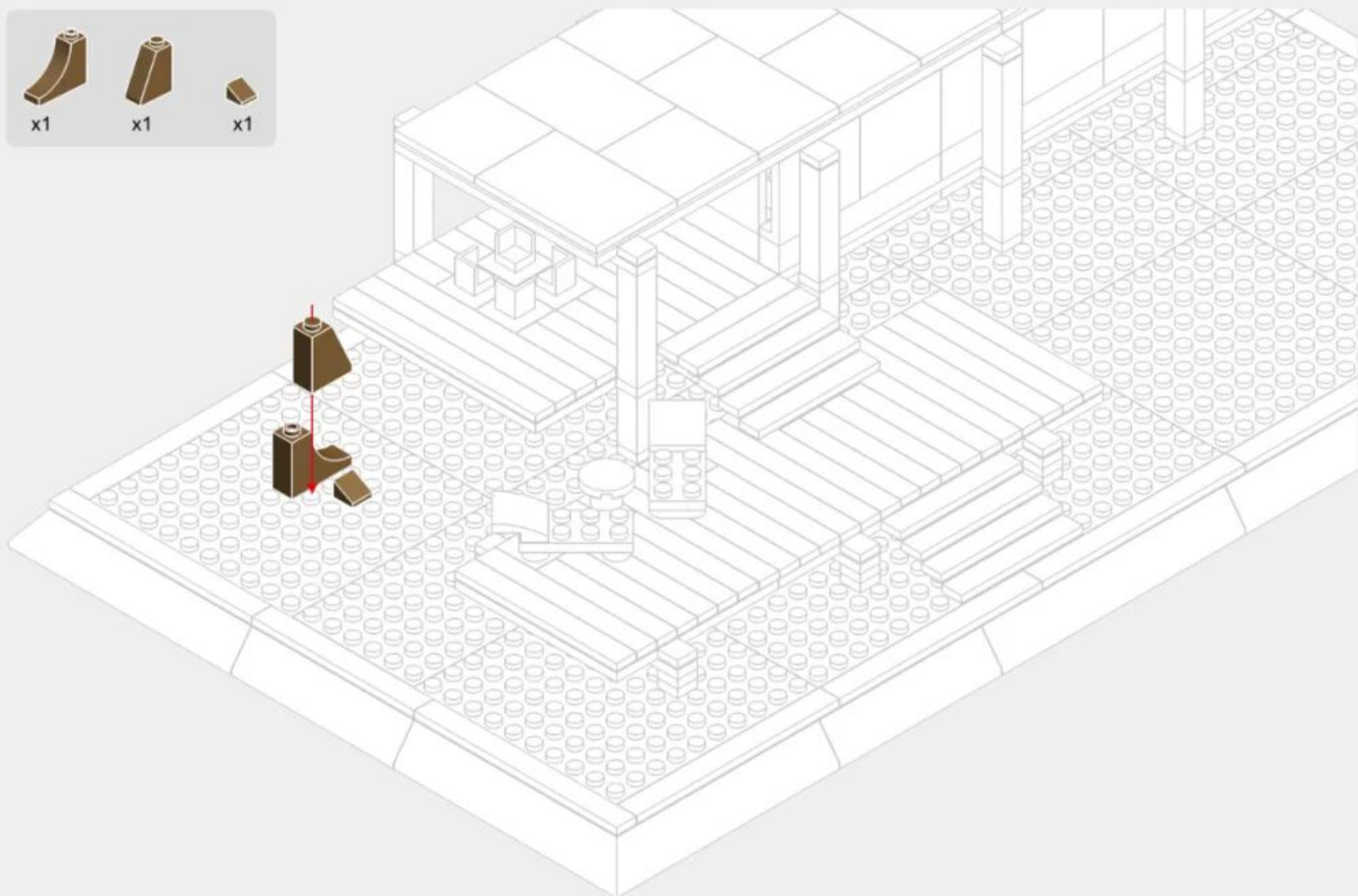

3-2

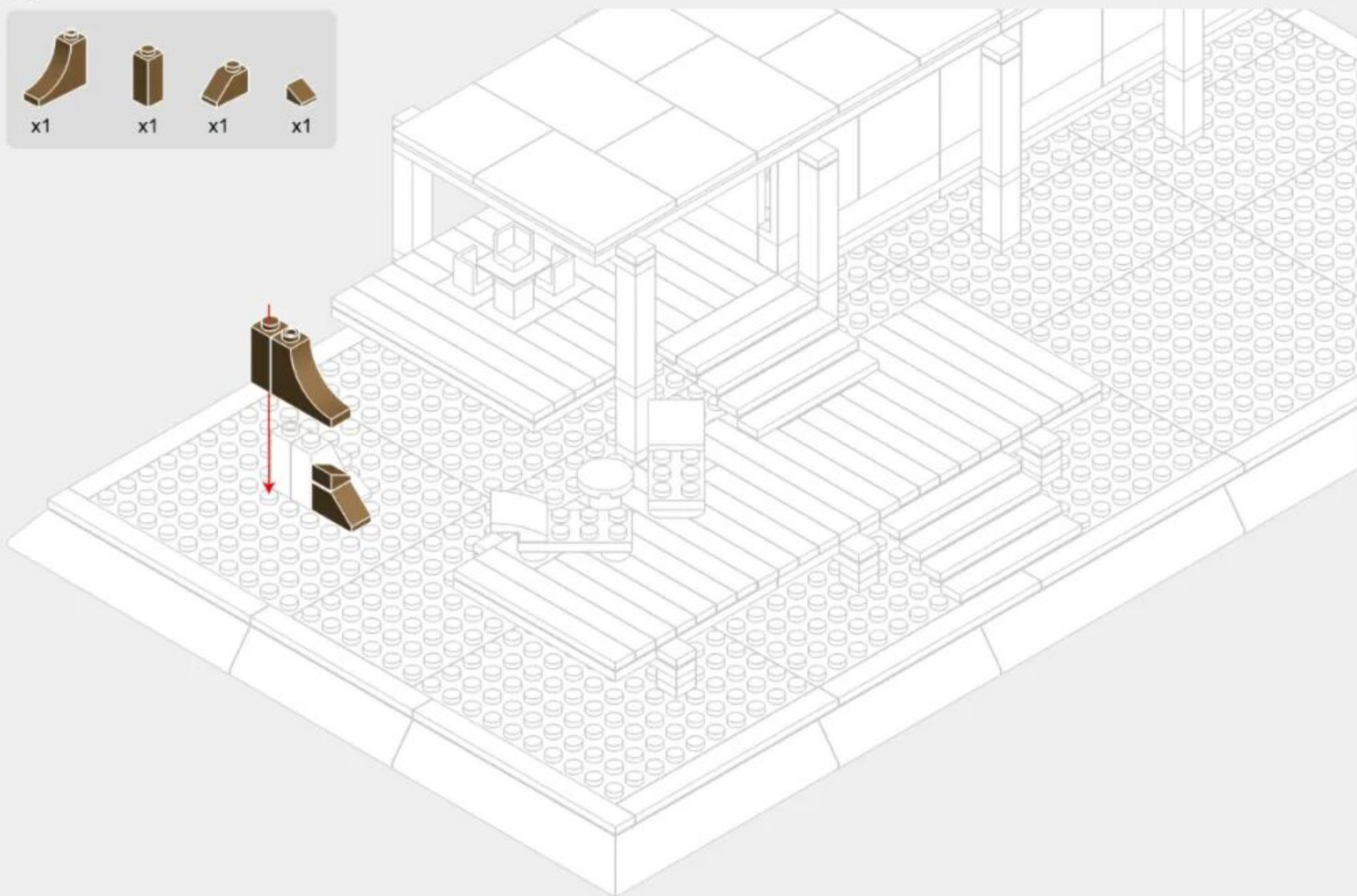

3-3



3-4

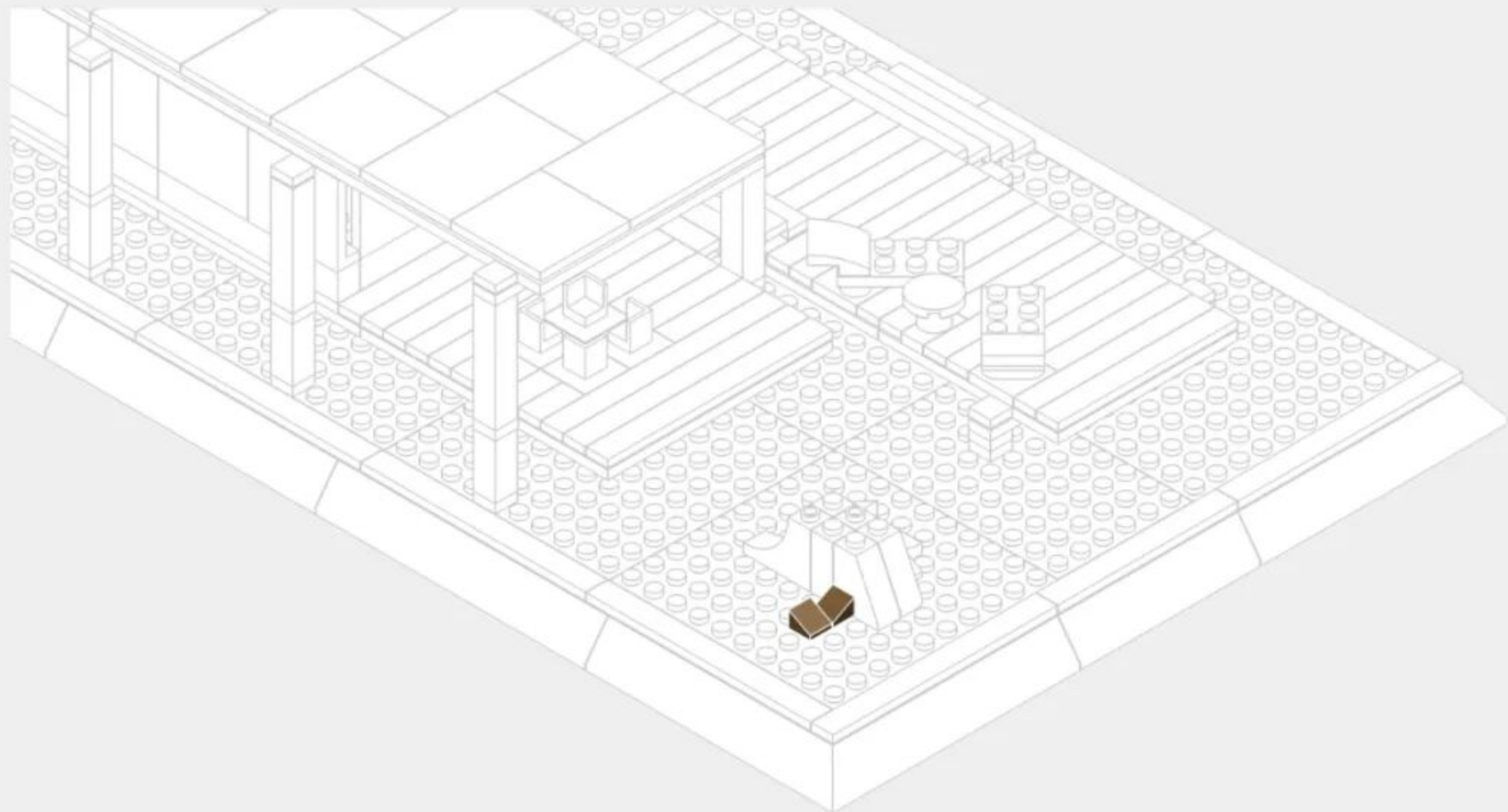

3-5

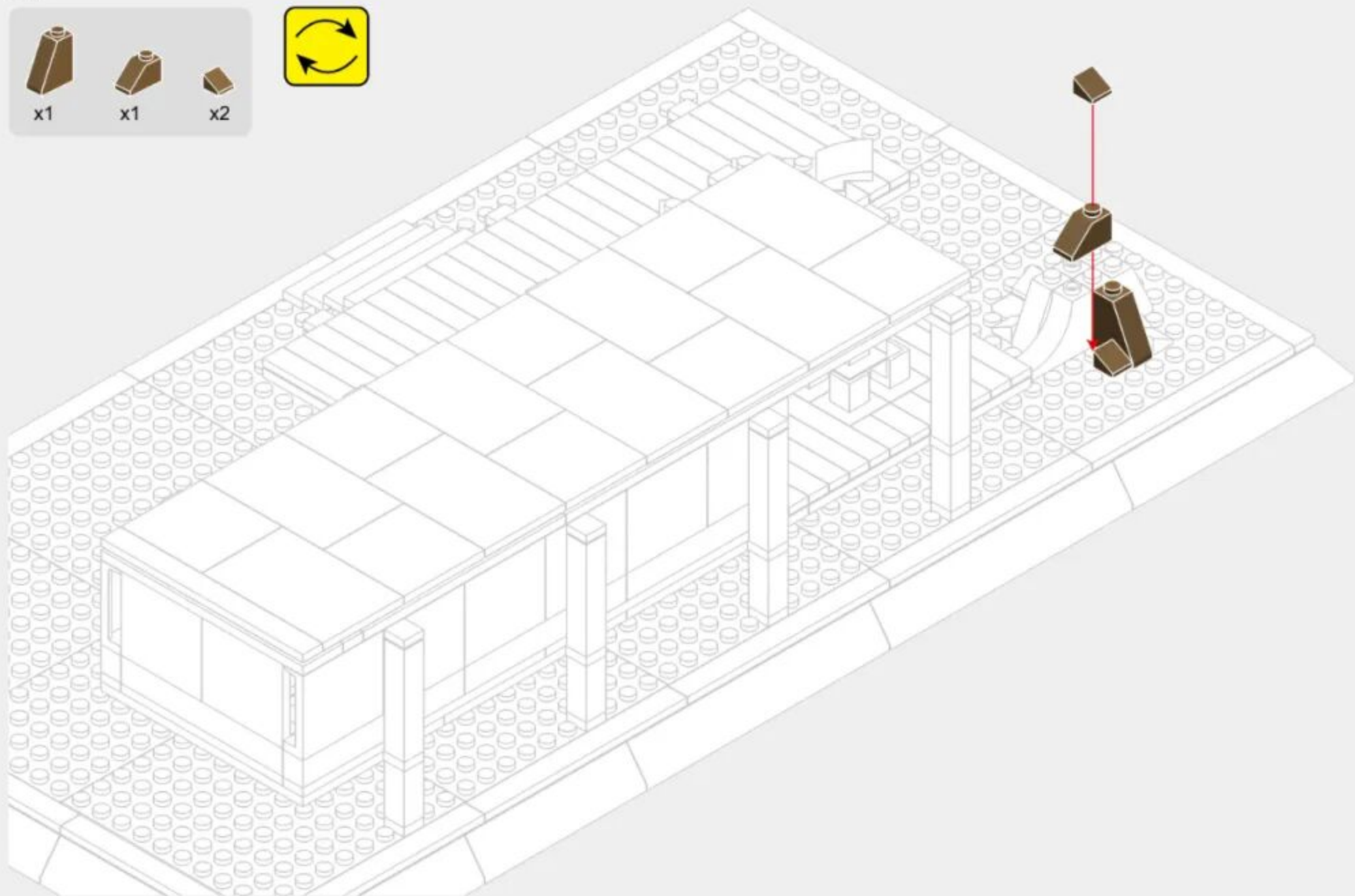

3-6

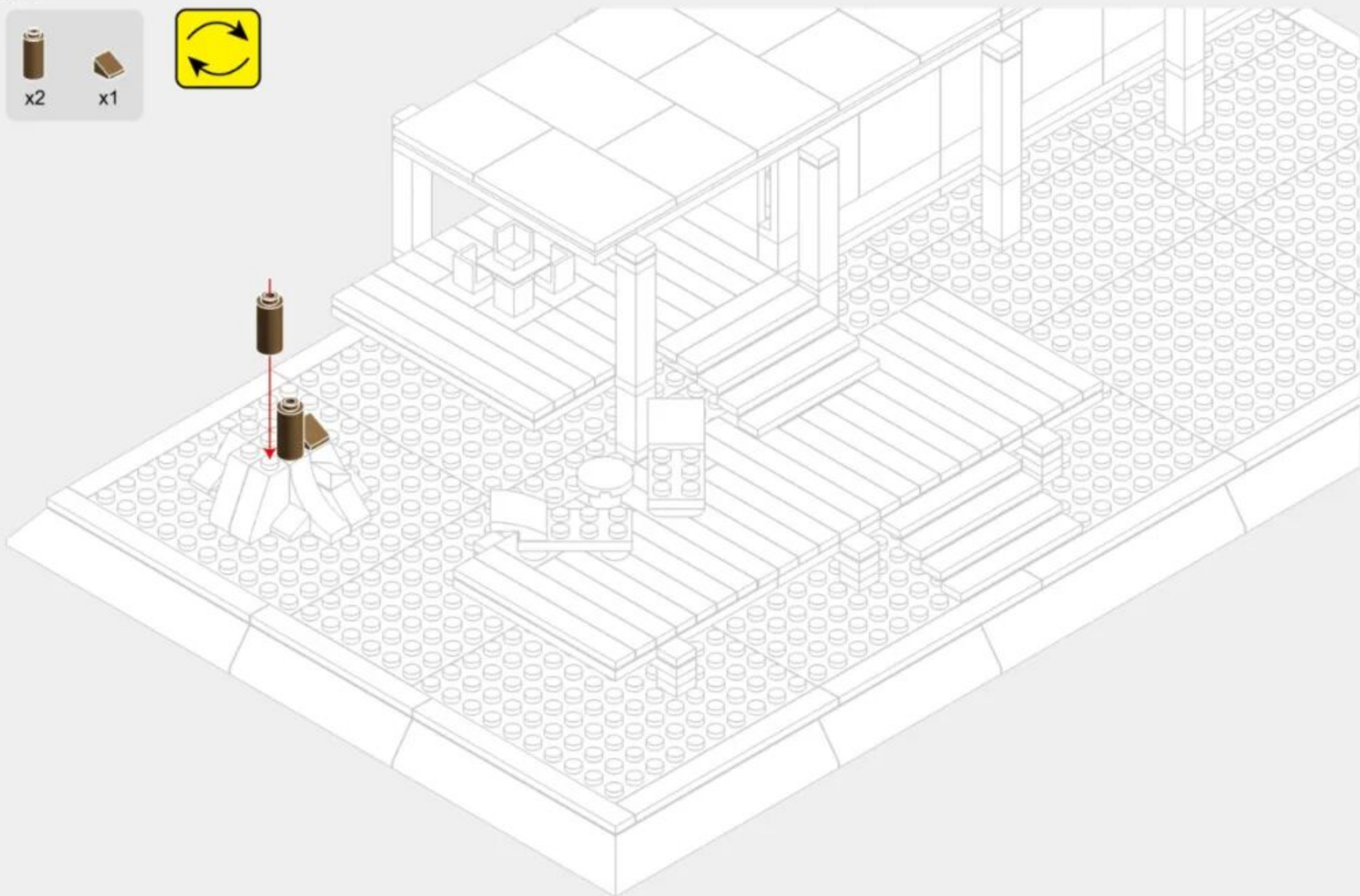

3-7

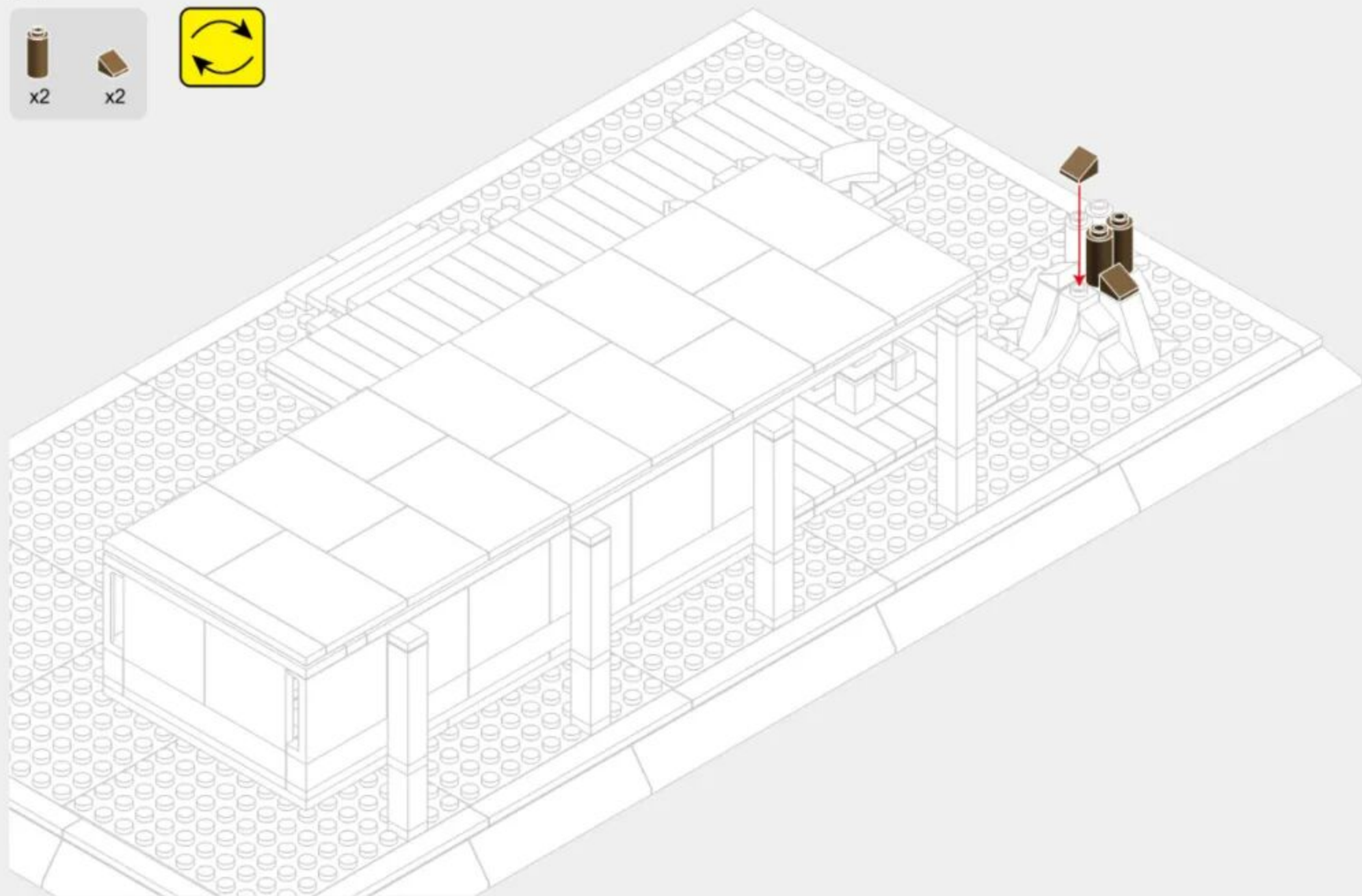

3-8

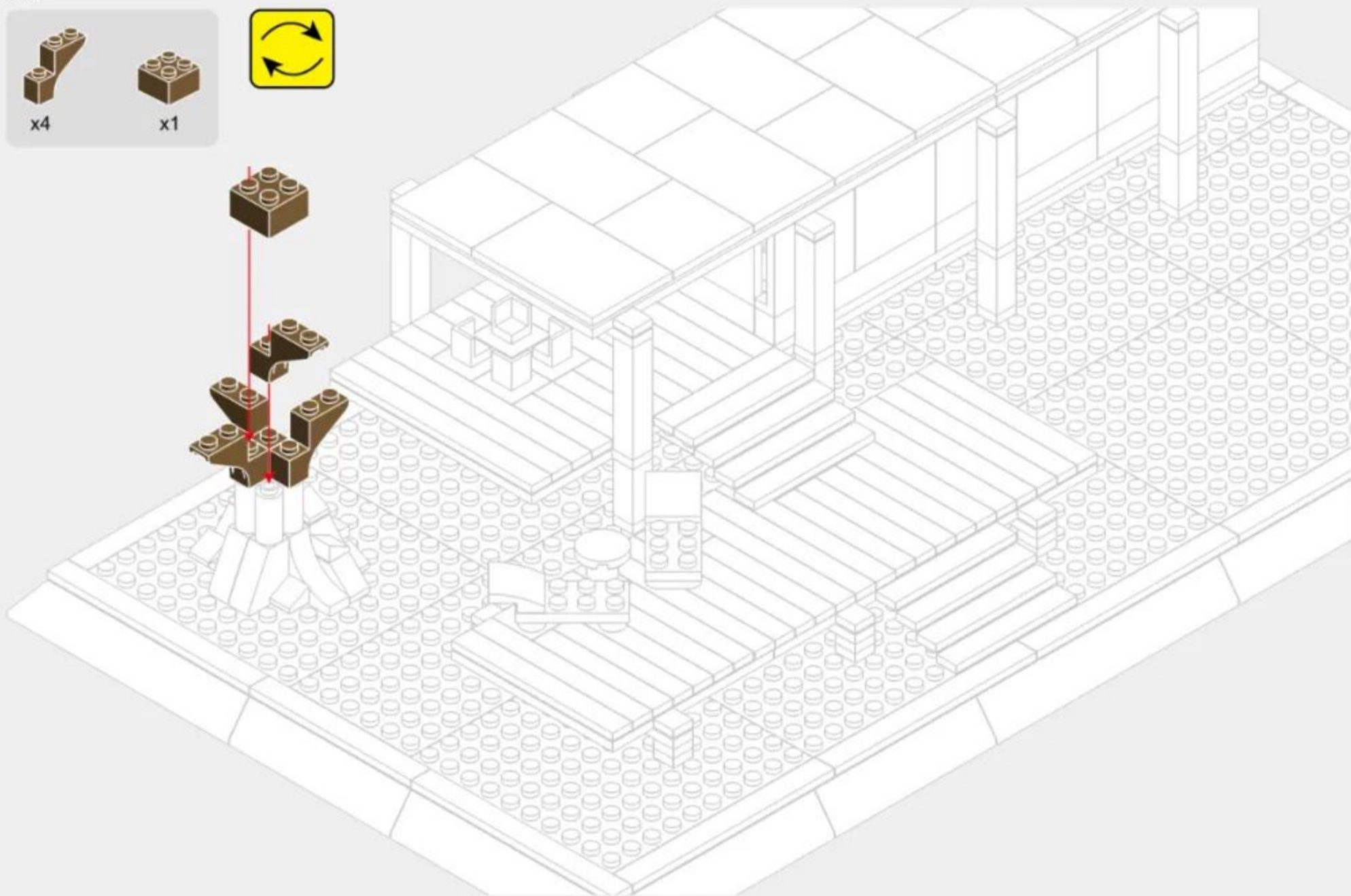

3-9

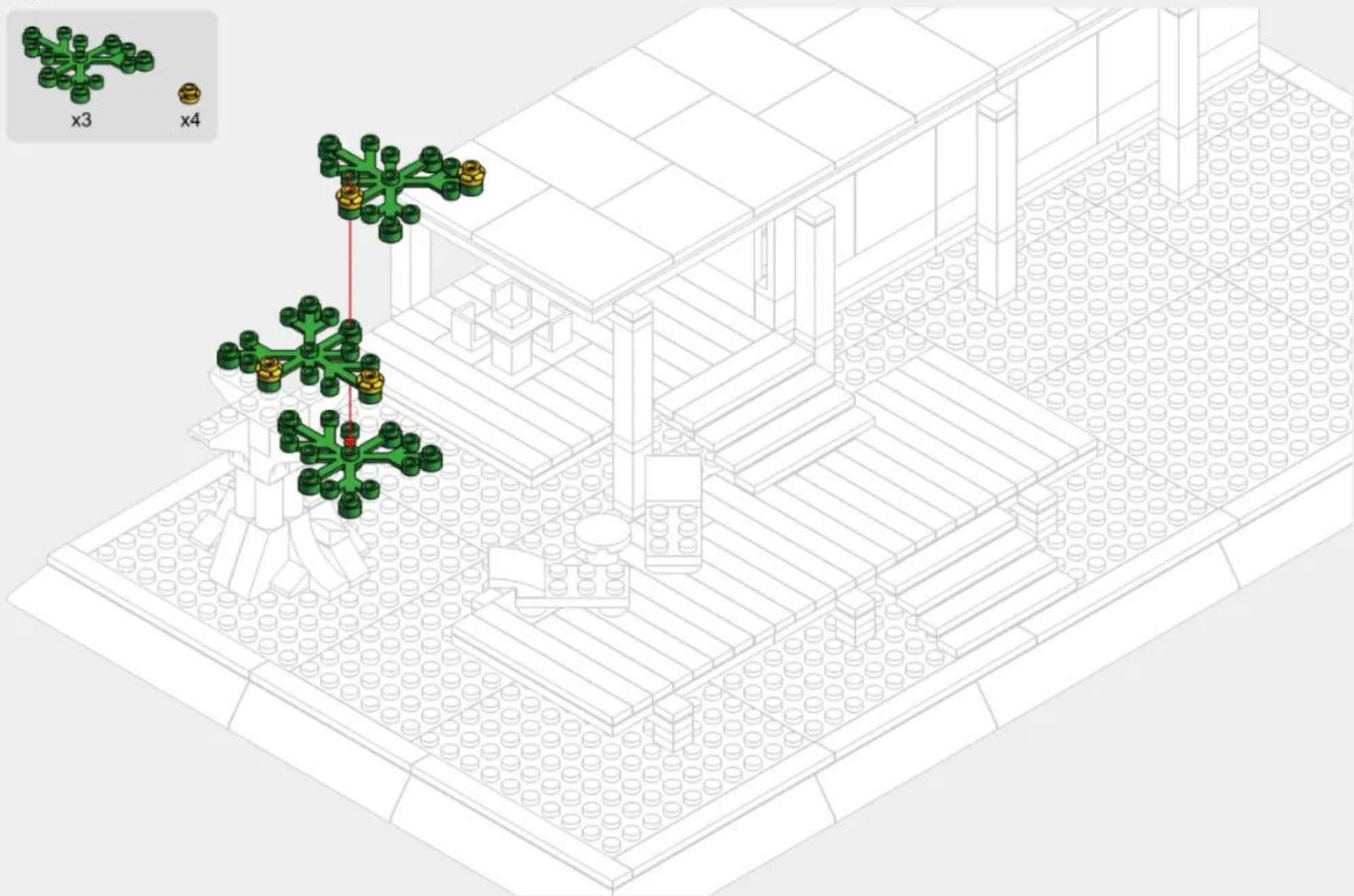
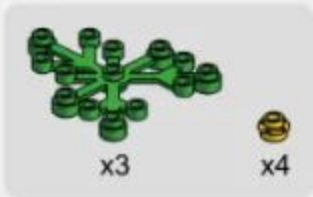

3-10

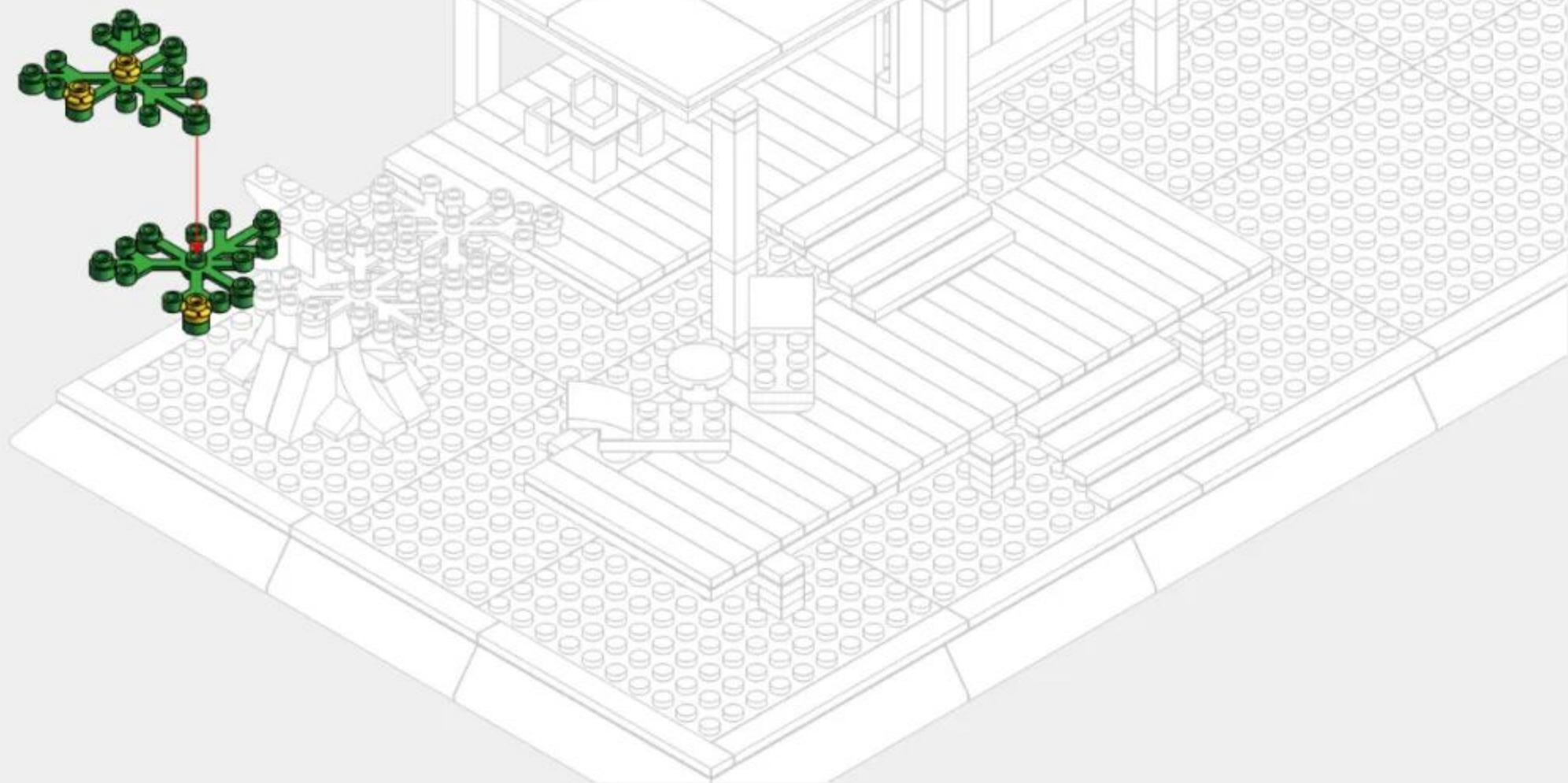
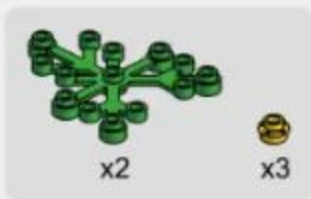

3-11

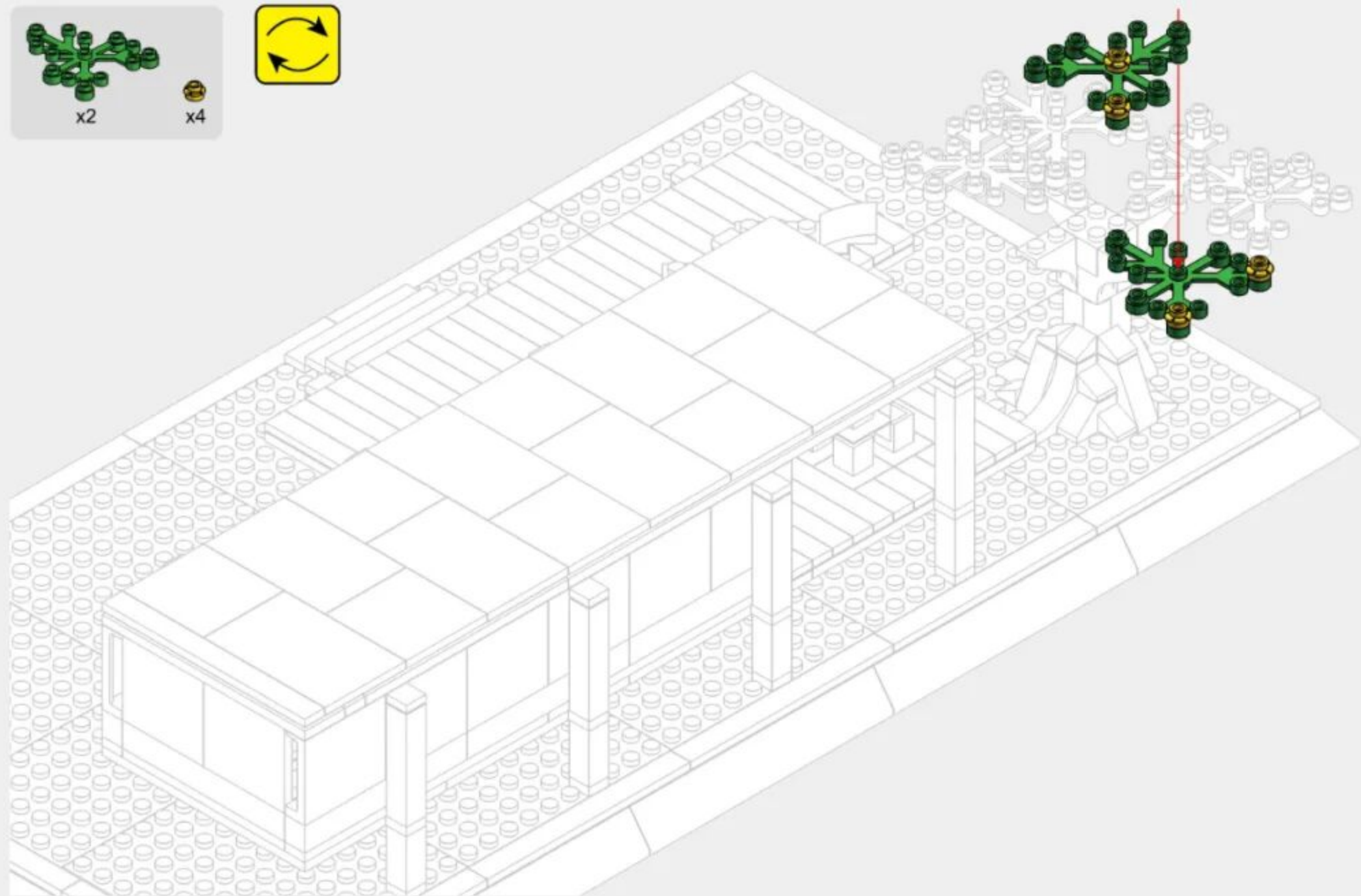
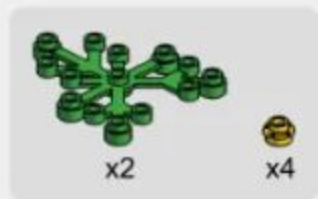

3-12

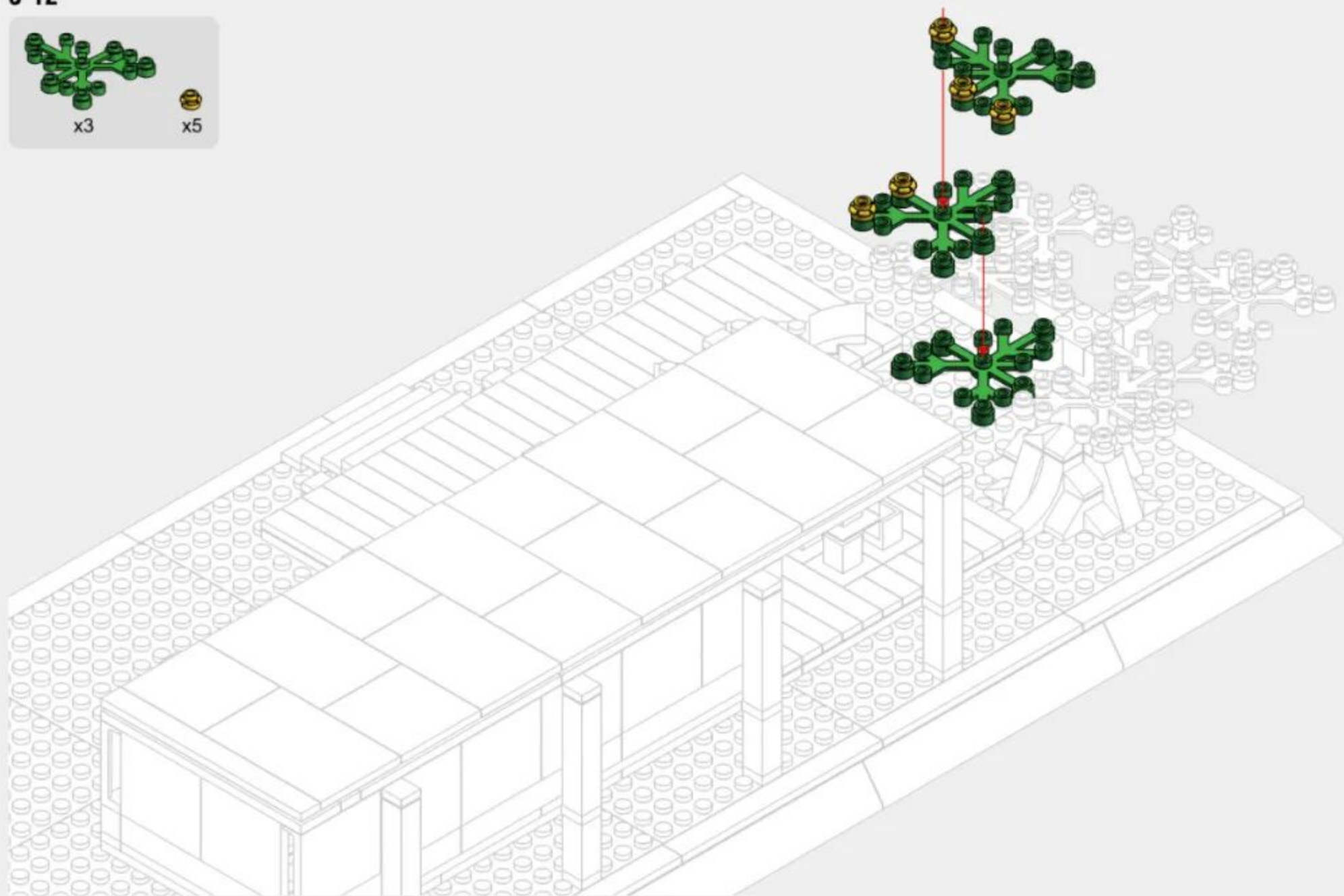
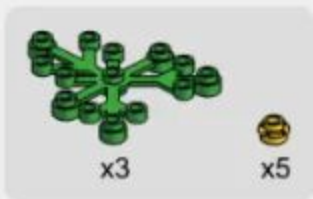

3-13

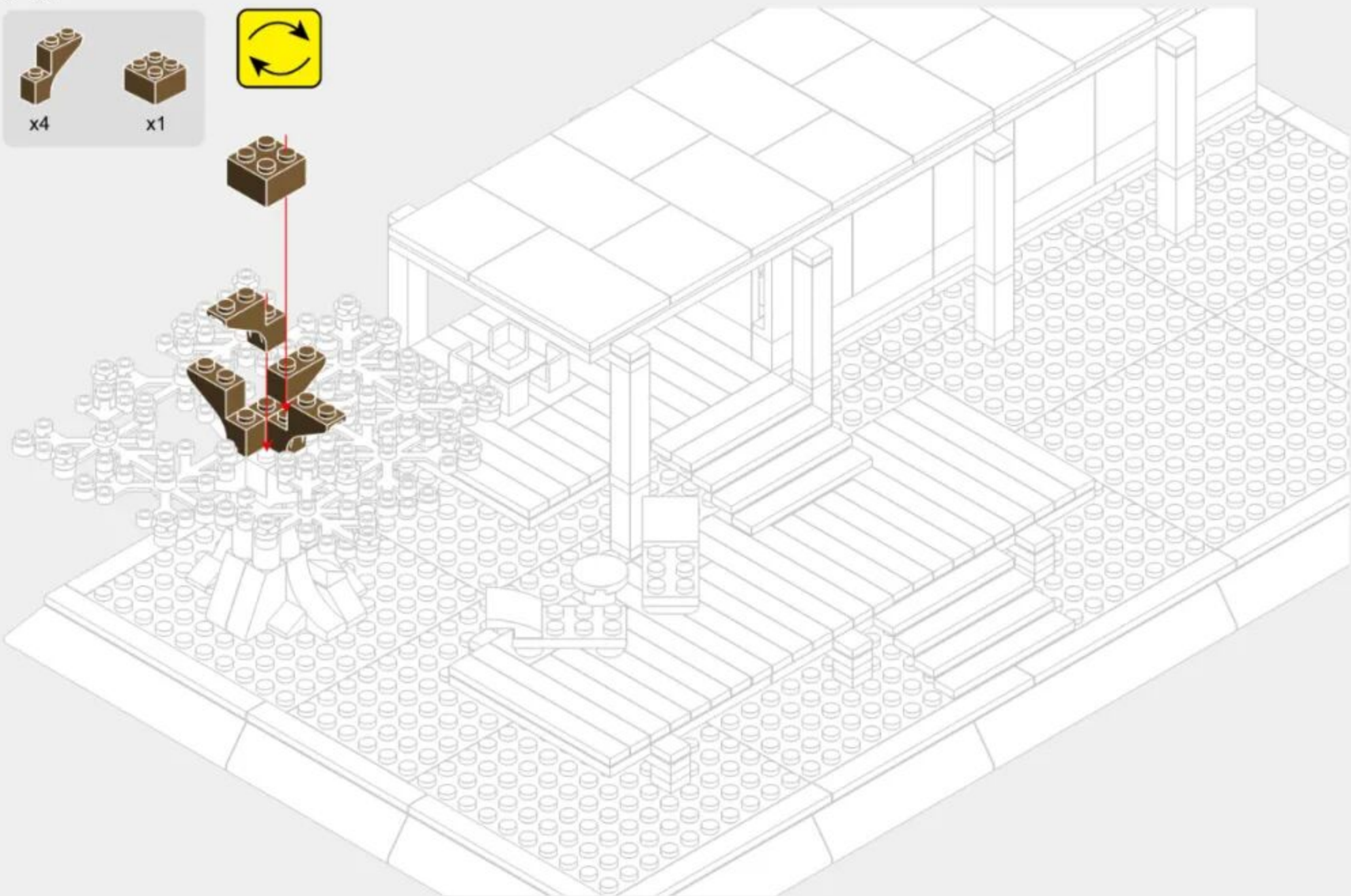
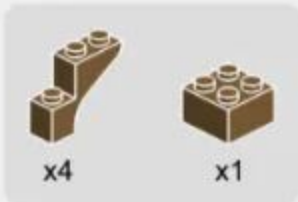

3-14

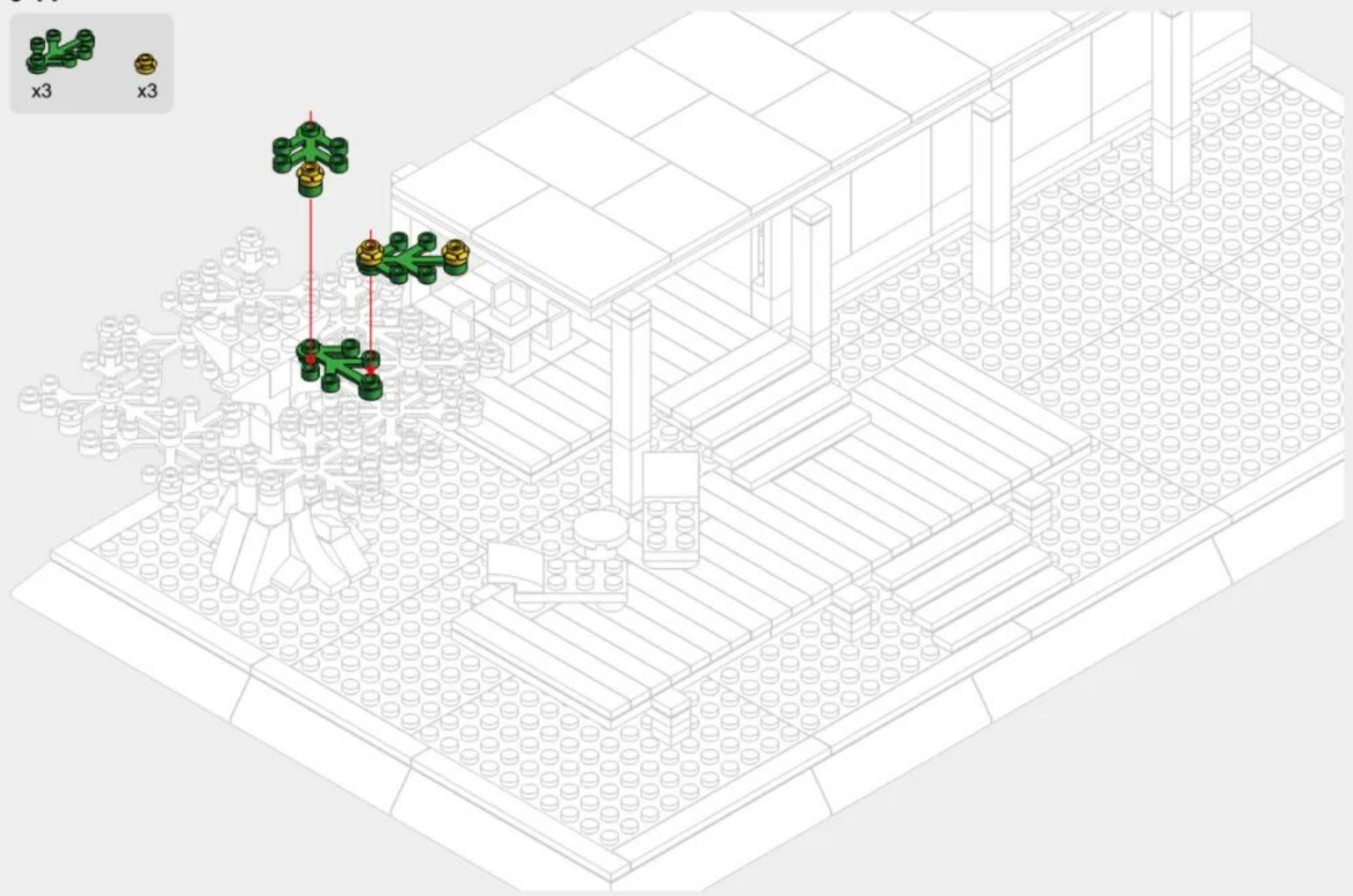
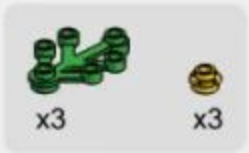

3-15

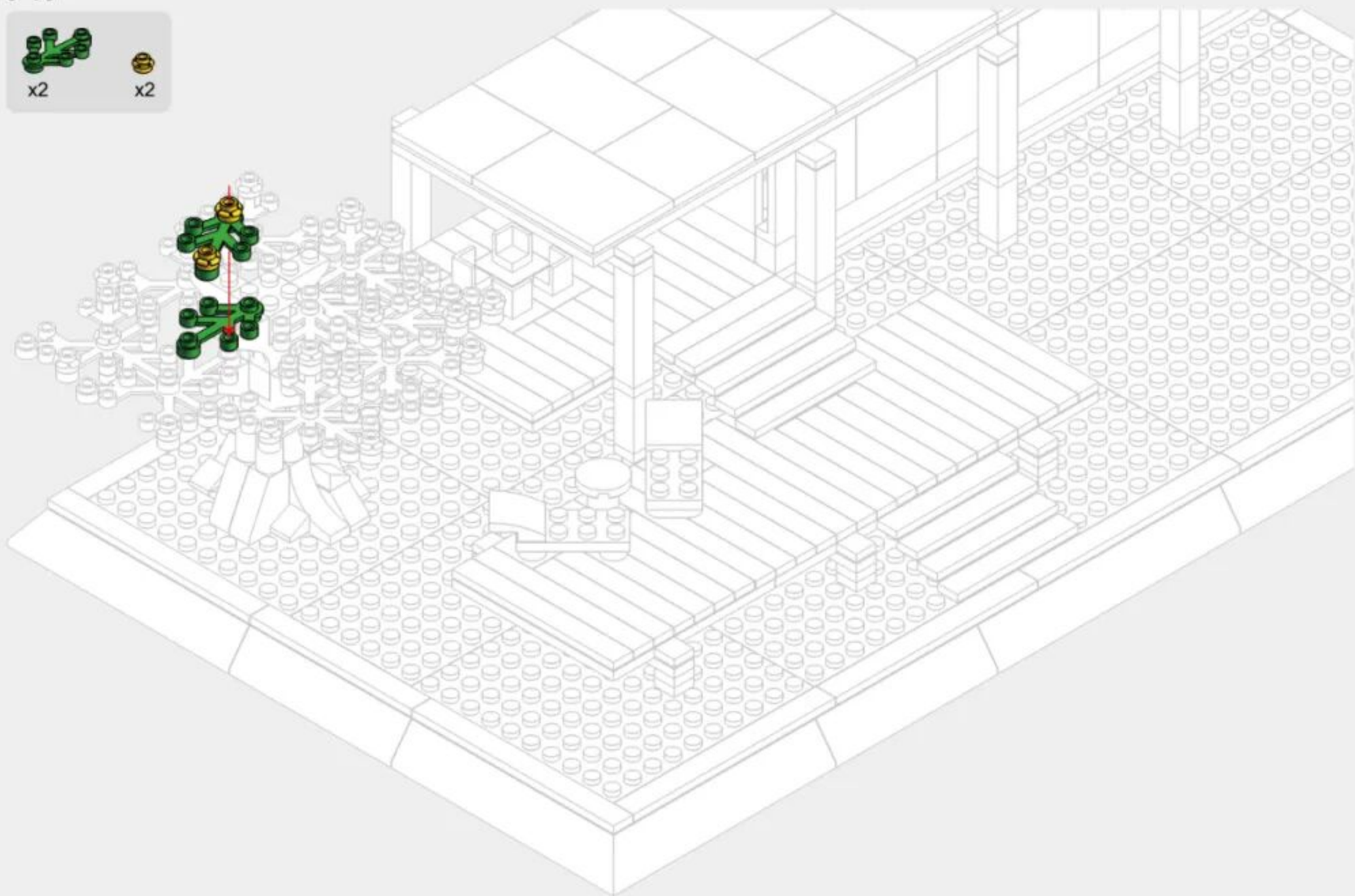
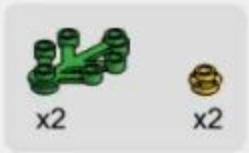

3-16

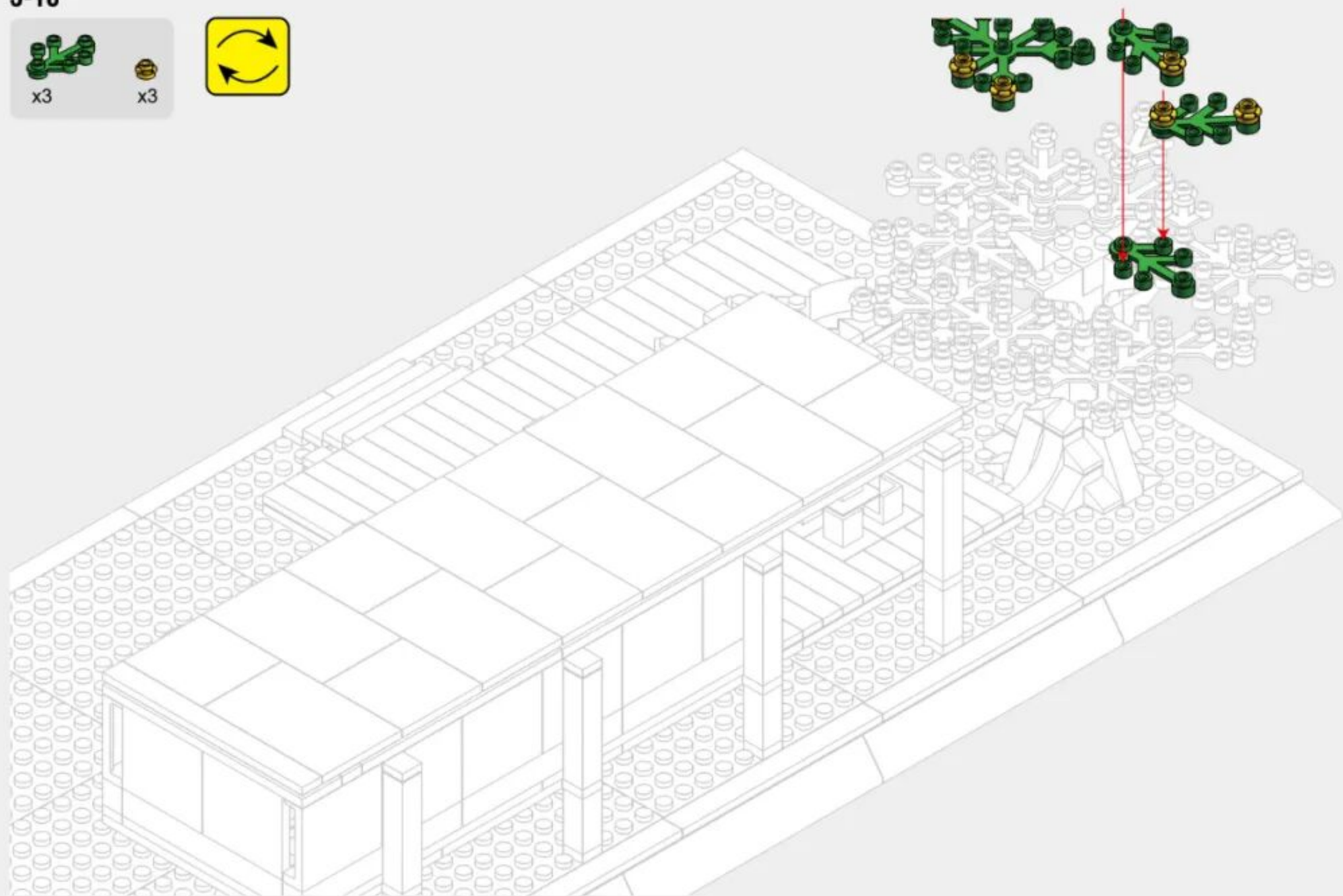
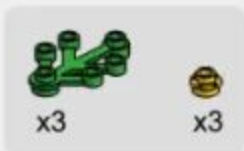

3-17

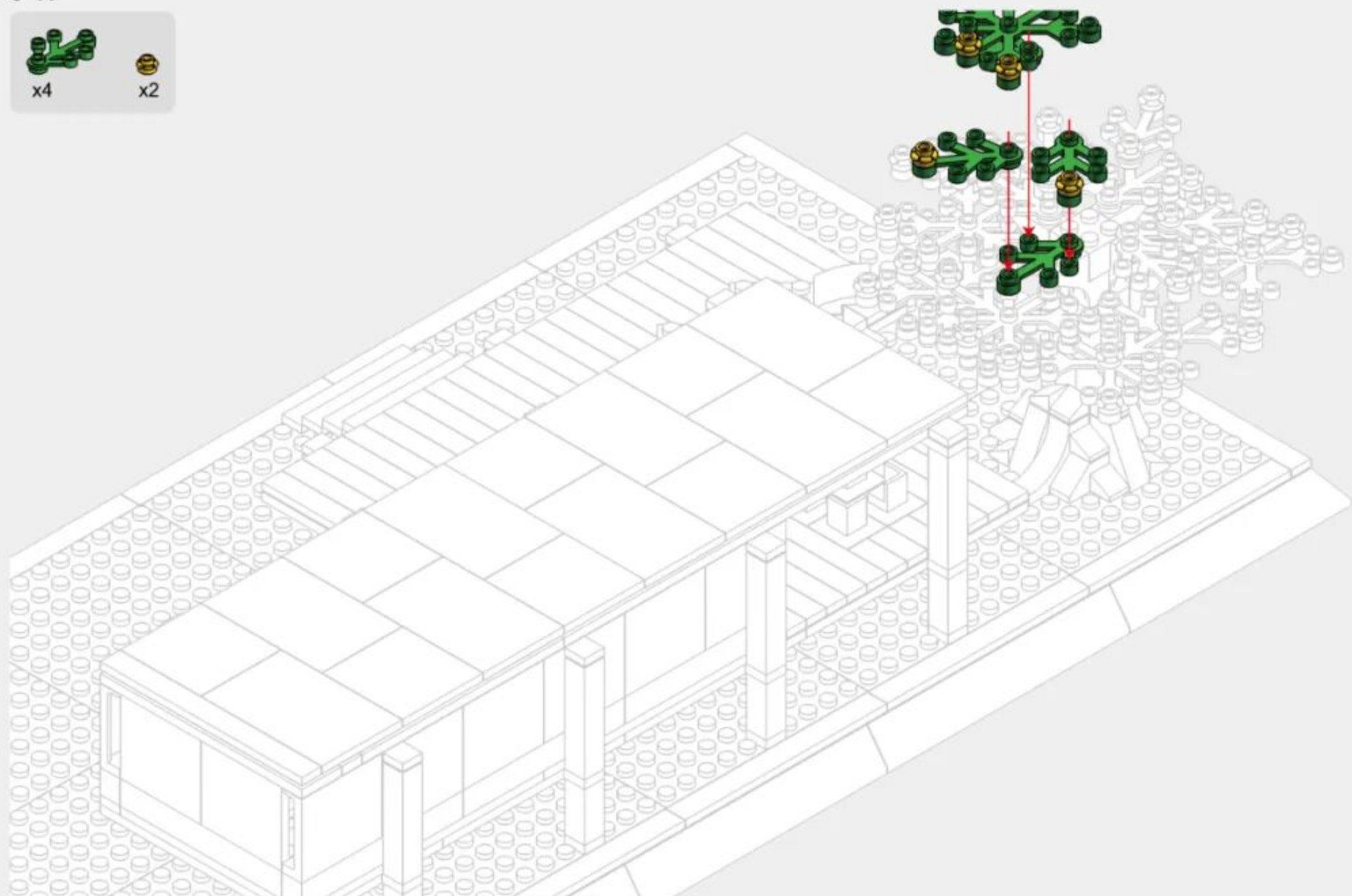
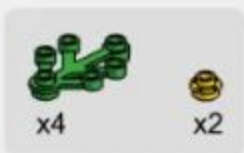

3-18

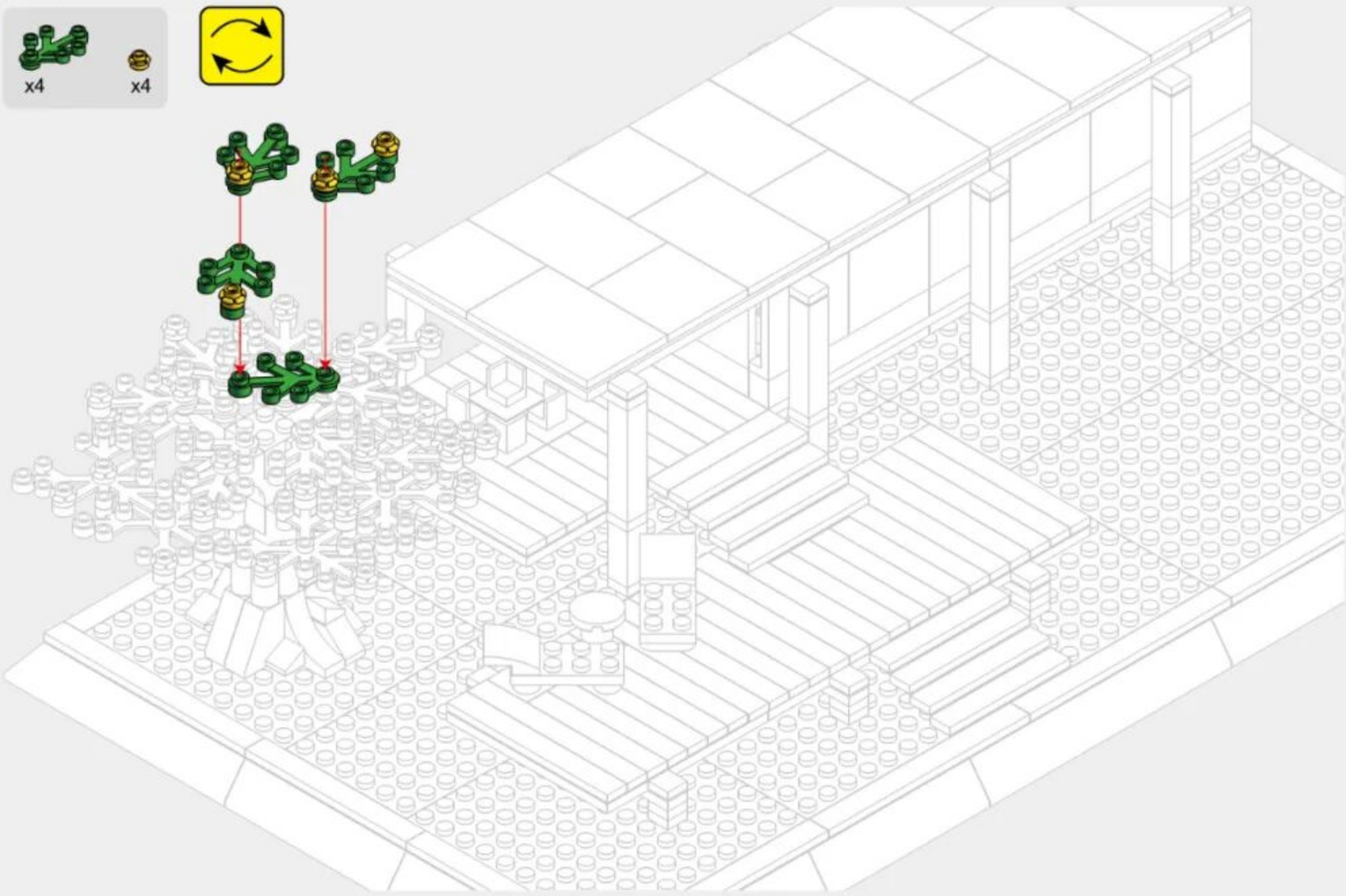
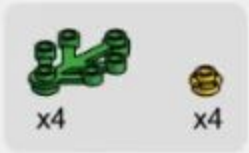

3-19

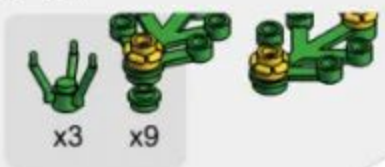

3-20



3-21

-  x5
-  x10
-  x26
-  x7

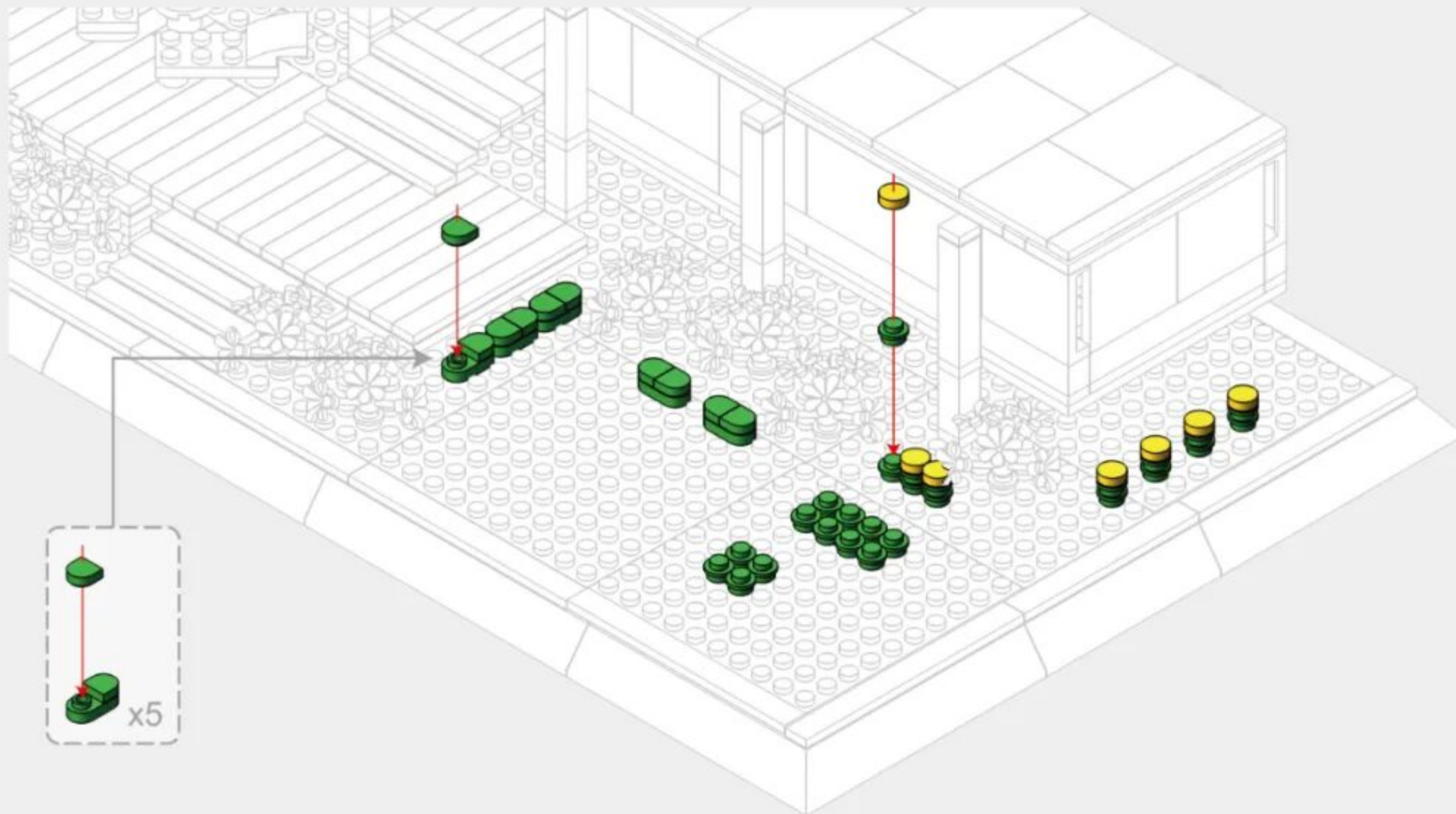

3-22



x6



x6



72

3-24



x4



x4



74

3-25

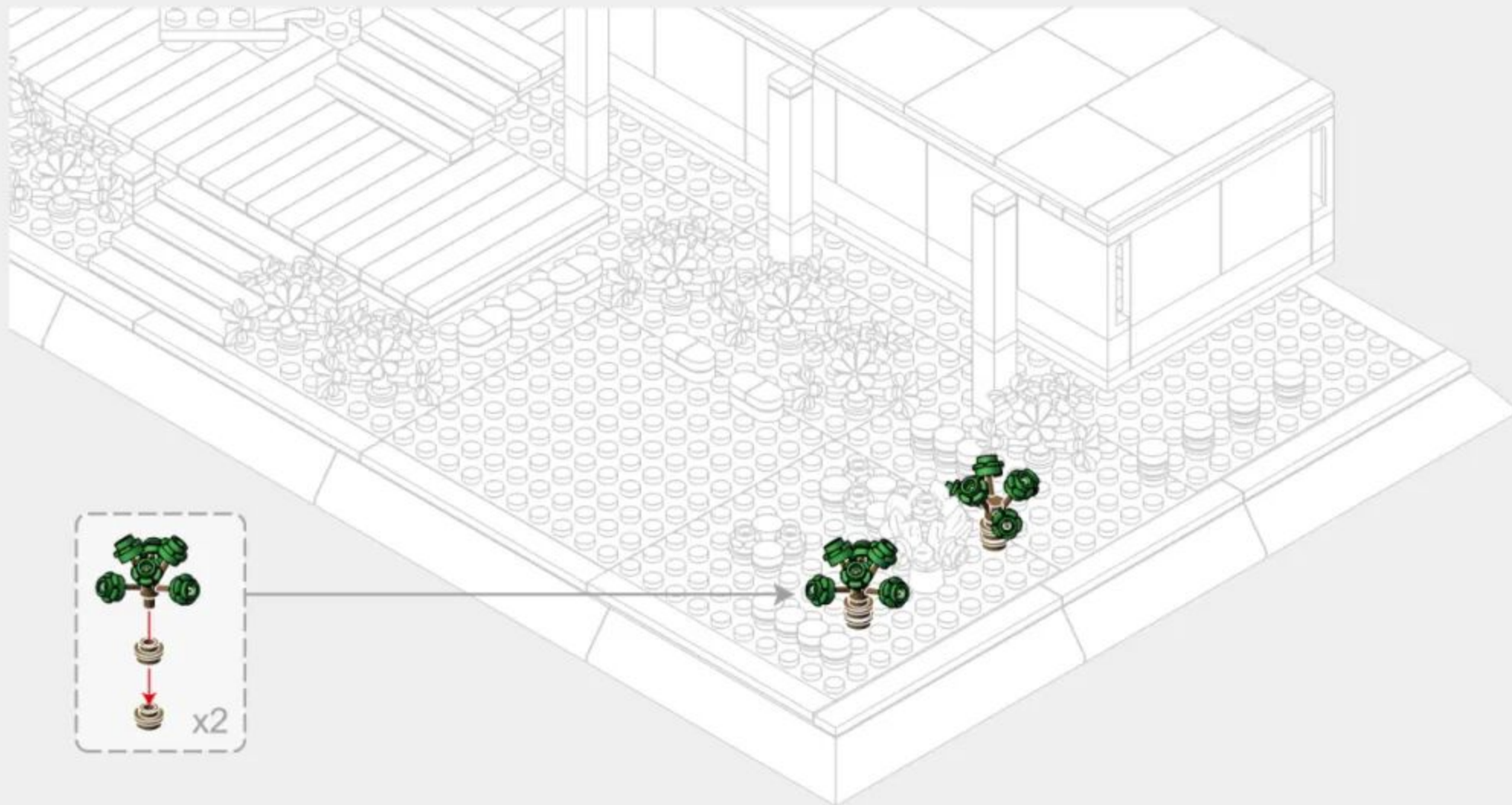
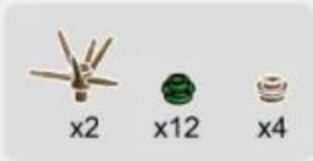

3-26

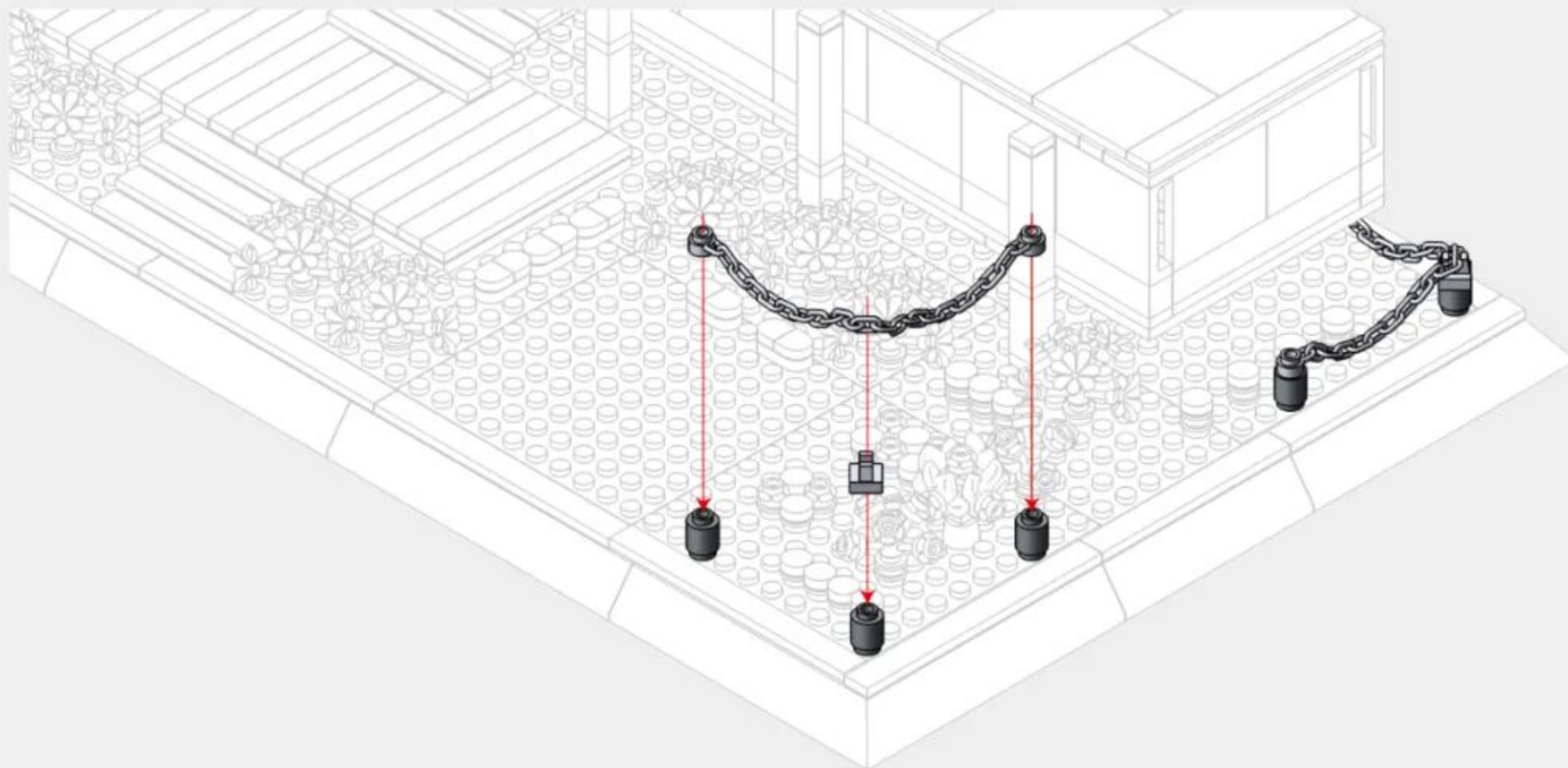

3-27

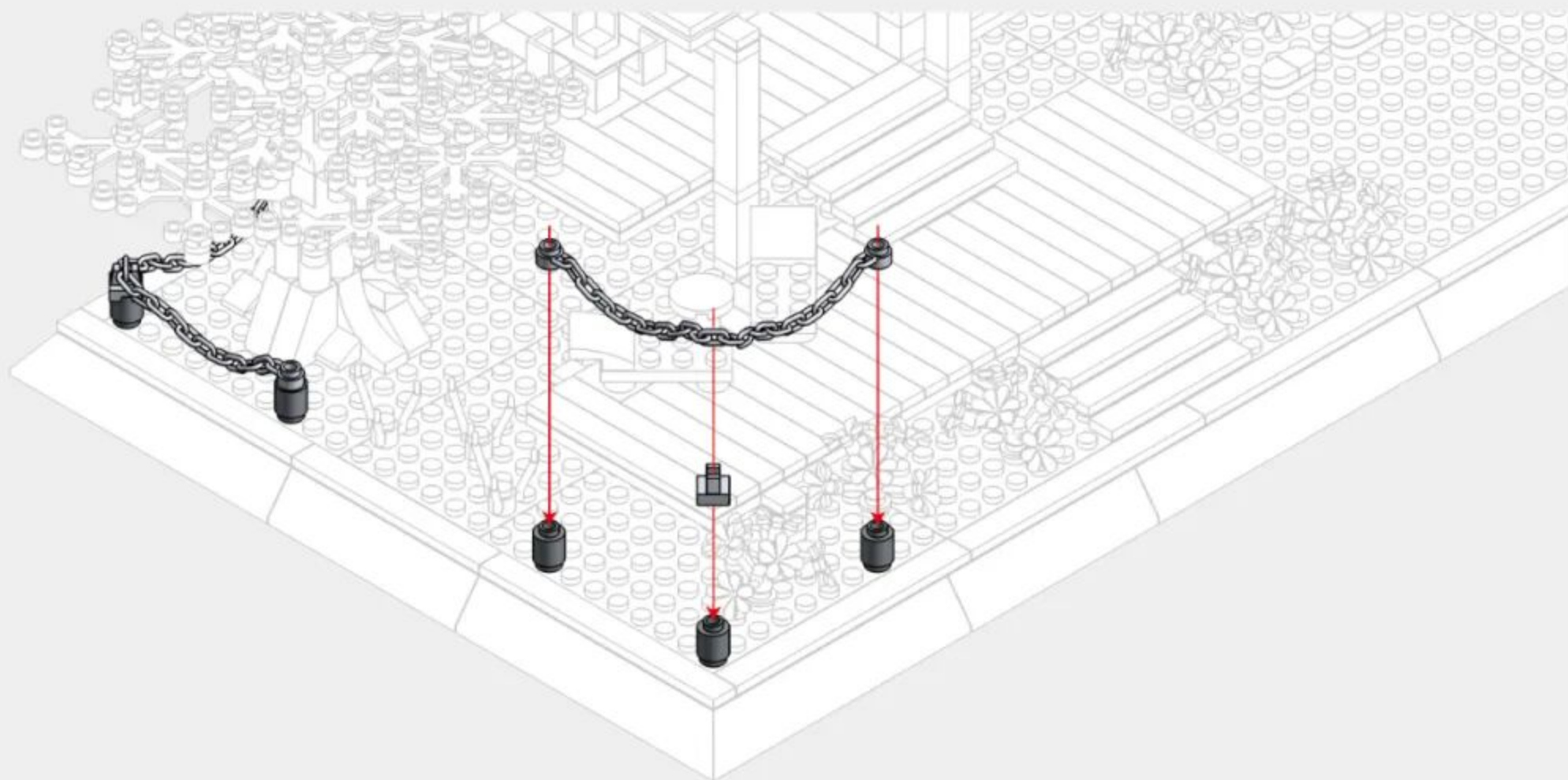
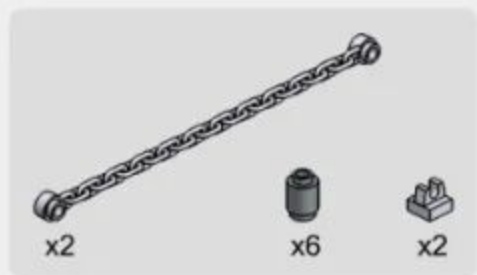

3-28

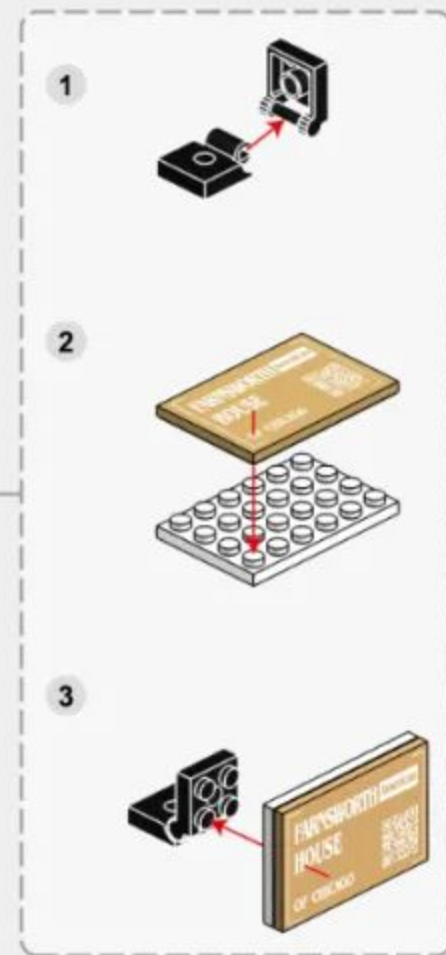
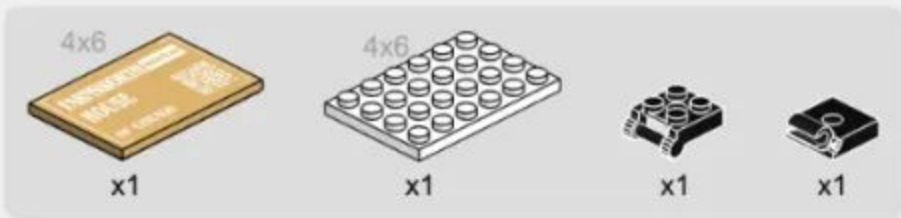



ARCHITECTURE

The World's great architecture

Shaping Skills Imagination & Curiosity Mathematical Self Discovery & Perception Parent-Child Interaction Problem Solving Creativity



6224 英国伦敦白金汉宫
BUCKINGHAM PALACE-LONDON,ENGLAND



5225 意大利罗马斗兽场
COLOSSEUM-ROME,ITALY



5226 日本东京帝国饭店
IMPERIAL HOTEL-TOKYO,JAPAN



6211 德国柏林勃兰登堡门
BRANDENBURG GATE-BERLIN, GERMANY



6222 中国甘肃长城-嘉峪关
JIAYU PASS-GANSU,CHINA



6212 日本京都清水寺仁王门
NIOMON GATE OF KIYOMIZU-DERA-KYOTO,JAPAN



6214 中国武汉黄鹤楼
YELLOW CRANE TOWER-WUHAN,CHINA



6215 英国伦敦眼
LONDON EYE-LONDON,ENGLAND



6221 中国北京故宫-太和殿
HALL OF SUPREME HARMONY-BEIJING,CHINA



6213 俄罗斯莫斯科瓦西里大教堂
SAINT BASIL'S CATHEDRAL-MOSCOW,RUSSIA



6220 沙特阿拉伯麦加大清真寺
GREAT MOSQUE OF MECCA,SAUDI ARABIA



6219 美国纽约联合国大厦
UNITED NATIONS HEADQUARTERS-NEW YORK,AMERICA



4214 美国华盛顿白宫
WHITE HOUSE-WASHINGTON D.C.,AMERICA



4212 意大利罗马许愿池
TREVI FOUNTAIN-ROME,ITALY



4213 法国巴黎卢浮宫
MUSÉE DU LOUVRE-PARIS,FRANCE



4218 新加坡-鱼尾狮
MERLION,SINGAPORE



4210 埃及开罗吉萨金字塔
GREAT PYRAMID OF GIZA-CAIRO,EGYPT



4219 英国伦敦双子塔桥
TOWER BRIDGE-LONDON,ENGLAND



4216 美国华盛顿林肯纪念堂
LINCOLN MEMORIAL-WASHINGTON D.C.,AMERICA



4217 新加坡-金沙酒店
MARINA BAY SANDS,SINGAPORE



7210 中国上海世博会中国馆
CHINA PAVILION AT EXPO-SHANGHAI, CHINA



4221 加拿大渥太华国会山庄
PARLIAMENT BUILDINGS-OTTAWA, CANADA



4211 英国伦敦伊丽莎白塔
ELIZABETH TOWER-ENGLAND



4220 美国纽约熨斗大厦
FLATIRON BUILDING-NEW YORK, AMERICA



5227 美国纽约自由女神像
STATUE OF LIBERTY-NEW YORK, AMERICA



4215 加拿大多伦多电视塔
THE CN TOWER-CANADA



4222 阿联酋迪拜哈利法塔
THE BURJ KHALIFA TOWER-DUBAI, UAE



5224 中国上海东方明珠广播电视塔
ORIENTAL PEARL TOWER-SHANGHAI, CHINA



5212 美国纽约帝国大厦
EMPIRE STATE BUILDING-NEW YORK, AMERICA



5213 马来西亚吉隆坡石油双塔
PETRONAS TWIN TOWERS-KUALA LUMPUR, MALAYSIA



5214 意大利托斯卡纳比萨斜塔
LEANING TOWER OF PISA-TUSCANY, ITALY



5216 英国伦敦伊丽莎白塔
ELIZABETH TOWER-LONDON, ENGLAND



5219 俄罗斯莫斯科克里姆林宫钟楼
SPASSKAYA TOWER-MOSCOW, RUSSIA



5220 阿联酋迪拜卓美亚帆船酒店
BURJ AL ARAB HOTEL-DUBAI, UAE



5217 法国巴黎埃菲尔铁塔
EIFFEL TOWER-PARIS, FRANCE



5221 中国台北101大楼
TAIPEI 101-TAIPEI, CHINA



6223 中国武汉长江大桥
WUHAN YANGTZE RIVER BRIDGE



5210 法国巴黎圣母院大教堂
CATHÉDRALE NOTRE DAME DE PARIS-PARIS, FRANCE



5223 法国巴黎凯旋门
ARC DE TRIOMPHE-PARIS, FRANCE



5211 印度阿格拉泰姬陵
TAJ MAHAL-AGRA, INDIA



5215 英国伦敦双子塔桥
TOWER BRIDGE-LONDON,ENGLAND



5222 中国北京天坛祈年殿
HALL OF PRAYER FOR GOOD HARVESTS-BEIJING,CHINA



6210 美国旧金山金门大桥
GOLDEN GATE BRIDGE-SAN FRANCISCO,AMERICA



6216 中国北京万里长城（八达岭）
THE GREAT WALL-BEIJING,CHINA



5218 中国北京天安门
TIAN'ANMEN TOWER-BEIJING,CHINA



6217 中国西藏布达拉宫
POTALA PALACE-TIBET,CHINA



6218 芬兰罗瓦涅米圣诞老人办公室
SANTA CLAUS OFFICE-ROVANIEMI,FINLAND



6225 墨西哥库库尔坎玛雅金字塔
EL CASTILLO-KUKULKAN,MEXICO



6226 德国巴伐利亚新天鹅堡
SCHLOSS NEUSCHWANSTEIN-BAYERN, DEUTSCHLAND



5228 美国芝加哥威利斯大厦
WILLIS TOWER-CHICAGO, AMERICA



5229 土耳其伊斯坦布尔其少女塔
MAIDEN TOWER-ISTANBUL,TURKEY



5230 中国湖南长沙爱晚亭
AIWAN TING PAVILION-HUNAN,CHINA



5231 巴西里约热内卢救世基督像
CRISTO REDENTOR-RIO DE JANEIRO, BRASIL



5232 美国宾夕法尼亚州流水别墅
FALLINGWATER-PENNSYLVANIA, AMERICA



5233 美国芝加哥范斯沃斯住宅
FARNSWORTH HOUSE-CHICAGO, AMERICA



FARNSWORTH HOUSE

COUNTRY: America

CITY: Chicago



微信扫一扫
补件更简单

