



# CHINA TOWN

华盛顿唐人街

America, Washington, D.C.

The world's great architecture



6+ / 5234 / 1245PCS  
Suitable Age    Product Number    Parts Total



# Architecture

It will be a city...

这将构成一座城市...

# ABOUT THE PRODUCT

关于产品



## ARCHITECTURE

WANGE The world's great architect since 1991

# China Town



Washington, D.C.'s Chinatown is a small, historic area east of Downtown Washington, D.C. along H and I Streets between 5th and 8th Streets.

# China Town



## Geography and culture

地理·文化



Chinatown's "Friendship Archway", as seen looking west on H Street, NW



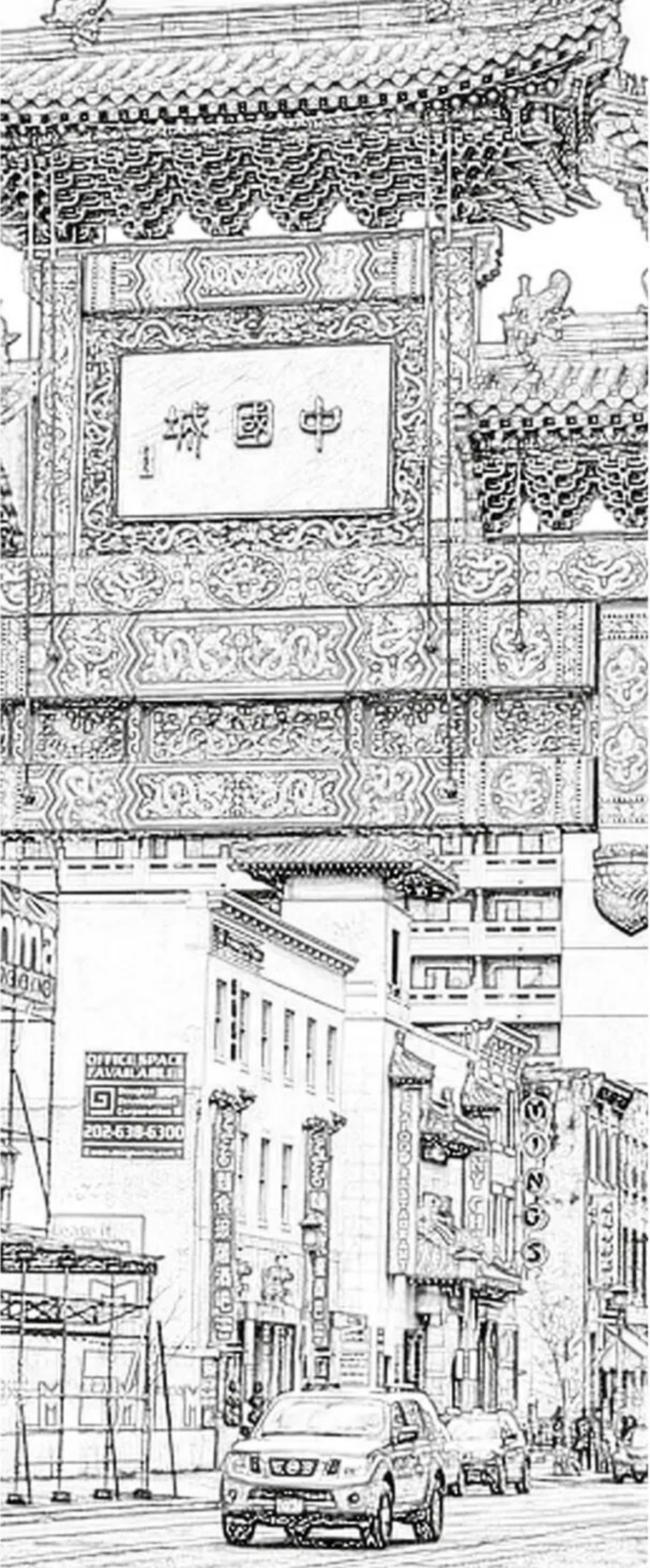

华盛顿唐人街

# China ■ town

America

The contents of this chapter refer to the Wikipedia website.

本章内容参考维基百科网站，更多资讯可自行查阅。

The world's great architecture

# Buildings and layout

■ 建筑物和布局



Washington, D.C.'s Chinatown is a small, historic area east of Downtown Washington, D.C. along H and I Streets between 5th and 8th Streets, Northwest. Historically, the area was once home to thousands of Chinese immigrants, which had shrunk to fewer than 300 in 2017. The current neighborhood was the second in Washington to be called "Chinatown" since 1931. Originally, the first Chinatown was built in the Federal Triangle on the south side of Pennsylvania Avenue some time after 1851, but was relocated to the H Street area when a new federal building was built there. A Chinese gate was built over H Street at 7th Street. By 1997, prominent landmarks such as the Capital One Arena, a sports and entertainment arena, had gentrified the area. The neighborhood is served by the Gallery Place station of the Washington Metro.

华盛顿的中国城（唐人街）形成于1851年。此后，越来越多的华侨华人移居到这里。1984年5月，华盛顿和北京结为友好城市。作为礼物馈赠，北京市政府专门派人，耗资百万美金，在7街和H街的交界点，建造了一座富有中国特色的木结构牌楼，官名“友谊牌楼”，由时任北京市市长陈希同题写楼名。牌匾上“中国城”三字，则出自著名书法家吴作人之手。美国旅游著名景点之一。



## Structure

The finished archway, or paifang in Chinese, is an impressive engineering achievement, standing 47 feet tall at the top of its highest roof, spanning 75 feet of roadway, and weighing over 128 tons. The roofing alone weighs 63 tons, supported by 27 tons of steel and 38 tons of concrete. Over 7,000 glazed tiles cover its five roofs, and 35,000 separate wooden pieces are decorated with 23-karat gold. A riot of dragons, 12 carved and 272 painted, glare and grin from every angle.

完工的牌坊是一项令人印象深刻的工程成就，其最高屋顶高达47英尺，横跨路面75英尺，重超过128吨。仅屋顶就重达63吨，由27吨钢材和38吨混凝土支撑。五座屋顶上覆盖着7000多块琉璃瓦，35000块独立的木片装饰着23克拉的黄金。雕刻了12条龙，彩绘了272条龙，从每个角度都闪耀着光芒和微笑。



## History

The Chinatown area was once home to many Chinese immigrants. Chinese immigrants began to move into the area in the 1930s, having been displaced from Washington's original Chinatown along Pennsylvania Avenue by the development of the Federal Triangle government office complex. The newcomers marked it with decorative metal latticework and railings as well as Chinese signage. At its peak, Chinatown extended from G Street north to Massachusetts Avenue, and from 9th Street east to 5th Street. In 1986, the city dedicated the Friendship Archway, a traditional Chinese gate. This was a collaboration between the Washington DC government and its sister city Beijing. It was intended to attract visitors in addition to recognizing the local Chinese residents.

唐人街地区曾经是许多中国移民的家园。20世纪30年代，由于联邦三角政府办公大楼的开发，中国移民从华盛顿原有的宾夕法尼亚大道上的唐人街搬到了这里。新来者用装饰性的金属网格和栏杆以及中文标牌来标记它。在巅峰时期，唐人街从G街向北延伸到马萨诸塞大道，从第九街向东延伸到第五街。1986年，这座城市建造了传统的中国大门——友谊牌坊。这是华盛顿特区政府与其姐妹城市北京之间的合作。它的目的是为了吸引游客，同时还为了表彰当地的中国居民。

# Force Balance

受力平衡

$$F = G \frac{m_1 m_2}{d^2}$$

Physical operations

物理运算

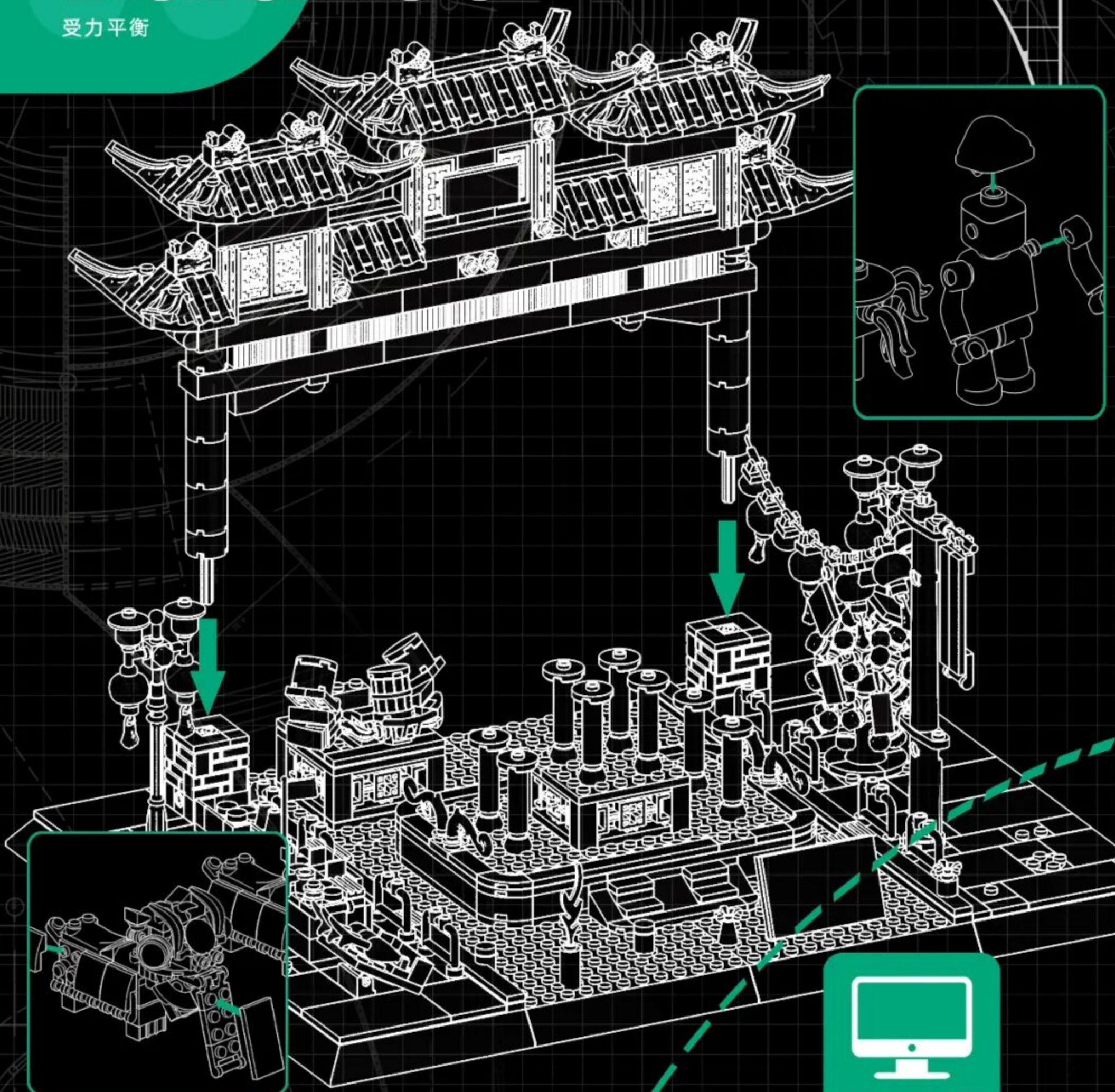

Creation and thinking

创作·思考

# Special parts

特殊零件的开发利用

$$S=4\pi \cdot r^2$$

$$a^2+b^2=c^2$$



**WG1305**  
中式推拉窗叶



**WG1284**  
2孔龙头砖



**WG1067**  
瓦片



**WG1179**  
小角瓦片

$$\sin^2 a + \cos^2 a = 1$$



features and function

特点.功能

# Main Color Matching

配色方案



## Color matching

Adopting 3 main colors, Orange, red and dark gray as the main color, the more reasonable and Green color matching on the original building, making the product more atmospheric and the whole design is more reasonable.

# China Town

华盛顿唐人街



Front

Left

Back

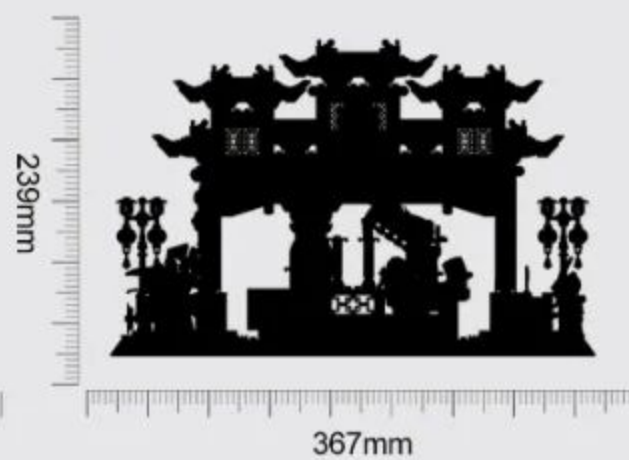
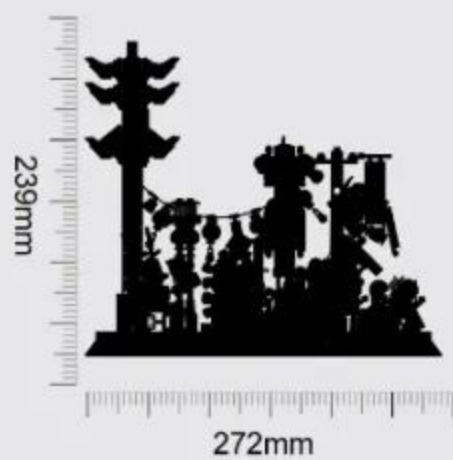
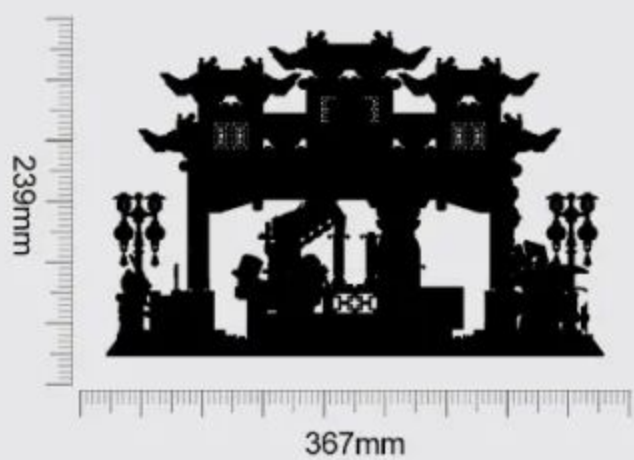

Product Size: 367X272X239mm





■ First open the product packaging according to the instructions.

按指导用正确方式拆解产品外包装。



■ Summarize all parts to count the number of familiar accessories.

对照说明书清单确认积木包数量与积木数量。



■ Arranging all accessories by color helps to quickly install the product.

把确认好的积木以类型、颜色进行分类排好以便安装。



■ Carefully install the product and learn about building.

按说明书步骤拼装并完成你的积木模型。



# Instructions For Use

积木起件器使用说明  
Brickseparator

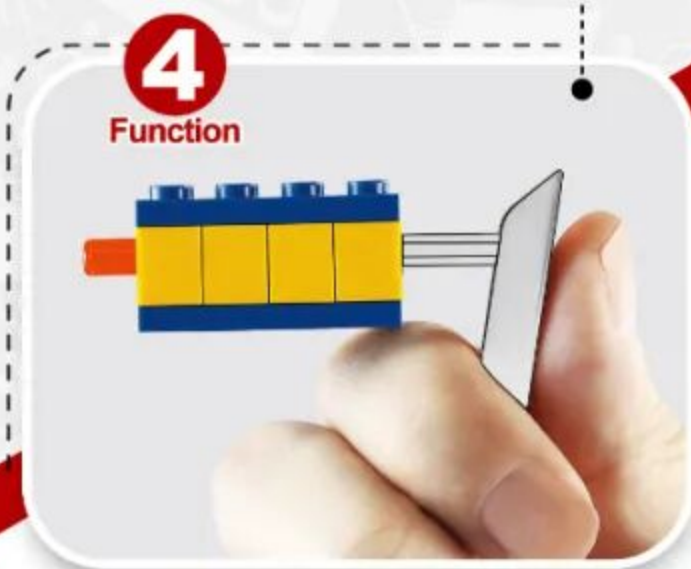
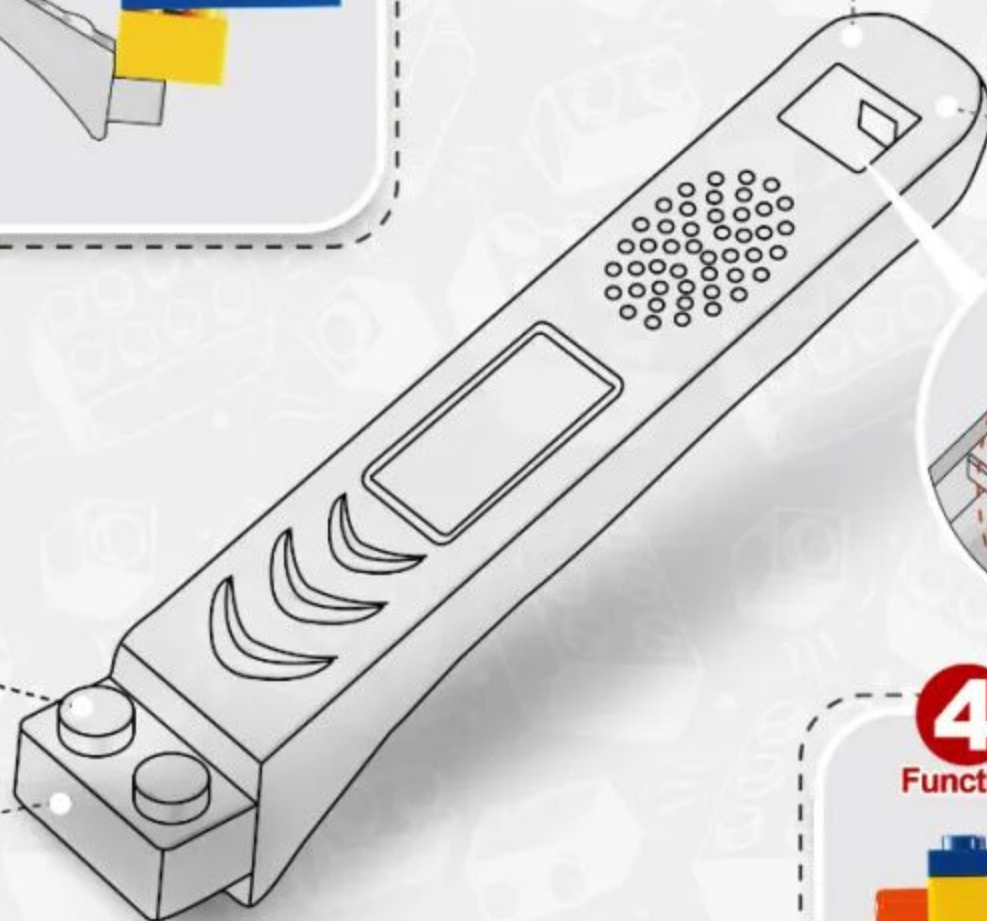
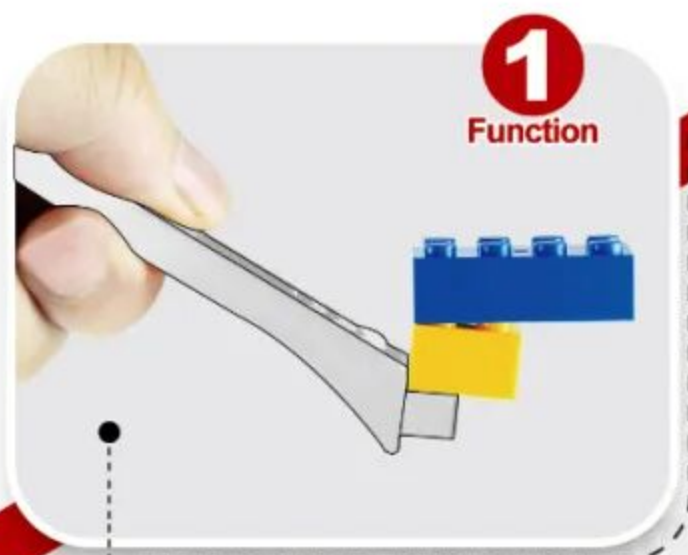

4 ways to make installation easier  
让安装更简单

# 1:1 Physical Reference Table

十字棒配件1:1尺寸参照表



Instructions For Use

让安装更简单



**2**  $(1 \times 2) = 2$

**3**  $(1 \times 3) = 3$

**4**  $(1 \times 4) = 4$

**5**  $(1 \times 5) = 5$

**6**  $(1 \times 6) = 6$

**7**  $(1 \times 7) = 7$

**8**  $(1 \times 8) = 8$

**9**  $(1 \times 9) = 9$

**10**  $(1 \times 10) = 10$

**12**  $(1 \times 12) = 12$

**16**  $(1 \times 16) = 16$

# PARTS LIST

配件清单

x1	x1	x2	x2	x6	x6	x1	x1
x2	x2	x5	x5	x2	x2	x2	x2
x1	x1	x1	x1	x1	x1	x1	x1
x1	x1	x3	x3	x3	x3	x3	x1
x1	x1	x2	x2	x6	x6	x4	x2
x1	x1	x1	x1	x4	x4	x1	x4
x3	x3	x1	x1	x2	x2	x4	x8
x4	x4	x4	x4	x2	x2	x1	x1
x1	x1	x1	x1	x2	x2	x1	x4
x1	x1	x6	x6	x2	x2	x1	x1
x4	x4	x4	x4	x1	x1	x8	x1
x4	x4	x2	x2	x3	x3	x1	x1
x4	x4	x1	x1	x1	x1	x6	x3

产品有增补件请以实物为准

If product has additional parts, please in kind prevail.

# PARTS LIST

配件清单



x6

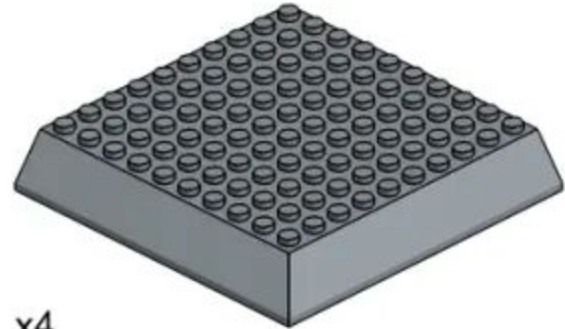

x4



x3



x1

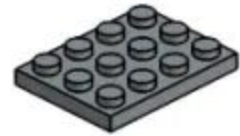

x1



x2

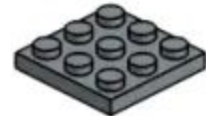

x2



x2



x8



x4



x4



x4



x2



x2



x2



x4



x16



x4



x2



x2



x1



x4



x4



x1



x2



x1

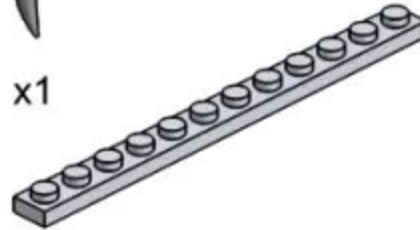

x4

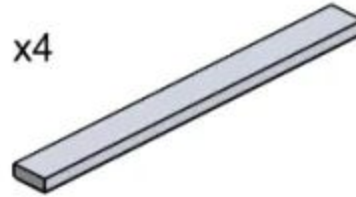

x4

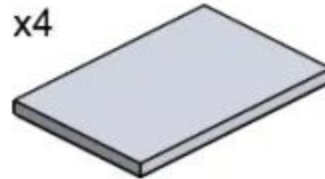

x9

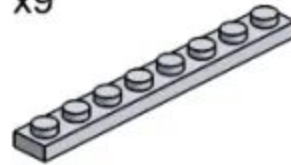

x2

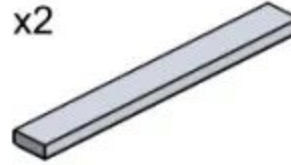

x2



x1

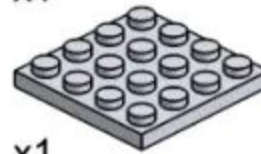

x1

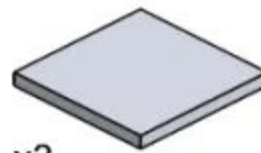

x3



x3

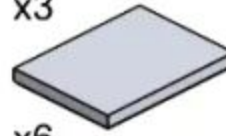

x6



x3



x3



x8

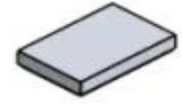

x6



x3

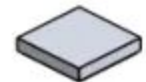

x2



x3



x2



x2



x1



x2



x6



x1



x2













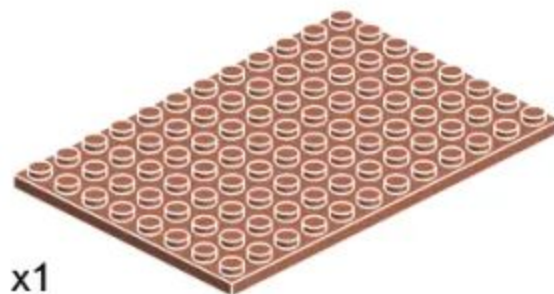

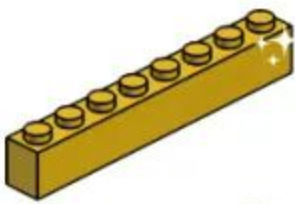

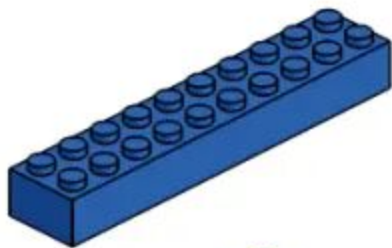

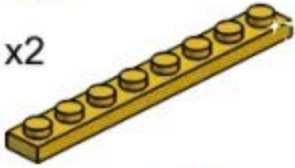

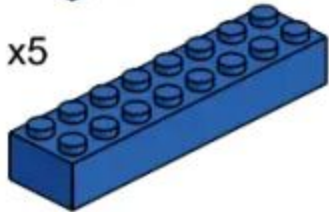



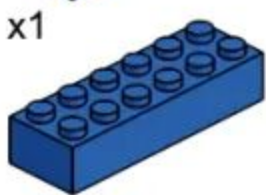
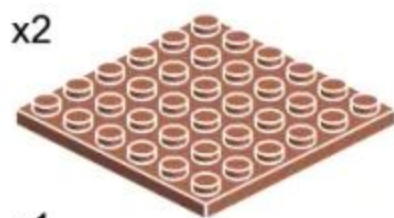







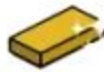

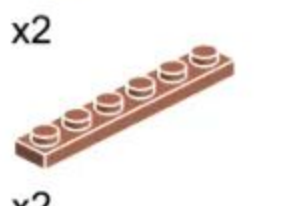



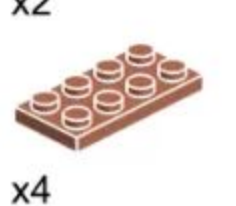





























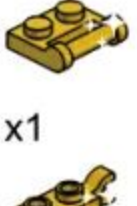







x3

产品有增补件请以实物为准

If product has additional parts, please in kind prevail.

# PARTS LIST

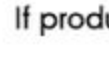
配件清单



















































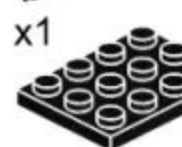



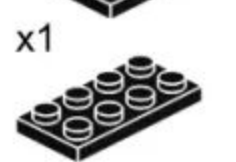



















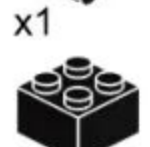

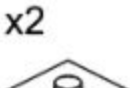







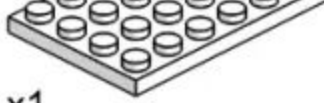



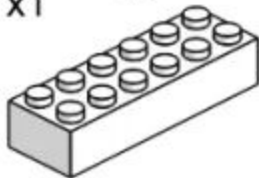

	x1		x2		x2		x6	
	x1		x2		x2		x1	
	x1		x1		x2		x4	
	x2		x4		x2		x2	
	x1		x2		x2		x8	
	x2		x2		x8		x4	
	x2		x8		x4		x13	
	x4		x1		x4		x8	
	x2		x1		x4		x8	
	x4		x1		x4		x4	
	x2		x2		x4		x1	
	x3		x4		x1		x10	
			x4		x4		x2	
			x2		x1		x8	
			x4		x4		x2	
			x4		x1		x4	
			x4		x1		x4	
			x1		x1		x4	

产品有增补件请以实物为准

If product has additional parts, please in kind prevail.

# PARTS LIST

配件清单

	x1		x6		x1		x2		x2
	x1		x2		x2		x4		x1
	x4		x11		x1		x2		x2
	x2		x8		x1		x2		x1
	x2		x2		x1		x2		x1
	x2		x8		x1		x13		x1
	x1		x4		x1		x2		x1
	x2		x2		x6		x4		x1
	x1		x32		x4		x4		x2
	x1		x2		x4		x4		x3
	x1		x2		x1		x4		x6
	x4		x2		x4		x2		x3
	x2		x4		x2		x4		x3
	x1		x2		x1		x1		x6
	x2		x2		x1		x6		x2
	x1		x1		x1		x1		x1
			x1		x1		x2		x1
			x1		x2		x2		x1
			x2		x1		x2		x1

产品有增补件请以实物为准

If product has additional parts, please in kind prevail.

# PARTS LIST

配件清单

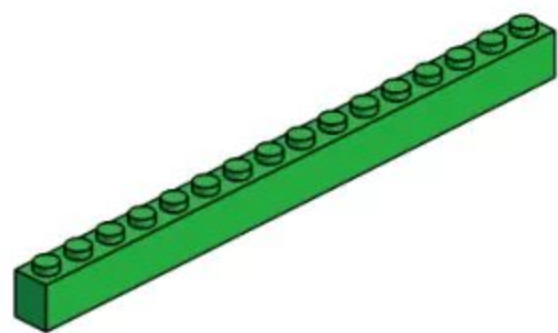

x1

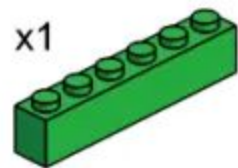

x2



x1



x9



x4



x1



x34



x1



x2



x1



x2



x36



x2



x1



x4



x8



x44

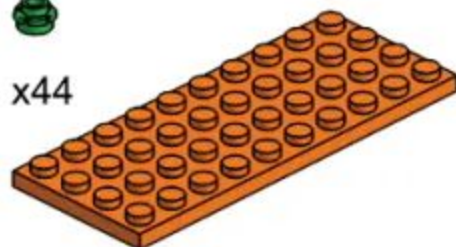

x1

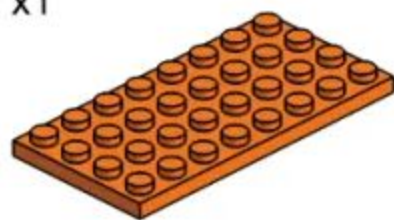

x2



x2



x2



x16



x40



x4



x1



x4



x40



x2



x3



x6



x1



x1



x8



x32



x2



x2



x2



x8



x4



x1



x1



x4



x2



x2



x2



x8



x9



x8



x8



x1

产品有增补件请以实物为准

If product has additional parts, please in kind prevail.



150PCS

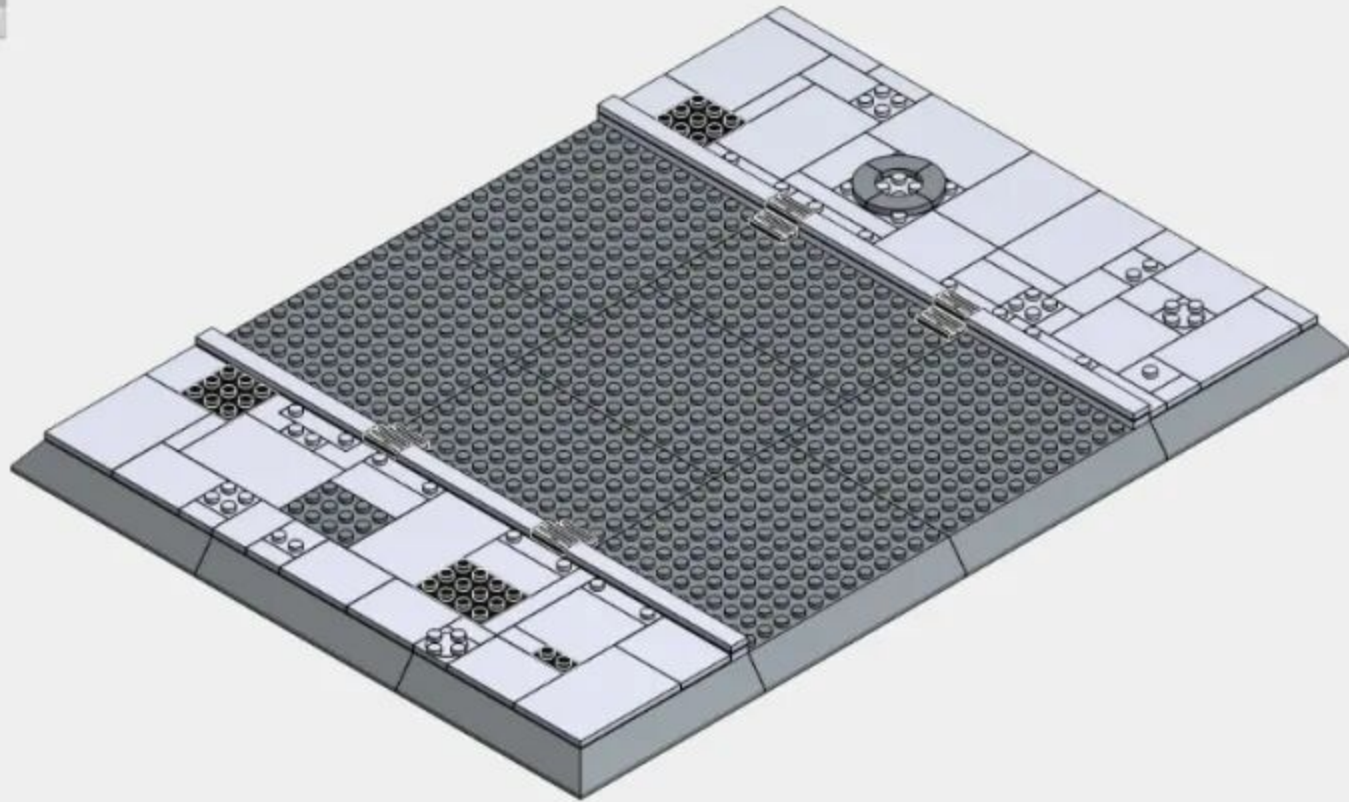

1-1

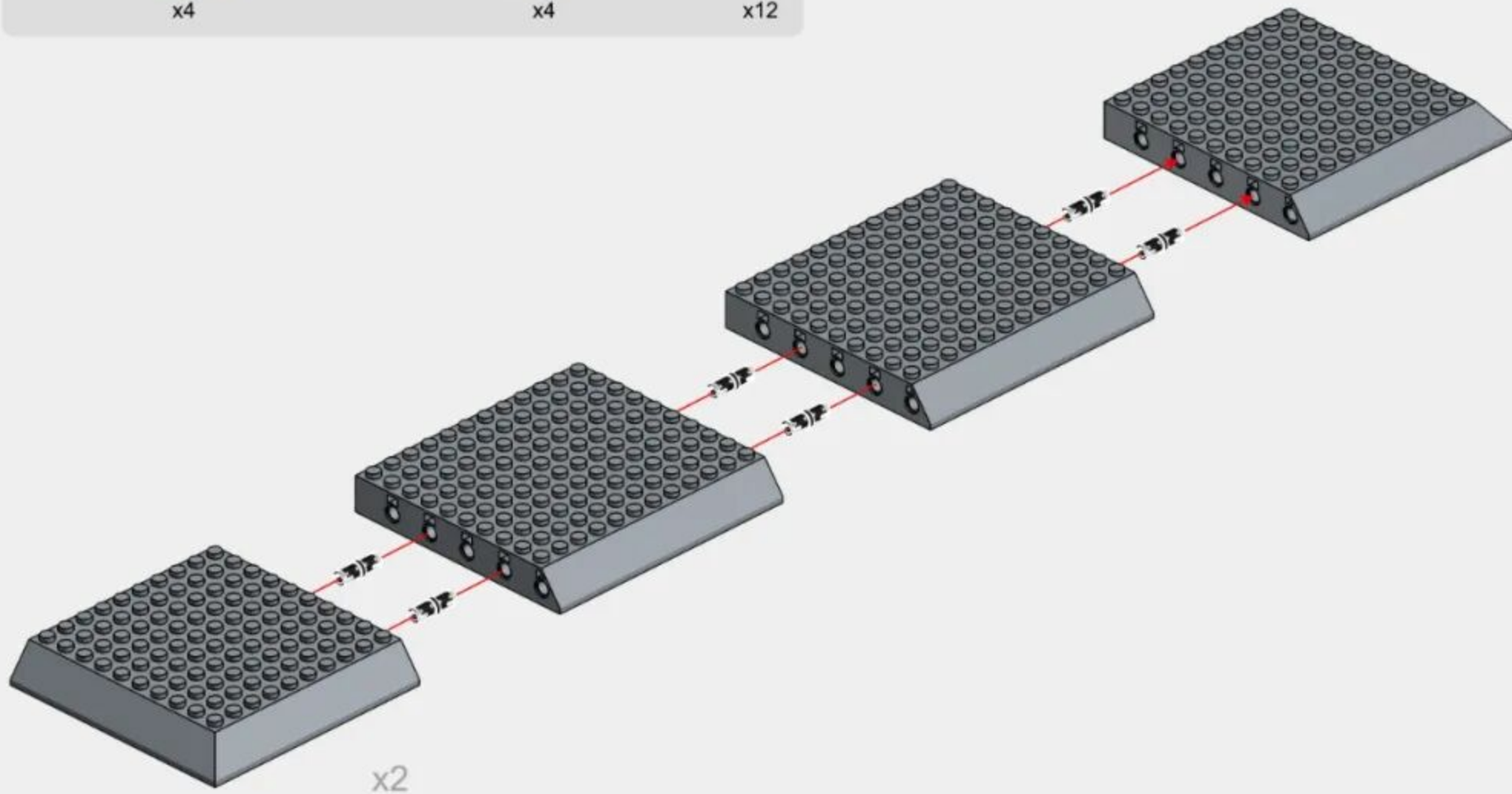
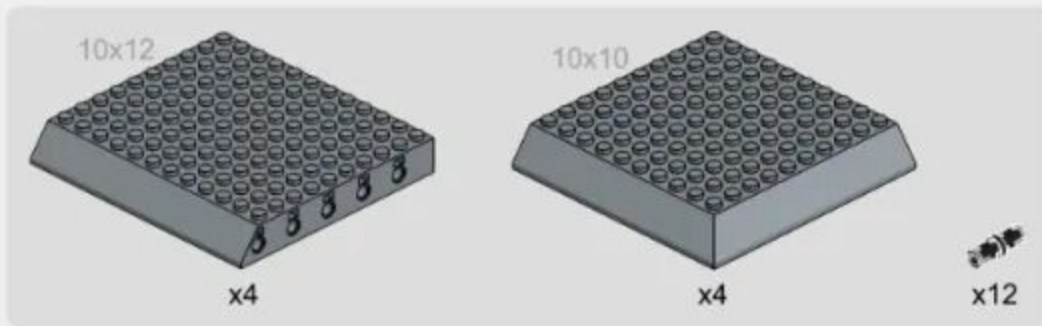

1-2

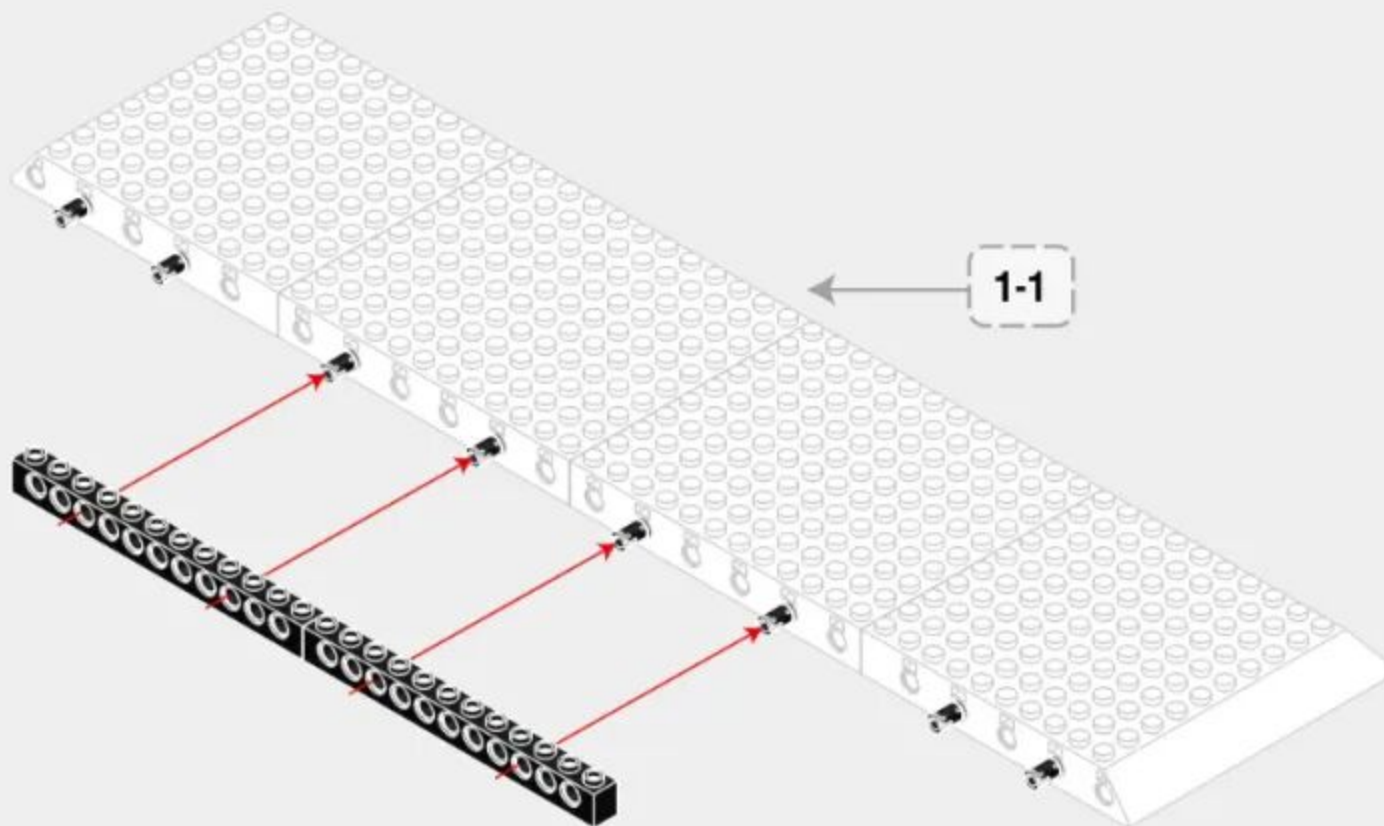
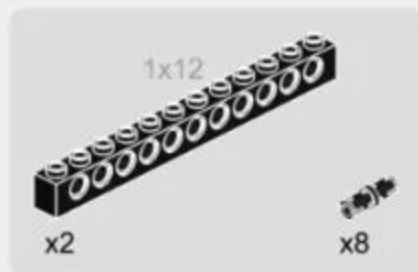

1-3

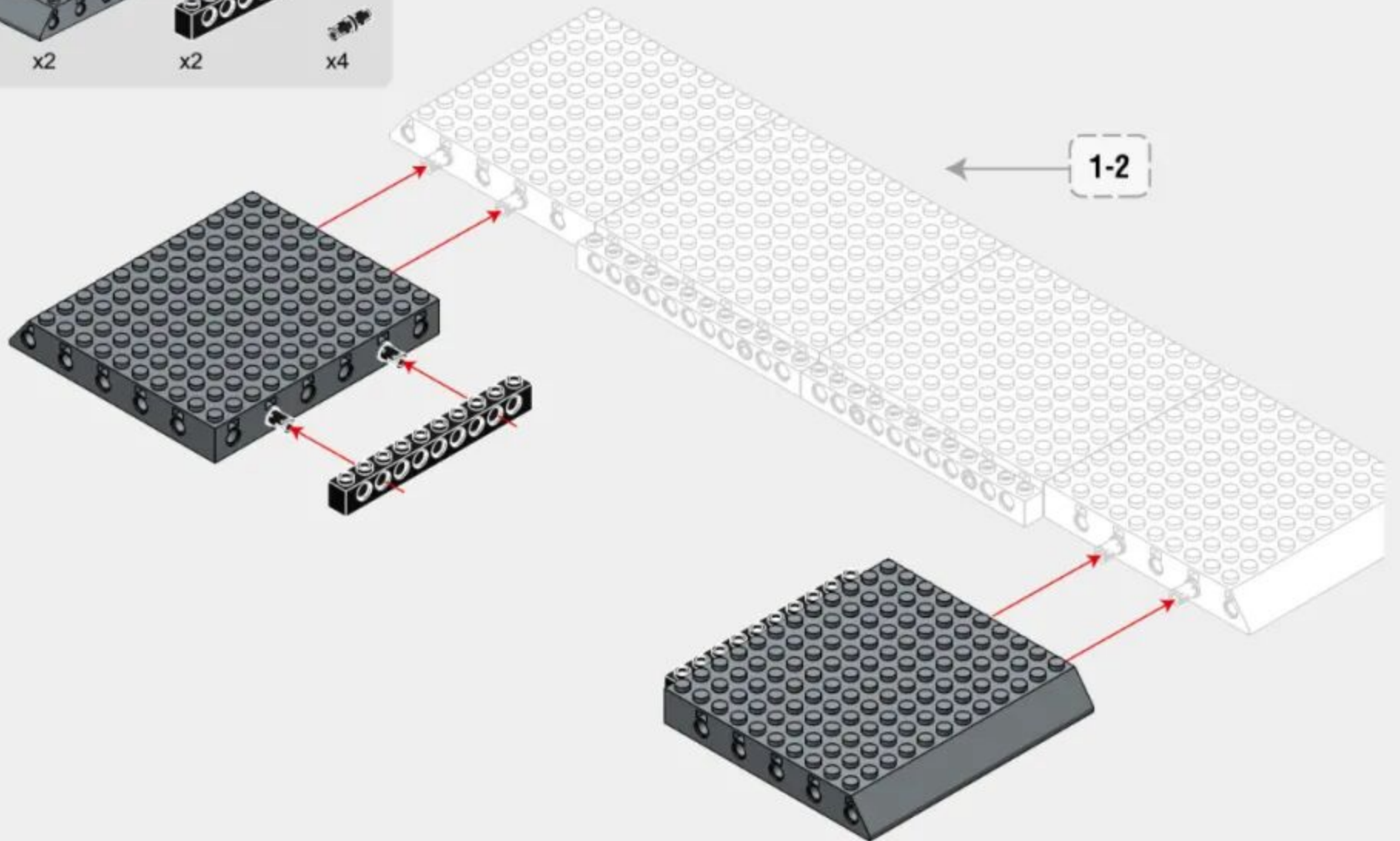
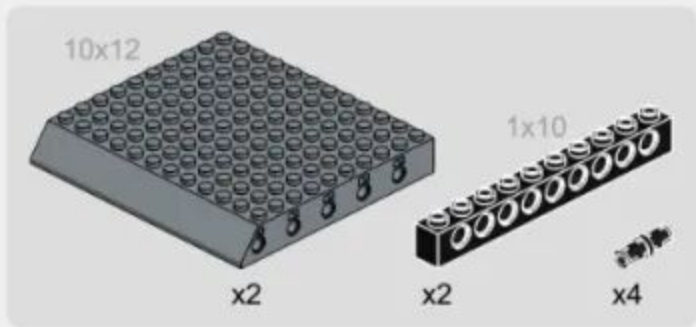

1-4

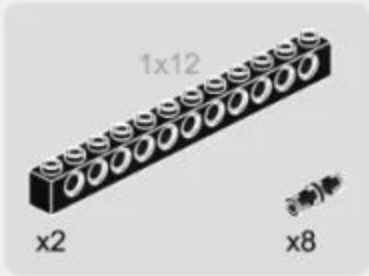

1-1 →

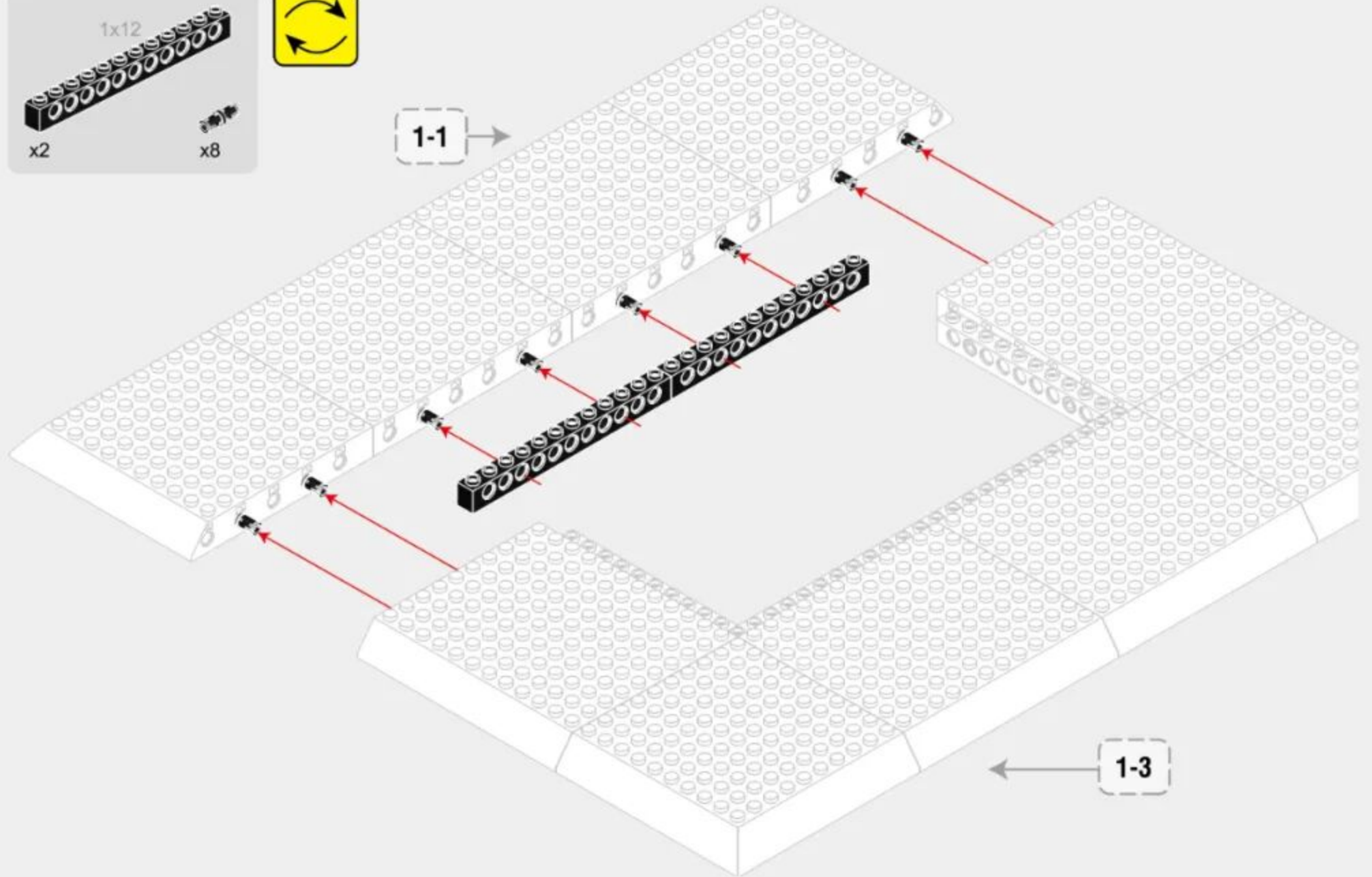

← 1-3

1-5

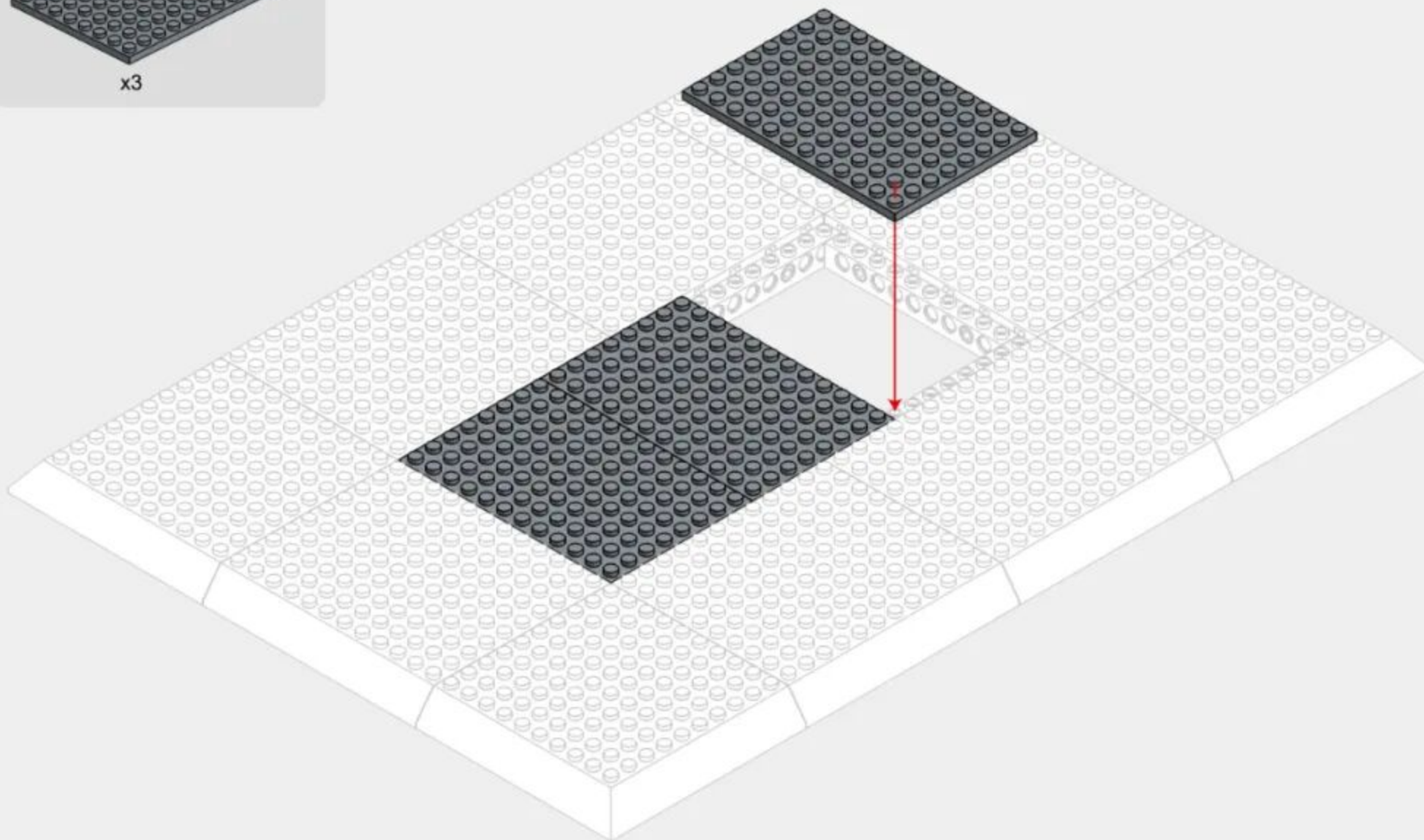
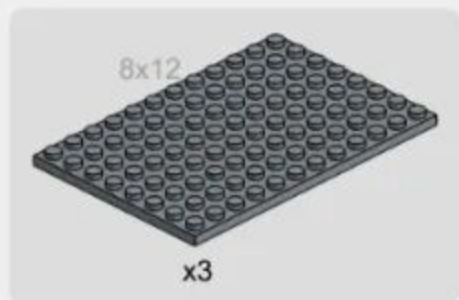

1-6

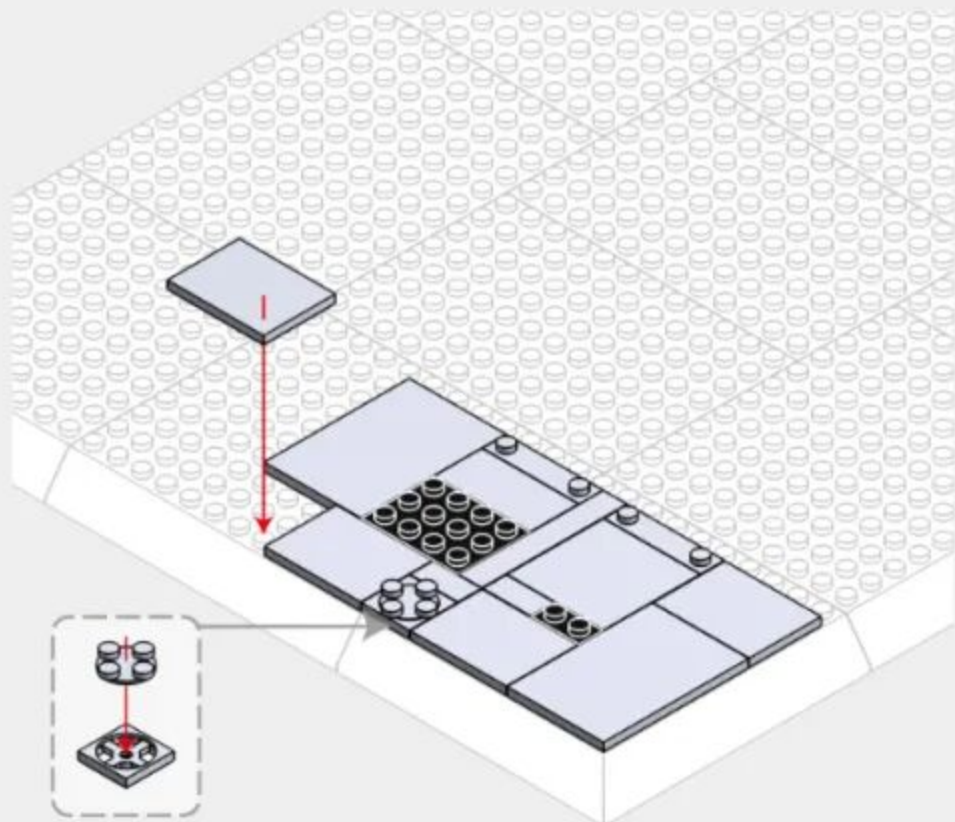
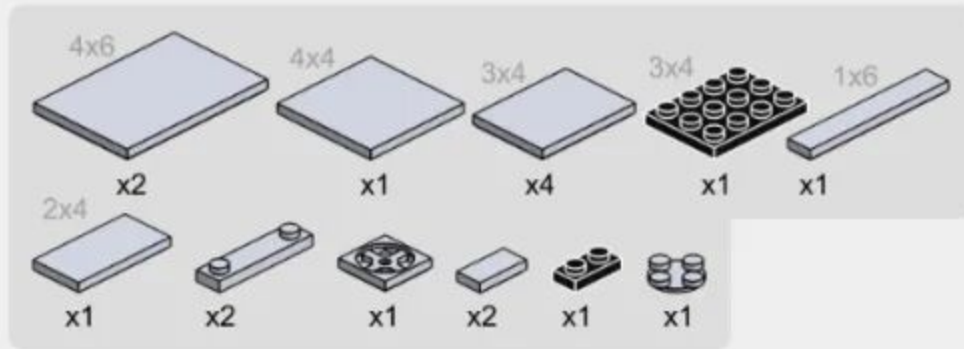

1-7

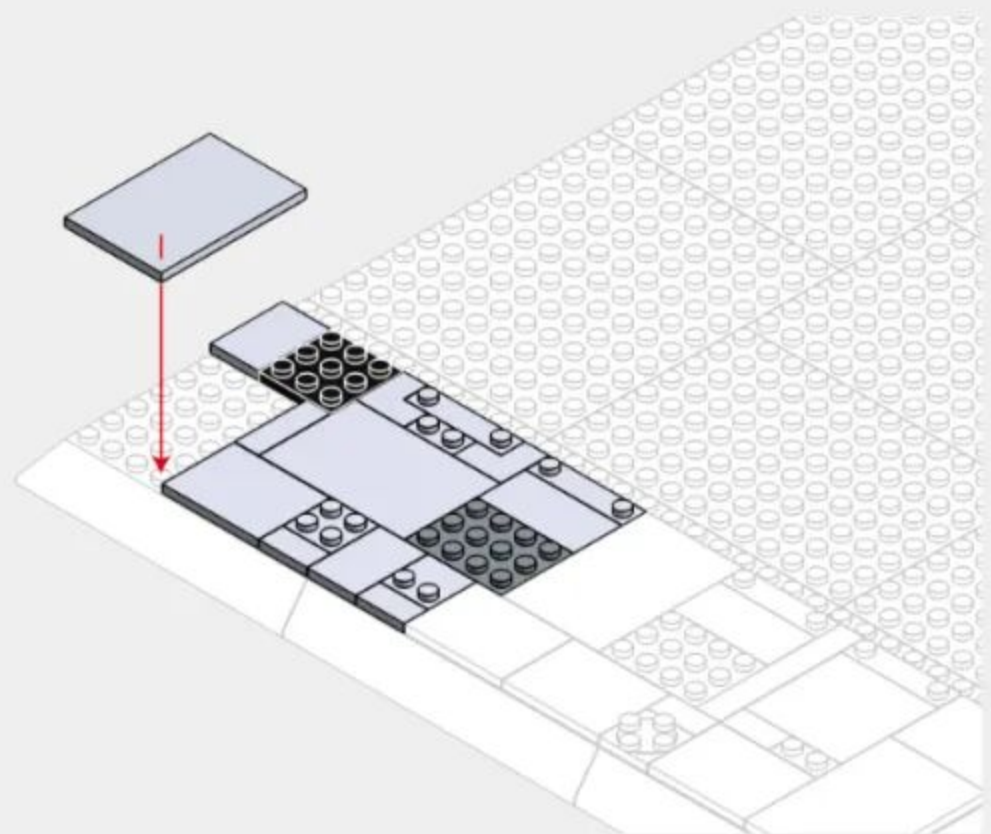
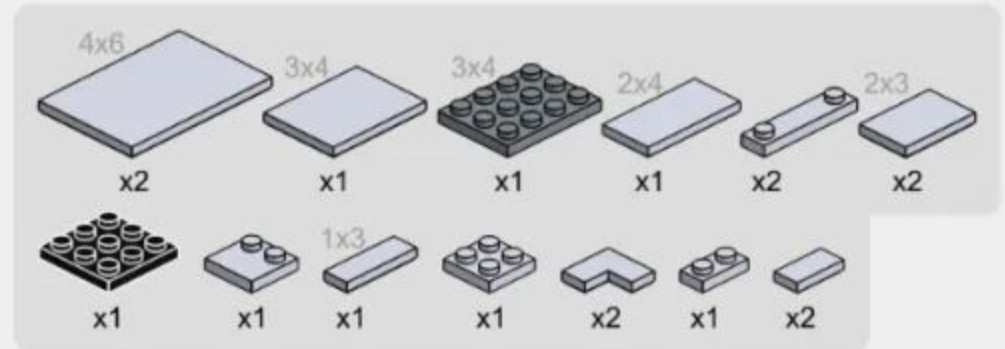

1-8

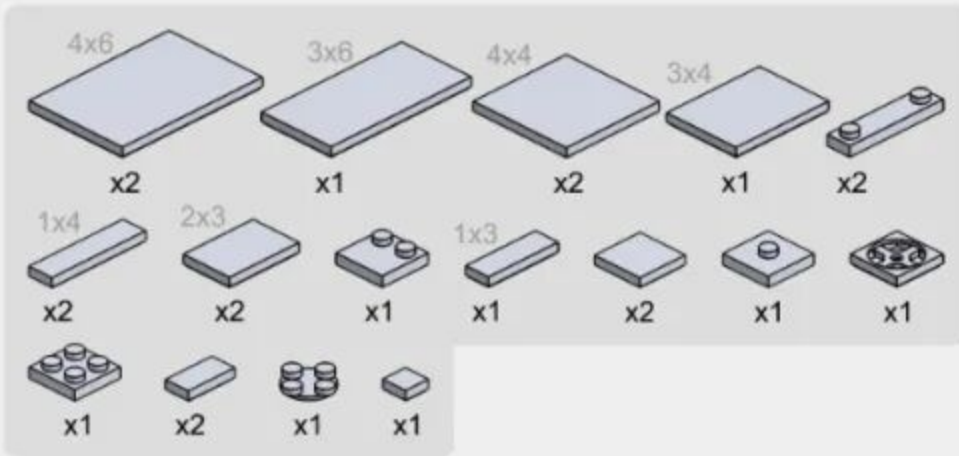

1-9

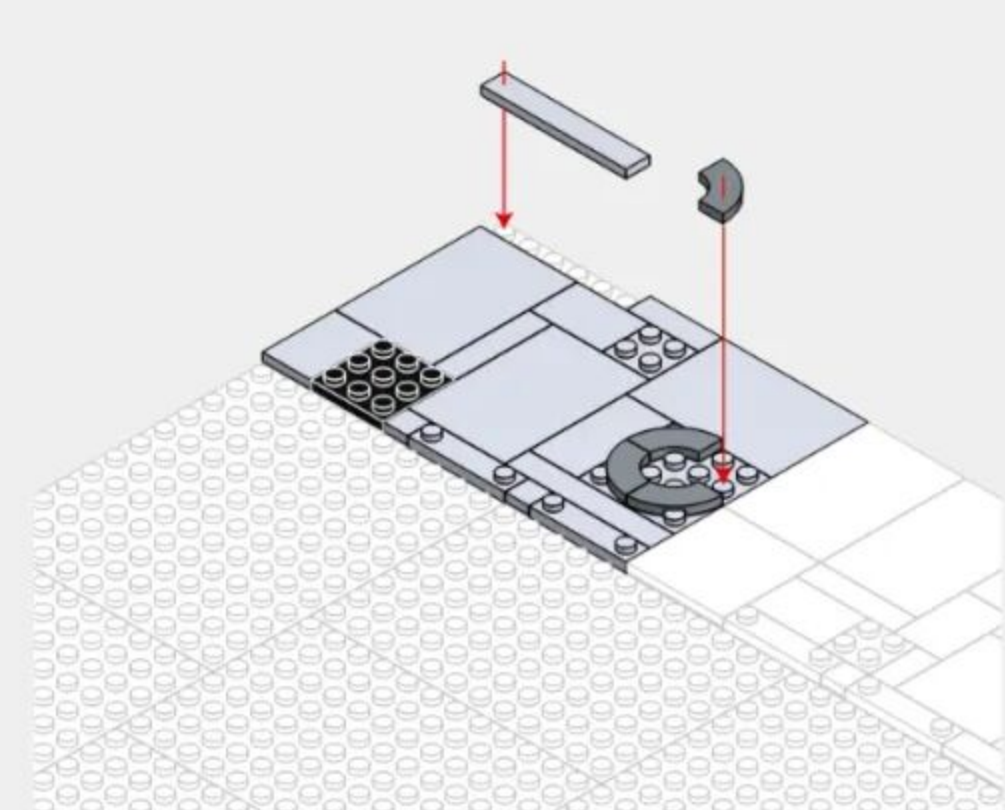
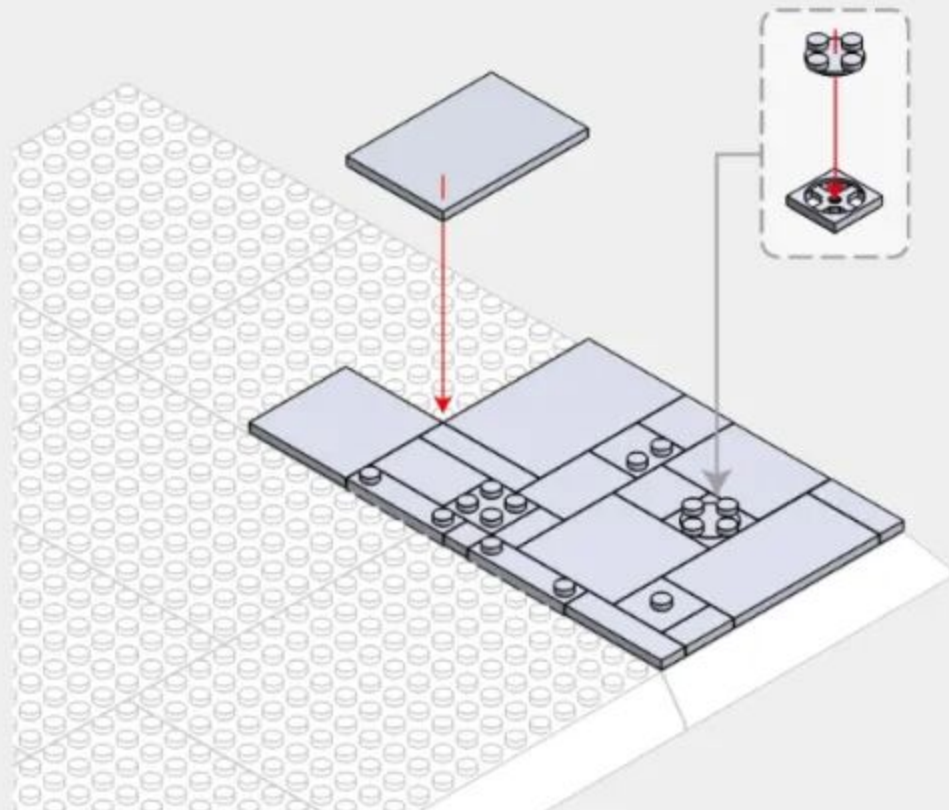
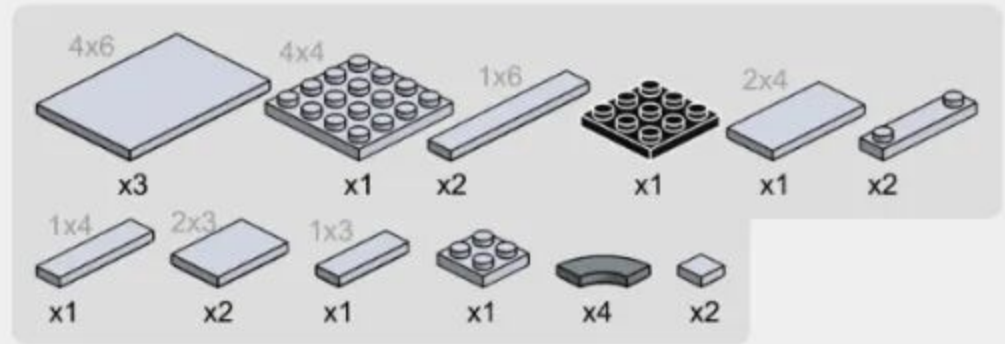

# 1-10

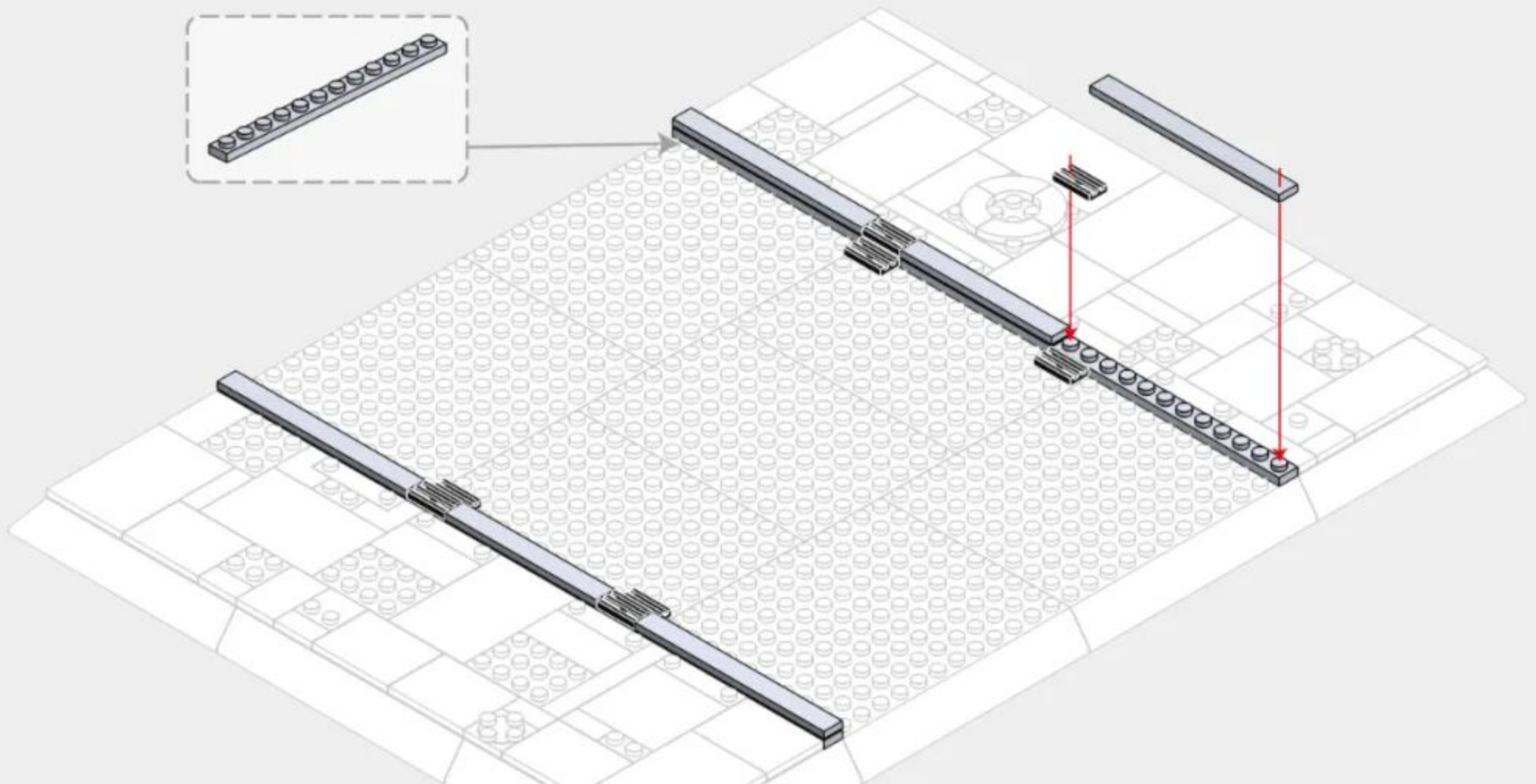
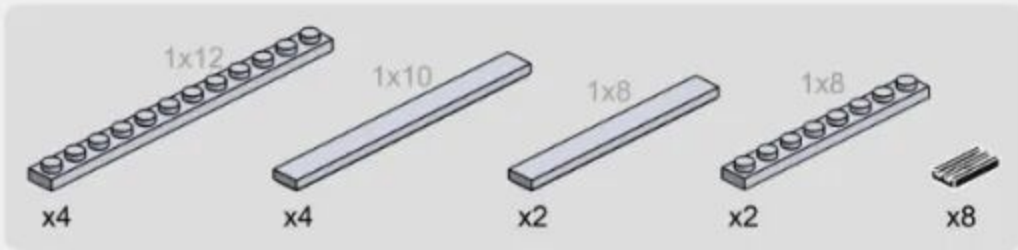



182PCS

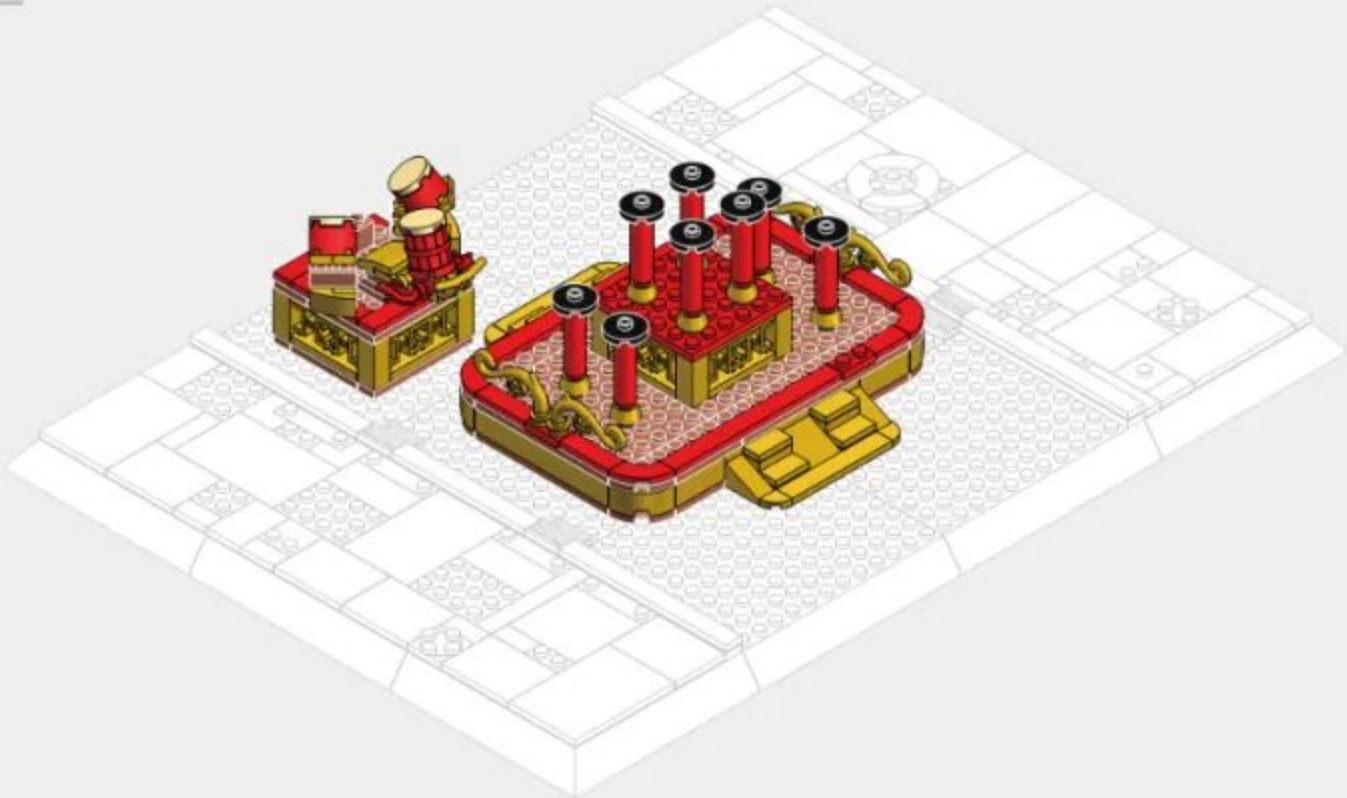

2-1

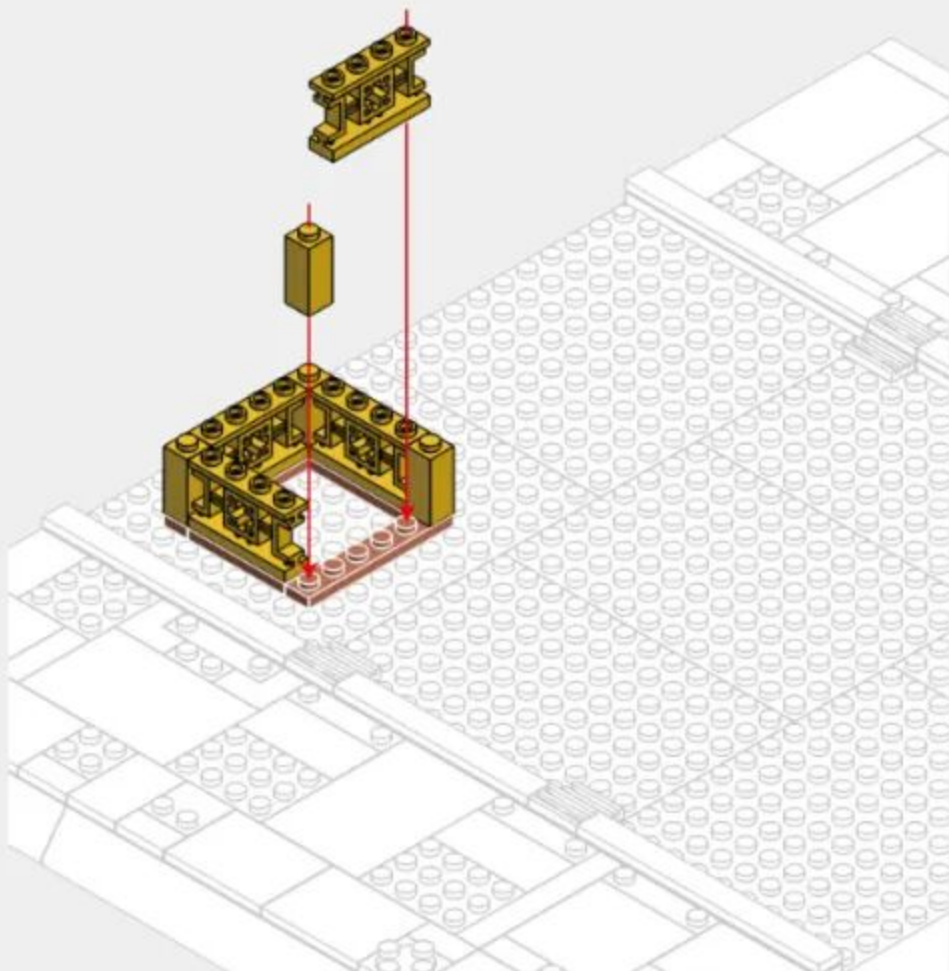

2-2

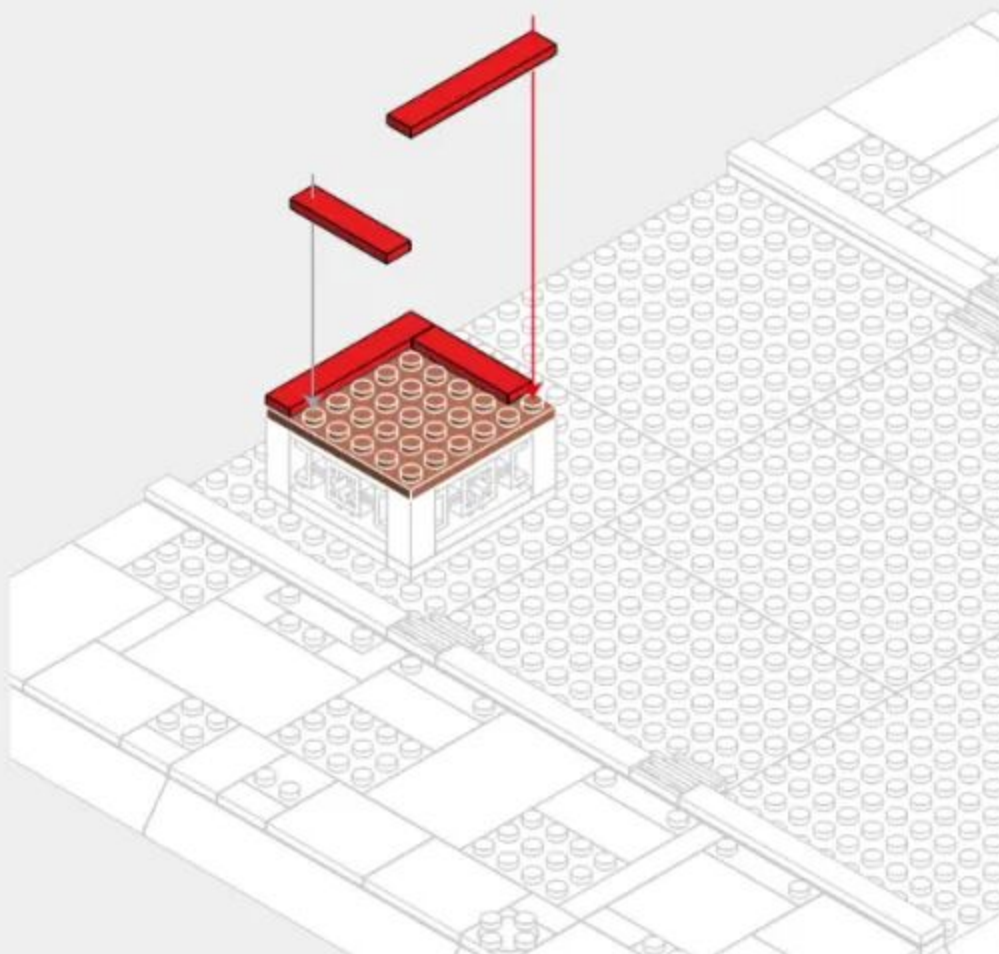
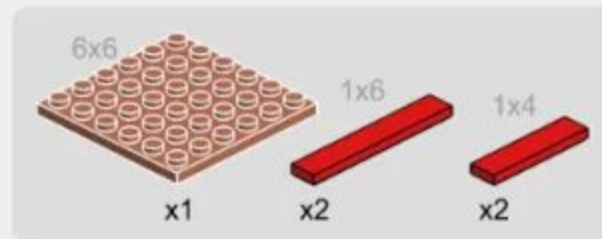

2-3

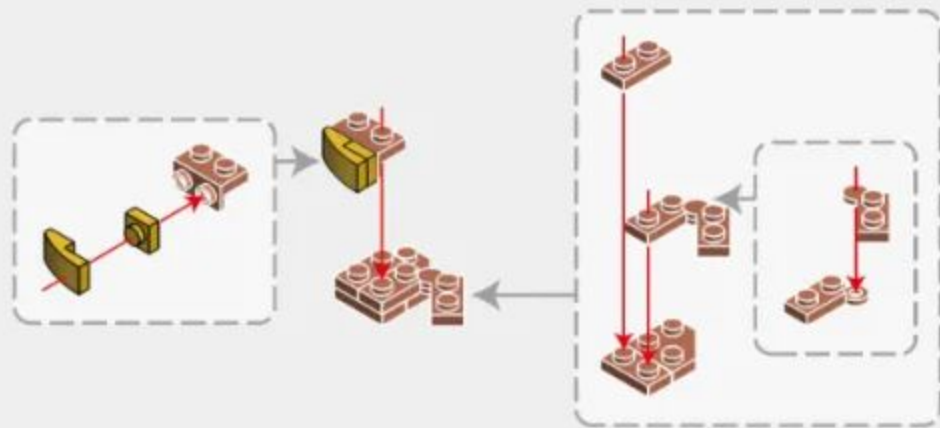

2-5

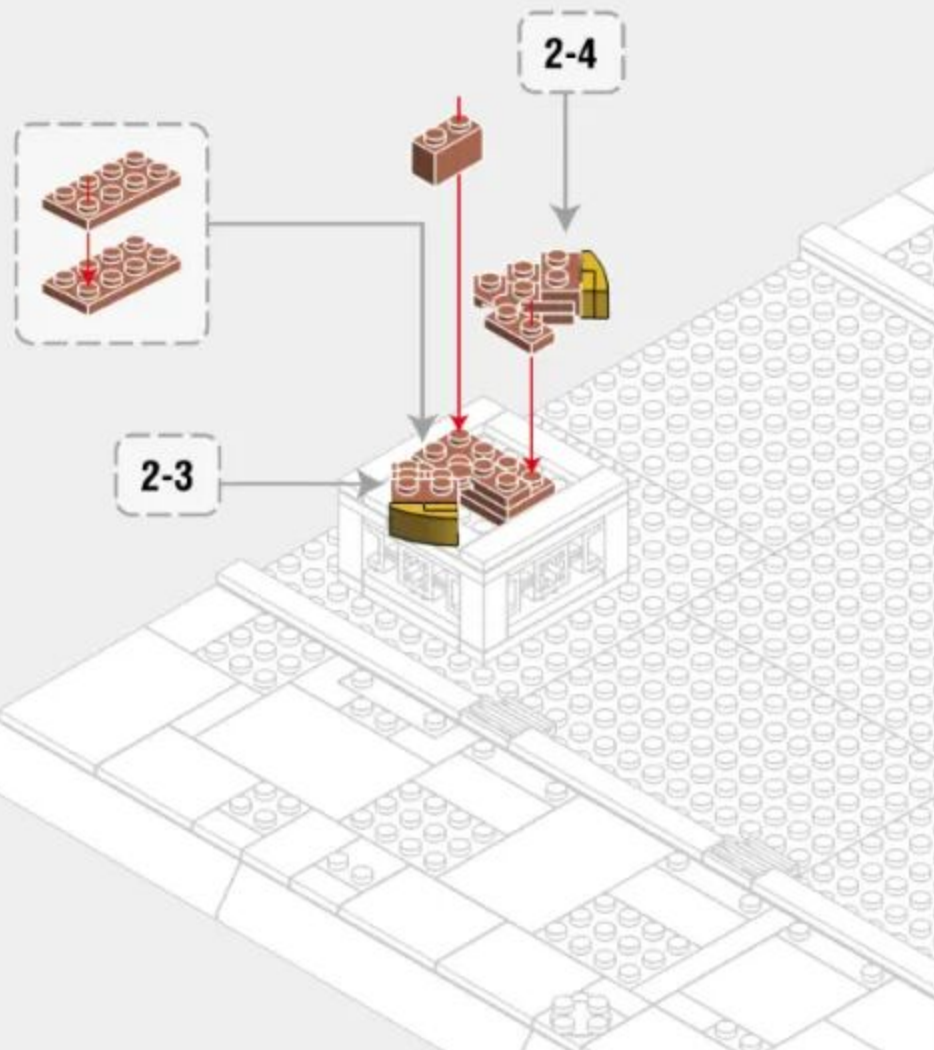

2-4

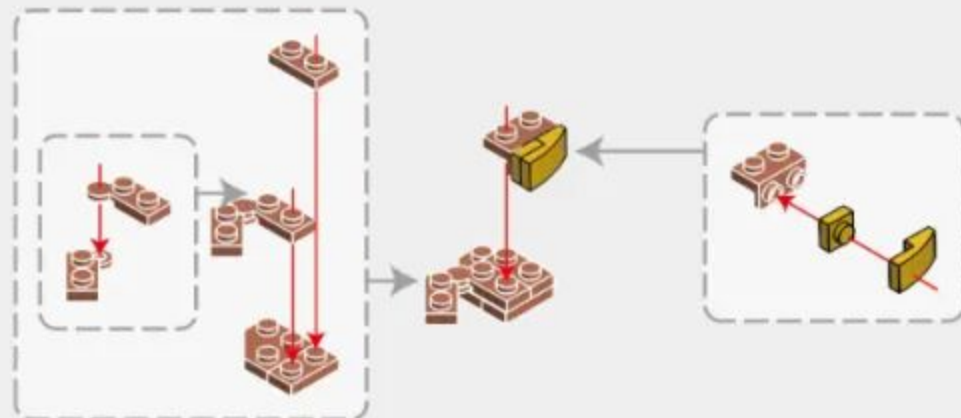



2-7

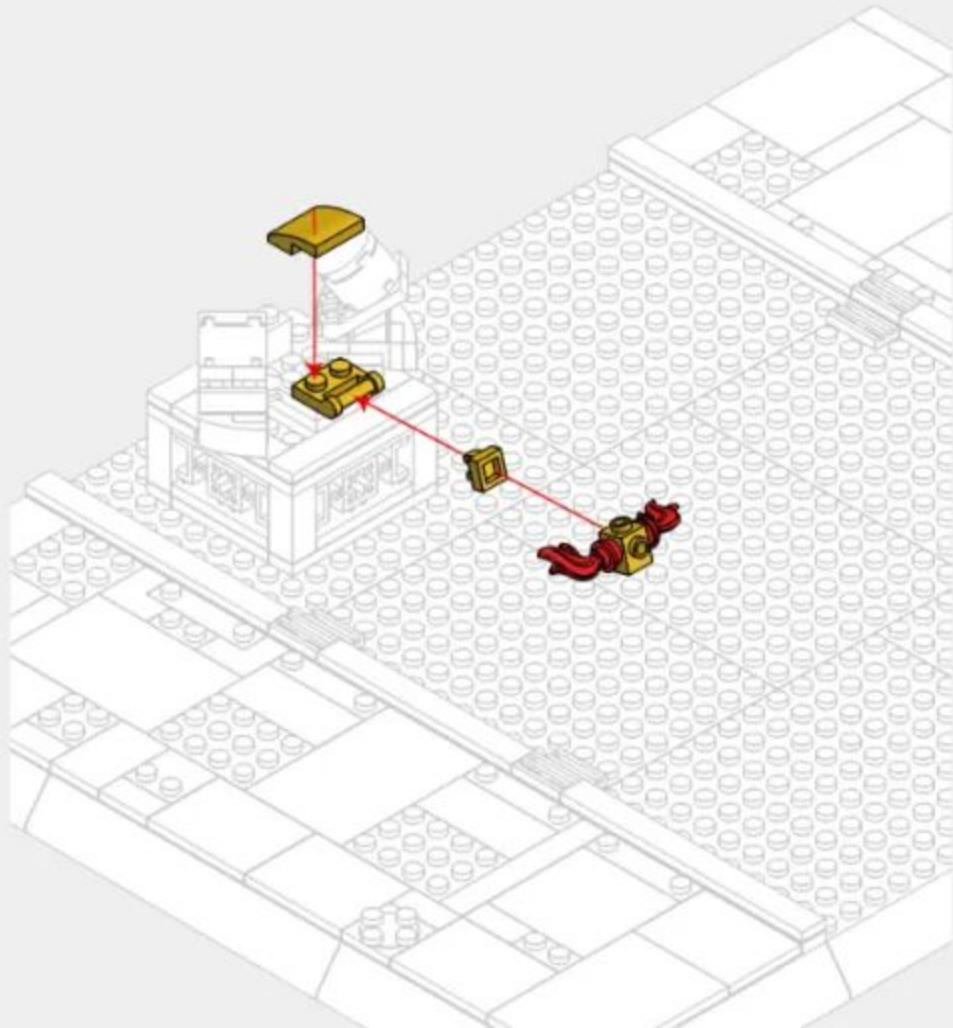
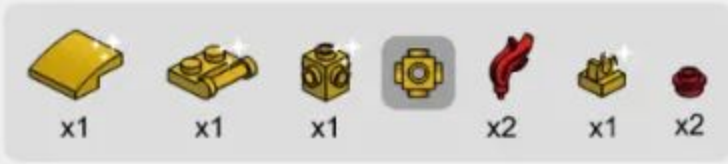

2-8

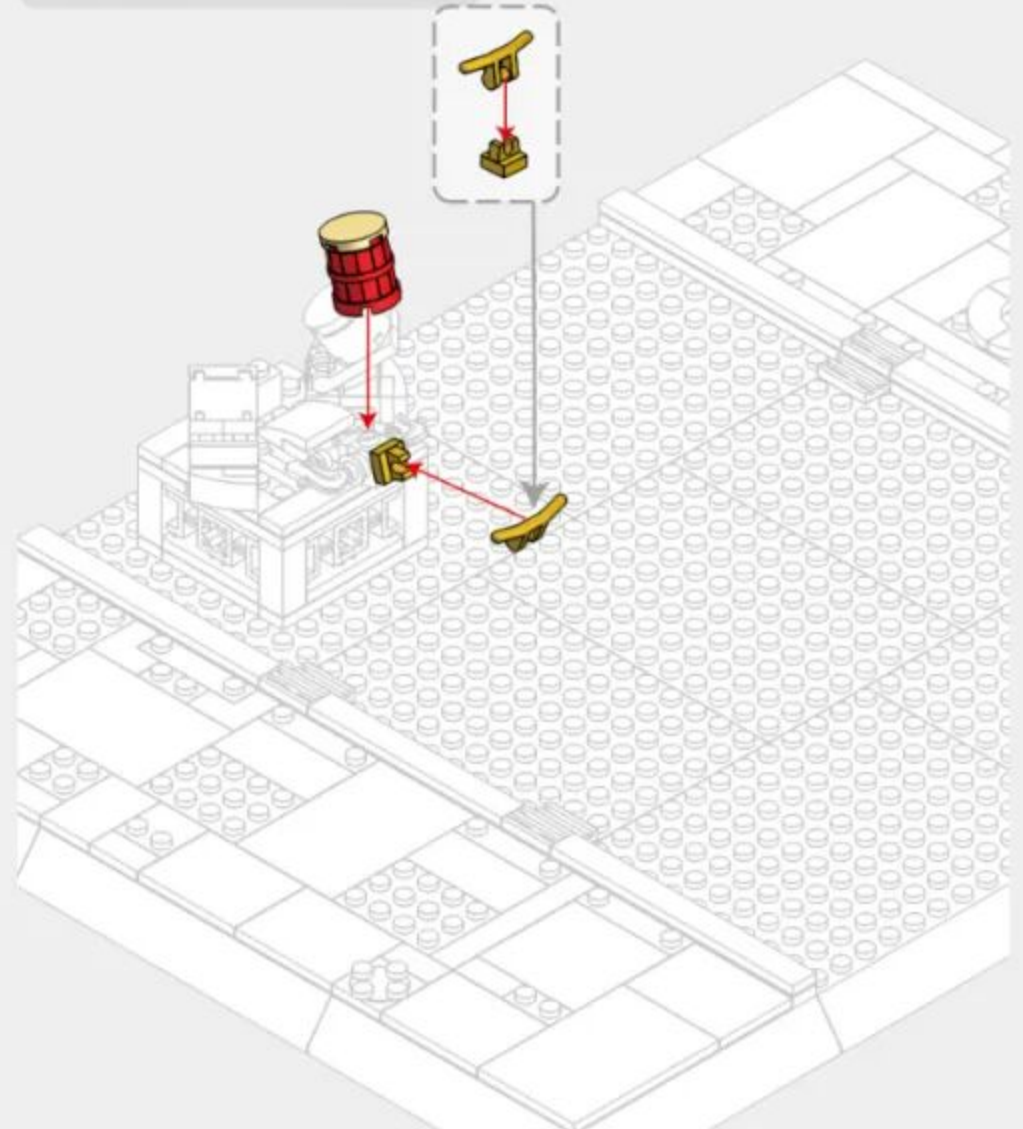

2-9

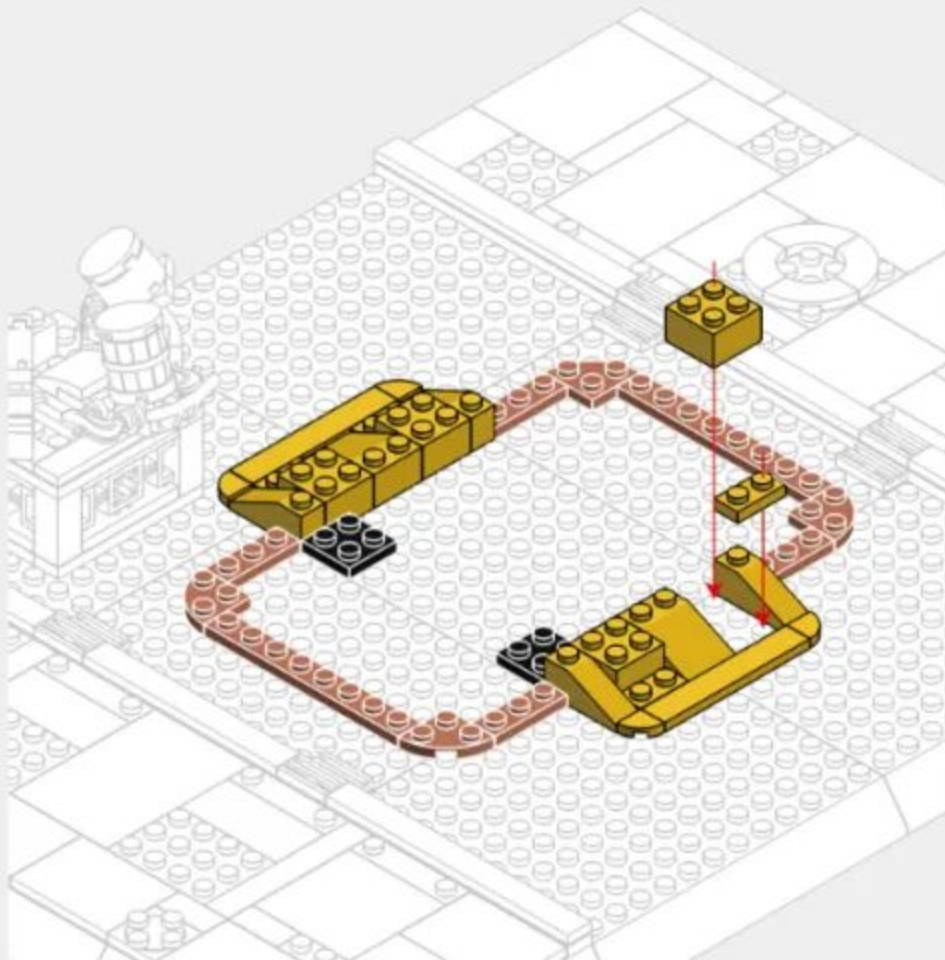

2-10

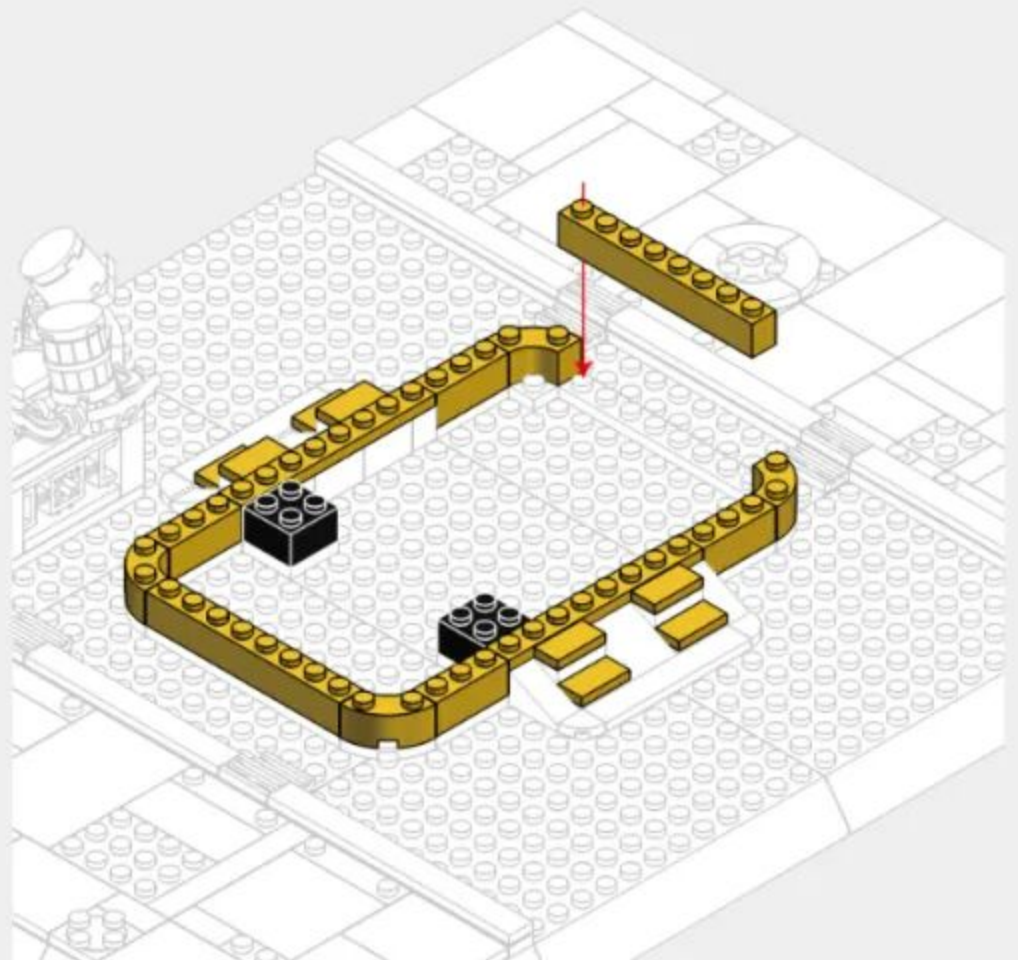
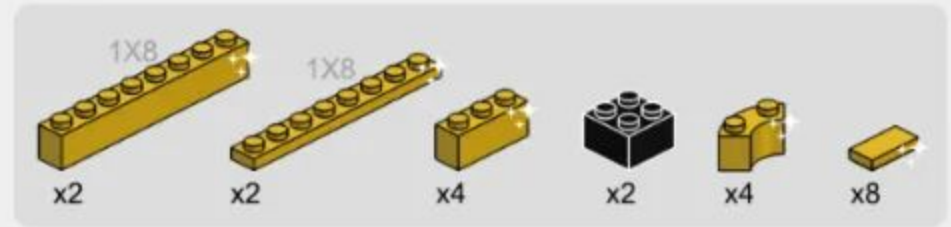

## 2-11

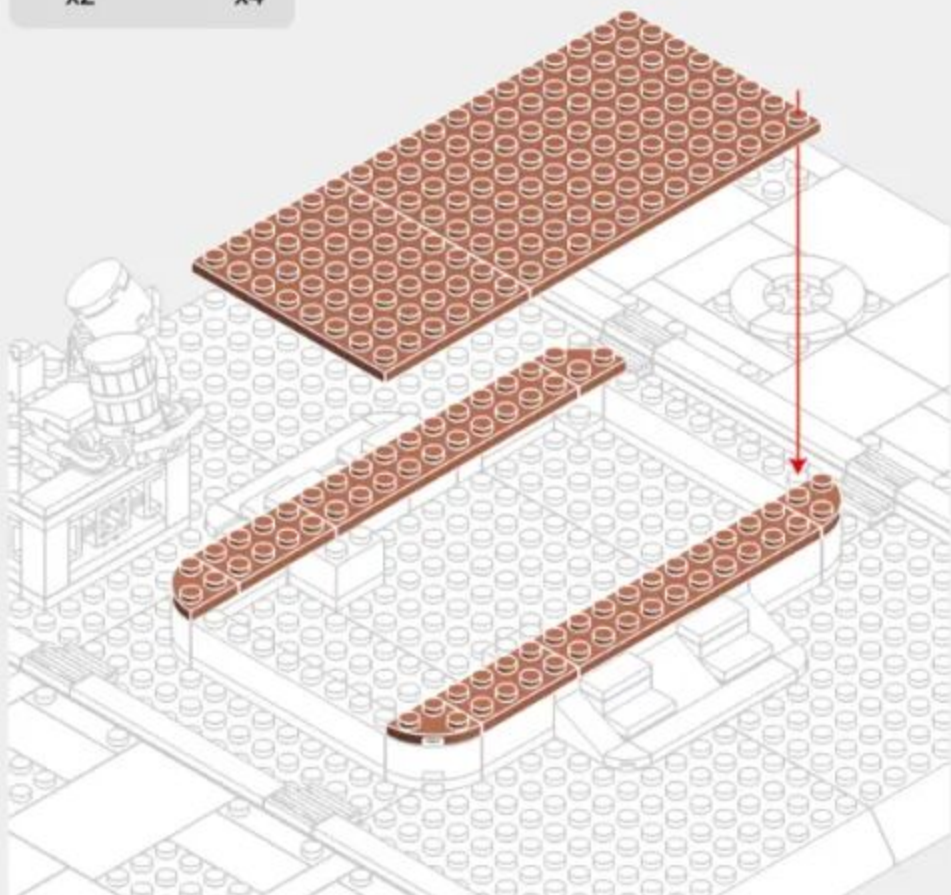
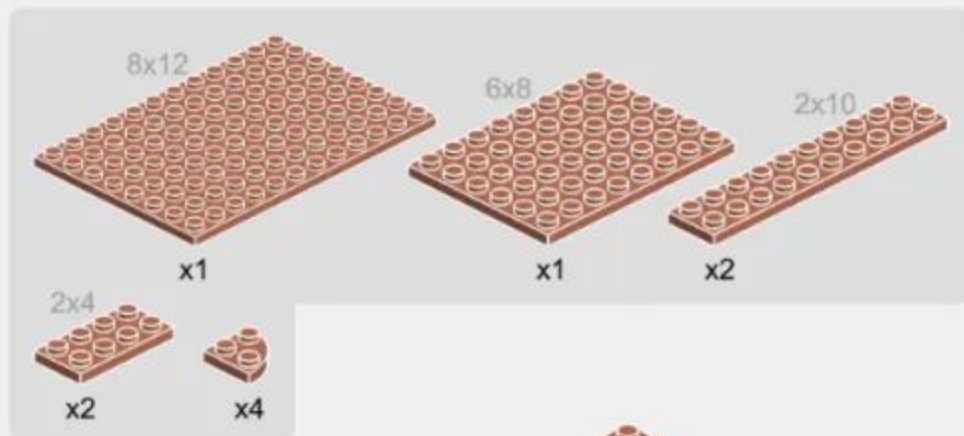

## 2-12

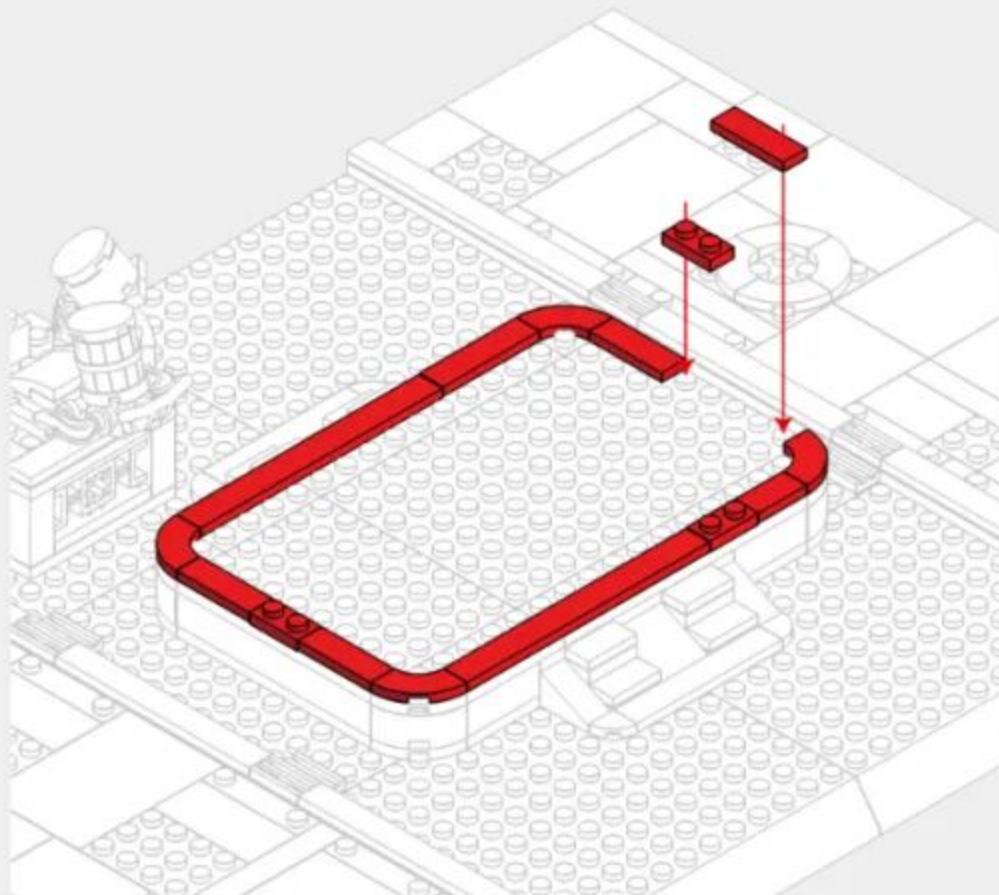
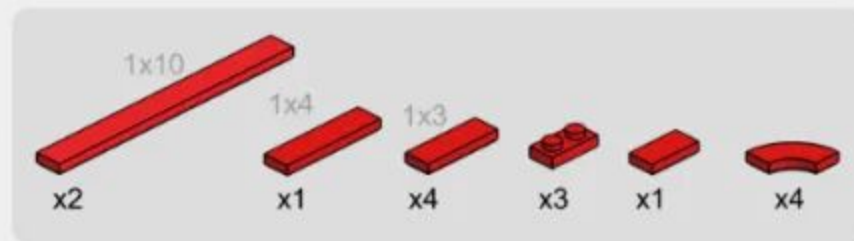

2-13

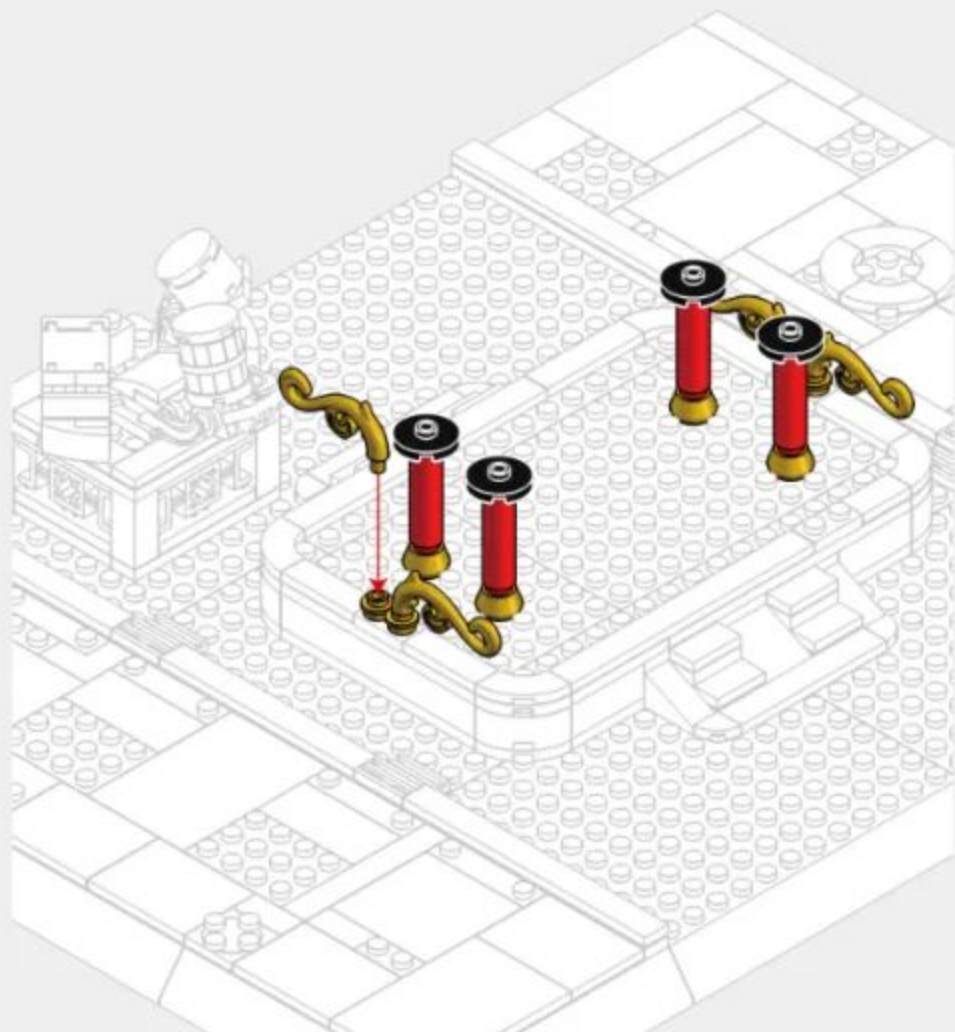

2-14

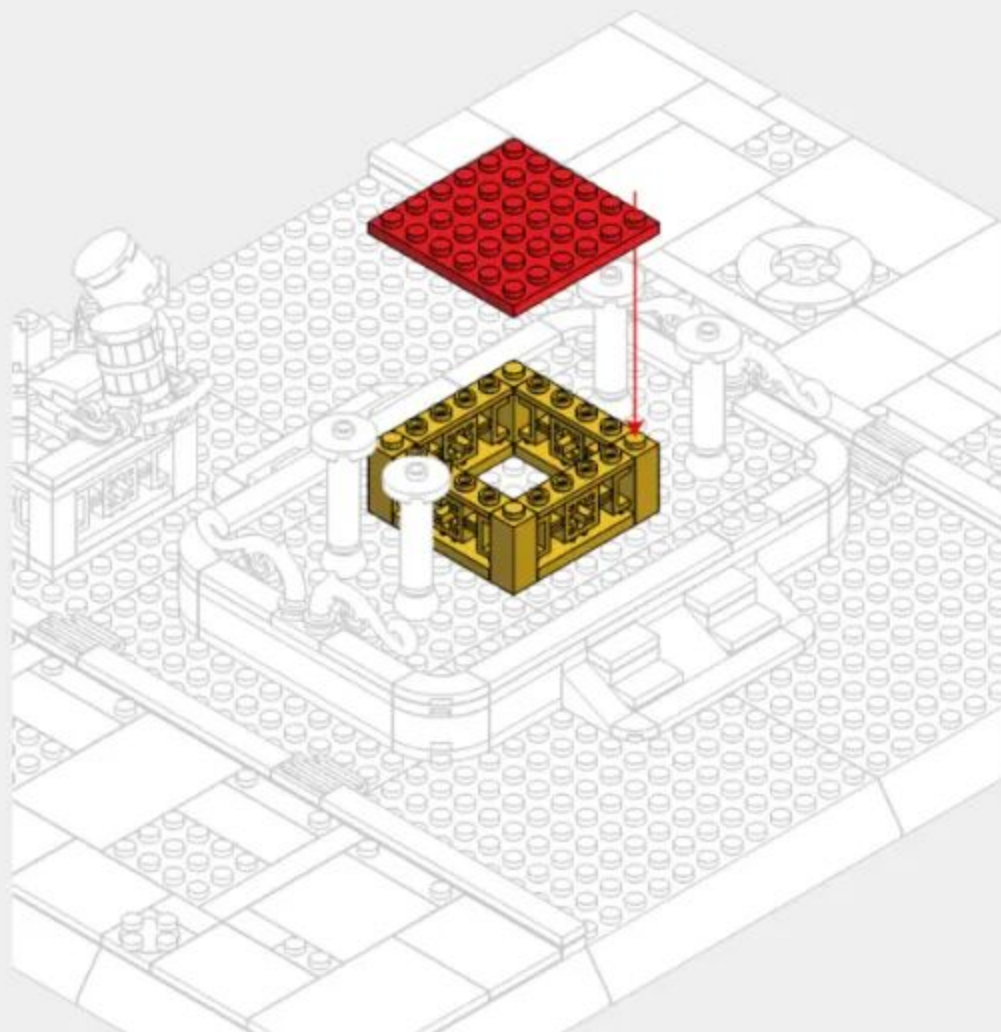
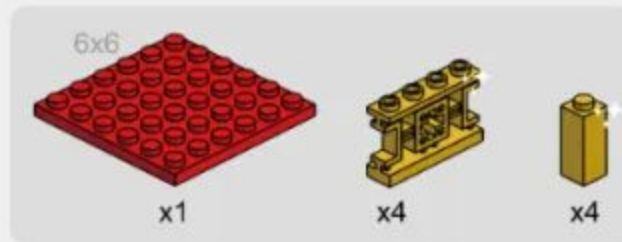

2-15



x4



x4



x4

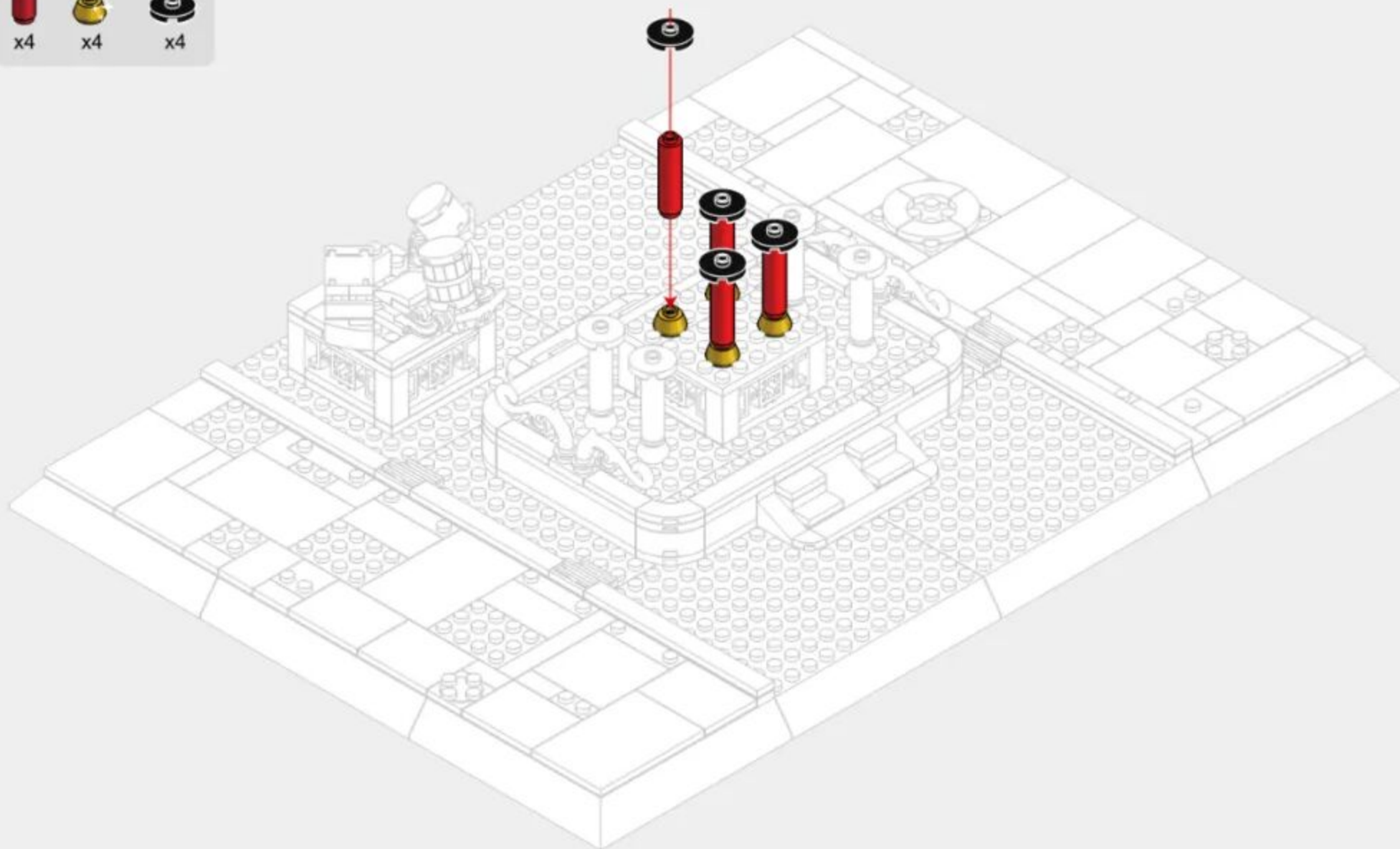



277 PCS

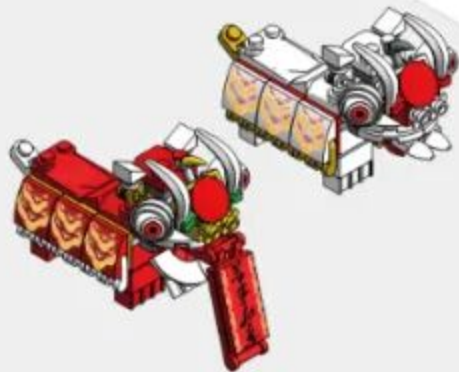

38

3-1

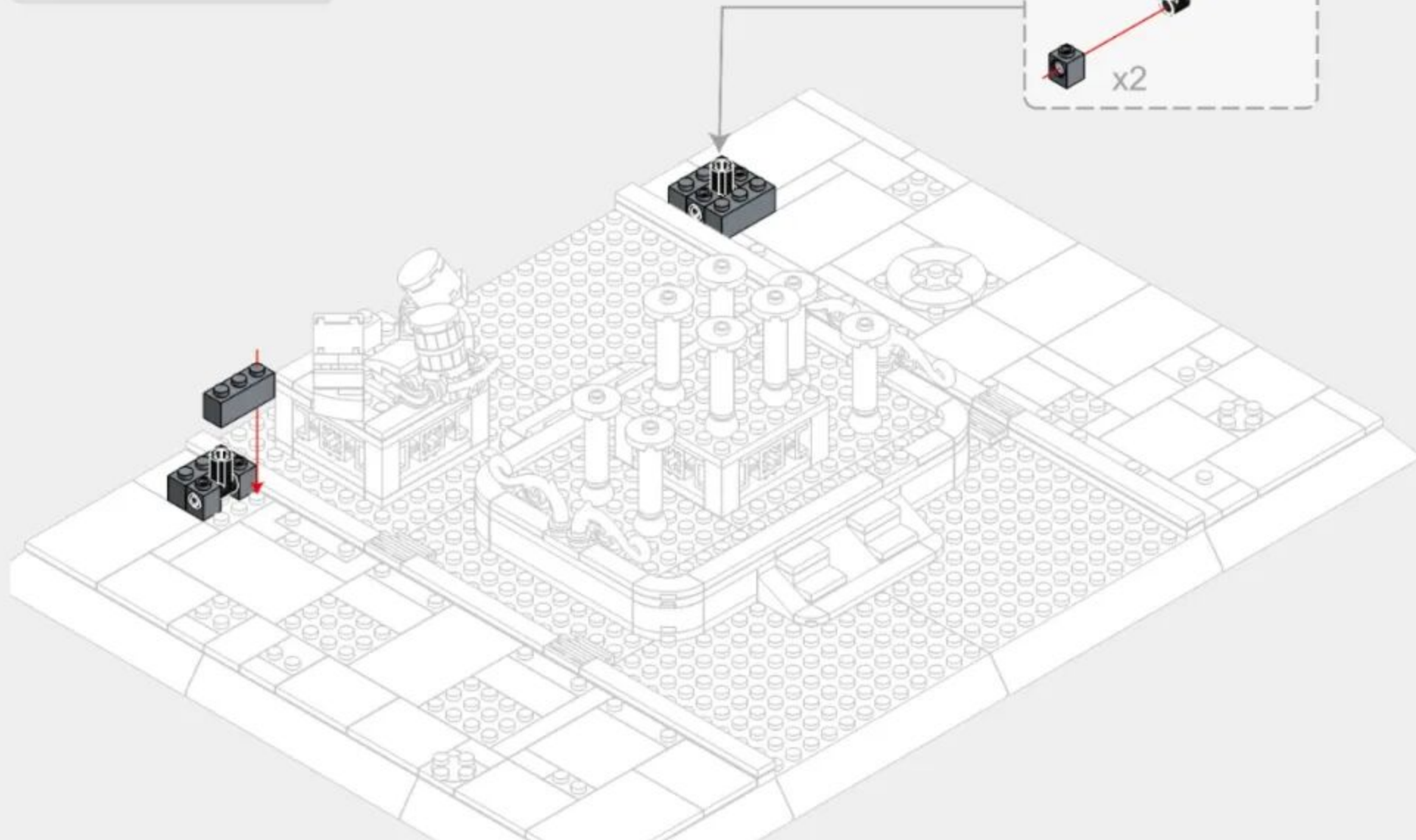
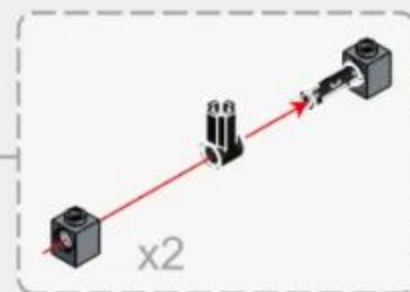

3-2

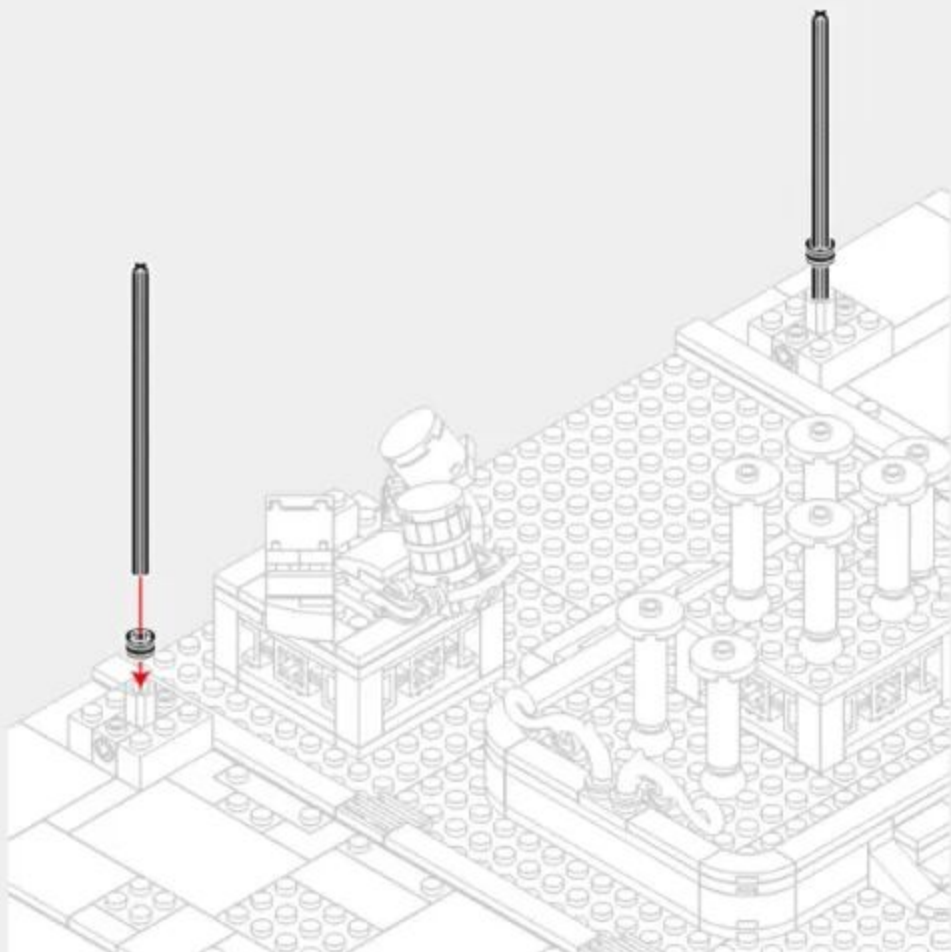

3-3

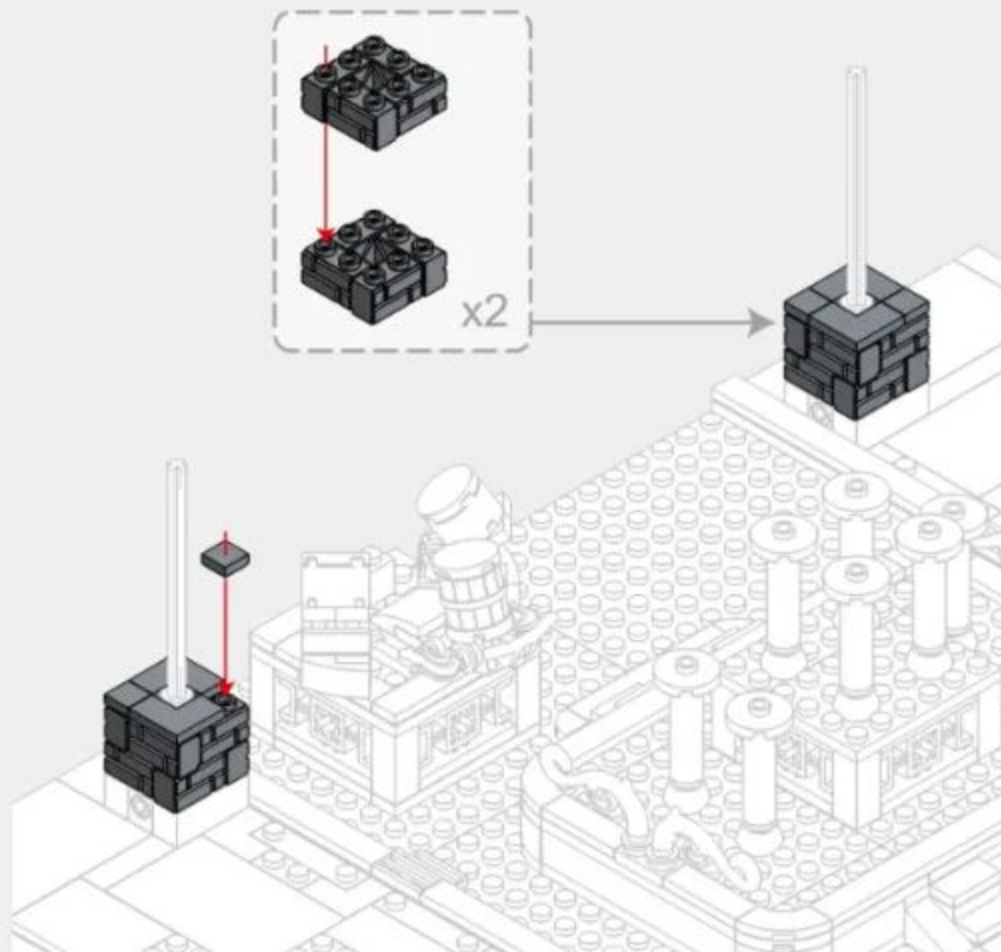
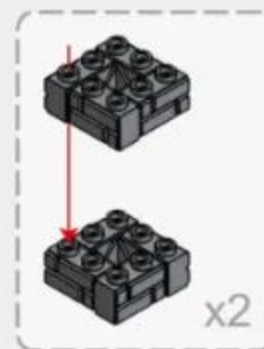





3-7

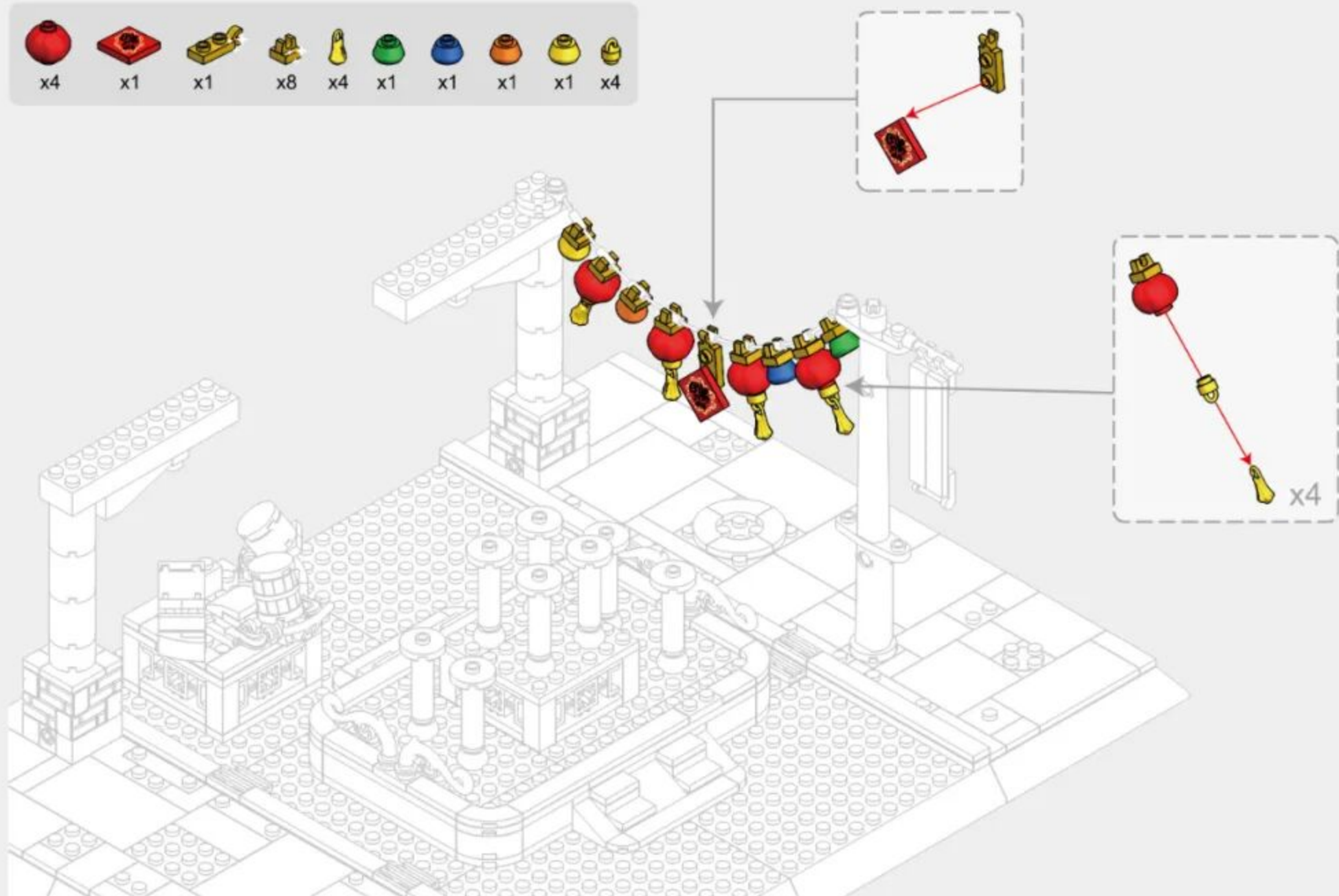
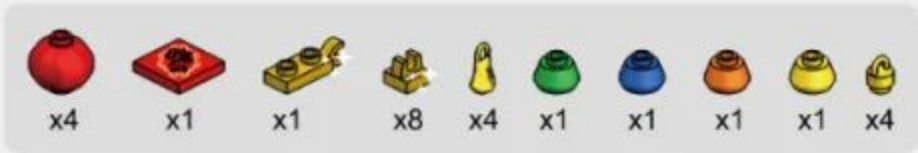

3-8

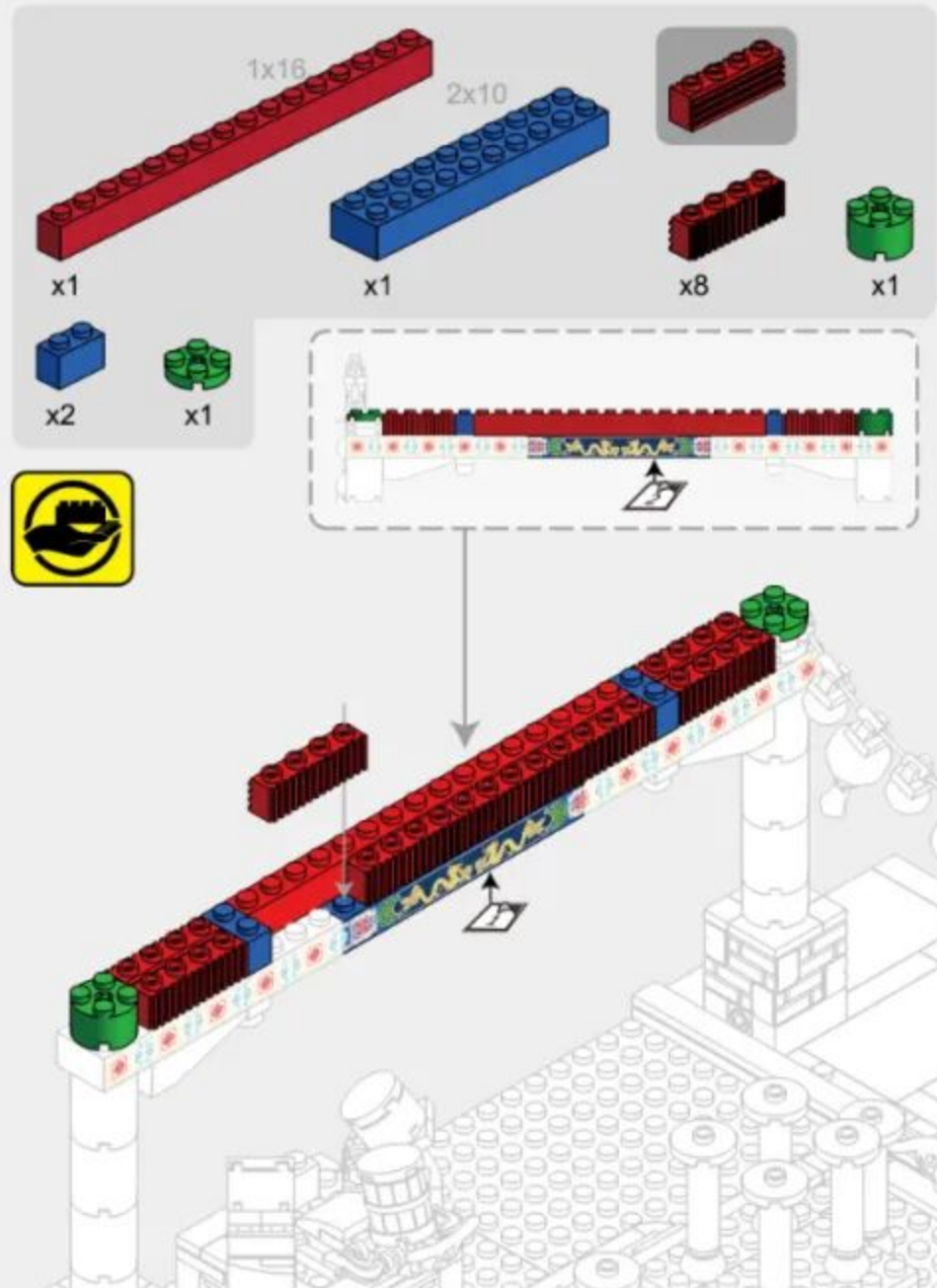

3-9

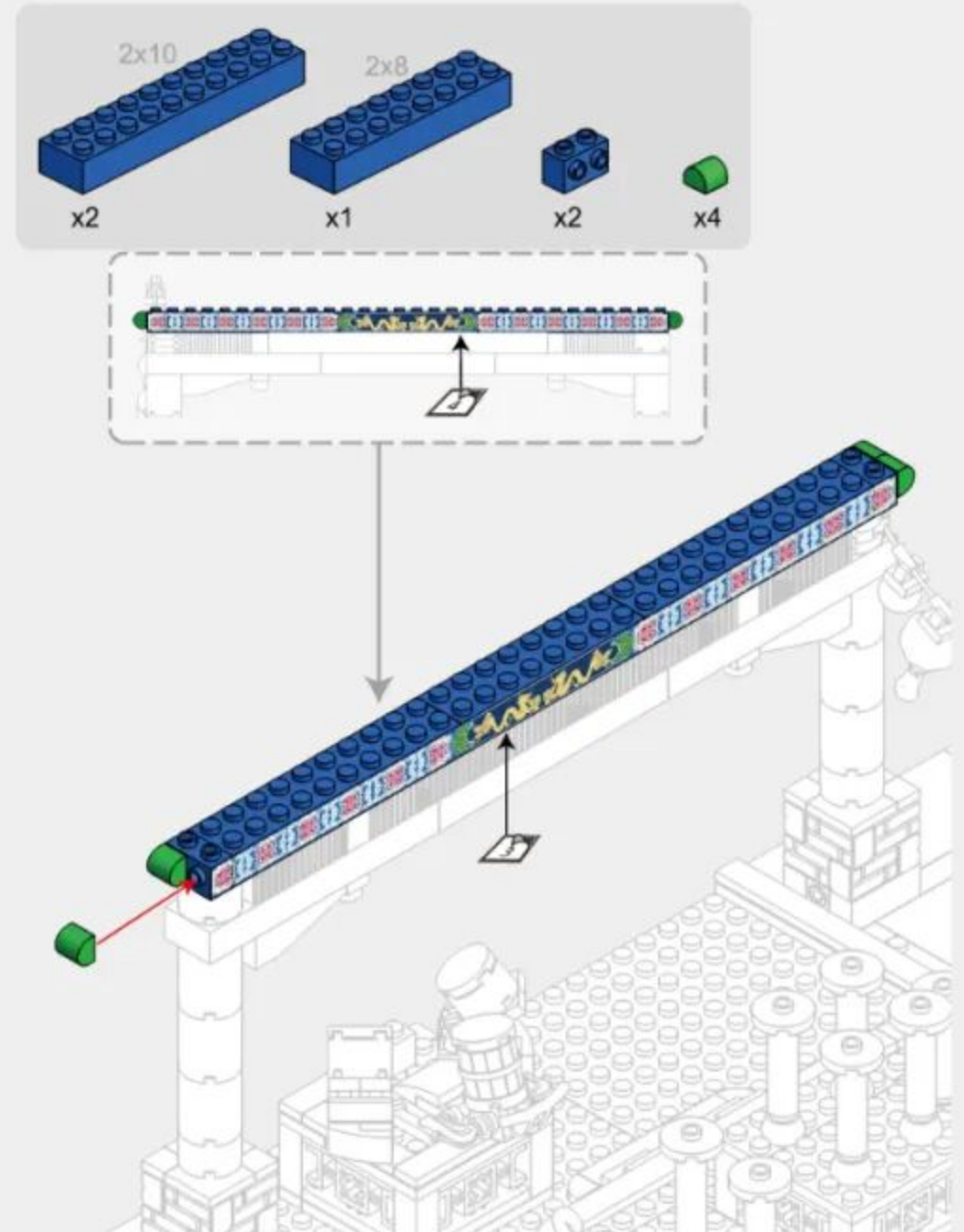



# 3-11

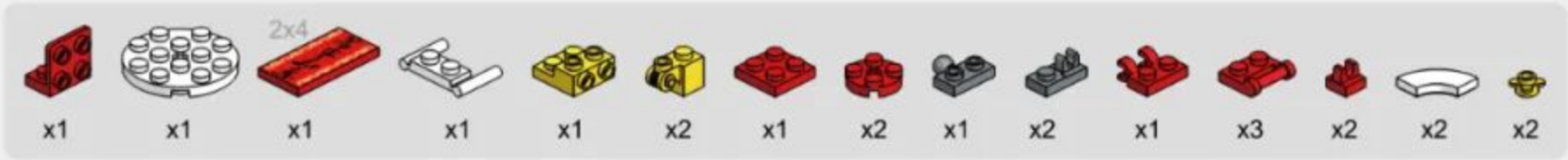

1

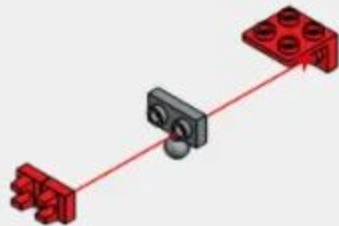

2



3

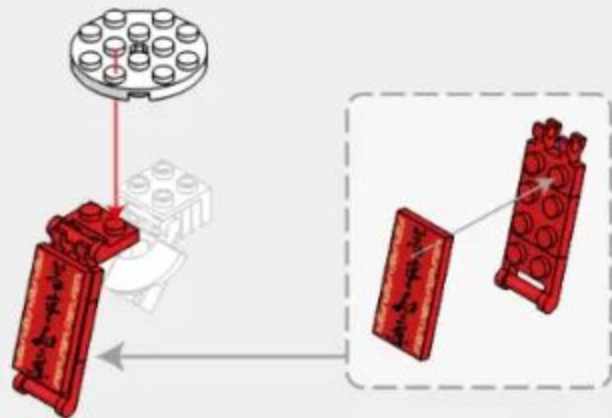

4

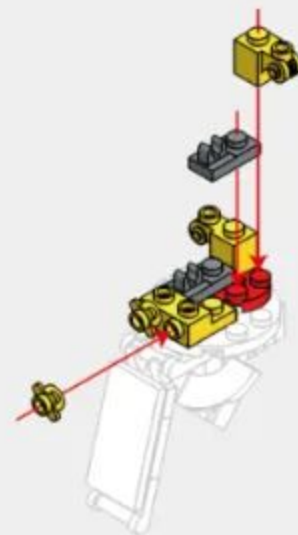

# 3-12

-  x1
-  x1
-  x2
-  x2
-  x2
-  x1
-  x1
-  x2
-  x1
-  x1
-  x2
-  x2
-  x2

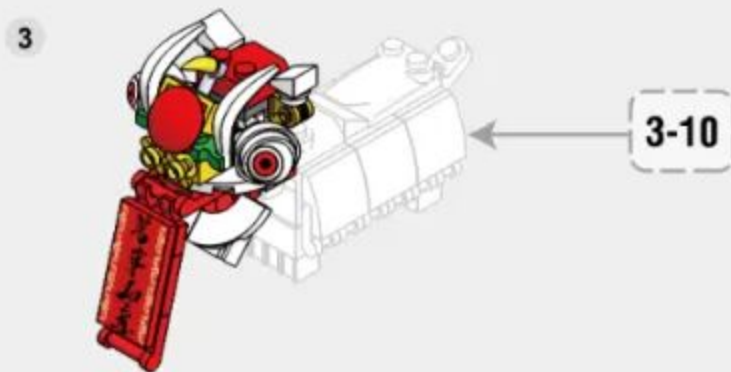
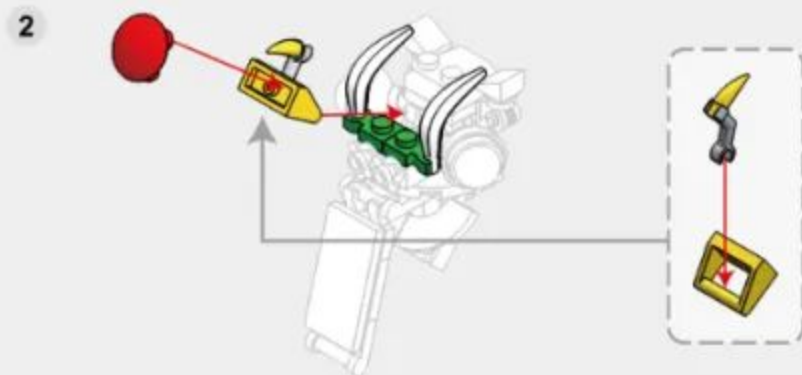
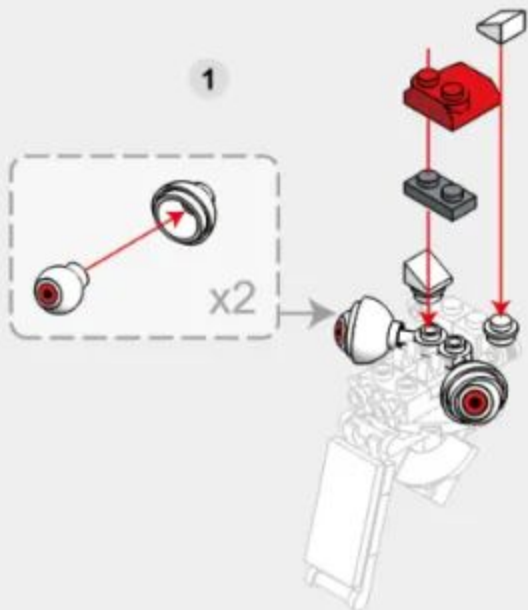

### 3-13

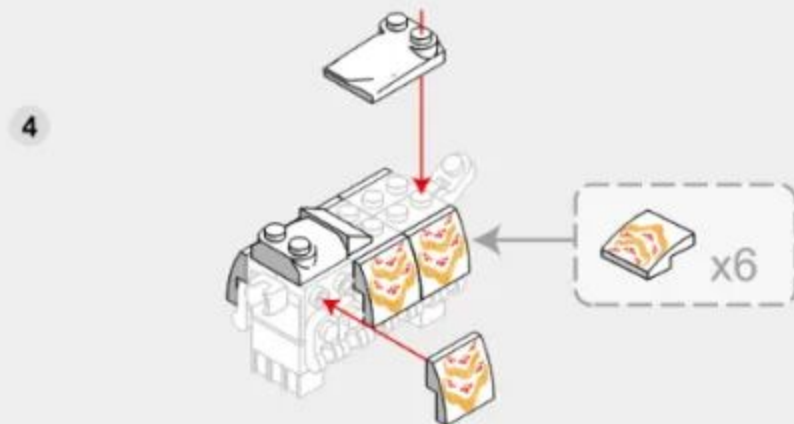
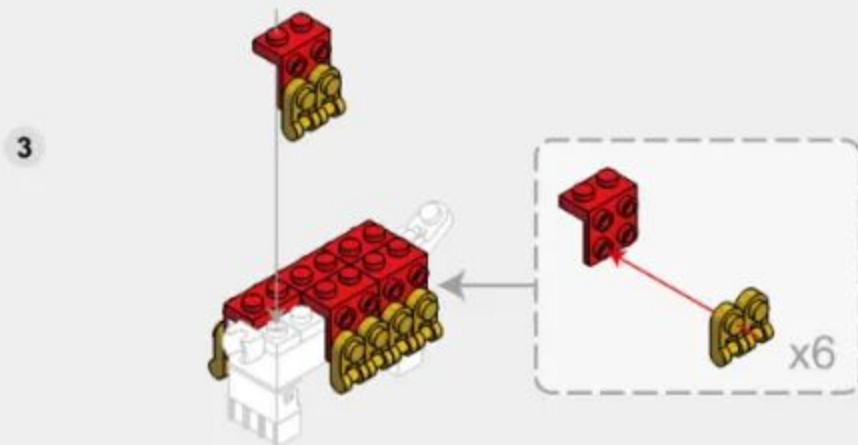
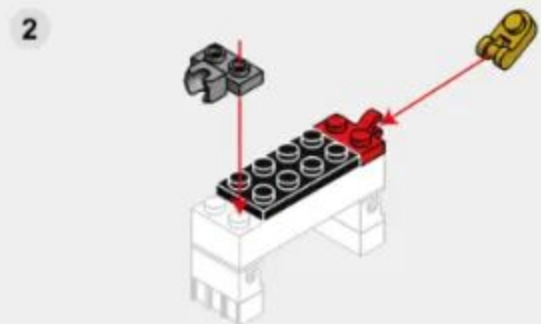
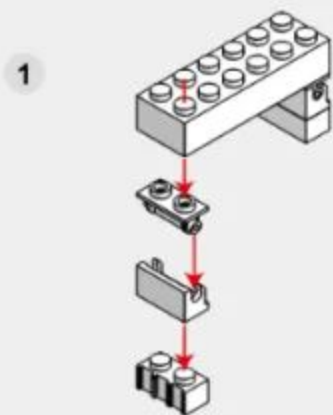

# 3-14

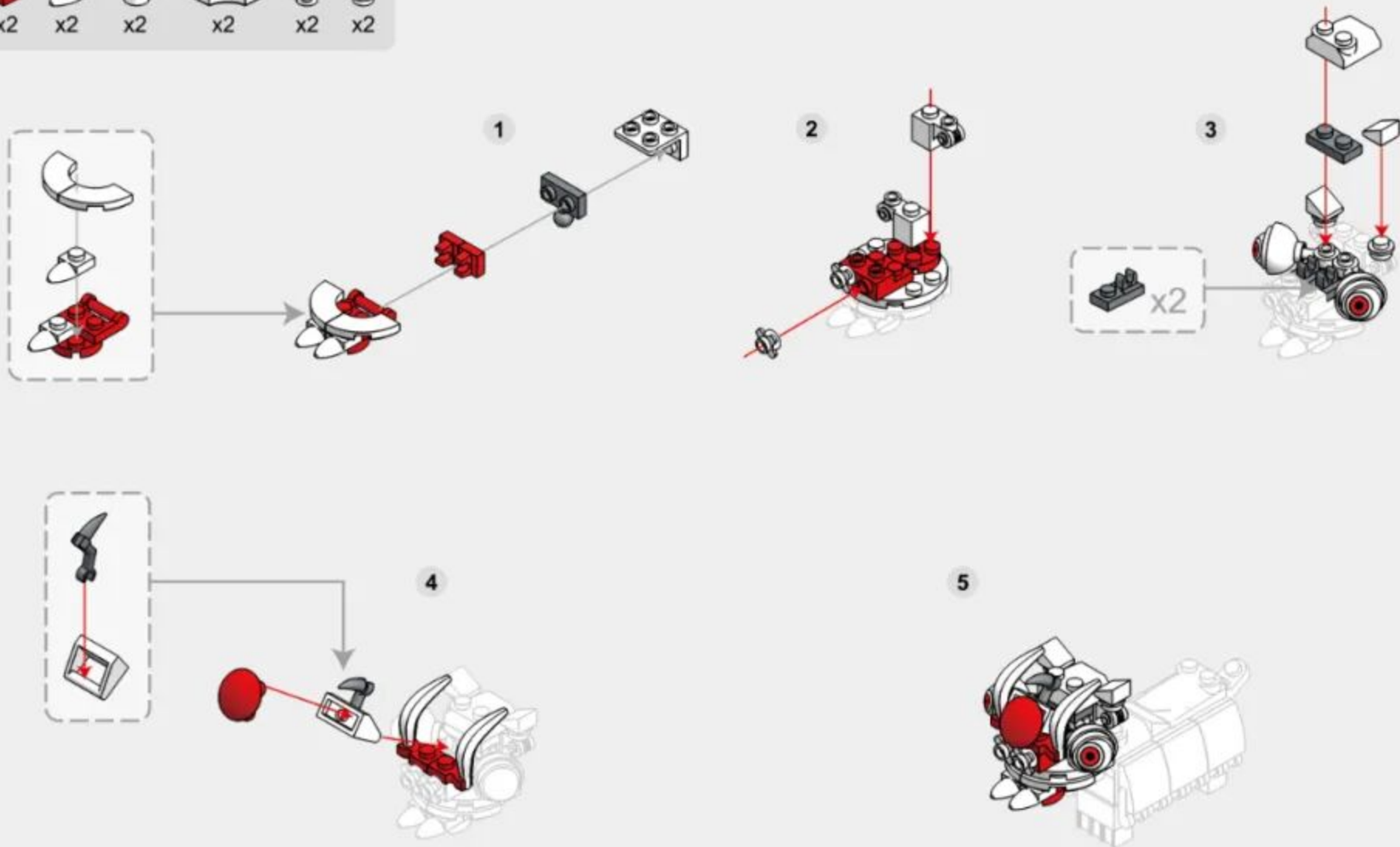



287 PCS

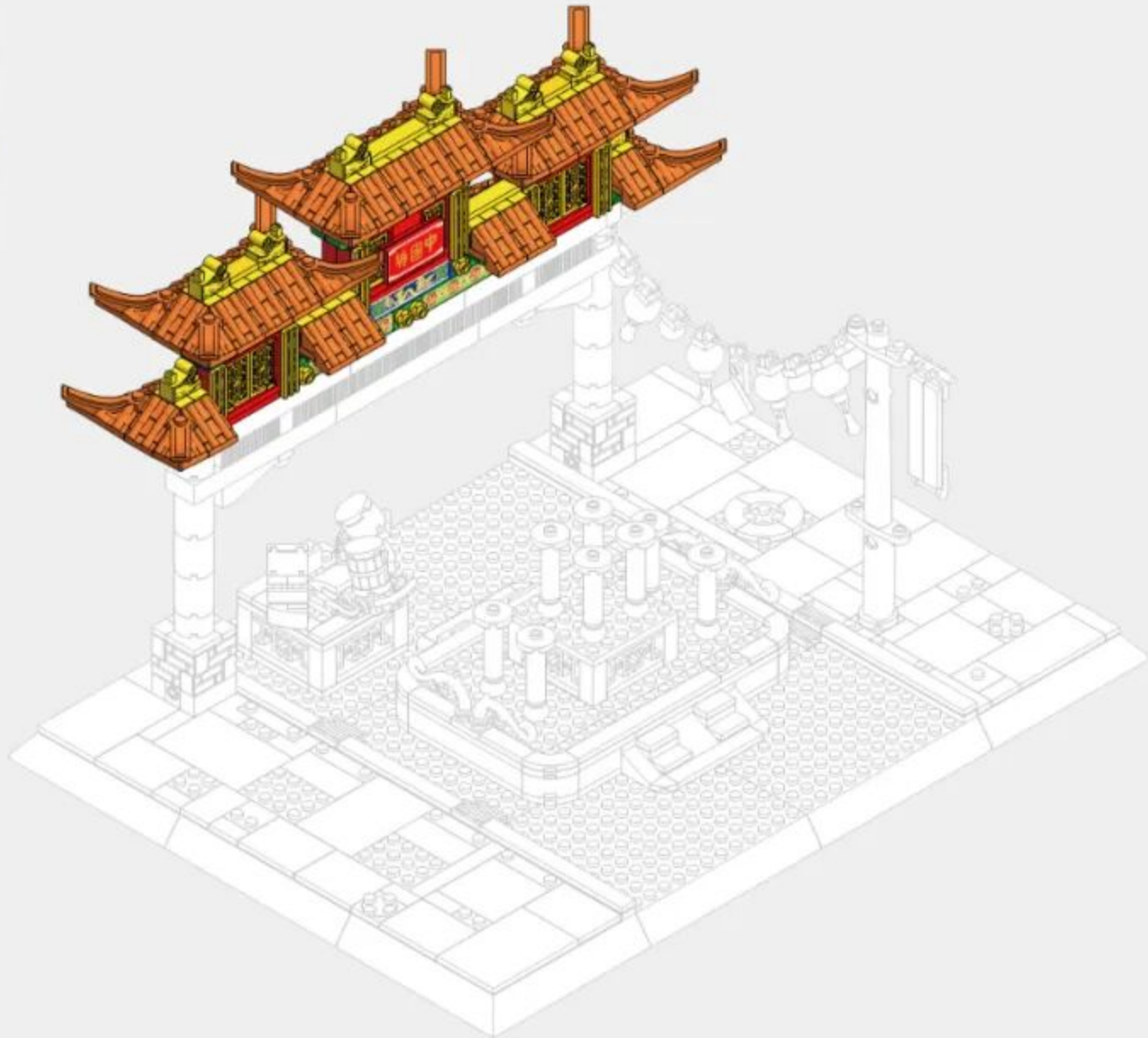

50

4-1

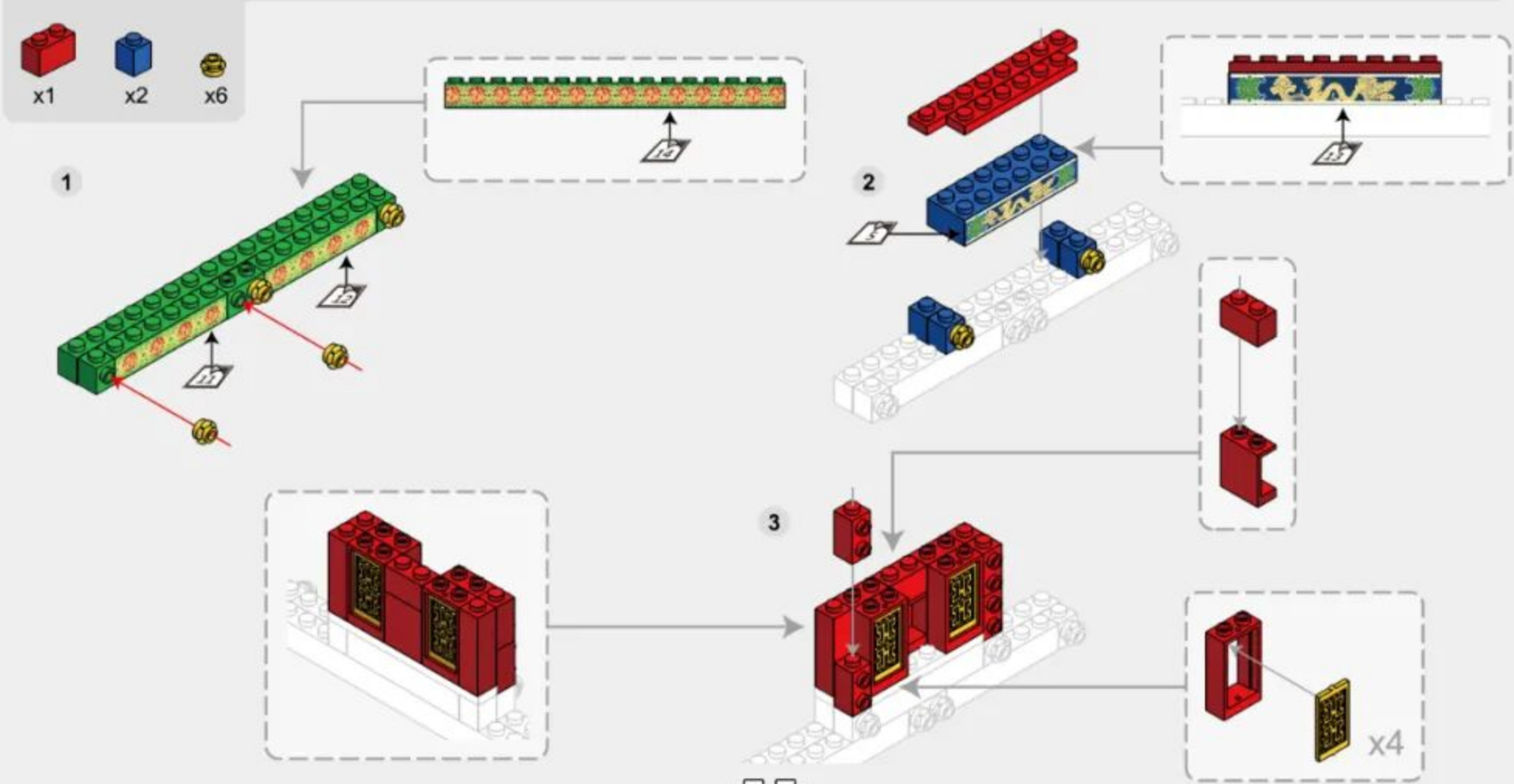
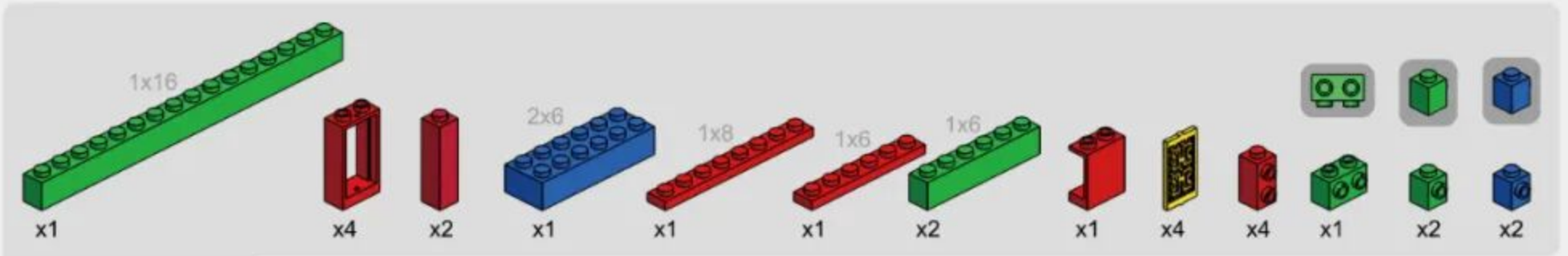

# 4-2

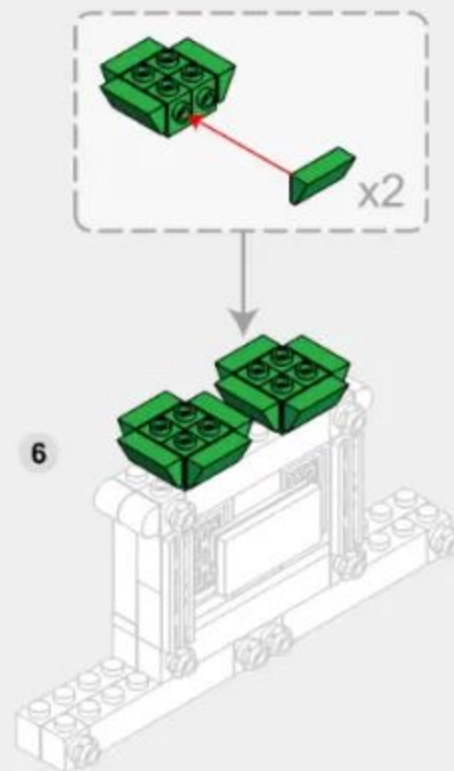
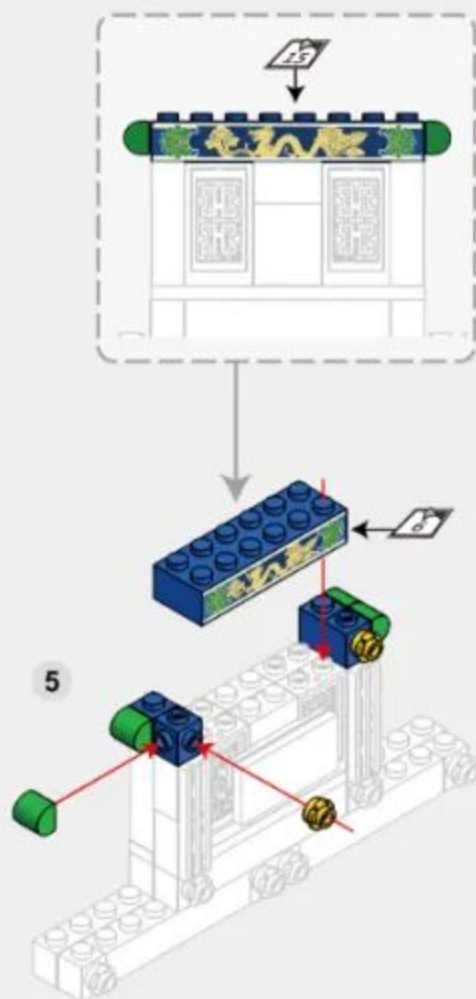
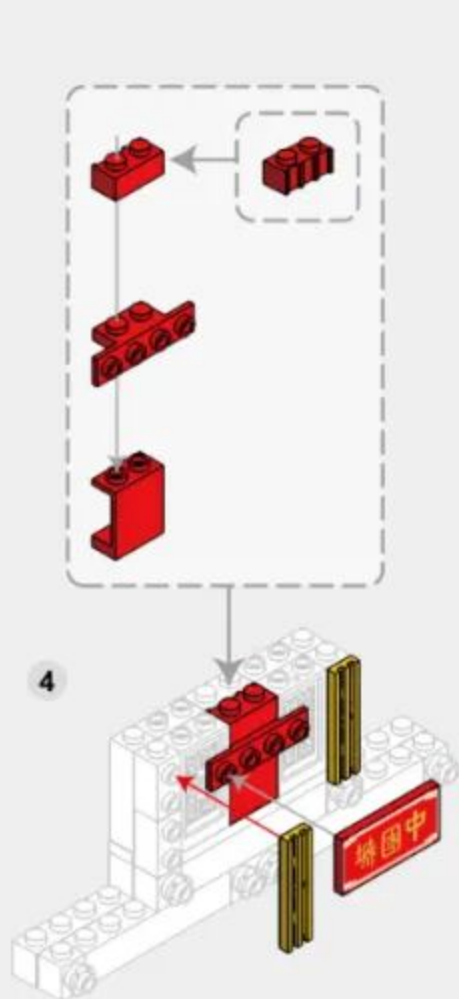

# 4-3

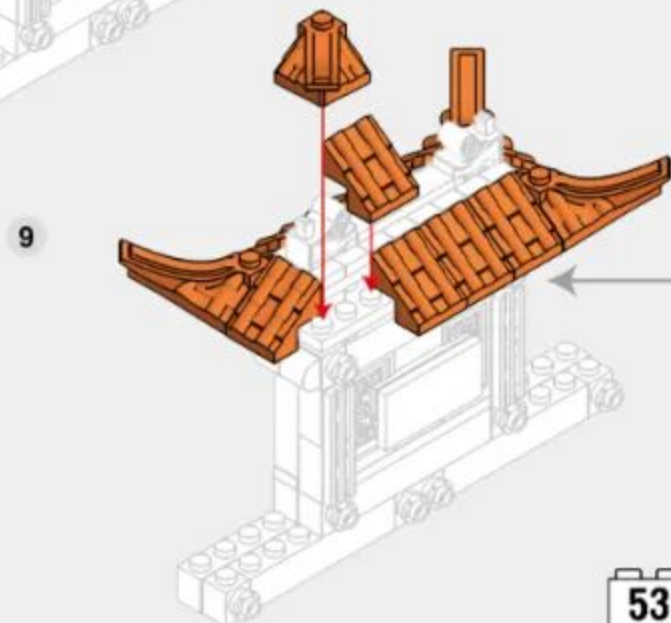
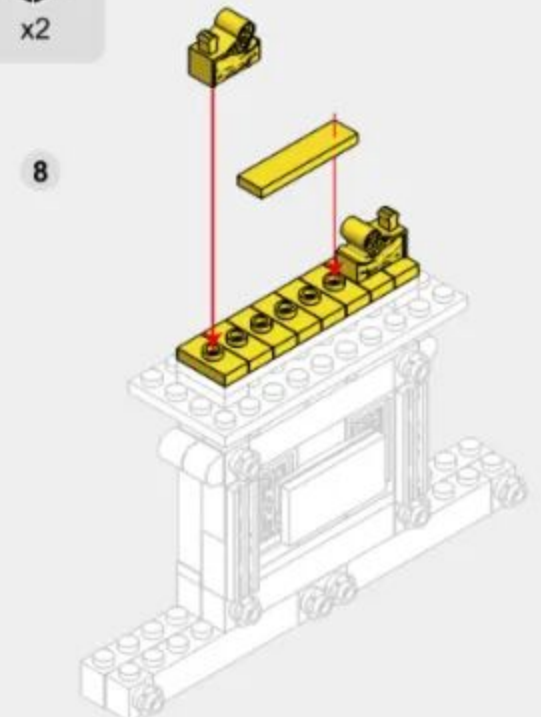
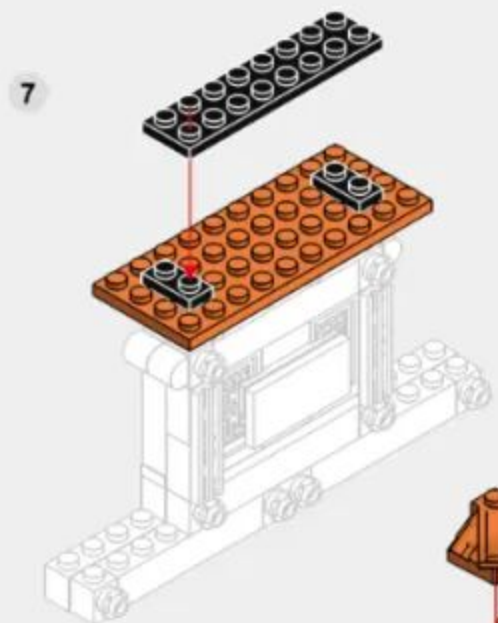

4-4

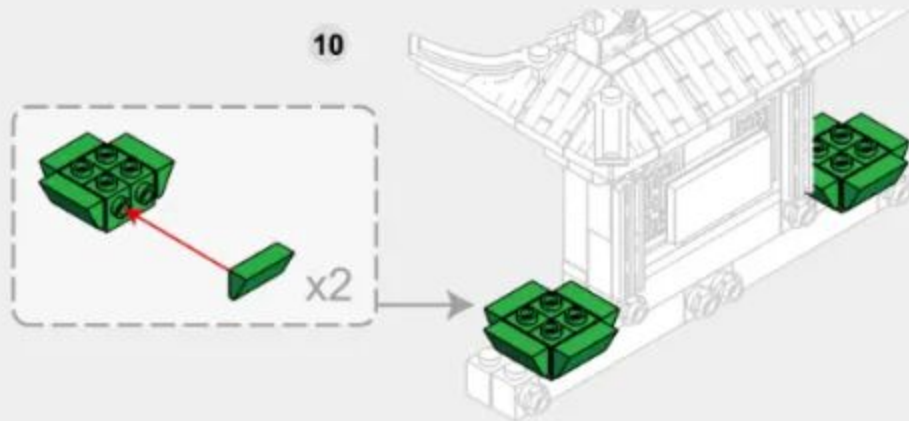
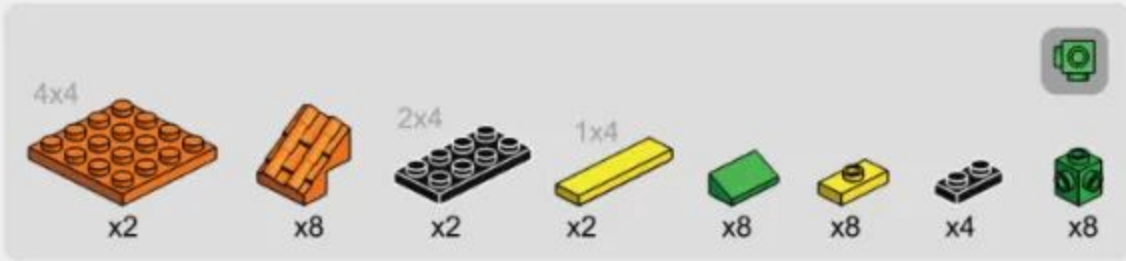

11

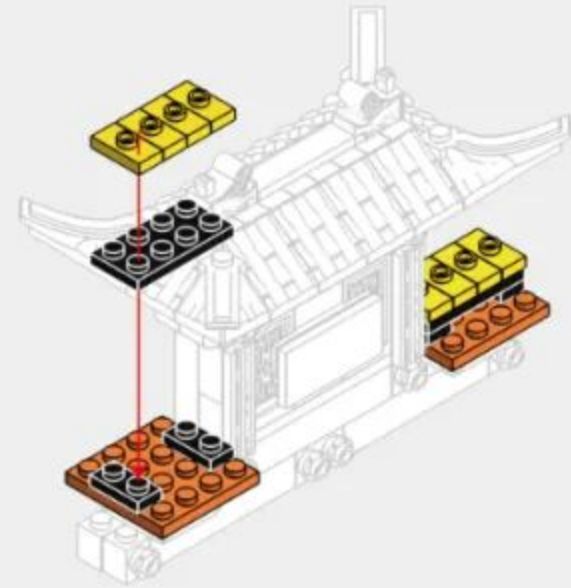

12

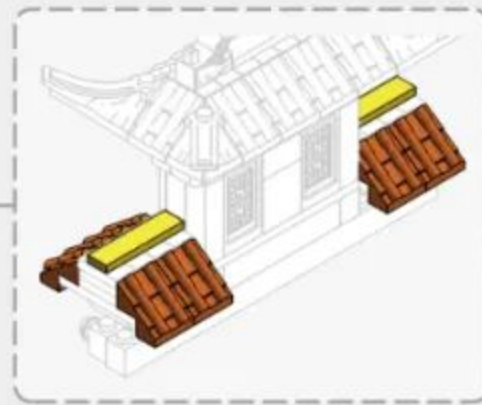
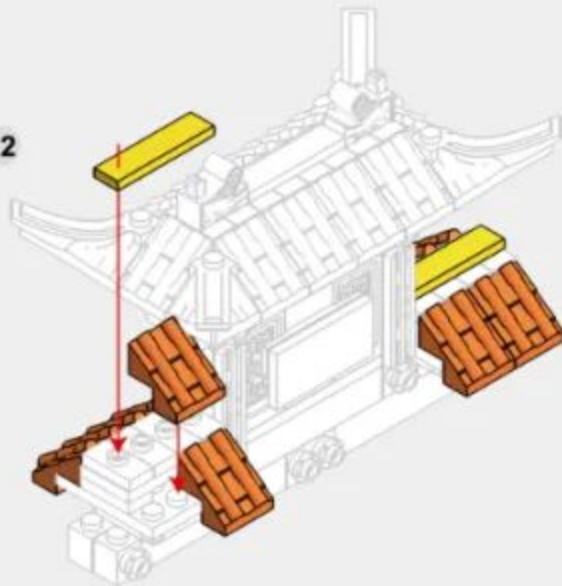

4-5

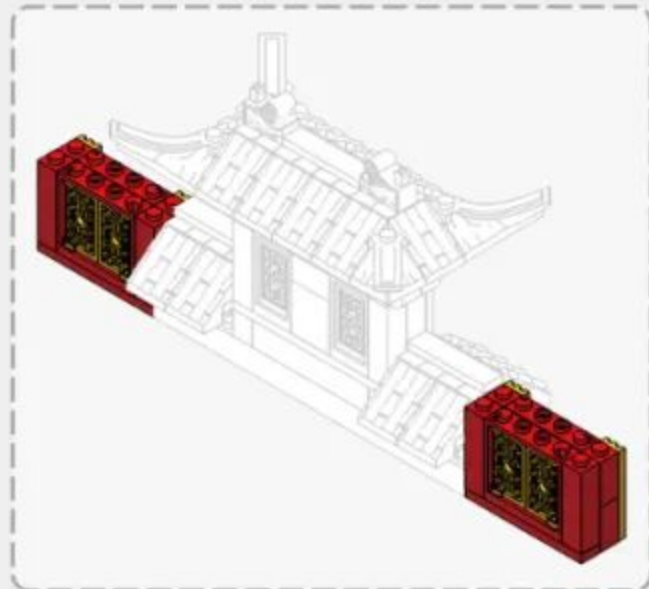
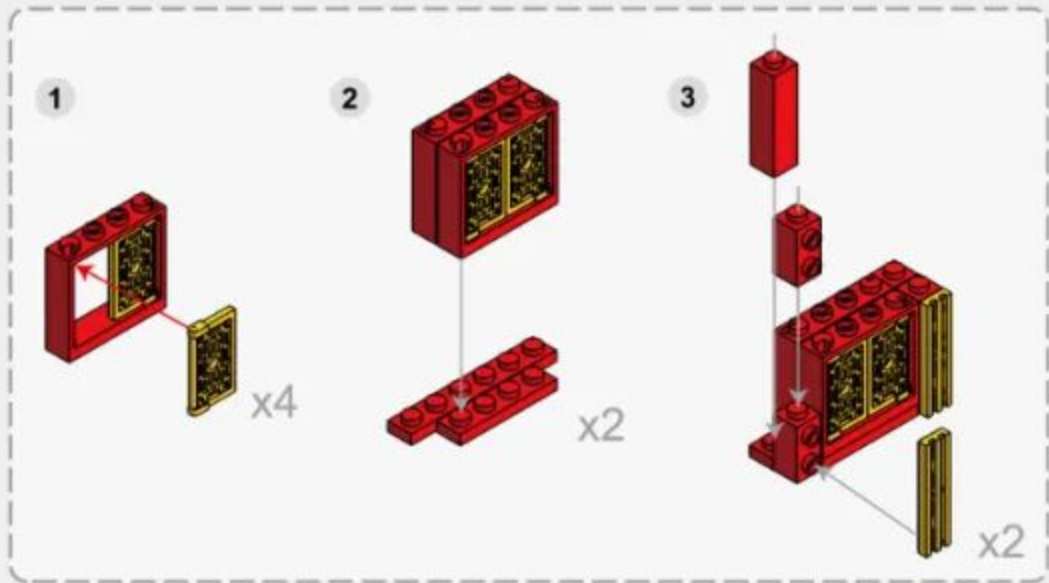
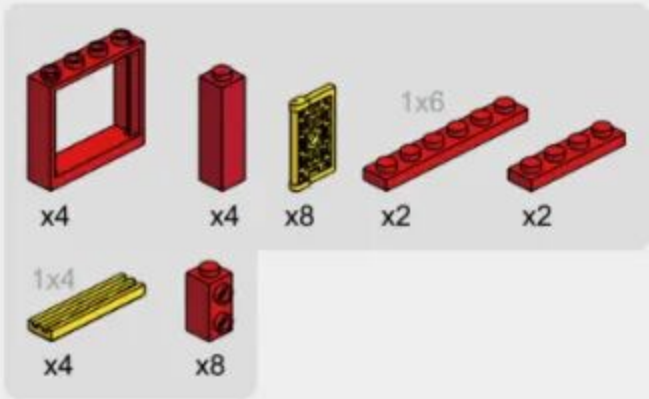

13

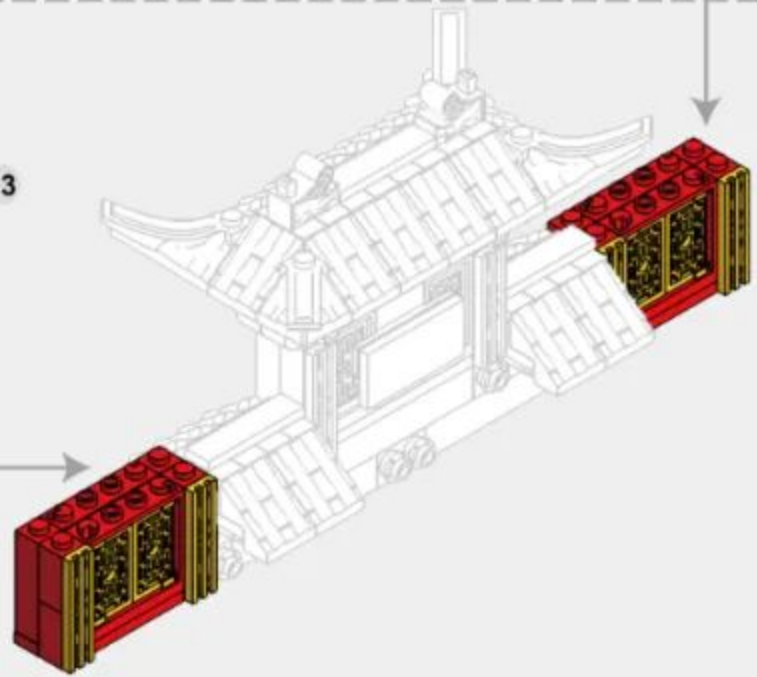



4-7

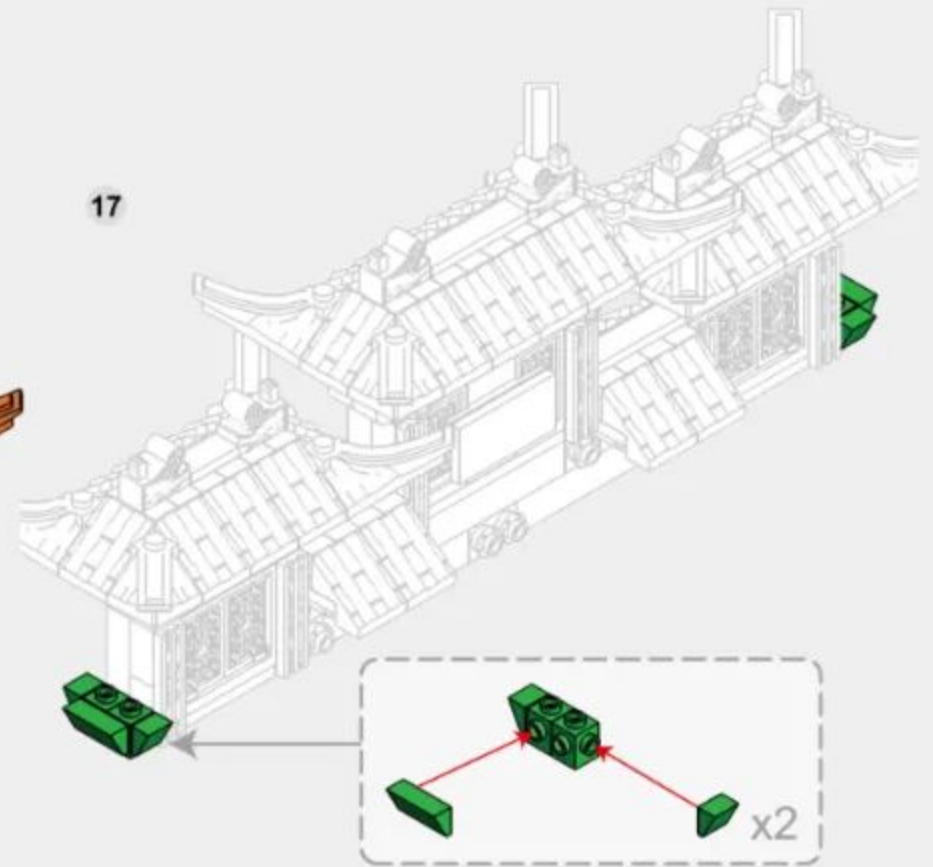
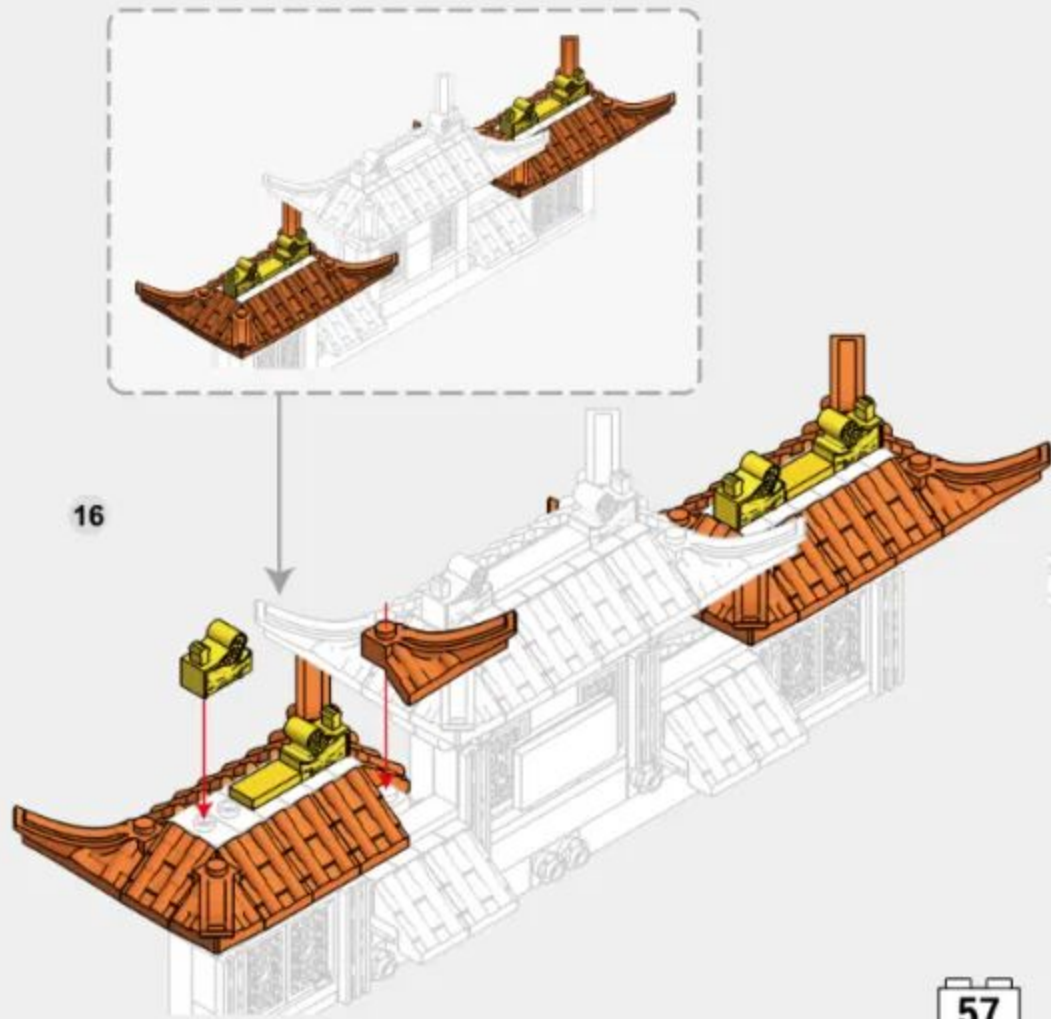
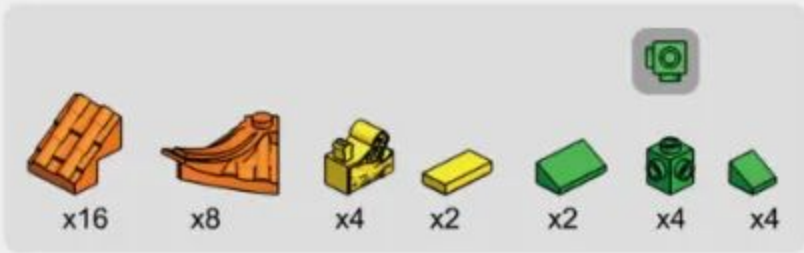

4-8

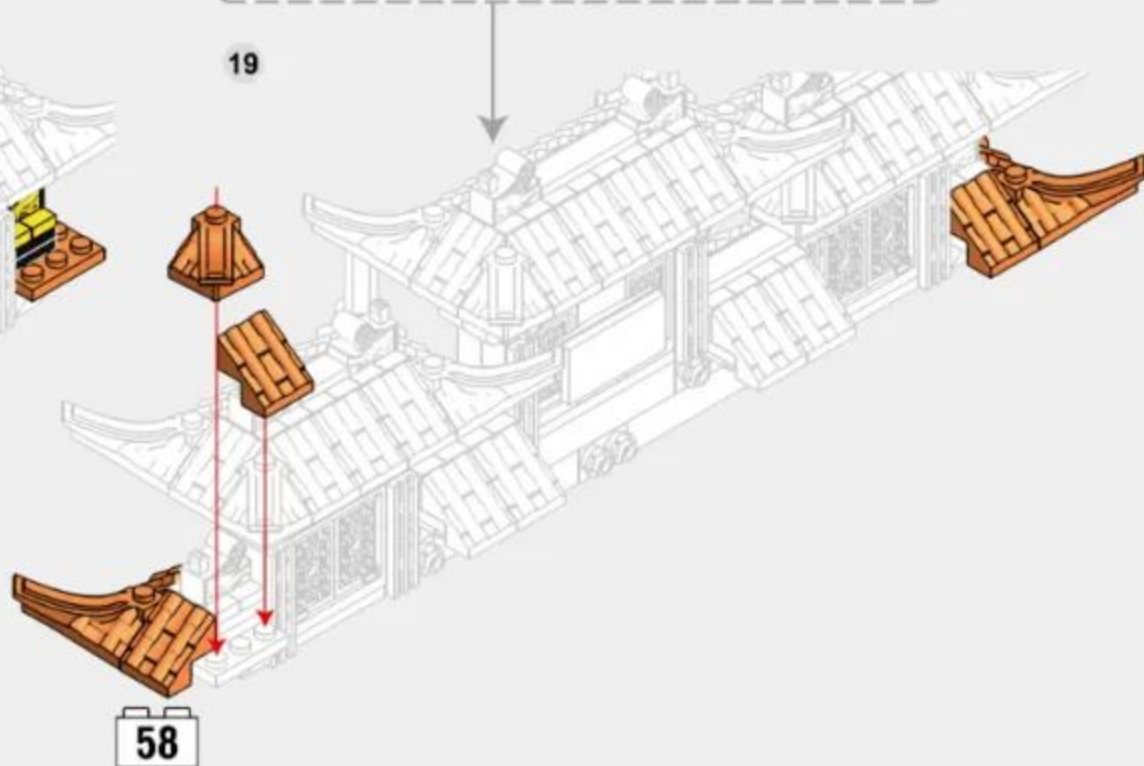
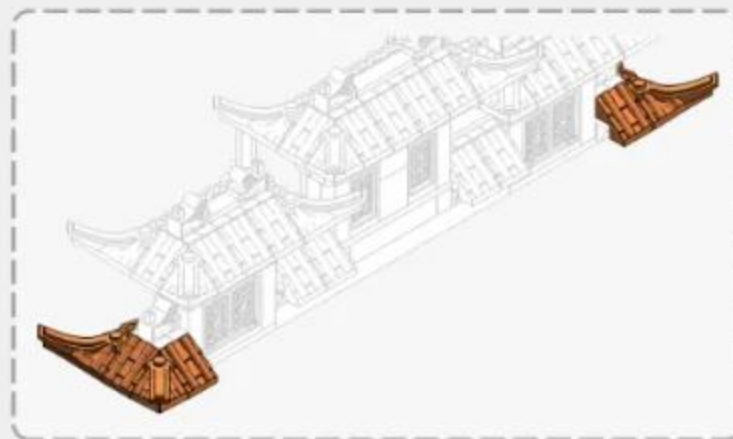
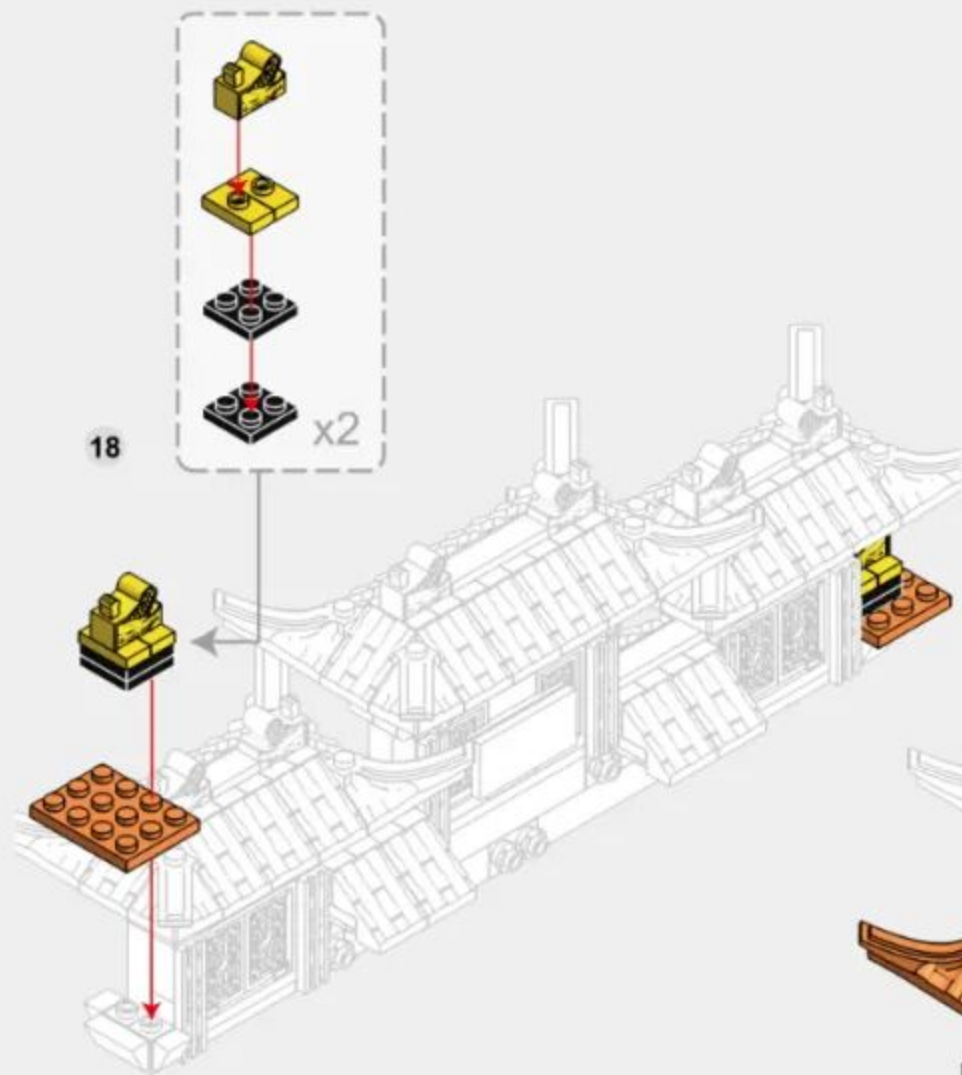

58

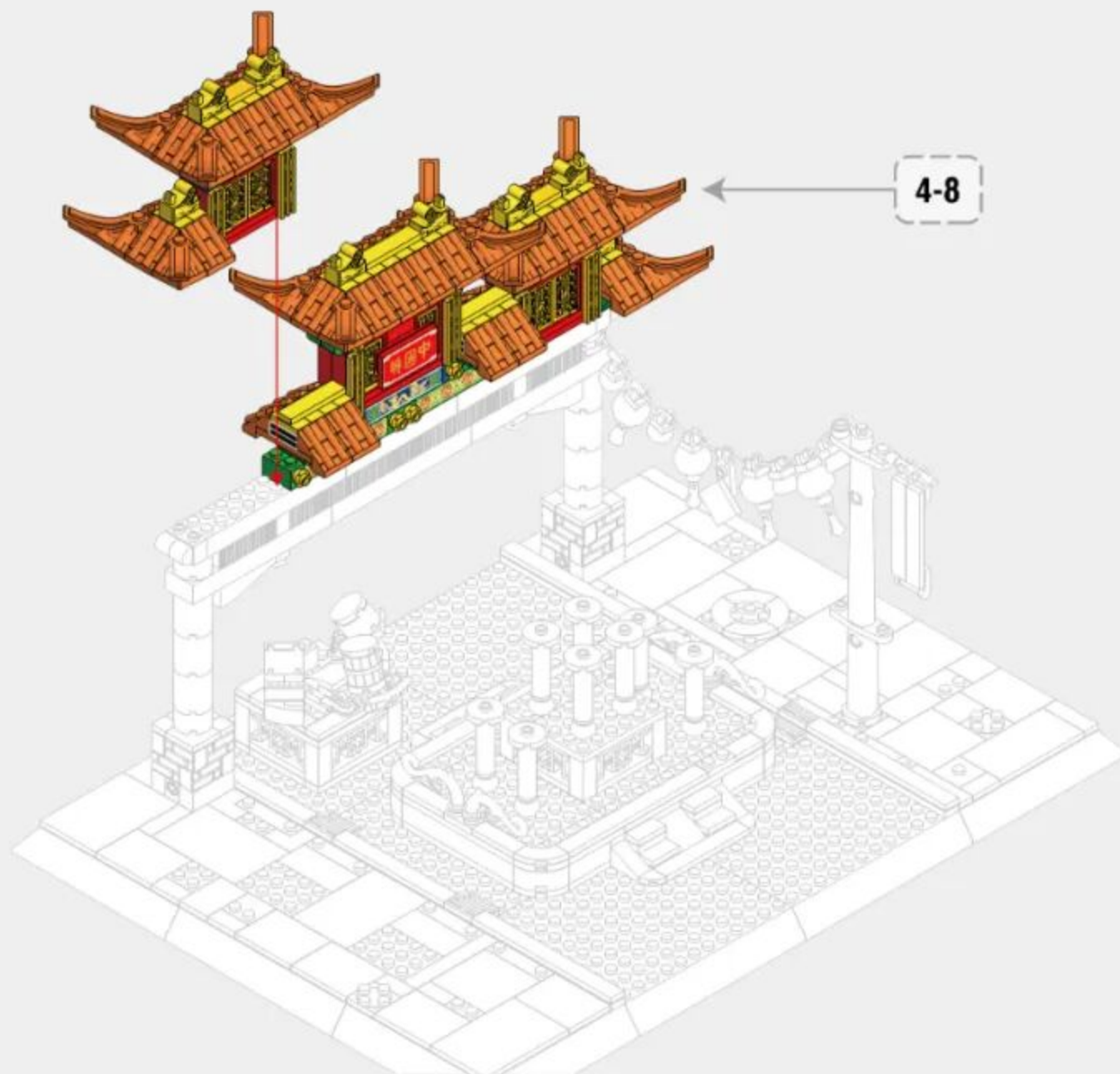



205PCS



60

5-1



x1



x1



x1



x1



x2



x3



x3



x3

5-2



x2



x2

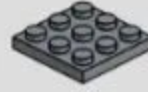

x1



x1



x1



x1



x1



x2



x2



x1



x1



x2



x1



x2



x1

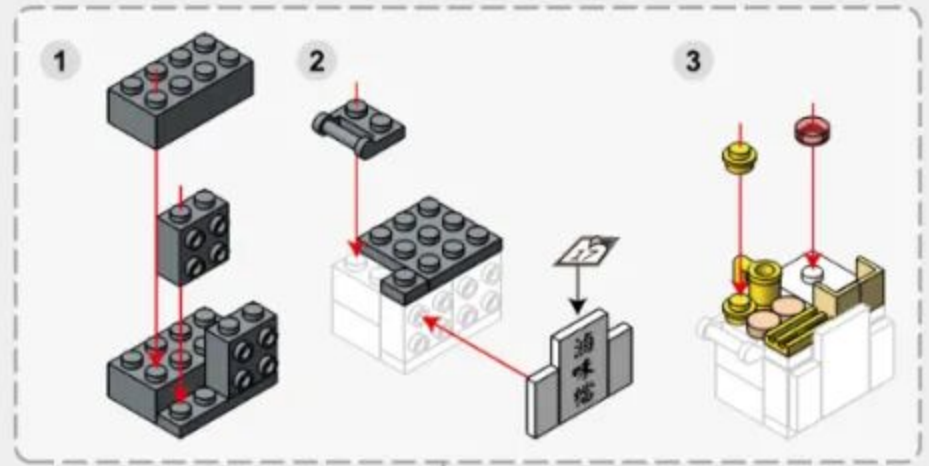
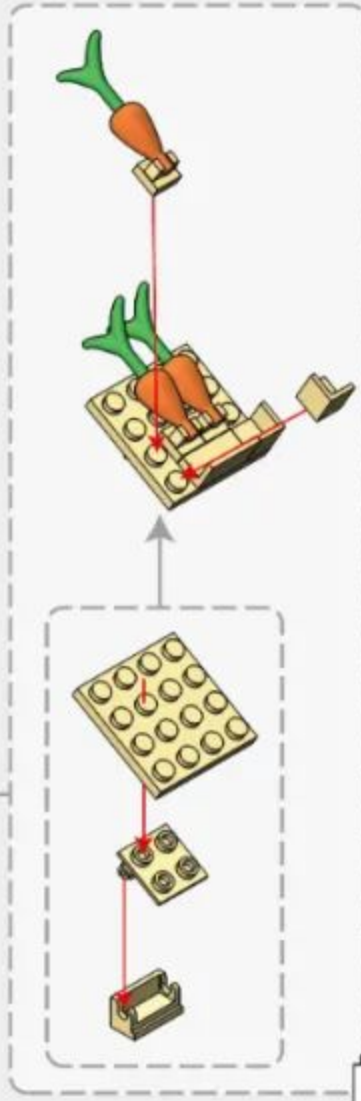



5-4

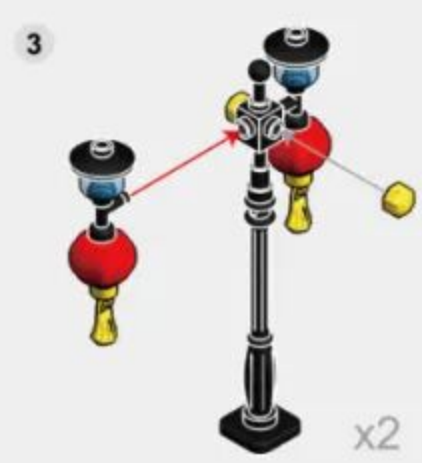
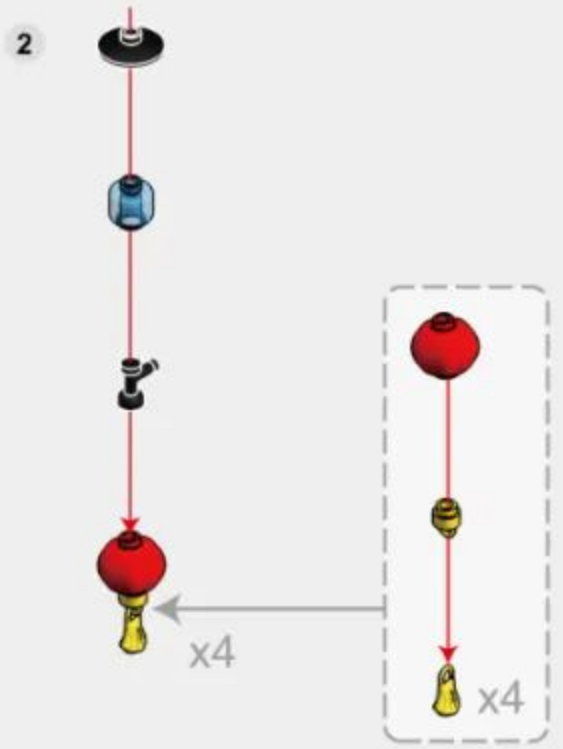
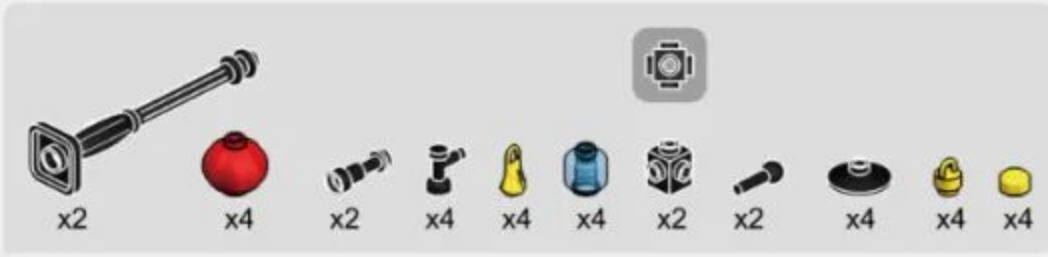



5-6

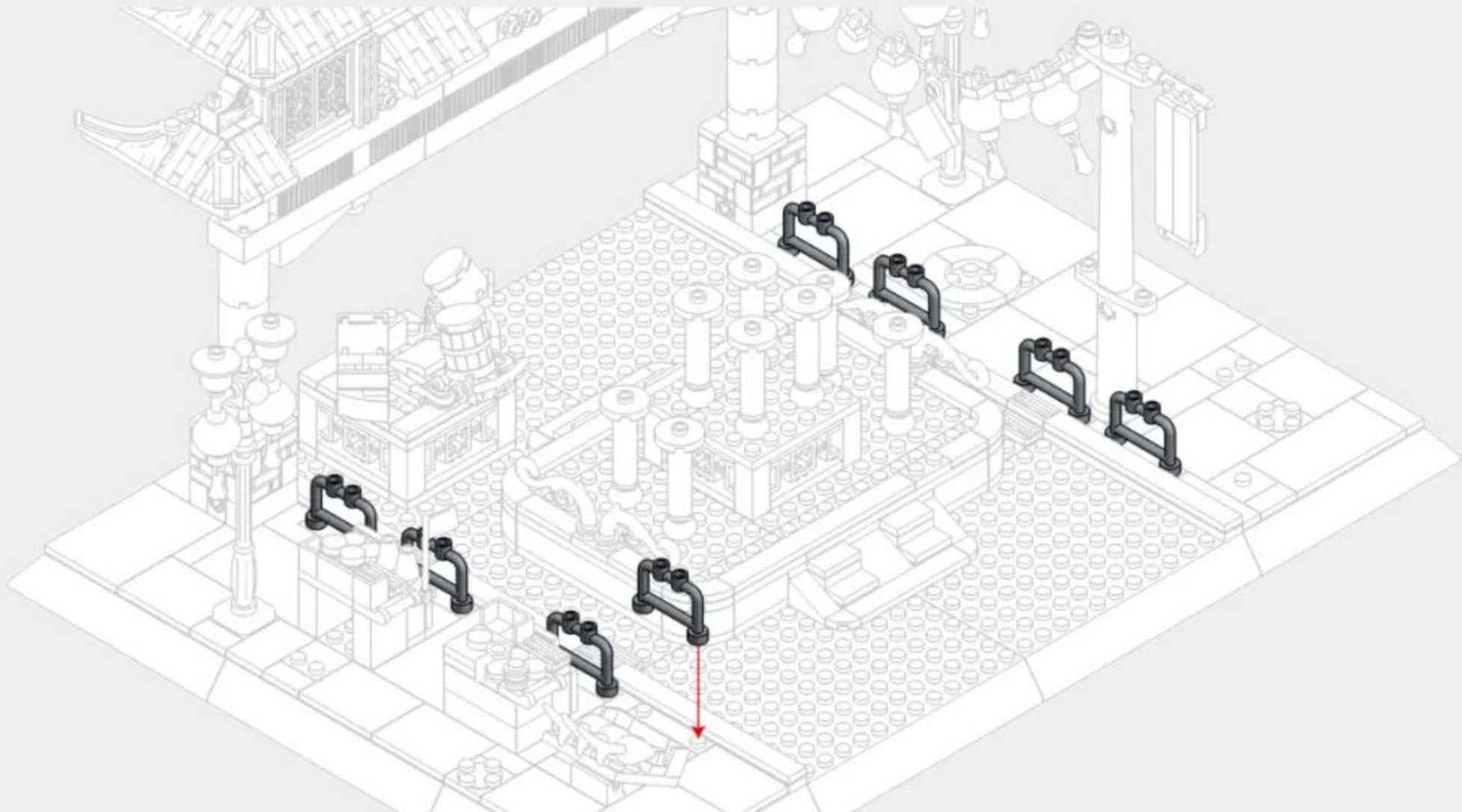

5-7

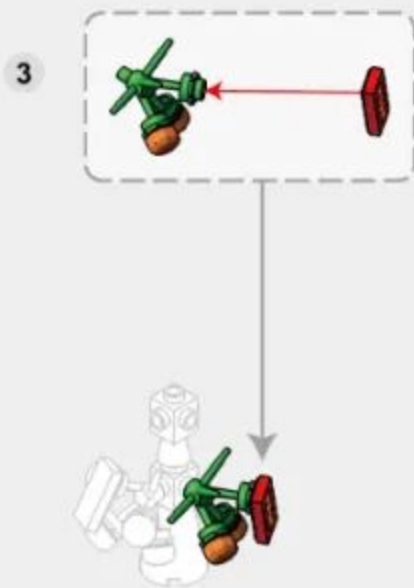
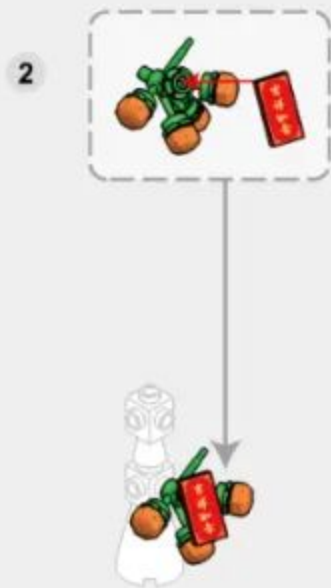

5-8



x5



x1



x1



x27



x25



5-9

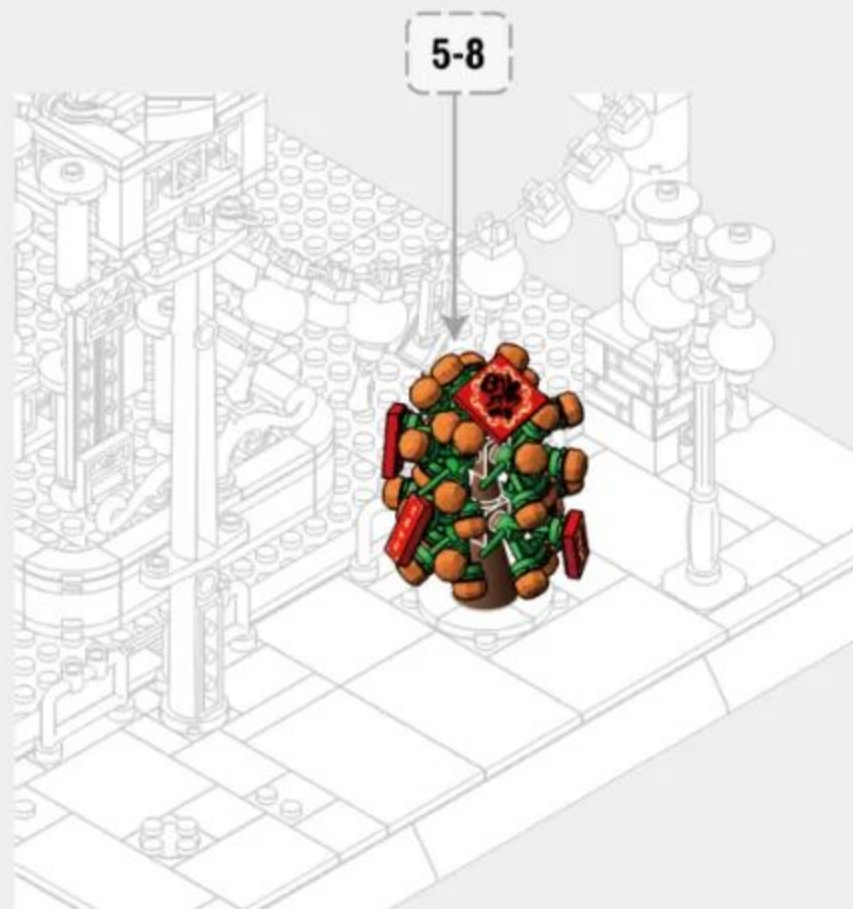
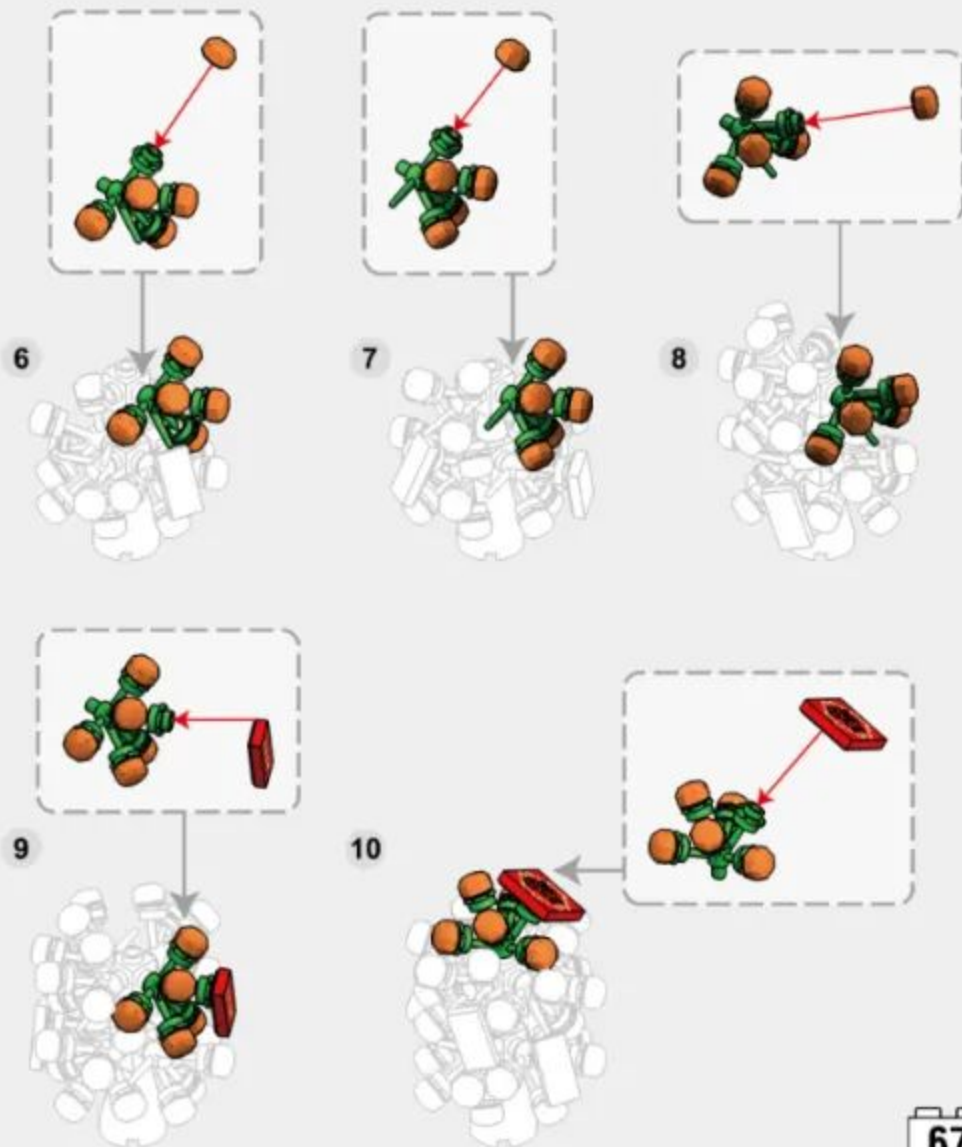



6-1



6-2

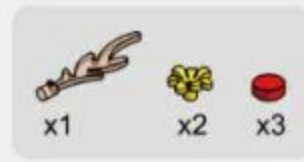

6-3

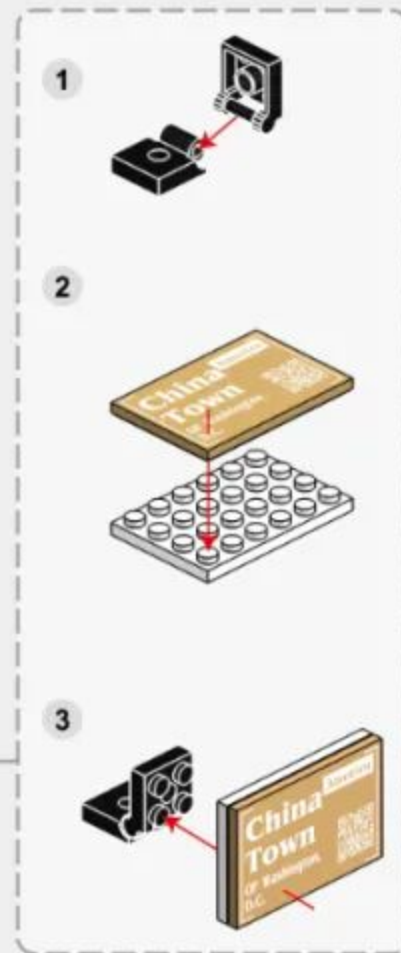
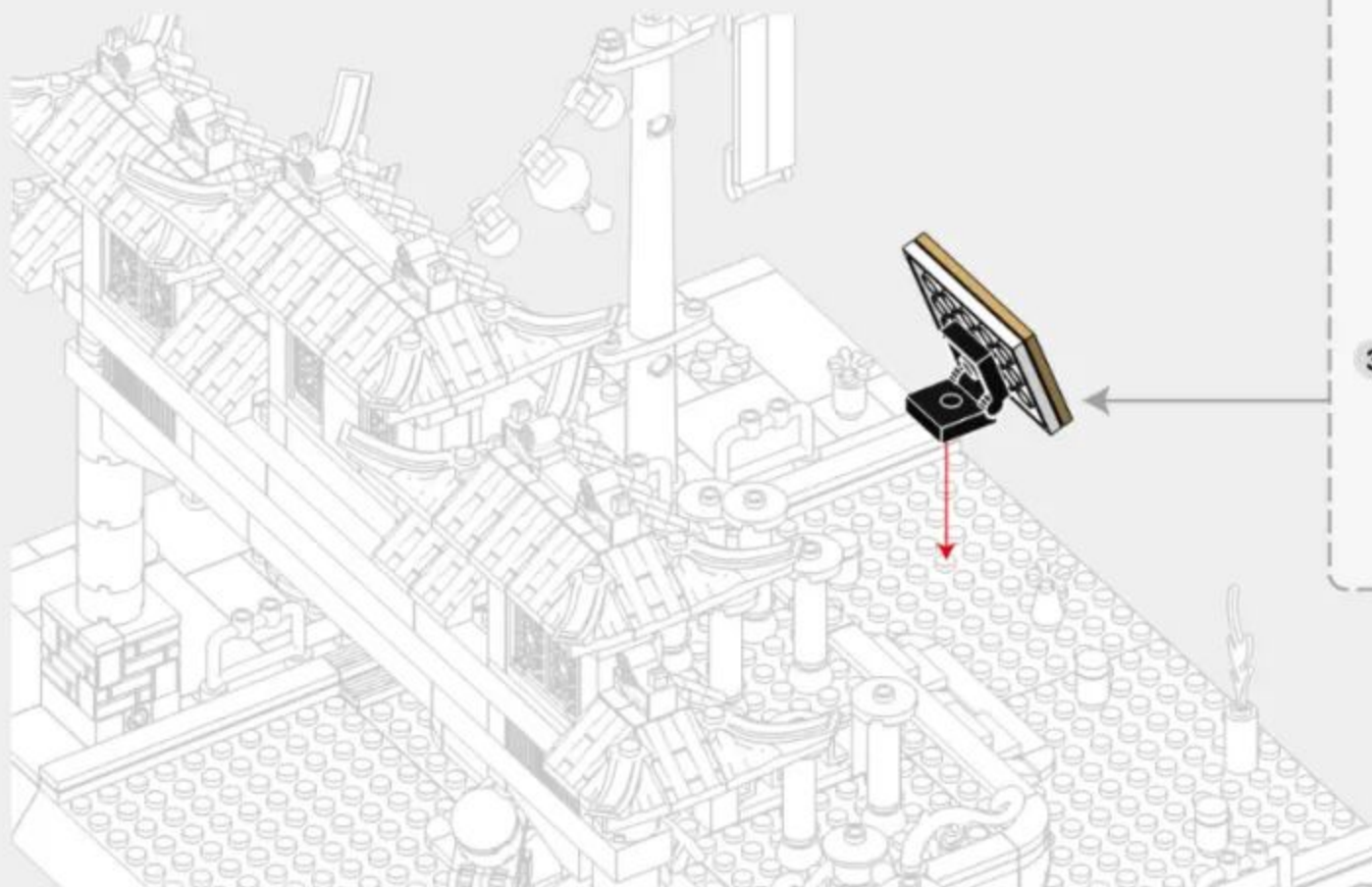
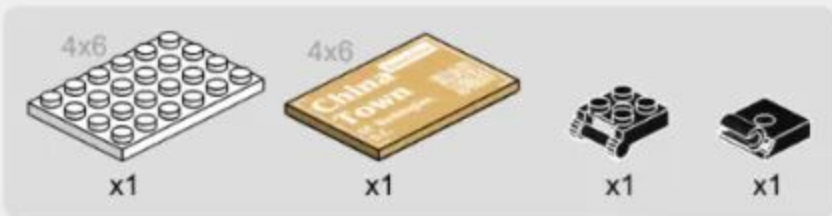

# 6-4

3x4 x1    x1    5 x1    1x4 x1    2x3 x1    x4    x6    x2    x2    x2    x1    x2    x2

x2    x1    x1    x4    x4

1:1  5

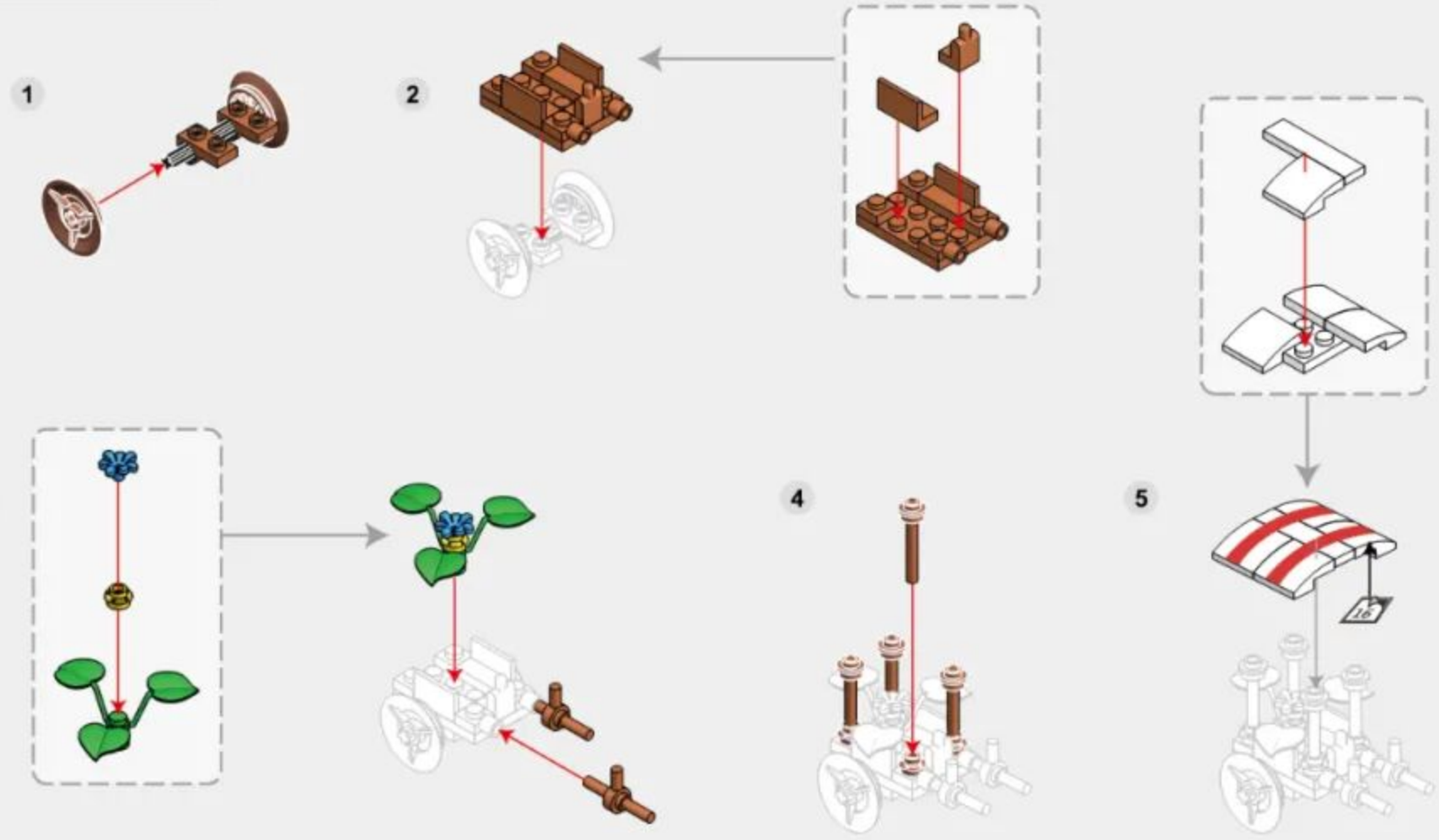

6-5

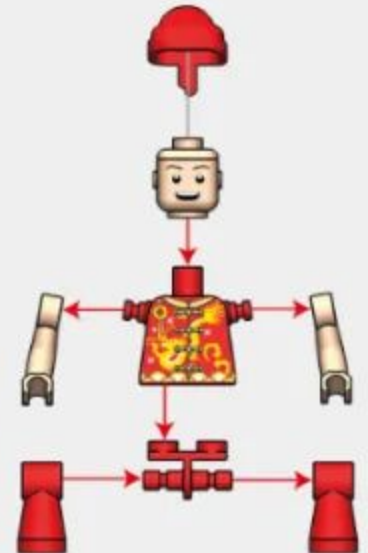
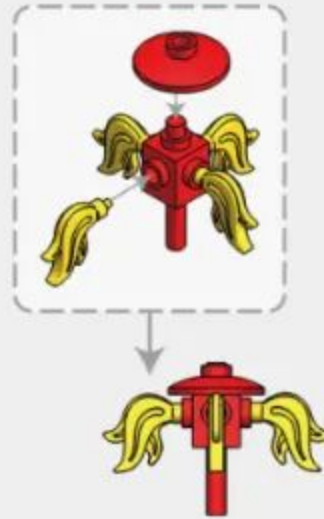
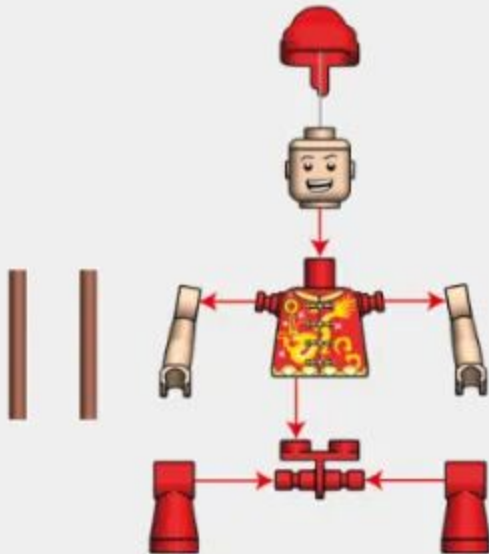
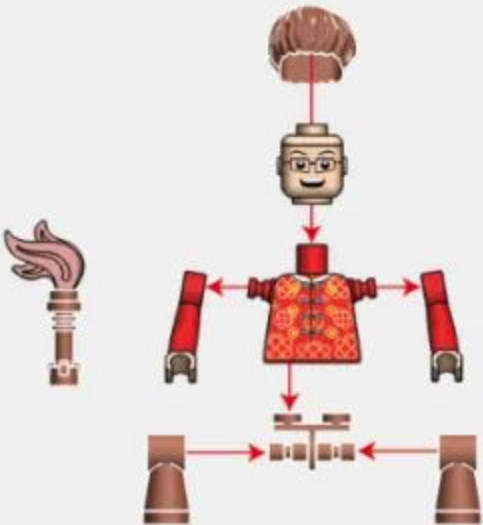
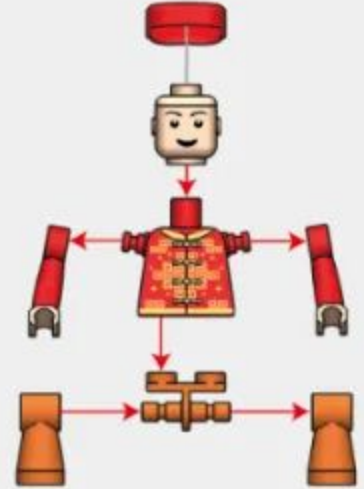
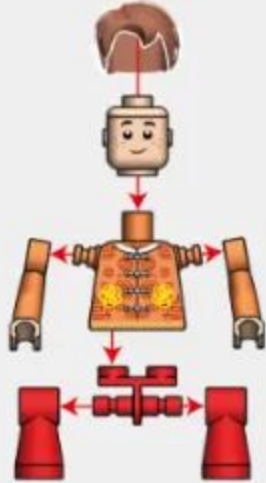
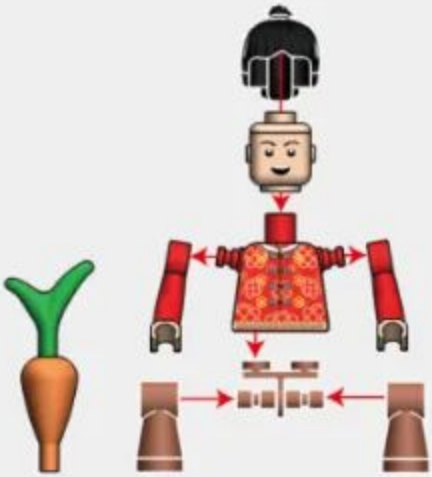



# ARCHITECTURE

The World's great architecture



**6224 英国伦敦白金汉宫**  
BUCKINGHAM PALACE-LONDON,ENGLAND



**5225 意大利罗马斗兽场**  
COLOSSEUM-ROME,ITALY



**5226 日本东京帝国饭店**  
IMPERIAL HOTEL-TOKYO,JAPAN



**6211 德国柏林勃兰登堡门**  
BRANDENBURG GATE-BERLIN, GERMANY



**6222 中国甘肃长城-嘉峪关**  
JIAYU PASS-GANSU,CHINA



**6212 日本京都清水寺仁王门**  
NIOMON GATE OF KIYOMIZU-DERA-KYOTO,JAPAN



**6214 中国武汉黄鹤楼**  
YELLOW CRANE TOWER-WUHAN,CHINA



**6215 英国伦敦眼**  
LONDON EYE-LONDON,ENGLAND



**6221 中国北京故宫-太和殿**  
HALL OF SUPREME HARMONY-BEIJING,CHINA



**6213 俄罗斯莫斯科瓦西里大教堂**  
SAINT BASIL'S CATHEDRAL-MOSCOW,RUSSIA



**6220 沙特阿拉伯麦加大清真寺**  
GREAT MOSQUE OF MECCA,SAUDI ARABIA



**6219 美国纽约联合国大厦**  
UNITED NATIONS HEADQUARTERS-NEW YORK,AMERICA



**4214 美国华盛顿白宫**  
WHITE HOUSE-WASHINGTON D.C.,AMERICA



**4212 意大利罗马许愿池**  
TREVI FOUNTAIN-ROME,ITALY



**4213 法国巴黎卢浮宫**  
MUSÉE DU LOUVRE-PARIS,FRANCE



**4218 新加坡-鱼尾狮**  
MERLION,SINGAPORE



**4210 埃及开罗吉萨金字塔**  
GREAT PYRAMID OF GIZA-CAIRO,EGYPT



**4219 英国伦敦双子塔桥**  
TOWER BRIDGE-LONDON,ENGLAND



**4216 美国华盛顿林肯纪念堂**  
LINCOLN MEMORIAL-WASHINGTON D.C.,AMERICA



**4217 新加坡-金沙酒店**  
MARINA BAY SANDS,SINGAPORE



**7210 中国上海世博会中国馆**  
CHINA PAVILION AT EXPO-SHANGHAI, CHINA



**4221 加拿大渥太华国会山庄**  
PARLIAMENT BUILDINGS-OTTAWA, CANADA



**4211 英国伦敦伊丽莎白塔**  
ELIZABETH TOWER-ENGLAND



**4220 美国纽约熨斗大厦**  
FLATIRON BUILDING-NEW YORK, AMERICA



**5227 美国纽约自由女神像**  
STATUE OF LIBERTY-NEW YORK, AMERICA



**4215 加拿大多伦多电视塔**  
THE CN TOWER-CANADA



**4222 阿联酋迪拜哈利法塔**  
THE BURJ KHALIFA TOWER-DUBAI, UAE



**5224 中国上海东方明珠广播电视塔**  
ORIENTAL PEARL TOWER-SHANGHAI, CHINA



**5212 美国纽约帝国大厦**  
EMPIRE STATE BUILDING-NEW YORK, AMERICA



**5213 马来西亚吉隆坡石油双塔**  
PETRONAS TWIN TOWERS-KUALA LUMPUR, MALAYSIA



**5214 意大利托斯卡纳比萨斜塔**  
LEANING TOWER OF PISA-TUSCANY, ITALY



**5216 英国伦敦伊丽莎白塔**  
ELIZABETH TOWER LONDON ENGLAND



**5219 俄罗斯莫斯科克里姆林宫钟楼**  
SPASSKAYA TOWER-MOSCOW, RUSSIA



**5220 阿联酋迪拜卓美亚帆船酒店**  
BURJ AL ARAB HOTEL-DUBAI, UAE



**5217 法国巴黎埃菲尔铁塔**  
EIFFEL TOWER-PARIS, FRANCE



**5221 中国台北101大楼**  
TAIPEI 101-TAIPEI, CHINA



**6223 中国武汉长江大桥**  
WUHAN YANGTZE RIVER BRIDGE



**5210 法国巴黎圣母院大教堂**  
CATHÉDRALE NOTRE DAME DE PARIS-PARIS, FRANCE



**5223 法国巴黎凯旋门**  
ARC DE TRIOMPHE-PARIS, FRANCE



**5211 印度阿格拉泰姬陵**  
TAJ MAHAL-AGRA, INDIA



5215 英国伦敦双子塔桥  
TOWER BRIDGE-LONDON,ENGLAND



5222 中国北京天坛祈年殿  
HALL OF PRAYER FOR GOOD HARVESTS-BEIJING,CHINA



6210 美国旧金山金门大桥  
GOLDEN GATE BRIDGE-SAN FRANCISCO,AMERICA



6216 中国北京万里长城（八达岭）  
THE GREAT WALL-BEIJING,CHINA



5218 中国北京天安门  
TIANANMEN TOWER-BEIJING,CHINA



6217 中国西藏布达拉宫  
POTALA PALACE-TIBET,CHINA



6218 芬兰罗瓦涅米圣诞老人办公室  
SANTA CLAUS OFFICE-ROVANIEMI,FINLAND



6225 墨西哥库库尔坎玛雅金字塔  
EL CASTILLO-KUKULKAN,MEXICO



6226 德国巴伐利亚新天鹅堡  
SCHLOSS NEUSCHWANSTEIN-BAYERN, DEUTSCHLAND



5228 美国芝加哥威利斯大厦  
WILLIS TOWER-CHICAGO, AMERICA



5229 土耳其伊斯坦布尔其少女塔  
MAIDEN TOWER-ISTANBUL,TURKEY



5230 中国湖南长沙爱晚亭  
AIWAN TING PAVILION-HUNAN,CHINA



5231 巴西里约热内卢救世基督像  
CRISTO REDENTOR-RIO DE JANEIRO, BRASIL



5232 美国宾夕法尼亚州流水别墅  
FALLINGWATER-PENNSYLVANIA, AMERICA



5233 美国芝加哥范斯沃斯住宅  
FARNSWORTH HOUSE-CHICAGO, AMERICA



5234 美国华盛顿唐人街  
CHINA TOWN-WASHINGTON, D.C., AMERICA



# CHINA TOWN

COUNTRY: America

CITY: Washington, D.C.



Ver:523421227