



TURRET OF PALACE MUSEUM

中国北京紫禁城角楼

Beijing, China

The world's great architecture



Creative Ability Family Interaction Observation Ability Thinking Ability Practical Ability

6+ / 5239 / 1252 PCS
Suitable Age Product Number Parts Total



Architecture

It will be a city...

这将构成一座城市...

ABOUT THE PRODUCT

关于产品



ARCHITECTURE

WANGE The world's great architect since 1991

Guangdong Baoge Educational Material Sci-Tech Co., Ltd.
©2014 Wange / Dubie. All Rights Reserved

Turret of Palace Museum



In Dongcheng District, Beijing, China, at the center of the Imperial City of Beijing.



Turret of Palace Museum



Geography and culture

地理·文化



Nearly all the city defense systems in China consist of turrets. The turrets of the Beijing Forbidden City are the most unique.



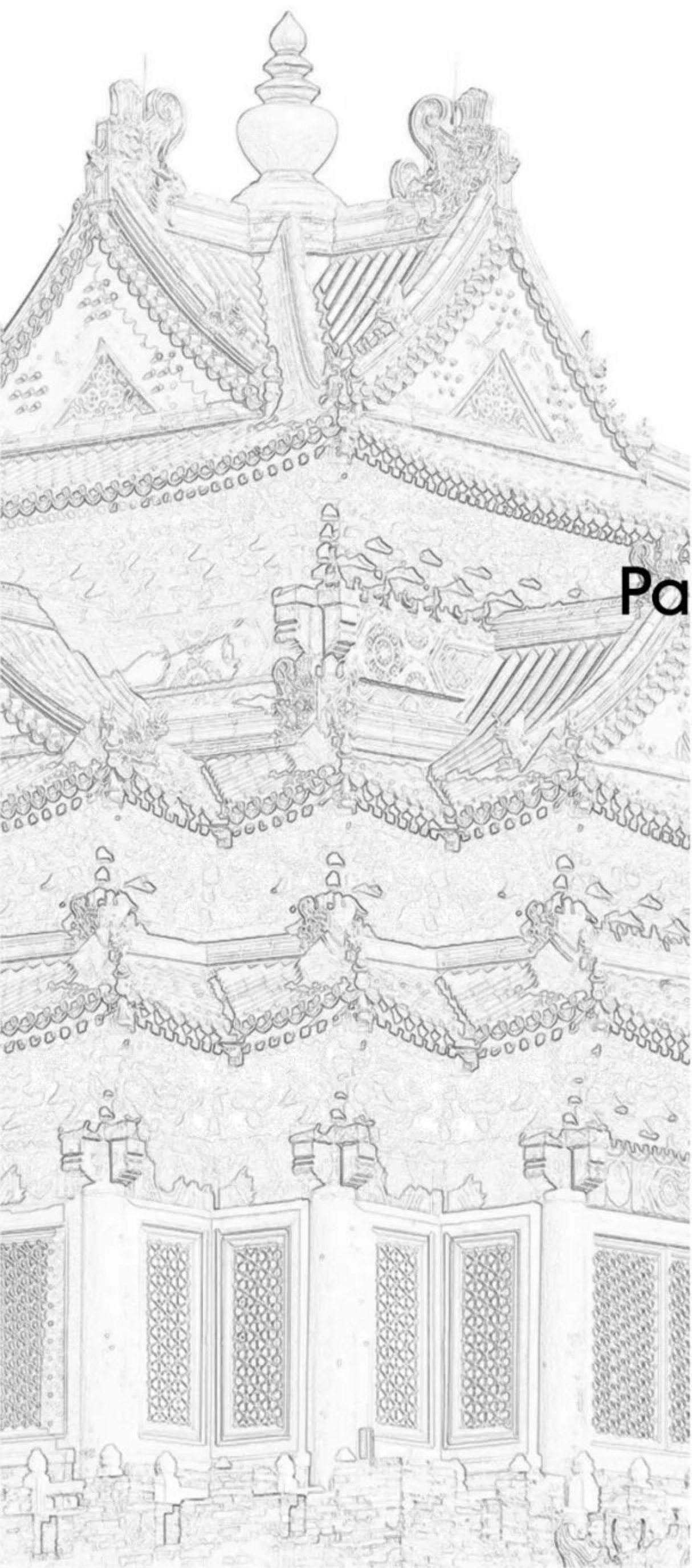

中国北京紫禁城角楼

Turret ■ of Palace Museum China

The contents of this chapter refer to the Wikipedia website.

本章内容参考维基百科网站，更多资讯可自行查阅。

Buildings and layout

■ 建筑物和布局

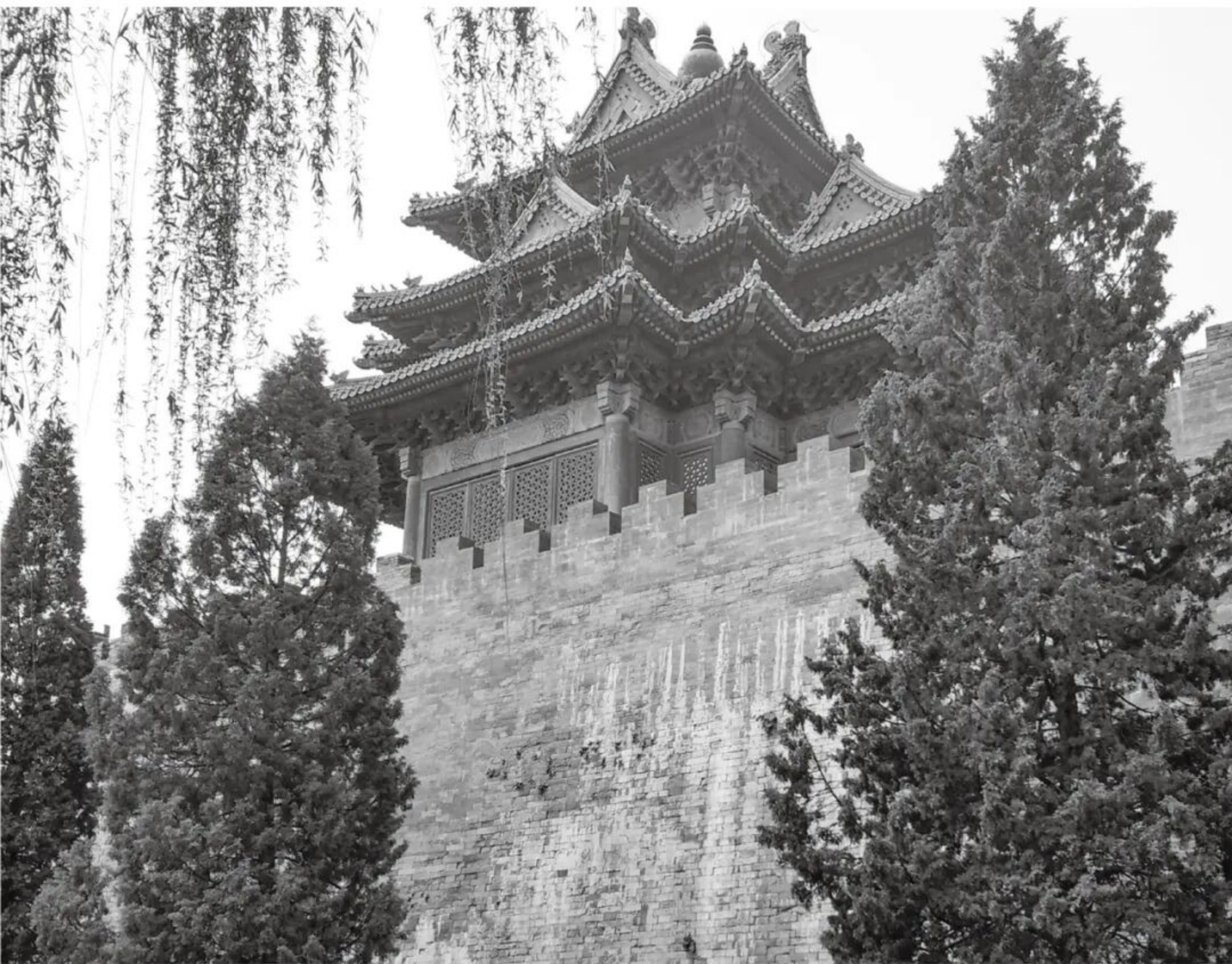

紫禁城角楼平面呈曲尺形，由地面至宝顶通高27.5米。屋顶三层檐，上层是纵横搭交的歇山顶，即由两坡流水的悬山顶与四面坡的庑殿组合而成。中层采用“勾连搭”做法，用四面抱厦歇山顶环拱中心屋顶，外观犹如众星拱月。下层檐为一圈半坡顶的腰檐，使上两层的五个屋顶形成一个复合式整体。自上而下共有10面山花、28面门窗、28个翼角、56个屋顶坡面、72条脊、230个脊吻和翼角小兽，建筑工艺之高超，世所罕见。整座建筑以多角、多檐、多山花、多屋脊著称，屋顶参差错落，屋角飞动，造型玲珑空灵。其中九梁、十八柱、七十二脊，均为九字的倍数。九在中国古代为阳数最大者，历来为帝王们所青睐。这种构思，不仅充满了皇权至上的象征意义，也为紫禁城平添了无限神韵。

Turret is try square in plane and 27.5meter high. The roof has three layers of eaves. They consist of slope roofs which jointing vertically and horizontally, forming a complex. From top to bottom, there are 10 pediments, 28 windows,28 corners, 56 lope roofs,72 ridges and 230 animal ornaments in all. The number of 9-girders, 18-columns and 72-ridges in the building are all multiple of 9. Nine is biggest Yang number (in Chinese philosophy, Yang expresses masculine or positive principle in nature) appreciated by monarchies in the past dynasties. These concepts and designs are full of symbols increasing infinitude verve.



construction

1421年，明朝正式迁都北京，建造起了规模宏大瑰丽的宫城紫禁城，占地面积72万平方米，建筑面积约15万平方米，屋宇9000多间，是中国古代建筑史上的空前杰作，显示出中国古代建筑艺术与工程技术的最高水平。围绕紫禁城的宫墙周长约3000米，高10米，四角各建有一座造型奇特、风姿绰约的角楼。因为地处皇城范围内，所以紫禁城角楼更侧重造型和外观，富有装饰性。

In 1421, Ming Dynasty moved the capital to Beijing and built magnificent Forbidden City which occupies 72ha. Its building area is about 150,000sq.m. It is a masterpiece in ancient architectural history of China and displays the highest level in the field of architectural art and technology of ancient China. The walls that surrounded Forbidden City are about 3000 meter long and 10 meter high. Because turrets are located inside emperor city, they are special for sculpture and appearance.



Symbolism

在建筑学中，炮塔是一座小塔，从中世纪城堡等建筑物的墙壁垂直突出。在军事防御工事时代，炮塔被用来提供一个突出的防御阵地，允许向相邻的墙壁掩护火力。随着它们的军事用途逐渐消失，炮塔被用于装饰目的，就像苏格兰男爵风格一样。角楼是一种用于城市防御的特殊建筑，它分布在城墙四隅，可供防御者登临了望敌情。在中国古代，几乎所有城市的城墙四角都建造有角楼，而其中最为奇特别致的要算北京紫禁城角楼。

In architecture, a turret is a small tower that projects vertically from the wall of a building such as a medieval castle. Turrets were used to provide a projecting defensive position allowing covering fire to the adjacent wall in the days of military fortification. As their military use faded, turrets were used for decorative purposes, as in the Scottish baronial style. Turret is a kind of particular building located on the four corner of city wall for defense. It can be used to scout enemy. Nearly all the city defense systems in China consist of turrets. The turrets of the Beijing Forbidden City are the most unique. arance.

Force Balance

受力平衡

Physical operations

物理运算

$$F = G \frac{m_1 m_2}{d^2}$$

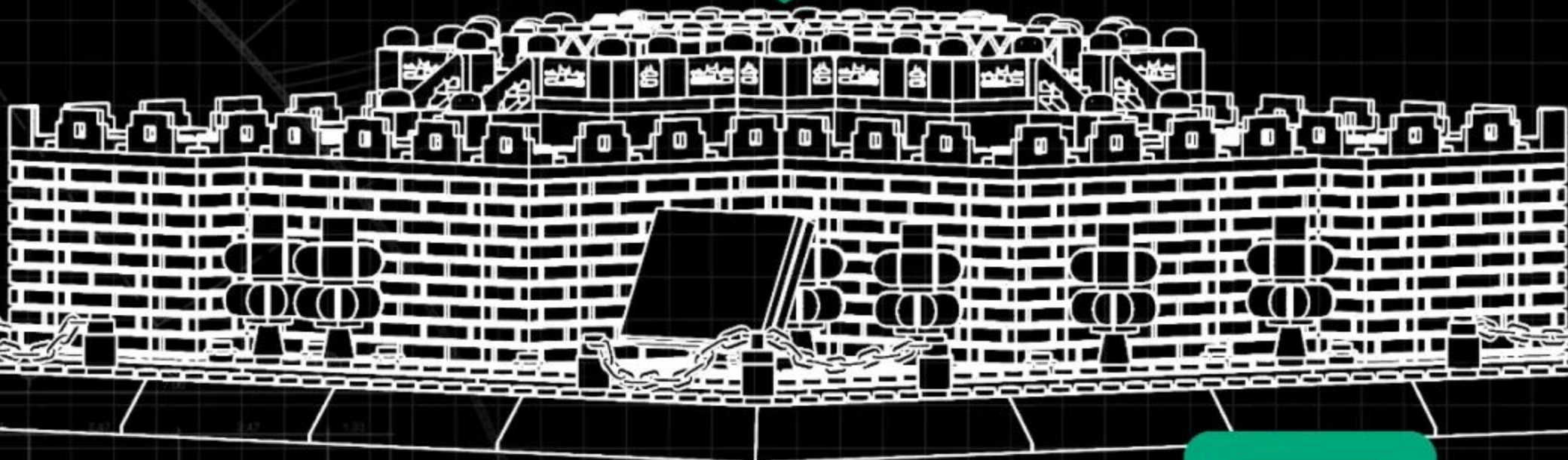
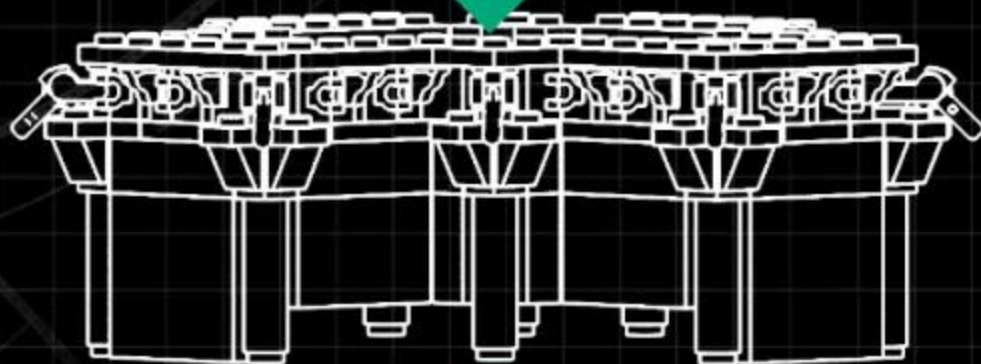
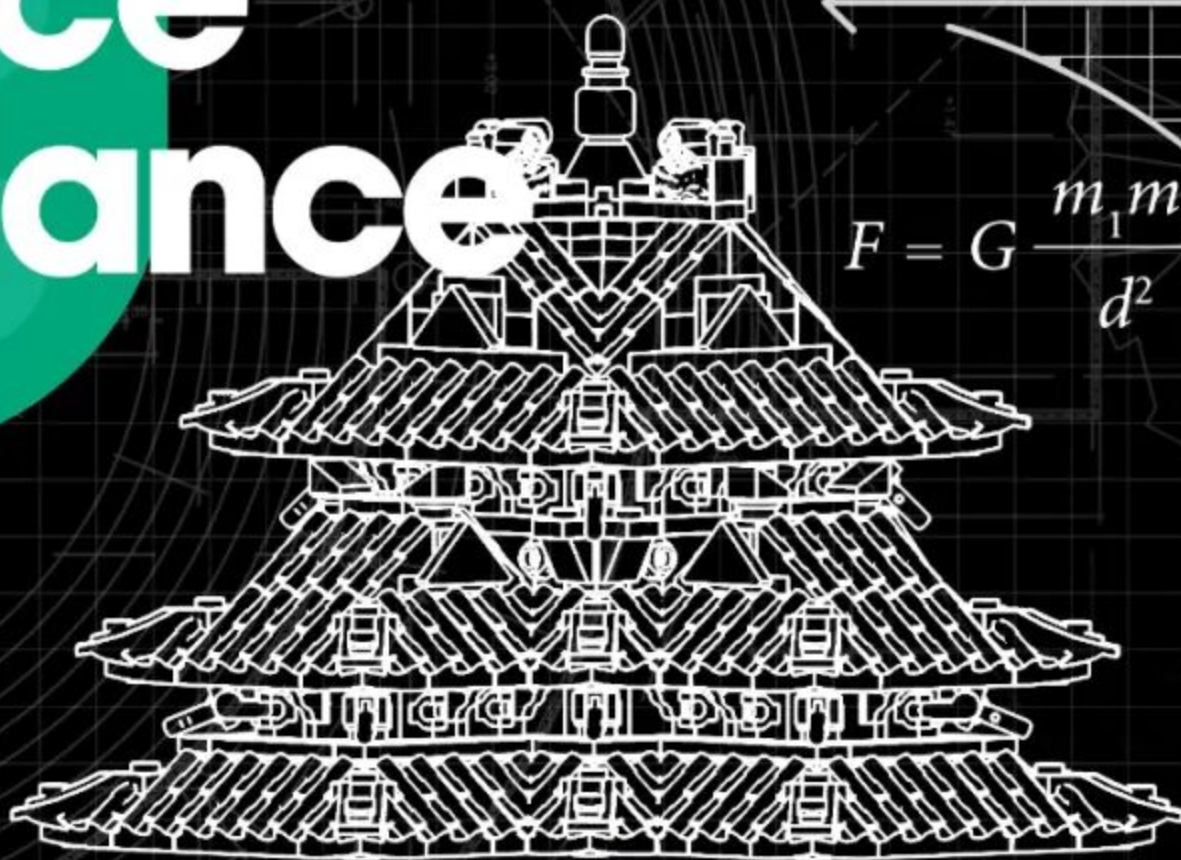

Creation and thinking

创作·思考

$$S=4\pi \cdot r^2$$

Special parts

特殊零件的开发利用

$$a^2+b^2=c^2$$



WG1512

1孔中式栏杆

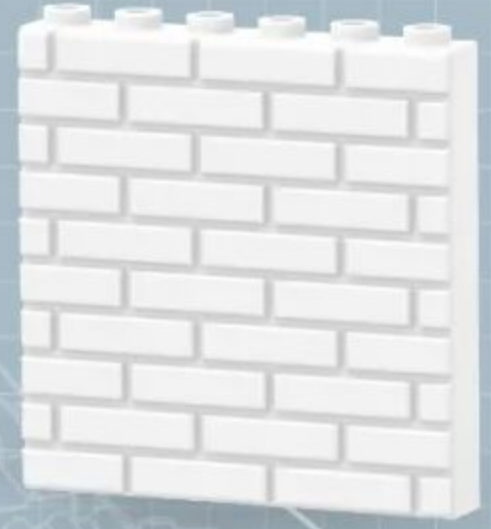

WG1510

5高6孔墙砖



WG1504

带孔小角瓦片



WG1463

十字架3孔



WG1509

小瓦片1孔



WG1316

2高4孔墙砖

$$\sin^2 a + \cos^2 a = 1$$



features and function

特点.功能

Main Color Matching

配色方案



Color matching

Adopting 3 main colors, lemon Yellow, Dark Blue Green and Jujube Red as the main color, the more reasonable and Green color matching on the original building, making the product more atmospheric and the whole design is more reasonable.

Turret of Palace Museum

中国北京紫禁城角楼

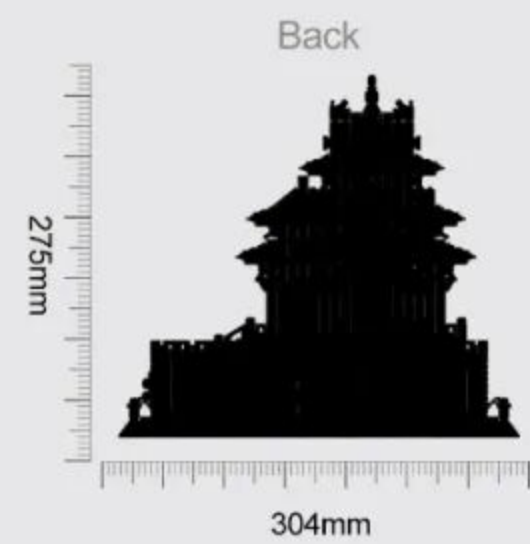
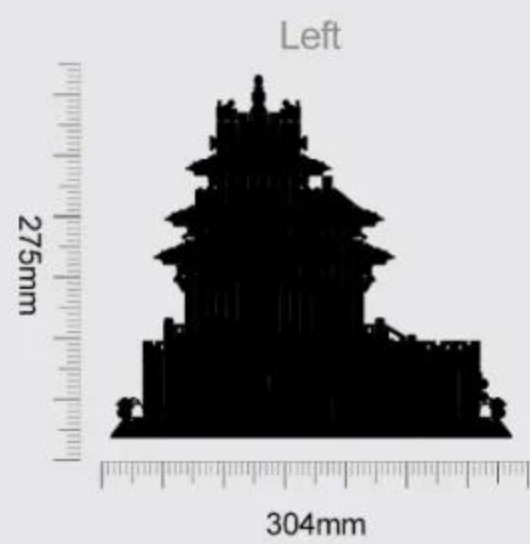
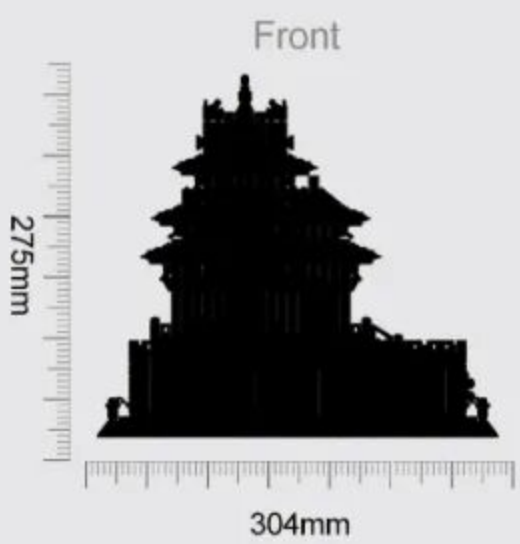

Product Size:304X304X275mm

- Creative Ability
- Family Interaction
- Observation Ability
- Thinking Ability
- Practical Ability

Instructions For Use

积木起件器使用说明
Brickseparator

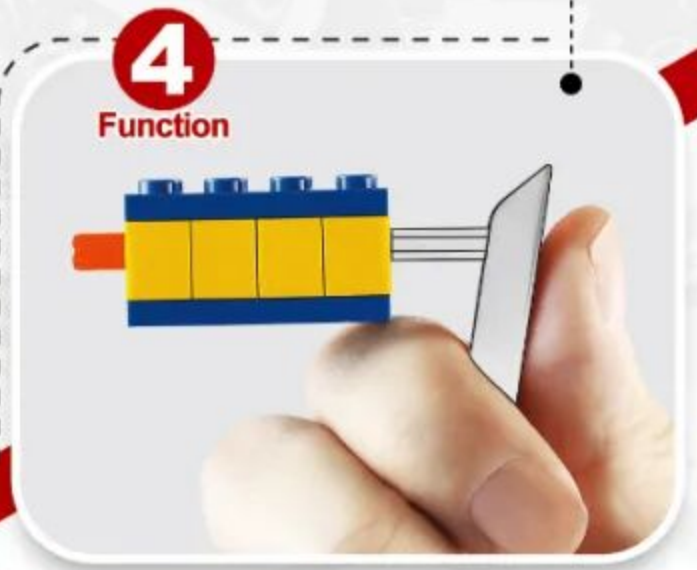
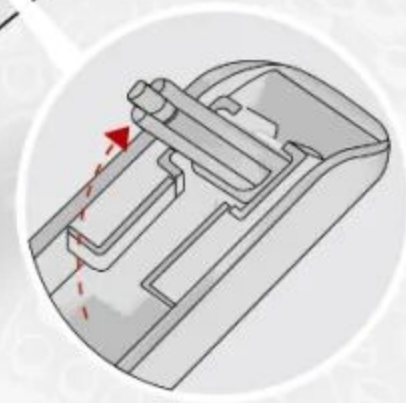
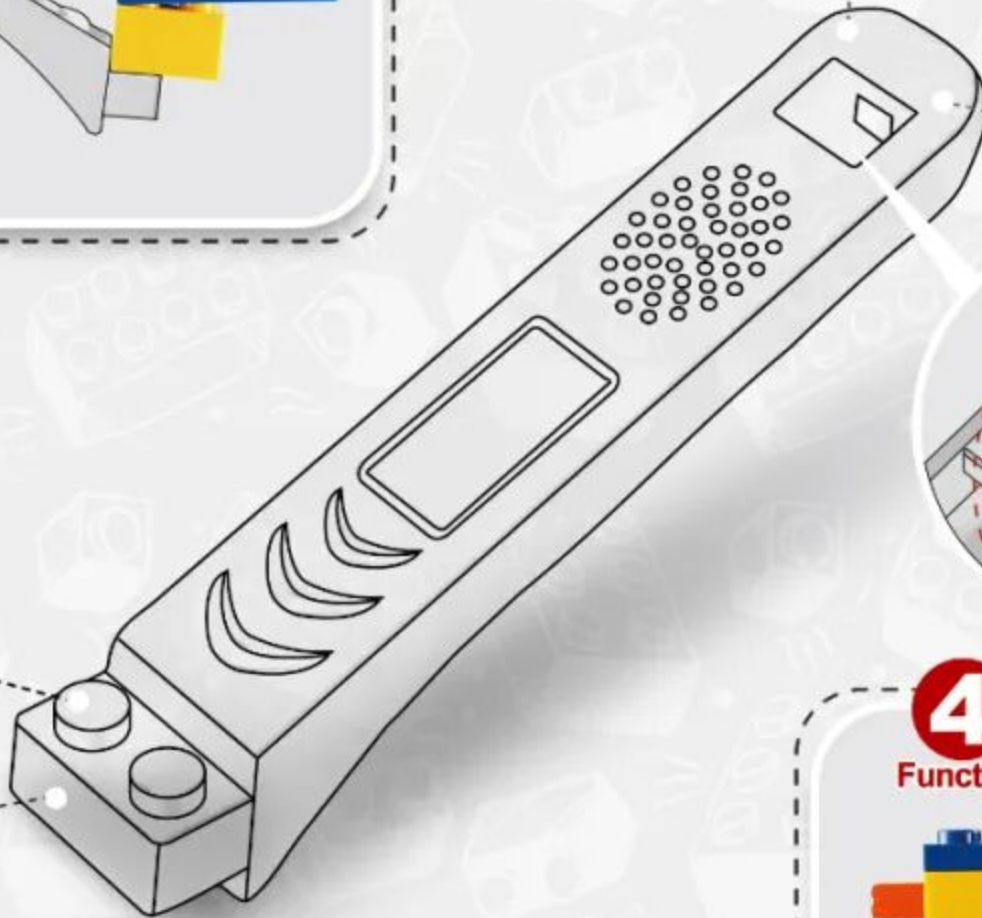
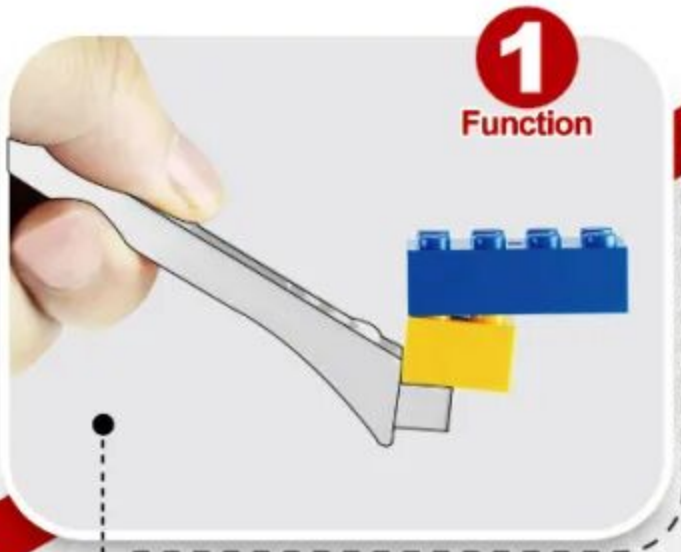

4 ways to make installation easier
让安装更简单



■ First open the product packaging according to the instructions.

按指导用正确方式拆解产品外包装。



■ Summarize all parts to count the number of familiar accessories.

对照说明书清单确认积木包数量与积木数量。



■ Arranging all accessories by color helps to quickly install the product.

把确认好的积木以类型、颜色进行分类排好以便安装。



■ Carefully install the product and learn about building.

按说明书步骤拼装并完成你的积木模型。



1:1 Physical Reference Table

十字棒配件1:1尺寸参照表



Instructions For Use

让安装更简单



2 $(1 \times 2) = 2$

3 $(1 \times 3) = 3$

4 $(1 \times 4) = 4$

5 $(1 \times 5) = 5$

6 $(1 \times 6) = 6$

7 $(1 \times 7) = 7$

8 $(1 \times 8) = 8$

9 $(1 \times 9) = 9$

10 $(1 \times 10) = 10$

12 $(1 \times 12) = 12$

16 $(1 \times 16) = 16$

PARTS LIST

配件清单

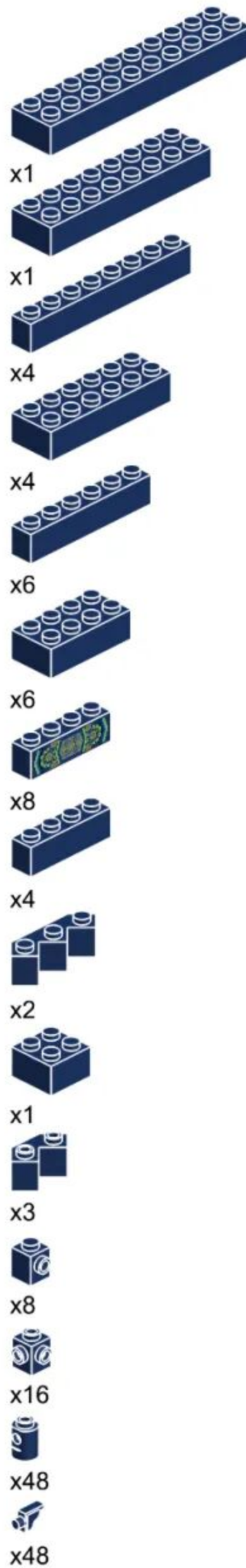
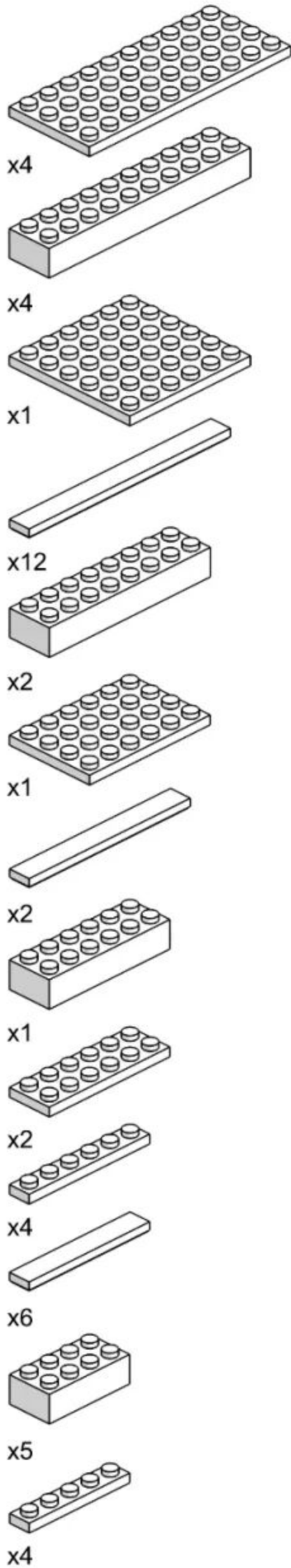

产品有增补件请以实物为准
 If product has additional parts, please in kind prevail.

PARTS LIST

配件清单

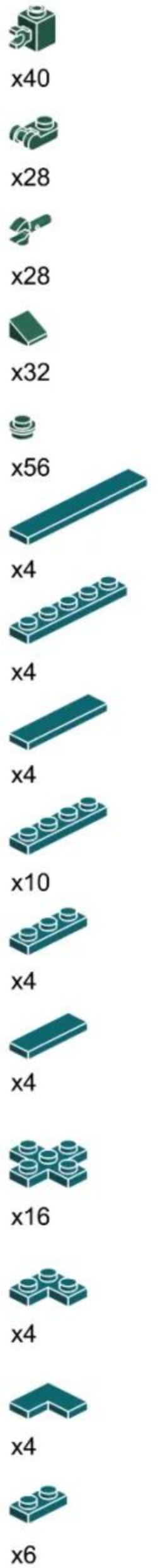
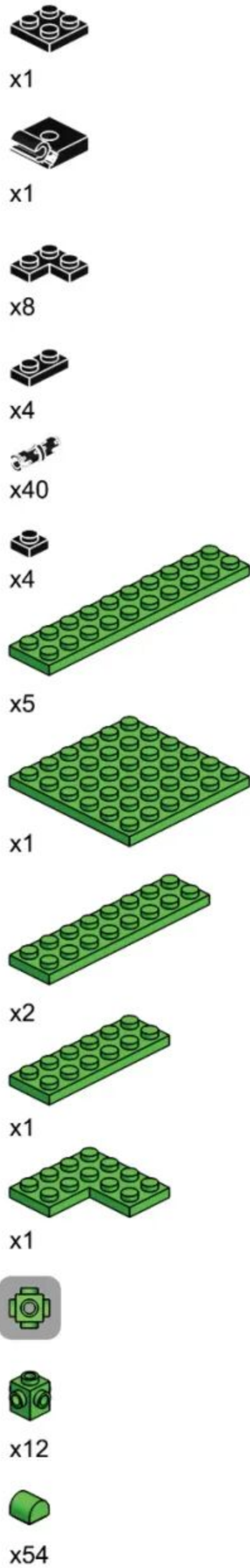
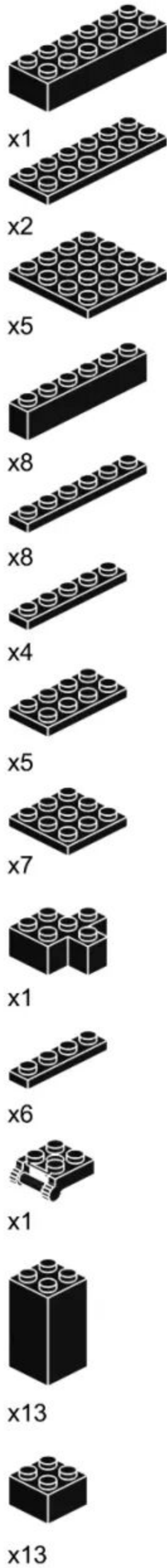
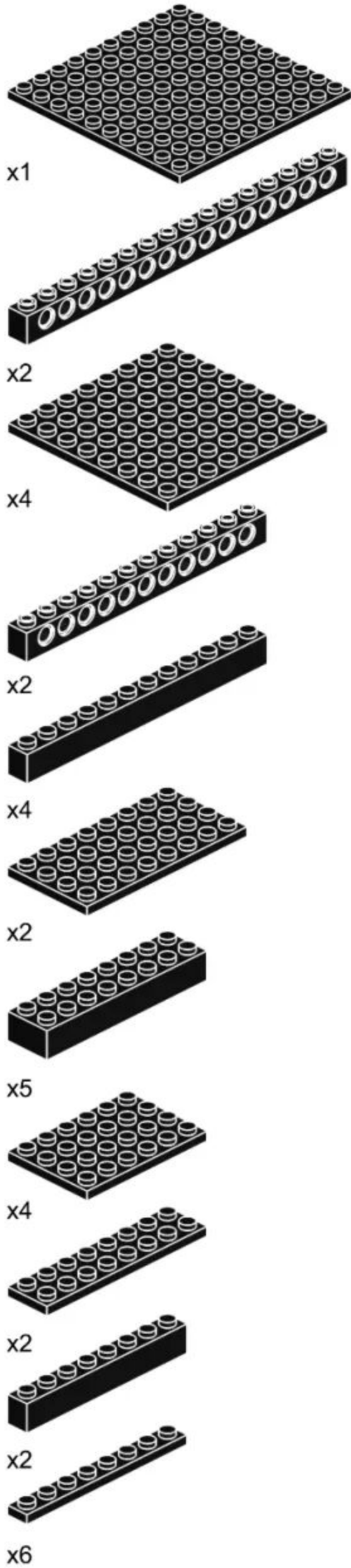









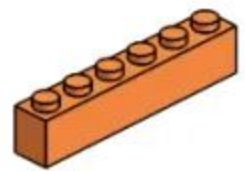



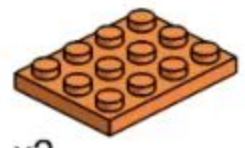





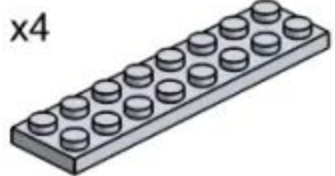



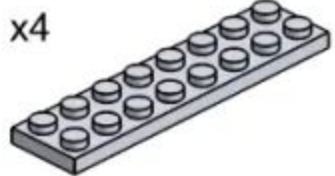
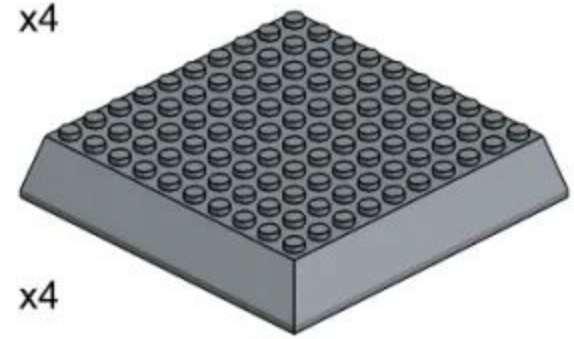
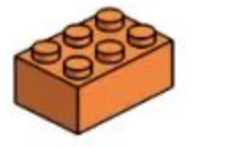

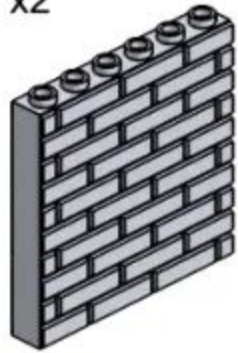
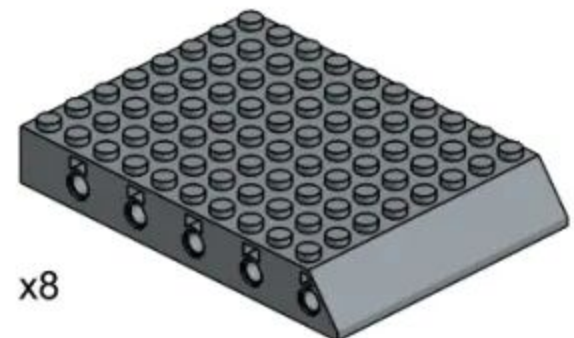



















产品有增补件请以实物为准

If product has additional parts, please in kind prevail.

PARTS LIST

配件清单

			
x4	x8		x40
			
x2	x4	x4	x2
			
x18	x2	x4	x4
			
x4	x4	x2	x4
			
x4	x1	x12	x8
			
x24	x1	x14	x12
			
x24	x4		x4
			
x4	x4	x13	x8
			
x4	x1	x35	x3
			
x28	x4		x2
			
x1	x1	x17	x6
			
	x1		
			x1

产品有增补件请以实物为准
If product has additional parts, please in kind prevail.



280PCS

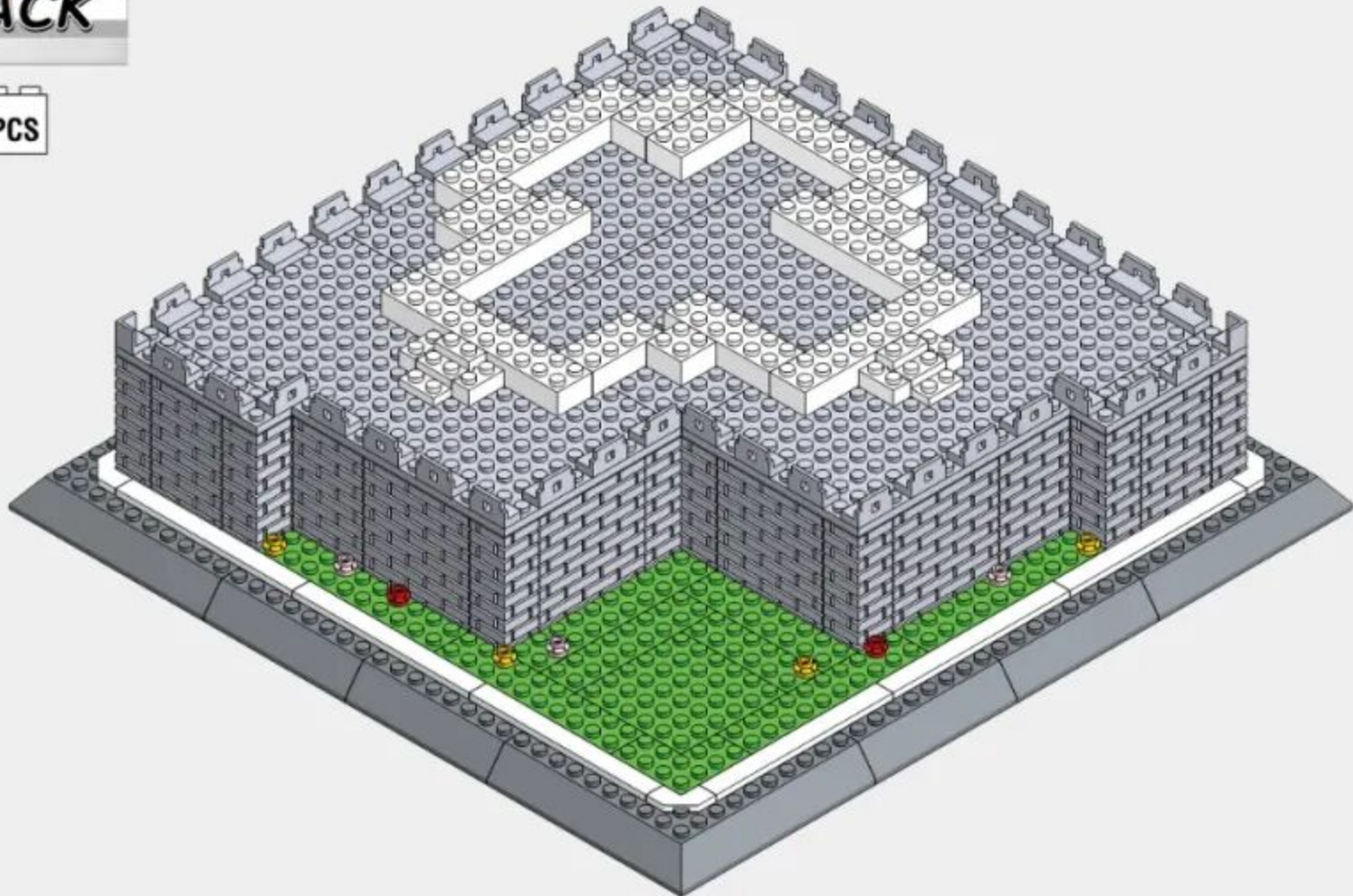

18

1-1

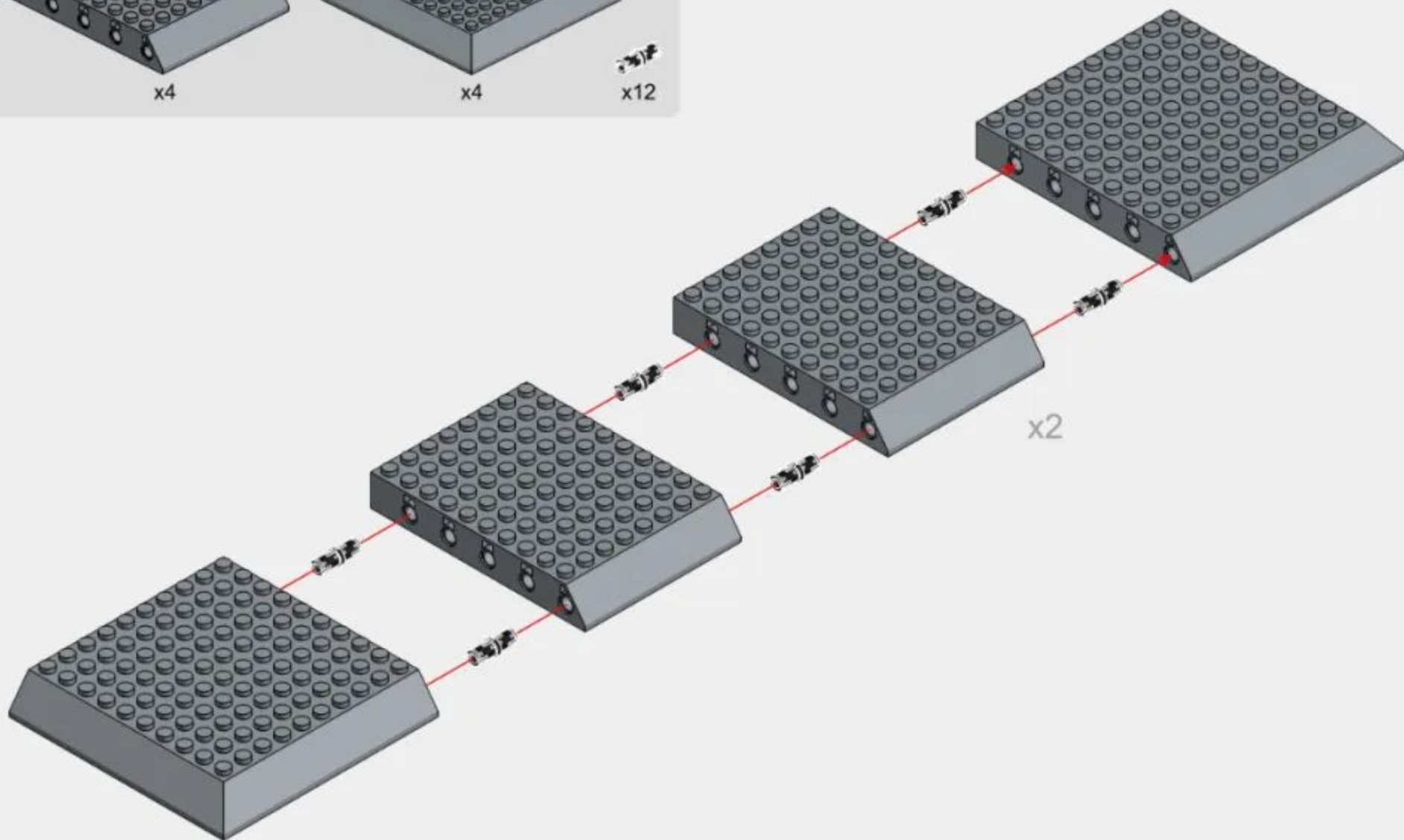
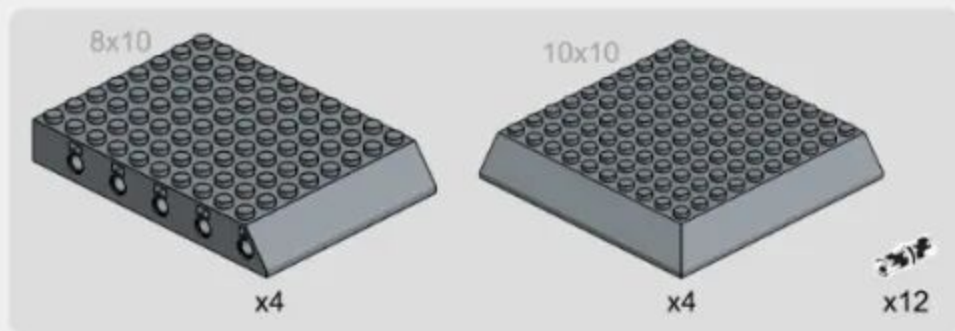

1-2

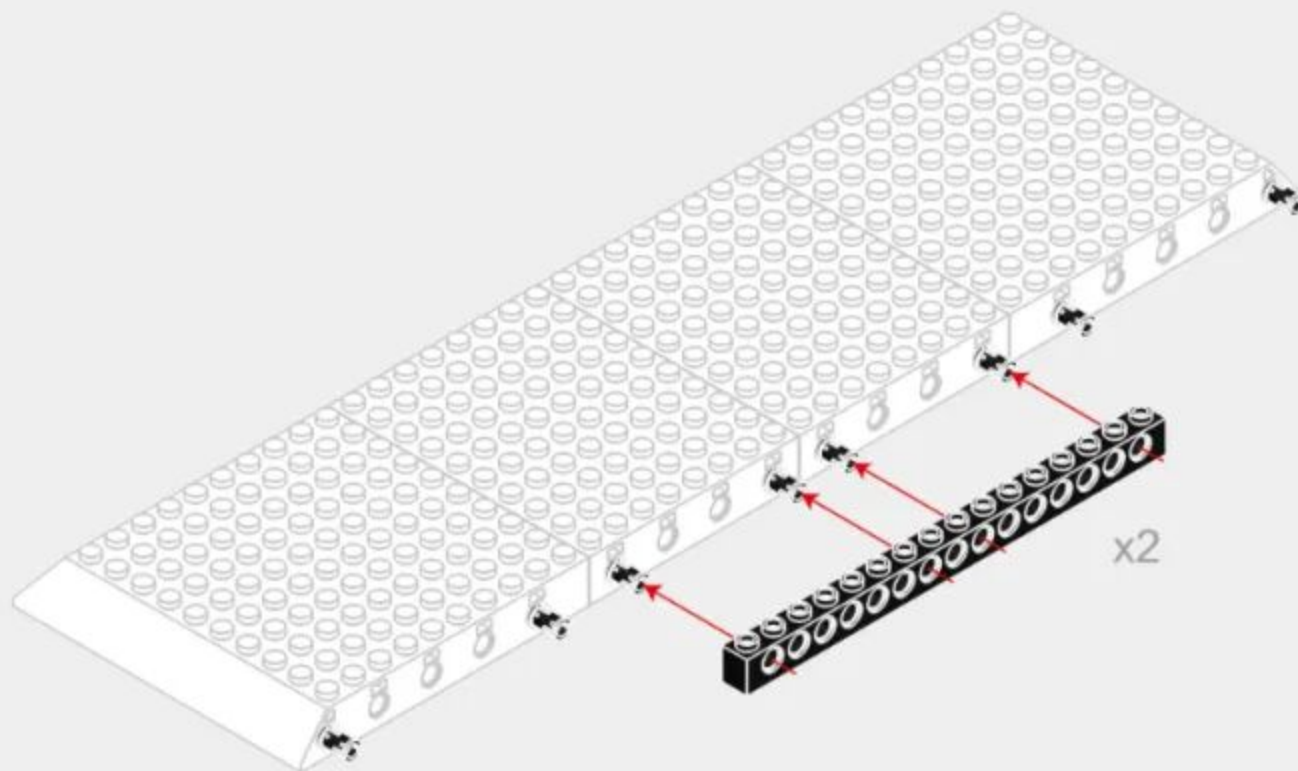
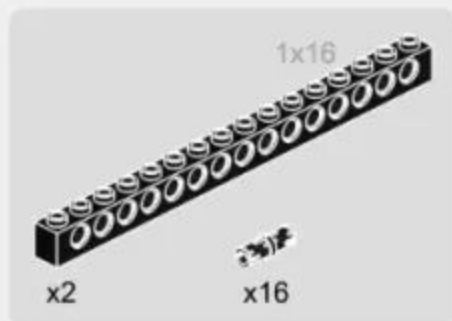

1-3

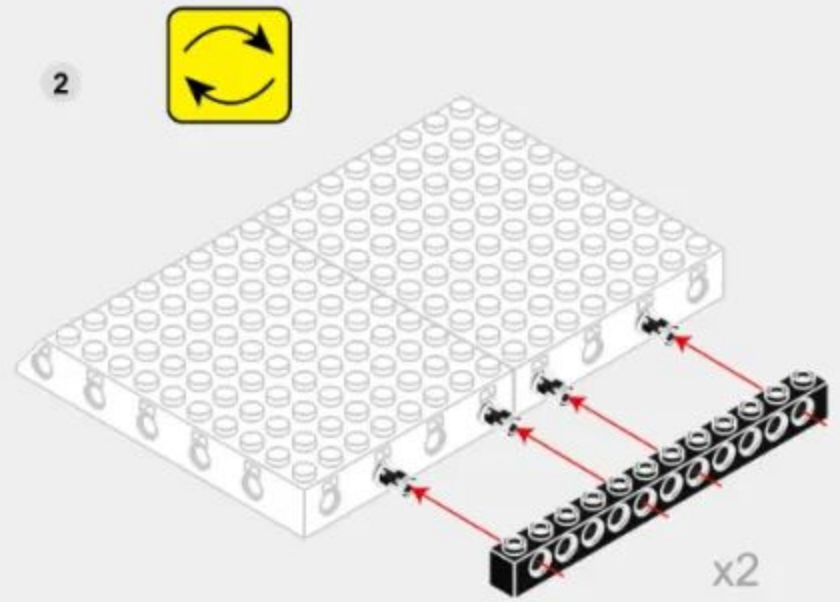
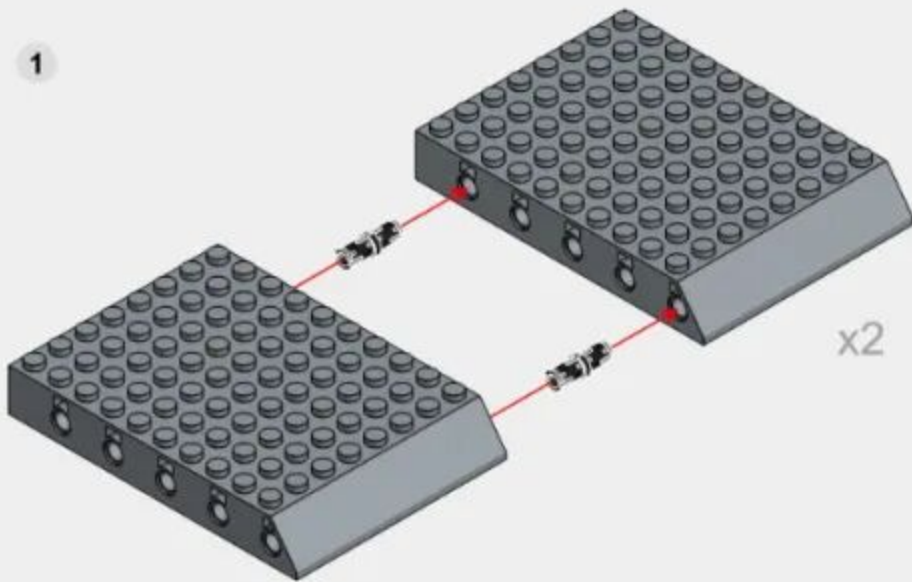
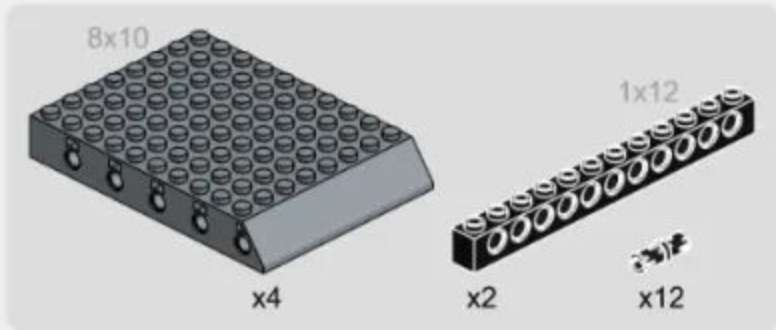

1-4

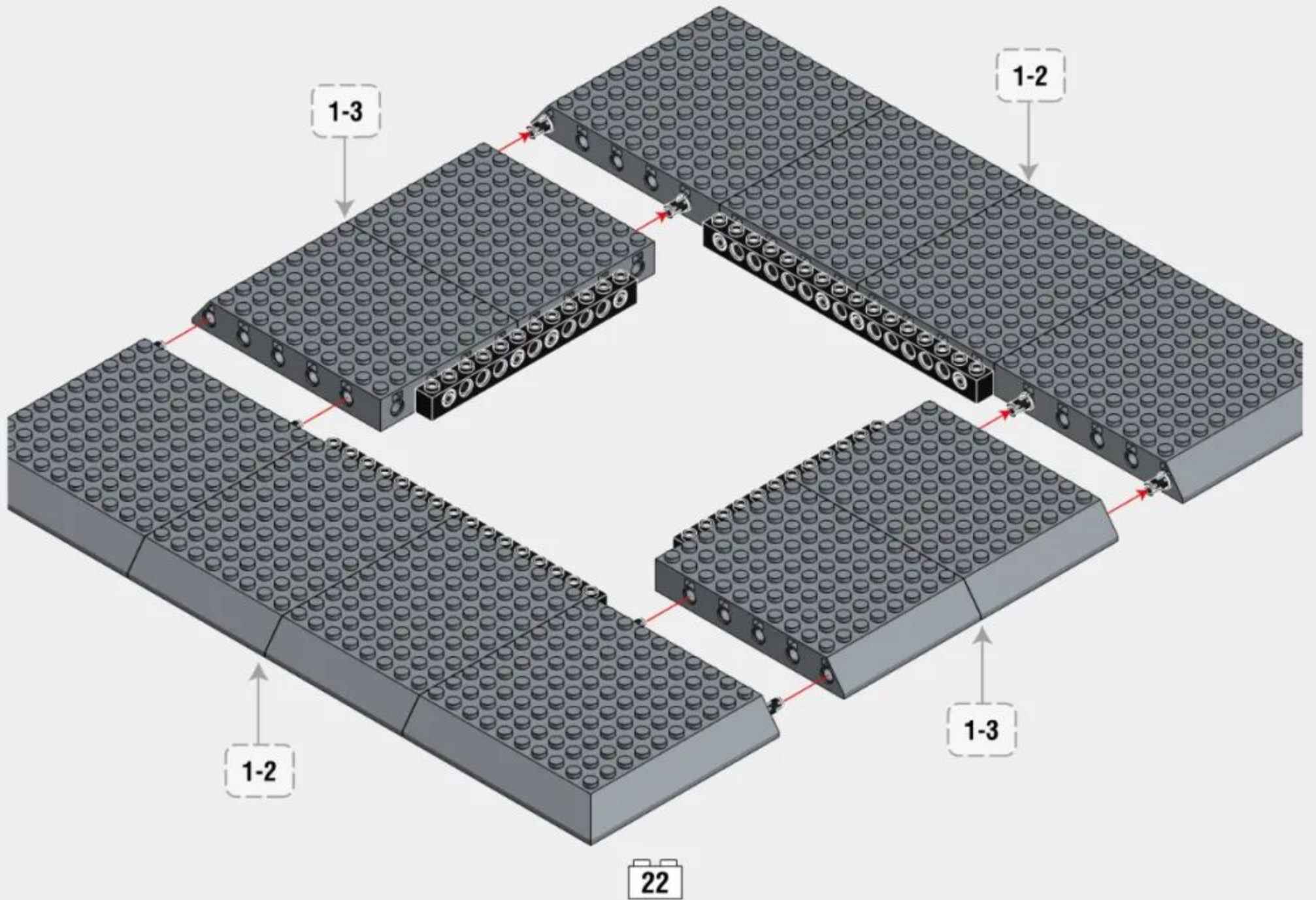

1-5

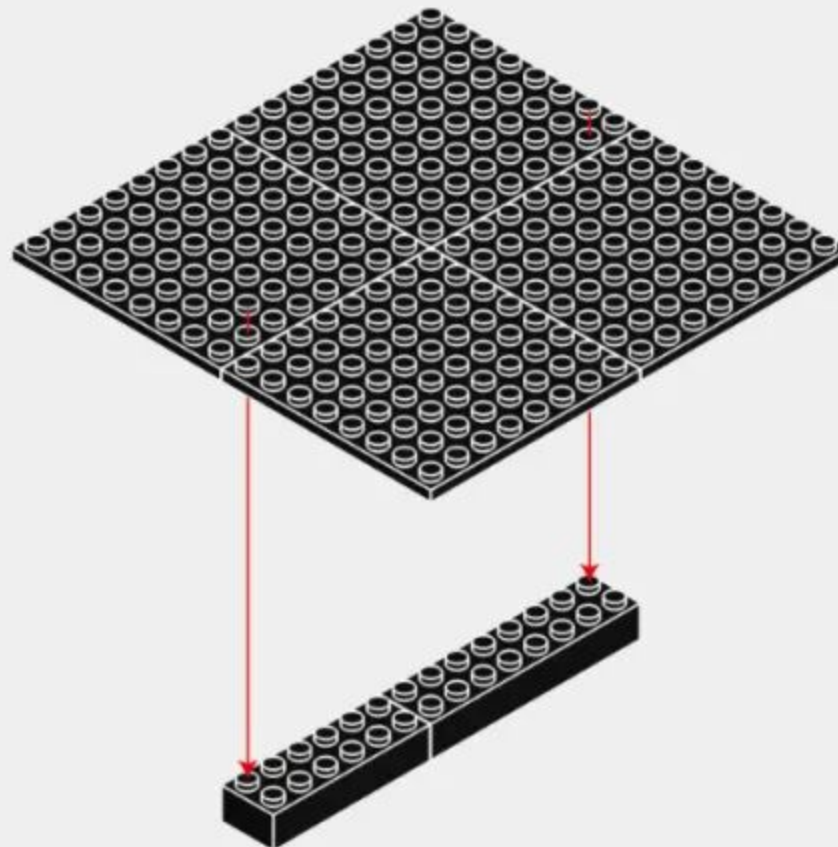
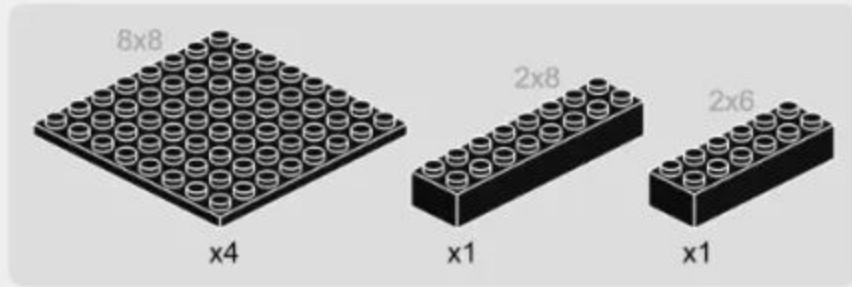

1-6

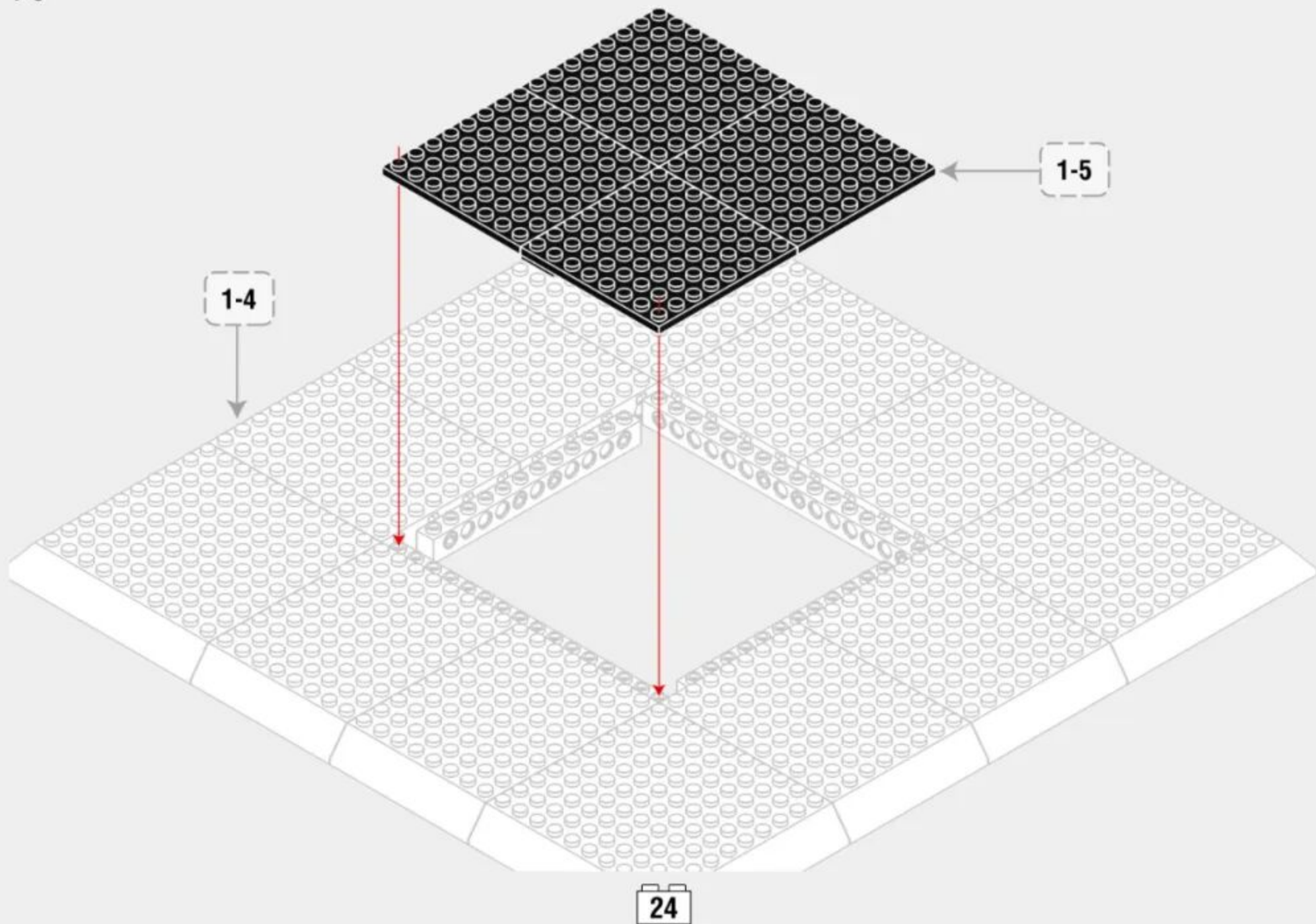

1-7

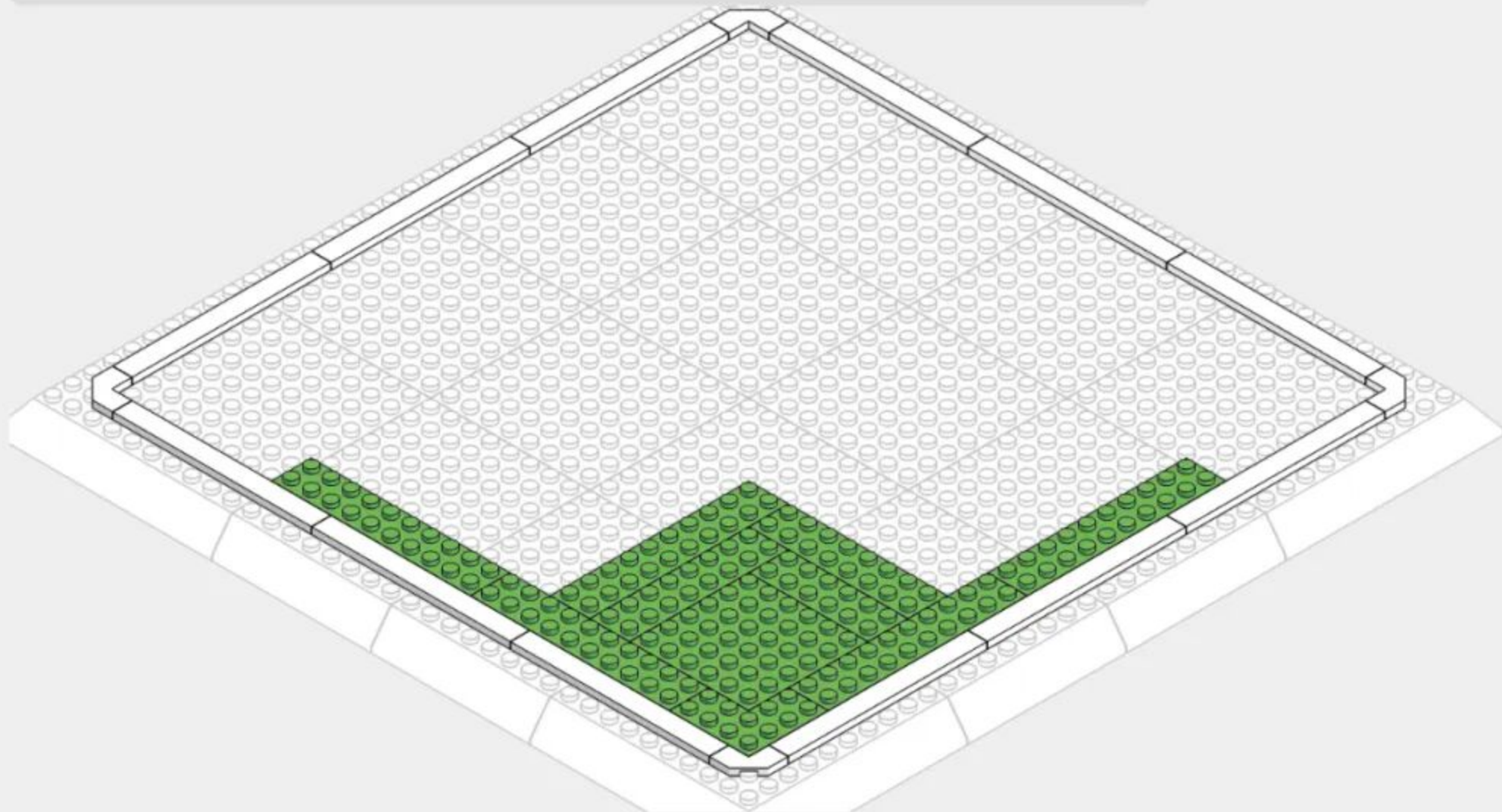
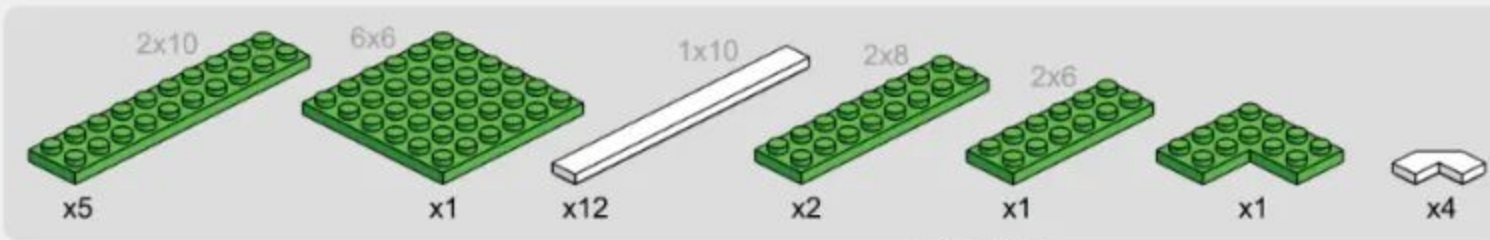

1-8

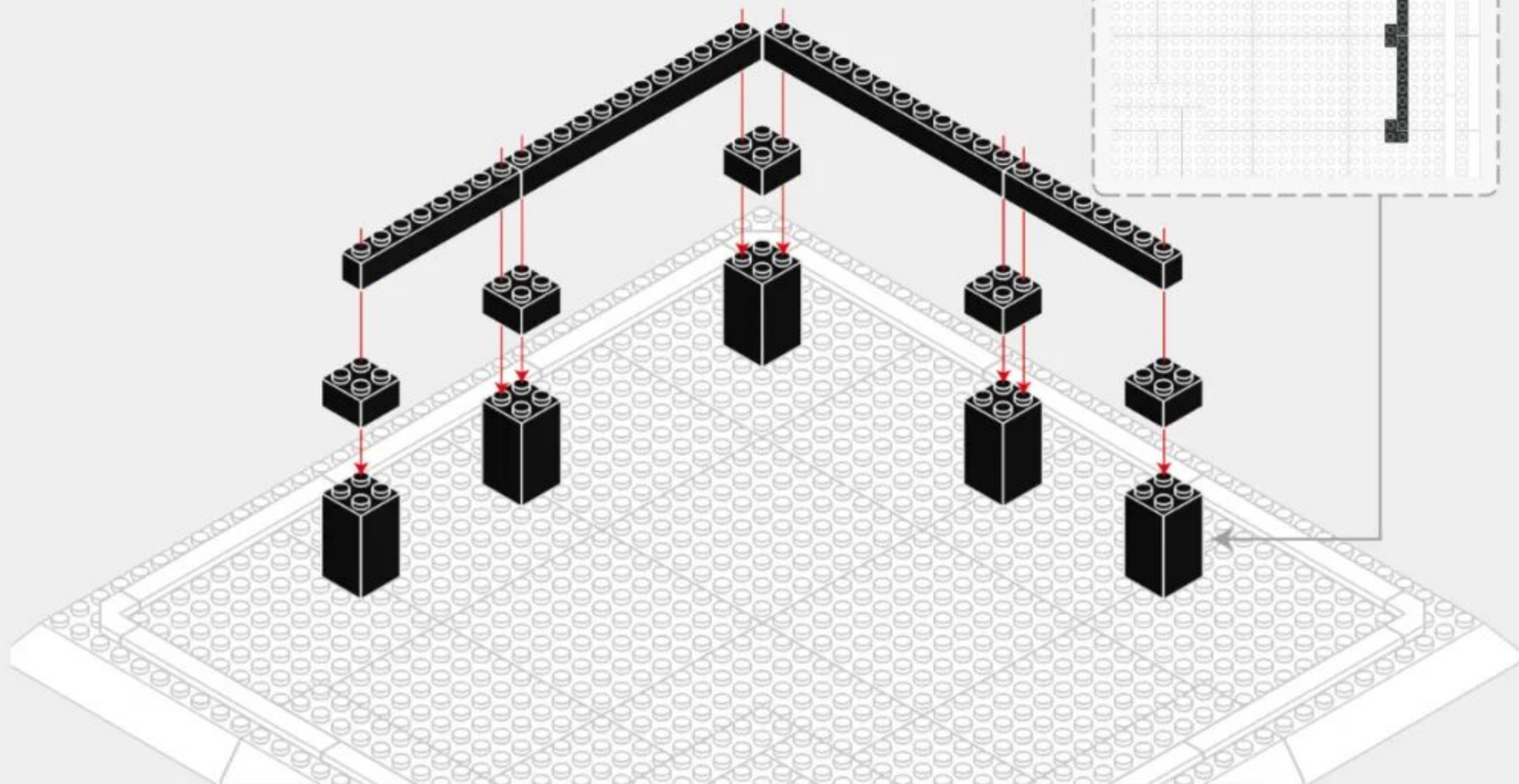
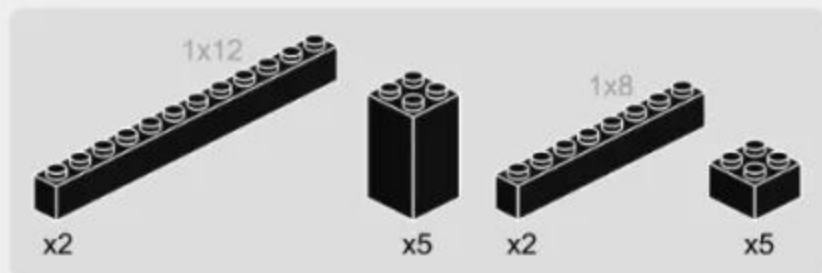

1-10

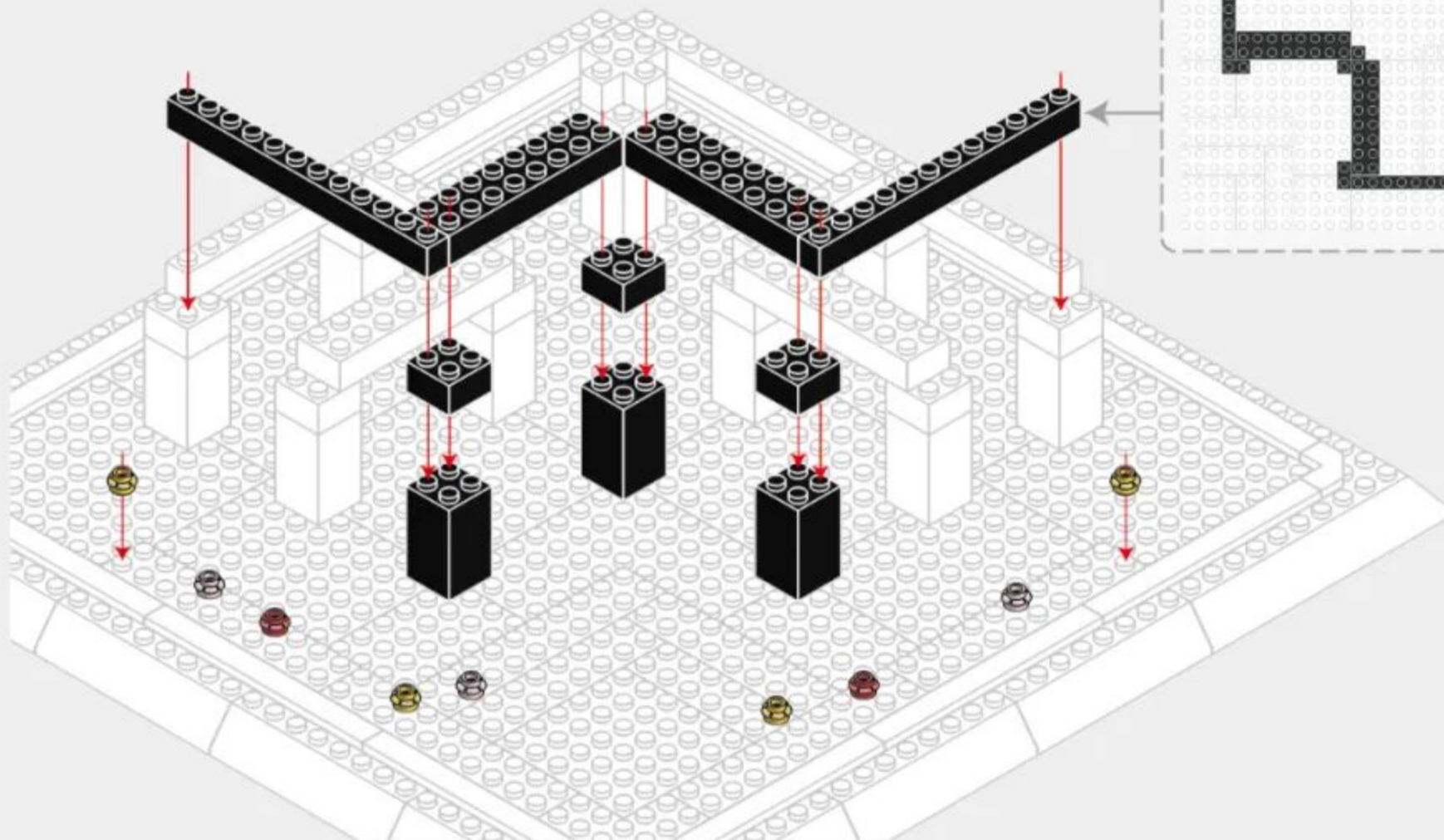
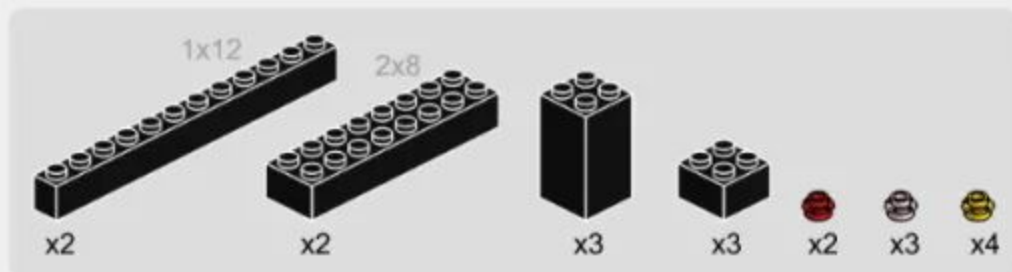

1-11

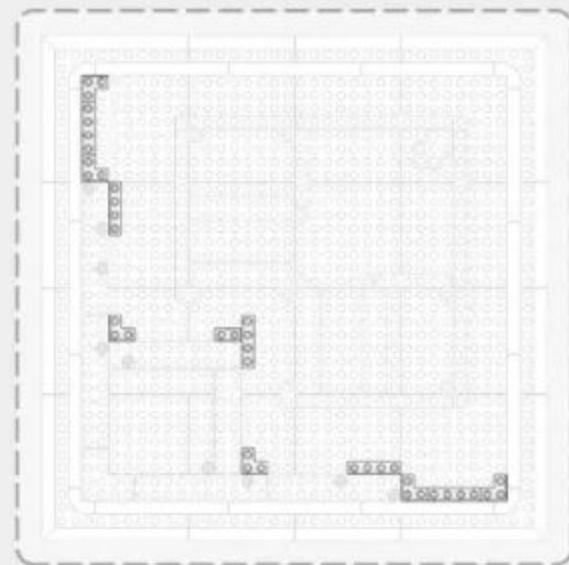
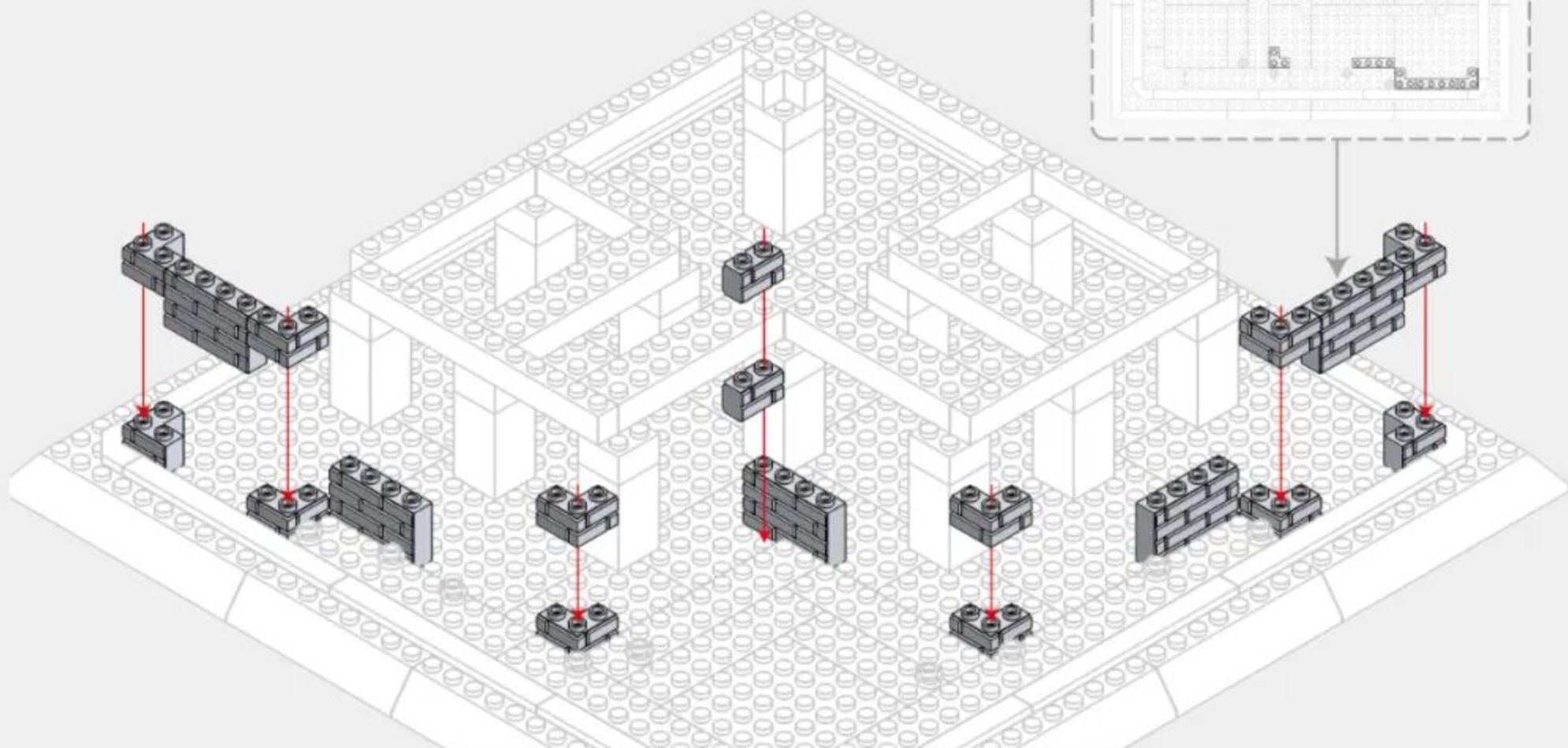
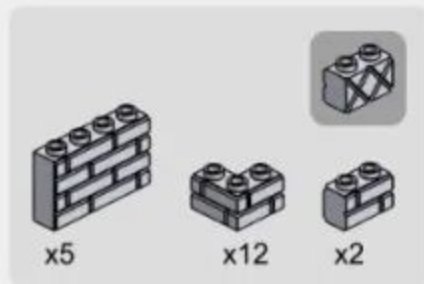

1-12

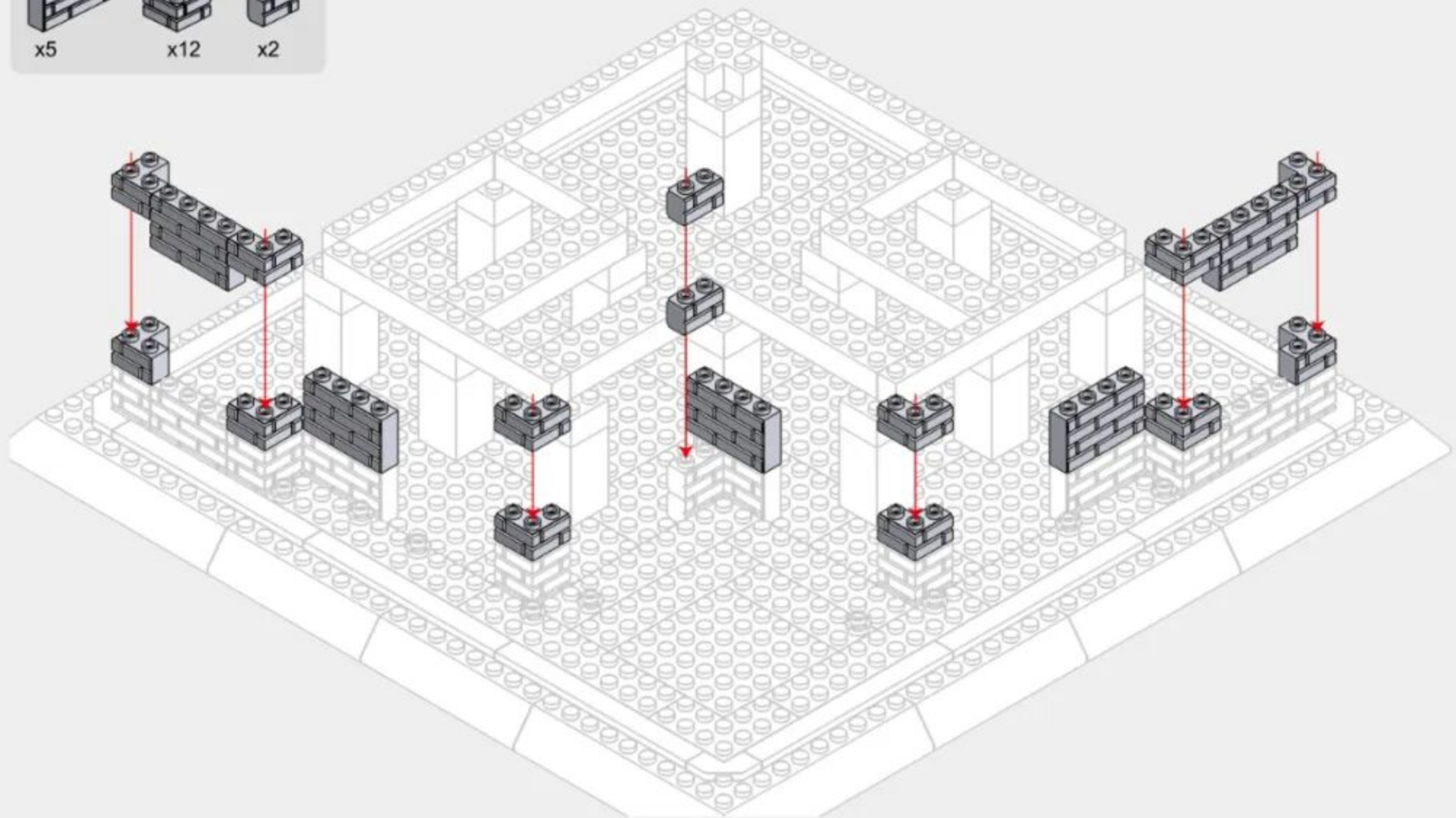
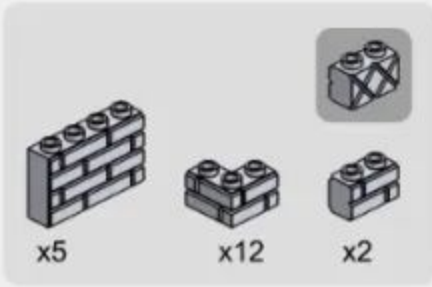

1-13

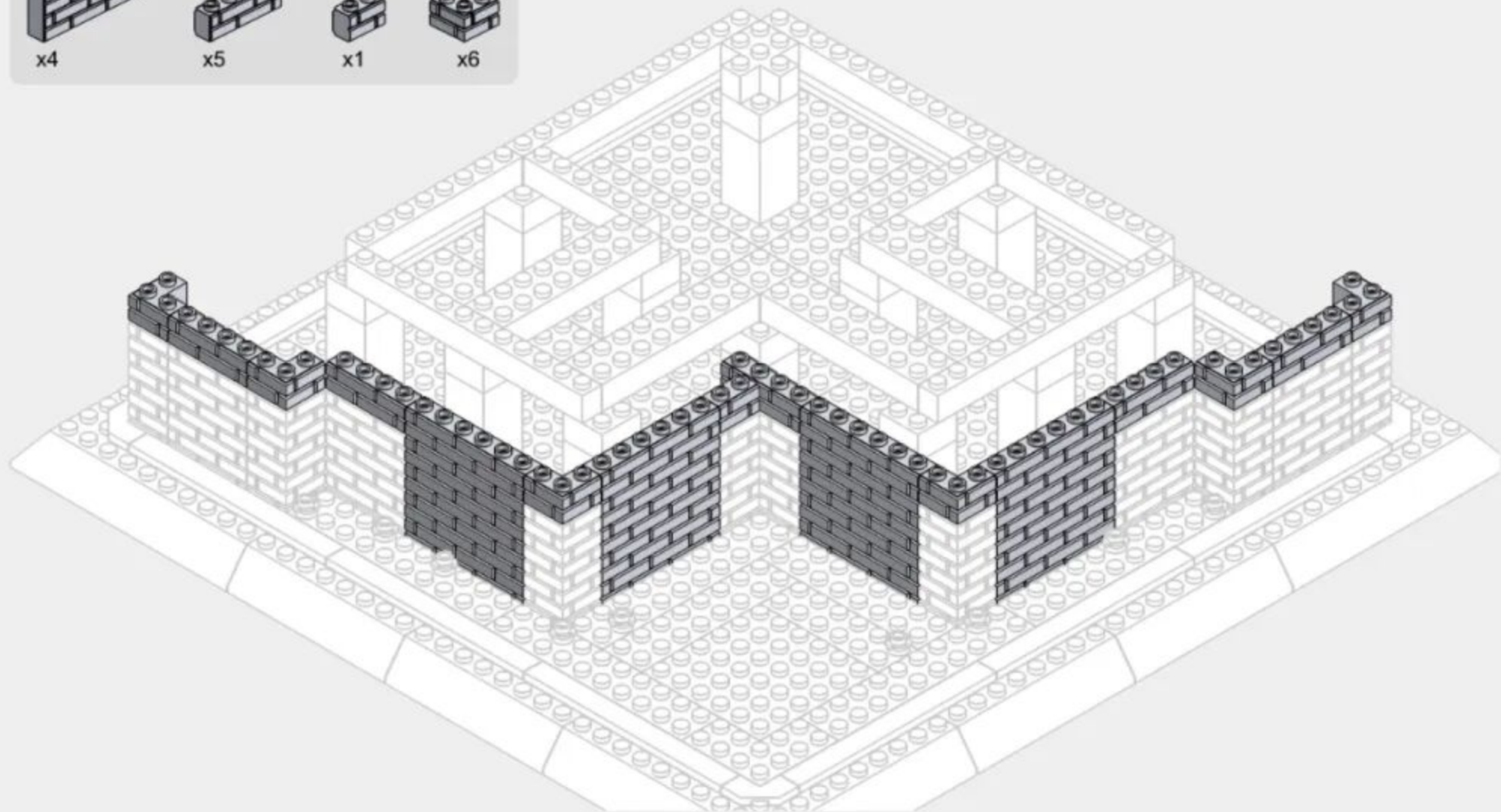
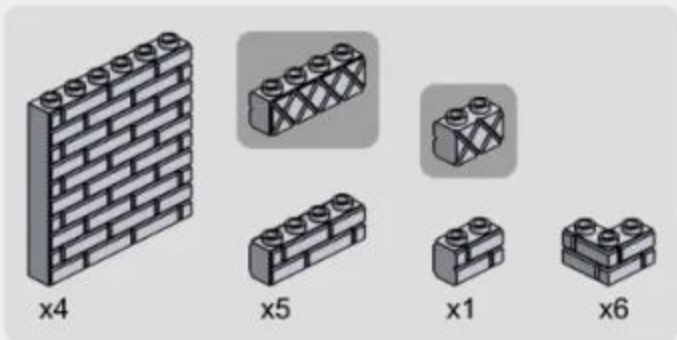

1-14

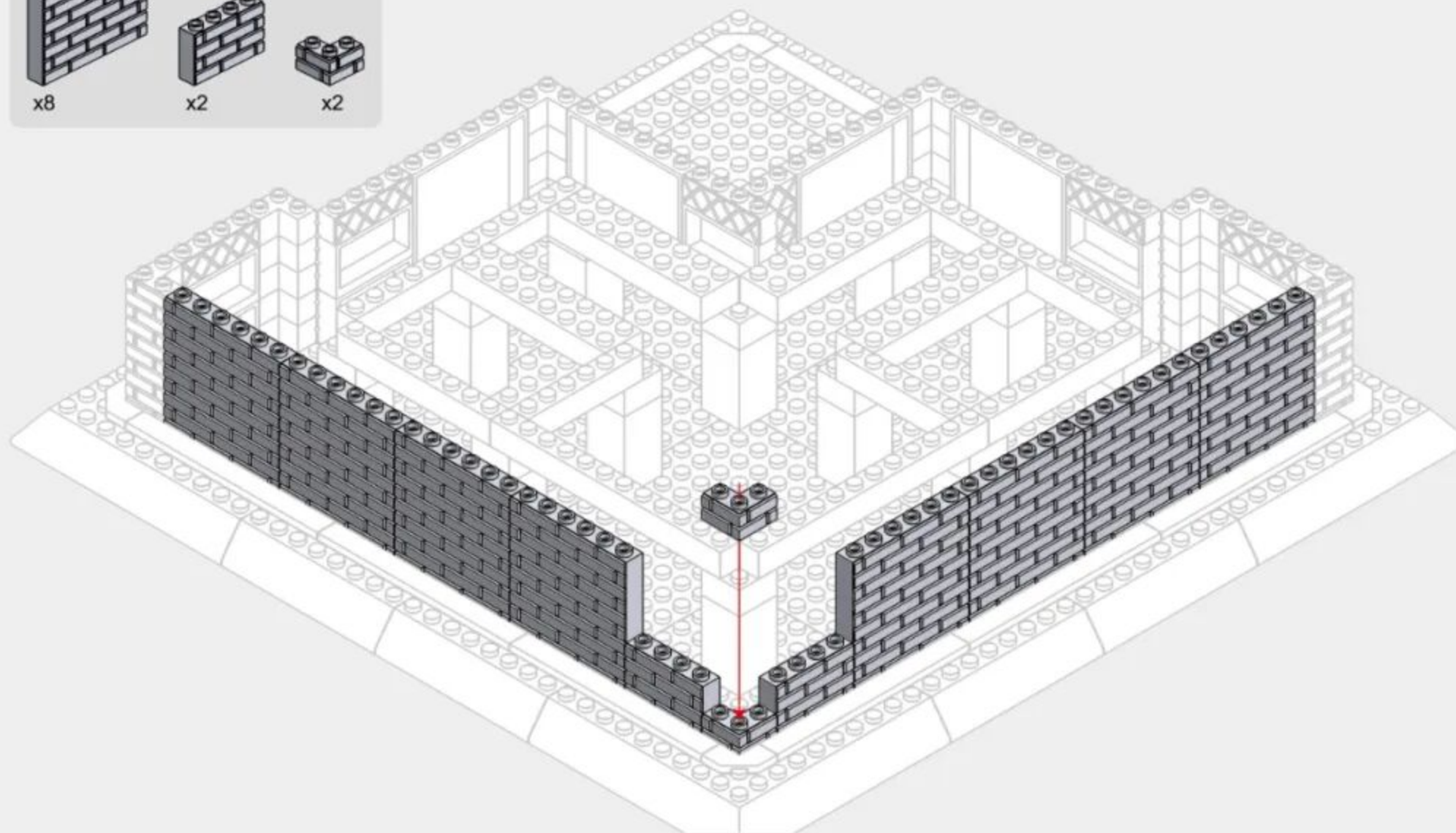
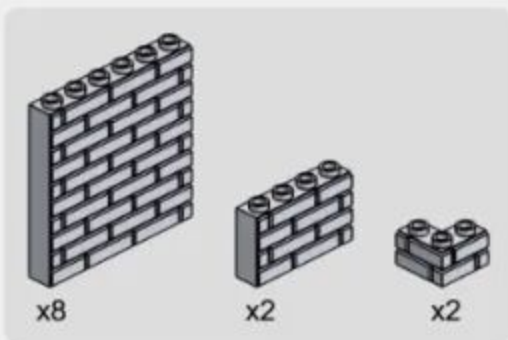

1-15

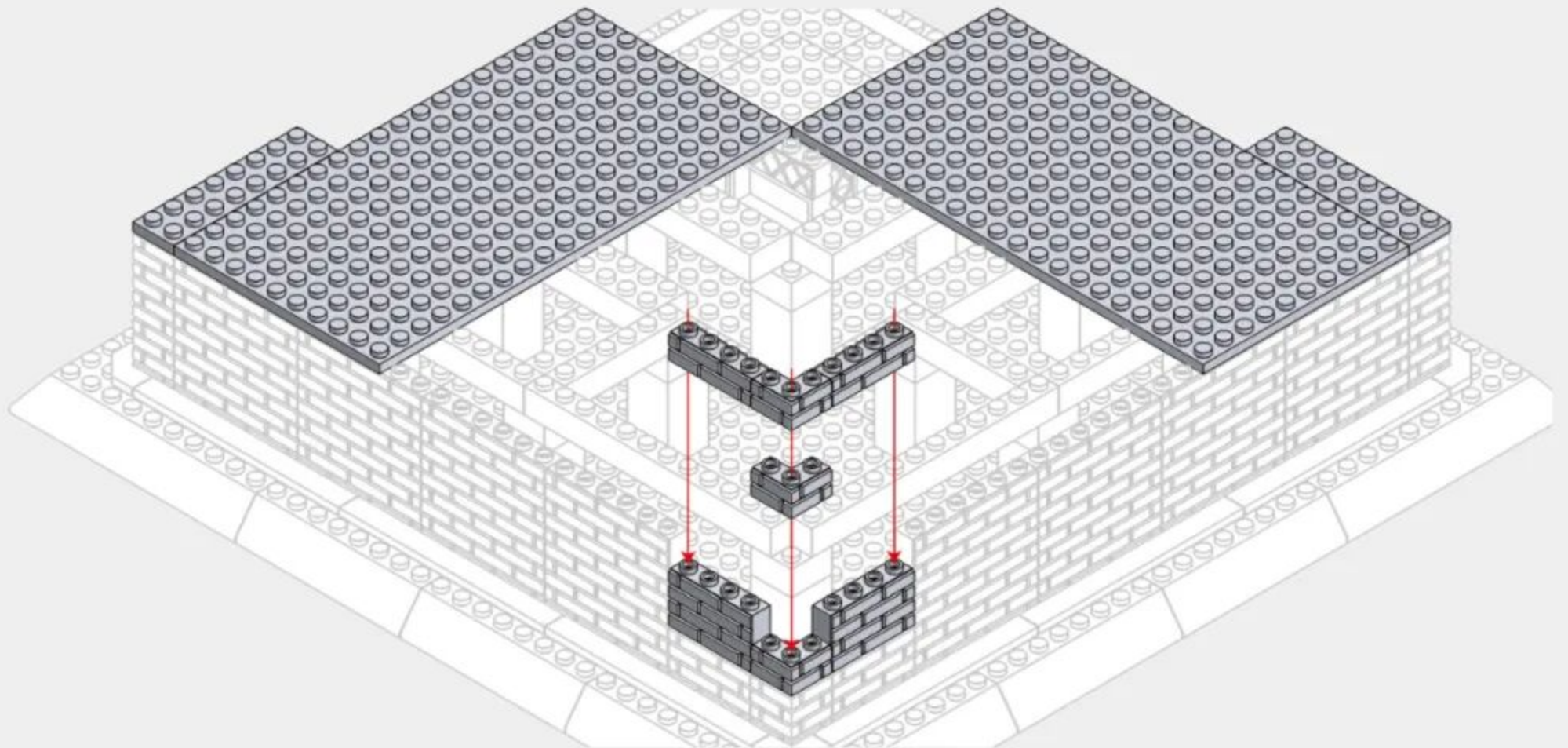
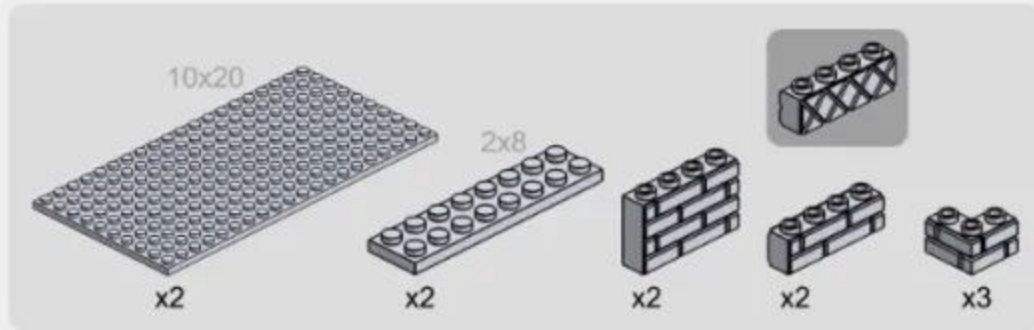

1-16

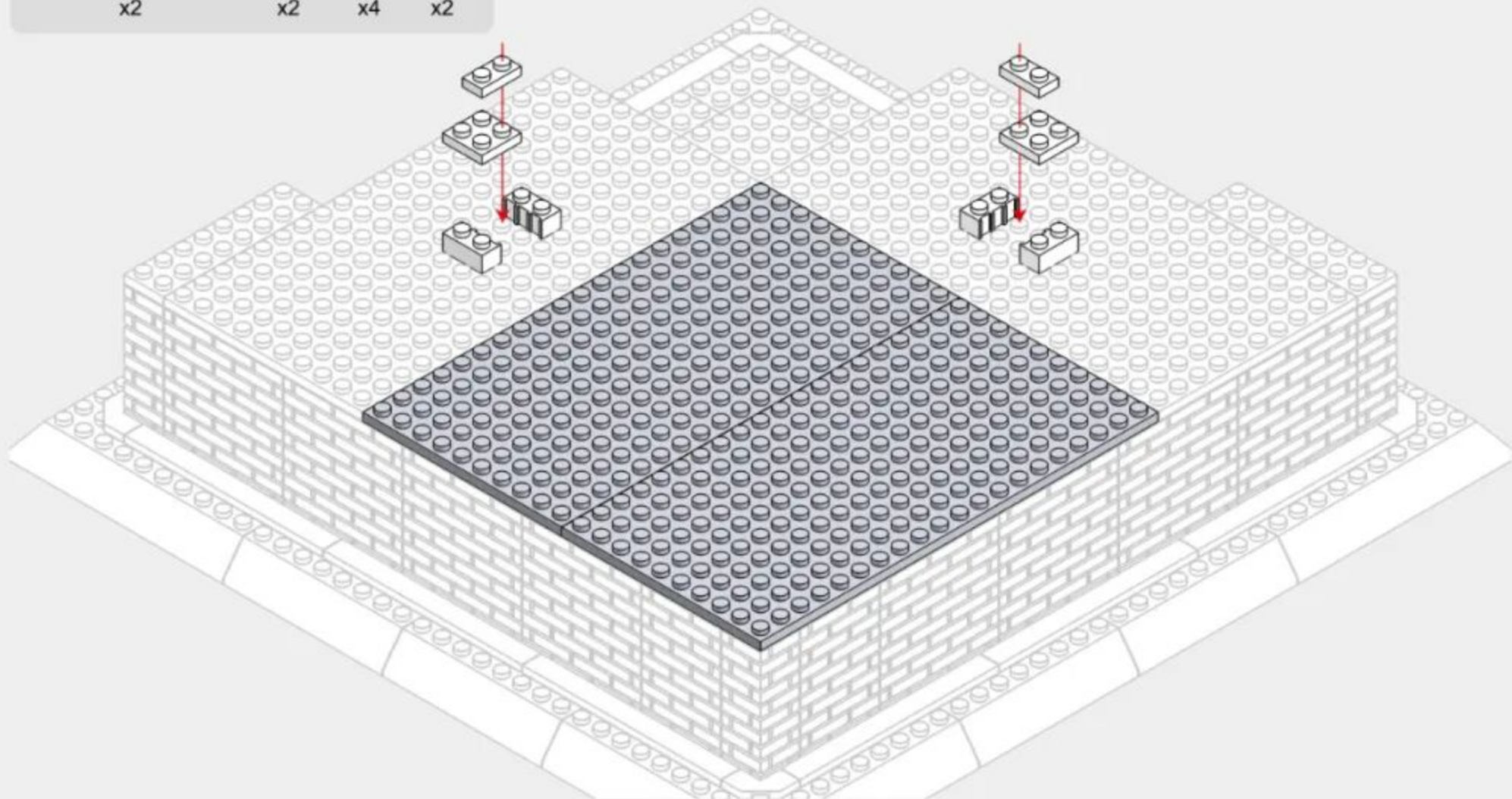
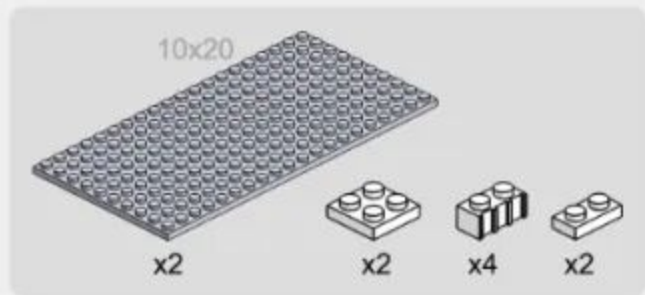

1-18



x40



x2

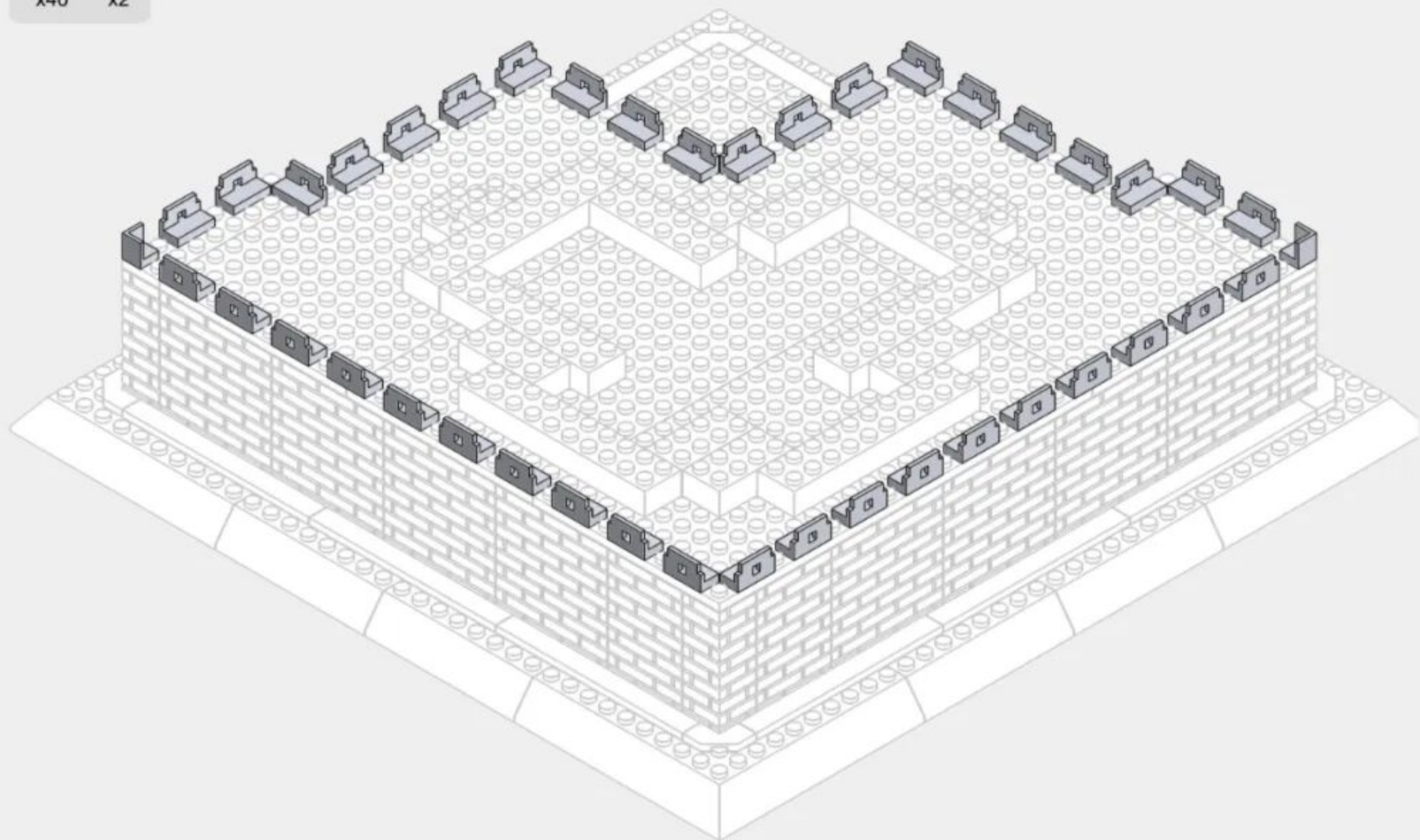

36



272PCS

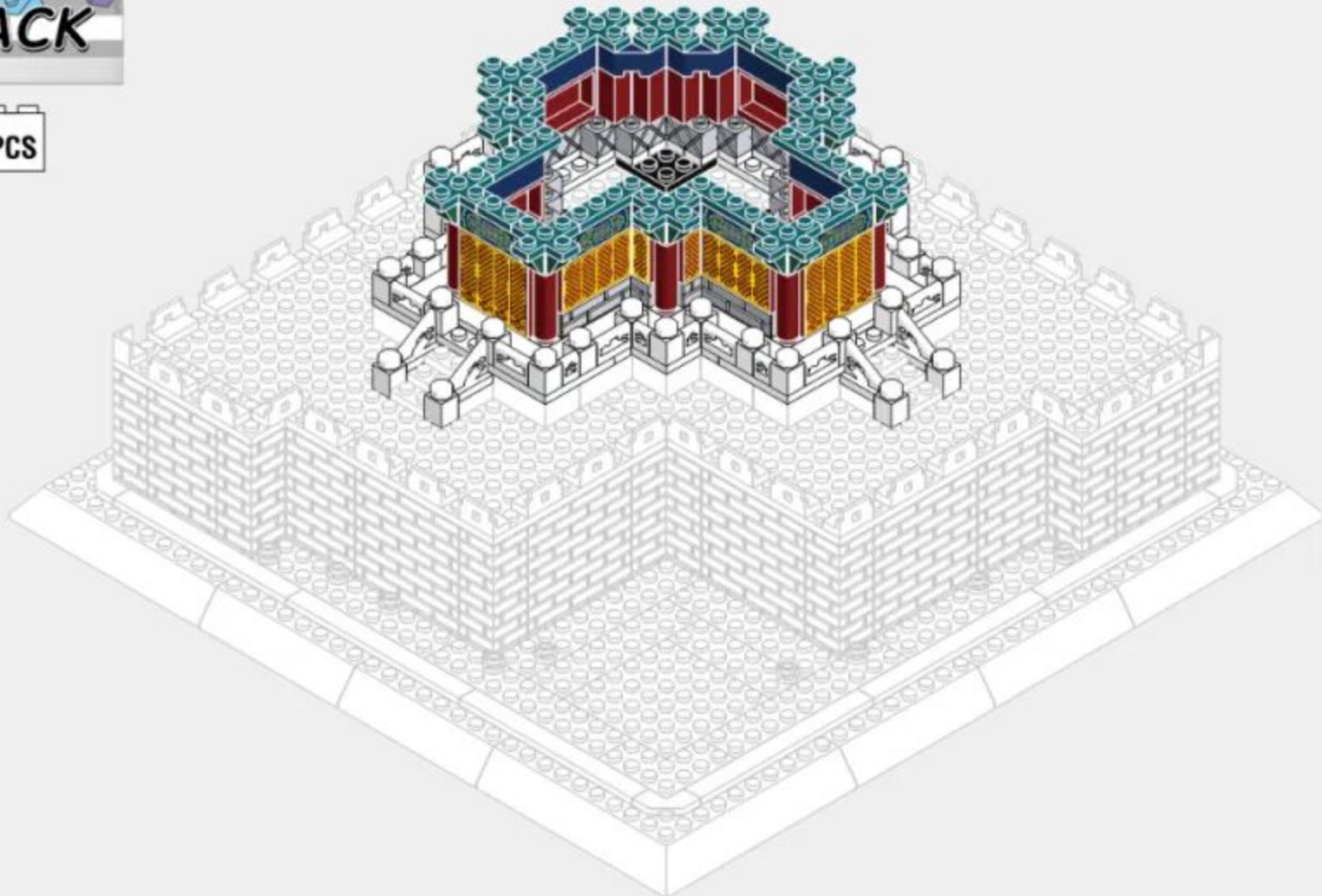

2-1

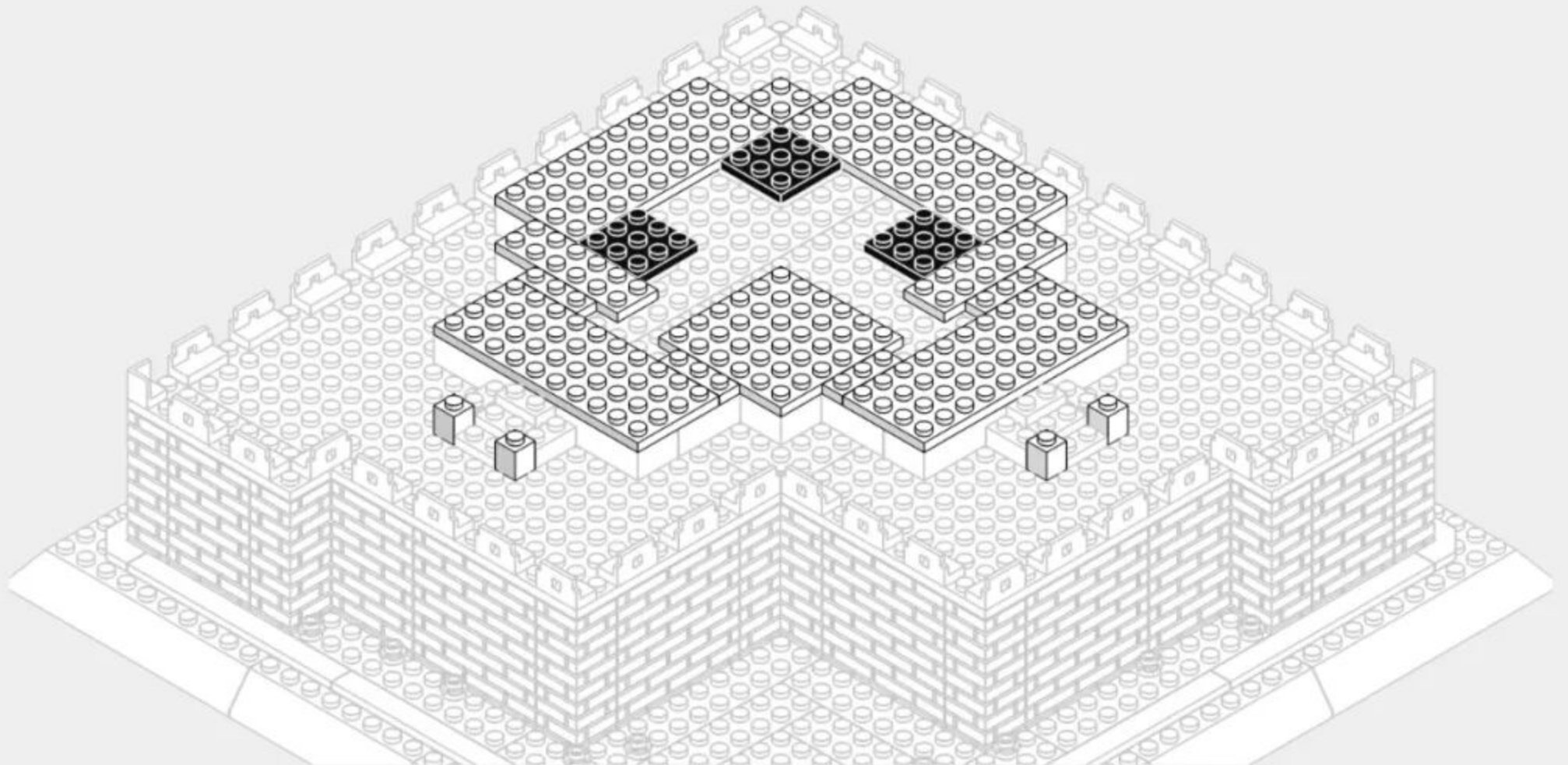
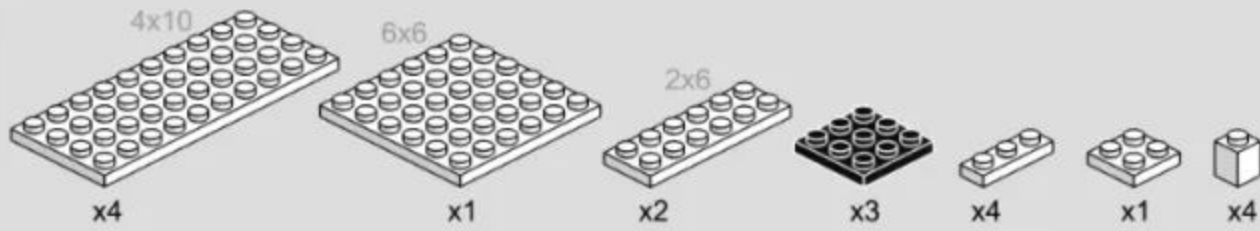

2-2

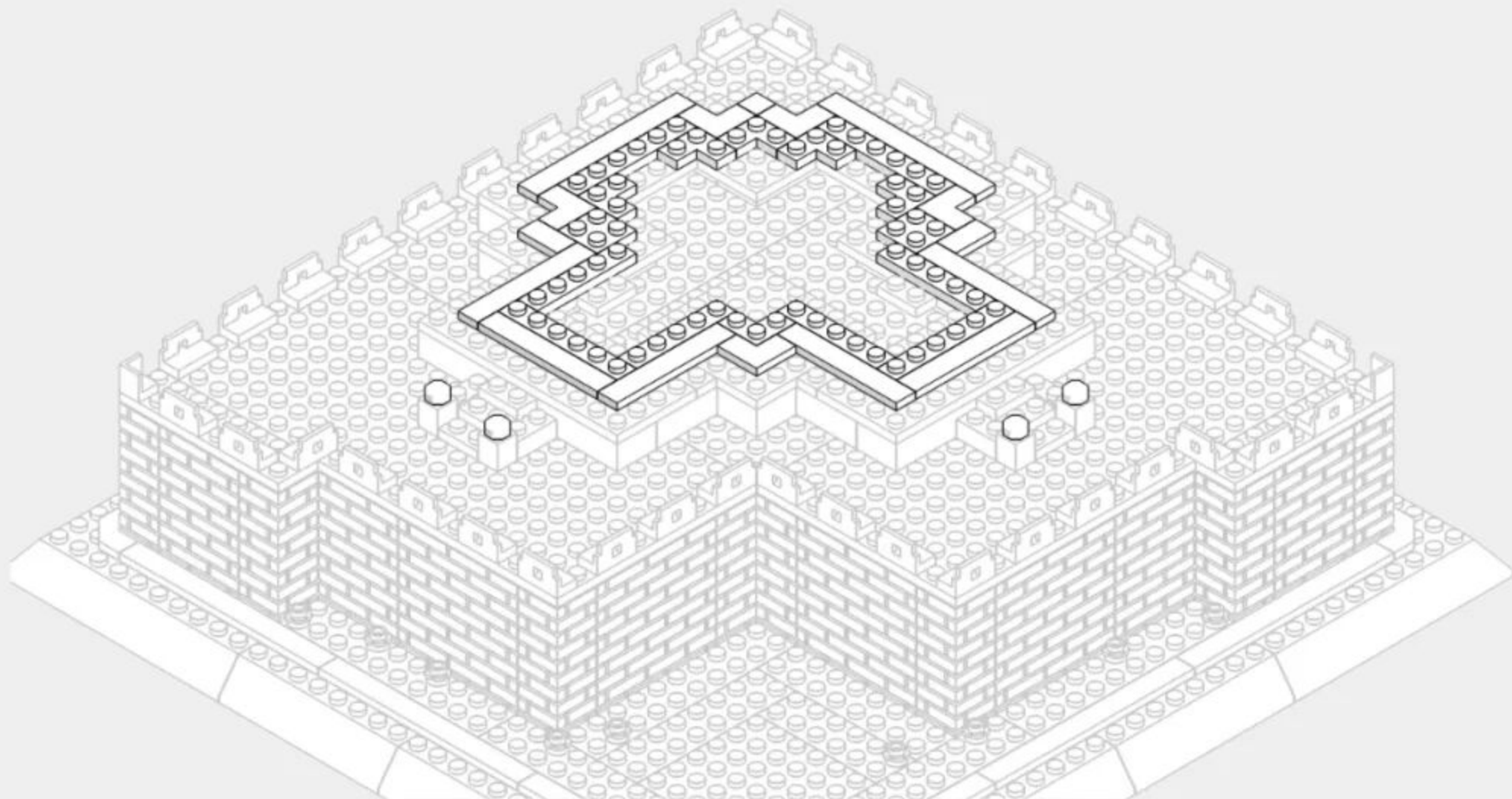
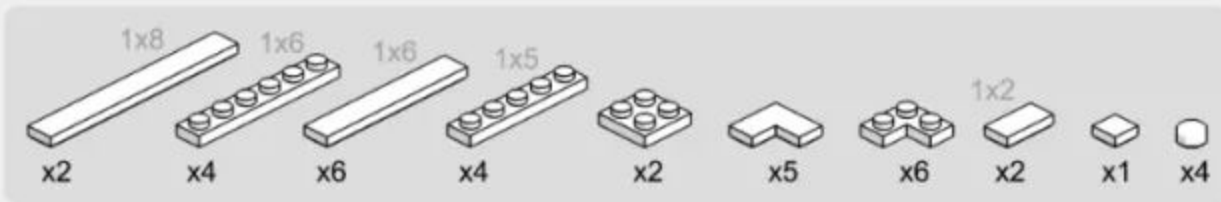

2-3



x10



x22



x12

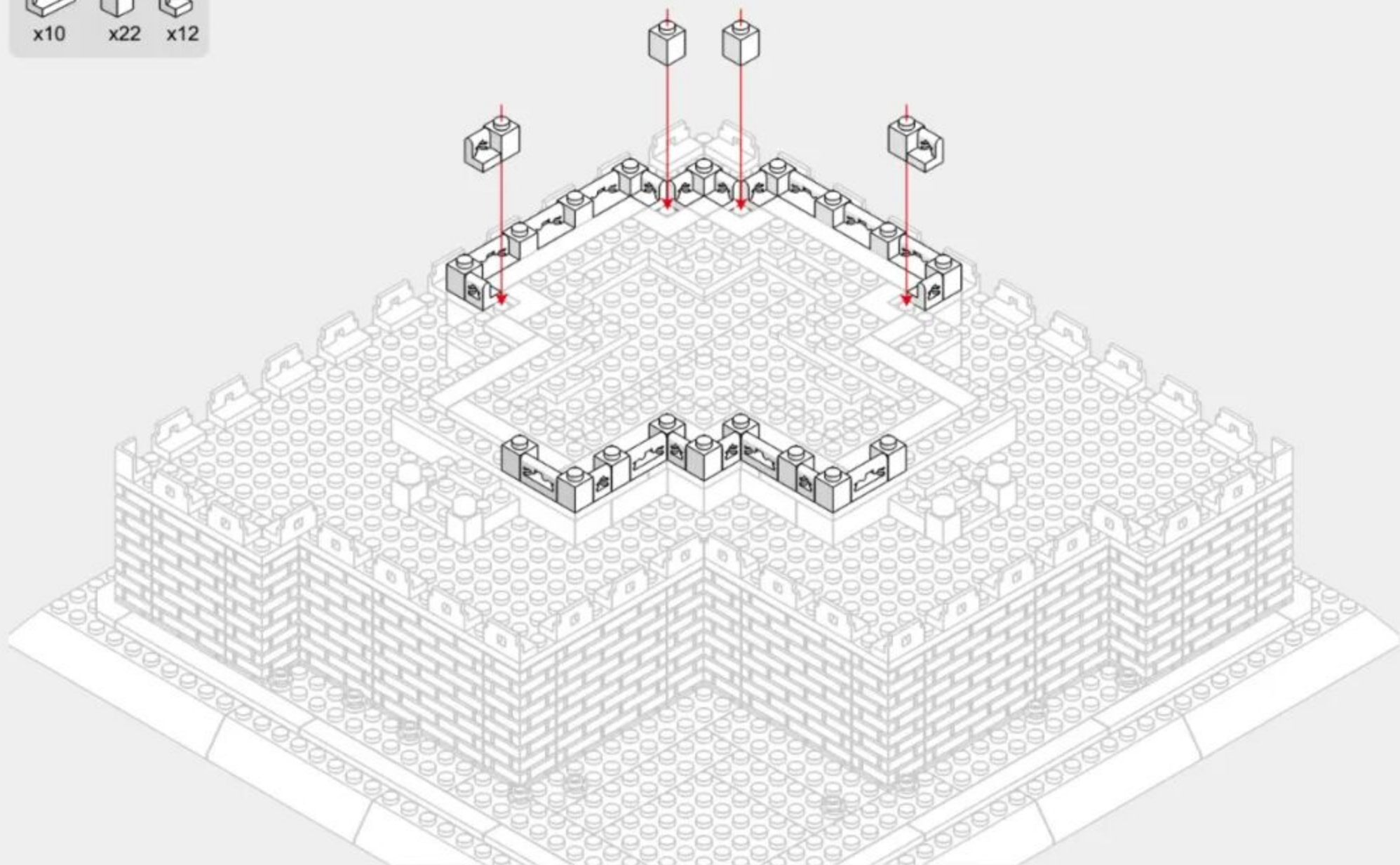

2-4



x4



x10



x4

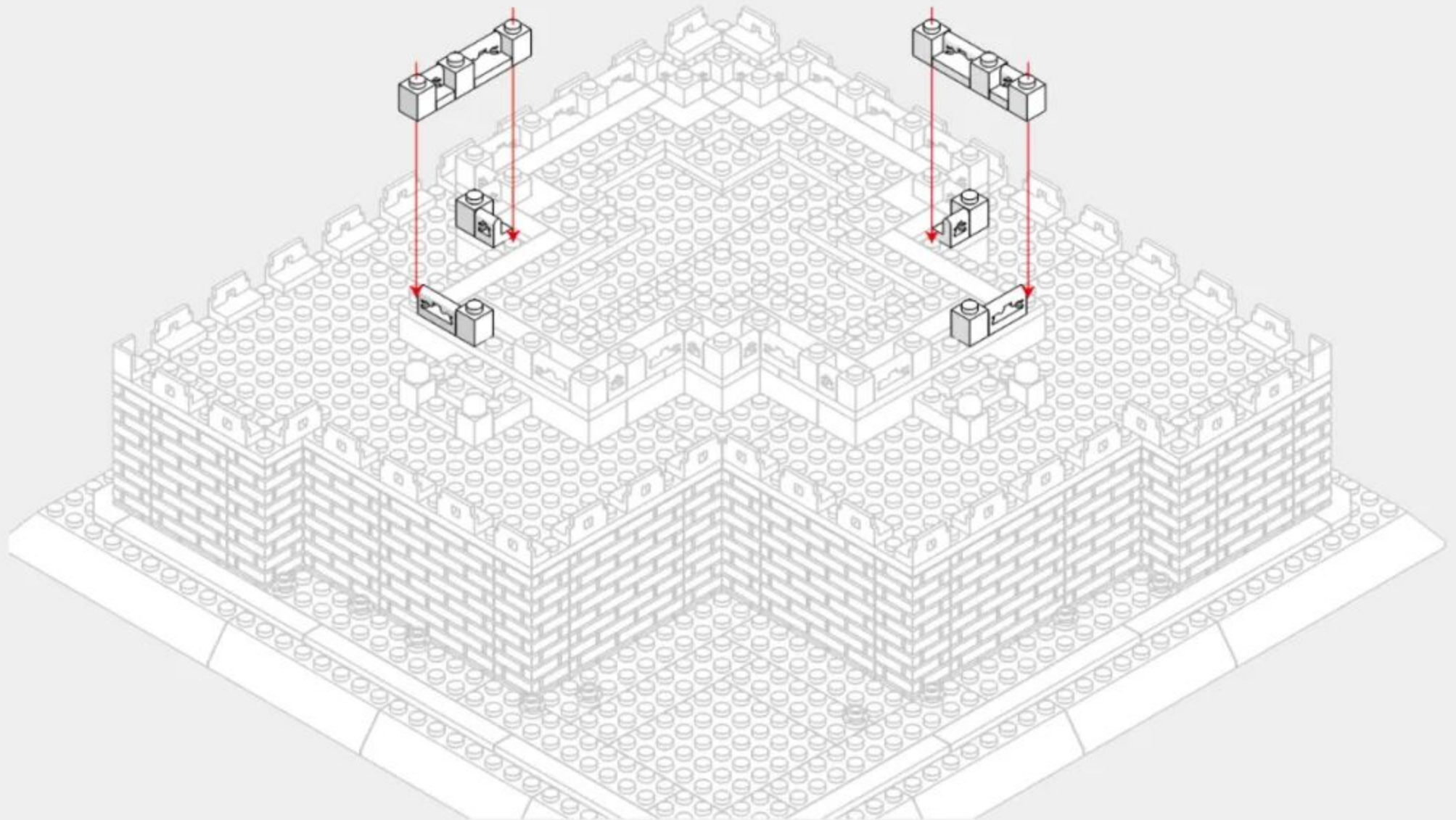

2-5



x4



x32

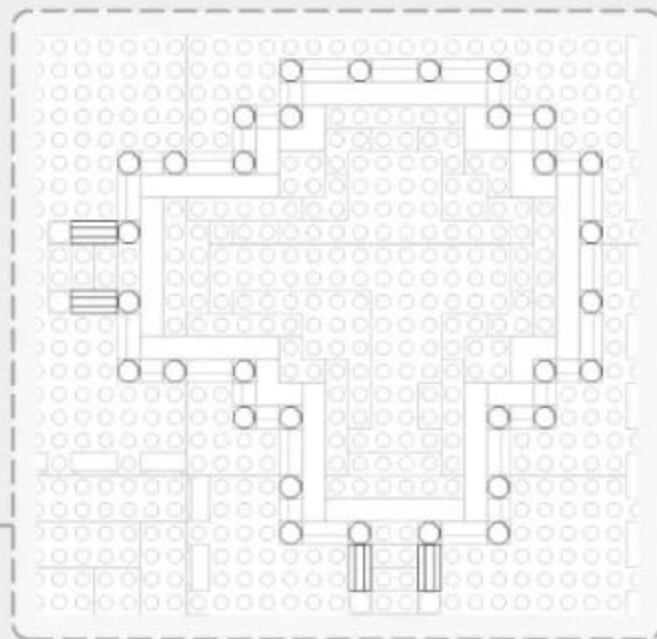
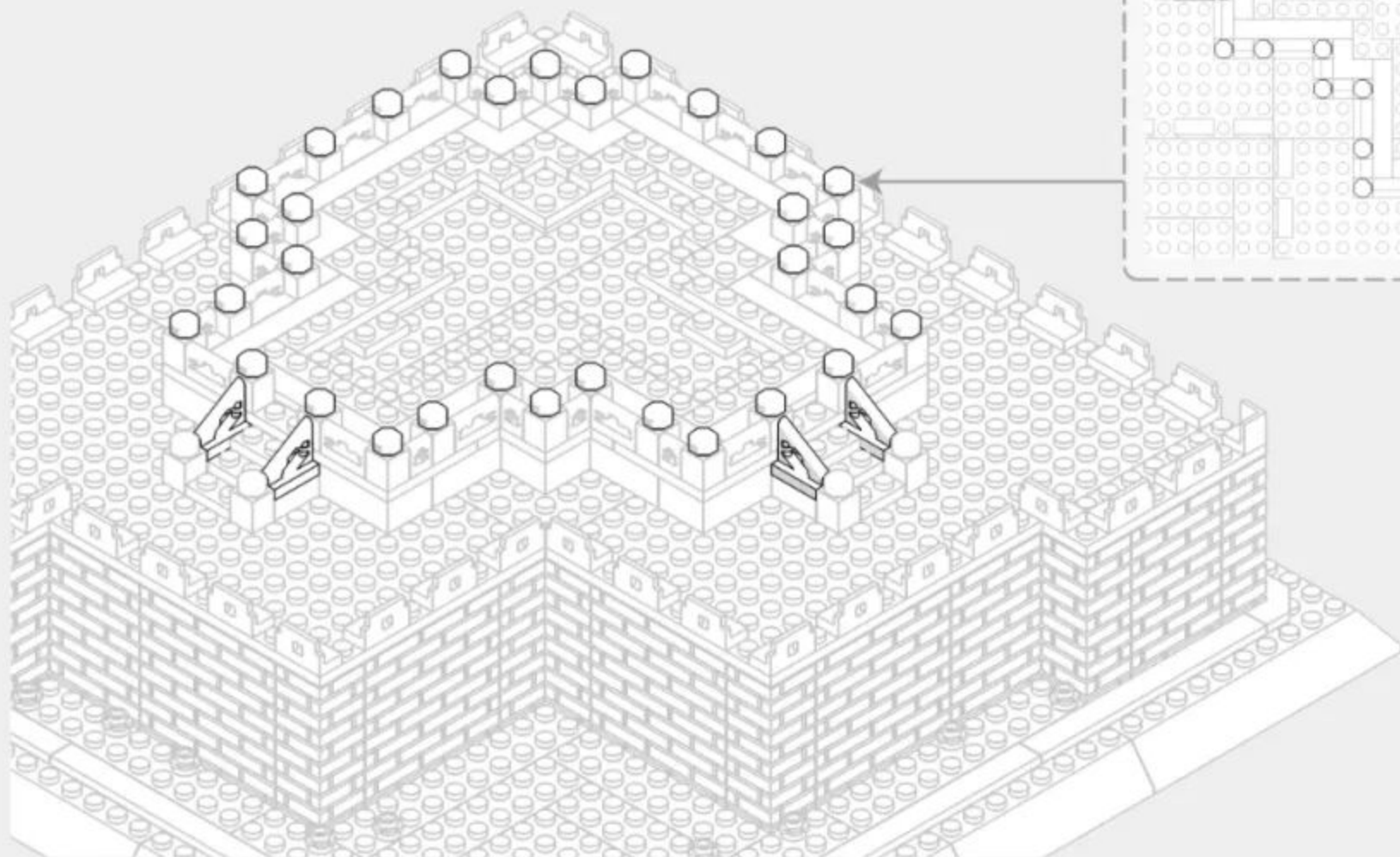

2-6

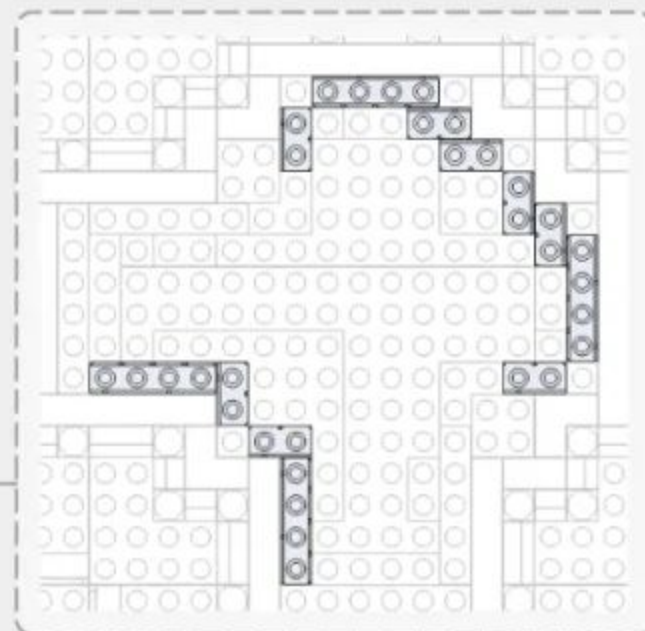
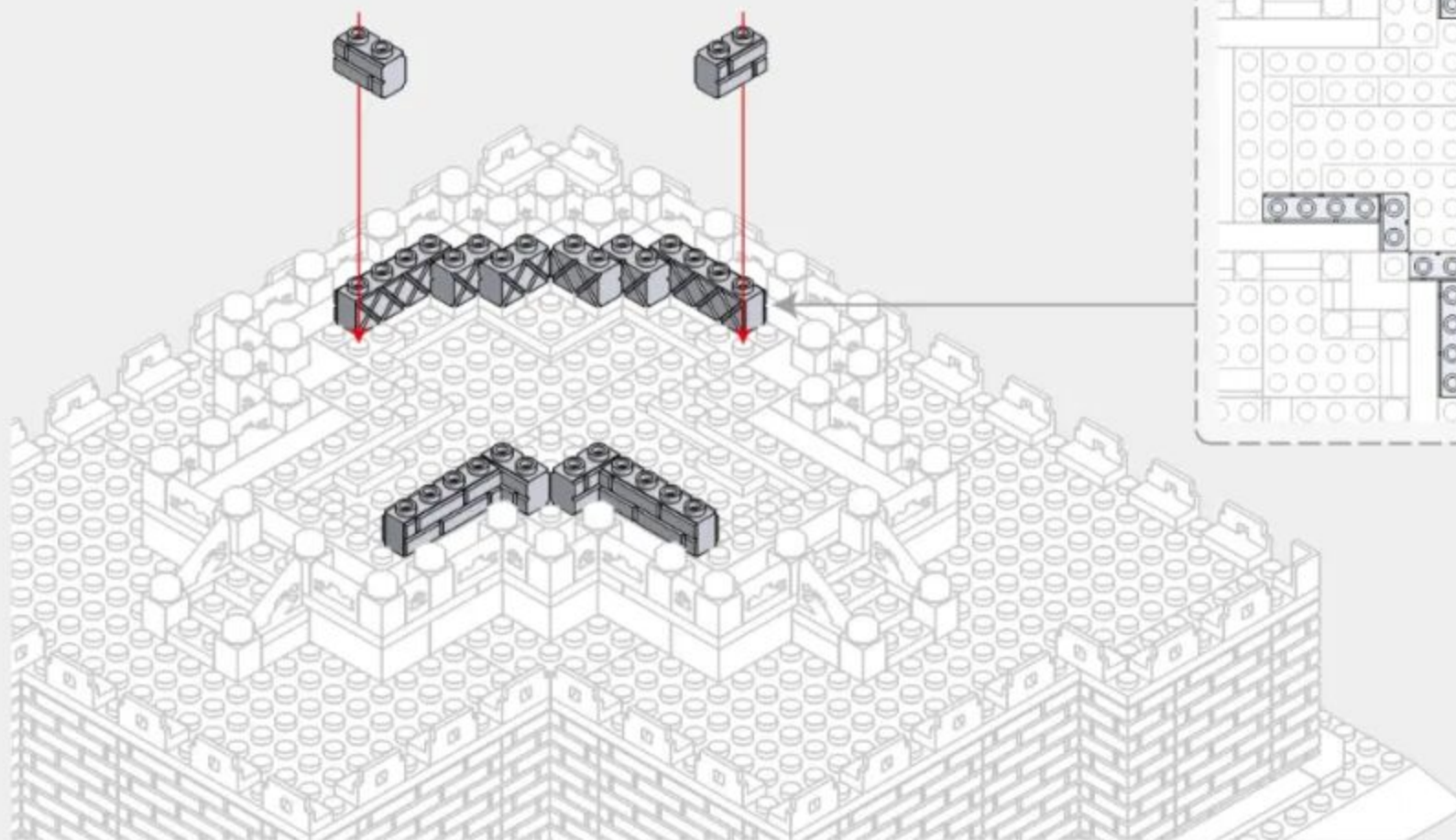
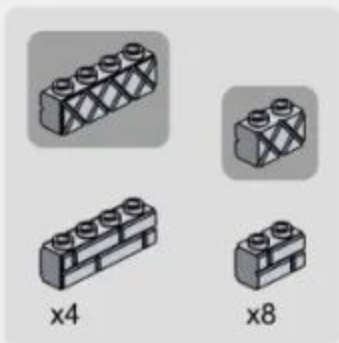

2-7

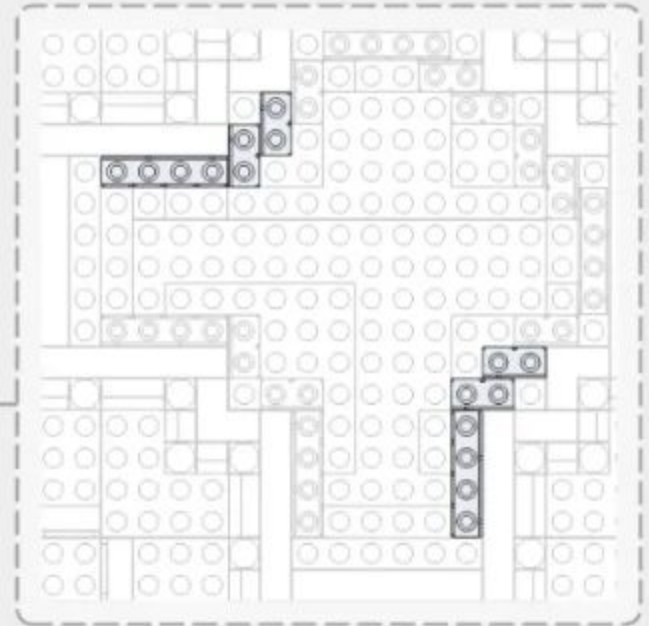
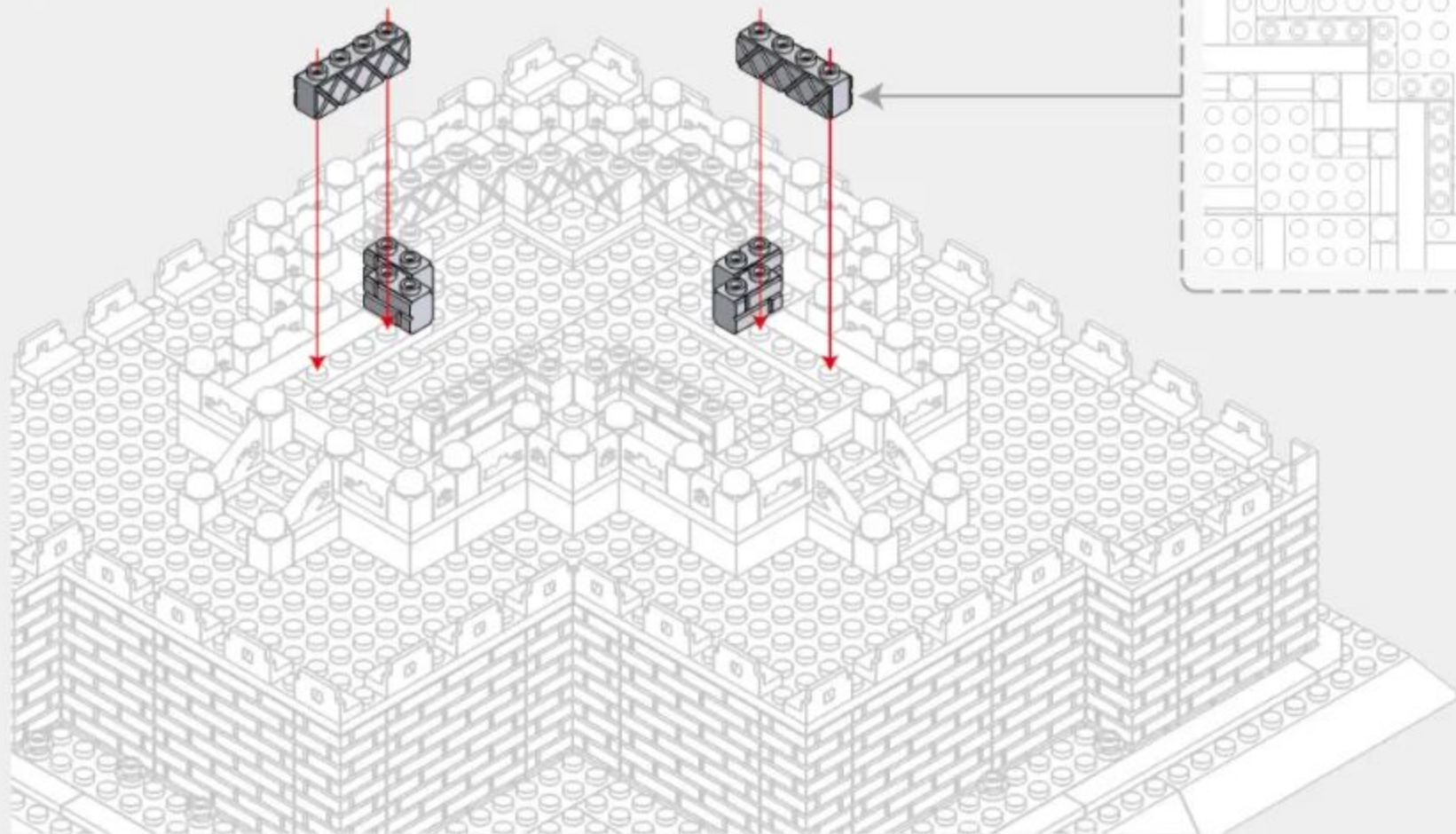
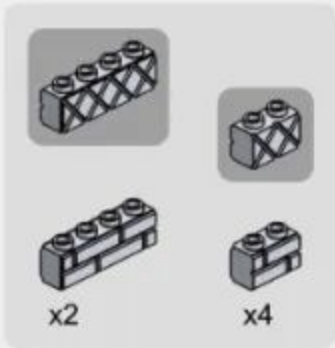

2-8

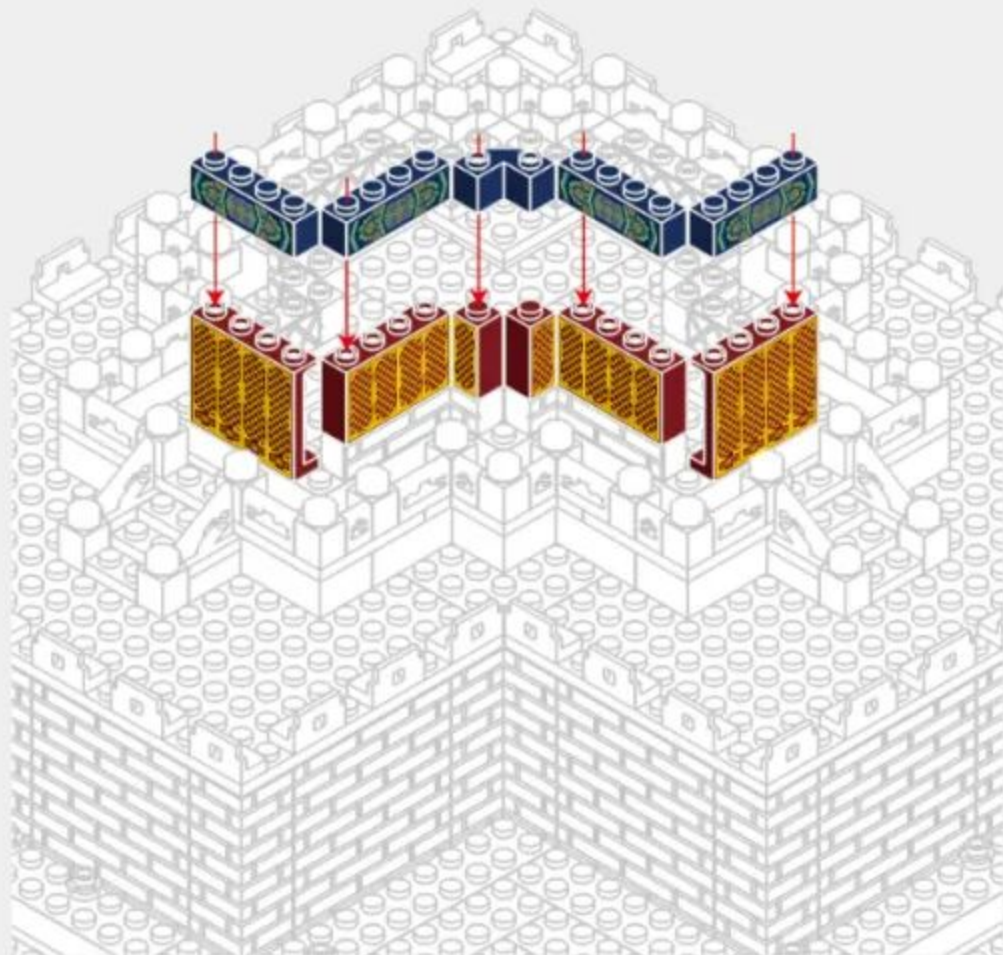
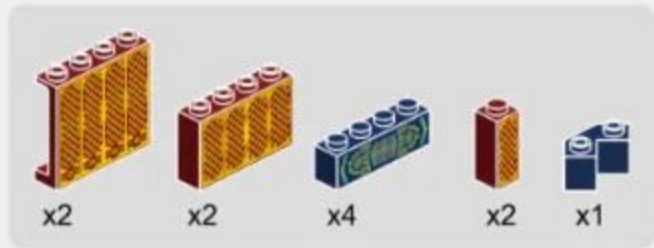

2-9

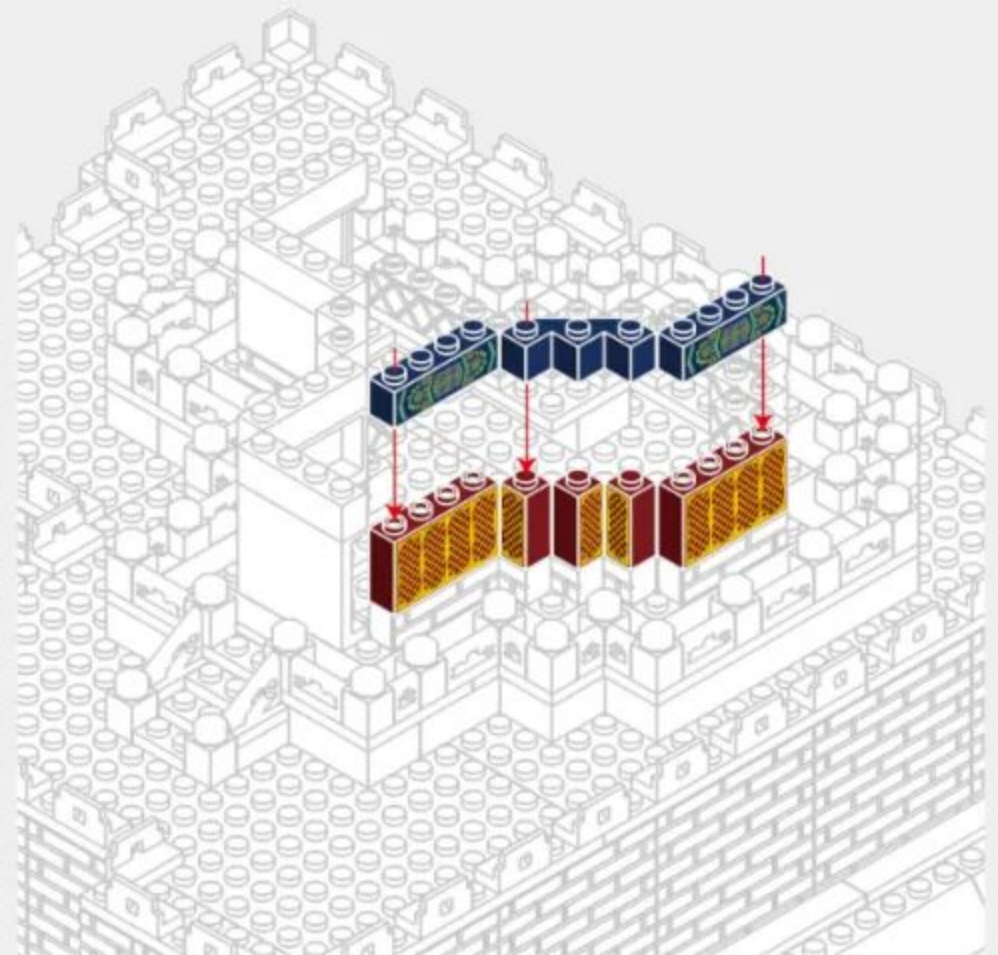

2-10

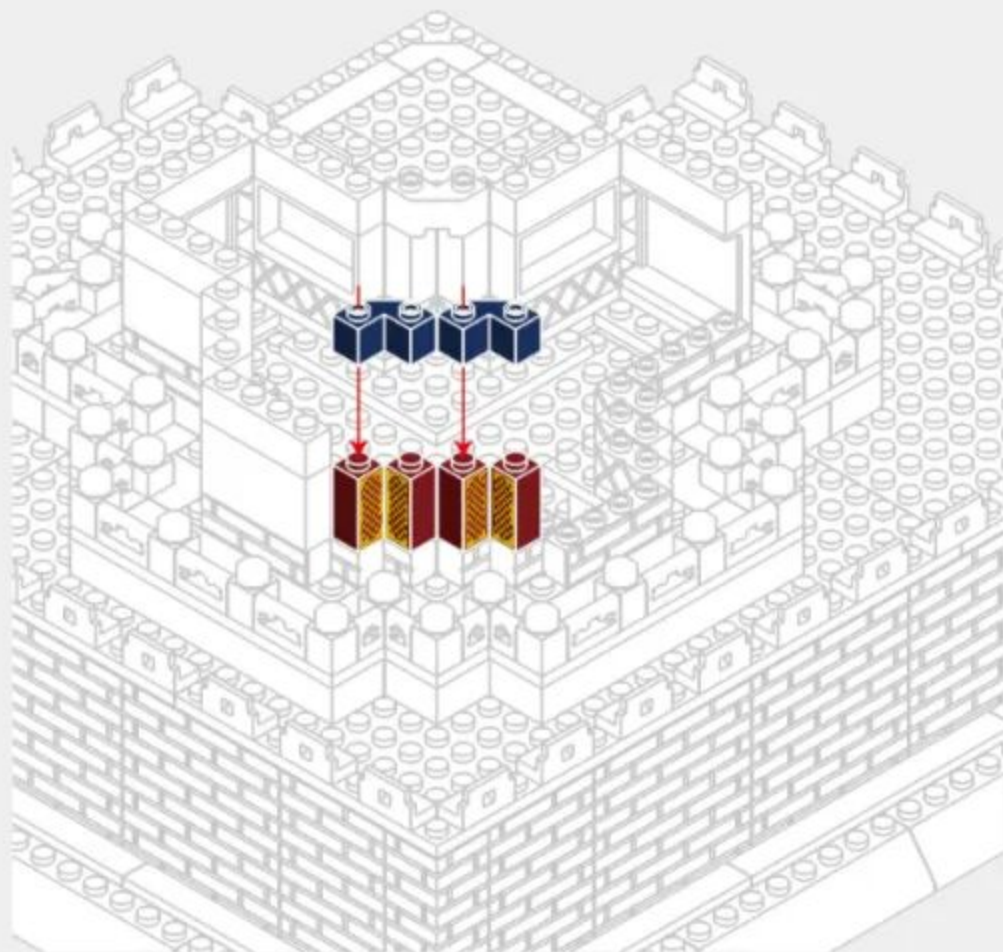

2-11

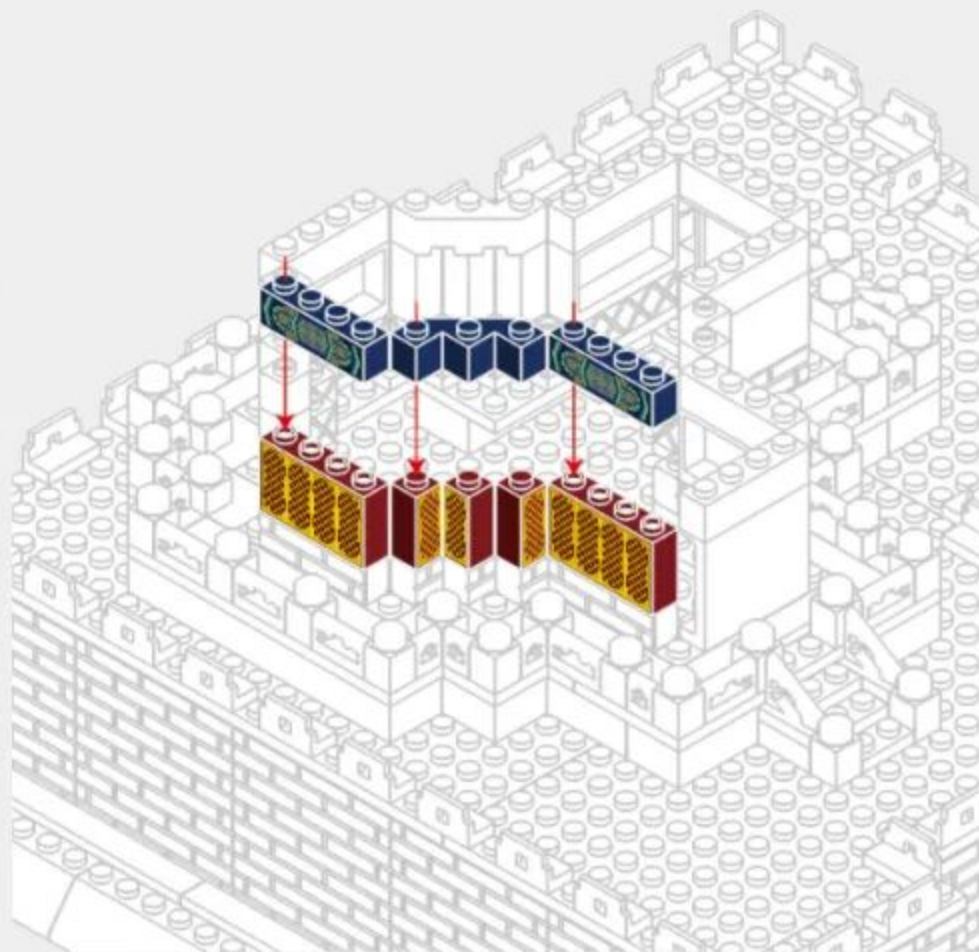

2-12

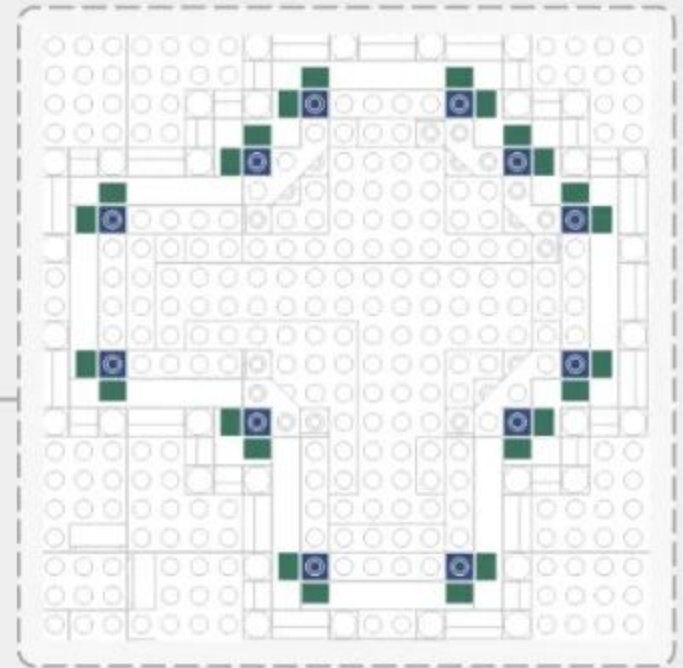
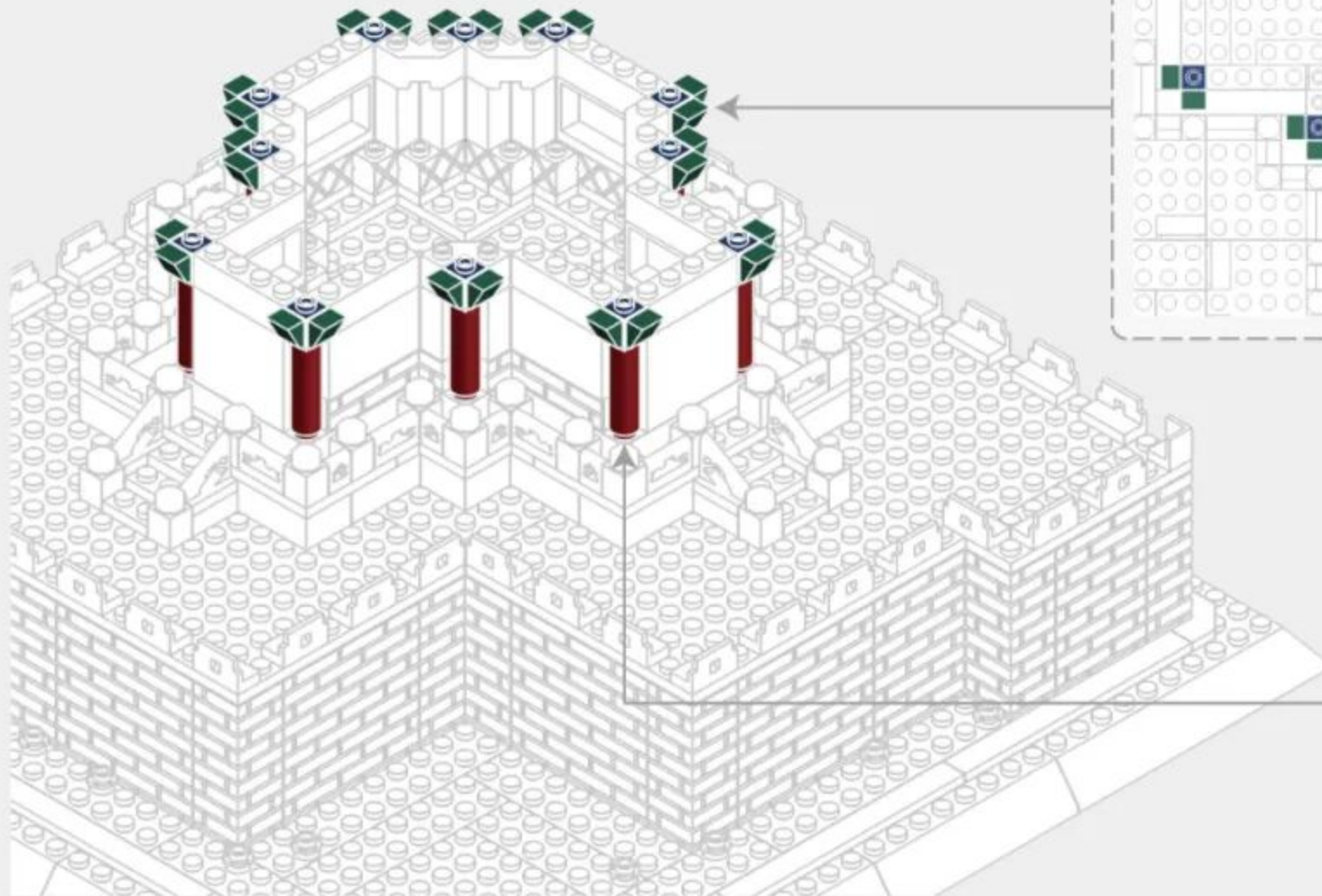

2-13

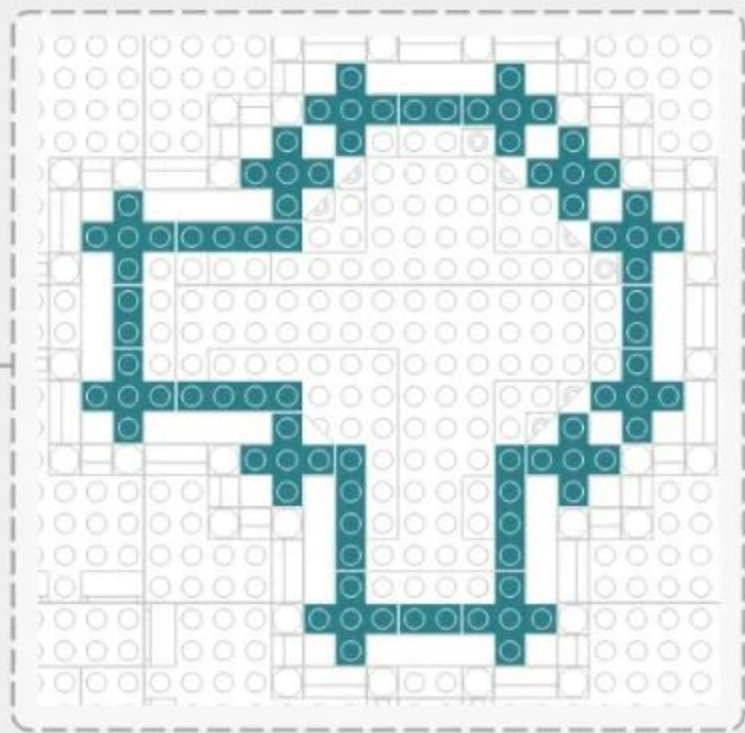
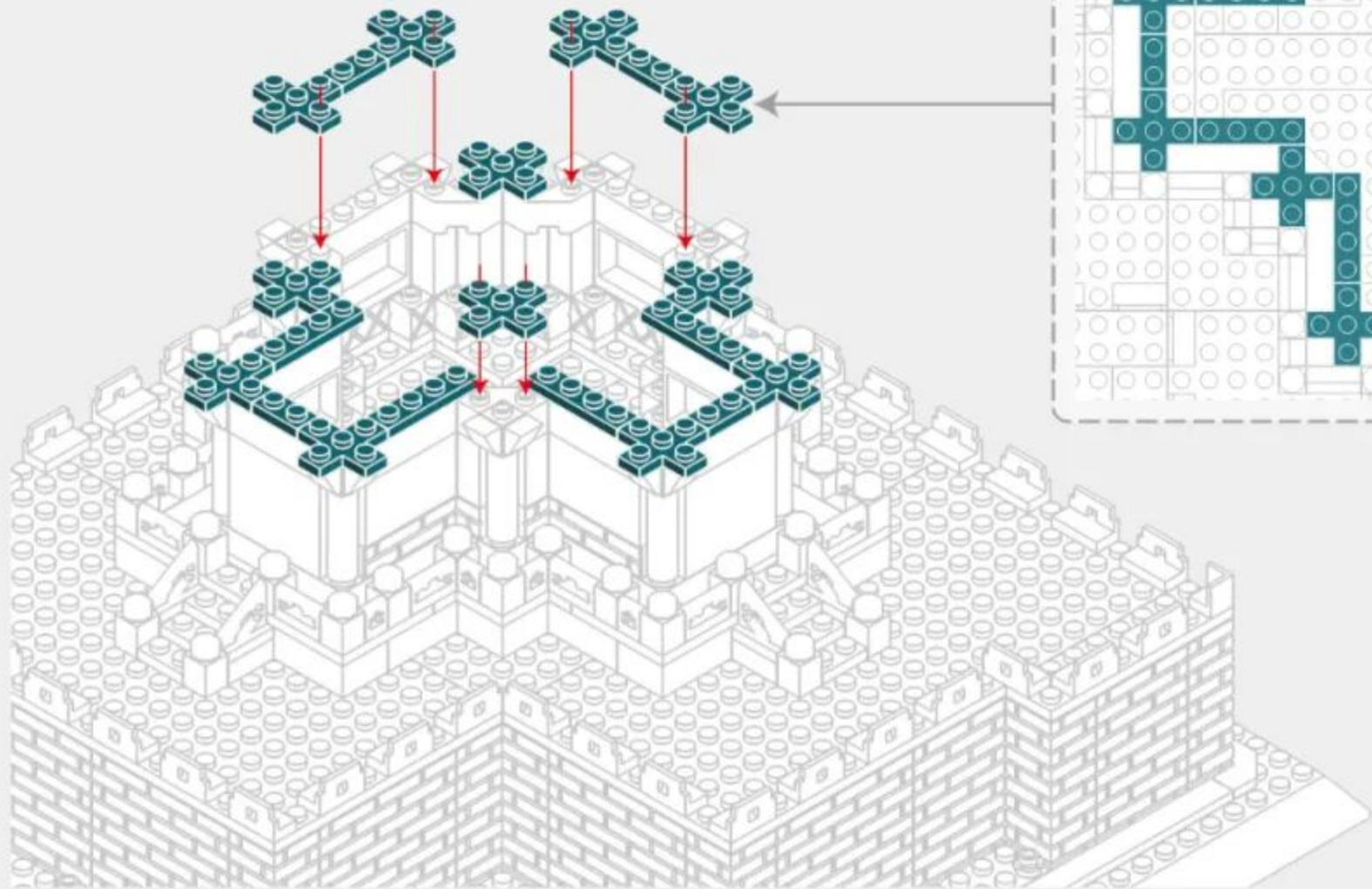



261 PCS

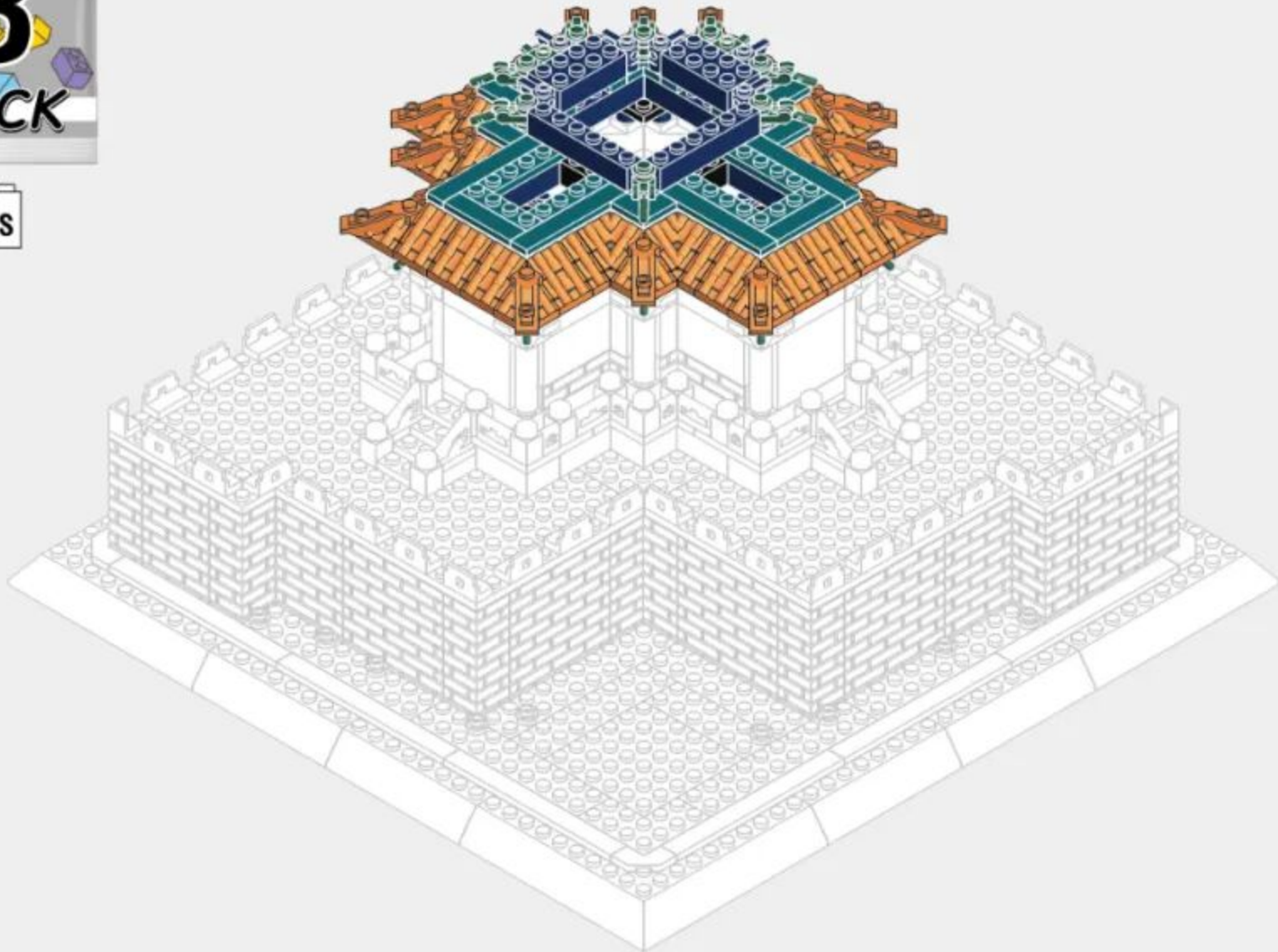

49

3-1

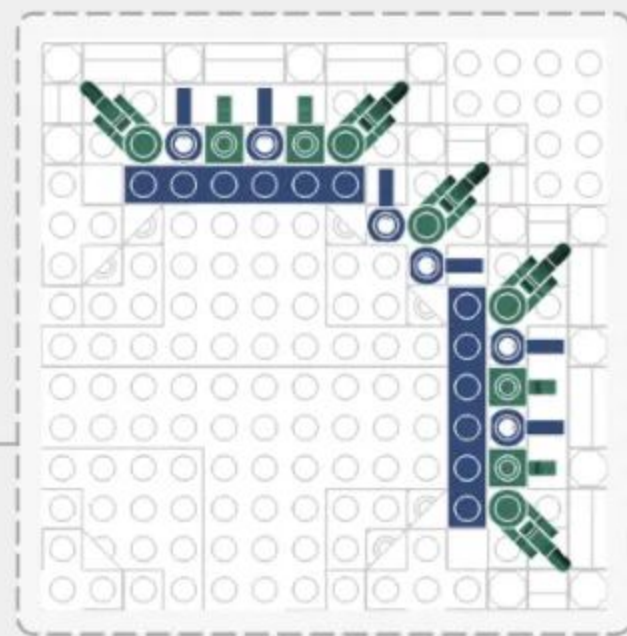
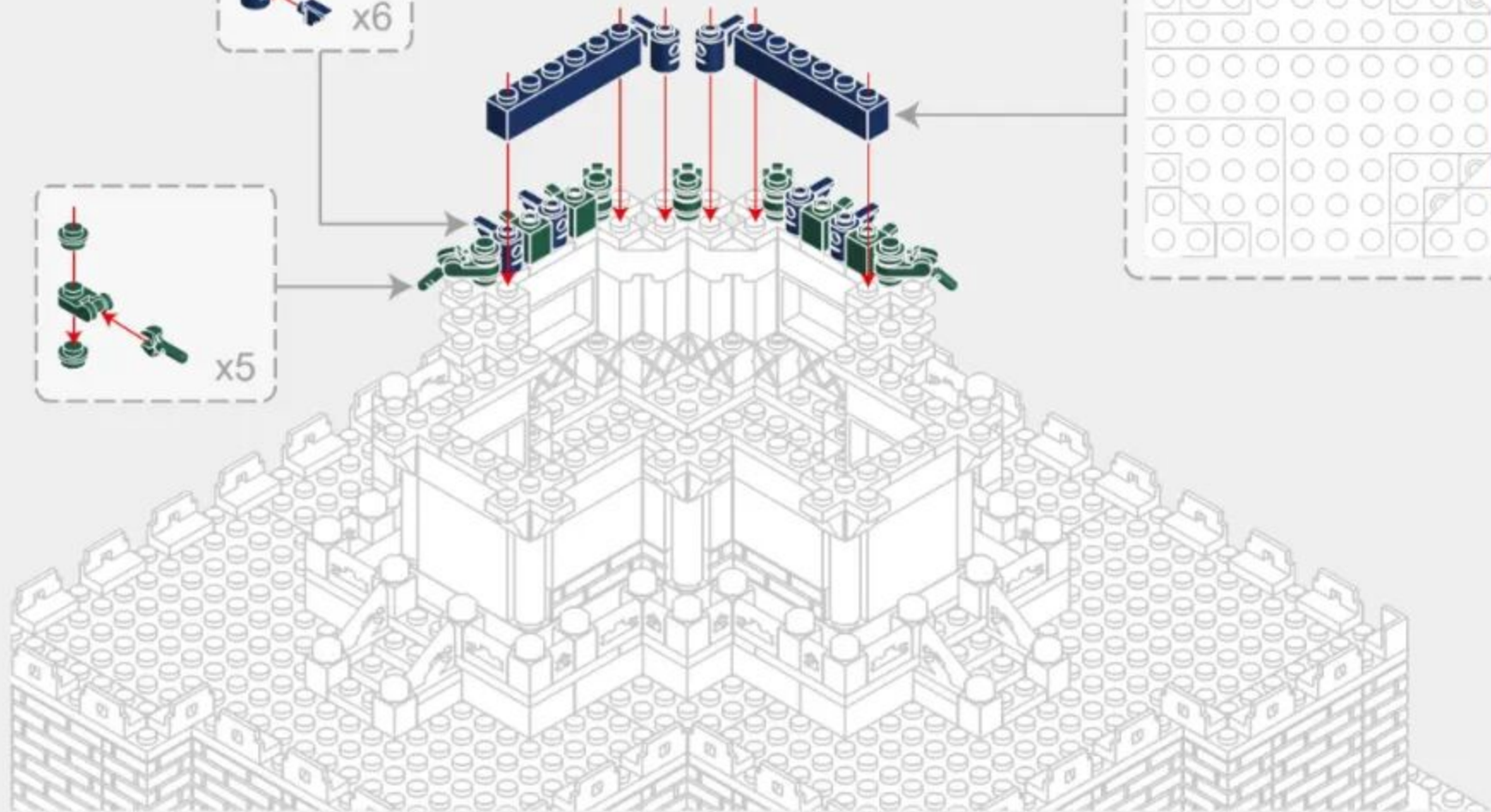
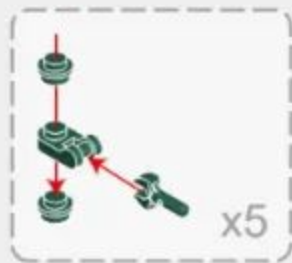

3-2

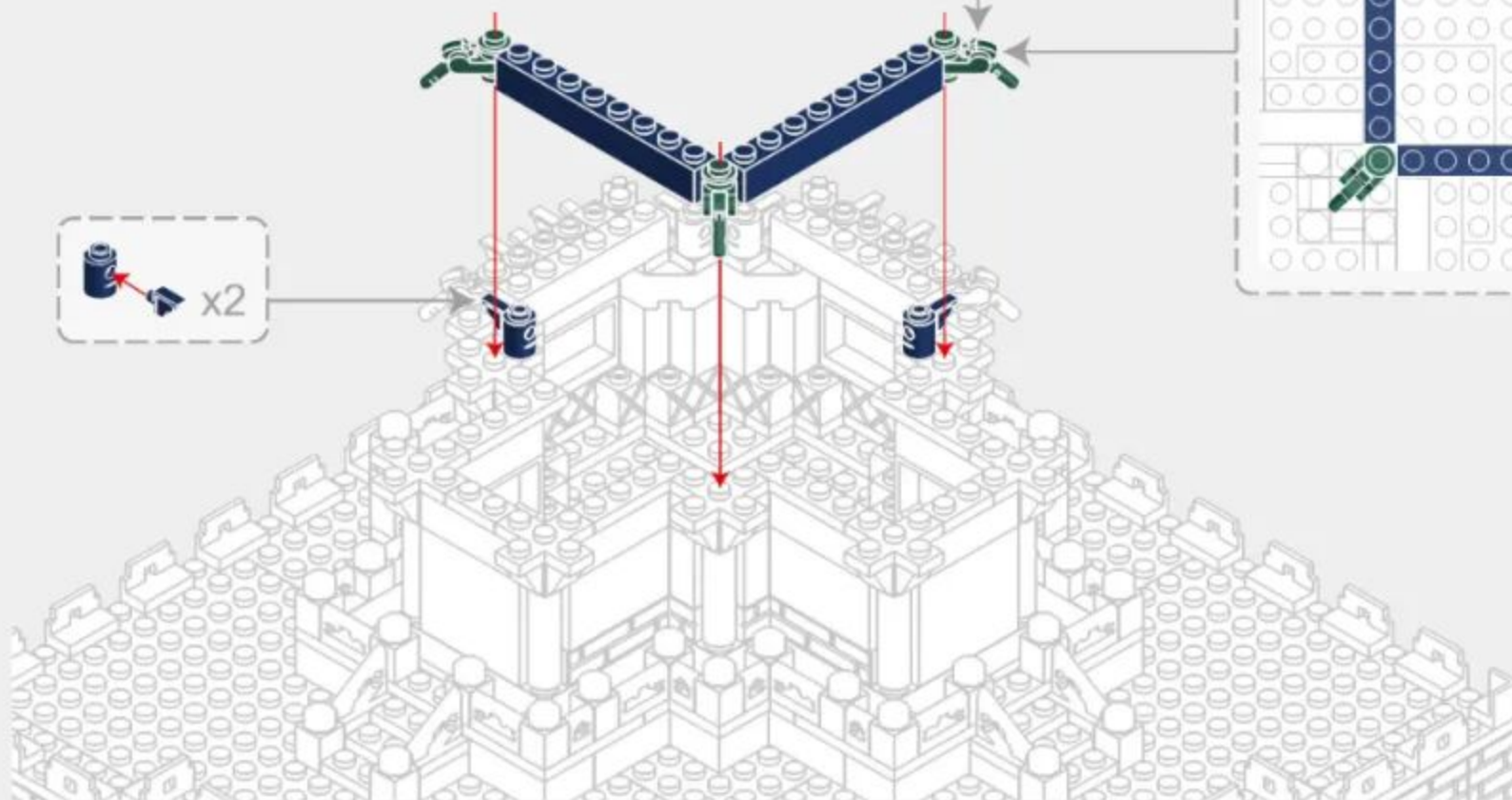
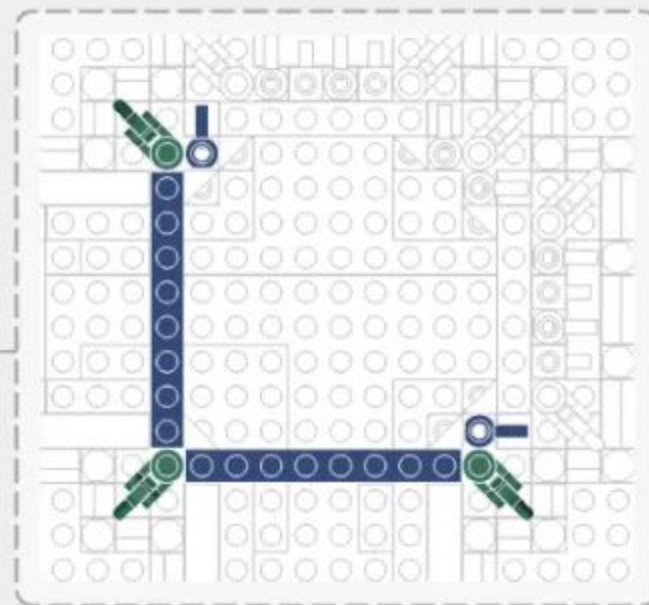
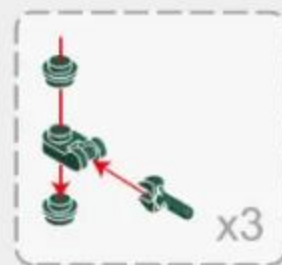

3-3

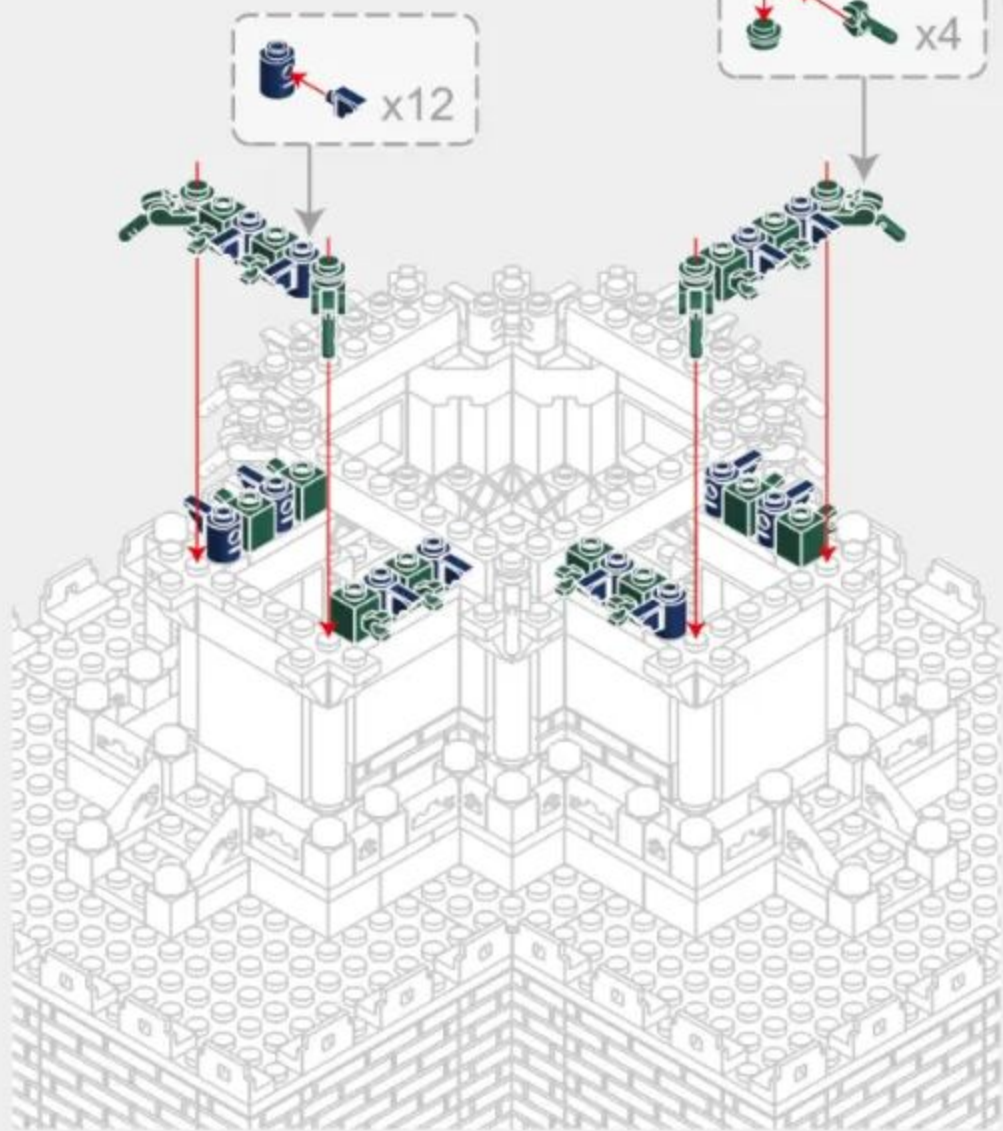

3-4

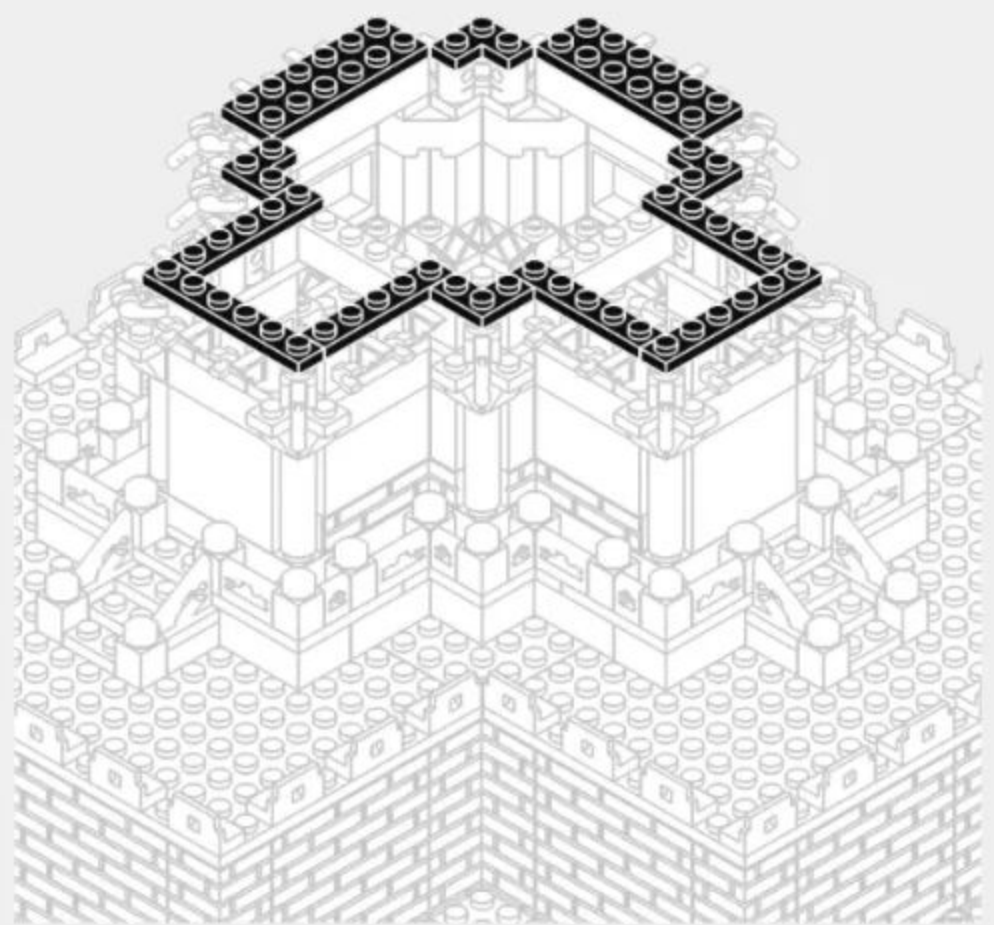
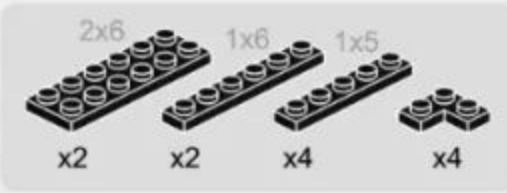

3-5

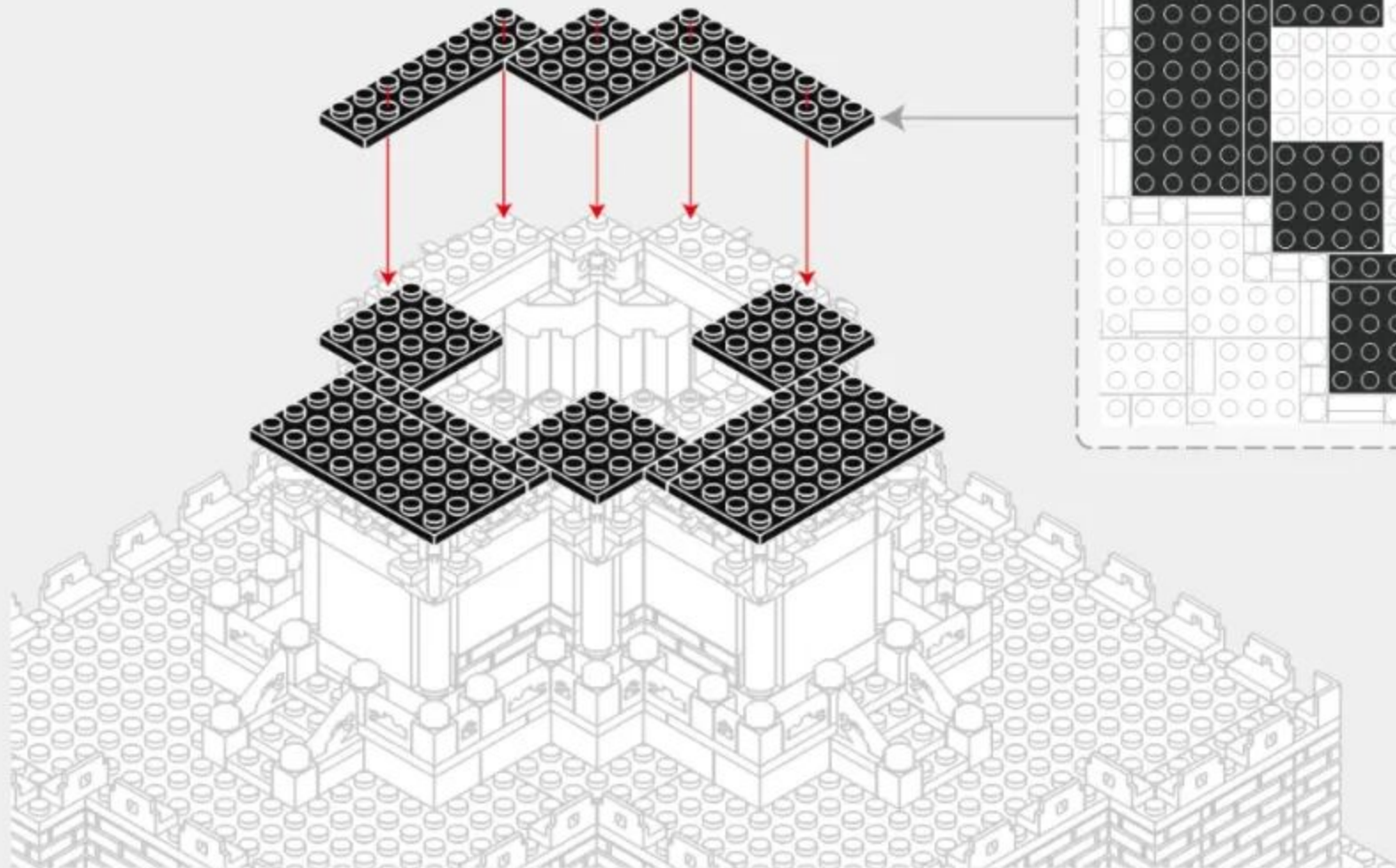
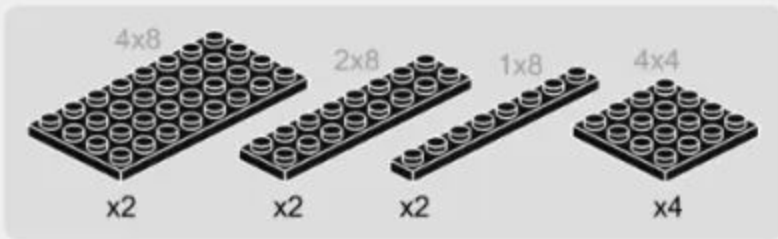

3-6

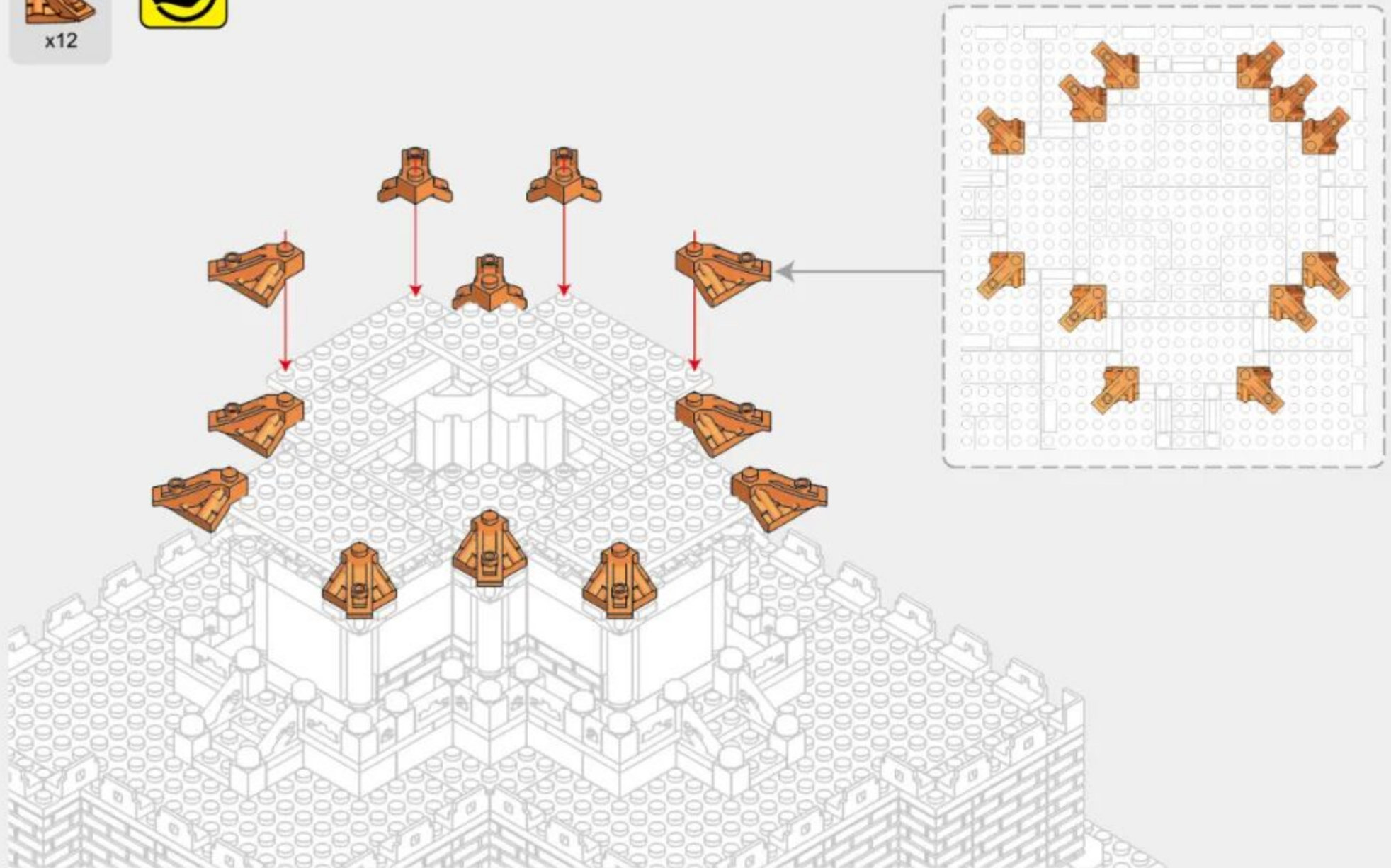

3-7

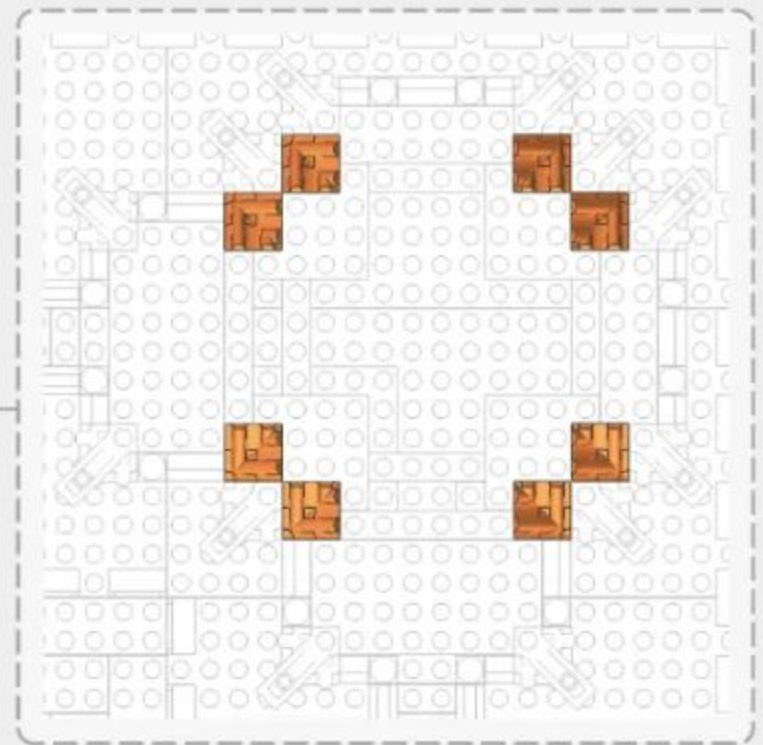
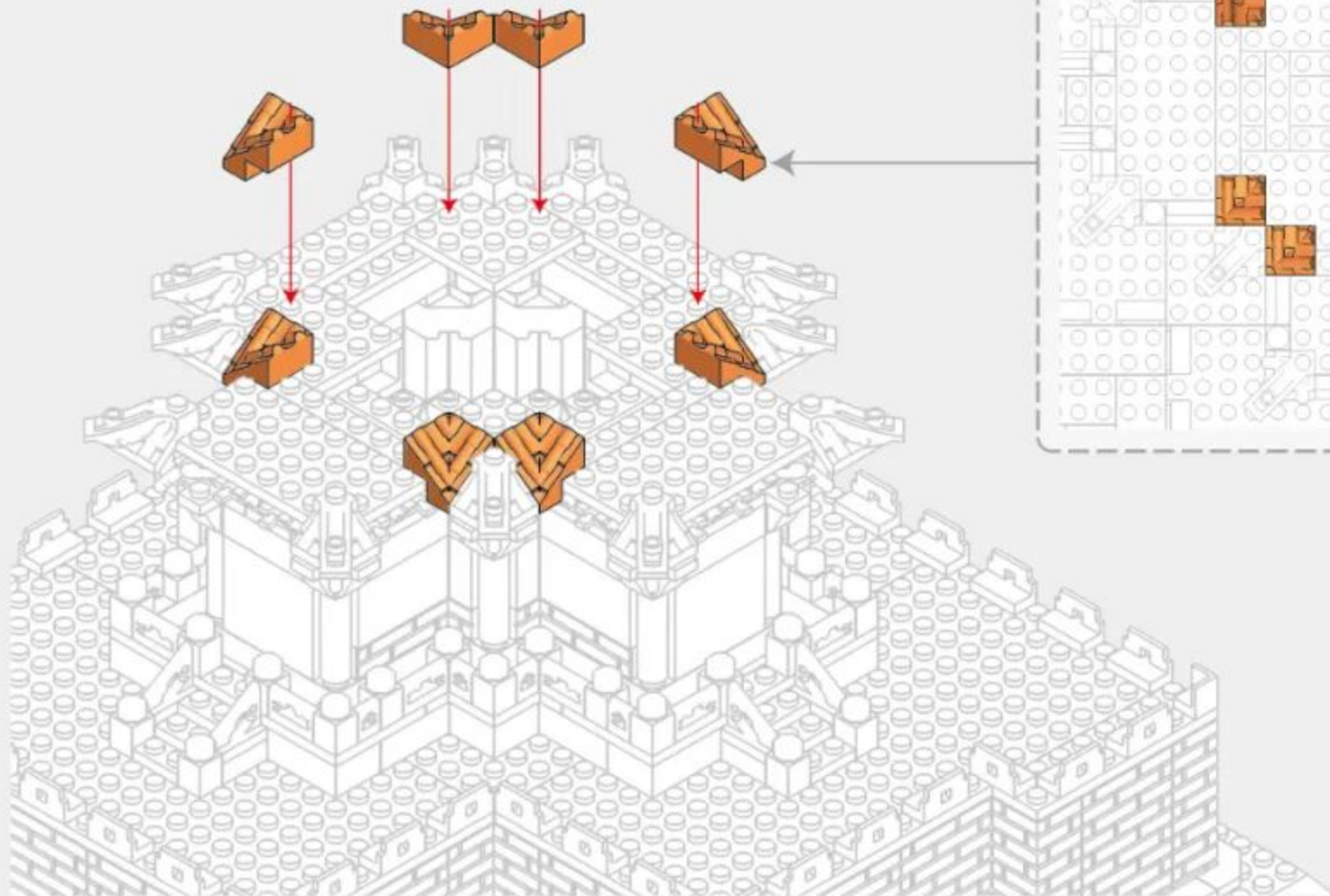

3-8

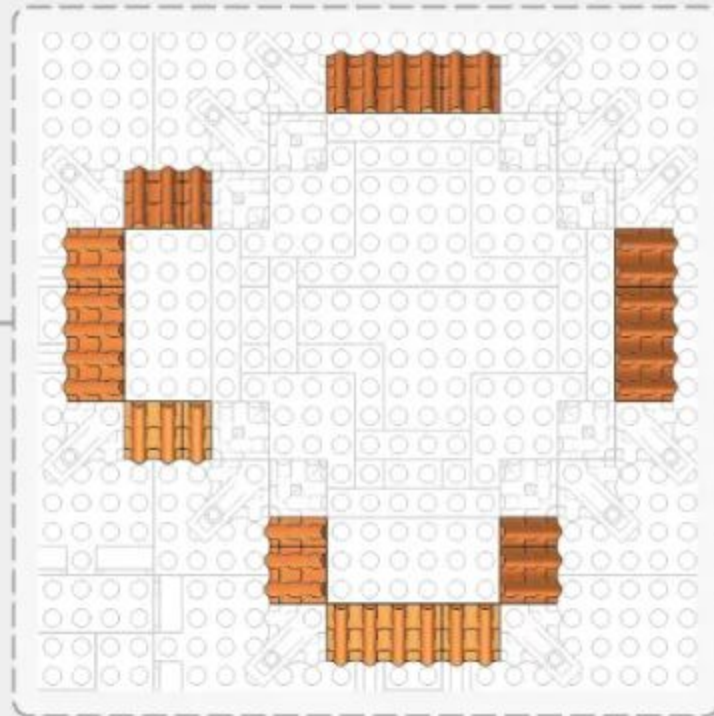
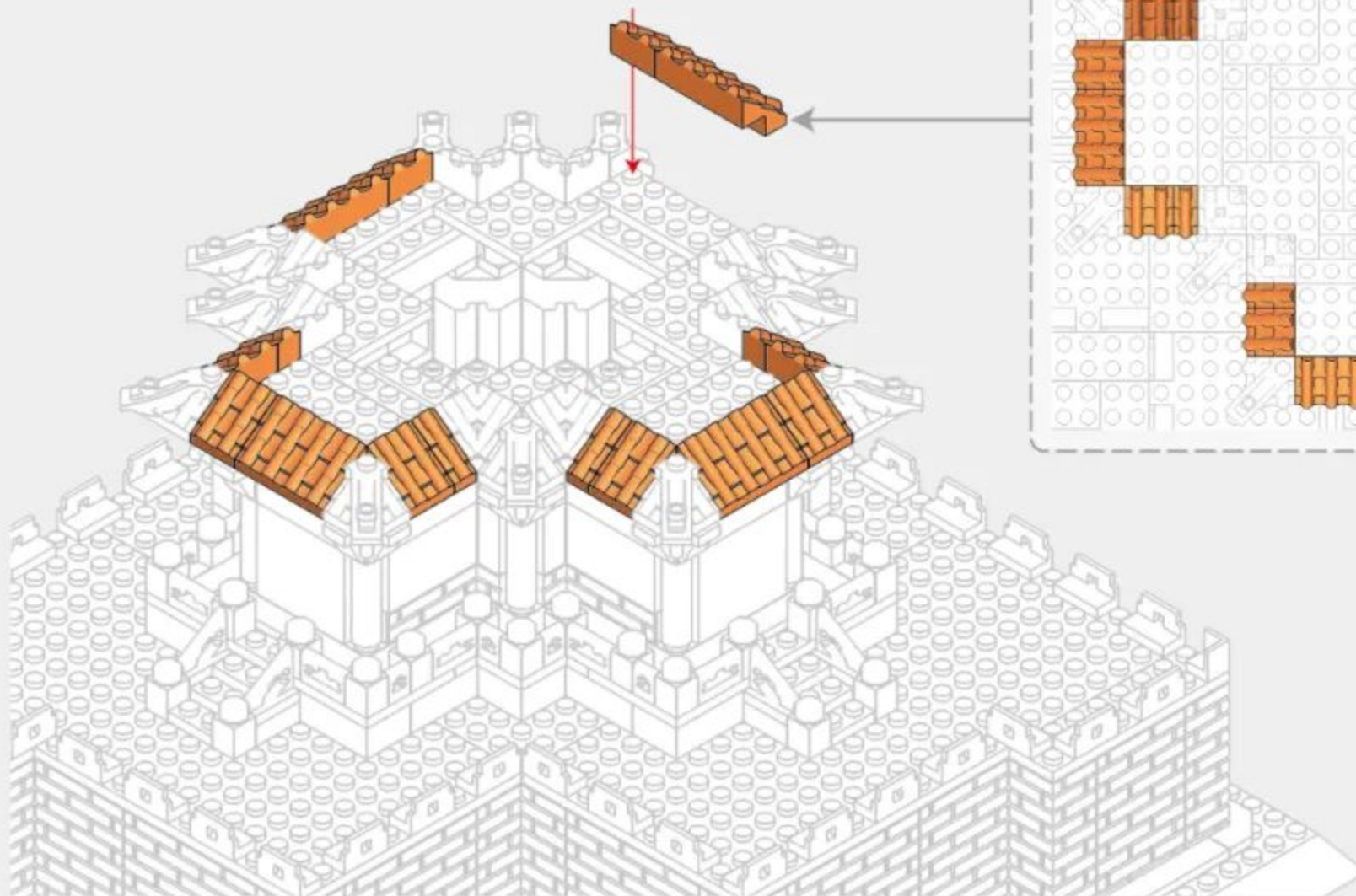

3-9

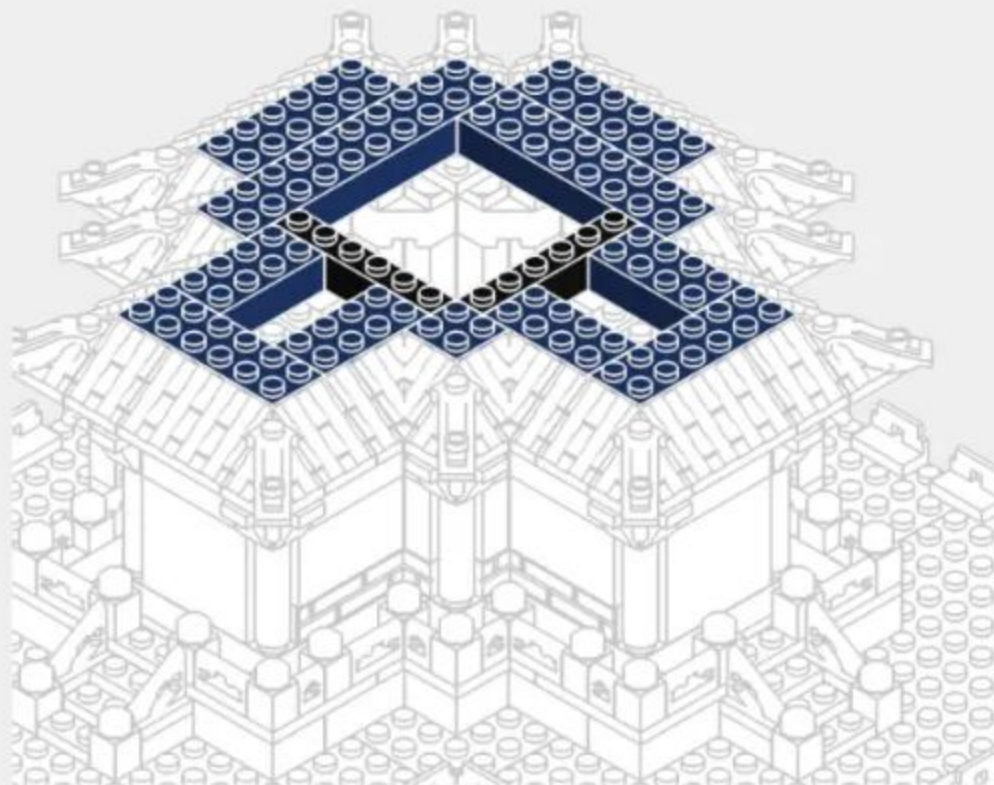
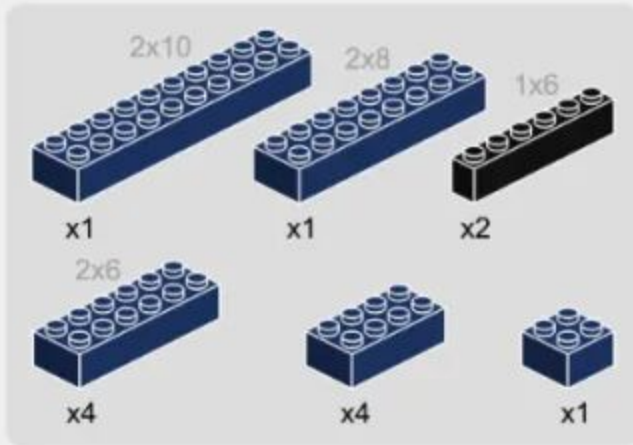

3-10

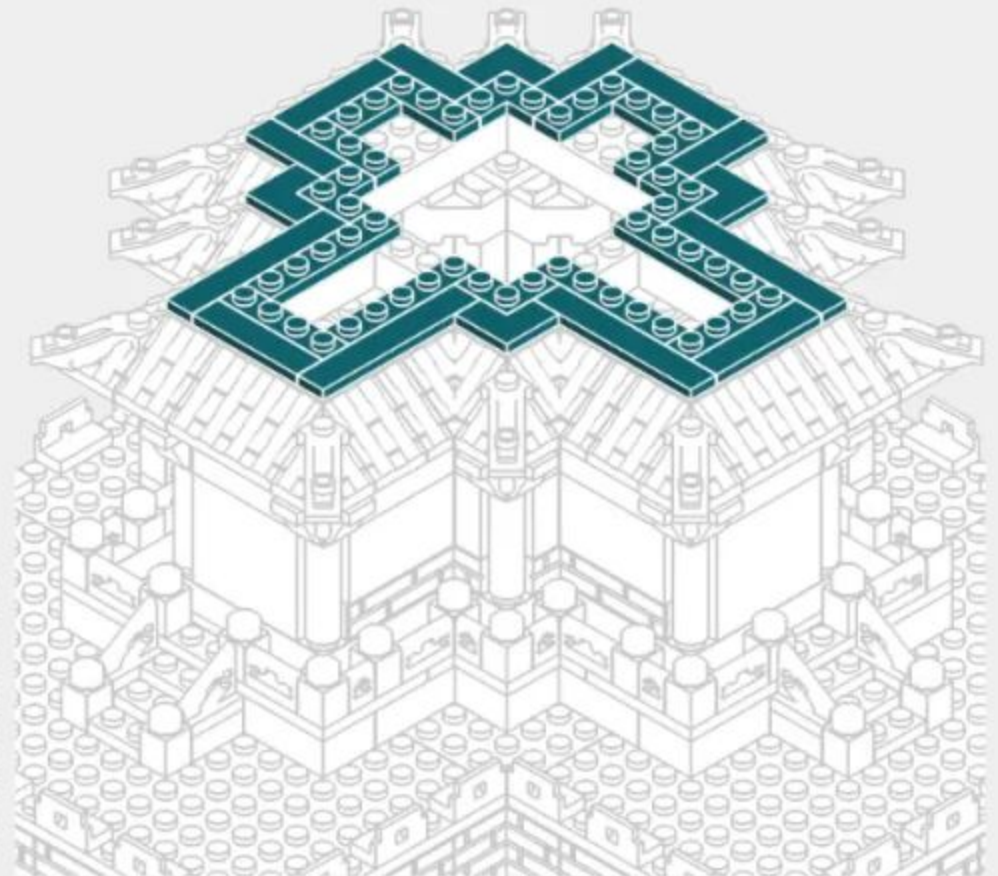
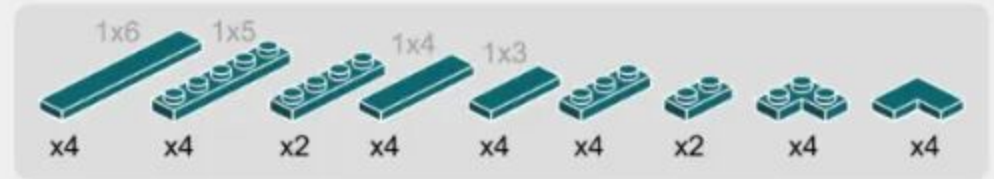

3-11

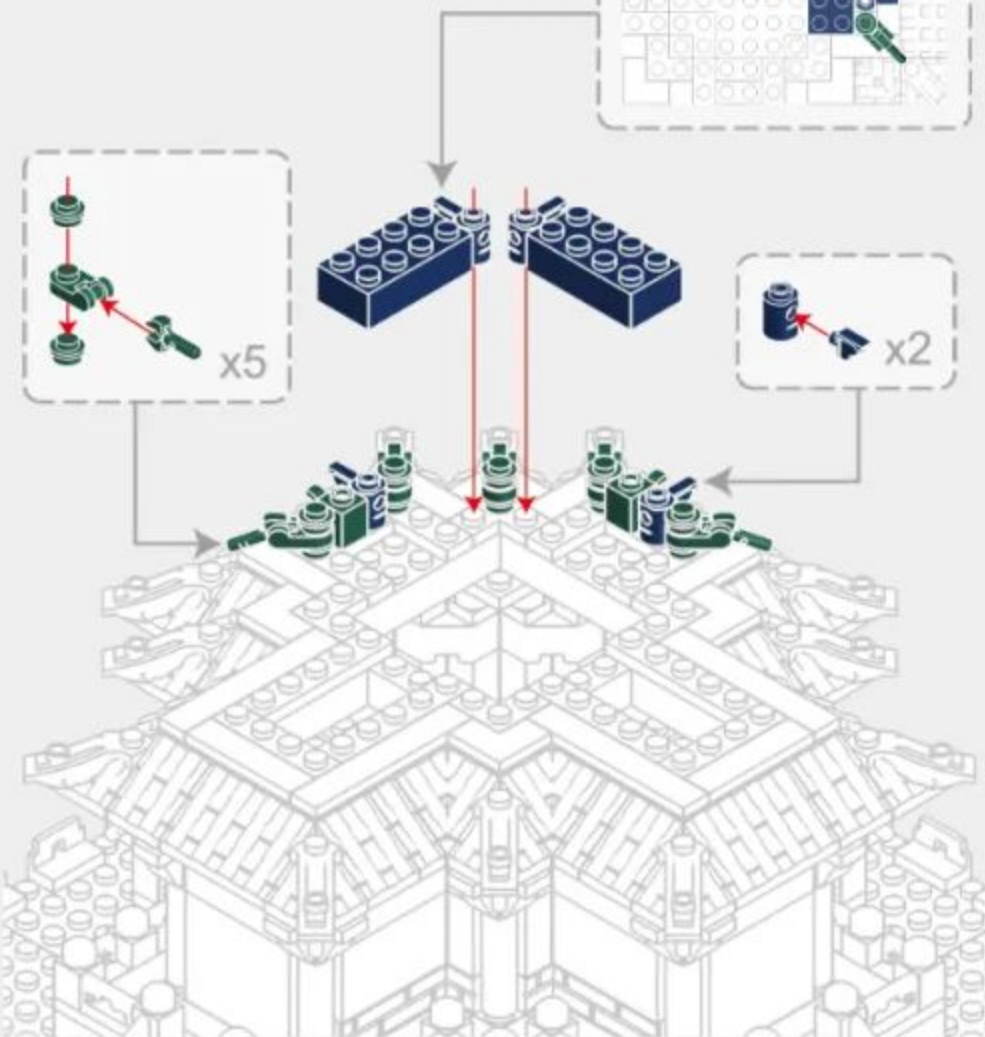
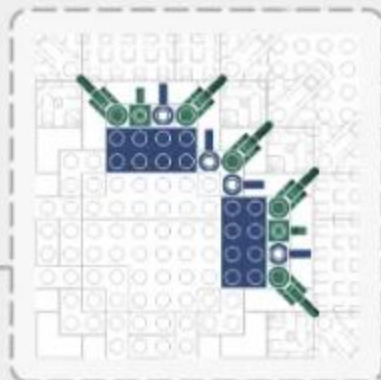

3-12

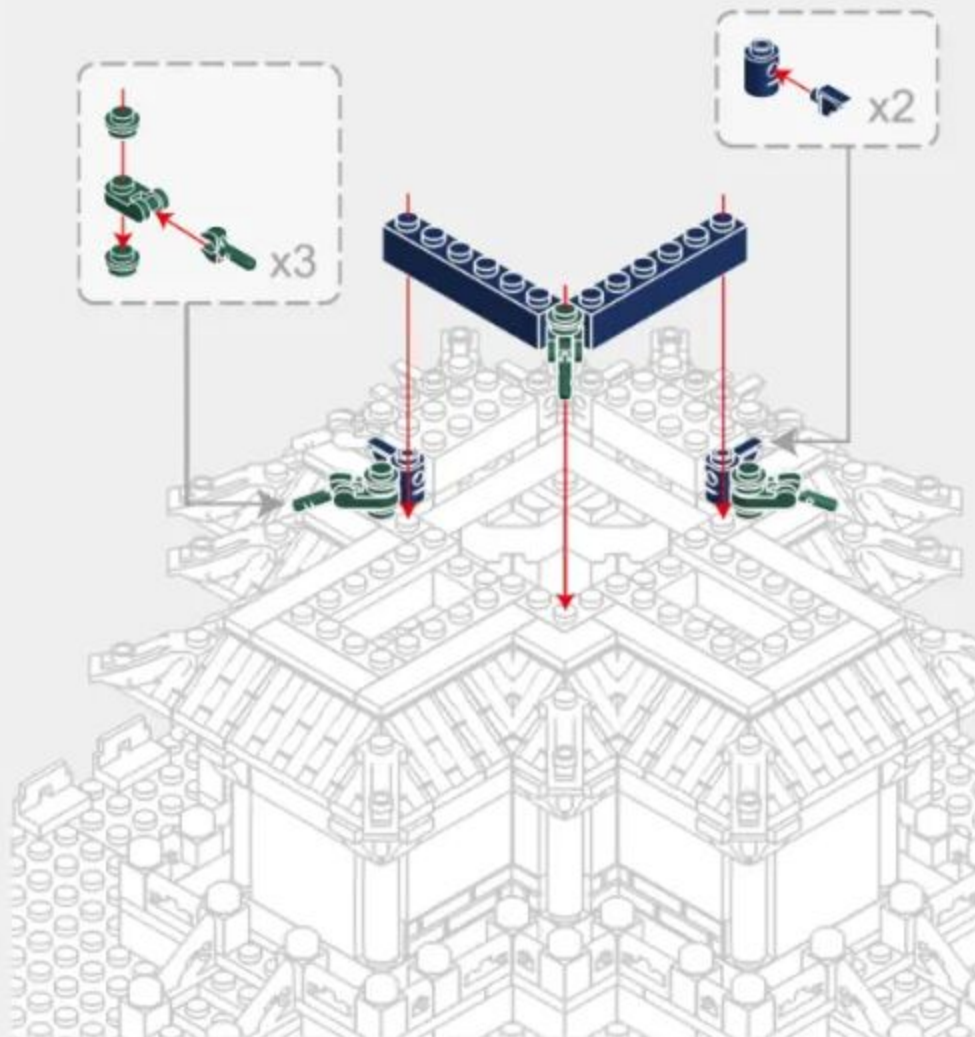



270PCS

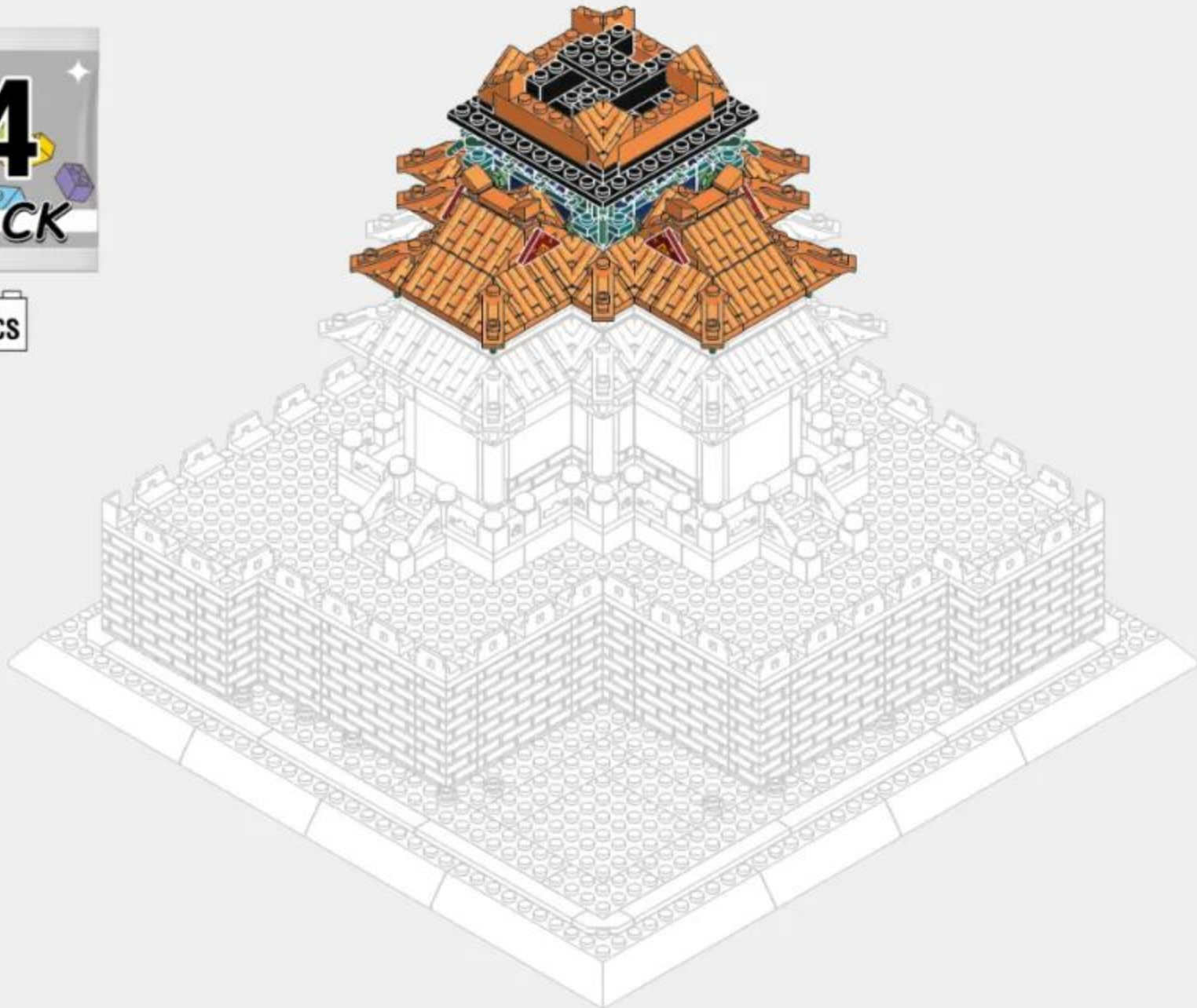

59

4-1

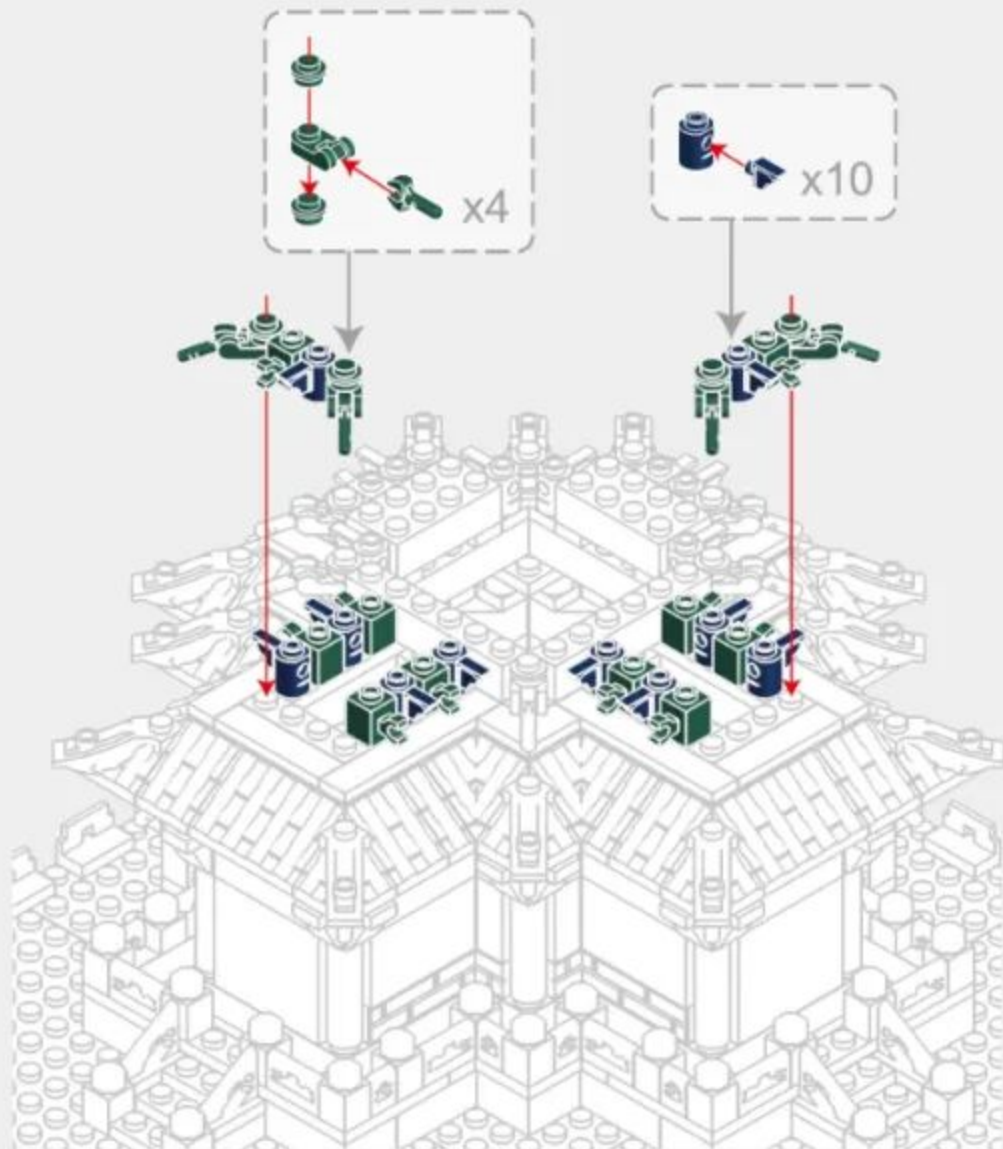

4-2

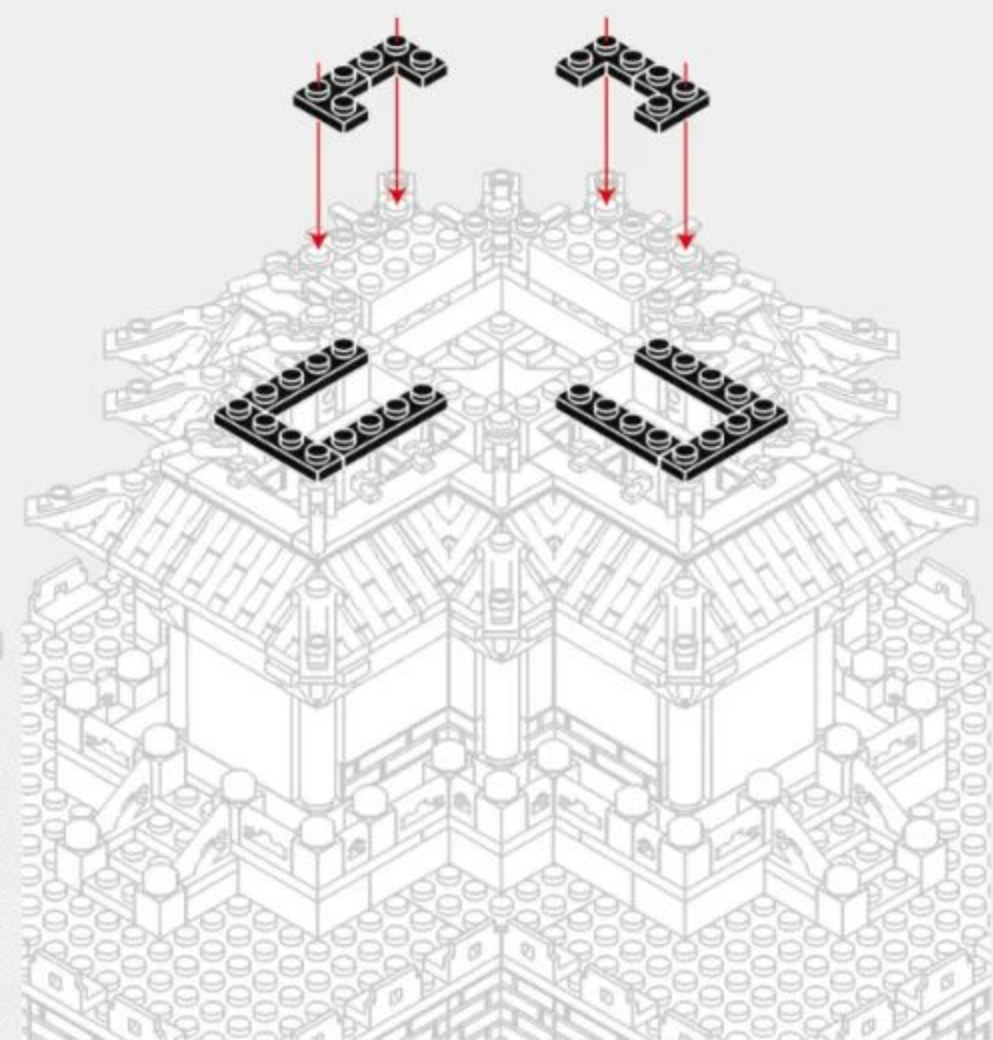

4-3

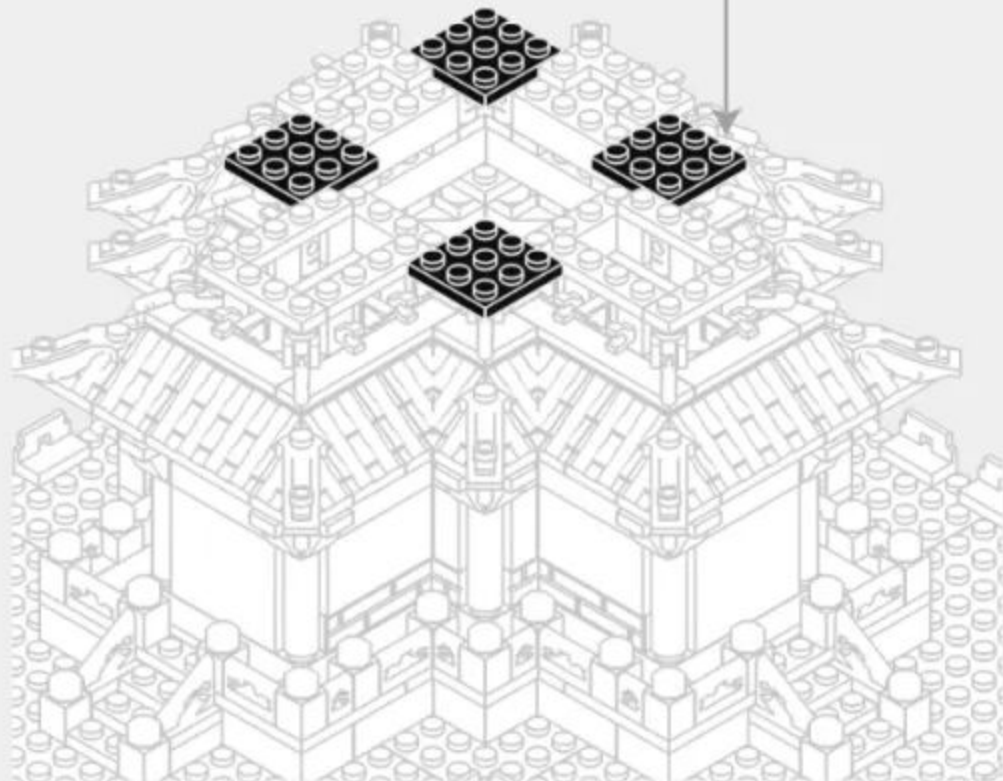
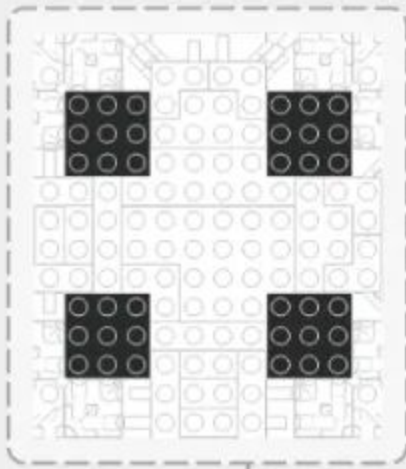

4-4

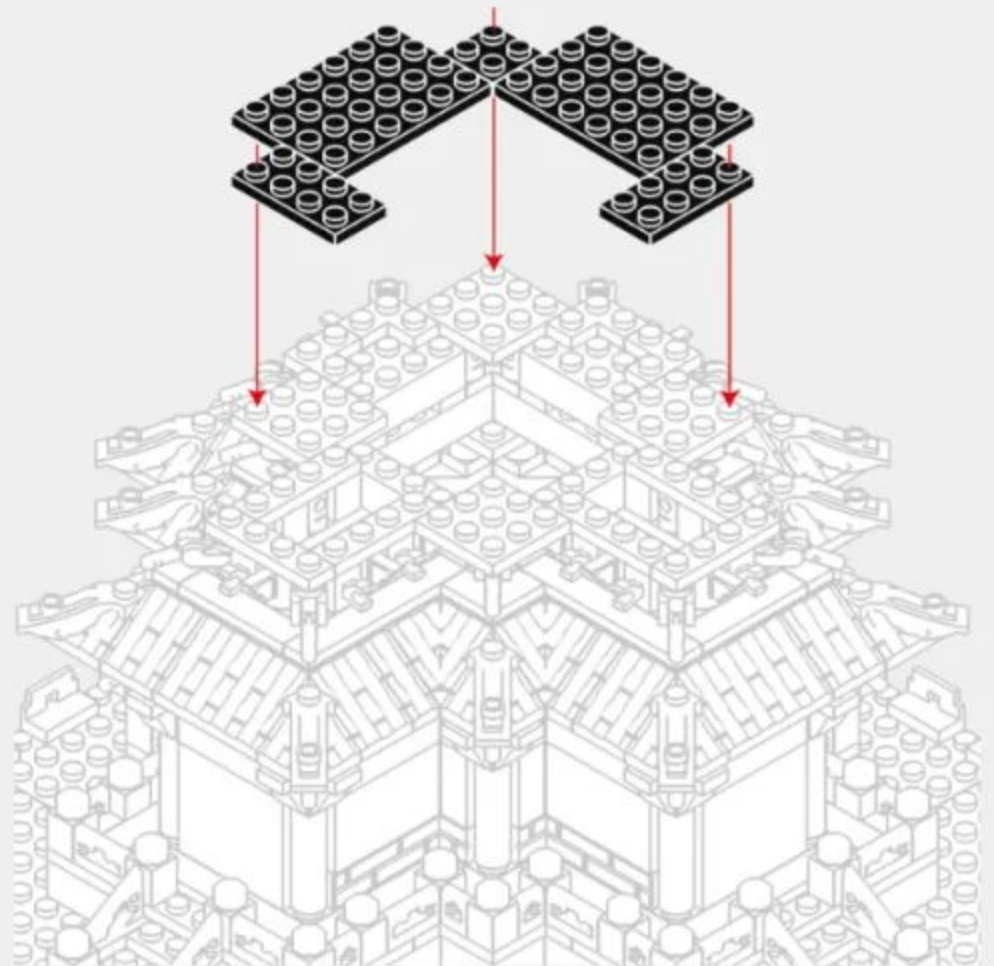
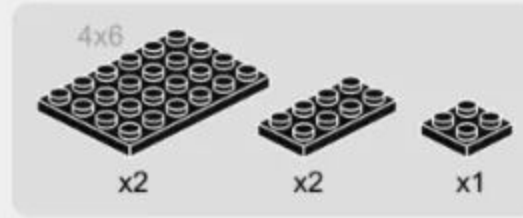

4-5

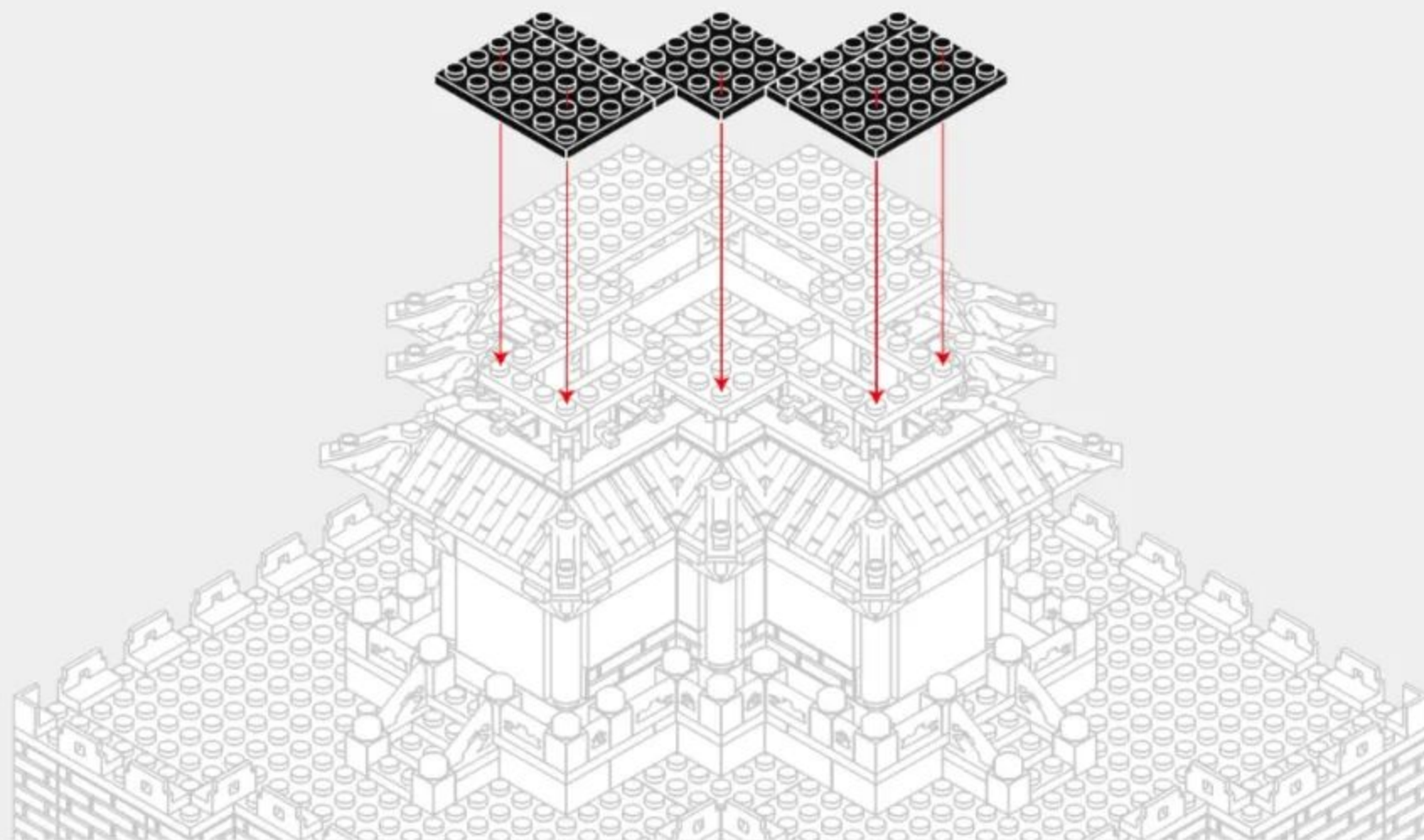
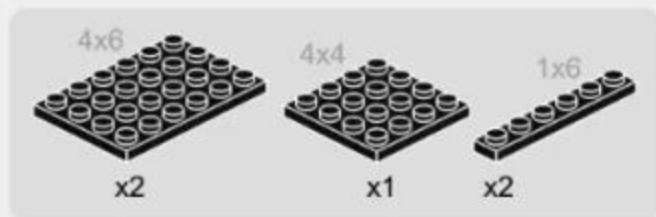

4-6

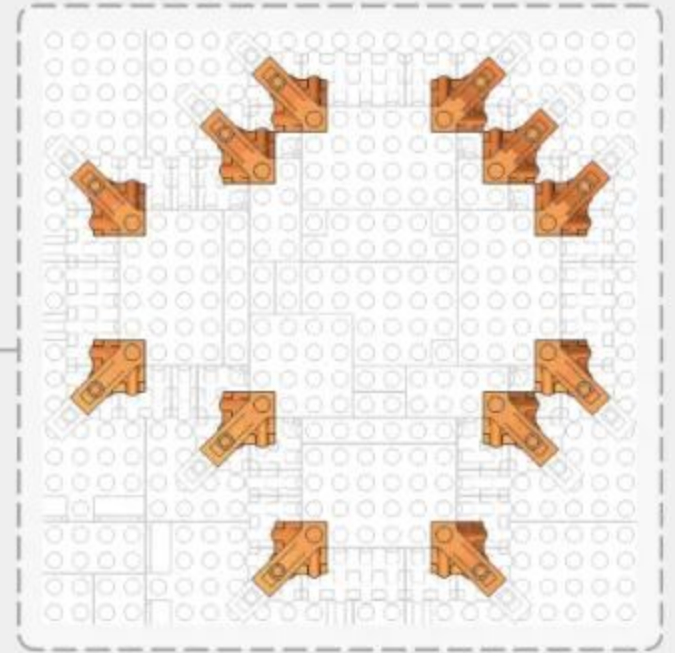
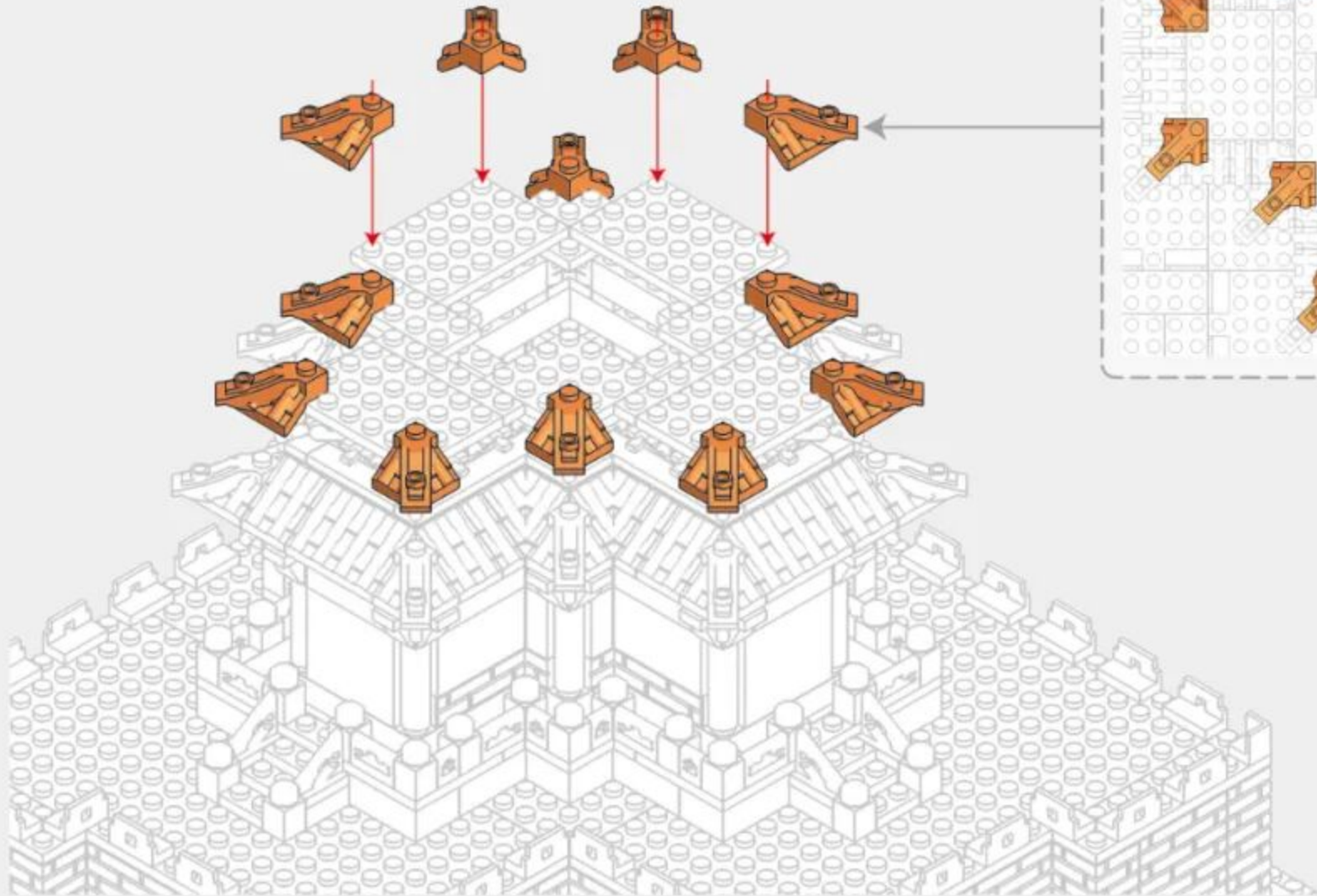

4-7

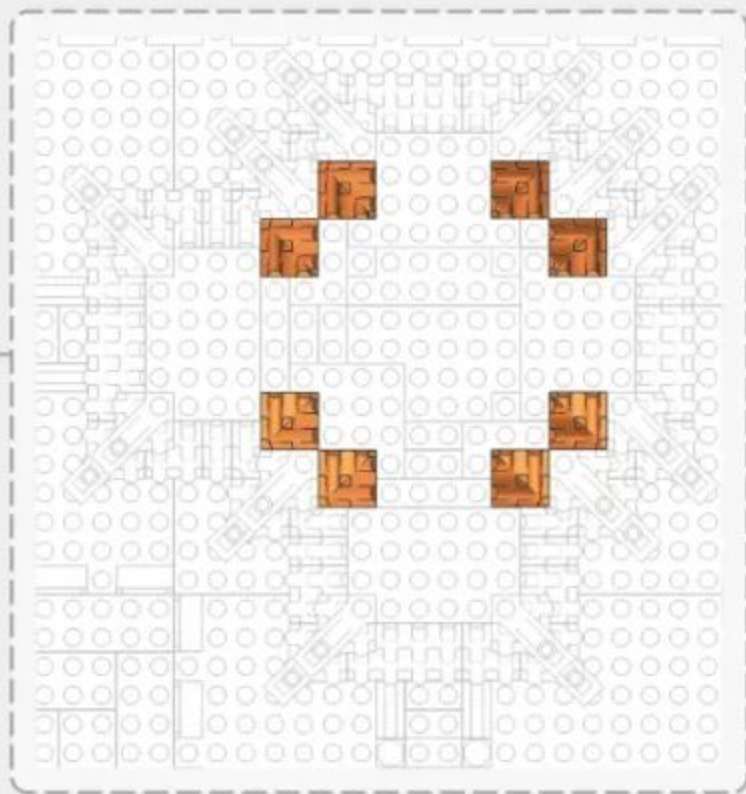
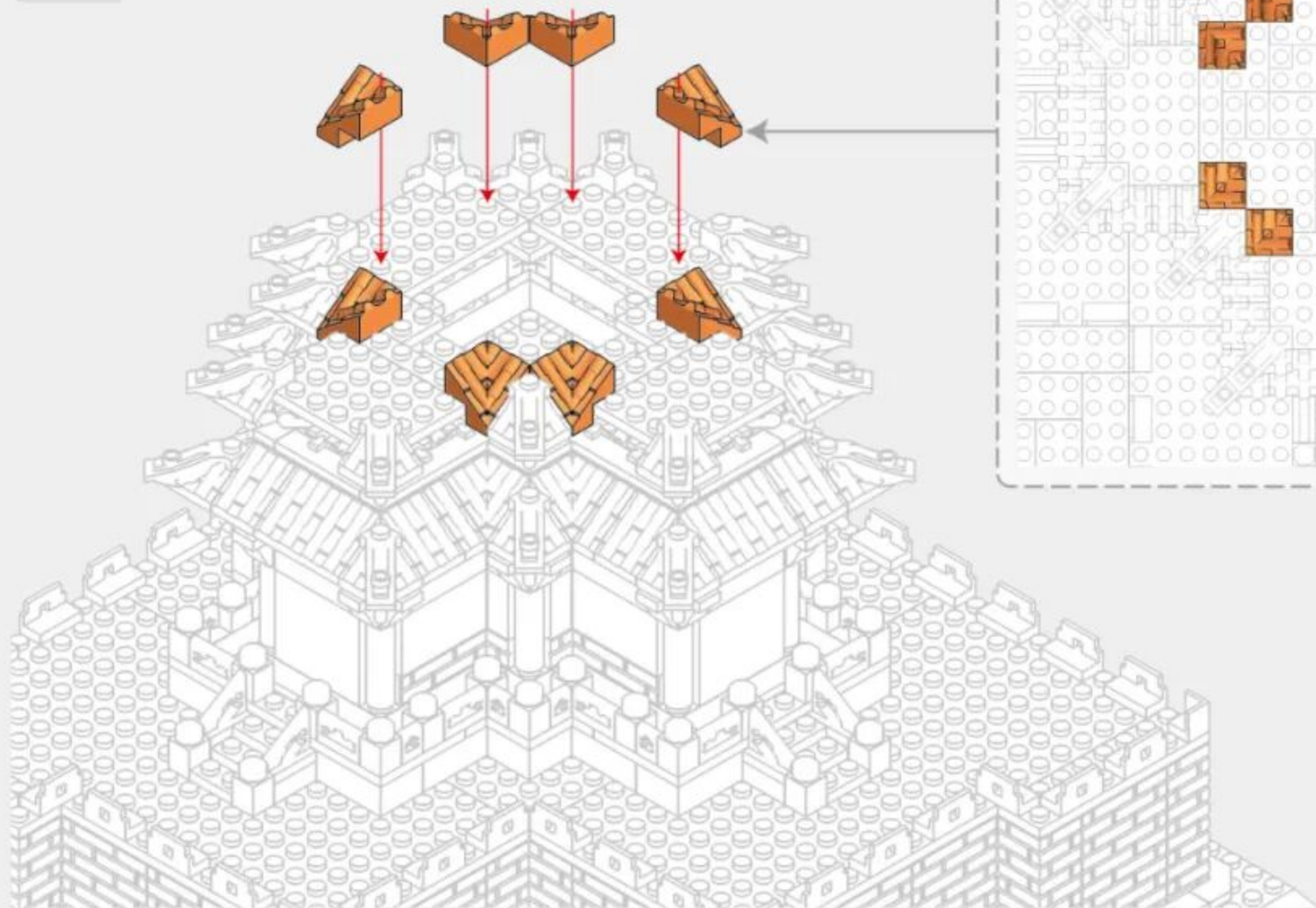
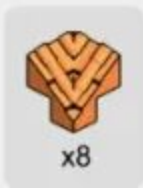

4-8

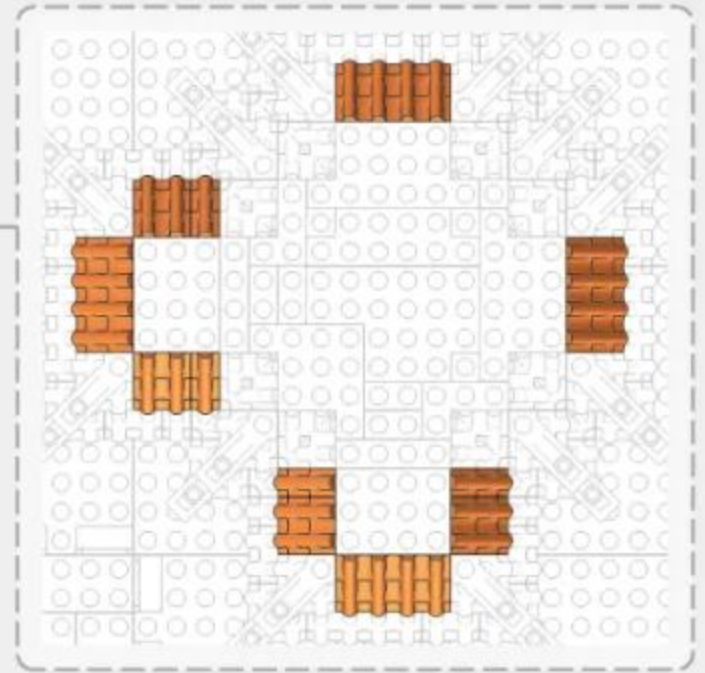
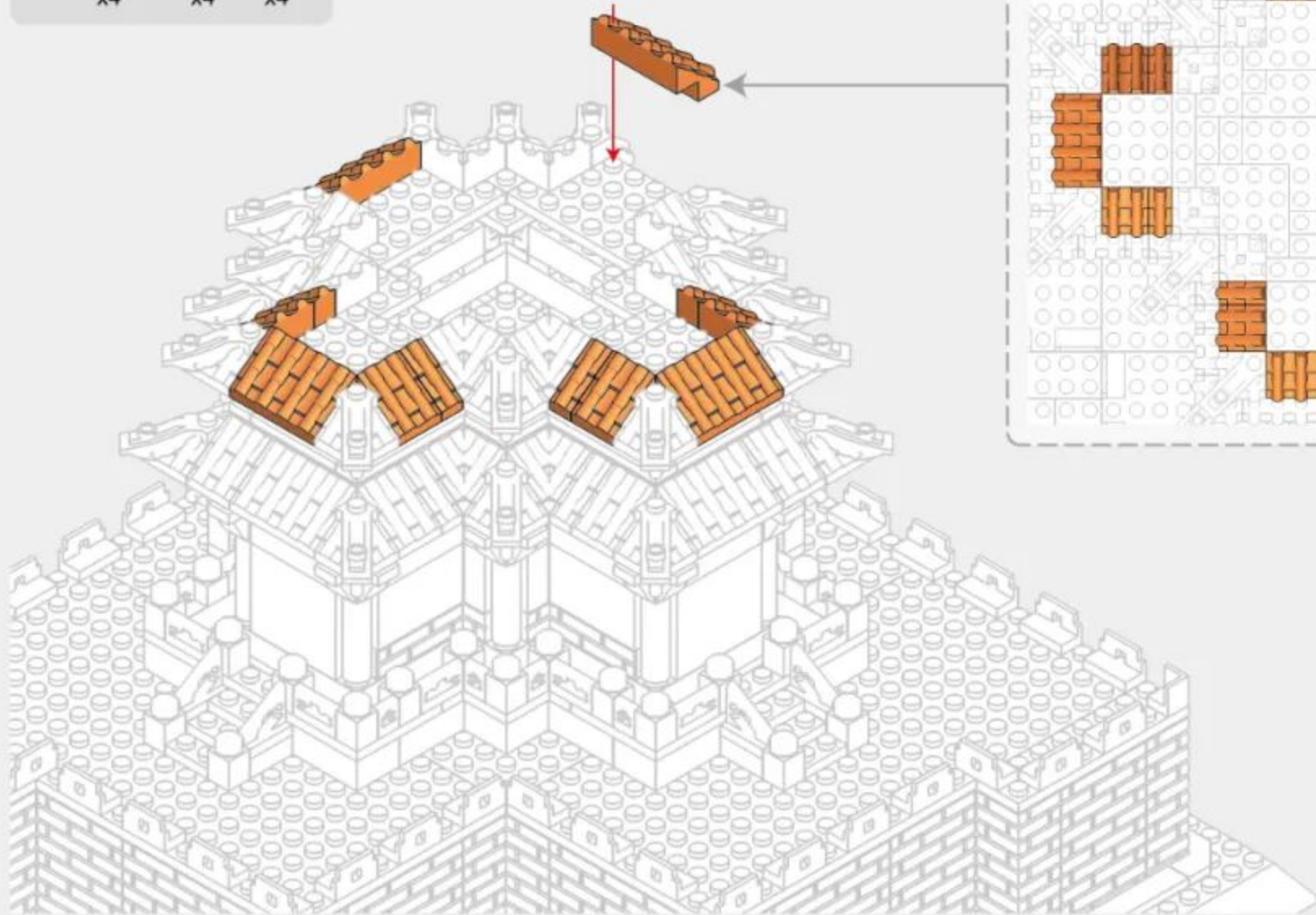
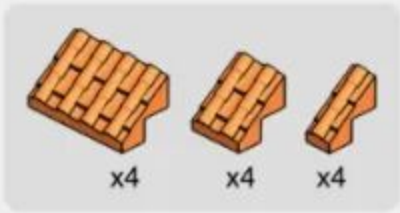

4-9

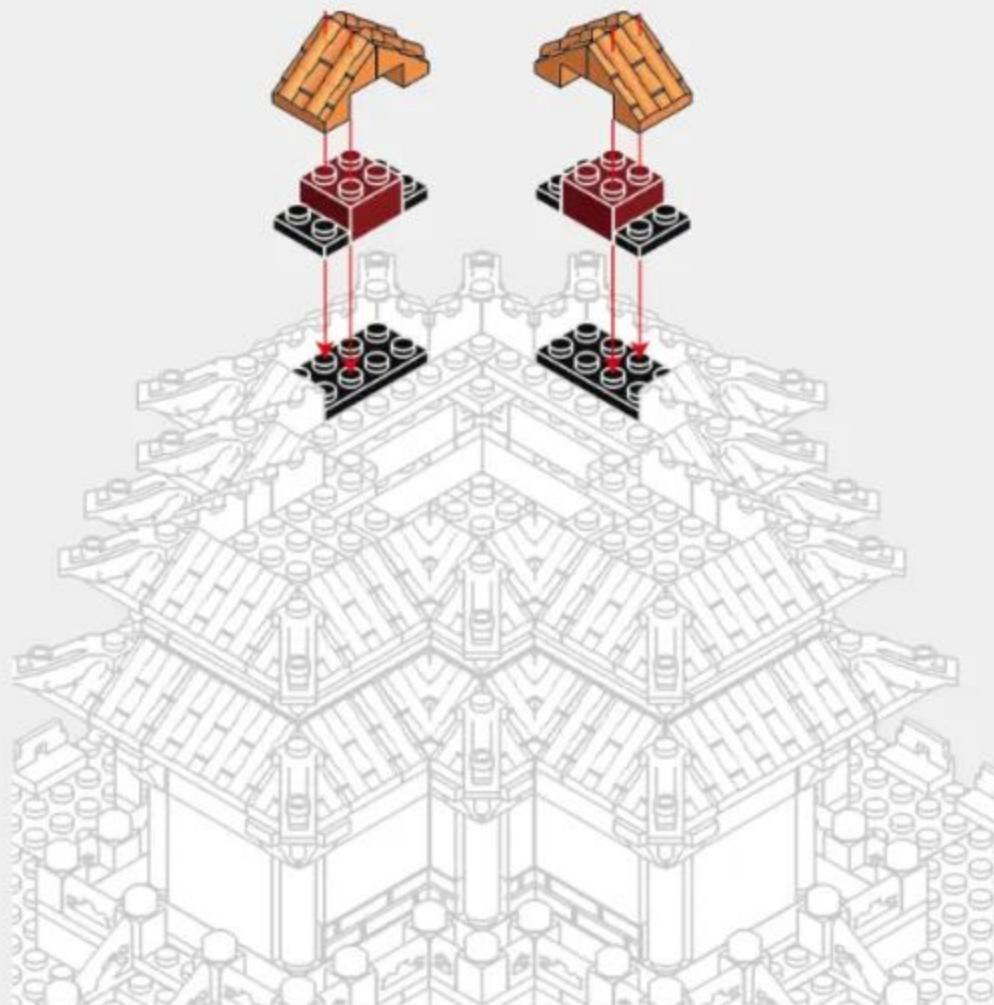
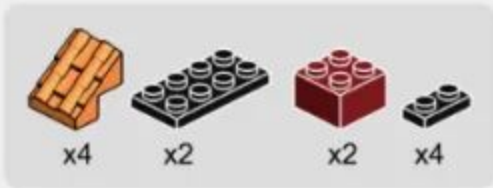

4-10

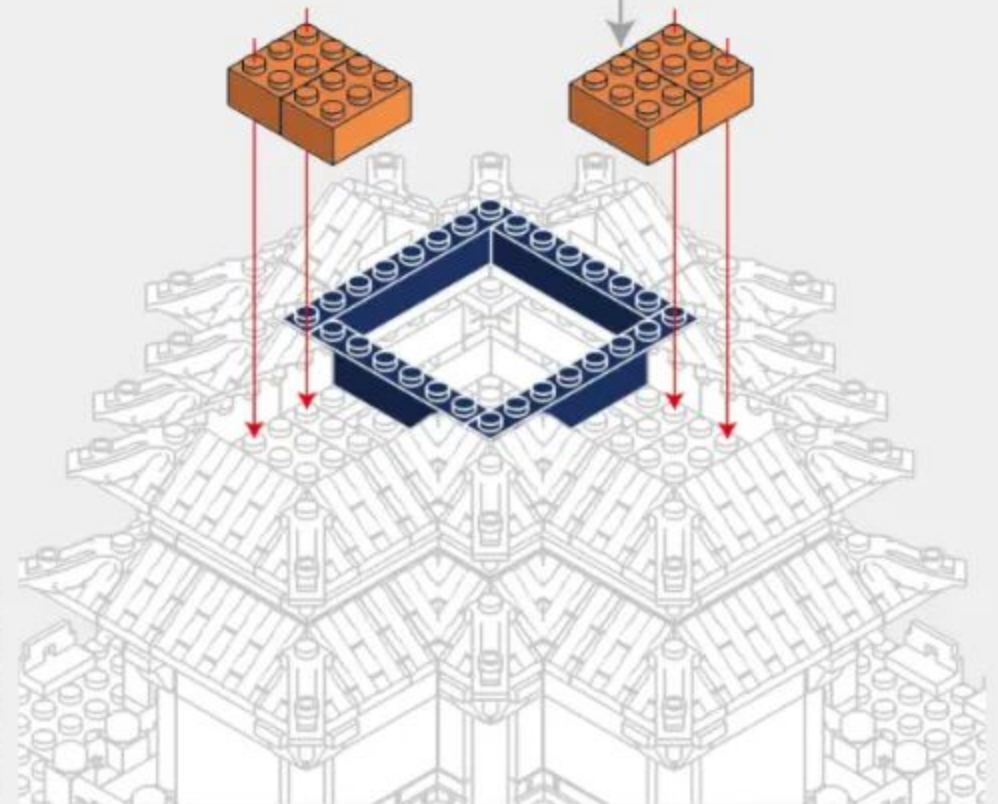
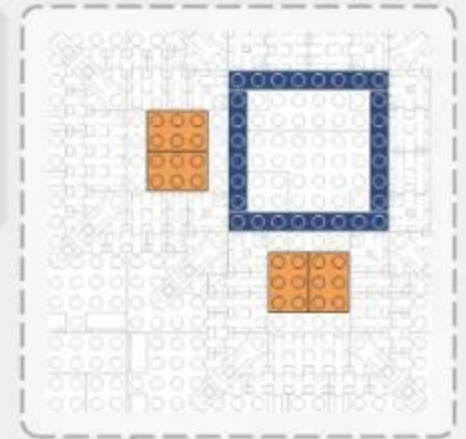
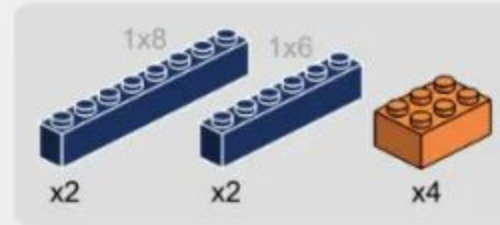

4-11

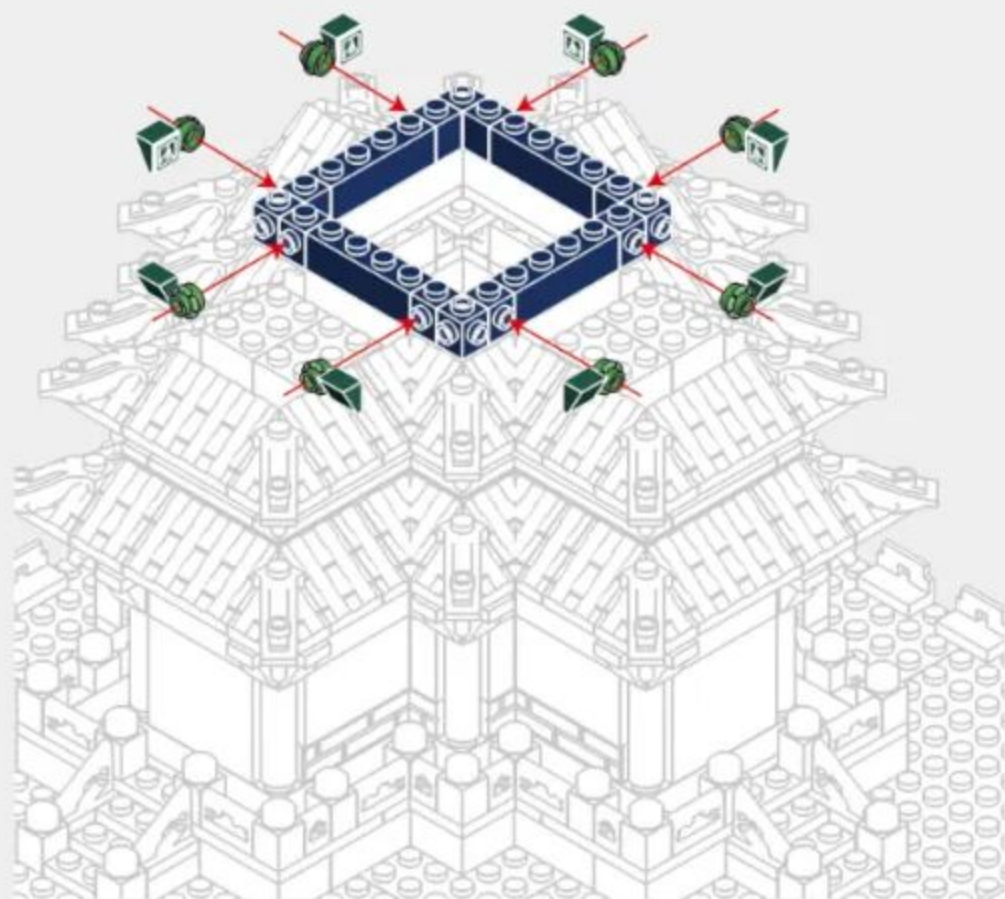

4-12

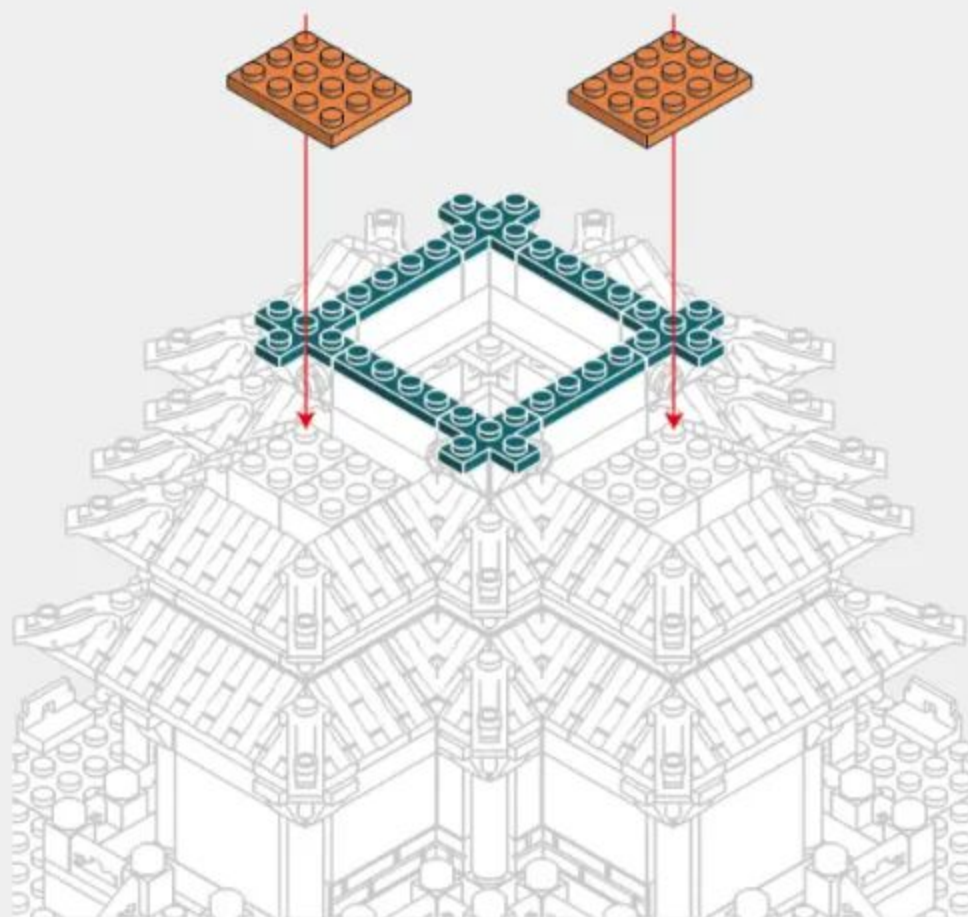
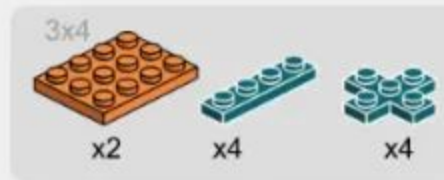

4-13

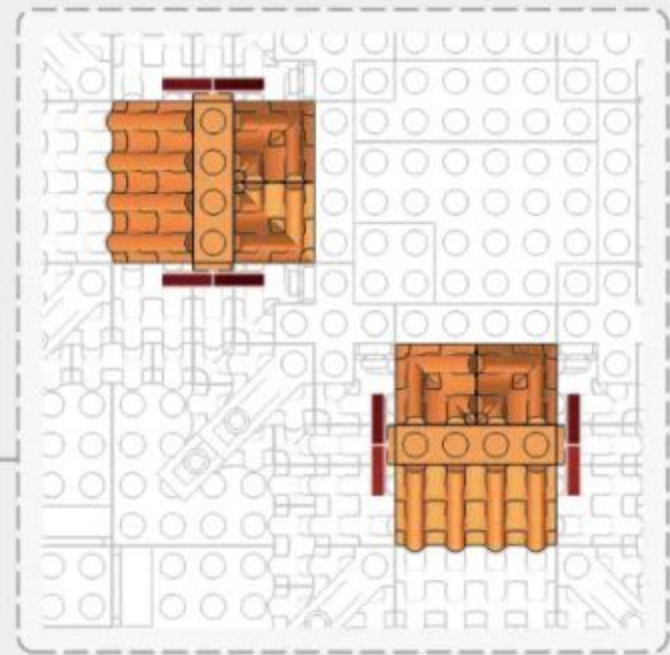
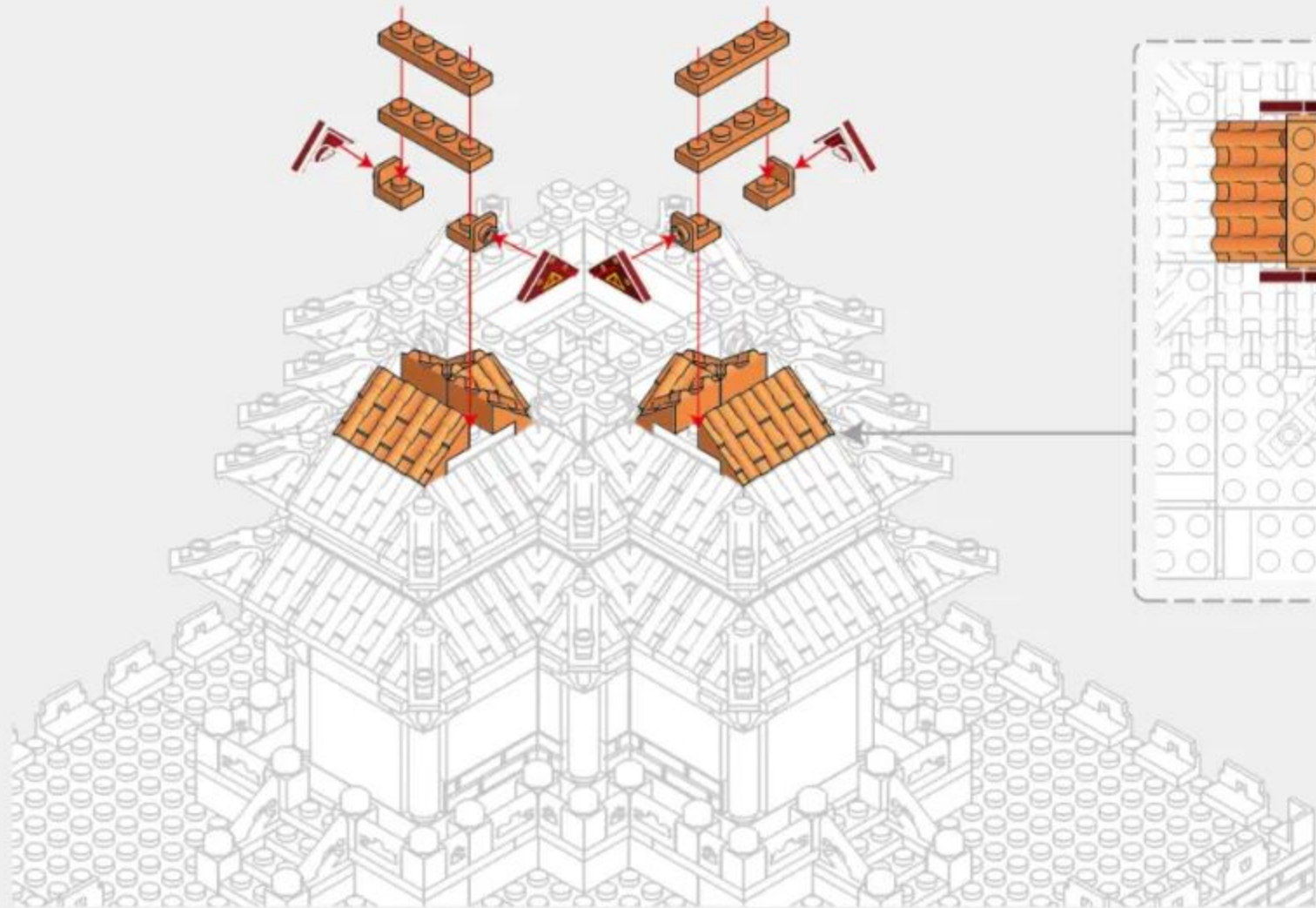

4-14

-  x12
-  x12
-  1x2 x2
-  x4
-  x4
-  x4
-  x12
-  x8
-  x4

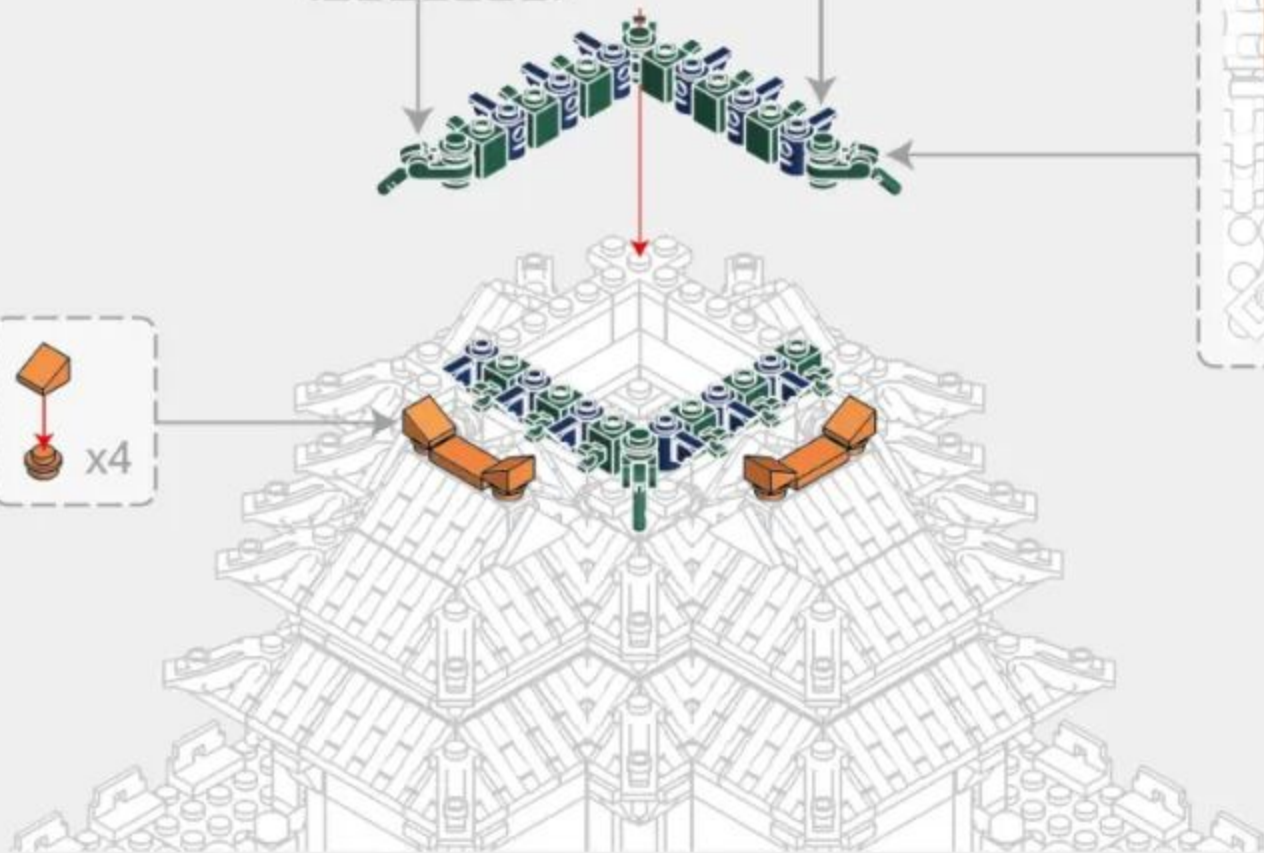
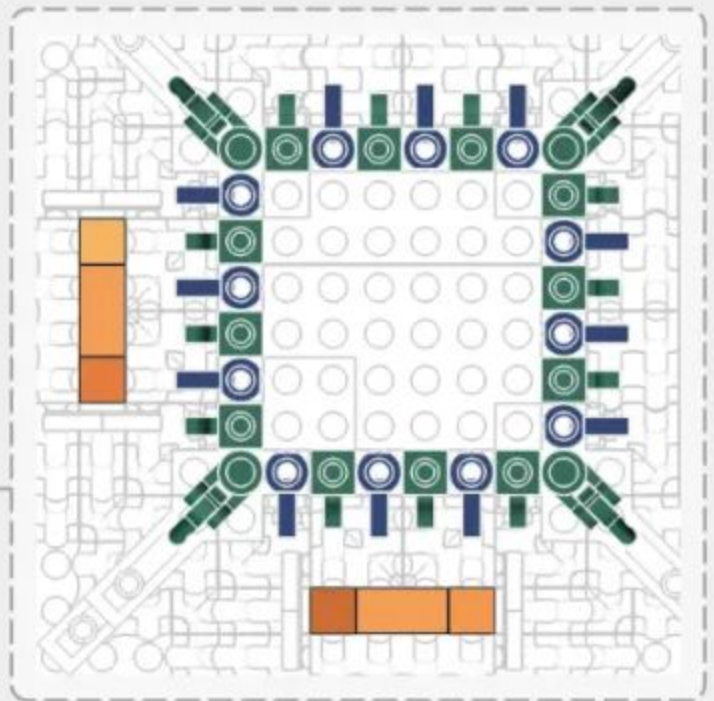
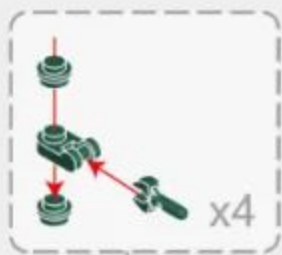

4-15

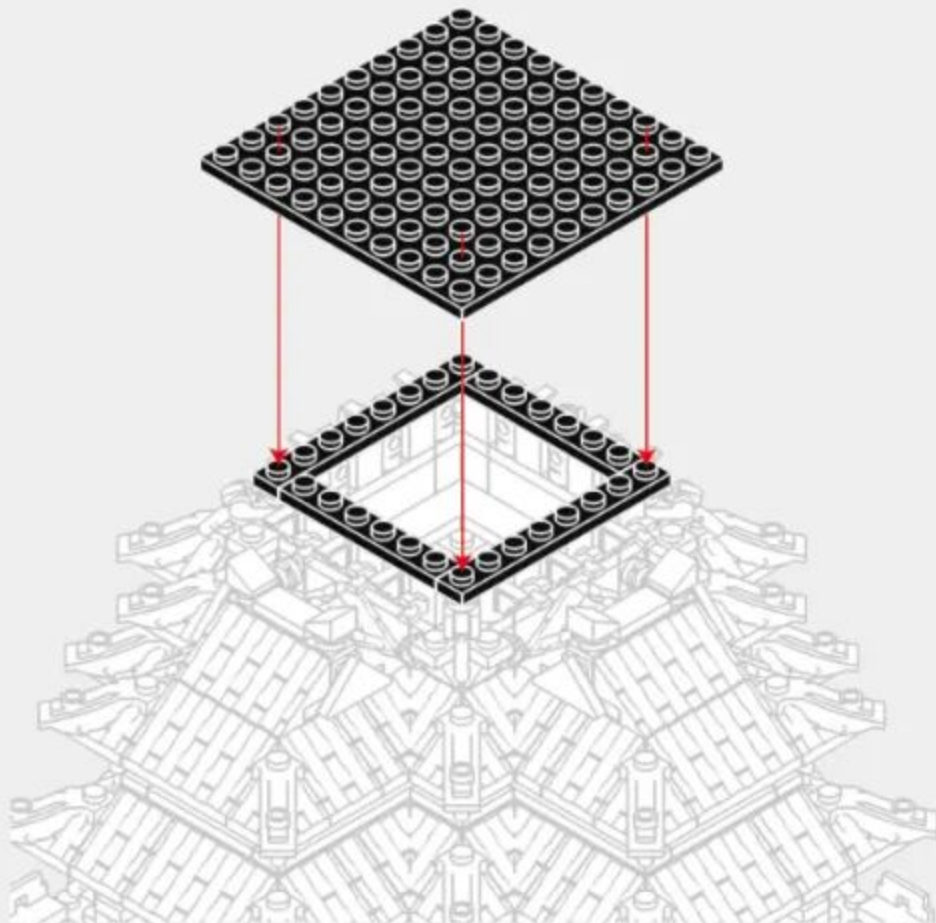
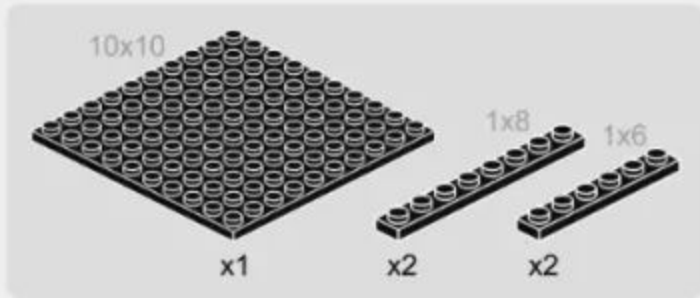

4-16

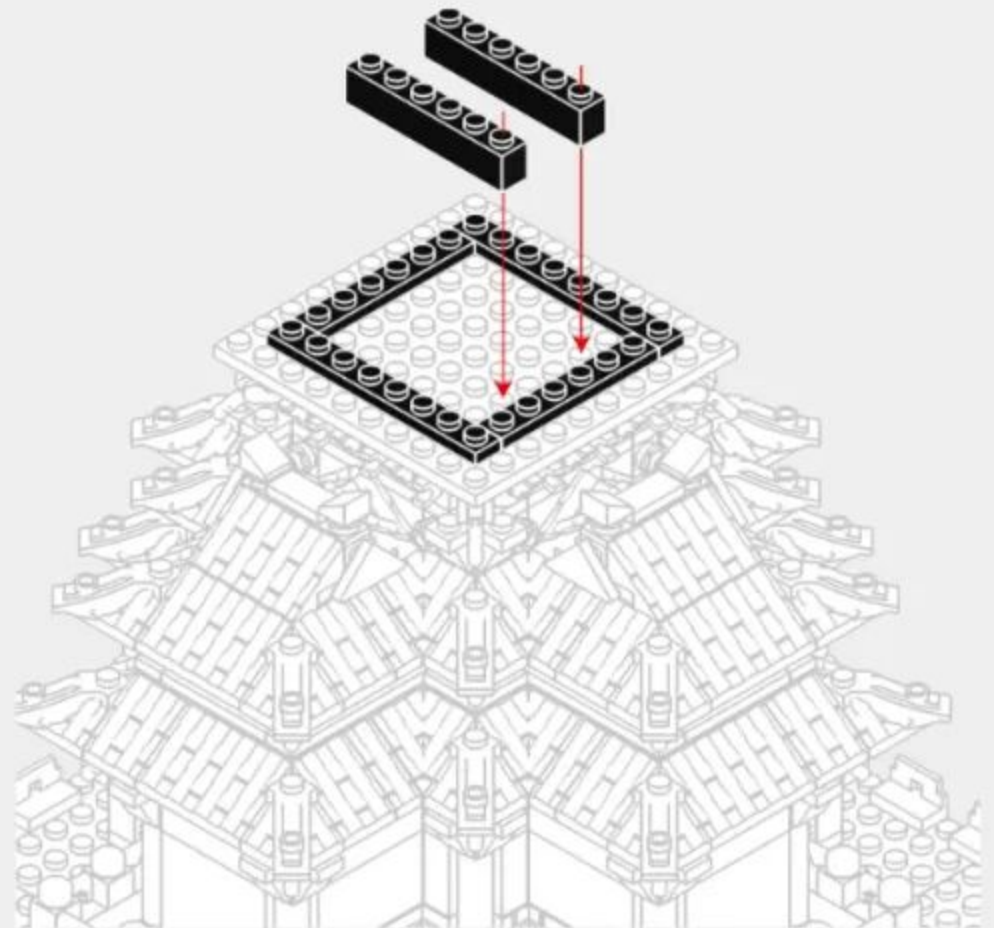
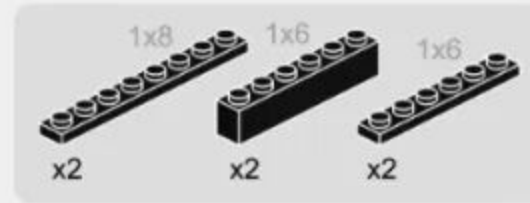

4-17

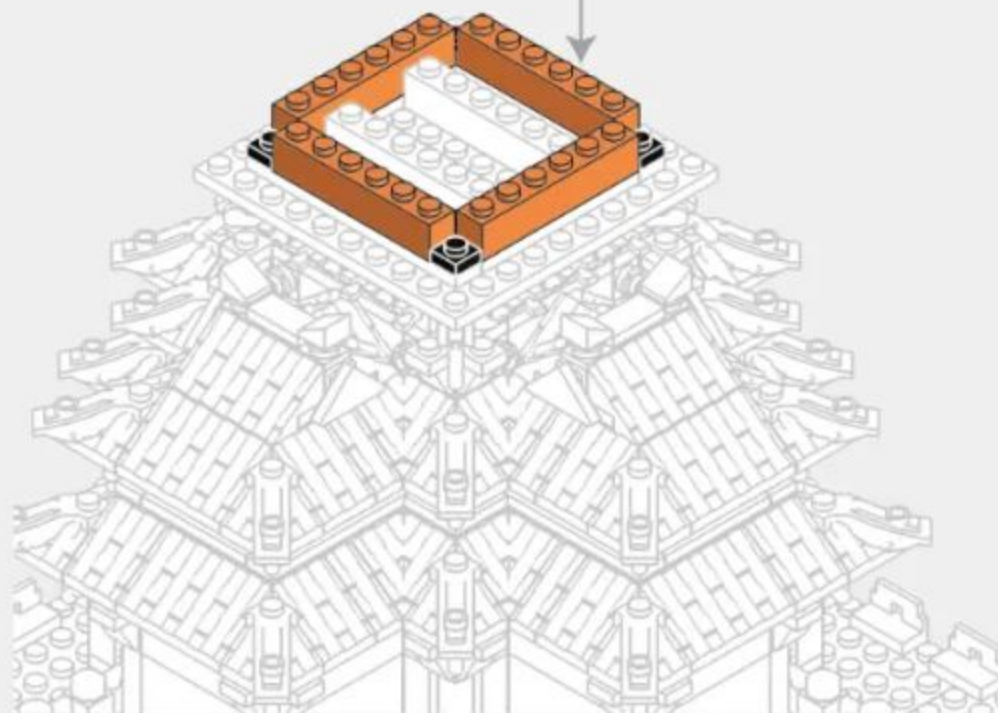
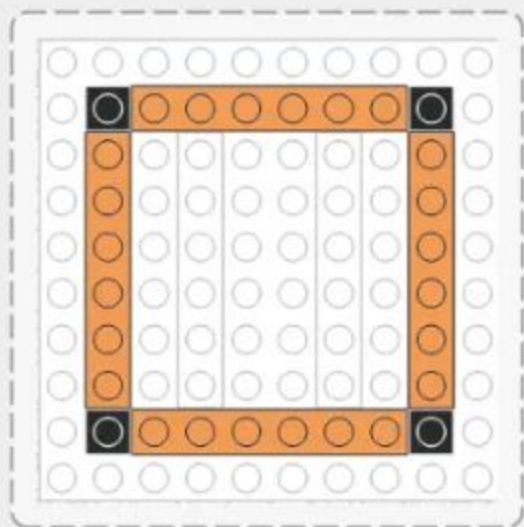

4-18

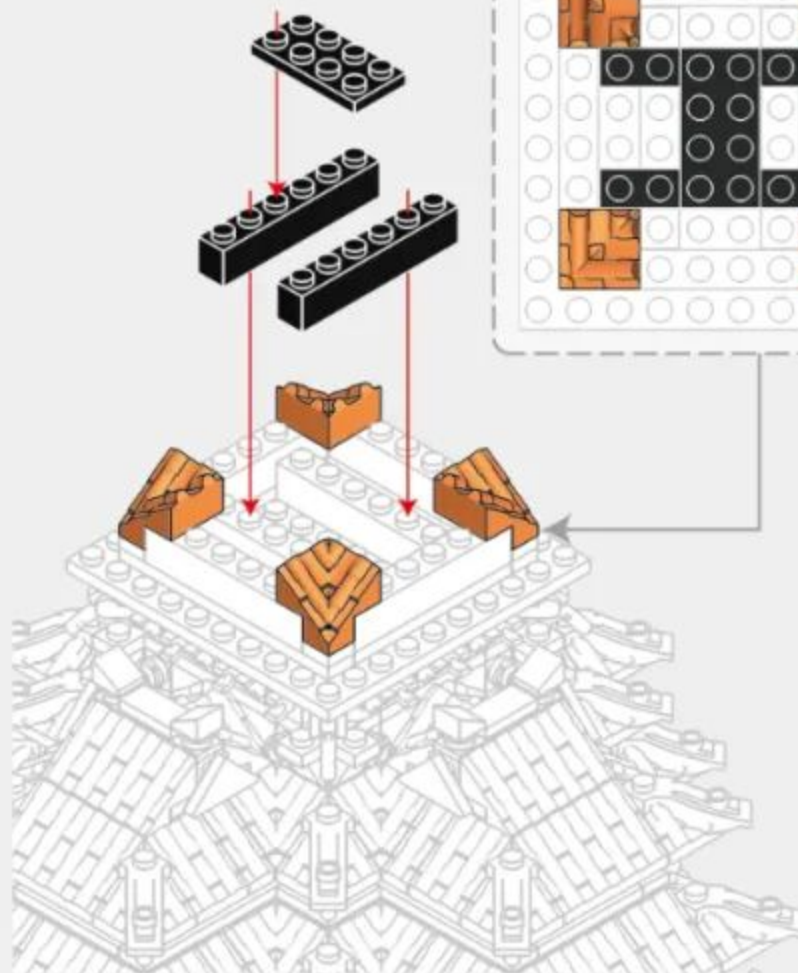
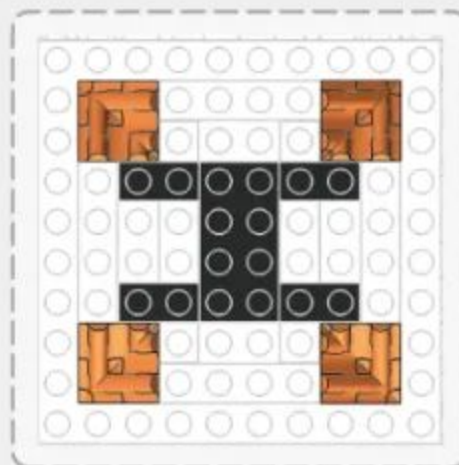
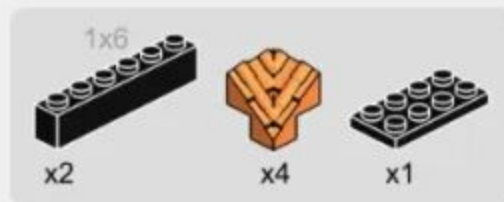



169PCS

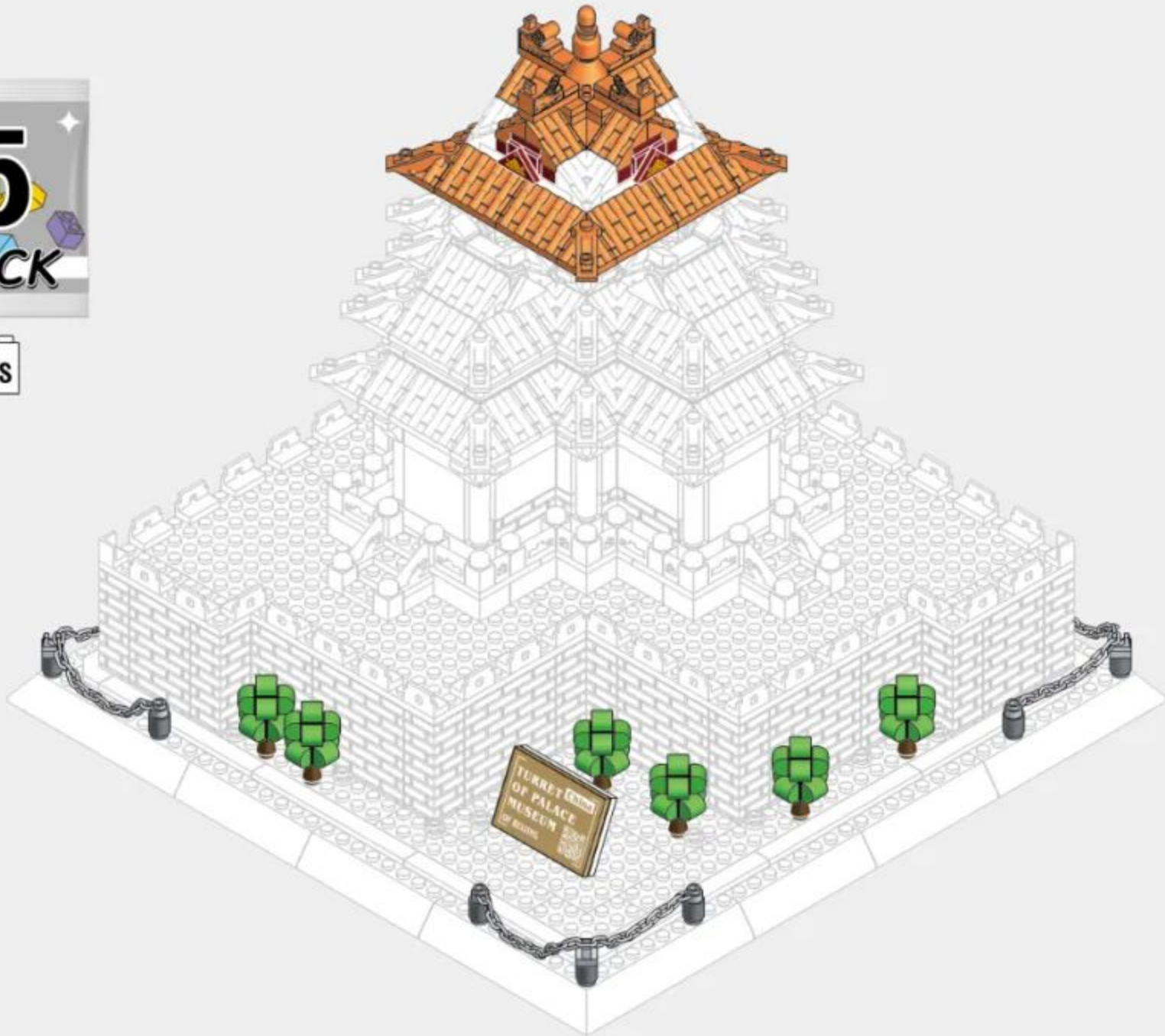

72

5-1

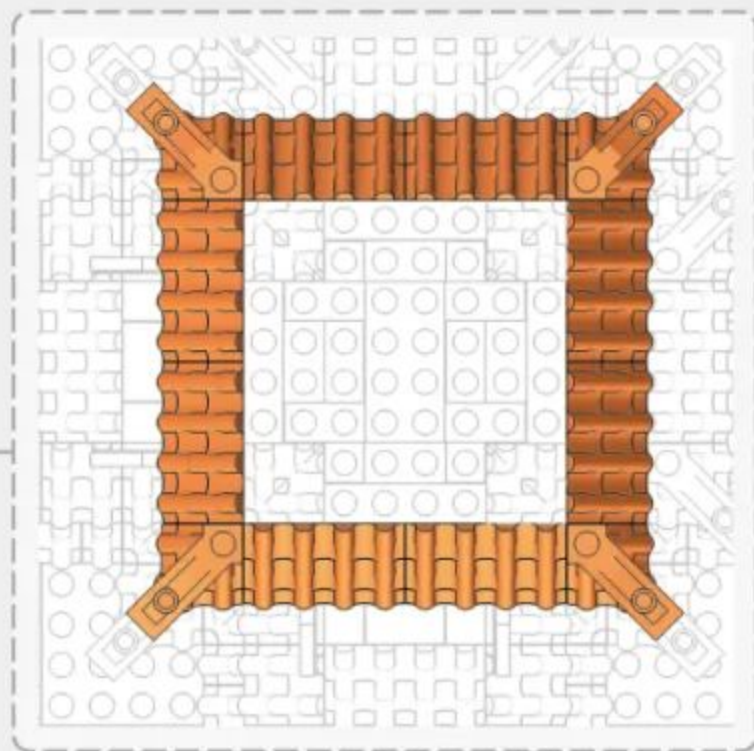
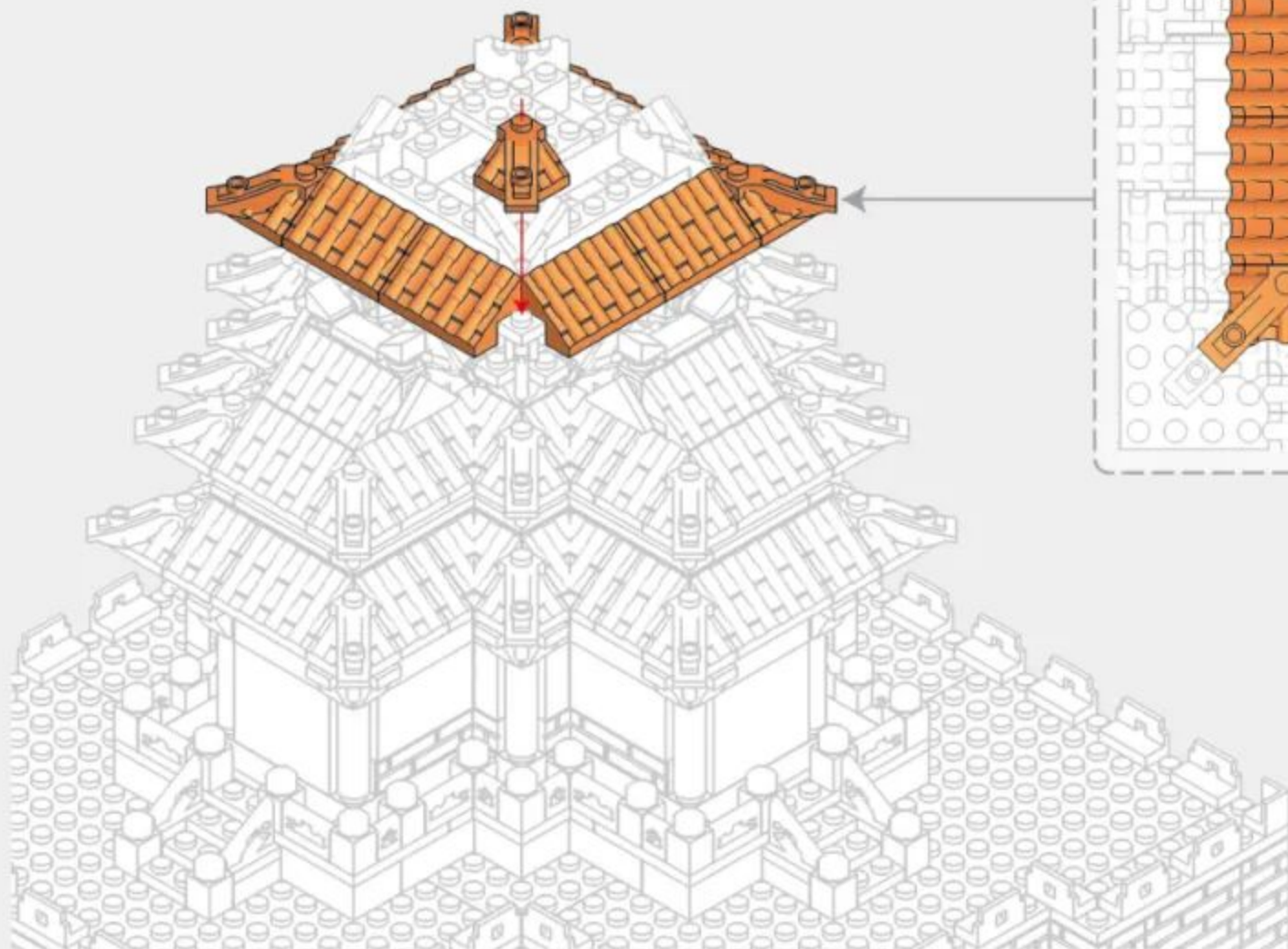

5-2

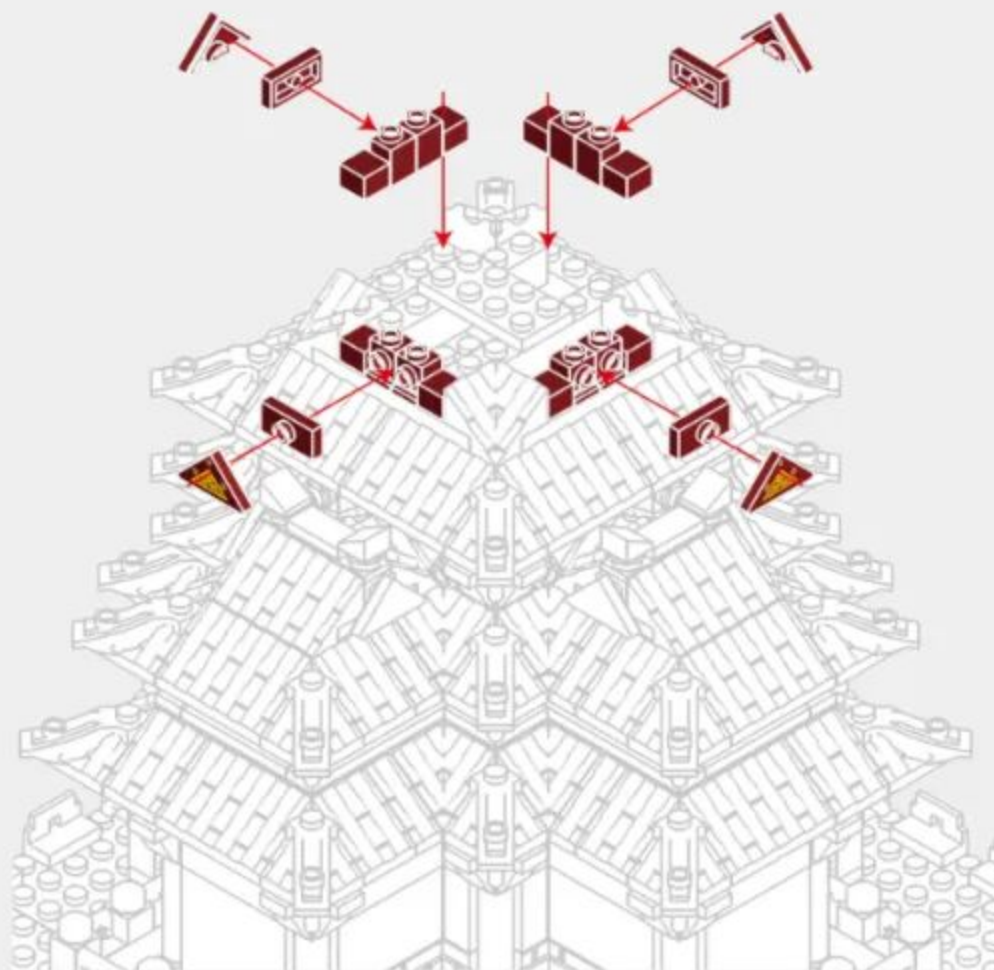

5-3

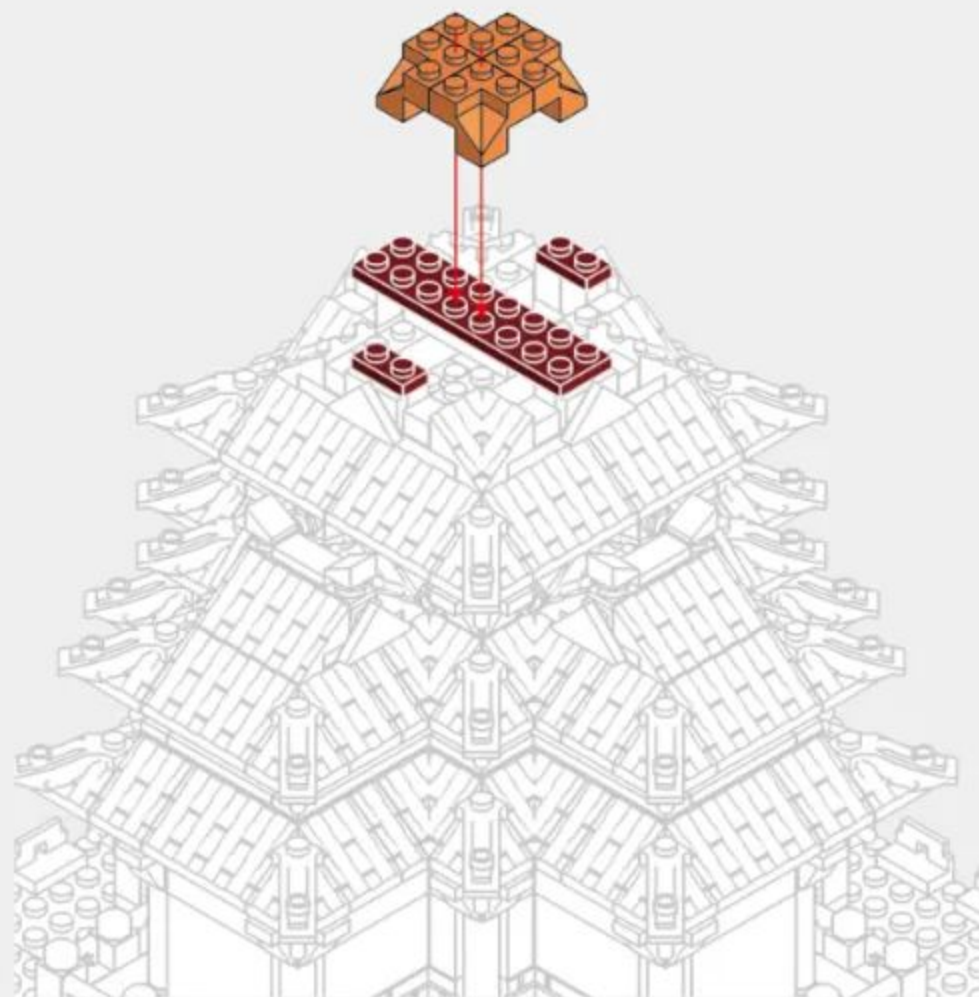

5-4

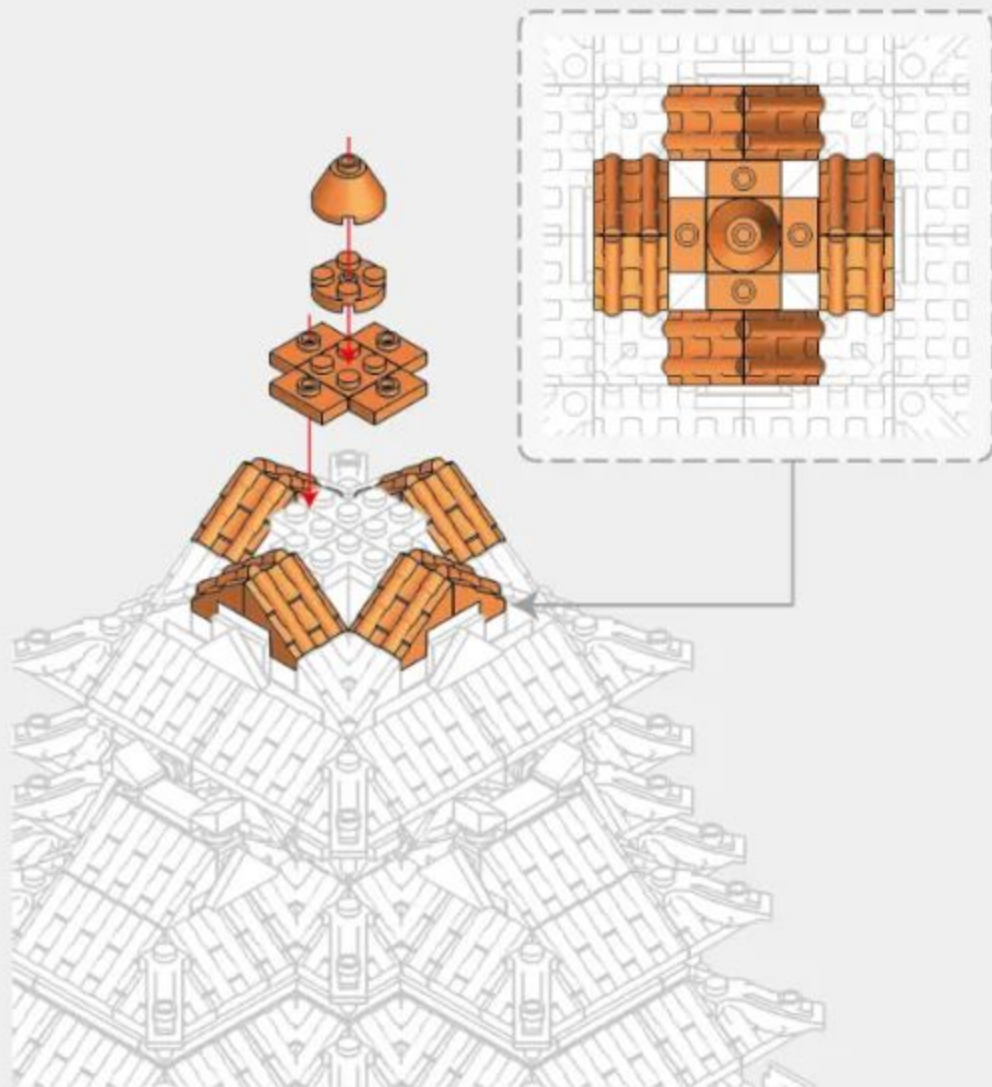

5-5

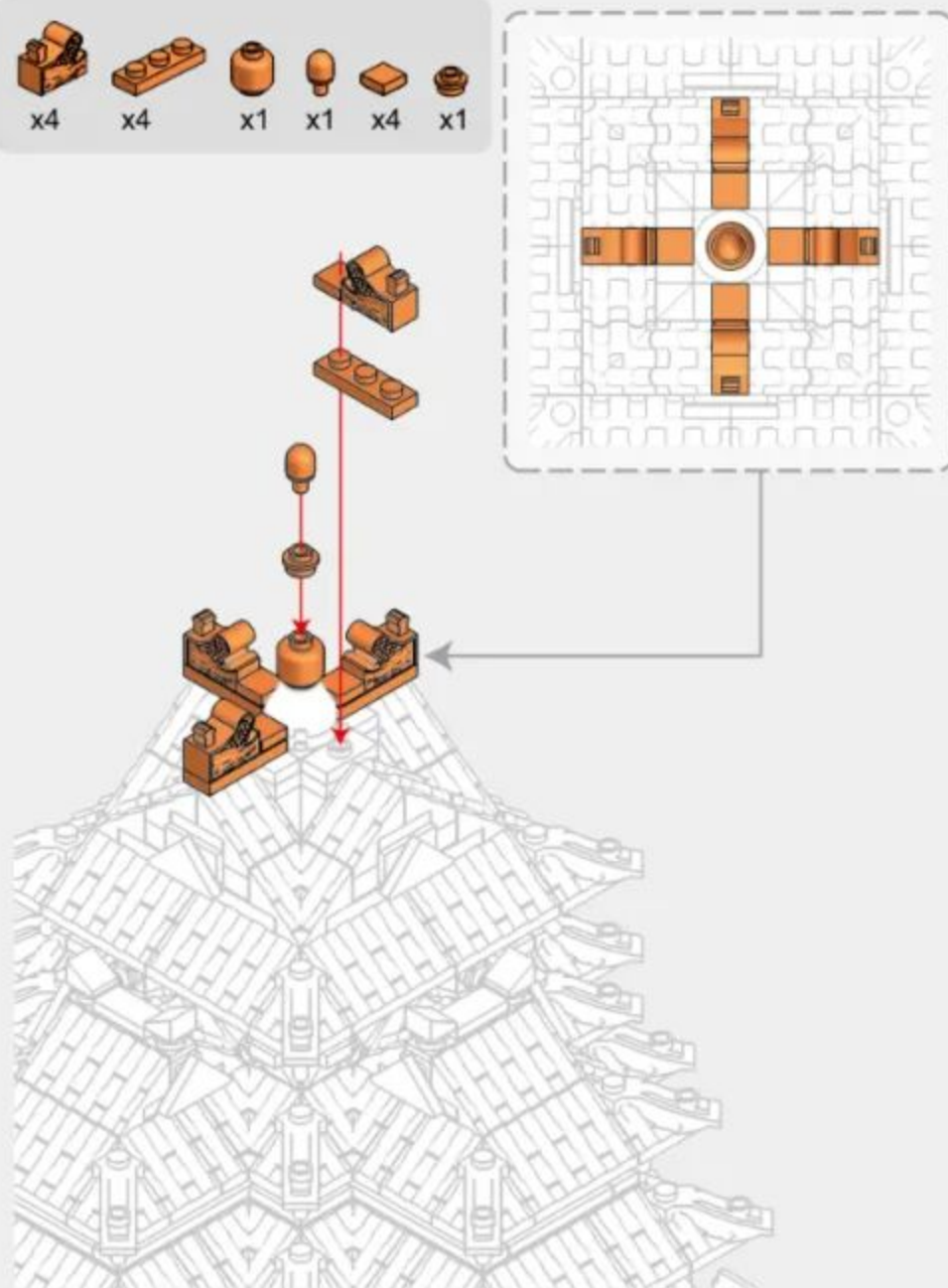

5-6

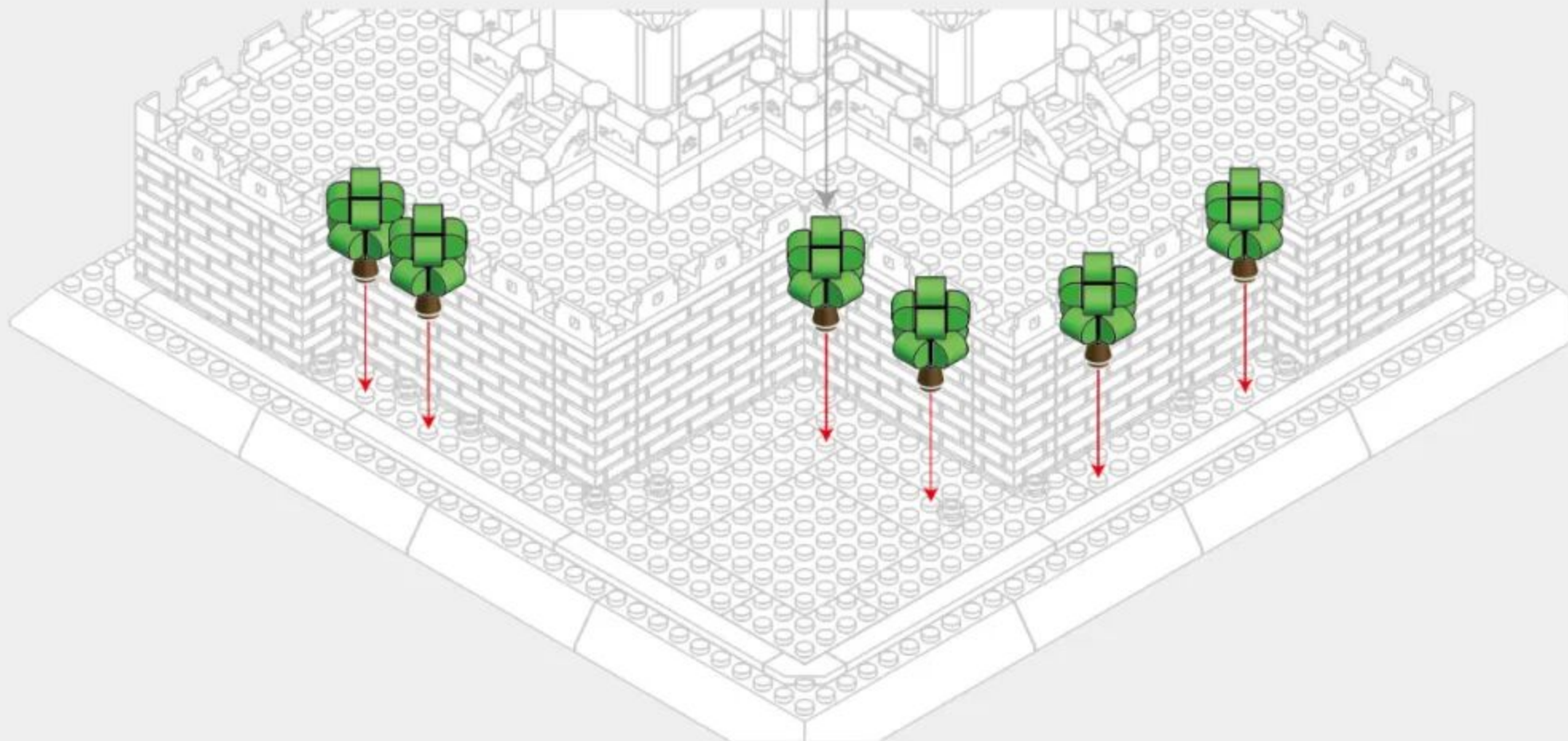
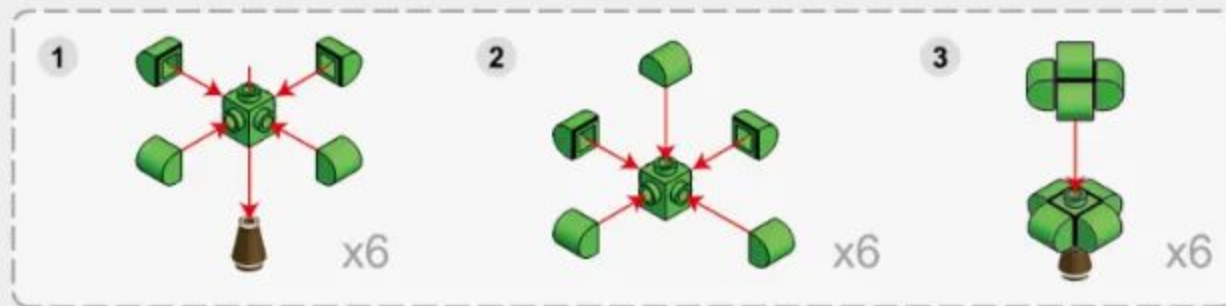

5-7

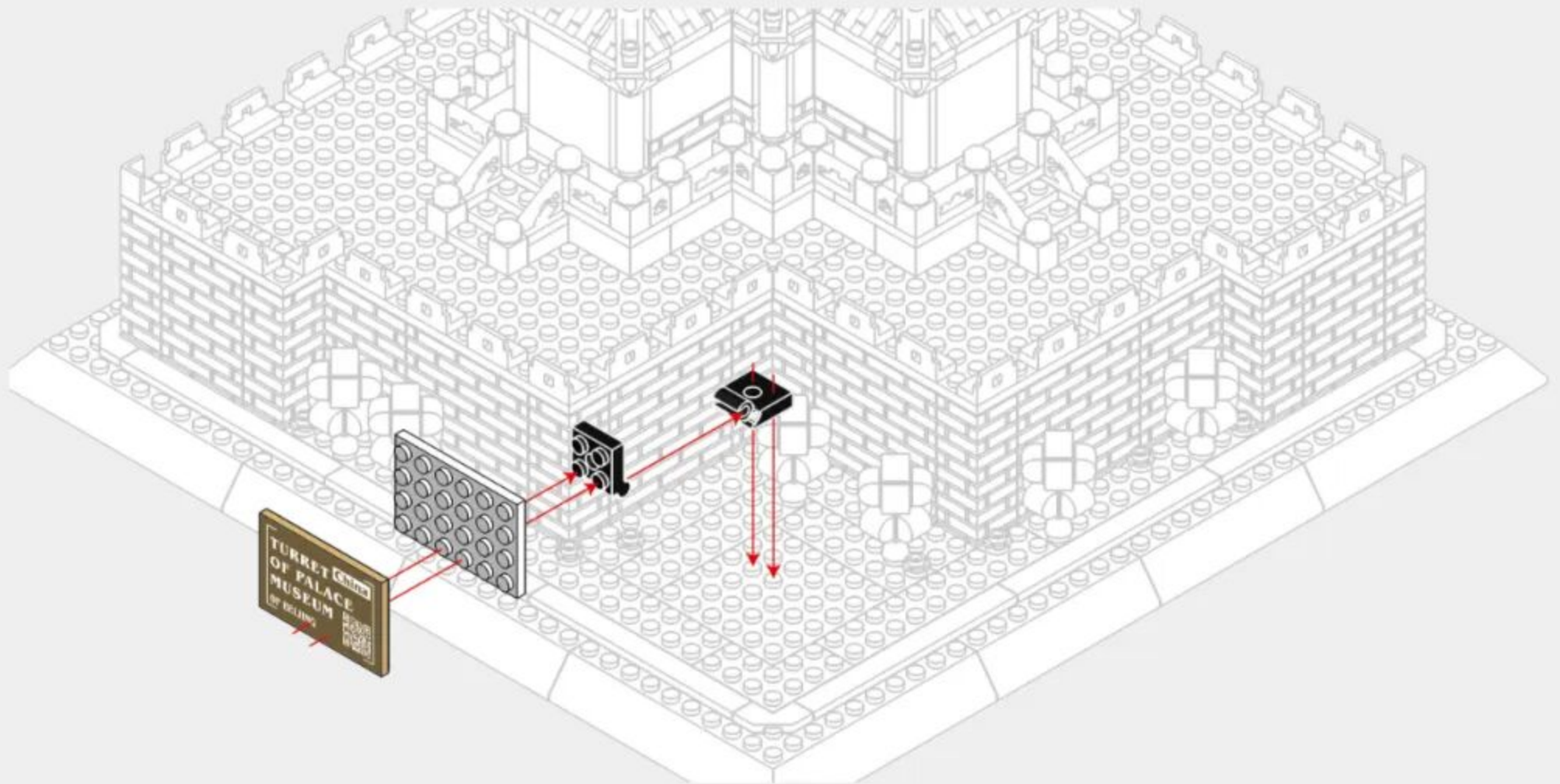
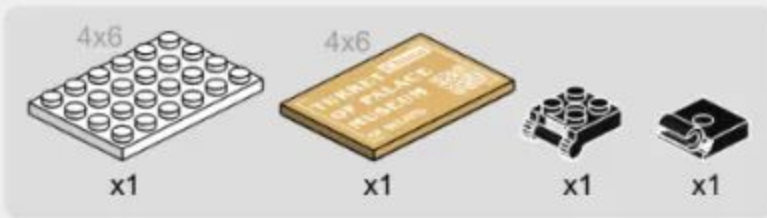

5-8

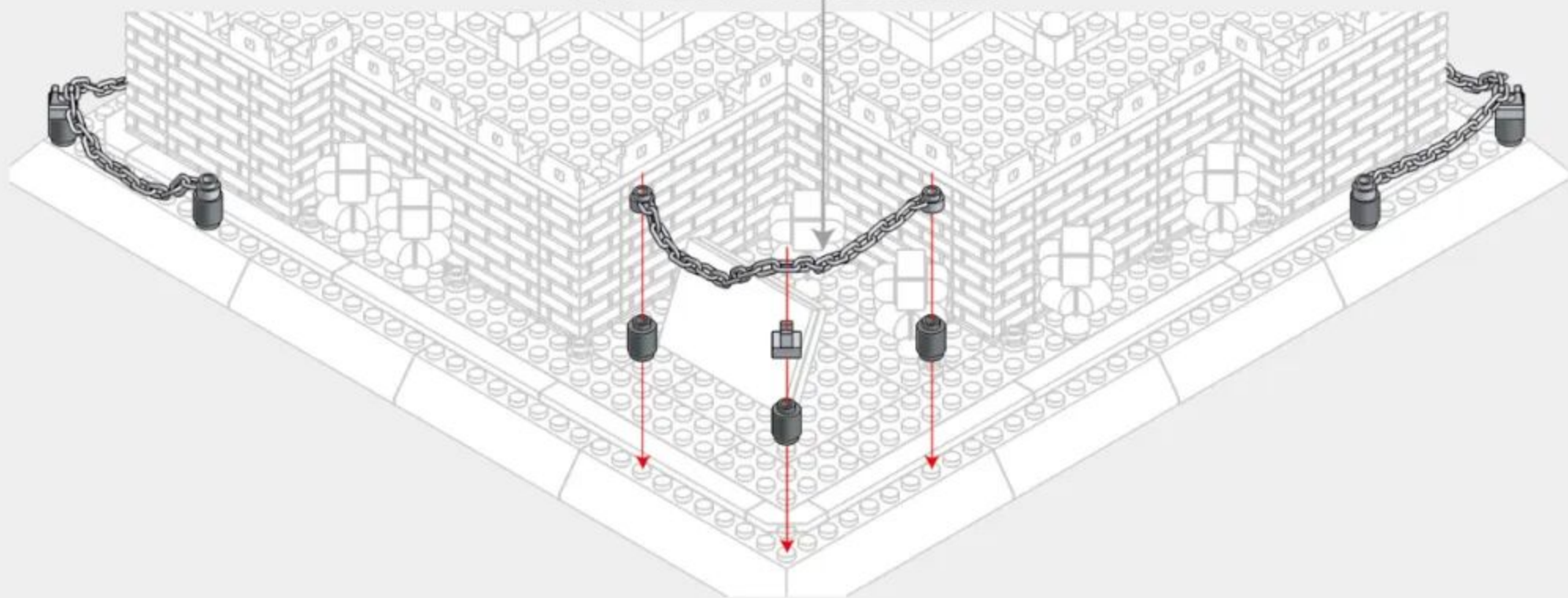
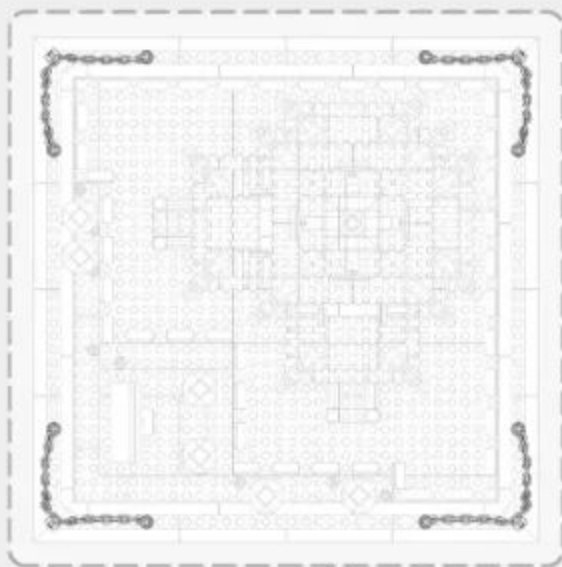
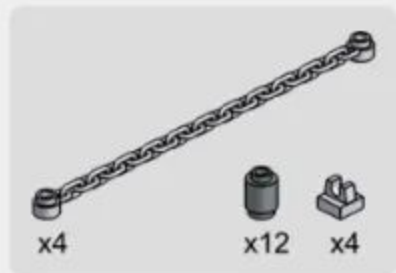

78



ARCHITECTURE

The World's great architecture

Shaping Skills Imagination & Curiosity Mathematical Self Discovery & Perception Parent-Child Interaction Problem Solving Creativity



6224 英国伦敦白金汉宫
BUCKINGHAM PALACE-LONDON,ENGLAND



5225 意大利罗马斗兽场
COLOSSEUM-ROME,ITALY



5226 日本东京帝国饭店
IMPERIAL HOTEL-TOKYO,JAPAN



5227 美国纽约自由女神像
STATUE OF LIBERTY-NEW YORK,AMERICA



6211 德国柏林勃兰登堡门
BRANDENBURG GATE-BERLIN, GERMANY



6222 中国甘肃长城-嘉峪关
JIAYU PASS-GANSU,CHINA



6212 日本京都清水寺仁王门
NIMON GATE OF KIYOMIZU-DEIRA-KYOTO,JAPAN



6213 俄罗斯莫斯科瓦西里大教堂
SAINT BASIL'S CATHEDRAL-MOSCOW,RUSSIA



6214 中国武汉黄鹤楼
YELLOW CRANE TOWER-WUHAN,CHINA



6215 英国伦敦眼
LONDON EYE-LONDON,ENGLAND



6221 中国北京故宫-太和殿
HALL OF SUPREME HARMONY-BEIJING,CHINA



6220 沙特阿拉伯麦加大清真寺
GREAT MOSQUE OF MECCA,SAUDI ARABIA



6219 美国纽约联合国大厦
UNITED NATIONS HEADQUARTERS-NEW YORK,AMERICA



4214 美国华盛顿白宫
WHITE HOUSE-WASHINGTON D.C.,AMERICA



4212 意大利罗马许愿池
TREVI FOUNTAIN-ROME,ITALY



4213 法国巴黎卢浮宫
MUSÉE DU LOUVRE-PARIS,FRANCE

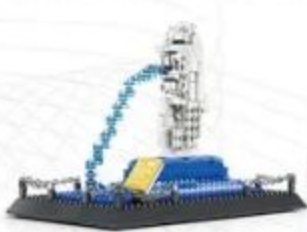

4218 新加坡-鱼尾狮
MERLION,SINGAPORE



4219 英国伦敦双子塔桥
TOWER BRIDGE-LONDON,ENGLAND



4216 美国华盛顿林肯纪念堂
LINCOLN MEMORIAL-WASHINGTON D.C.,AMERICA



4217 新加坡-金沙酒店
MARINA BAY SANDS,SINGAPORE



4210 埃及开罗吉萨金字塔
GREAT PYRAMID OF GIZA-CAIRO,EGYPT



4221 加拿大渥太华国会山庄
PARLIAMENT BUILDINGS-OTTAWA,CANADA



4211 英国伦敦伊丽莎白塔
ELIZABETH TOWER-ENGLAND



4215 加拿大多伦多电视塔
THE CN TOWER-CANADA



4220 美国纽约熨斗大厦
FLATIRON BUILDING-NEW YORK,AMERICA



4222 阿联酋迪拜哈利法塔 THE BURJ KHALIFA TOWER-DUBAI, UAE
 5224 中国上海东方明珠广播电视塔 ORIENTAL PEARL TOWER-SHANGHAI, CHINA
 5212 美国纽约帝国大厦 EMPIRE STATE BUILDING-NEW YORK, AMERICA
 5213 马来西亚吉隆坡石油双塔 PETRONAS TWIN TOWERS-KUALA LUMPUR, MALAYSIA
 5214 意大利托斯卡纳比萨斜塔 LEANING TOWER OF PISA-TUSCANY, ITALY
 5216 英国伦敦伊丽莎白白塔 ELIZABETH TOWER-LONDON, ENGLAND



5219 俄罗斯莫斯科克里姆林宫钟楼 SPASSKAYA TOWER-MOSCOW, RUSSIA
 5220 阿联酋迪拜卓美亚帆船酒店 BURJ AL ARAB HOTEL-DUBAI, UAE
 5217 法国巴黎埃菲尔铁塔 EIFFEL TOWER-PARIS, FRANCE
 5221 中国台北101大楼 TAIPEI 101-TAIPEI, CHINA
 5228 美国芝加哥威利斯大厦 WILLIS TOWER-CHICAGO, AMERICA
 5231 巴西里约热内卢救世基督像 CRISTO REDENTOR-RIO DE JANEIRO, BRASIL



6223 中国武汉长江大桥 WUHAN YANGTZE RIVER BRIDGE
 5210 法国巴黎圣母院大教堂 CATHÉDRALE NOTRE DAME DE PARIS-PARIS, FRANCE
 5211 印度阿格拉泰姬陵 TAJ MAHAL-AGRA, INDIA
 5223 法国巴黎凯旋门 ARC DE TRIOMPHE-PARIS, FRANCE
 5215 英国伦敦双子塔桥 TOWER BRIDGE-LONDON, ENGLAND



5222 中国北京天坛祈年殿 HALL OF PRAYER FOR GOOD HARVESTS-BEIJING, CHINA
 6210 美国旧金山金门大桥 GOLDEN GATE BRIDGE-SAN FRANCISCO, AMERICA
 6216 中国北京万里长城(八达岭) THE GREAT WALL-BEIJING, CHINA
 5218 中国北京天安门 TIANANMEN TOWER-BEIJING, CHINA
 6217 中国西藏布达拉宫 POTALA PALACE-TIBET, CHINA



6218 芬兰罗瓦涅米圣诞老人办公室 SANTA CLAUS OFFICE-ROVANIEMI, FINLAND
 6225 墨西哥库库尔坎玛雅金字塔 EL CASTILLO-KUKULKAN, MEXICO
 6226 德国巴伐利亚新天鹅堡 SCHLOSS NEUSCHWANSTEIN-BAYERN, DEUTSCHLAND
 5229 土耳其伊斯坦布尔少女塔 MAIDEN TOWER-ISTANBUL, TURKEY
 5230 中国湖南长沙爱晚亭 AIWANTING PAVILION-HUNAN, CHINA



7210 中国上海世博会中国馆
CHINA PAVILION AT EXPO-SHANGHAI, CHINA



5232 美国宾夕法尼亚州流水别墅
FALLINGWATER-PENNSYLVANIA, AMERICA



5233 美国芝加哥范斯沃斯住宅
FARNSWORTH HOUSE-CHICAGO, AMERICA



5234 美国华盛顿唐人街
CHINA TOWN-WASHINGTON, D.C., AMERICA



3210 美国纽约自由女神像
STATUE OF LIBERTY-NEW YORK, AMERICA



4223 中国北京清华园
TSINGHUA CAMPUS-BEIJING, CHINA



7211 中国湖南岳阳楼
YUEYANG TOWER-HUNAN, CHINA



8210 澳大利亚悉尼歌剧院
SYDNEY OPERA HOUSE-BENNELONG POINT, AUSTRALIA



7212 中国江西南昌滕王阁
PAVILION OF PRINCE TENG-JIANGXI, CHINA



6227 中国河南郑州嵩山少林寺
SHAOLIN TEMPLE-HENAN, CHINA



7213 中国重庆洪崖洞
HONGYADONG-CHONGQING, CHINA



5235 美国华盛顿国会大厦
UNITED STATES CAPITOL-WASHINGTON D.C., AMERICA



5236 中国安徽滁州醉翁亭
ZUIWENG PAVILION-ANHUI, CHINA



6228 中国陕西西安钟楼
XI'AN BELL TOWER-SHAANXI, CHINA



5238 美国西雅图太空针塔
SPACE NEEDLE-SEATTLE, AMERICA



5237 法国巴黎萨伏伊别墅
VILLA SAVOYE-PARIS, FRANCE



6229 中国山西运城鹳雀楼
STORK TOWER-SHANXI, CHINA



6230 希腊爱情海圣托里尼岛
SANTORINI-FIRA, GREECE



6231 中国上海海关大楼
SHANGHAI CUSTOMS HOUSE-SHANGHAI, CHINA



5239 中国北京紫禁城角楼
TURRET OF PALACE MUSEUM-BEIJING, CHINA

TURRET OF PALACE MUSEUM

COUNTRY: China
CITY: Beijing



Ver: 523920221008