



CONFUCIUS TEMPLE

中国江苏南京夫子庙

Jiangsu, China

The world's great architecture



6+ / 5241 / 966 PCS
Suitable Age / Product Number / Parts Total



Architecture

It will be a city...

这将构成一座城市...

ABOUT THE PRODUCT

关于产品

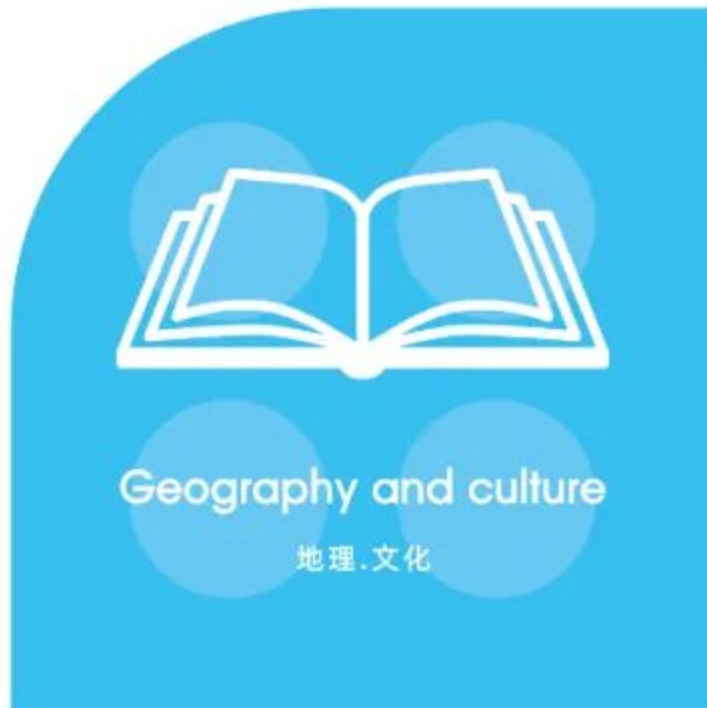

ARCHITECTURE

WANGE The world's great architect since 1991

Confucius Temple



Nanjing Confucius Temple is located in the core area of Confucius Temple Qinhuai Scenic Belt, which is located on the west of Gongyuan Street and Jiangnan Gongyuan on the north bank of Qinhuai River in Qinhuai District of Nanjing City.

Confucius Temple

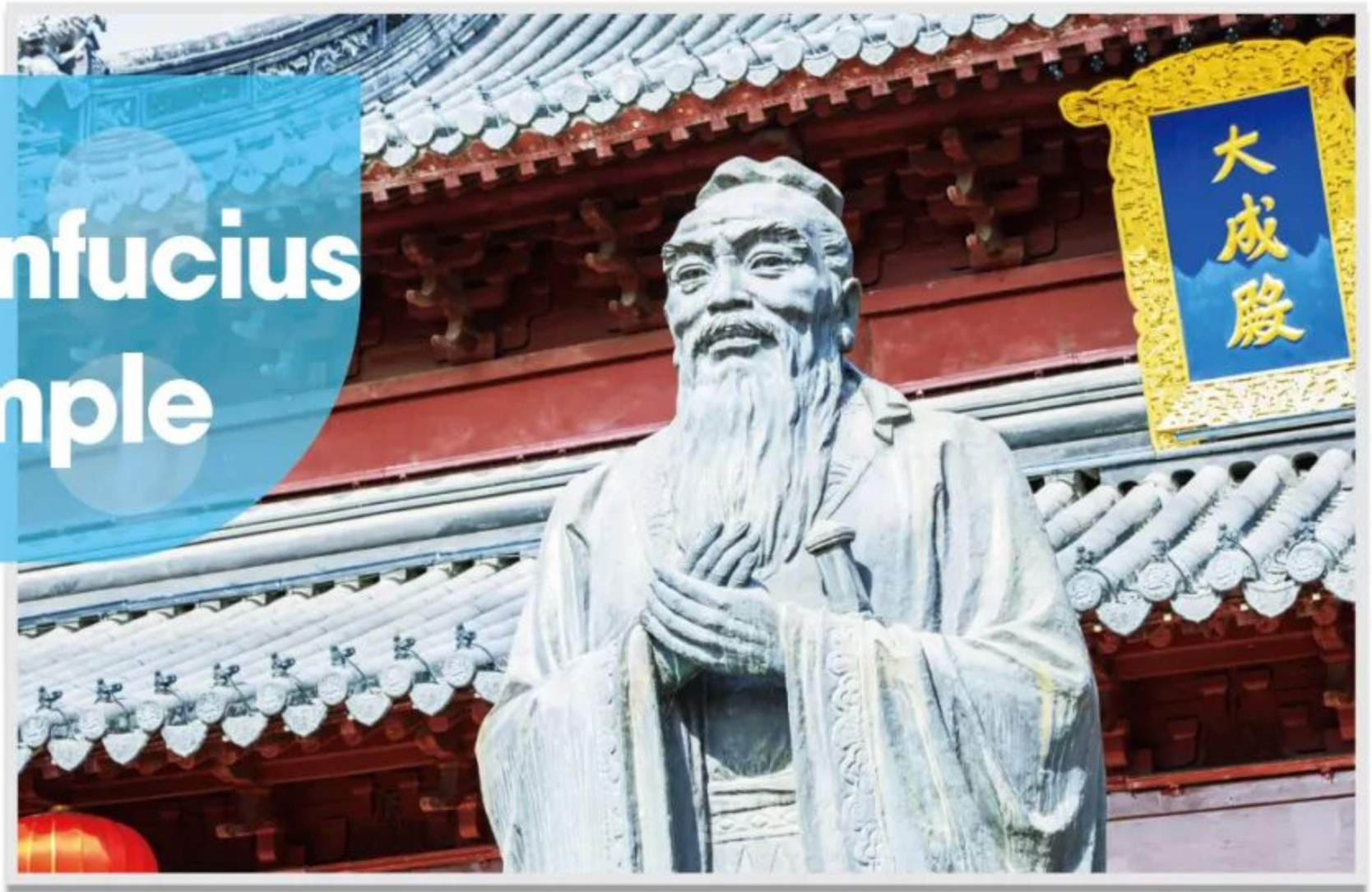

Geography and culture

地理·文化



The Confucius Temple in Nanjing was built in the third year of Xiankang in the Eastern Jin Dynasty (337). It is the first national highest institution in China, one of the four major Confucian temples in China, the hub of ancient Chinese culture, and the gathering place of Jinling history and humanities.



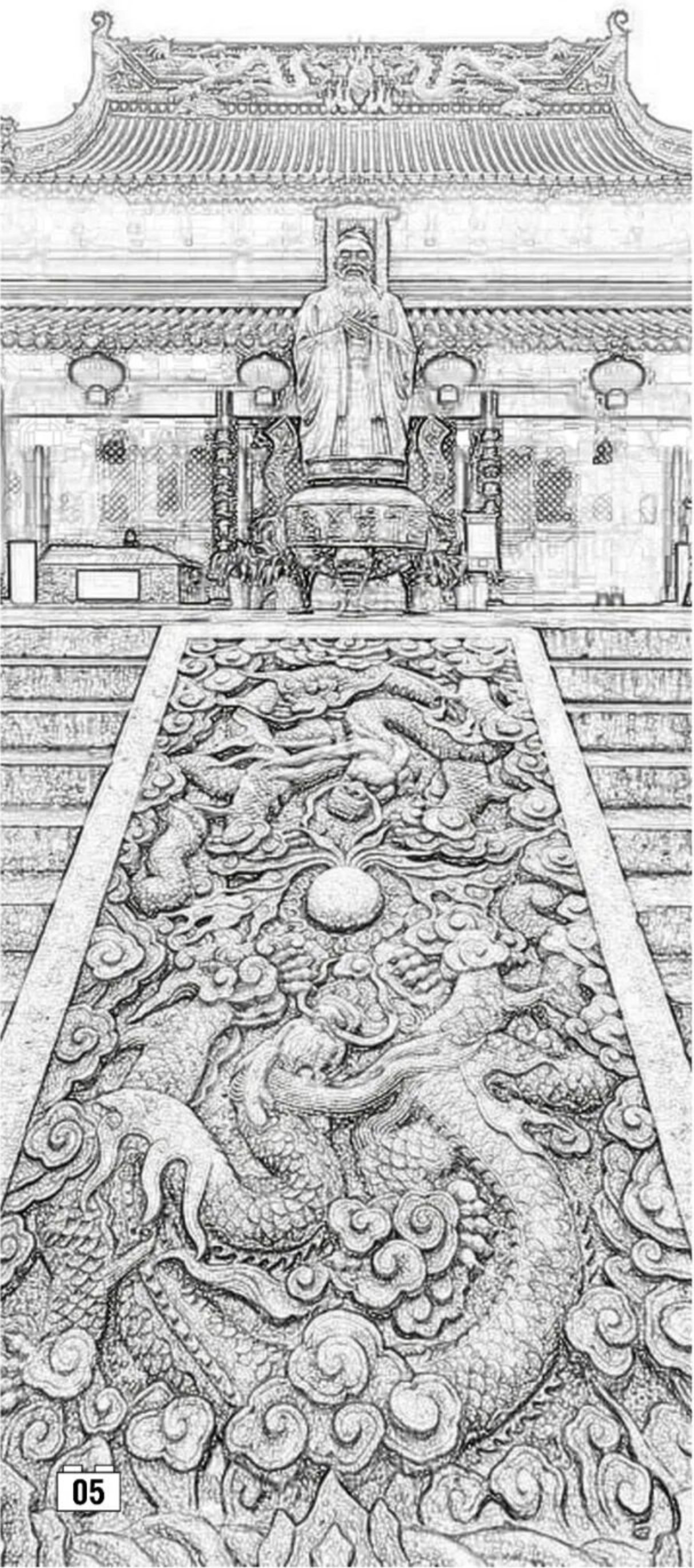

中国江苏南京夫子庙

Confucius ■ Temple China

The contents of this chapter refer to the Wikipedia website.

本章内容参考维基百科网站，更多资讯可自行查阅。

The world's great architecture

Buildings and layout

■ 建筑物和布局



夫子庙是一组规模宏大的古建筑群，主要由孔庙、学宫、贡院三大建筑群组成，占地极大。正中是为“大成殿”，现大殿是按清代同治八年（1869年）的建筑为蓝本修建的，取消了原孔庙的后墙，使之与学宫融为一体。大殿七间，高18米，重檐歇山顶。原殿内正中为“大成至圣先师孔子之神位”牌位，两旁配享四亚圣。现殿内有孔子铜像，两旁配有孔子十二弟子汉白玉像。殿前有宽敞的露台，四周绕以石栏板，它是古时祭祀举行乐舞的地方。殿前两侧有廊庑相连，原是供奉孔门七十二贤人和历代大儒，及存放祭器的地方。现改作碑廊，墙上镶嵌陈列当今名流的书法碑石30多块。

Confucius Temple is a group of grand ancient buildings, mainly by the Confucian Temple, School Palace, Gongyuan three buildings, covers an area of great. The center is the ' Dacheng Hall ', seven halls, 18 meters high, heavy eaves Xieshan top. There is a spacious terrace in front of the palace, surrounded by stone slabs, it is the ancient sacrificial dance place. There are corridors on both sides of the front of the hall, which were originally dedicated to the seventy-two sages of the Confucius Gate and the great Confucians of the past dynasties, and the place where the sacrificial vessels were stored. Now converted into a stone corridor, the wall inlaid display of today 's famous calligraphy stone more than 30.



Structure

夫子庙的建筑富有明清色彩。它以大成殿为中心，从照壁至卫山南北成一条中轴线，左右建筑对称配列，占地广约26300平方米。四周围以高墙，配以门坊、角楼。大成门内为中心庙院，院内植有银杏八棵，古灯对称有致，中间一条笔直的石砌甬道通向大成殿前的丹墀，此丹墀是祭孔时举行乐舞的地方，正中竖立一尊青铜孔子塑像，高4.18米、重2500公斤，是中国最大的孔子青铜像。巍峨庄严的大成殿，重檐飞翘，斗拱交错，龙吻脊中有双楷戏珠立雕，双重飞檐中海蓝色竖匾上三个金色大字“大成殿”，是姬鹏飞的手书。

Confucius Temple to the Dacheng Hall as the center, from the wall to the Weishan north and south into a central axis, symmetrical arrangement of the left and right buildings, covers an area of about 26,300 square meters. Surrounded by high walls, with doors, corner buildings. A bronze statue of Confucius was erected in the center of the temple, which is 4.18 meters high and weighs 2500 kg. It is the largest bronze statue of Confucius in China.



Architectural form

南京夫子庙是前庙后学的布局。大成殿作为夫子庙的核心景区，是供奉和祭祀中国古代著名思想家、教育家孔子的庙宇，因孔子对中国古代文化作出了集大成的贡献而得名。门前古狮雄踞、门左右辟角门。封建时代只有官员可以由大门出入，一般士子只能从旁边进出。进入门内，映入眼帘是一座汉白玉卧碑，正面是古代名书法家题的“南京夫子庙”，北面镌刻详细记载了重建夫子庙的经过。庙院被两庑碑廊环抱，墙壁上镶有30块赵朴初、林散之、武中奇等著名书法家的墨宝真迹碑刻，碑廊里陈列着被誉为“中华一绝”的南京特产雨花石精品展览，色彩缤纷，玲珑剔透。巍峨庄严的大成殿主殿高16.22米，阔28.1米，深21.7米，重檐飞翘，斗拱交错。殿内正中悬挂一幅全国最大的孔子画像，高6.5米，宽3.15米，两侧有四亚圣贤回、曾参、孔伋、孟轲的汉白玉雕像，四周墙壁展出38幅反映孔子生平事迹的巨幅彩石镶嵌壁画。

Nanjing Confucius Temple is the layout of the former temple. As the core scenic spot of Confucius Temple, Dacheng Hall is a temple dedicated to and sacrificed to Confucius, a famous thinker and educator in ancient China. It was named after Confucius's comprehensive contribution to ancient Chinese culture. The ancient lion in front of the door, the door left and right corner door. In the feudal era, only officials could enter and leave through the gate, and ordinary scholars could only enter and leave from the side. Into the door, reflected in the curtain is a Chinese white jade bedstone, front is the ancient famous calligrapher title 'Nanjing Confucius Temple', north engraved detailed records of the reconstruction of Confucius Temple.

Force Balance

受力平衡

Physical operations

物理运算

$$F = G \frac{m_1 m_2}{d^2}$$

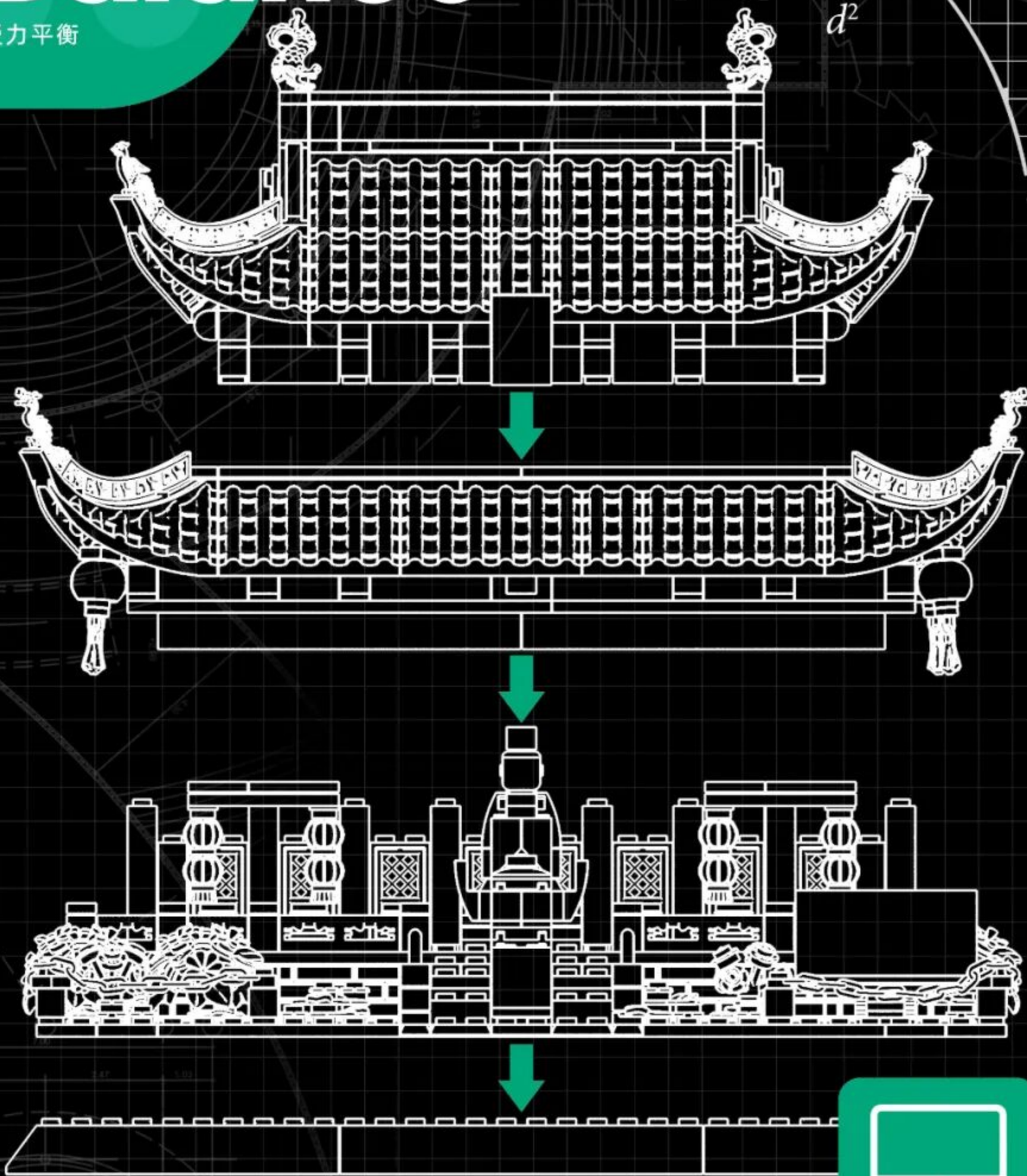

Creation and thinking

创作·思考

08

Special parts

特殊零件的开发利用

$$S=4\pi \cdot r^2$$



$$a^2+b^2=c^2$$

WG1276

斜角栏杆

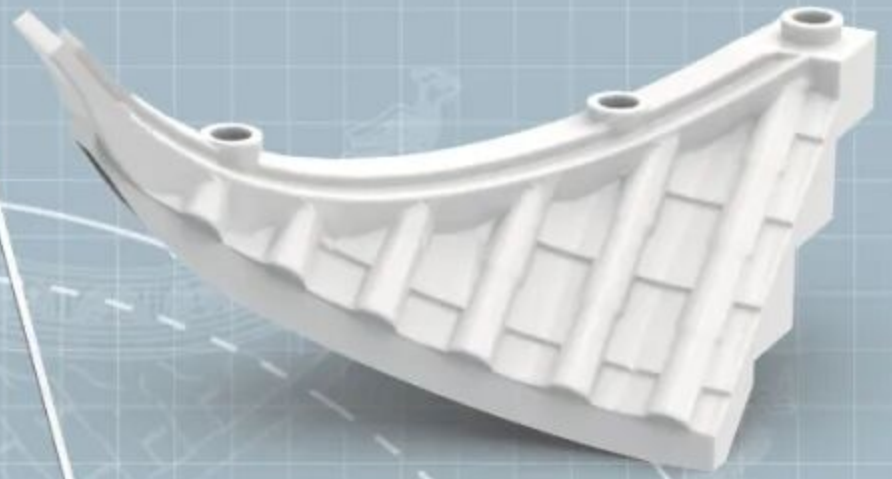

WG1427

翘角瓦片



WG1392

鱼龙脊兽



WG1526

灯笼



WG1527

灯笼穗1孔



WG1522

门形窗叶



WG1514

4孔矮中式栏杆

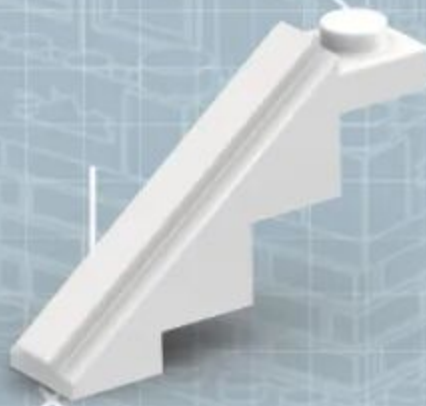

WG0531

屋脊



WG1404

4倍柱珠

$$\sin^2 a + \cos^2 a = 1$$



features and functions

特点.功能

Main Color Matching

配色方案



Pantone 7427C



Pantone 7620C



Pantone 2346C



Pantone 1575C



Pantone 123C



Pantone 477C



Pantone 7509C



Pantone 7500C



Pantone 348C



Pantone 2422C



Pantone Black 6C



Pantone 655C



Pantone 431C



Pantone Cool Gray 6C

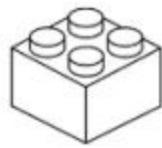

White



Color matching

Adopting 4 main colors, Black, Red, Beige and Green as the main color, the more reasonable and Green color matching on the original building, making the product more atmospheric and the whole design is more reasonable.

Confucius Temple

中国南京夫子庙



Front

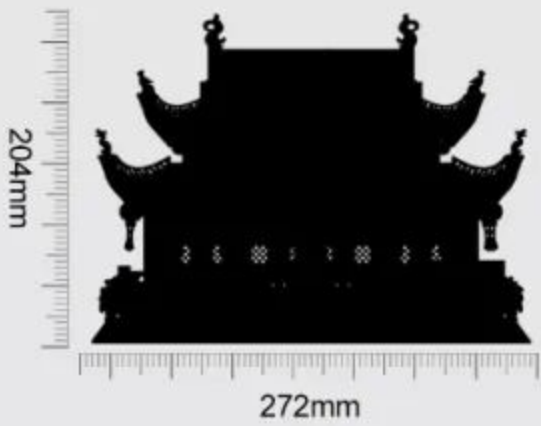

Left

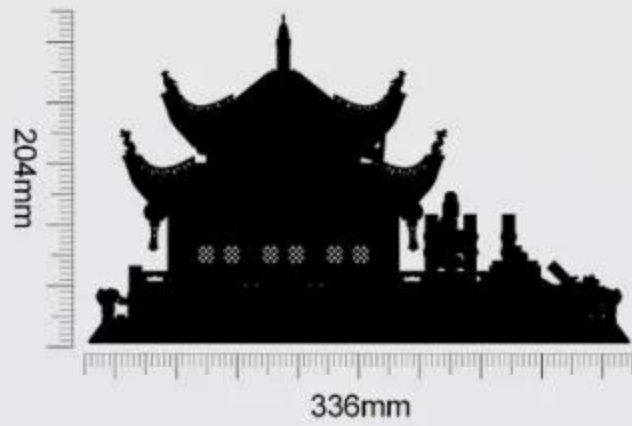

Back

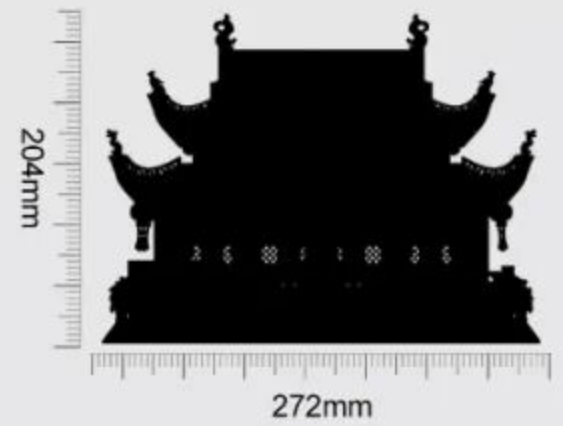

Product Size:336X272X204mm



Instructions For Use

积木起件器使用说明
Brickseparator

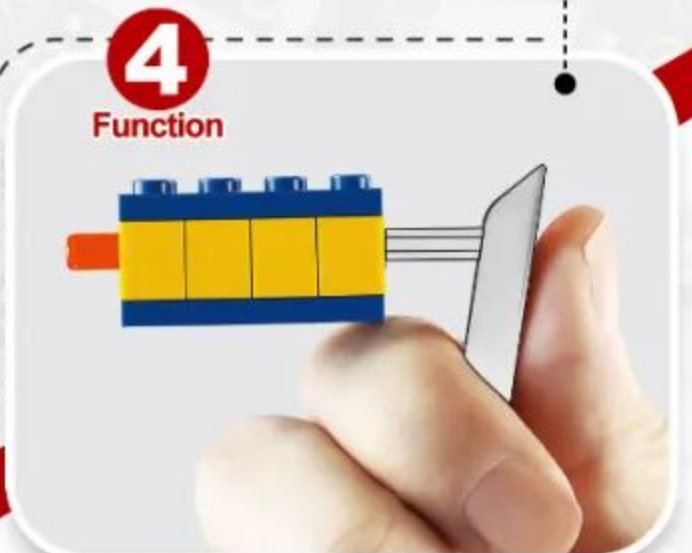
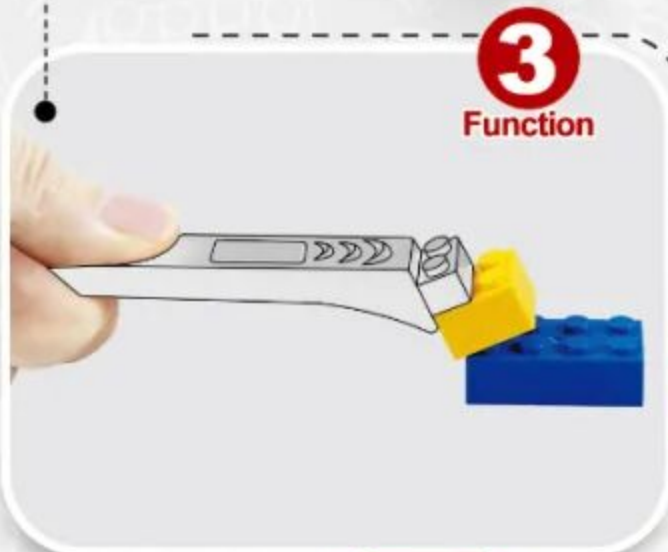
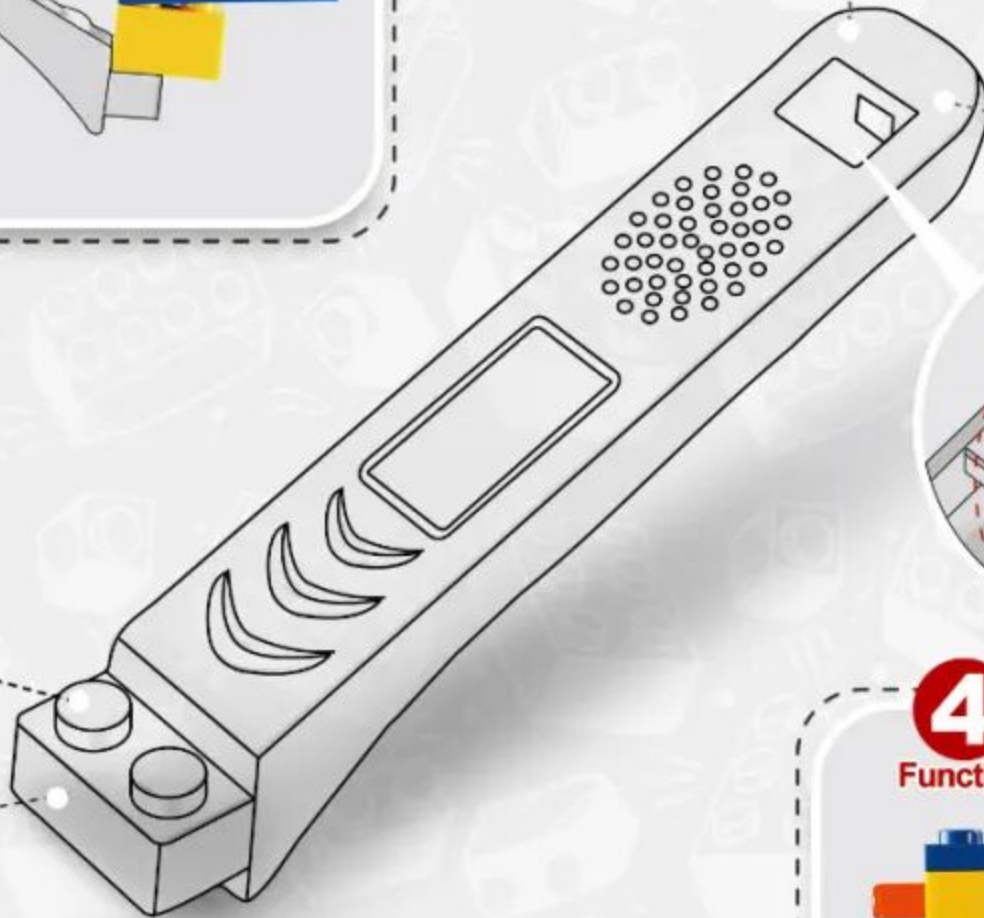
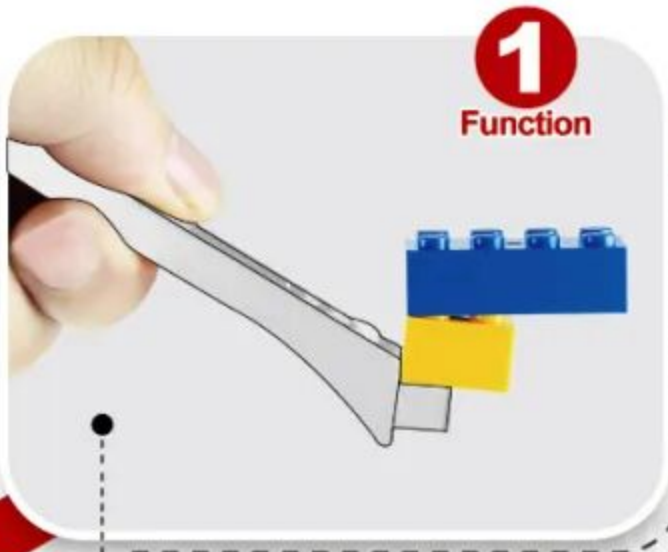

4 ways to make installation easier
让安装更简单



■ First open the product packaging according to the instructions.

按指导用正确方式拆解产品外包装。



■ Summarize all parts to count the number of familiar accessories.

对照说明书清单确认积木包数量与积木数量。



■ Arranging all accessories by color helps to quickly install the product.

把确认好的积木以类型、颜色进行分类排好以便安装。



■ Carefully install the product and learn about building.

按说明书步骤拼装并完成你的积木模型。



1:1 Physical Reference Table

十字棒配件1:1尺寸参照表



Instructions For Use

让安装更简单

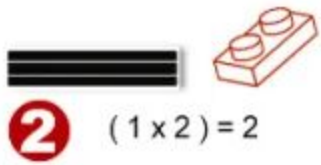

2 $(1 \times 2) = 2$

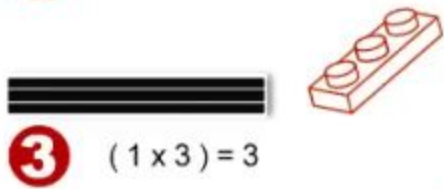

3 $(1 \times 3) = 3$

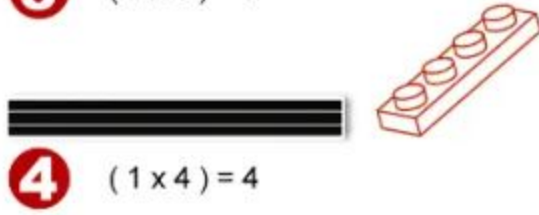

4 $(1 \times 4) = 4$



5 $(1 \times 5) = 5$



6 $(1 \times 6) = 6$



7 $(1 \times 7) = 7$



8 $(1 \times 8) = 8$



9 $(1 \times 9) = 9$



10 $(1 \times 10) = 10$



12 $(1 \times 12) = 12$











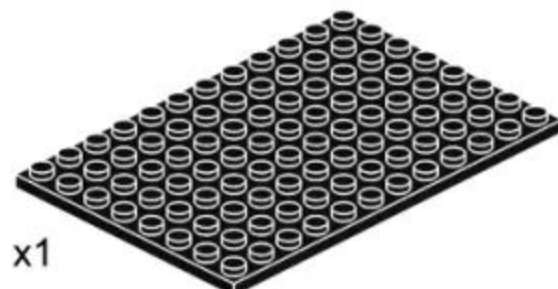



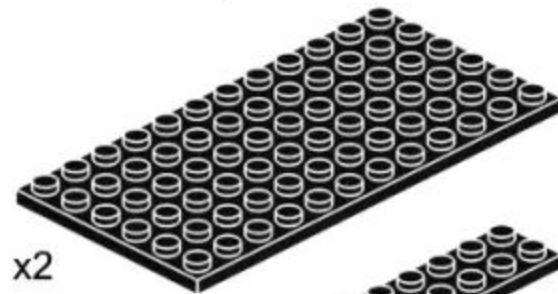









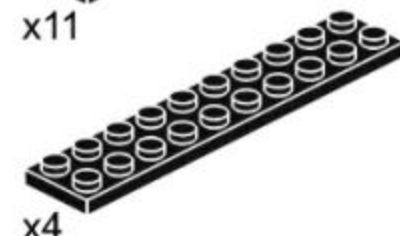
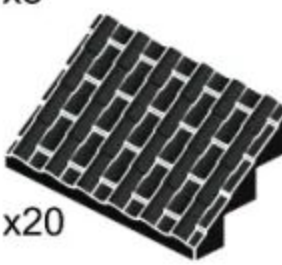



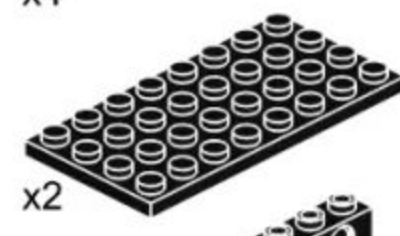







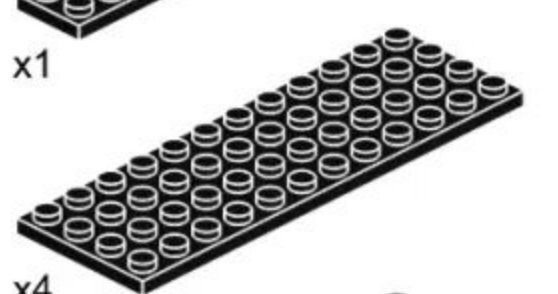









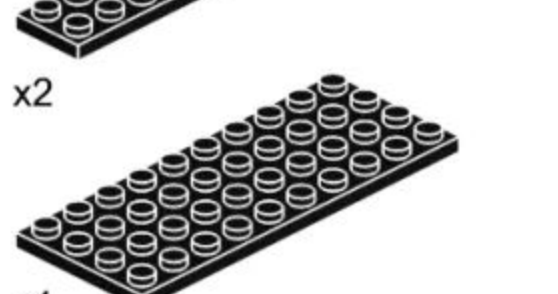



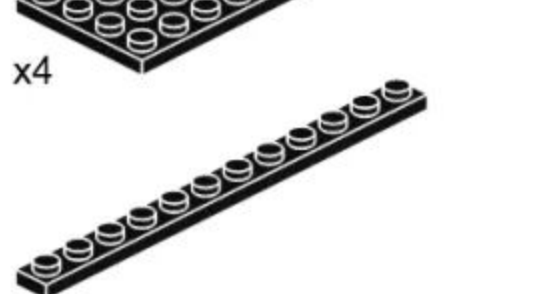











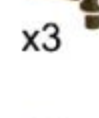
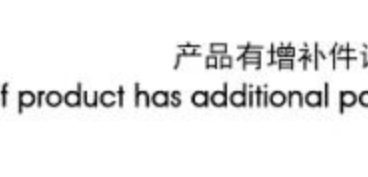





16 $(1 \times 16) = 16$



PARTS LIST

配件清单

 x1	 x1	 x4	 x4	
 x2	 x1	 x19	 x1	 x1
 x2	 x11	 x3	 x8	 x2
 x2	 x4	 x20	 x1	 x8
 x4	 x2	 x3	 x1	 x2
 x2	 x2	 x2	 x1	 x2
 x1	 x2	 x2	 x1	 x31
 x4	 x4	 x4	 x5	 x4
 x2	 x4	 x3	 x4	 x18
 x4	 x5	 x4	 x7	 x3
 x4	 x2	 x3	 x4	 x12
	 x8	 x2	 x4	 x3
	 x8	 x6	 x4	 x4
			 x28	 x4
			 x1	 x4
			 x2	 x13
			 x2	 x4
				 x4
				 x4
				 x12

产品有增补件请以实物为准

If product has additional parts, please in kind prevail.

PARTS LIST

配件清单



x4

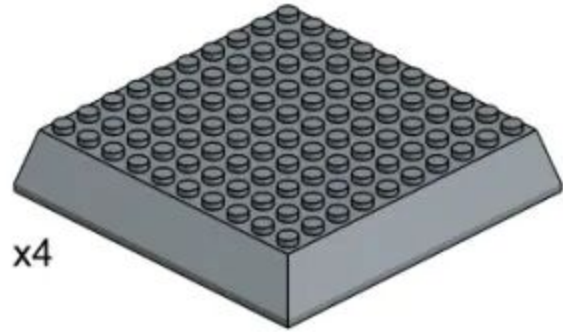

x4

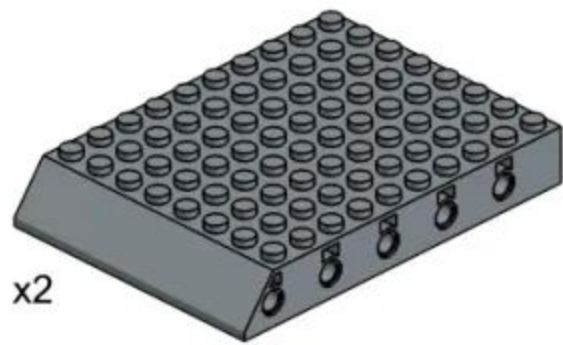

x2



x4



x4



x4



x3



x3



x1



x4



x1



x2



x2



x2



x1



x1



x1



x1



x2



x2



x1



x1



x2



x4



x4



x3



x2



x6



x1



x12



x1



x4



x2



x4

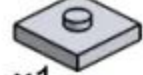

x1



x1



x1



x5



x1



x4



x1

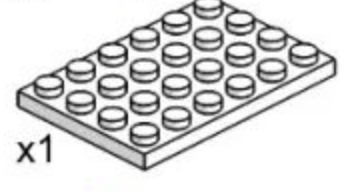

x1



x1



x6



x6



x6



x4



x46



x28



x24



x6



x16



x12



x6



x4

产品有增补件请以实物为准

If product has additional parts, please in kind prevail.



249PCS



1-1

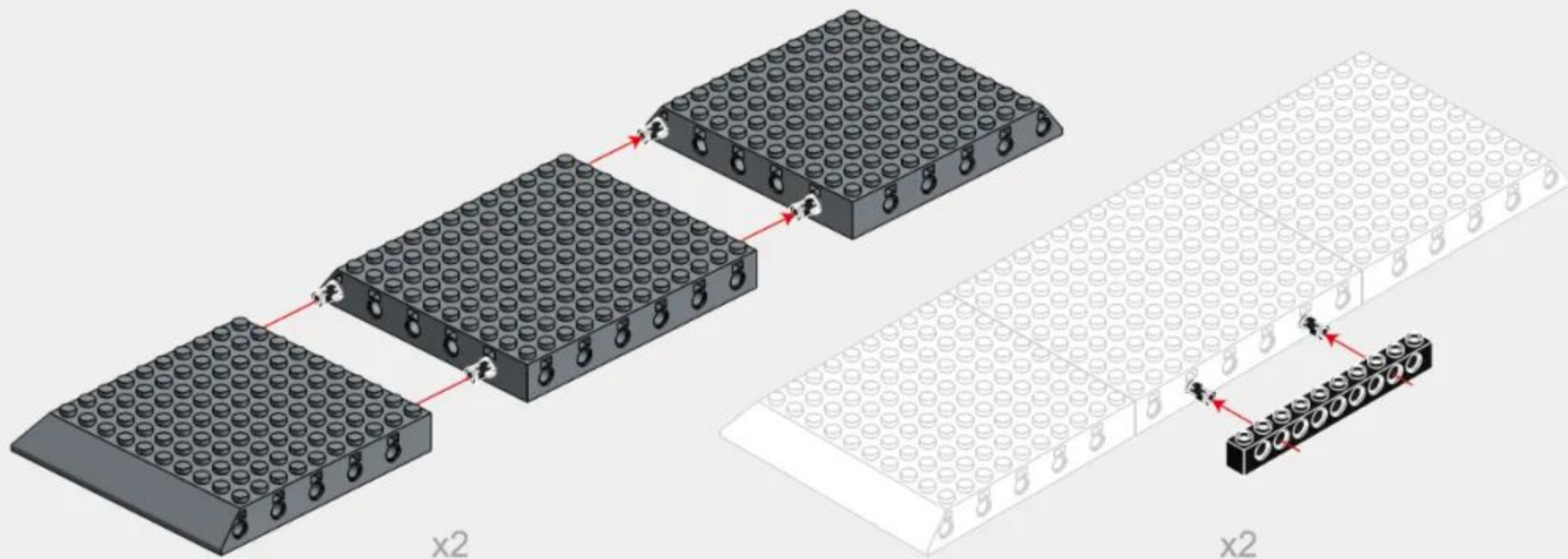
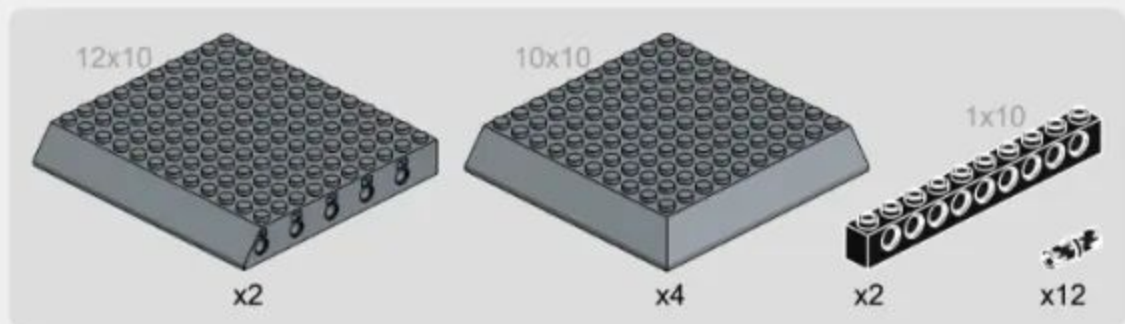

1-2

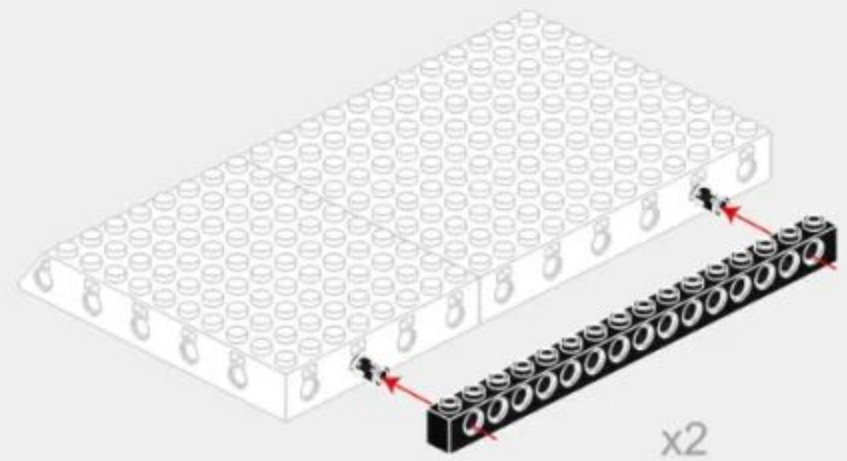
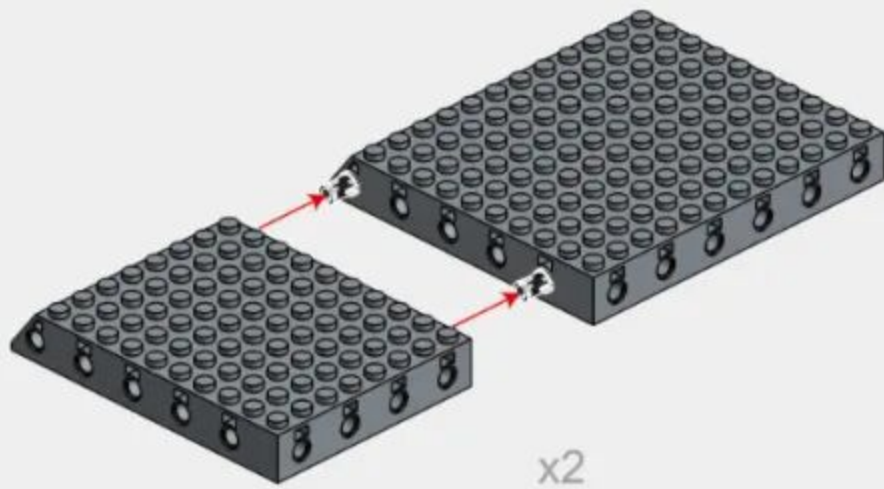
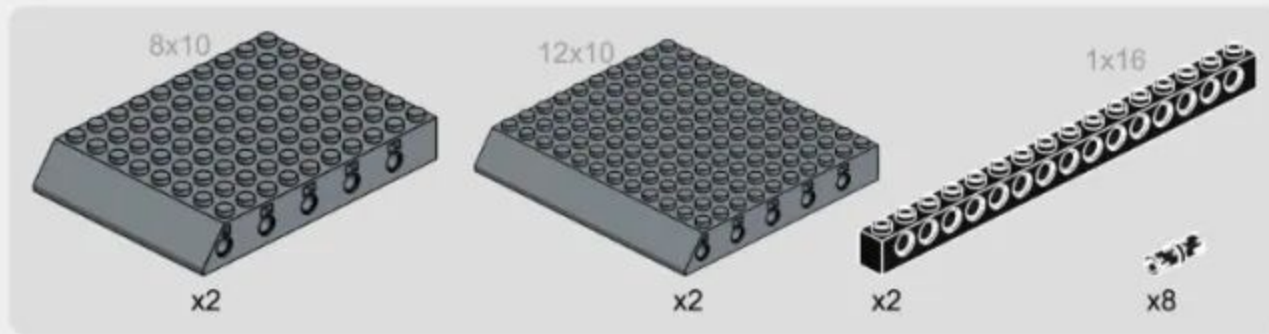

1-3

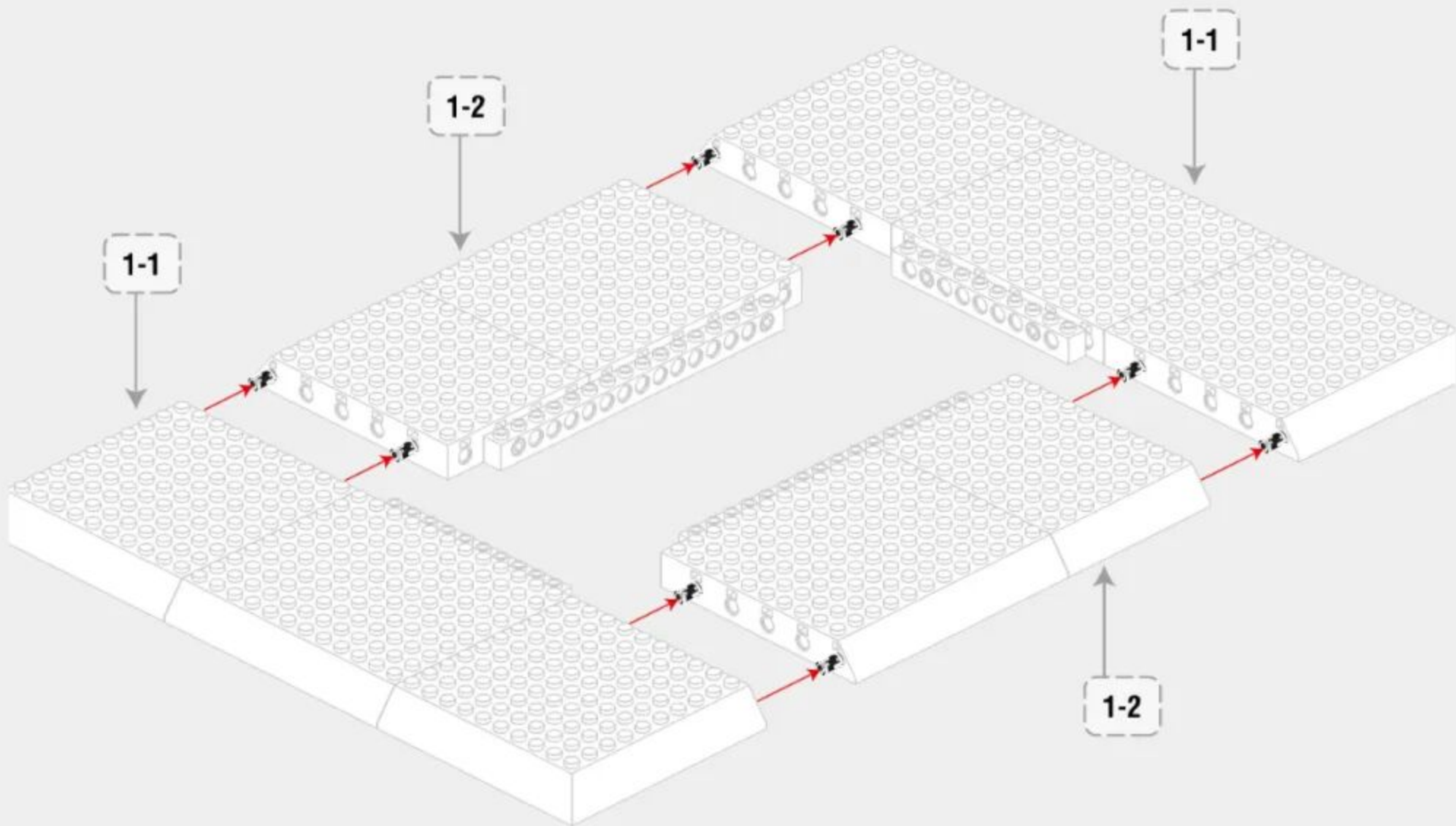

21

1-4

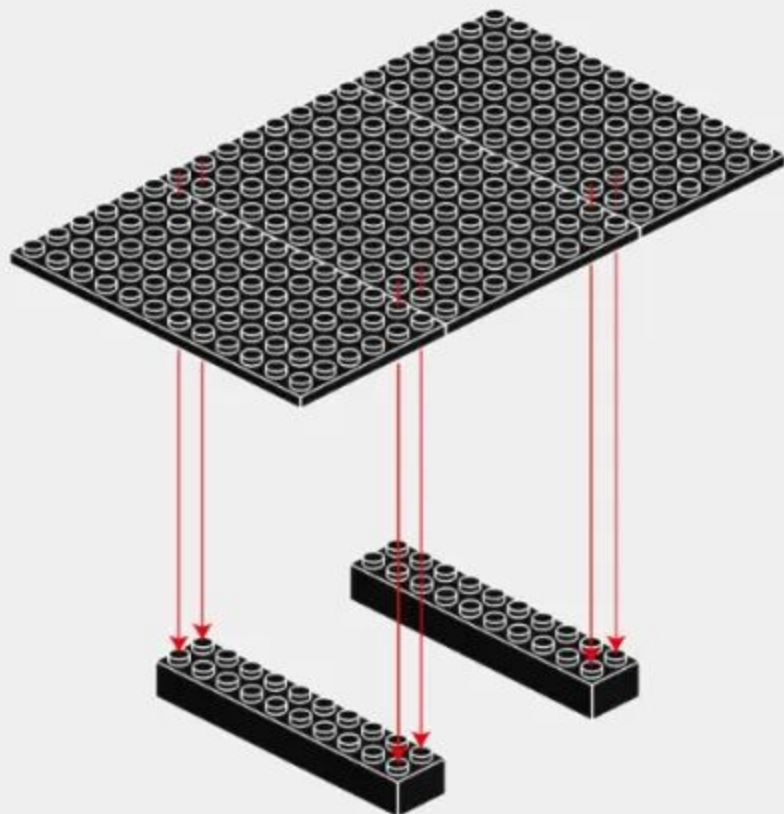
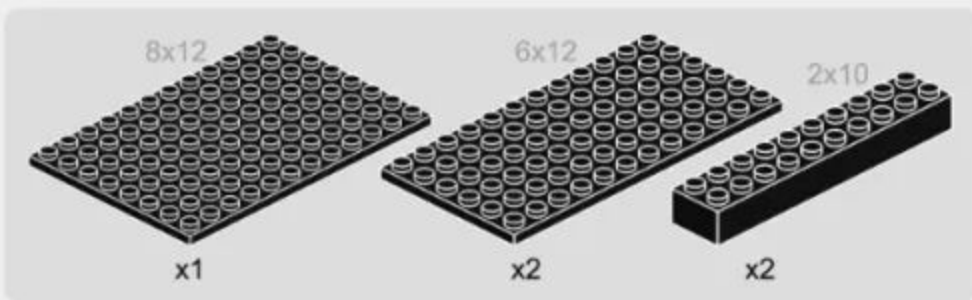

1-5

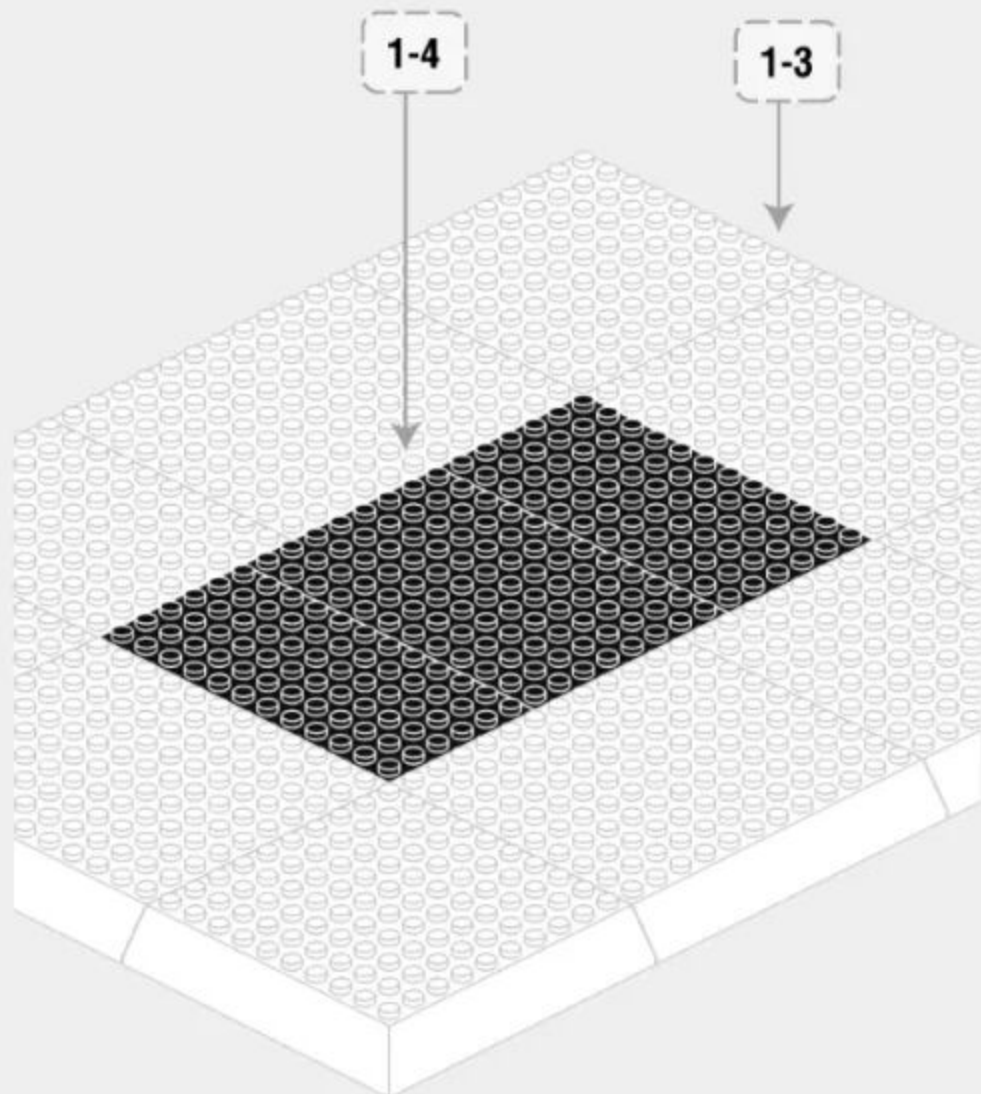

1-6

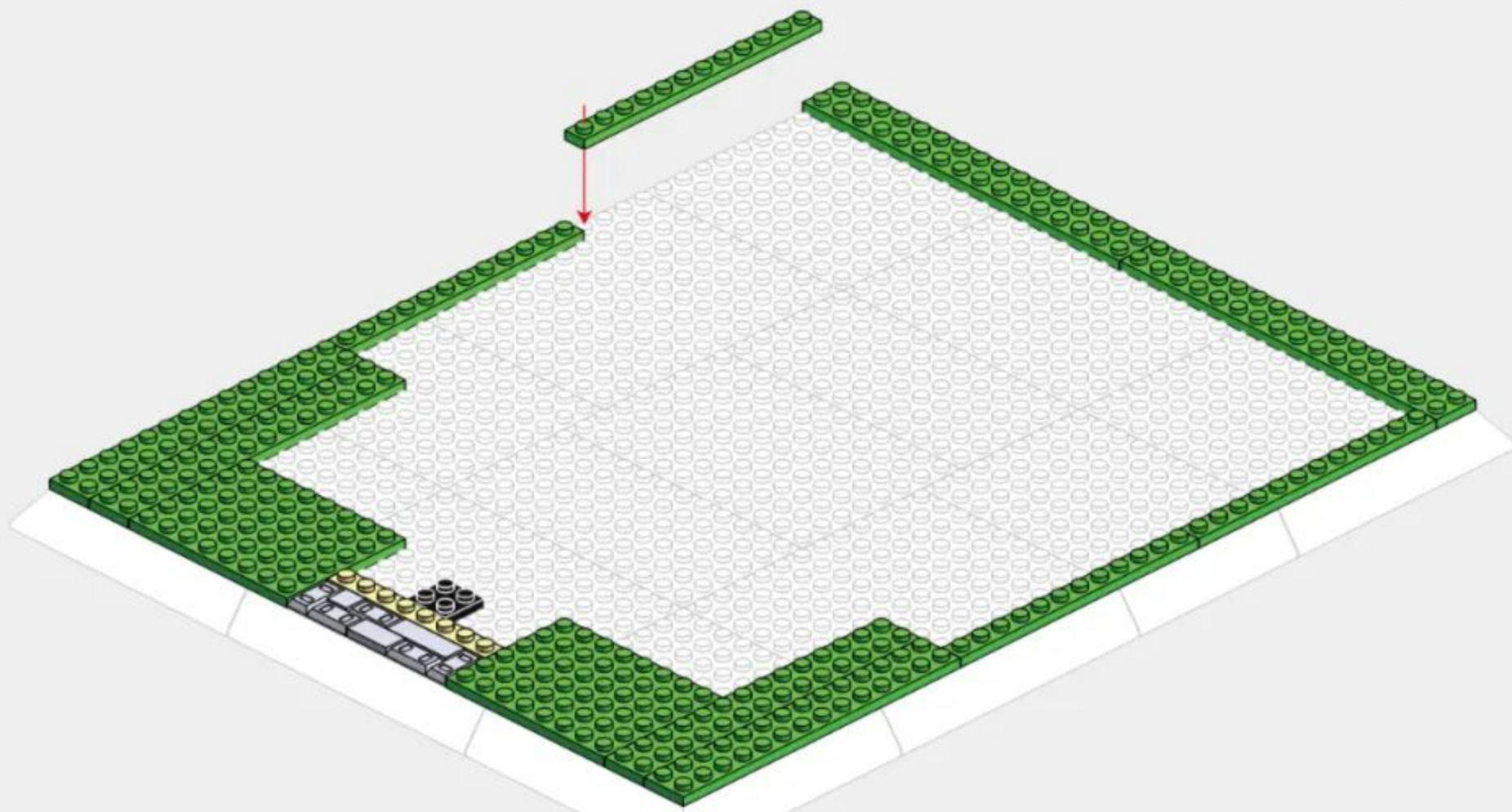
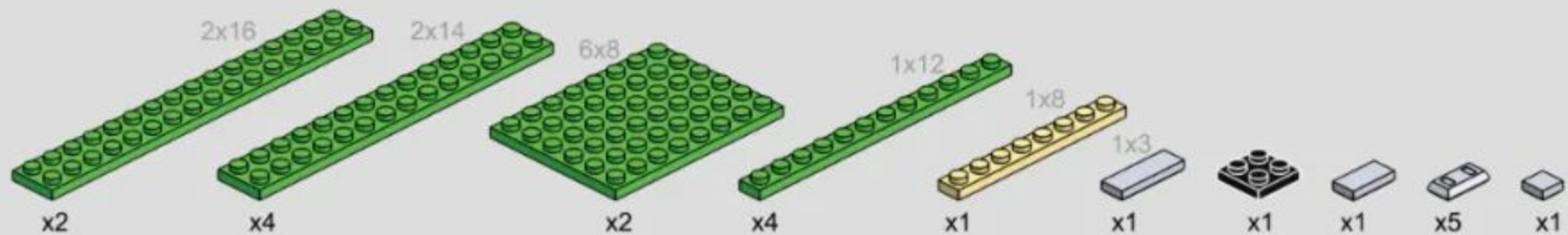

1-7

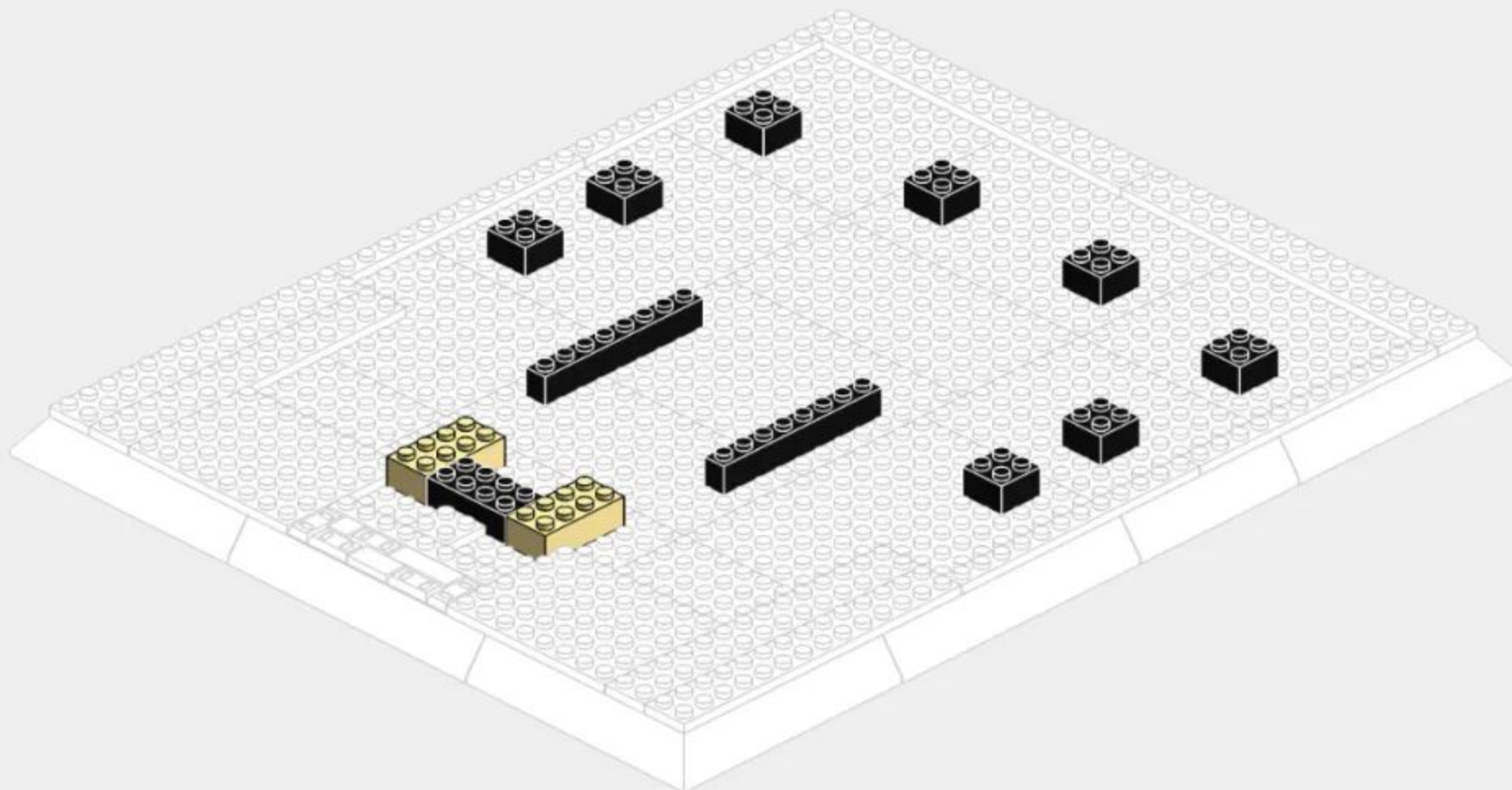
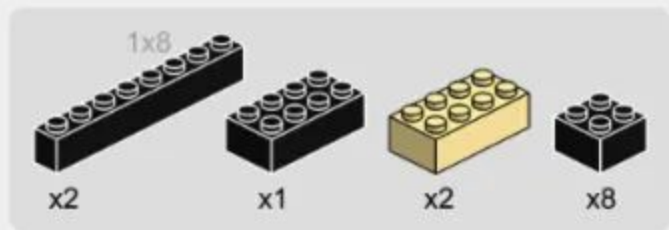

1-8

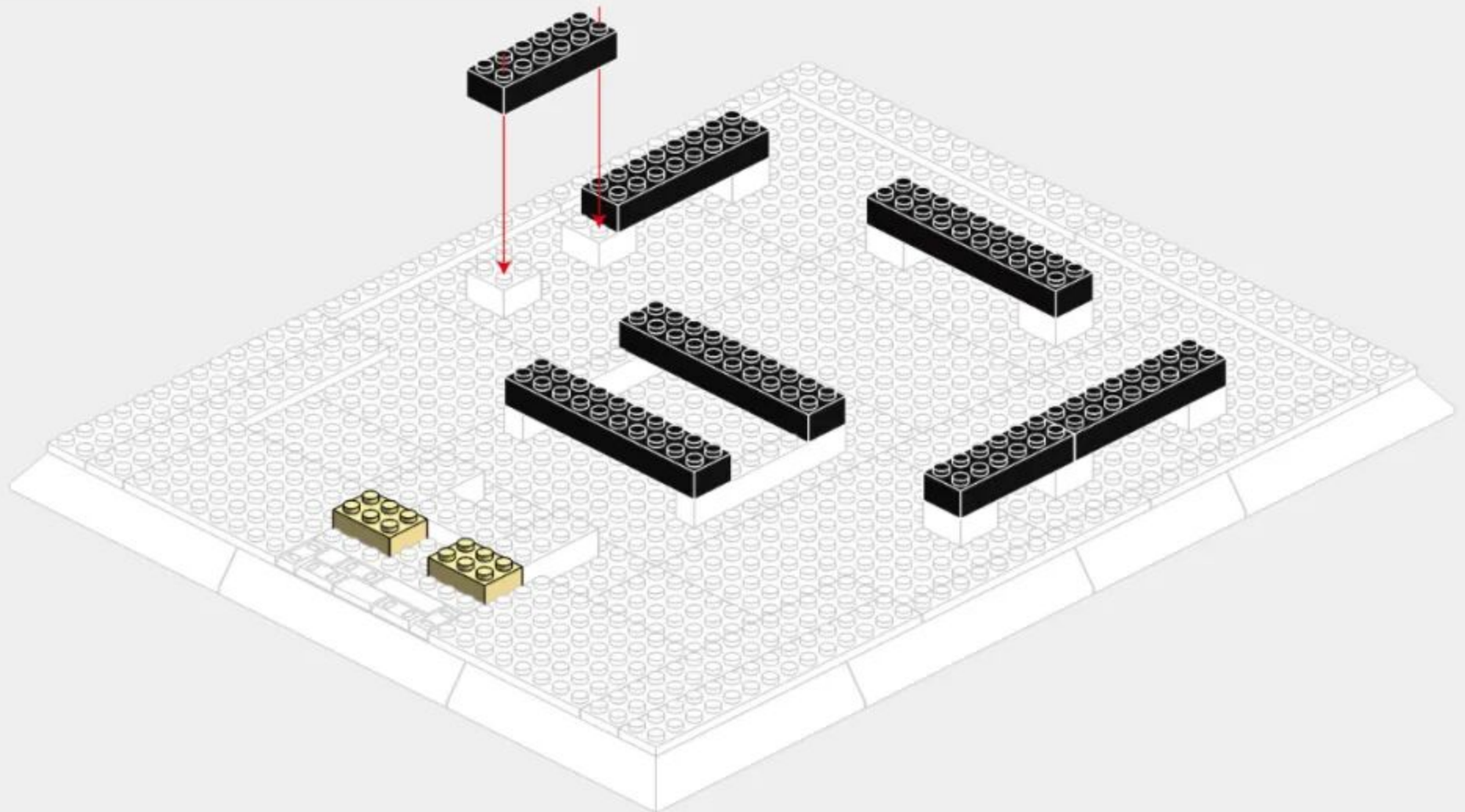
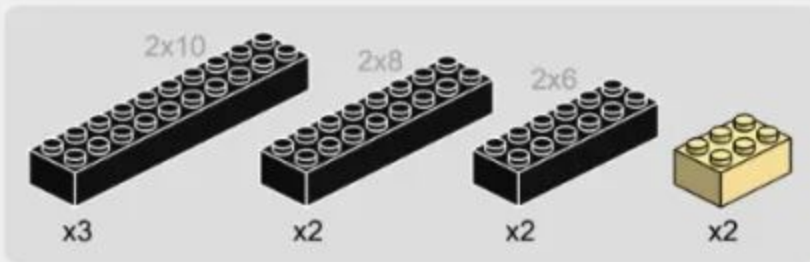

1-9

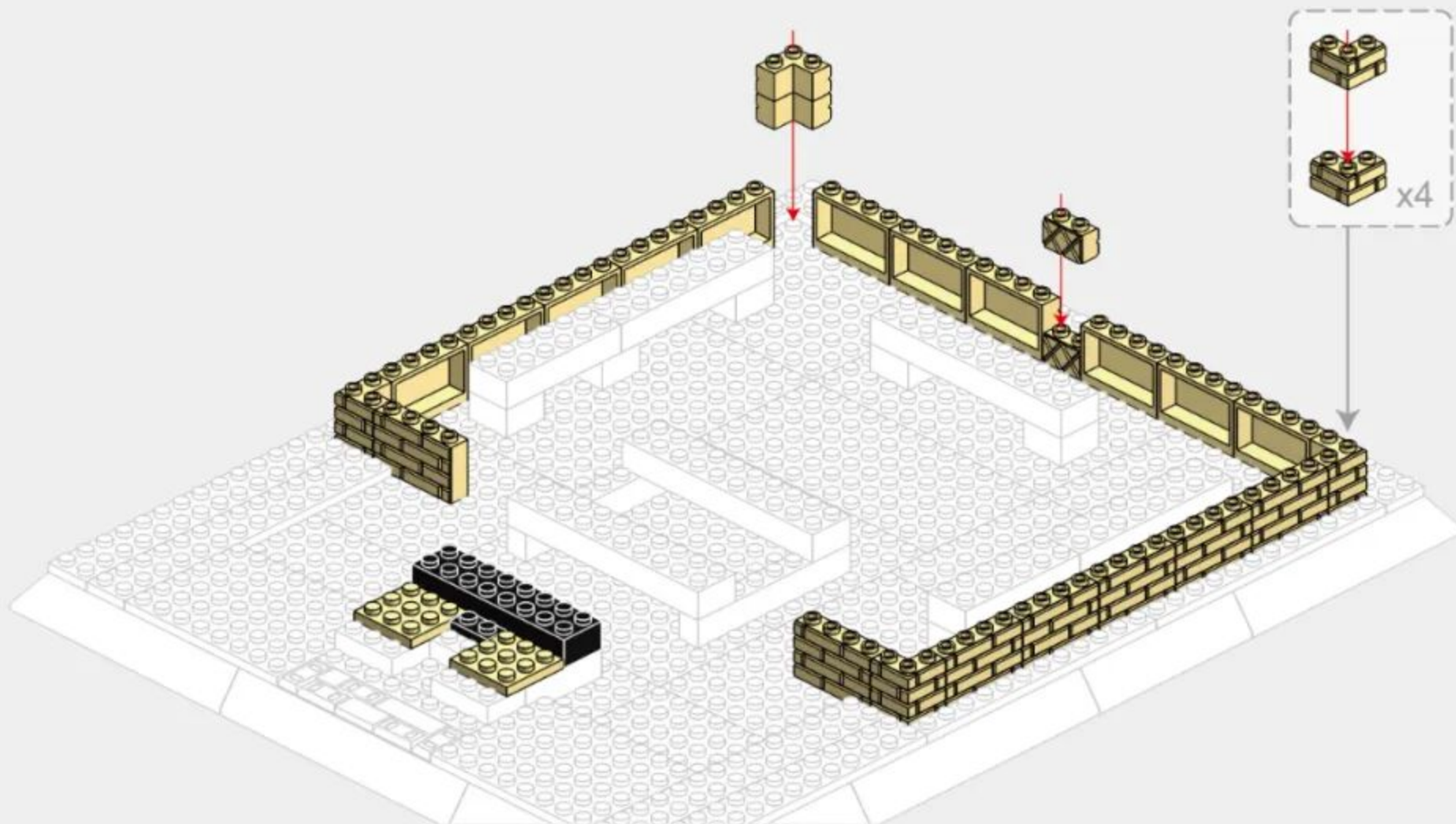
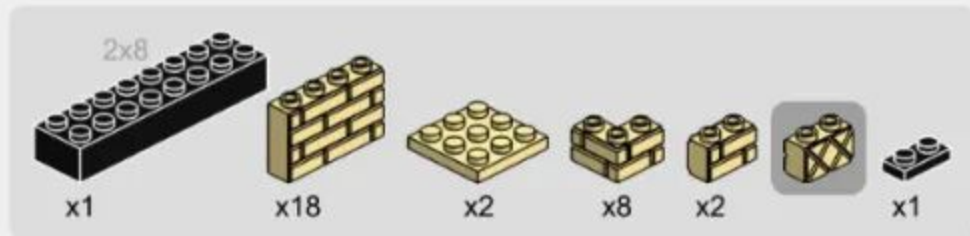

1-10

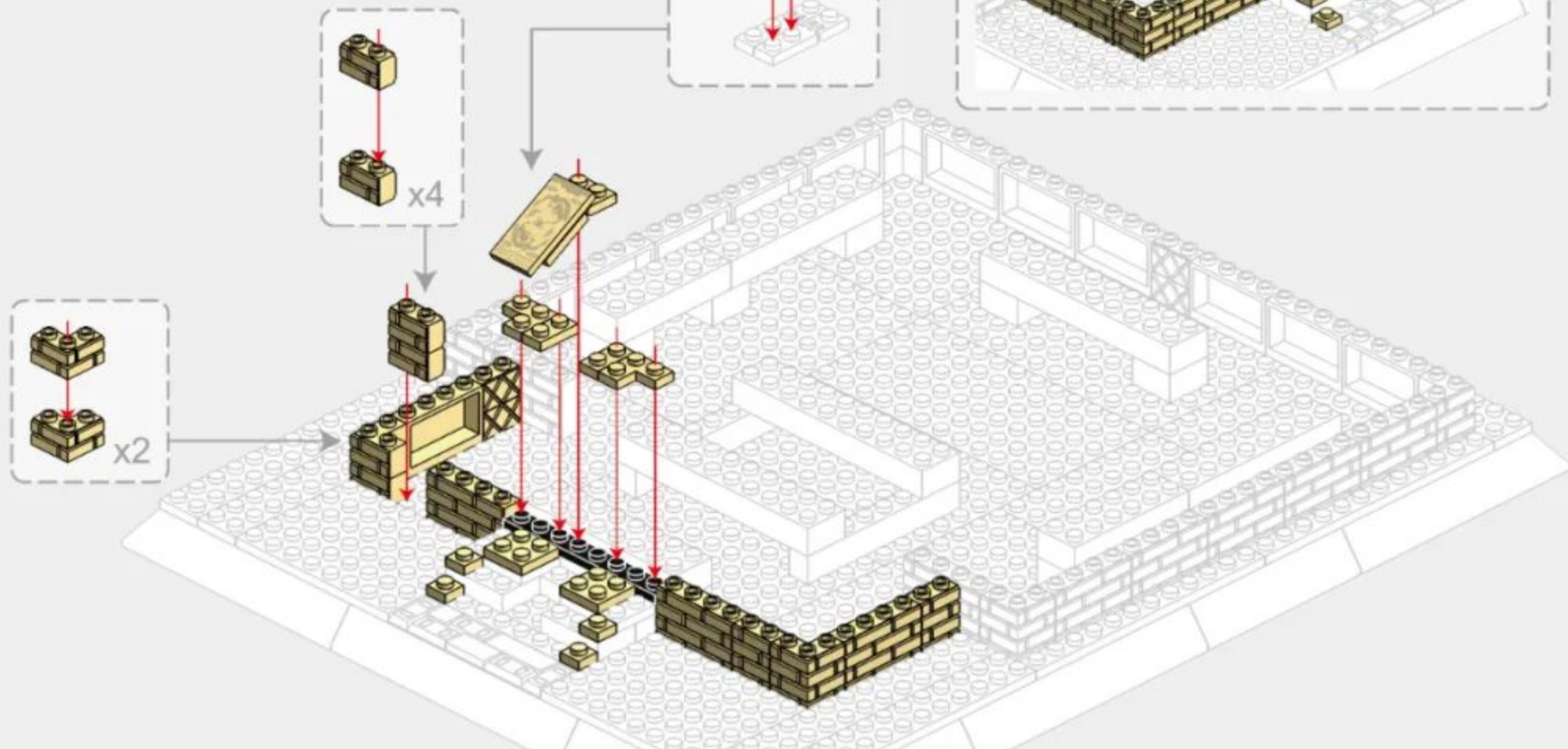
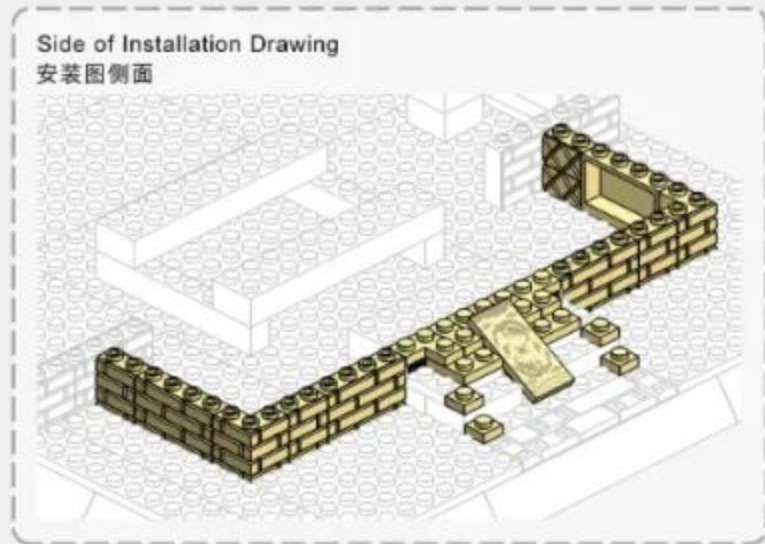
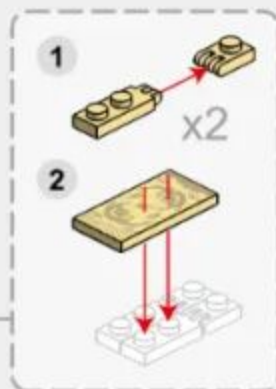
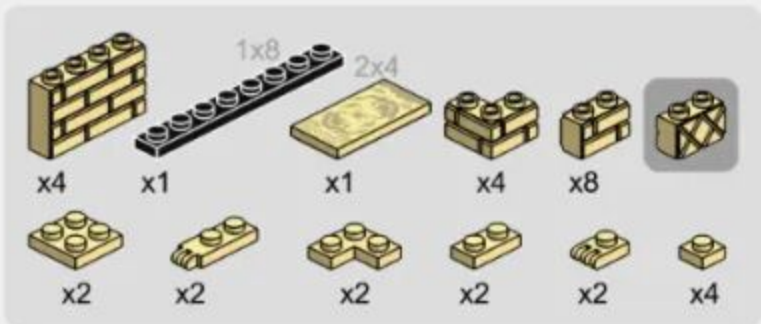

1-11

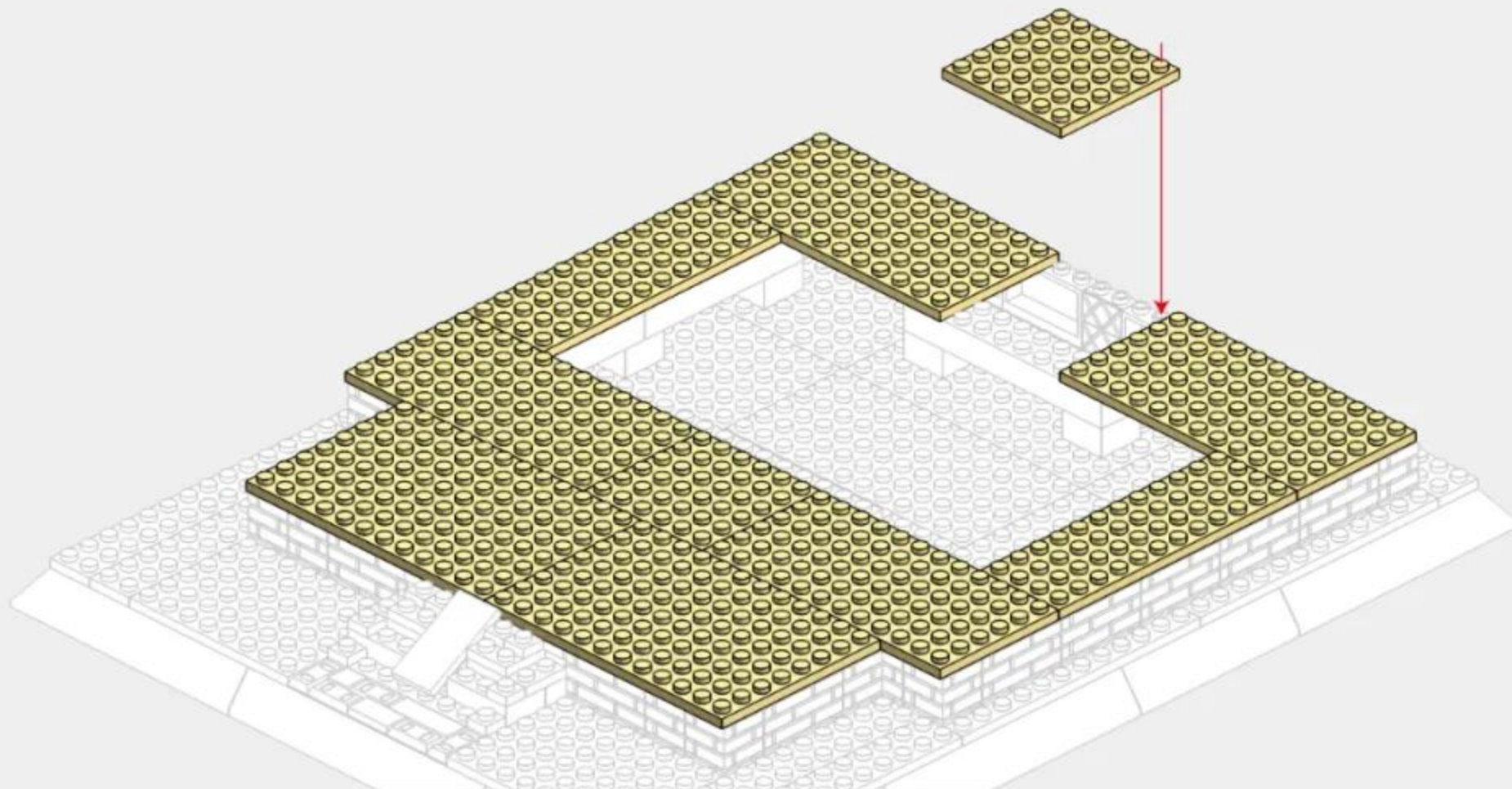
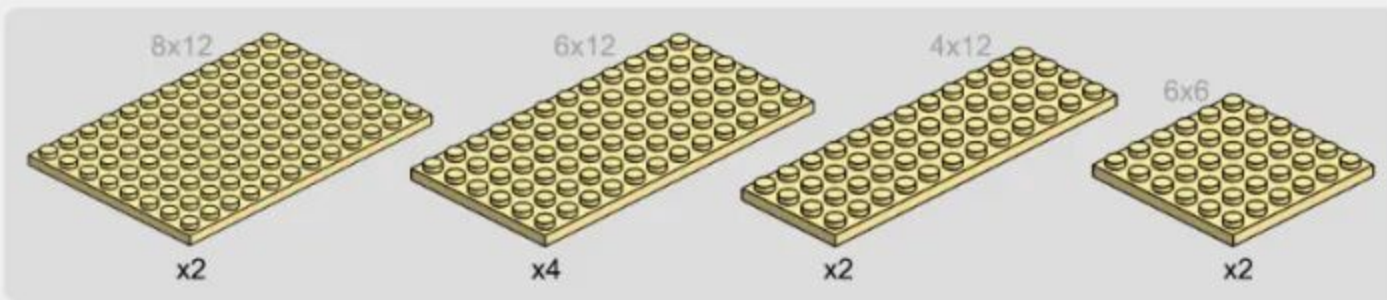

1-12

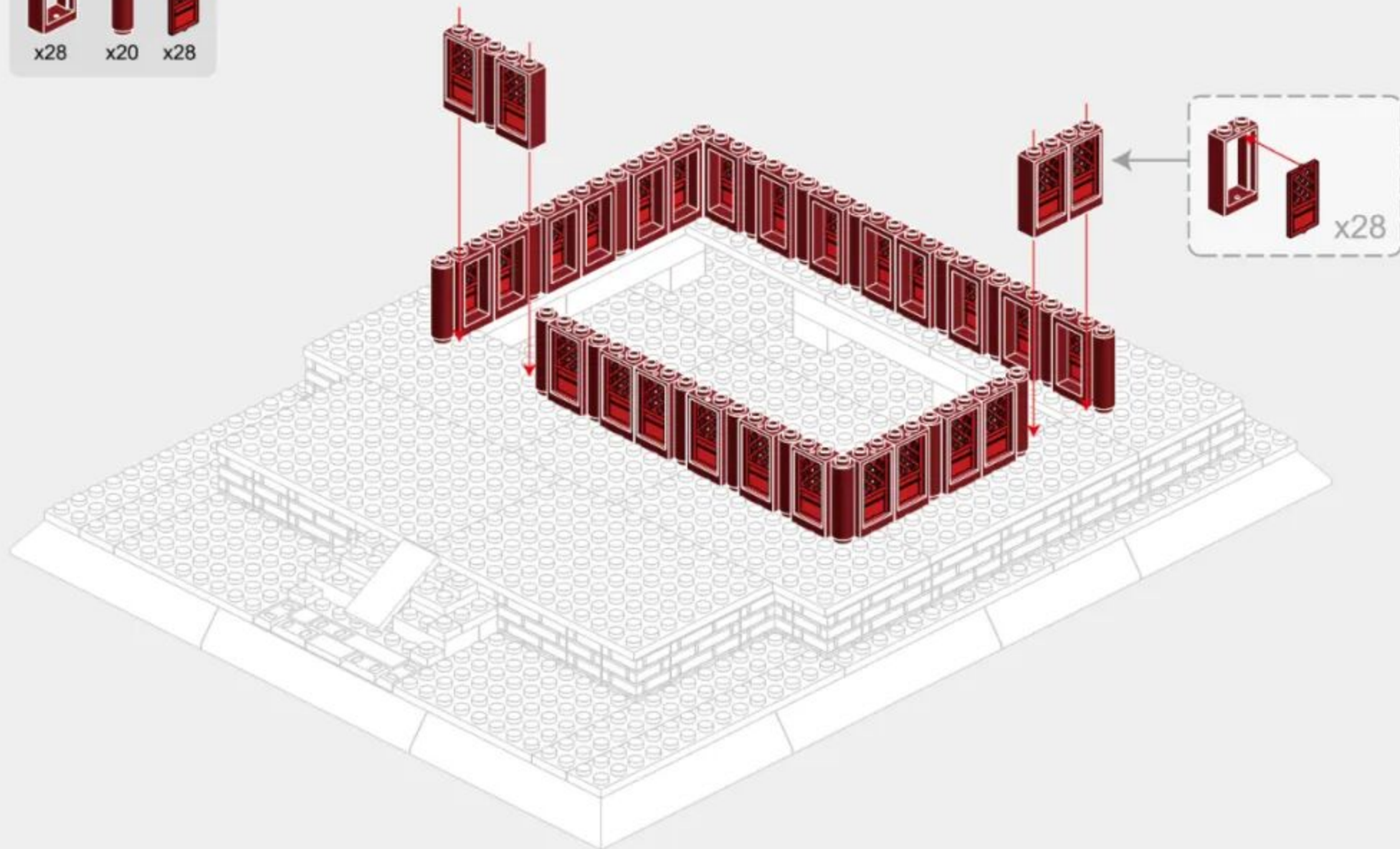

1-13

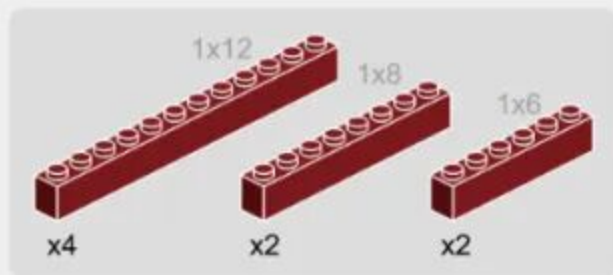



234PCS

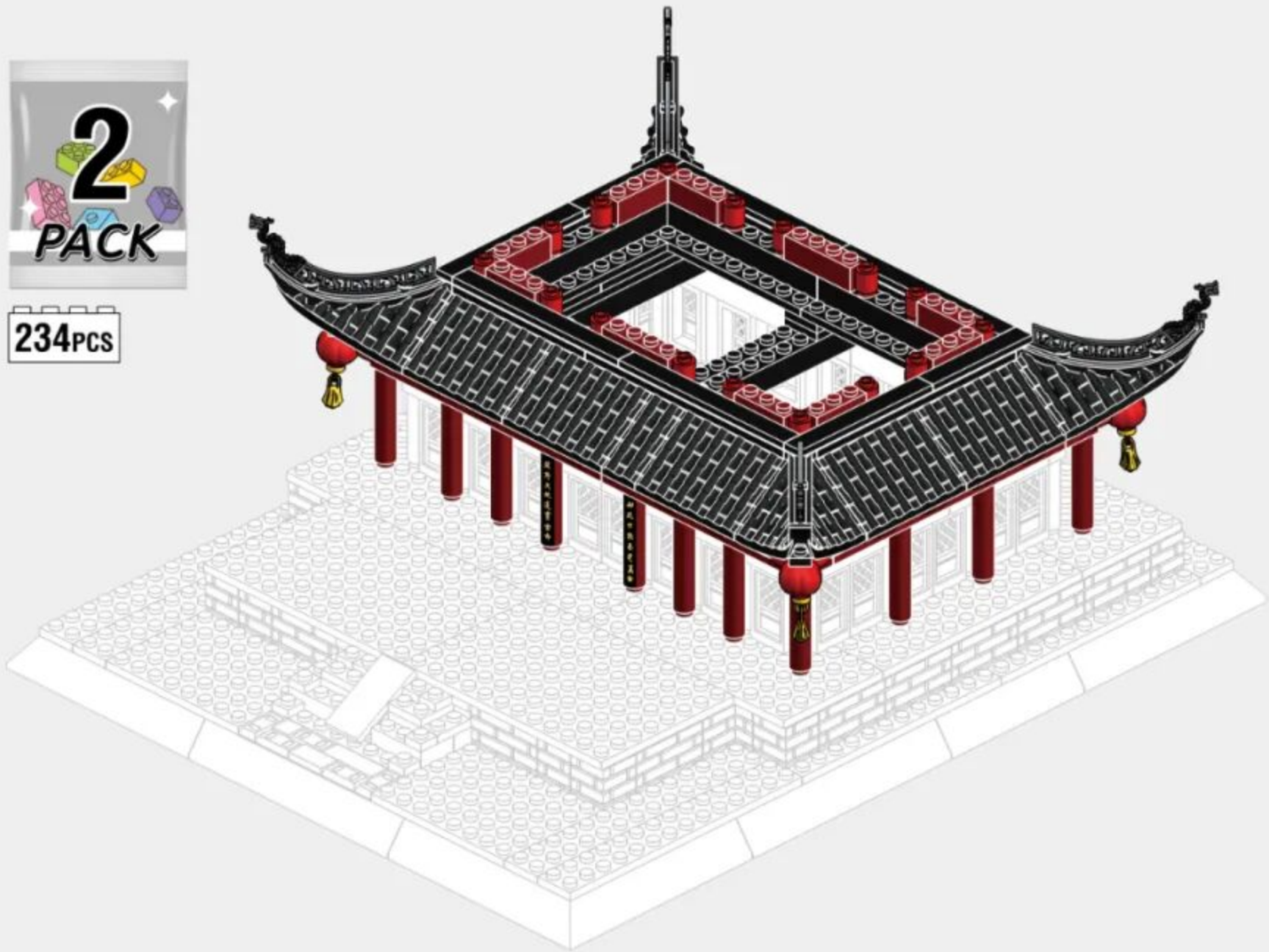

2-1

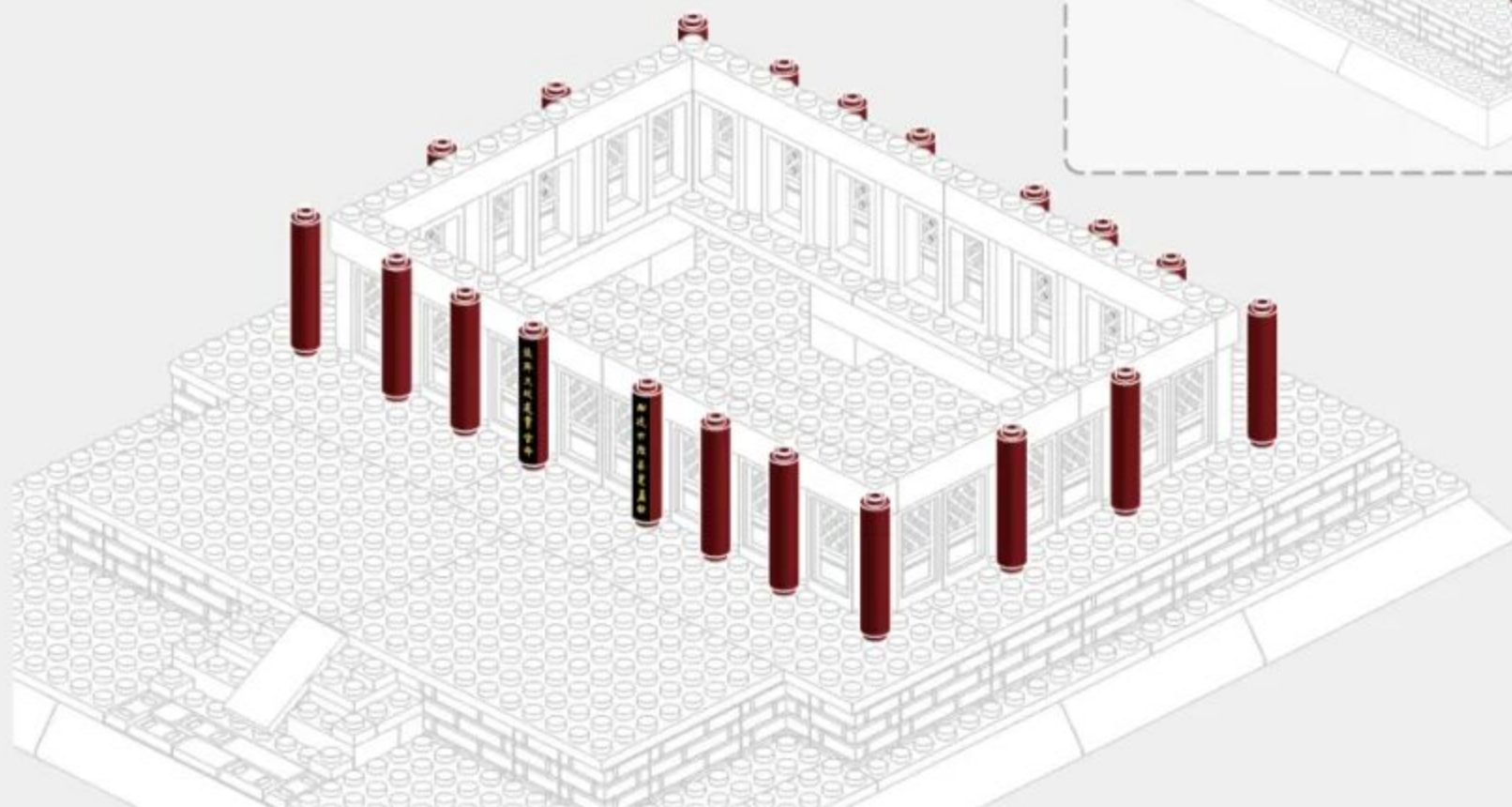

Back Side of Installation Drawing
安装图背面

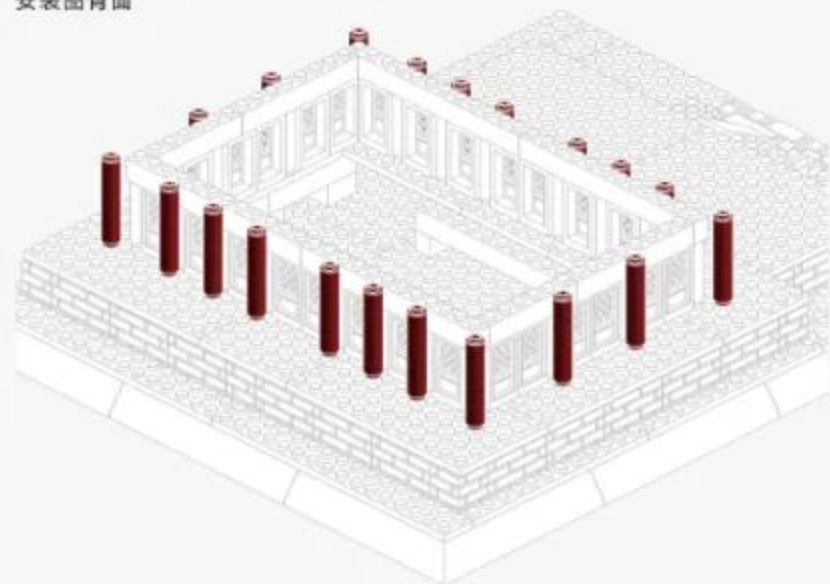

2-2

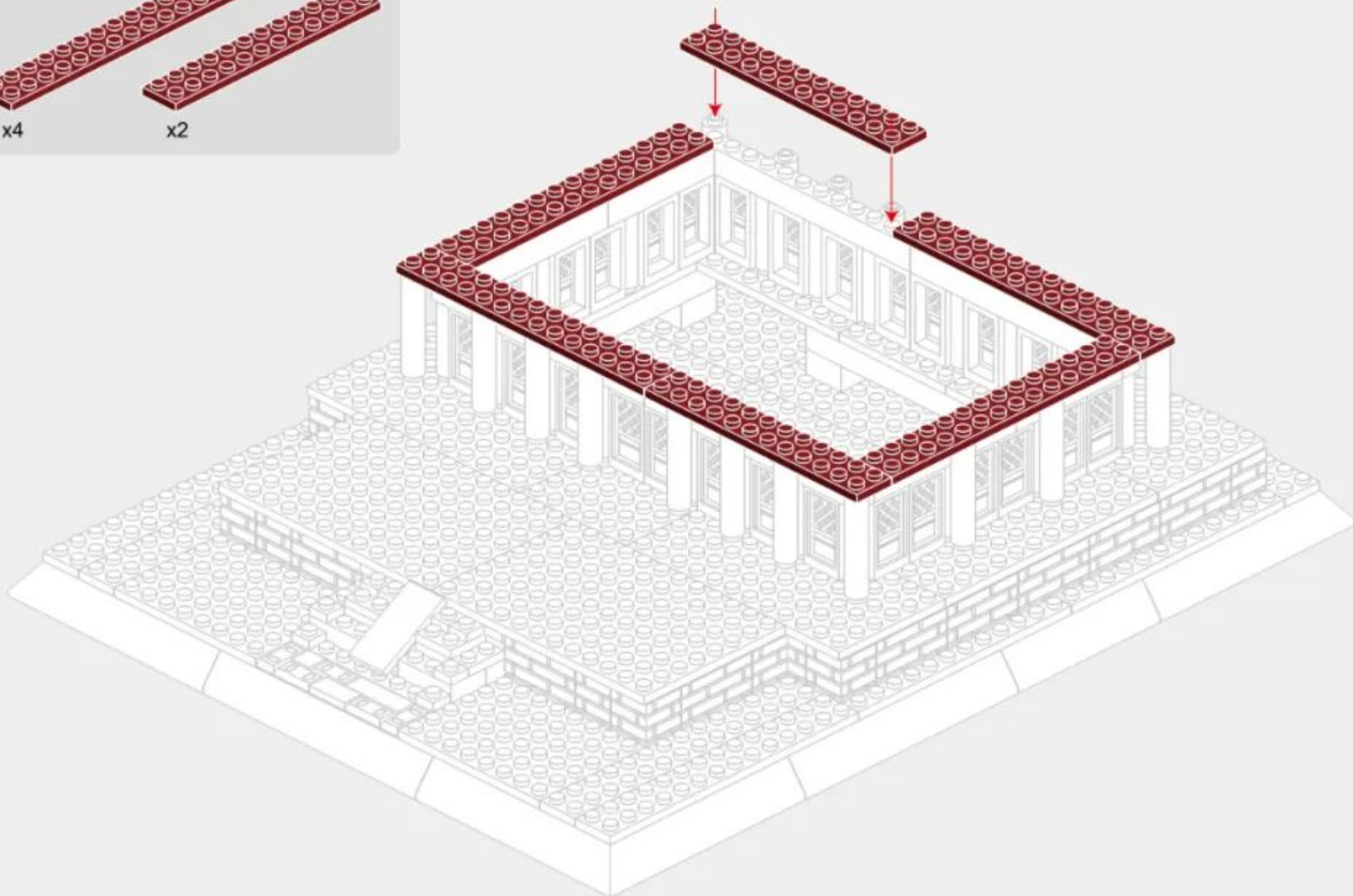
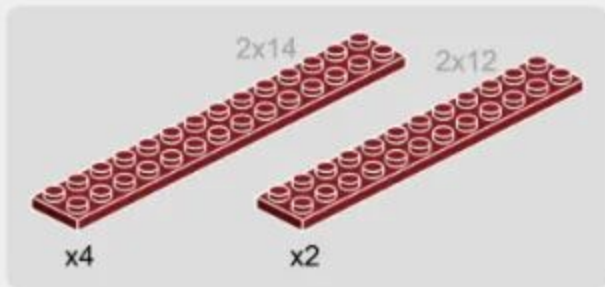

2-3

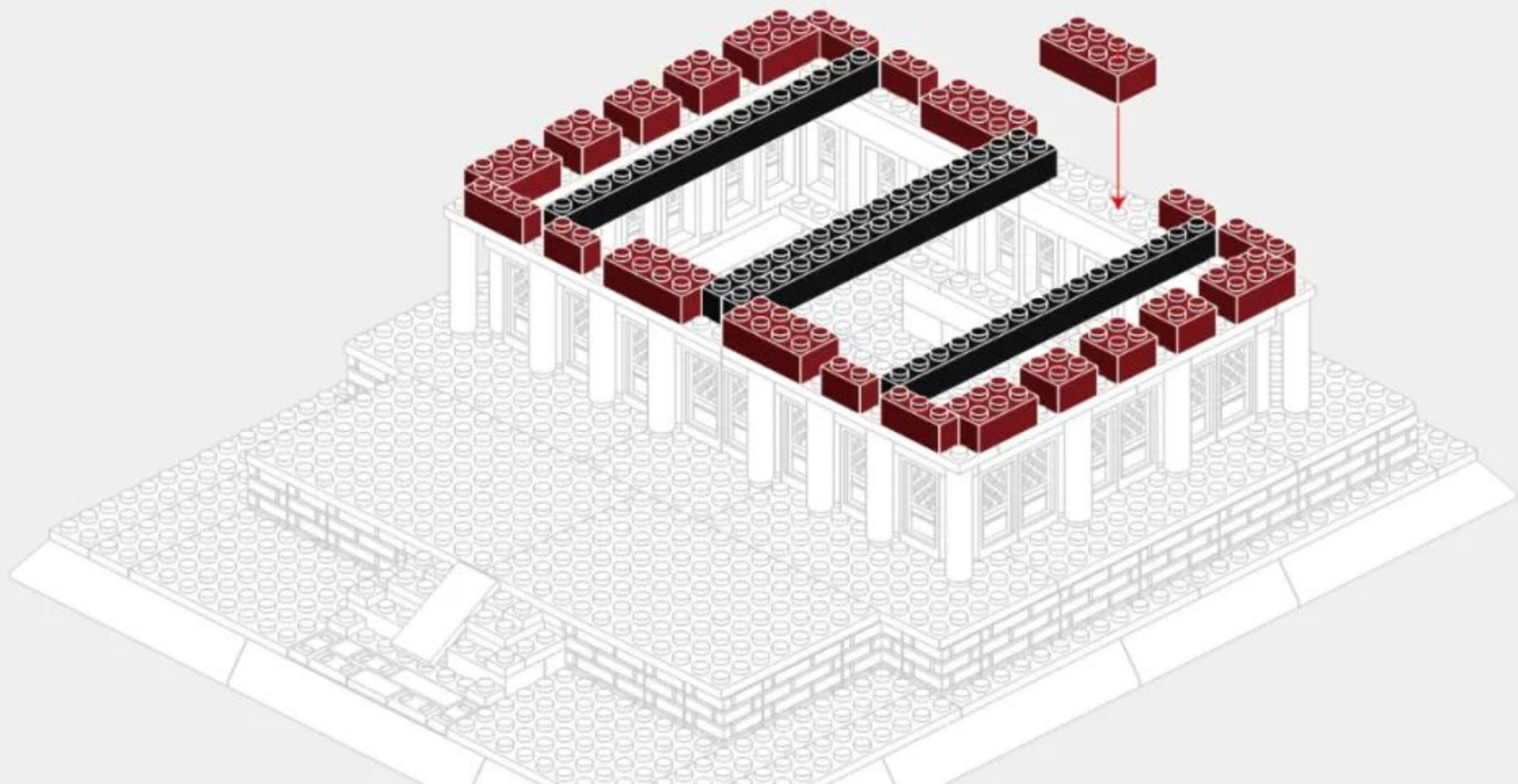
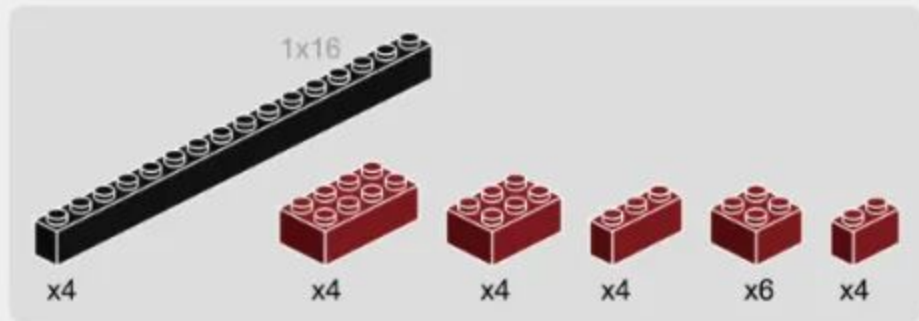

2-4

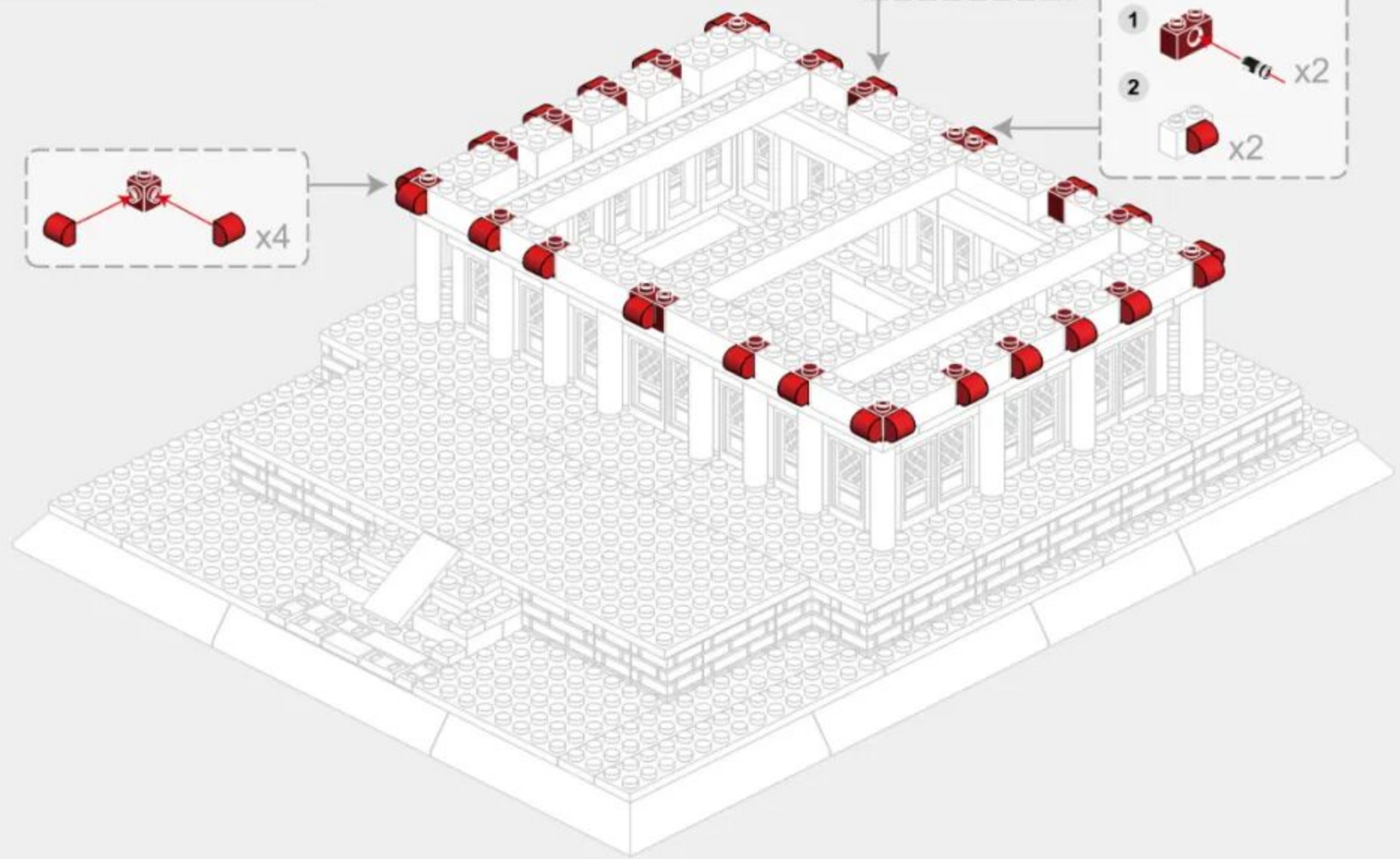
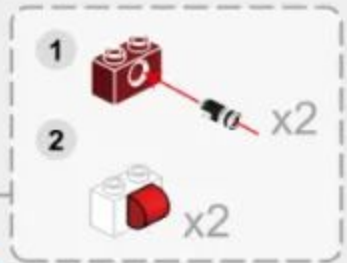
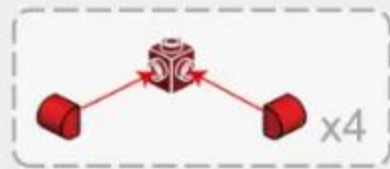

2-5

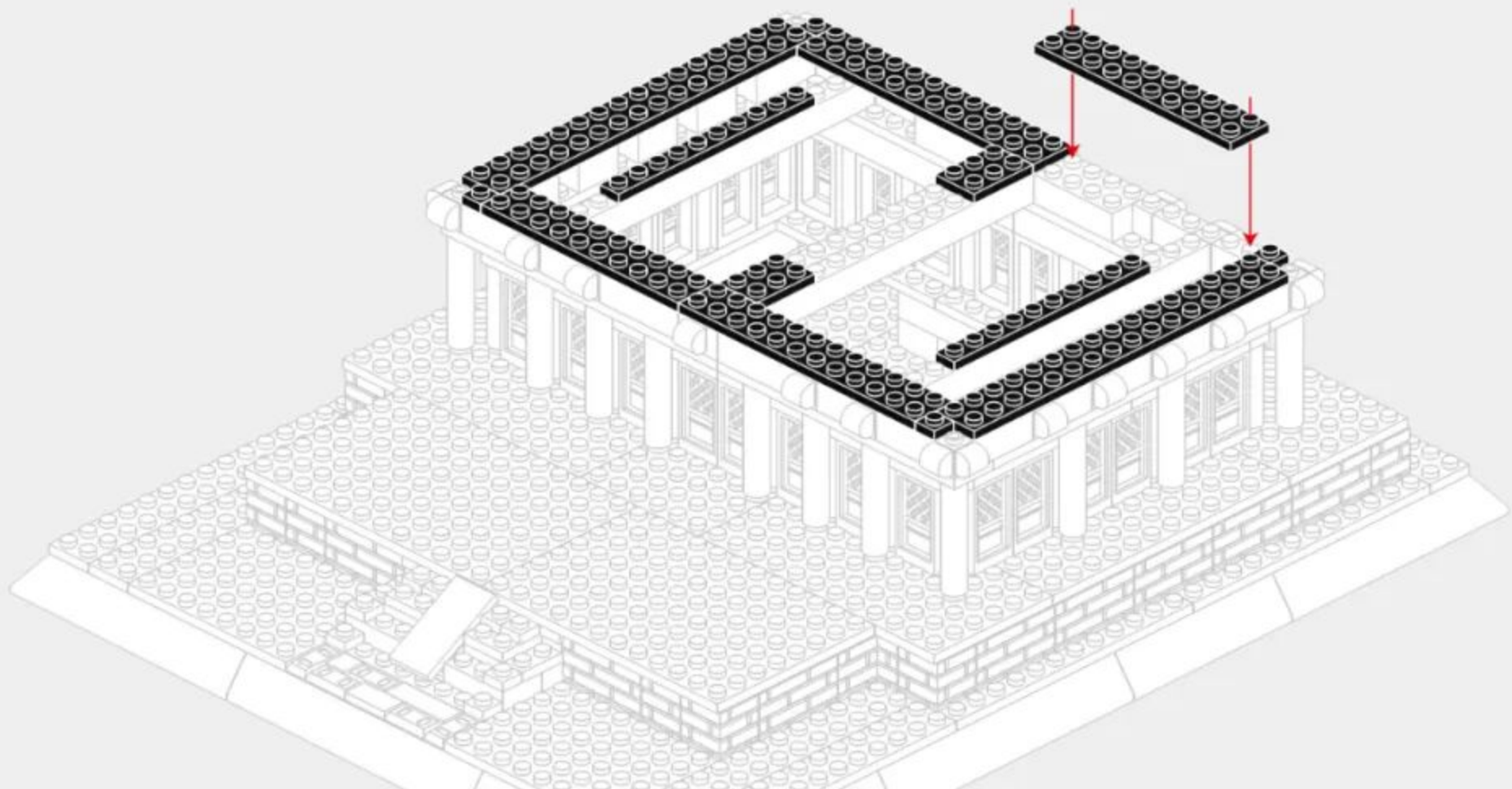
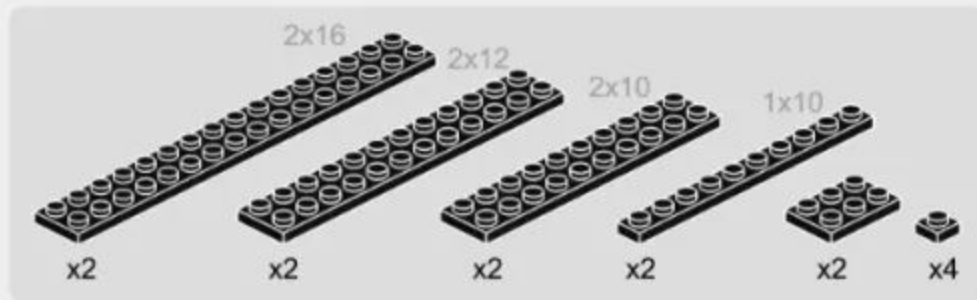

2-6

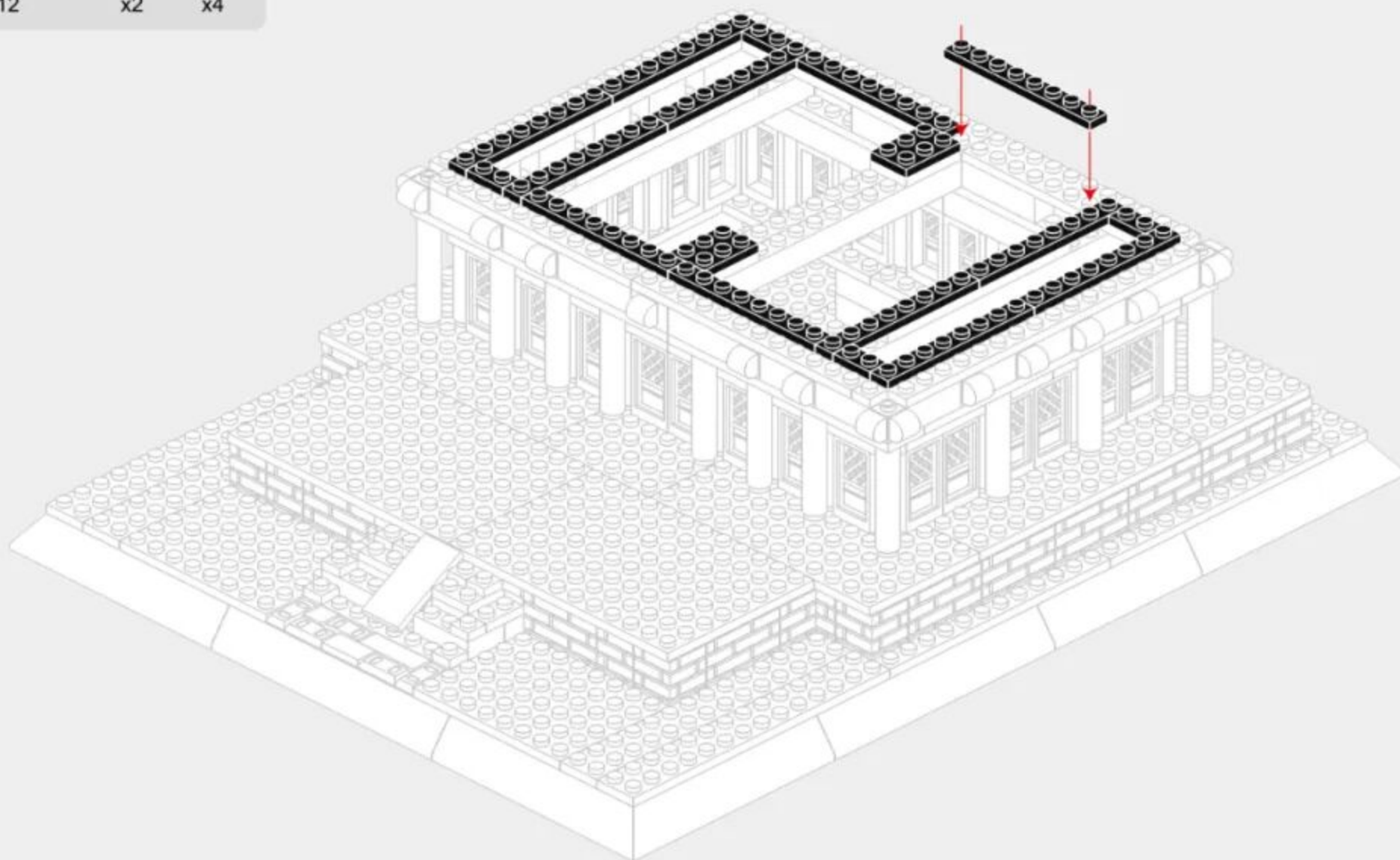
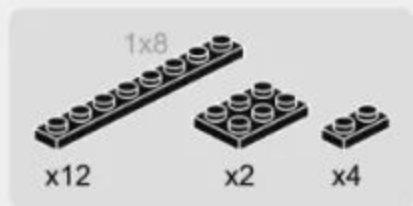

2-7

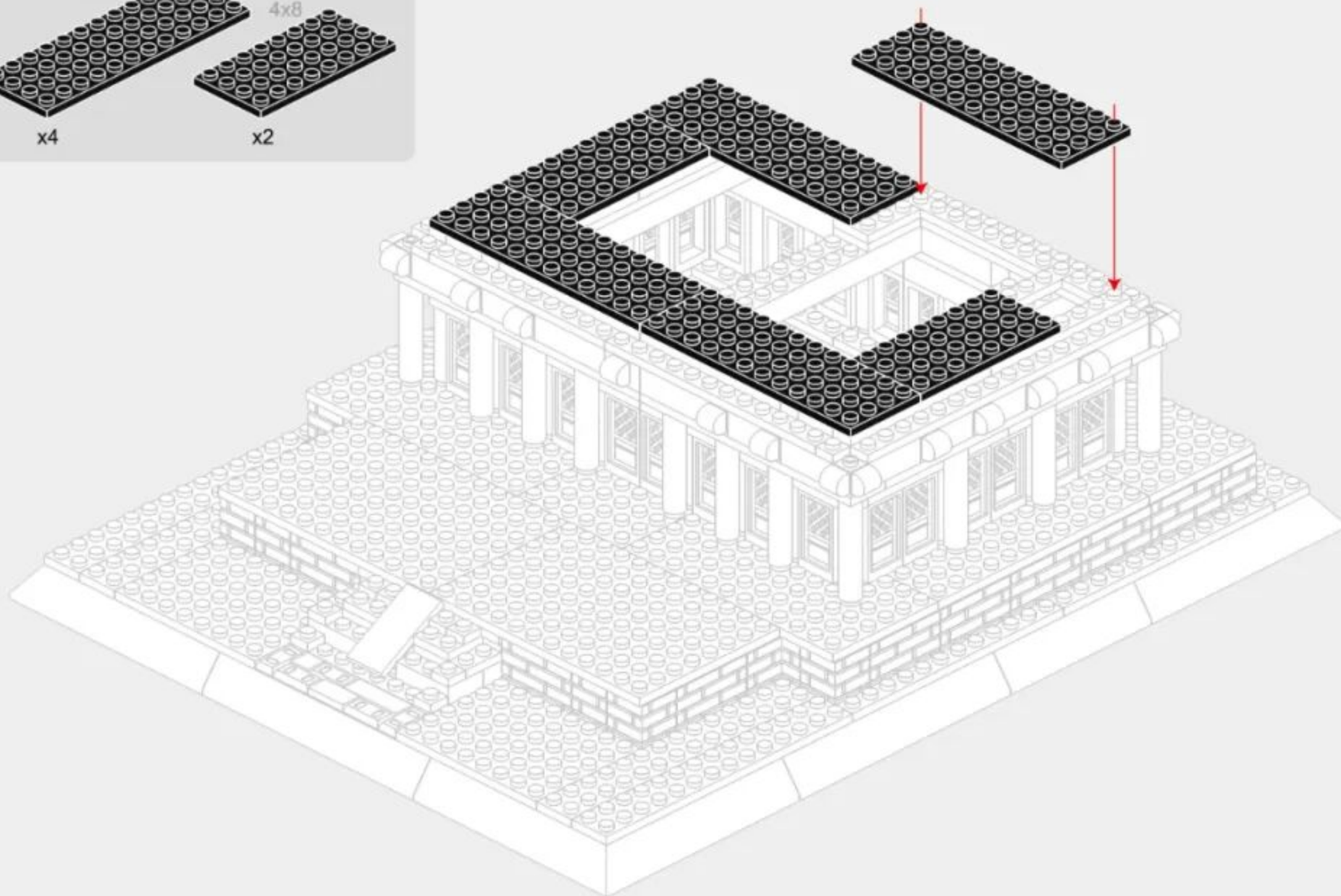
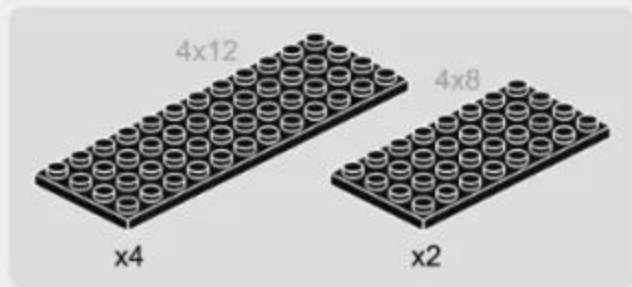

2-8

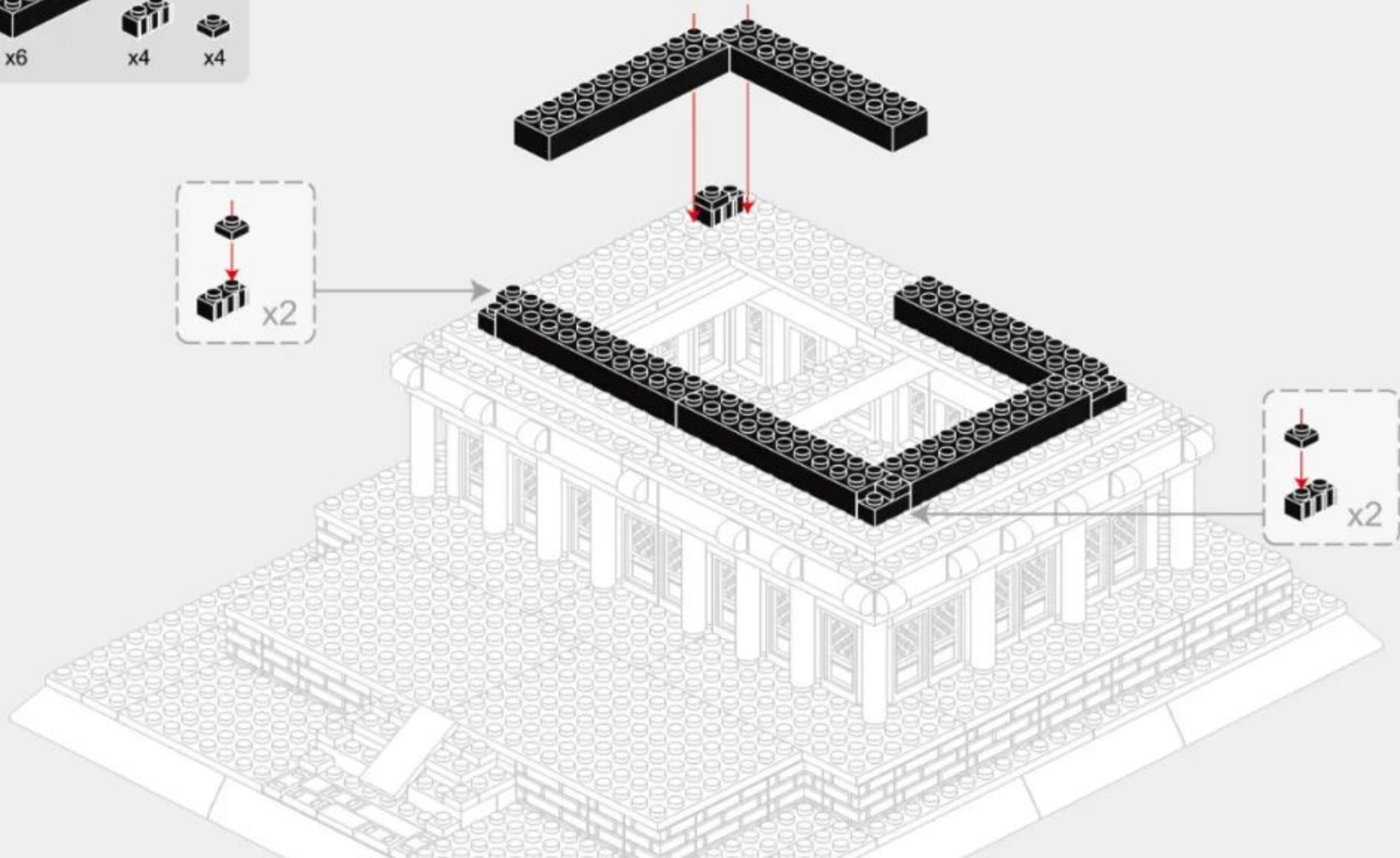
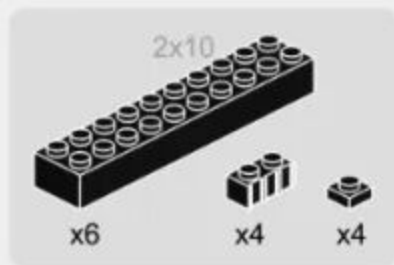

2-9

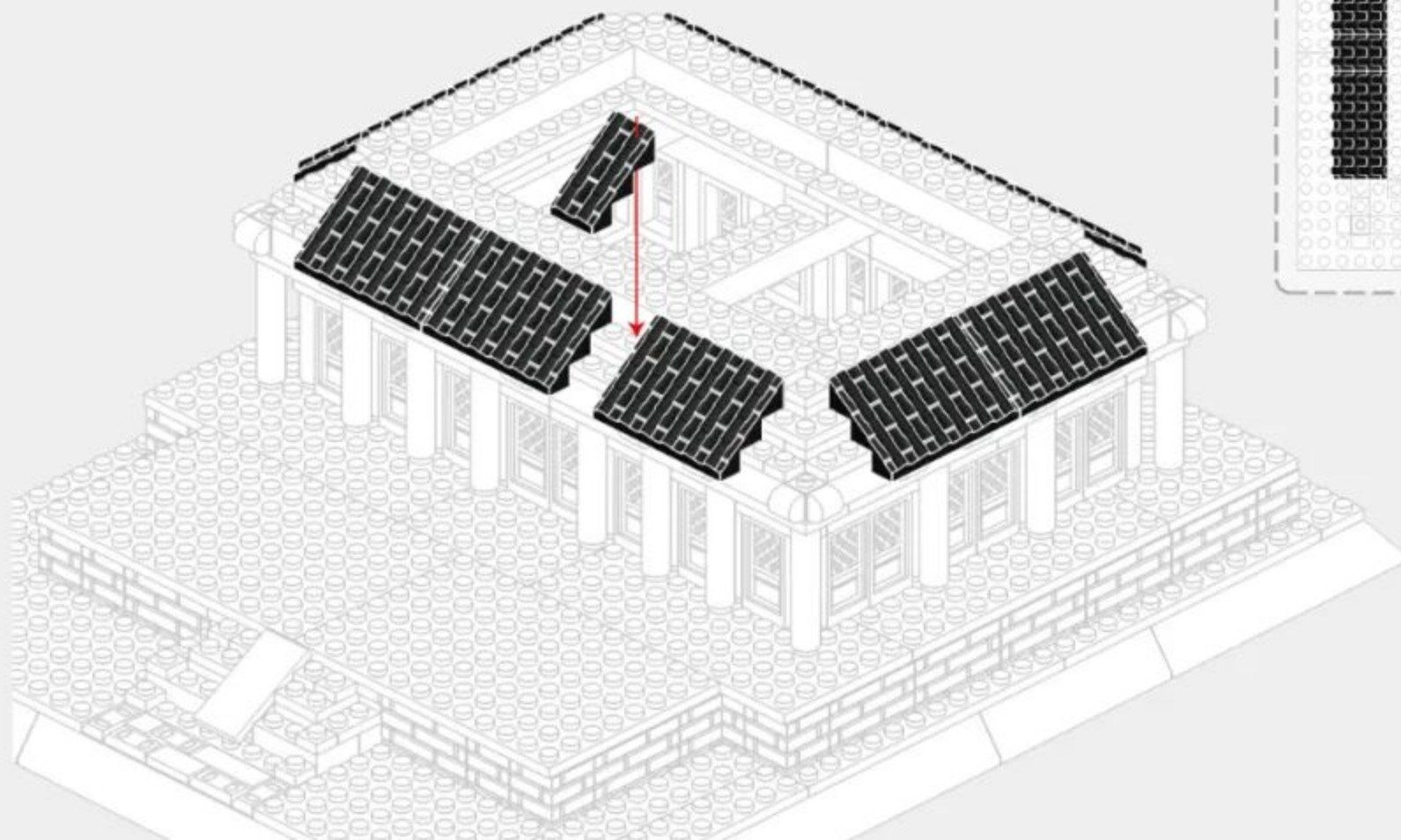
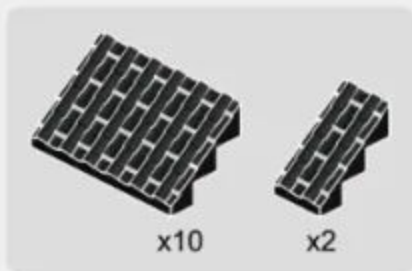

Vertical View of Installation Drawing
安装图顶面

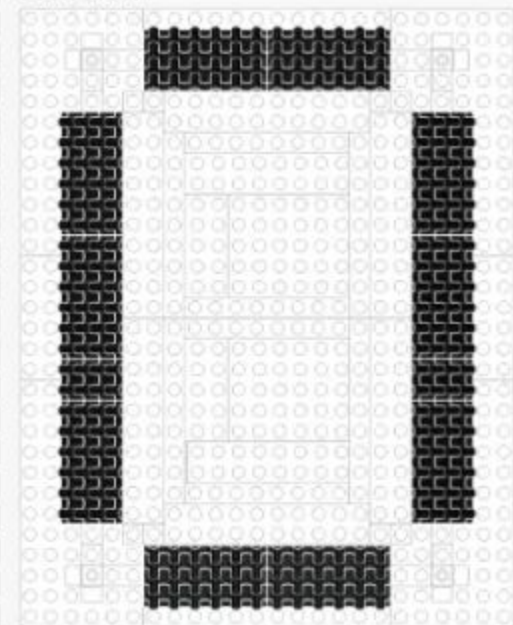

2-10



x4



x4



x4



x4



x4

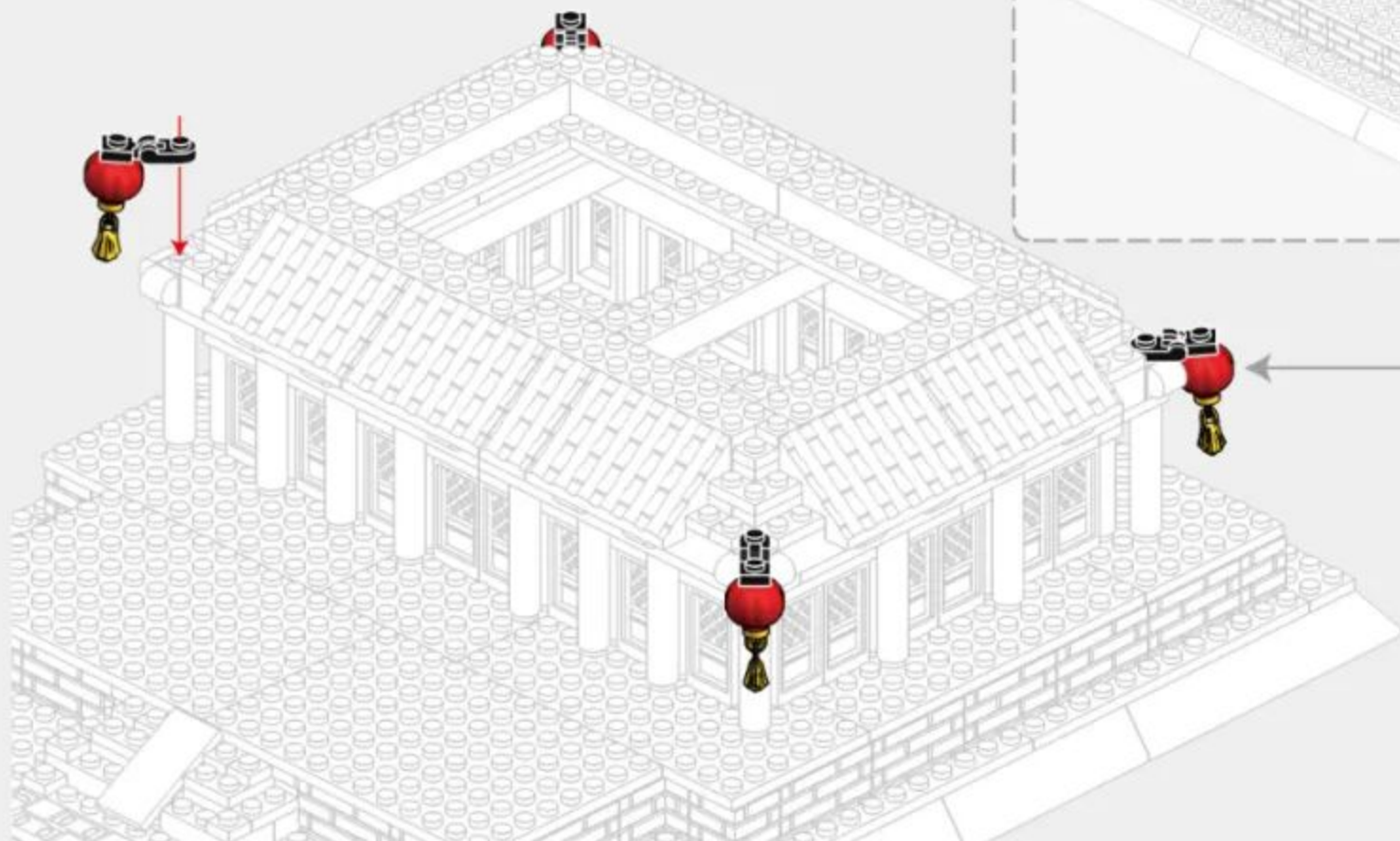

Back Side of Installation Drawing
安装图背面

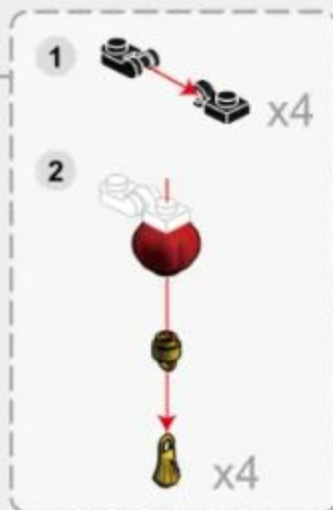
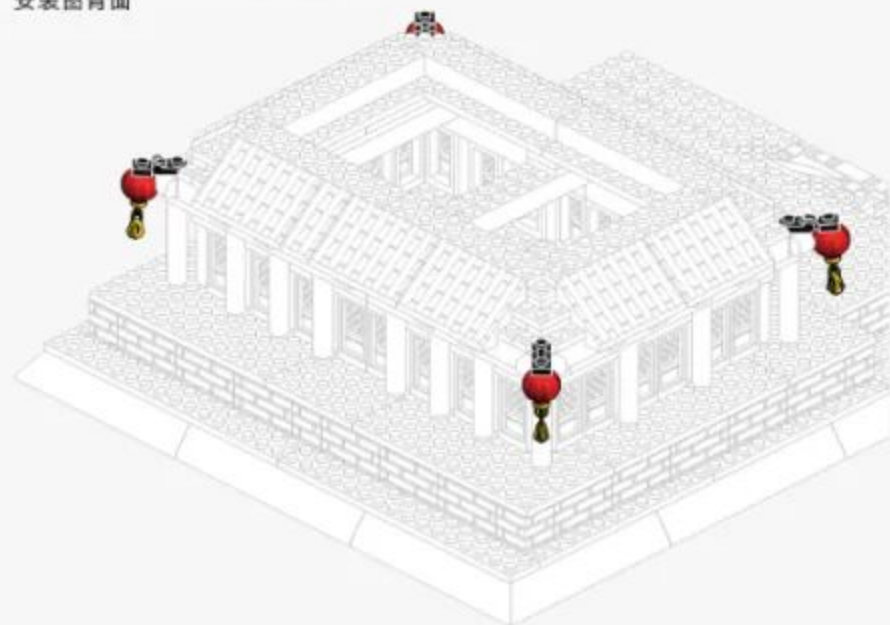

2-11

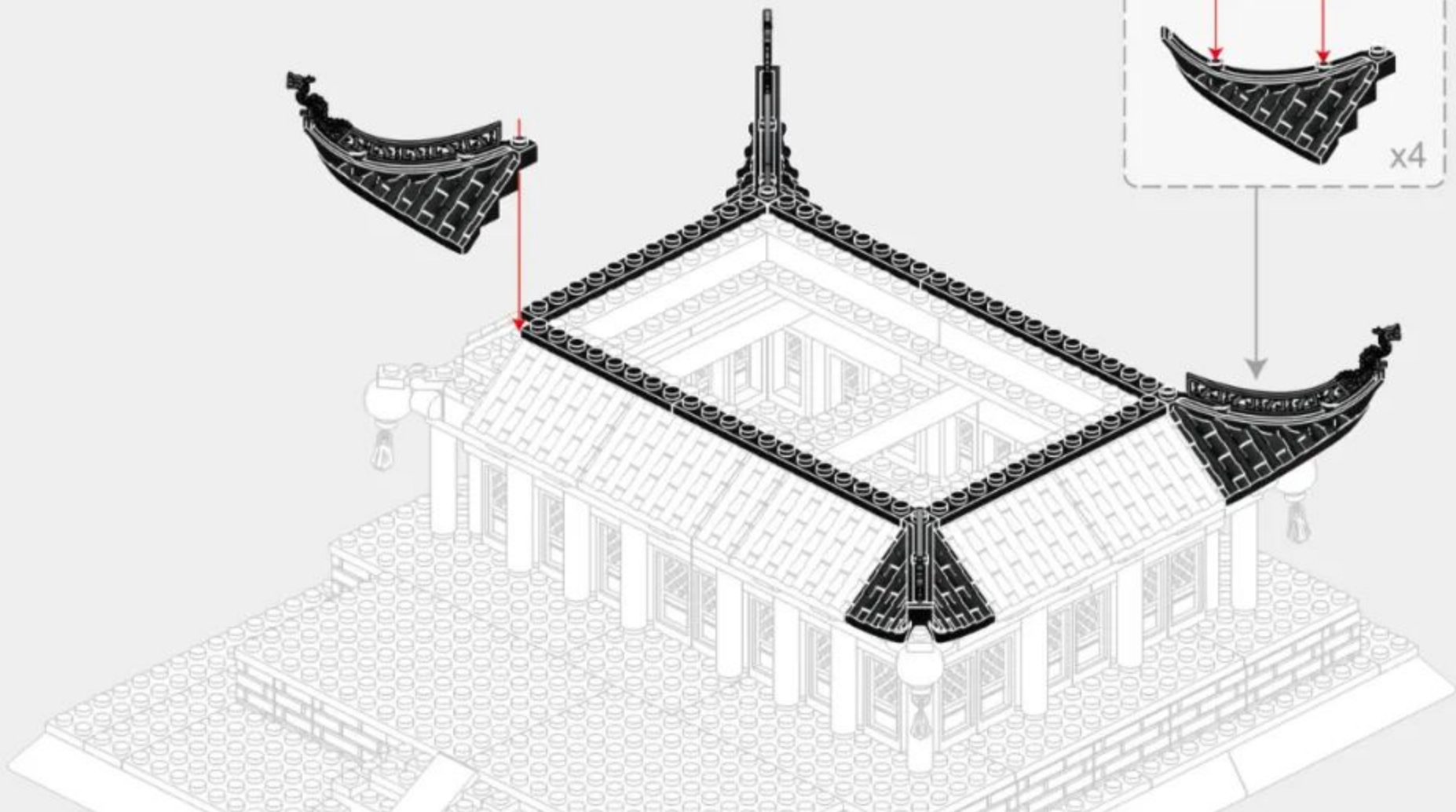
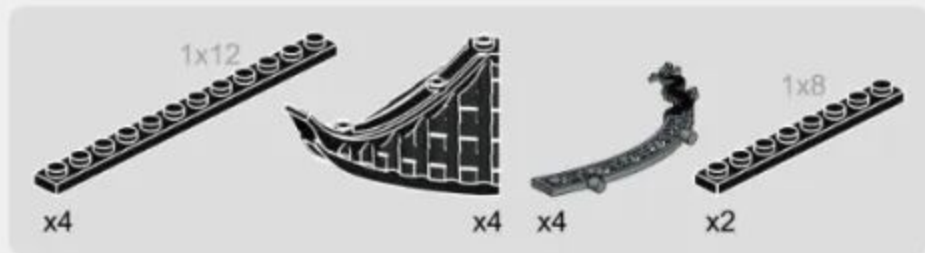

2-12

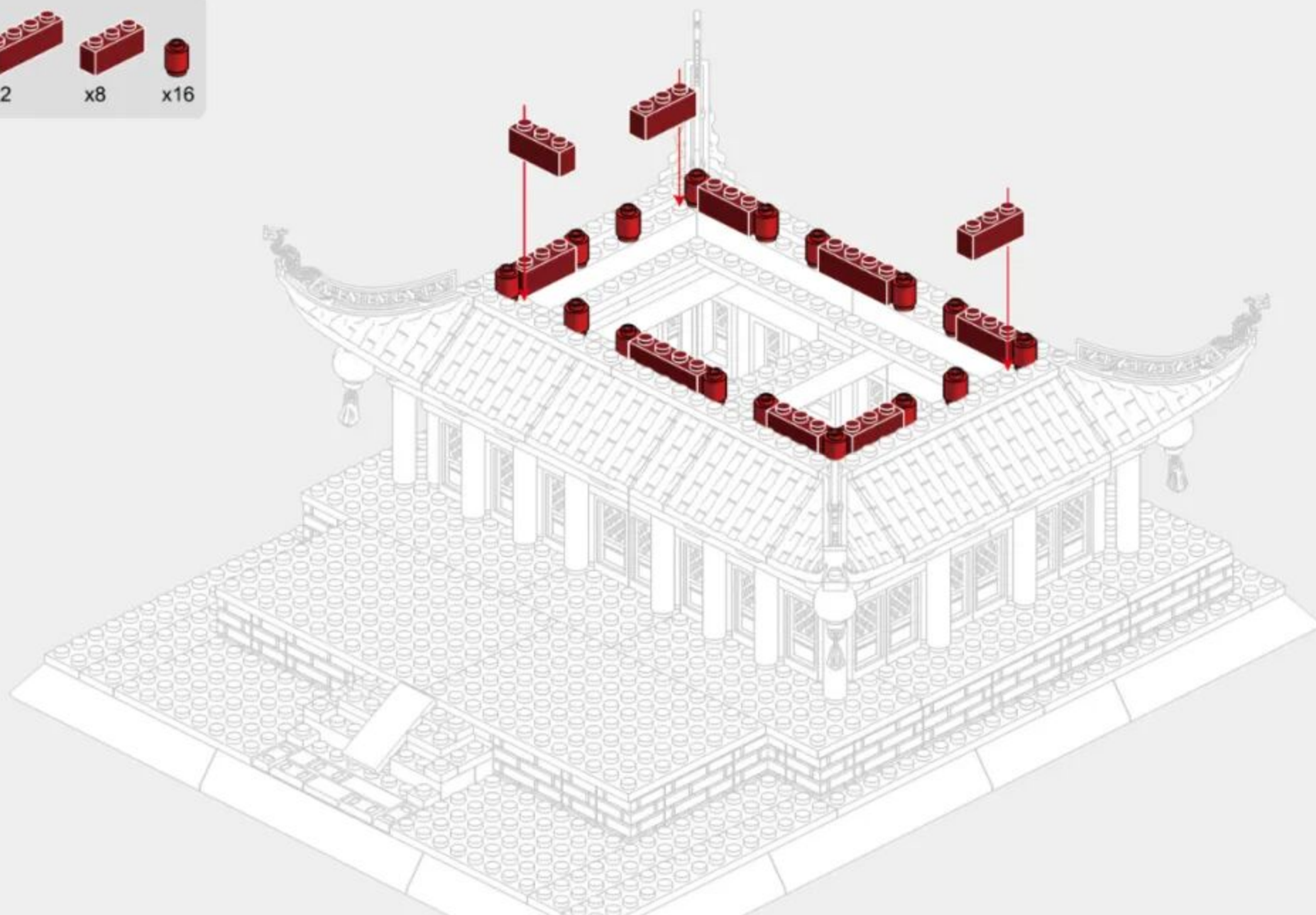
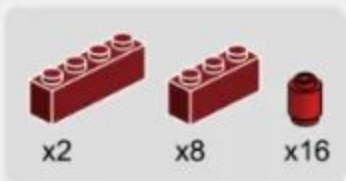

2-13

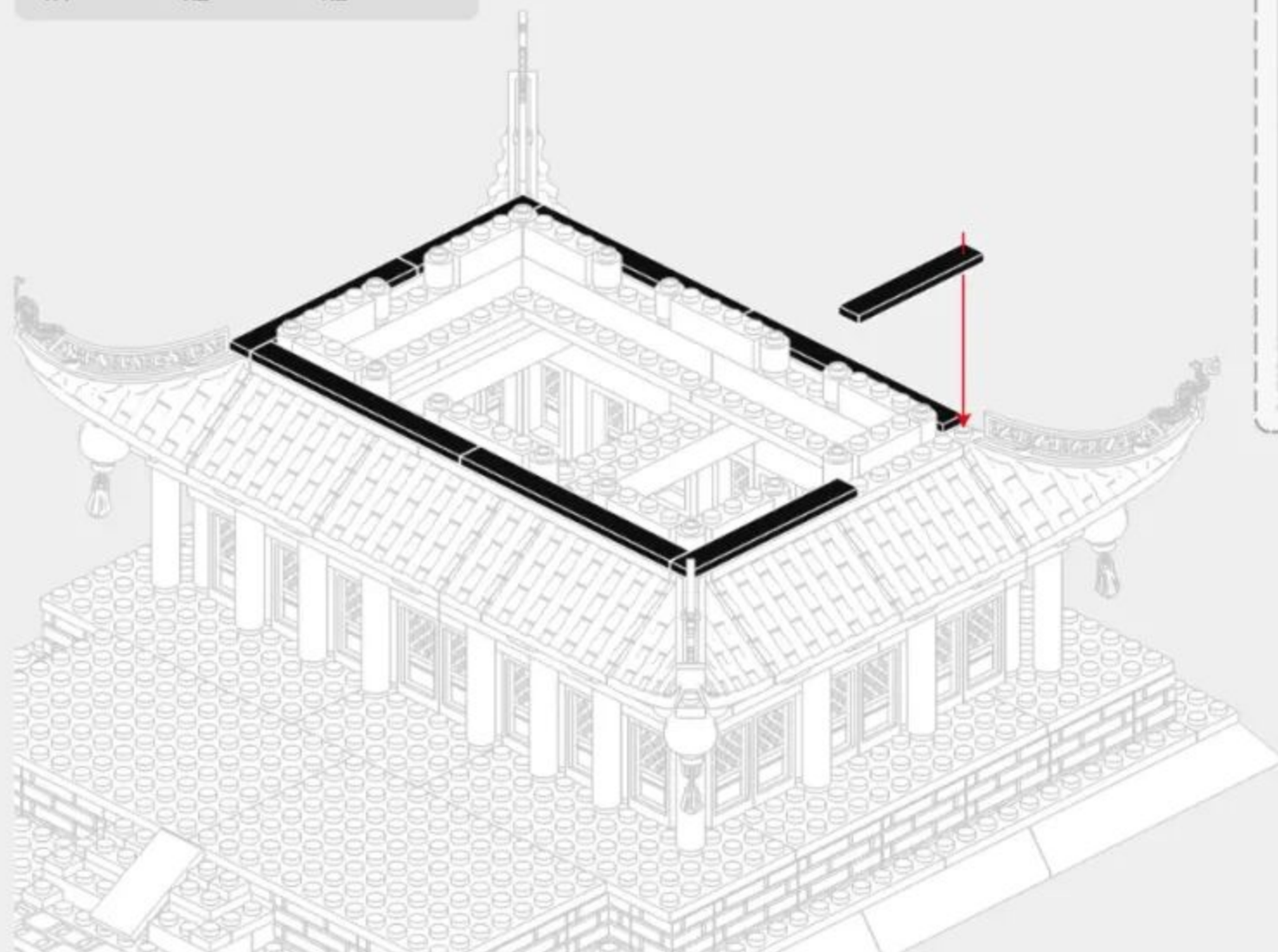

Vertical View of Installation Drawing
安装图顶面

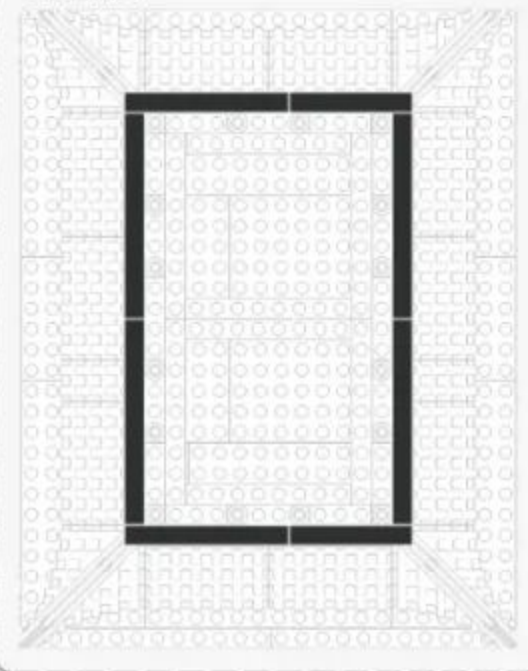



281 PCS

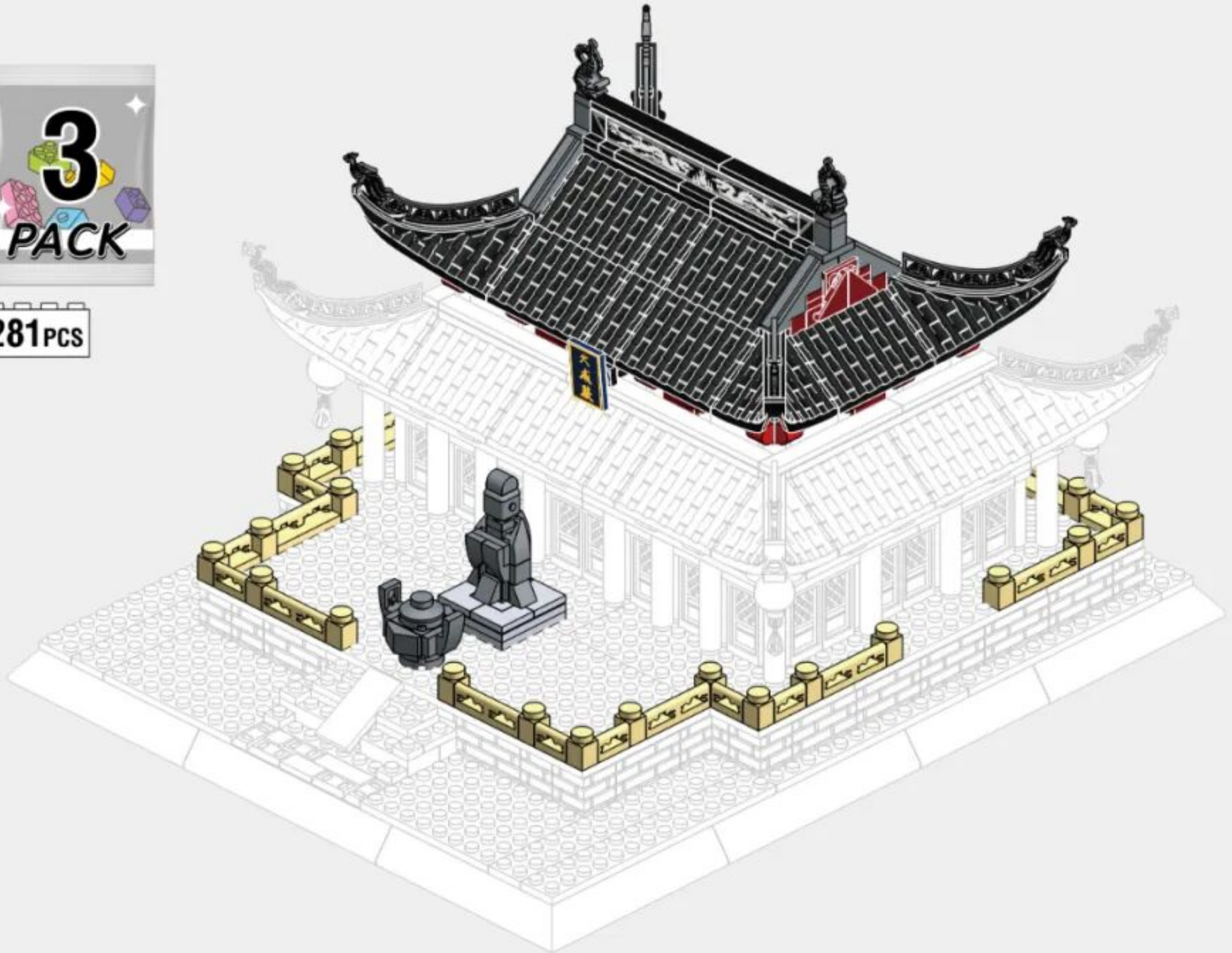

45

3-1

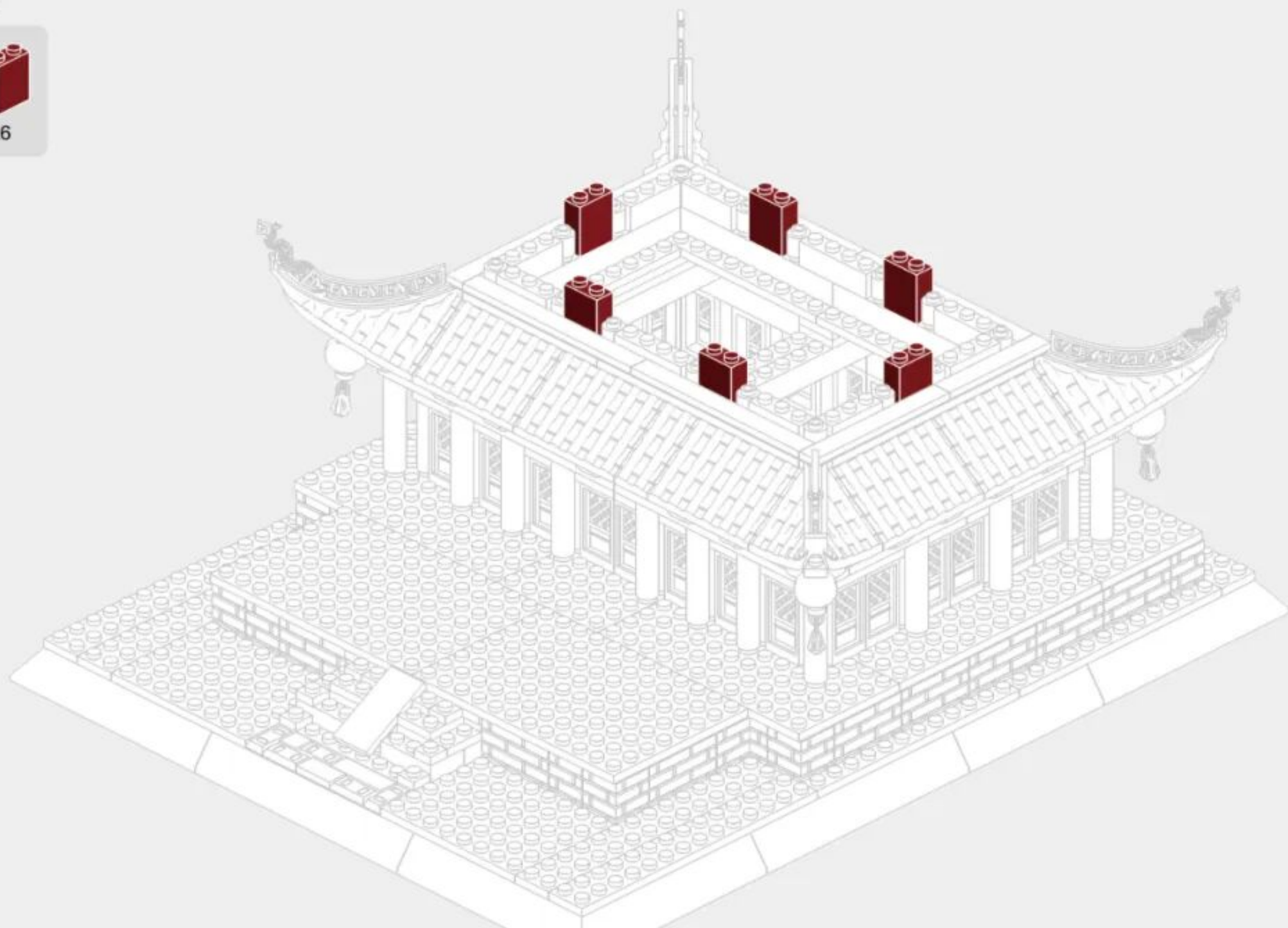

3-2

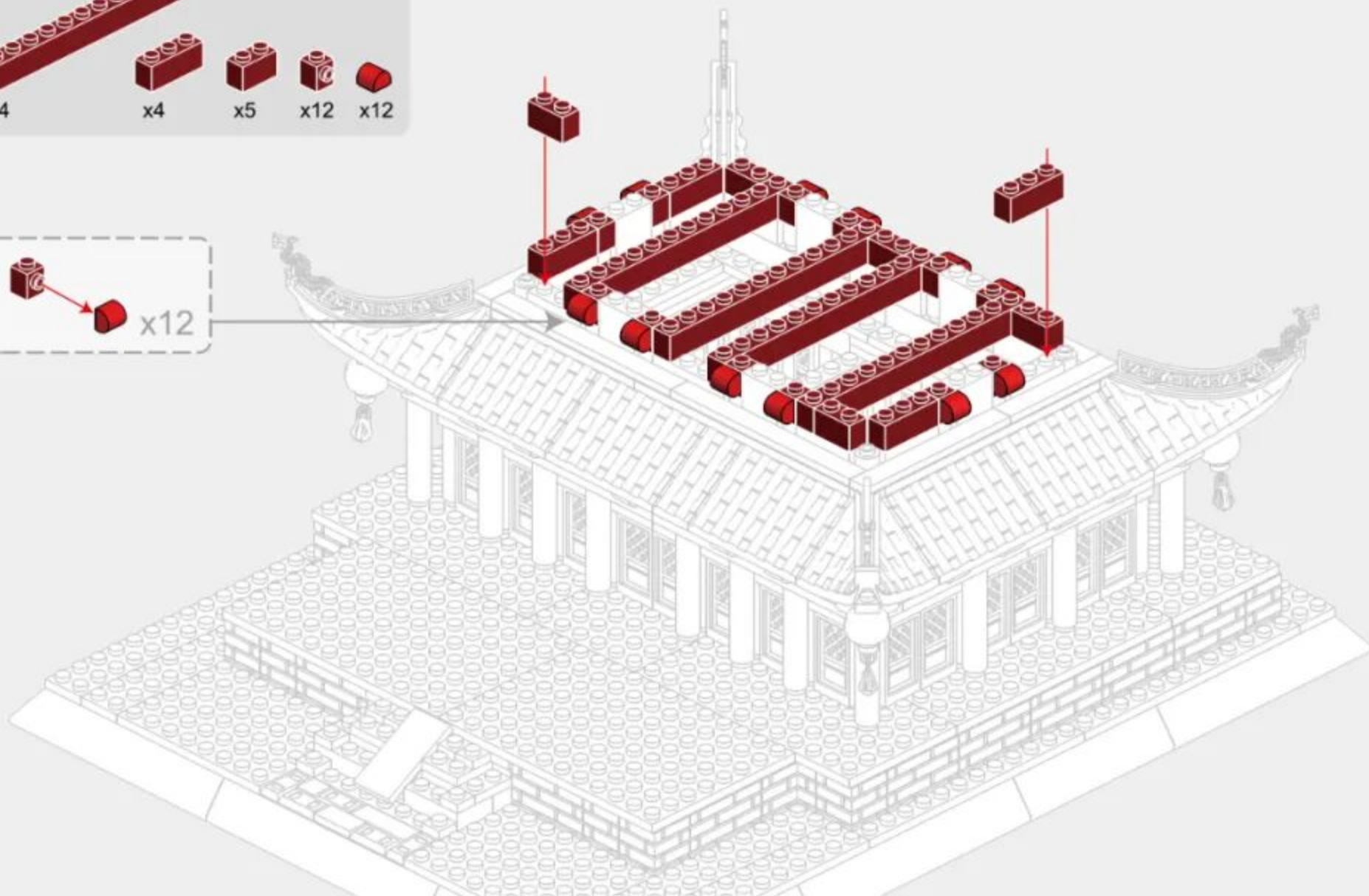
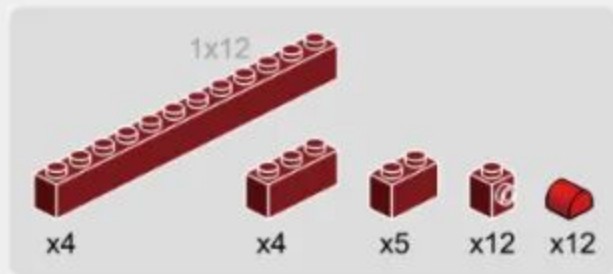

3-3

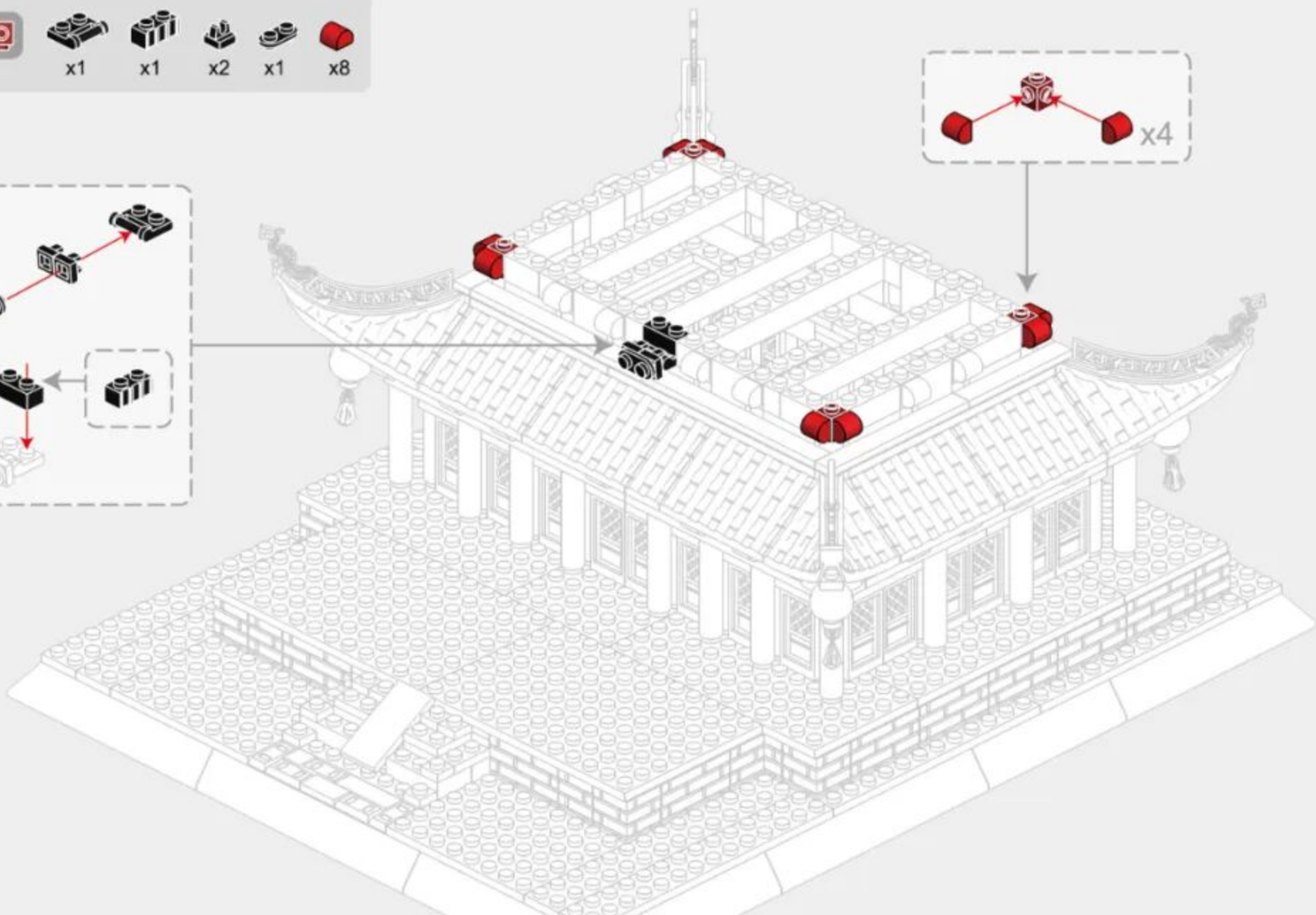
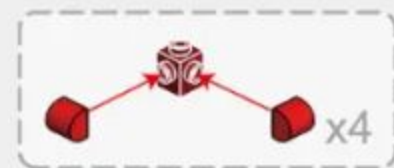
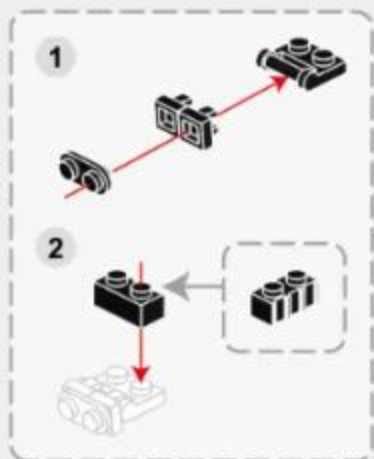

3-4

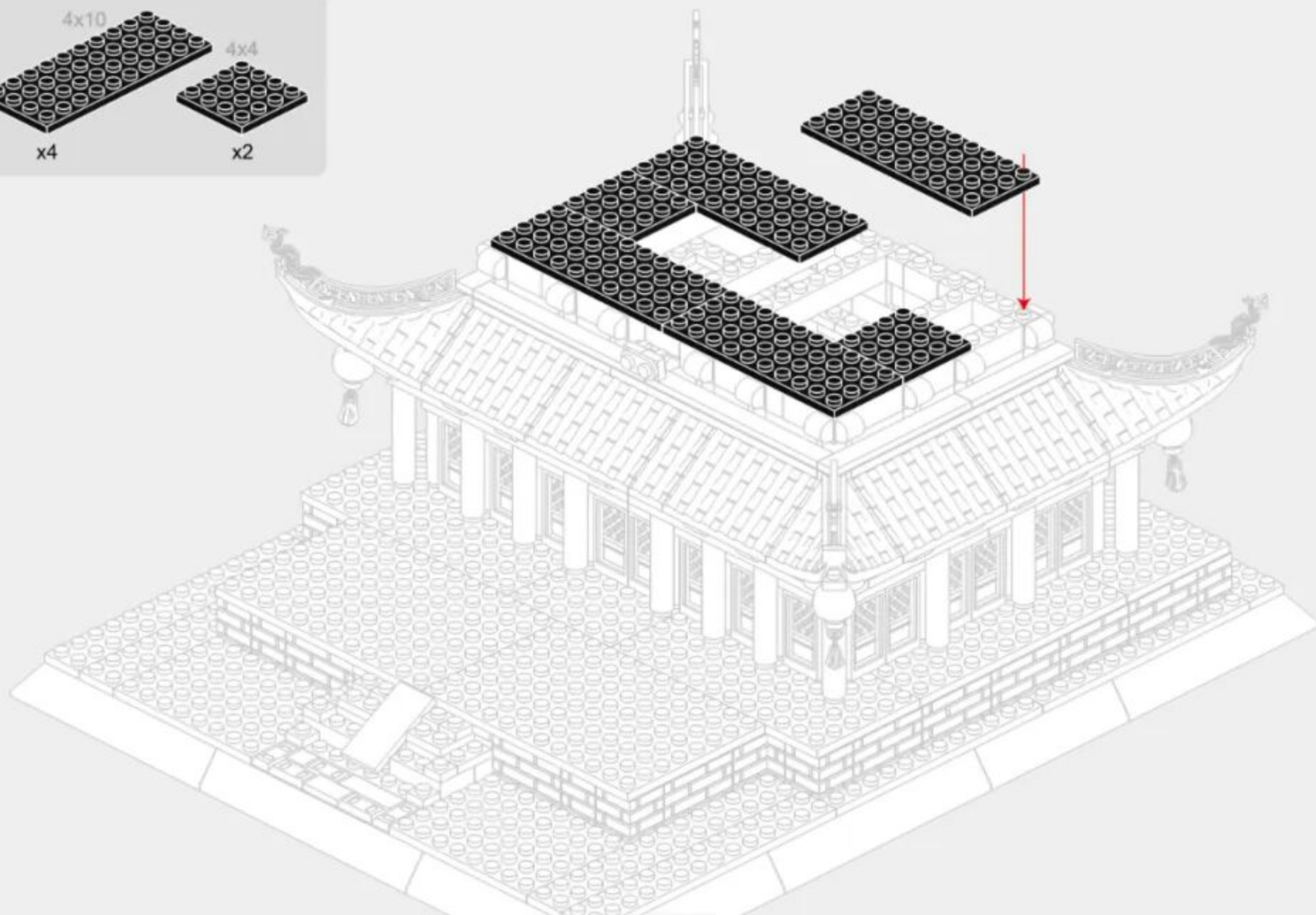
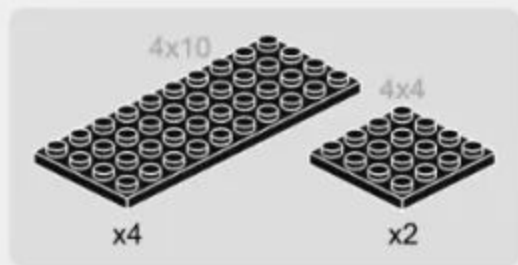

3-6

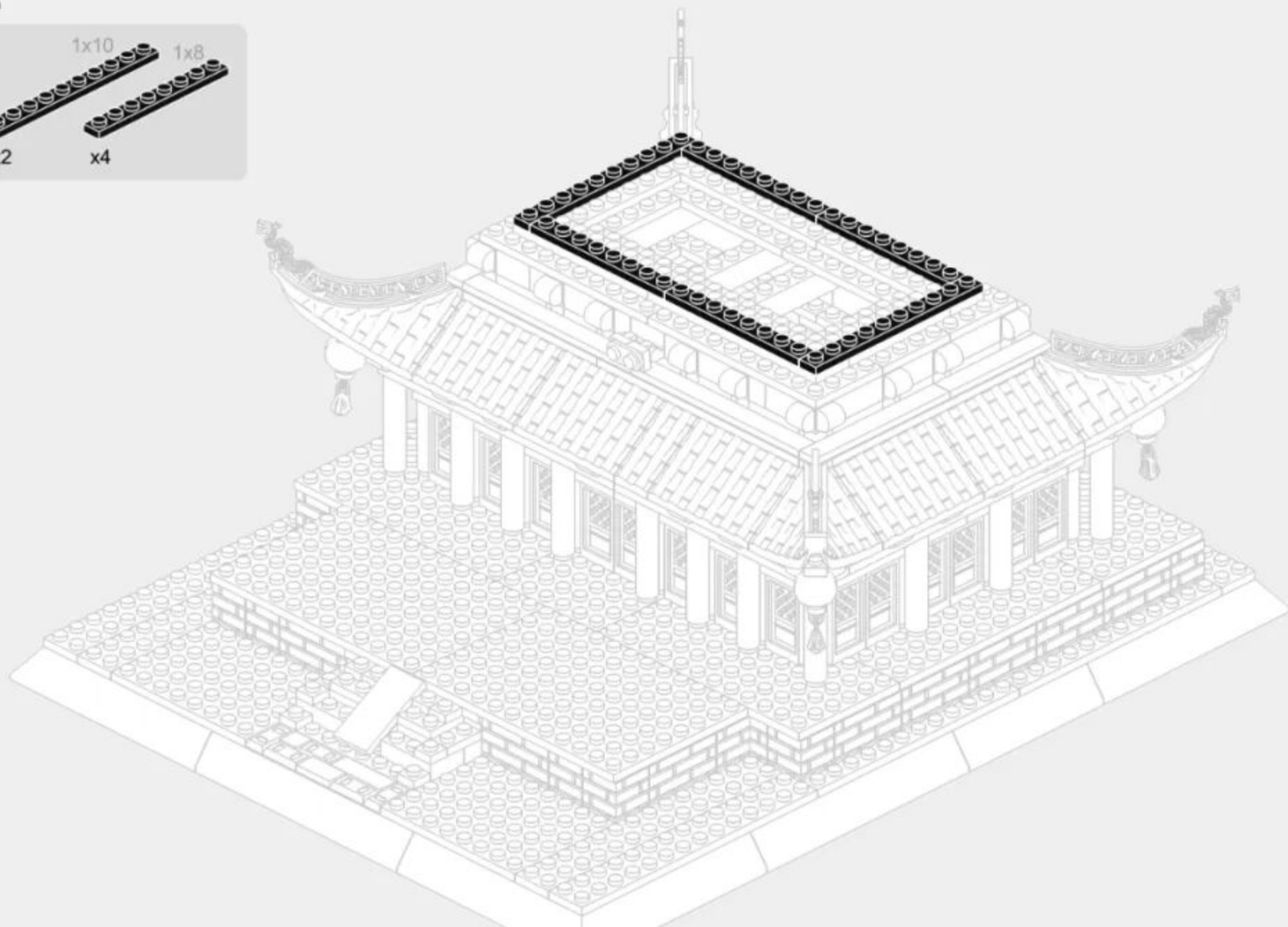
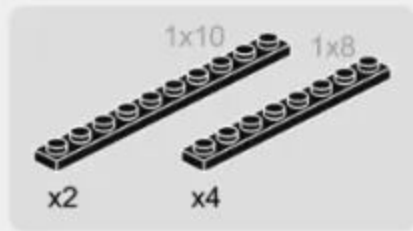

3-7

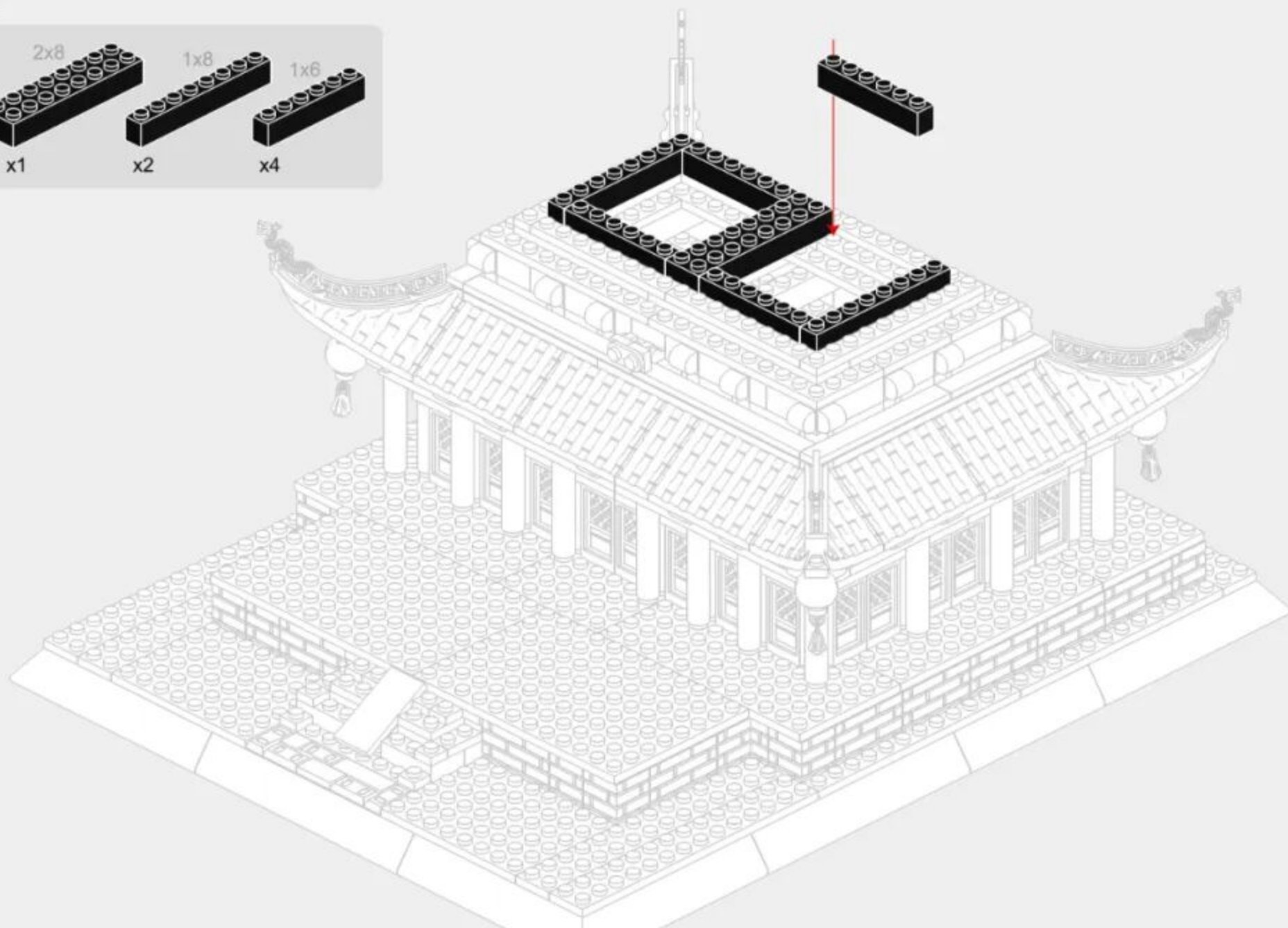
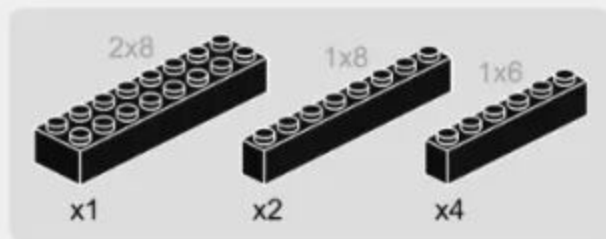

3-8

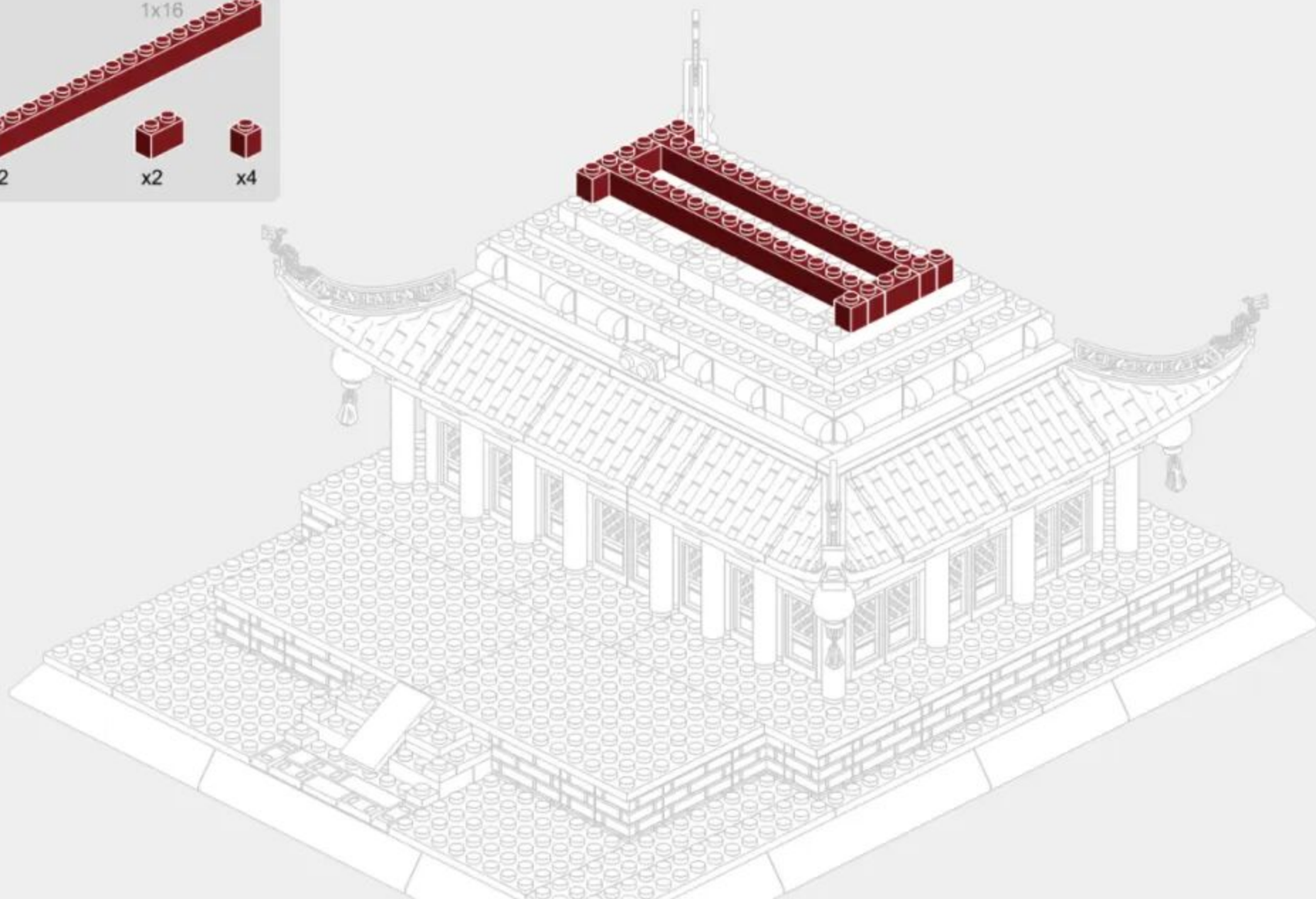
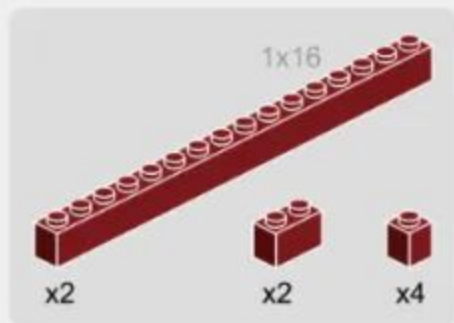

3-9

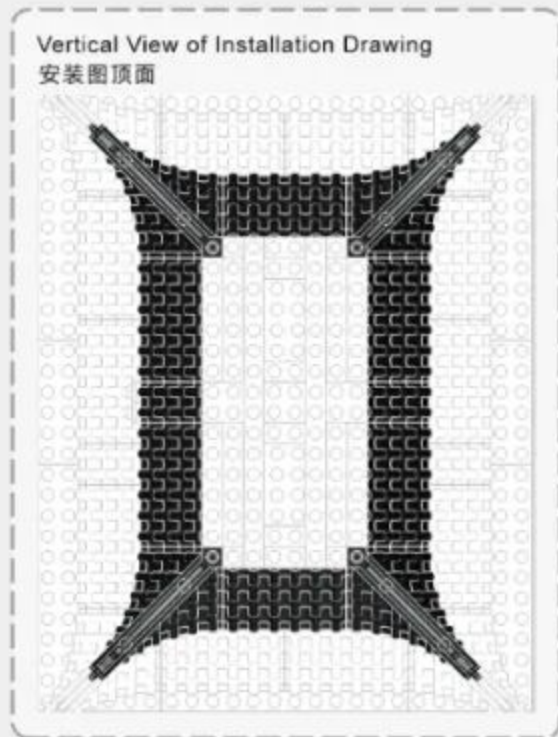
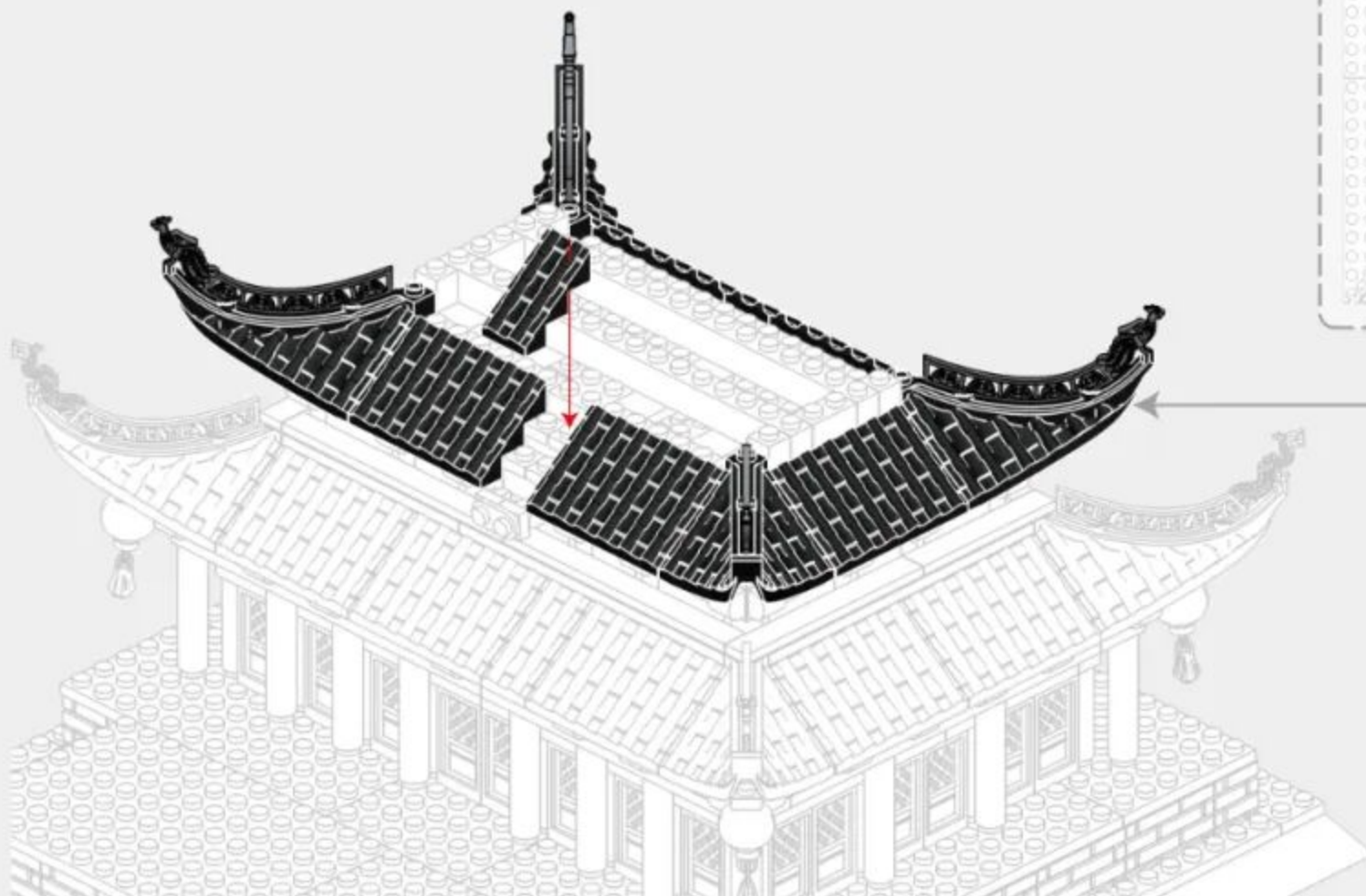
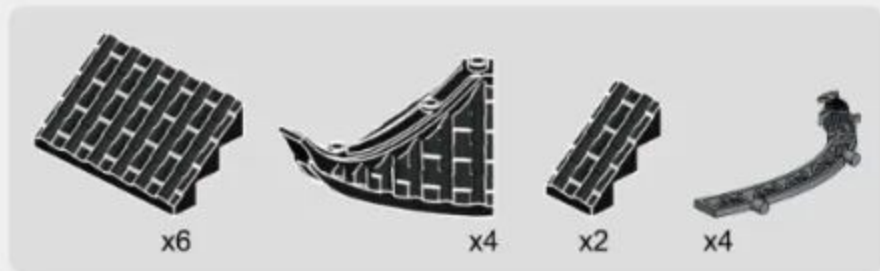

3-10

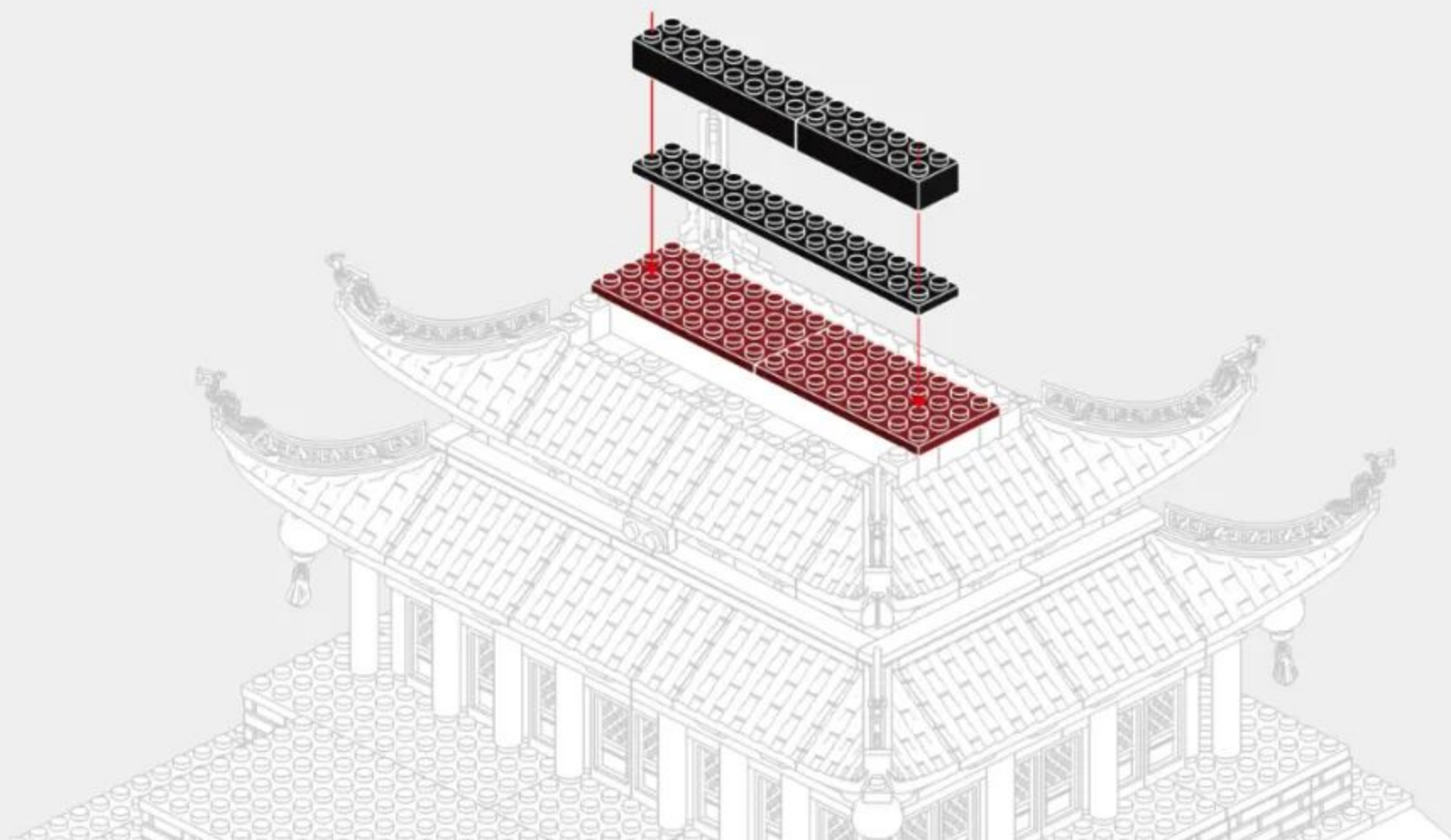
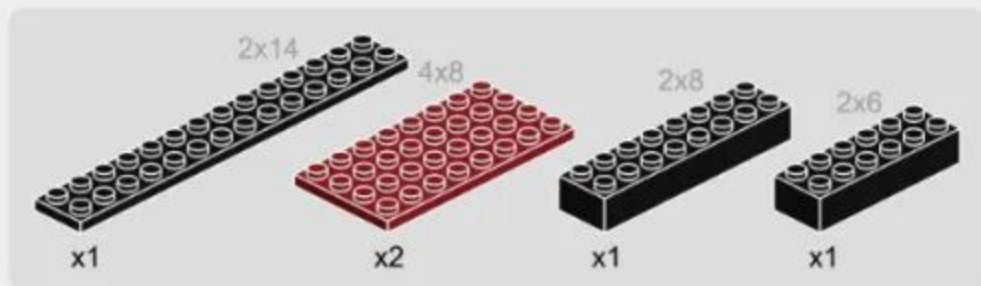

3-11

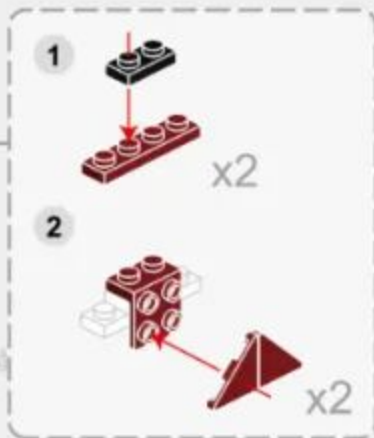
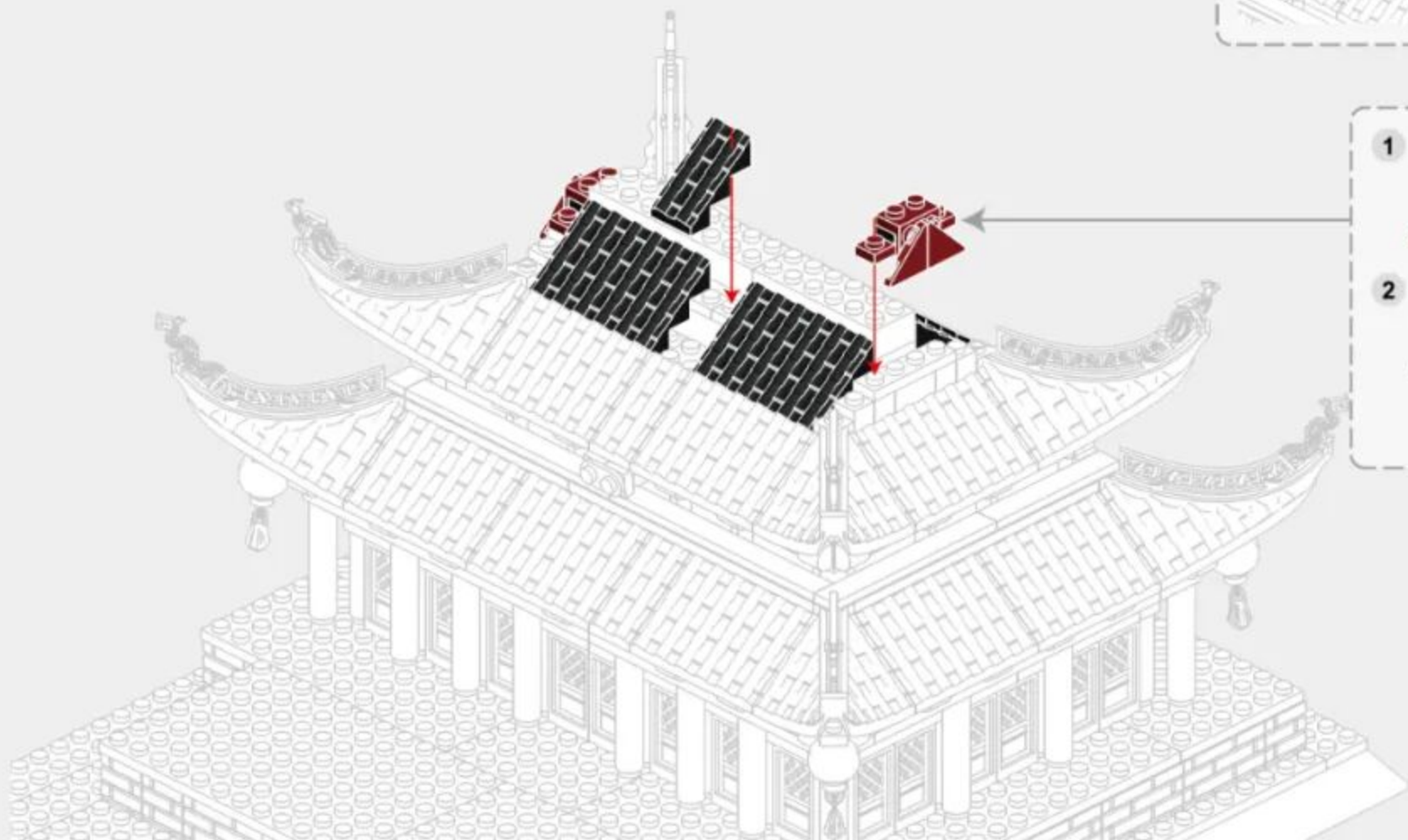
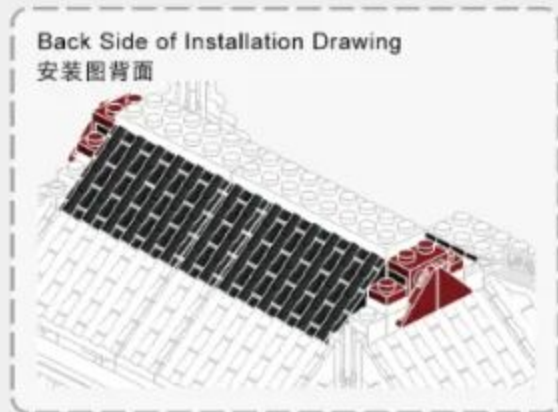

3-12

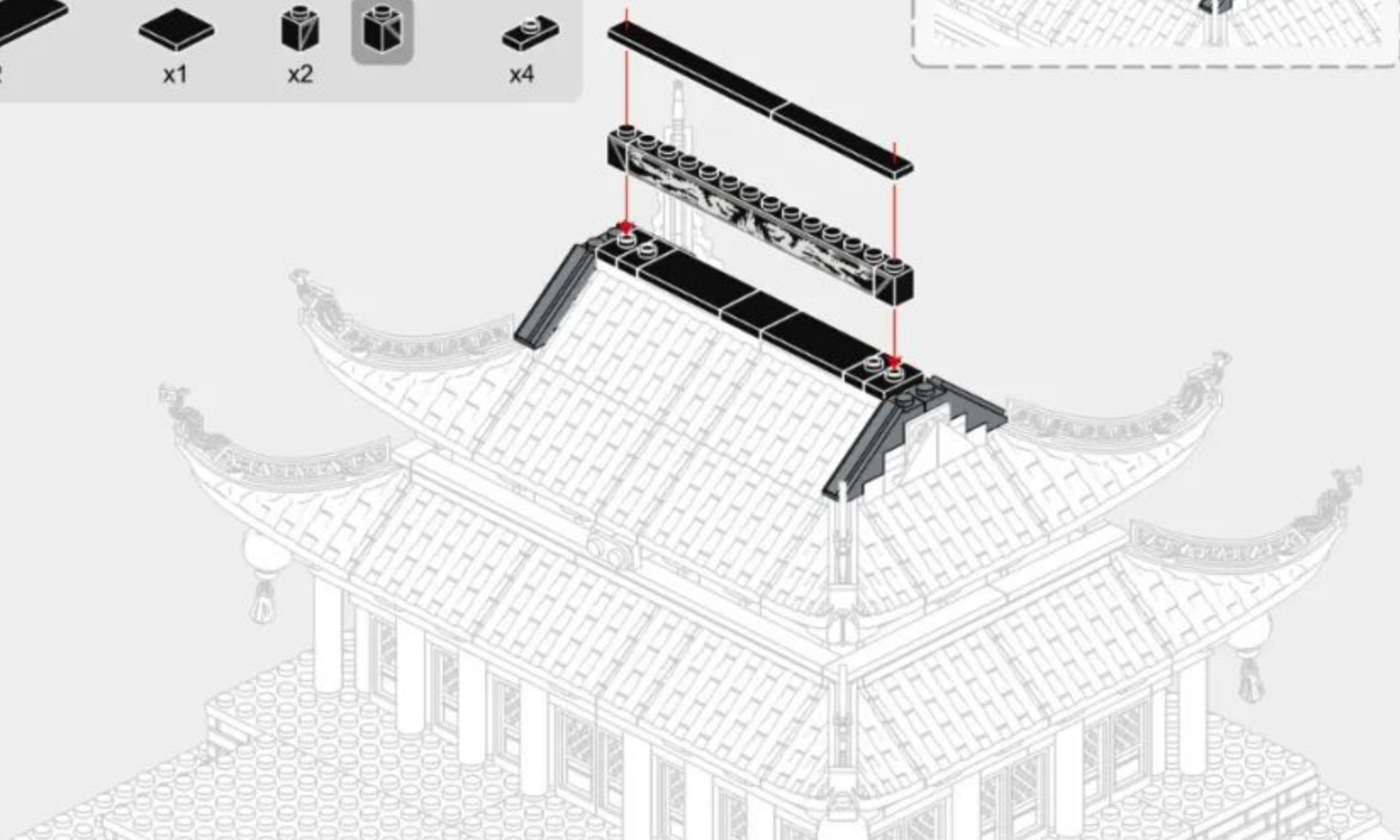
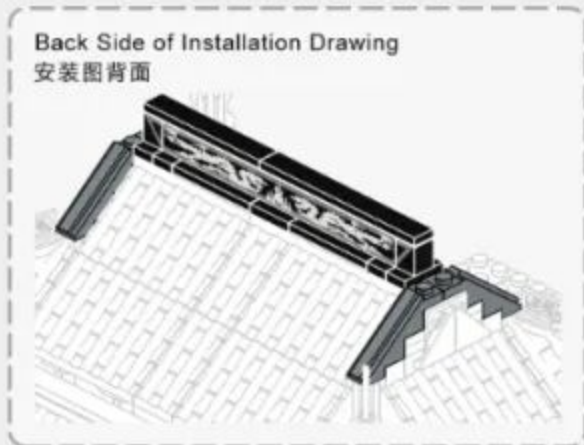
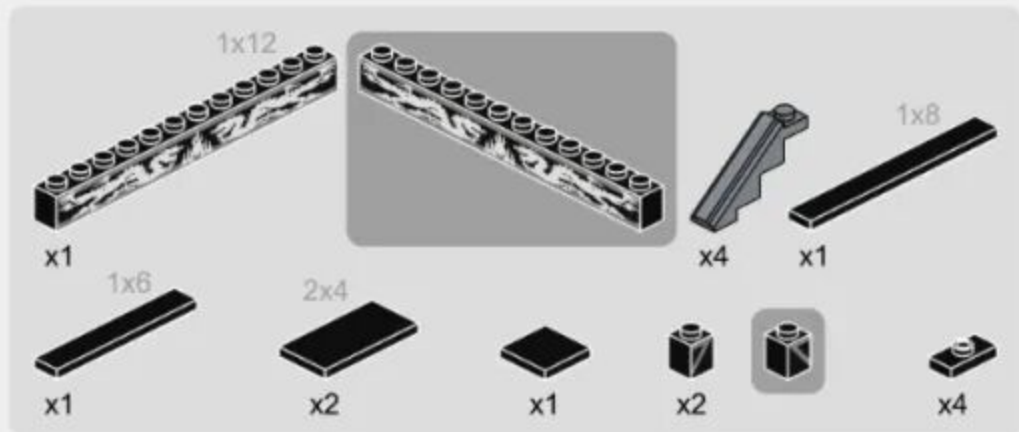

3-13

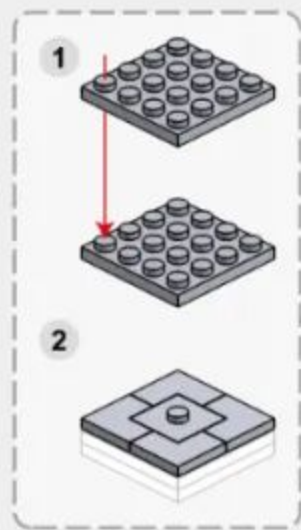
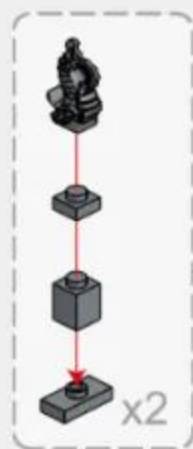

3-16

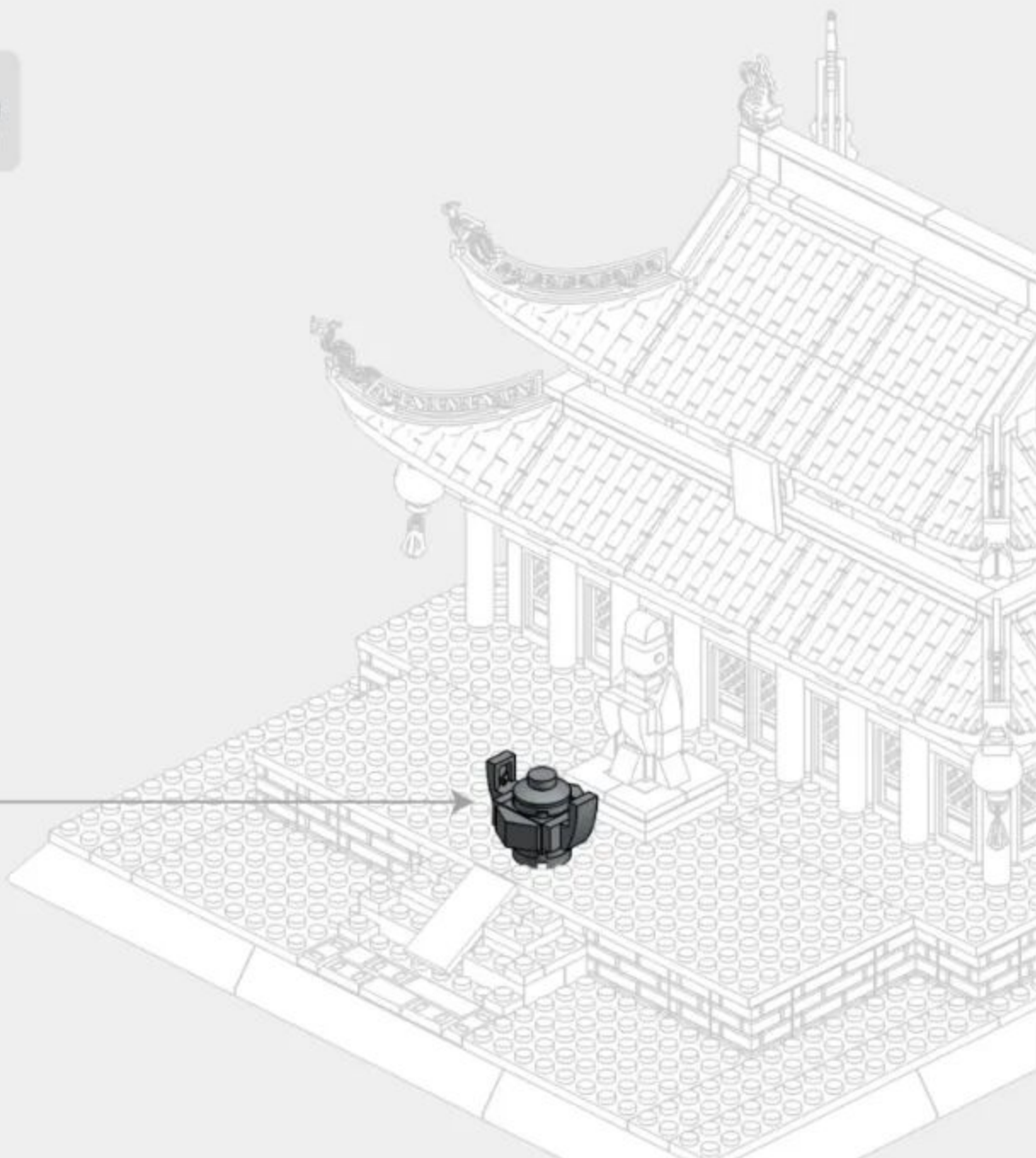
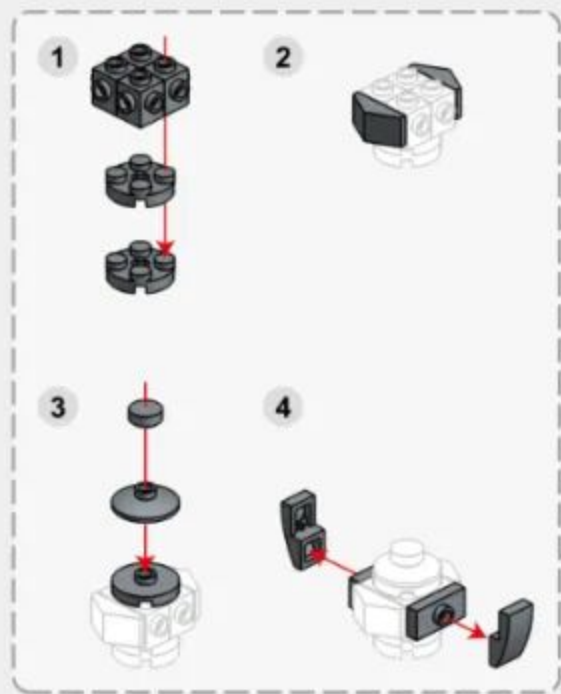

3-17

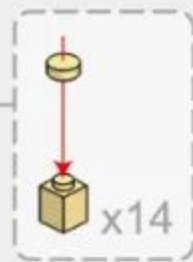
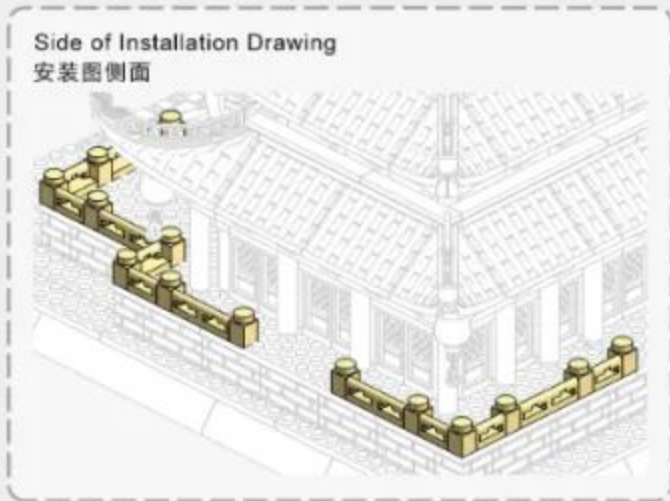
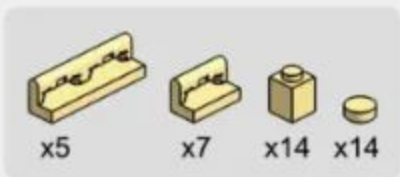

3-18

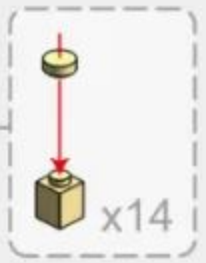
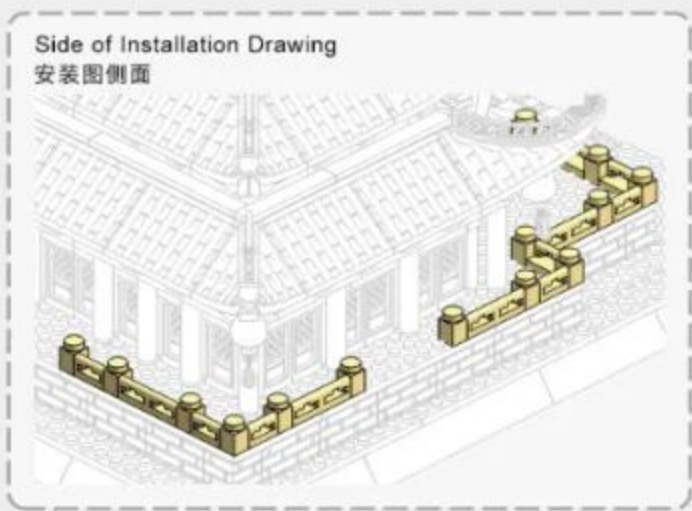
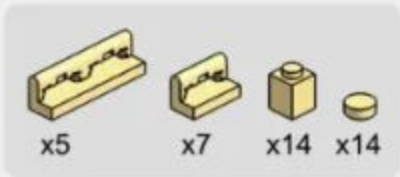



202PCS



63

4-1

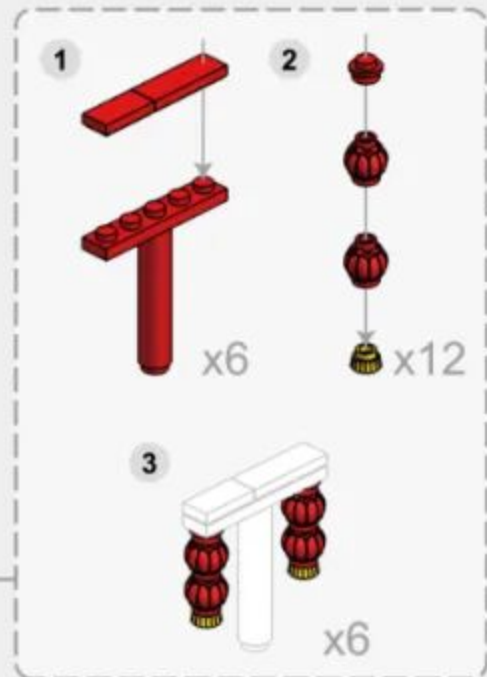
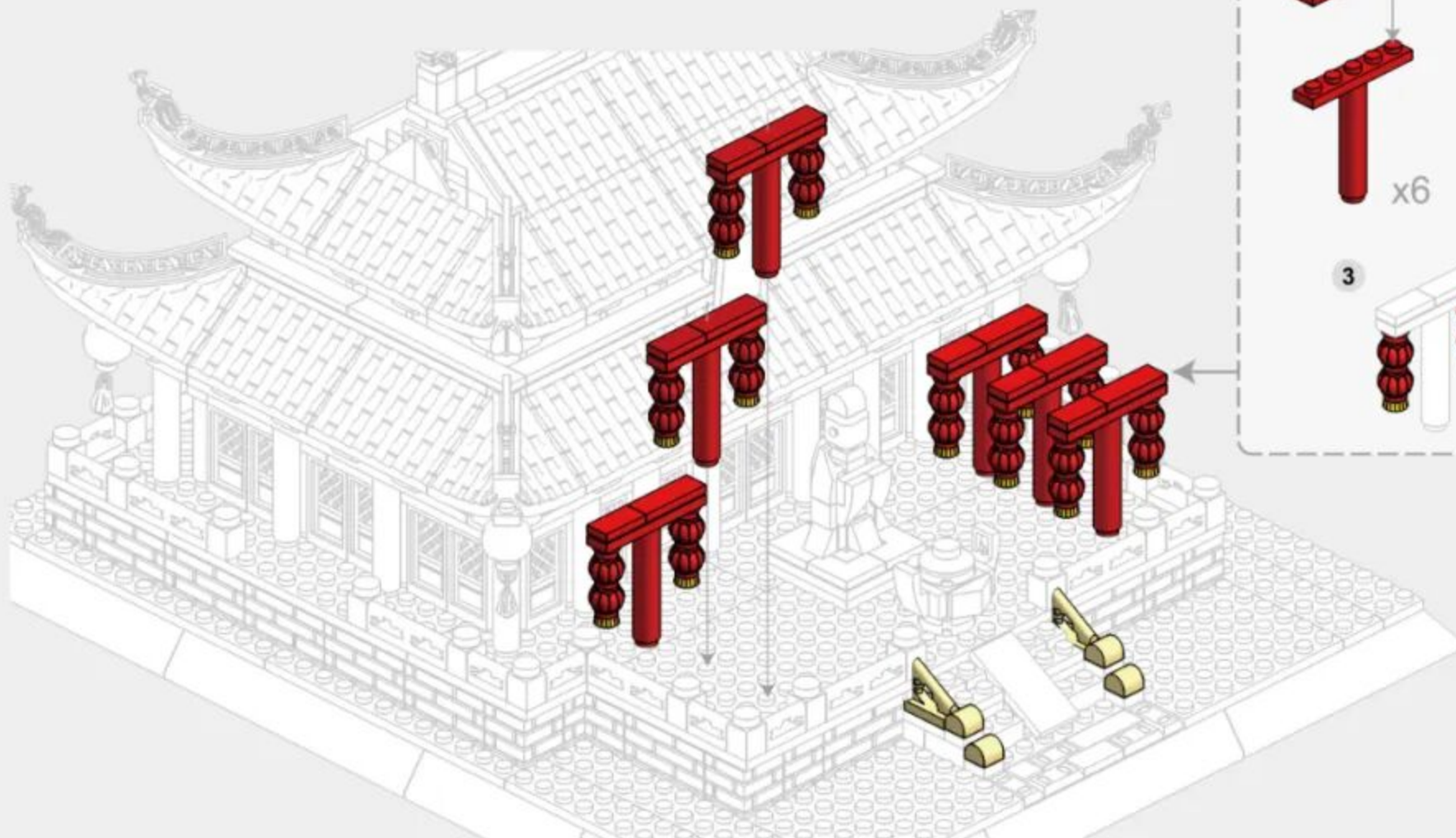

4-2

					
x1	x3	x2	x2	x7	x1

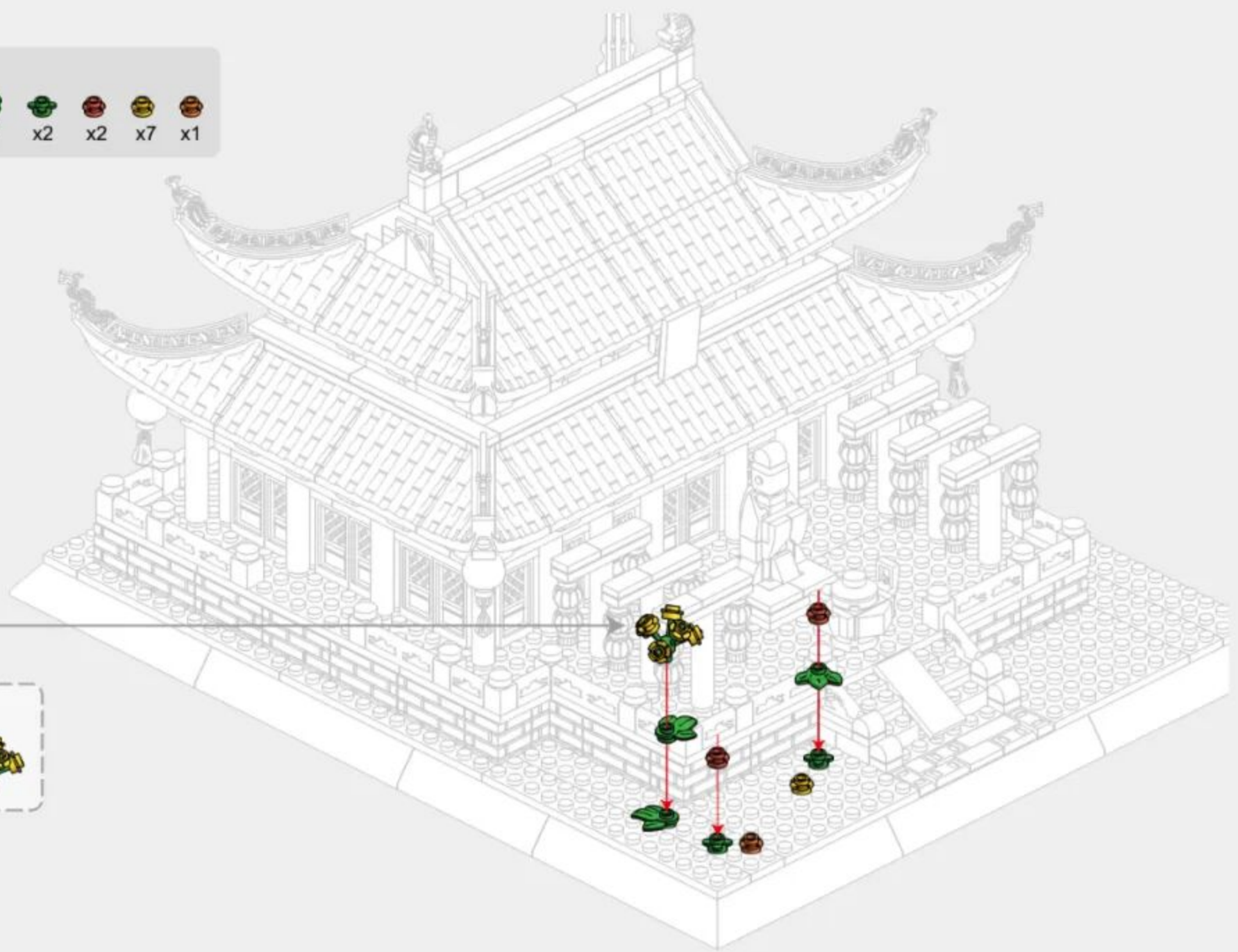

4-3

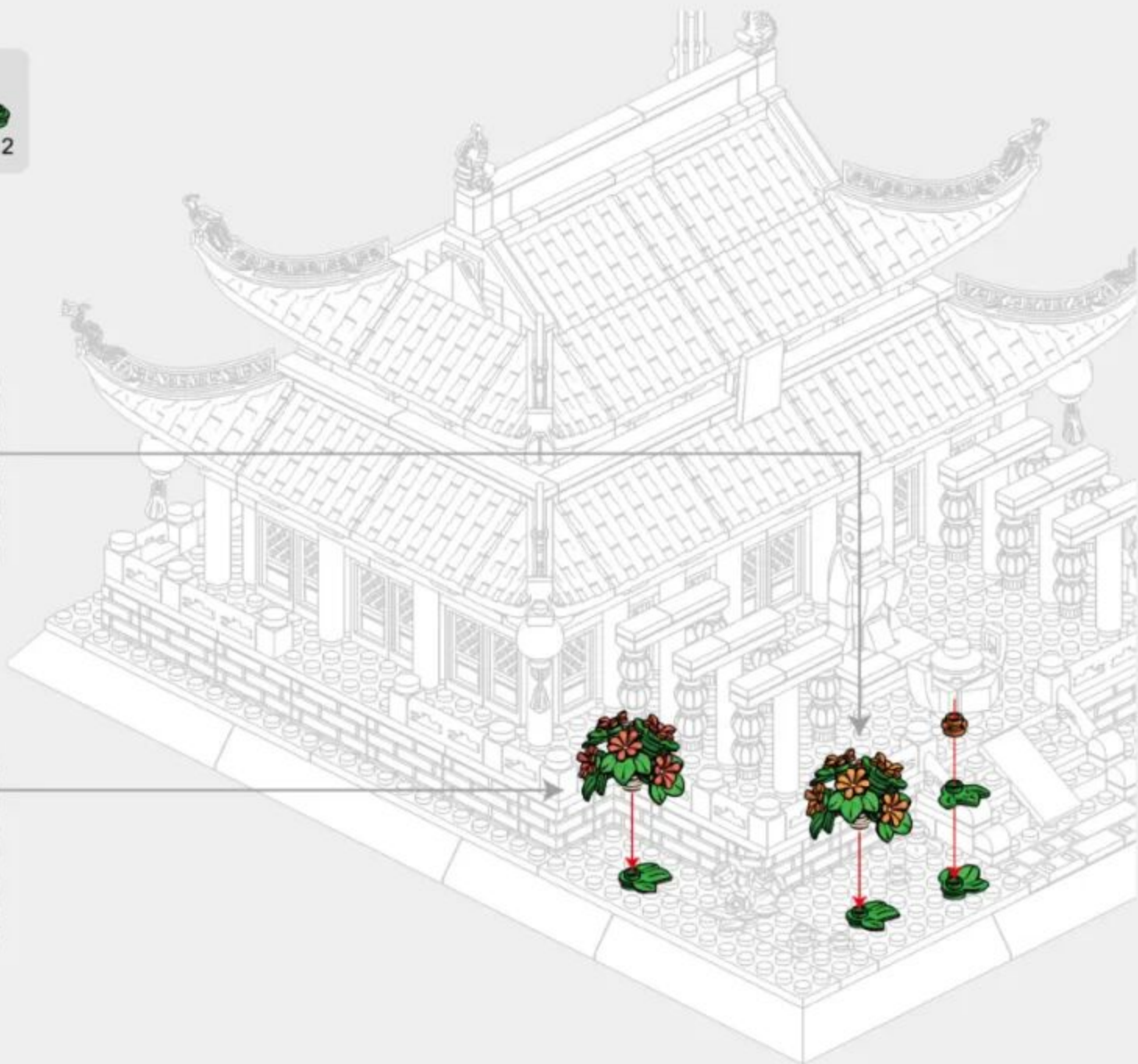
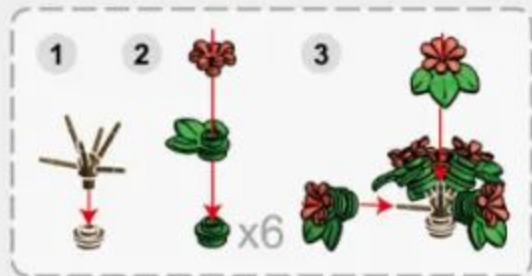
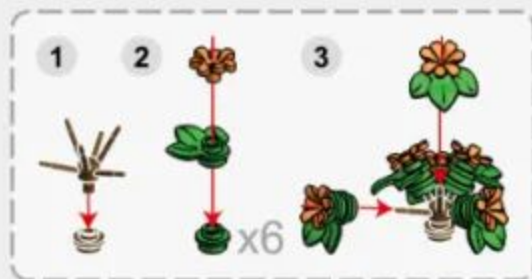

4-4

-  x3
-  x2
-  x2
-  x2

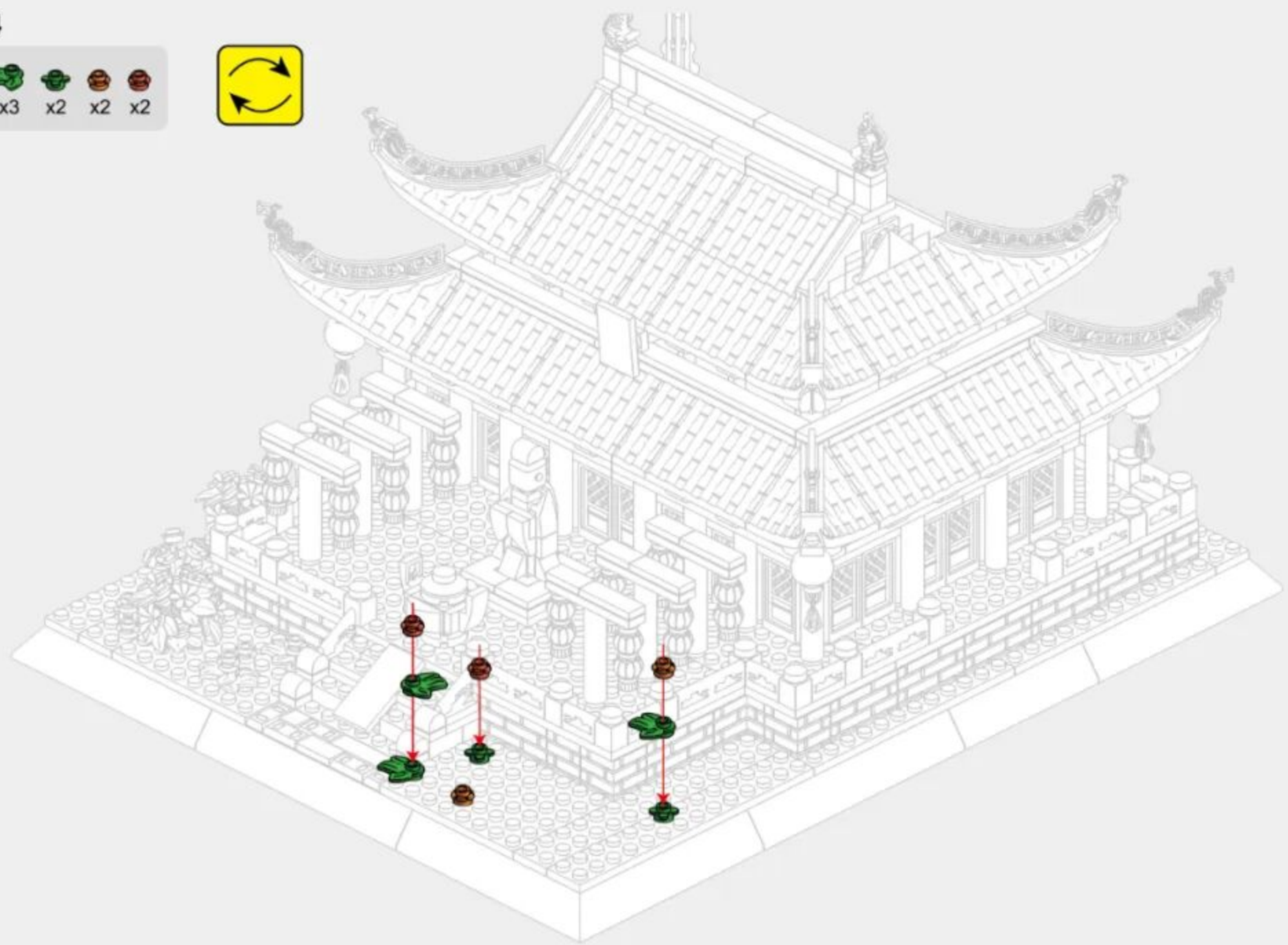

4-5

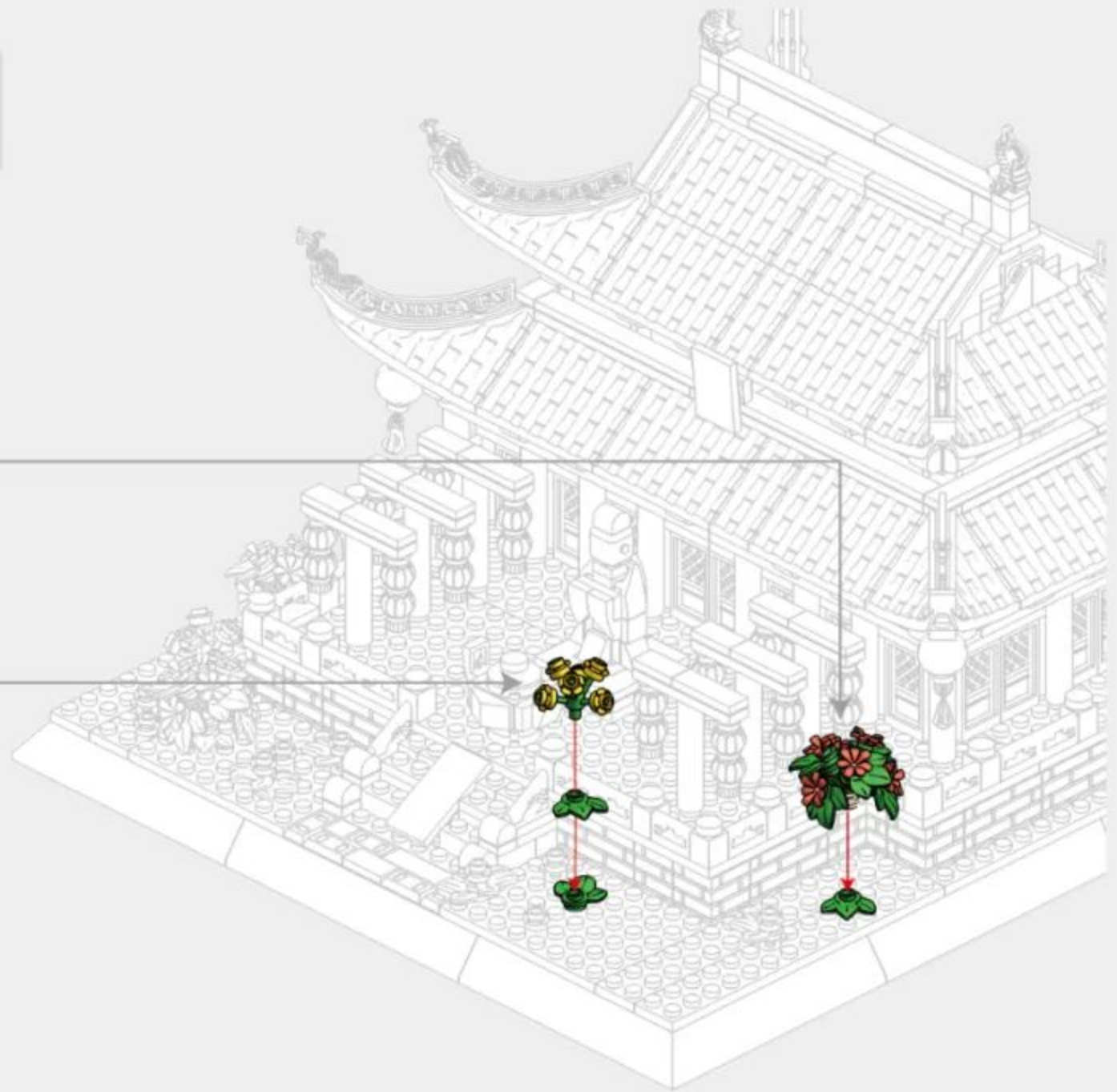
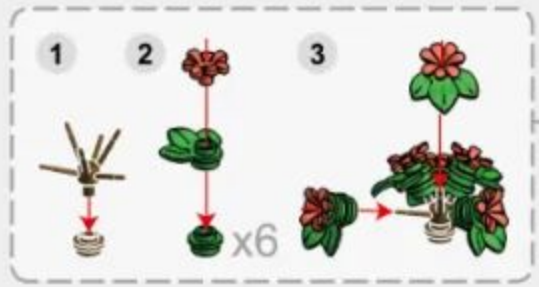

4-6



Vertical View of Installation Drawing
安装图顶面

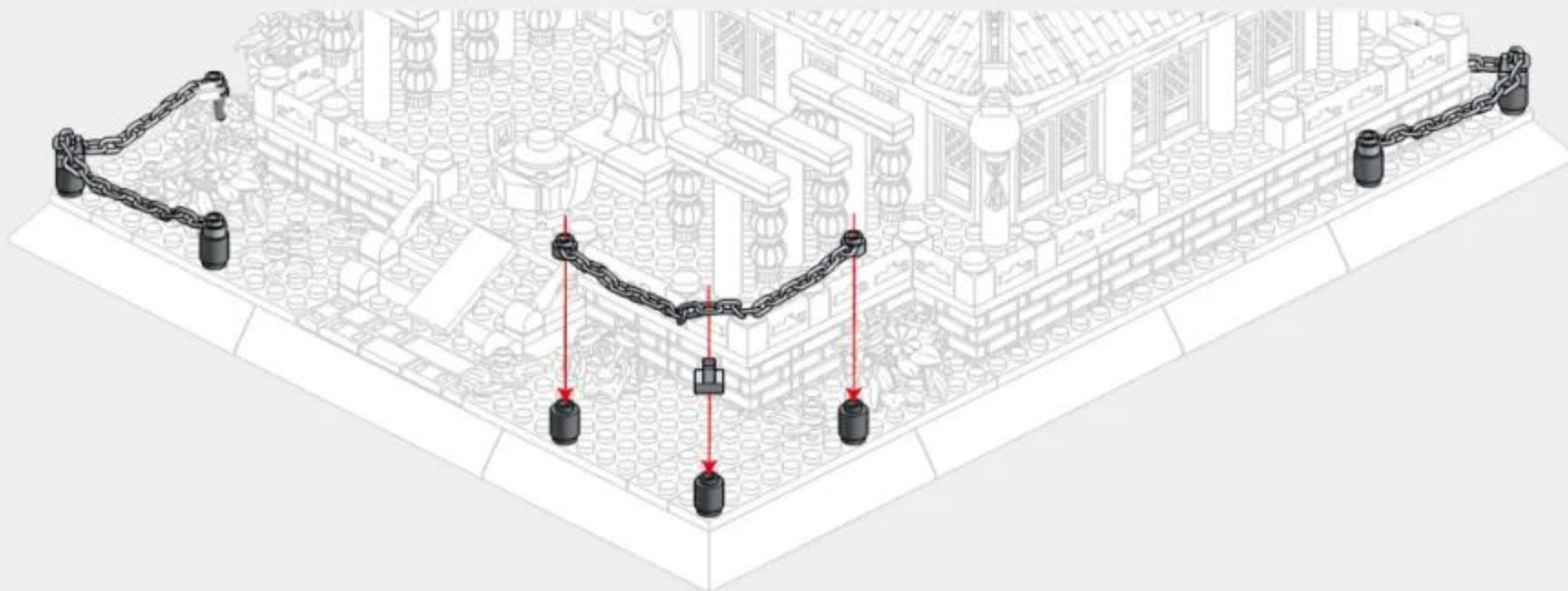
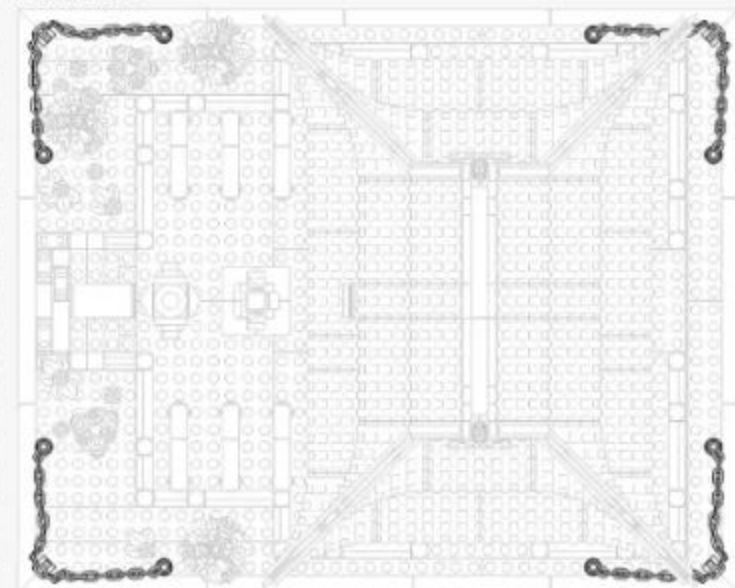

4-7

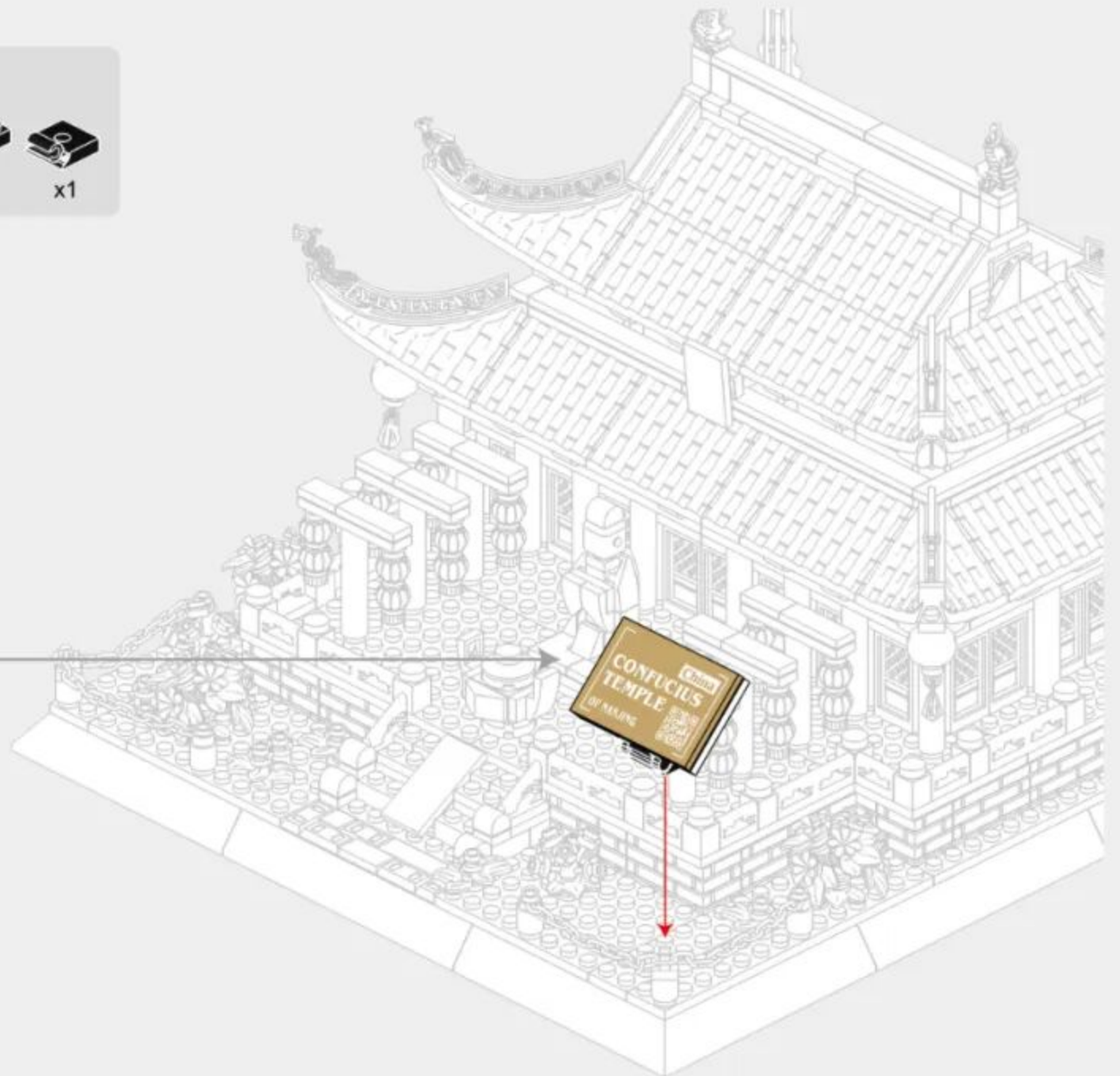
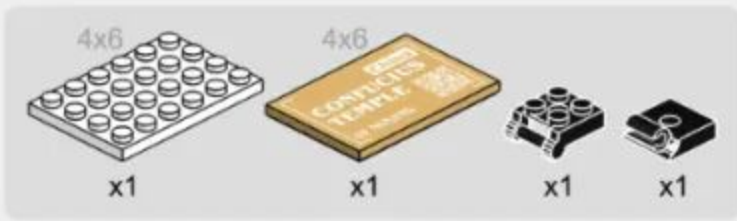



ARCHITECTURE

The World's great architecture



Shaping Skills



Imagination & Curiosity



Mathematical



Self Discovery & Perception



Parent-Child Interaction



Problem Solving



Creativity



6224 英国伦敦白金汉宫
BUCKINGHAM PALACE-LONDON,ENGLAND



5225 意大利罗马斗兽场
COLOSSEUM-ROME,ITALY



5226 日本东京帝国饭店
IMPERIAL HOTEL-TOKYO,JAPAN



5227 美国纽约自由女神像
STATUE OF LIBERTY-NEW YORK,AMERICA



6211 德国柏林勃兰登堡门
BRANDENBURG GATE-BERLIN, GERMANY



6222 中国甘肃长城-嘉峪关
JIAYU PASS-GANSU,CHINA



6212 日本京都清水寺仁王门
NIYON GATE OF KIYOMIZU-DERA-KYOTO,JAPAN



6213 俄罗斯莫斯科瓦西里大教堂
SAINT BASIL'S CATHEDRAL-MOSCOW,RUSSIA



6214 中国武汉黄鹤楼
YELLOW CRANE TOWER-WUHAN,CHINA



6215 英国伦敦眼
LONDON EYE-LONDON,ENGLAND



6221 中国北京故宫-太和殿
HALL OF SUPREME HARMONY-BEIJING,CHINA



6220 沙特阿拉伯麦加大清真寺
GREAT MOSQUE OF MECCA,SAUDI ARABIA



6219 美国纽约联合国大厦
UNITED NATIONS HEADQUARTERS-NEW YORK,AMERICA



4214 美国华盛顿白宫
WHITE HOUSE-WASHINGTON D.C.,AMERICA



4212 意大利罗马许愿池
TREV FOUNTAIN-ROME,ITALY



4213 法国巴黎卢浮宫
MUSÉE DU LOUVRE-PARIS,FRANCE

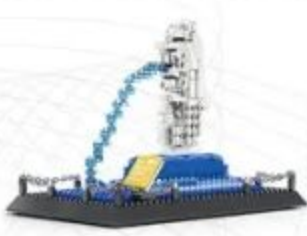

4218 新加坡-鱼尾狮
MERLION,SINGAPORE



4219 英国伦敦双子塔桥
TOWER BRIDGE-LONDON,ENGLAND



4216 美国华盛顿林肯纪念堂
LINCOLN MEMORIAL-WASHINGTON D.C.,AMERICA



4217 新加坡-金沙酒店
MARINA BAY SANDS,SINGAPORE



4210 埃及开罗吉萨金字塔
GREAT PYRAMID OF GIZA-CAIRO,EGYPT



4221 加拿大渥太华国会山庄
PARLIAMENT BUILDINGS-OTTAWA,CANADA



4211 英国伦敦伊丽莎白塔
ELIZABETH TOWER-ENGLAND



4215 加拿大多伦多电视塔
THE CN TOWER-CANADA



4220 美国纽约熨斗大厦
FLATIRON BUILDING-NEW YORK,AMERICA



4222 阿联酋迪拜哈利法塔 THE BURJ KHALIFA TOWER-DUBAI, UAE
 5224 中国上海东方明珠广播电视塔 ORIENTAL PEARL TOWER-SHANGHAI, CHINA
 5212 美国纽约帝国大厦 EMPIRE STATE BUILDING-NEW YORK, AMERICA
 5213 马来西亚吉隆坡石油双塔 PETRONAS TWIN TOWERS-KUALA LUMPUR, MALAYSIA
 5214 意大利托斯卡纳比萨斜塔 LEANING TOWER OF PISA-TUSCANY, ITALY
 5216 英国伦敦伊丽莎白白塔 ELIZABETH TOWER-LONDON, ENGLAND



5219 俄罗斯莫斯科克里姆林宫钟楼 SPASSKAYA TOWER-MOSCOW, RUSSIA
 5220 阿联酋迪拜卓美亚帆船酒店 BURJ AL ARAB HOTEL-DUBAI, UAE
 5217 法国巴黎埃菲尔铁塔 EIFFEL TOWER-PARIS, FRANCE
 5221 中国台北101大楼 TAIPEI 101-TAIPEI, CHINA
 5228 美国芝加哥威利斯大厦 WILLIS TOWER-CHICAGO, AMERICA
 5231 巴西里约热内卢救世基督像 CRISTO REDENTOR-RIO DE JANEIRO, BRASIL



6223 中国武汉长江大桥 WUHAN YANGTZE RIVER BRIDGE
 5210 法国巴黎圣母院大教堂 CATHÉDRALE NOTRE DAME DE PARIS-PARIS, FRANCE
 5211 印度阿格拉泰姬陵 TAJ MAHAL-AGRA, INDIA
 5223 法国巴黎凯旋门 ARC DE TRIOMPHE-PARIS, FRANCE
 5215 英国伦敦双子塔桥 TOWER BRIDGE-LONDON, ENGLAND



5222 中国北京天坛祈年殿 HALL OF PRAYER FOR GOOD HARVESTS-BEIJING, CHINA
 6210 美国旧金山金门大桥 GOLDEN GATE BRIDGE-SAN FRANCISCO, AMERICA
 6216 中国北京万里长城(八达岭) THE GREAT WALL-BEIJING, CHINA
 5218 中国北京天安门 TIANANMEN TOWER-BEIJING, CHINA
 6217 中国西藏布达拉宫 POTALA PALACE-TIBET, CHINA



6218 芬兰罗瓦涅米圣诞老人办公室 SANTA CLAUS OFFICE-ROVANIEMI, FINLAND
 6225 墨西哥库库尔坎玛雅金字塔 EL CASTILLO-KUKULKAN, MEXICO
 6226 德国巴伐利亚新天鹅堡 SCHLOSS NEUSCHWANSTEIN-BAYERN, DEUTSCHLAND
 5229 土耳其伊斯坦布尔少女塔 MAIDEN TOWER-ISTANBUL, TURKEY
 5230 中国湖南长沙爱晚亭 AIWANTING PAVILION-HUNAN, CHINA



7210 中国上海世博会中国馆
CHINA PAVILION AT EXPO-SHANGHAI, CHINA



5232 美国宾夕法尼亚州流水别墅
FALLINGWATER-PENNSYLVANIA, AMERICA



5233 美国芝加哥范斯沃斯住宅
FARNSWORTH HOUSE-CHICAGO, AMERICA



5234 美国华盛顿唐人街
CHINA TOWN-WASHINGTON, D.C., AMERICA



3210 美国纽约自由女神像
STATUE OF LIBERTY-NEW YORK, AMERICA



4223 中国北京清华园
TSINGHUA CAMPUS-BEIJING, CHINA



7211 中国湖南岳阳楼
YUEYANG TOWER-HUNAN, CHINA



8210 澳大利亚悉尼歌剧院
SYDNEY OPERA HOUSE-BENELONG POINT, AUSTRALIA



7212 中国江西南昌滕王阁
PAVILION OF PRINCE TENG-JIANGXI, CHINA



6227 中国河南郑州嵩山少林寺
SHAOLIN TEMPLE-HENAN, CHINA



7213 中国重庆洪崖洞
HONGYADONG-CHONGQING, CHINA



5235 美国华盛顿国会大厦
UNITED STATES CAPITOL-WASHINGTON D.C., AMERICA



5236 中国安徽滁州醉翁亭
ZUIWENG PAVILION-ANHUI, CHINA



6228 中国陕西西安钟楼
XIAN BELL TOWER-SHAANXI, CHINA



5238 美国西雅图太空针塔
SPACE NEEDLE-SEATTLE, AMERICA



5237 法国巴黎萨伏伊别墅
VILLA SAVOYE-PARIS, FRANCE



6229 中国山西运城鹳雀楼
STORK TOWER-SHANXI, CHINA



6230 希腊爱情海圣托里尼岛
SANTORINI-FIRA, GREECE



6231 中国上海海关大楼
SHANGHAI CUSTOMS HOUSE-SHANGHAI, CHINA



5239 中国北京紫禁城角楼
TURRET OF PALACE MUSEUM-BEIJING, CHINA



5240 韩国首尔崇礼门
NAMDAEMUN-SEOUL, KOREA



5241 中国江苏南京夫子庙
CONFUCIUS TEMPLE-JIANGSU, CHINA



5242 美国纽约古根海姆博物馆
GUGGENHEIM MUSEUM-NEW YORK, AMERICA

CONFUCIUS TEMPLE

COUNTRY: China
CITY: Nanjing

