



# GIANT WILD GOOSE PAGODA

中国陕西西安大雁塔

Shaanxi, China

The world's great architecture



Creative Ability



Family Interaction



Observation Ability



Handing Ability



Problem Ability



6+  
Minimum Age

5247  
Product Number

672 PCS  
Parts Total



# Architecture

It will be a city...

这将构成一座城市...

# ABOUT THE PRODUCT

关于产品

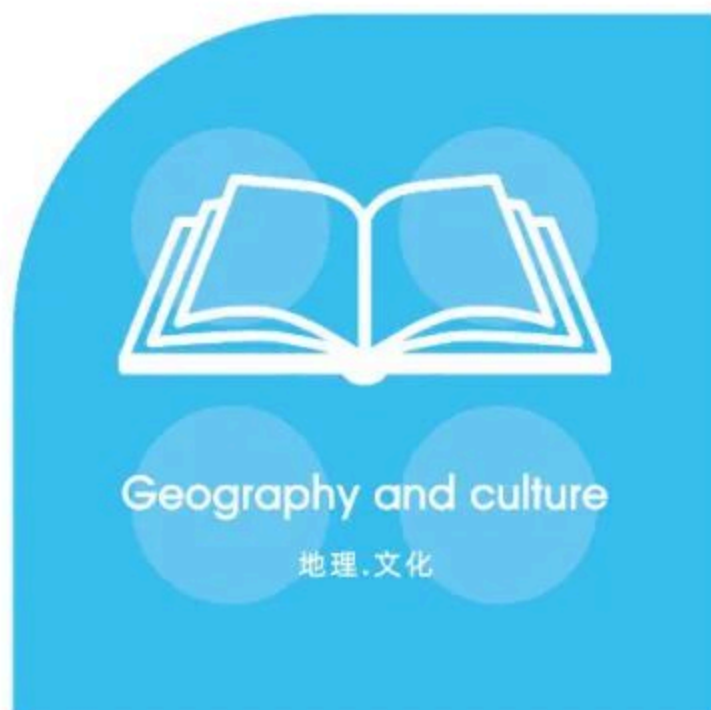

## ARCHITECTURE

WANGE The world's great architect since 1991

# Giant Wild Goose Pagoda



Giant Wild Goose Pagoda, is a monumental Buddhist pagoda located in southern Xi'an, Shaanxi, China.

# Giant Wild Goose Pagoda



Geography and culture

地理·文化



This pagoda was added to the World Heritage List, along with many other sites along the Silk Road, as part of the "Silk Roads: the Routes Network of Chang'an-Tianshan Corridor" site in 2014.





中国陕西西安大雁塔

# Giant Wild Goose Pagoda

China

The contents of this chapter refer to the Wikipedia website.

本章内容参考维基百科网站，  
更多资讯可自行查阅。

The world's great architecture

# Buildings and layout

■ 建筑物和布局



**大雁塔**位于唐长安城晋昌坊（今陕西省西安市南）的大慈恩寺内，又名“慈恩寺塔”。唐永徽三年（652年），玄奘为保存由天竺经丝绸之路带回长安的经卷佛像主持修建了大雁塔，最初五层，后加盖至九层，再后层数和高度又有数次变更，最后固定为所看到的七层塔身，通高64.517米，底层边长25.5米。1961年3月4日，国务院公布大雁塔为第一批全国重点文物保护单位。2014年6月22日，在卡塔尔多哈召开的联合国教科文组织第38届世界遗产委员会会议上，大雁塔作为中华人民共和国、哈萨克斯坦和吉尔吉斯斯坦三国联合申遗的“丝绸之路：长安-天山廊道的路网”中的一处遗址点成功列入《世界遗产名录》。

Giant Wild Goose Pagoda, was built during the reign of Emperor Gaozong of Tang (r. 649–683), then standing at a height of 60 metres (200 ft). This construction of rammed earth with a stone exterior facade collapsed five decades later. The ruling Empress Wu Zetian had the pagoda rebuilt and added five new stories by the year 704. A massive earthquake in 1556 heavily damaged the pagoda and reduced it by three stories, to its current height of seven stories.

One of the pagoda's many functions was to hold sutras and figurines of Gautama Buddha that were brought to China from India by the seventh-century Buddhist monk, scholar, traveller, and translator Xuanzang. Today, the interior walls of the pagoda feature engraved statues of Buddha by the renowned 7th-century artist Yan Liben.



## History

北魏道武帝时在此建净觉寺，隋文帝在净觉寺故址修建无漏寺，后废。唐贞观二十二年（648年），太子李治为追念其生母文德皇后（即长孙氏）祈求冥福，报答慈母恩德，奏请太宗敕建佛寺，赐名“慈恩寺”。

寺建成之初，迎请高僧玄奘担任上座法师，玄奘于此创立了大乘佛教法相宗，此寺遂成中国大乘佛教的圣地。

唐显庆元年（656年），唐高宗御书《大慈恩寺碑记》，从此寺名为“大慈恩寺”。大雁塔坐落在慈恩寺内，故又名“慈恩寺塔”。

新建佛塔名雁塔，由于后来在长安荐福寺内修建了一座较小的雁塔，因此慈恩寺塔又被称为叫作大雁塔，荐福寺塔称为小雁塔，一直流传至今。

除了保存从天竺取回的贝多罗树叶梵文经，大雁塔内还存有舍利子万余颗。

The tower sits inside the Daci'en Temple complex ("mercy and kindness"). The Daci'en Temple was built in 648 to honor the Empress Zhangsun.

The pagoda currently stands at a height of 64 metres (210 ft) tall and from the top it offers views over the city of Xi'an.



## Architectural features

大雁塔是砖仿木结构的四方形楼阁式塔，由塔基、塔身、塔刹三部分组成。全塔通高64.7米，塔基高4.2米，南北长约48.7米，东西长约45.7米；塔身底层边长25.5米，呈方锥形；塔刹高4.87米。1、2两层有9间，3、4两层有7间，5、6、7、8层有五间，每层四面均有券门。

大雁塔基座皆有石门，门楣门框上均有精美的线刻佛像及砖雕对联。底层南门洞两侧嵌置碑石，西龛是由右向左书写，唐太宗李世民亲自撰文、时任中书令的大书法家褚遂良手书的《大唐三藏圣教序》碑，东龛是由左向右书写，唐高宗李治撰文、褚遂良手书的《大唐三藏圣教序记》碑，人称“二圣三绝碑”。两碑规格形式相同，碑头为蟠螭圆首，碑身两边线有明显收分，呈上窄下宽的梯形（此为唐碑典型形制），碑座为有线刻图案的方形碑座，两碑通高337.5厘米，碑面上宽86厘米，下宽100厘米。碑文高度赞扬玄奘法师西天取经，弘扬佛法的历史功绩和非凡精神，世称《雁塔圣教》。

在唐代，新进士及第后，有大唐天子于杏园赐宴，于曲江聚会饮酒，慈恩塔下题名等风俗活动，这就是人们常说的“曲江流饮”和“雁塔题名”。进入南门，洞壁两侧镶嵌有多通明代题名碑，其中“名题雁塔，天地间第一流人第一等事也”，乃当时“雁塔”之风光写照。此外，还有描写玄奘辉煌一生的《玄奘负笈像碑》、《玄奘译经图碑》。在塔内一层通天明柱之上，悬挂着四幅长联，写的是唐代的历史、人物、故事。

大雁塔作为现存最早、规模最大的唐代四方楼阁式砖塔，是佛塔这种古印度佛寺的建筑形式随佛教传入中原地区，并融入华夏文化的典型物证，是凝聚了中国古代劳动人民智慧结晶的标志性建筑。

大雁塔最初仿西域窠堵坡形制，砖面土心，不可攀登，每层皆存舍利，由玄奘法师亲自主持修建。而后经历代改建、修缮，逐渐由原西域窠堵坡形制逐渐演变成具有中原建筑特点的砖仿木结构，成为可登临的楼阁式塔。这一过程生动地体现了古印度佛教建筑艺术传入中国并逐渐的中国化的过程。大雁塔是唐长安城保留至今的标志之一。

# Force Balance

受力平衡

Physical operations

物理运算



$$F = G \frac{m_1 m_2}{d^2}$$



Creation and thinking

创作·思考

08

$$S=4\pi \cdot r^2$$

# Special parts

$$a^2+b^2=c^2$$

特殊零件的开发利用



**WG1270**

小拱形2高窗框

**WG1544**

2孔小瓦片

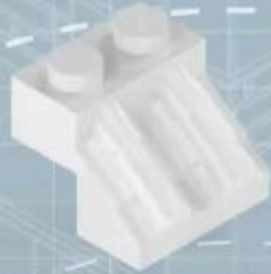

**WG1431**

半椭圆罩1孔



**WG1449**

大圆珠



**WG1504**

带孔小角瓦片



**WG1316**

2高4孔墙砖



**WG1317**

直角墙砖



$$\sin^2 a + \cos^2 a = 1$$

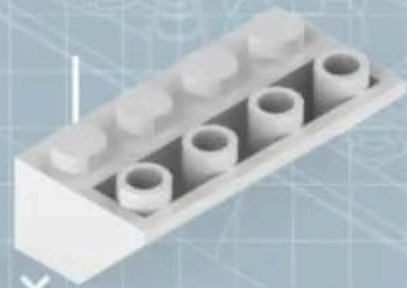

**WG1436**

反斜2X4孔

**WG1529**

斜4柱反3X4孔



features and functions

特点.功能

# Main Color Matching

配色方案



Pantone 7620C



Pantone 1575C



Pantone 723C



Pantone 123C



Pantone 7500C



Pantone 473C



Pantone 218C



Pantone 7671C



Pantone 285C



Pantone 477C



Pantone 348C



Pantone 2422C



Pantone Black 6C



Pantone 431C



Pantone Cool Gray 6C

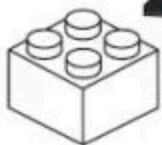

White



## Color matching

Adopting 2 main colors, Tan and Dark Gray as the main color, the more reasonable and Dark green and Light Gray color matching on the original building, making the product more atmospheric and the whole design is more reasonable.

# Giant Wild Goose Pagoda

中国陕西西安大雁塔



Front

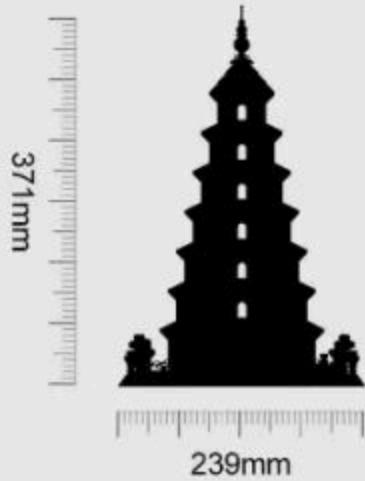

Left

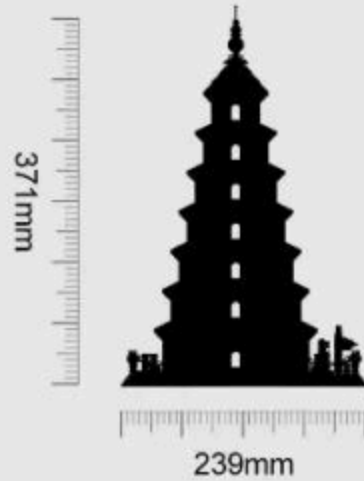

Back

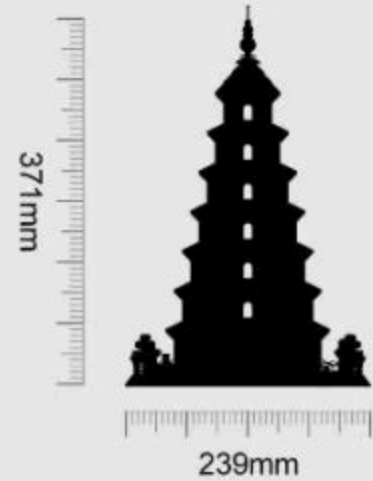

Product Size:239X239X371mm



# Building Blocks

拼装小技巧

小提示：积木包分为底板包、整版配件包及普通配件包,底板包标识为A/B/C...,普通配件包编码与说明书对应,整版配件包无标识。

Tip: Building block packs are divided into baseplate packs, runner accessory packs, and standard accessory packs. Baseplate packs are labeled A/B/C..., regular accessory packs have codes that correspond to the instructions, and runner accessory packs have no labels.



- Open the product packaging correctly and classify the building block packs by type.

用正确方式拆解产品外包装,按积木包类型进行分类。



- Confirm the quantity of building block packs and cross-check them with the pack identifiers and the instructions.

确认积木包数量, 对照积木包标识和说明书步骤。



- Open the building block packs according to the pack identifier steps. Sort them in order by type and color for easier assembly.

按积木包标识步骤拆开积木包,按顺序以类型、颜色进行分类以便搭建。



- Assemble your building block model following the steps in the instruction manual.

按说明书步骤拼装并完成你的积木模型。



INSTALLATION  
TIPS

# 1:1 Physical Reference Table

十字棒配件1:1尺寸参照表



Instructions For Use

让安装更简单



**2**  $(1 \times 2) = 2$



**3**  $(1 \times 3) = 3$



**4**  $(1 \times 4) = 4$



**5**  $(1 \times 5) = 5$



**6**  $(1 \times 6) = 6$



**7**  $(1 \times 7) = 7$



**8**  $(1 \times 8) = 8$



**9**  $(1 \times 9) = 9$



**10**  $(1 \times 10) = 10$



**12**  $(1 \times 12) = 12$



**16**  $(1 \times 16) = 16$



# PARTS LIST

配件清单



x4



x3

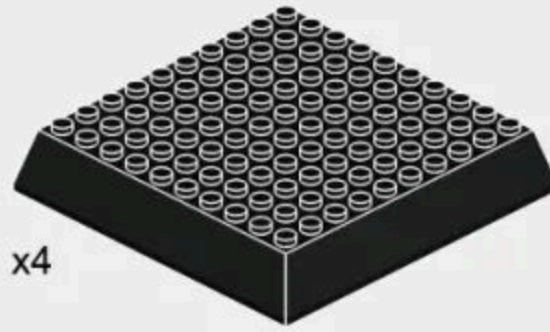

x4



x2

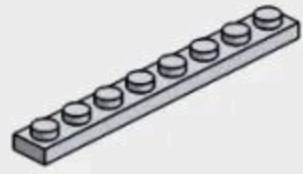

x2



x1



x2

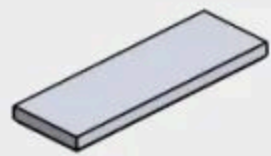

x9



x7

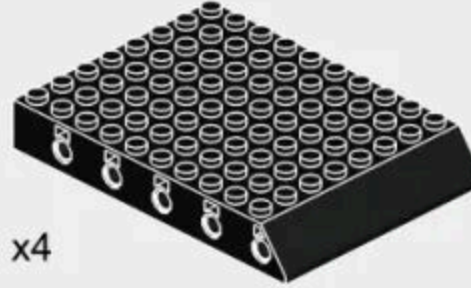

x4



x1

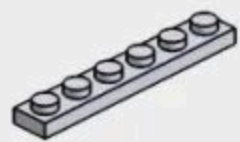

x2

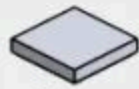

x6

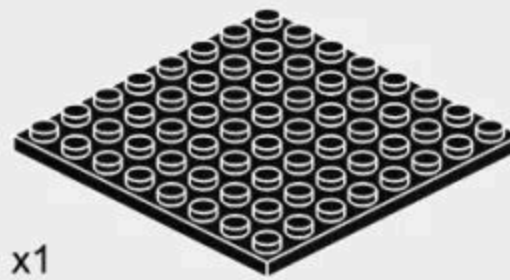

x1



x1



x17



x7



x6

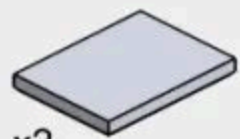

x2



x6



x2



x1

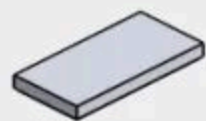

x3



x2



x2



x24



x8



x2



x6



x2



x1



x4



x2



x7



x14

产品有增补件请以实物为准

If product has additional parts, please in kind prevail.

# PARTS LIST

配件清单

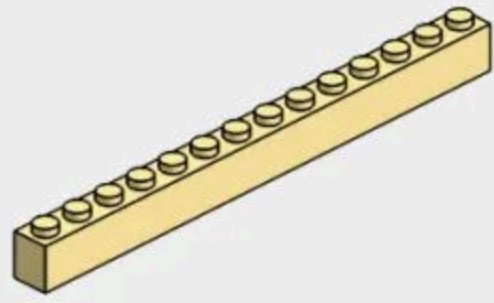

x4



x30

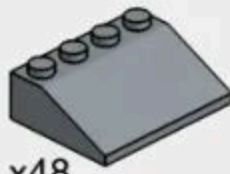

x48



x2



x2



x1



x28



x1



x4



x8



x2



x1



x64



x4



x2



x1



x24



x16



x1



x1



x28



x10



x12



x4



x1



x3



x1



x1



x1



x12

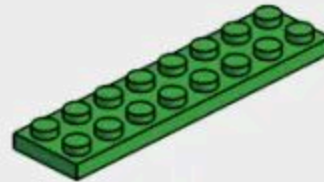

x1



x1



x1



x1



x28



x1



x1



x4



x36



x1



x12



x2



x1



x7



x8



x1



x4



x36



x2



x16



x12



x1



x12



x2

产品有增补件请以实物为准

If product has additional parts, please in kind prevail.



282PCS



1-1

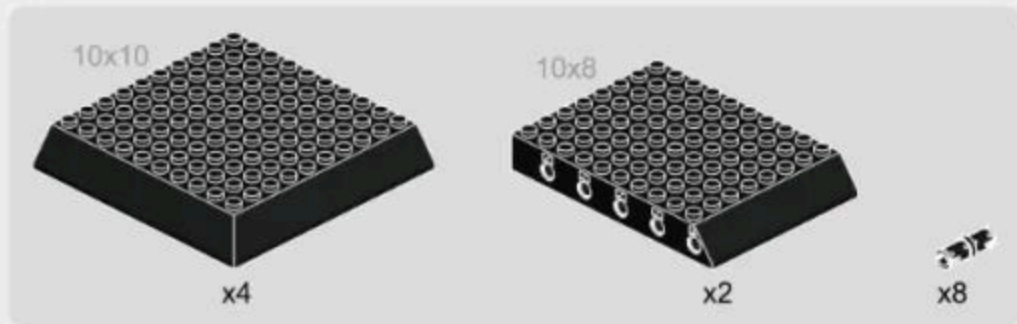

微信扫一扫  
补件更简单

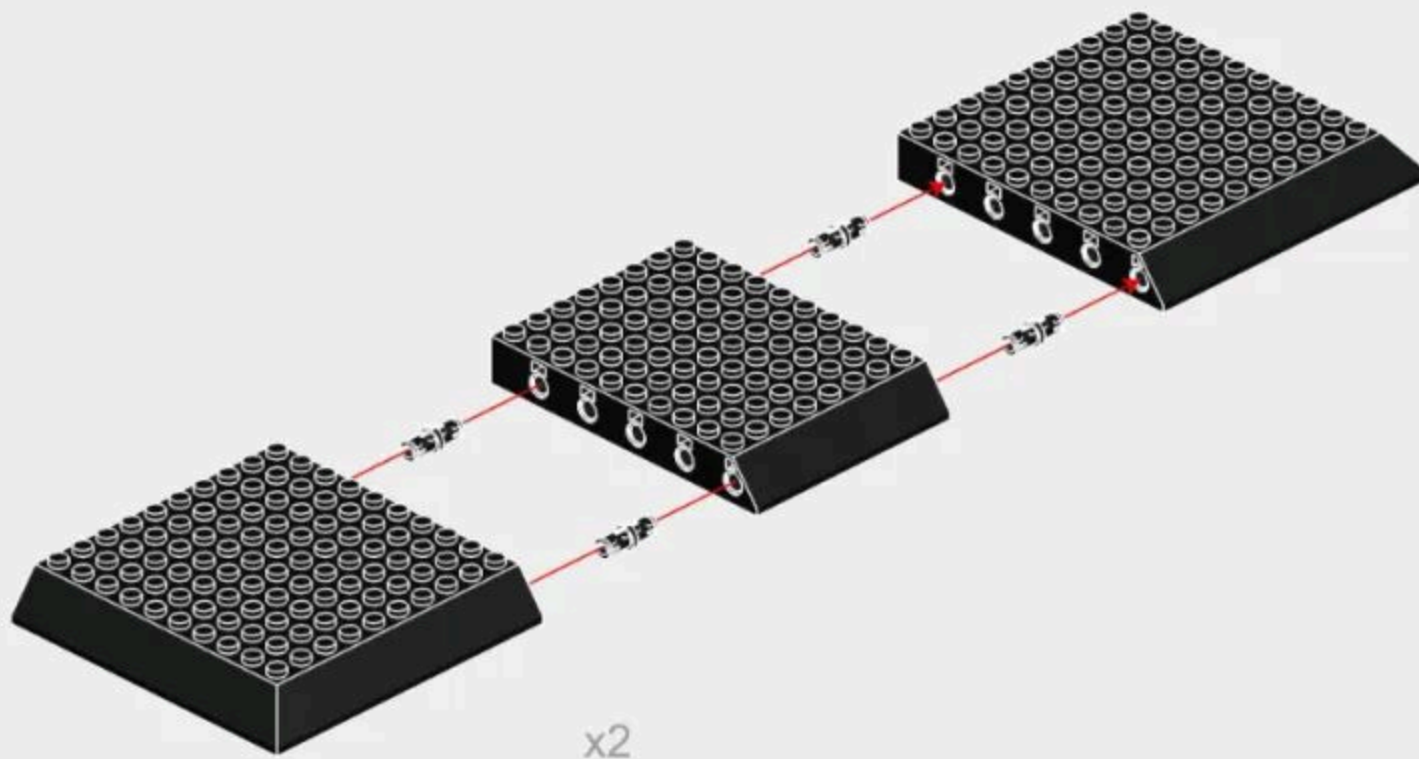

1-2



1-3

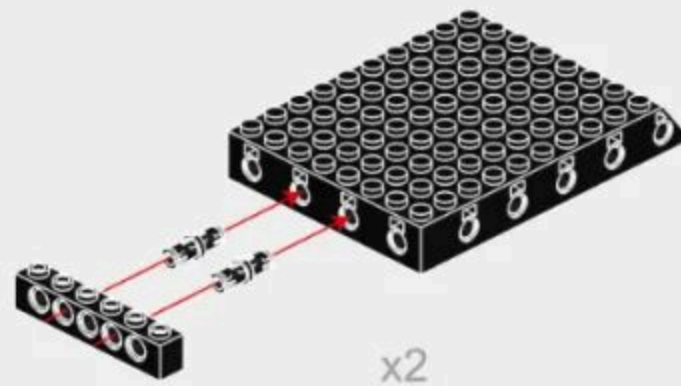
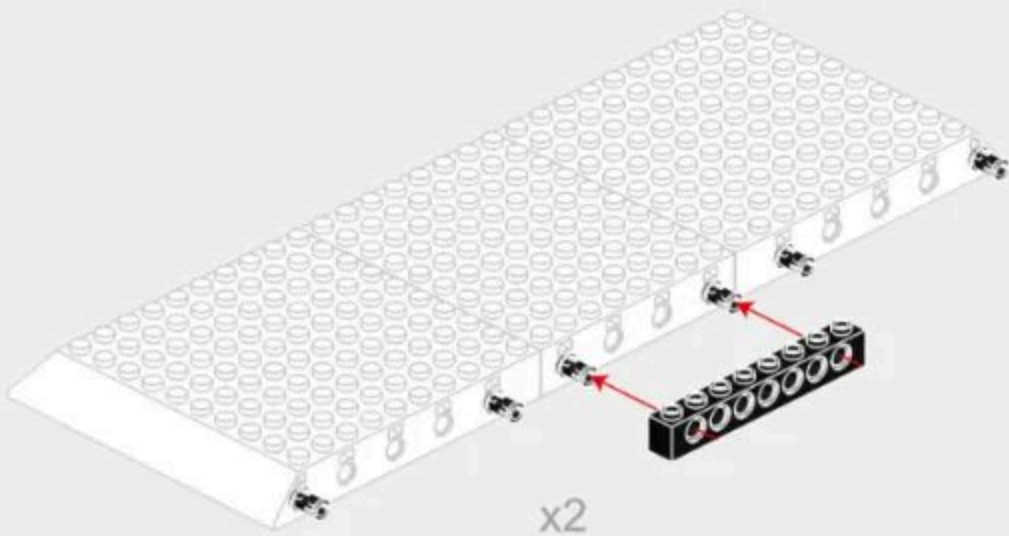
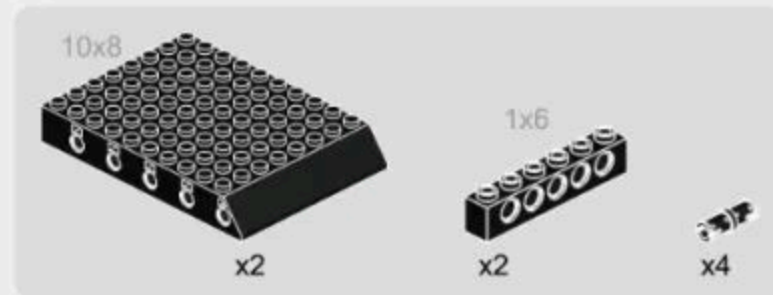

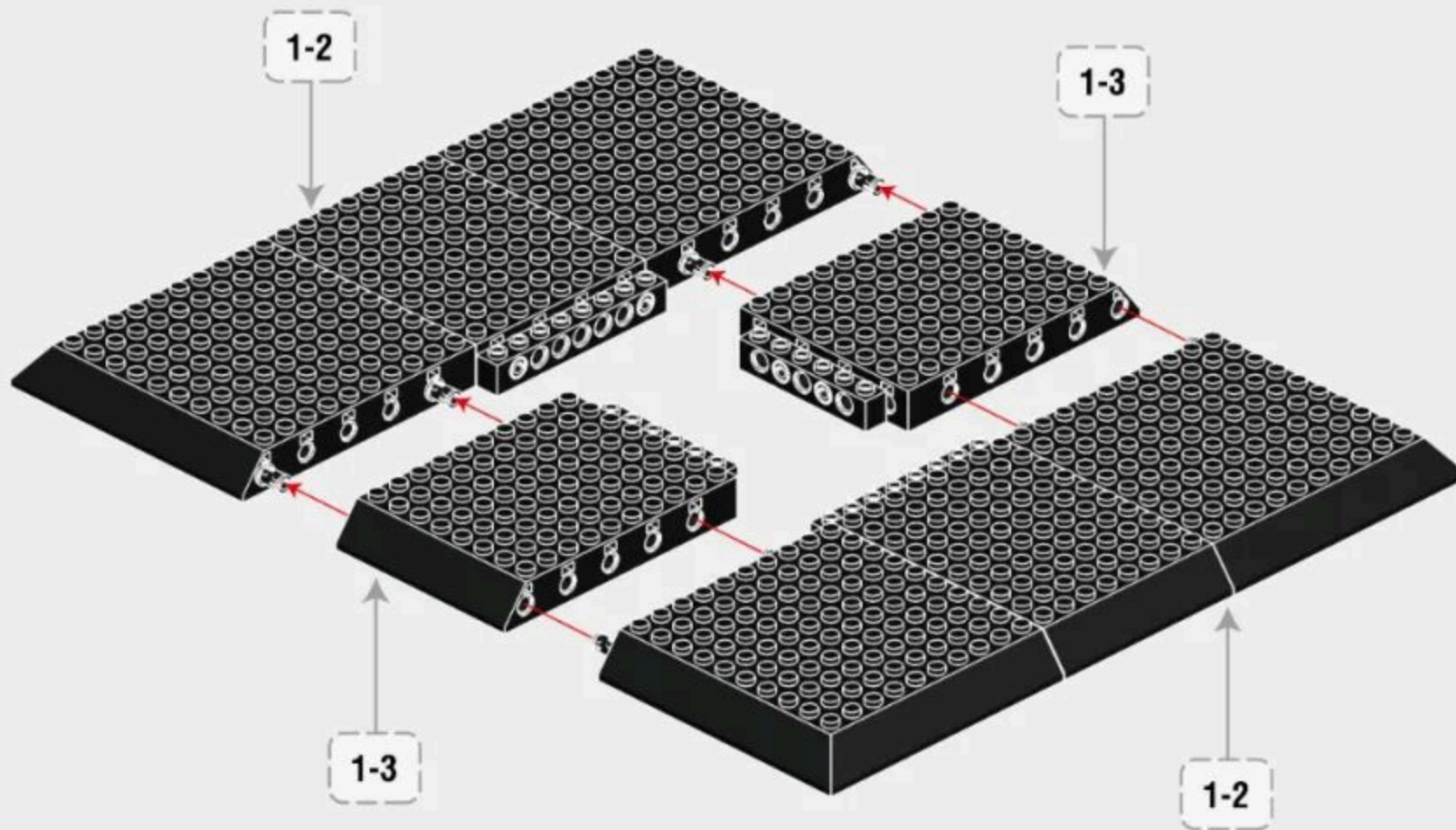

1-5

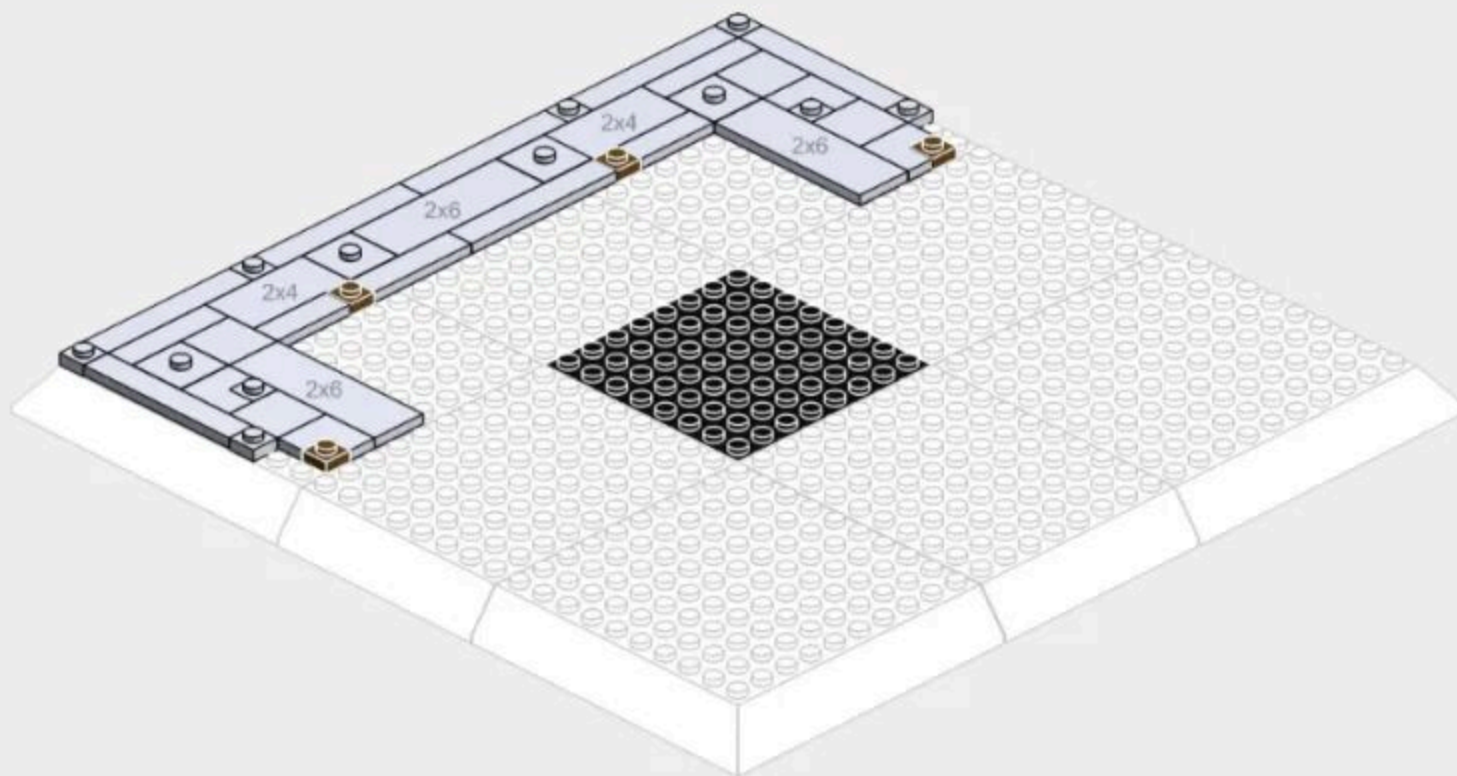
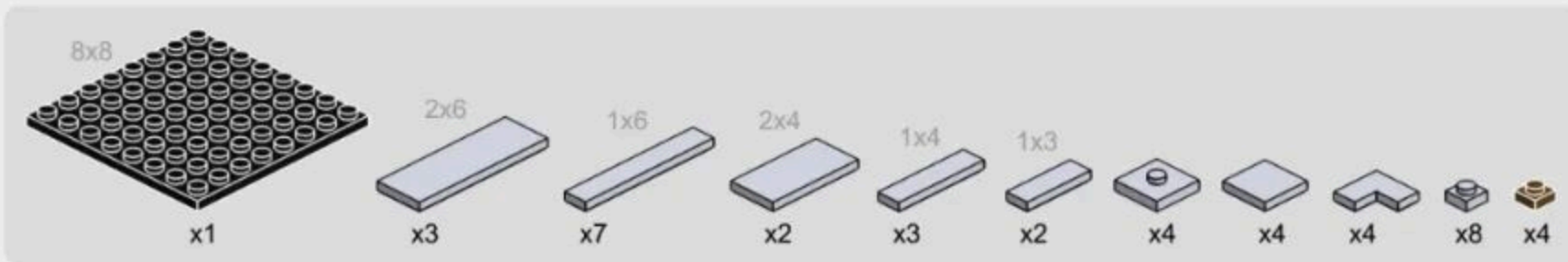

1-6

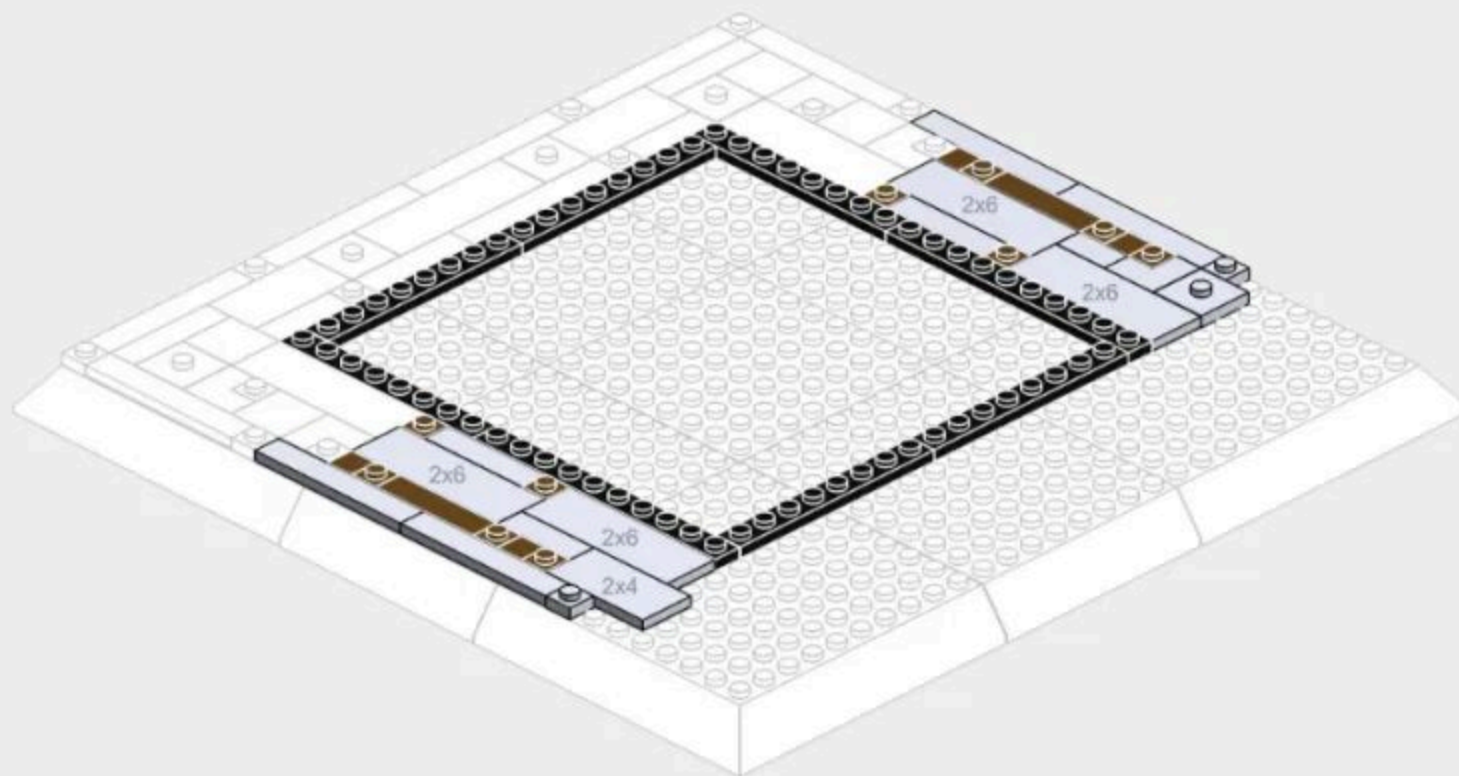
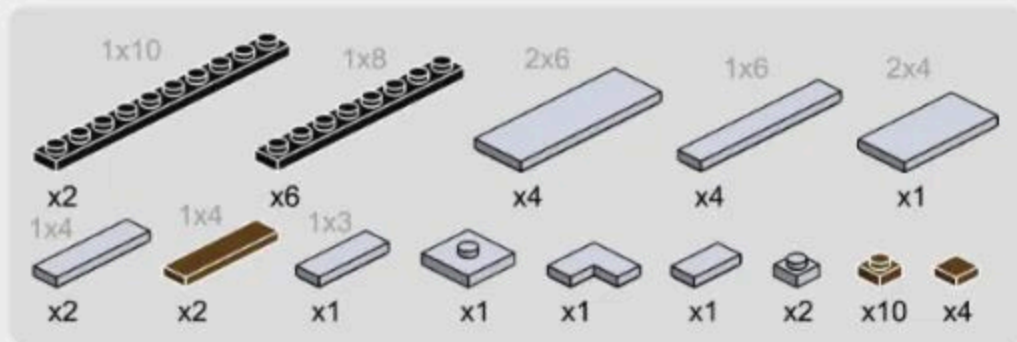

1-7

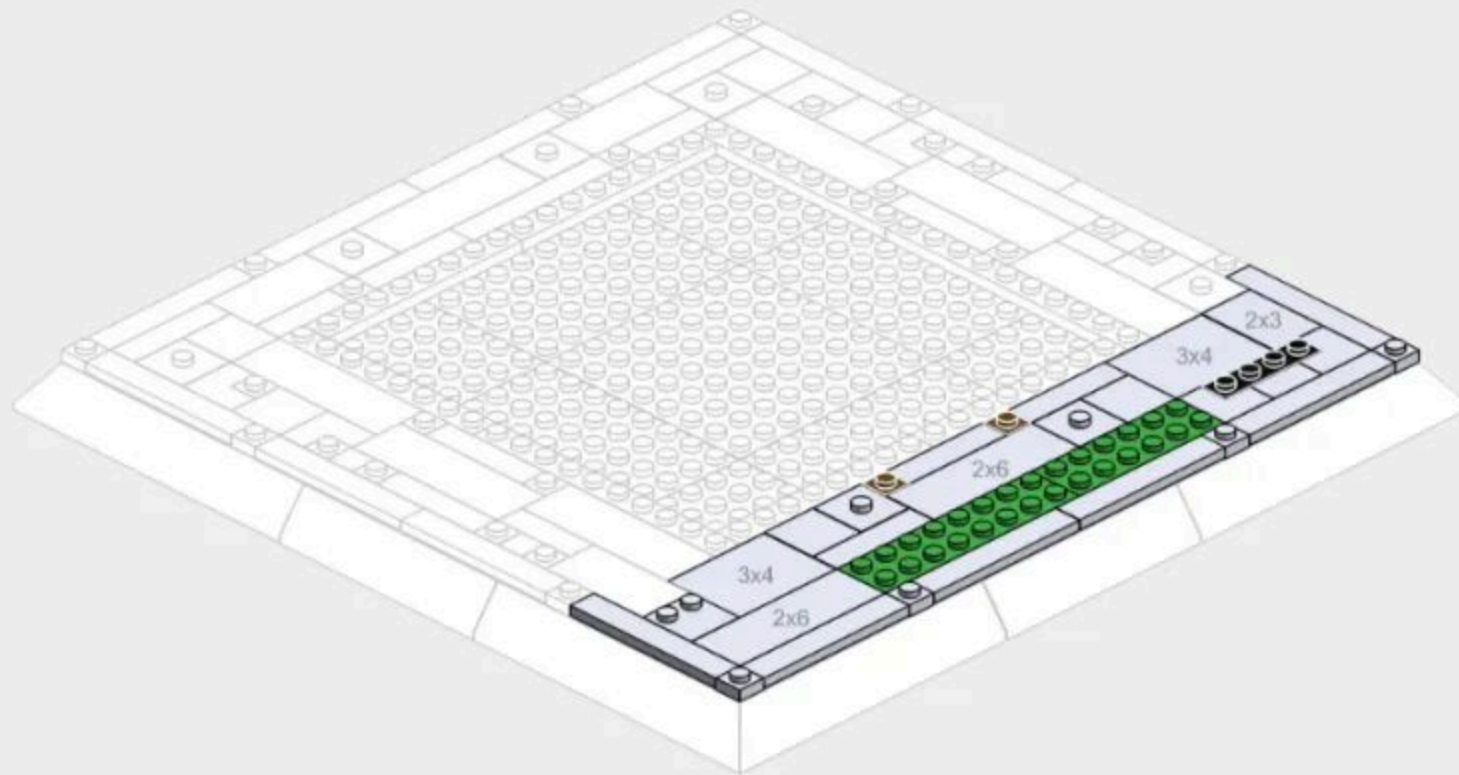
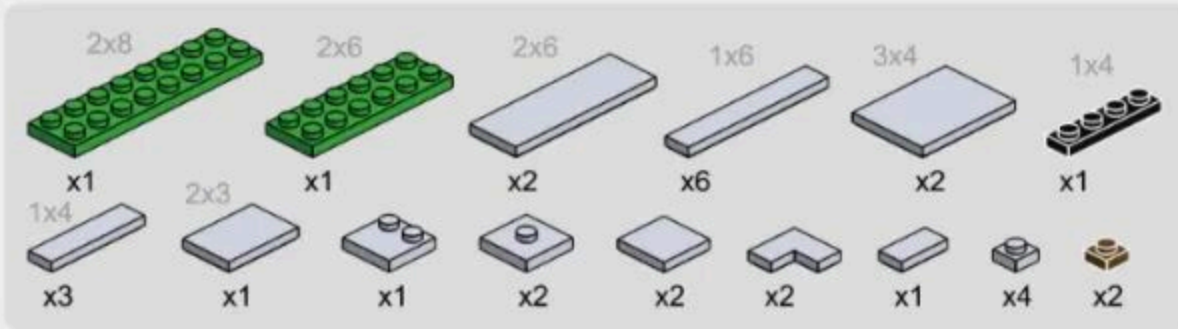

1-8



x12



x6



x2



x4

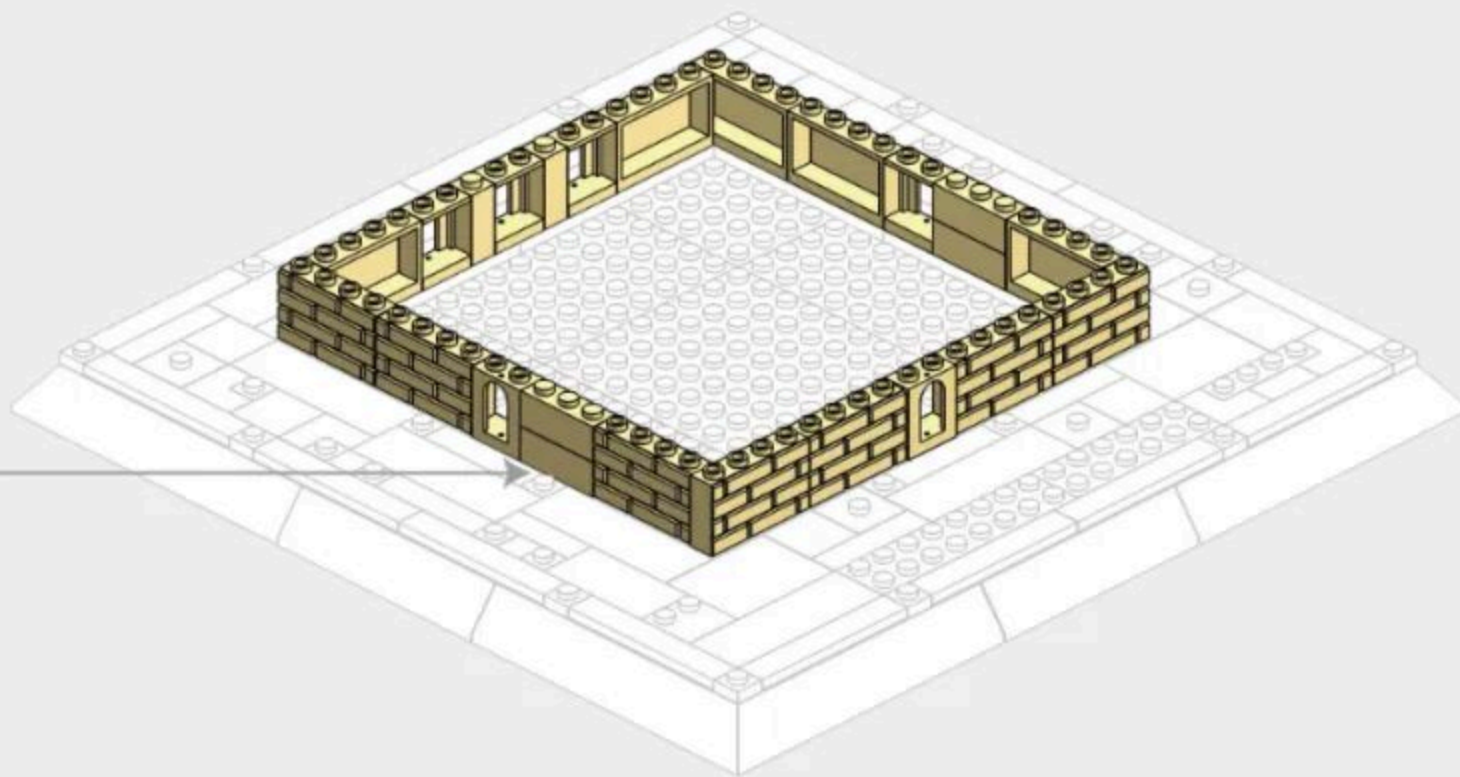
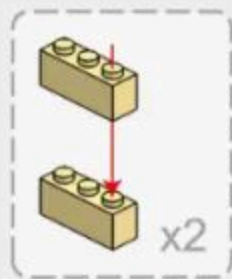
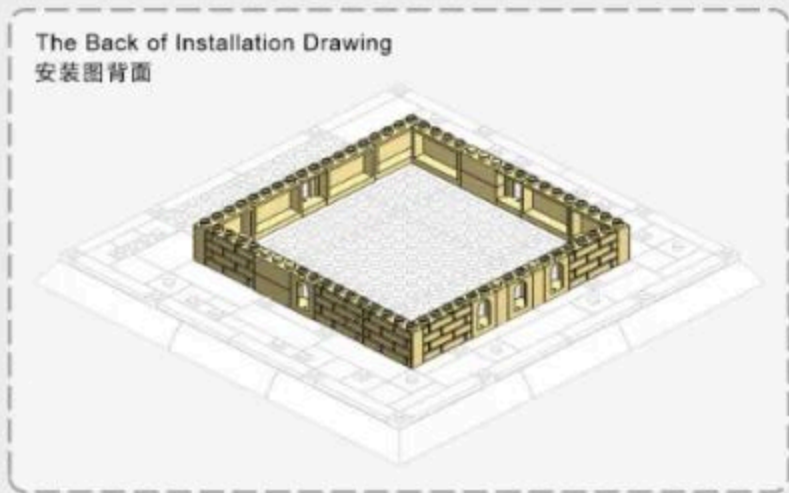

1-9

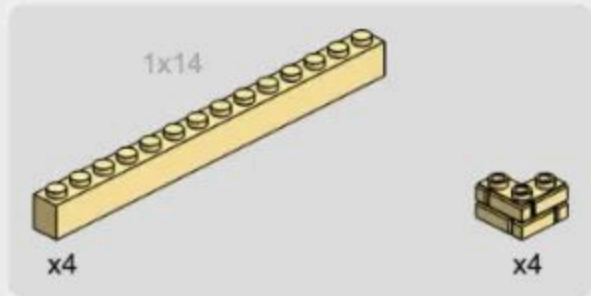

1-10

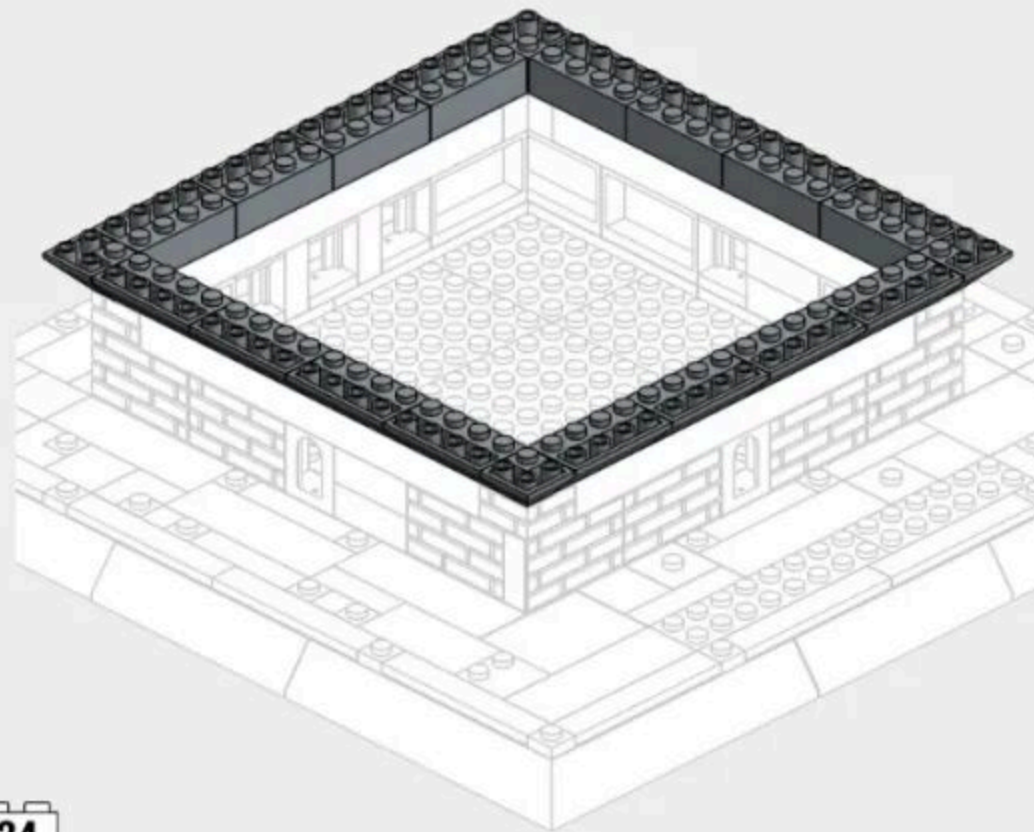
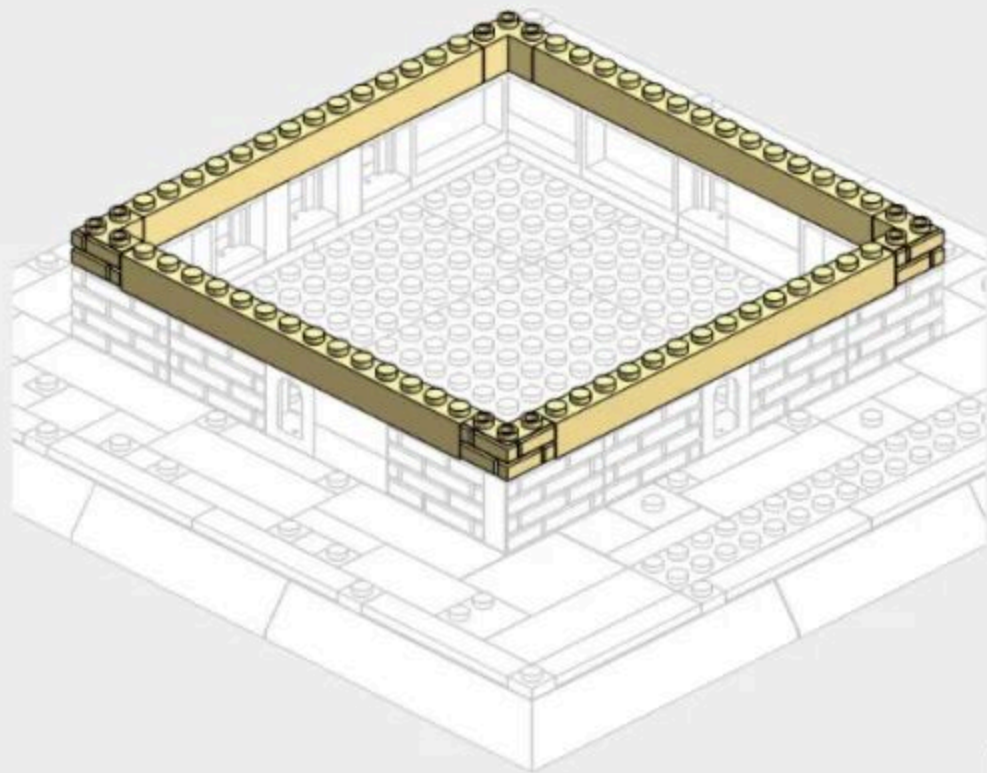

1-11

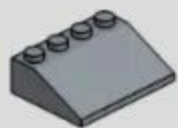

x12



x4



x4

1-12



x8



x4



x4



x8

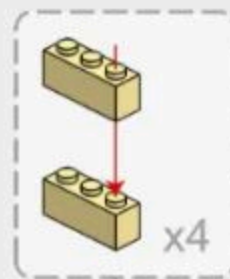

x4

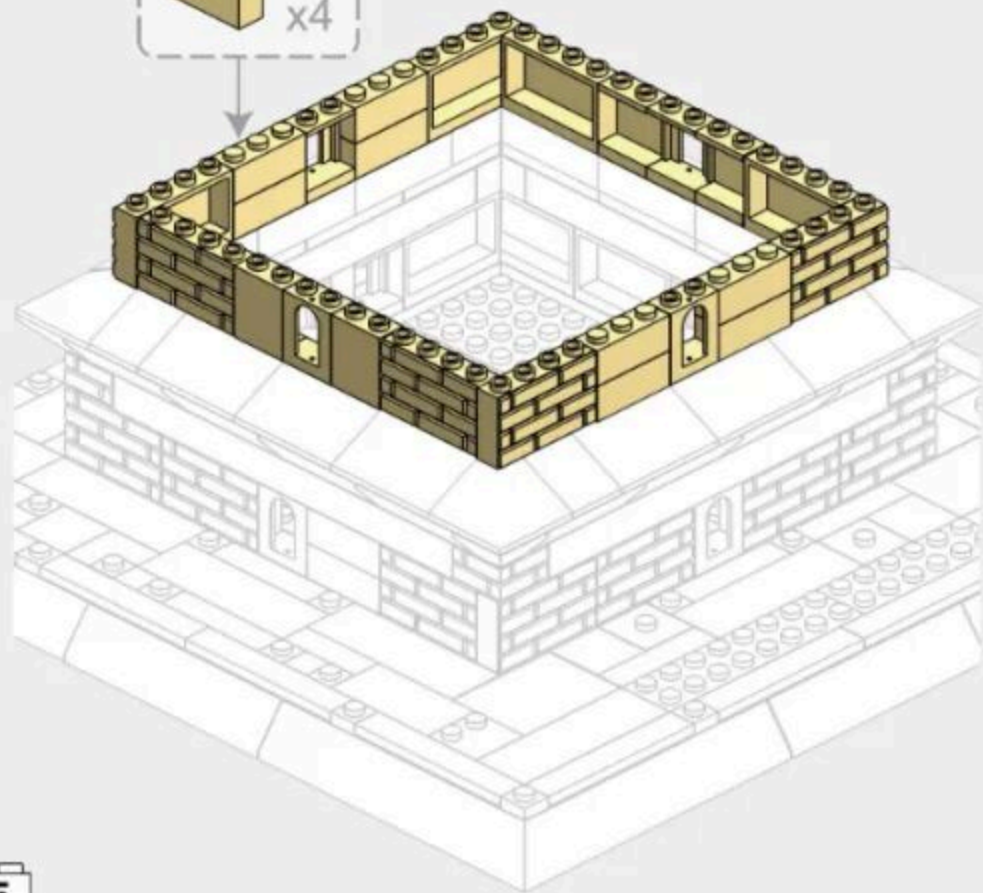
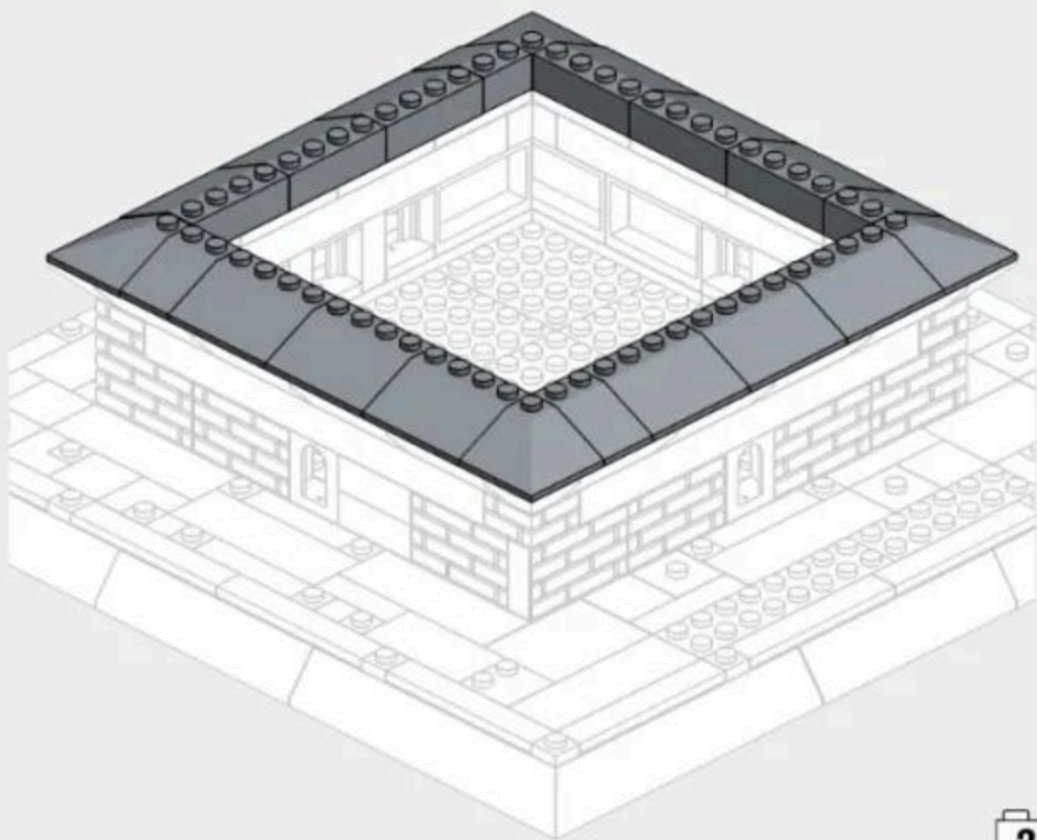

1-13



x12



x4



x4

1-14

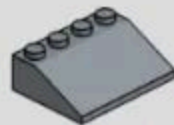

x12



x4

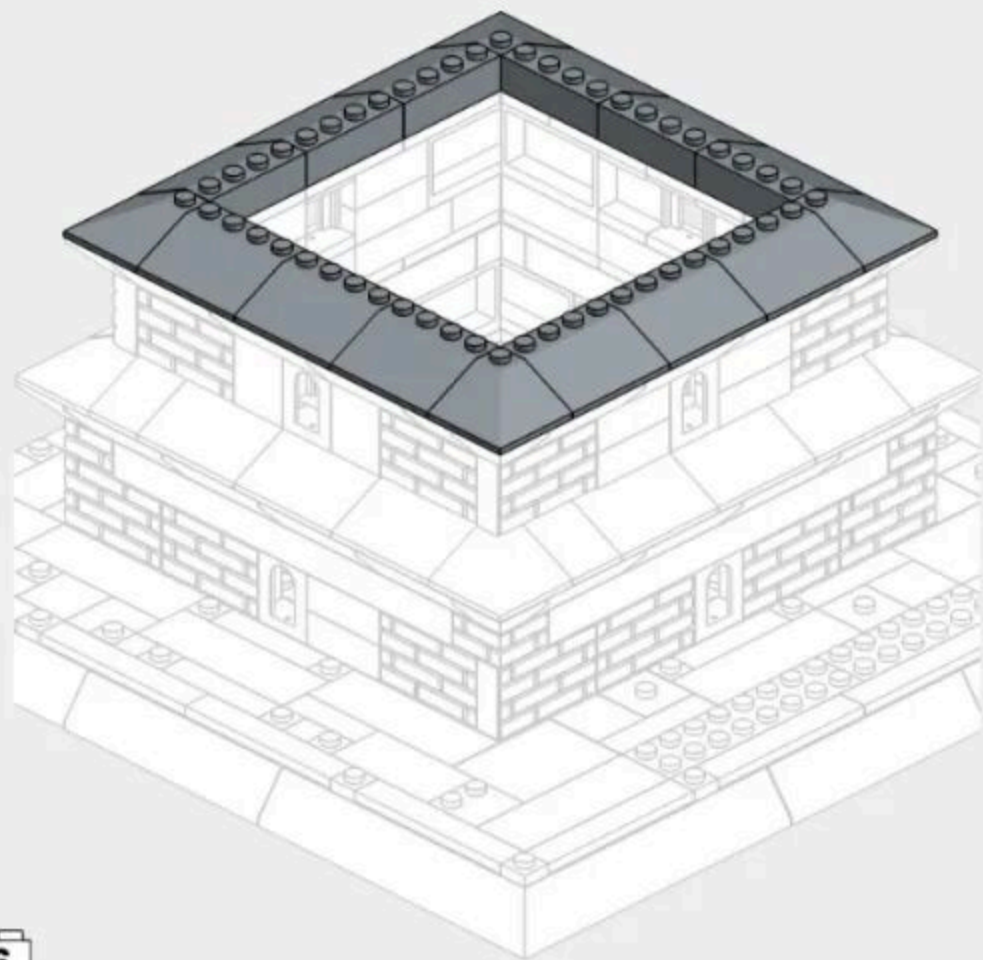
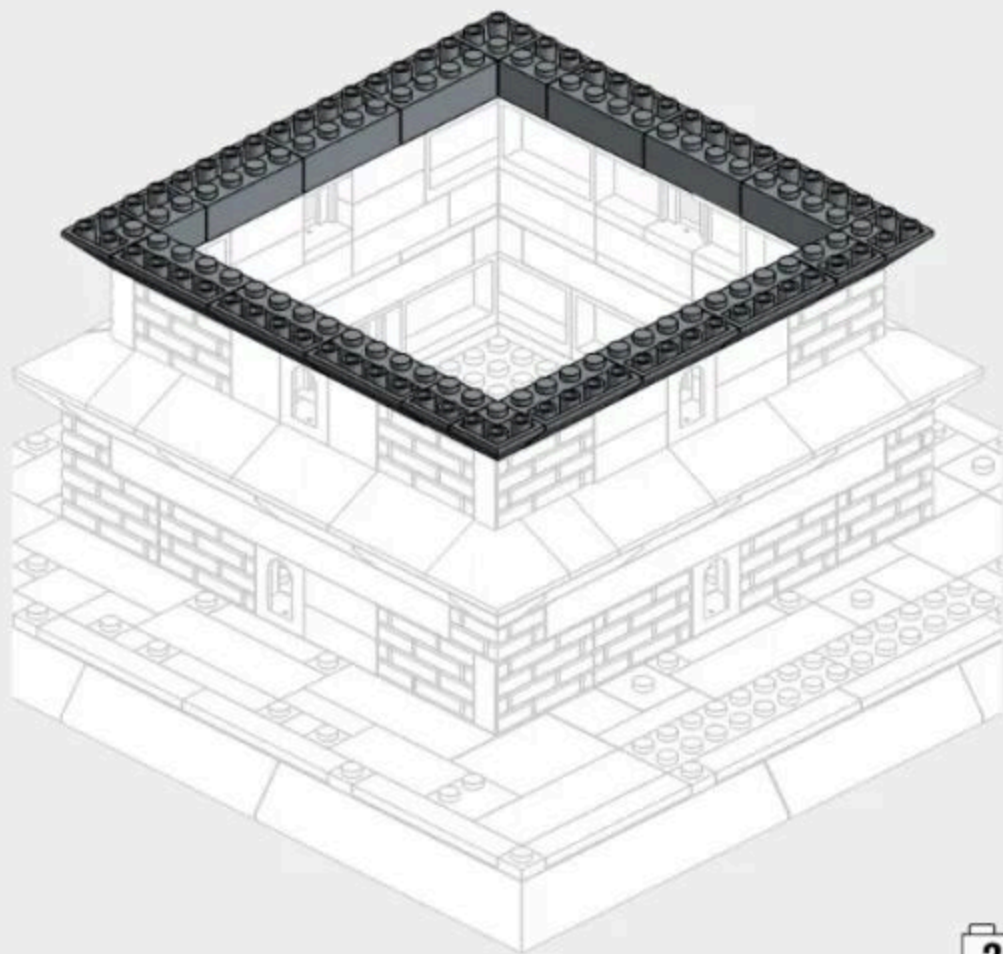



240PCS



27

2-1



x8



x4



x8

2-2



x12



x4

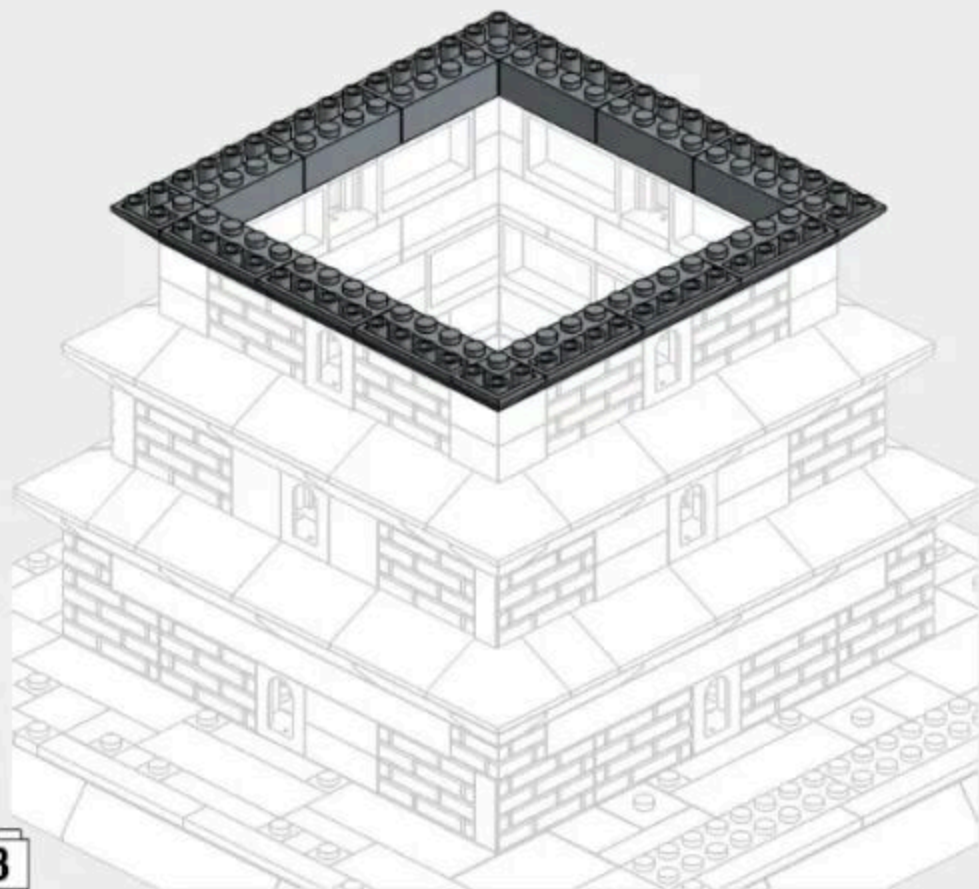
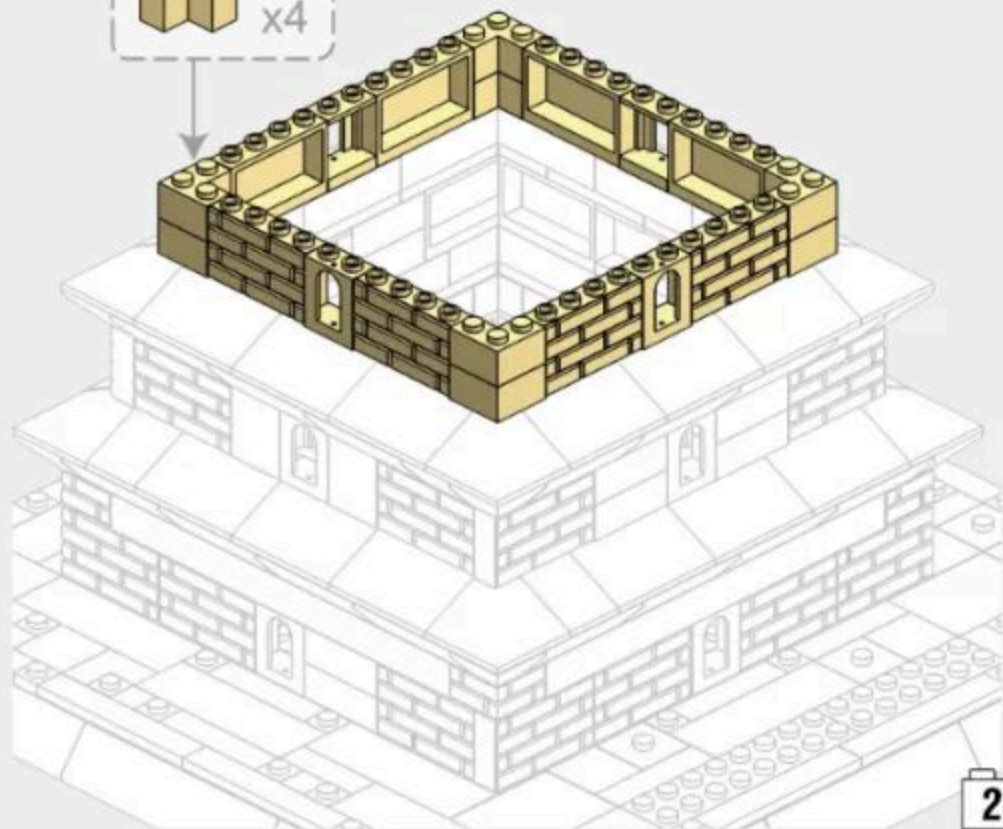
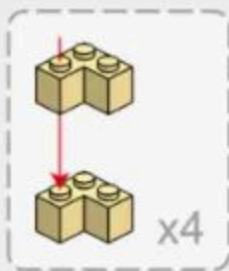

2-3

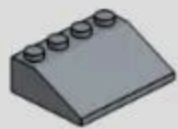

x8



x4



x4

2-4



x4



x16



x8

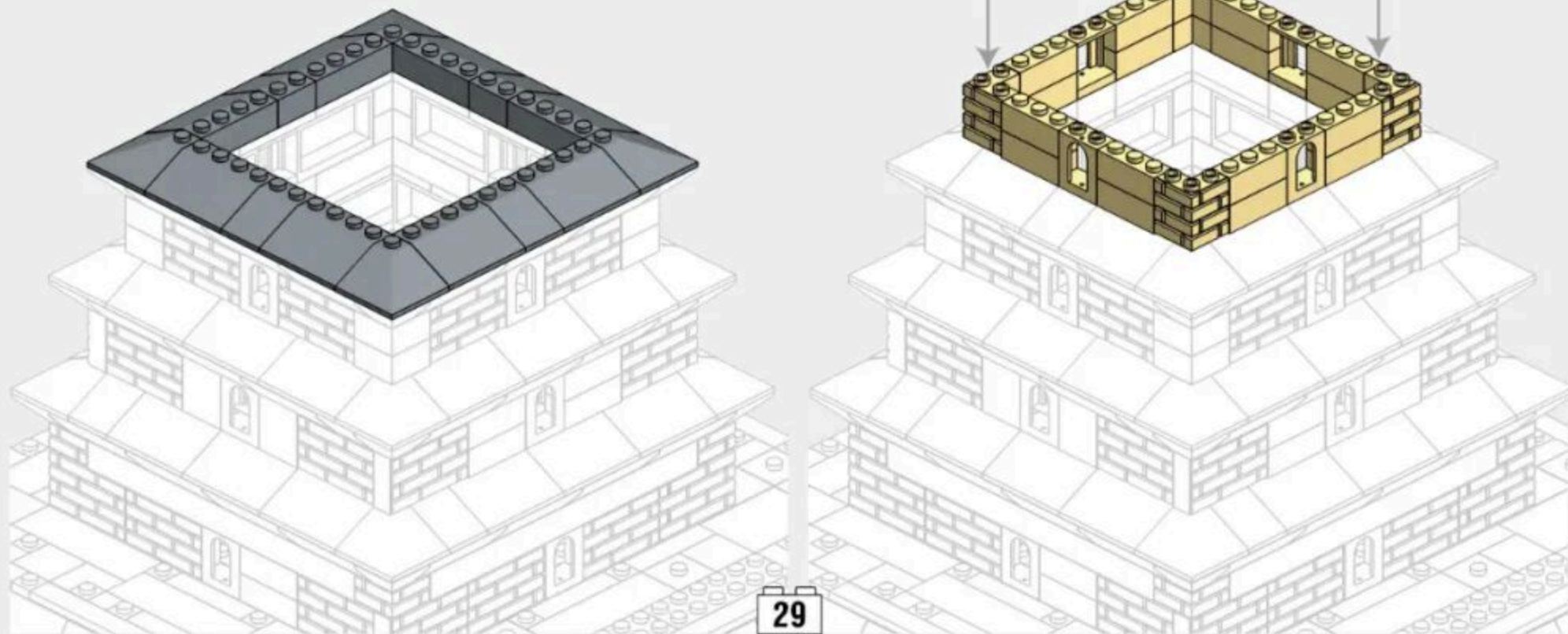
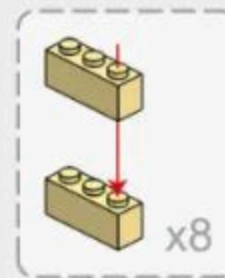
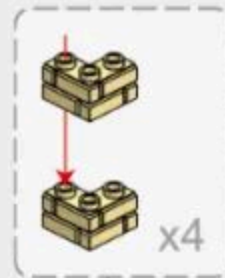

2-5



x8



x4



x4

2-6

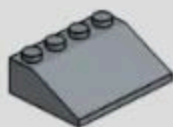

x8

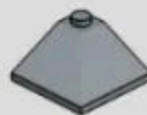

x4

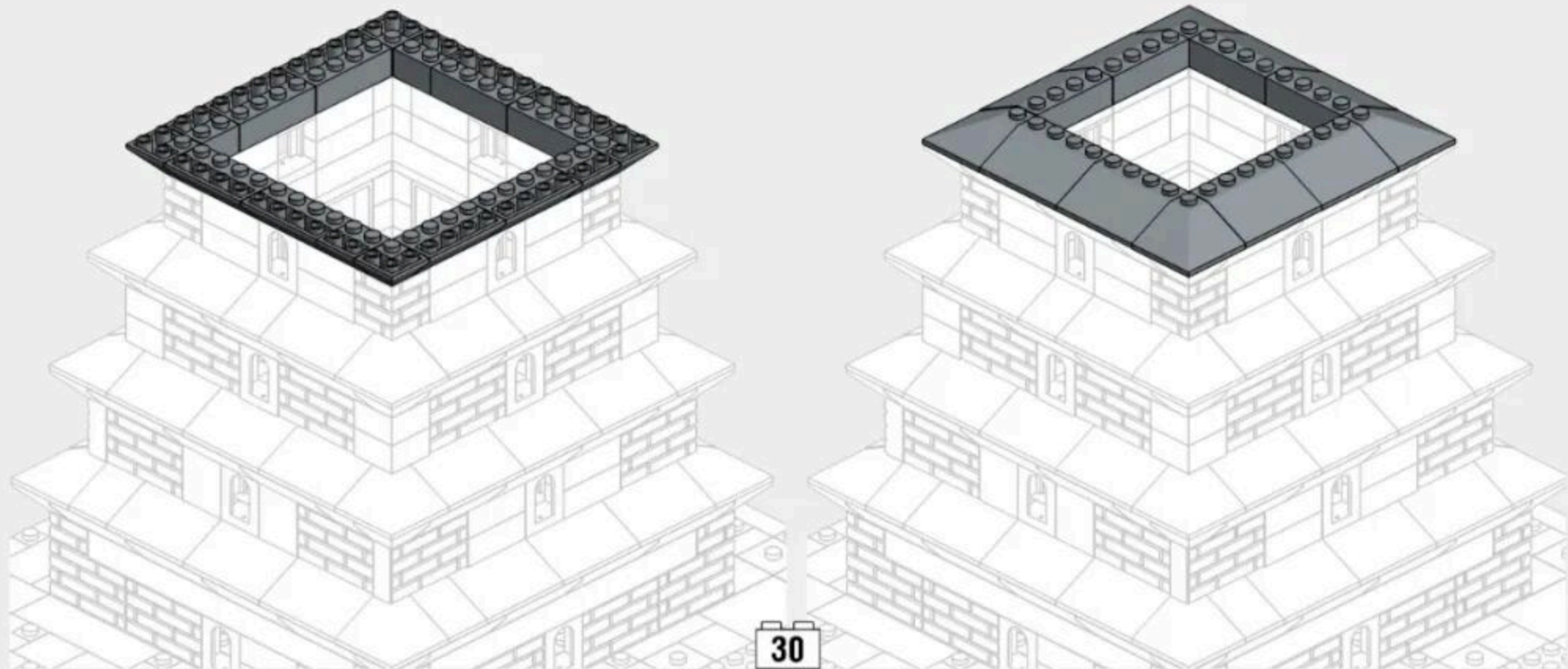

2-7

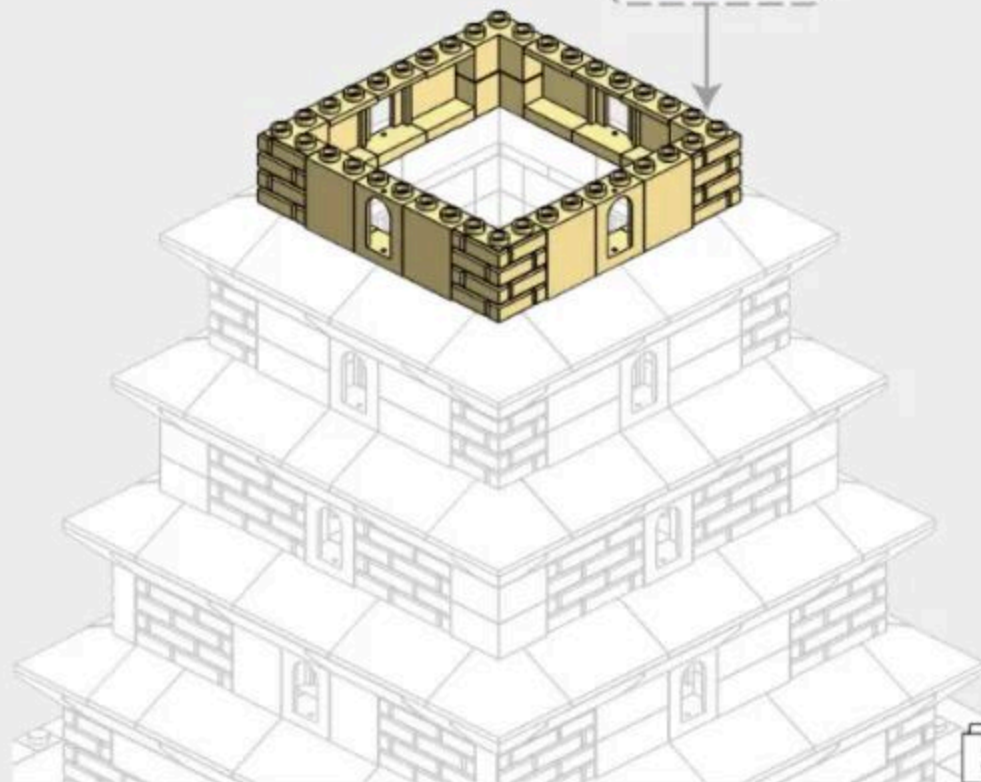
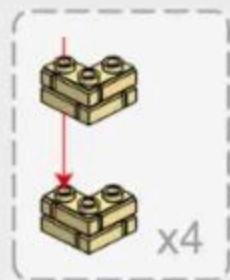

2-8

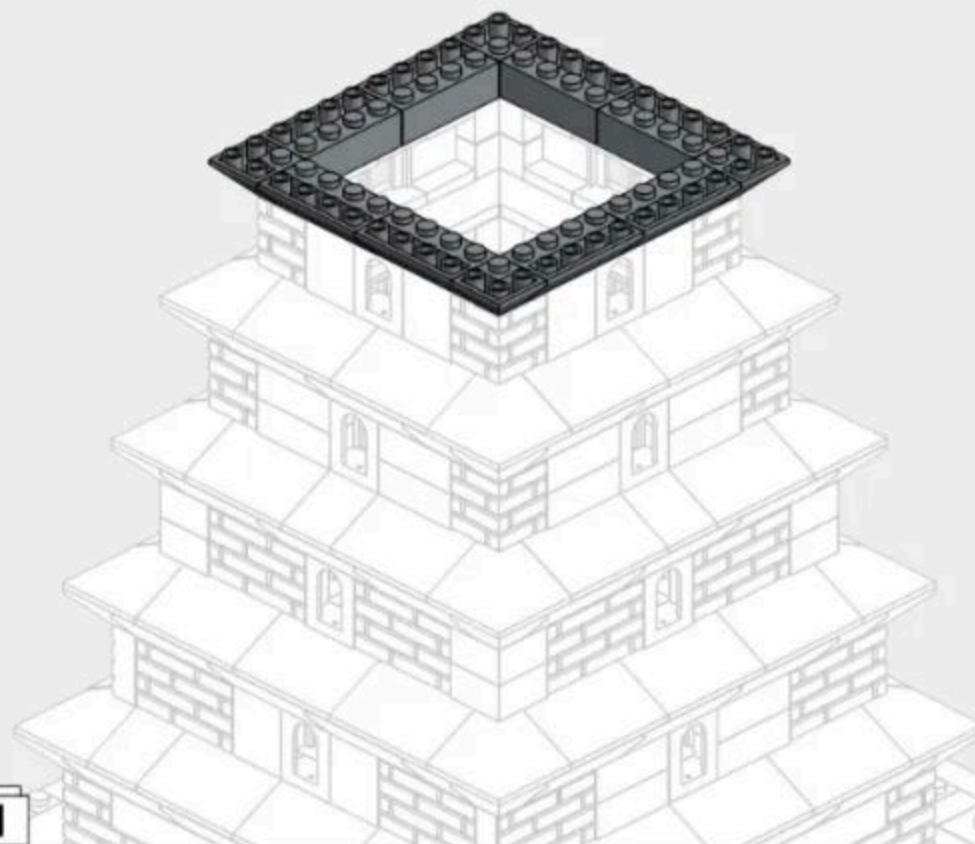

2-9

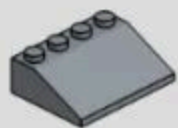

x4



x4



x4

2-10



x4



x8



x8

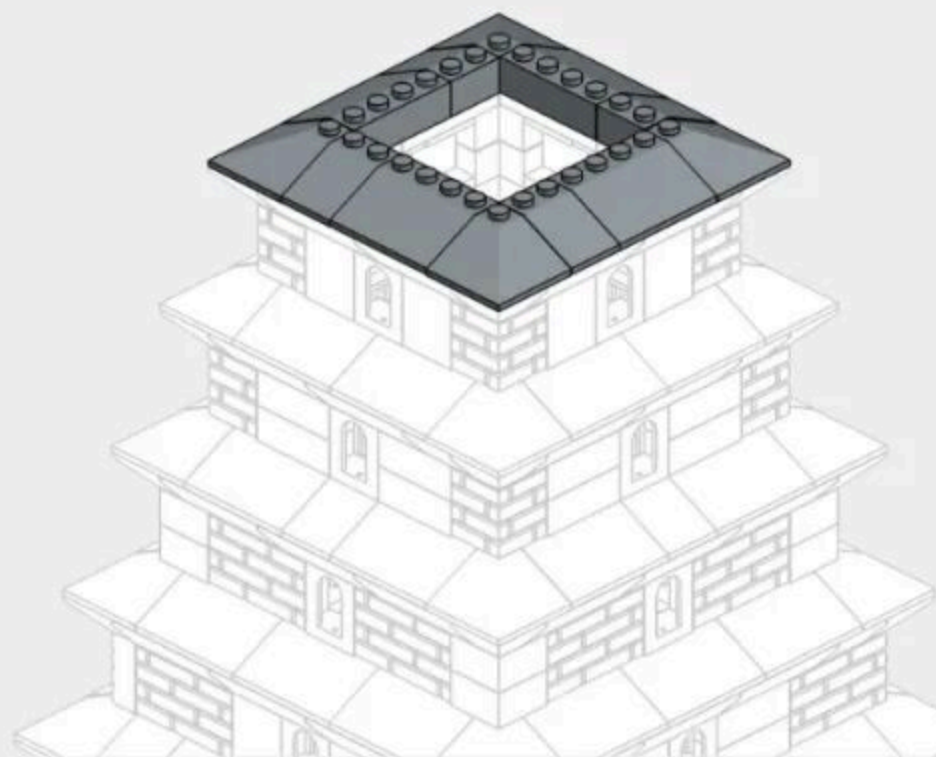

32

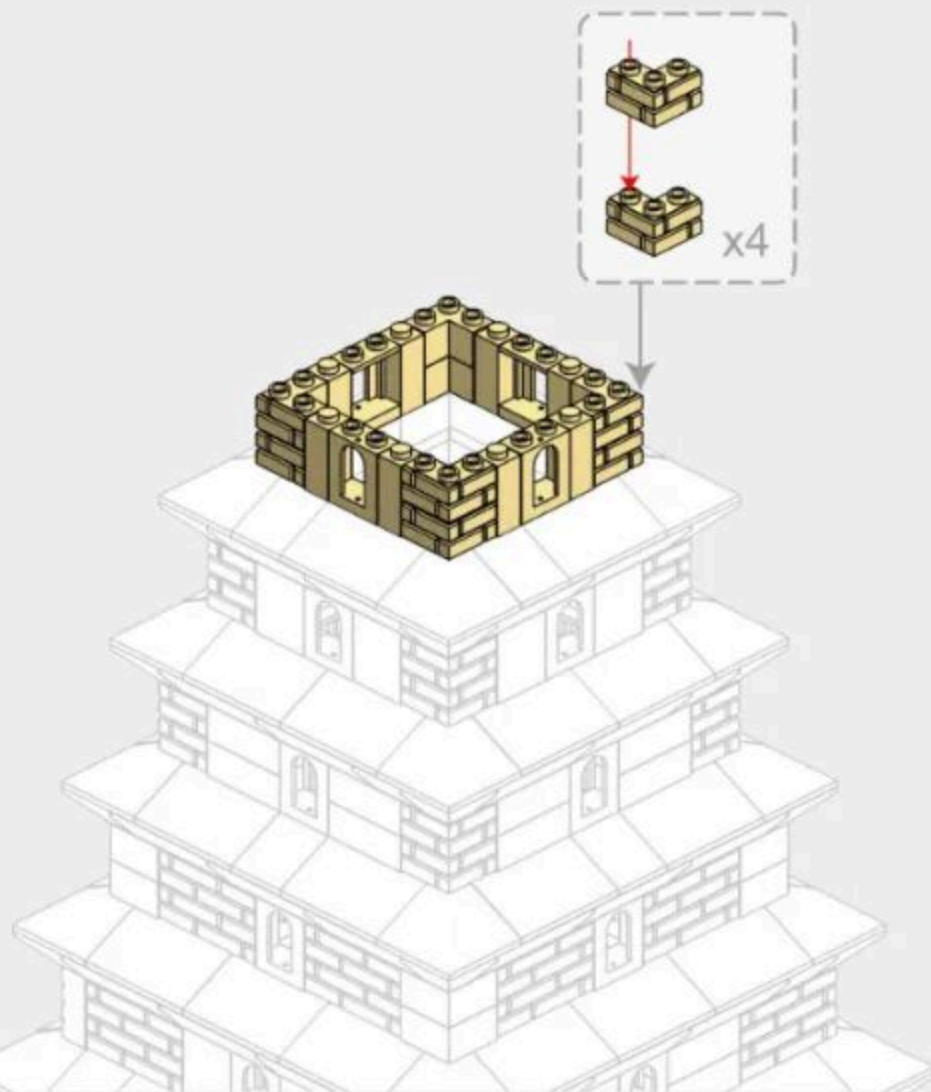

2-11

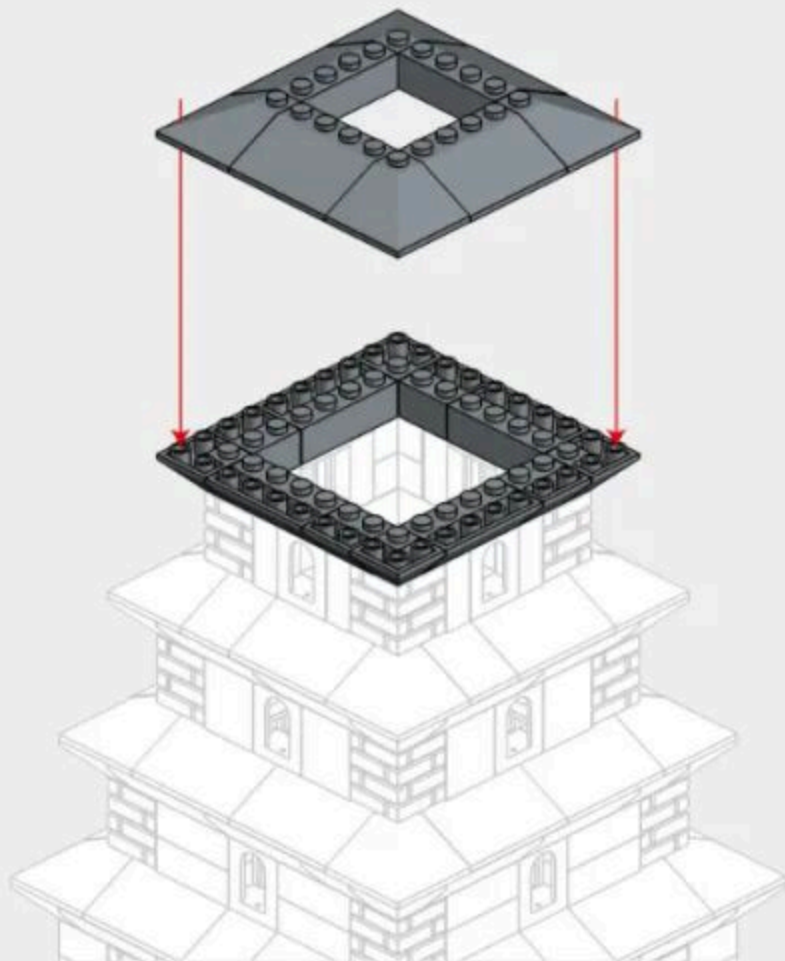
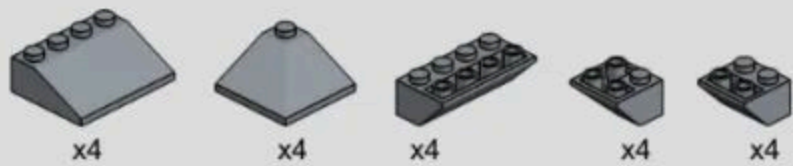

2-12

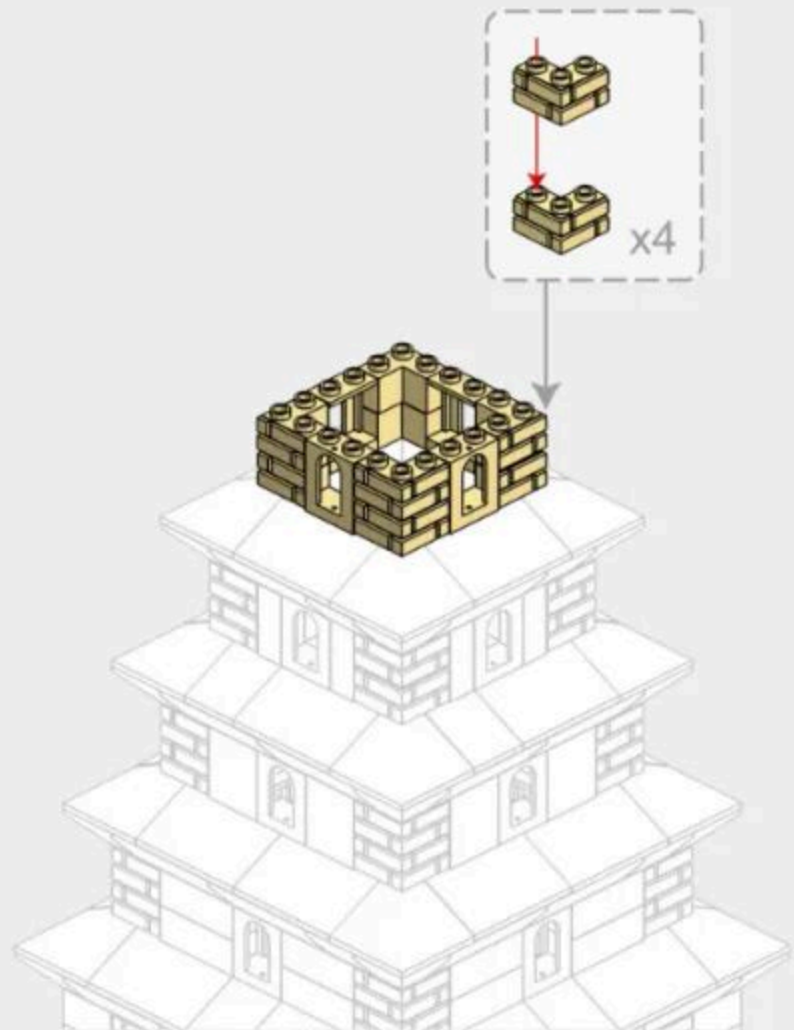

2-13



x4



x4



x4



x4

2-14



x8



x4



x1

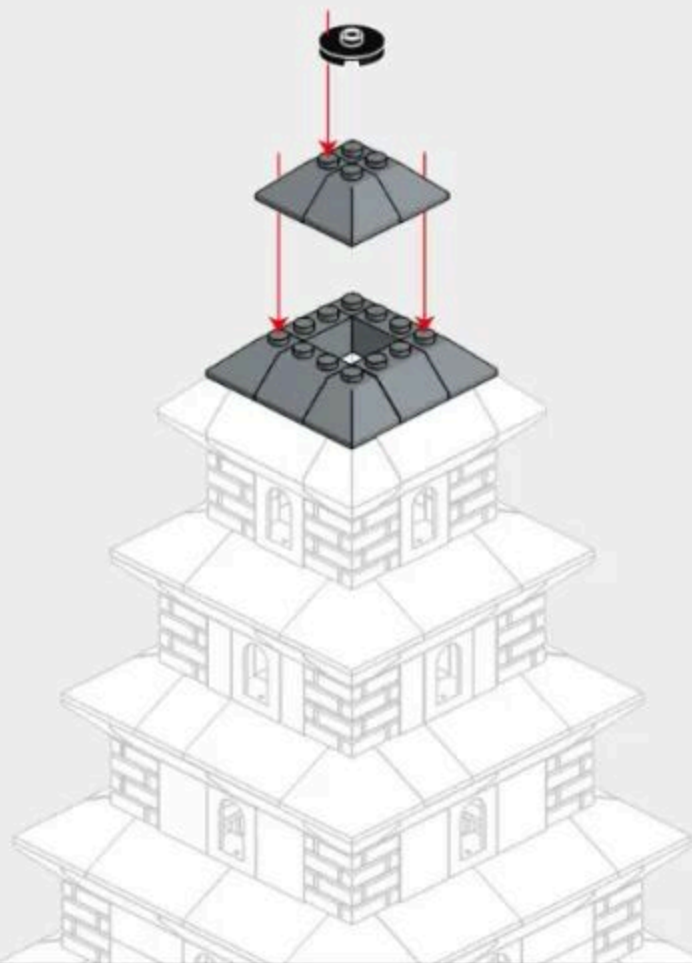
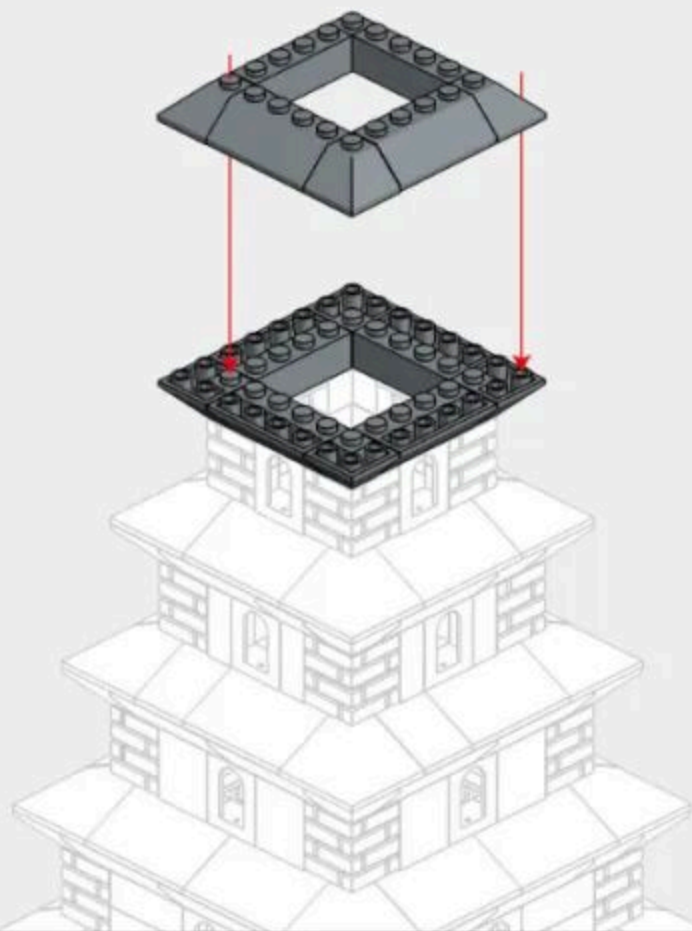

2-15

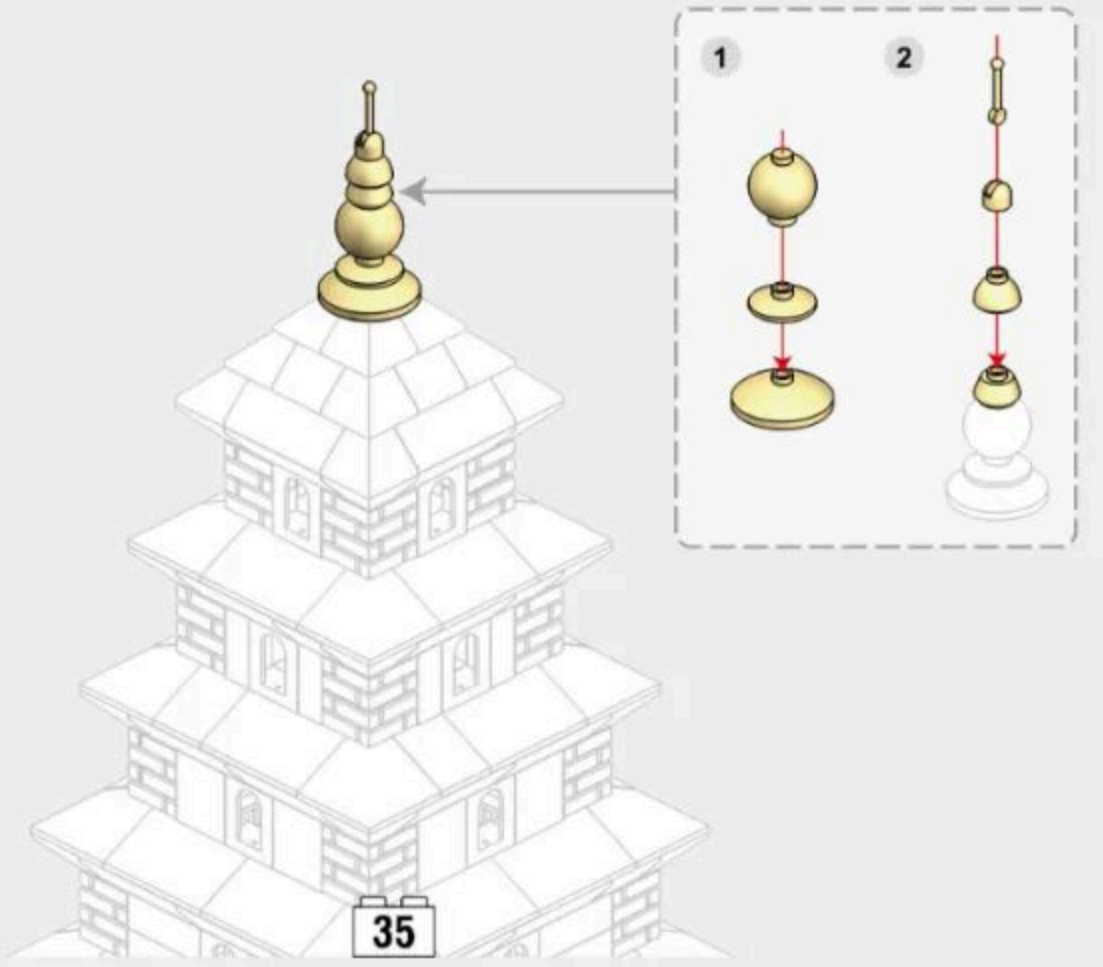



150PCS



36

### 3-1

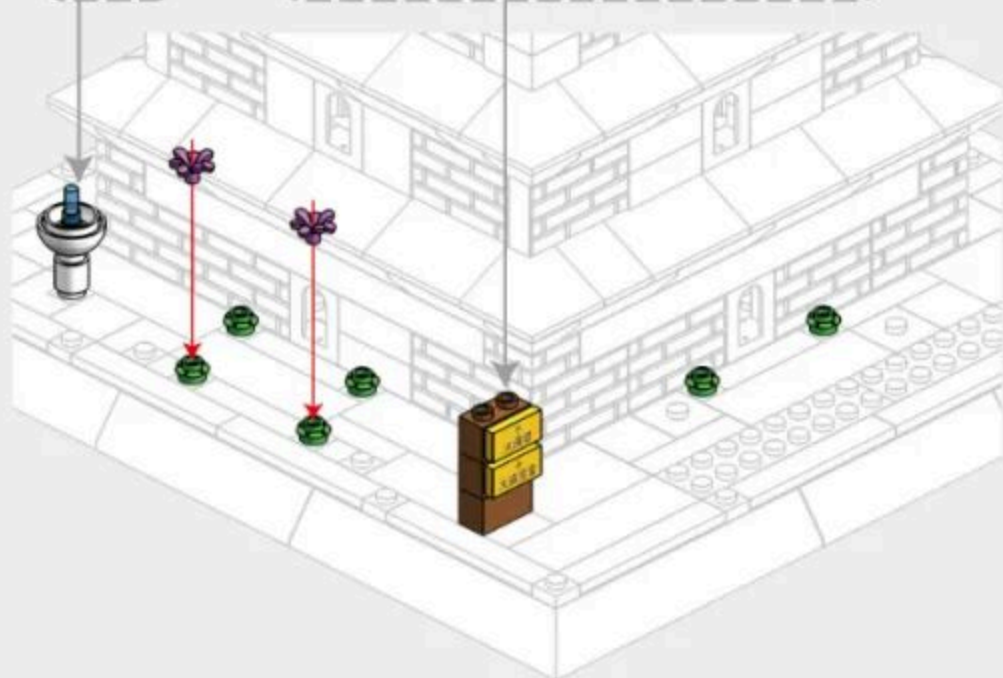
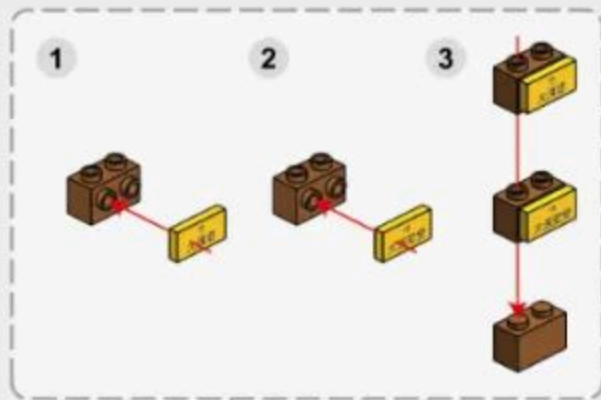

### 3-2

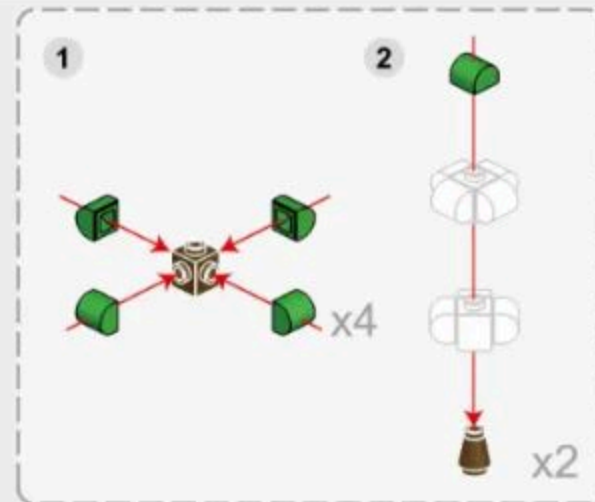

3-3

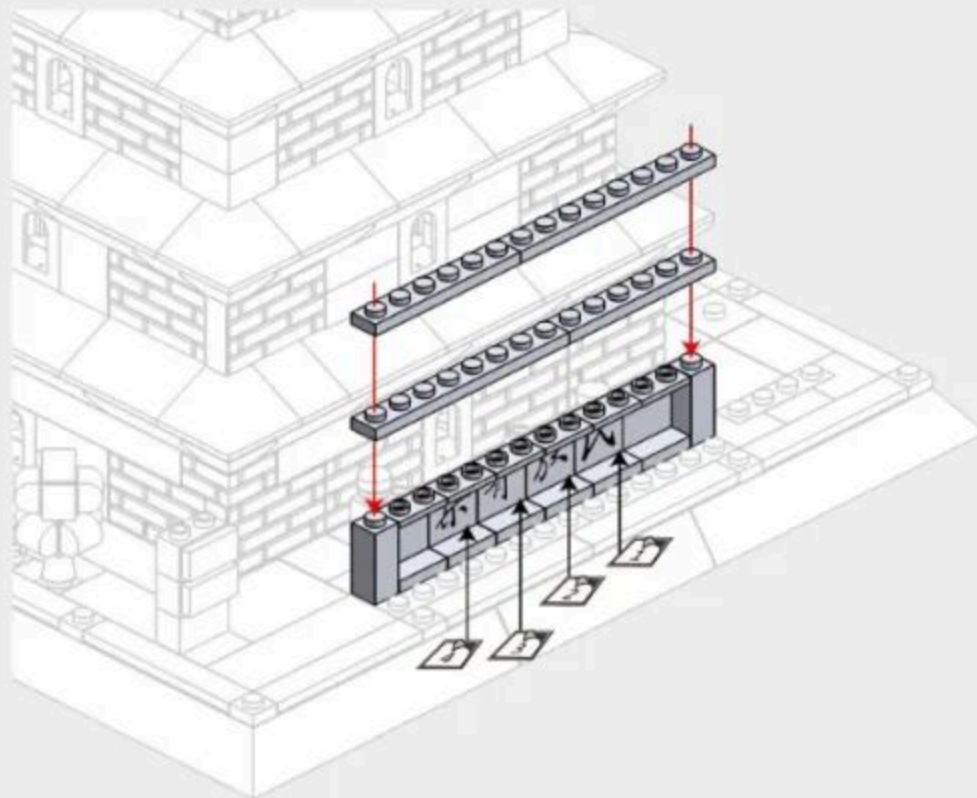
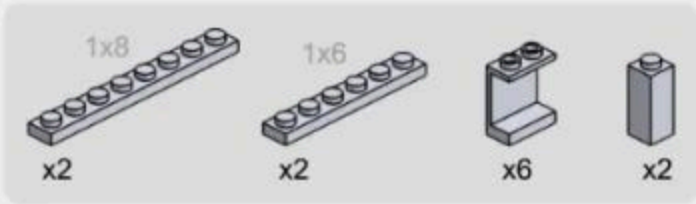

3-4

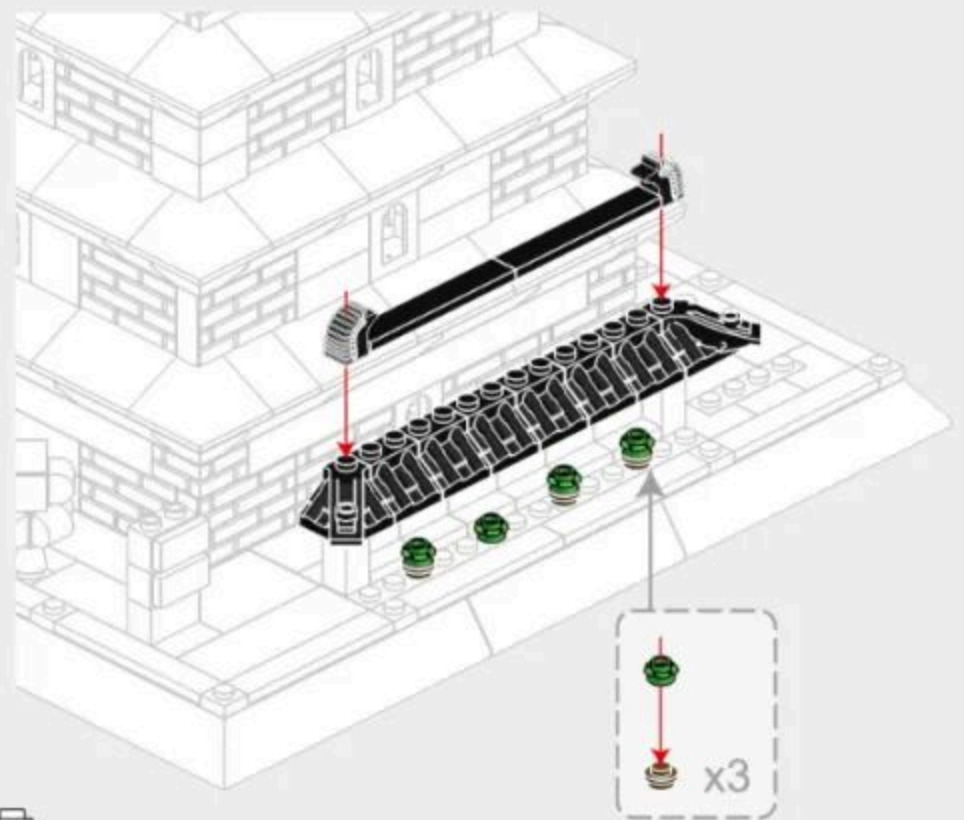

3-5

-  x1
-  x1
-  x1
-  x1
-  x1
-  x2
-  x2
-  x1
-  x6
-  x2

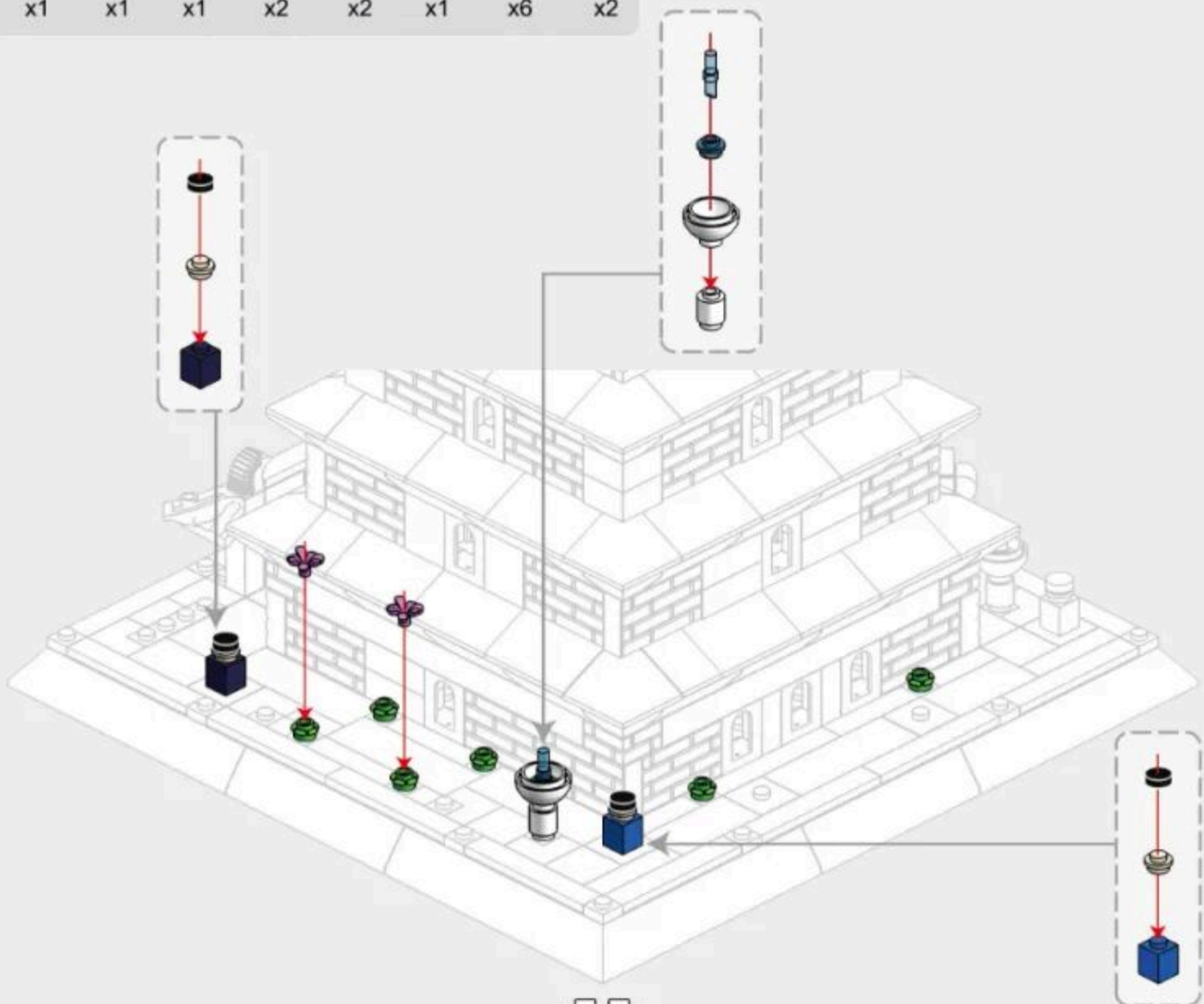

# 3-6

-  x4
-  x1
-  x1
-  x1
-  x2
-  x18
-  x2
-  x2

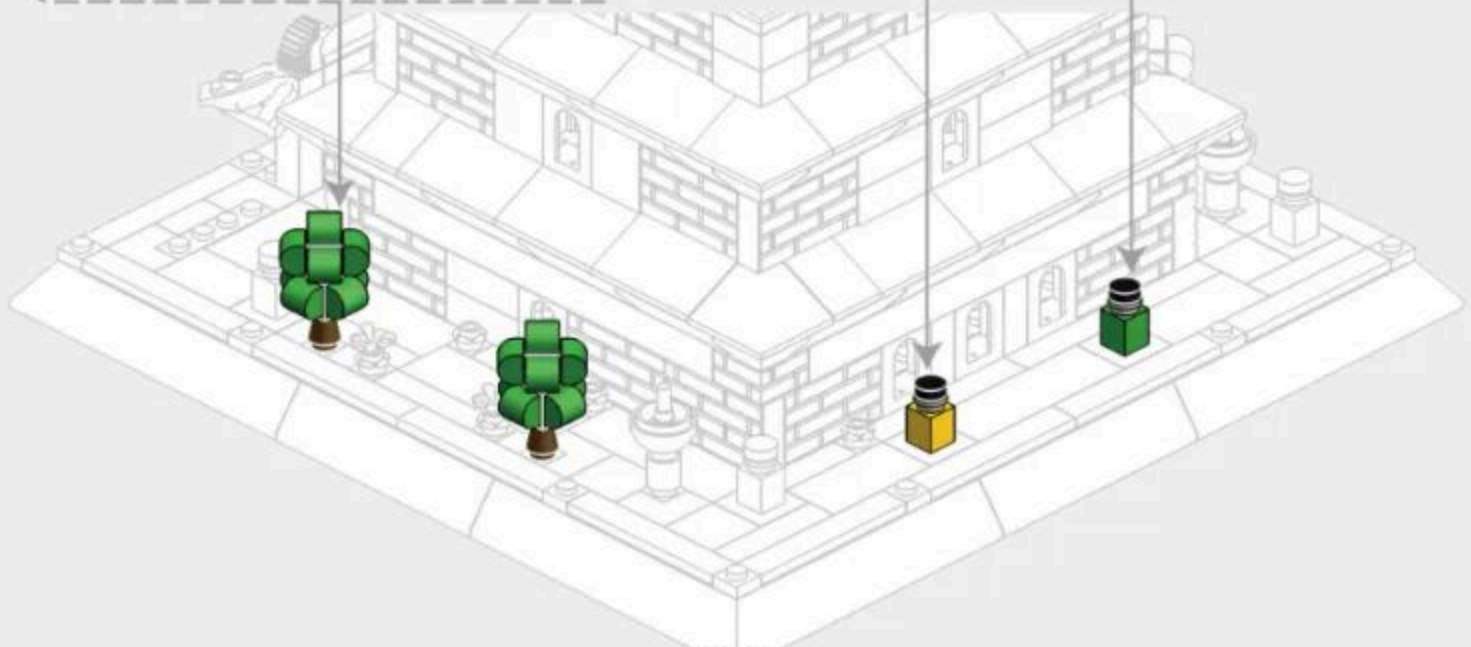
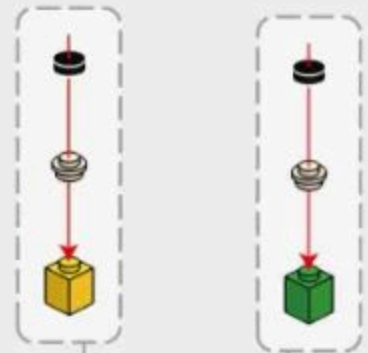
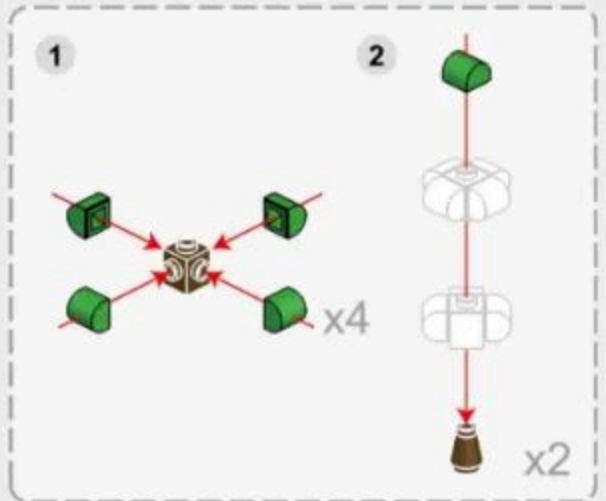

3-7





扫一扫  
了解产品更多信息



# ARCHITECTURE

The World's great architecture



Shaping Skills



Imagination & Curiosity



Mathematical



Self Discovery & Perception



Parent-Child Interaction



Problem Solving



Creativity



**6224** 英国伦敦白金汉宫  
BUCKINGHAM PALACE-LONDON,ENGLAND



**5225** 意大利罗马斗兽场  
COLOSSEUM-ROME,ITALY



**5226** 日本东京帝国饭店  
IMPERIAL HOTEL-TOKYO,JAPAN



**5227** 美国纽约自由女神像  
STATUE OF LIBERTY-NEW YORK,AMERICA



**6211** 德国柏林勃兰登堡门  
BRANDENBURG GATE-BERLIN,GERMANY

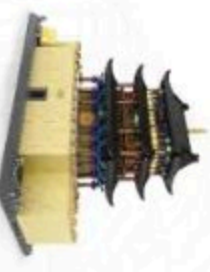

**6222** 中国甘肃长城-嘉峪关  
JIAYU PASS-CANSU,CHINA



**6212** 日本京都清水寺仁王门  
KIYOMIZU GATE OF KYOMIZU-dera,AYOTOJI,JAPAN



**6213** 俄罗斯莫斯科瓦西里大教堂  
SAINT BASIL'S CATHEDRAL,MOSCOW,RUSSIA



**6214** 中国武汉黄鹤楼  
YELLOW CRANE TOWER,WUHAN,CHINA



**6215** 英国伦敦眼  
LONDON EYE-LONDON,ENGLAND



**6221** 中国北京故宫-太和殿  
HALL OF SUPREME HARMONY-BEIJING,CHINA

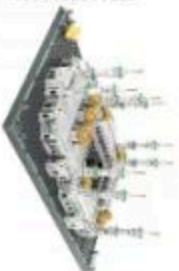

**6220** 沙特阿拉伯麦加大清真寺  
GREAT MOSQUE OF MECCA,SAUDI ARABIA



**6219** 美国纽约联合国大厦  
UNITED NATIONS SECRETARIAT BLDG,NEW YORK,AMERICA



**4214** 美国华盛顿白宫  
WHITE HOUSE,WASHINGTON D.C,AMERICA



**4212** 意大利罗马许愿池  
TREVI FOUNTAIN-ROME,ITALY



**4213** 法国巴黎卢浮宫  
MUSEE DU LOUVRE-PARIS,FRANCE



**4218** 新加坡-鱼尾狮  
MERLION,SINGAPORE



**4219** 英国伦敦双子塔桥  
TOWER BRIDGE-LONDON,ENGLAND



**4216** 美国华盛顿林肯纪念馆  
LINCOLN MEMORIAL,ASHINGTON D.C,AMERICA



**4217** 新加坡-金沙酒店  
MARINA BAY SANDS,SINGAPORE



**4210** 埃及开罗吉萨金字塔  
GREAT PYRAMID OF GIZA-CAIRO,EGYPT



**4221** 加拿大渥太华国会山庄  
PARLIAMENT BUILDINGS,OTTAWA,CANADA



**4211** 英国伦敦伊丽莎白白塔  
ELIZABETH TOWER-ENGLAND



**4215** 加拿大多伦多电视塔  
THE CN TOWER-CANADA



**4220** 美国纽约熨斗大厦  
FLATIRON BUILDING-NEW YORK,AMERICA



4222 阿联酋迪拜哈利法塔 THE EMIRATIHALLS TOWER-KU BAHUAE ORIENTAL PEARL TOWER-SHANGHAI,CHINA



5224 中国上海东方明珠广播电视塔 SHIPHS STATE BUILDING-NEW YORK,AMERICA



5212 美国纽约帝国大厦 EIFFEL TOWER-PARIS,FRANCE

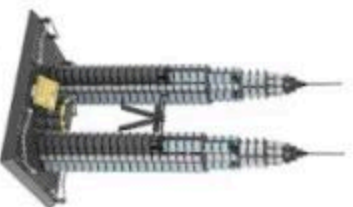

5213 马来西亚吉隆坡石油双塔 PETRONAS TWIN TOWERS-KUALUMPUR,MALAYSIA



5214 意大利托斯卡纳比萨斜塔 LEANING TOWER OF PISA-IT-SCANY ITALY



5219 俄罗斯莫斯科克里姆林宫塔楼 SPASSKAYA TOWER-MOSCOW,RUSSIA



5220 阿联酋迪拜卓美亚酒店 RIJAL AL-ARH-KOJIB-DJ BAHUAE



5217 法国巴黎埃菲尔铁塔 EIFFEL TOWER-PARIS,FRANCE



5221 中国台北101大楼 TAIPEI 101-TAIPEI,CHINA



5228 美国芝加哥威利斯大厦 WILISTOWER-CHICGO,AMERICA



5231 巴西里约热内卢救世基督像 CRISTO REDENTOR-BAJO DE JAVIRO, BRAZIL



6223 中国武汉长江大桥 WUHAN YANGTZE RIVER BRIDGE



5210 法国巴黎圣母院大教堂 CATHEDRALE NOIRE DAME DE PARIS-PARIS,FRANCE



5211 印度阿格拉泰姬陵 TAJ MAHAL-AGRA,INDIA



5223 法国巴黎凯旋门 ARC DE TRIOMPHE-PARIS,FRANCE



5215 英国伦敦双子塔桥 TOWER BRIDGE-LONDON,ENGLAND



5222 中国北京天坛祈年殿 HALL OF PRAYER FOR GOOD HARVESTS-BEIJING,CHINA



6210 美国旧金山金门大桥 GOLDEN GATE BRIDGE-SAN FRANCISCO,AMERICA



6216 中国北京万里长城(八达岭) THE GREAT WALL-BEIJING,CHINA



5218 中国北京天安门 TIANANMEN TOWER-BEIJING,CHINA



6217 中国西藏布达拉宫 POTALA PALACE-TIBET,CHINA



6218 芬兰罗瓦涅米圣诞老人办公室 SANTA CLAUS OFFICE-ROVANIEMI,FINLAND



6225 墨西哥库库尔坎玛雅金字塔 EL CASTILLO-KUKULKAN,MEXICO



6226 德国巴伐利亚新天鹅堡 SCHLOSS NEUSCHWANSTEIN-BAYERN,GERMANY



5229 土耳其伊斯坦布尔少女塔 MAJLIS TOWER-ISTANBUL,TURKEY



5230 中国湖南长沙爱晚亭 PAGODA PALACE-TIBET,CHINA



**7210** 中国上海世博会中国馆  
CHINA PAVILION AT EXPO-SHANGHAI, CHINA



**5232** 美国宾夕法尼亚州流水别墅  
FALINCWATER, PENNSYLVANIA, AMERICA



**5233** 美国芝加哥范斯沃斯住宅  
FARNSWORTH HOUSE, CHICAGO, AMERICA



**5234** 美国华盛顿唐人街  
CHINA TOWN, WASHINGTON, D.C., AMERICA



**3210** 美国纽约自由女神像  
STATUE OF LIBERTY, NEW YORK, AMERICA

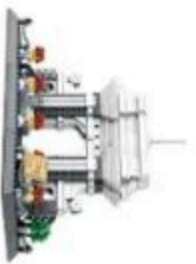

**4223** 中国北京清华园  
TIANHUA CAMPUS, BEIJING, CHINA



**7211** 中国湖南岳阳楼  
YUEYANG TOWER, HUNAN, CHINA



**8210** 澳大利亚悉尼歌剧院  
SYDNEY OPERA HOUSE, BENNEWONG POINT, AUSTRALIA



**7212** 中国江西南昌滕王阁  
PAVILION OF PRINCE TENG, JIANGXI, CHINA



**6227** 中国河南郑州嵩山少林寺  
SHAOLIN TEMPLE, HENAN, CHINA



**7213** 中国重庆洪崖洞  
HONGYADONG, CHONGQING, CHINA



**5235** 美国华盛顿国会大厦  
UNITED STATES CAPITOL, WASHINGTON, D.C., AMERICA



**5236** 中国安徽省滁州市醉翁亭  
ZHENZONG PAVILION, ANHUI, CHINA



**6228** 中国陕西西安钟鼓楼  
YAN BELL TOWER, SHAANXI, CHINA



**5238** 美国西雅图太空针塔  
SPACE NEEDLE, SEATTLE, AMERICA



**5237** 法国巴黎萨伏伊别墅  
VILLA SAVOYE, PARIS, FRANCE

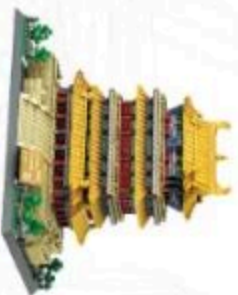

**6229** 中国山西运城鹳雀楼  
SHOUK TOWER, SHANXI, CHINA



**6230** 希腊爱情海圣托里尼岛  
SAINT-NICOLAS CHURCH



**6231** 中国上海海关大楼  
SHANGHAI CUSTOMS HOUSE, SHANGHAI, CHINA



**5239** 中国北京紫禁城角楼  
THURST OF PALACE, WESTERN BEIJING, CHINA



**5240** 韩国首尔崇礼门  
NAEDEUNG, SEOUL, KOREA



**5241** 中国江苏南京夫子庙  
CONFUCIUS TEMPLE, JIANGSU, CHINA



**5242** 美国纽约古根海姆博物馆  
GUGONHEIM MUSEUM, NEW YORK, AMERICA



**6232** 中国江苏南京秦淮河画舫  
QINHUAI BOAT, NANJING, JIANGSU, CHINA



**6233** 法国诺曼底圣米歇尔山  
SAINT MICHAELS MOUNT, NORMANDY, FRANCE



**6234** 中国河南省阳菜川老君山  
THE LAOJUN MOUNTAIN-HENAN, CHINA



**5243** 耶路撒冷岩石圆顶  
DOME OF THE ROCK-JERUSALEM



**6235** 中国江苏苏州寒山寺 (普明宝塔)  
HANSHAN TEMPLE-JIANGSU, CHINA



**4224** 英国威尔特郡巨石阵  
STONEHENGE-WILTSHIRE, ENGLAND



**4225** 中国内蒙古自治区蒙古包  
MONGOLIAN YURT-INNER MONGOLIA, CHINA



**8211** 中国福建土楼(承启楼)  
CHENGQI EARTH BUILDING-FUJIAN, CHINA



**4226** 沙特阿拉伯麦加大清真寺(克尔白)  
KERBAL GREAT MOSQUE OF MECCA, SAUDI ARABIA



**5244** 俄罗斯圣彼得堡冬宫  
WINTER PALACE-ST. PETERSBURG, RUSSIA



**7214** 中国陕西西安鼓楼  
XIAN DRUM TOWER-SHAANXI, CHINA



**5245** 中国重庆李子坝站  
LIZIBA STATION-CHONGQING, CHINA



**4227** 俄罗斯莫斯科国立大学  
MOSCOW STATE UNIVERSITY-MOSCOW, RUSSIA



**4228** 沙特阿拉伯麦地那先知清真寺  
PROPHET'S MOSQ. E-MEDINA, SAUDI ARABIA

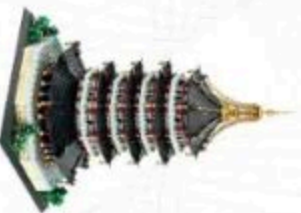

**6236** 中国浙江杭州雷峰塔  
LEIFENG PAGODA-HANGZHOU, ZHEJIANG, CHINA



**5246** 美国芝加哥罗宾别墅  
ROBIE HOUSE-CHICAGO, AMERICA



**5247** 中国陕西西安大雁塔  
GIANT WILD GOOSE PAGODA-SHAANXI, CHINA

# GIANT WILD GOOSE PAGODA

COUNTRY: China  
CITY: Xi'an

