



GOLDEN GATE

BRIDGE OF SAN FRANCISCO

France
The World's great architecture

Ages
6+



NO.6210
1977 PCS

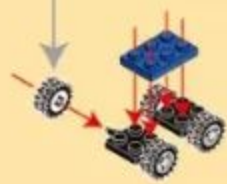
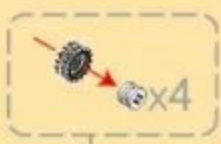
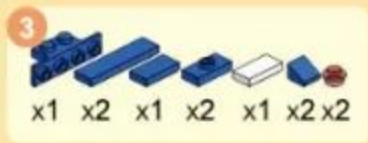
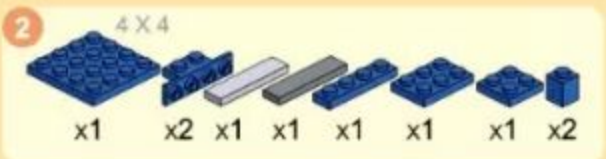

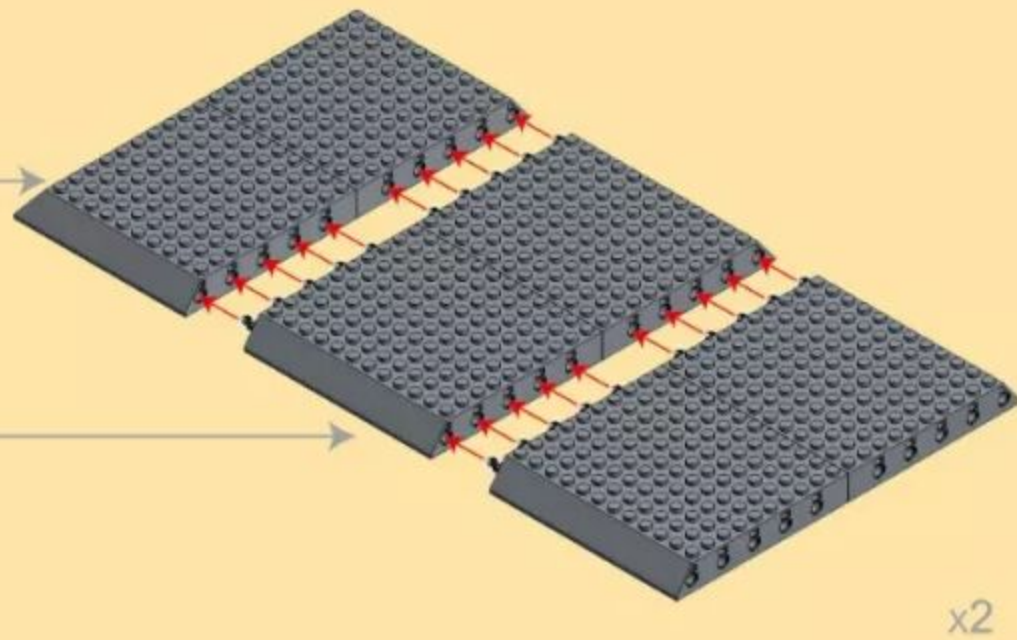
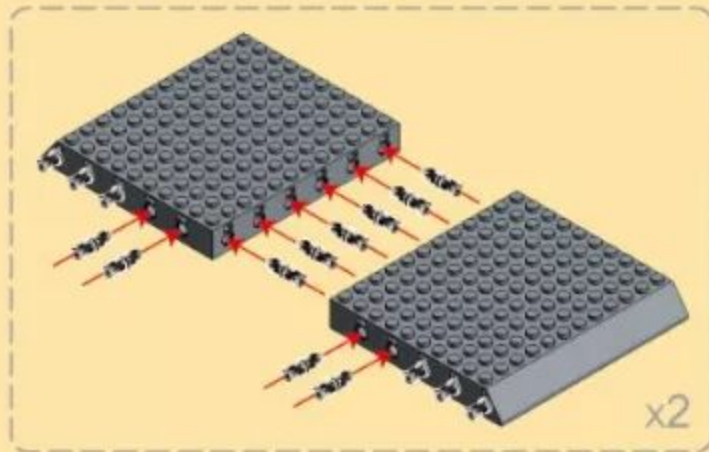
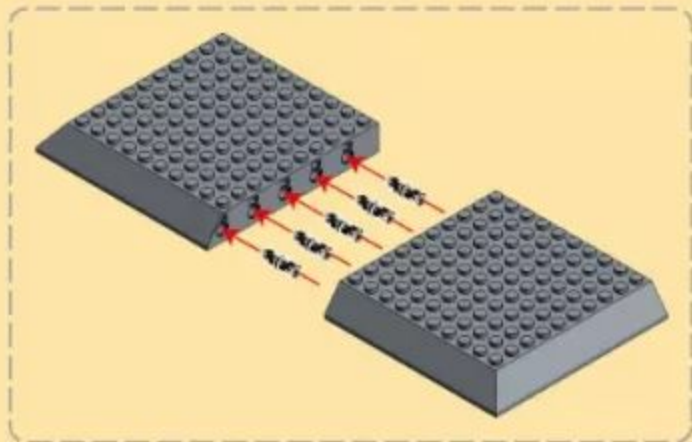
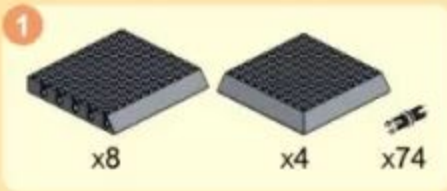

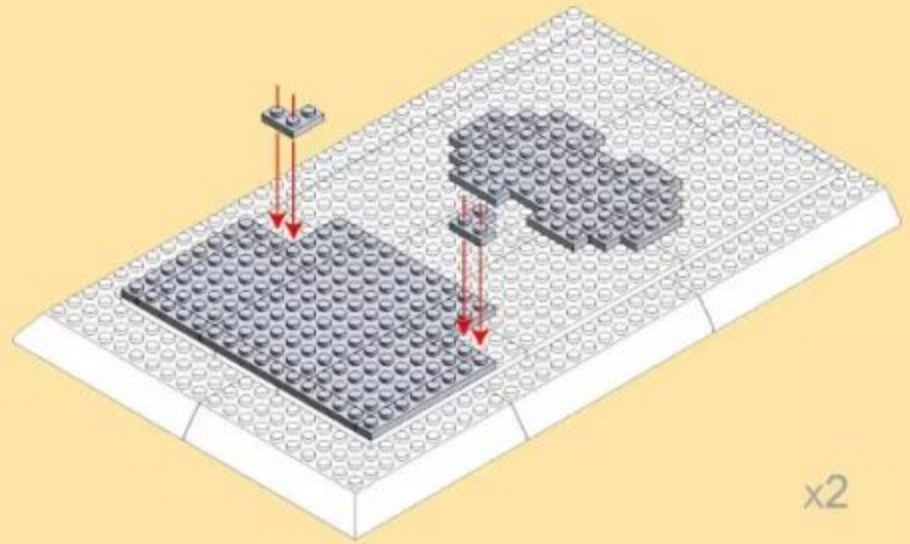
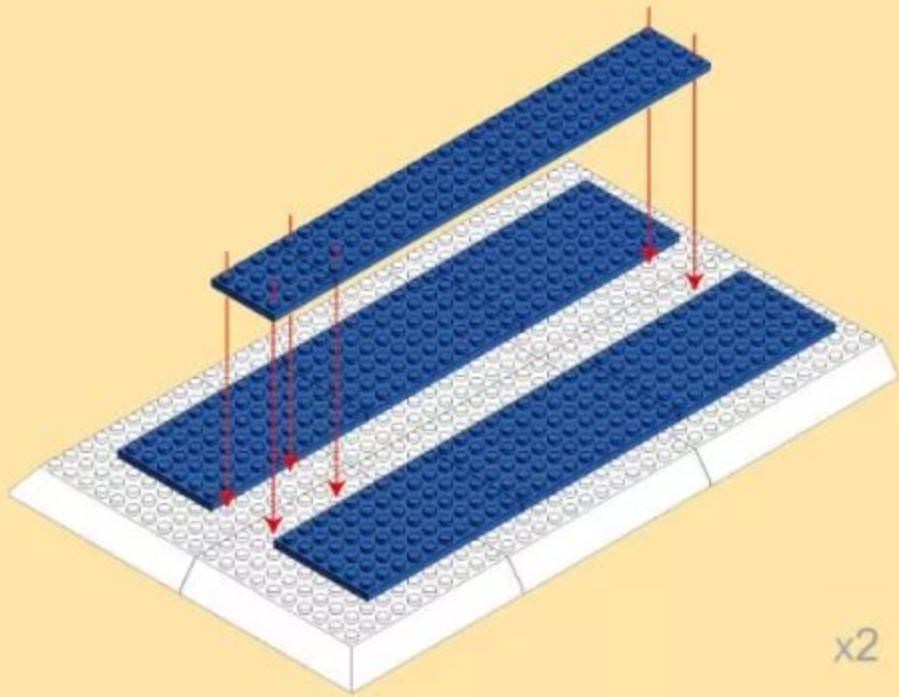
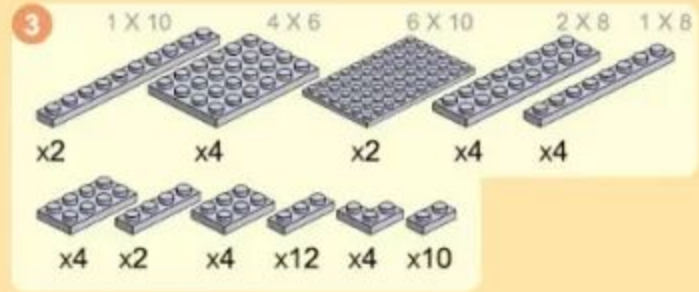

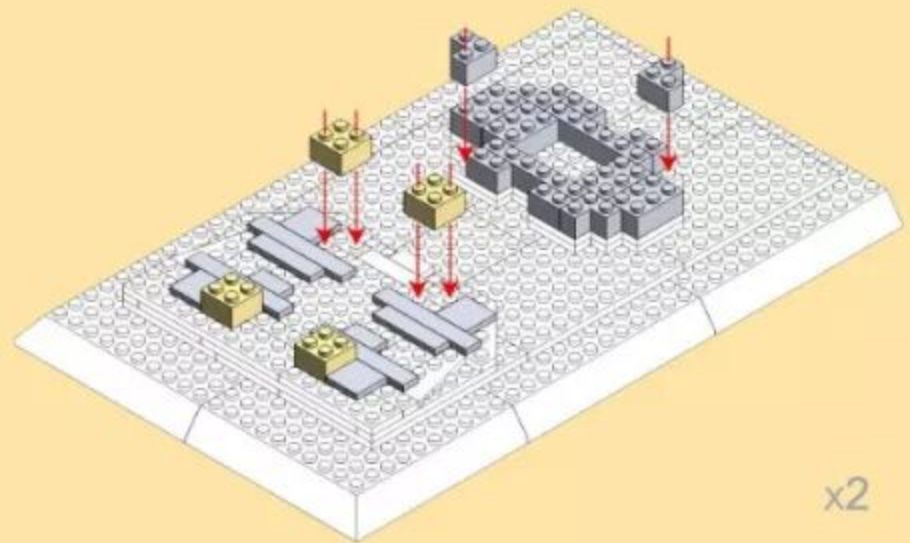
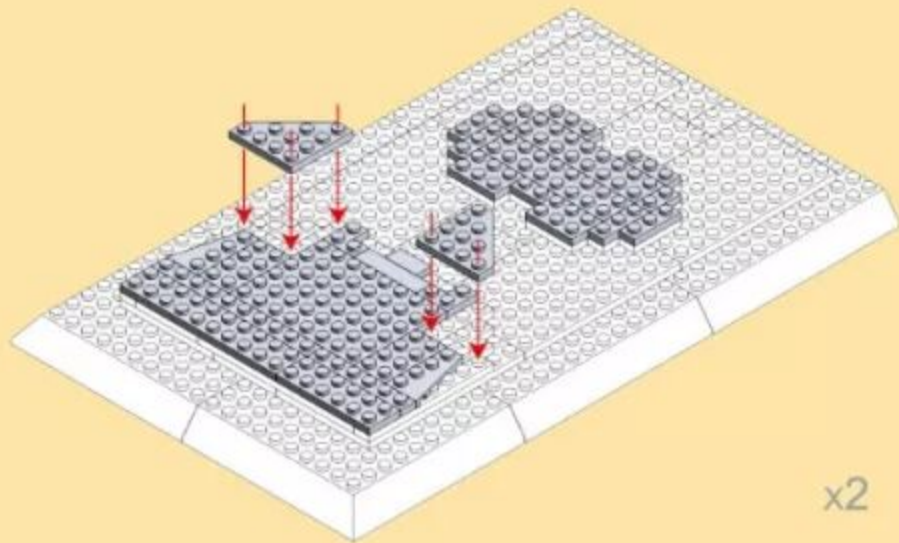
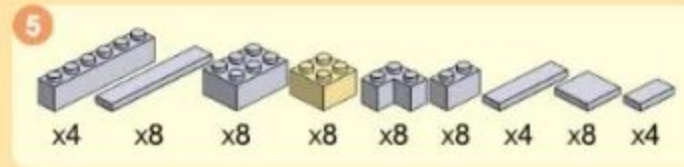
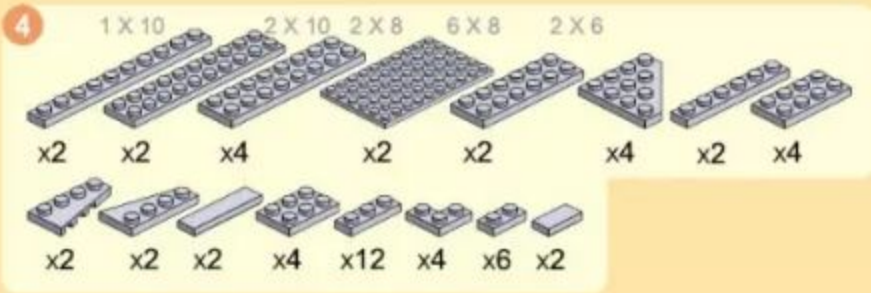

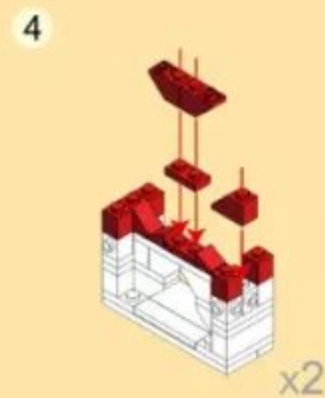
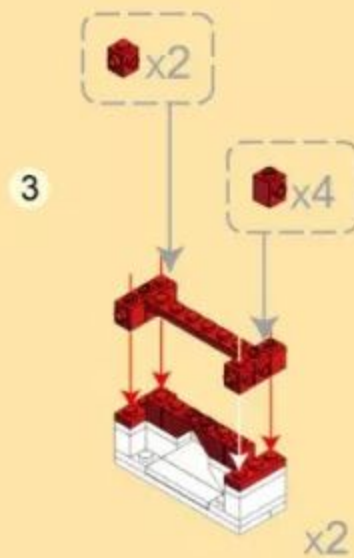
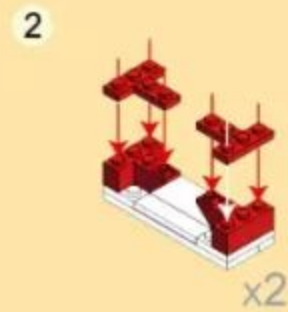
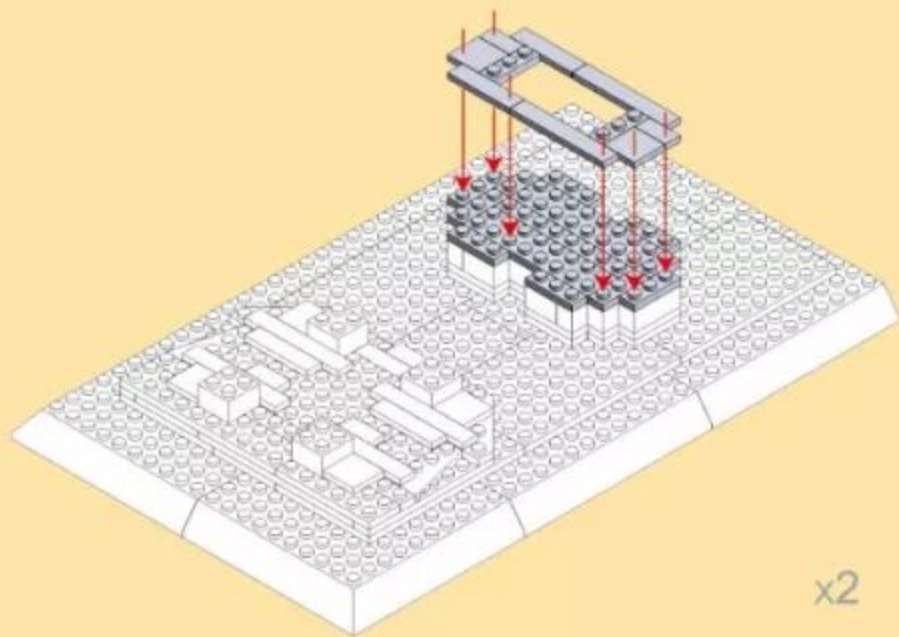
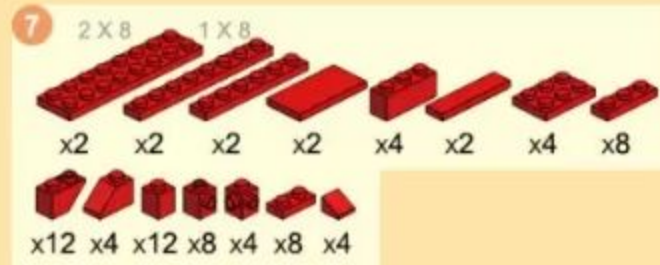
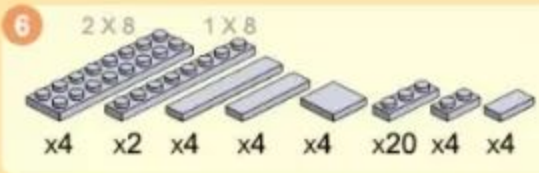

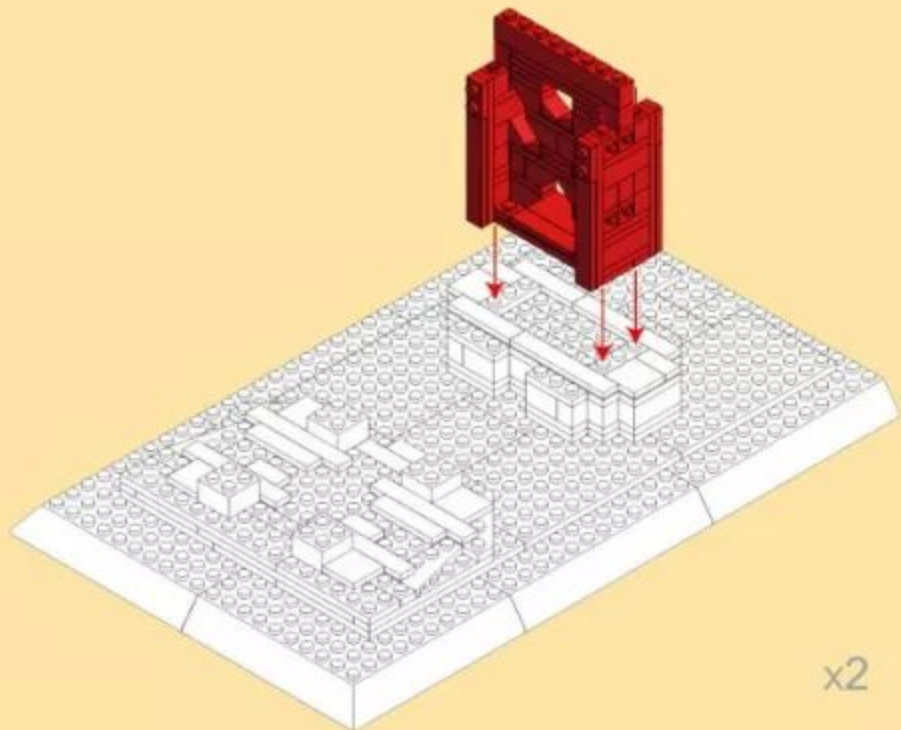
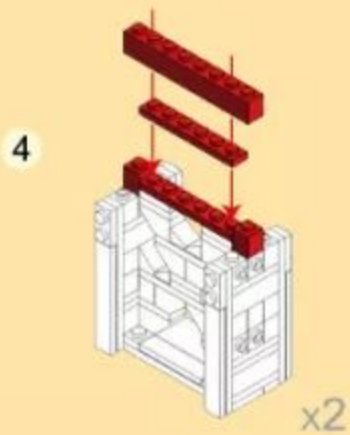
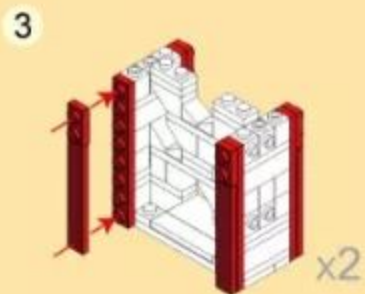
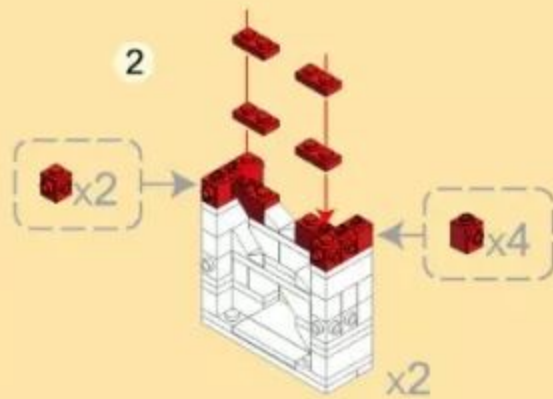
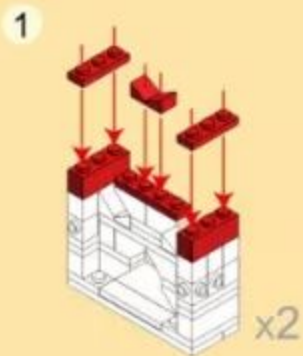
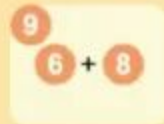
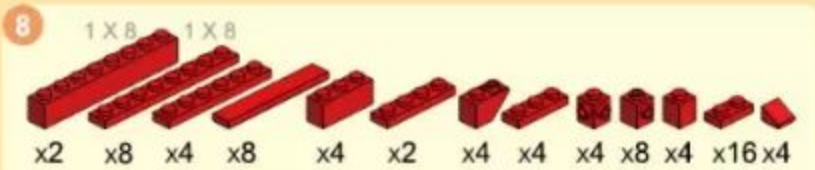

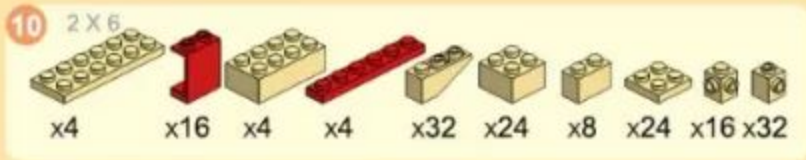

1



2

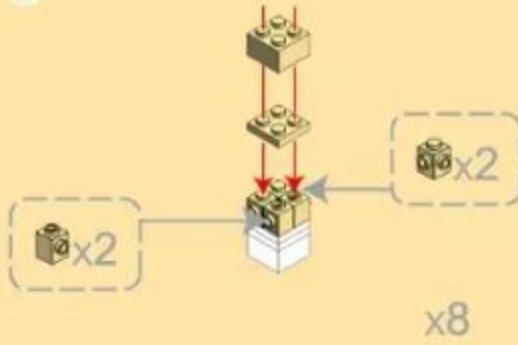

3

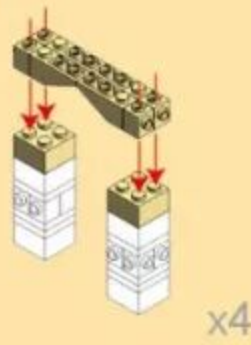

4

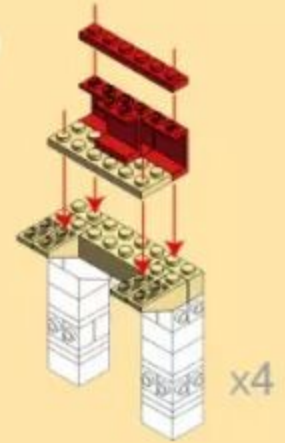

11

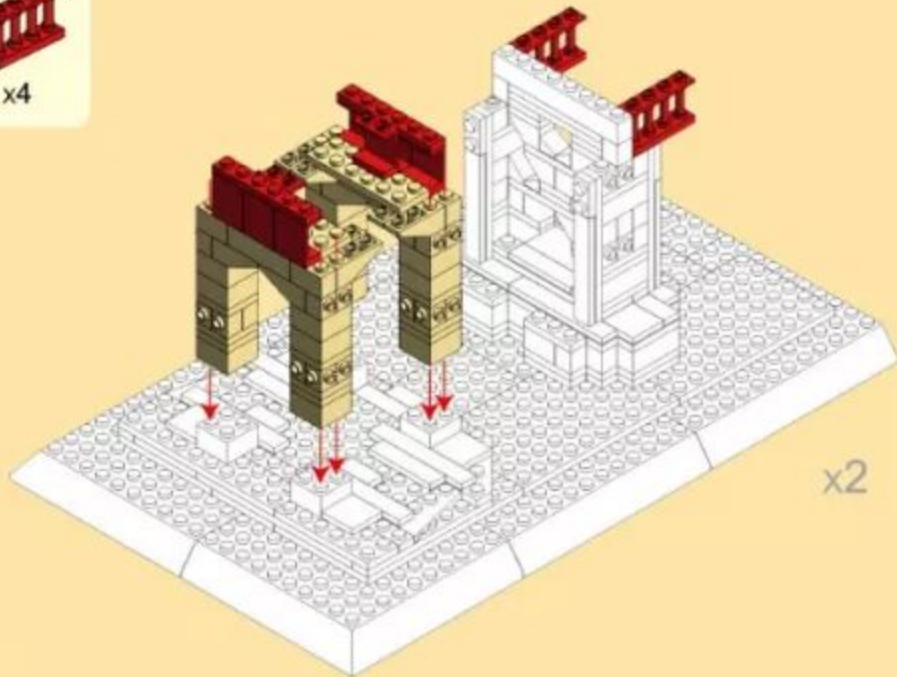

12

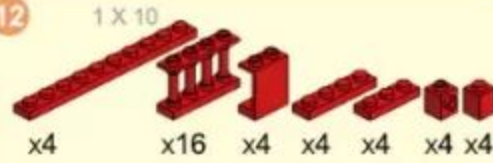

1

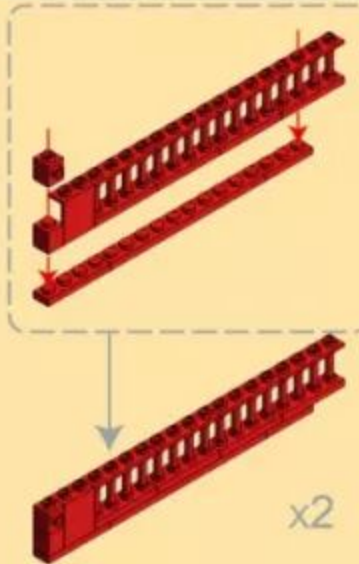

2

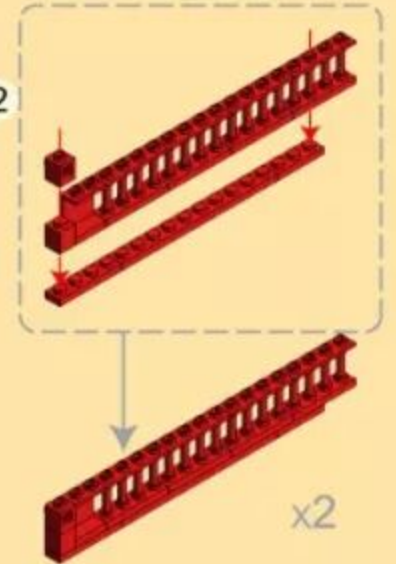

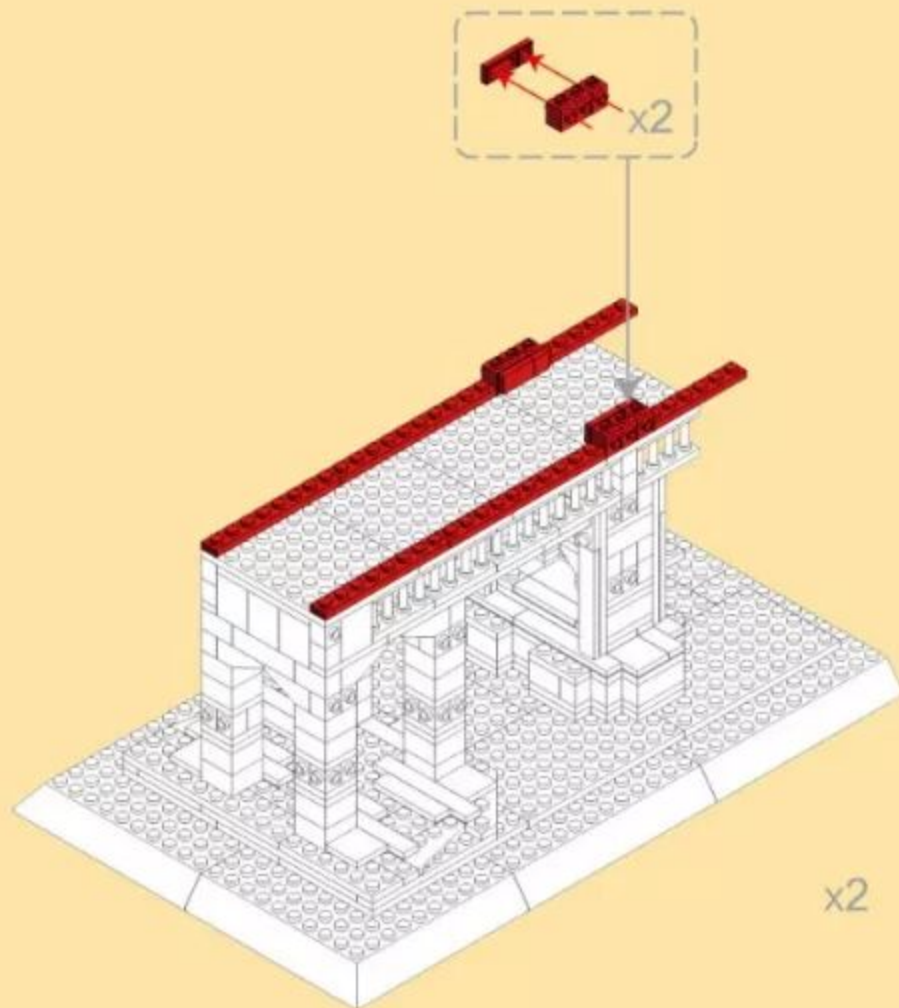
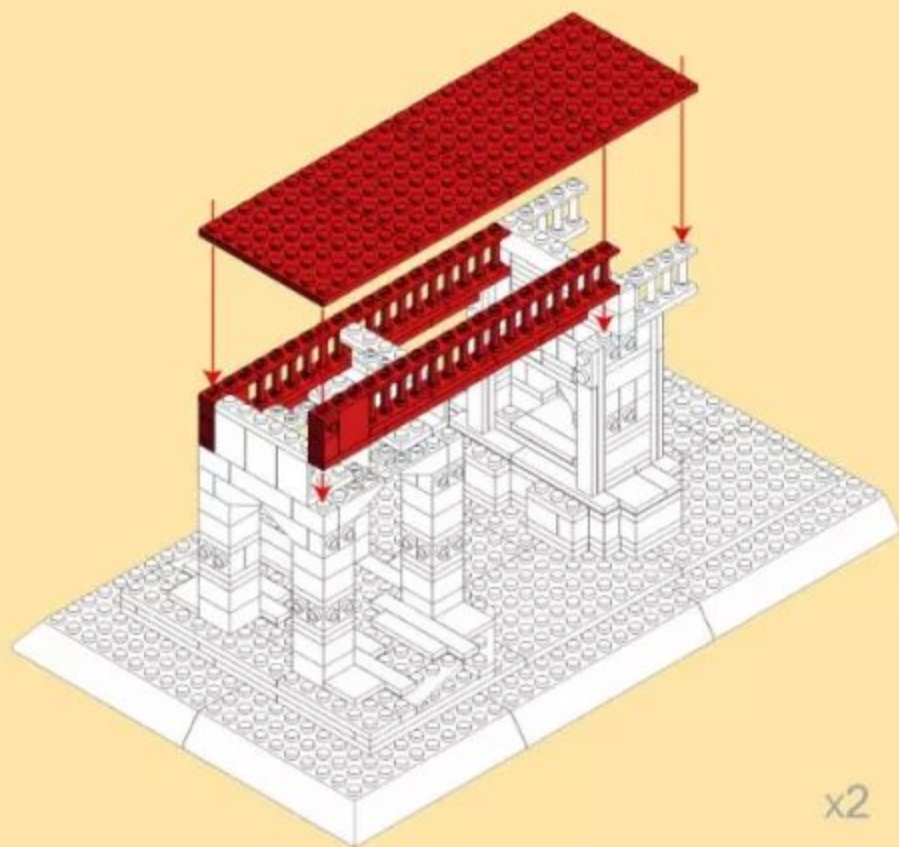

15



x4 x16 x8 x12 x8 x4

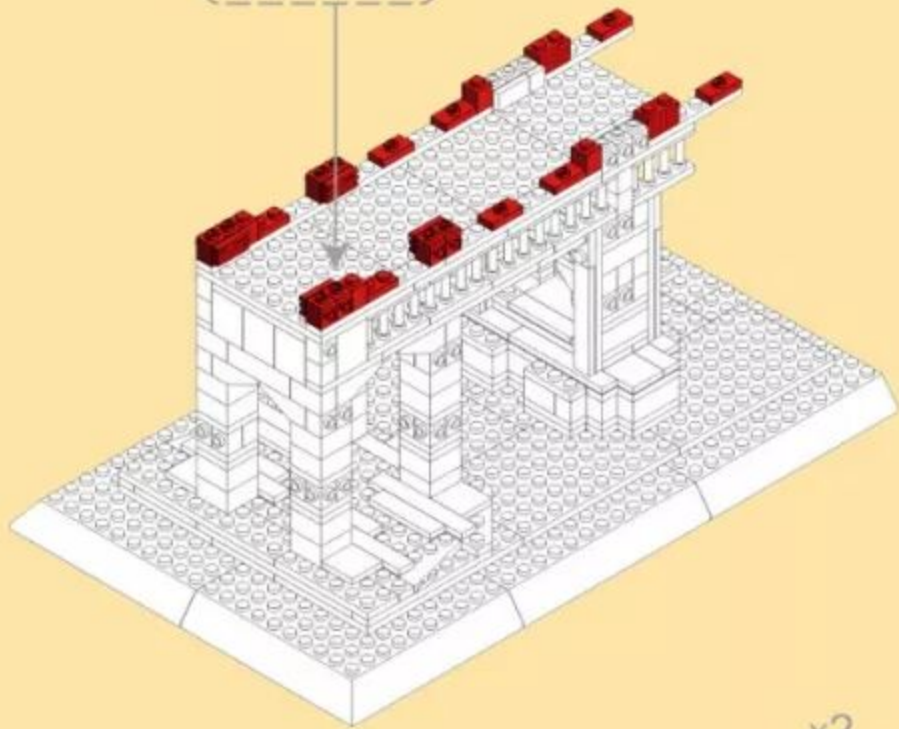
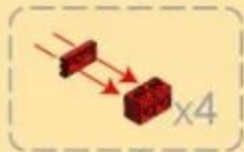

x2

16



x4 x4 x4 x16 x12 x12

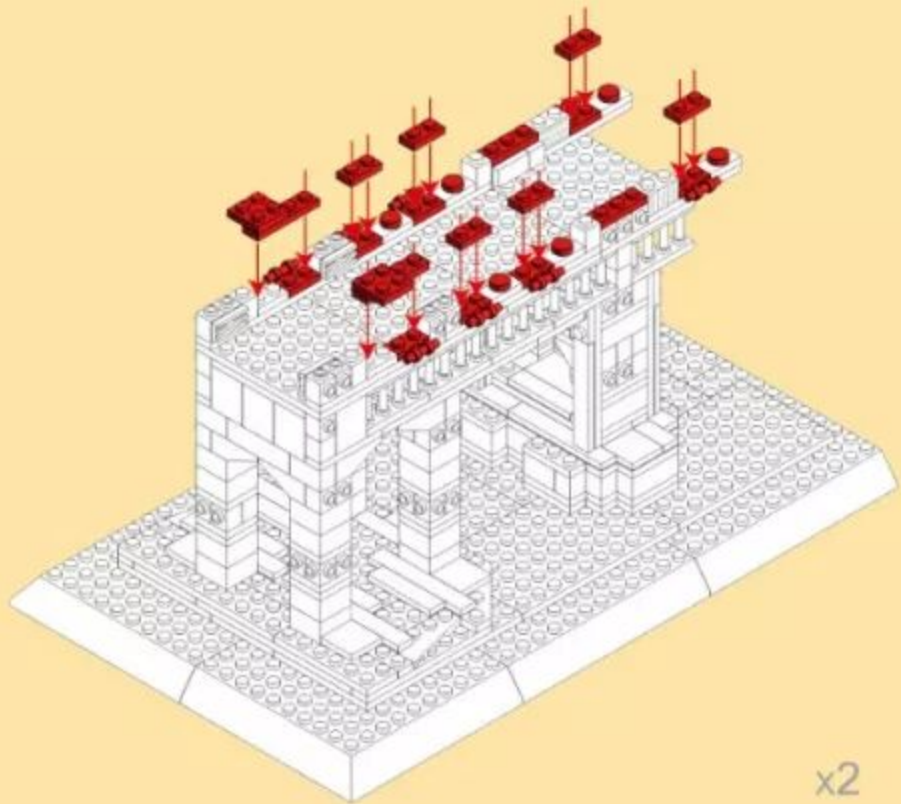

x2

17



x4 x4 x4 x20 x4

18



x4 x8 x4 x8 x4

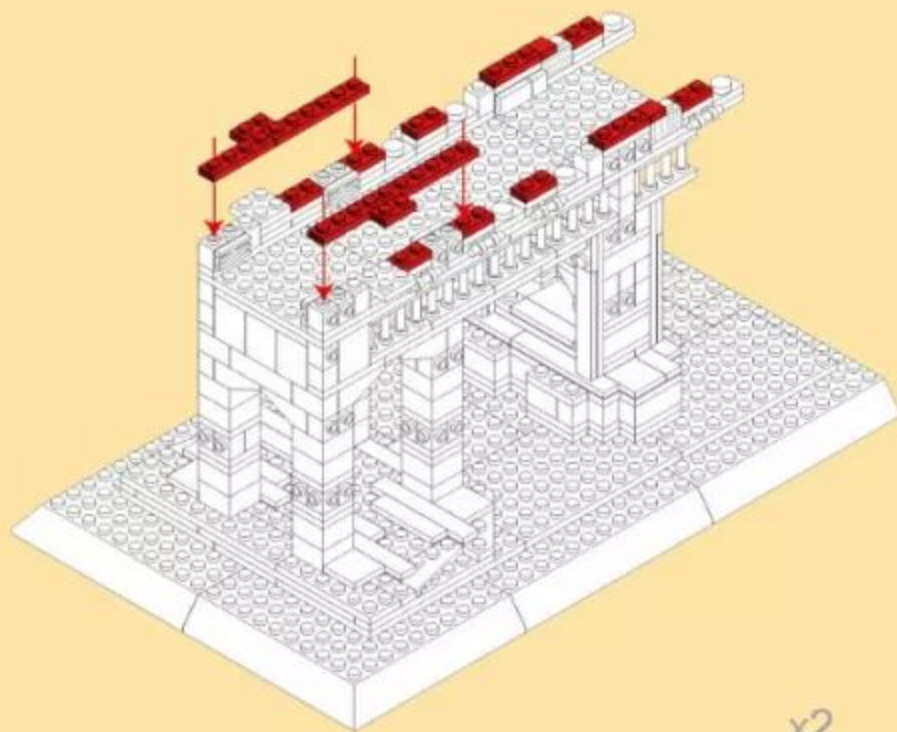

x2

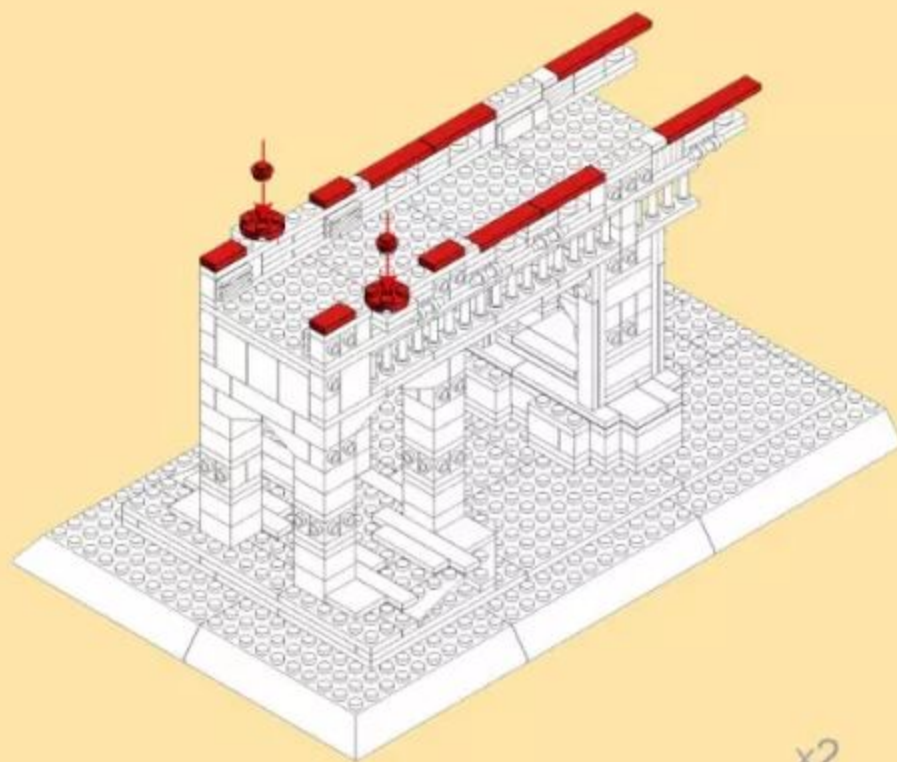

x2

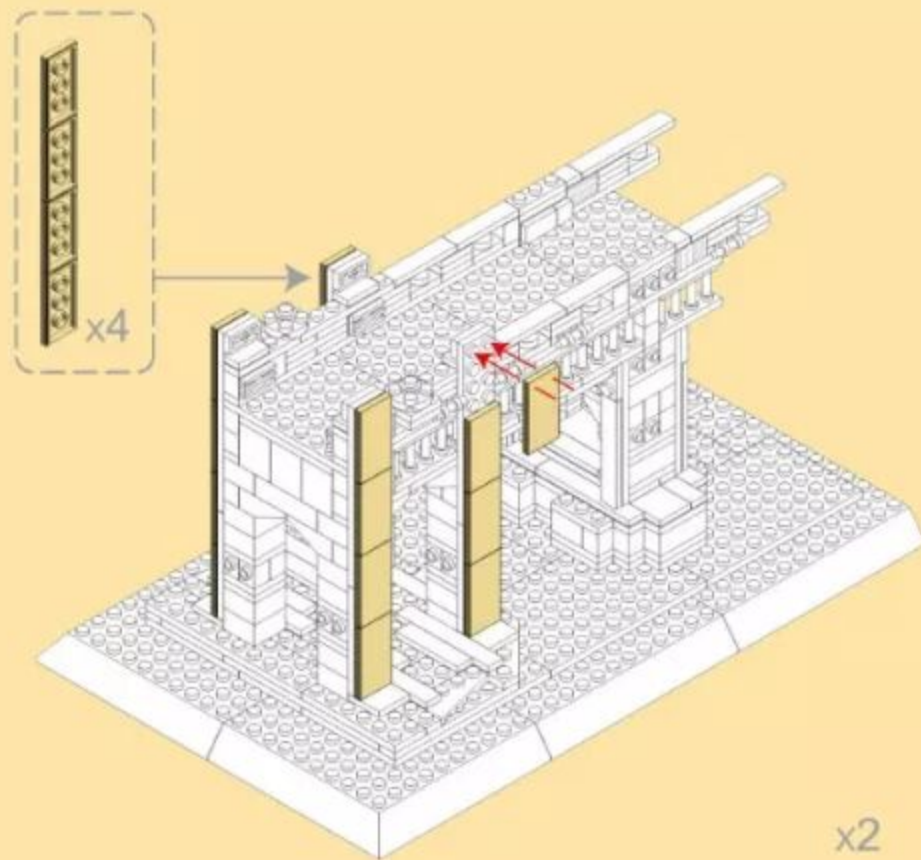
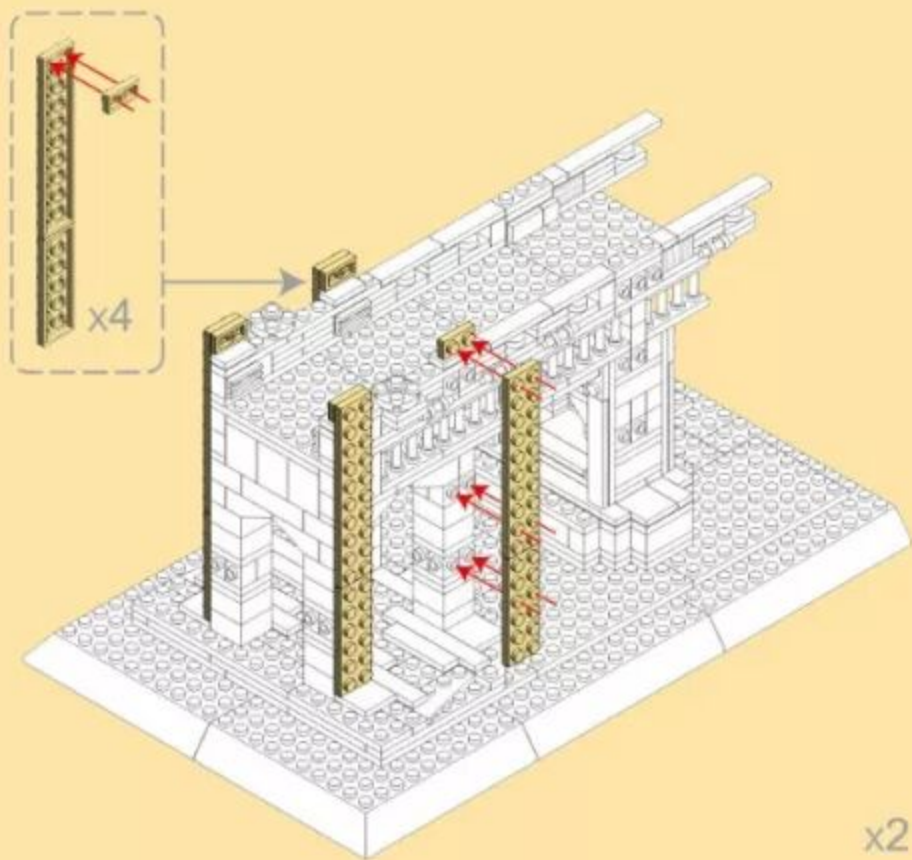
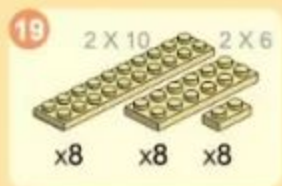

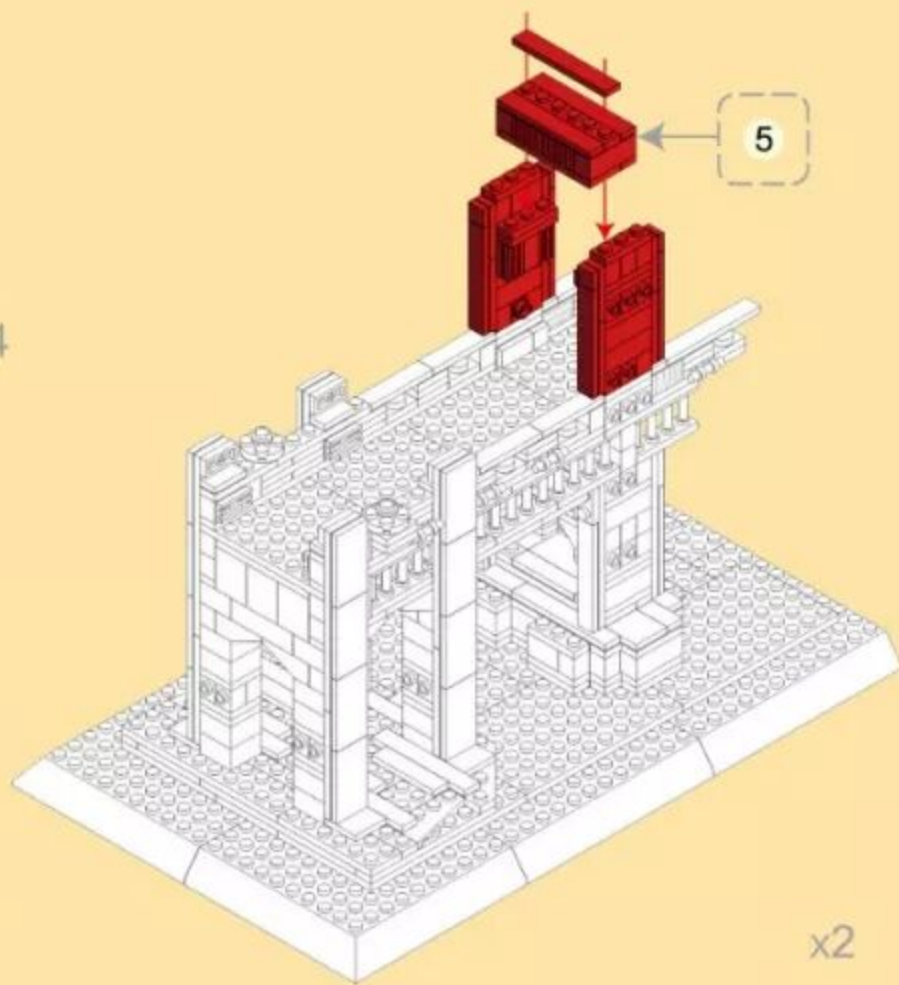
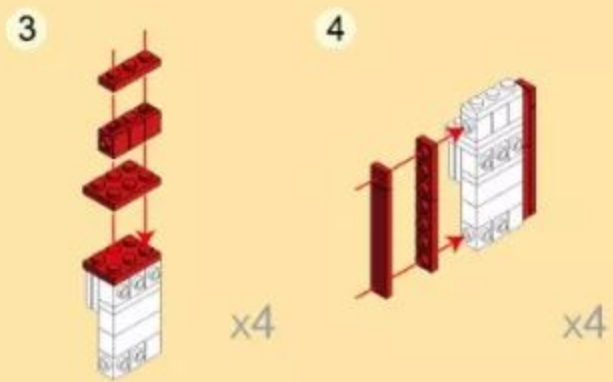
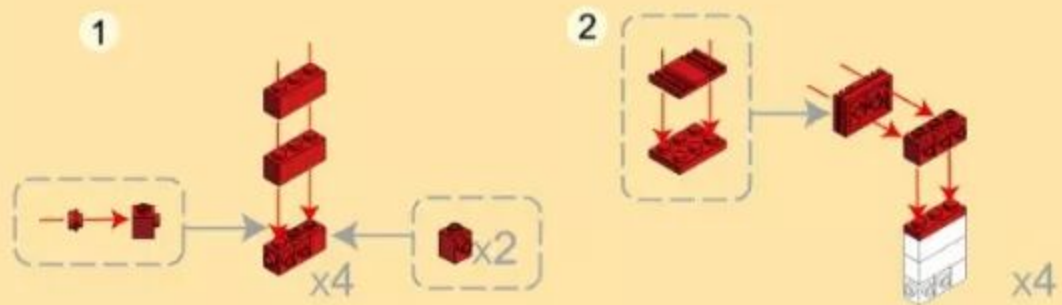

23

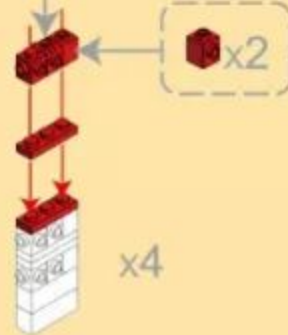
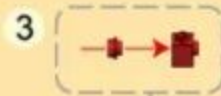
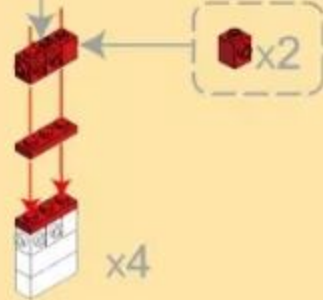
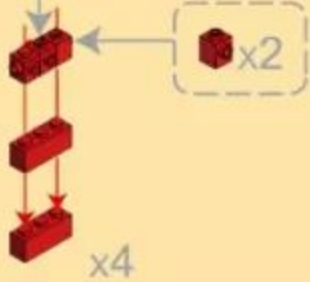
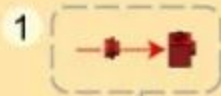

4

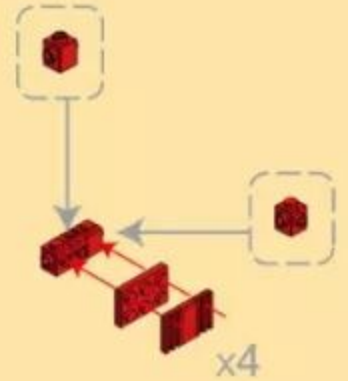

5



6

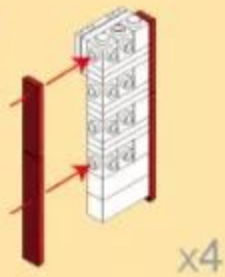

7



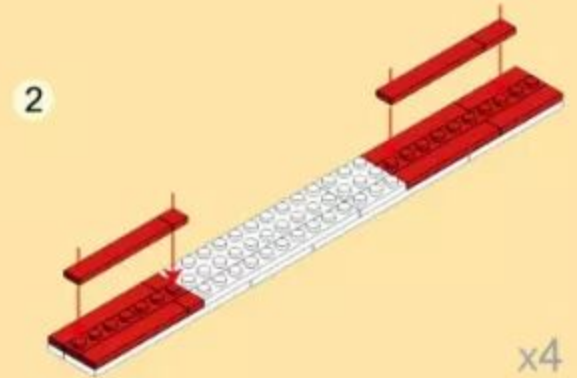
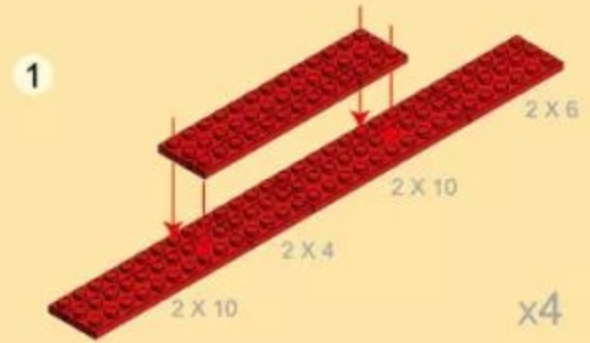
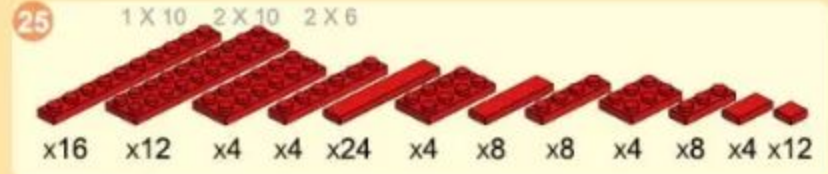
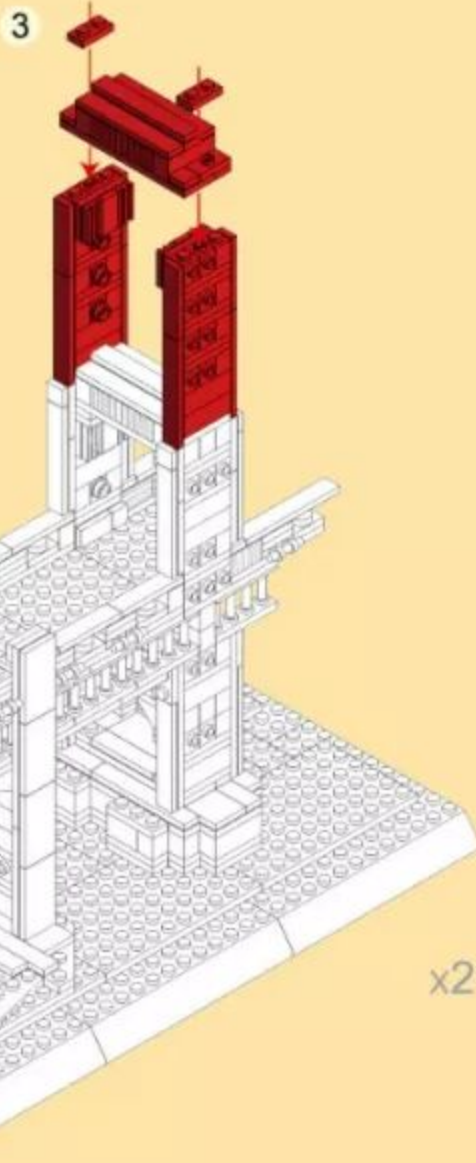
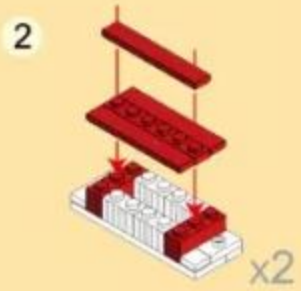
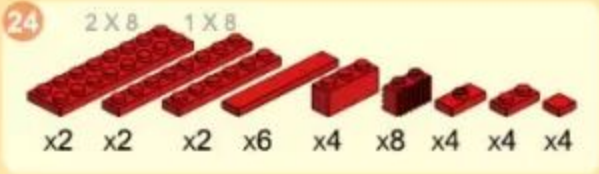

26 1 X 10
 x4 x12 x16 x24 x36

27
 24 + 26

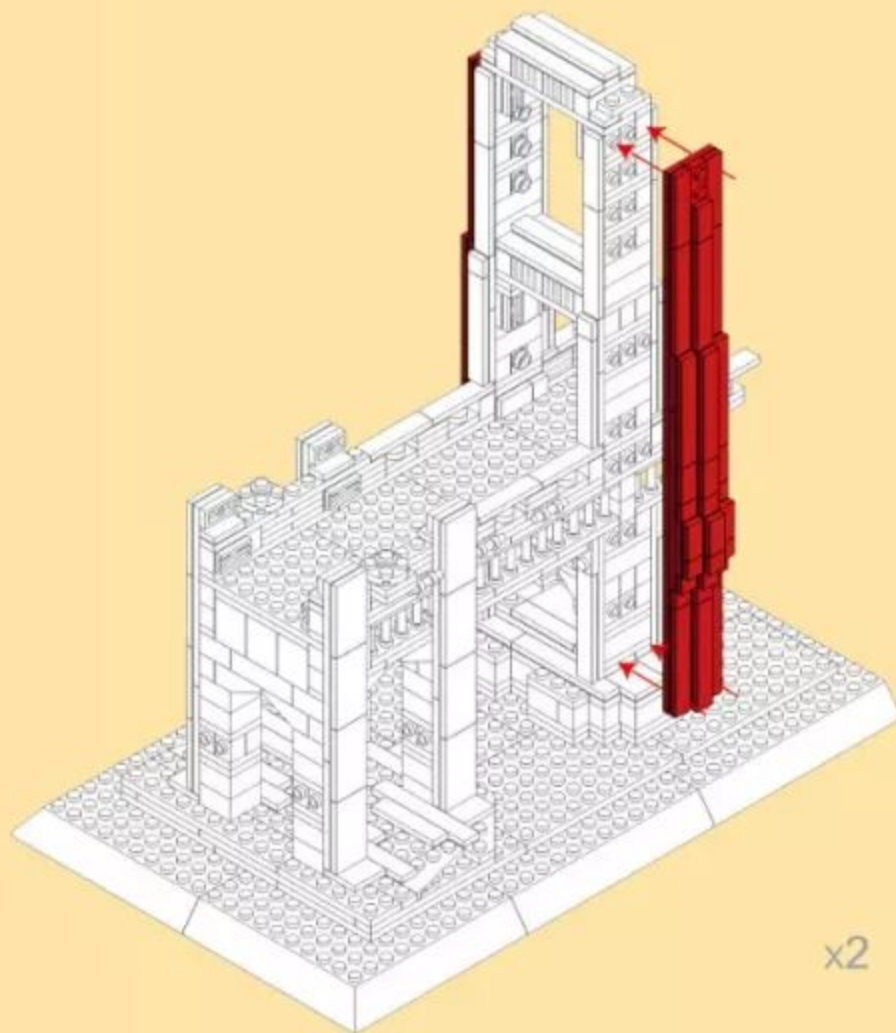
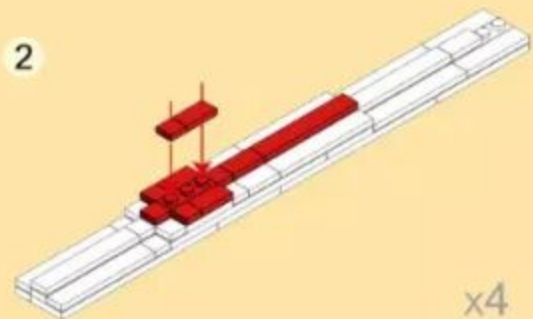
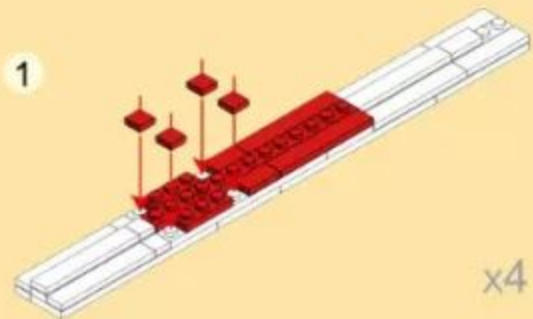

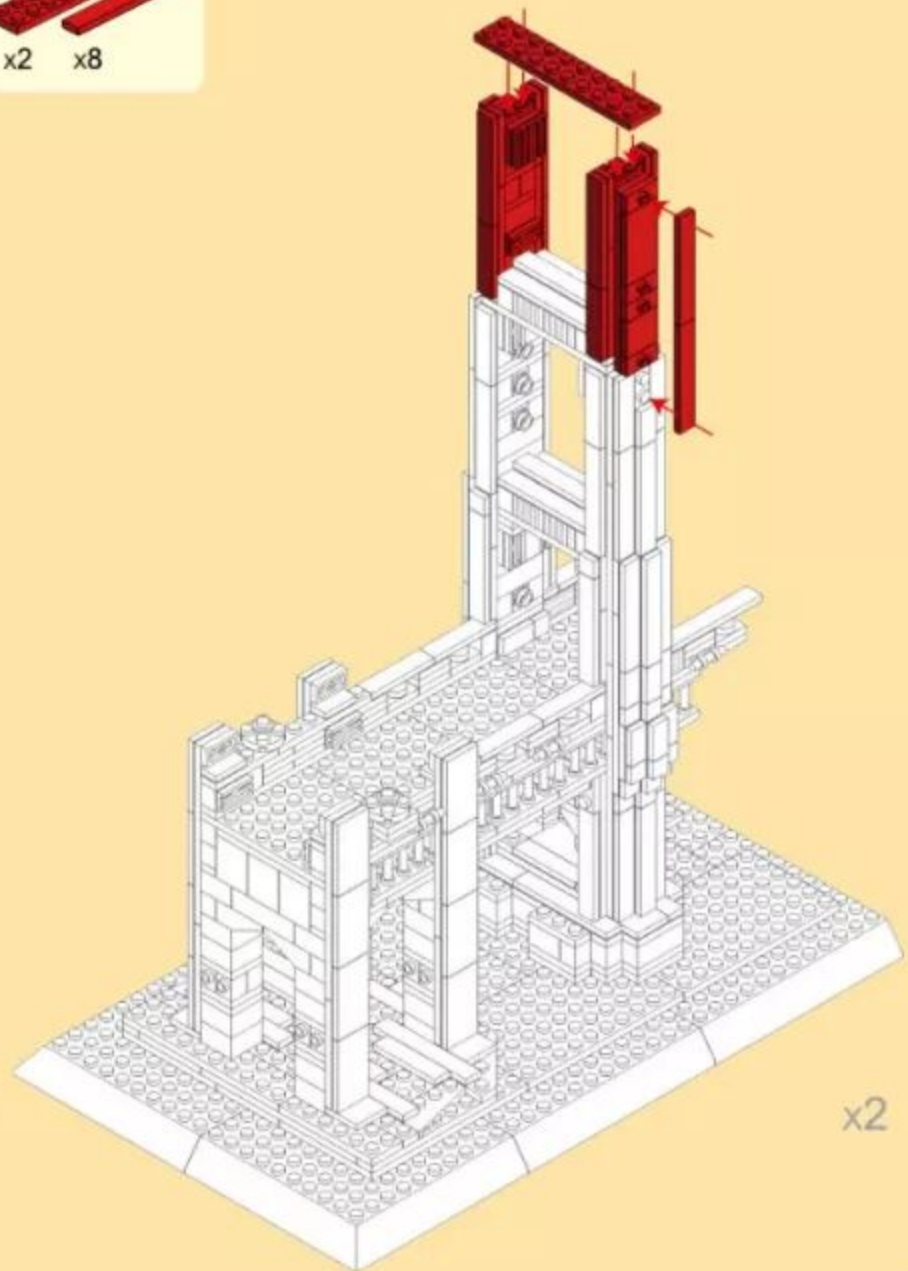
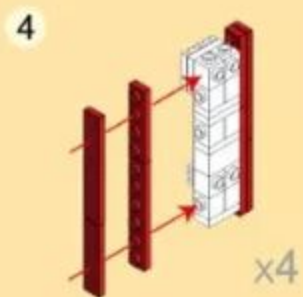
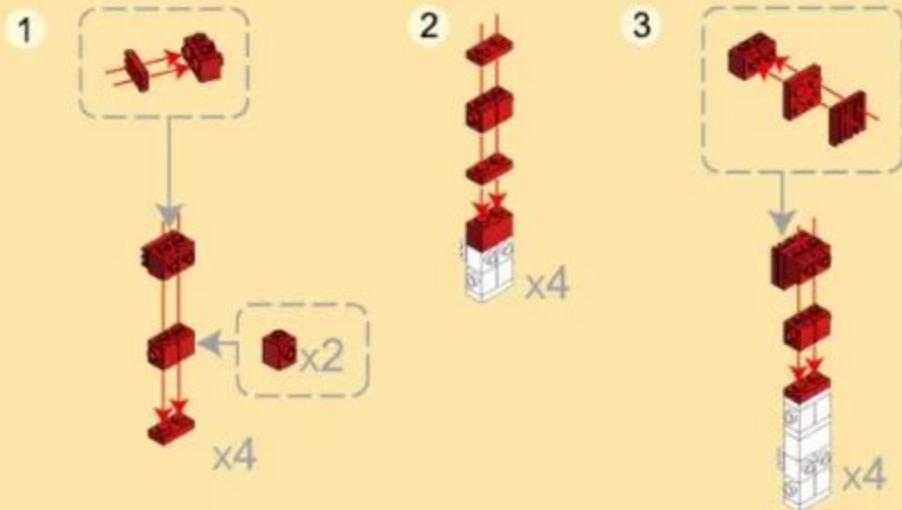
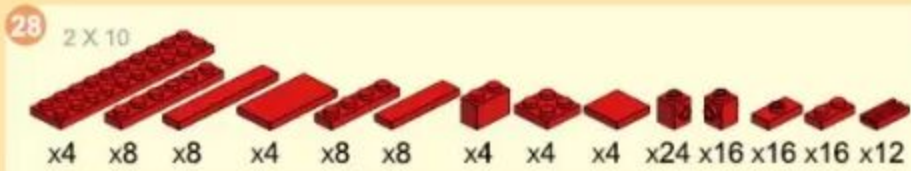

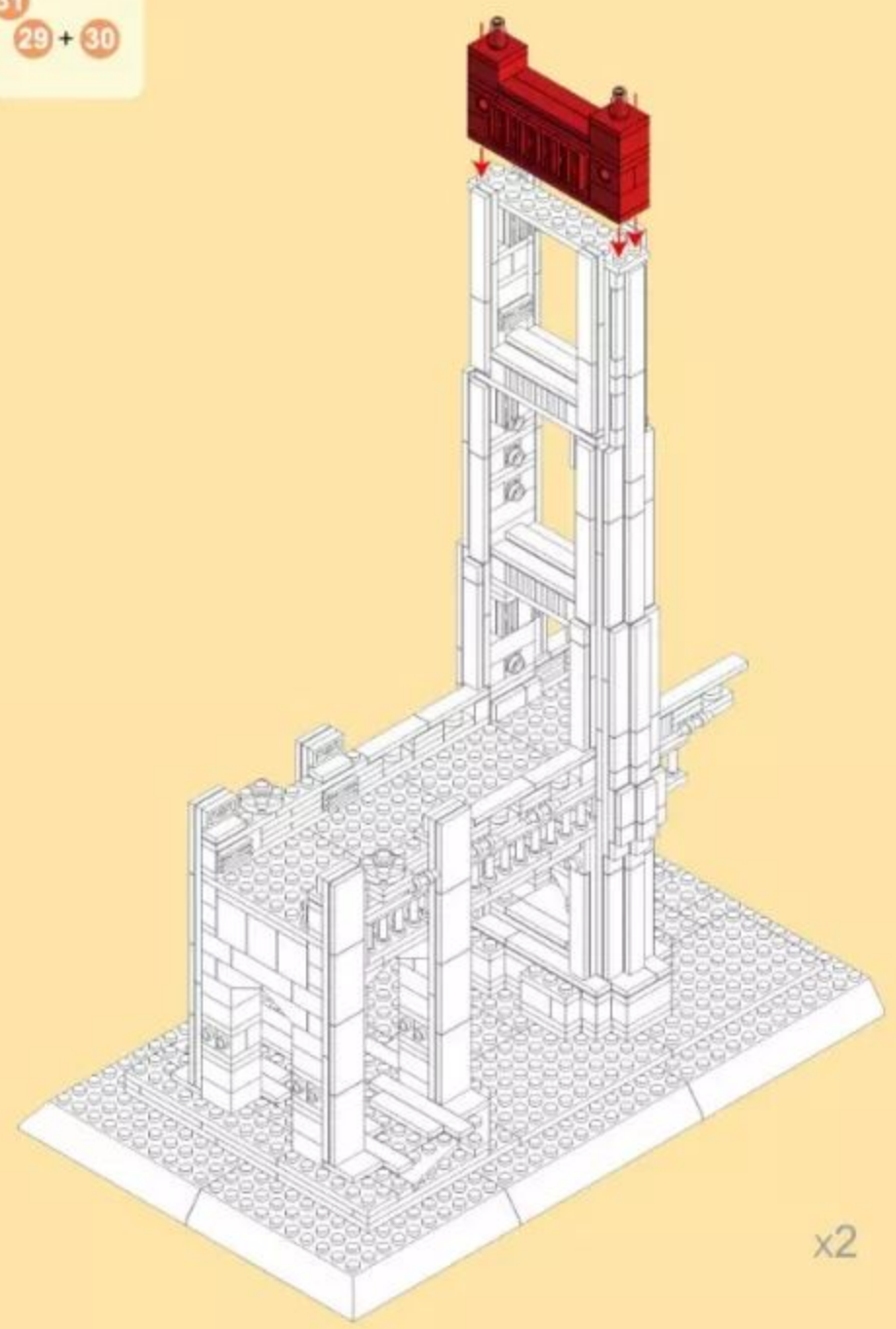
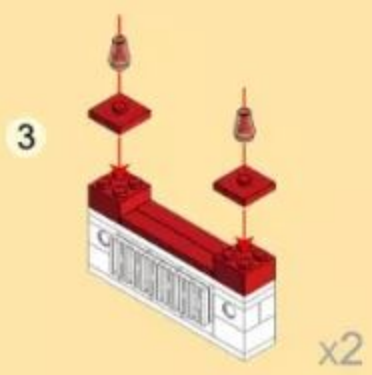
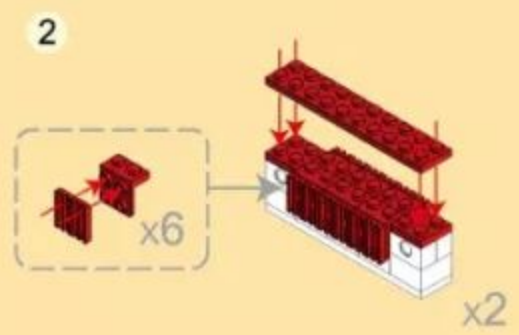
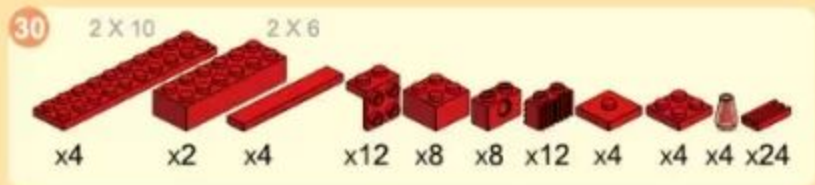

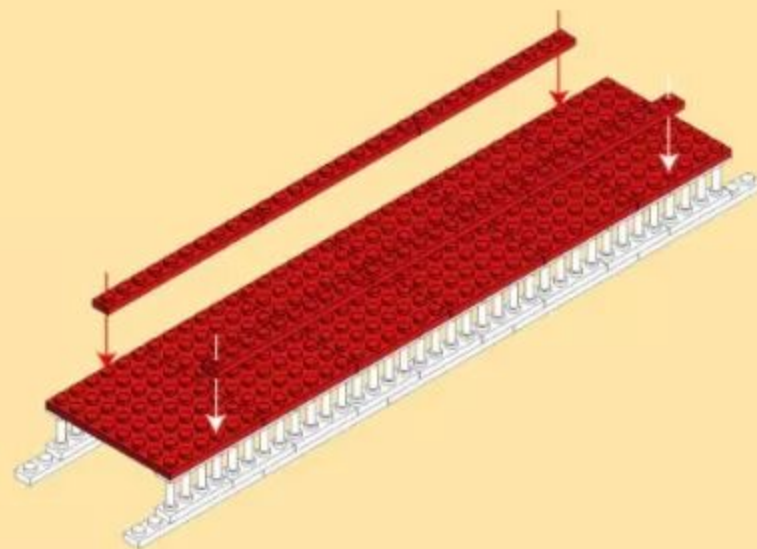

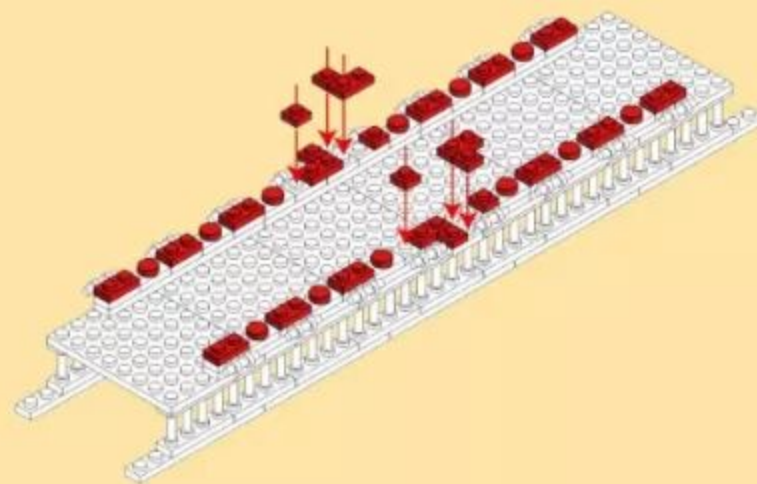
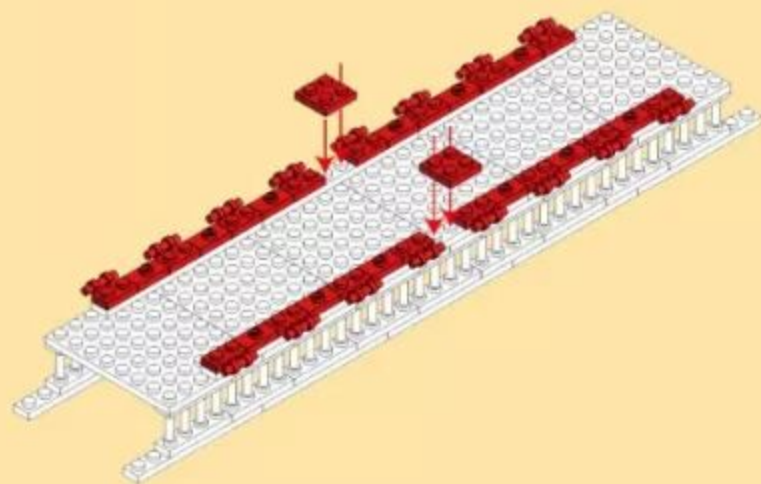

36



x12 x2 x4 x16

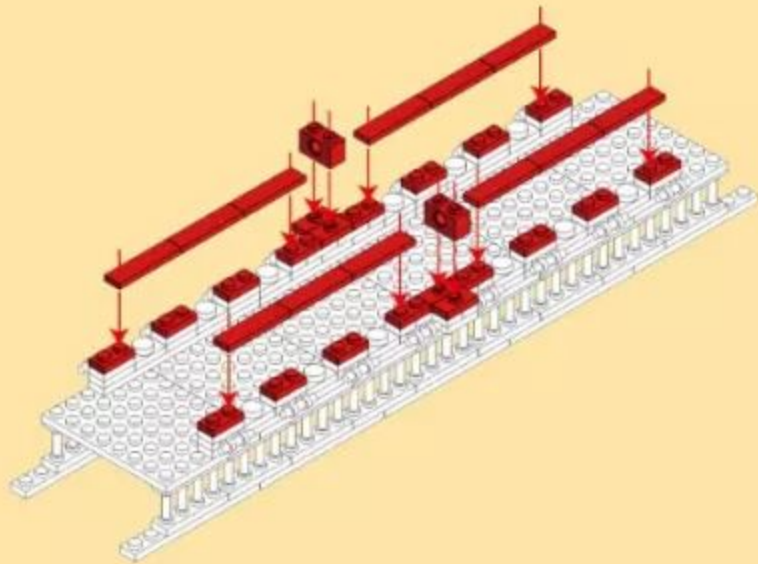

37

4 X 6



x1

x1



38

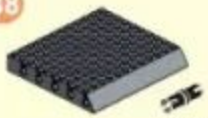

x4 x42

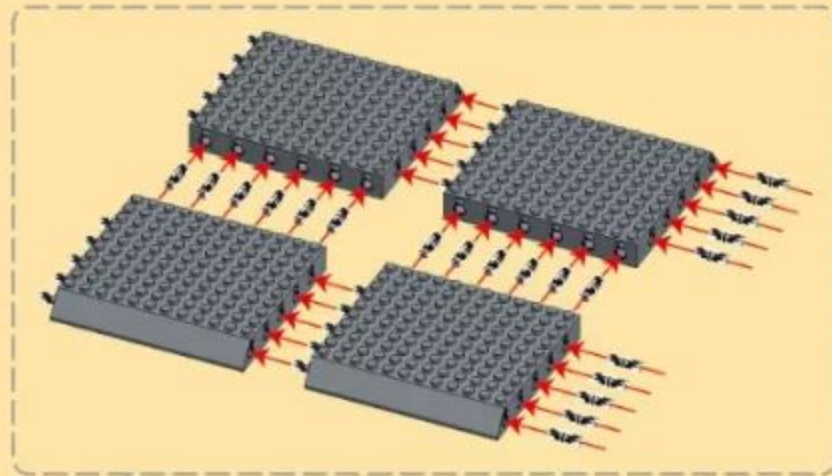
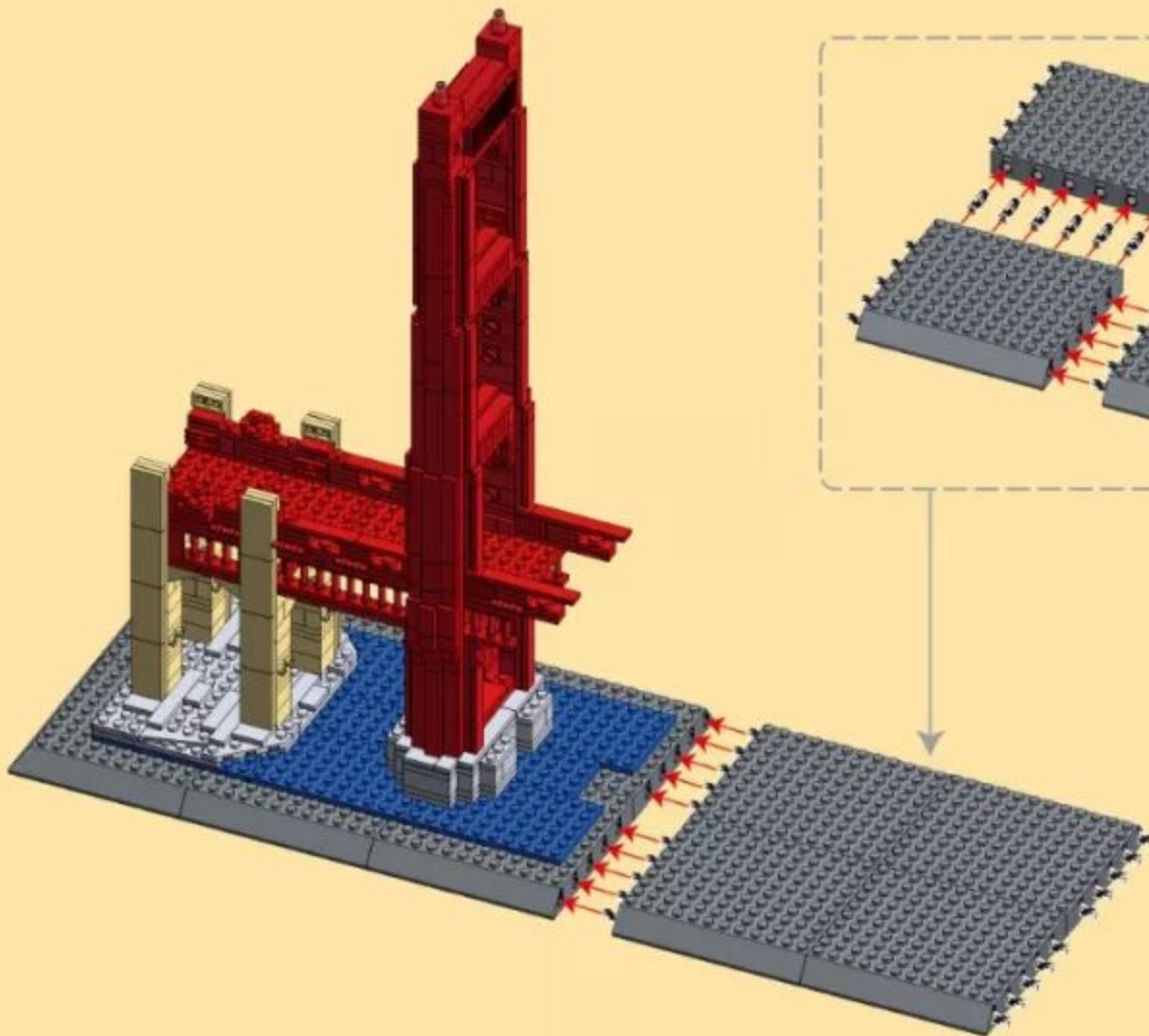

39

31 + 38

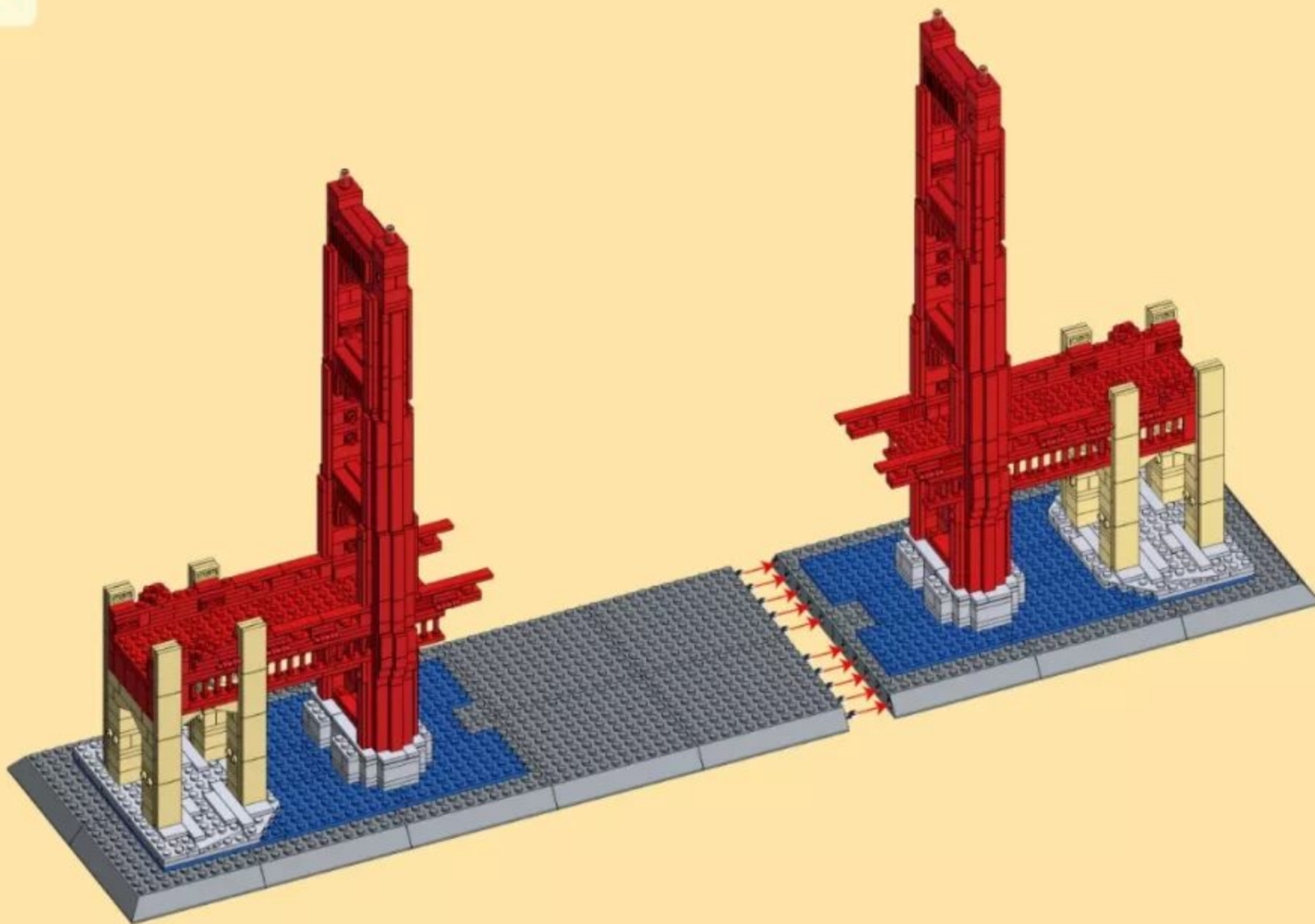

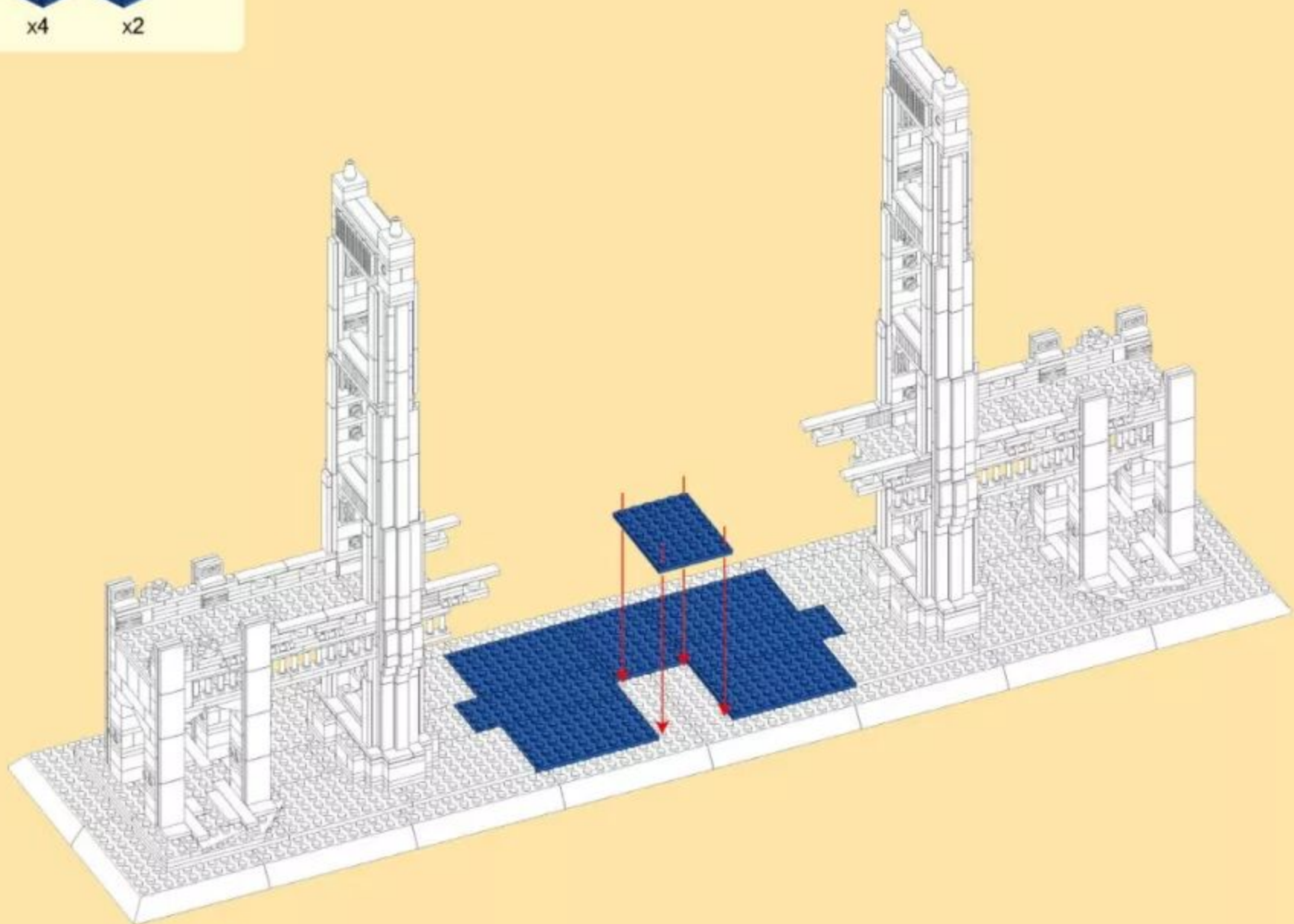
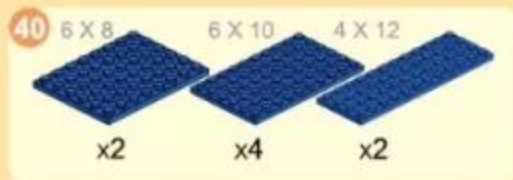

41

36 + 40

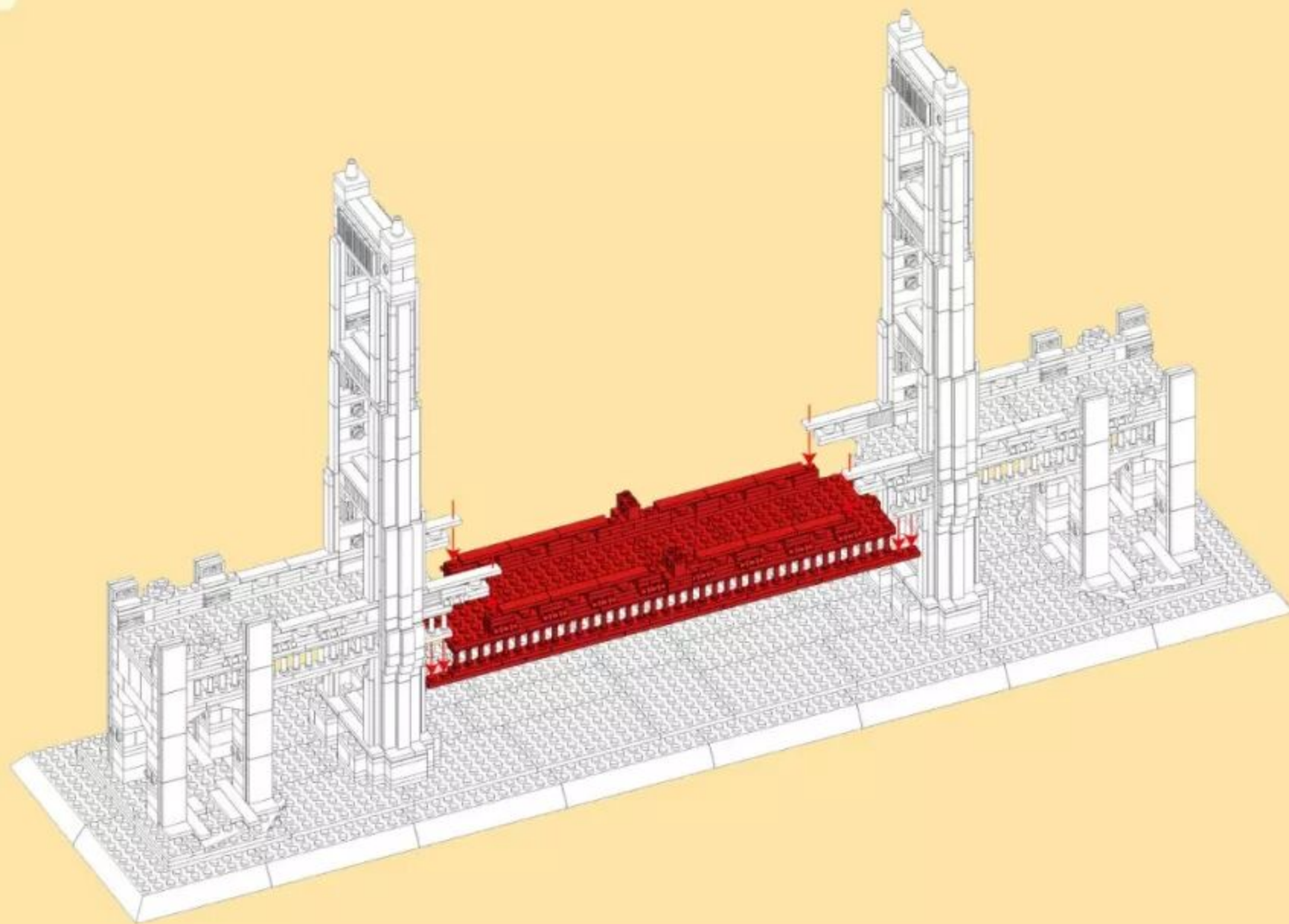

42

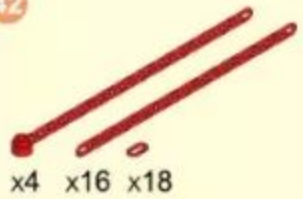

1



2



3

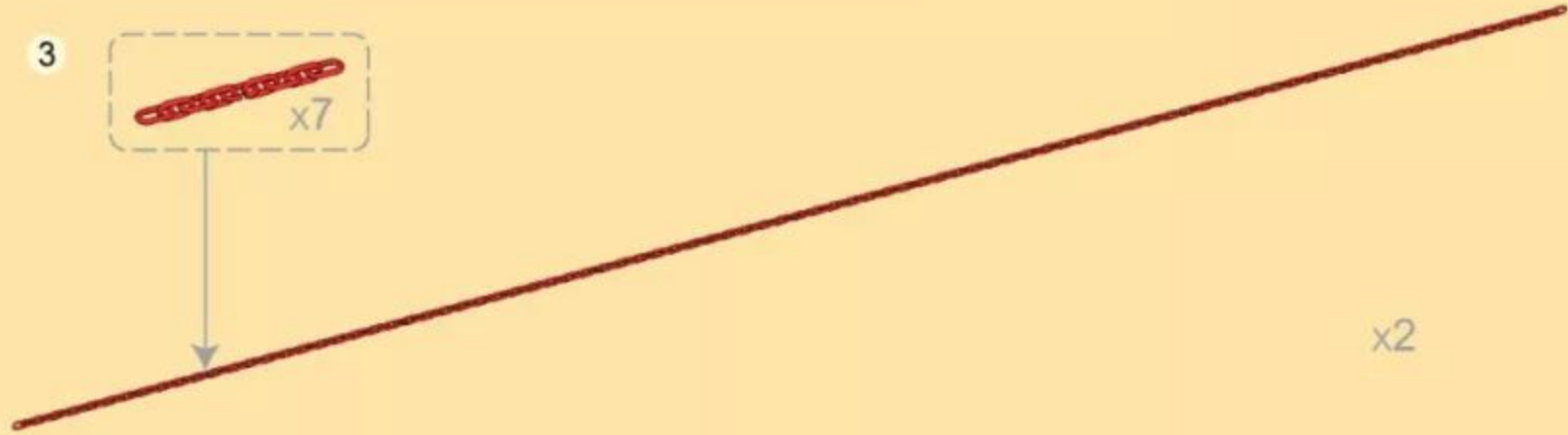

43

41 + 42

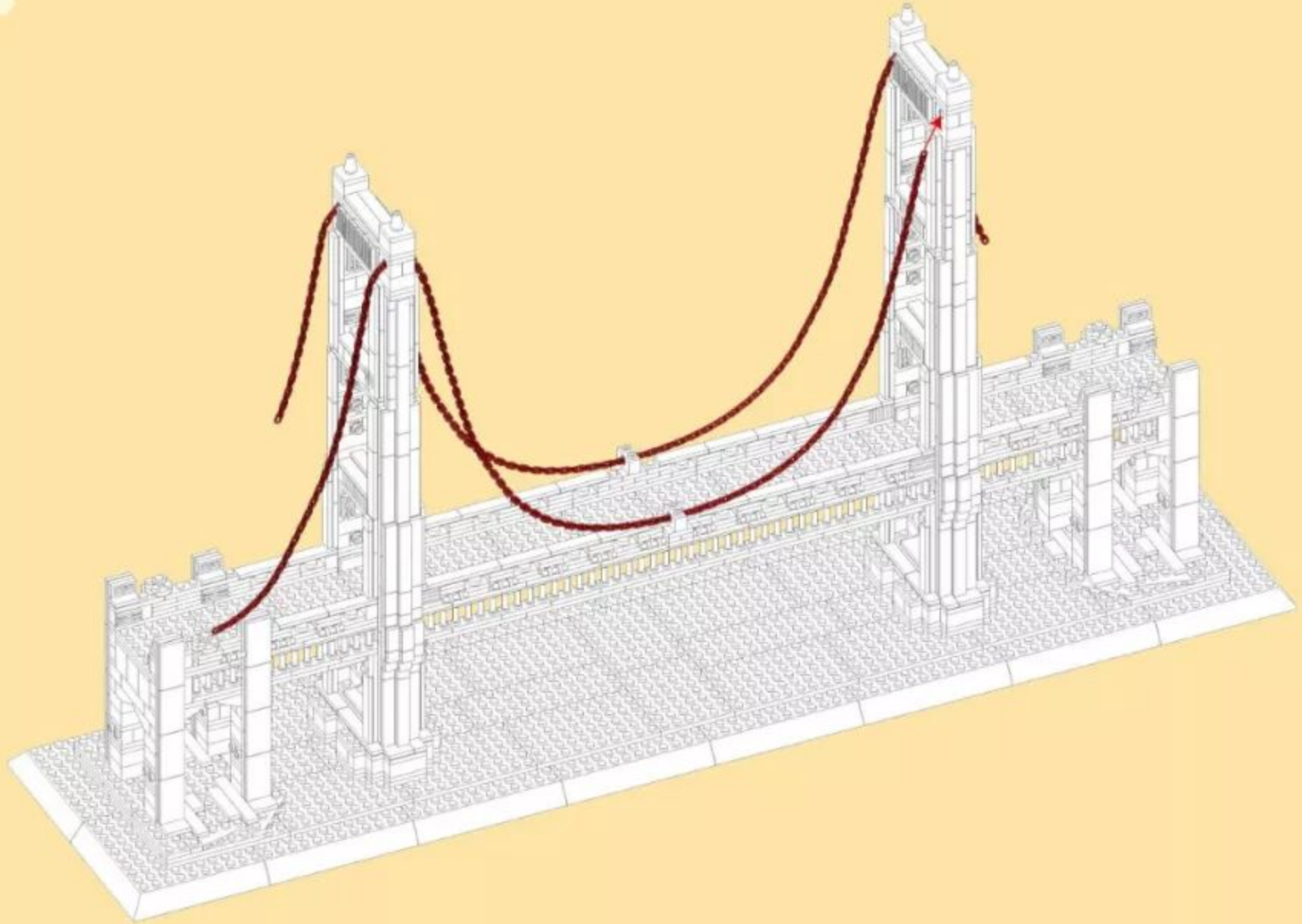

44
37 + 41 + 42 ●
x4

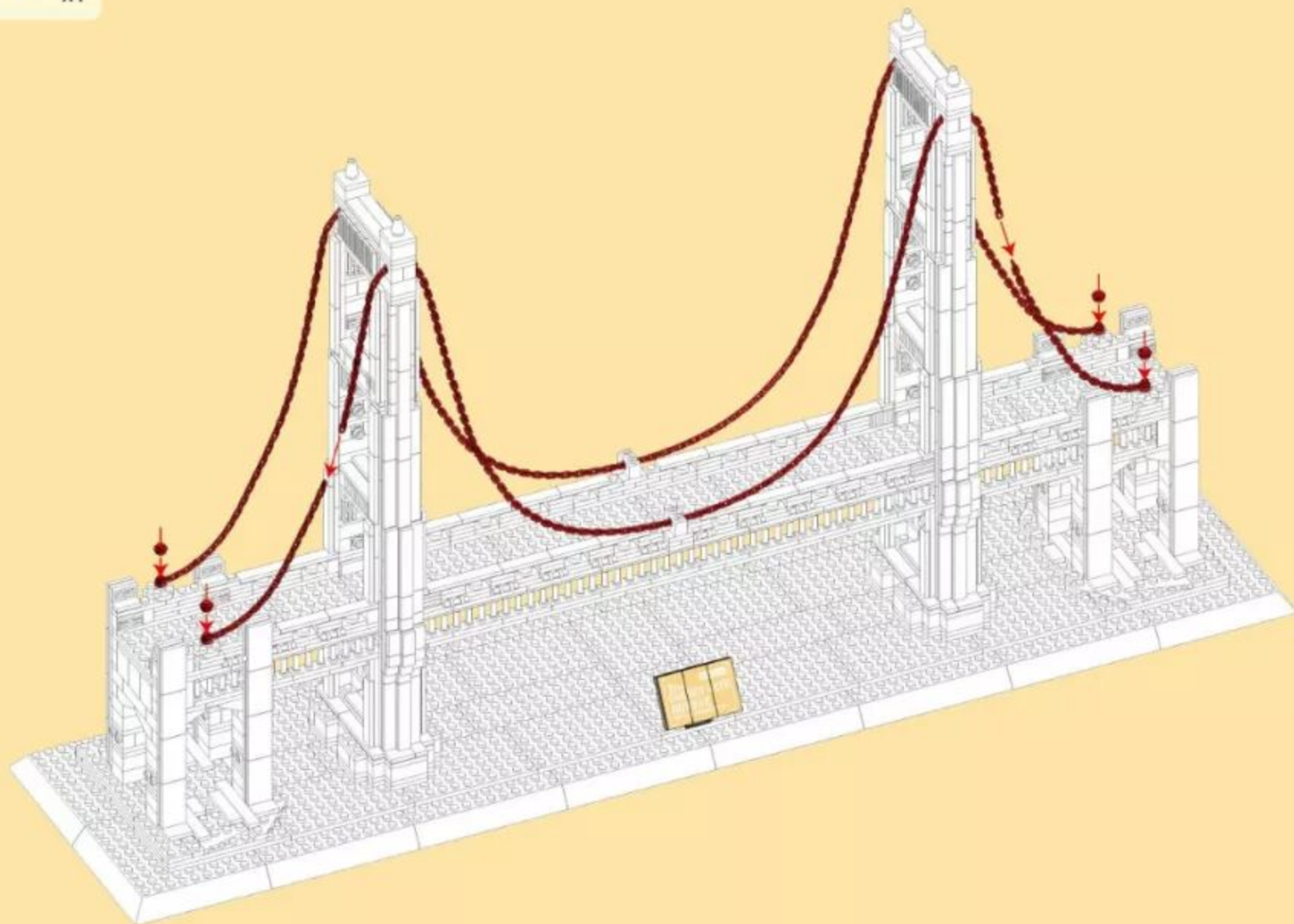



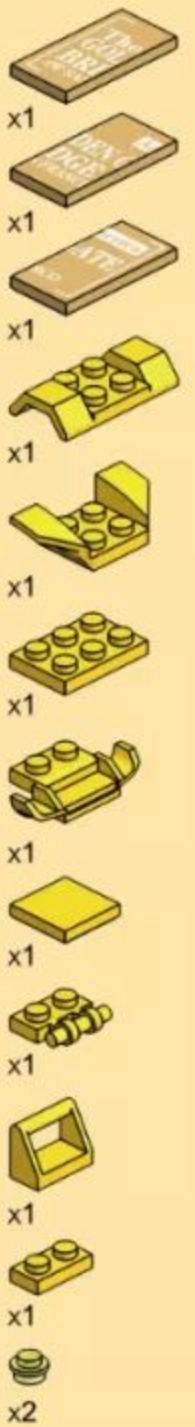
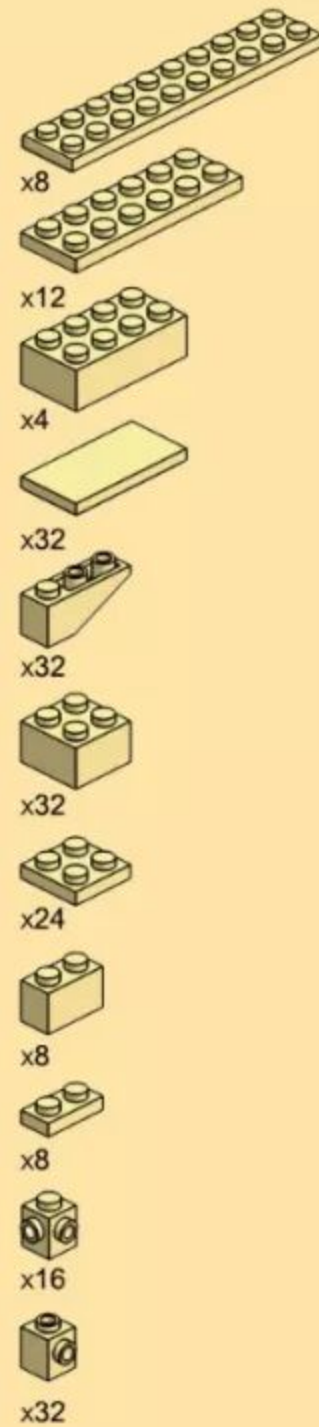
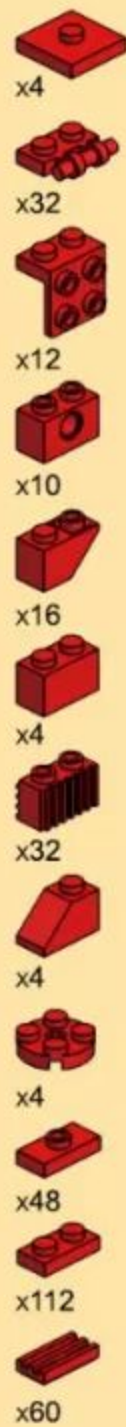
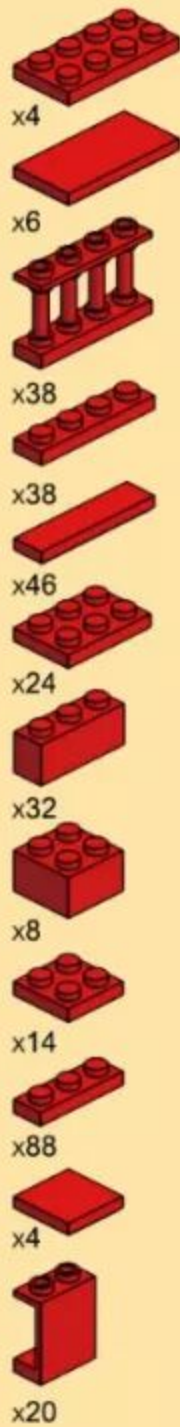
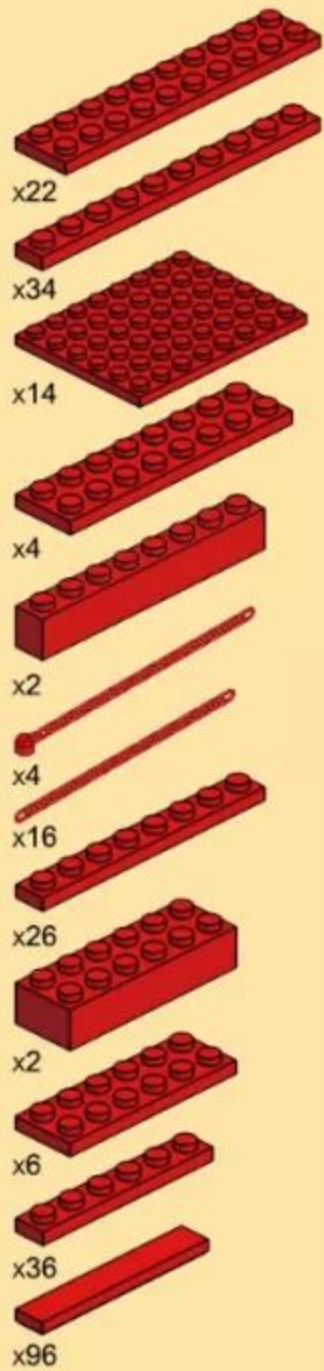



x12

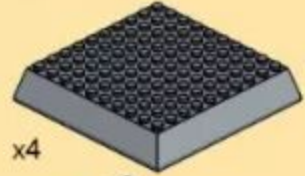

x4



x1



x1



x4



x116



x8



x2



x2



x2



x1



x6



x2



x16



x3



x1



x2



x3



x4



x1



x1



x2

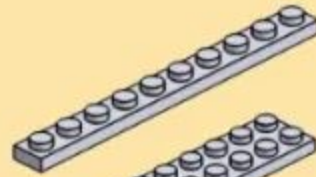

x4

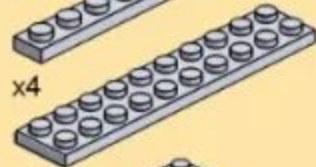

x2



x2



x2



x4

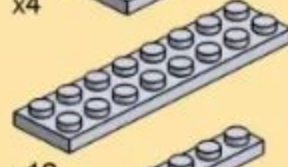

x12

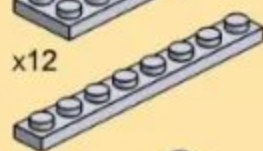

x6



x3

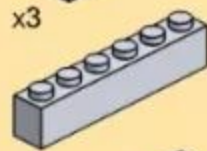

x4



x12

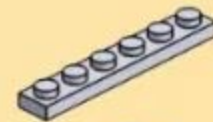

x2



x8



x2



x2



x2



x4



x8

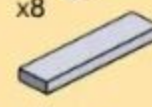

x11



x8



x1



x8



x8

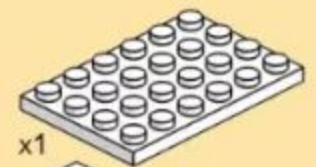

x1



x1



x1



x8



x3



x44



x12



x8



x1



x2



x20

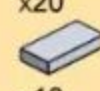

x10



x2

GOLDEN GATE

BRIDGE OF SANFRANCISCO

INTRODUCTION

The Golden Gate Bridge is a suspension bridge spanning the Golden Gate, the one-milewide (1.6 km) strait connecting San Francisco Bay and the Pacific Ocean. The structure links the American city of San Francisco, California – the northern tip of the San Francisco Peninsula – to Marin County, carrying both U.S. Route 101 and California State Route 1 across the strait. The bridge is one of the most internationally recognized symbols of San Francisco, California, and the United States. It has been declared one of the Wonders of the Modern World by the American Society of Civil Engineers.

The Frommer's travel guide describes the Golden Gate Bridge as "possibly the most beautiful, certainly the most photographed, bridge in the world." [8] It opened in 1937 and was, until 1964, the largest suspension bridge main span in the world, at 4,200 feet (1,280 m).

