



LONDON EYE

London Eye

London, England

The world's great architecture



6+ / 6215 / 1528PCS
Suitable Age / Product Number / Parts Total

Perseverance

积木匠心·颗粒匠者



The Temple of Heaven



The Eiffel Tower



The Brandenburg Gate



The Leaning Tower Of Pisa



The Taj Mahal



The Big Ben



The White House



The Burj Al-Arab Hotel



The Golden Gate Bridge



The CN Tower



The Spasskaya Tower



The Triumphal Arch

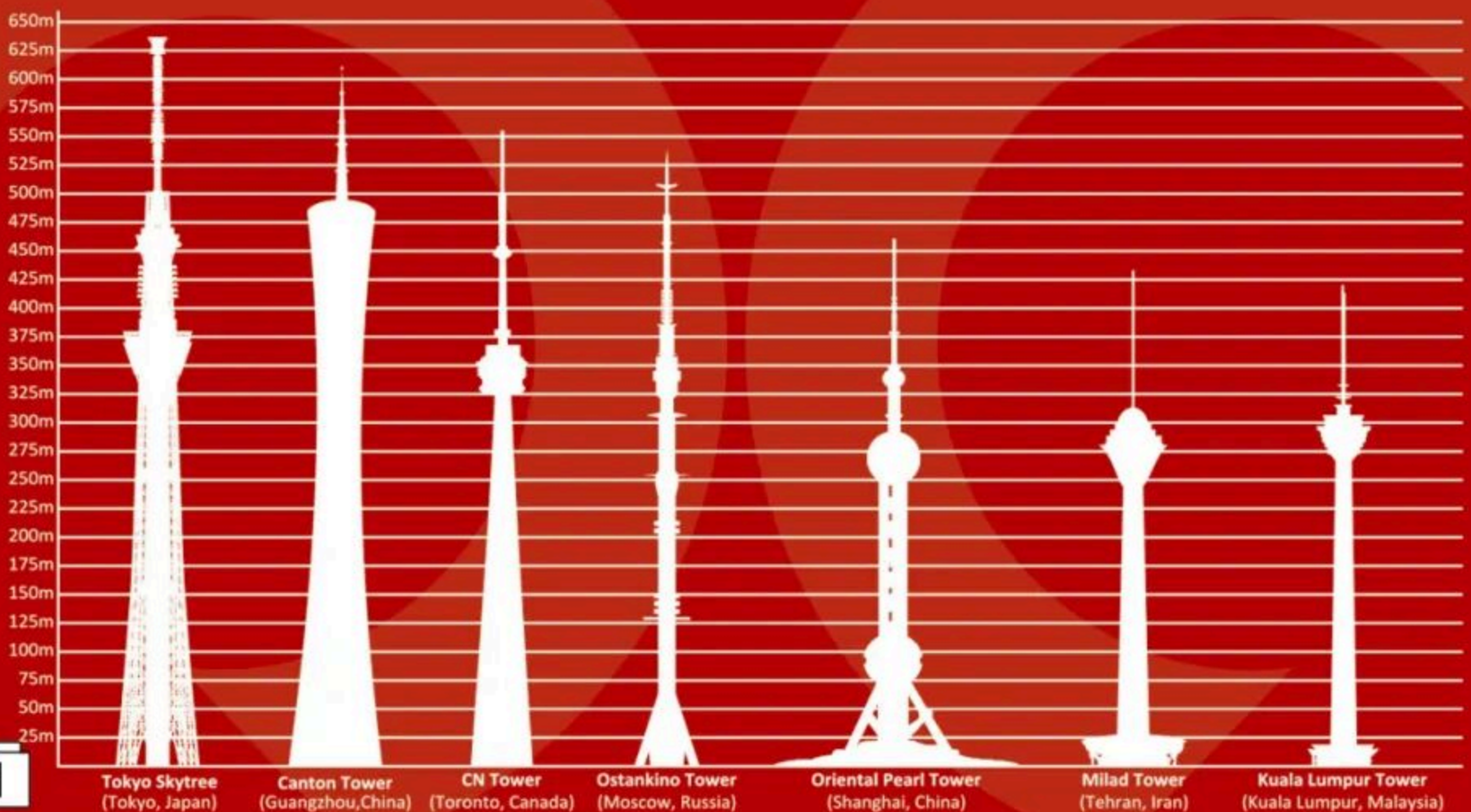



Architecture

It will be a city...

这将构成一座城市...



Building Block

The world's great architecture

3D construction

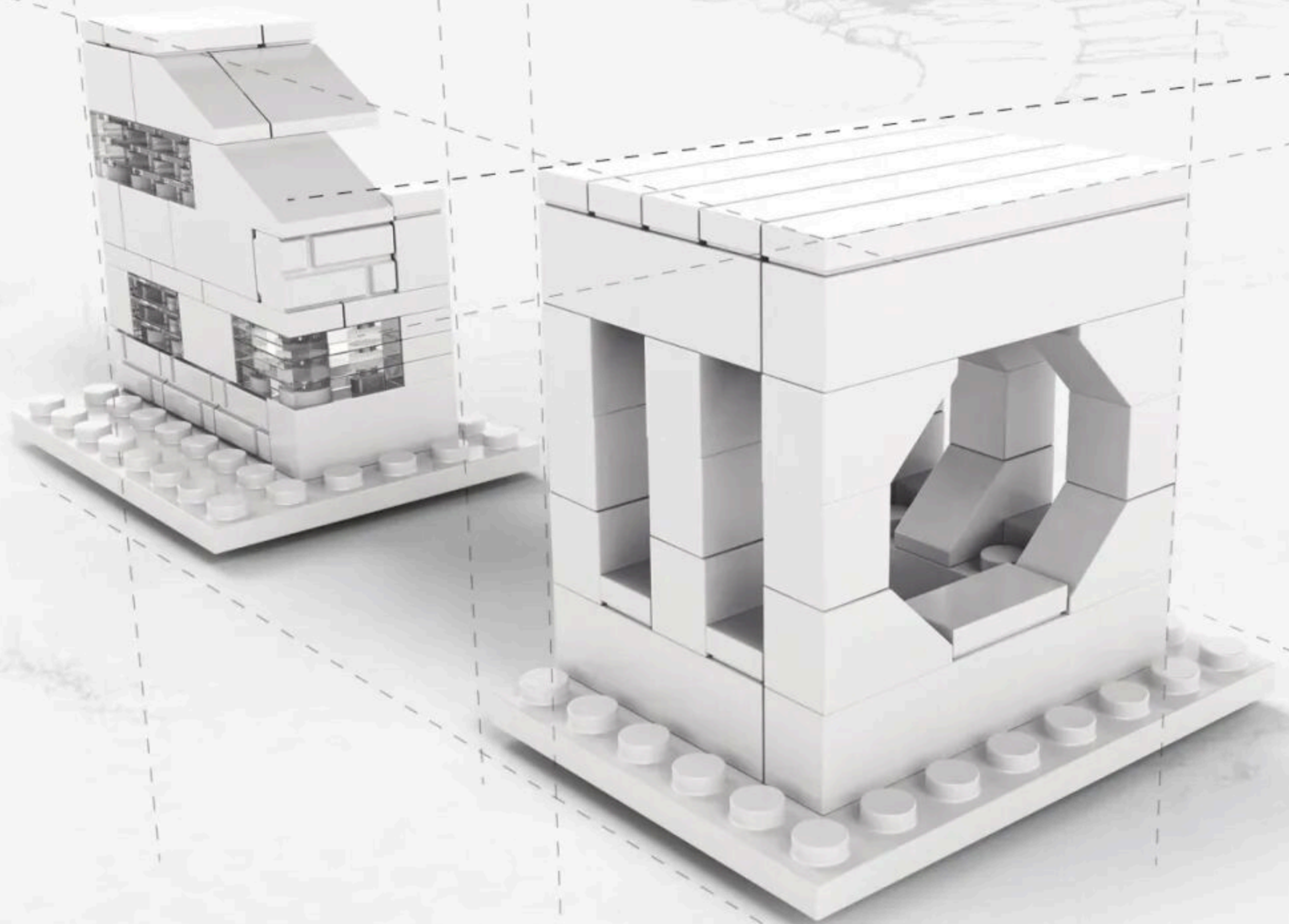

proportion

对产品精确分析运用3维技术最大限度还原实物比例

Accurate analysis of the product, using 3D technology to maximize the reduction of physical objects.

Creativity

外观设计结合黄金比例更好展现美感

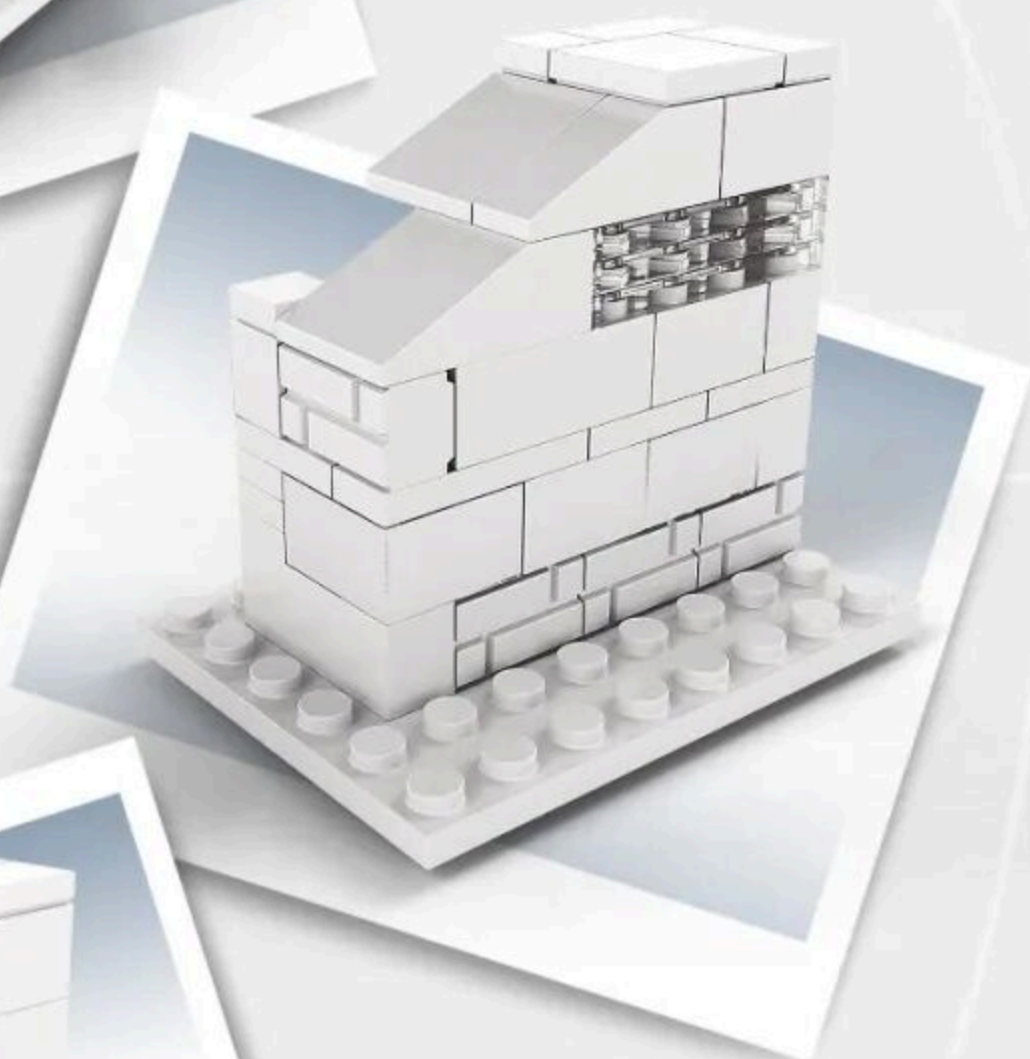
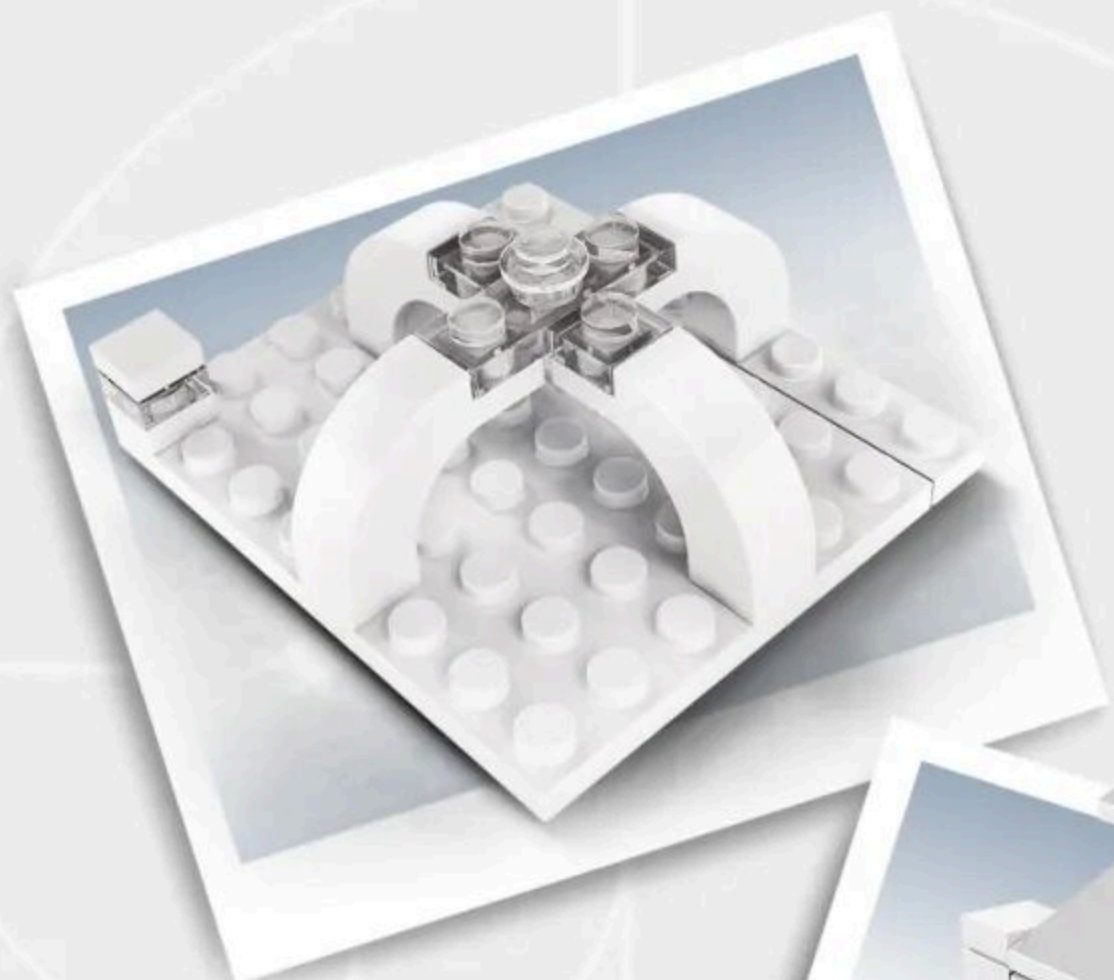

Architecture

Use the golden ratio in the design and development of the product to better show the beauty of the product.

Instructions For Use

积木起件器使用说明
Brickseparator

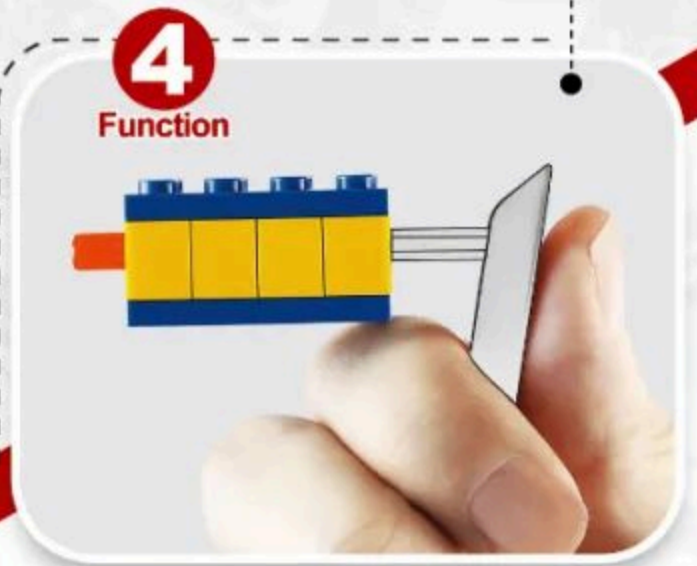
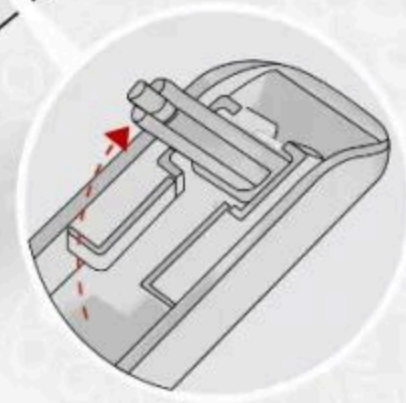
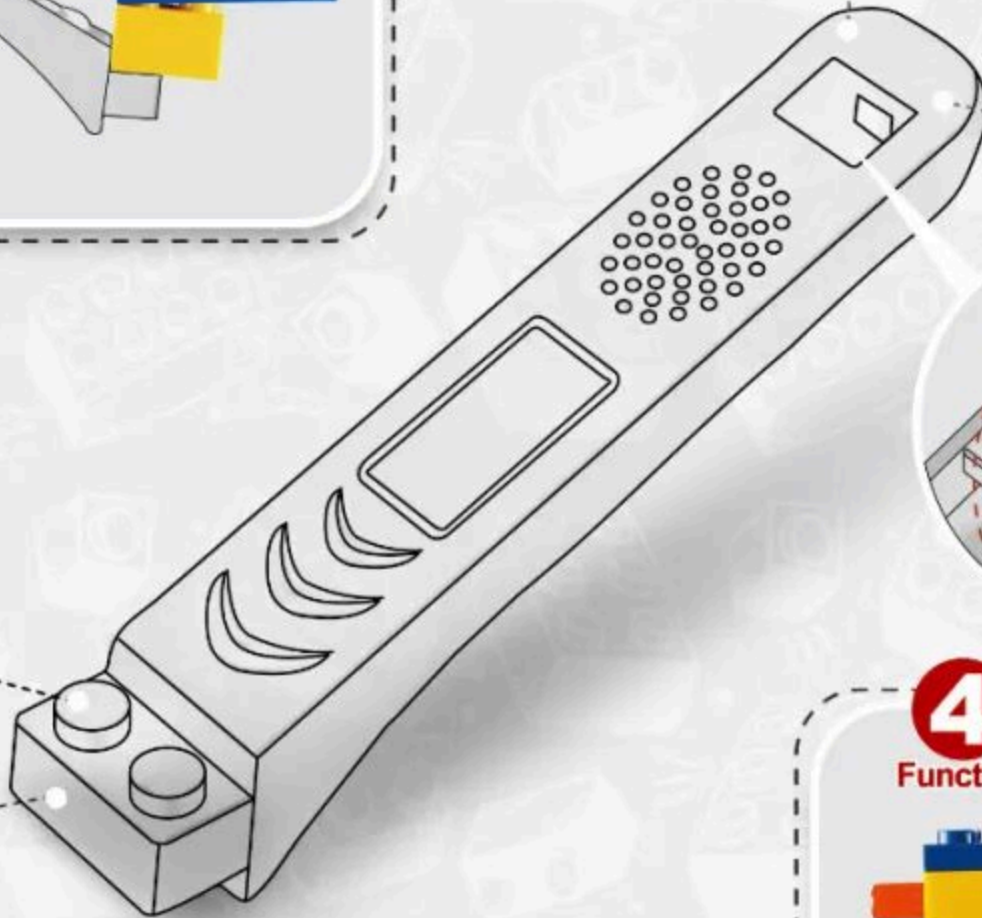
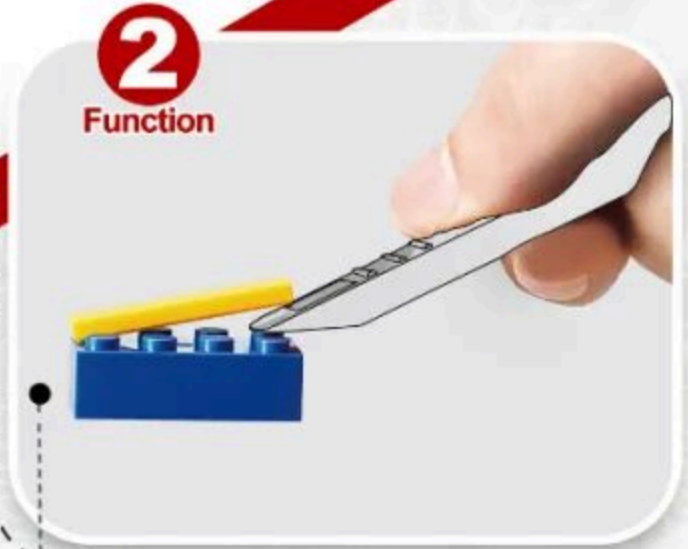
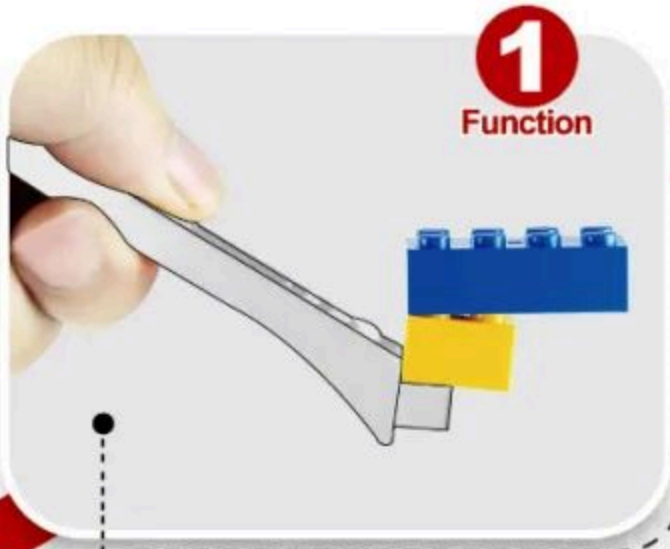

4 ways to make installation easier
让安装更简单



■ First open the product packaging according to the instructions.

按指导用正确方式拆解产品外包装。



■ Summarize all parts to count the number of familiar accessories.

对照说明书清单确认积木包数量与积木数量。



■ Arranging all accessories by color helps to quickly install the product.

把确认好的积木以类型、颜色进行分类排好以便安装。



■ Carefully install the product and learn about building.

按说明书步骤拼装并完成你的积木模型。



1:1 Physical Reference Table

十字棒配件1:1尺寸参照表



Instructions For Use

让安装更简单



2 $(1 \times 2) = 2$

3 $(1 \times 3) = 3$

4 $(1 \times 4) = 4$

5 $(1 \times 5) = 5$

6 $(1 \times 6) = 6$

7 $(1 \times 7) = 7$

8 $(1 \times 8) = 8$

9 $(1 \times 9) = 9$

10 $(1 \times 10) = 10$

12 $(1 \times 12) = 12$

16 $(1 \times 16) = 16$

ABOUT THE PRODUCT

关于产品

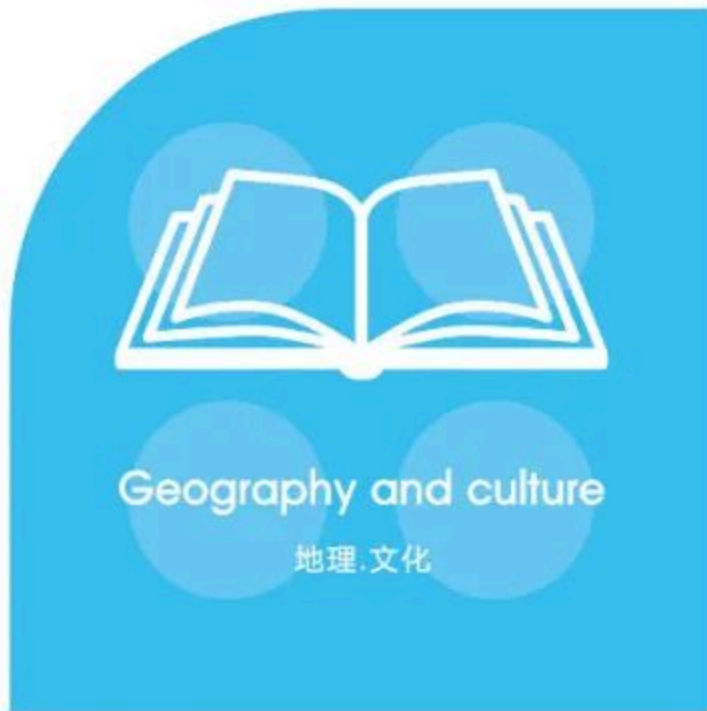

ARCHITECT

WANGE The world's great architect since 1991

The London Eye

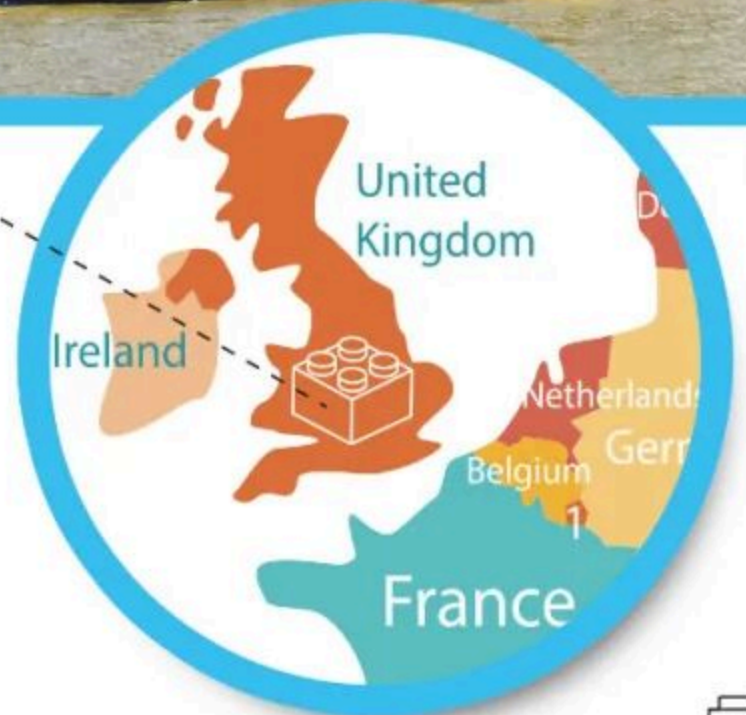

The London Eye, or the Millennium Wheel, is a cantilevered observation wheel on the South Bank of the River Thames in London.

The Millennium Wheel



Geography and culture

地理.文化



It is Europe's tallest cantilevered observation wheel, and is the most popular paid tourist attraction in the United Kingdom with over 3 million visitors annually, and has made many appearances in popular culture.





英国伦敦眼

The London Eye ■

England

The contents of this chapter refer to the Wikipedia website.

本章内容参考维基百科网站，更多资讯可自行查阅。

The world's great architecture

About The Building



The London Eye, or the Millennium Wheel, is a cantilevered observation wheel on the South Bank of the River Thames in London. It is Europe's tallest cantilevered observation wheel, and is the most popular paid tourist attraction in the United Kingdom with over 3 million visitors annually, and has made many appearances in popular culture.

The structure is 135 metres (443 ft) tall and the wheel has a diameter of 120 metres (394 ft). When it opened to the public in 2000 it was the world's tallest Ferris wheel. Its height was surpassed by the 160-metre (525 ft) Star of Nanchang in 2006, the 165-metre (541 ft) Singapore Flyer in 2008, and the 167-metre-tall (547.9 ft) High Roller (Las Vegas) in 2014. Supported by an A-frame on one side only, unlike the taller Nanchang and Singapore wheels, the Eye is described by its operators as "the world's tallest cantilevered observation wheel".



Design And Construction

The London Eye was designed by the husband-and-wife team of Julia Barfield and David Marks of Marks Barfield Architects.

Mace was responsible for construction management, with Hollandia as the main steelwork contractor and Tilbury Douglas as the civil contractor. Consulting engineers Tony Gee & Partners designed the foundation works while Beckett Rankine designed the marine works.

Nathaniel Lichfield and Partners assisted The Tussocks Group in obtaining planning and listed building consent to alter the wall on the South Bank of the Thames.



Passenger Capsules

The wheel's 32 sealed and air-conditioned ovoidal passenger capsules, designed and supplied by Poma, are attached to the external circumference of the wheel and rotated by electric motors. The capsules are numbered from 1 to 33, excluding number 13 for superstitious reasons. Each of the 10-tonne (11-short-ton) capsules represents one of the London Boroughs, and holds up to 25 people, who are free to walk around inside the capsule, though seating is provided.



El London Eye es una gran noria situada en el South Bank del río Támesis en Londres, Reino Unido. Es la noria más alta de Europa y la atracción turística más popular del Reino Unido con más de 3,75 millones de visitantes al año.

Tiene 135 m de altura y el círculo de la noria tiene un diámetro de 120 m. Cuando abrió al público en el año 2000 era la noria más alta del mundo.

About The Building



El London Eye era el mirador público más alto de Londres¹⁰ hasta que fue superado por el mirador situado en la planta 72 de The Shard, a 245 m de altura, que abrió al público el 1 de febrero de 2013.

El London Eye linda con el lado oeste de los Jubilee Gardens (que previamente albergaron el antiguo Dome of Discovery), y está situado en el South Bank del río Támesis entre el Puente de Westminster y el Puente de Hungerford, junto al Salón Condal, en el Municipio de Lambeth.

Creation and thinking
创作·思考

Drawing Design

手绘设计



Shantou VeryFun Toys & Nursery Co., Ltd.
©2014 Wange / Dubie. All Rights Reserved

Creation and thinking
创作.思考

Drawing Design

手绘设计



Shantou VeryFun Toys & Nursery Co., Ltd.
©2014 Wange / Dubie. All Rights Reserved

Design Points

结构难点

Angle calculation
角度的计算

$$S=4\pi\cdot r^2$$

$$a^2+b^2=c^2$$



$$\sin^2 a + \cos^2 a = 1$$



Creation and thinking

创作·思考

Physical operations

物理运算

Force Balance

受力平衡



$$F = G \frac{m_1 m_2}{d^2}$$



Creation and thinking

创作·思考

Special parts

特殊零件的开发利用

$$S=4\pi \cdot r^2$$



WG1217

2高圆4孔

$$a^2+b^2=c^2$$



WG1218

5倍圆棒



WG1221

横直双头叉2孔



WG1219

凸双面圆4孔



WG1220

双头横叉5孔

$$\sin^2 a + \cos^2 a = 1$$



features and function

特点.功能

Main Color Matching

配色方案



Pantone Cool Gray 6C



Pantone 1575C



Pantone 431C



Pantone 2310C



Pantone 285C



Pantone 2234C



Color matching

Adopting 6 main colors, beige, brown and gray as the main color, the more reasonable and bold color matching on the original building, making the product more atmospheric and the whole design is more reasonable.

The London Eye
英国伦敦眼



Front

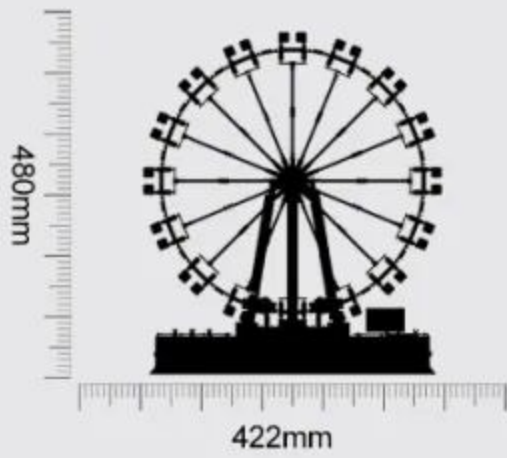

Left

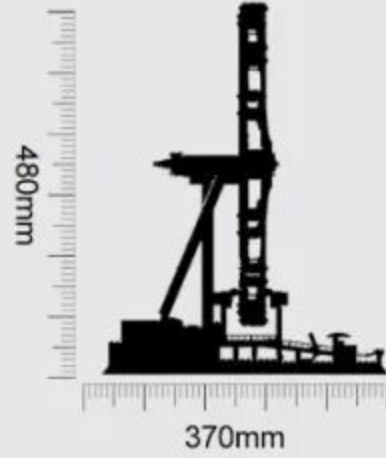

Back

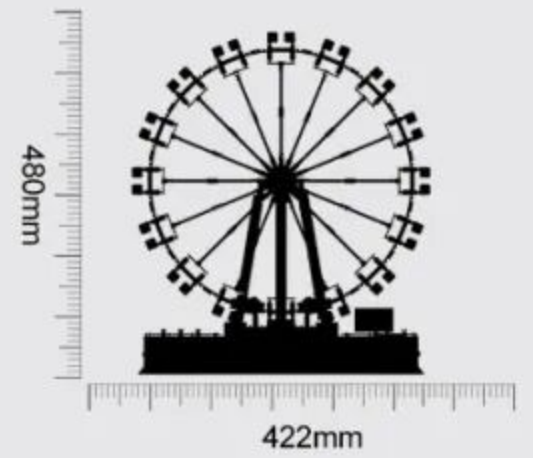









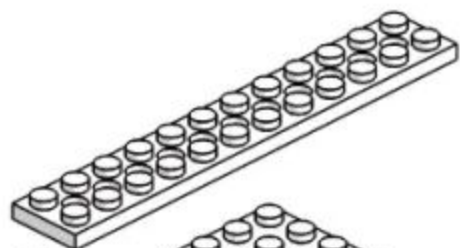
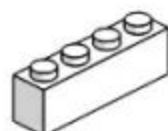



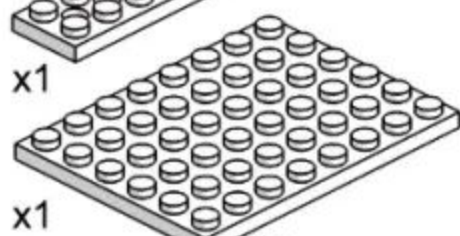





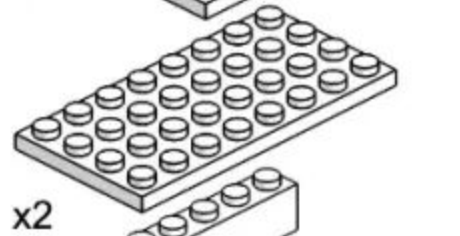
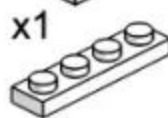

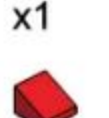





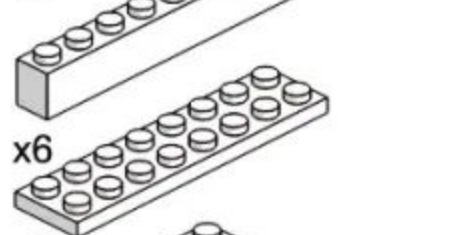









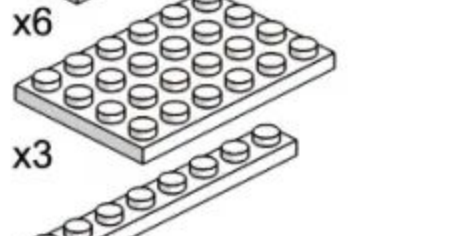







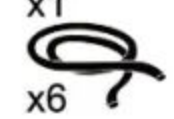









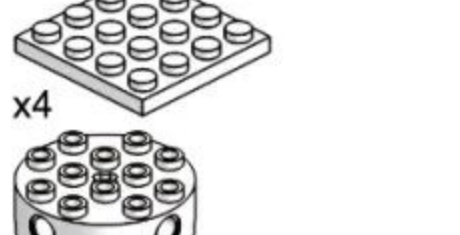









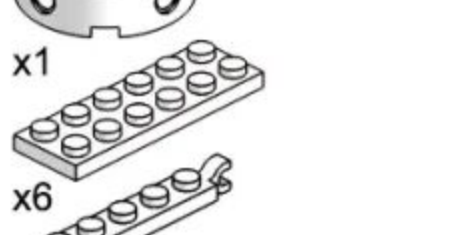





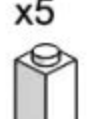





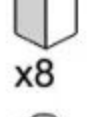







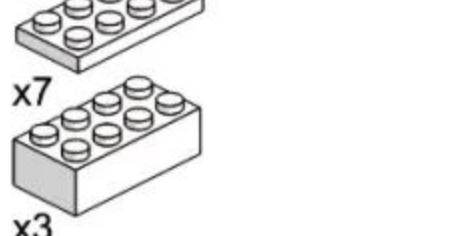
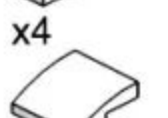













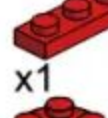



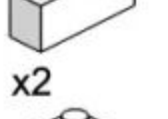



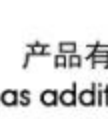
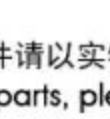









Product Size:370X422x480mm

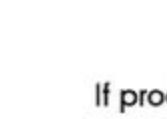

PARTS LIST

配件清单

					
x1	x6	x2	x16	x2	x2
					
x1	x1	x4	x1	x2	x6
					
x1	x6				
					
x2	x2				
					
x6	x33				
					
x6	x6				
					
x6	x36				
					
x6	x1				
					
x6	x4				
					
x3	x6				
					
x4	x2				
					
x4	x4				
					
x1	x2				
					
x1	x4				
					
x1	x6				
					
x1	x4				
					
x1	x4				
					
x1	x4				
					
x1	x4				
					
x1	x4				
					
x1	x4				
					
x1	x4				
					
x1	x4				
x1	x4				
x1	x4				
x1	x4				
x1	x4				
x1	x4				
x1	x4				



233PCS

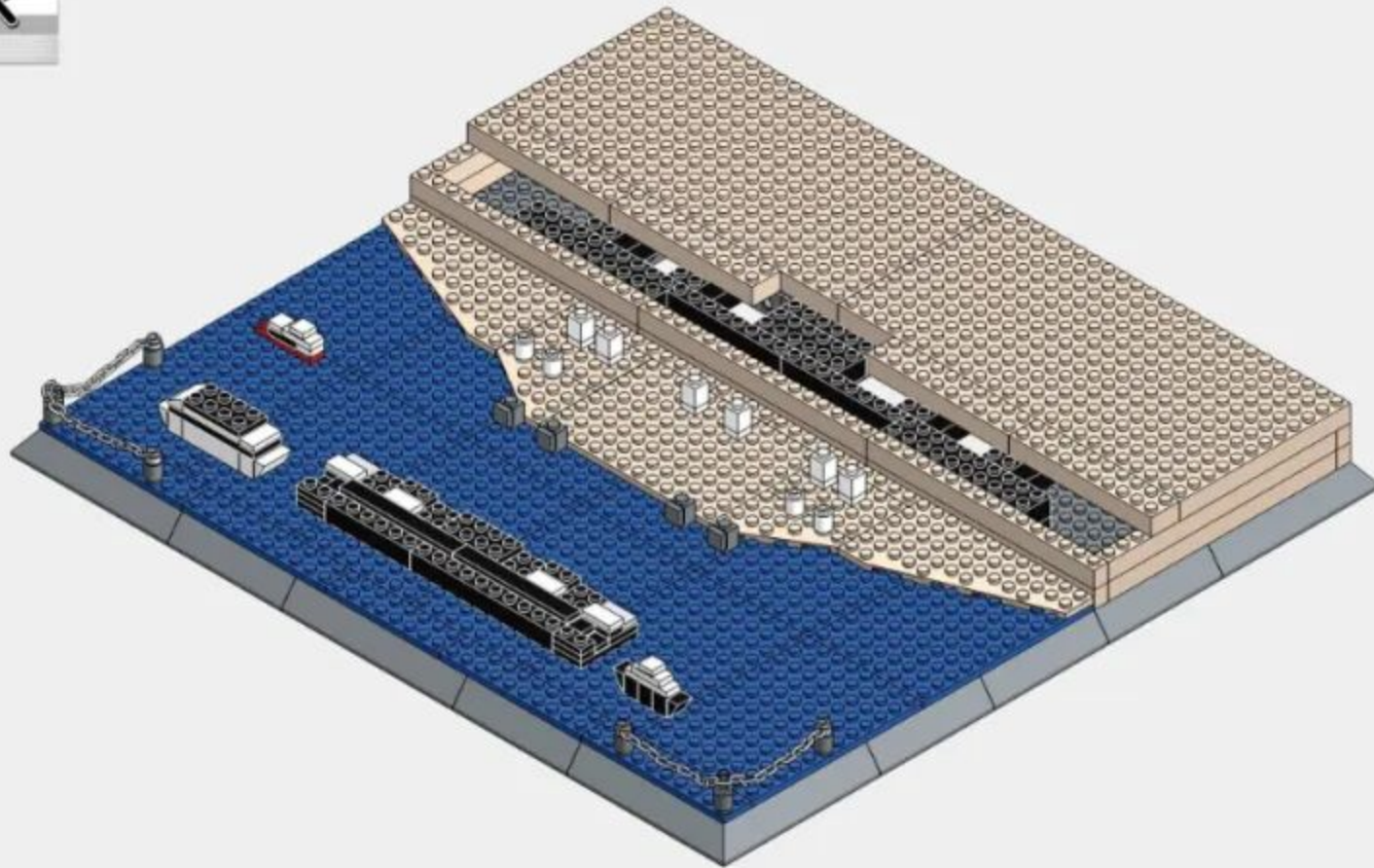

25

1-1

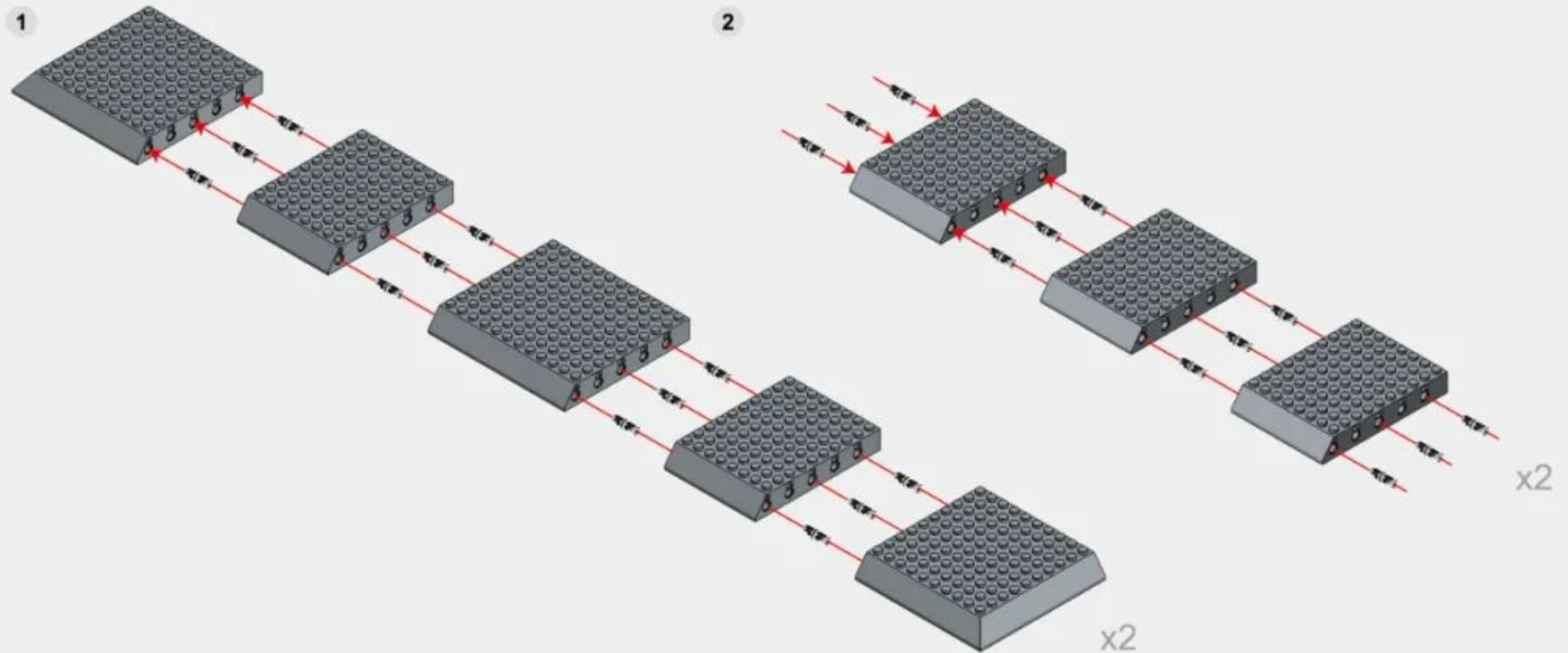
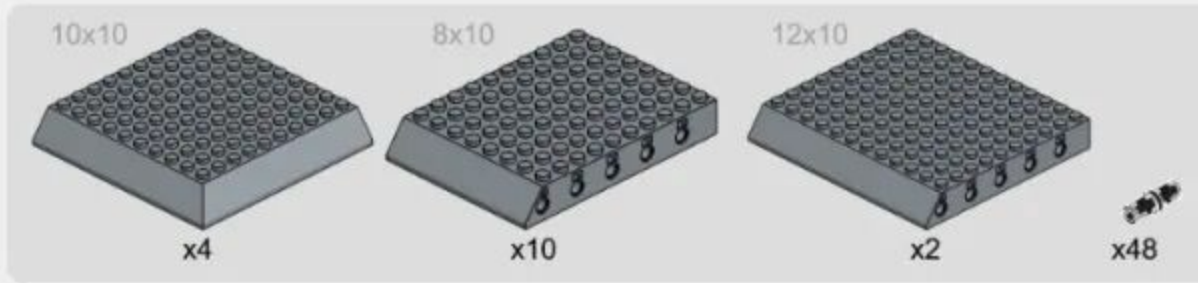

1-2

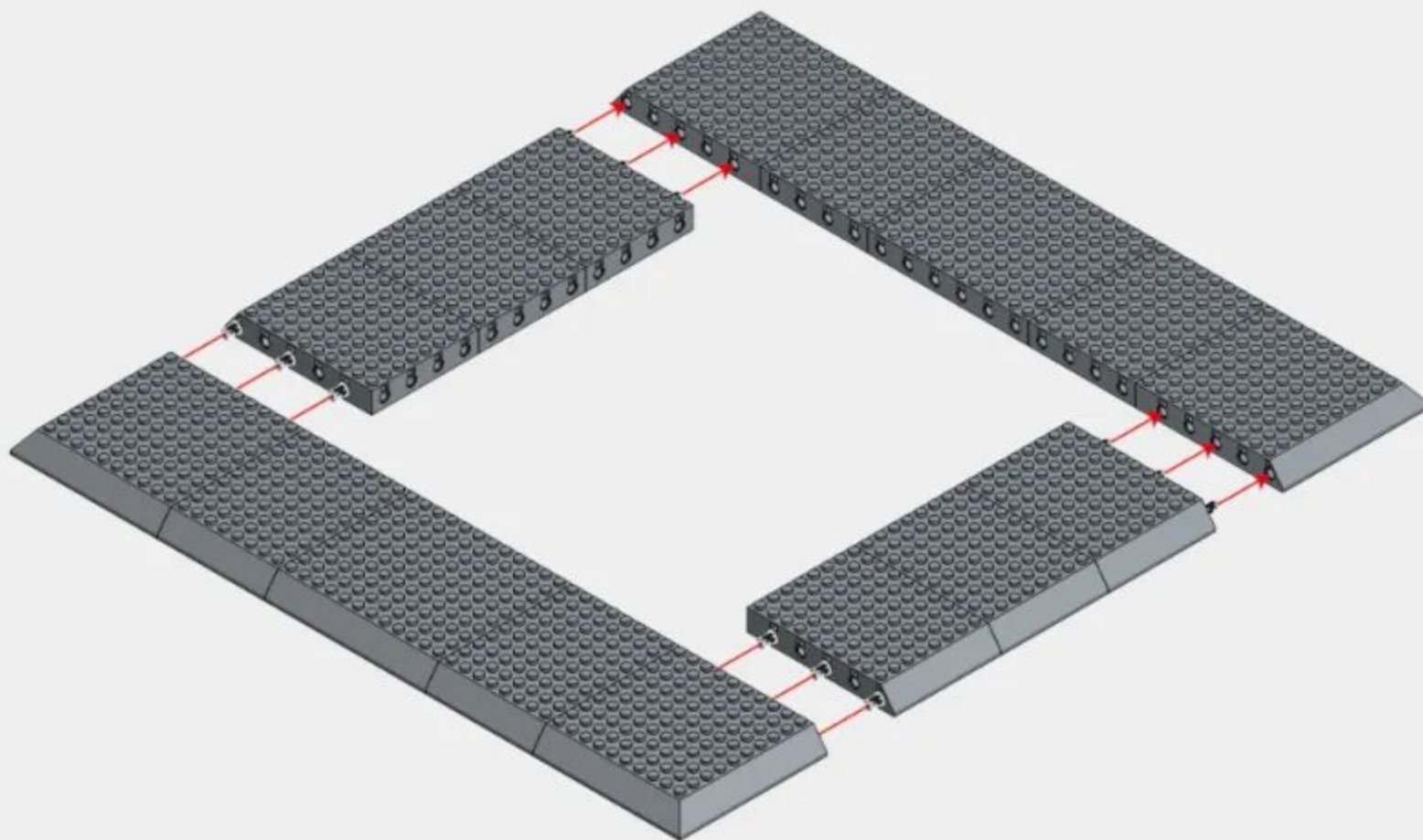

1-3

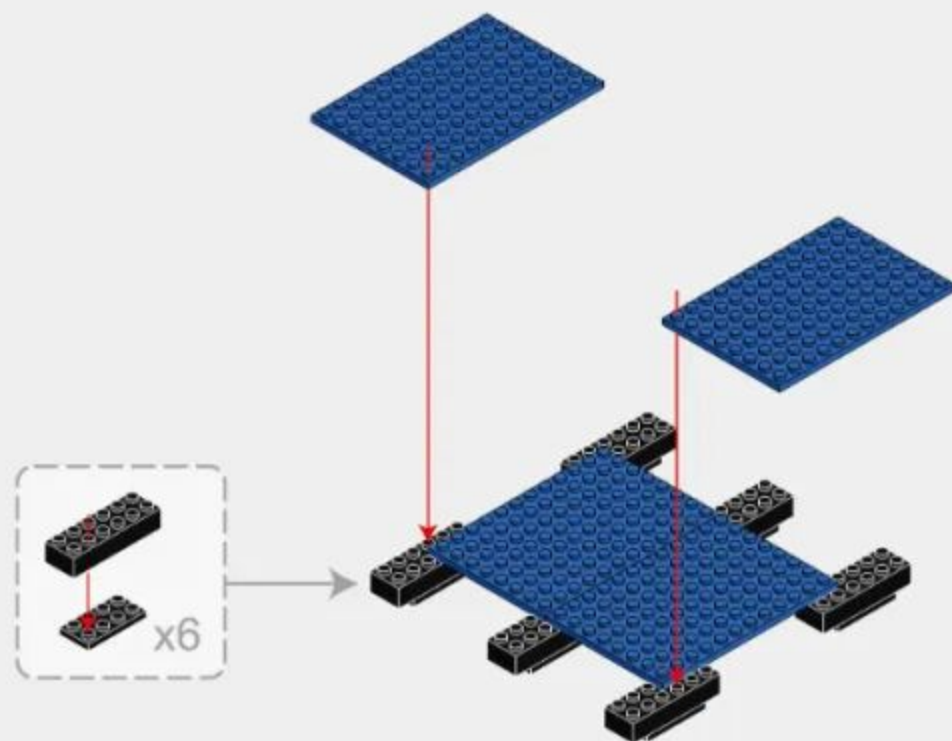
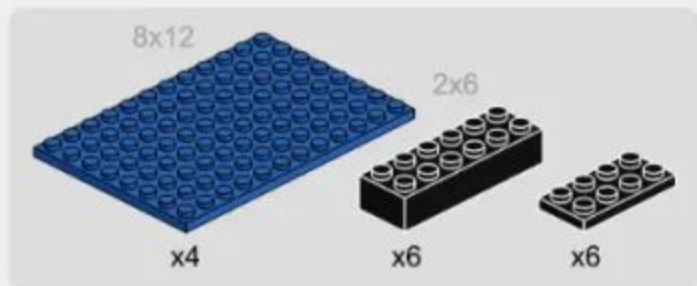

1-4

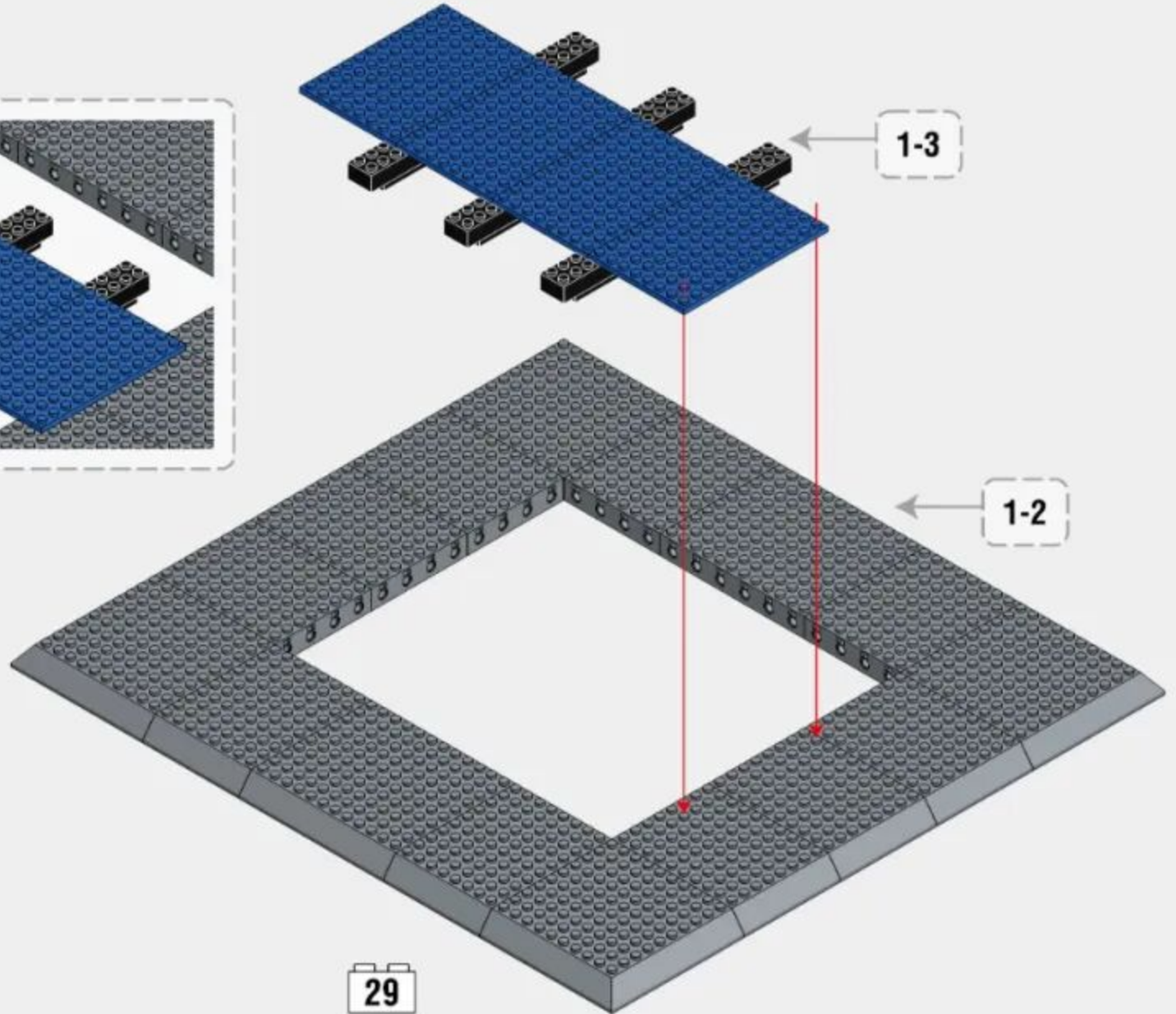
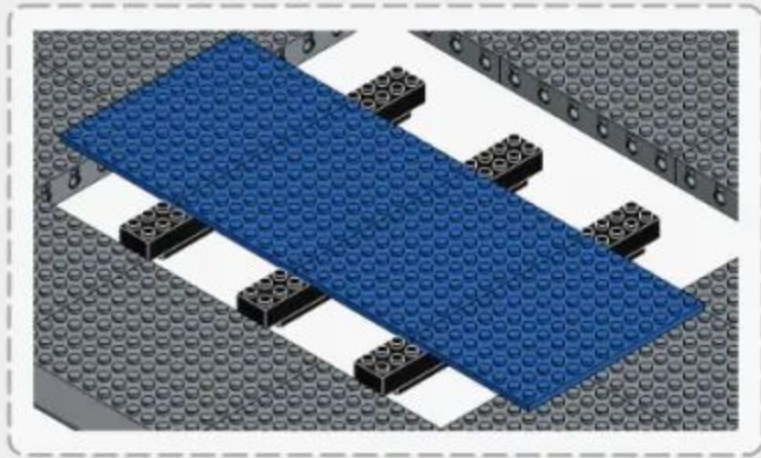

1-5

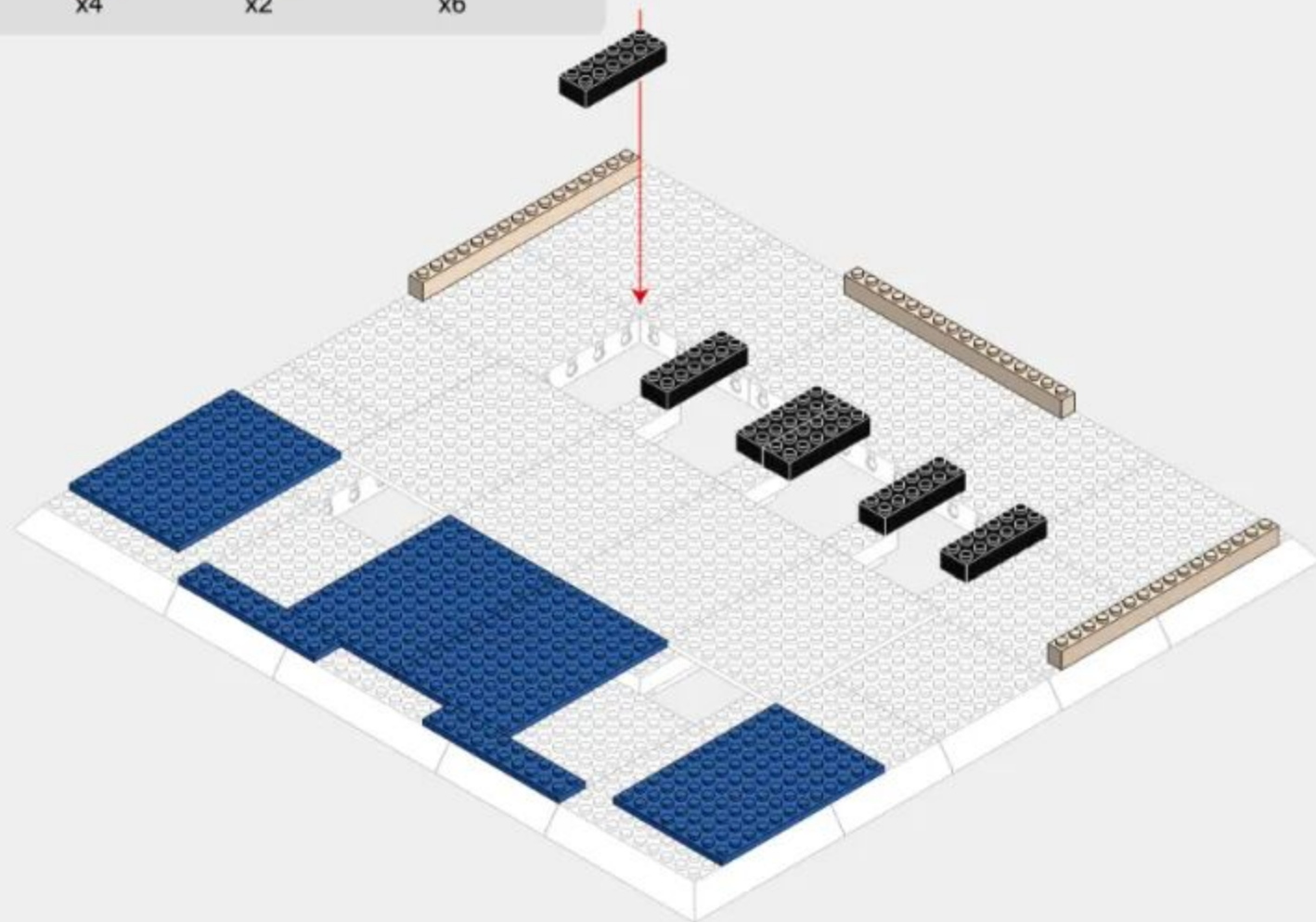
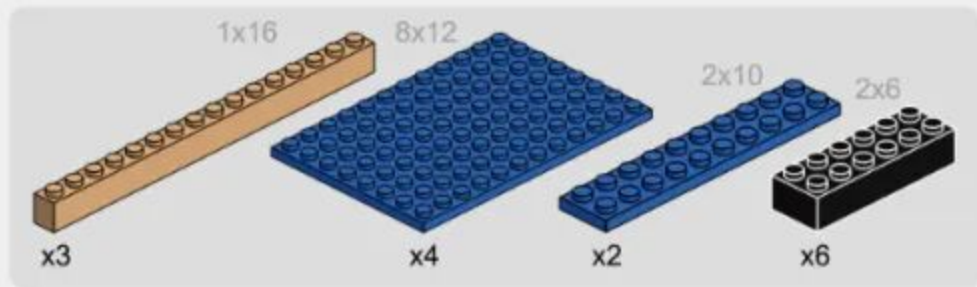

1-6

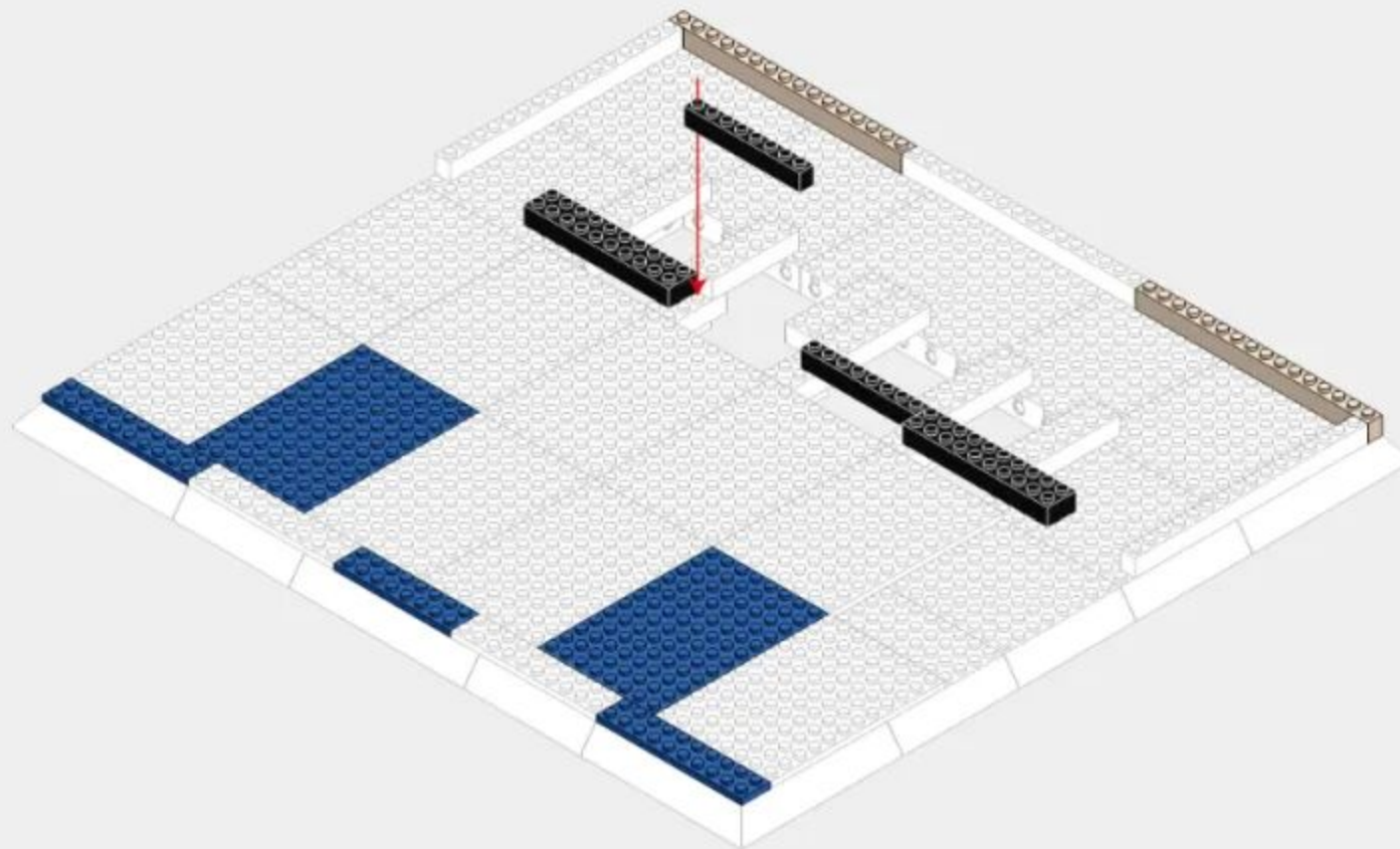
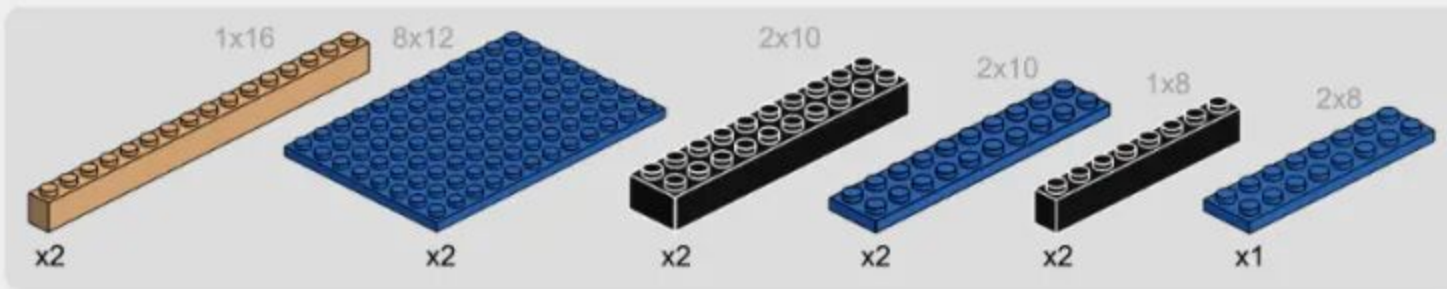

1-7

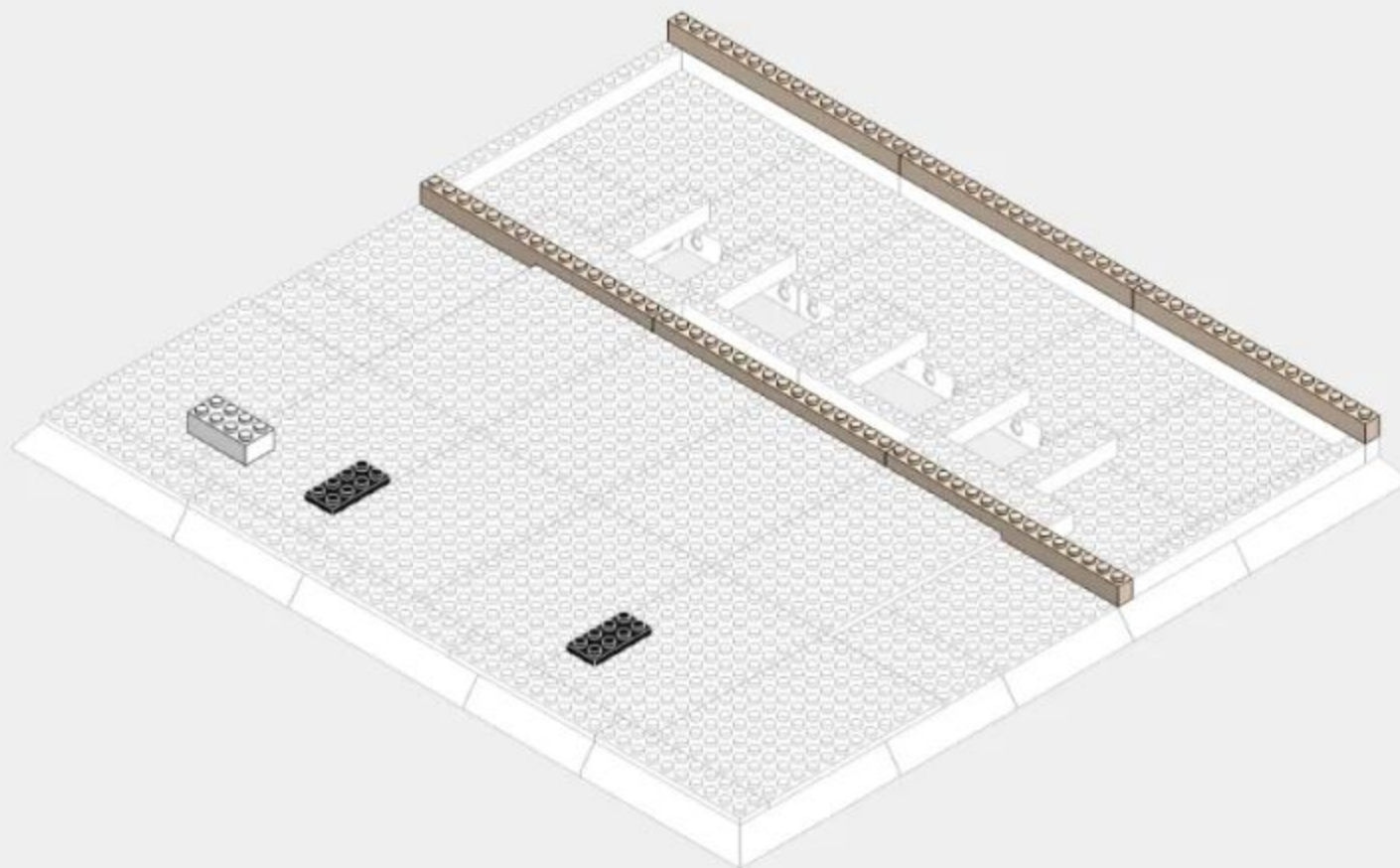
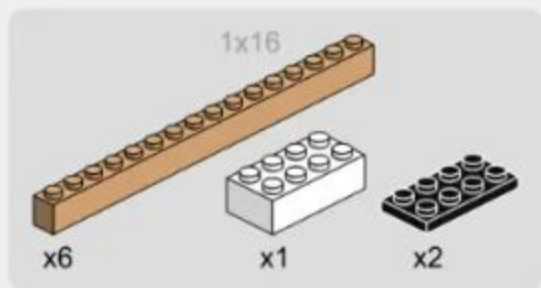

1-8

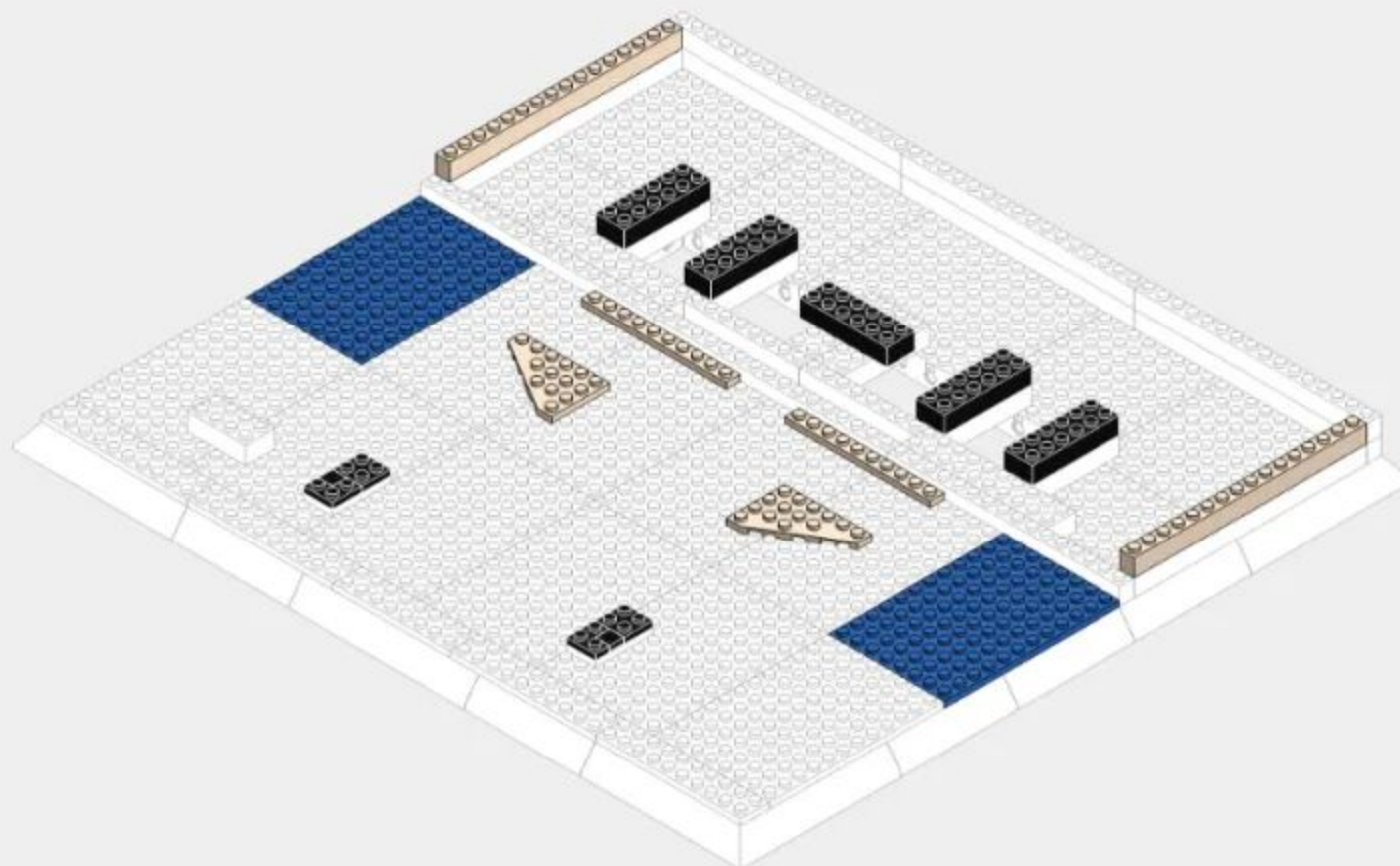
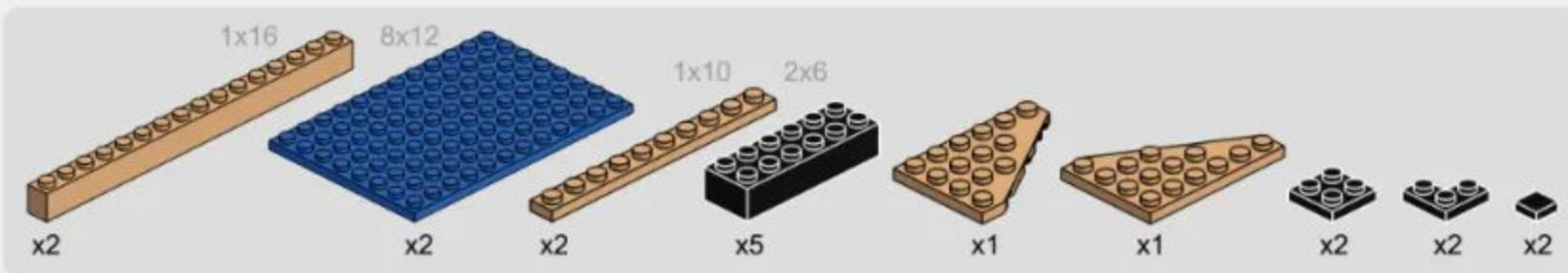

1-9

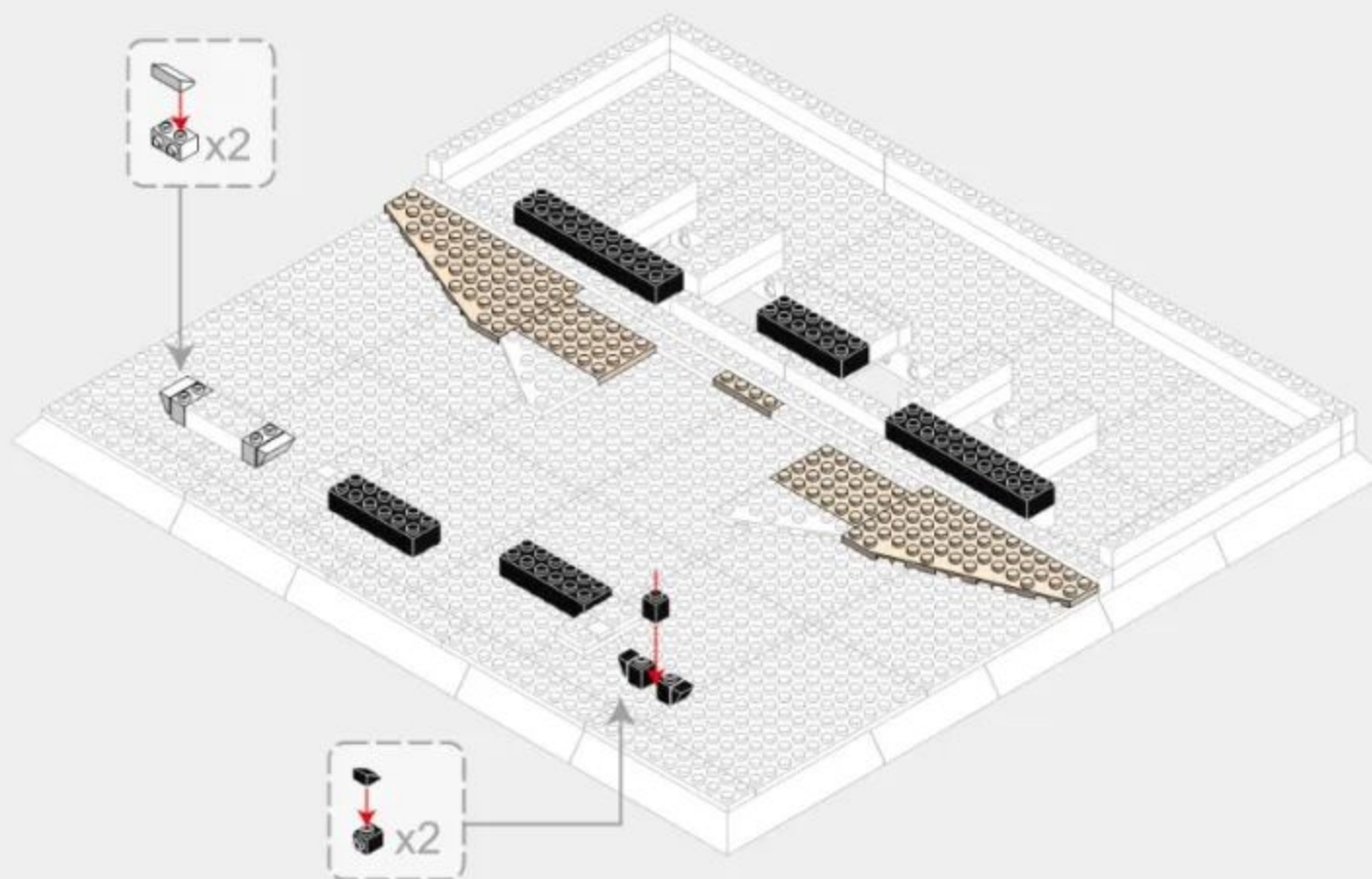
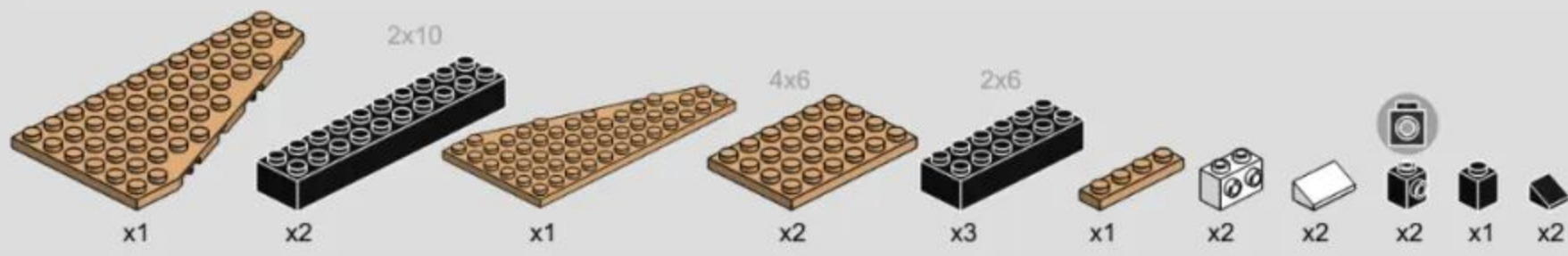

1-10

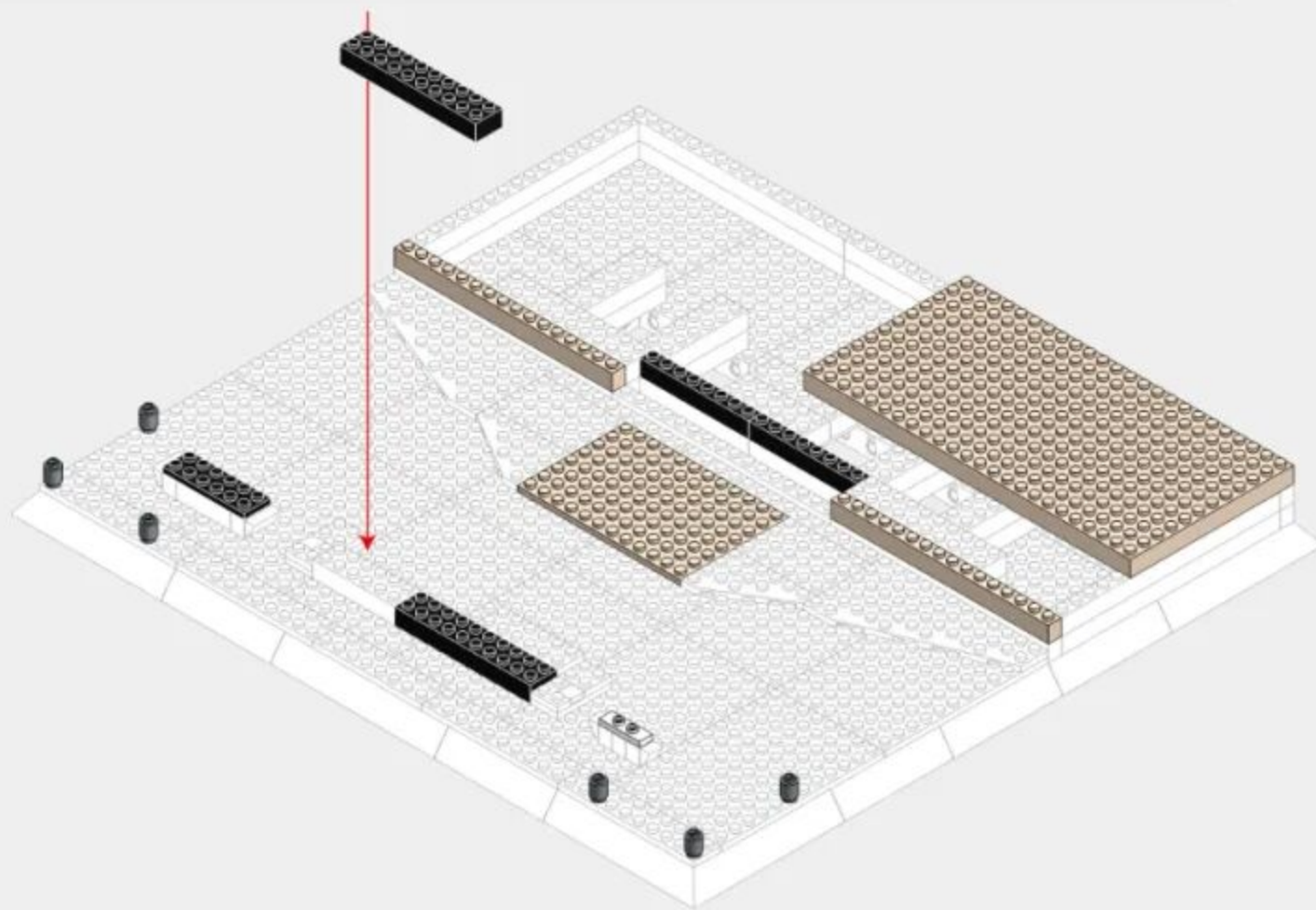
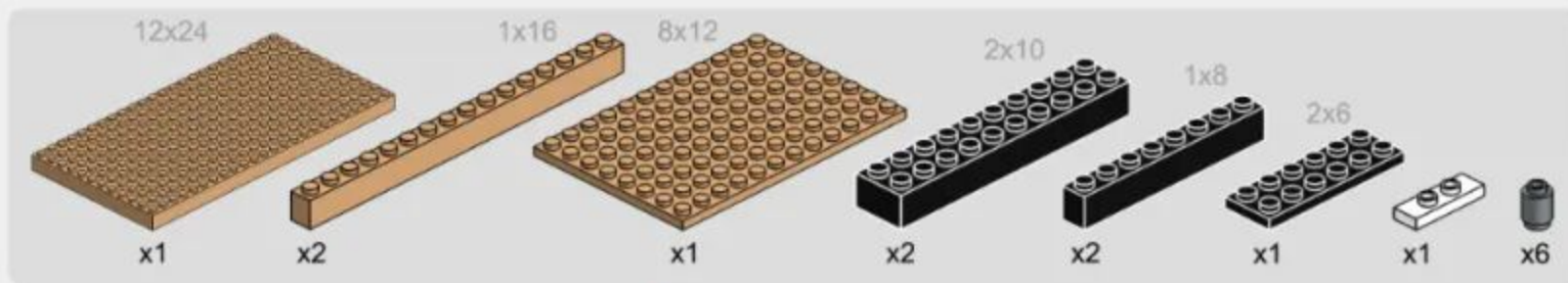

1-12

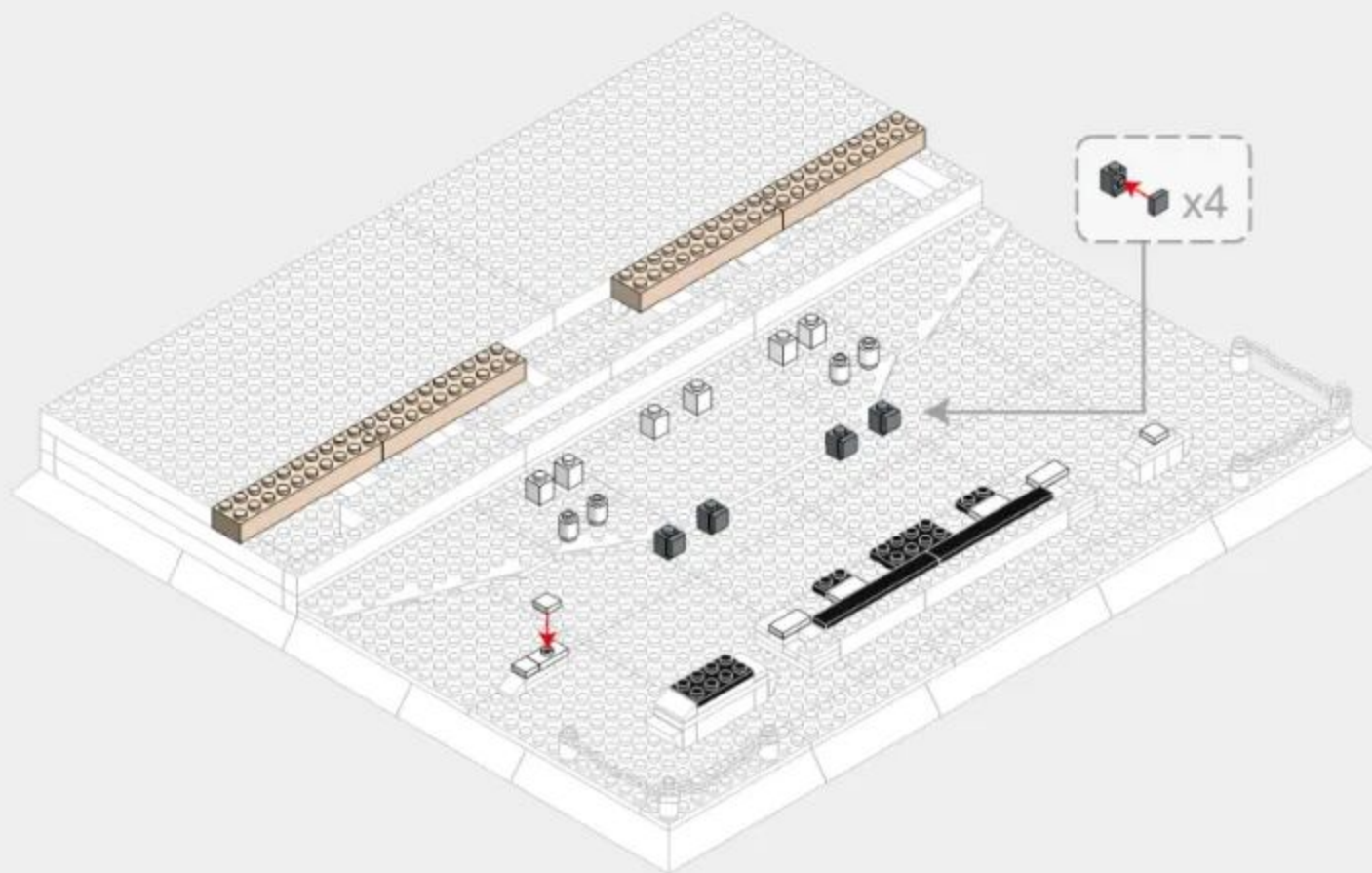



203PCS

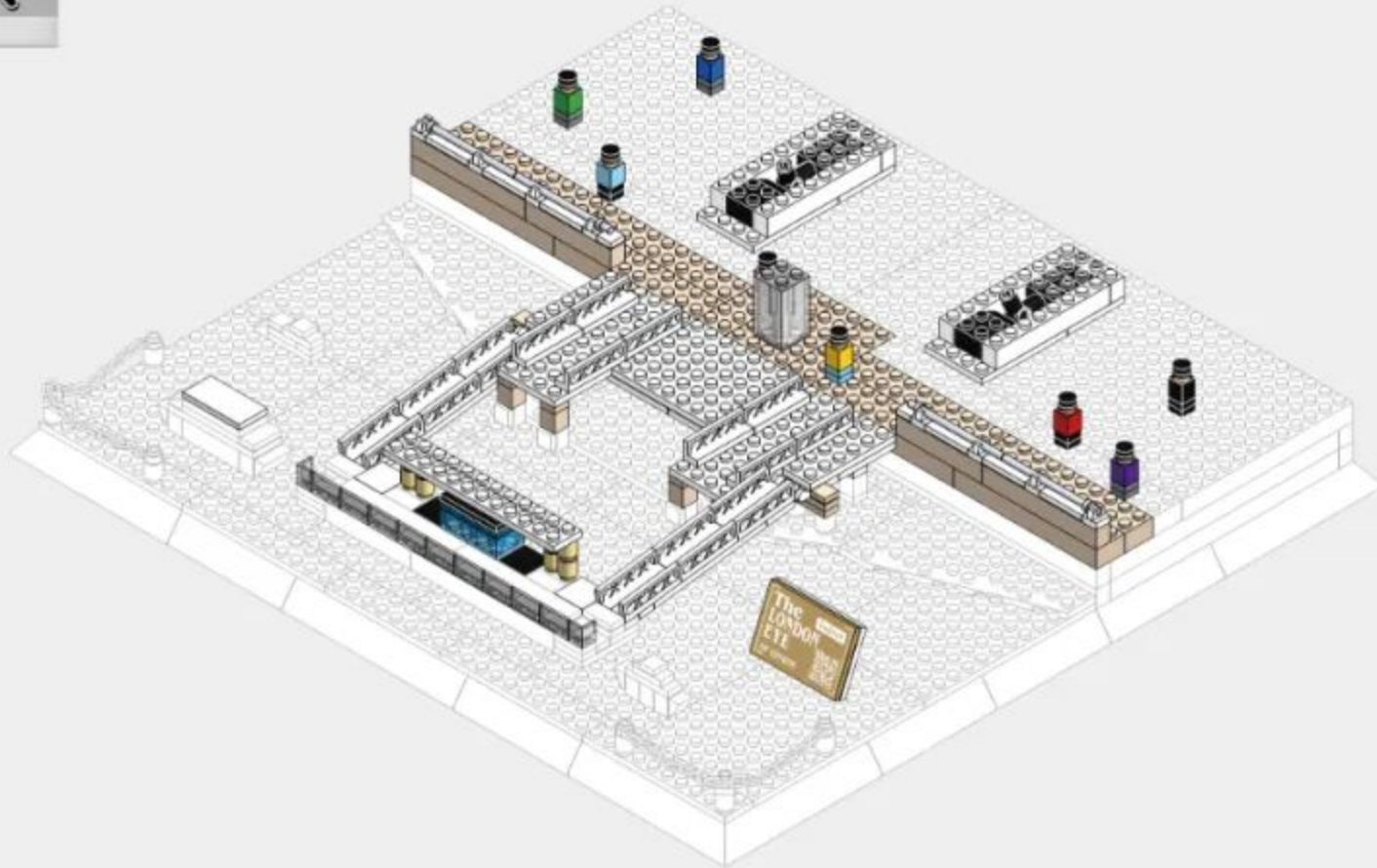

2-1

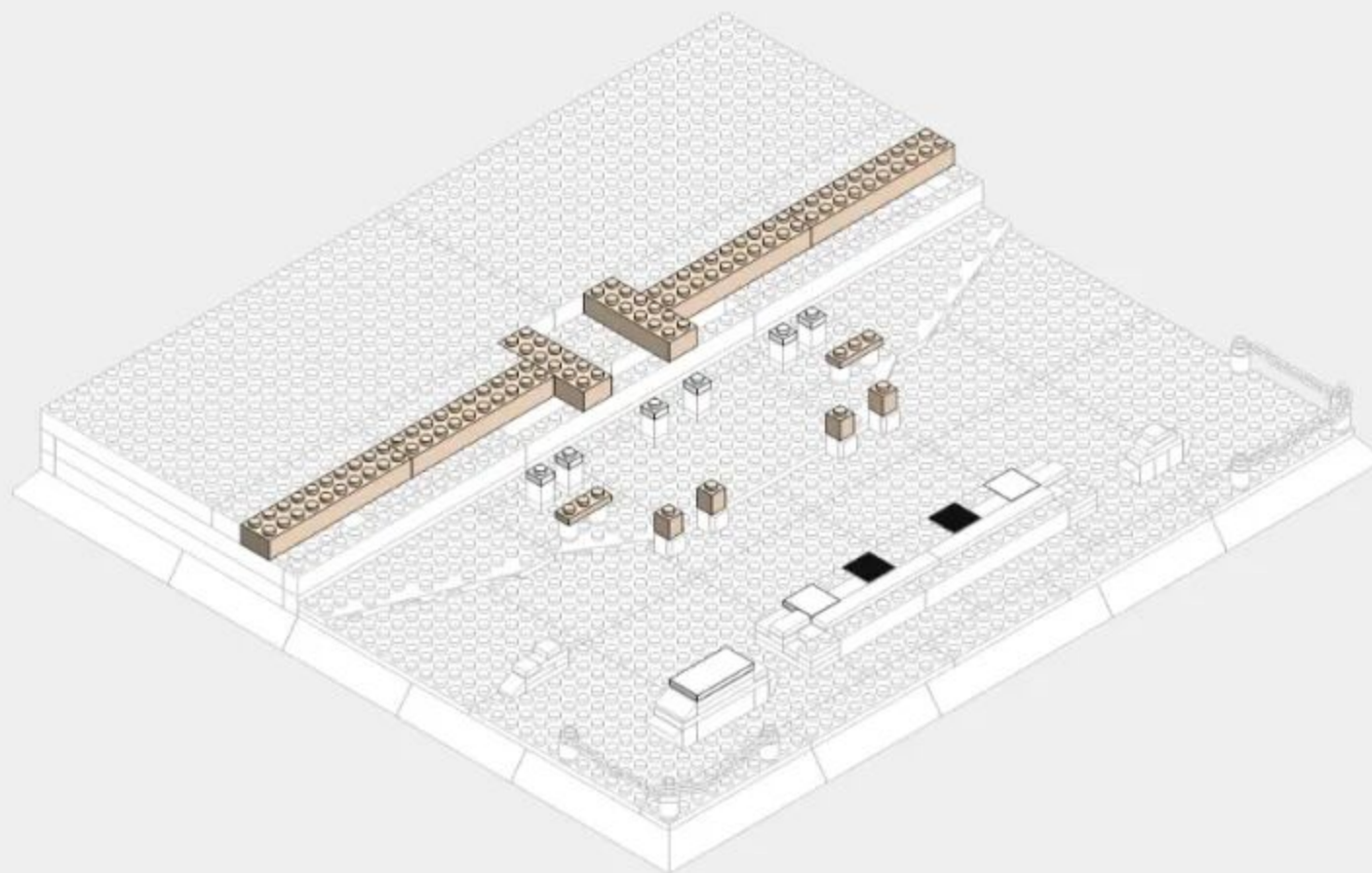
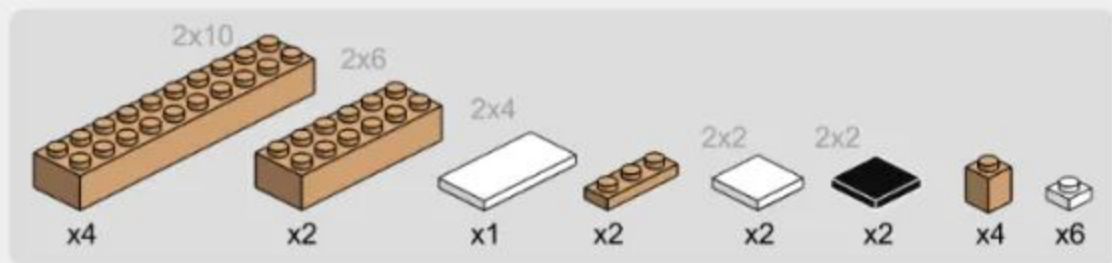

2-3

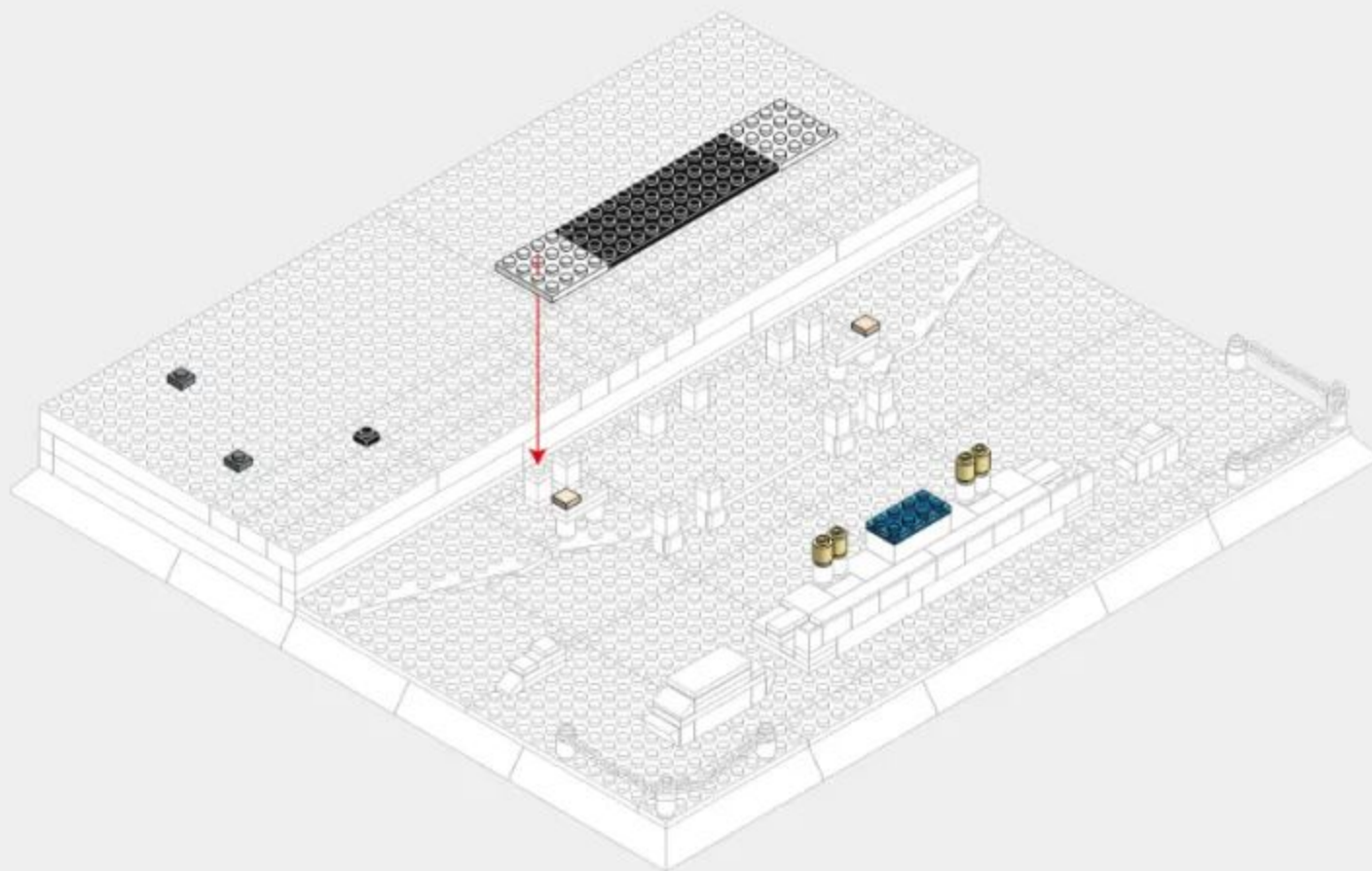
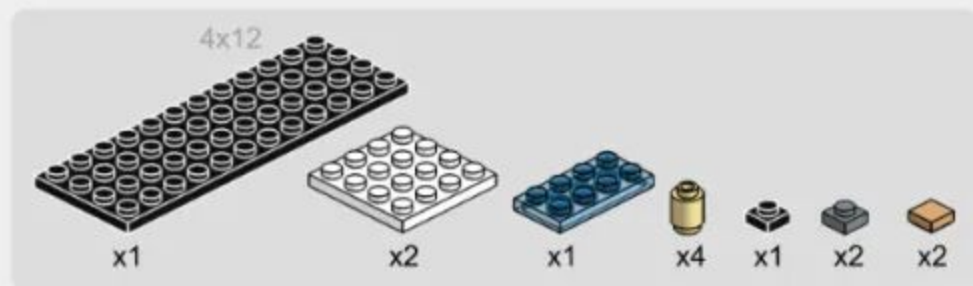

2-4

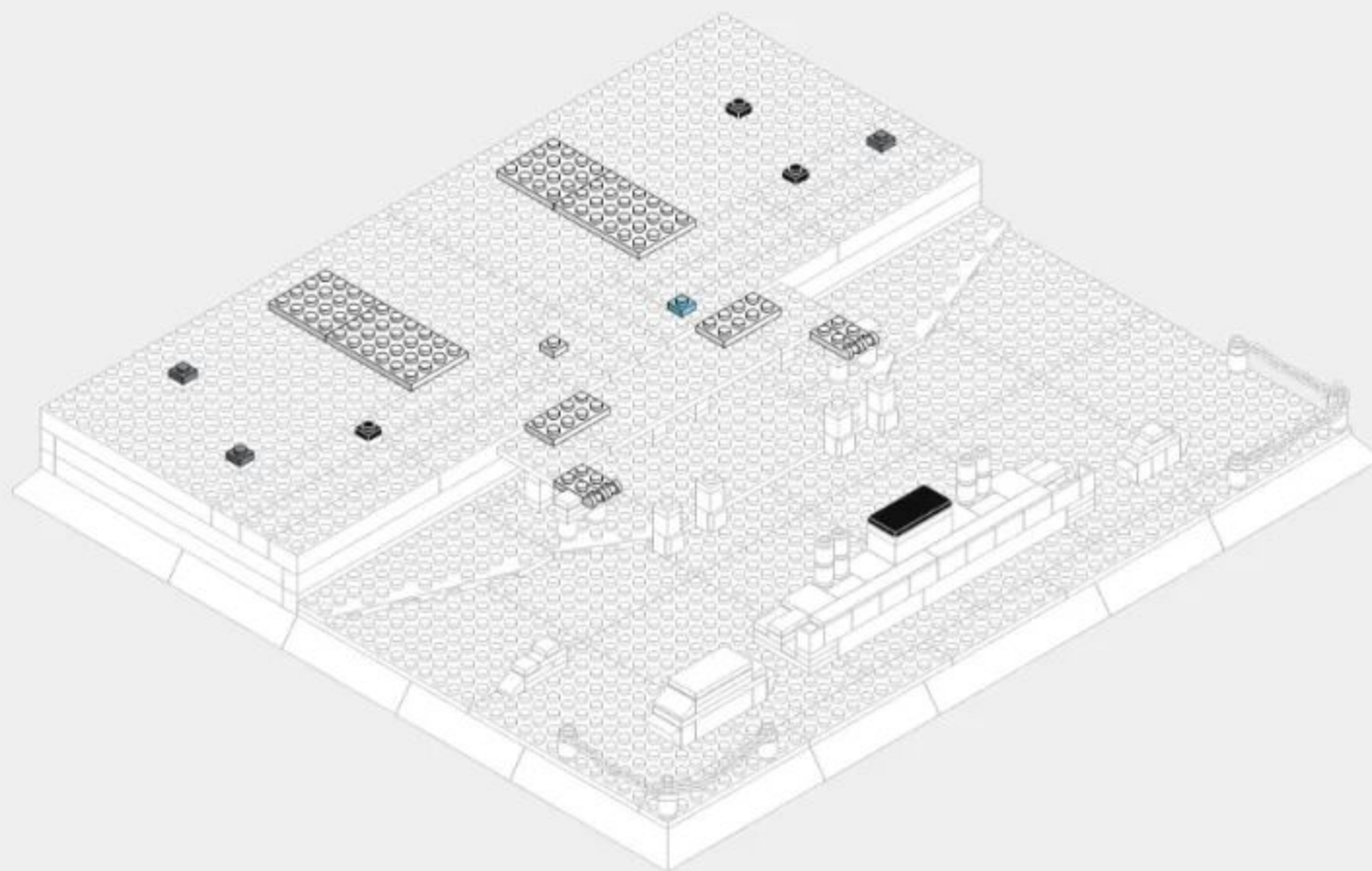
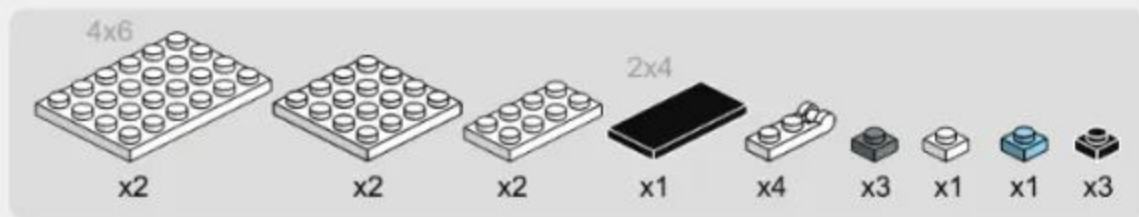

2-5

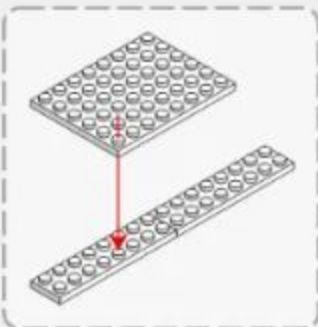
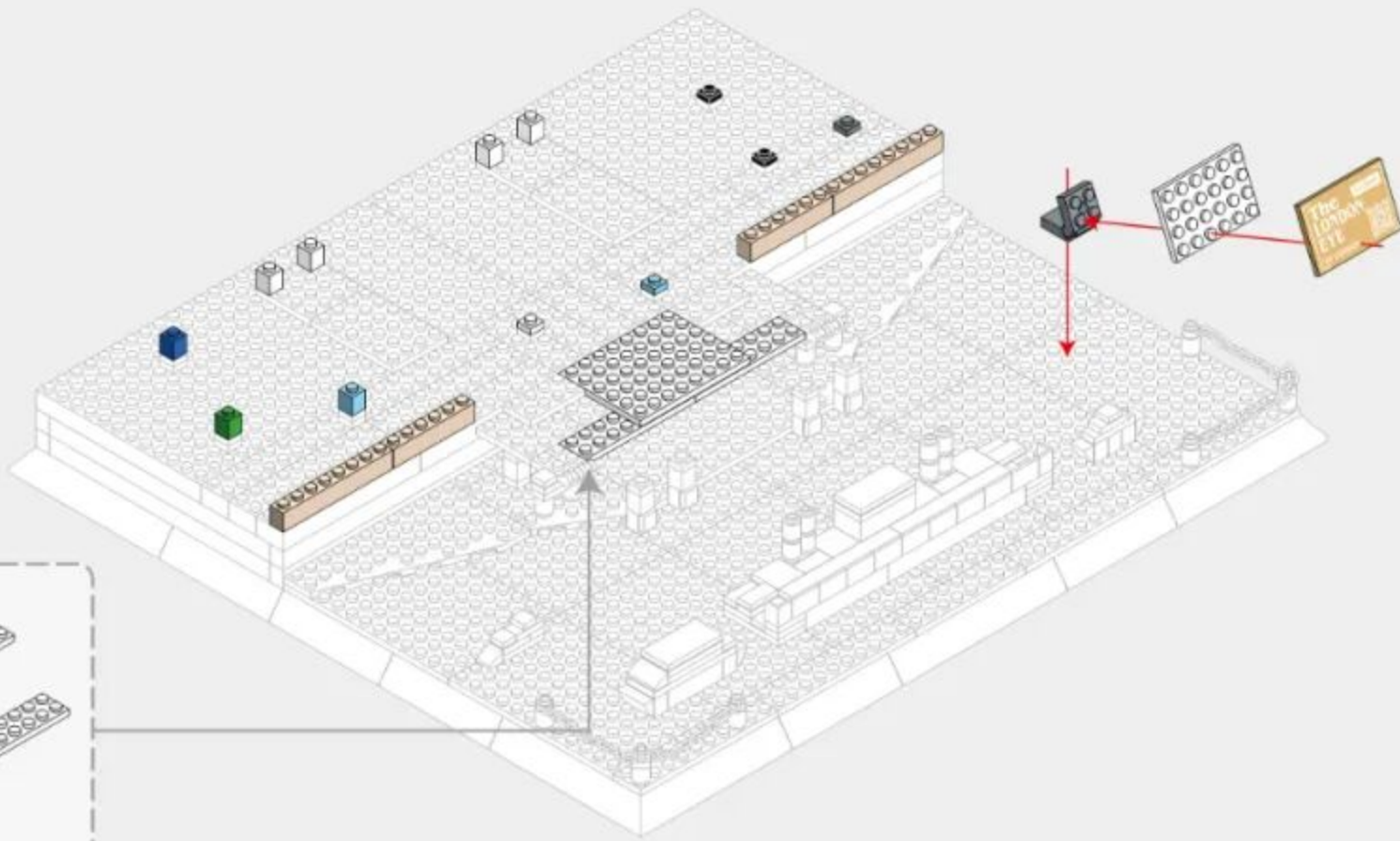
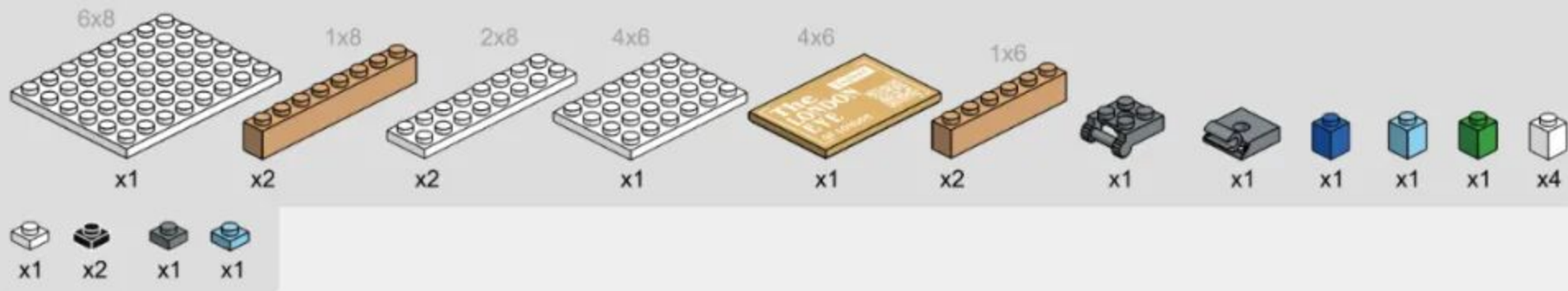

2-6

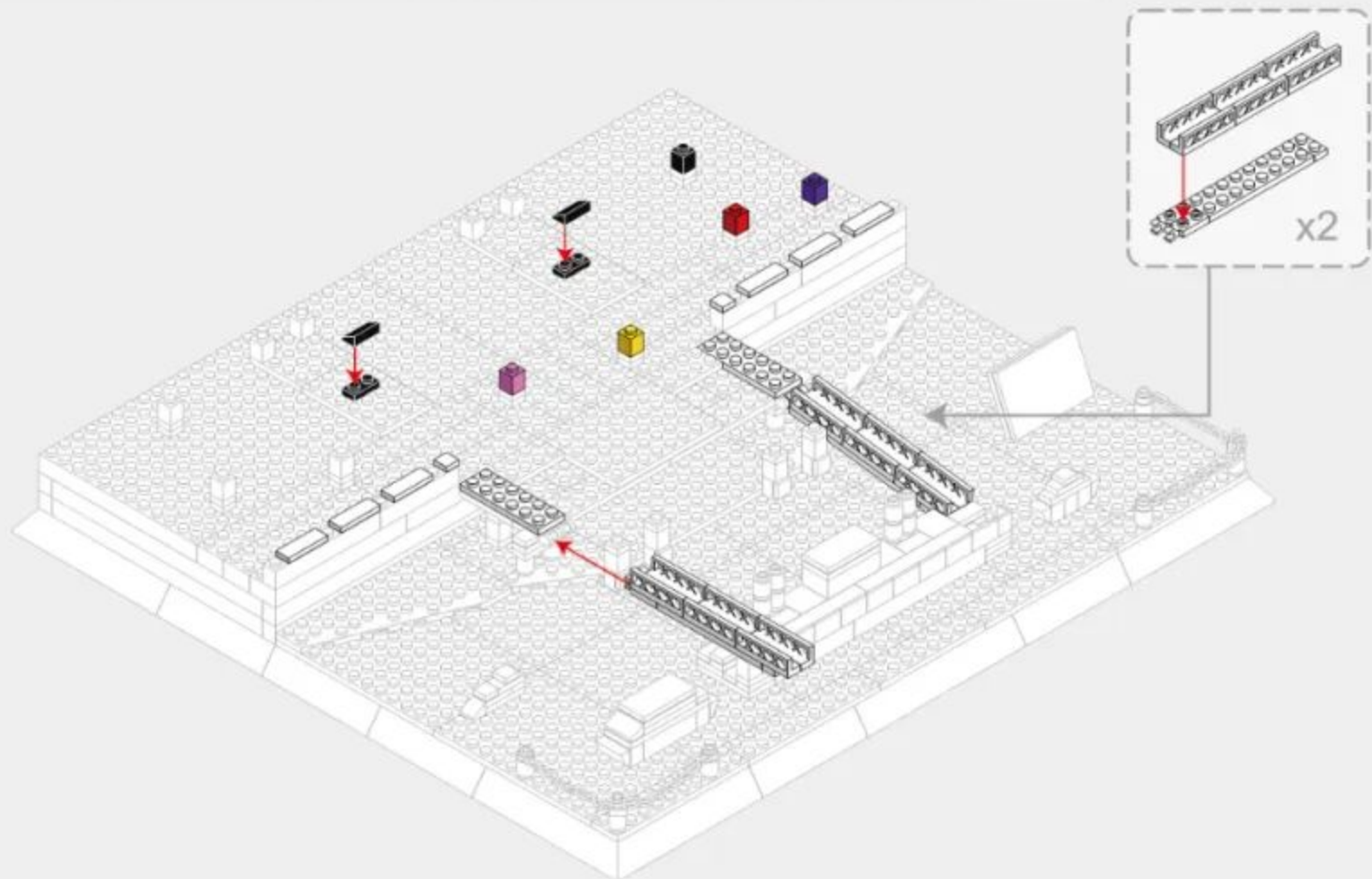
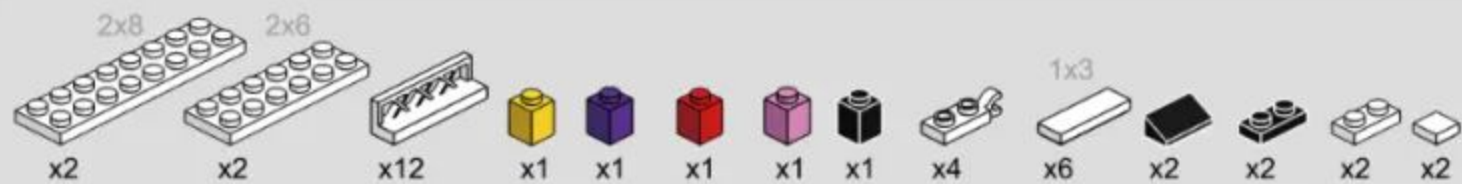

2-7

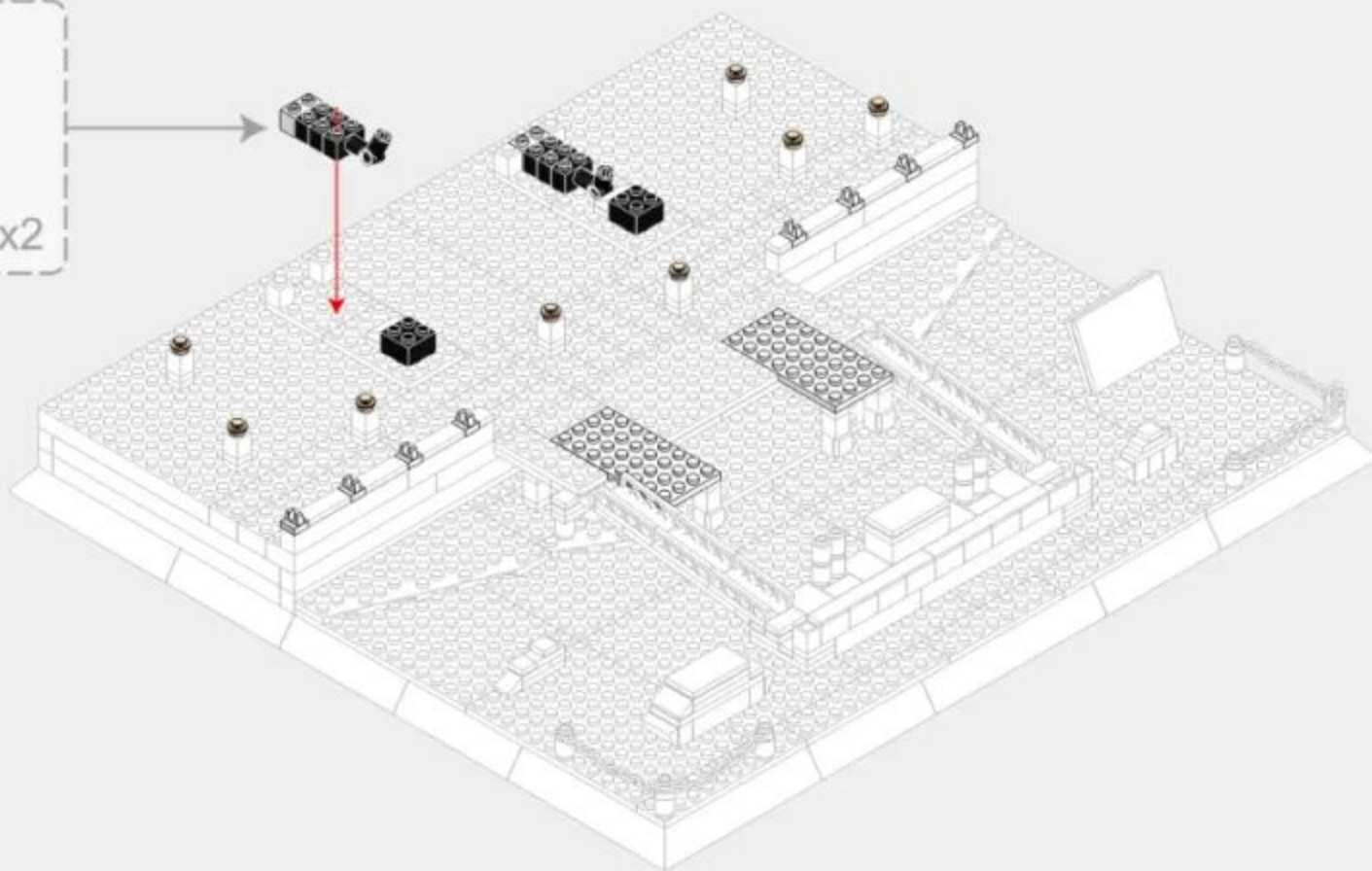
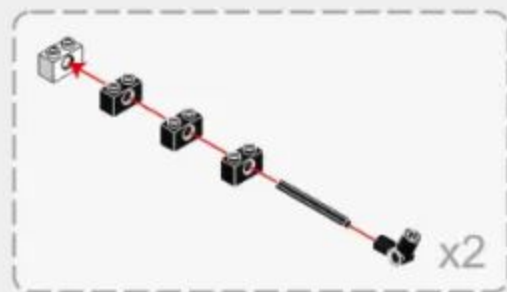

2-8

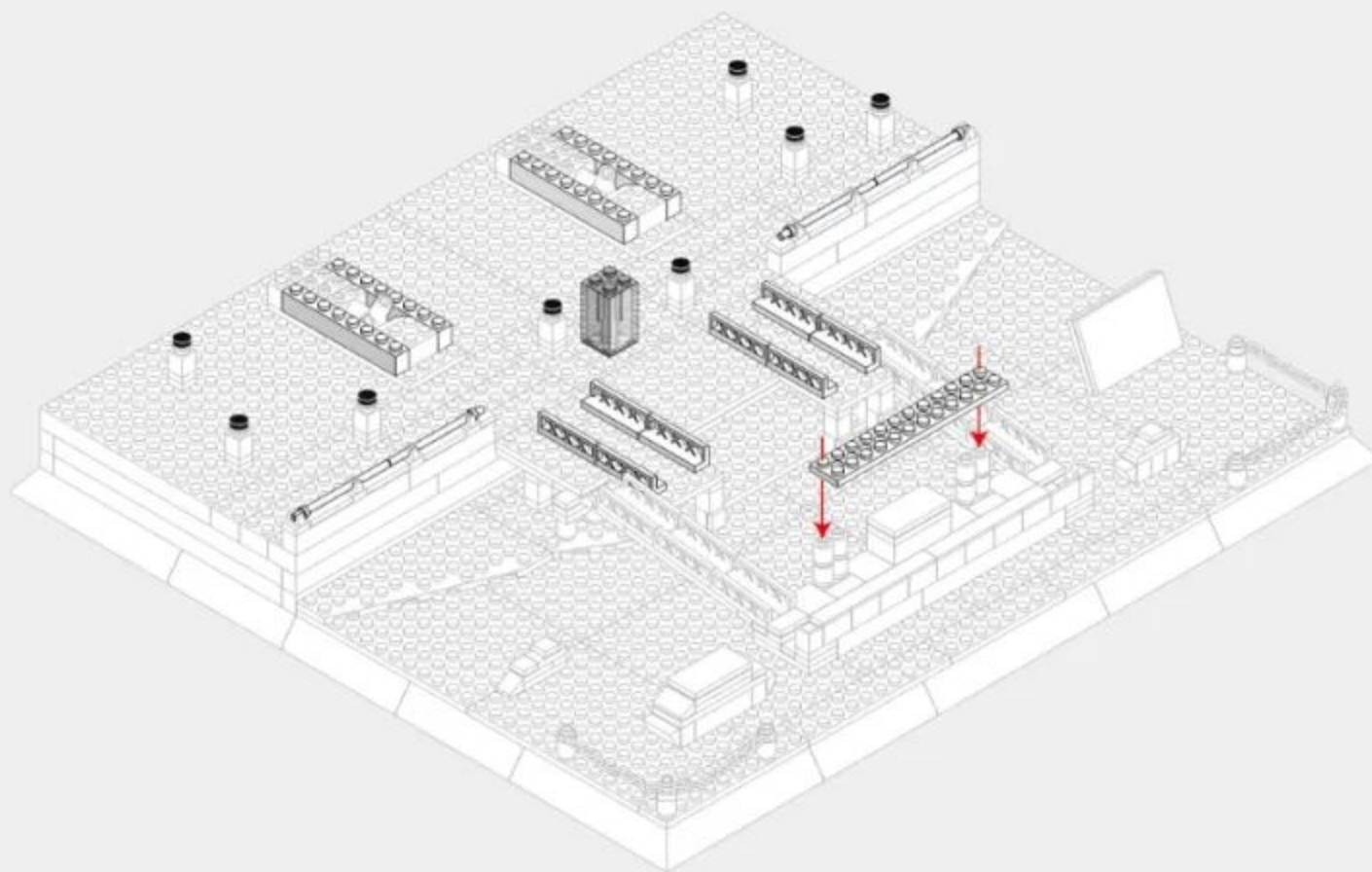
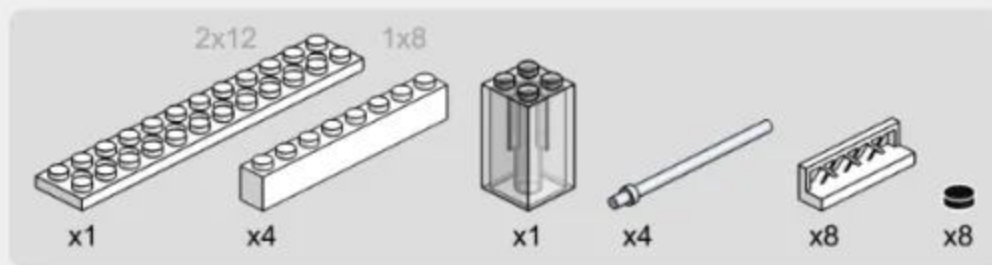



223PCS

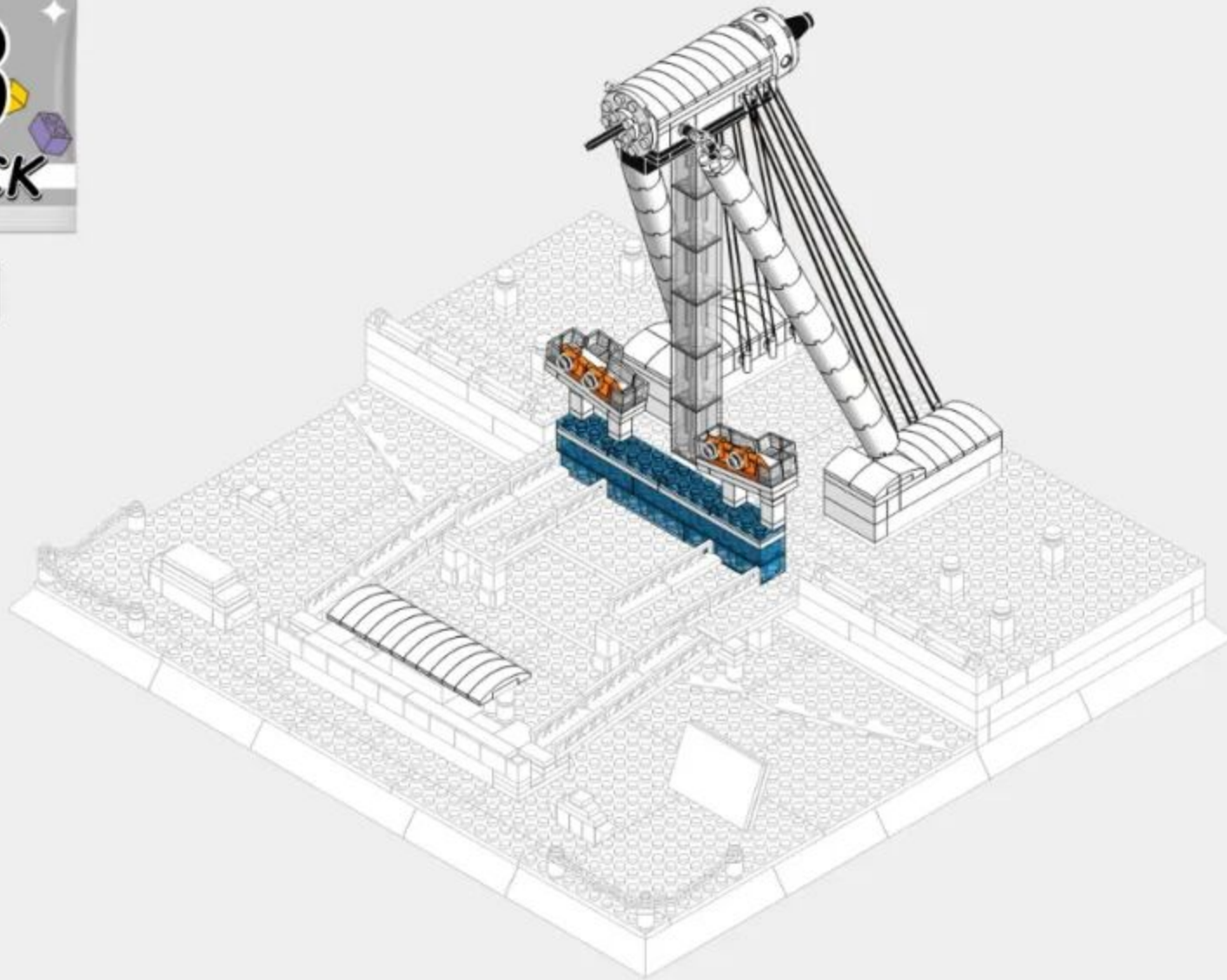

3-1

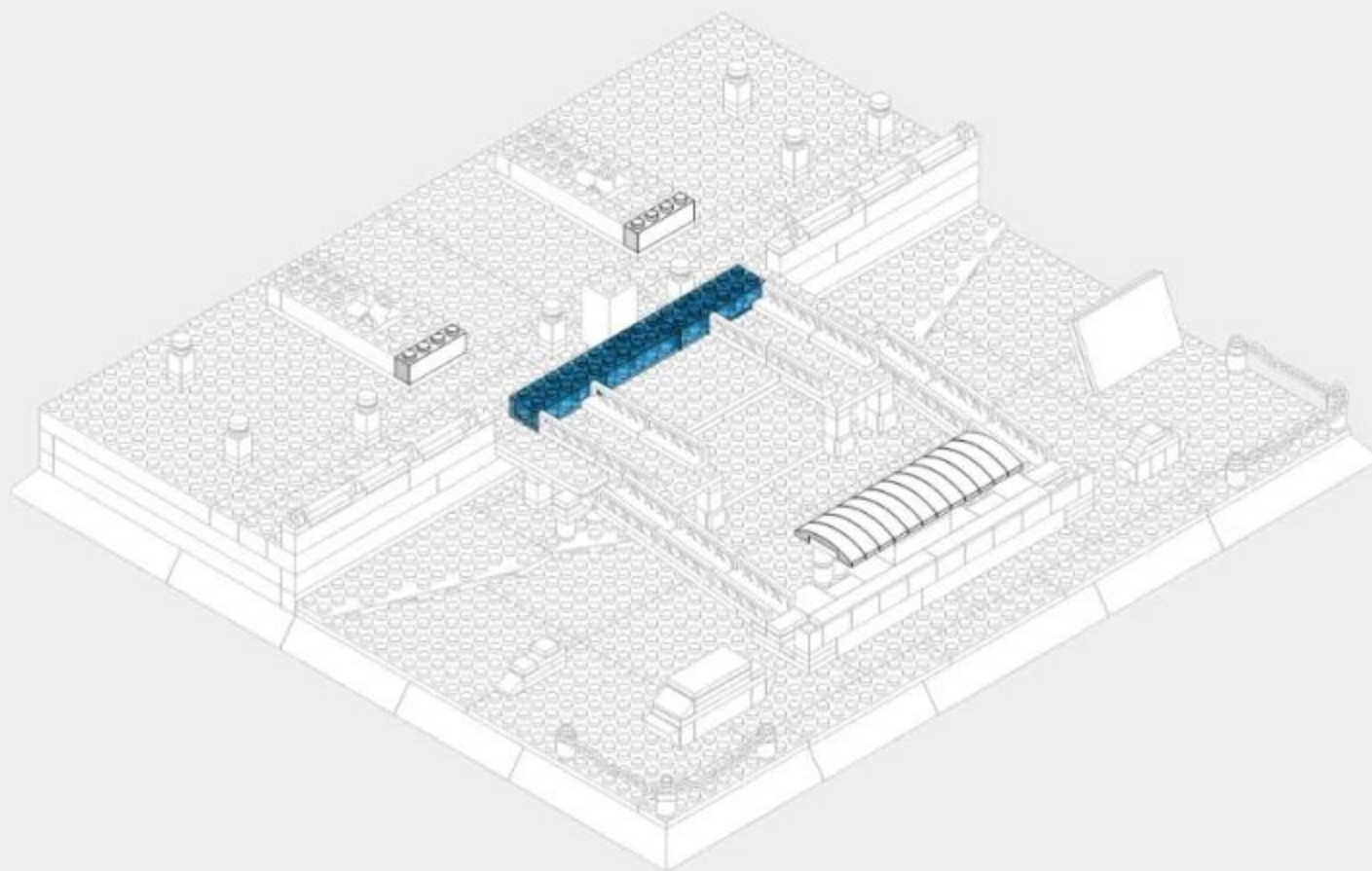
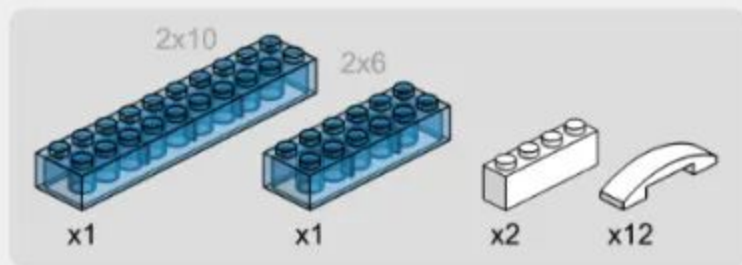

3-2

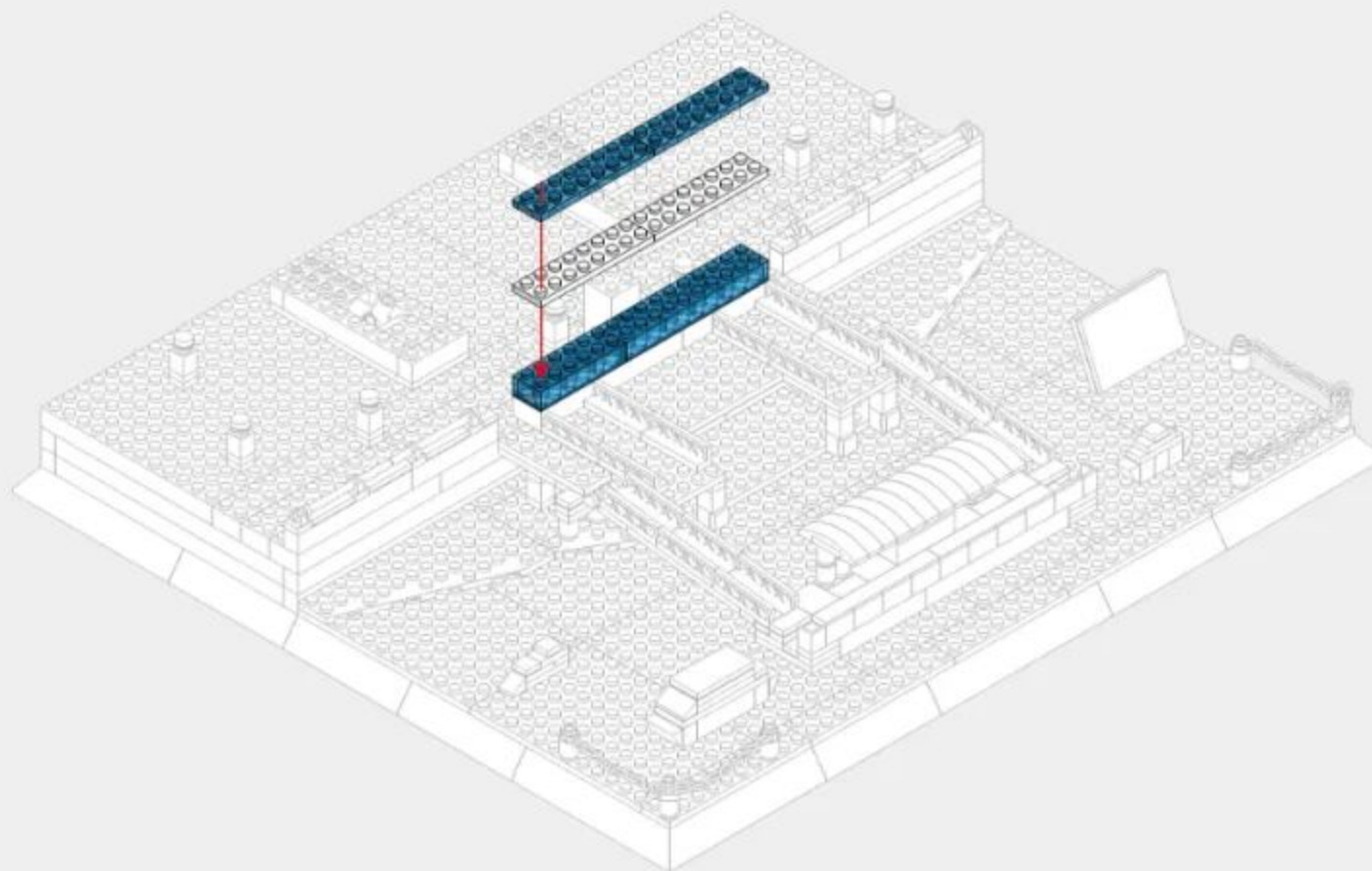
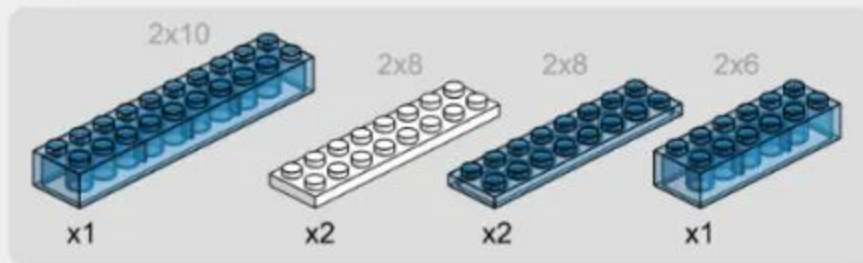

3-3

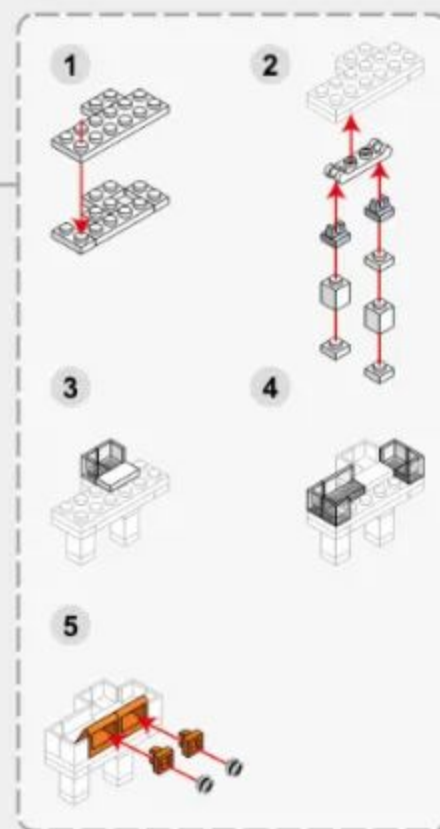
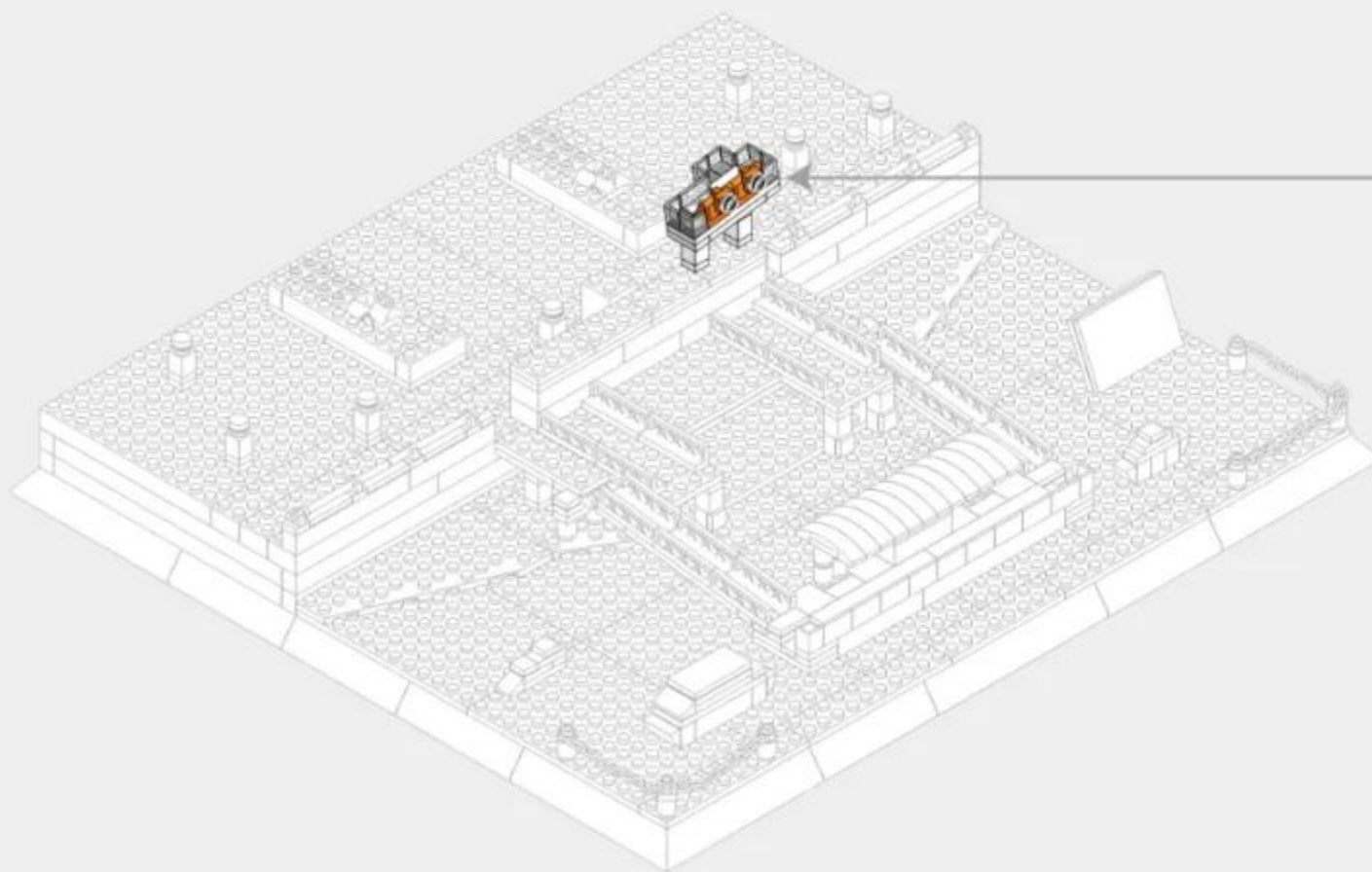

3-4

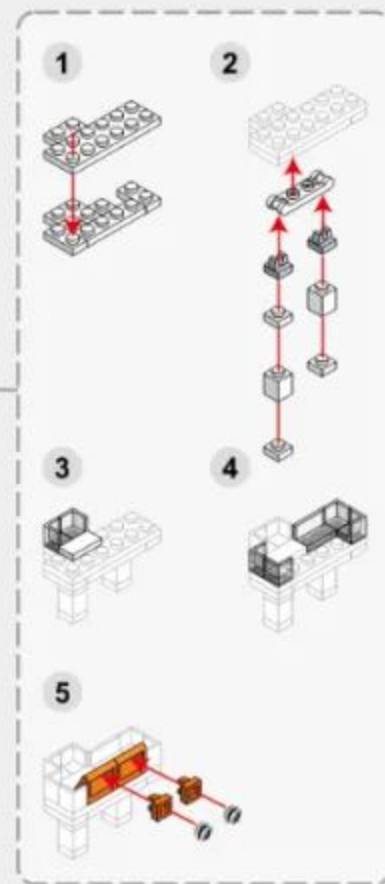
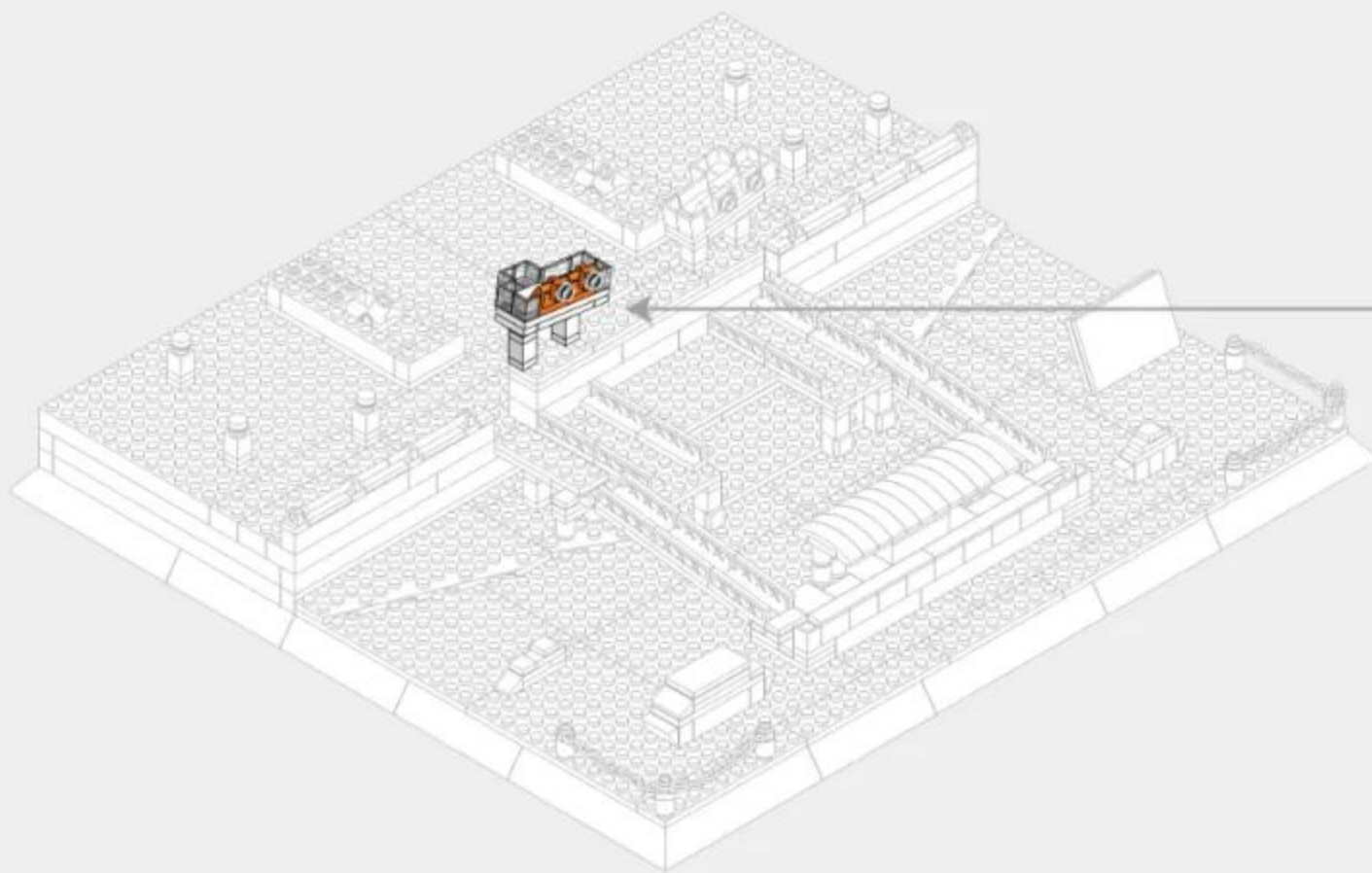

3-5

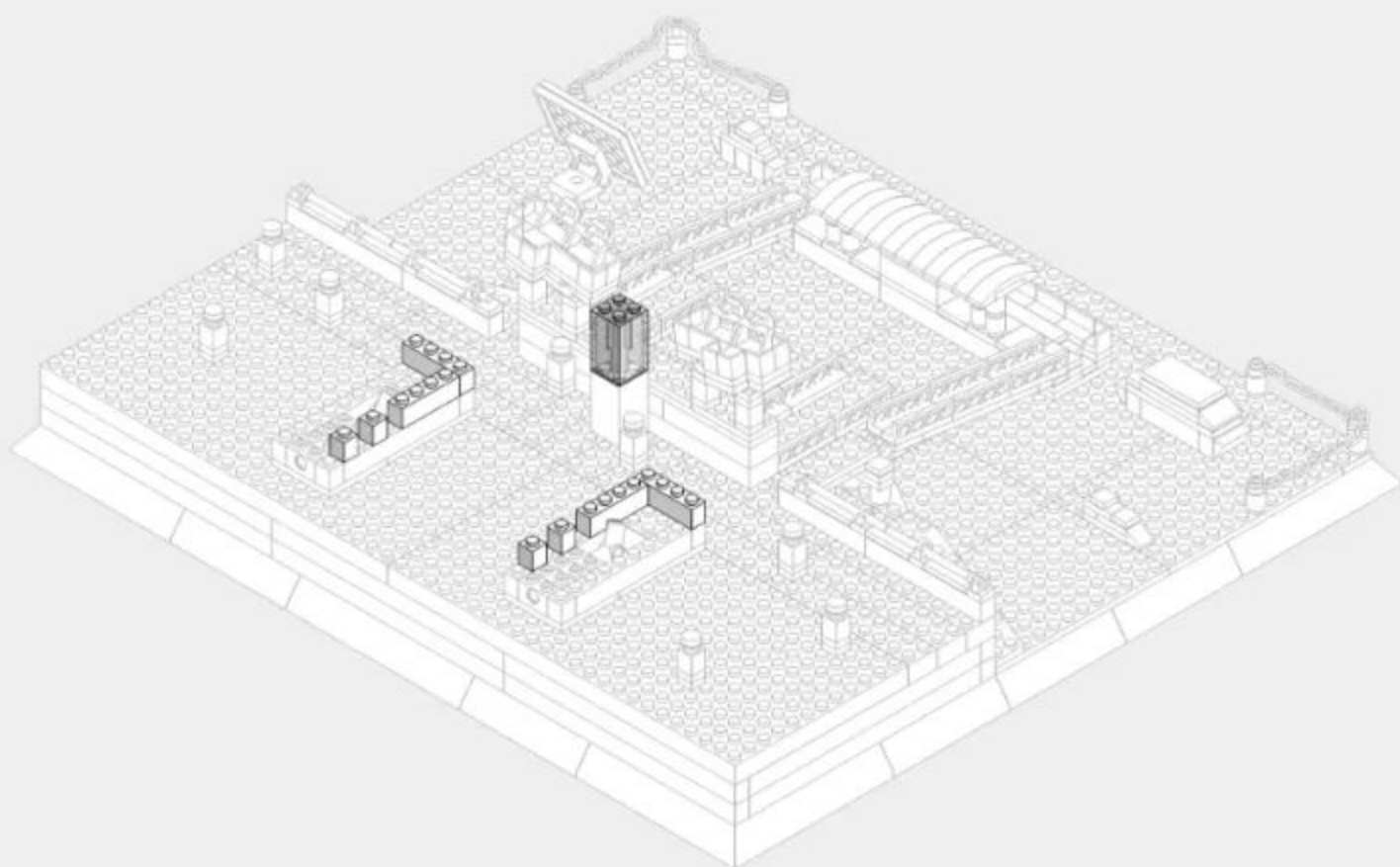
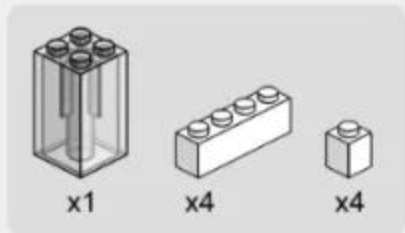

3-6



x1



x2



x6

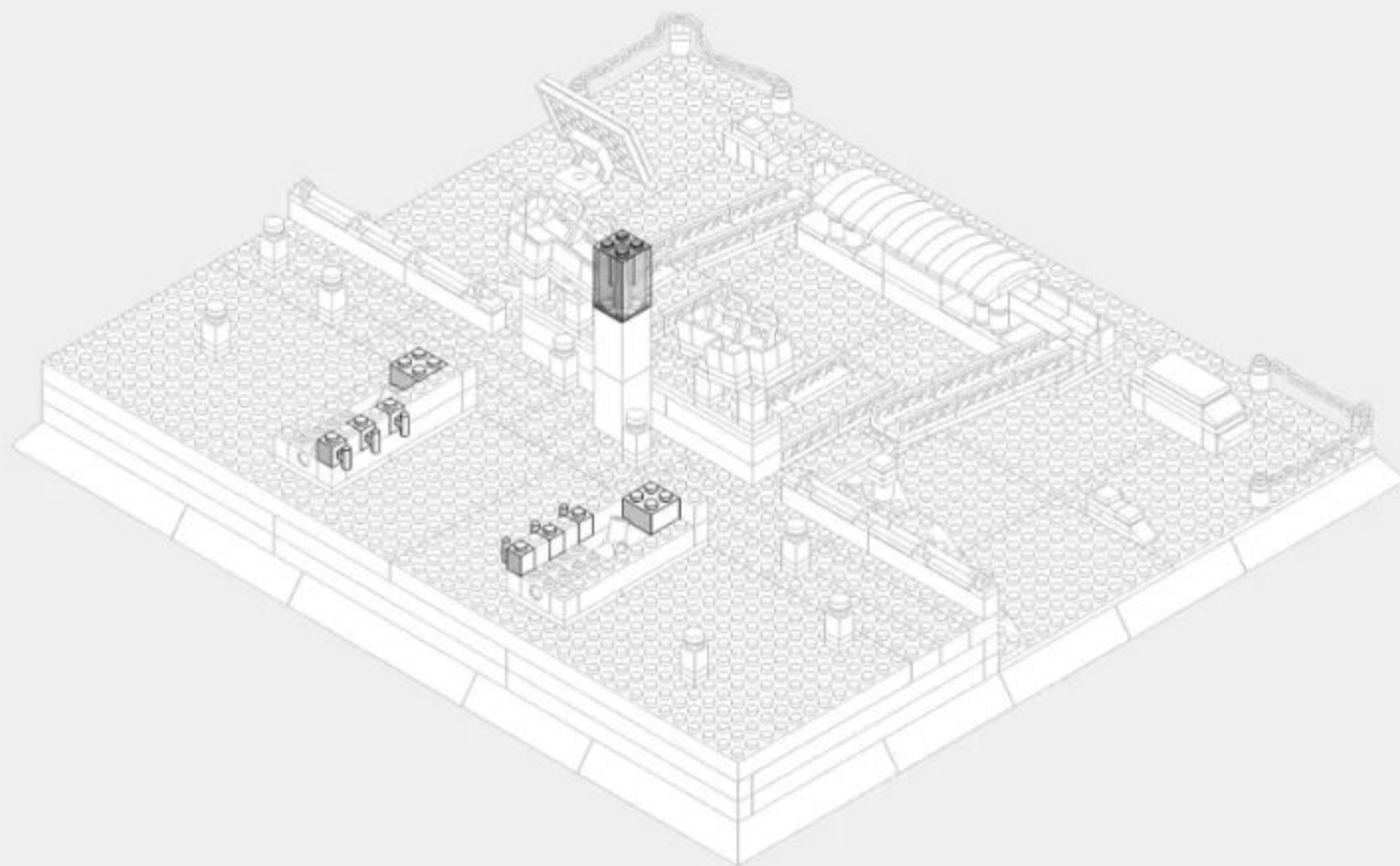

3-7



x1

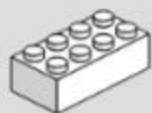

x2



x2

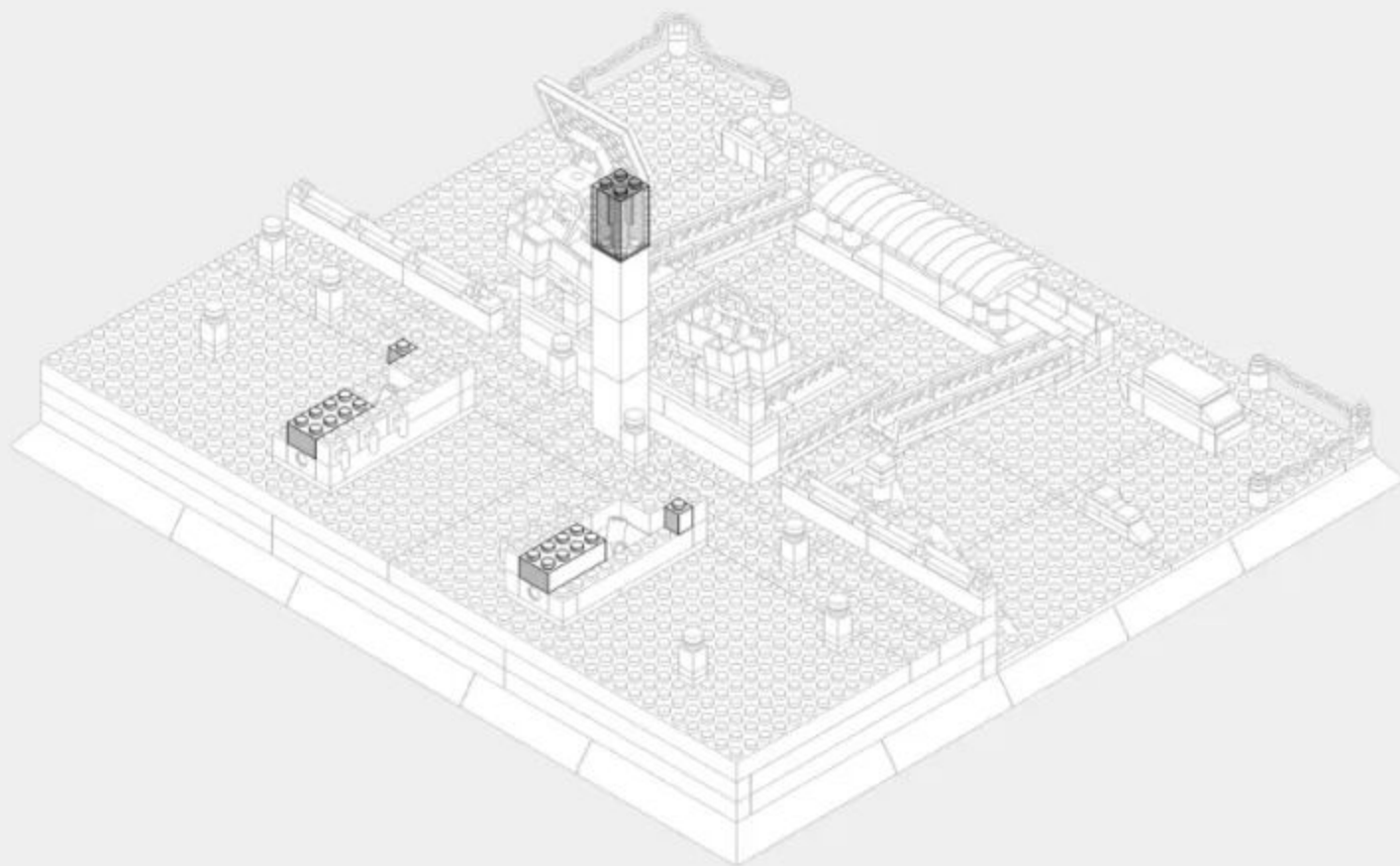

3-8



x3

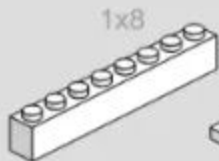

x2

1x8



x2



x2

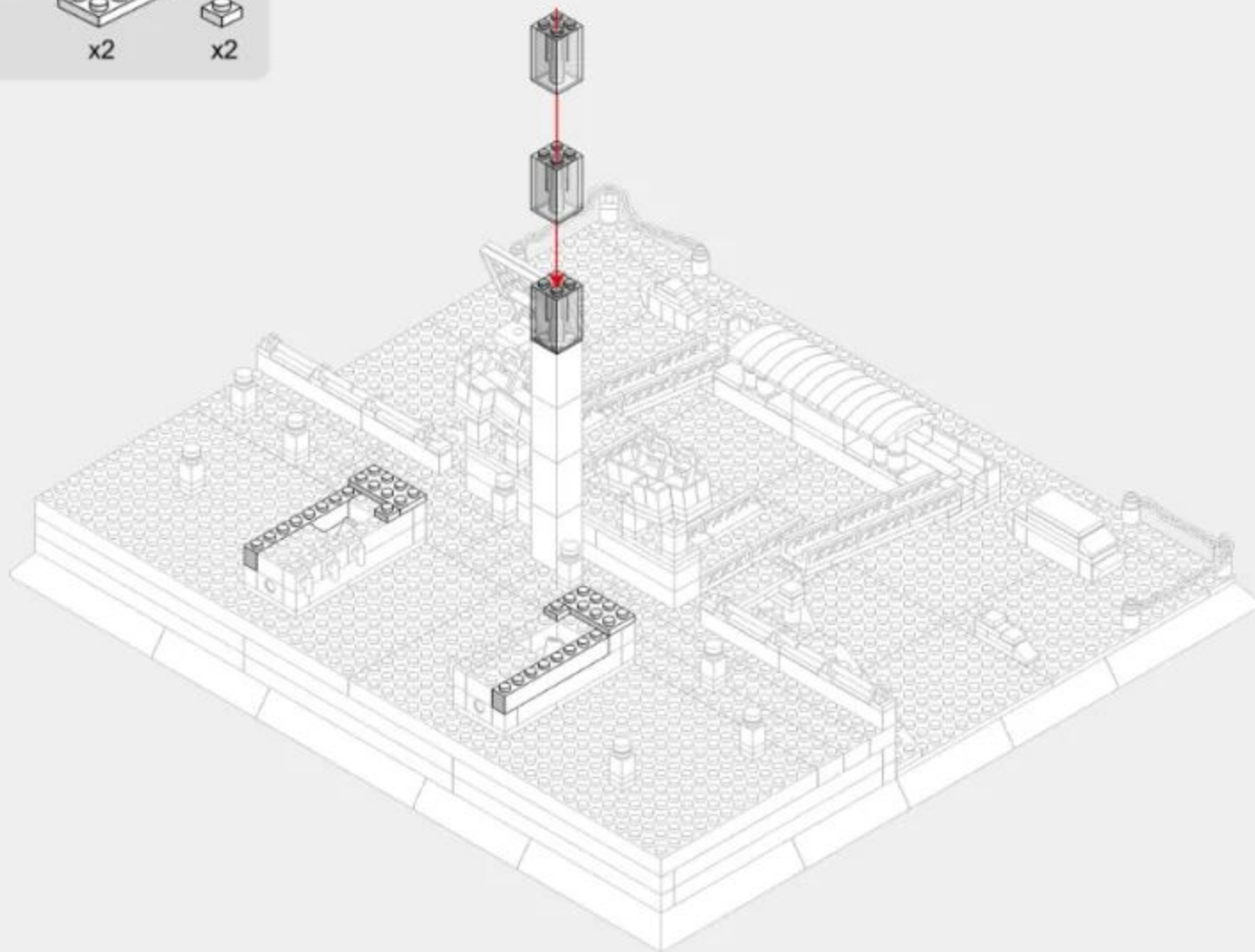

3-9

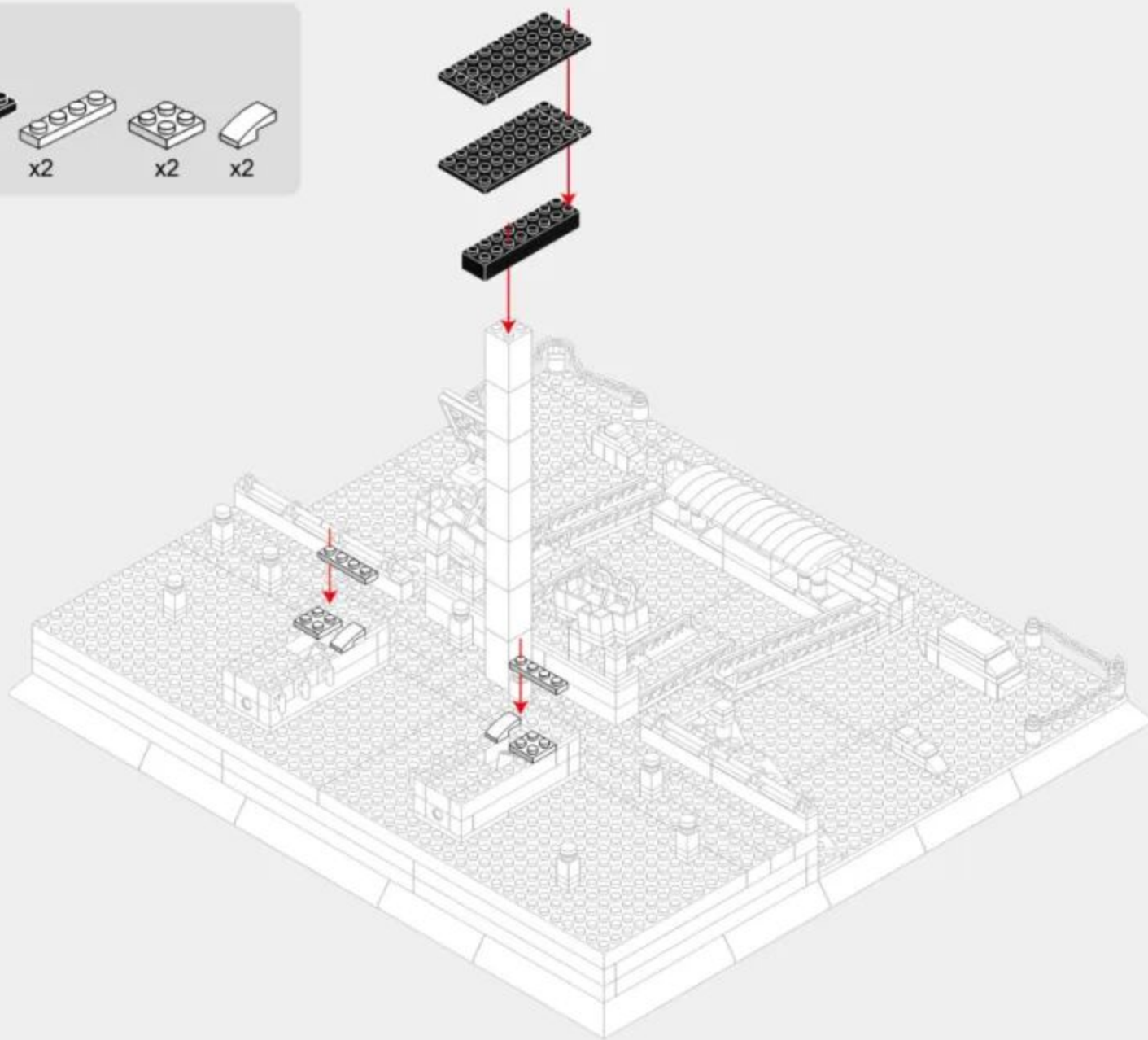
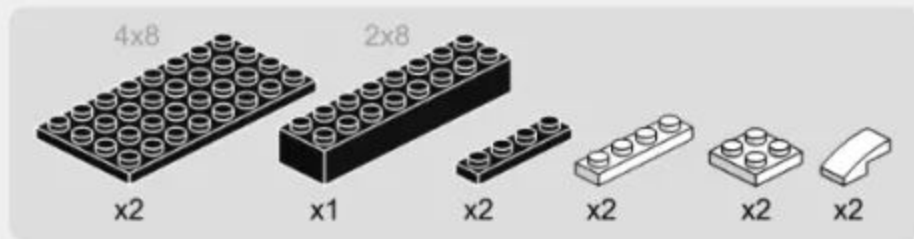

3-10

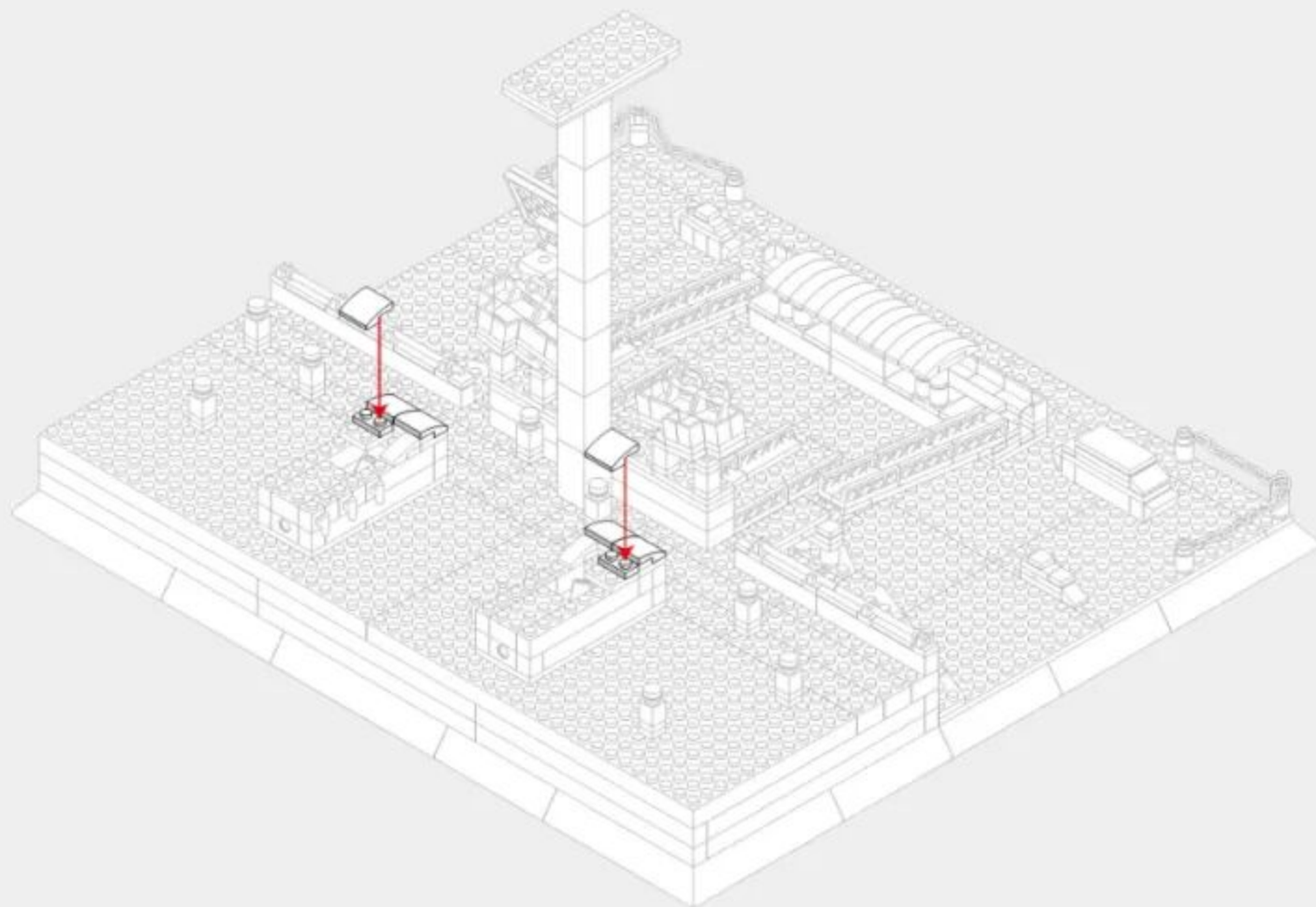

3-11

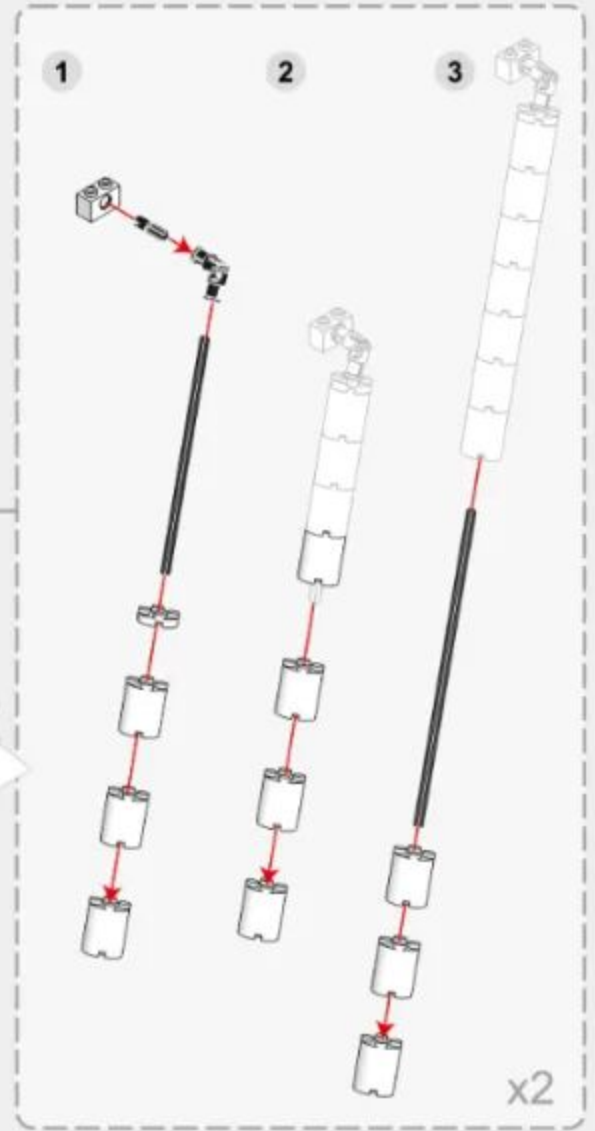
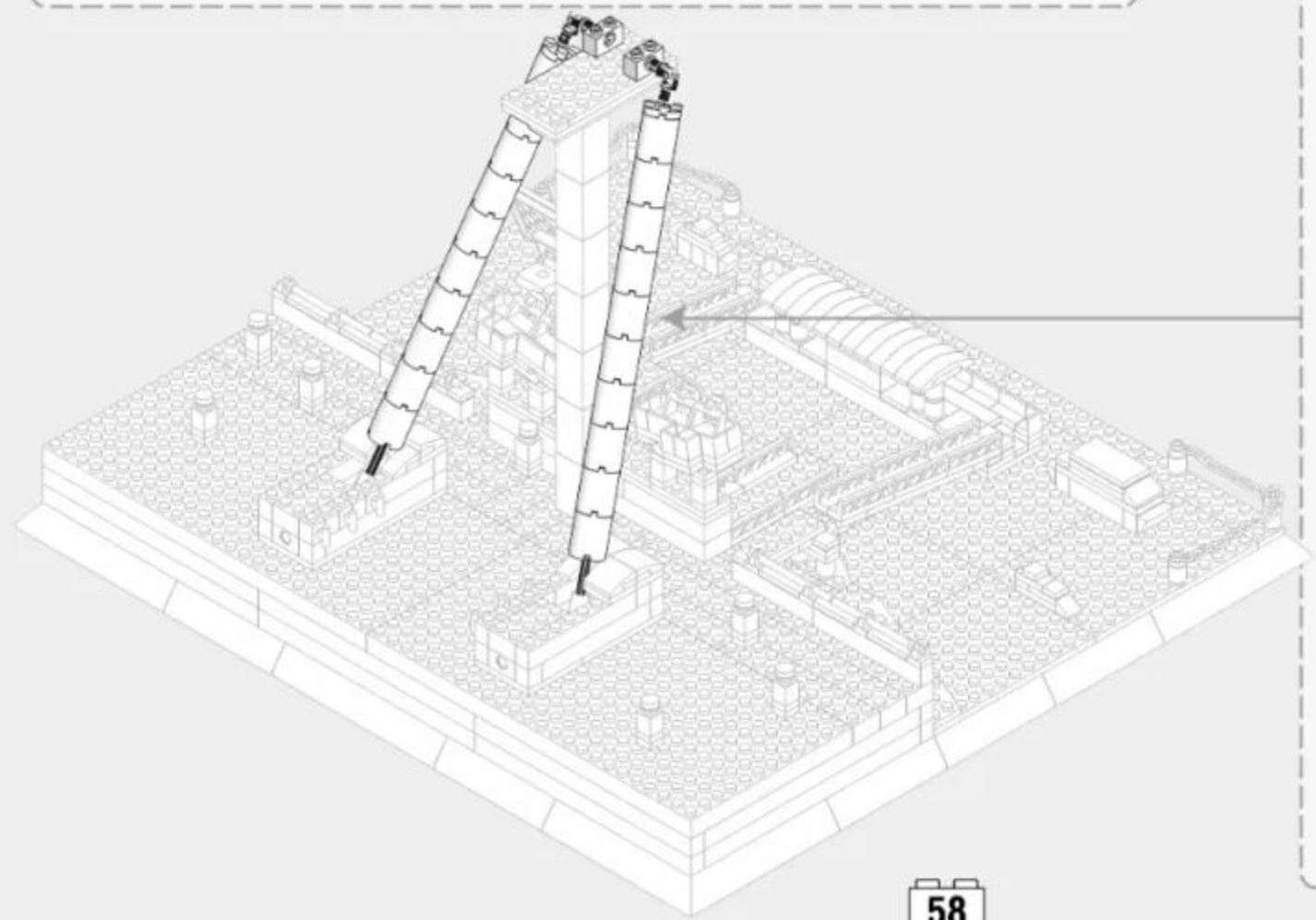
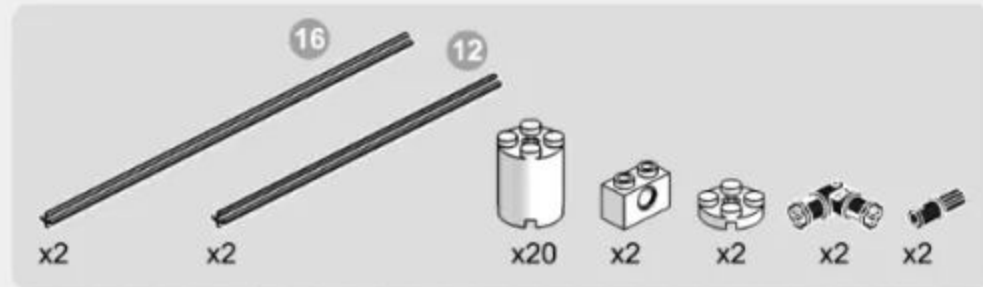

3-12



x2



x12



x2



x6



x2

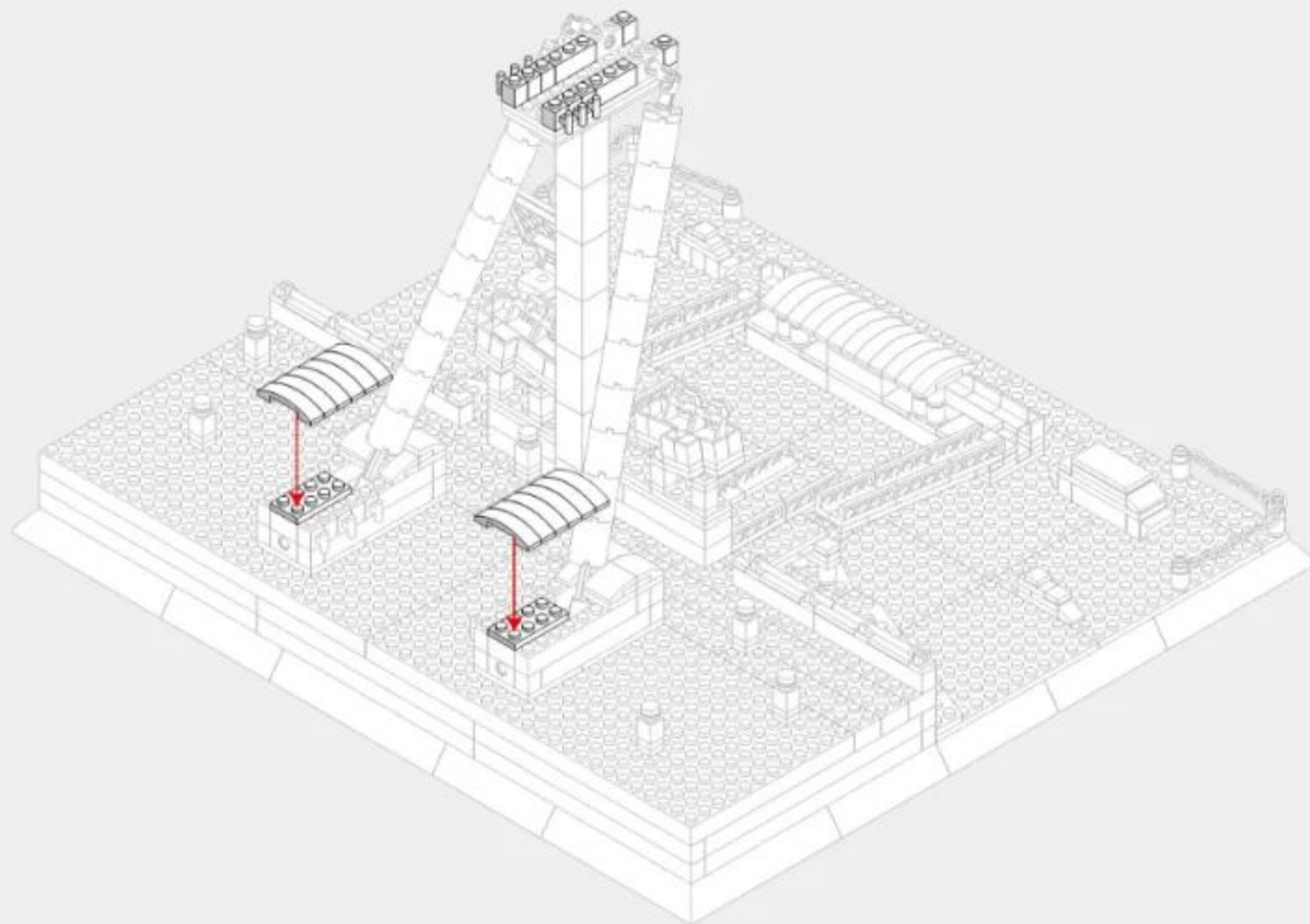

3-13

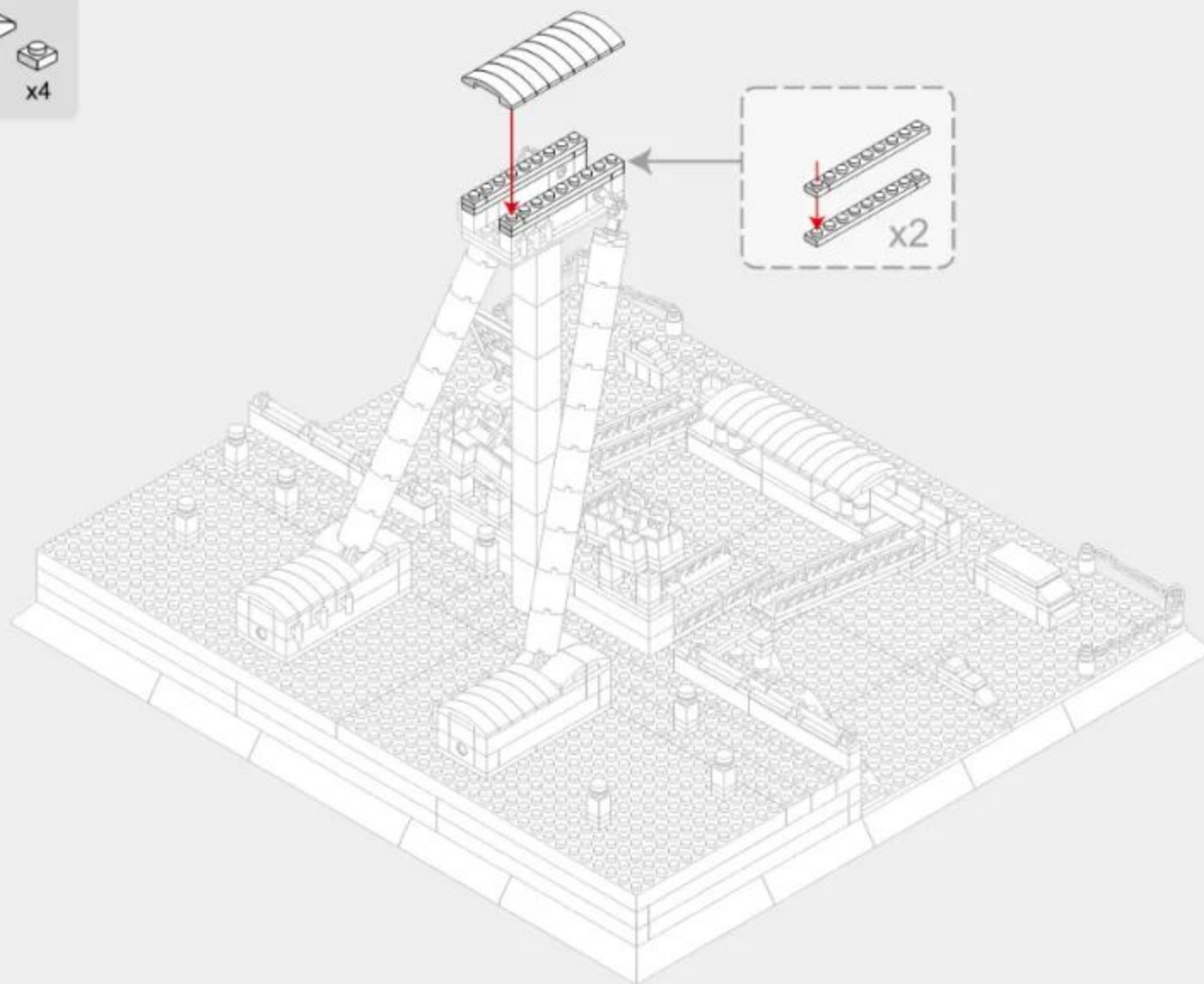
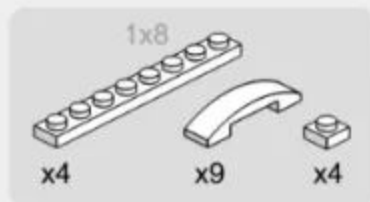

3-15



x1



x2



x1



x1

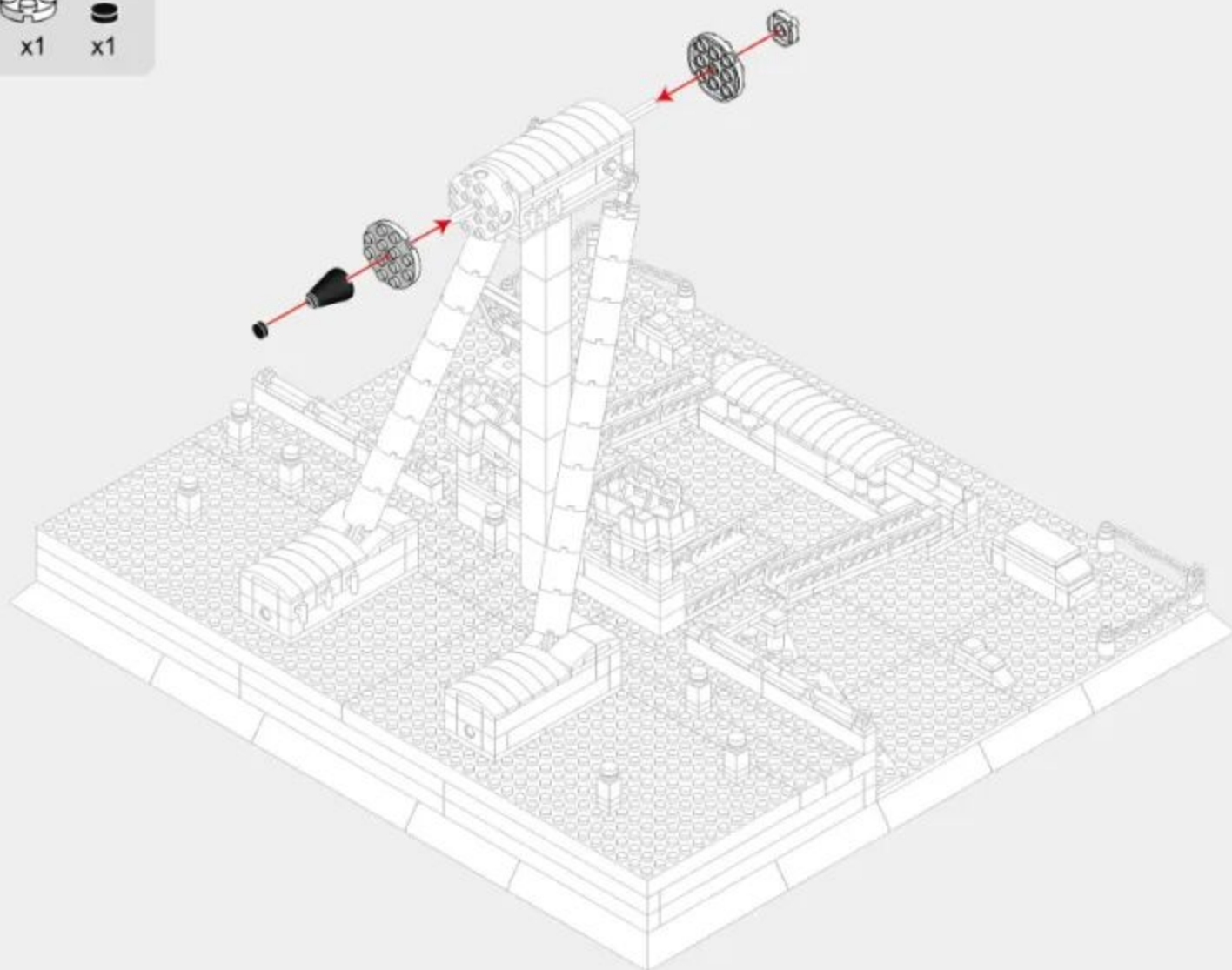

3-16



length: 22cm

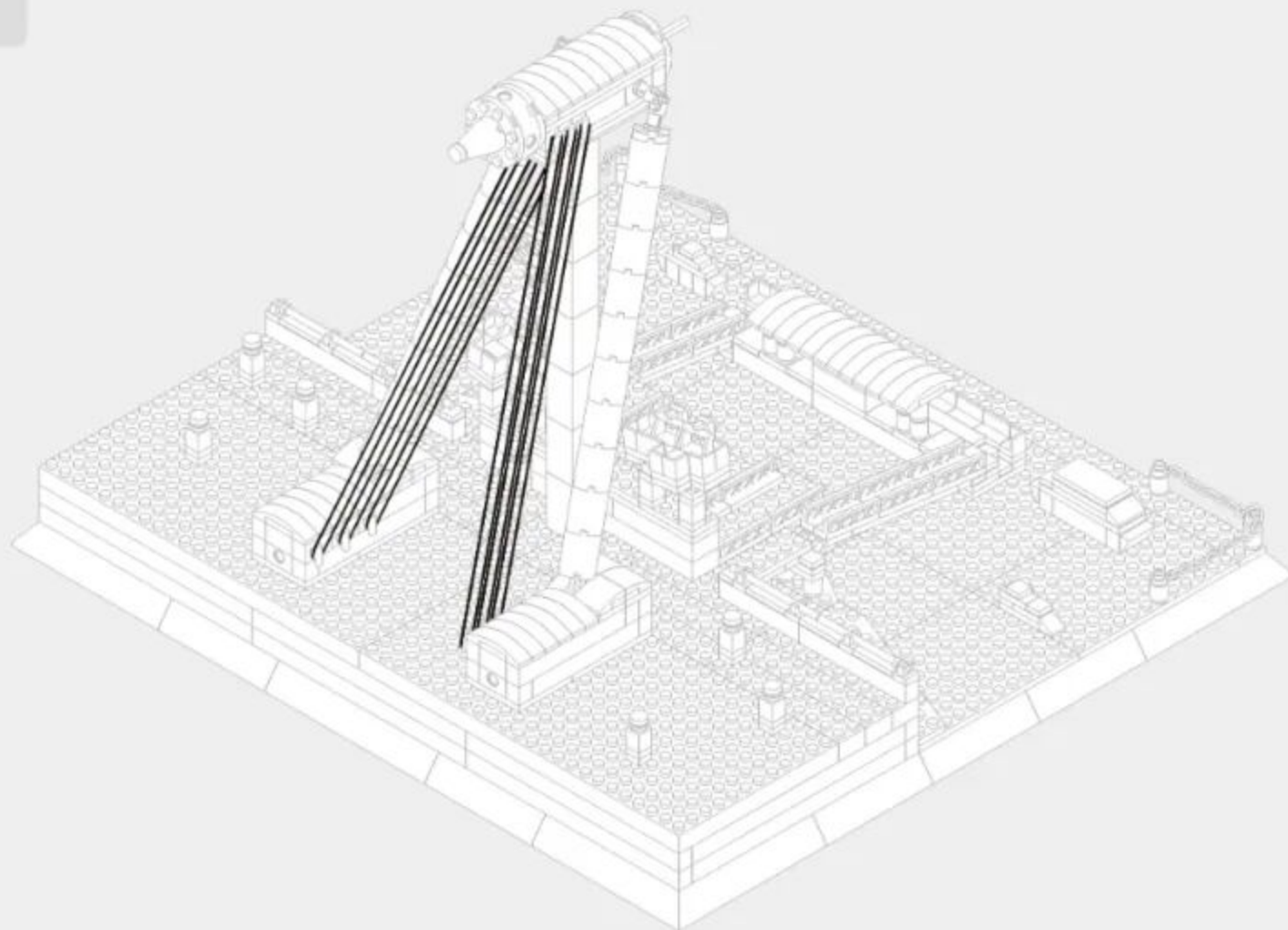

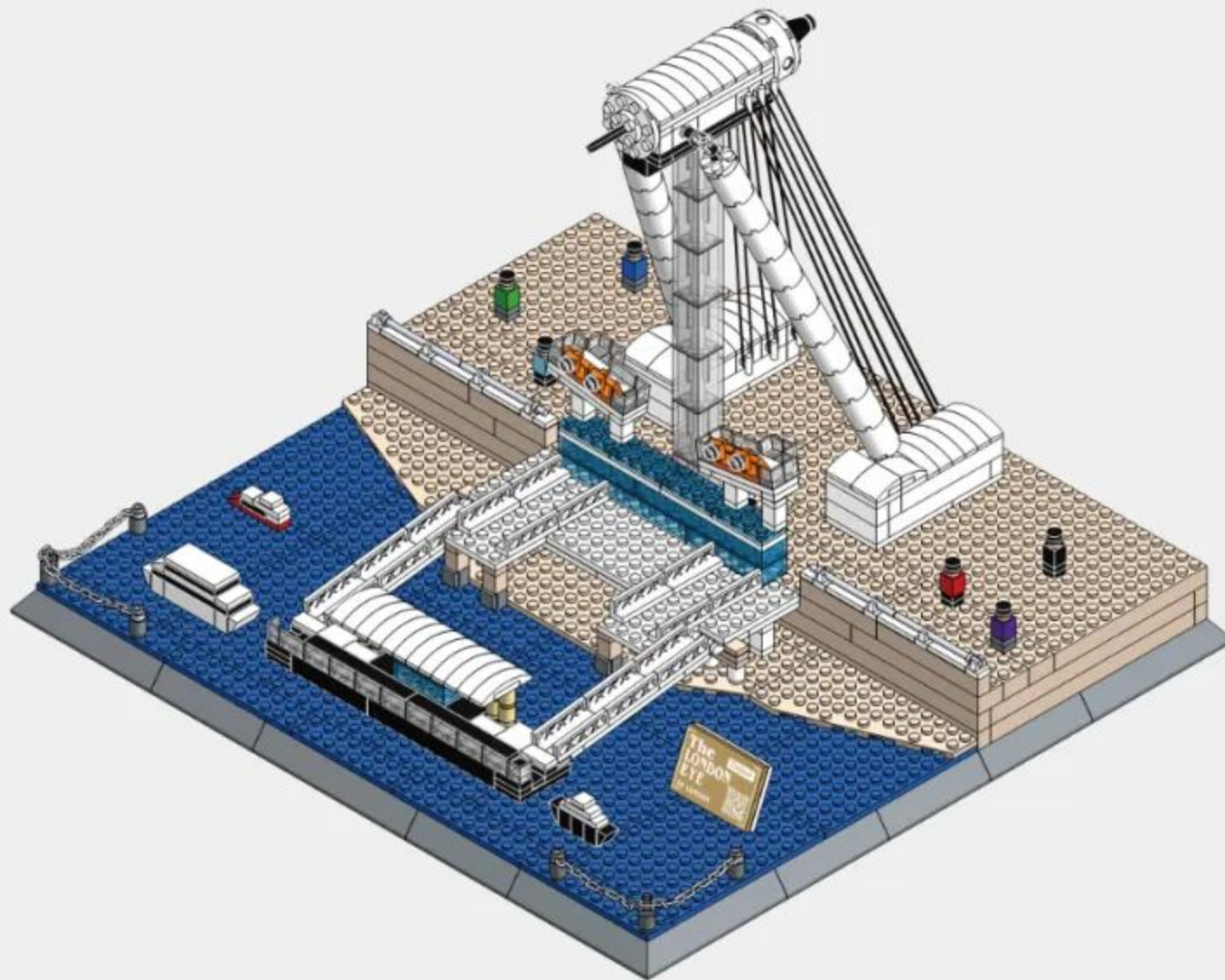



256PCS

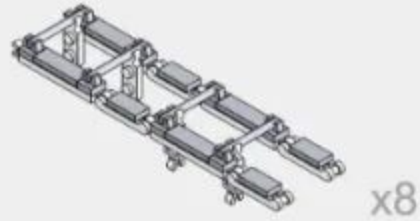

x8

4-1



4-2

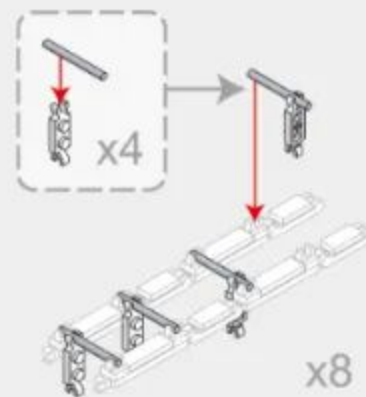



208PCS

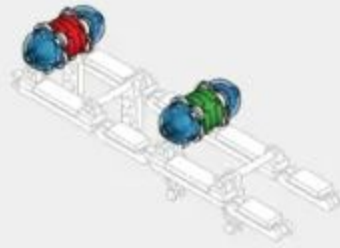

x8

67

5-1



x32



x8



x8



x16



x16



x32



x96

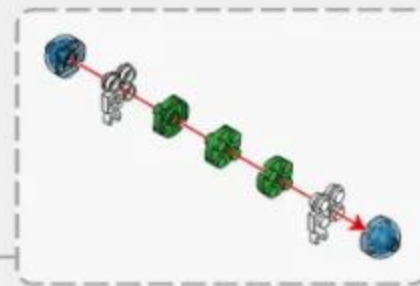
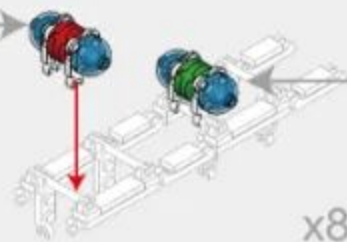
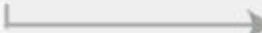
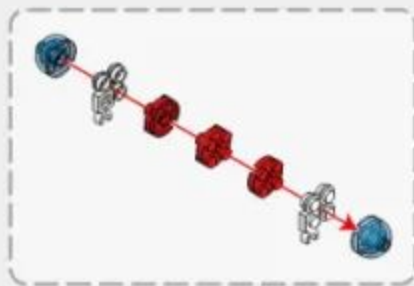









208PCS



x8

6-1

-  x32
-  x8
-  x8
-  x16
-  x16
-  x32
-  x96

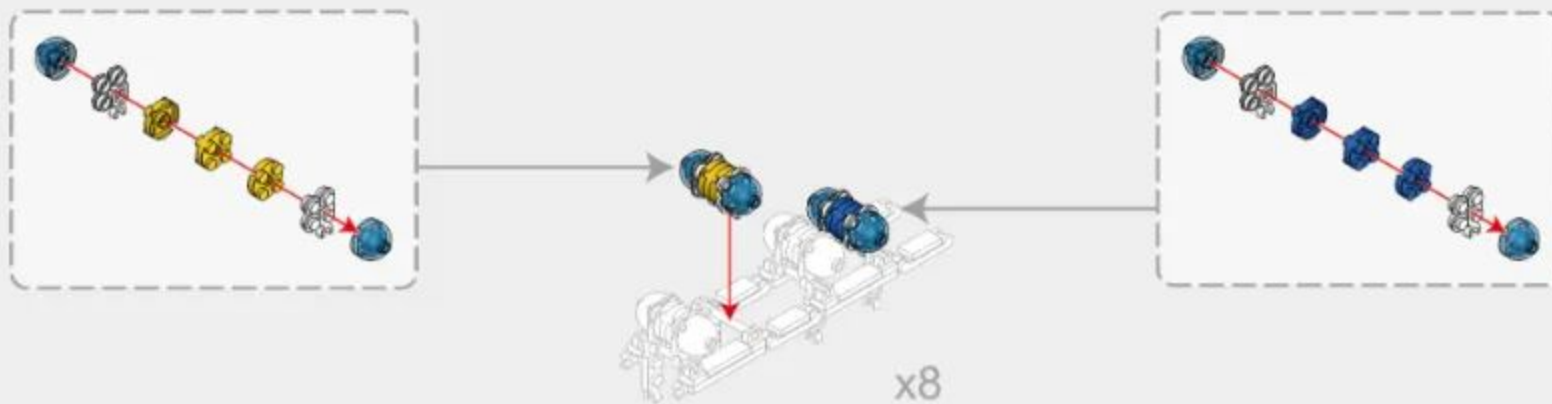



197PCS

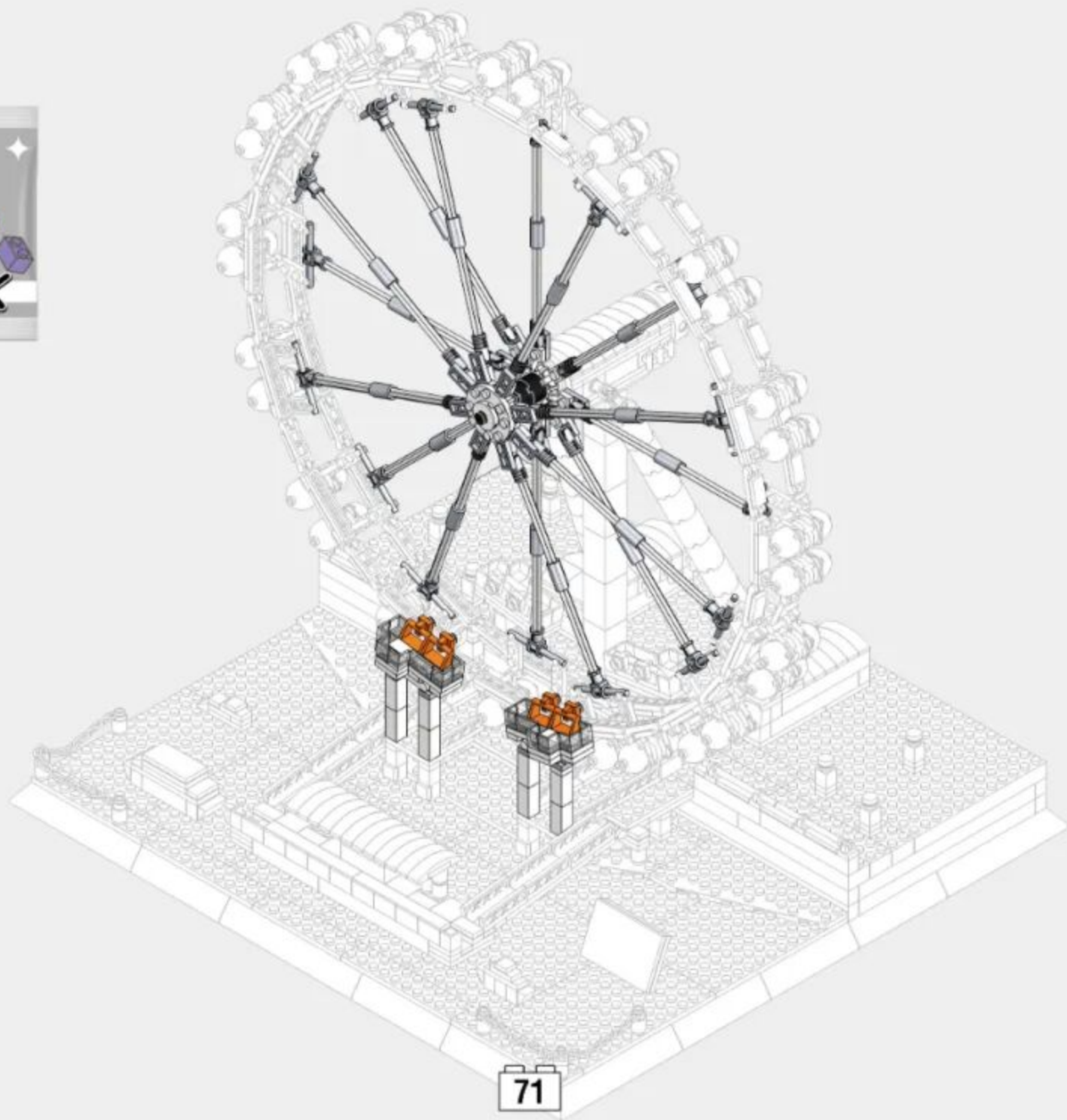

71

7-1

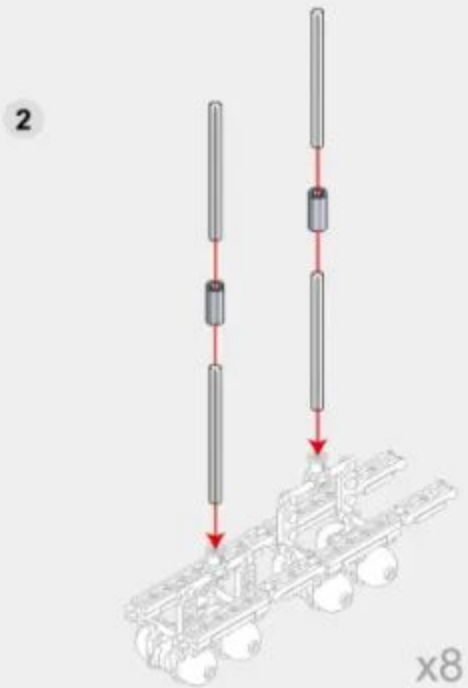
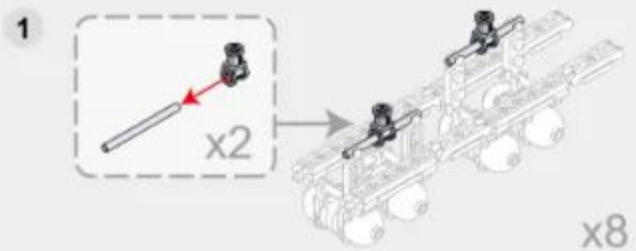

7-2

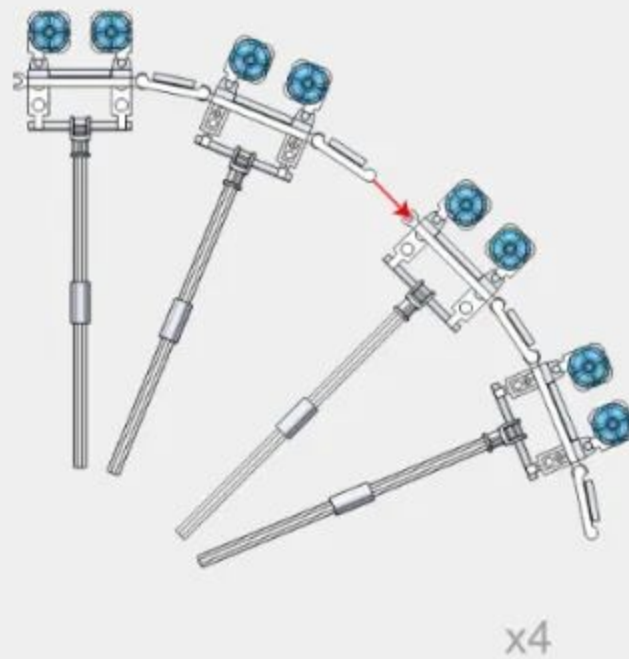

7-3

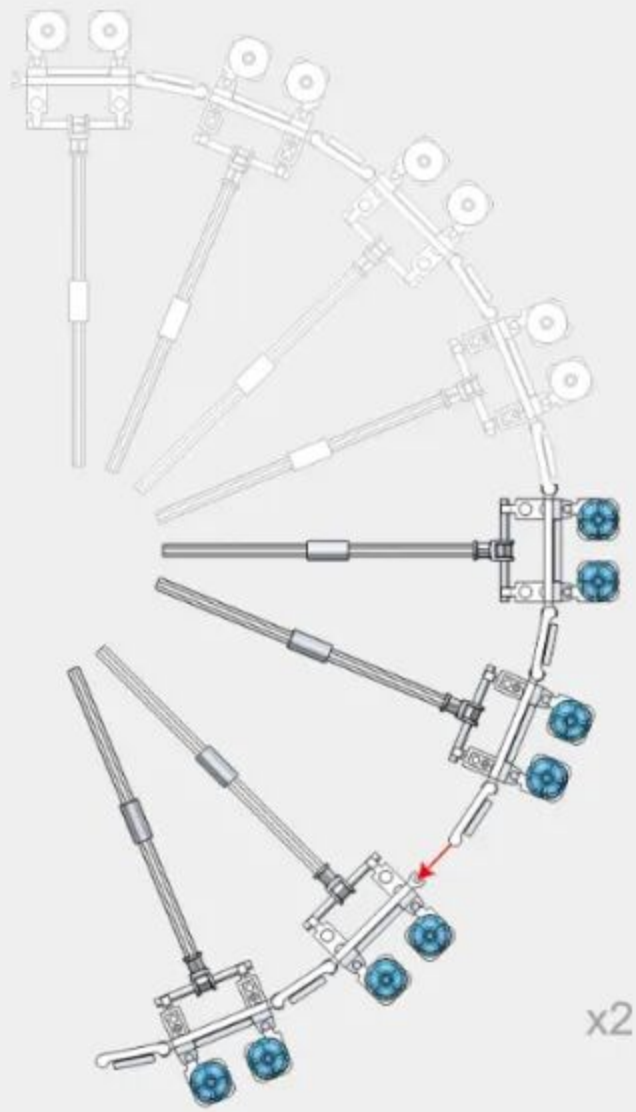

7-4

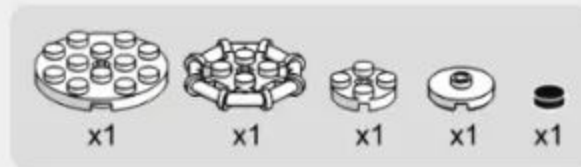

7-5



x8



x8



x8

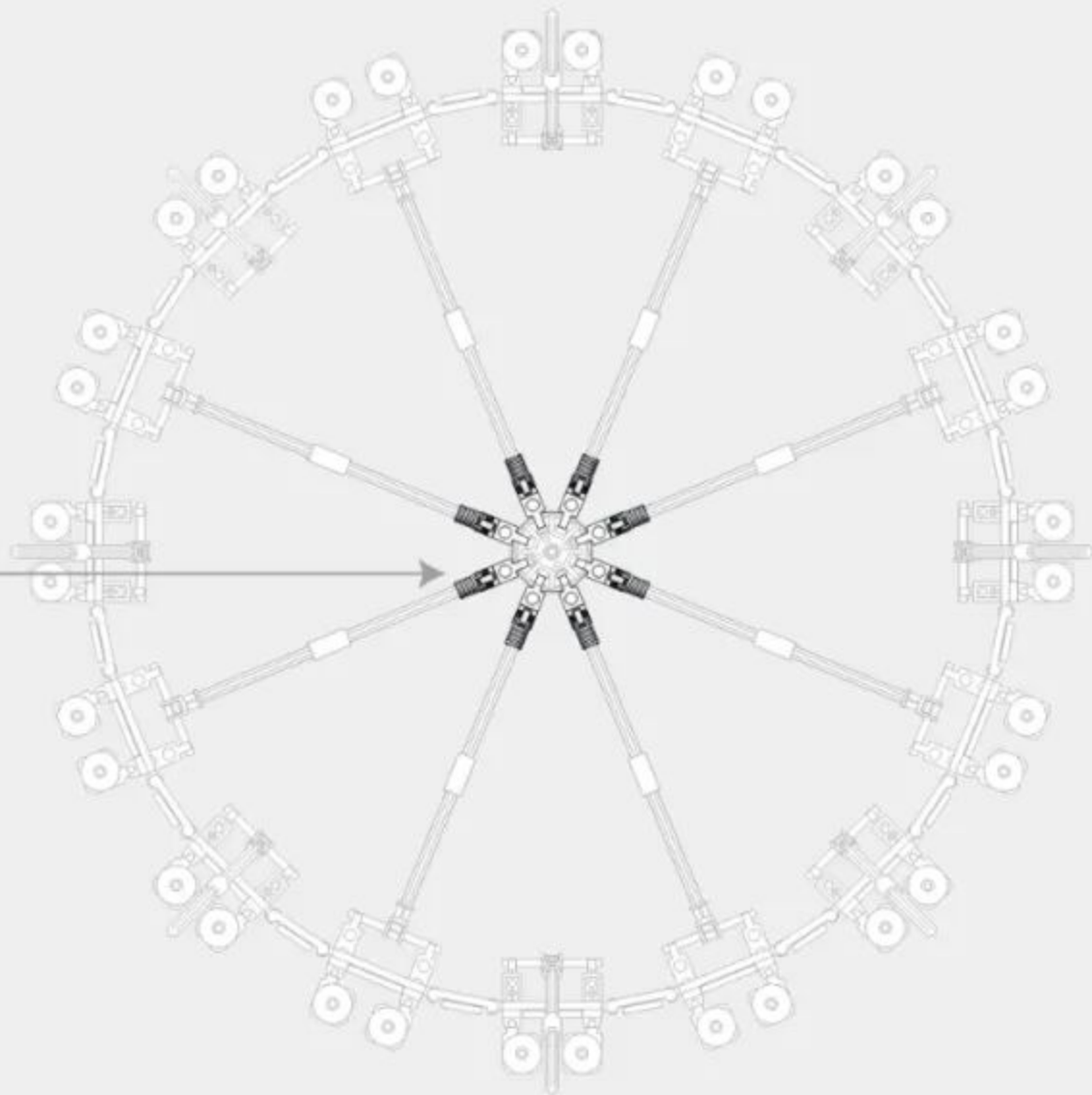

7-6



x1



x2



x1



x1



x1

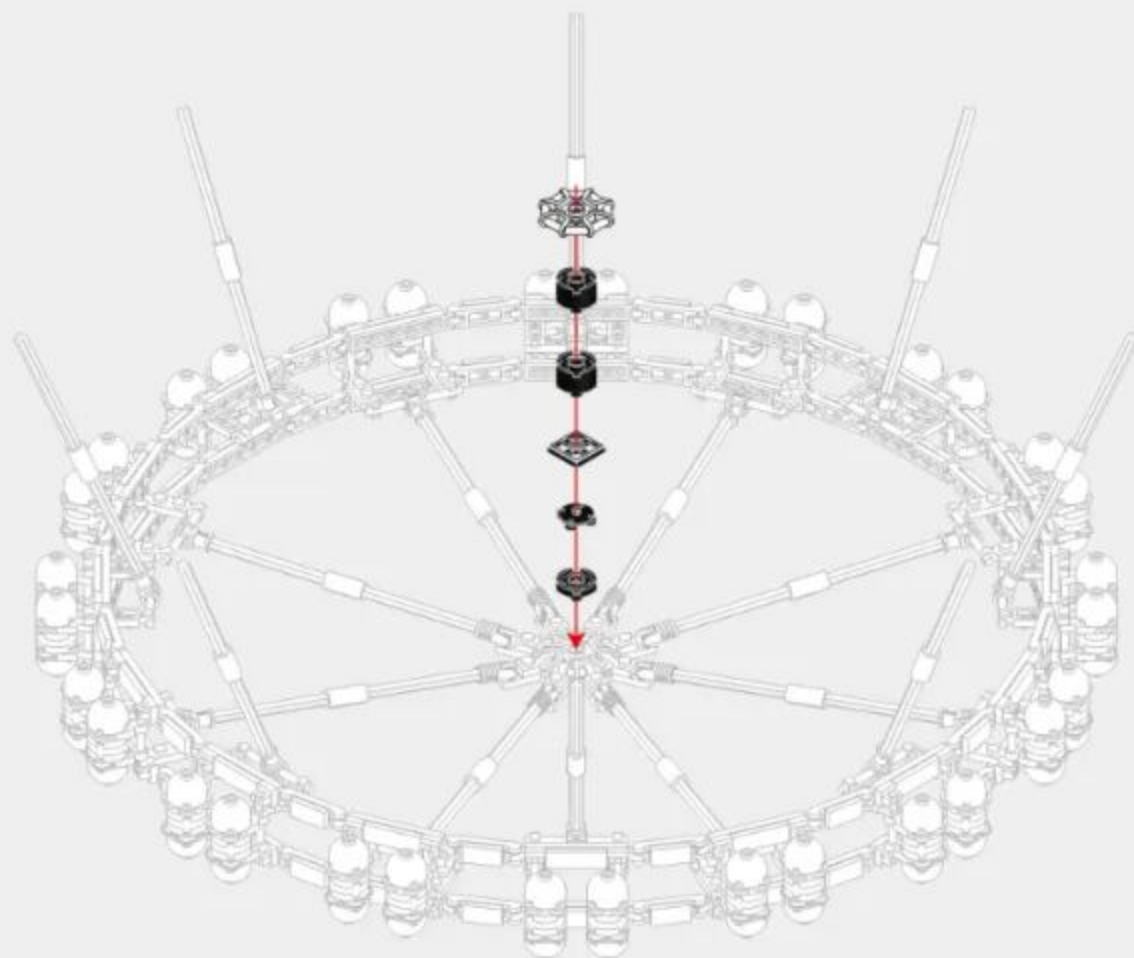

7-7

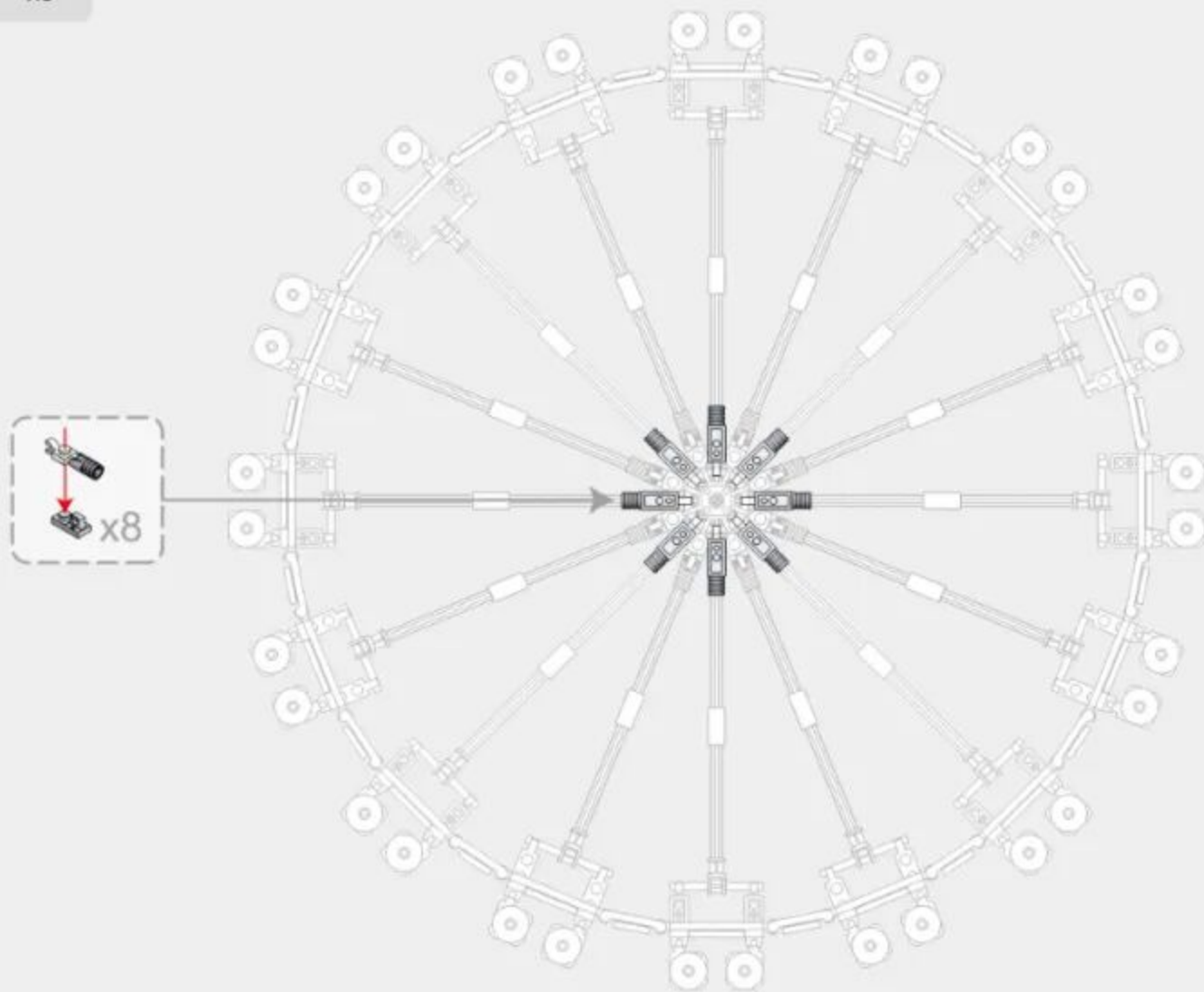



7-9

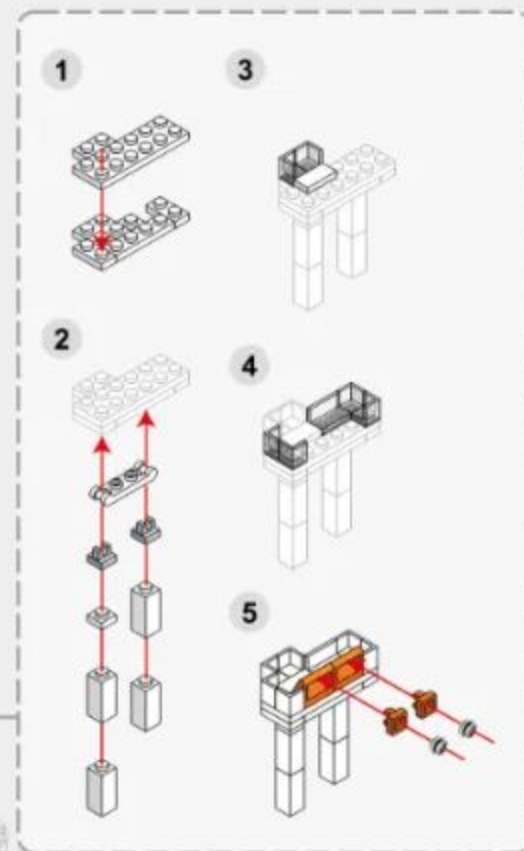
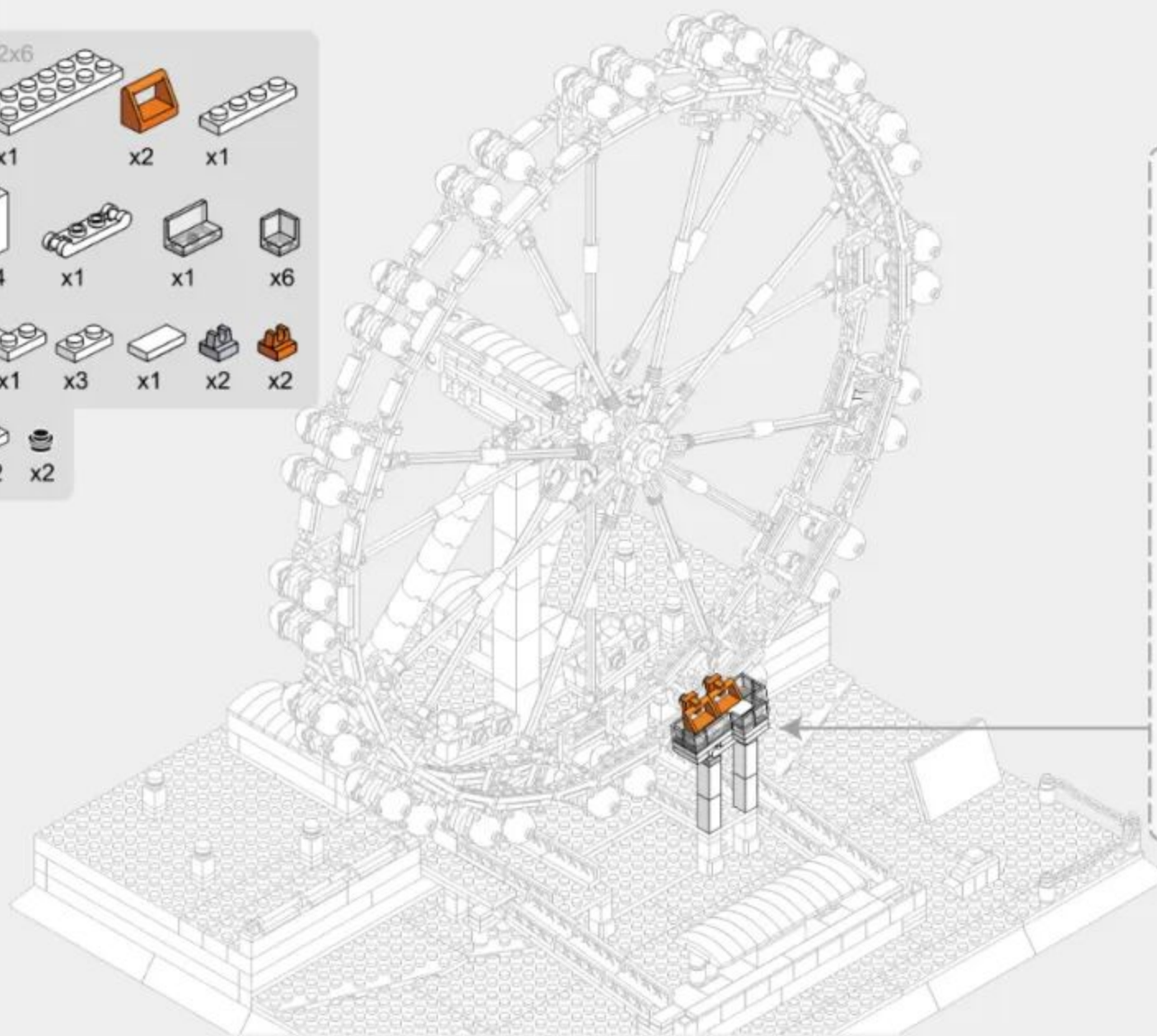

7-10

2x6

x1 x2 x1

x4 x1 x1 x6

x1 x3 x1 x2 x2

x2 x2

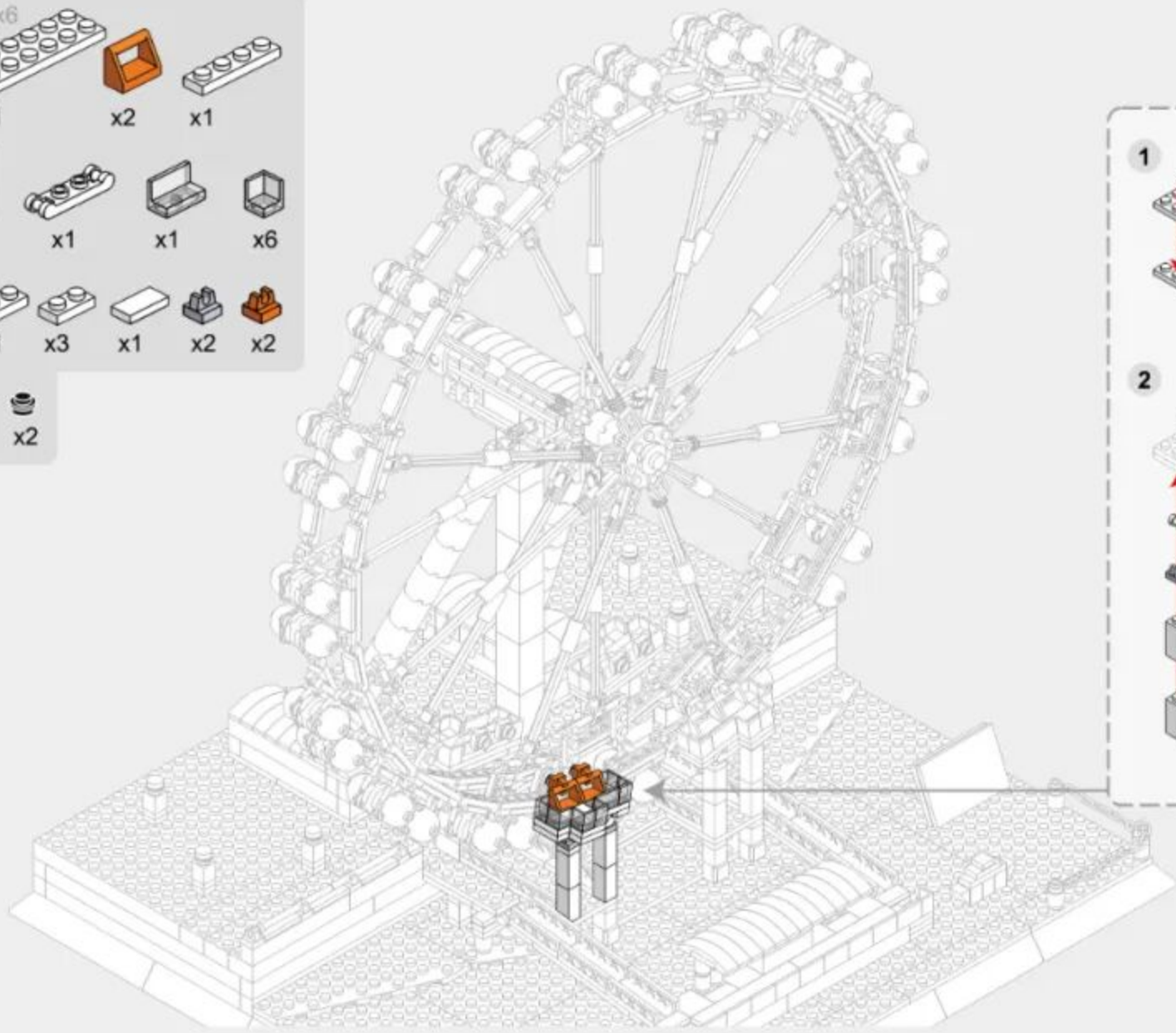



ARCHITECTURE

The World's great architecture

Shaping Skills Imagination & Curiosity Mathematical Self Discovery & Perception Parent-Child Interaction Problem Solving Creativity



6223 英国伦敦白金汉宫
BUCKINGHAM PALACE-LONDON,ENGLAND



5225 意大利罗马斗兽场
COLOSSEUM-ROME,ITALY



5226 日本东京帝国饭店
IMPERIAL HOTEL-TOKYO,JAPAN



5227 美国纽约自由女神像
STATUE OF LIBERTY-NEW YORK,AMERICA



6211 德国柏林勃兰登堡门
BRANDENBURG GATE-BERLIN, GERMANY



6222 中国甘肃长城-嘉峪关
JIAYU PASS-GANSU,CHINA



6212 日本京都清水寺仁王门
NIOMON GATE OF KIYOMIZU-DERA-KYOTO,JAPAN



6213 俄罗斯莫斯科瓦西里大教堂
SAINT BASIL'S CATHEDRAL-MOSCOW,RUSSIA



6214 中国武汉黄鹤楼
YELLOW CRANE TOWER-WUHAN,CHINA



6215 英国伦敦眼
LONDON EYE-LONDON,ENGLAND



6221 中国北京故宫-太和殿
HALL OF SUPREME HARMONY-BEIJING,CHINA



6220 沙特阿拉伯麦加大清真寺
GREAT MOSQUE OF MECCA,SAUDI ARABIA



6219 美国纽约联合国大厦
UNITED NATIONS HEADQUARTERS-NEW YORK,AMERICA



4214 美国华盛顿白宫
WHITE HOUSE-WASHINGTON D.C.,AMERICA



4212 意大利罗马许愿池
TREVİ FOUNTAIN-ROME,ITALY



4213 法国巴黎卢浮宫
MUSÉE DU LOUVRE-PARIS,FRANCE



4218 新加坡-鱼尾狮
MERLION,SINGAPORE



4219 英国伦敦双子塔桥
TOWER BRIDGE-LONDON,ENGLAND



4216 美国华盛顿林肯纪念堂
LINCOLN MEMORIAL-WASHINGTON D.C.,AMERICA



4217 新加坡-金沙酒店
MARINA BAY SANDS,SINGAPORE



4210 埃及开罗吉萨金字塔
GREAT PYRAMID OF GIZA-CAIRO,EGYPT



4221 加拿大渥太华国会山庄
PARLIAMENT BUILDINGS-OTTAWA,CANADA



4211 英国伦敦伊丽莎白塔
ELIZABETH TOWER-ENGLAND



4215 加拿大多伦多电视塔
THE CN TOWER-CANADA



4220 美国纽约熨斗大厦
FLATIRON BUILDING-NEW YORK,AMERICA



4222 阿联酋迪拜哈利法塔
THE BURJ KHALIFA TOWER-DUBAI,UAE



5224 中国上海东方明珠广播电视塔
ORIENTAL PEARL TOWER-SHANGHAI,CHINA



5212 美国纽约帝国大厦
EMPIRE STATE BUILDING-NEW YORK,AMERICA



5213 马来西亚吉隆坡石油双塔
PETRONAS TWIN TOWERS-KUALA LUMPUR,MALAYSIA



5214 意大利托斯卡纳比萨斜塔
LEANING TOWER OF PISA-TUSCANY,ITALY



5216 英国伦敦伊丽莎白塔
ELIZABETH TOWER-LONDON,ENGLAND



5219 俄罗斯莫斯科克里姆林宫钟楼
SPASSKAYA TOWER-MOSCOW,RUSSIA



5220 阿联酋迪拜卓美亚帆船酒店
BURJ AL ARAB HOTEL-DUBAI,UAE



5217 法国巴黎埃菲尔铁塔
EIFFEL TOWER-PARIS,FRANCE



5221 中国台北101大楼
TAIPEI 101-TAIPEI,CHINA



6223 中国武汉长江大桥
WUHAN YANGTZE RIVER BRIDGE



5210 法国巴黎圣母院大教堂
CATHÉDRALE NOTRE DAME DE PARIS-PARIS,FRANCE



5211 印度阿格拉泰姬陵
TAJ MAHAL-AGRA,INDIA



5223 法国巴黎凯旋门
ARC DE TRIOMPHE-PARIS,FRANCE



5215 英国伦敦双子塔桥
TOWER BRIDGE-LONDON,ENGLAND



5222 中国北京天坛祈年殿
HALL OF PRAYER FOR GOOD HARVESTS-BEIJING,CHINA



6210 美国旧金山金门大桥
GOLDEN GATE BRIDGE-SAN FRANCISCO,AMERICA



6216 中国北京万里长城（八达岭）
THE GREAT WALL-BEIJING,CHINA



5218 中国北京天安门
TIANANMEN TOWER-BEIJING,CHINA



6217 中国西藏布达拉宫
POTALA PALACE-TIBET,CHINA



6218 芬兰罗瓦涅米圣诞老人办公室
SANTA CLAUS OFFICE-ROVANIEMI,FINLAND

LONDON EYE

COUNTRY: England

CITY: London



England
The world's great architecture



621520210813.01