



THE GREAT WALL

万里长城 (八达岭)

Beijing, China

The world's great architecture

Ages 6+



NO.6216
1517 PCS

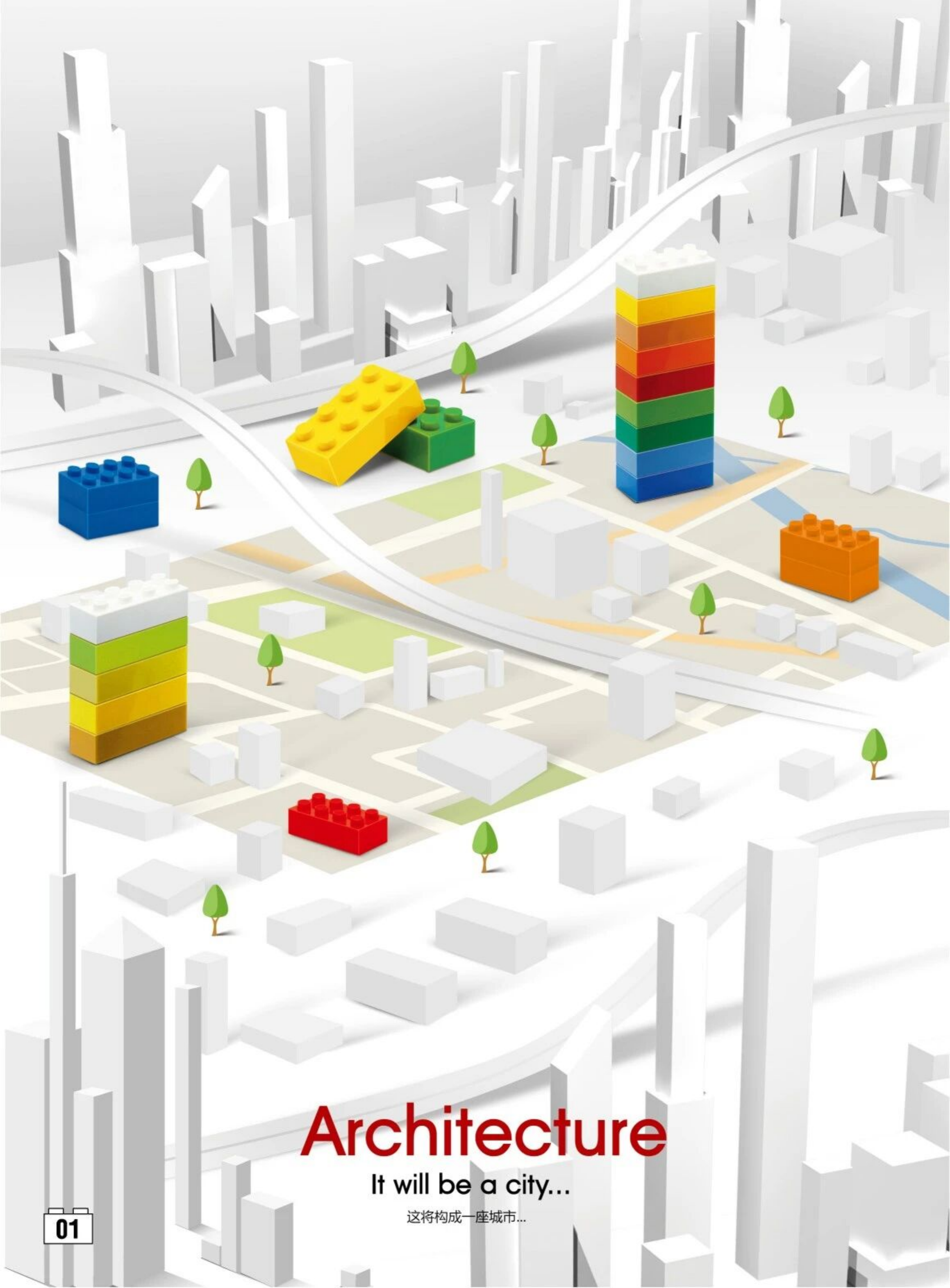

Architecture

It will be a city...

这将构成一座城市...

Instructions For Use

积木起件器使用说明
Brickseparator

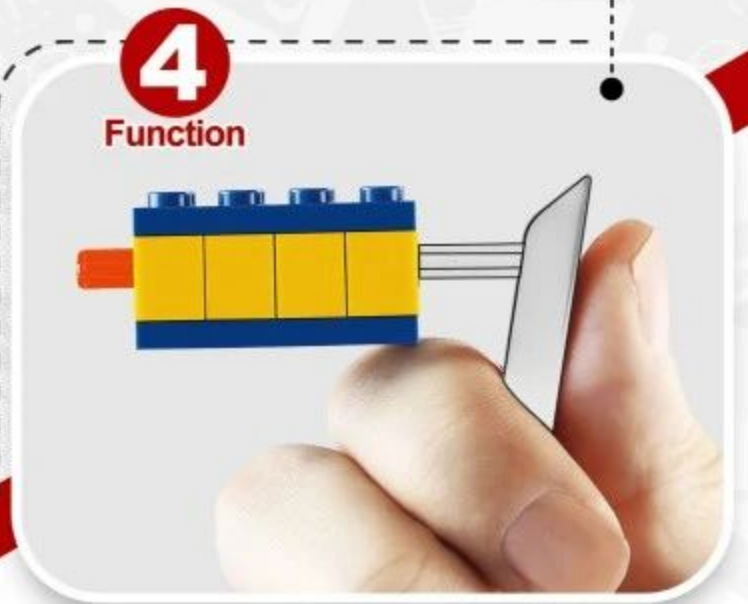
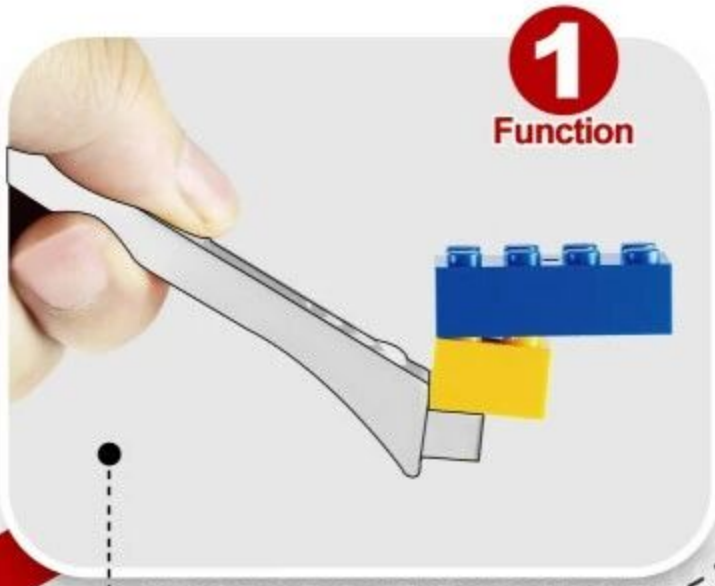

4 ways to make installation easier
让安装更简单



- First open the product packaging according to the instructions.

按指导用正确方式拆解产品外包装。



- Summarize all parts to count the number of familiar accessories.

对照说明书清单确认积木包数量与积木数量。



- Arranging all accessories by color helps to quickly install the product.

把确认好的积木以类型、颜色进行分类排好以便安装。



- Carefully install the product and learn about building.

按说明书步骤拼装并完成你的积木模型。



INSTALLATION
TIPS

1:1 Physical Reference Table

十字棒配件1:1尺寸参照表



Instructions For Use
让安装更简单

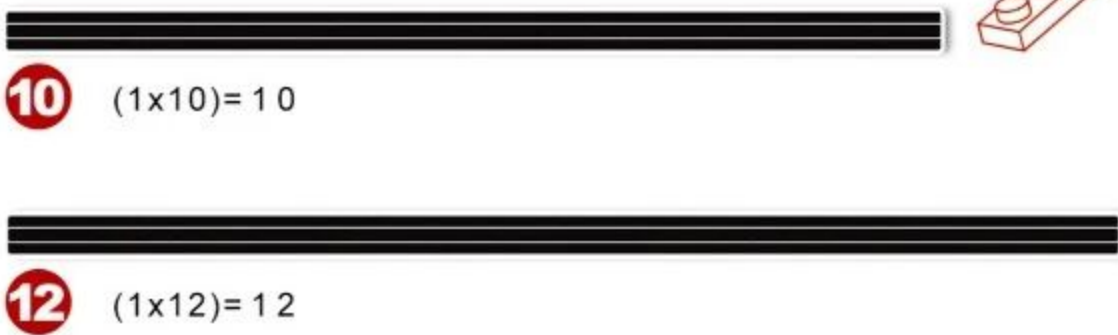
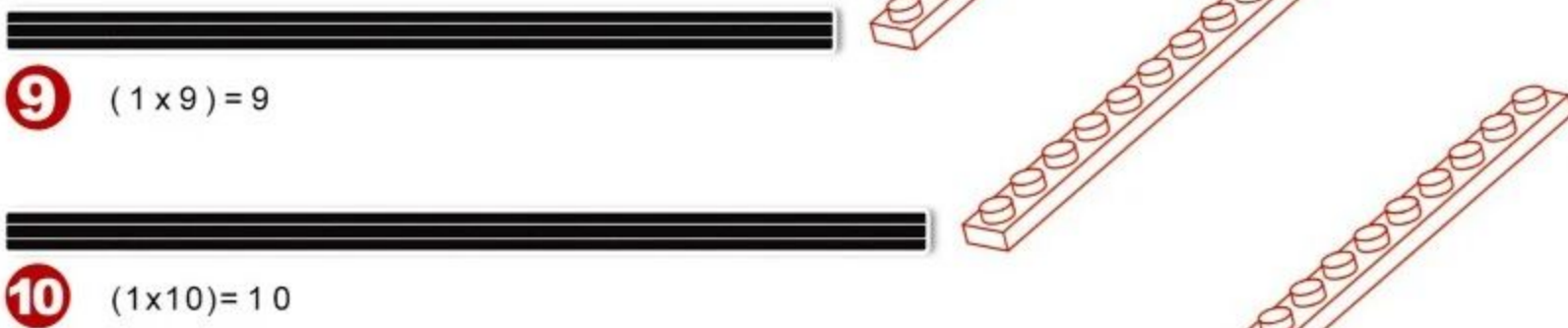
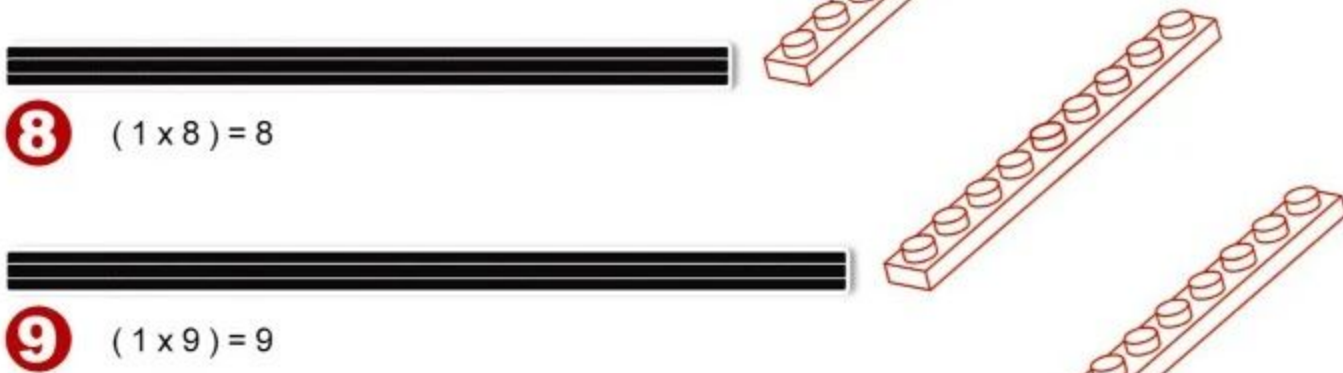
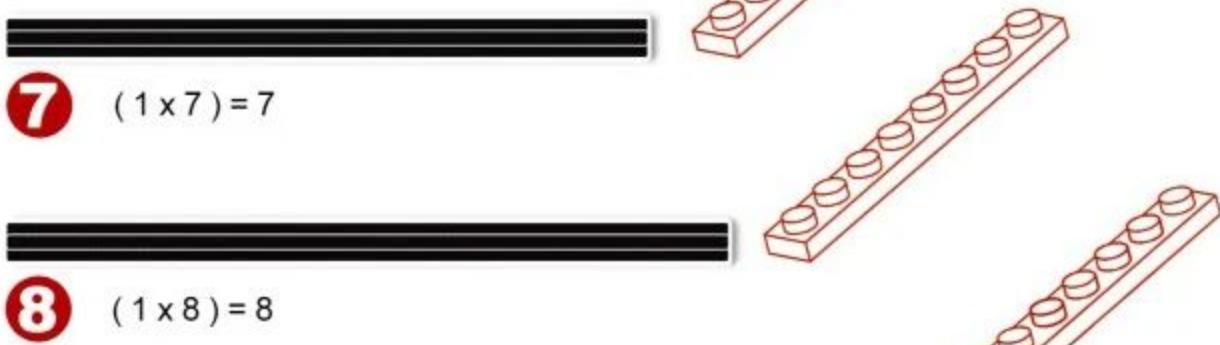
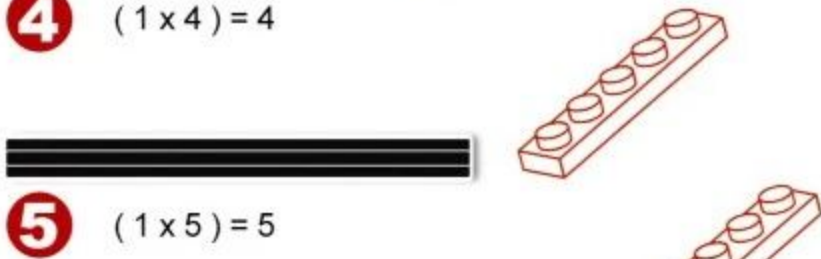
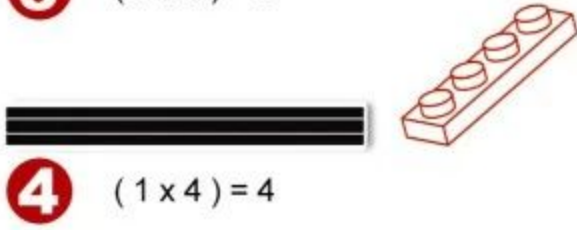
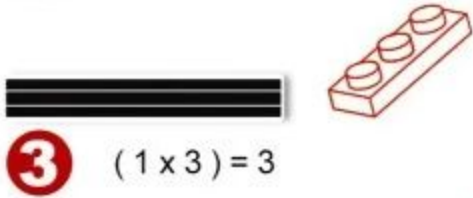
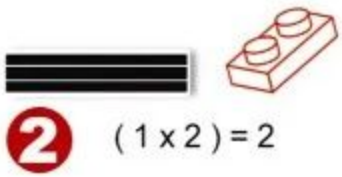

ABOUT THE PRODUCT

关于产品

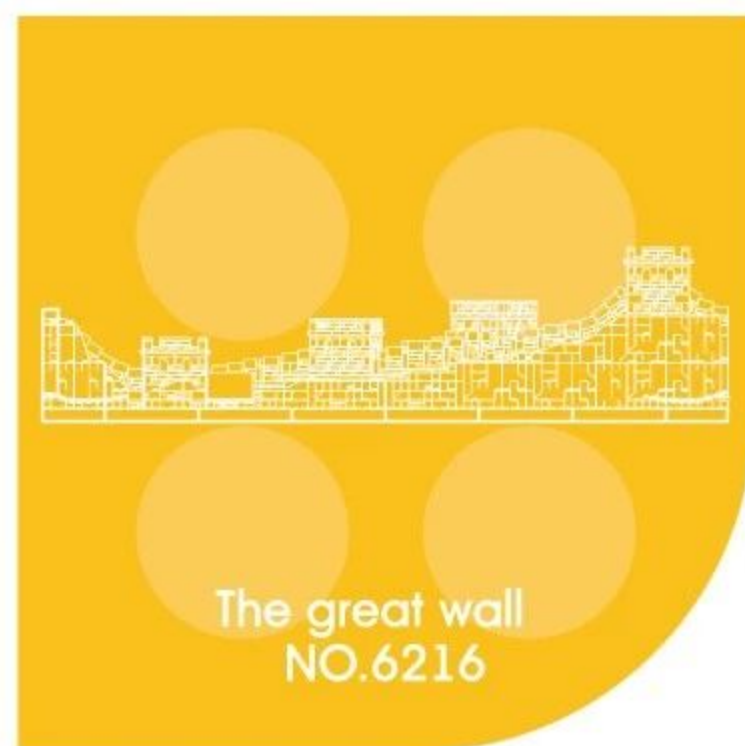
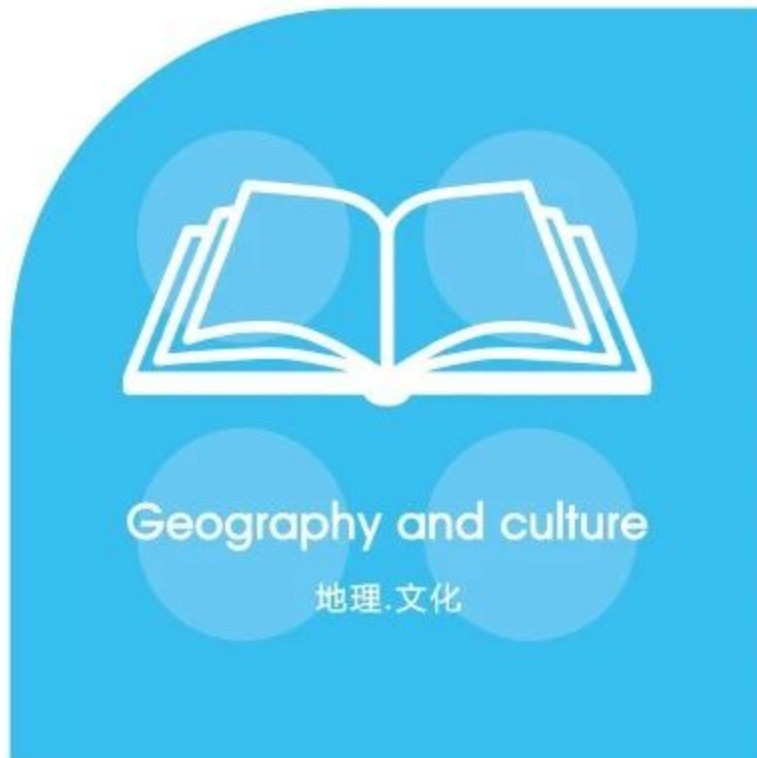

ARCHITECT

WANGE The world's great architect since 1991

The Great Wall



Geography and culture

地理·文化



selective stretches were later joined together by Qin Shi Huang (220–206 BC), the first emperor of China. The most well-known sections of the wall were built by the Ming dynasty (1368–1644).



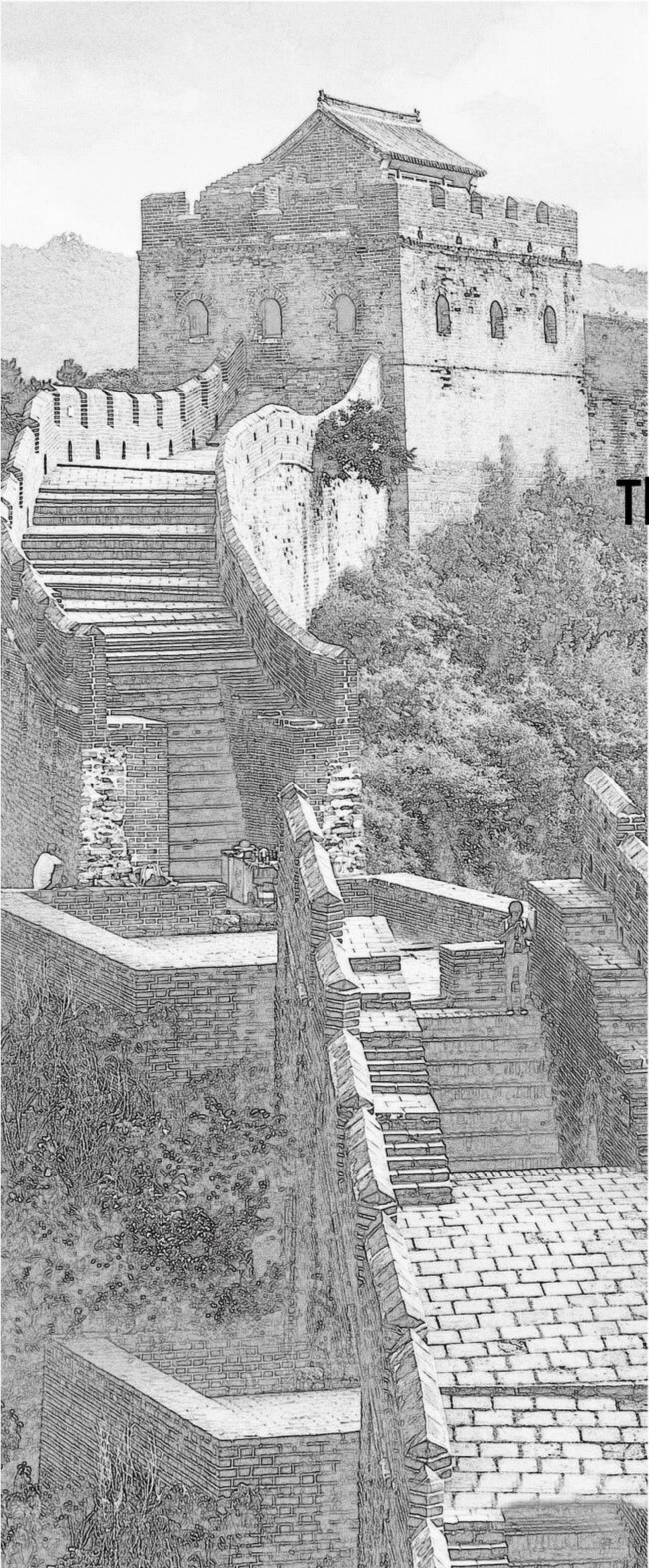

中国万里长城(八达岭)

The Great Wall ■

China

The contents of this chapter refer to the Wikipedia website.

本章内容参考维基百科网站，更多资讯可自行查阅。

The world's great architecture

About The Building



The Great Wall of China is the collective name of a series of fortification systems generally built across the historical northern borders of China to protect and consolidate territories of Chinese states and empires against various nomadic groups of the steppe and their polities. Several walls were being built from as early as the 7th century BC by ancient Chinese states;^[2] selective stretches were later joined together by Qin Shi Huang (220–206 BC), the first emperor of China. Little of the Qin wall remains.^[3] Later on, many successive dynasties have built and maintained multiple stretches of border walls. The most well-known sections of the wall were built by the Ming dynasty (1368–1644).



About the building

Apart from defense, other purposes of the Great Wall have included border controls, allowing the imposition of duties on goods transported along the Silk Road, regulation or encouragement of trade and the control of immigration and emigration.[4] Furthermore, the defensive characteristics of the Great Wall were enhanced by the construction of watch towers, troop barracks, garrison stations, signaling capabilities through the means of smoke or fire, and the fact that the path of the Great Wall also served as a transportation corridor.

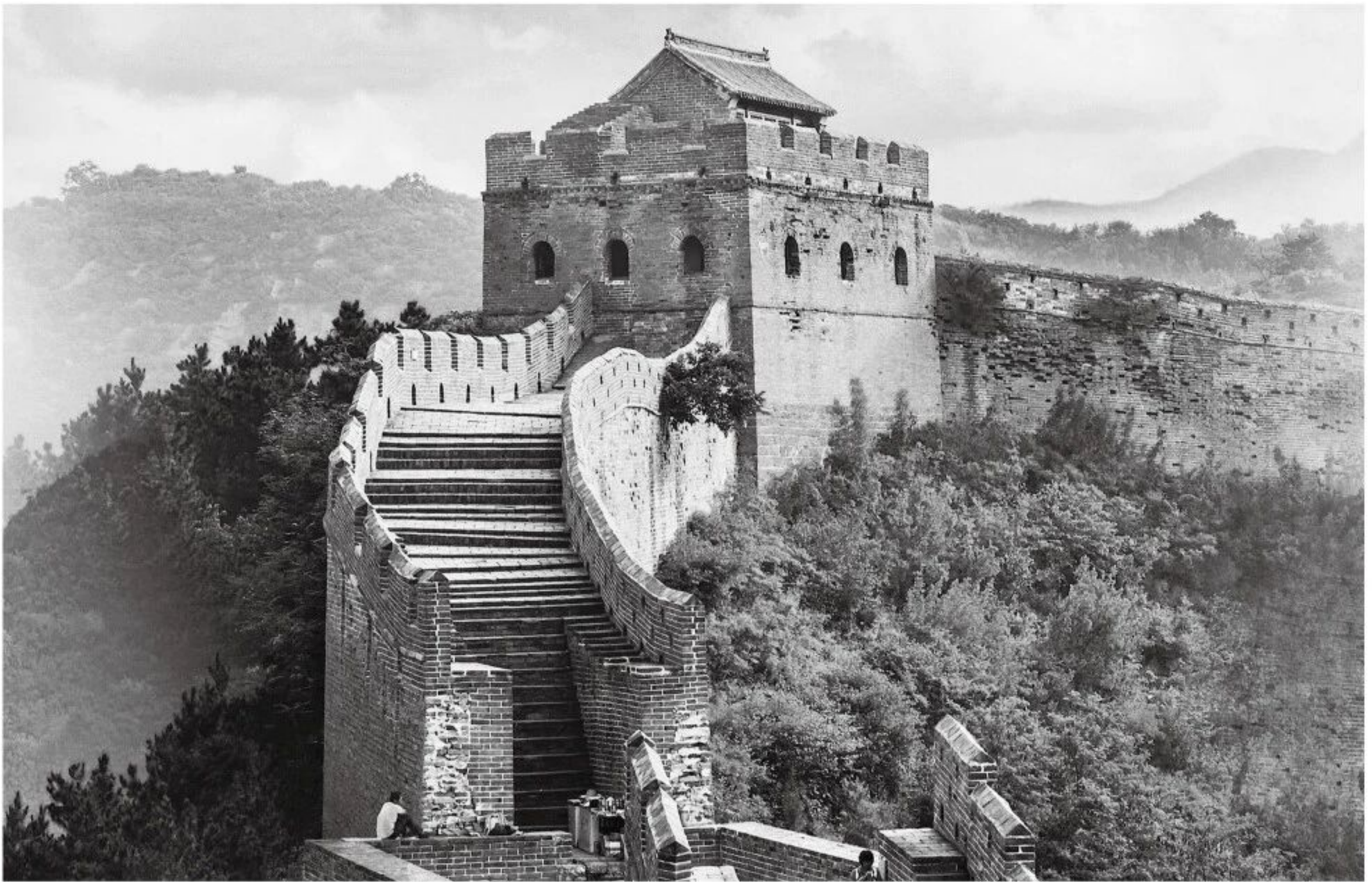

History

长城是古代中国为抵御不同时期塞北游牧部落联盟的侵袭，修筑规模浩大的隔离墙或军事工程的统称。长城东西绵延上万华里，因此又称作万里长城。现存的长城遗迹主要为始建于14世纪的明长城，西起嘉峪关，东至虎山长城，长城遗址跨越北京、天津、山西、陕西、宁夏、甘肃等15个省市自治区，总计有43721处长城遗产，长城也是自人类文明以来最巨大的建筑物。1961年起，一批长城重要点段被陆续公布为全国重点文物保护单位。1987年，长城被联合国教科文组织列为世界文化遗产，该遗产目前不仅包含上述15个省、市、自治区境内的长城，还额外包括了湖南和四川境内的苗疆长城（南长城）等。

Design Points

结构难点

Angle calculation
角度的计算

$$S=4\pi \cdot r^2$$

$$a^2+b^2=c^2$$

$$\sin^2 a + \cos^2 a = 1$$



Creation and thinking

创作·思考

Force Balance

受力平衡

Physical operations

物理运算

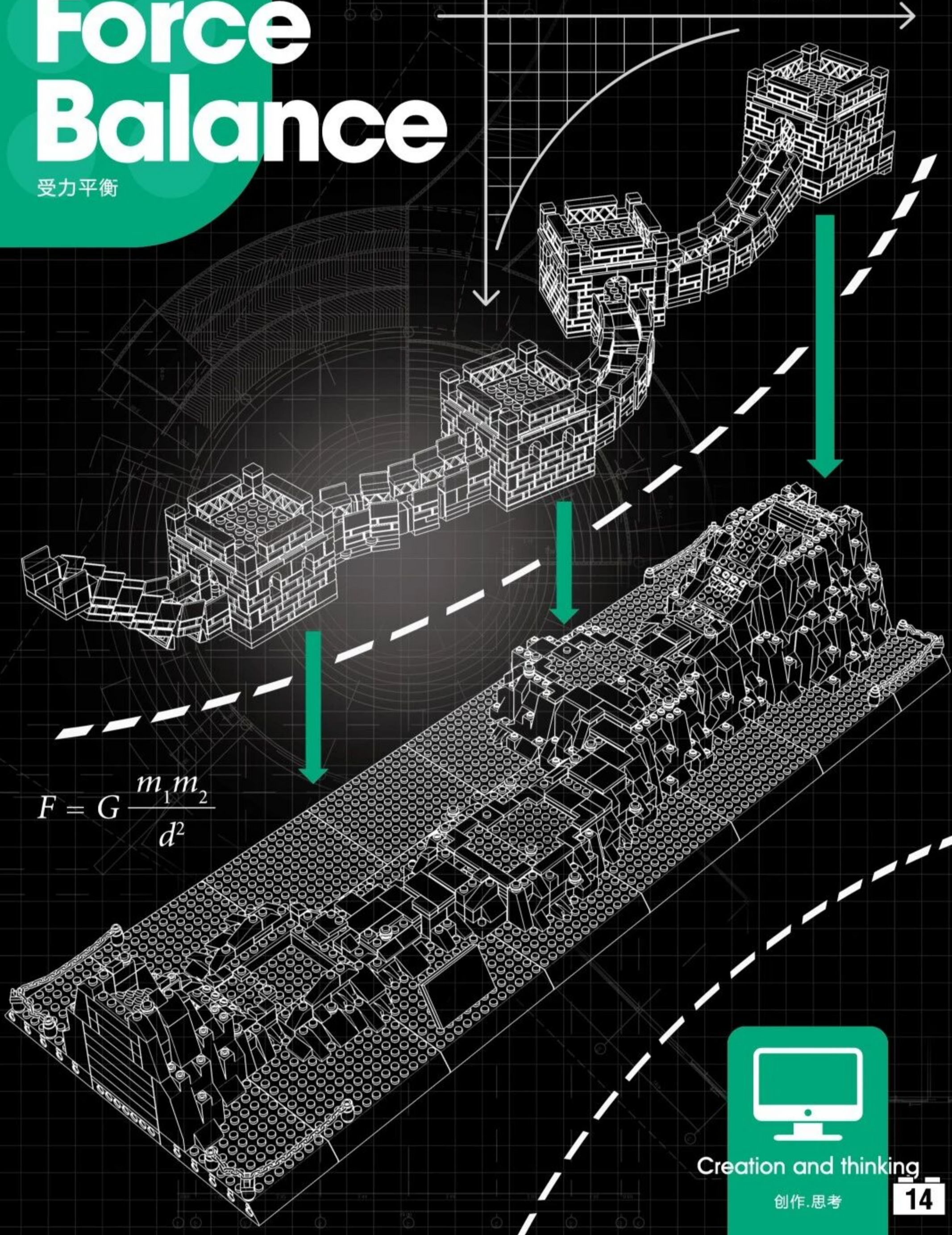

$$F = G \frac{m_1 m_2}{d^2}$$



Creation and thinking

创作·思考

Special parts

特殊零件的开发利用



WG1254

岩块

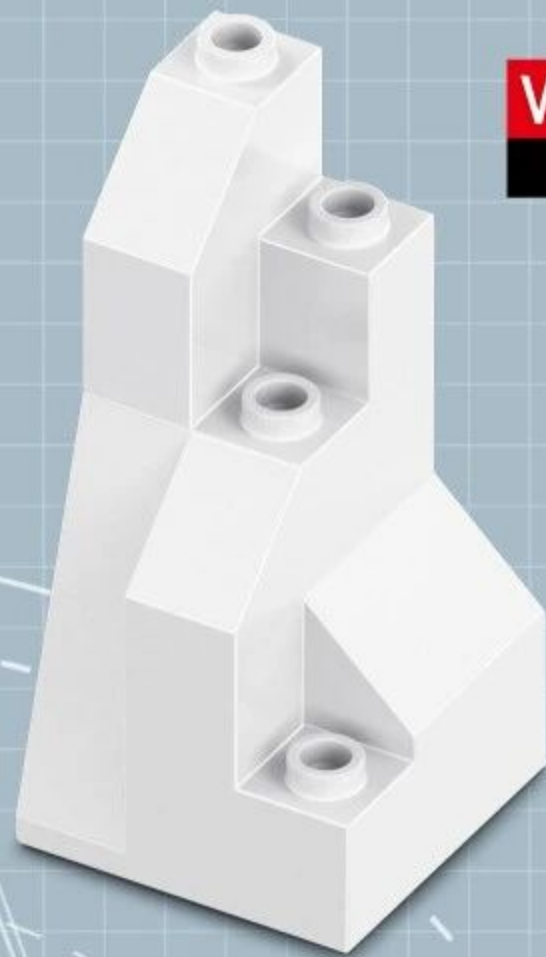

WG0559

山角

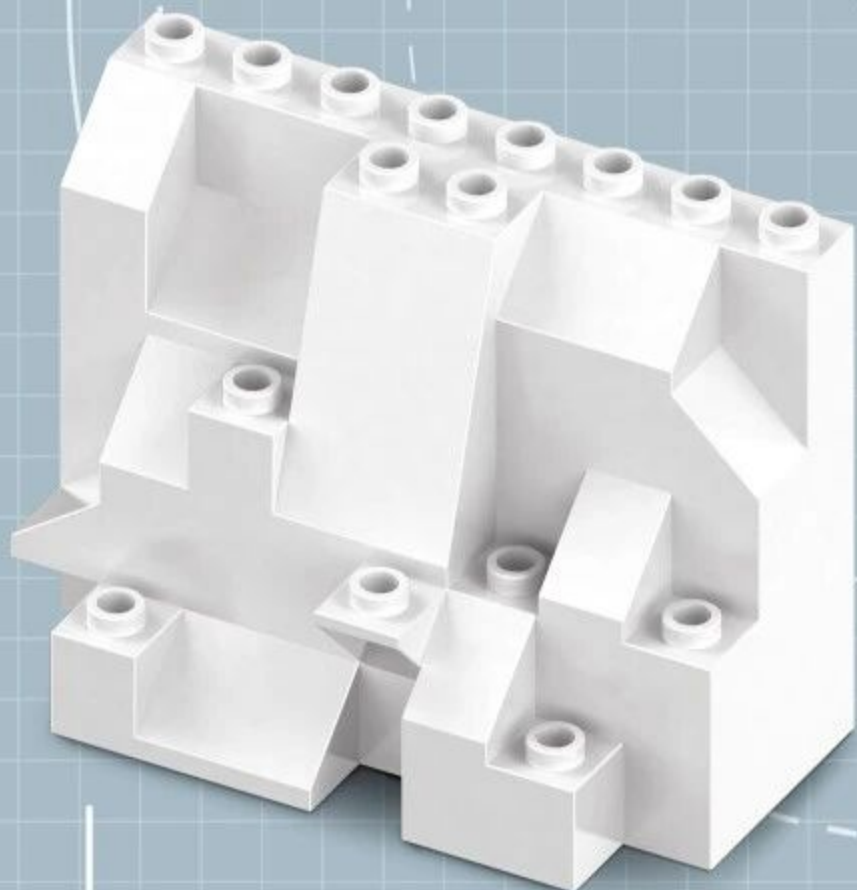

WG0558

山边8孔

WG0557

山边4孔



features and functions

特点·功能

Creation and thinking
创作.思考

Drawing Design

手绘设计

Shantou VeryFun Toys & Nursery Co., Ltd.
©2014 Wange / Dubie. All Rights Reserved

Creation and thinking
创作.思考

Drawing Design

手绘设计



Shantou VeryFun Toys & Nursery Co., Ltd.
©2014 Wange / Dubie. All Rights Reserved

Main Color Matching

配色方案



Pantone Cool Gray 6C



Pantone 3435C



Pantone 431C



Pantone 7509C



Pantone 7500C

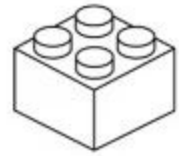

White



Color matching

Adopting 2 main colors, beige and gray as the main color, the more reasonable and bold color matching on the original building, making the product more atmospheric and the whole design is more reasonable.

The Great Wall

万里长城 (八达岭)



Front

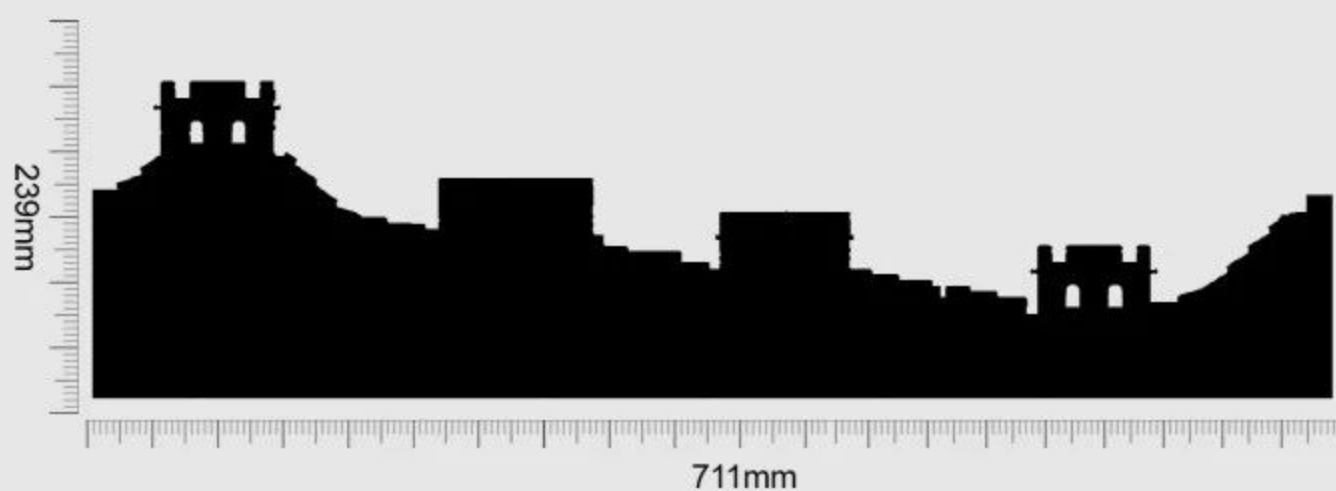

Left

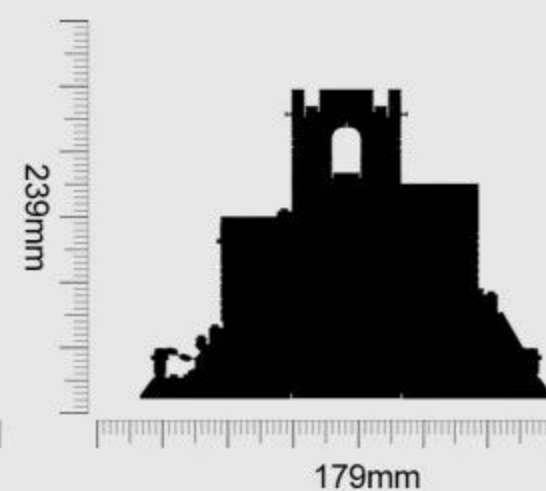

Product Size: 711X239x179mm





100PCS

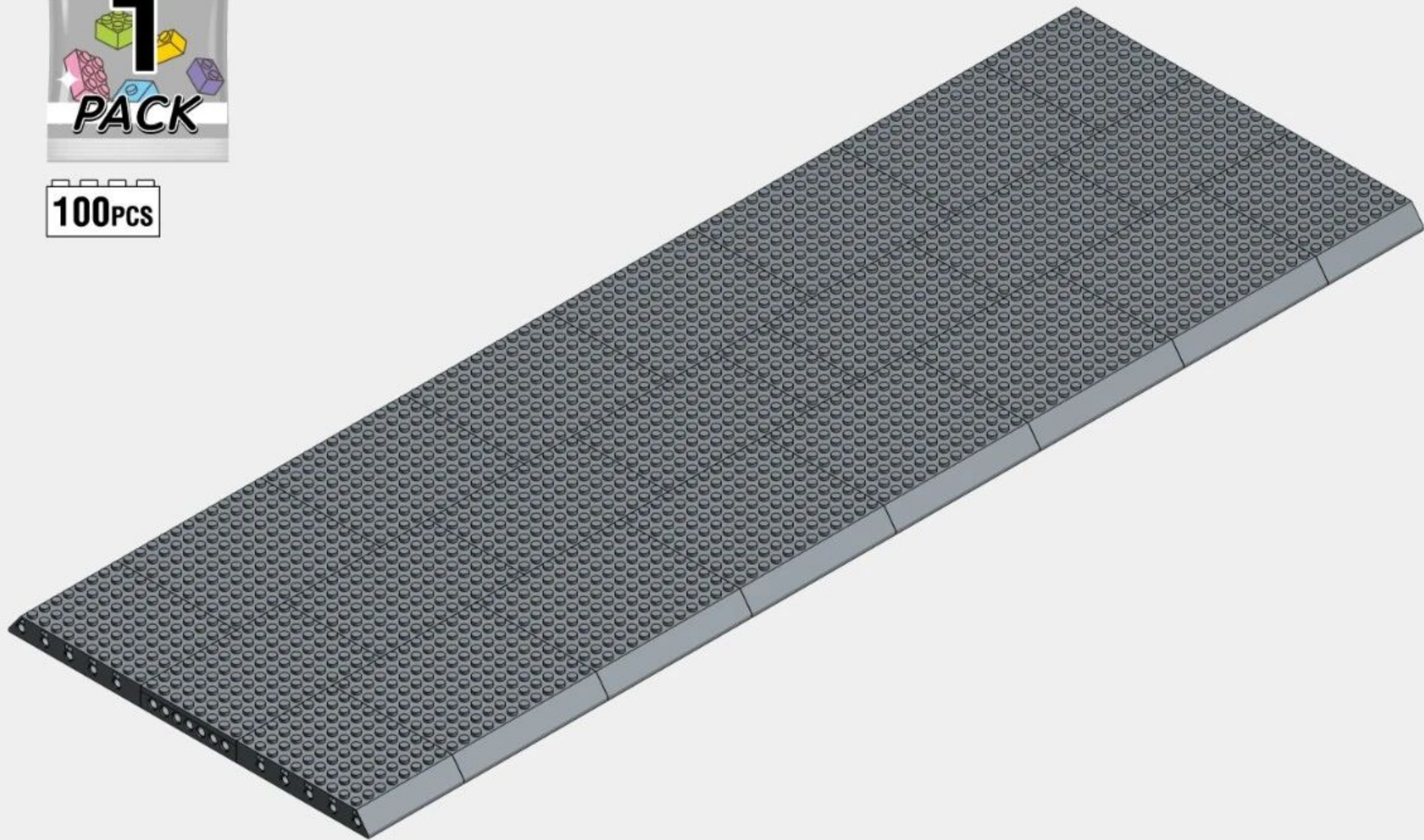

20

1-1

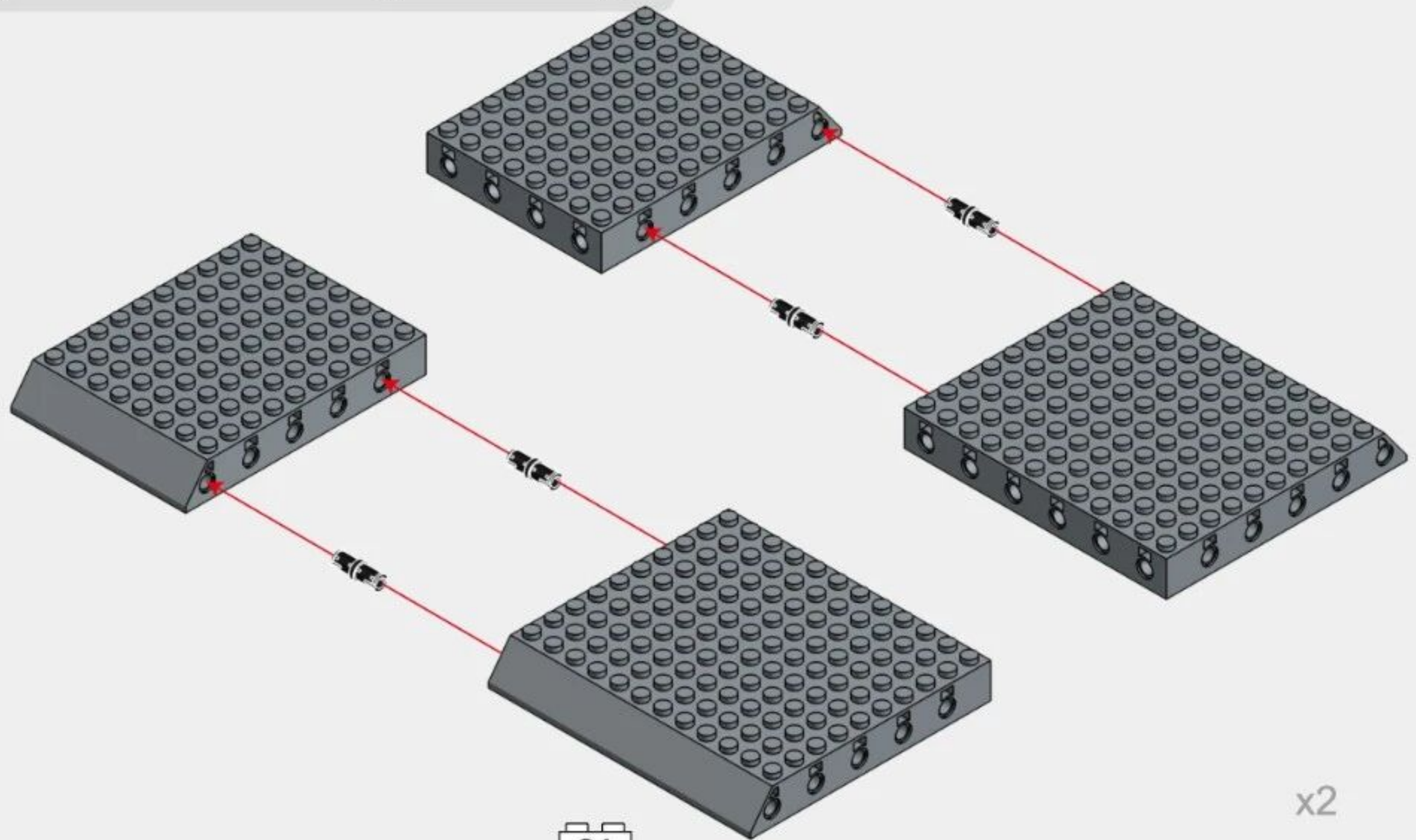
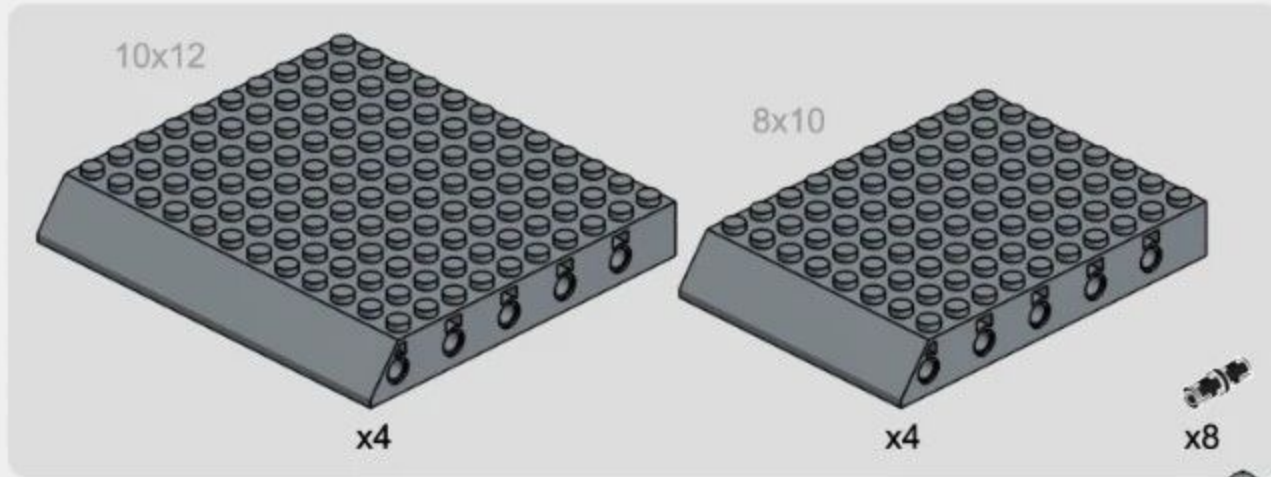

21

x2

1-2

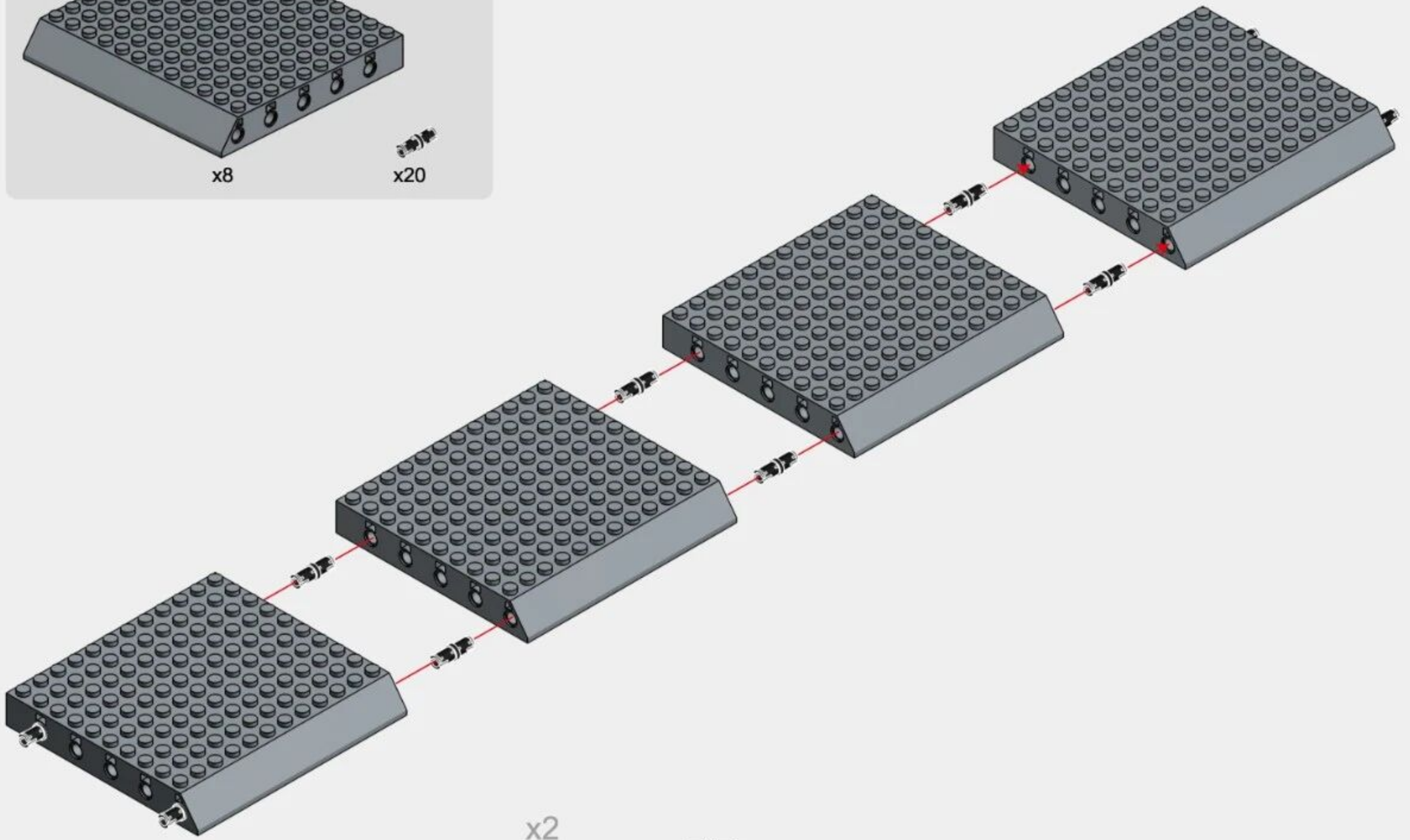
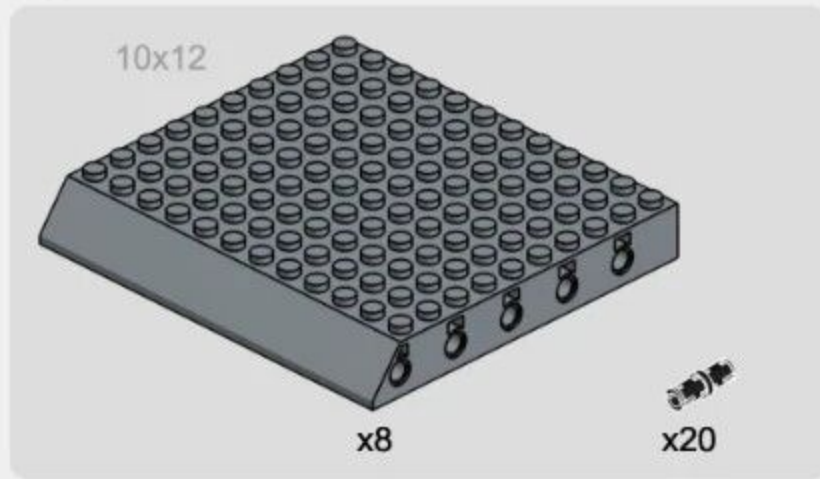

x2

1-3

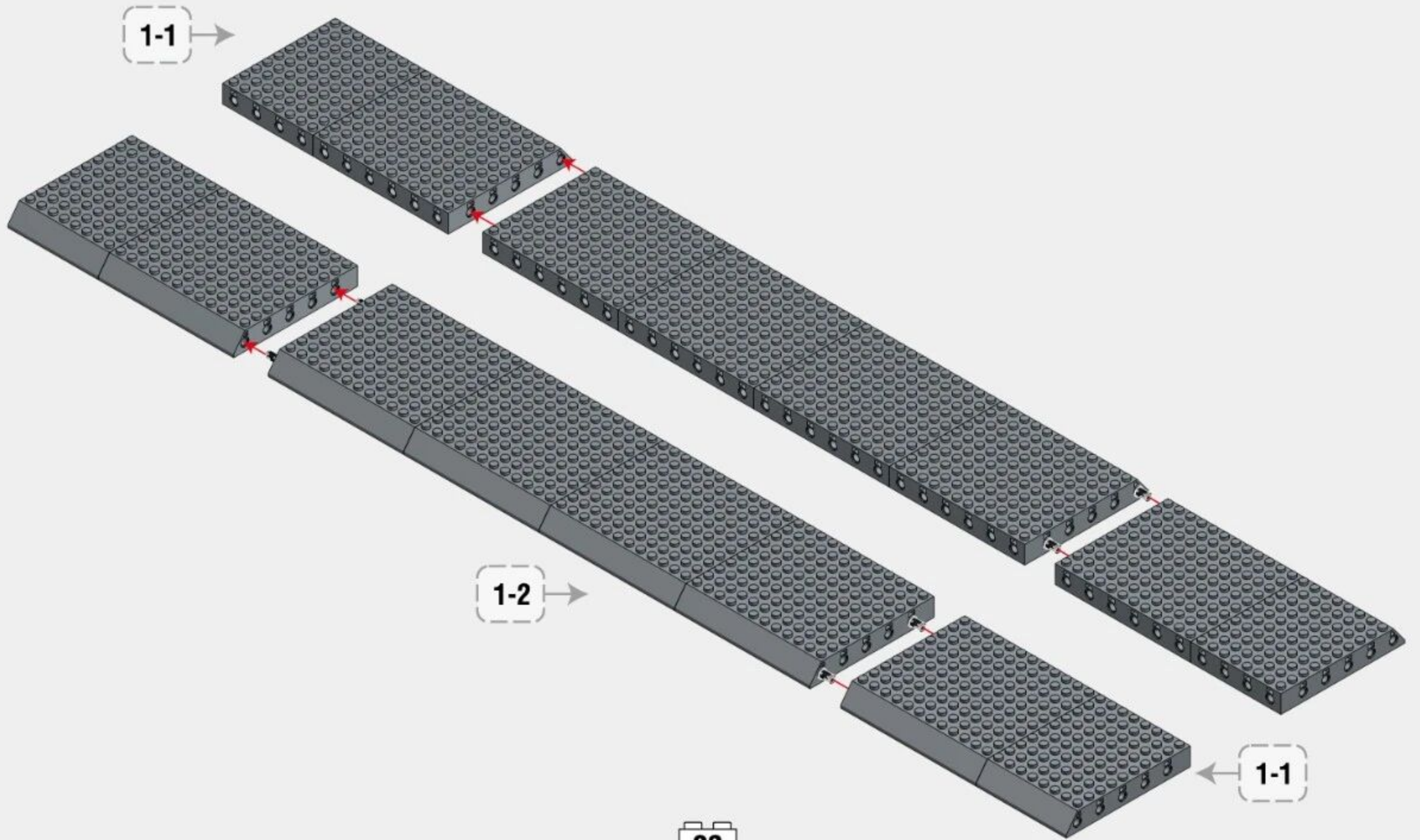

1-4

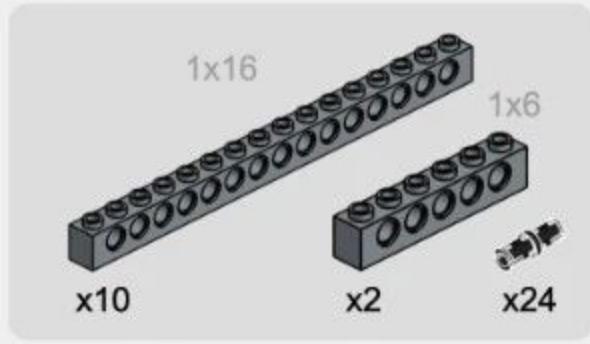

1-5

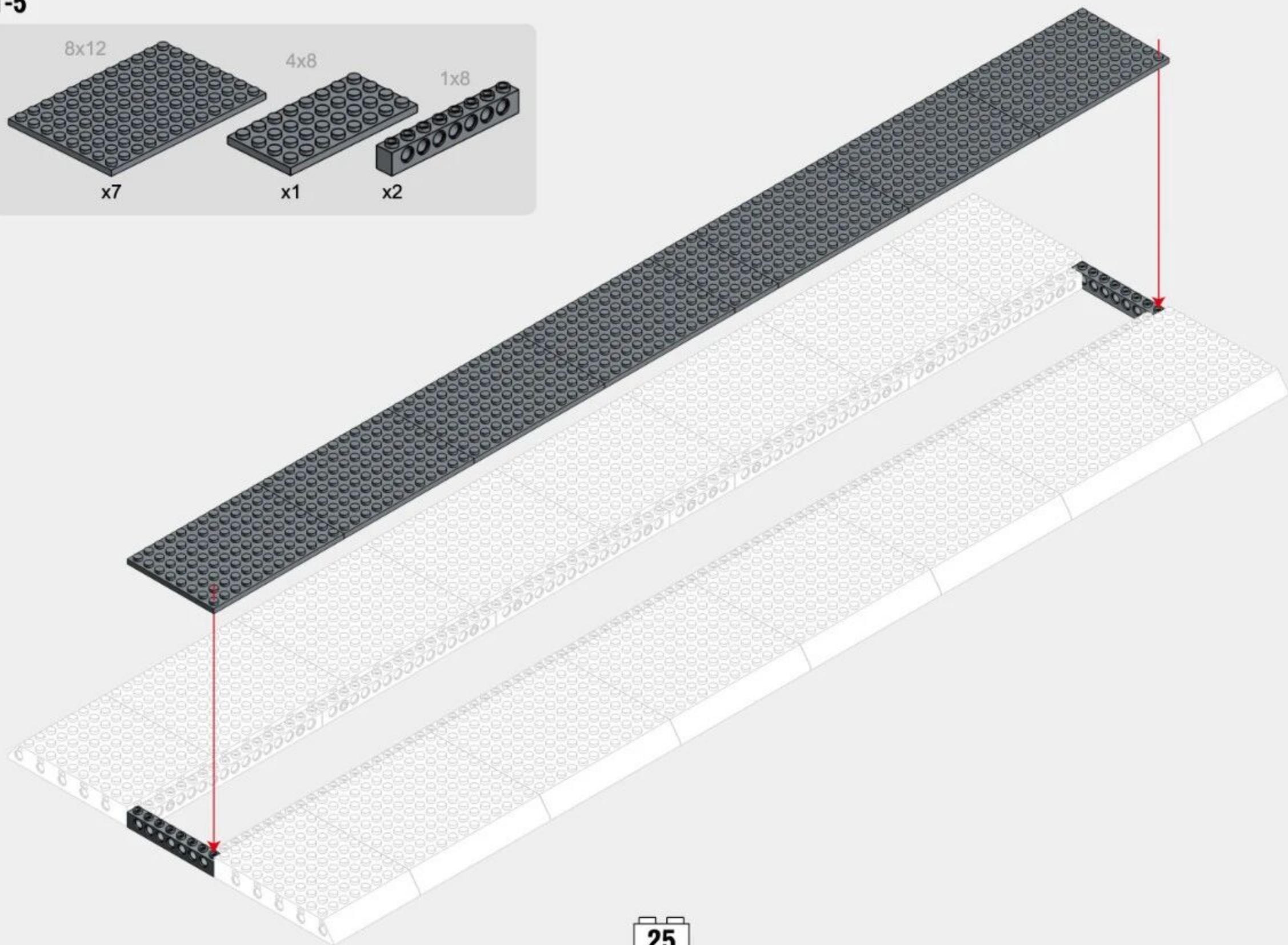
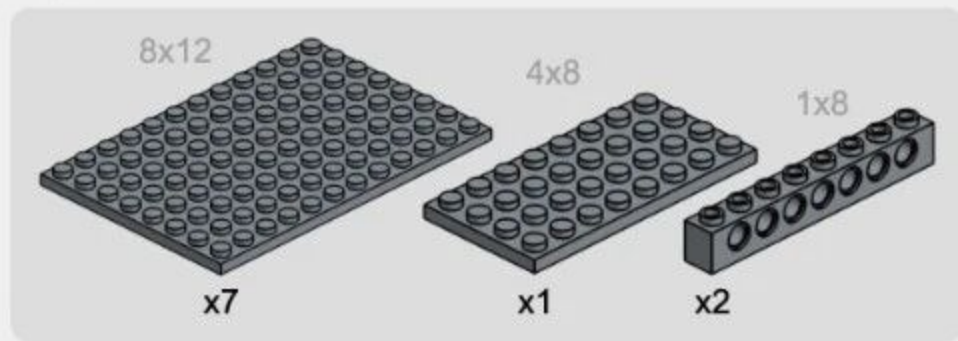



240PCS

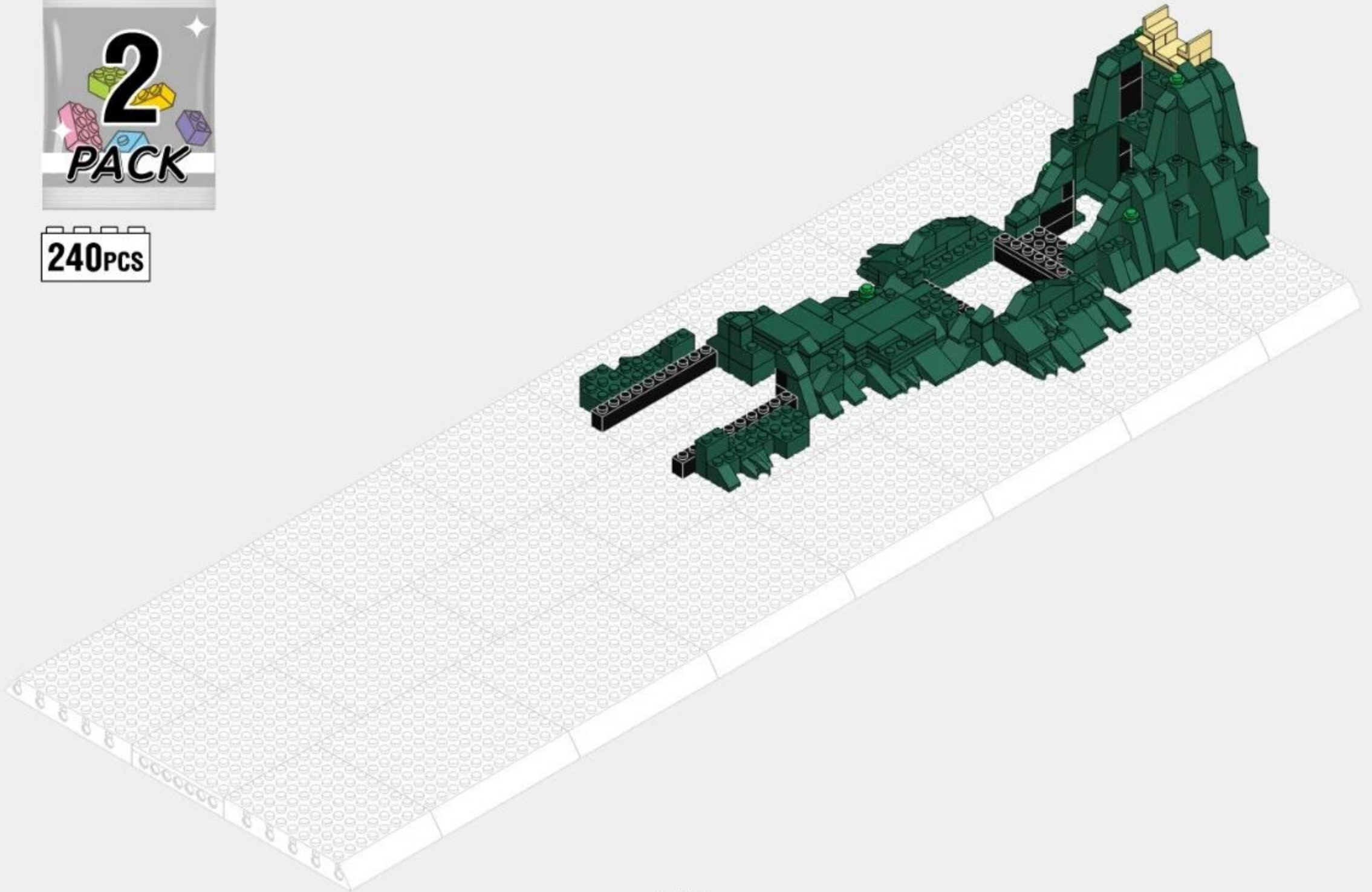

2-1

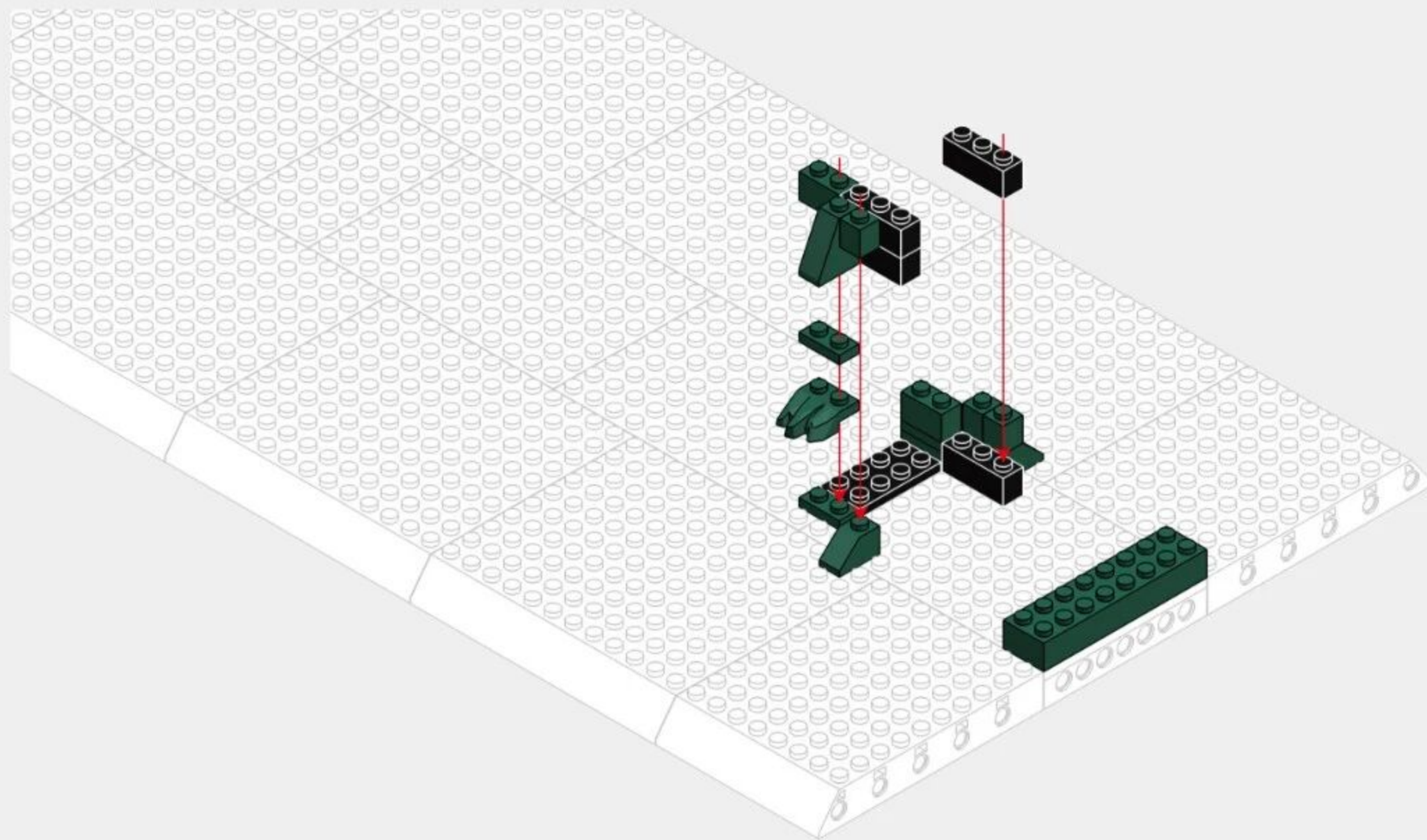
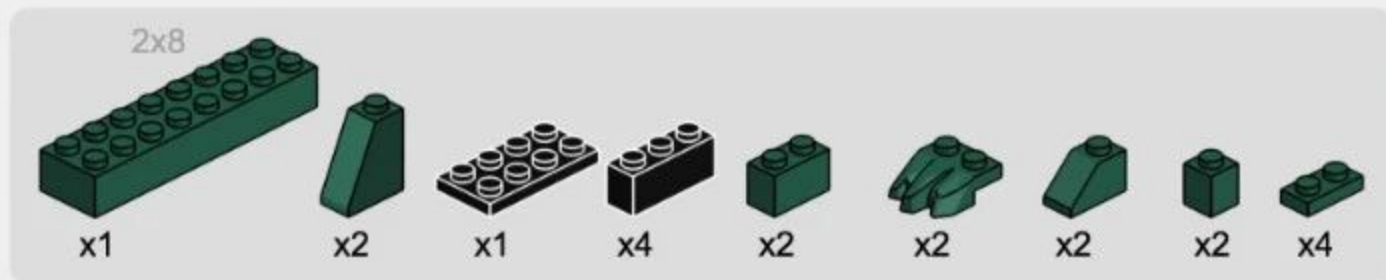

2-2

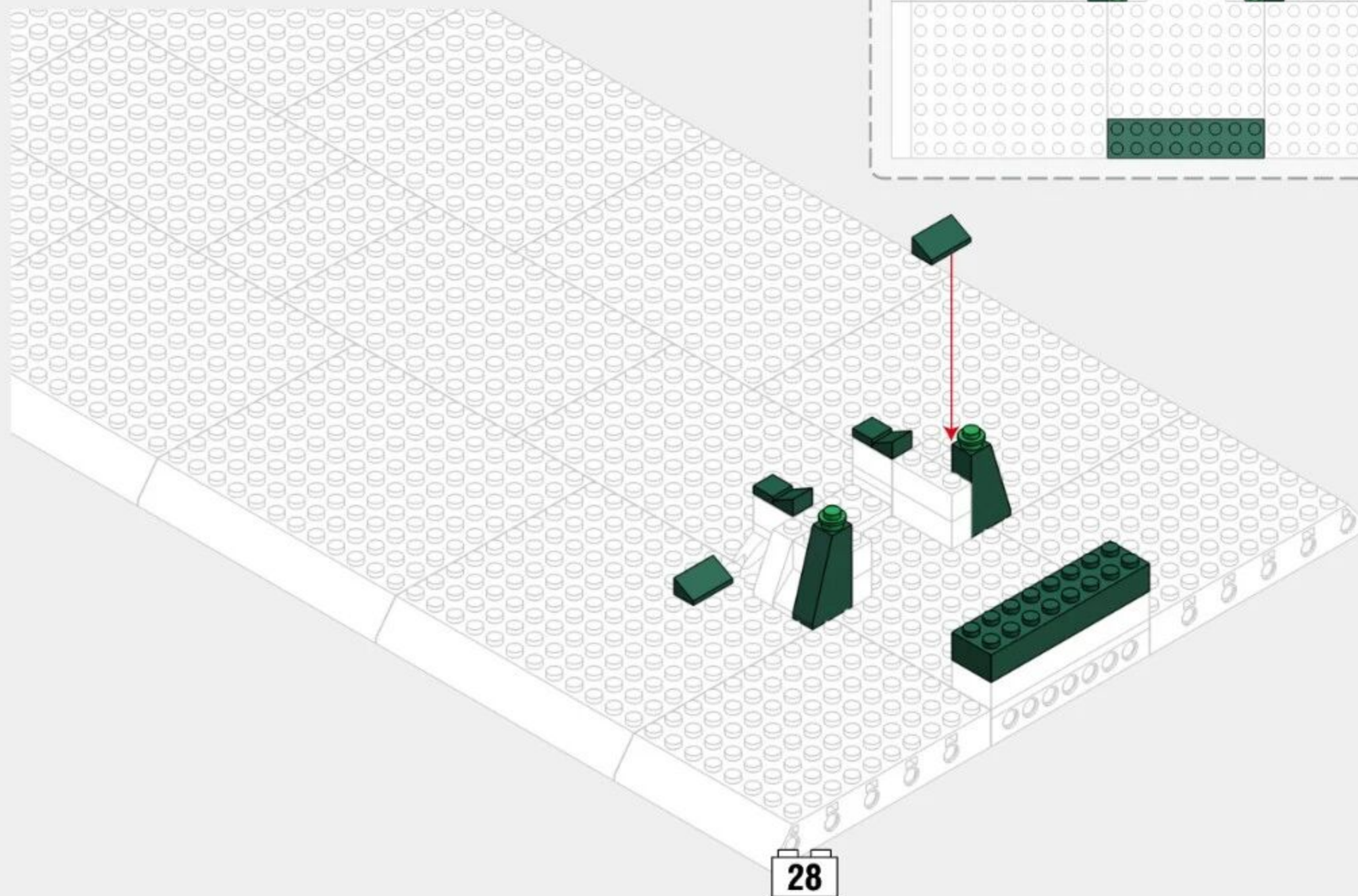
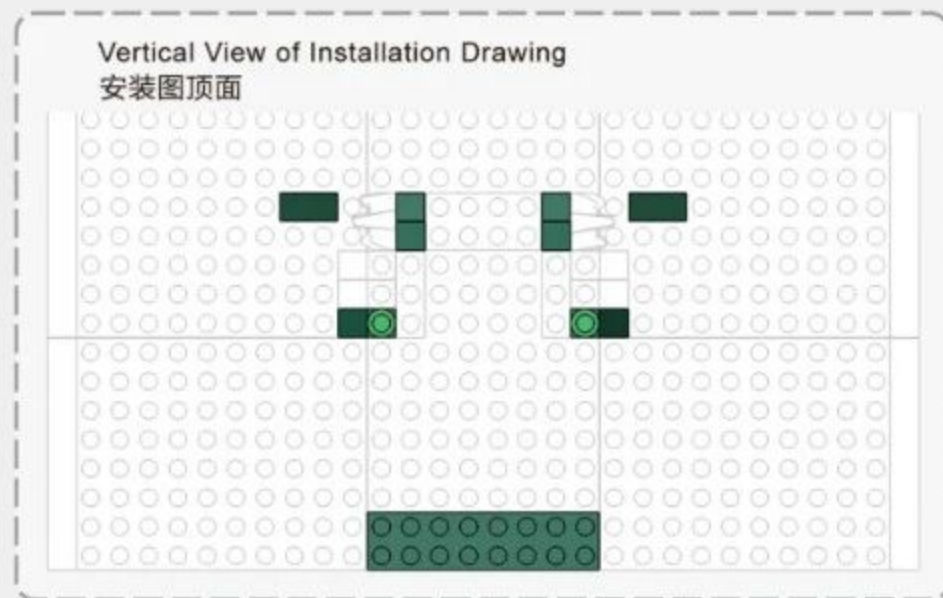
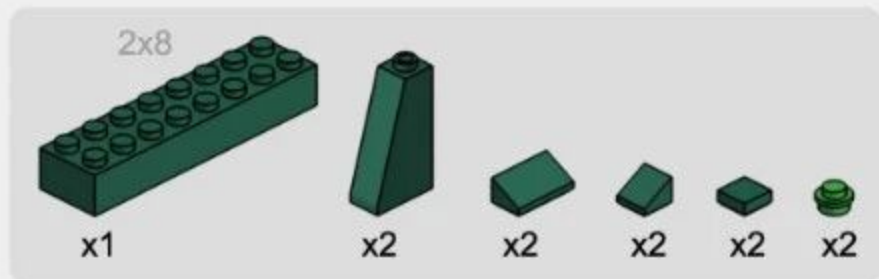

2-3

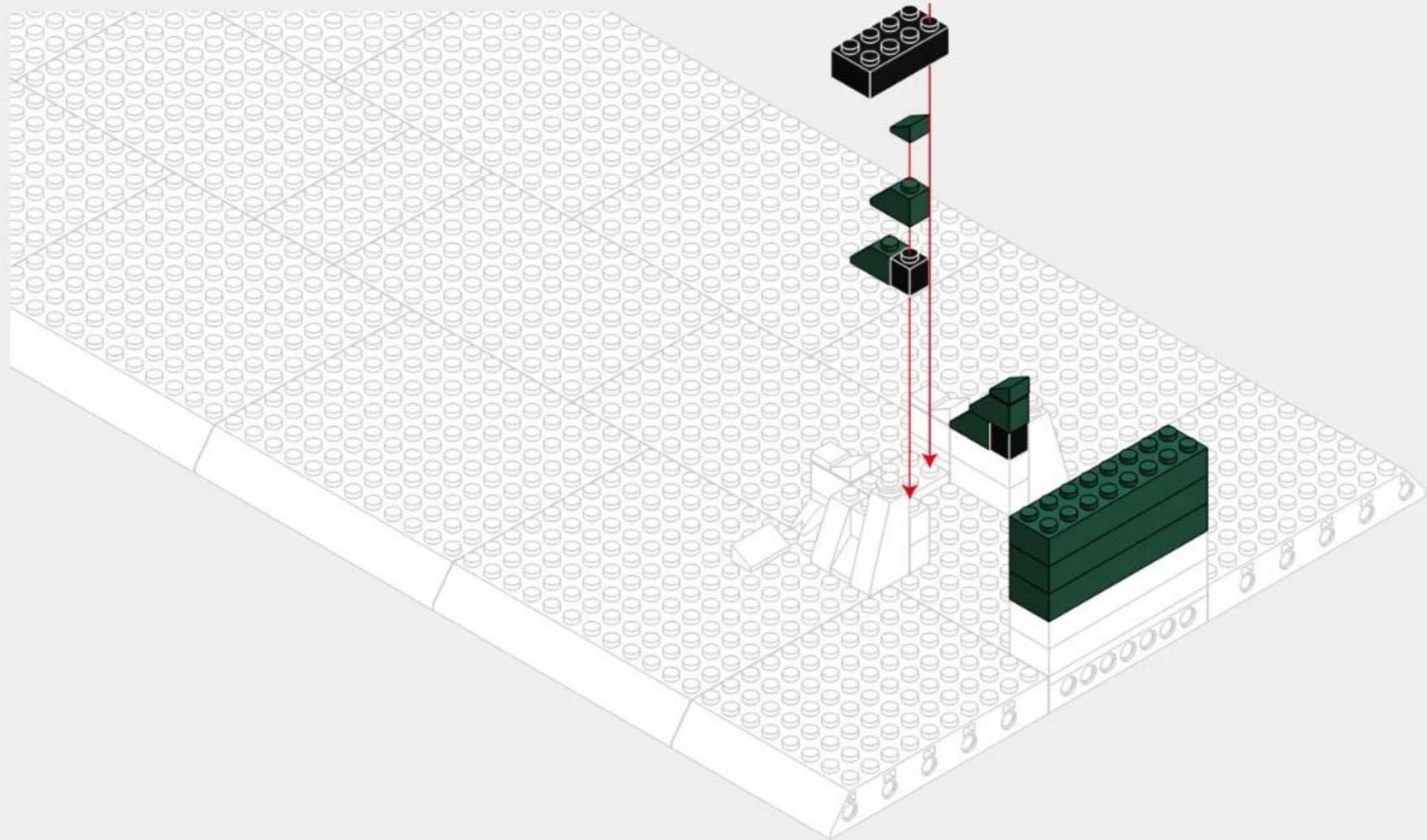
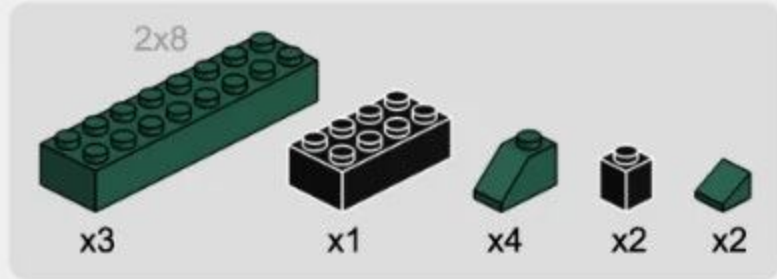

2-4

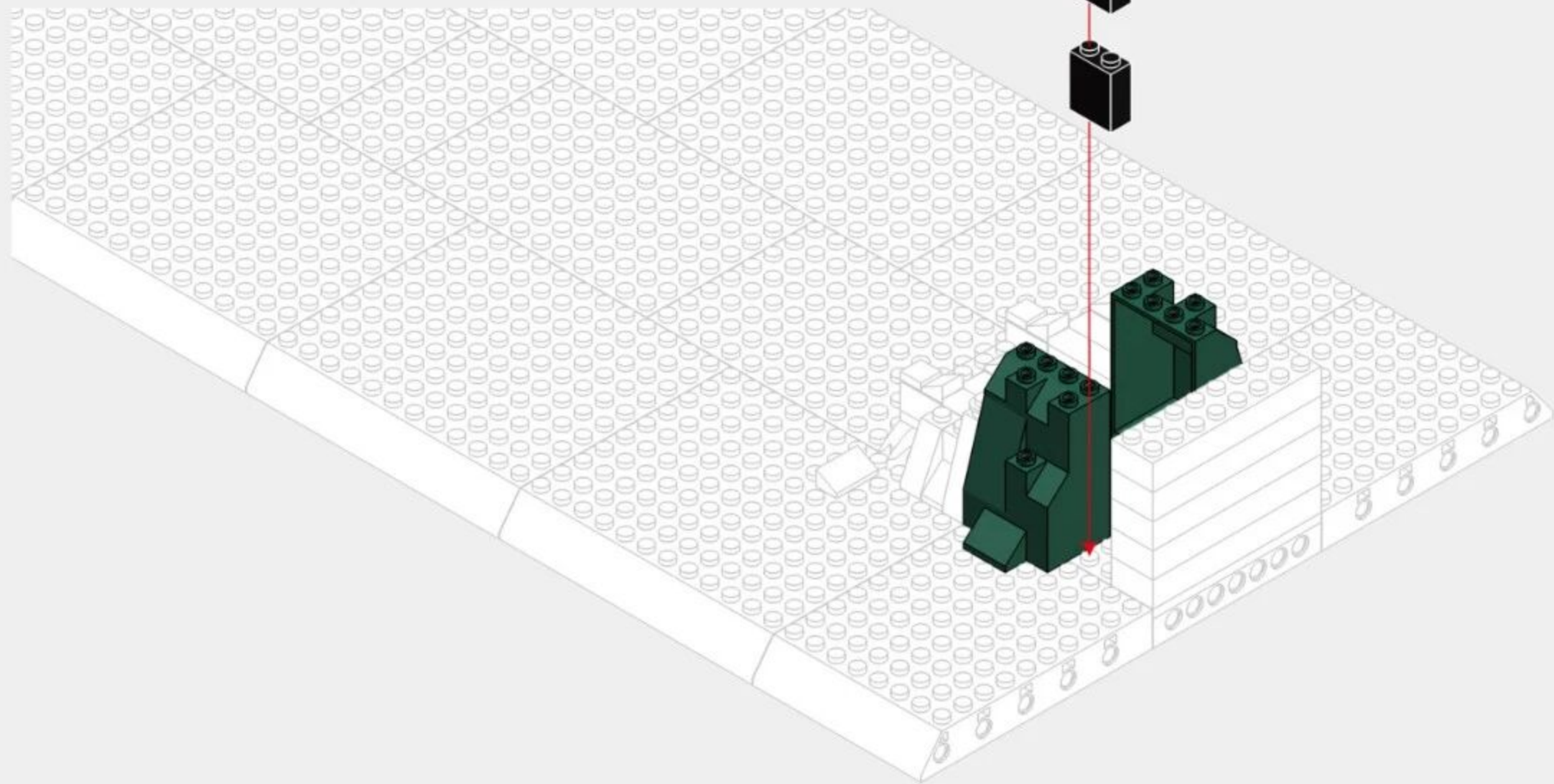
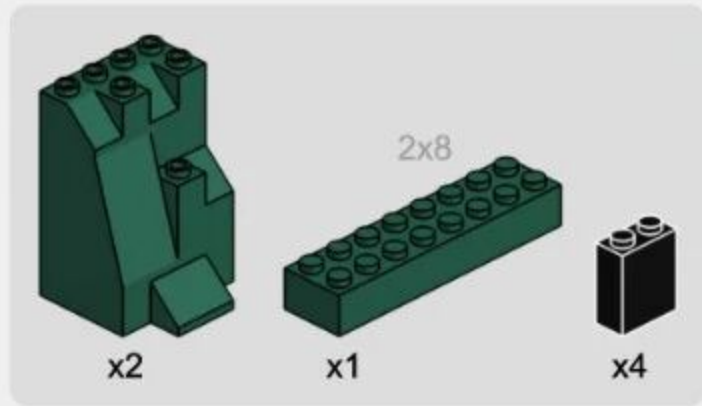

2-5

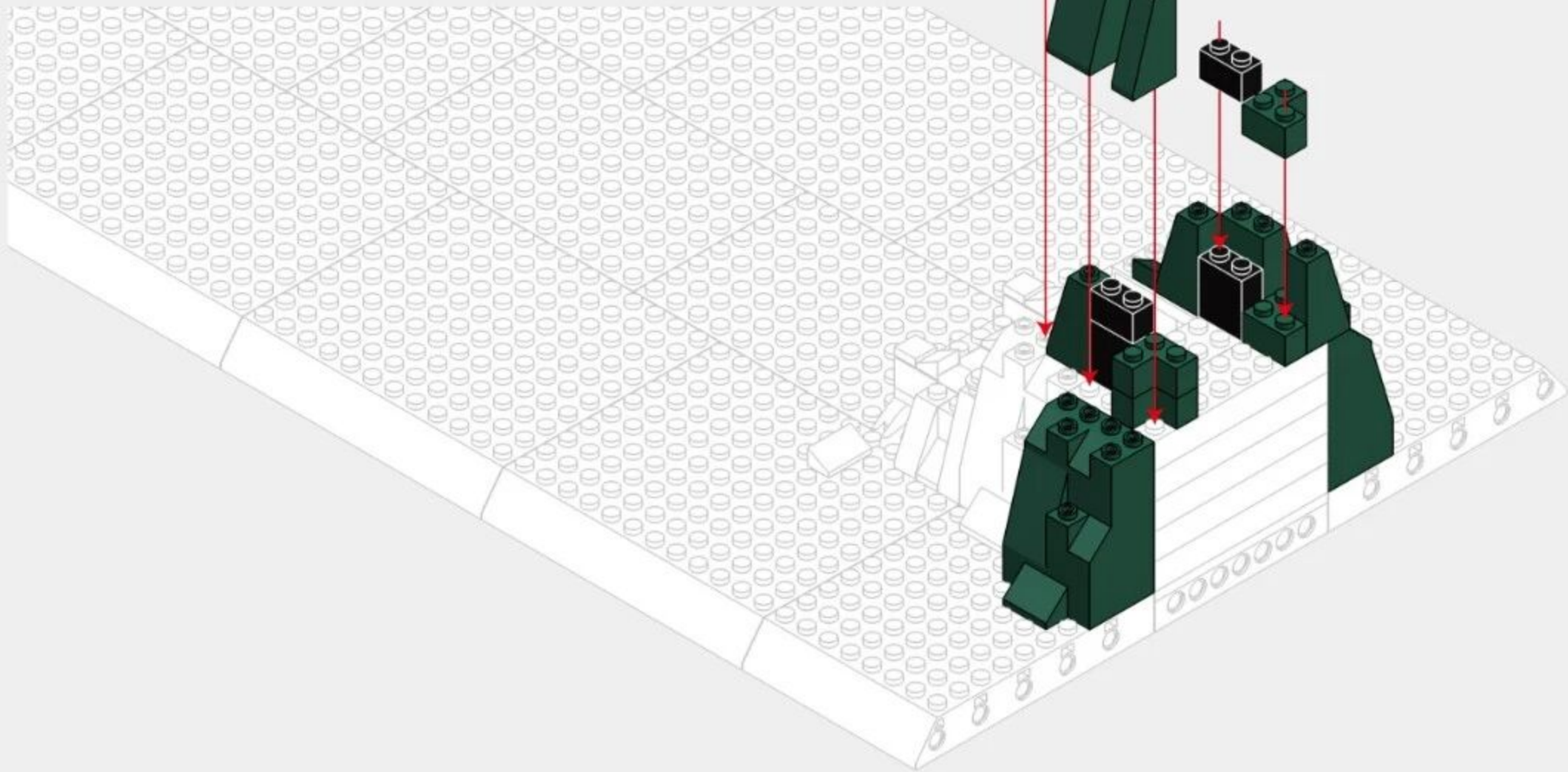
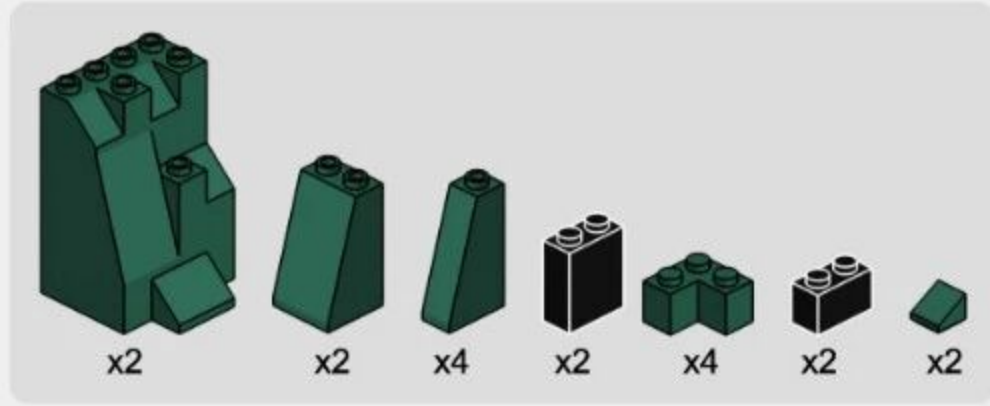

2-6

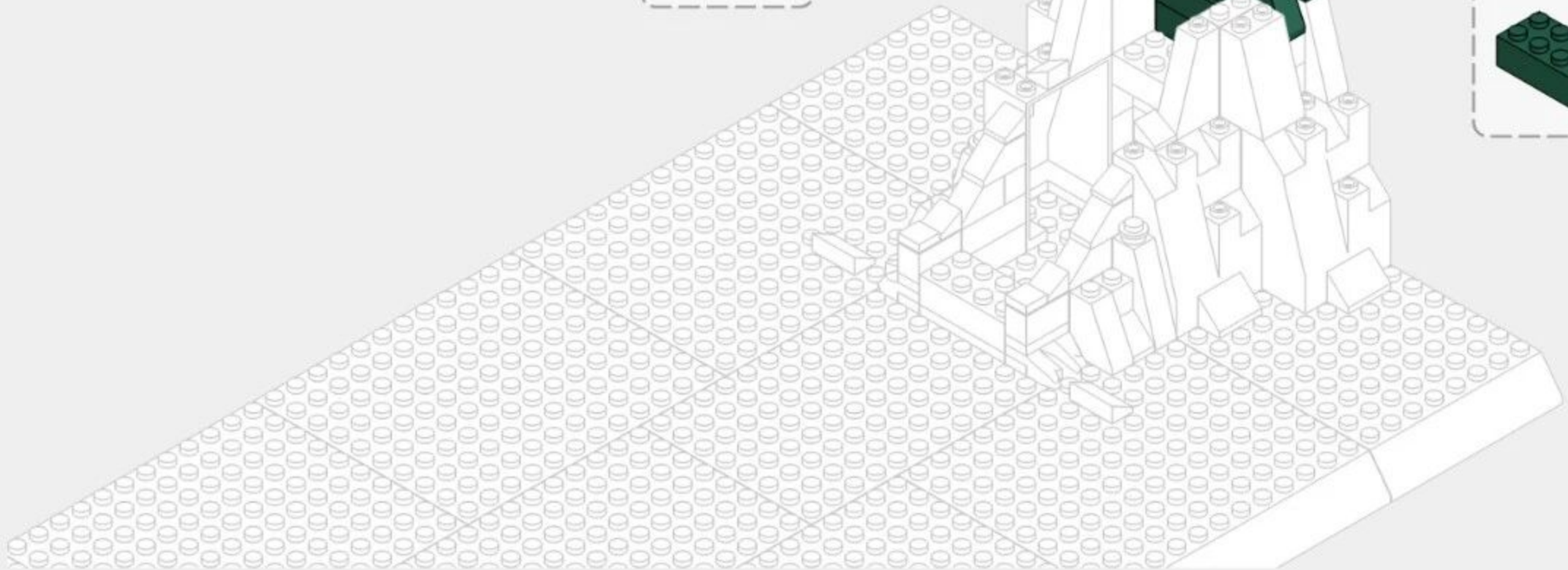
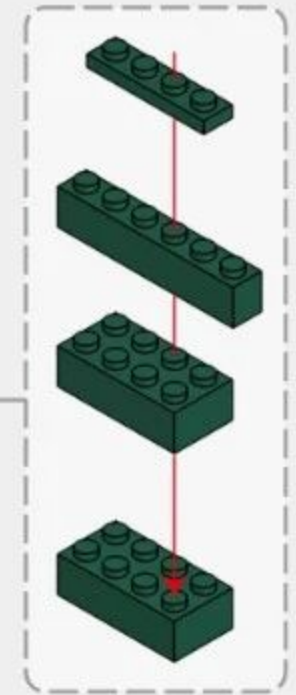
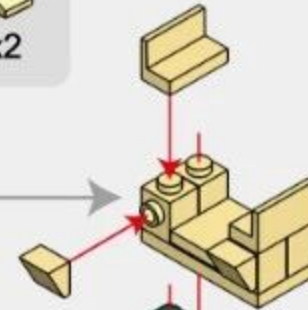
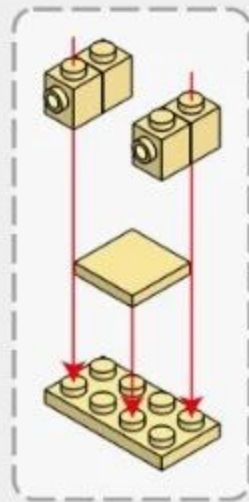
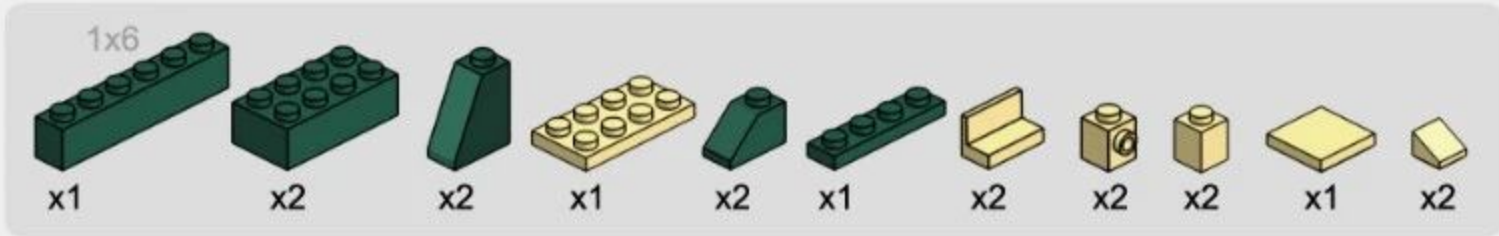

2-7

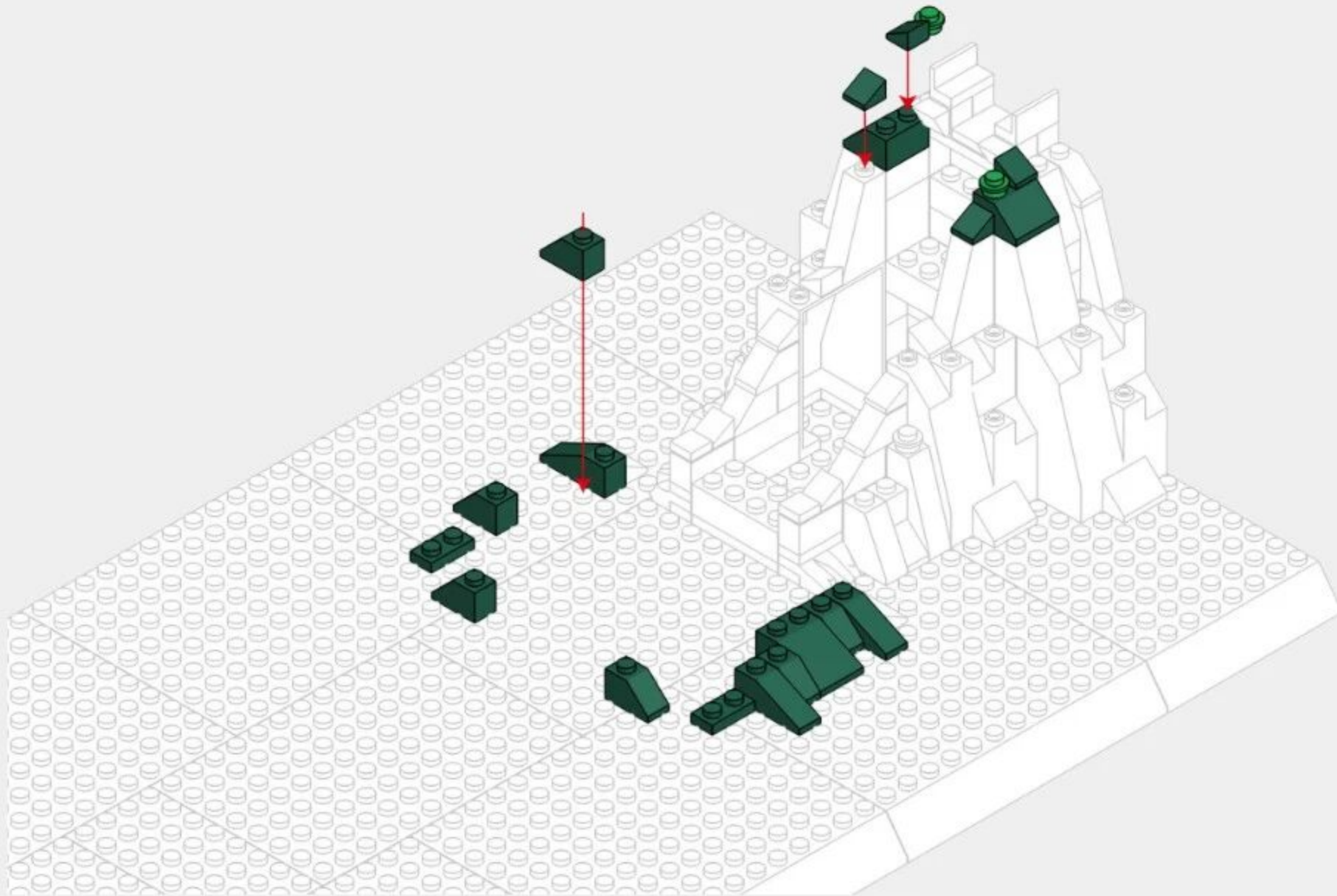
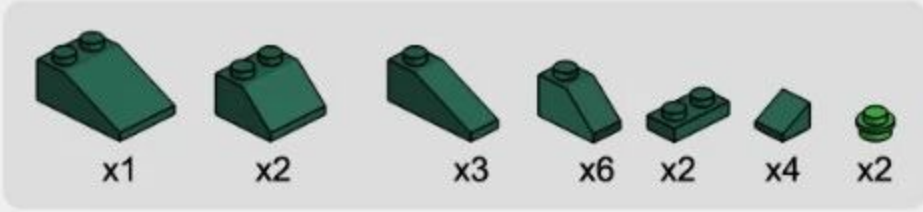

2-8

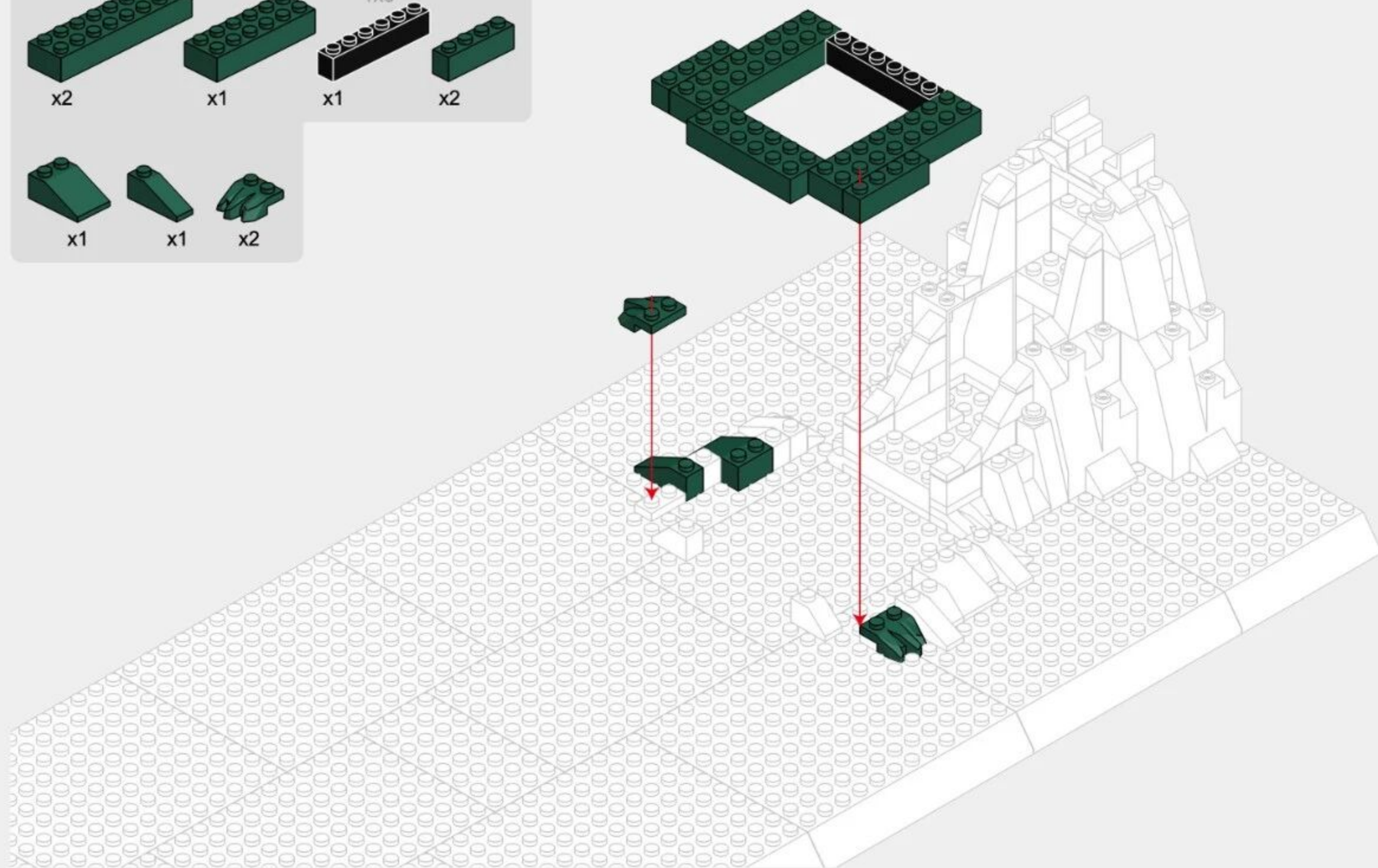
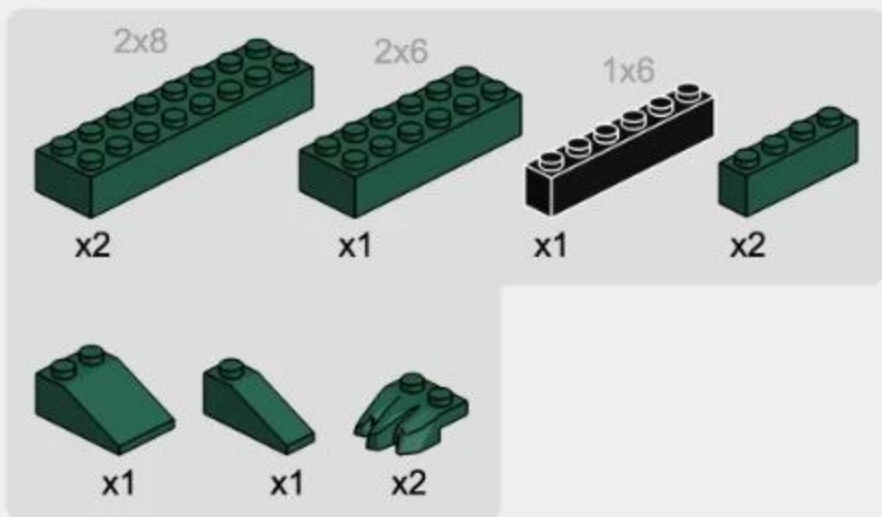

2-9

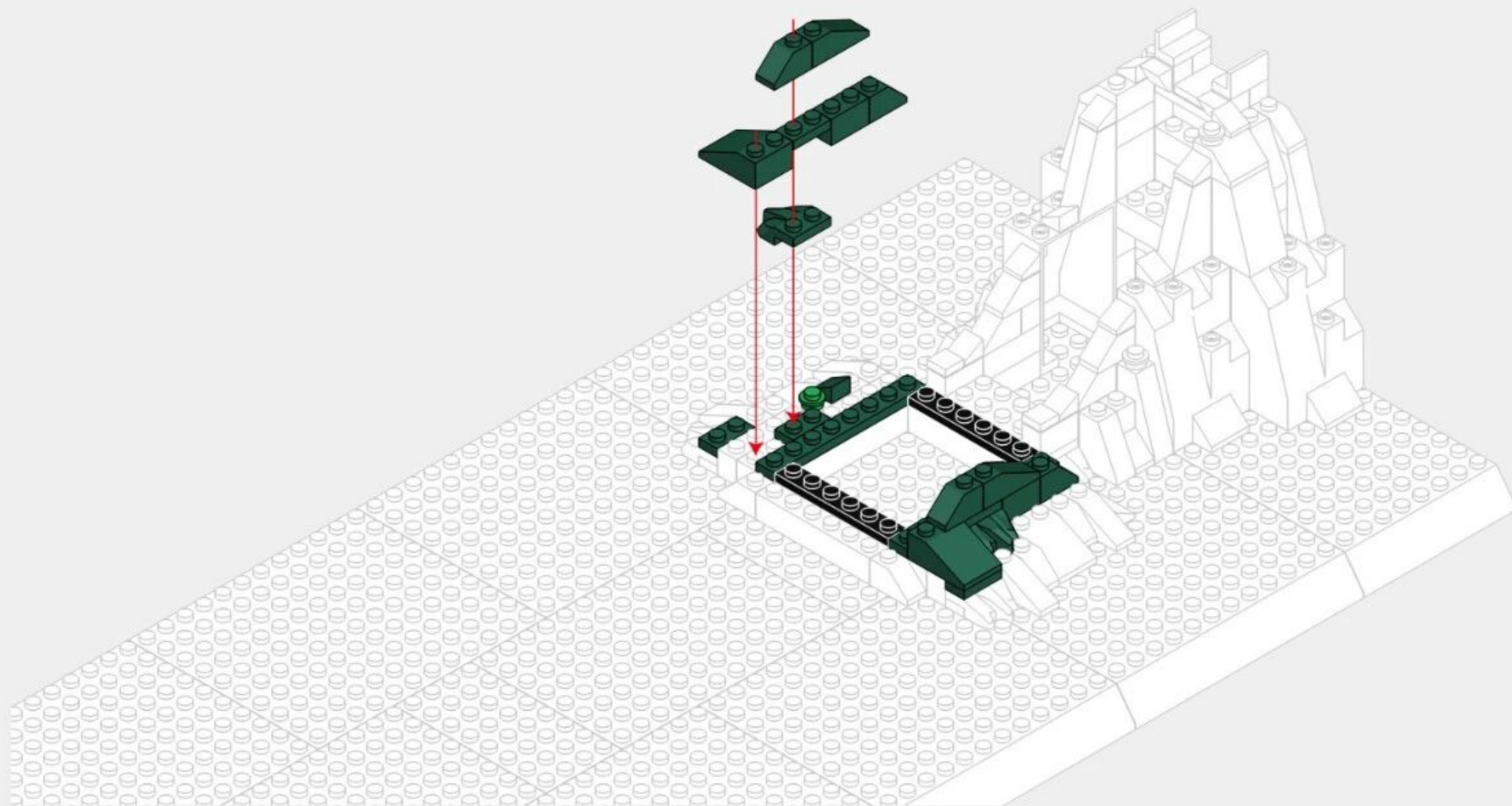
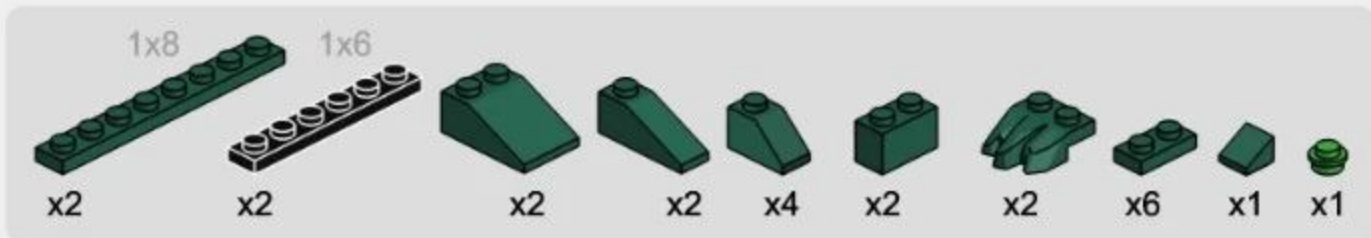

2-10

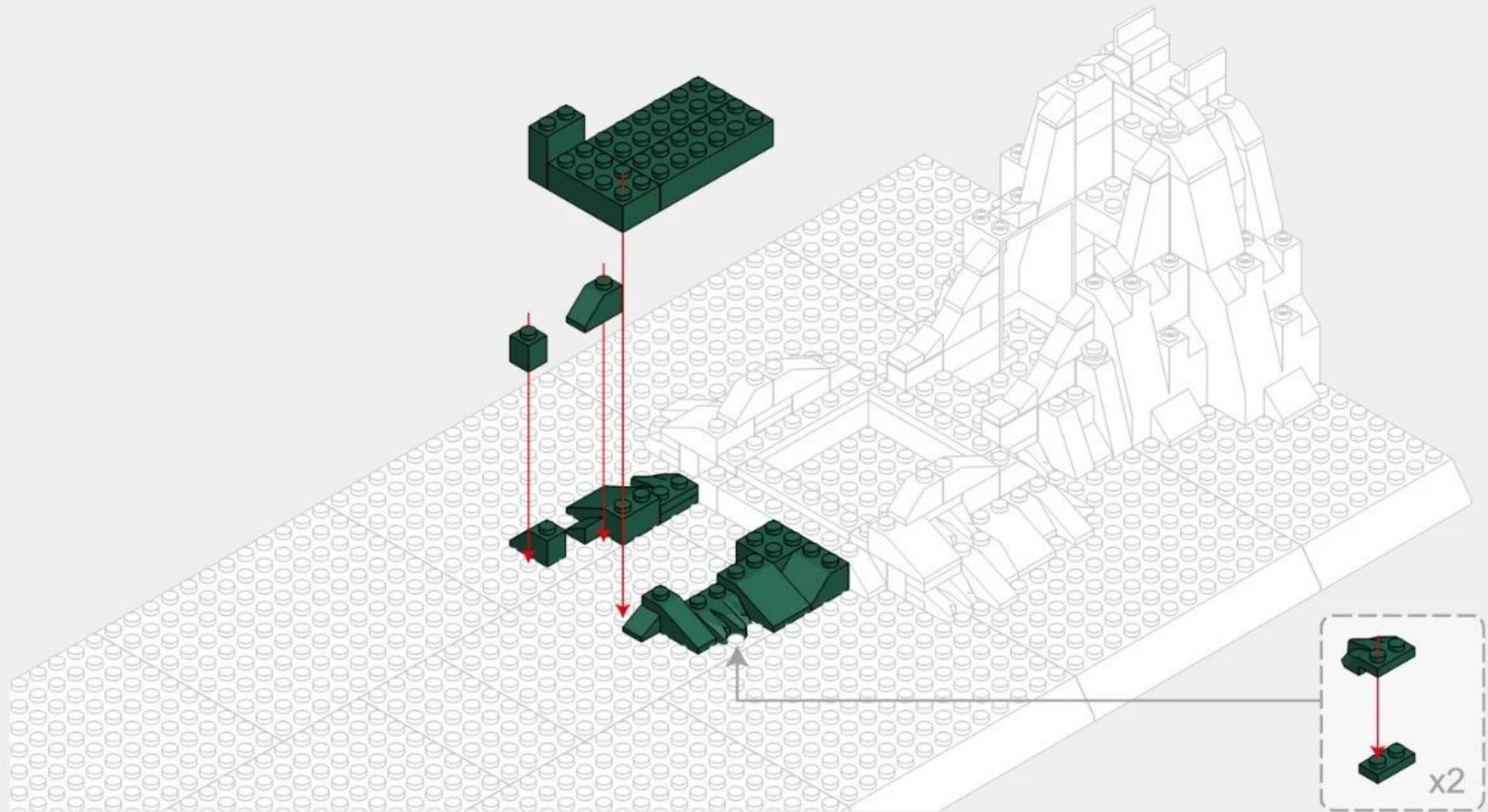
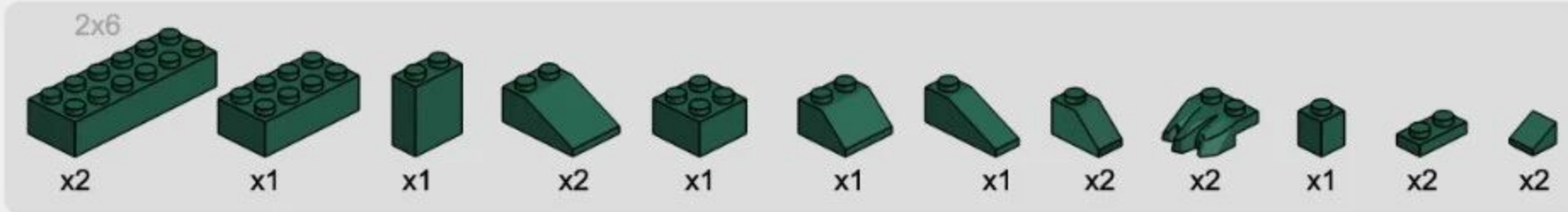

2-11

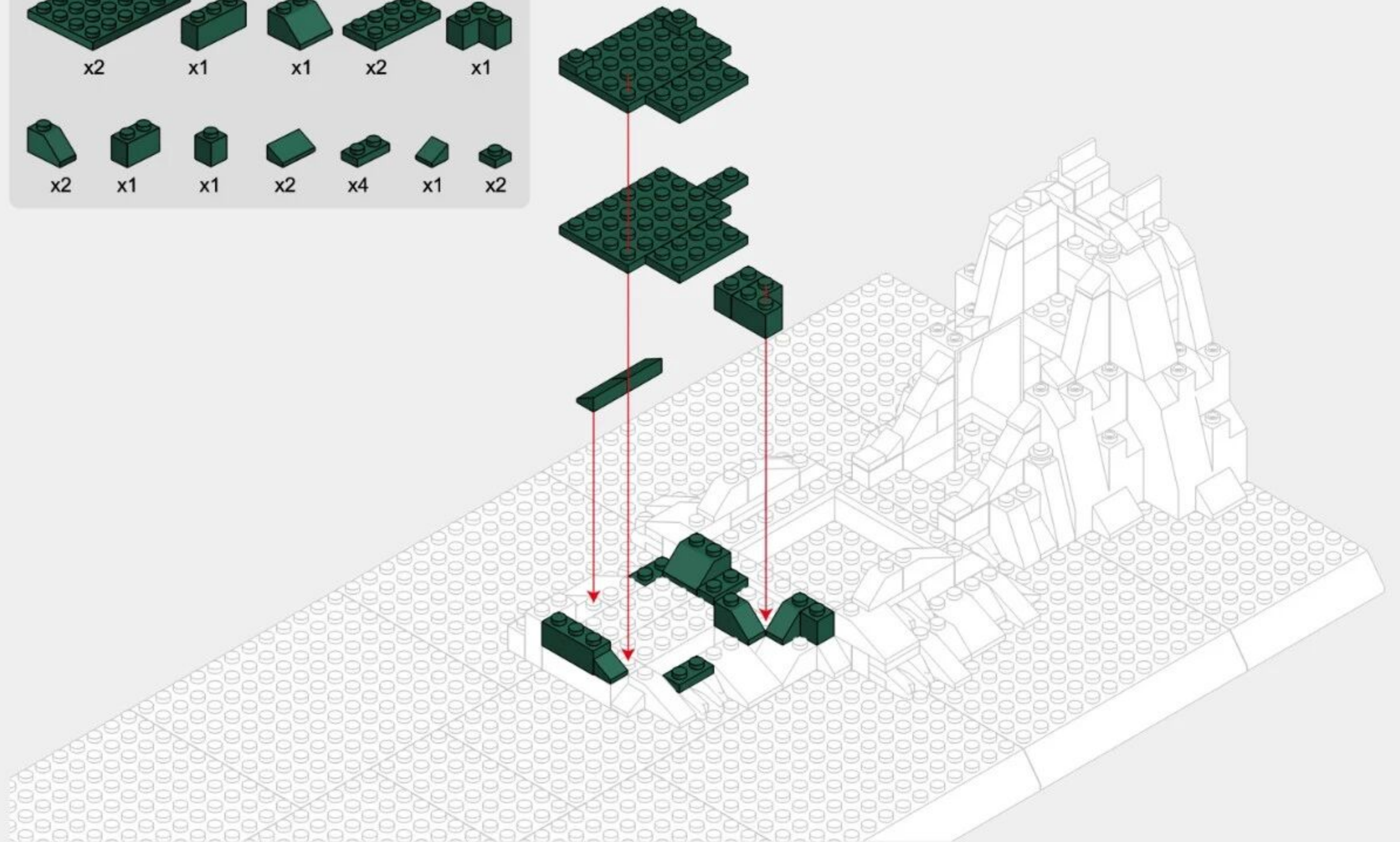
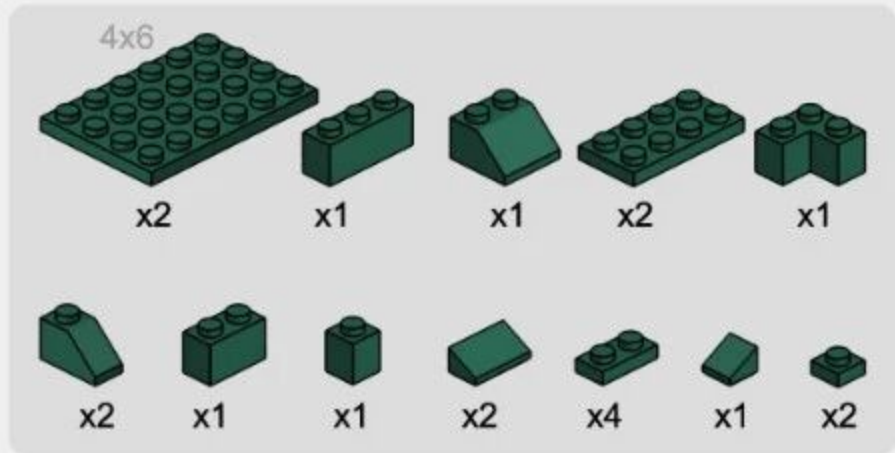

2-12

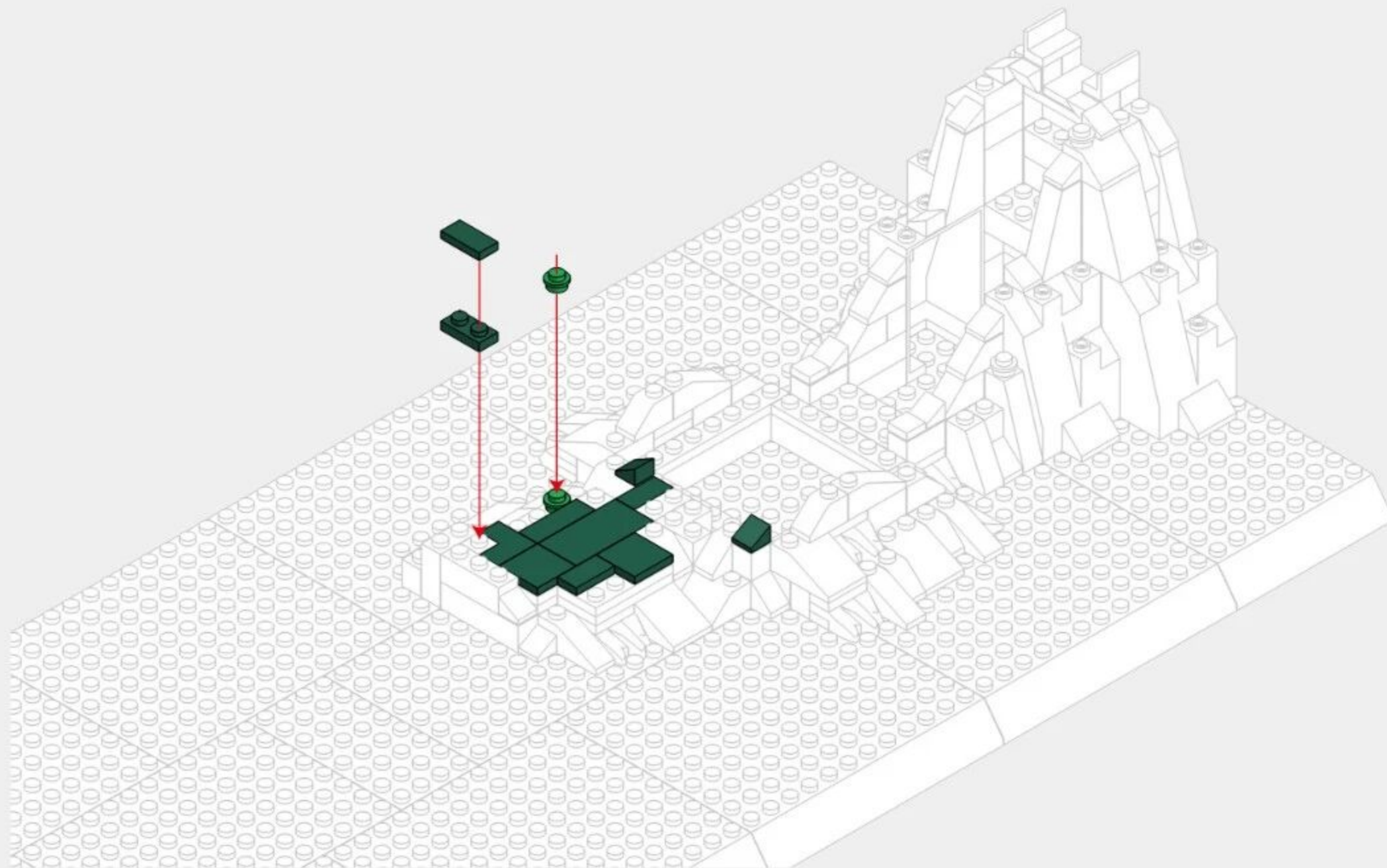
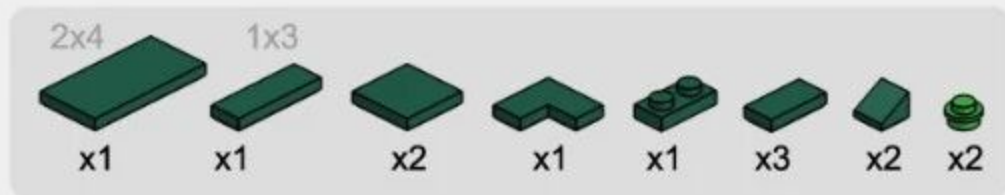

2-13

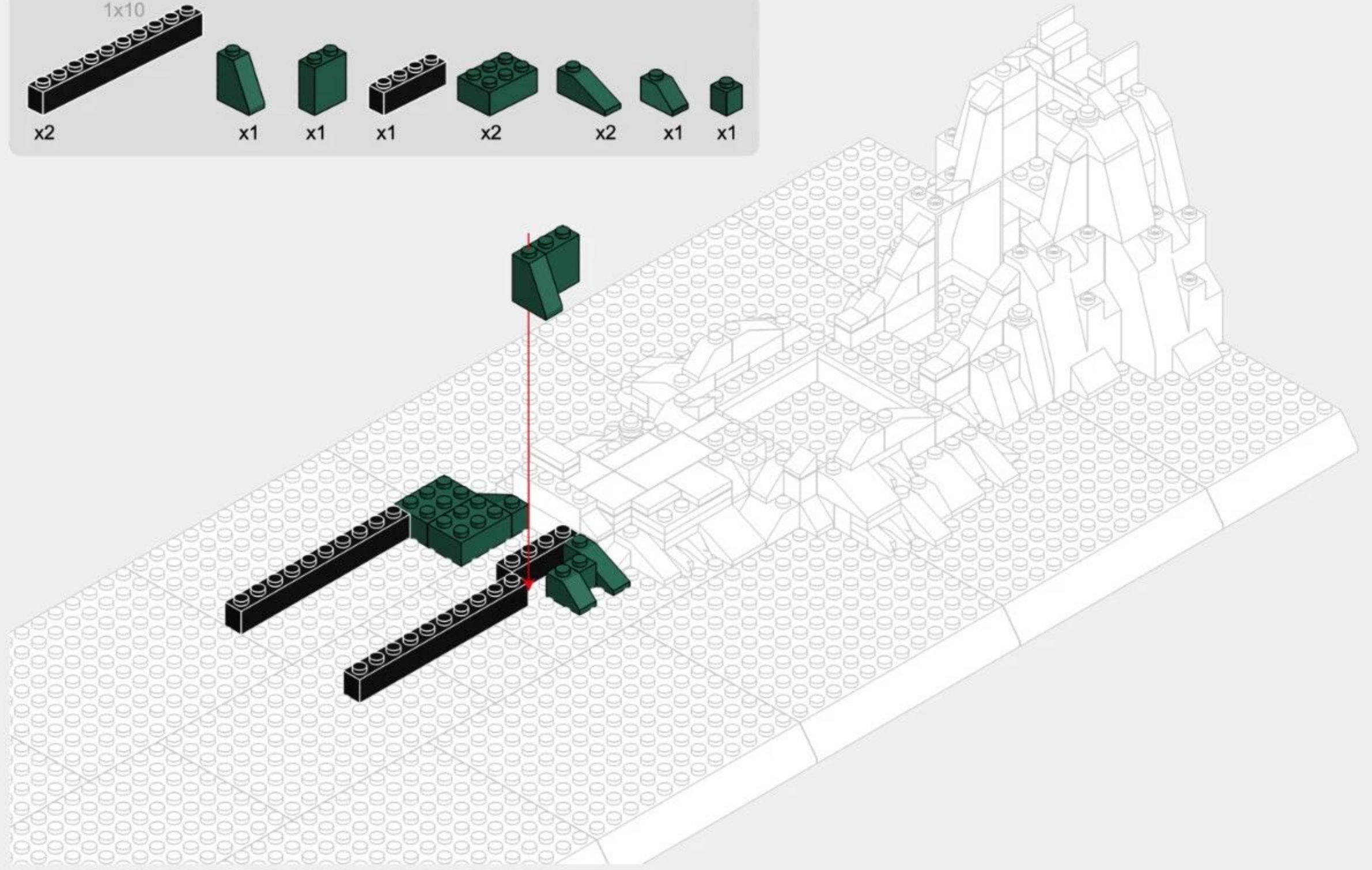
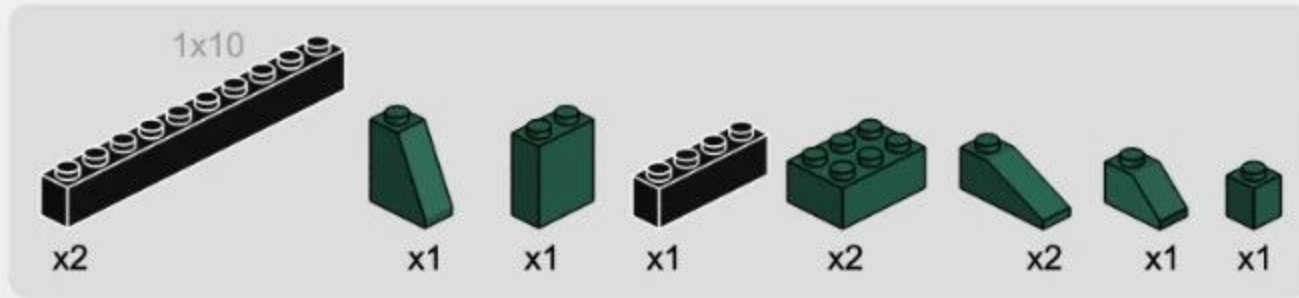

2-14

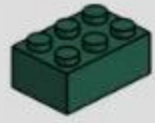

x1



x1



x1



x1



x1



x2

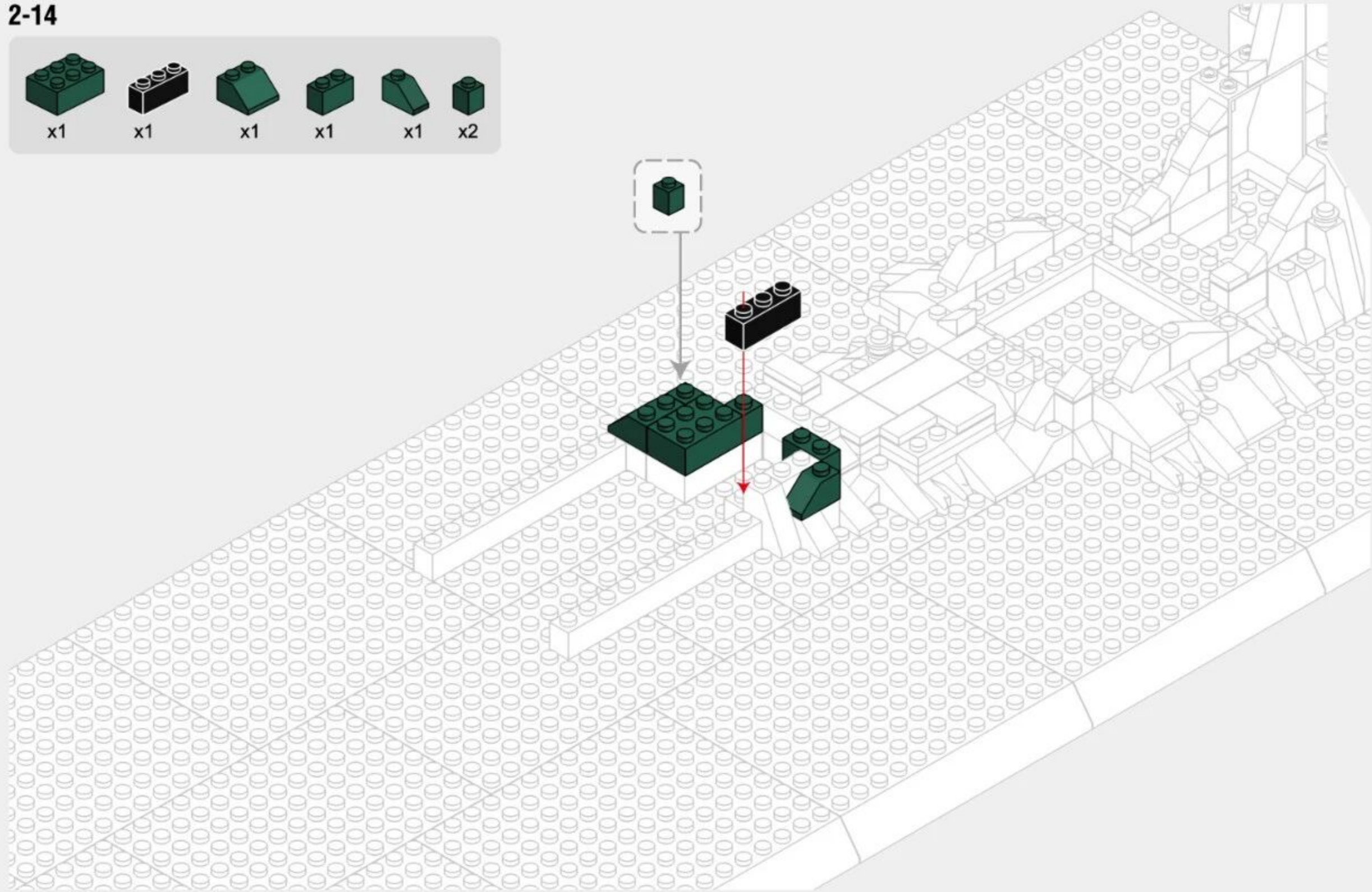

2-15

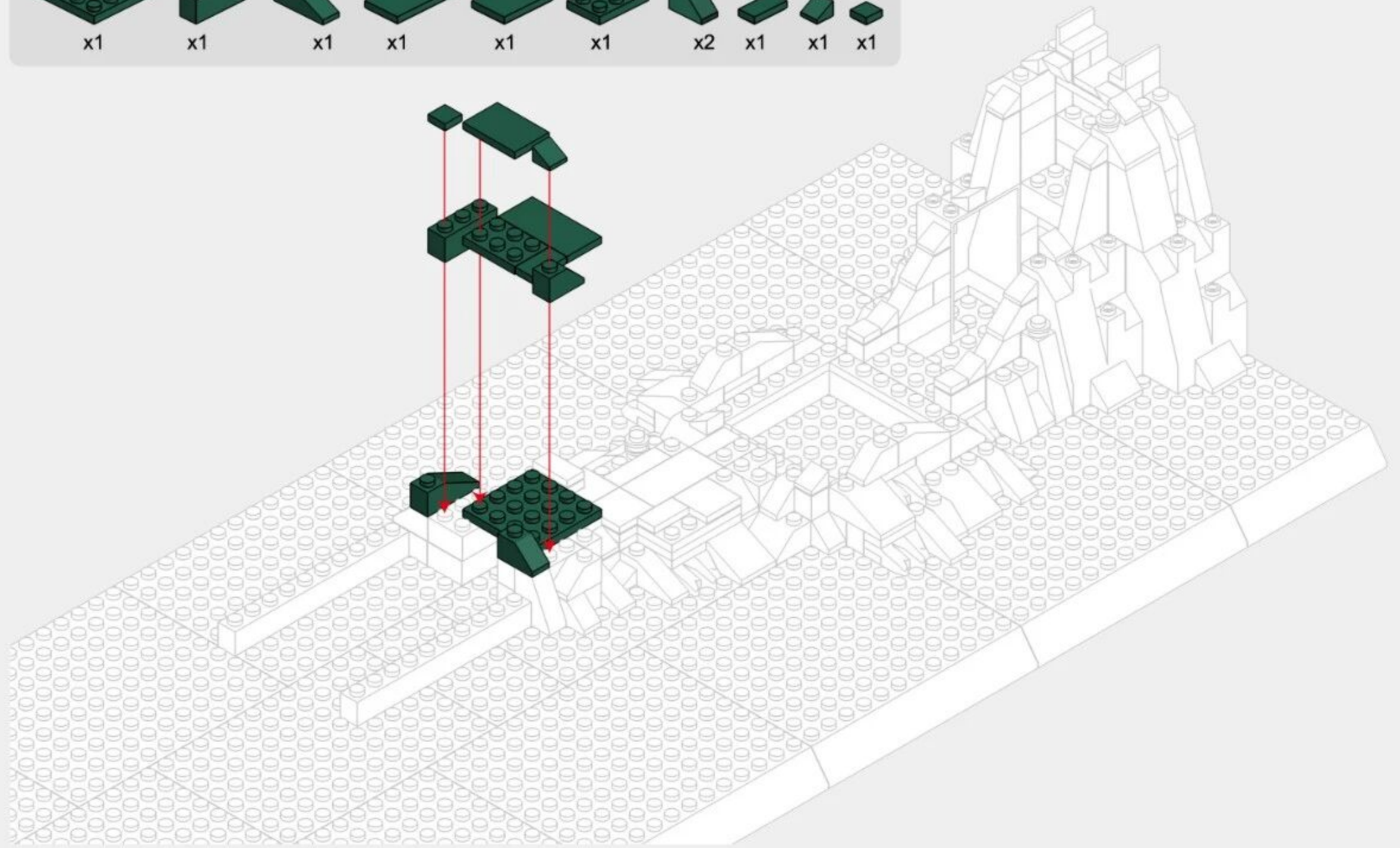
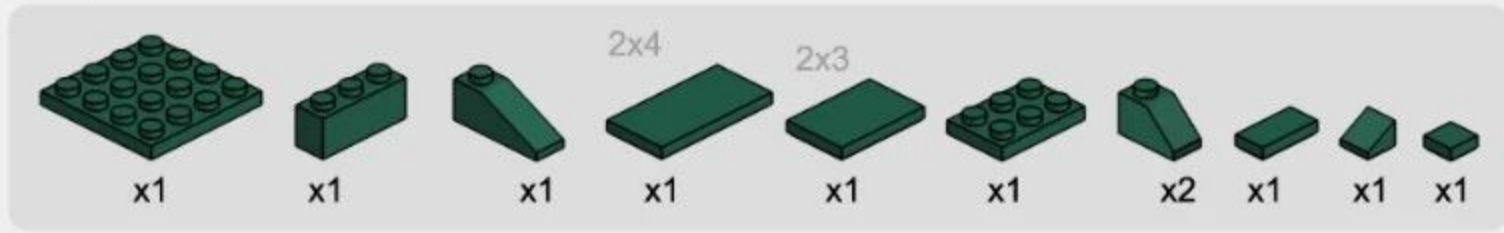

2-16

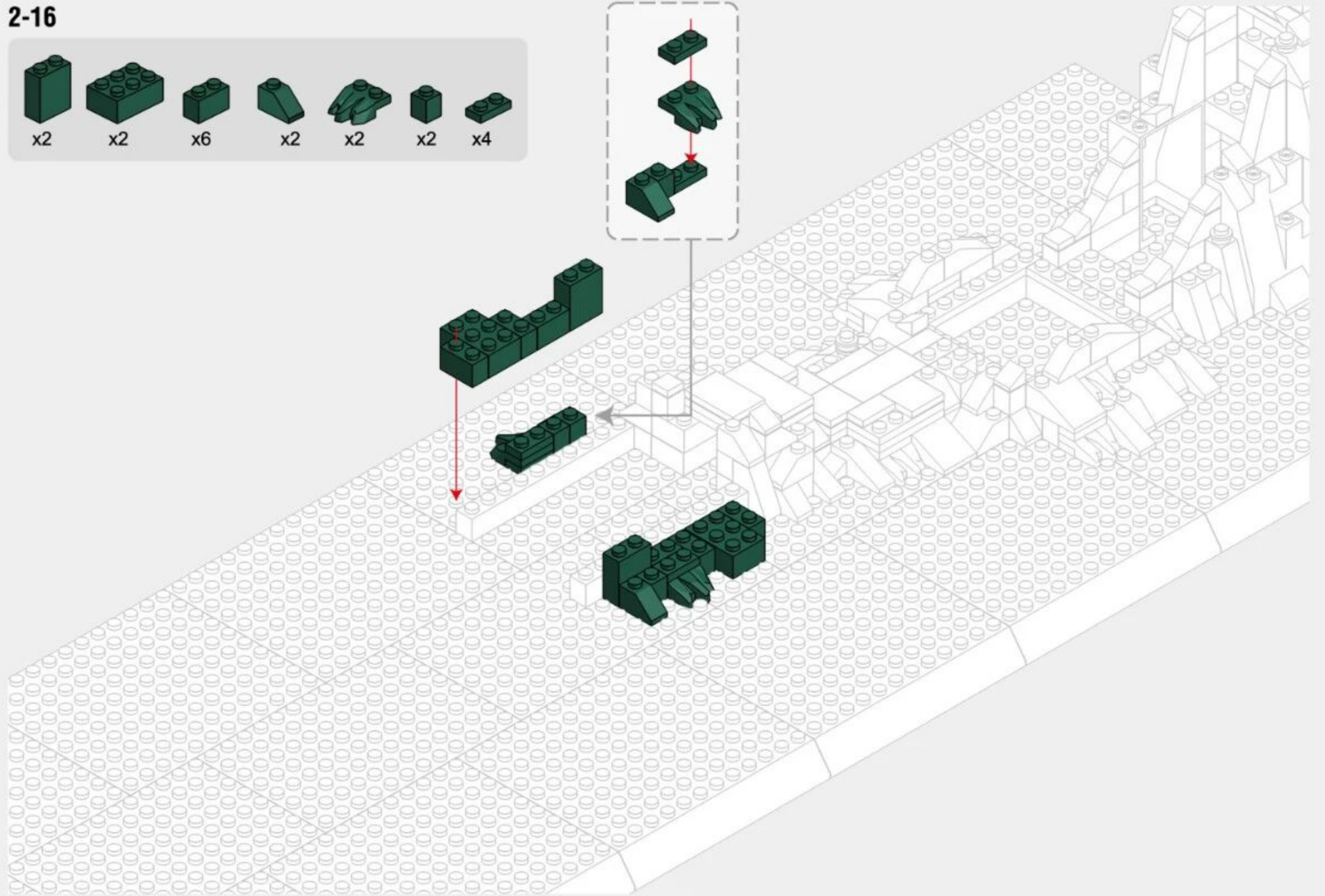
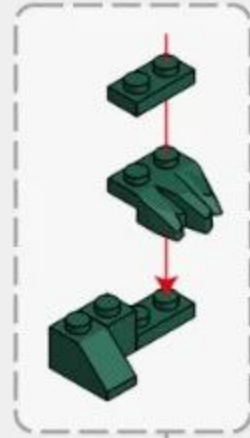
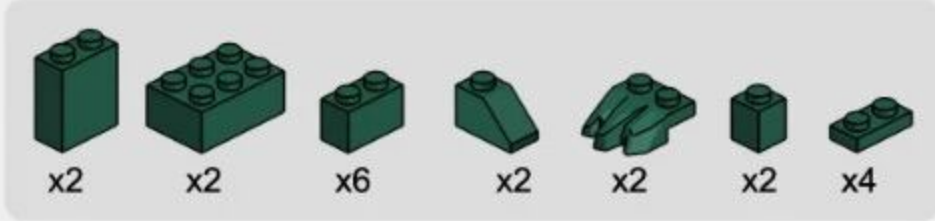



219PCS

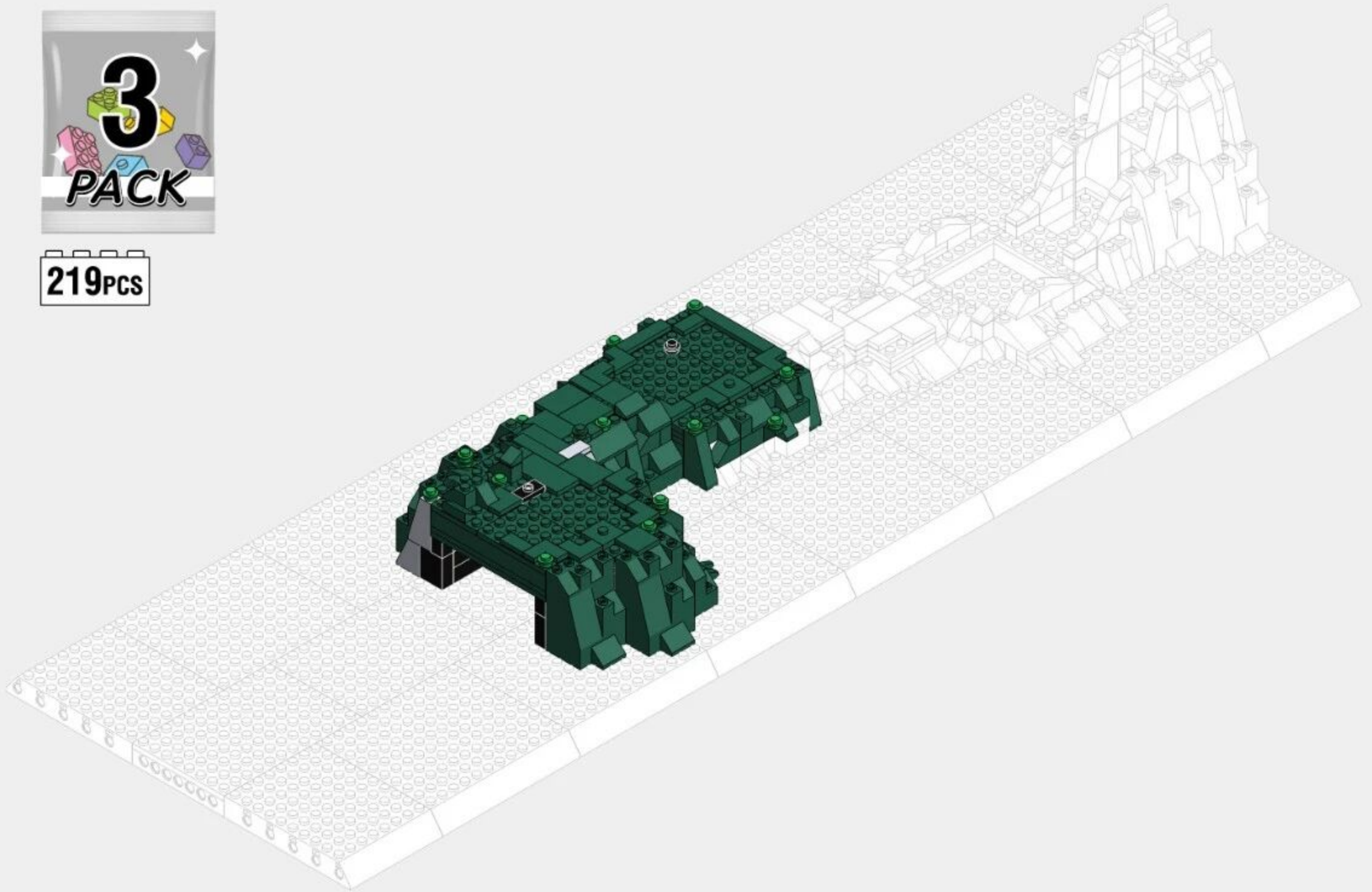

43

3-1

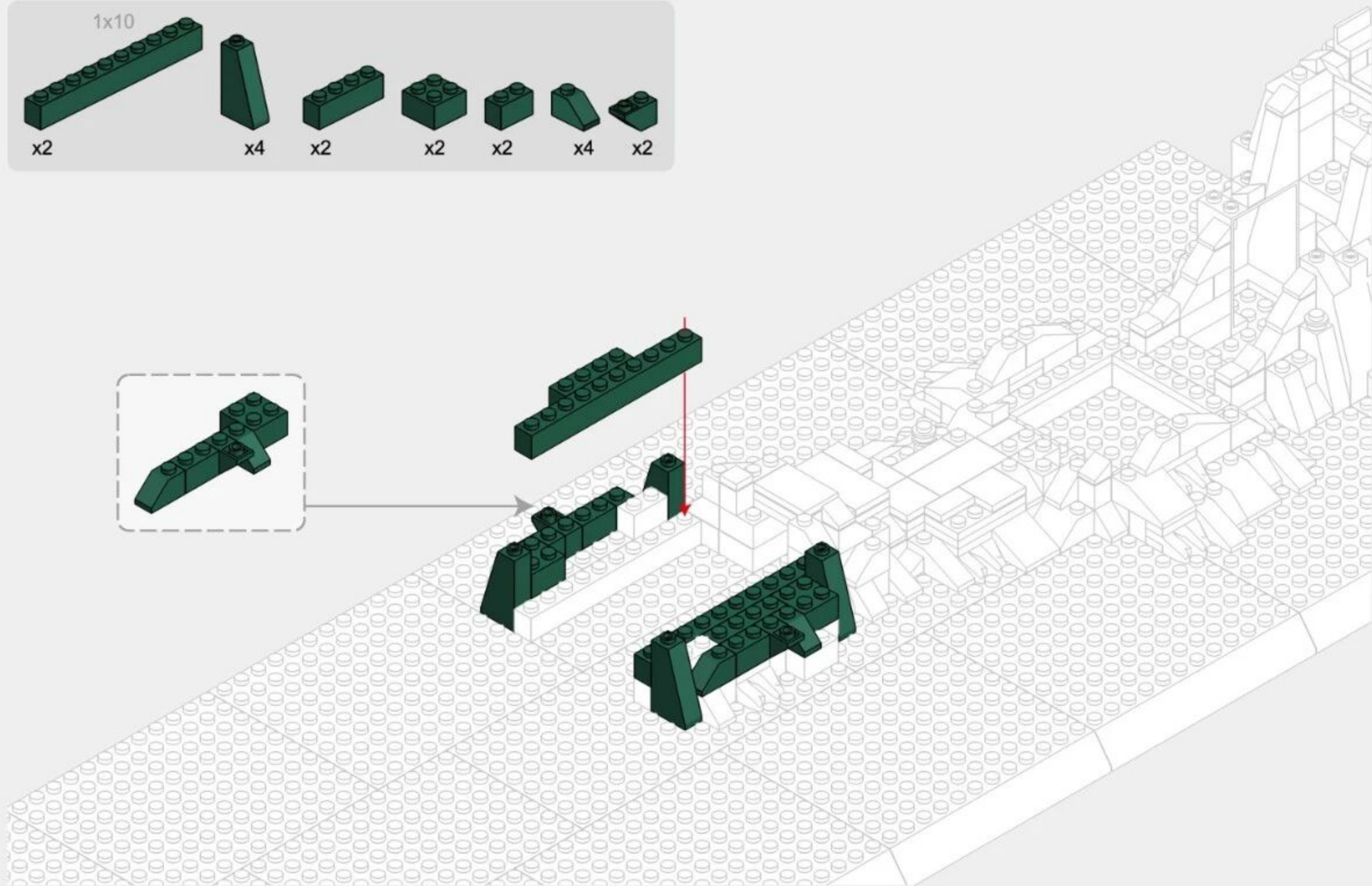
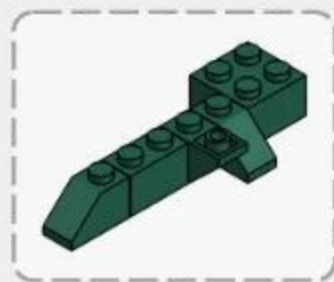
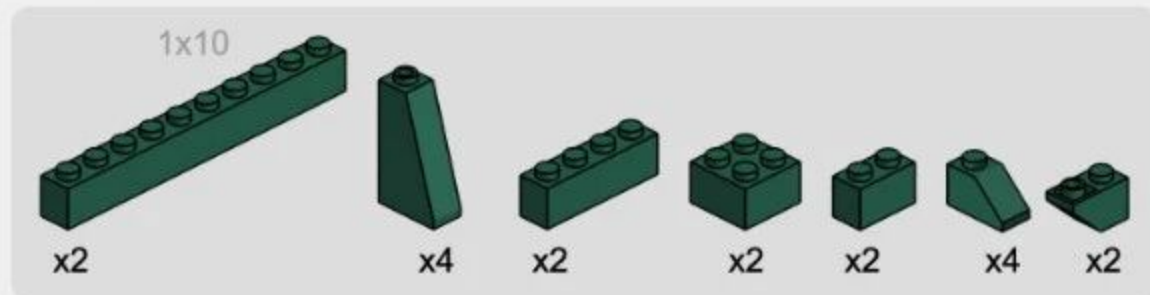

3-2

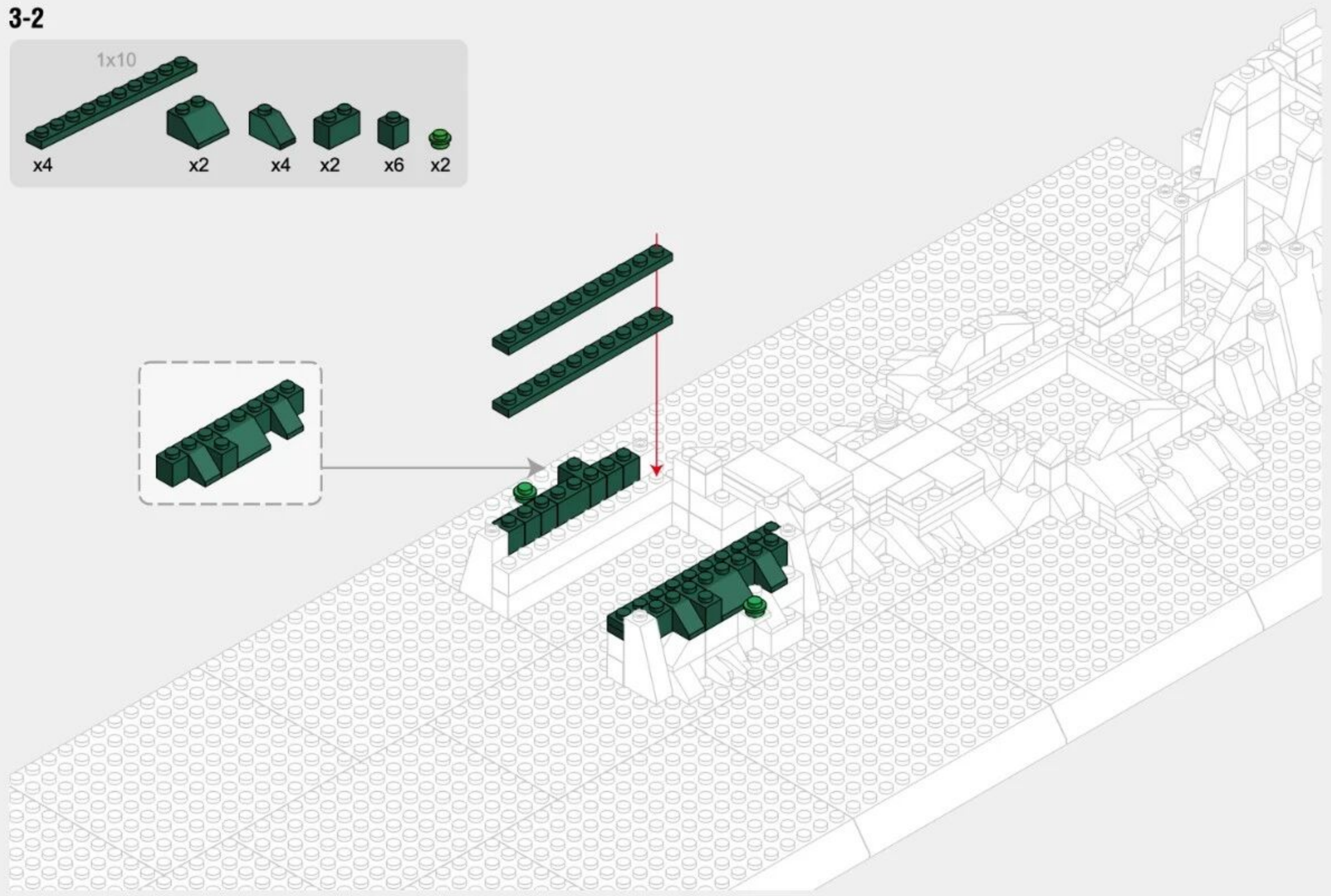
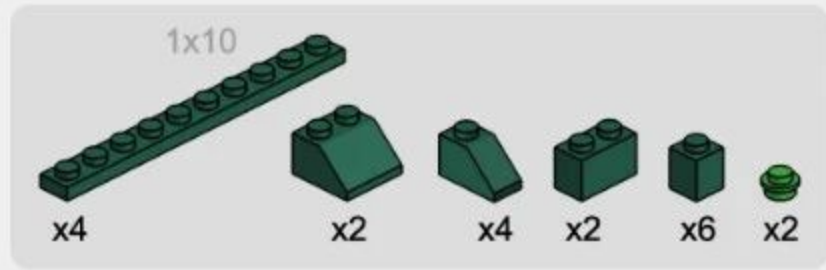

3-3

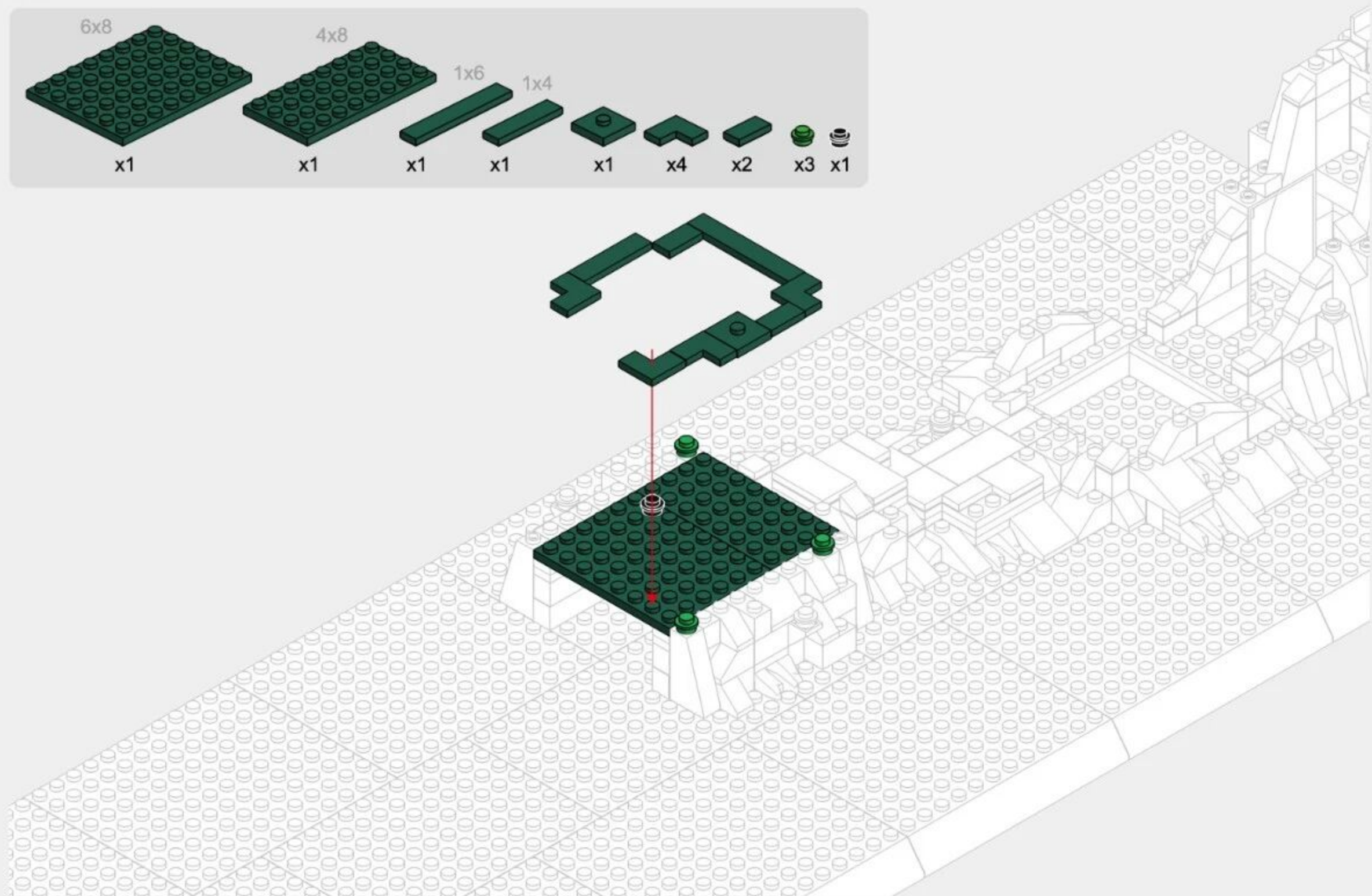
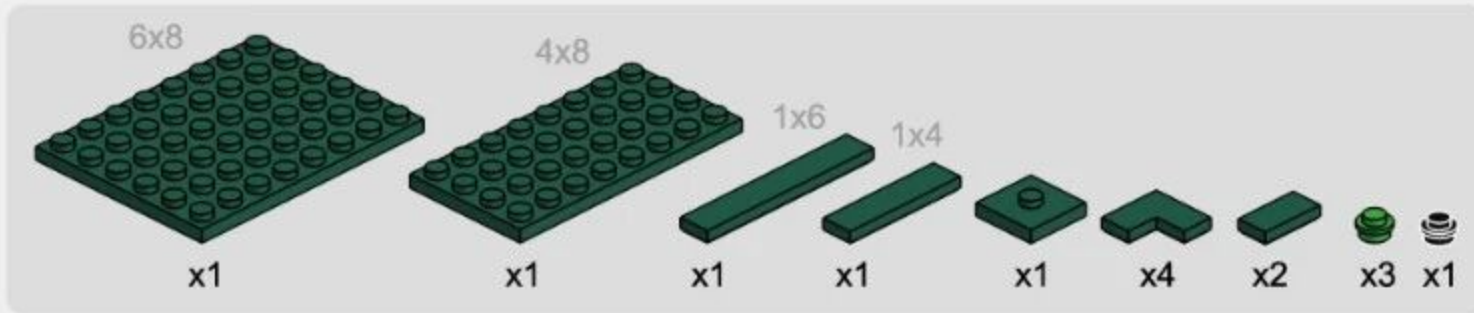

3-5

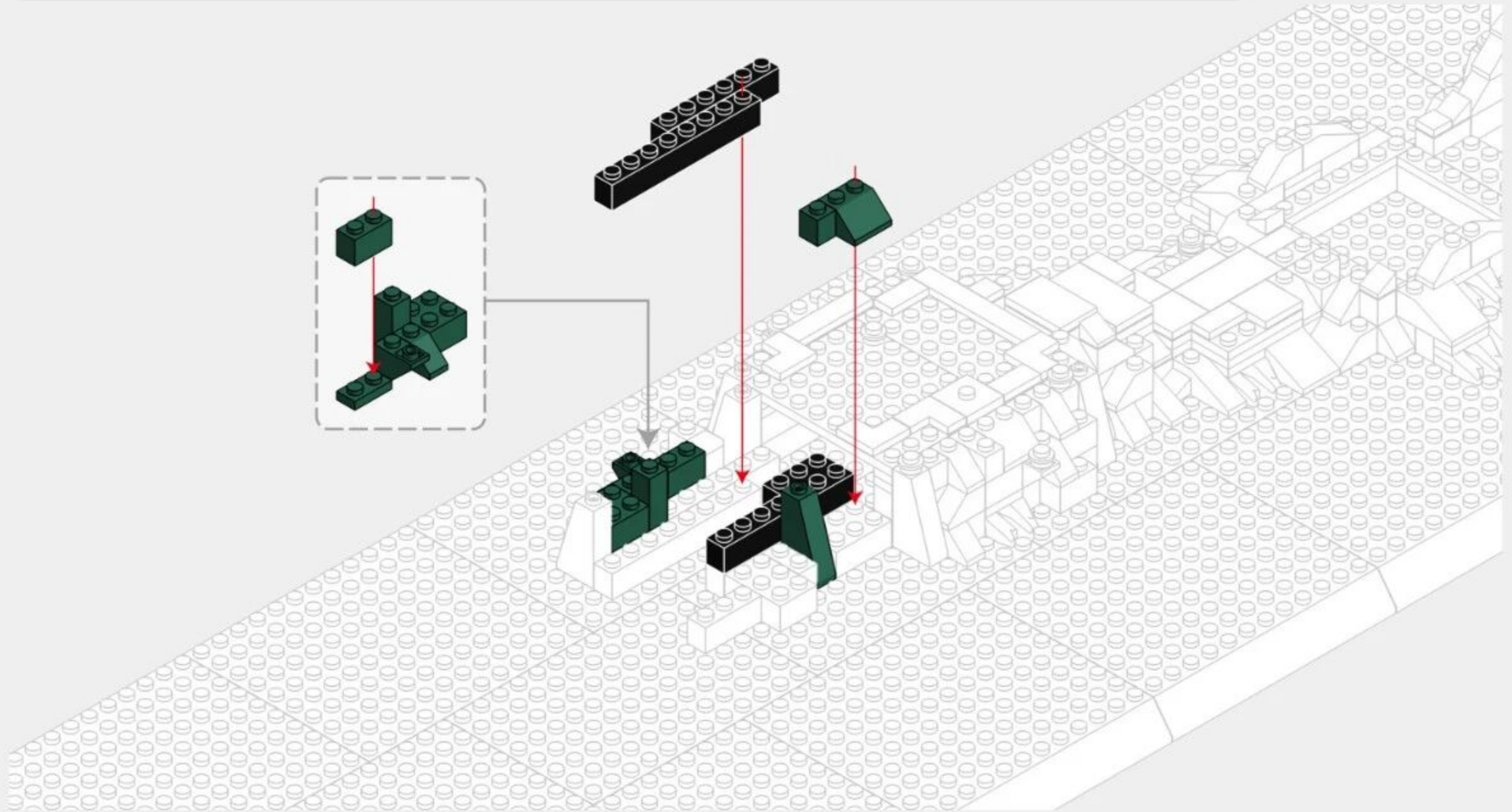
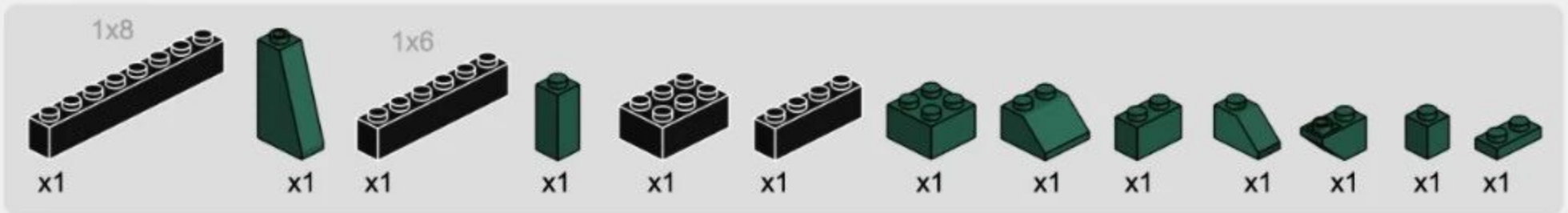

3-7

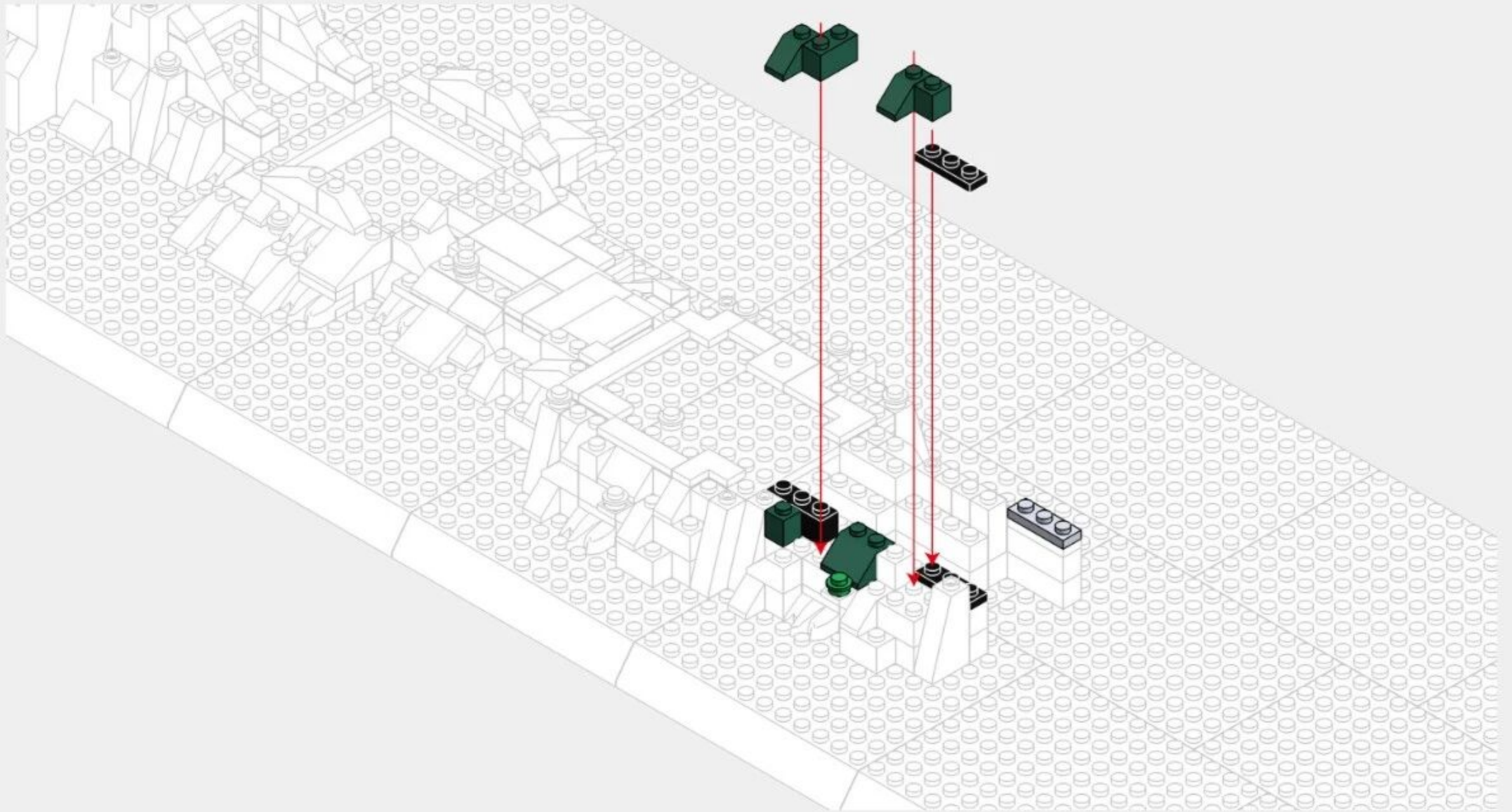
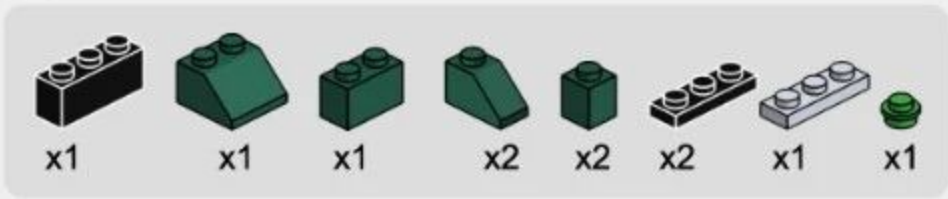

3-8

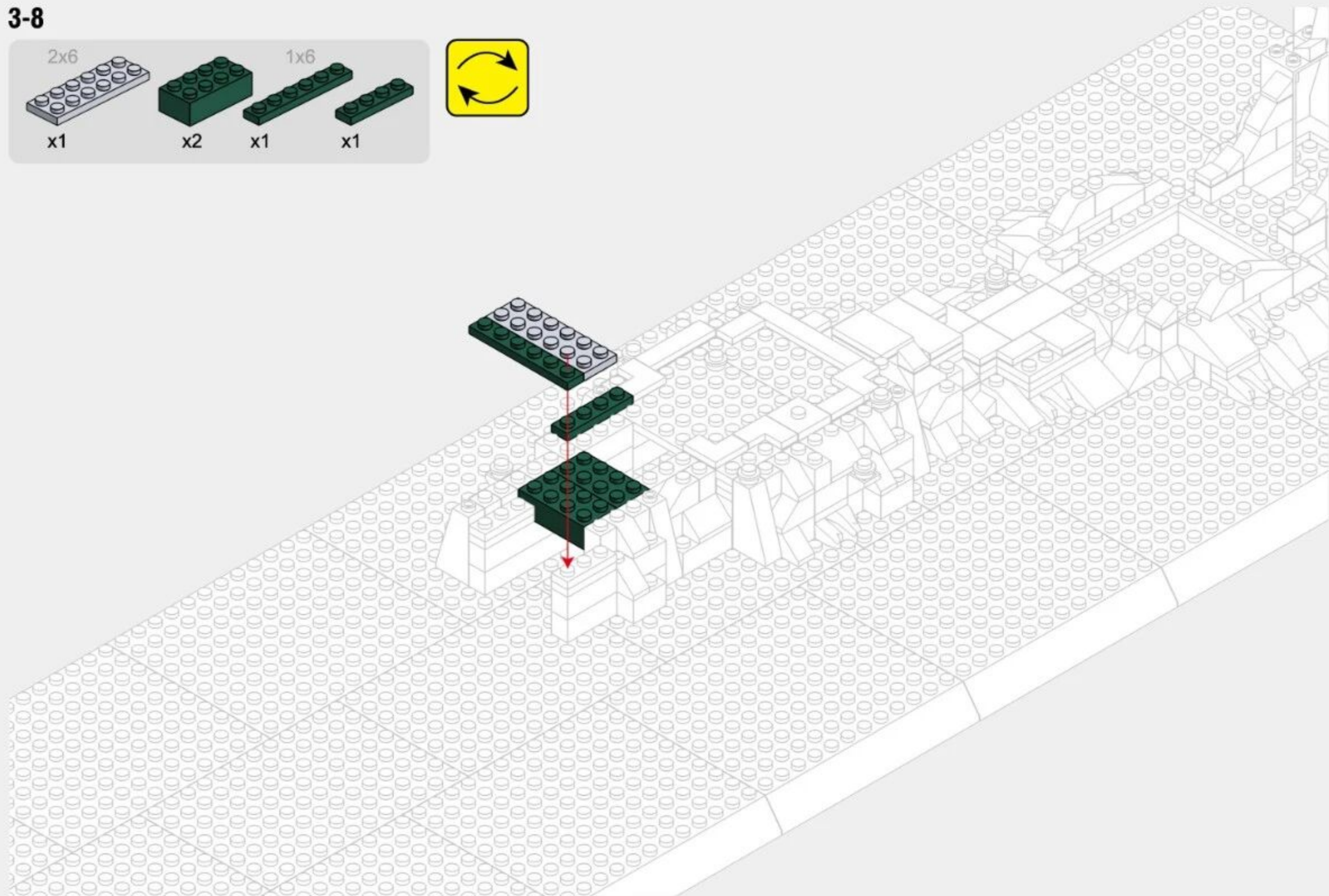
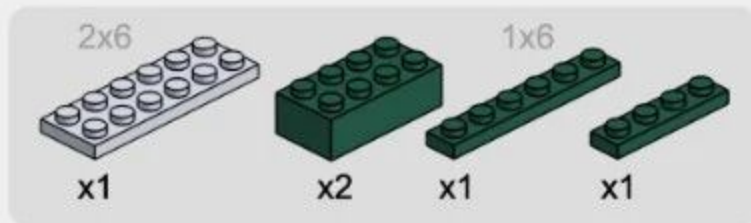

3-9

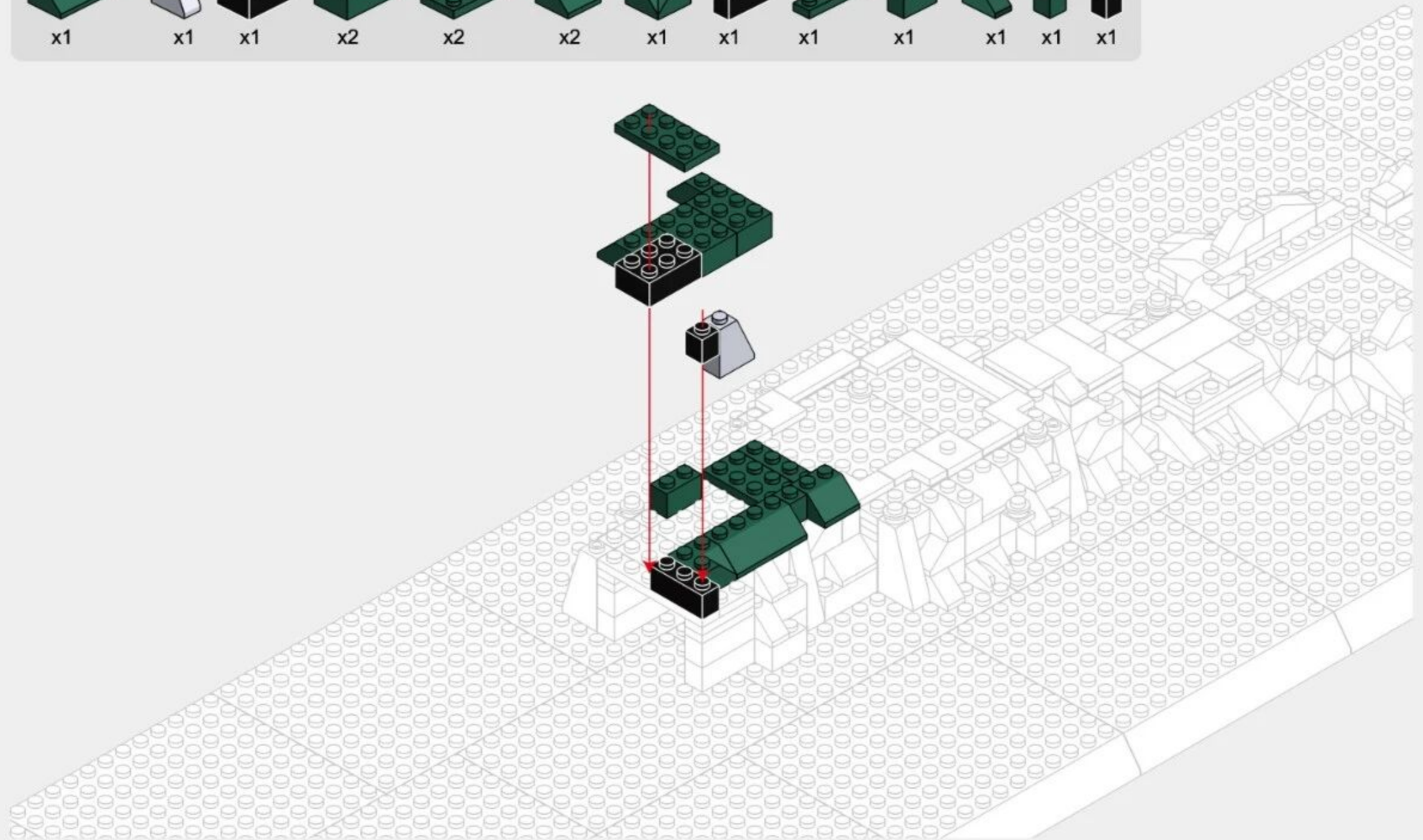

3-13

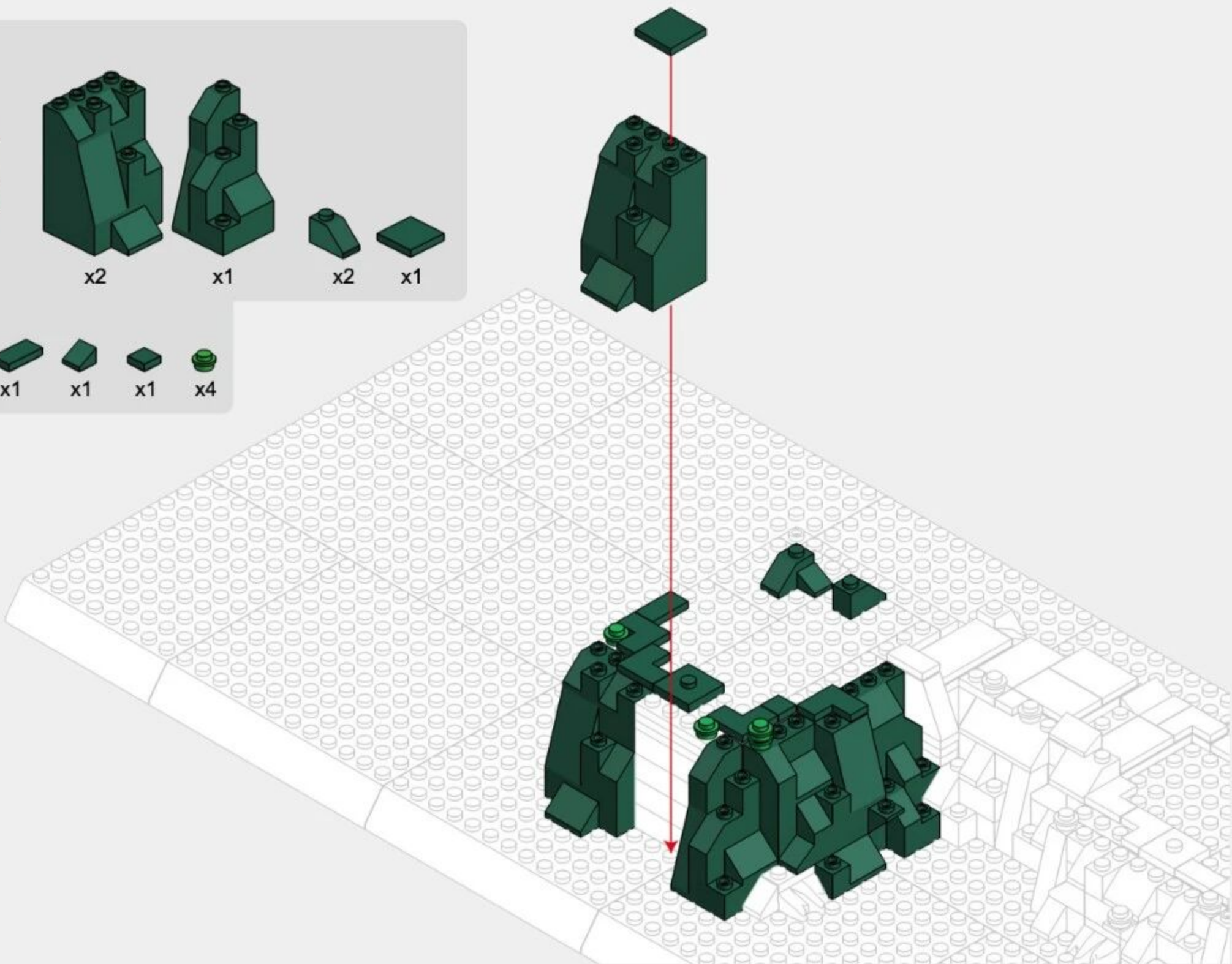
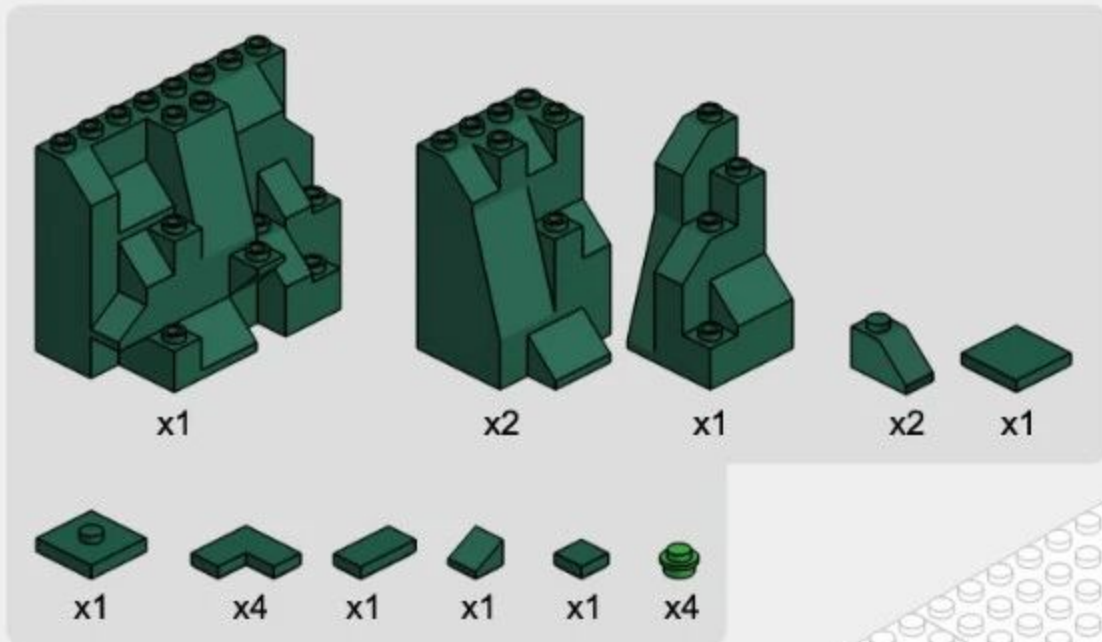

3-14

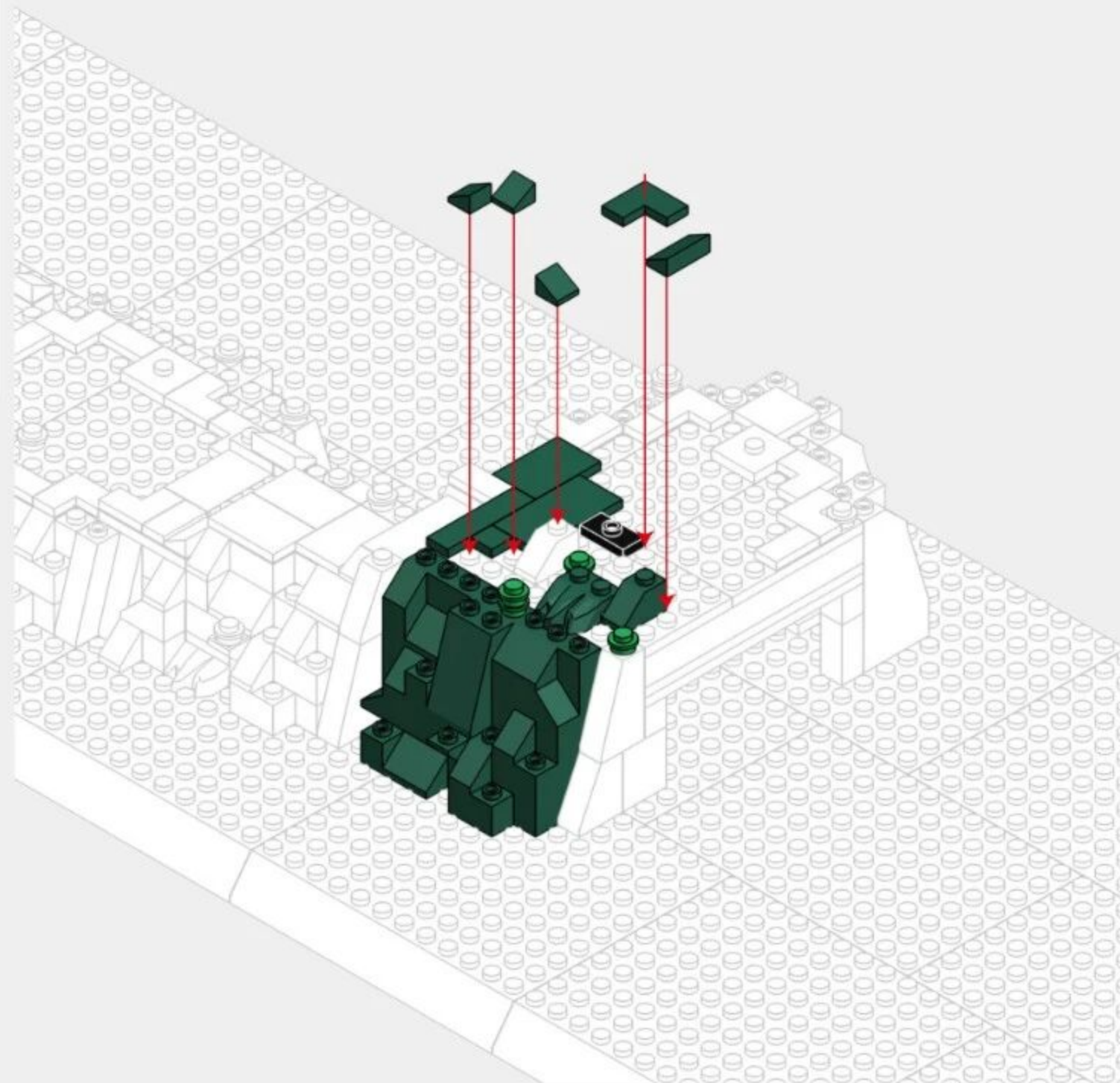
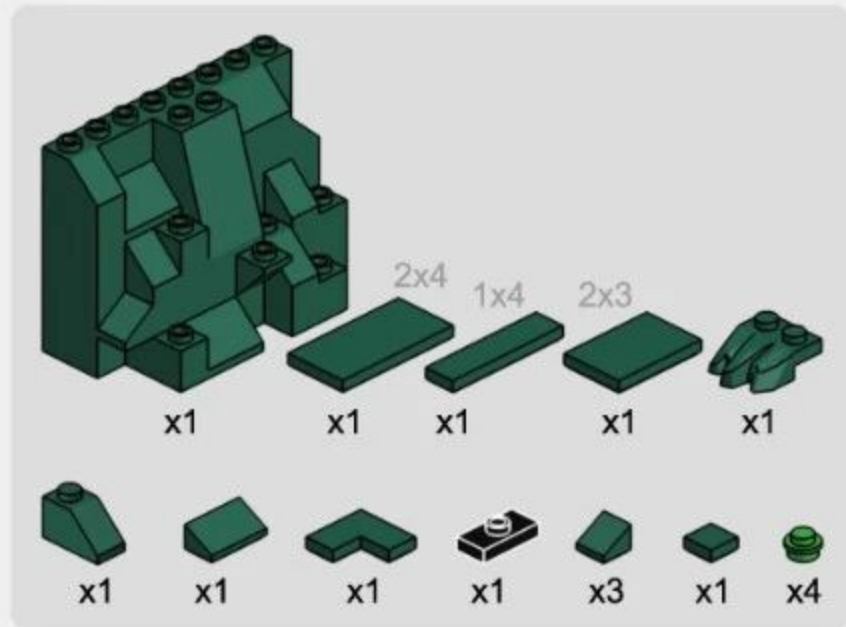



145PCS

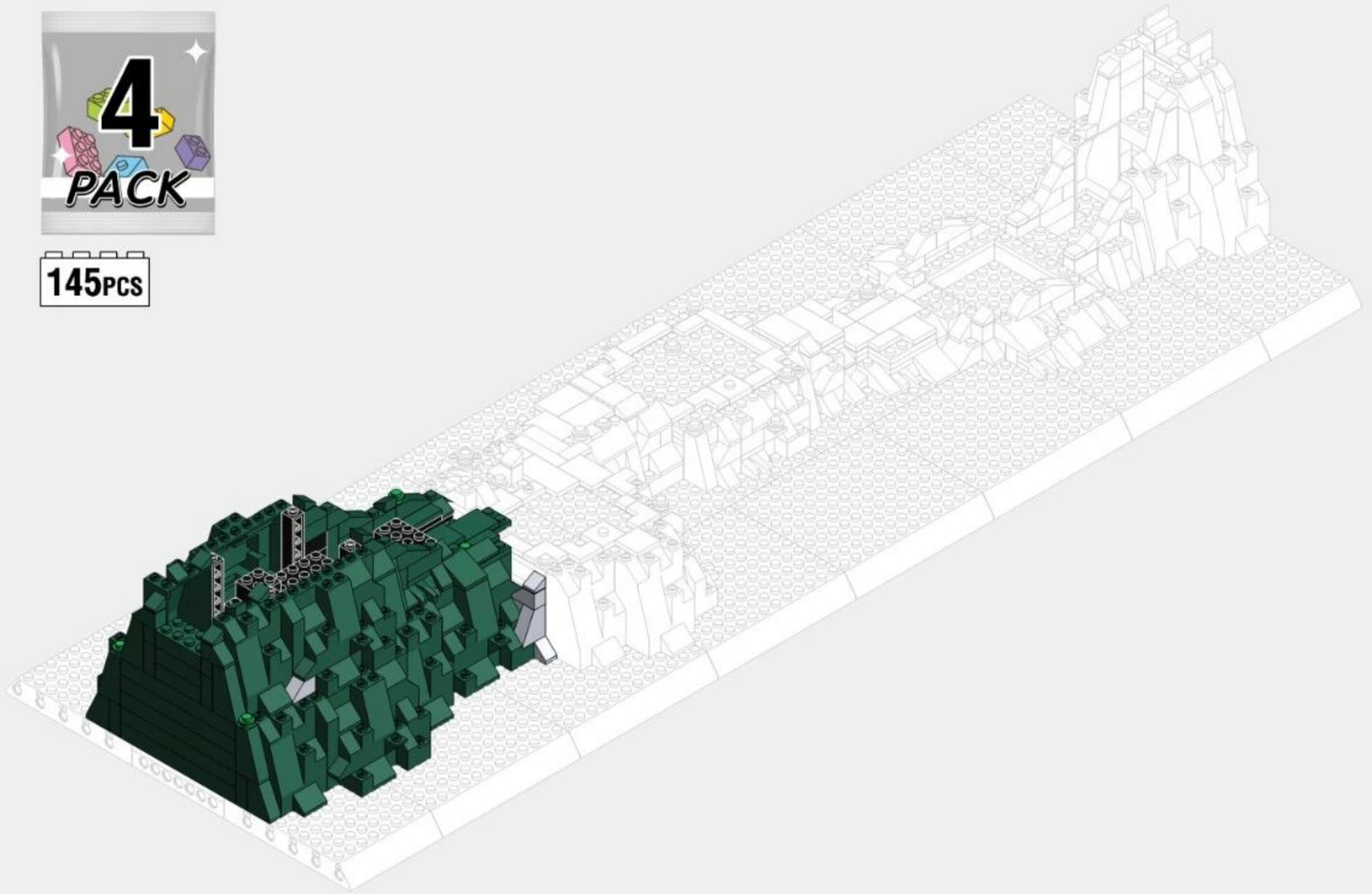

4-1

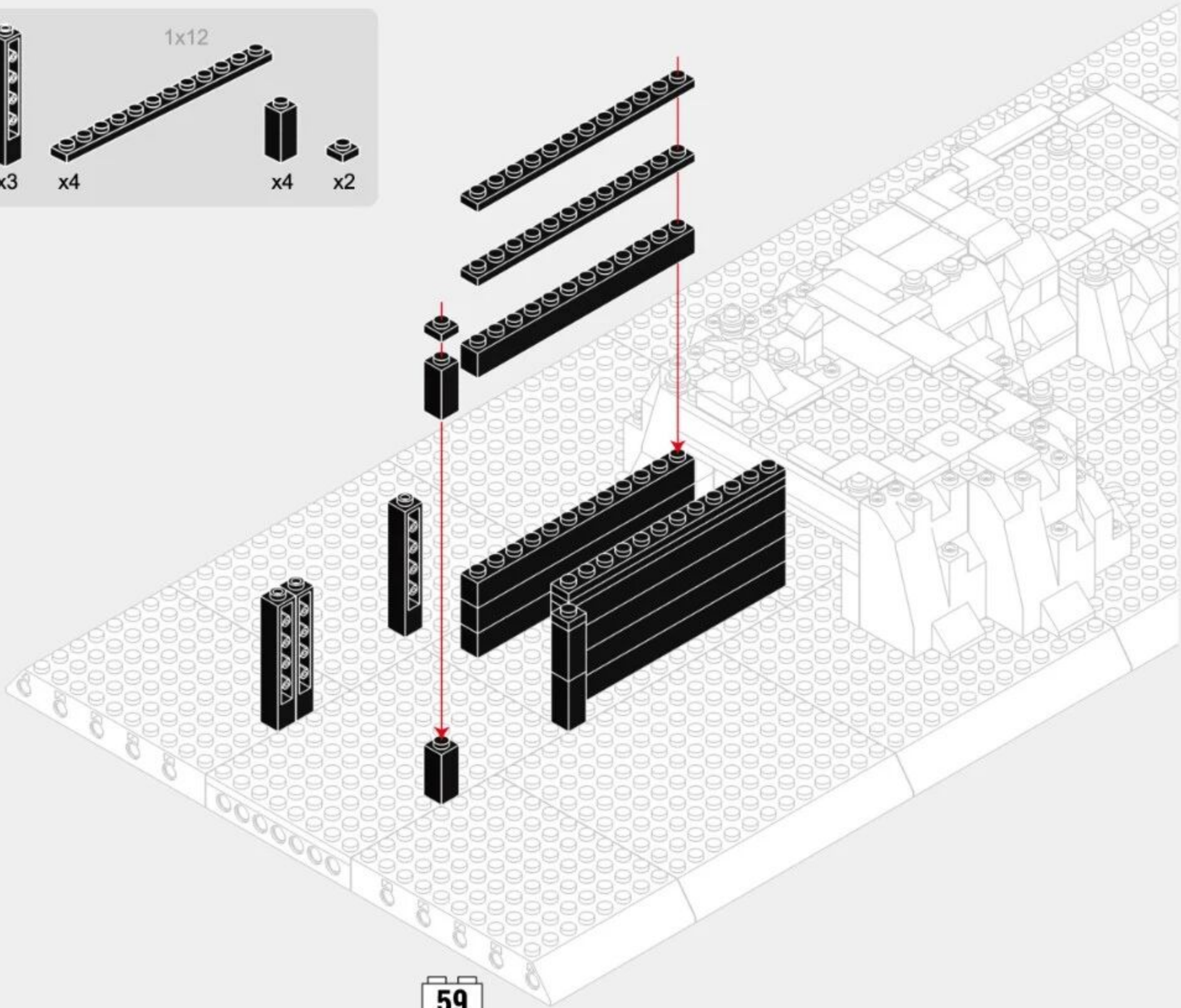
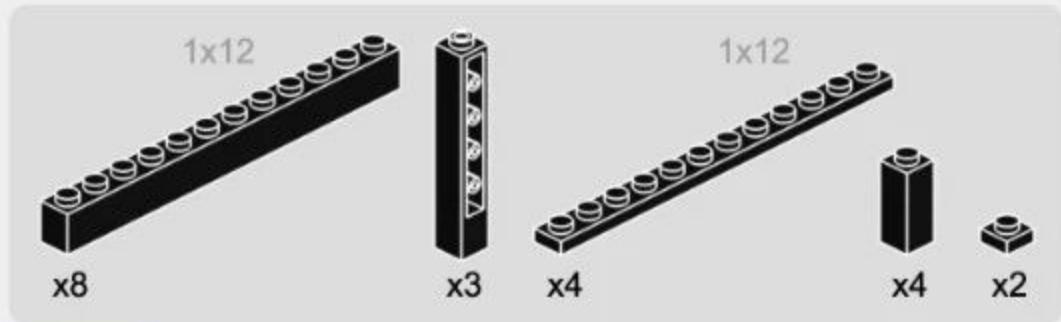

4-2

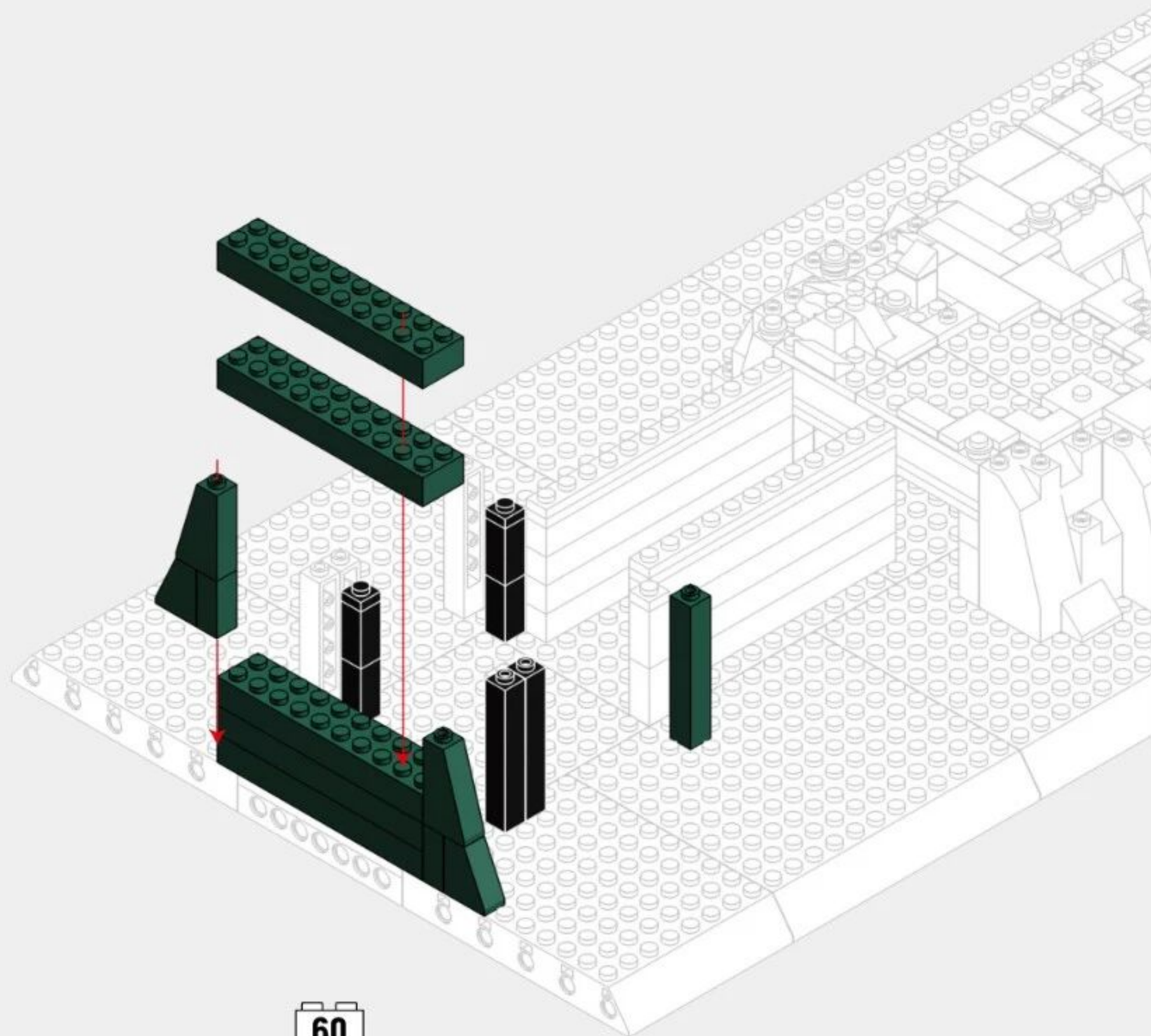
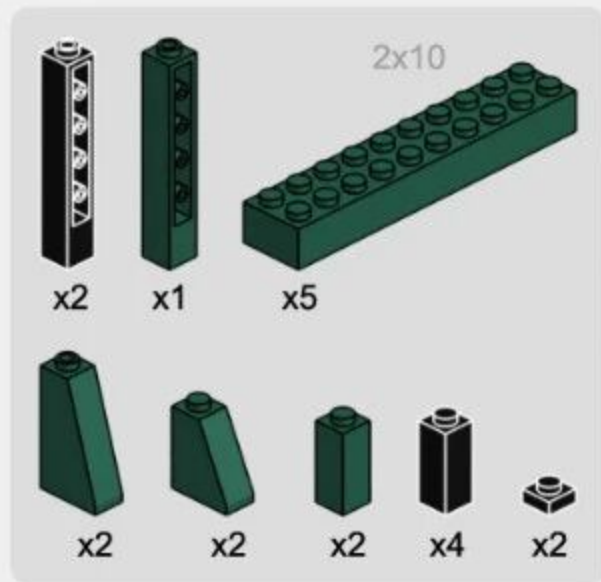

4-3

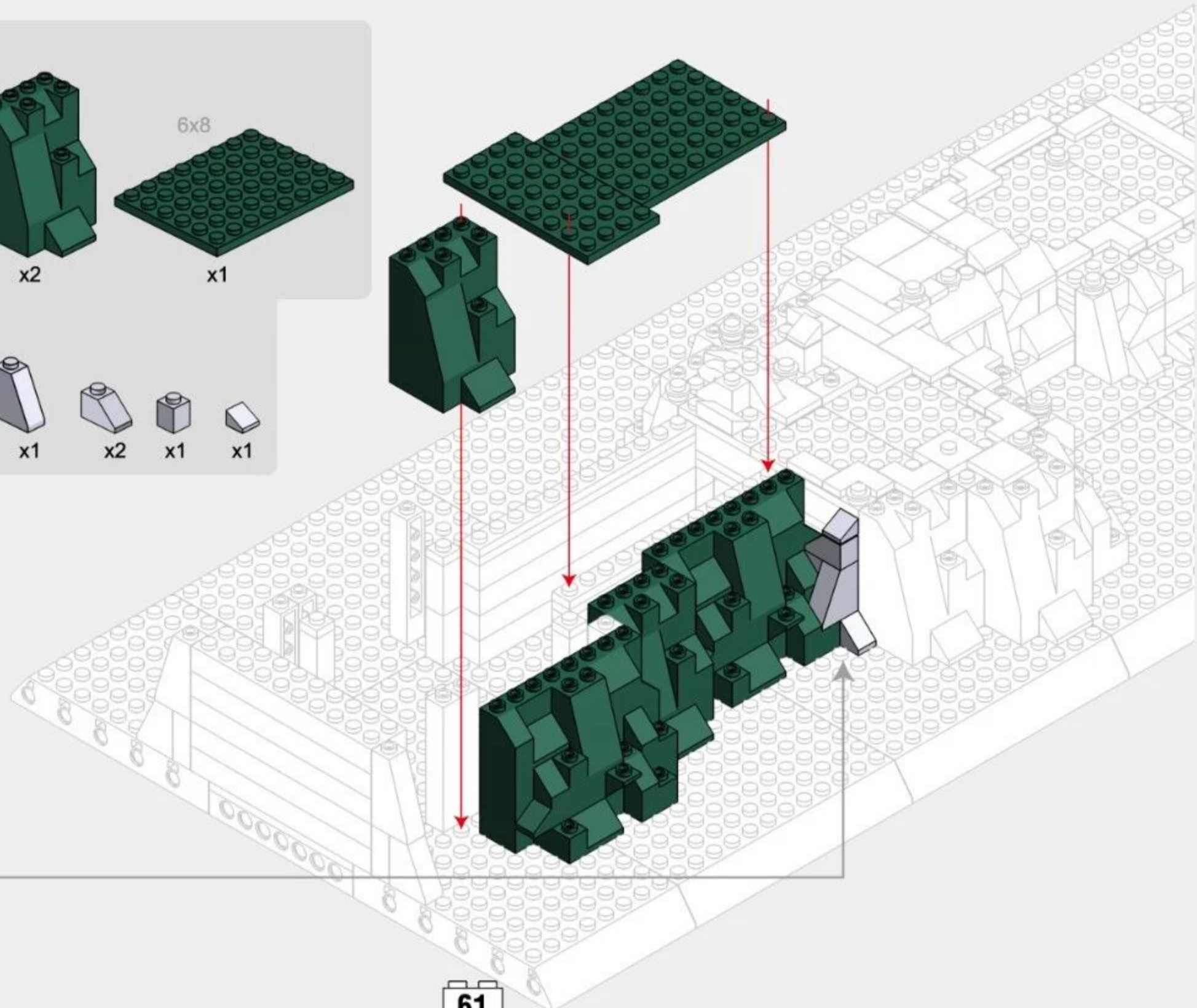
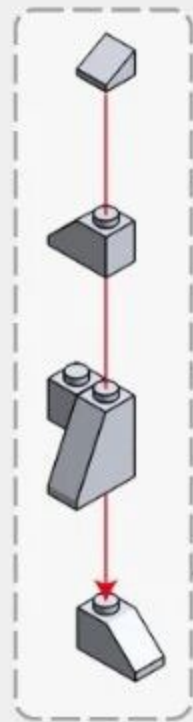
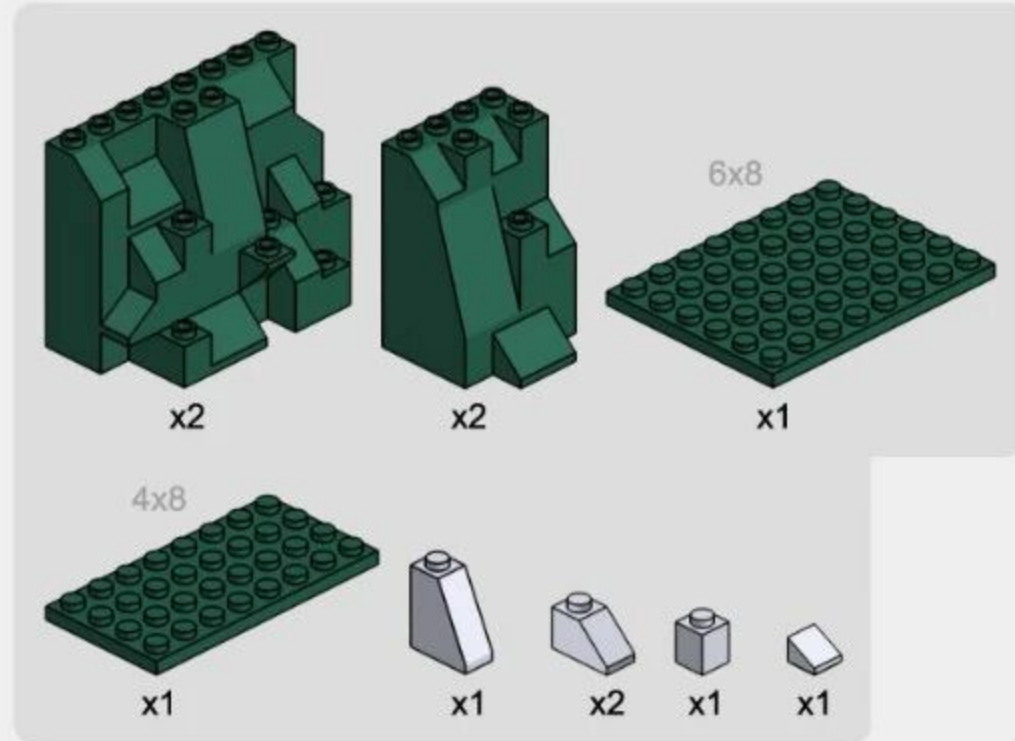

4-4

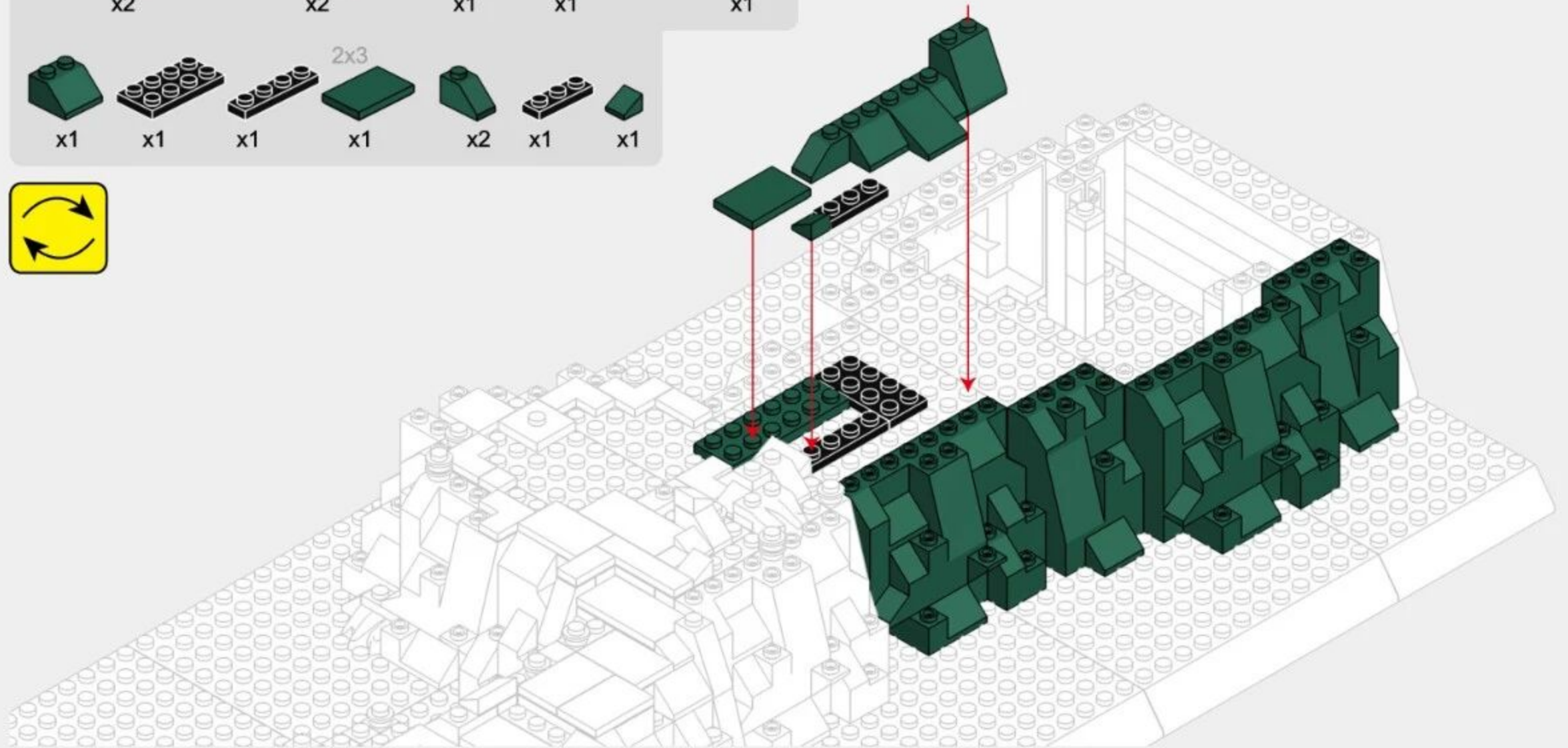
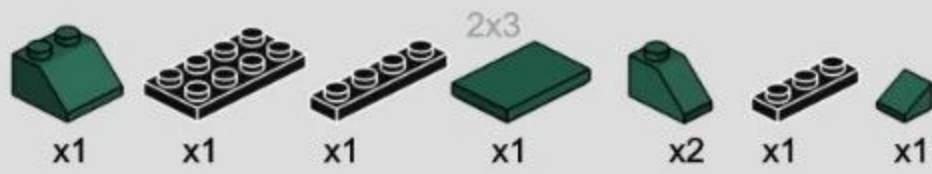
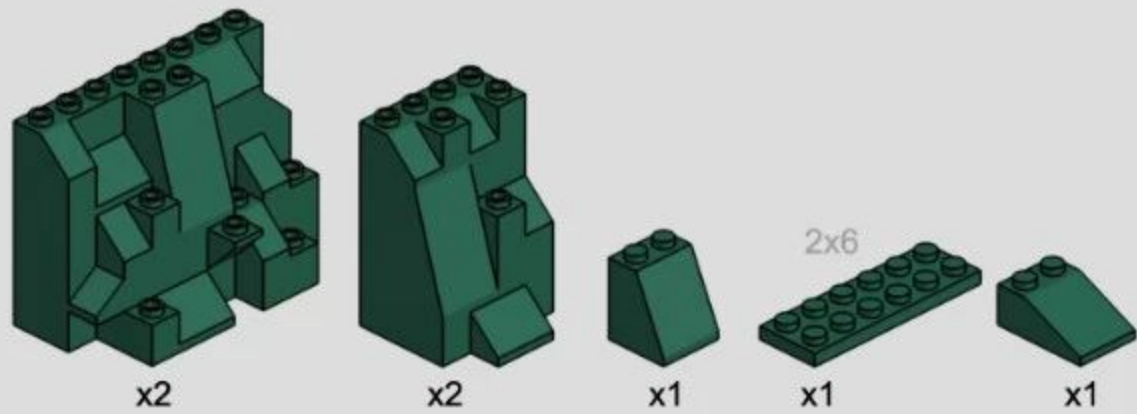

4-6

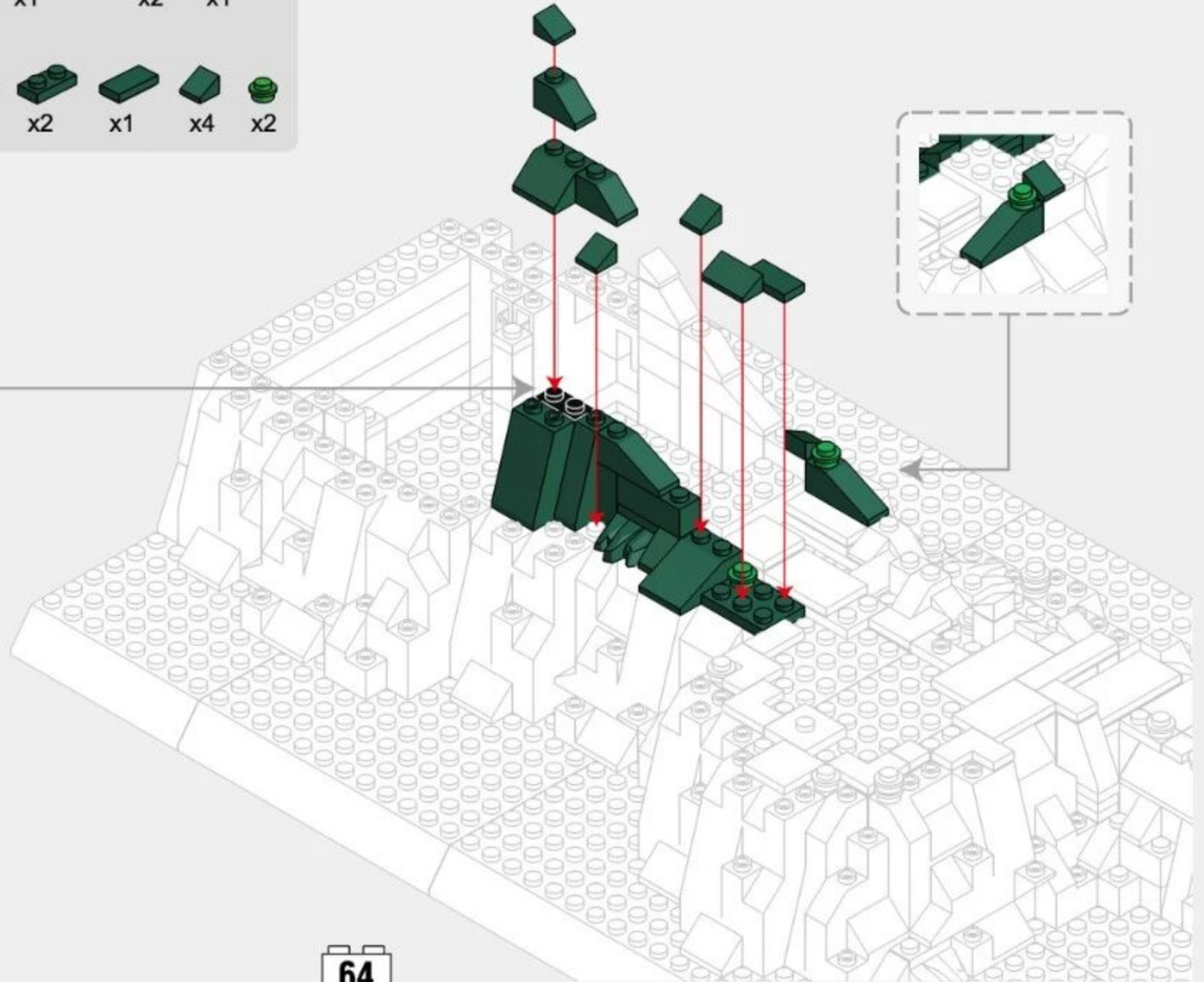
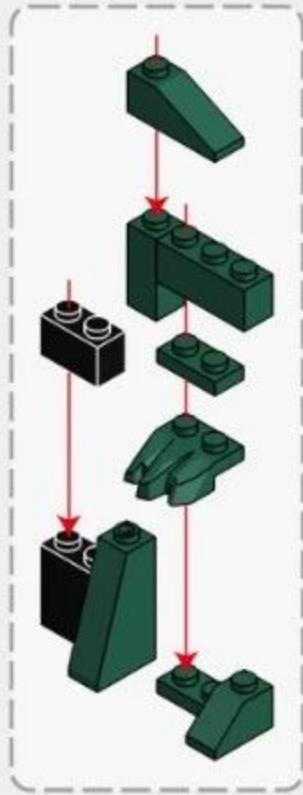
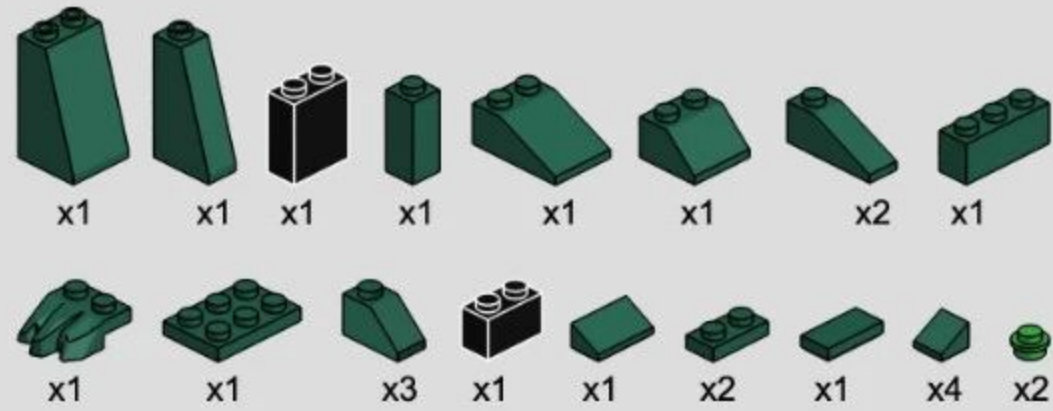

4-7

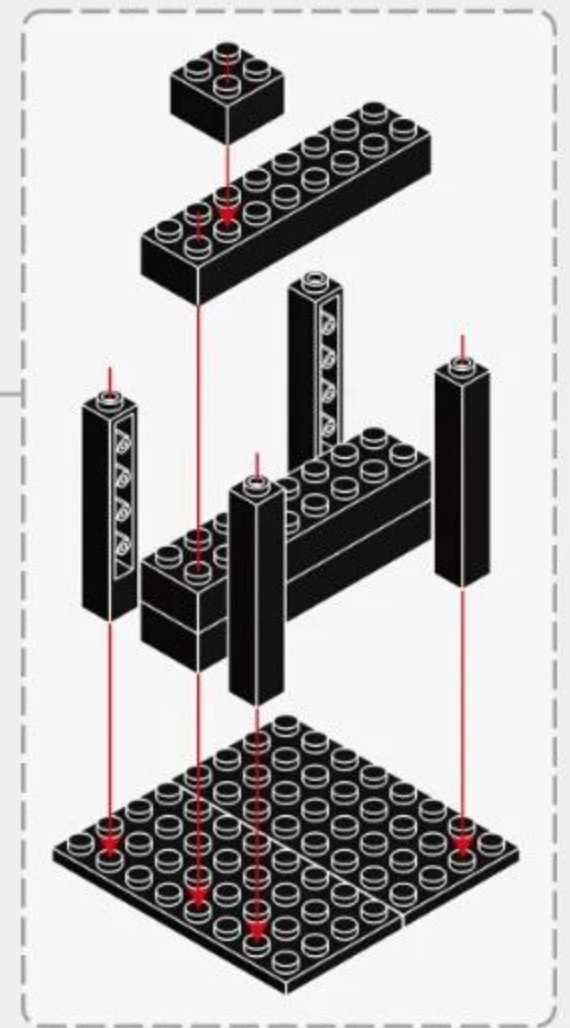
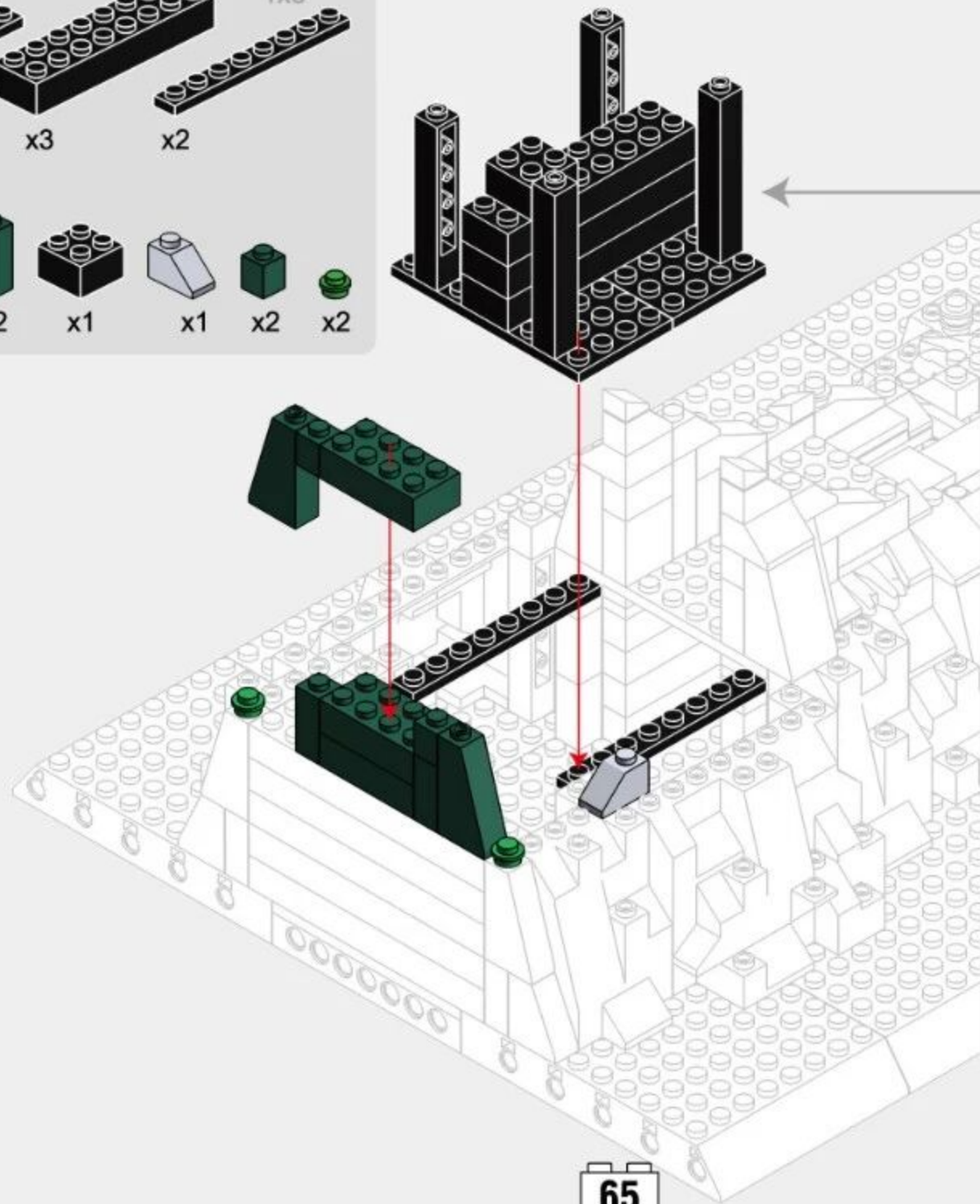
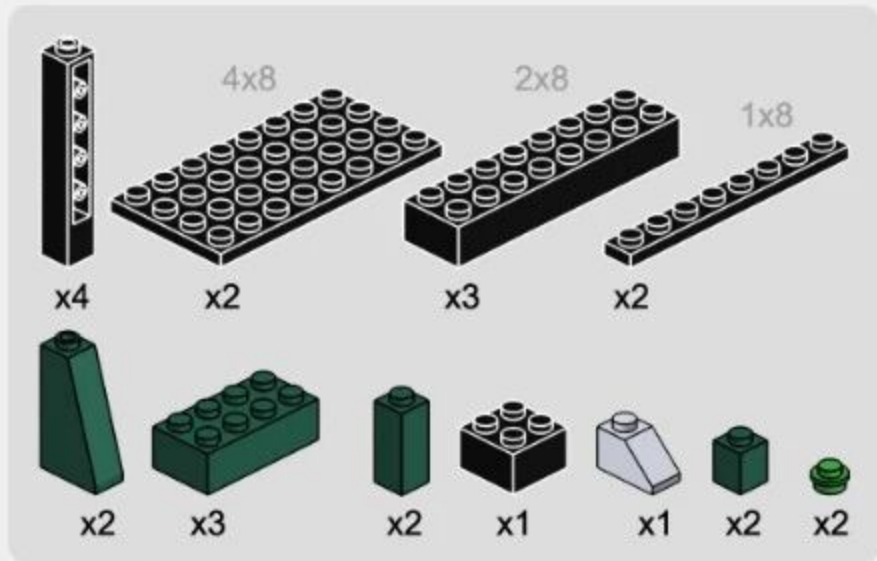

4-8

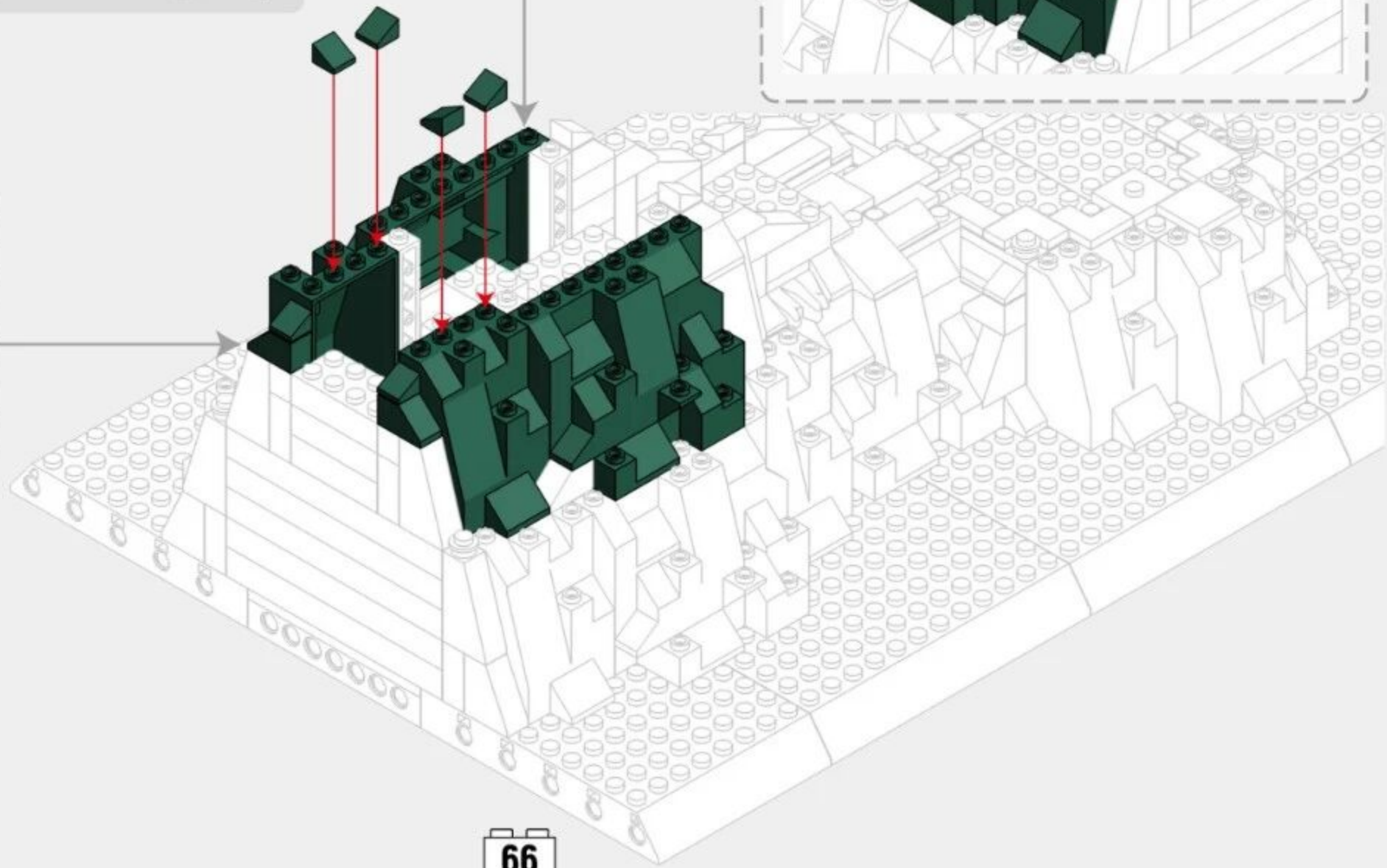
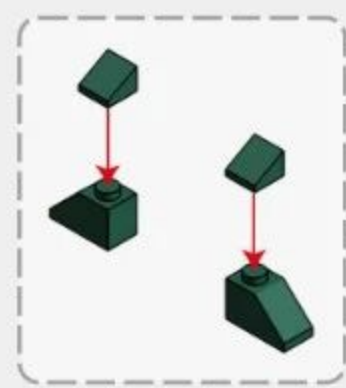
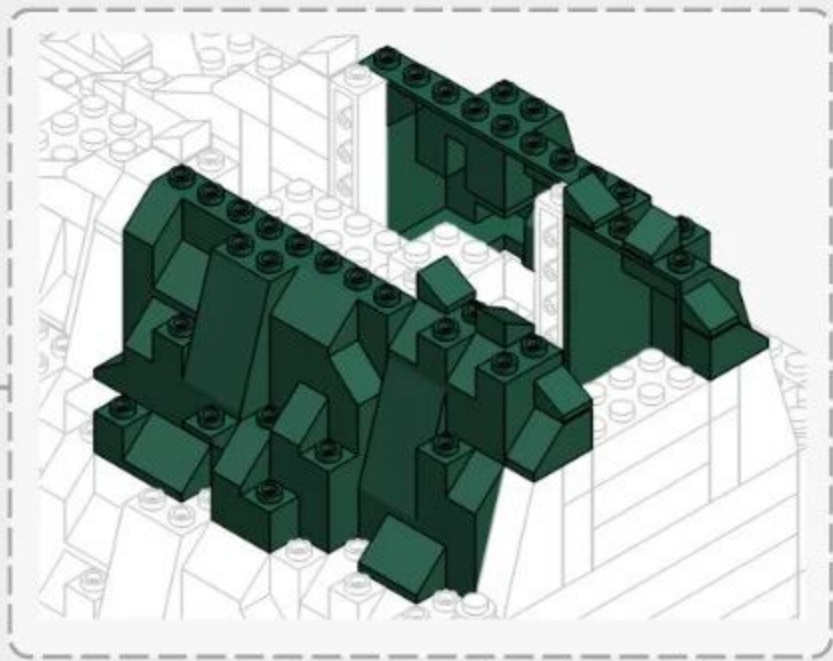
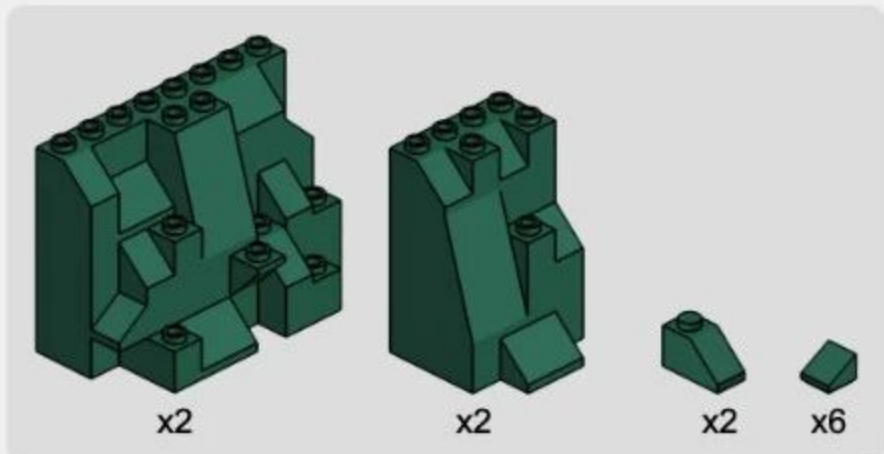



196PCS

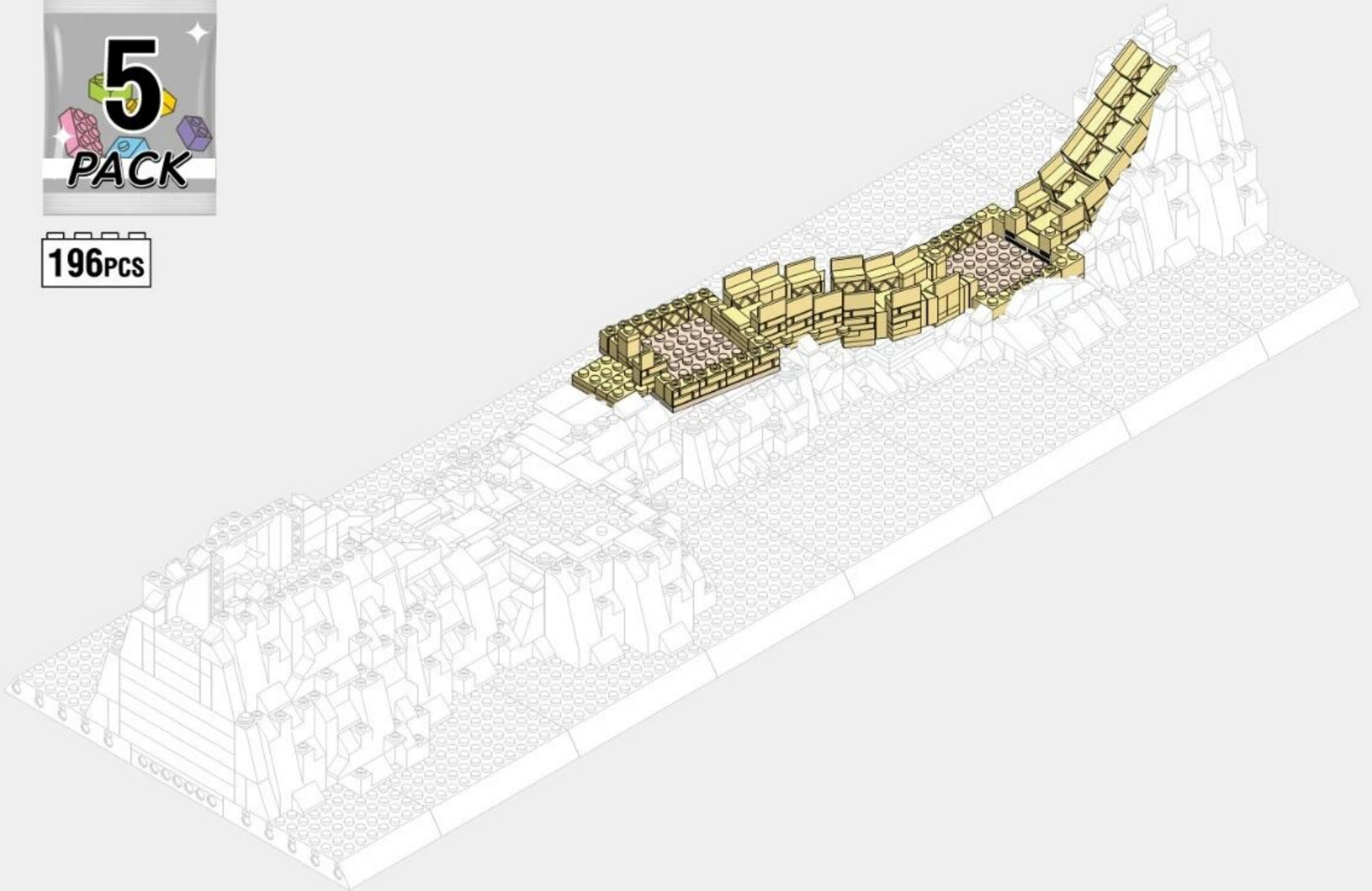

67

5-1

- 4x4
- x3
 - x3
 - x1
 - x4
 - x2
 - x10
 - x10
 - x4
 - x4
 - x5
 - x4
 - x4

1

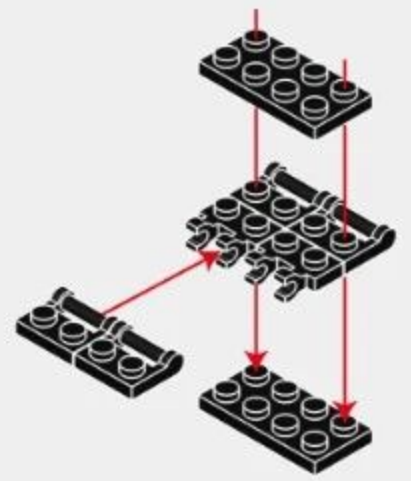

2

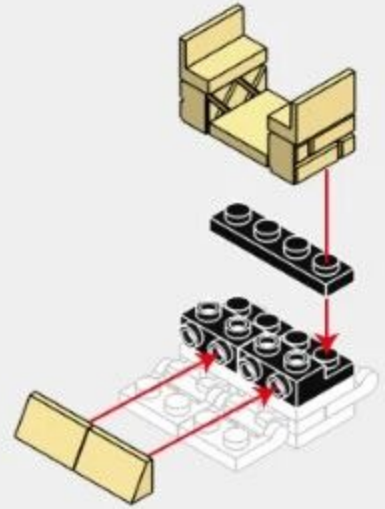

3

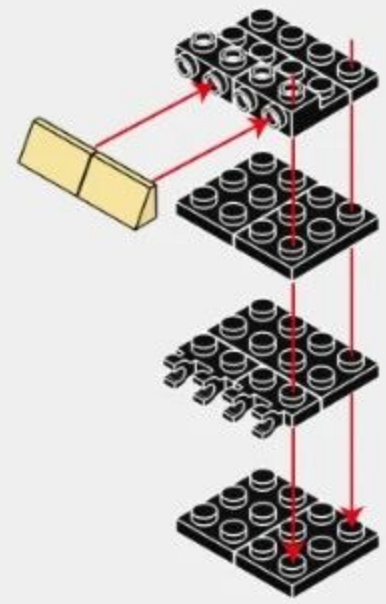

4

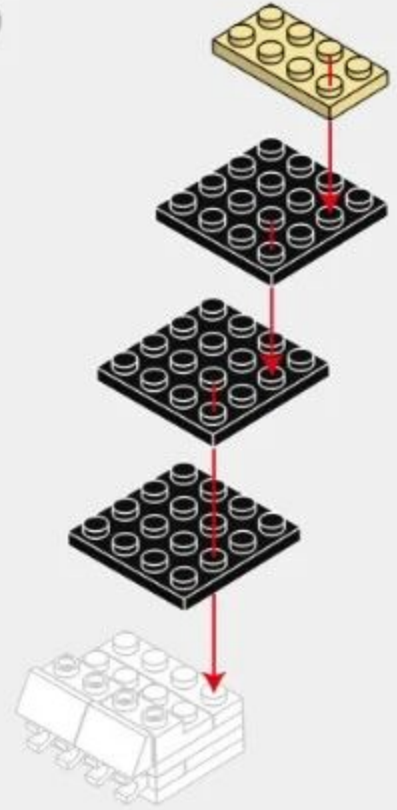

5

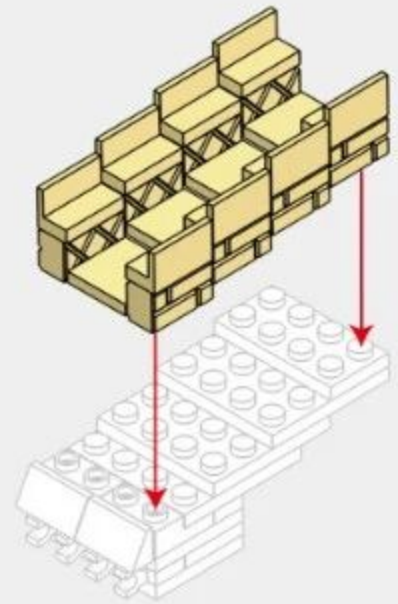

6

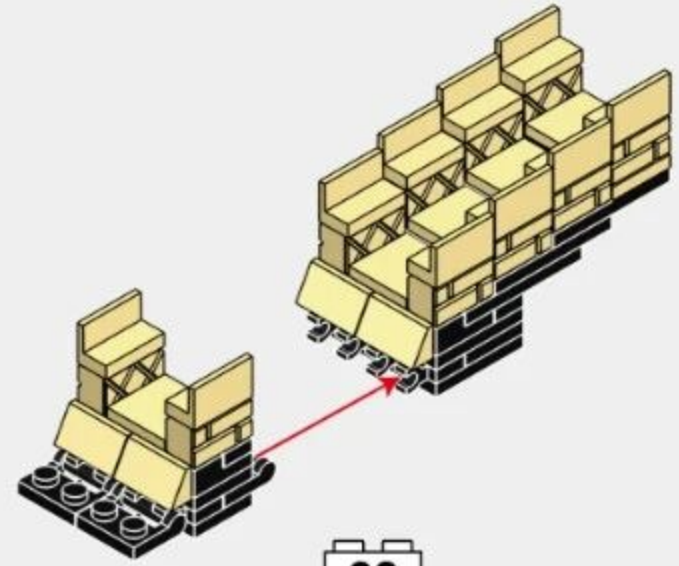

7

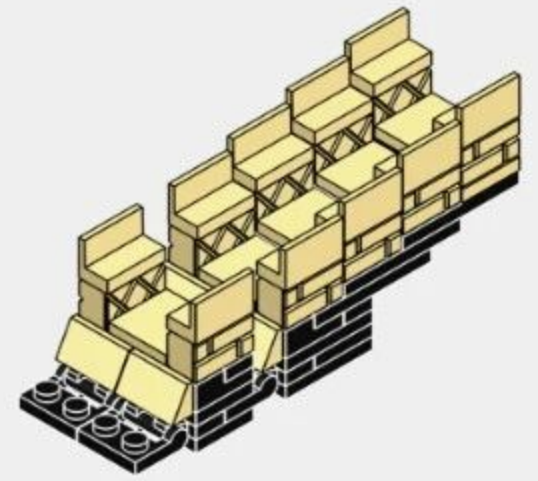

5-2

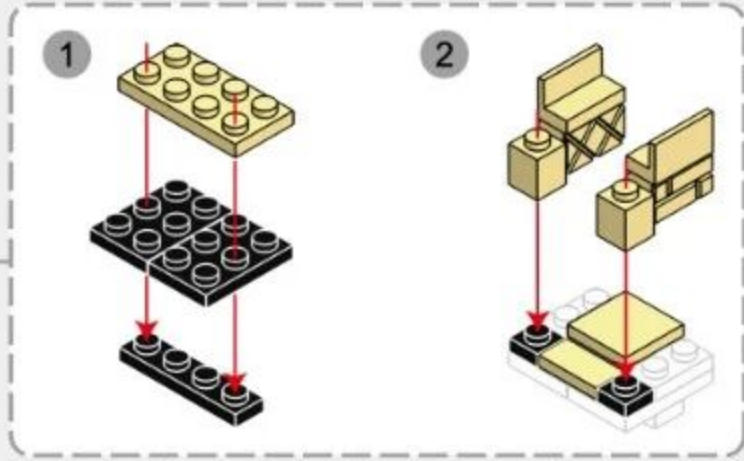
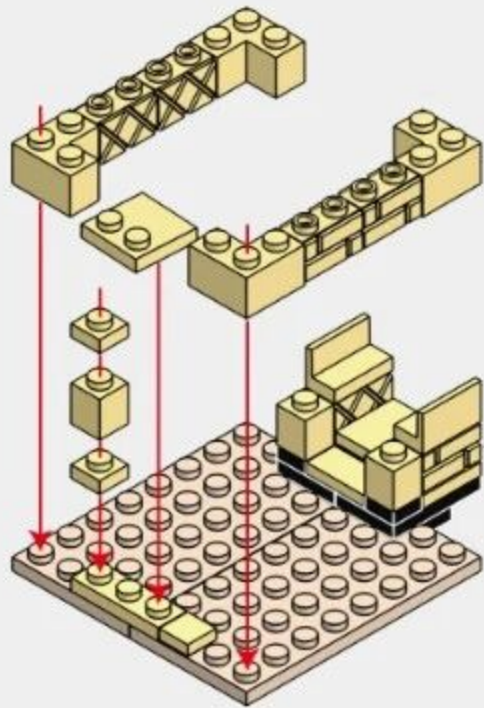
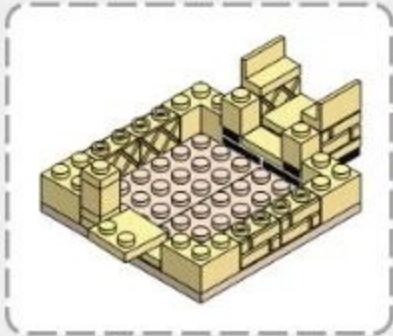
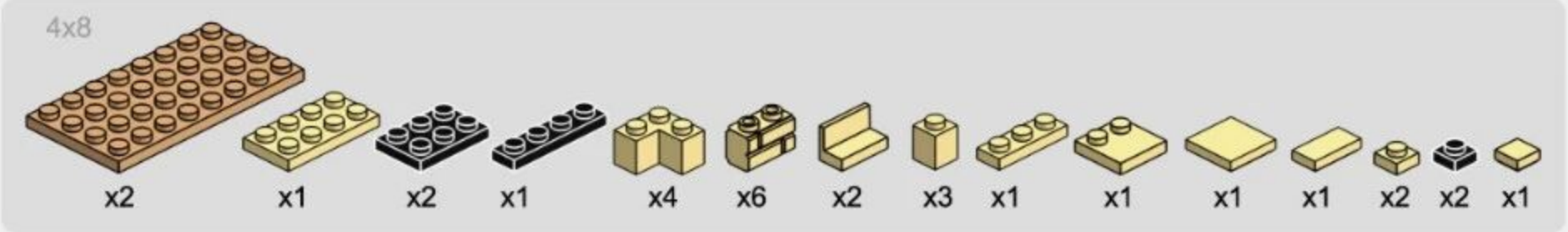

5-3

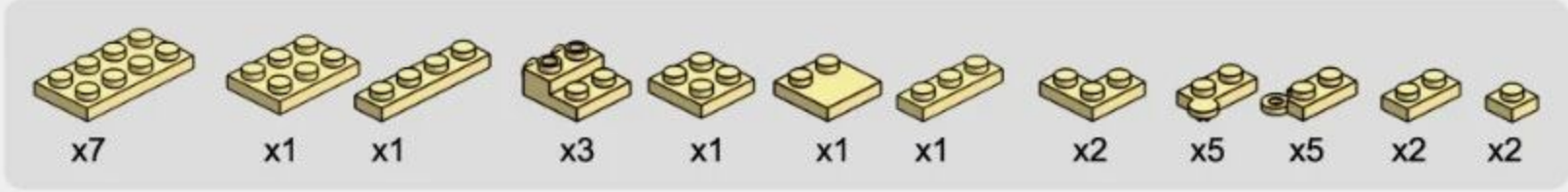

1

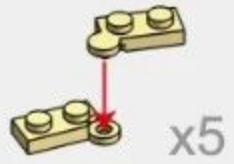

2

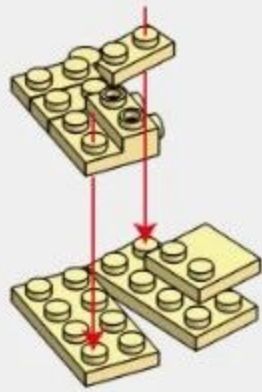

3

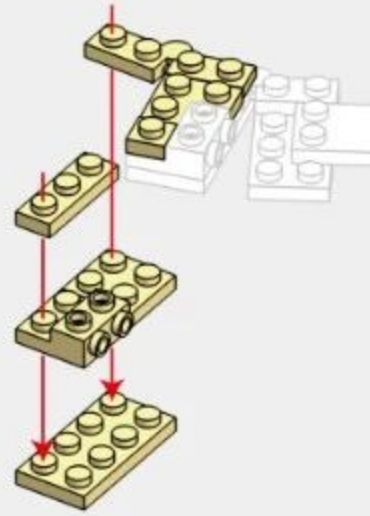

4

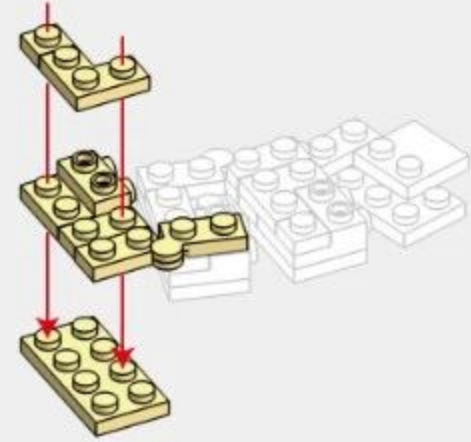

5

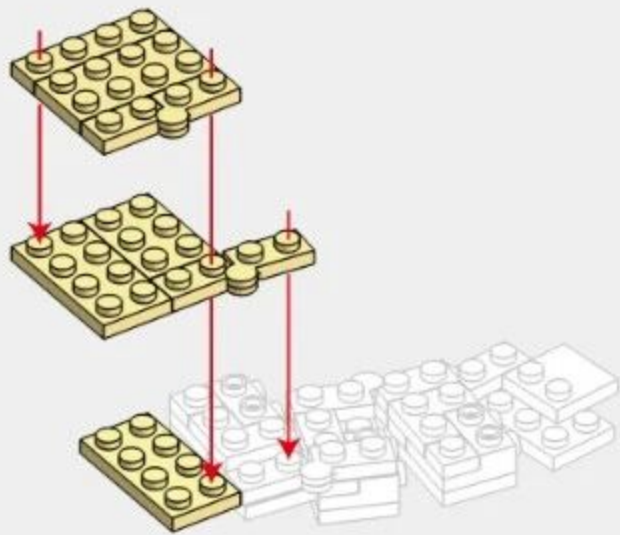

6



5-6

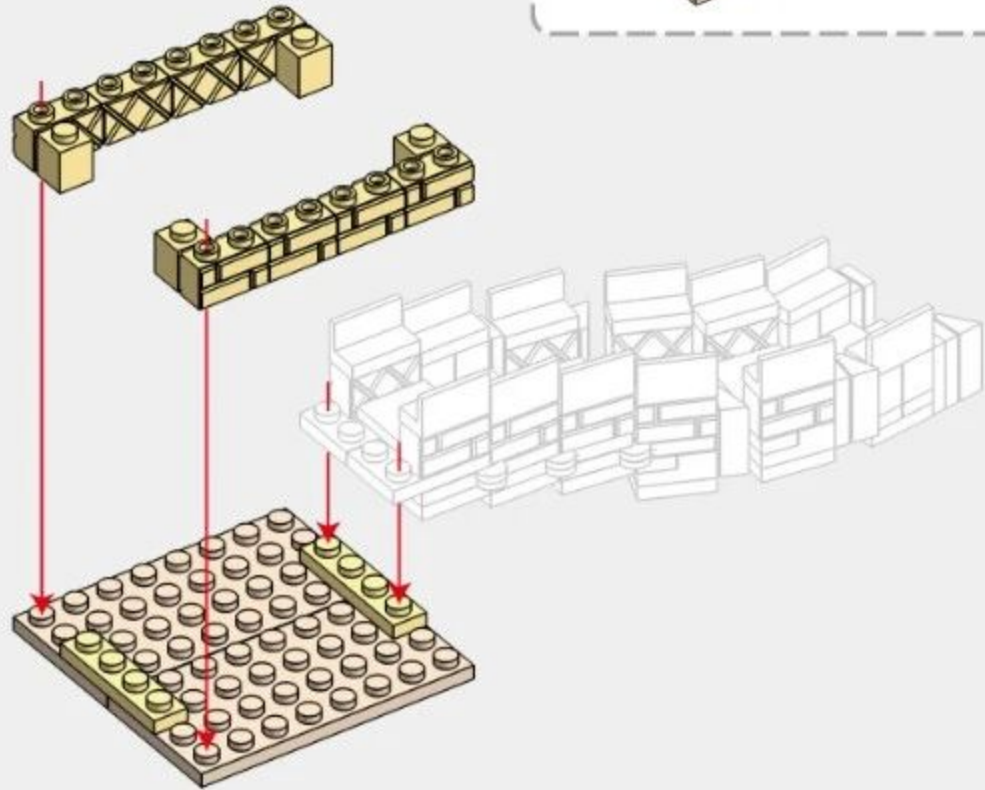
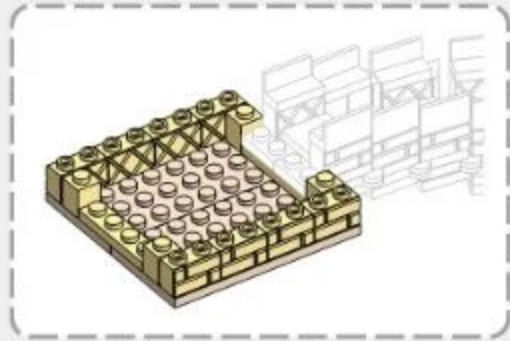
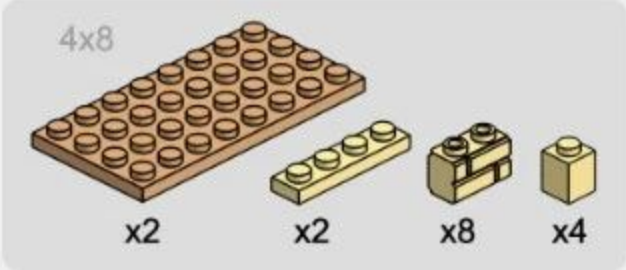

5-7

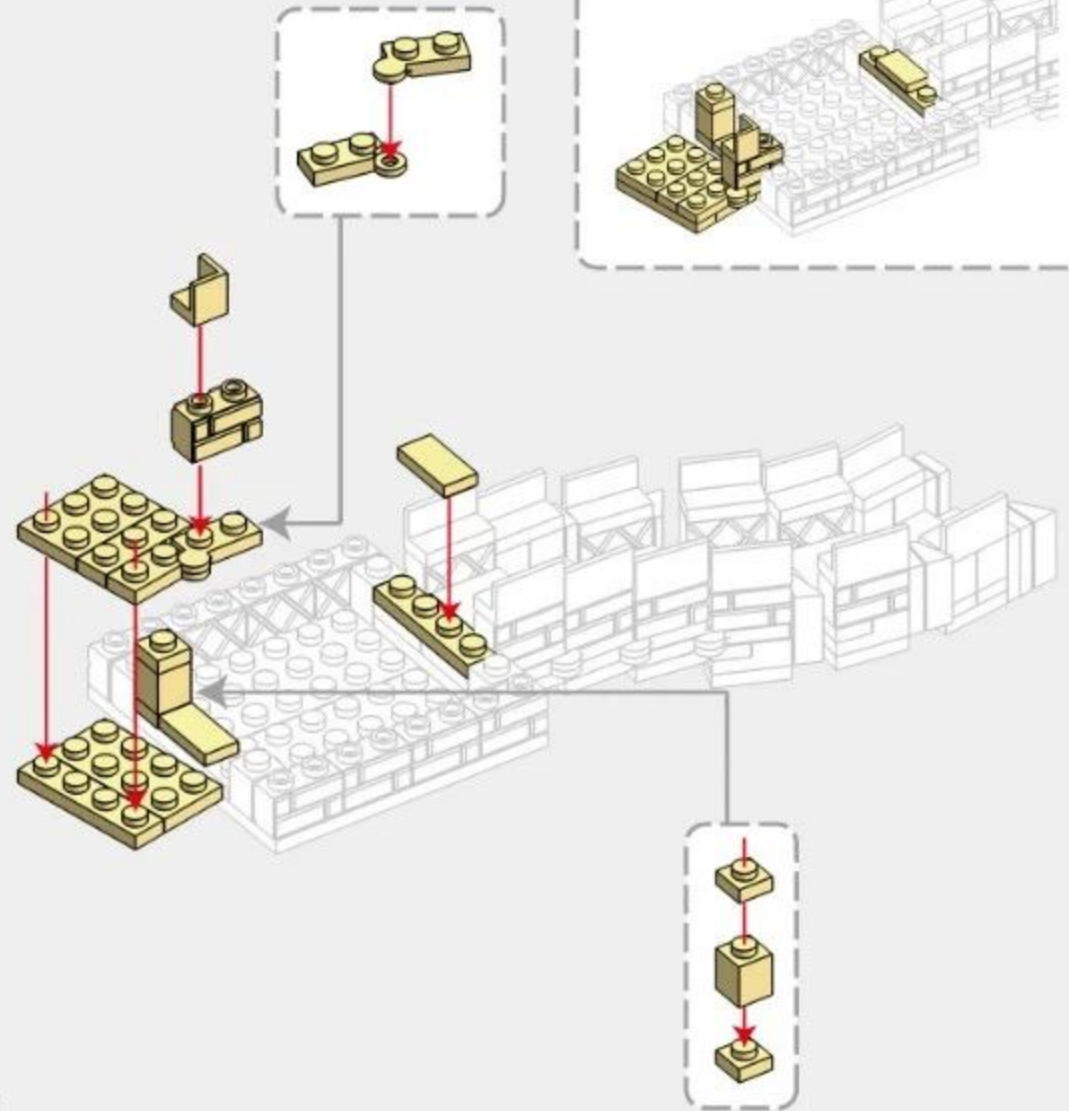
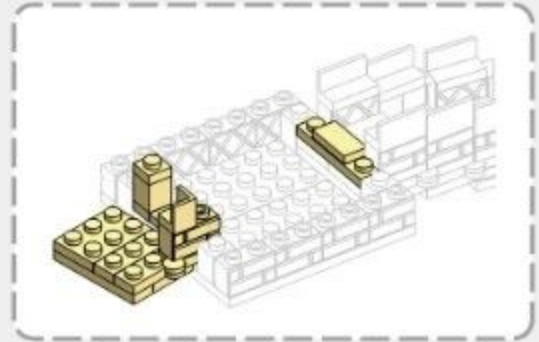
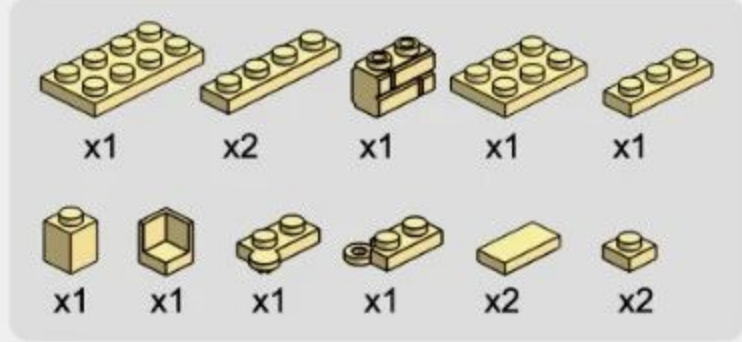

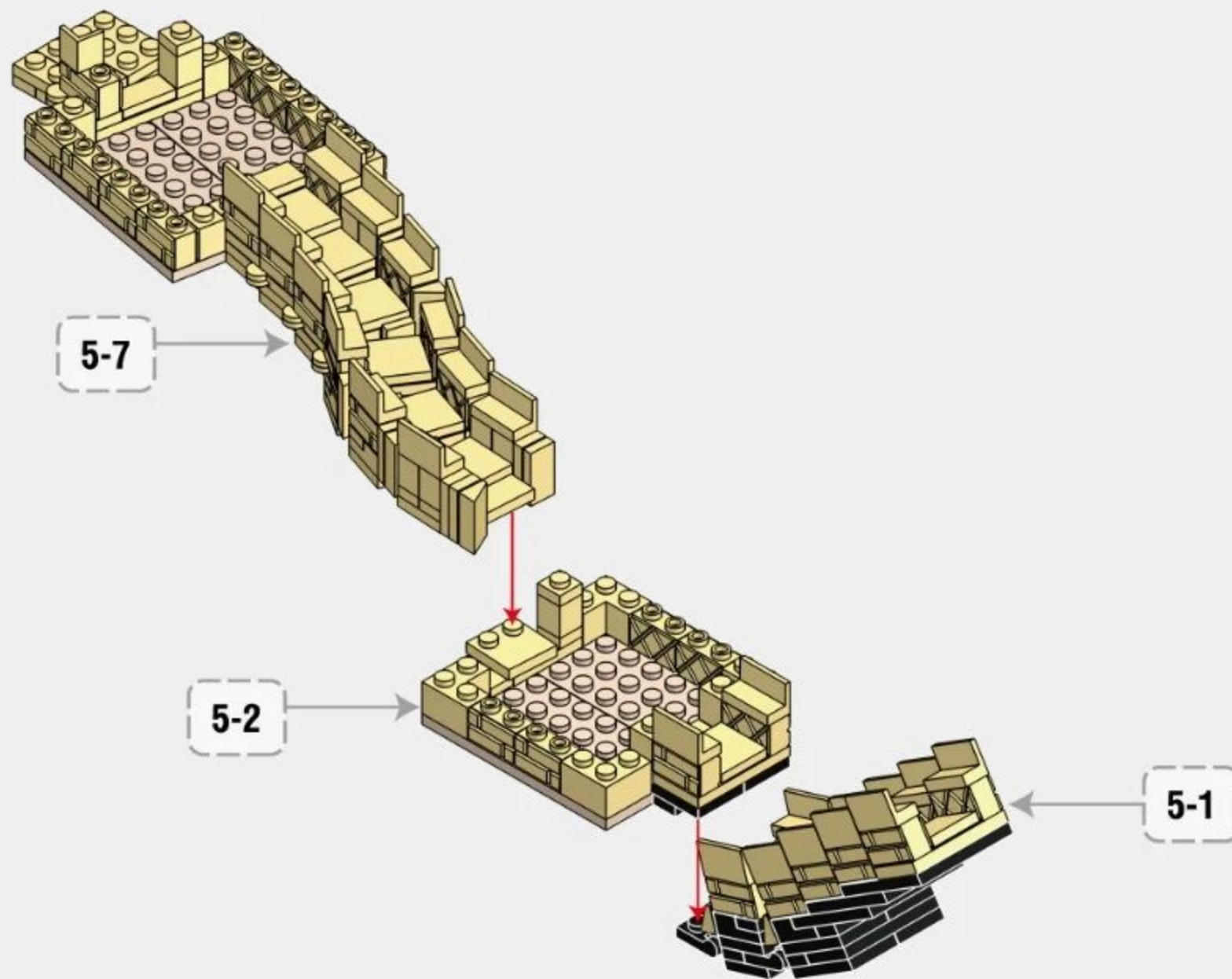

5-8

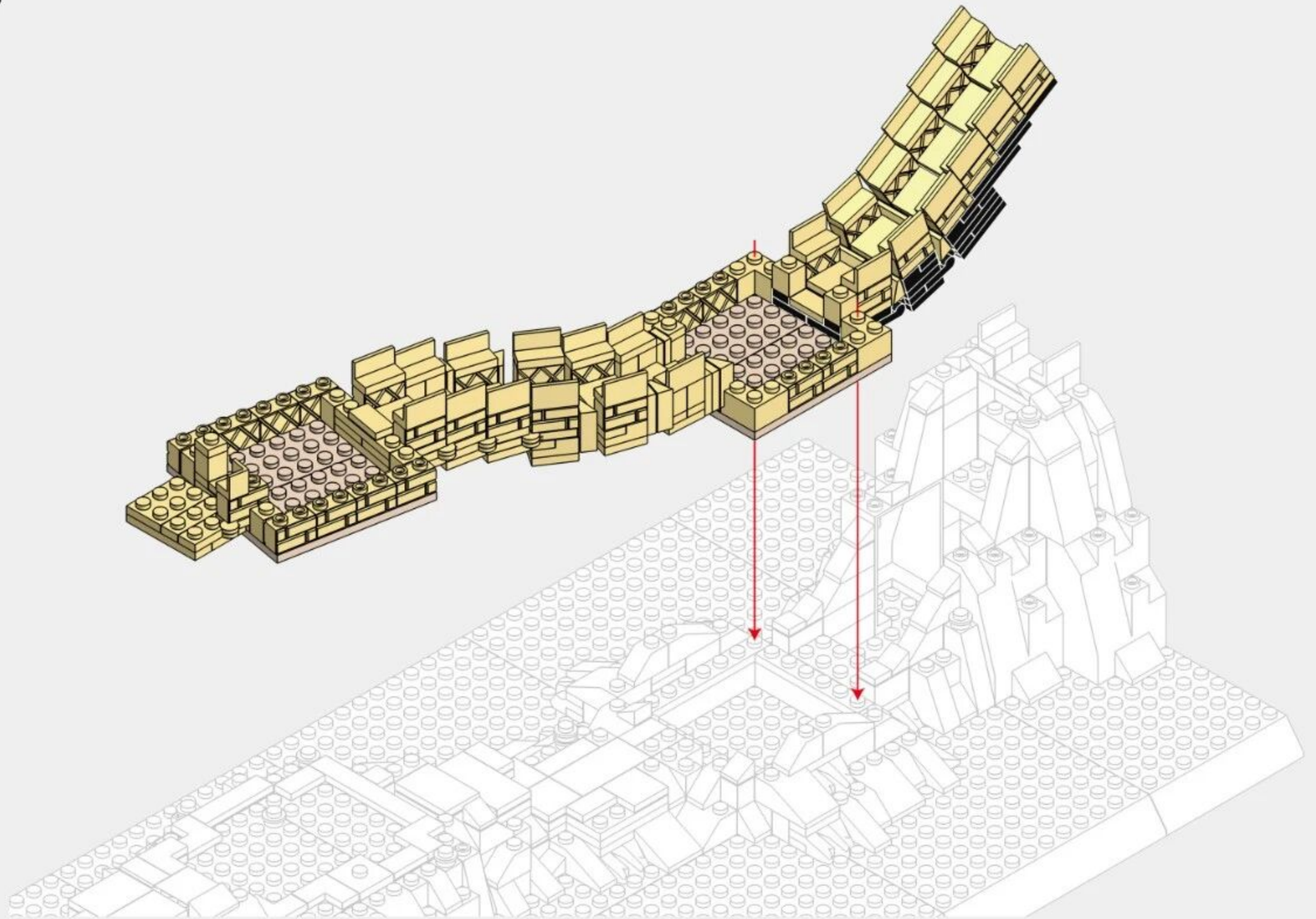



169PCS

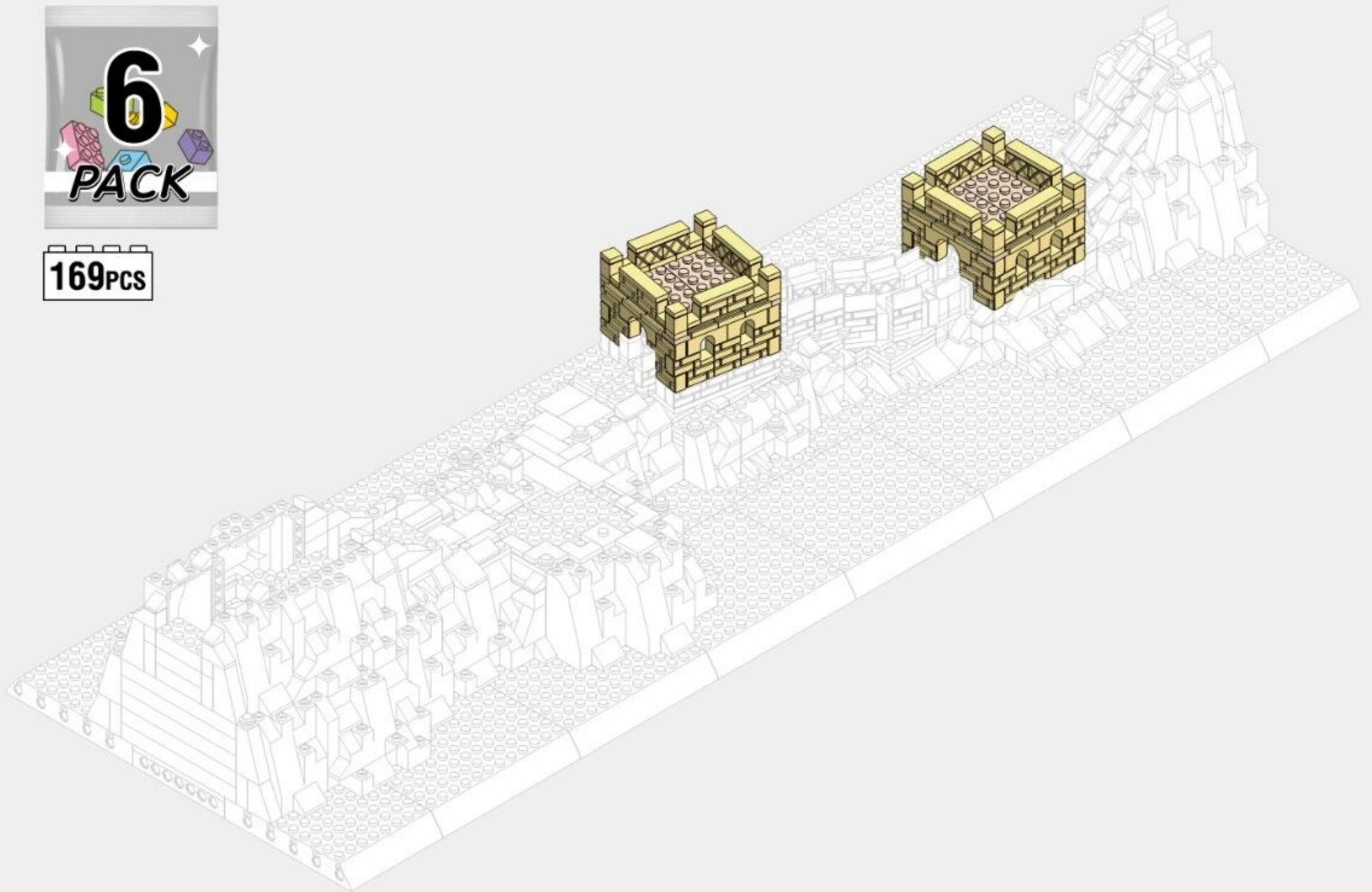

75

6-1

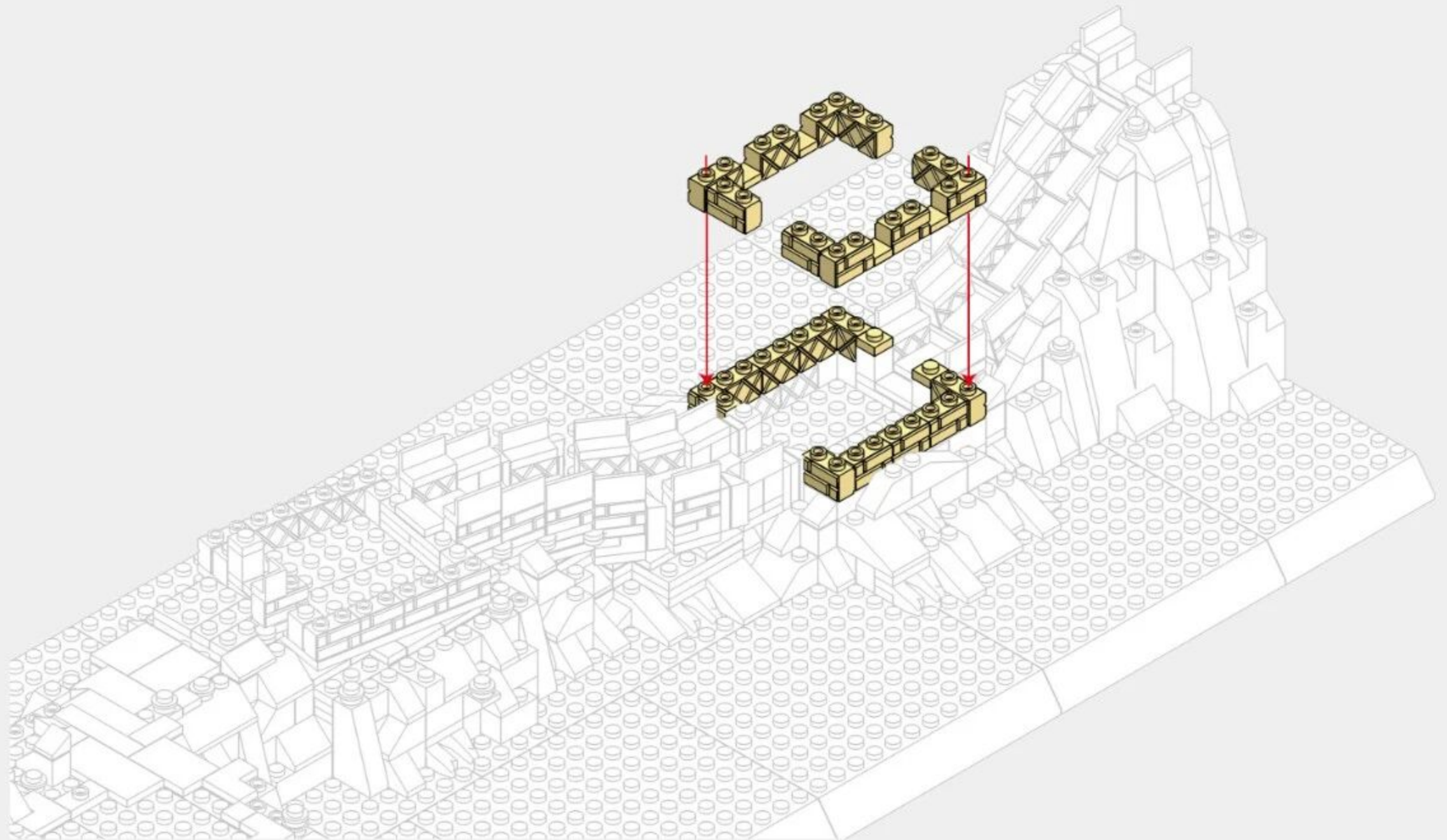

6-2

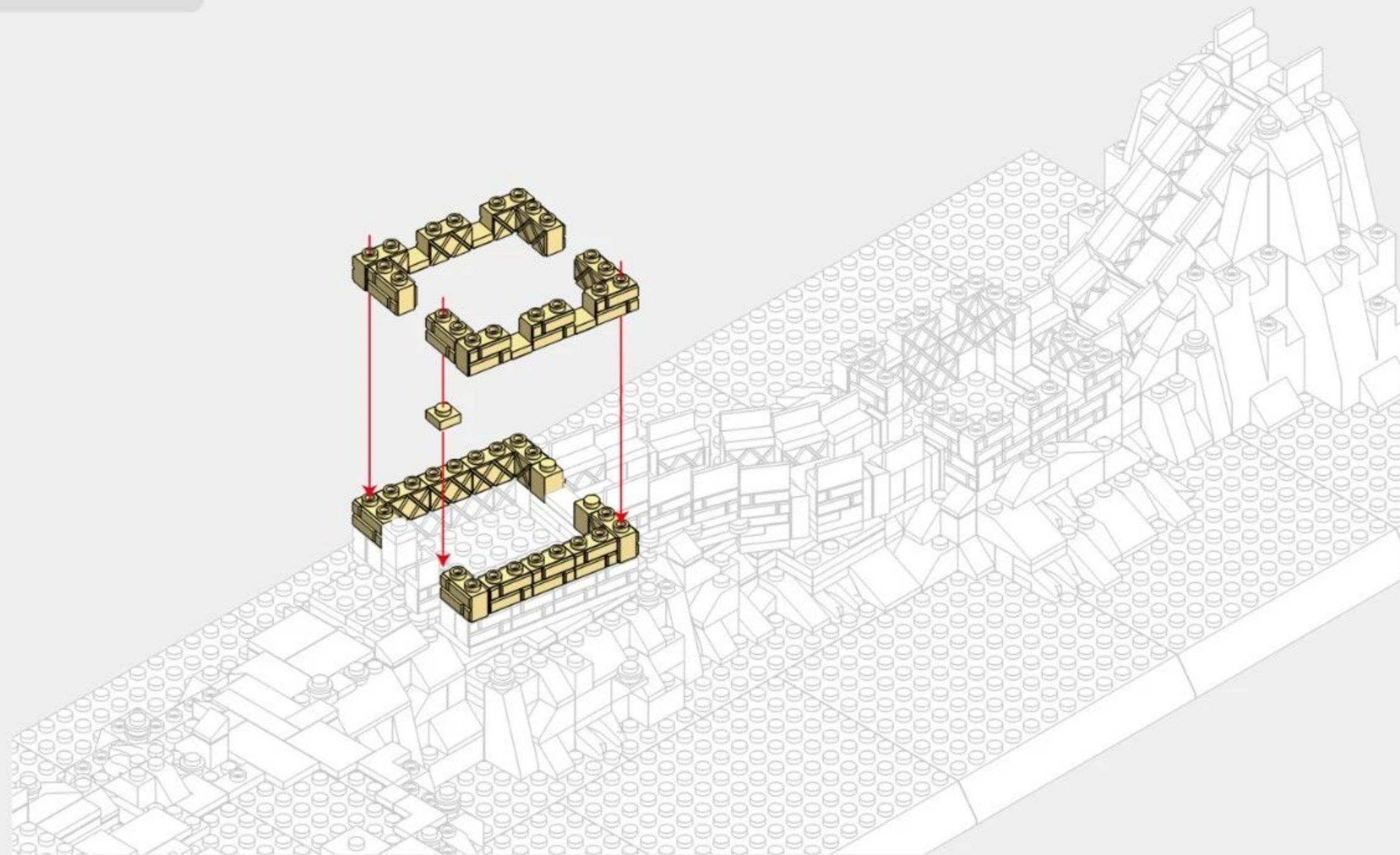

6-3

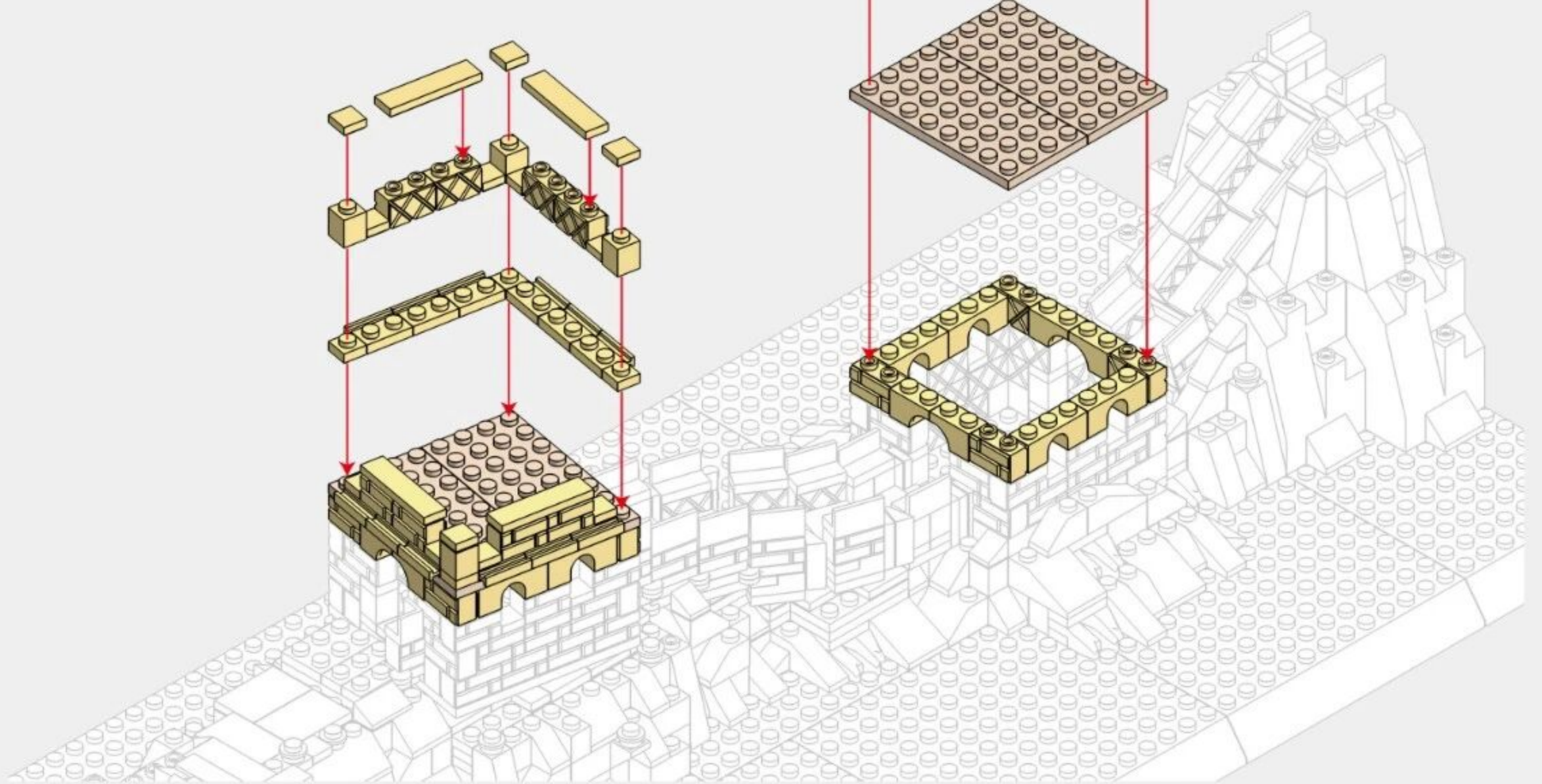
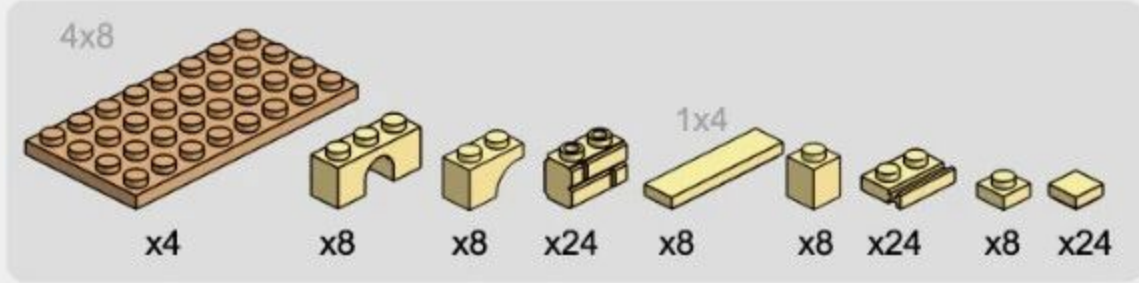



235PCS

7-1



1

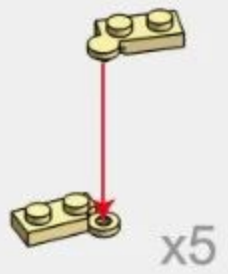

2

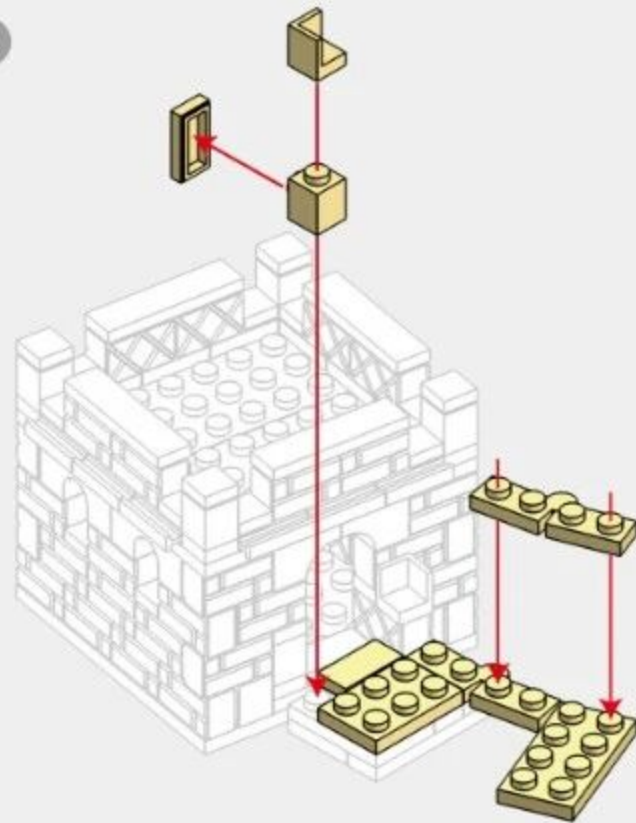

3

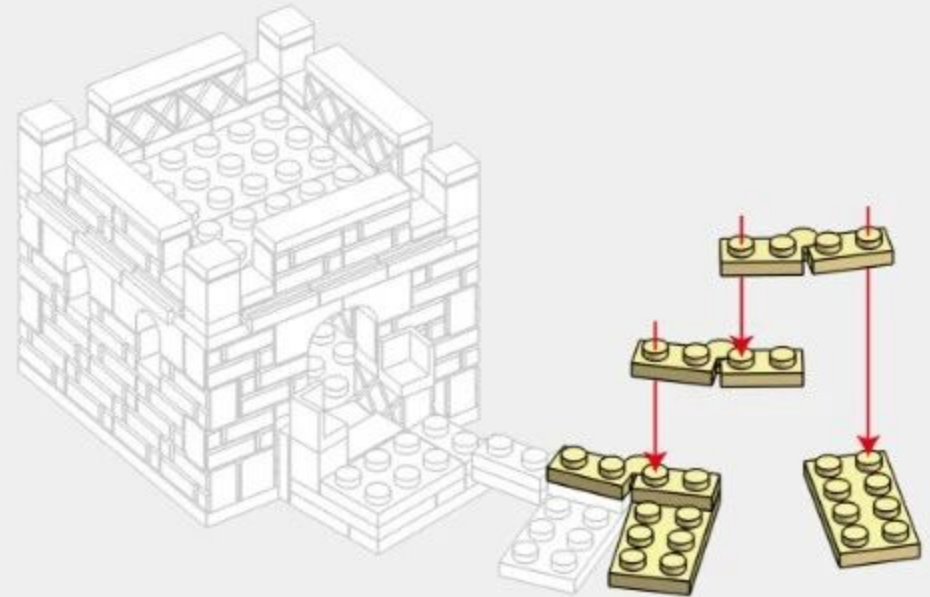

7-2

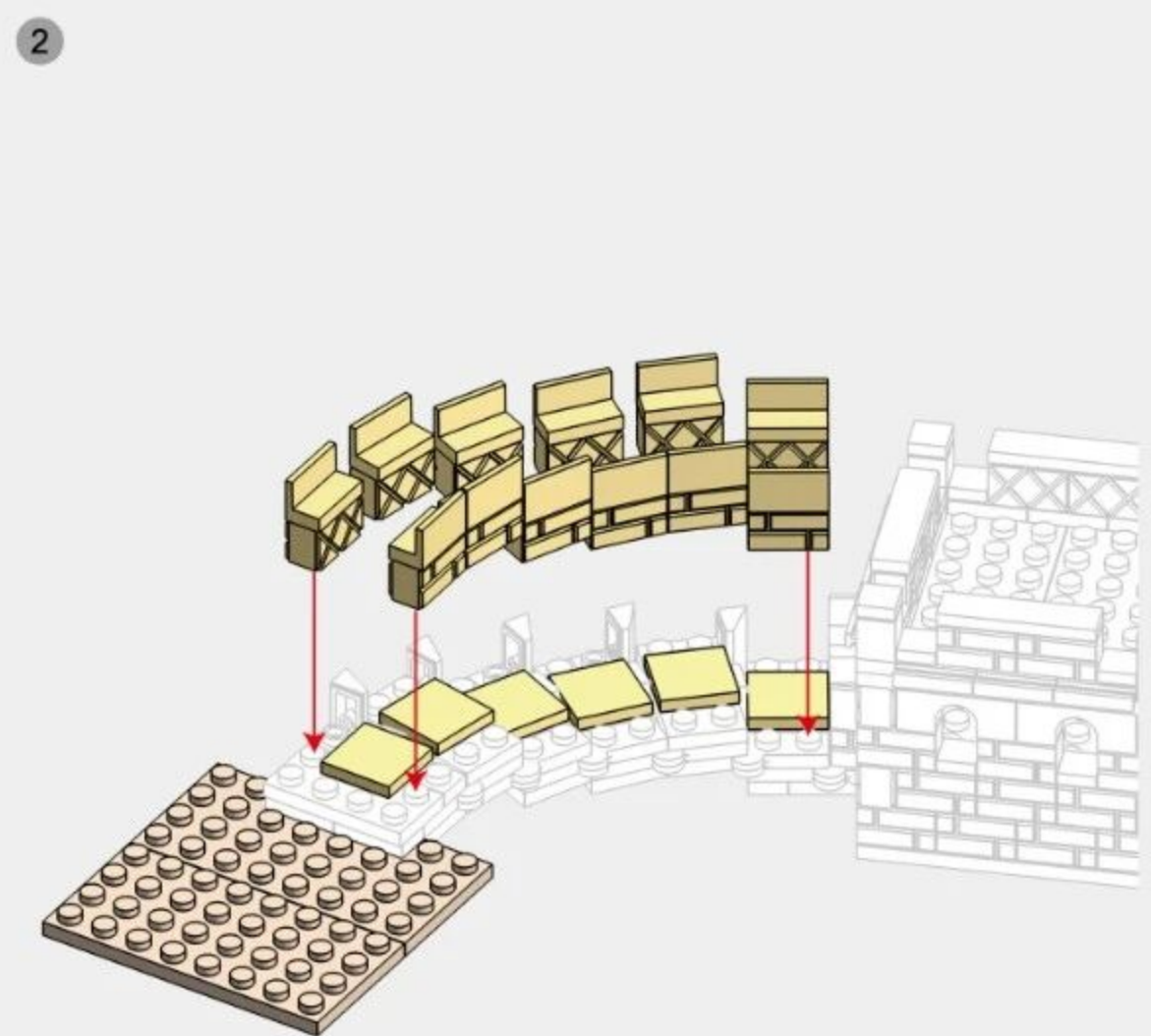
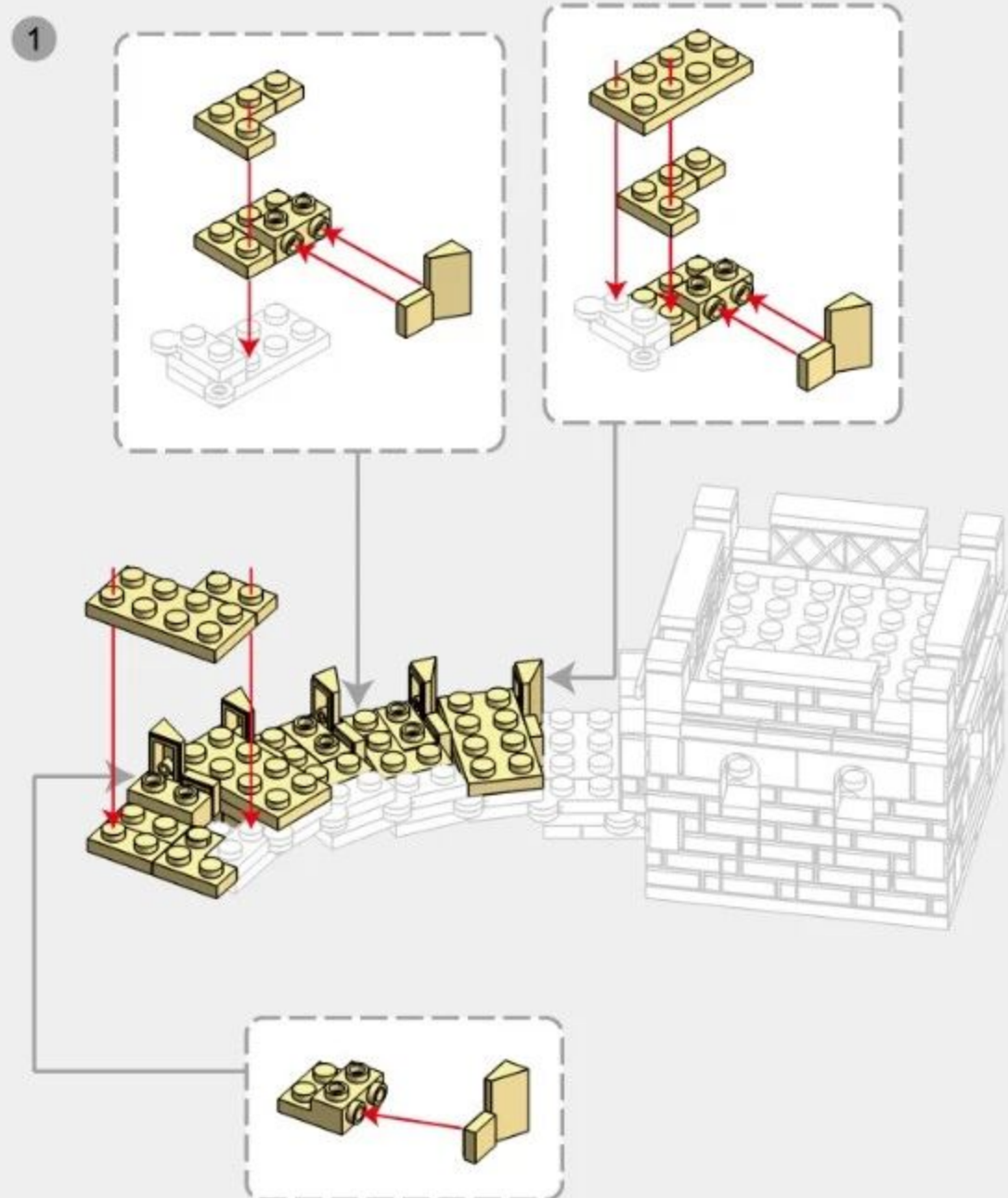

7-3

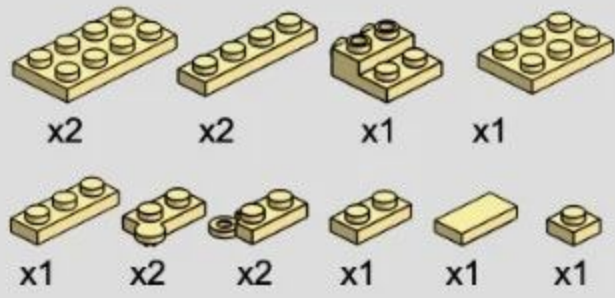

7-4

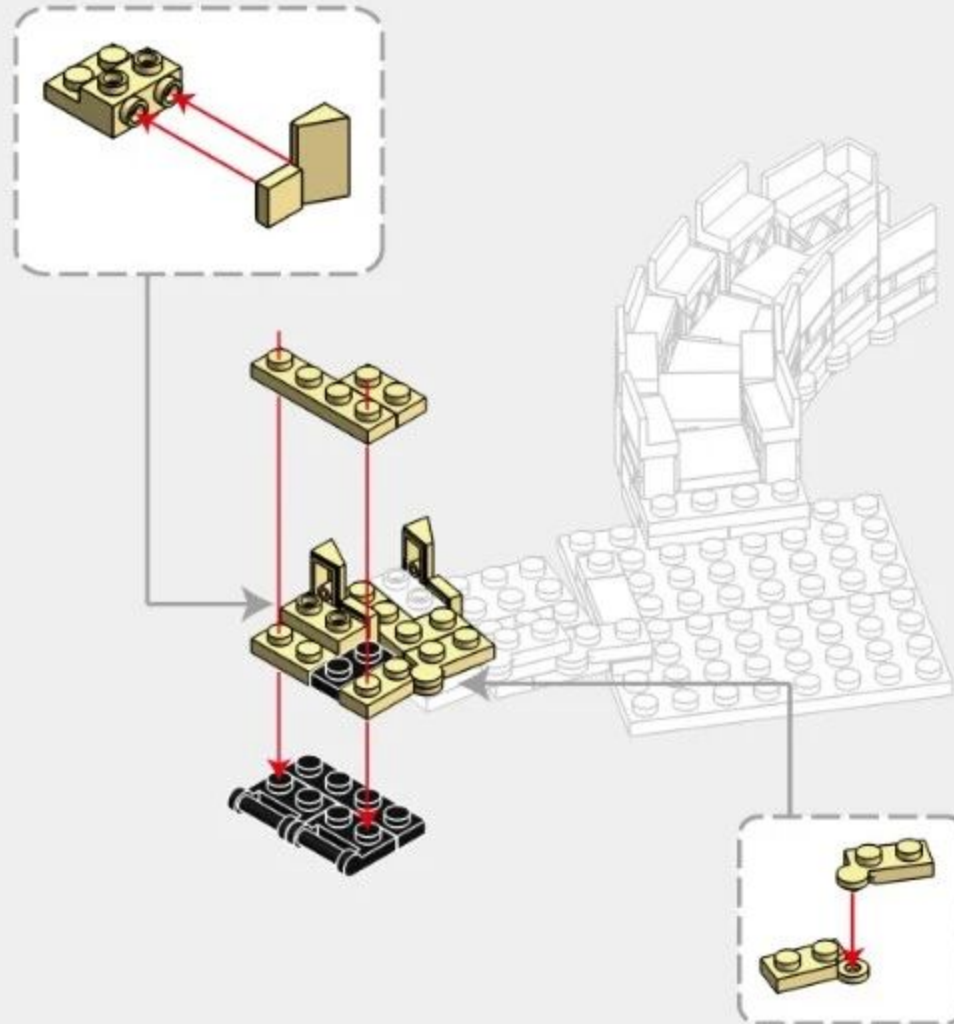
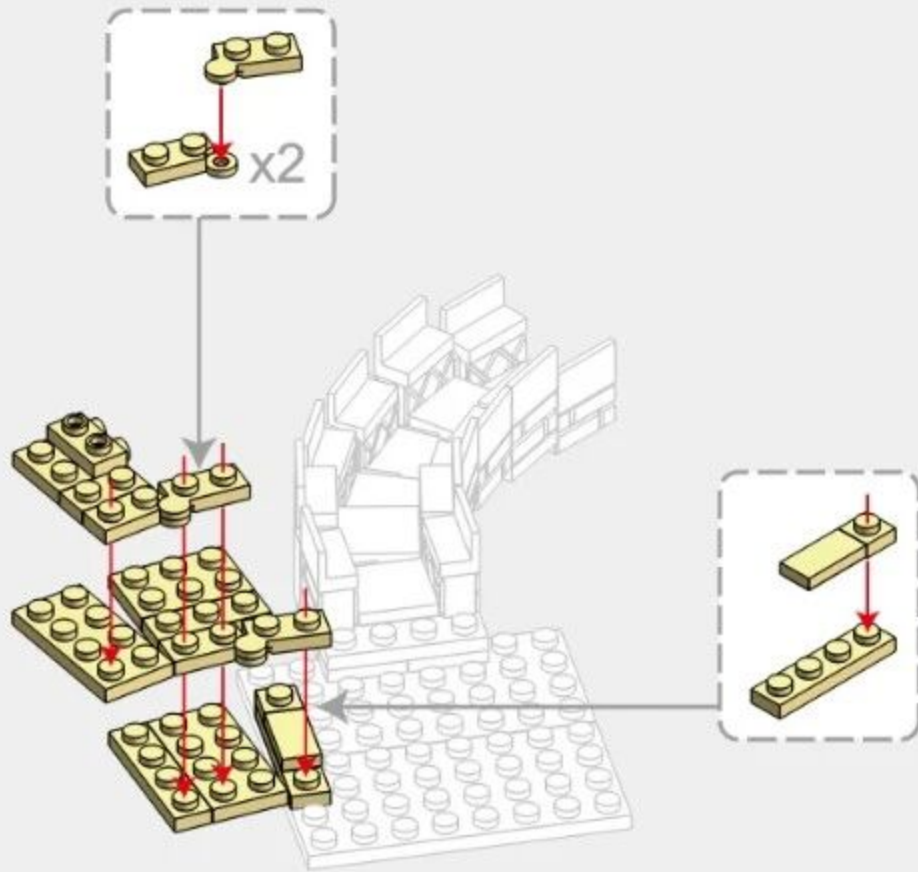
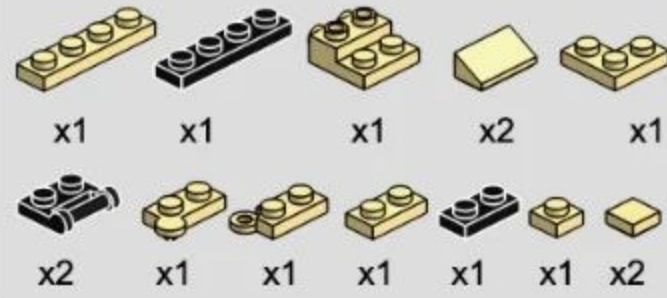

7-5

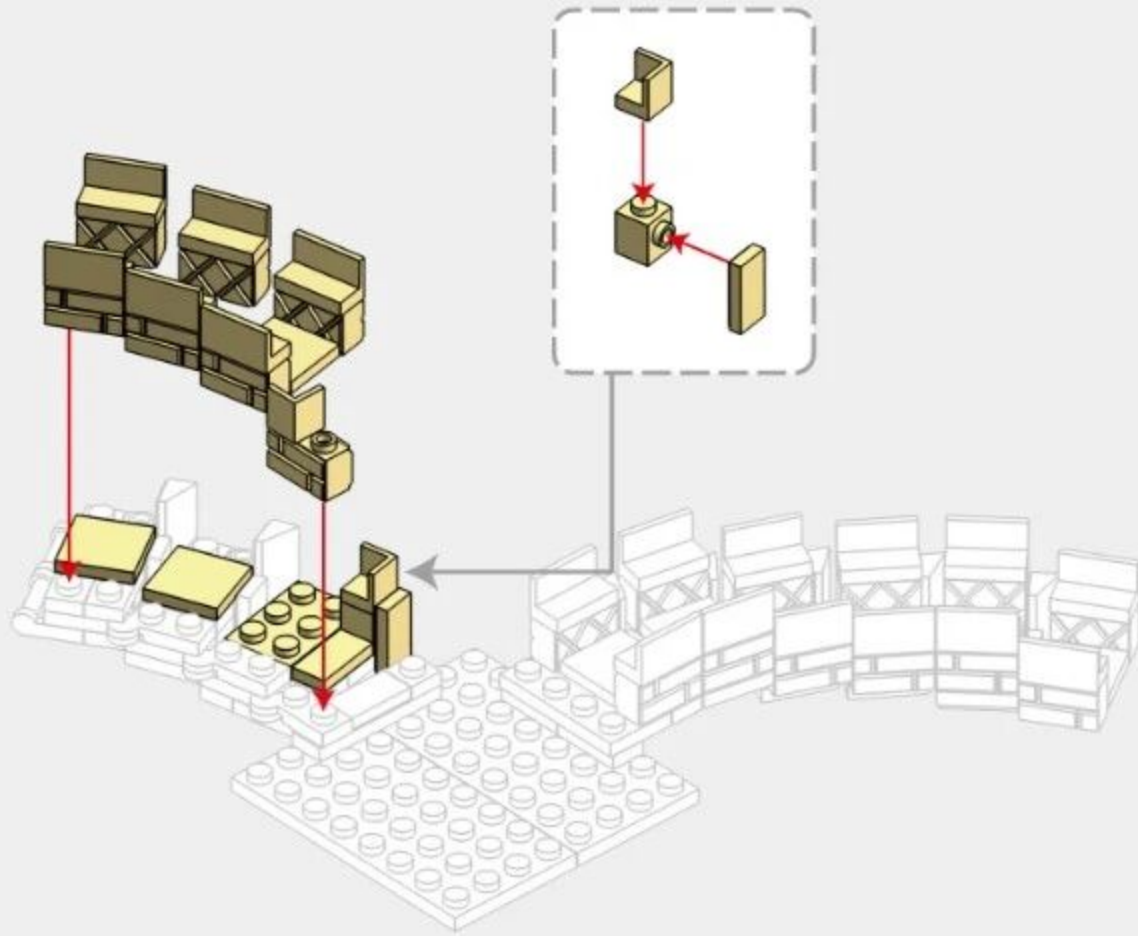
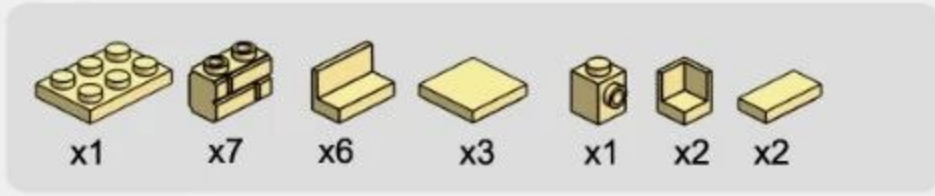

7-6

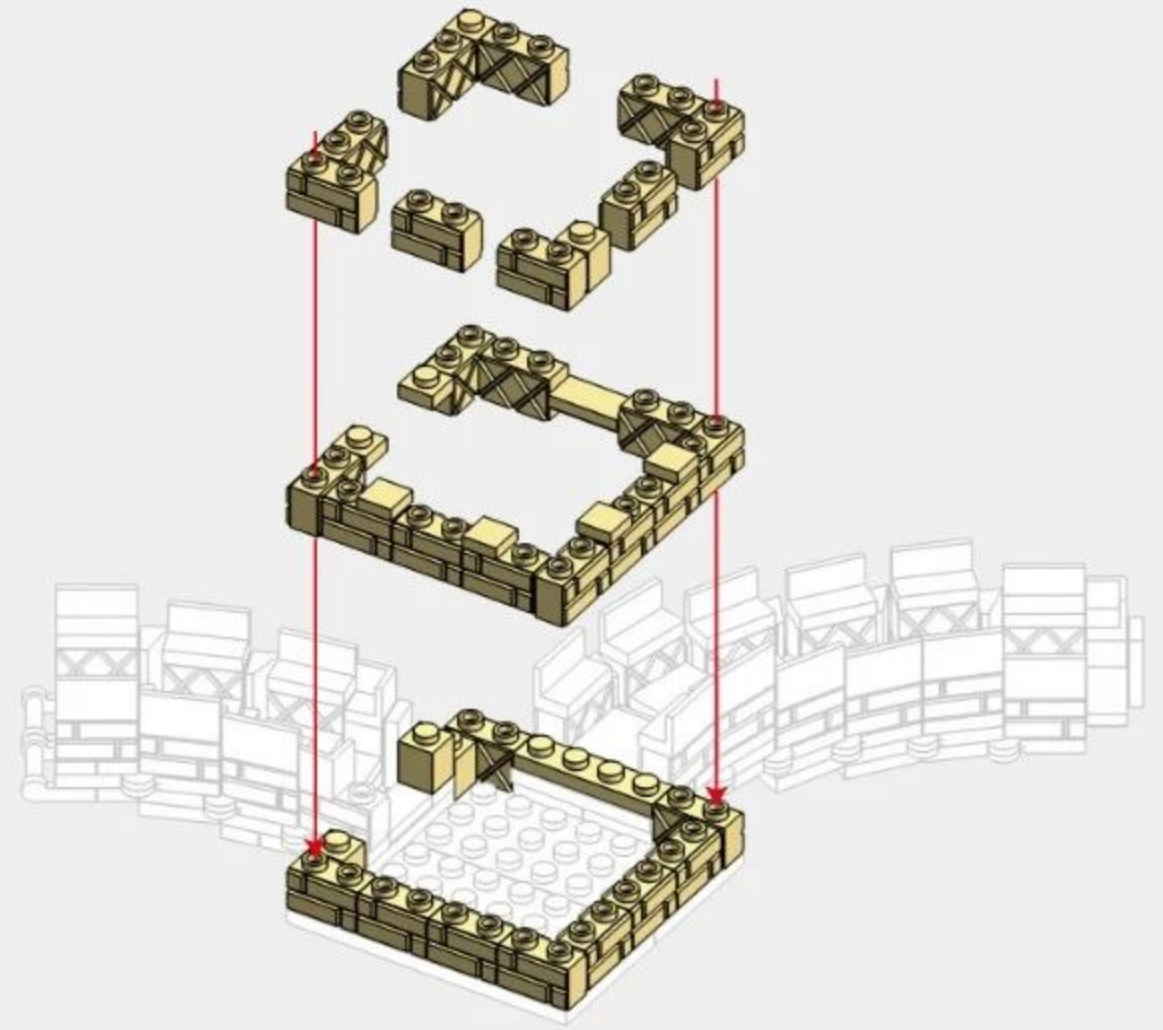



223PCS

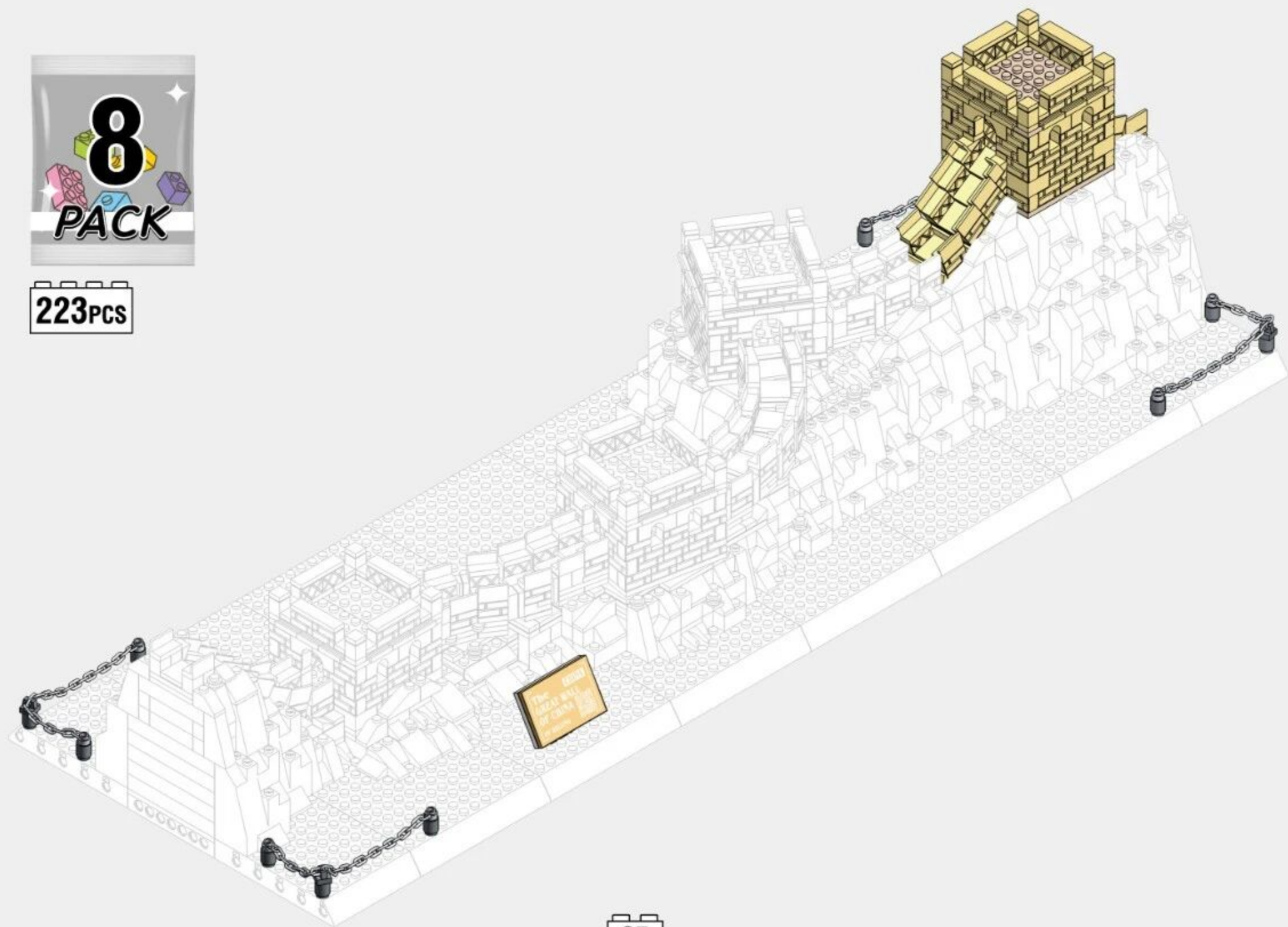

85

8-1

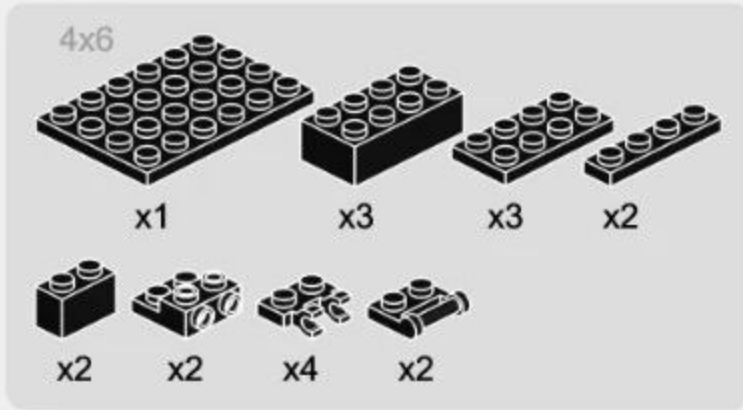

8-2

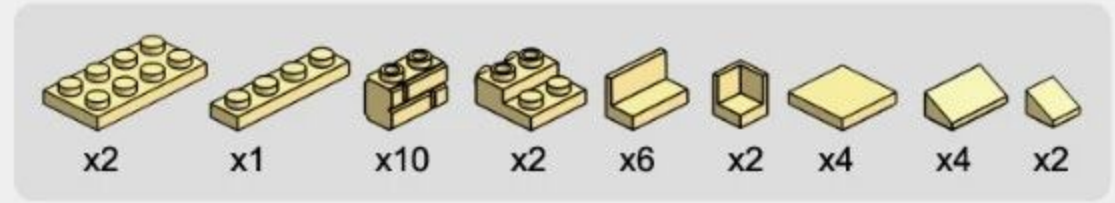

1

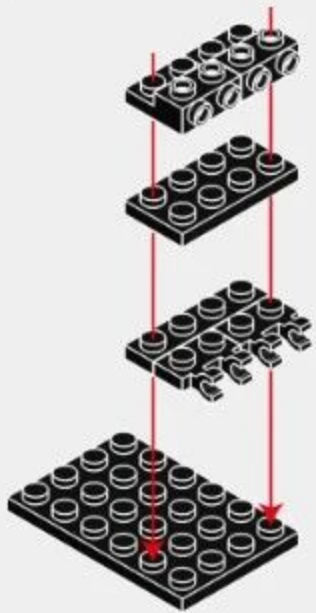

2

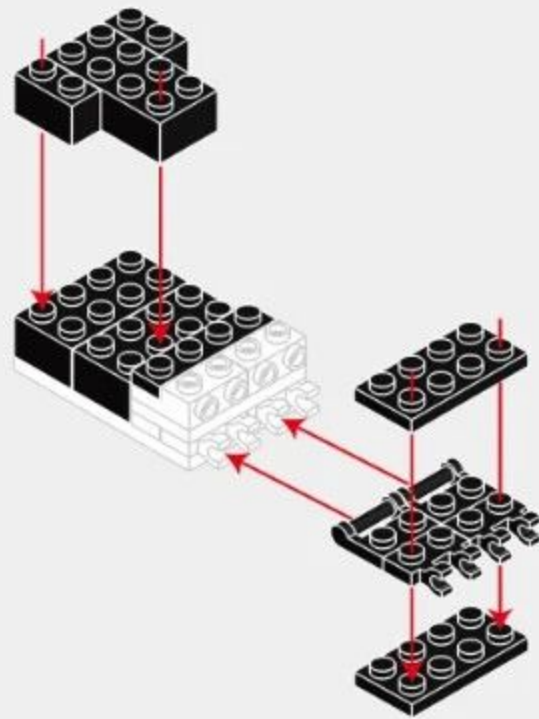

1

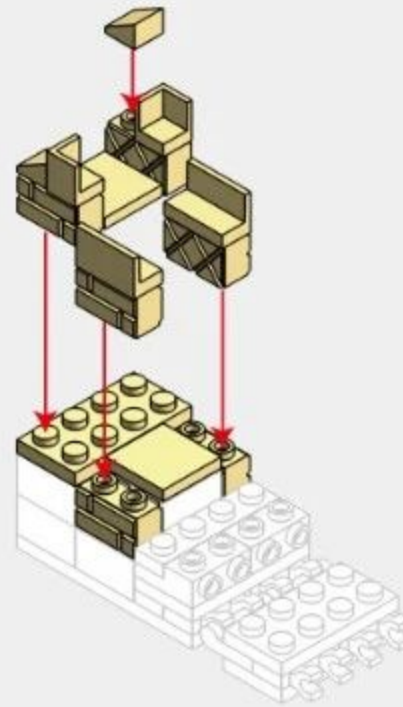

2

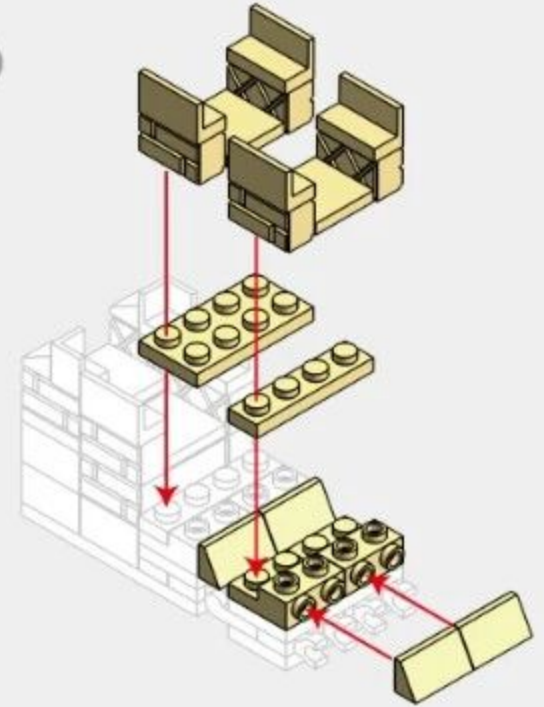

8-3

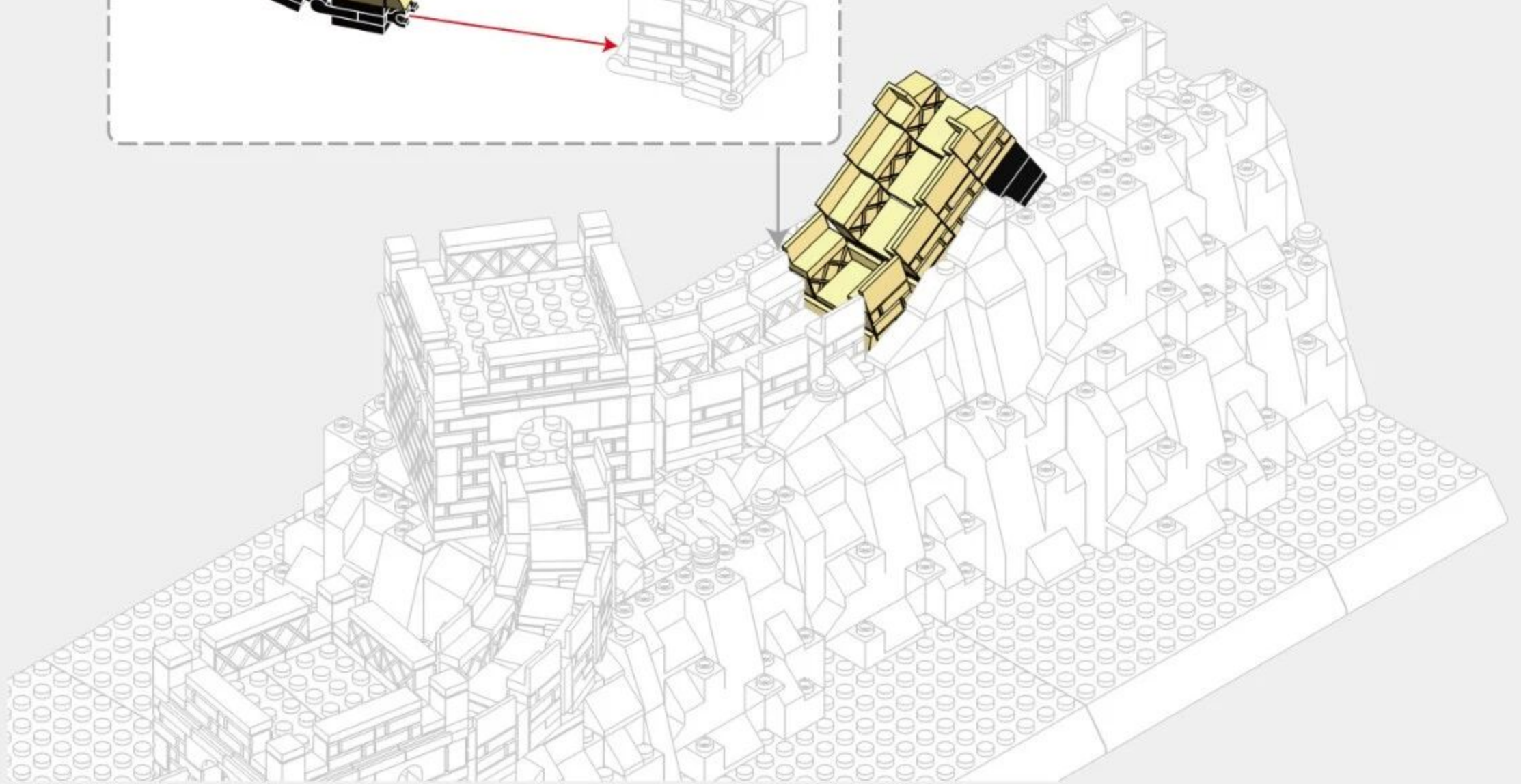
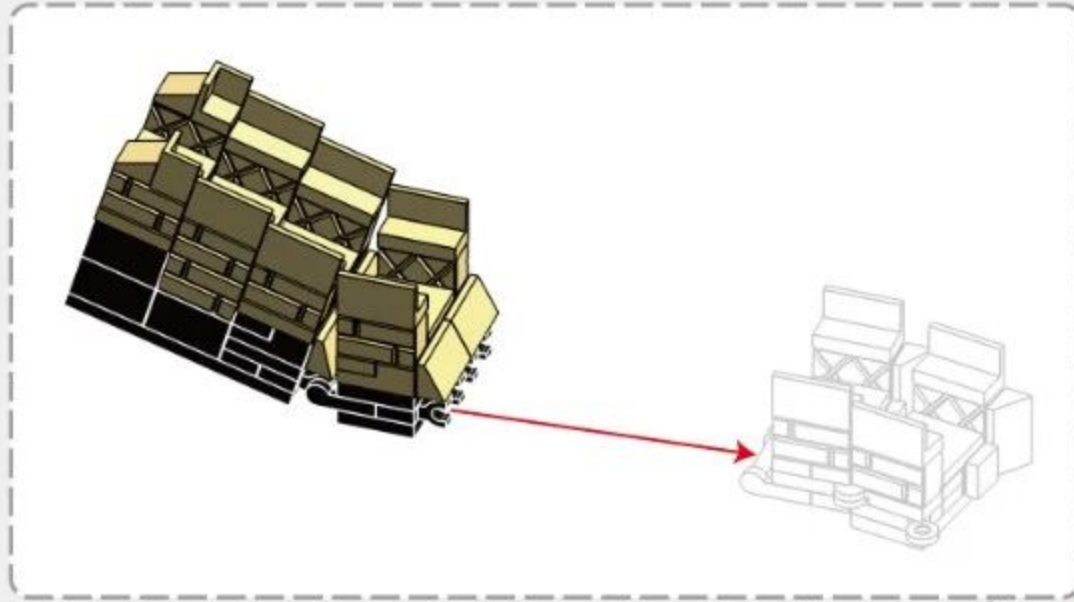

8-4

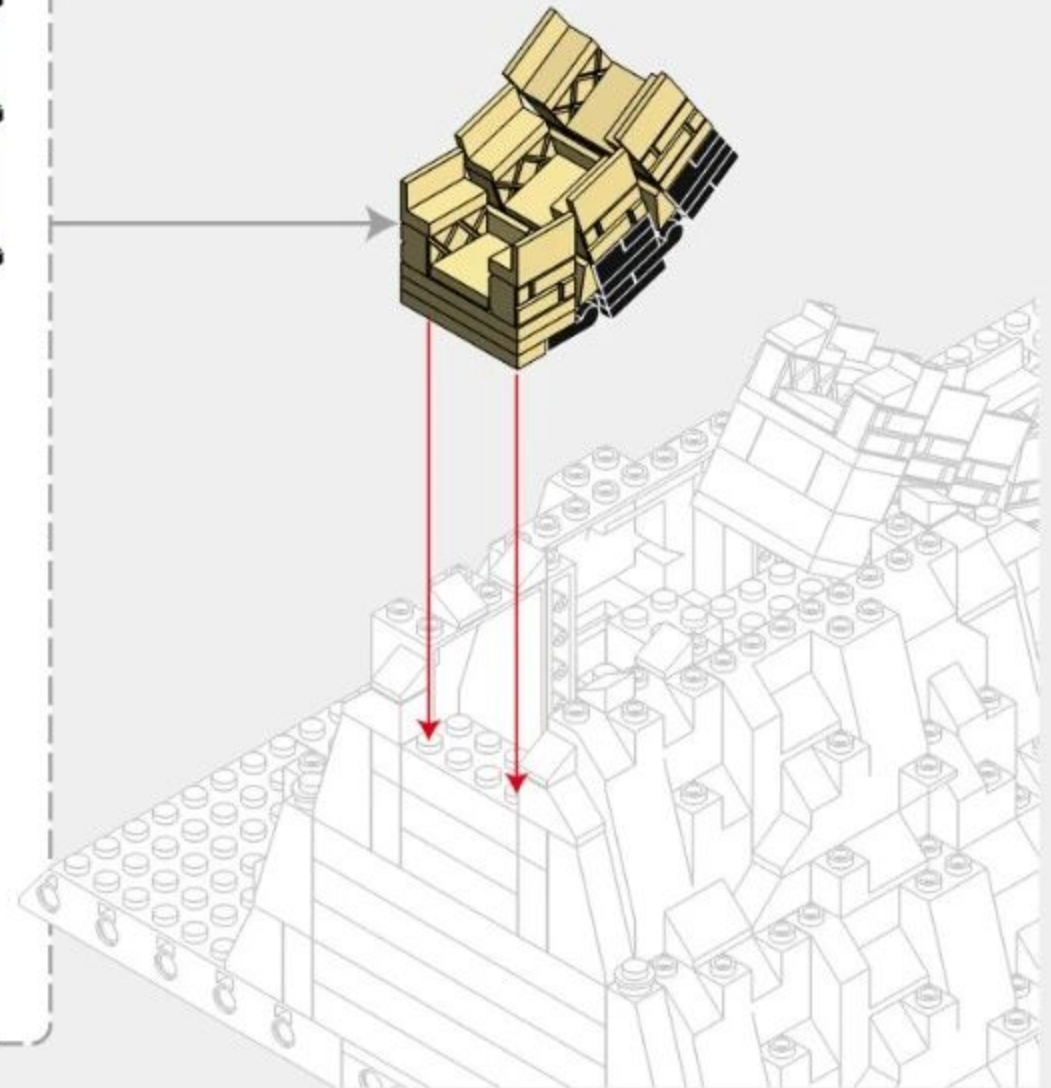
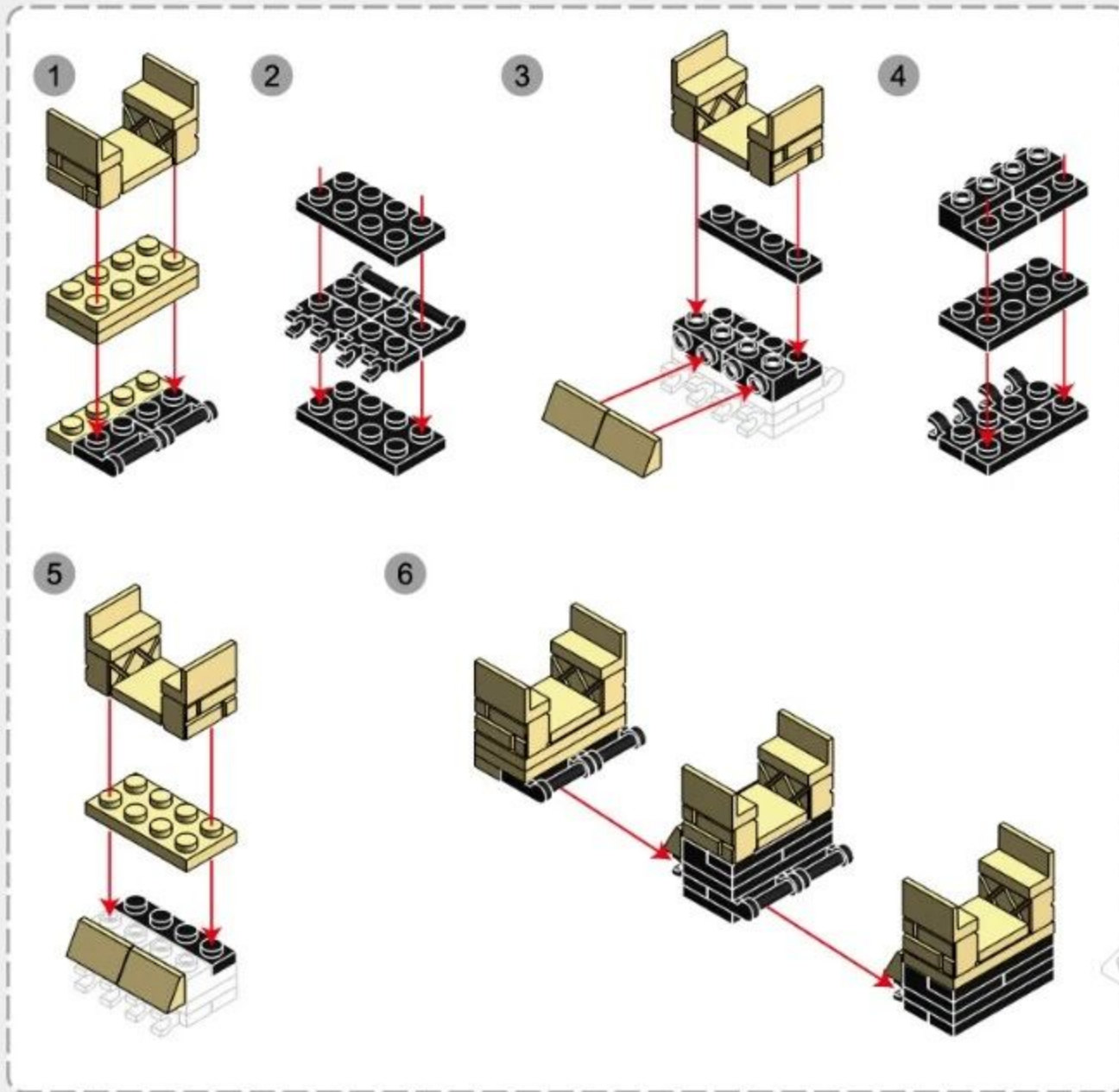

8-5

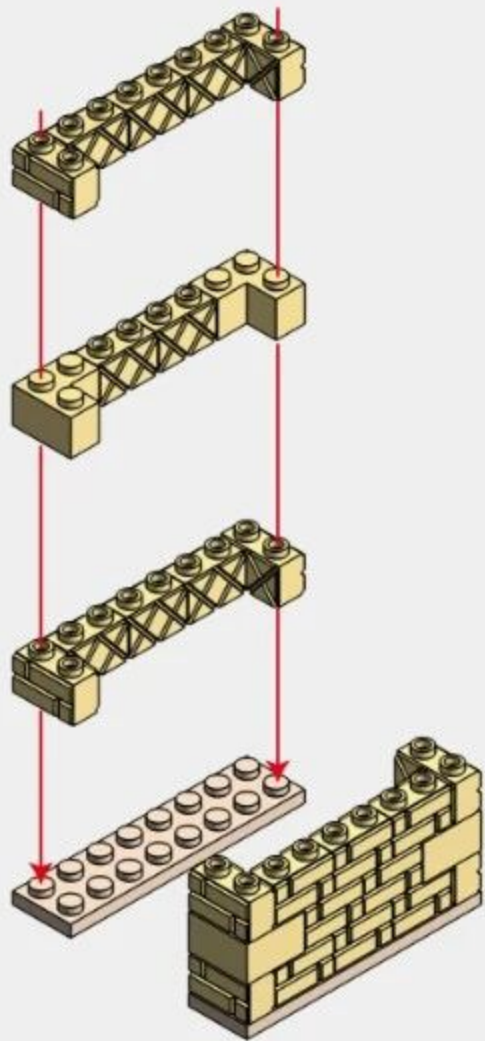
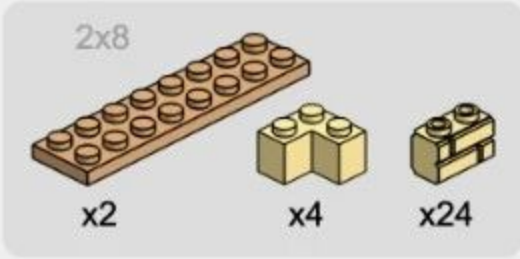

8-6

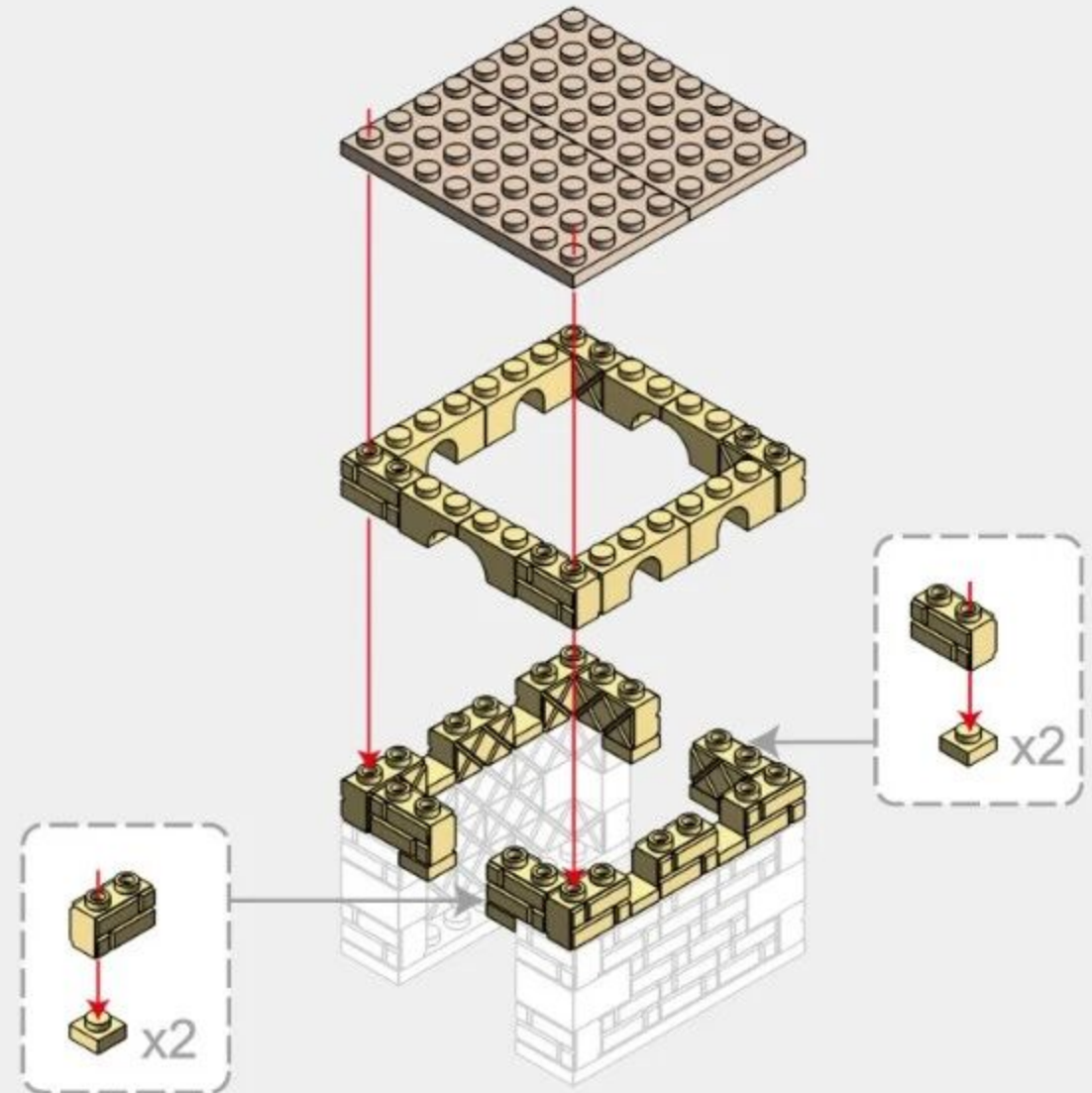
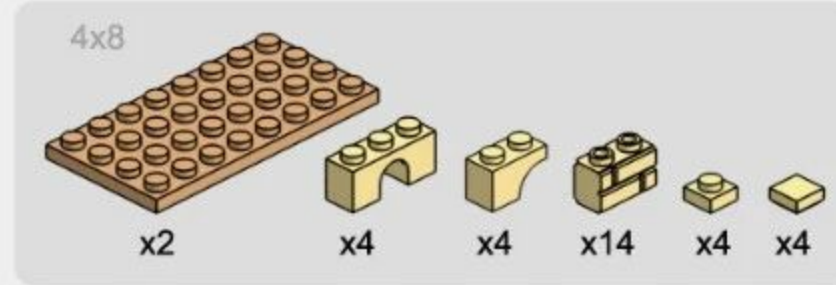

8-7

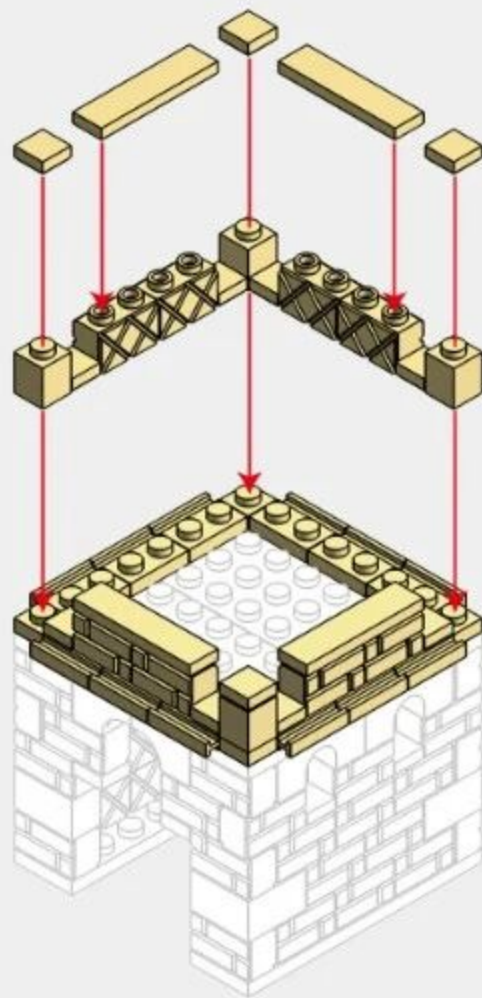

8-8

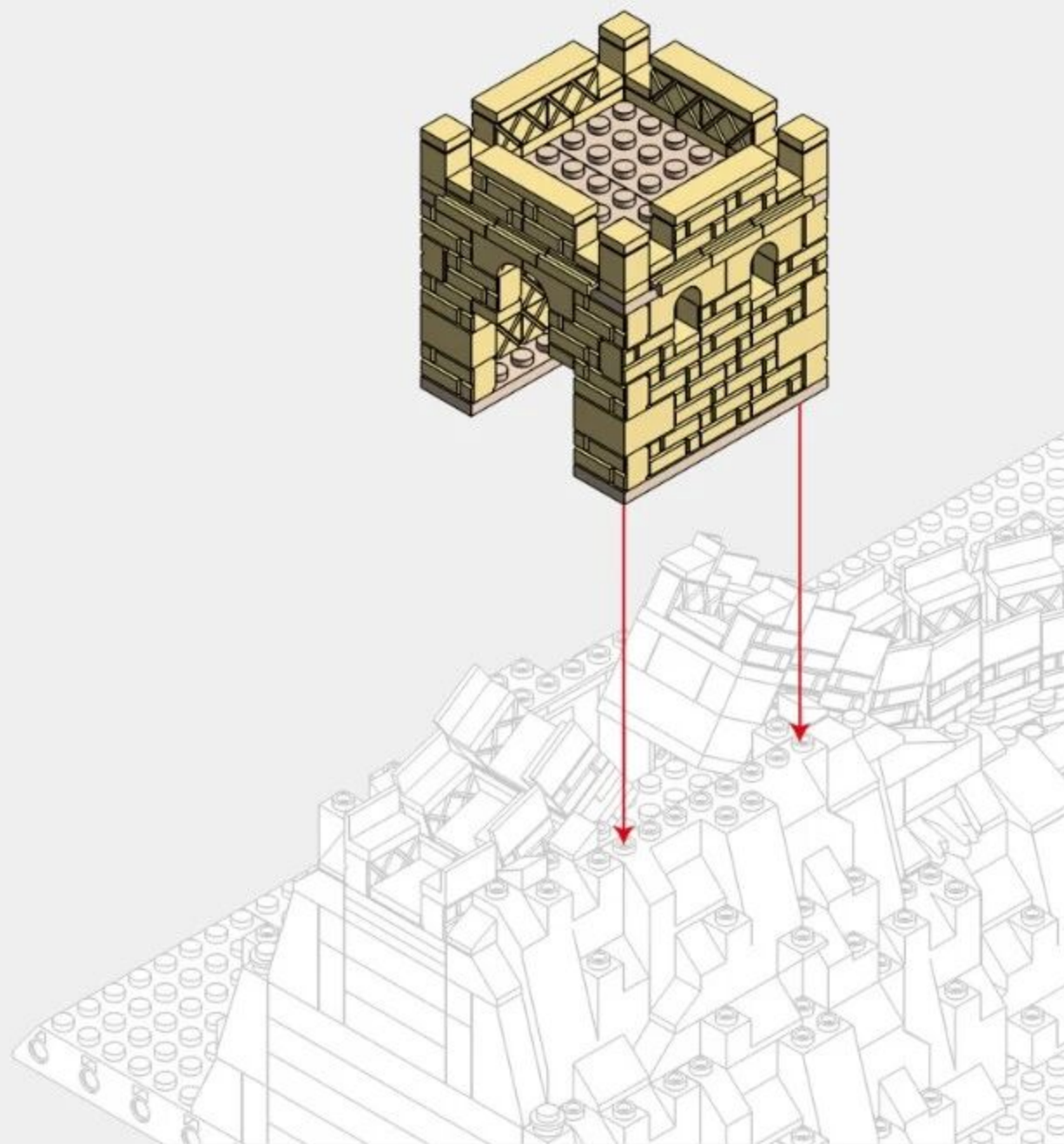

8-9

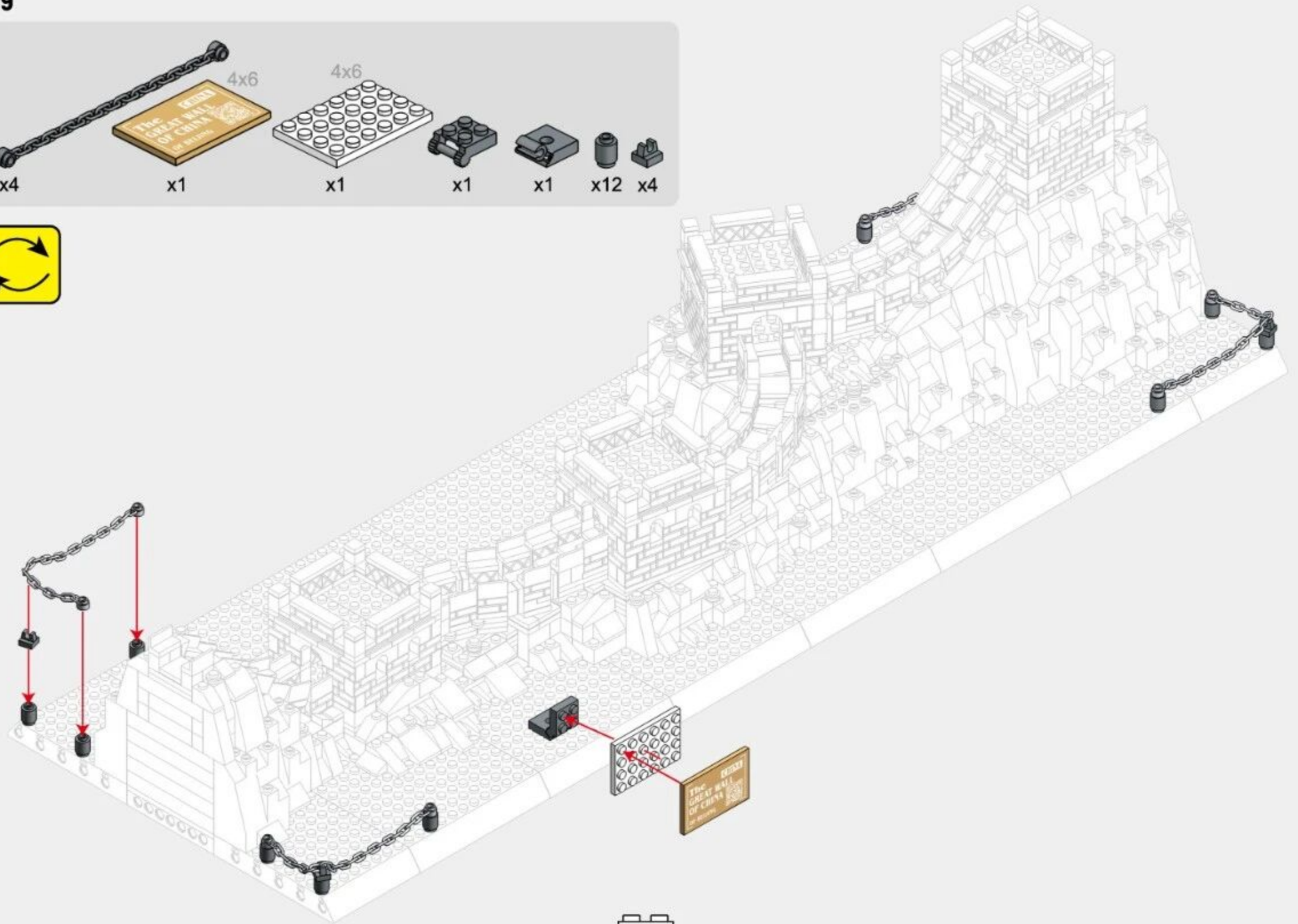
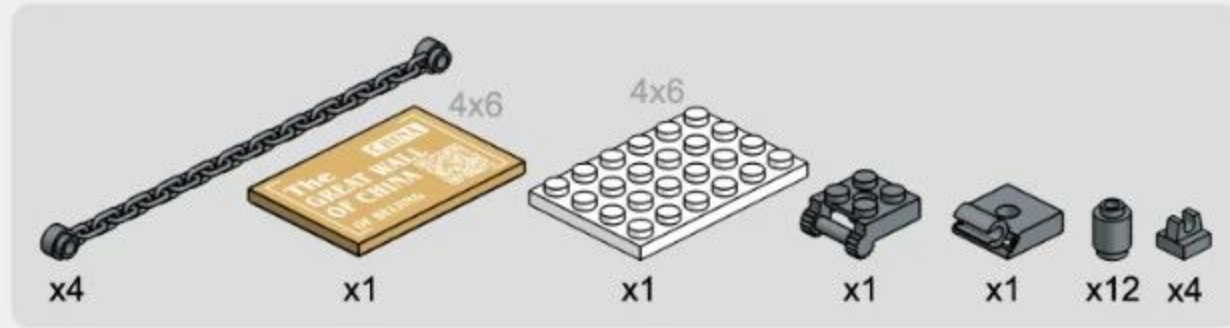

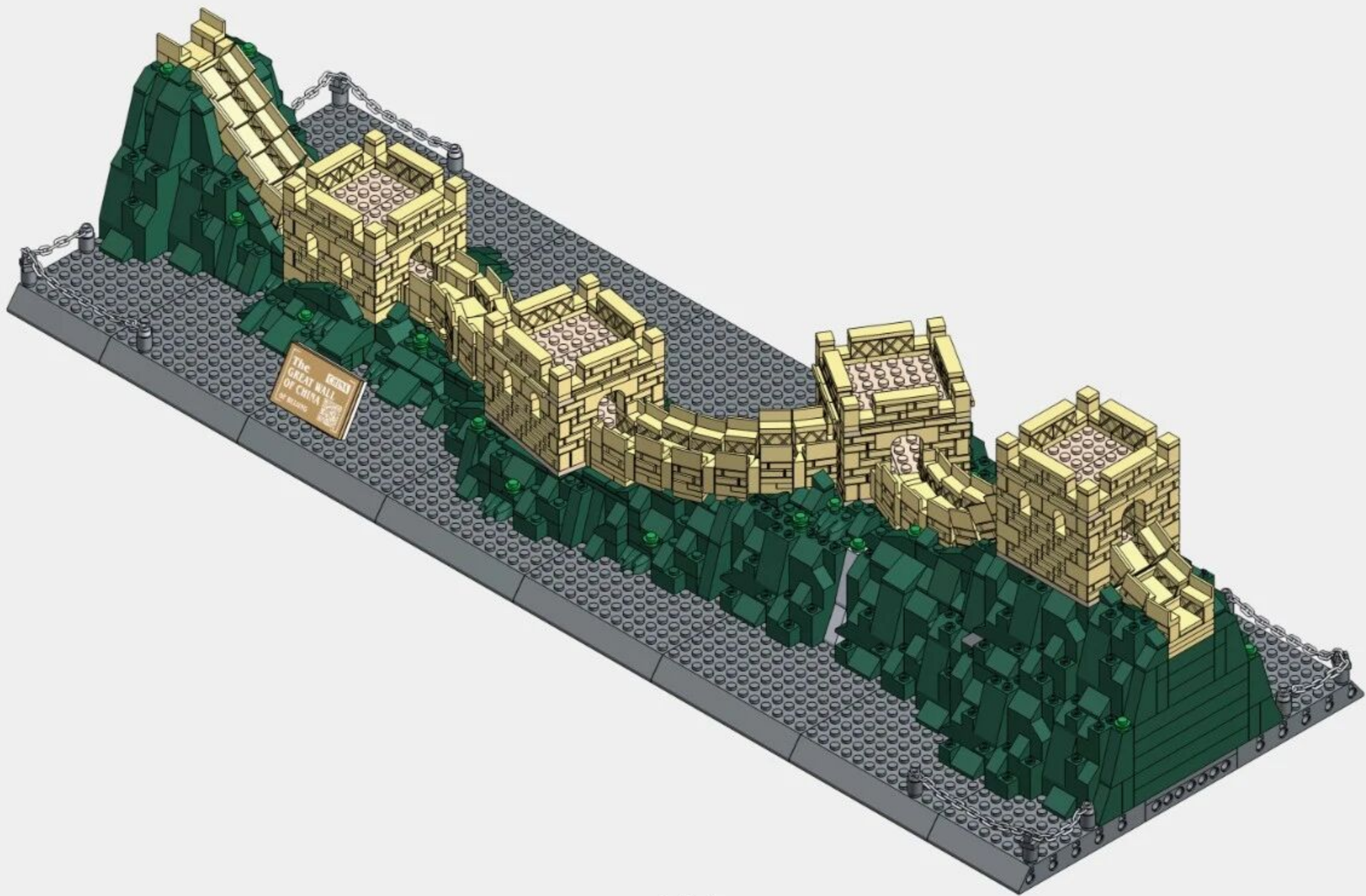

ARCHITECTURE

The World's great architecture



Shaping Skills



Imagination & Curiosity



Mathematical



Self Discovery & Perception



Parent-Child Interaction



Problem Solving



Creativity



✦ THE NIOMON OF KYOTO
Item NO.6212 50X40X11.6CM 2409PCS
京都仁王门



✦ THE COLOSSEUM OF ROME
Item NO.5225 50X35X8CM 1758PCS
罗马斗兽场



✦ THE STATUE OF LIBERTY
Item NO.5227 50X35X8CM 1686PCS
纽约自由女神



✦ THE YELLOW CRANE TOWER OF WUHAN
Item NO.6214 50X40X11.6CM 2912PCS
黄鹤楼



✦ THE BRANDENBURG
Item NO.6211 50X40X11.6CM 1552PCS
德国勃兰登堡门



✦ THE IMPERIAL HOTEL
Item NO.5226 50X35X8CM 1375PCS
东京帝国饭店



✦ THE TRIUMPHAL ARCH
Item NO.6213 50X40X11.6CM 3213PCS
俄罗斯瓦西里升天教堂



✦ THE LONDON EYE
Item NO.6215 50X40X11.6CM 1528PCS
伦敦眼



✦ GREAT PYRAMIDS OF GIZA
Item NO.4210 40X25X8.7CM 643PCS
埃及吉萨金字塔



✦ ELIZABETH TOWER
Item NO.4211 40X25X8.7CM 910PCS
英国伦敦伊丽莎白塔



✦ FONTANA DI TREVİ
Item NO.4212 40X25X8.7CM 688PCS
罗马许愿池



✦ THE LOUVRE
Item NO.4213 40X25X8.7CM 821PCS
法国巴黎卢浮宫



✦ THE WHITE HOUSE
Item NO.4214 40X25X8.7CM 979PCS
美国华盛顿白宫



✦ THE CN TOWER-CANADA
Item NO.4215 40X25X8.7CM 424PCS
加拿大多伦多电视塔



✦ LINCOLN MEMORIAL
Item NO.4216 40X25X8.7CM 979PCS
美国林肯纪念堂



✦ MARINA BAY SANDS
Item NO.4217 40X25X8.7CM 881PCS
新加坡金沙酒店



✦ MERLION STATUE-SINGAPORE
Item NO.4218 40X25X8.7CM 503PCS
新加坡鱼尾狮雕像



✦ THE TOWER BRIDGE OF LONDON
Item NO.4219 40X25X8.7CM 969PCS
伦敦塔桥



✦ FLATIRON BUILDING
Item NO.4220 40X25X8.7CM 838PCS
美国熨斗大厦



✦ NOTRE-DAME DE PARIS
Item NO.5210 50X35X8CM 1380PCS
法国巴黎圣母院大教堂



✦ **THE PARLIAMENT BUILDING**
Item NO.4222 40X25X8.7CM 595PCS
迪拜哈利法塔



✦ **THE EMPIRE STATE BUILDING**
Item NO.5212 50X35X8CM 1995PCS
美国纽约帝国大厦



✦ **PETRONAS TOWERS**
Item NO.5213 50X35X8CM 1160PCS
马来西亚吉隆坡国油双峰塔



✦ **THE LEANING TOWER**
Item NO.5214 50X35X8CM 1392PCS
意大利比萨斜塔



✦ **THE BIG BEN**
Item NO.5216 50X35X8CM 1642PCS
英国伦敦大笨钟



✦ **THE TOWER BRIDGE**
Item NO.5215 50X35X8CM 1033PCS
英国伦敦双子桥



✦ **THE PARLIAMENT BUILDING OF OTTAWA**
Item NO.4221 40X25X8.7CM 608PCS
国会大厦



✦ **THE EIFFEL TOWER**
Item NO.5217 50X35X8CM 978PCS
法国巴黎埃菲尔铁塔



✦ **THE ORIENTAL PEARL TOWER**
Item NO.5224 50X35X8CM 1109PCS
中国上海东方明珠



✦ **TAJ MAHAL OF AGRA**
Item NO.5211 50X35X8CM 1505PCS
印度阿格拉泰姬陵



✦ **THE SPASSKAYA TOWER**
Item NO.5219 50X35X8CM 1044PCS
俄罗斯克里姆林宫



✦ **THE BURJAL ARAB HOTEL**
Item NO.5220 50X35X8CM 1307PCS
迪拜帆船酒店



✦ **THE TAIPEL 101**
Item NO.5221 50X35X8CM 1511PCS
中国台北101大楼



✦ **THE GOLDEN GATE BRIDGE**
Item NO.6210 50X40X11.6CM 1977PCS
美国旧金山金门大桥



✦ **THE TRIUMPHAL ARCH**
Item NO.5223 50X35X8CM 1401PCS
法国巴黎凯旋门



✦ **THE TEMPLE OF HEAVEN**
Item NO.5222 50X35X8CM 999PCS
中国北京故宫天坛



✦ **THE TIAN AN MEN**
Item NO.5218 50X35X8CM 758PCS
中国北京天安门

THE GREAT WALL

COUNTRY: China
CITY: Beijing

China
The world's great architecture

