

# UNITED NATIONS HEADQUARTERS

SEDE DE LAS NACIONES UNIDAS

New York, America

The world's great architecture

Ages 6+



6219  
**1601 PCS**



# Architecture

It will be a city...

这将构成一座城市...

# ABOUT THE PRODUCT

关于产品

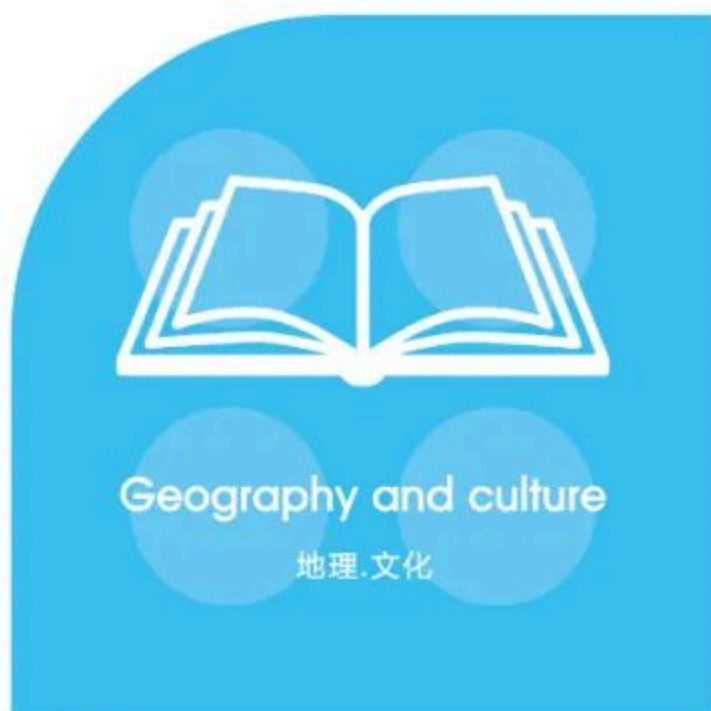

## ARCHITECT

WANGE The world's great architect since 1991

Shantou VeryFun Toys & Nursery Co., Ltd.  
©2014 Wange / Dubie. All Rights Reserved

# United Nations Headquarters



The United Nations Headquarters is located on the east side of Manhattan, New York City, United States. It is an international territory.

# United Nations Headquarters



## Geography and culture

地理·文化



This building was built between 1949 and 1950. The land was purchased from William Jackendorf, a New York real estate expert at the time, and it covers an area of 17 acres.

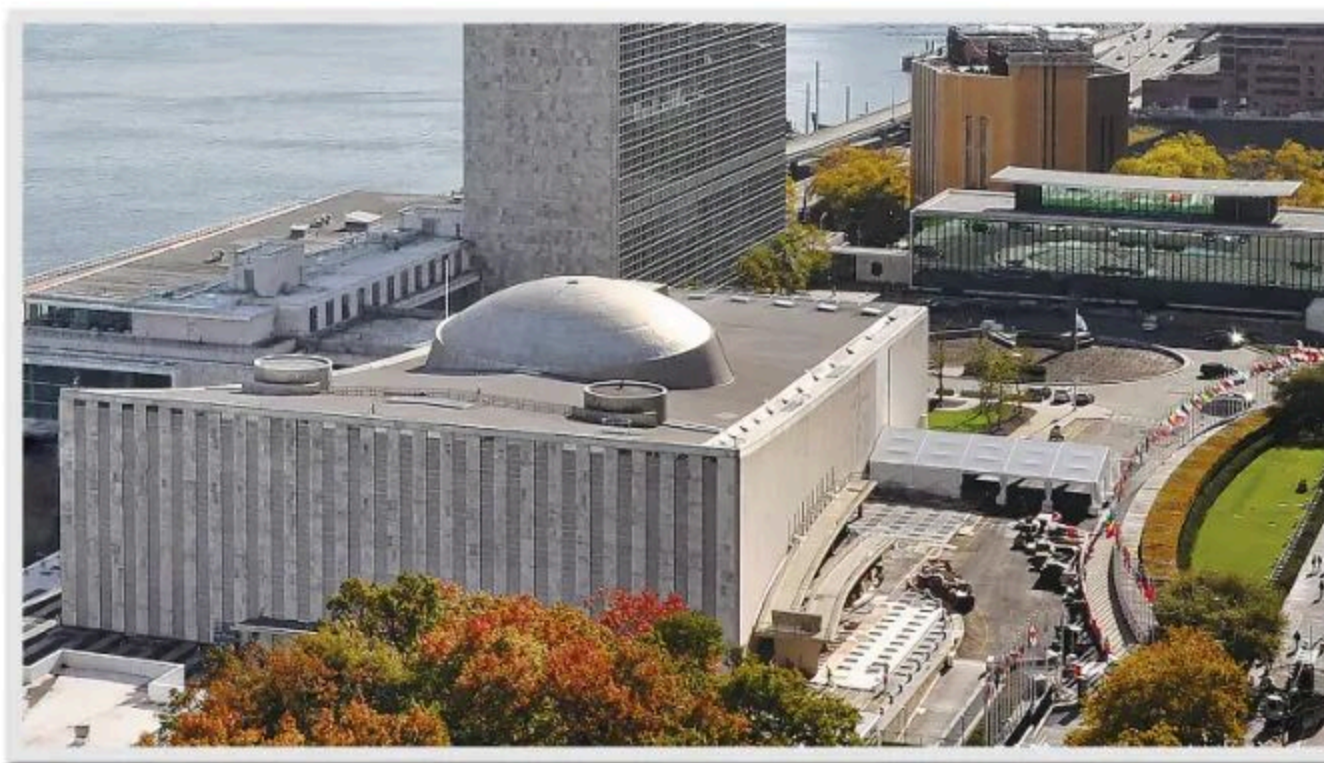

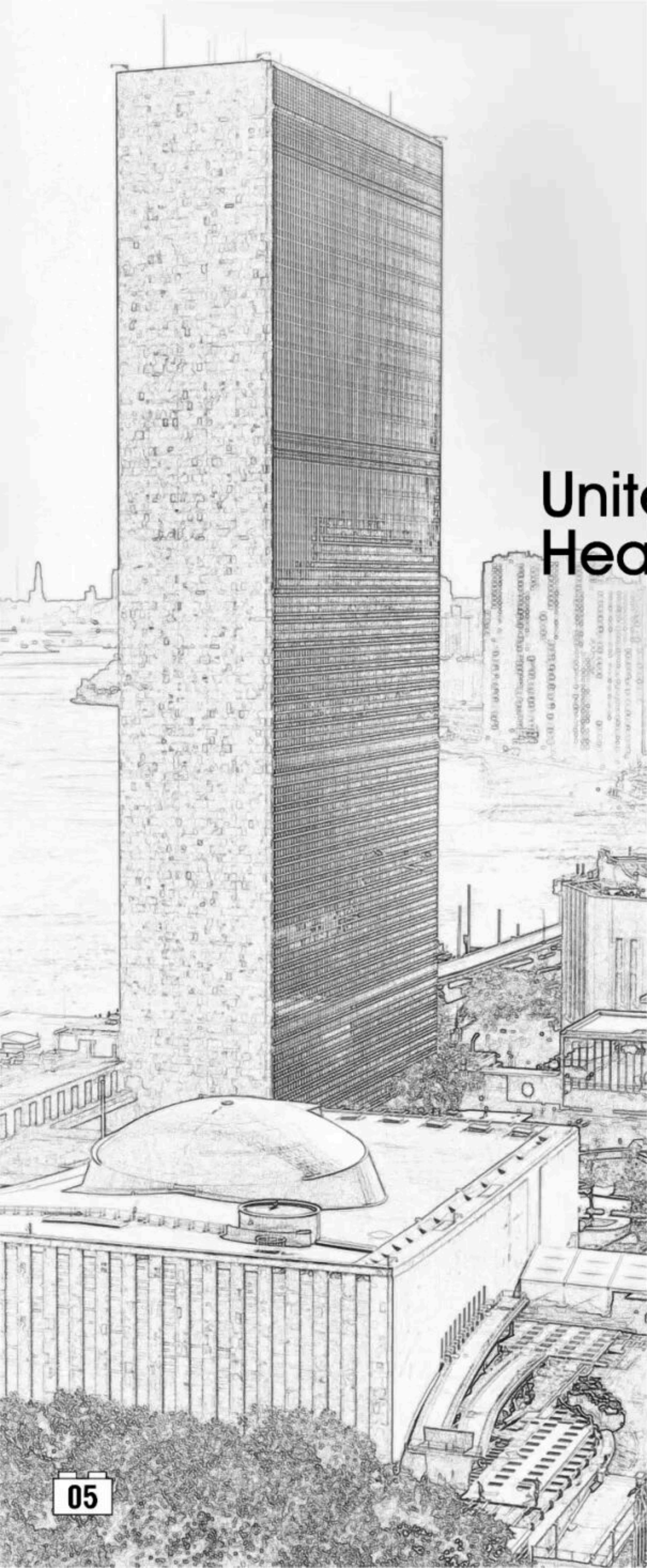

联合国总部大楼

# United Nations Headquarters ■ America

The contents of this chapter refer to the Wikipedia website.

本章内容参考维基百科网站，更多资讯可自行查阅。

The world's great architecture

# About The Building



**The United Nations**, is headquartered in New York City in a complex designed by a board of architects led by Wallace Harrison and built by the architectural firm Harrison & Abramovitz. The complex has served as the official headquarters of the United Nations since its completion in 1952.

# Diseño y historia posterior

El Edificio de la Sede de las Naciones Unidas (también conocido como Edificio de las Naciones Unidas) es la ubicación de la Sede de las Naciones Unidas. Está ubicado en el lado este de Manhattan en la ciudad de Nueva York. Es un territorio internacional. Por lo tanto, los ciudadanos de los estados miembros pueden ingresar con pasaportes, incluidos los estados miembros de las Naciones Unidas que no tienen relaciones diplomáticas con los Estados Unidos. Desde el edificio de la sede de las Naciones Unidas se puede pasar por alto el East River. Este edificio fue construido entre 1949 y 1950. El terreno fue comprado por William Jackendorf, un agente inmobiliario de Nueva York en ese momento, y cubre un área de 17 acres (aproximadamente 6.897973 hectáreas).



La pared interior de la sala es curva, el techo es una estructura de cable suspendido y la cúpula está superpuesta. Al sur se encuentra el edificio de la Secretaría de las Naciones Unidas con una altura de 153,9 metros y una altura de 39 pisos. Es uno de los primeros edificios de gran altura con paneles y el primer edificio en adoptar muros cortina de vidrio. Las fachadas delantera y trasera están todas hechas de muros cortina de vidrio absorbente de calor de color verde oscuro con hojas de aleación de aluminio. La estructura de acero mide 90 cm de largo y los frontones de ambos extremos están chapados con mármol blanco. El edificio es de forma simple,

# Force Balance

受力平衡

Scene Matching

场景搭配

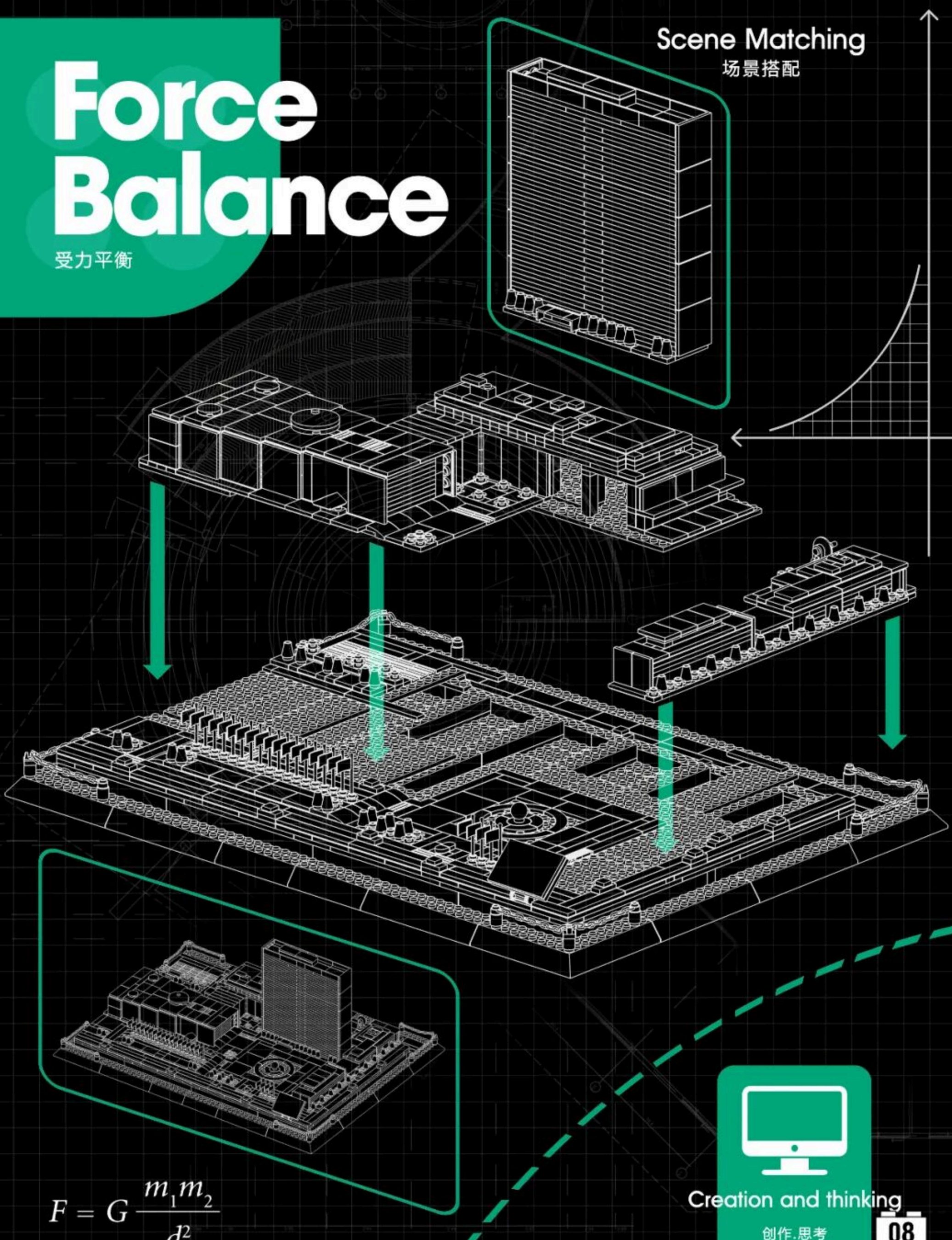

$$F = G \frac{m_1 m_2}{d^2}$$



Creation and thinking

创作·思考

# Special parts

特殊零件的开发利用

$$a^2+b^2=c^2$$



**WG0874**  
4X4无孔

$$S=4\pi \cdot r^2$$



**WG1206**  
旗子

**WG0138**  
a.b链接



**WG1188**  
4X6无孔

$$\sin^2 a + \cos^2 a = 1$$



features and functions

特点.功能

# Main Color Matching

配色方案

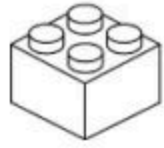

white



Pantone 284C



Pantone 7500C



Pantone 347C



Pantone 3435C



Pantone 431C



Pantone 7620C



Pantone 123C



Pantone Cool Gray 6C



## Color matching

Adopting 9 main colors, beige, brown and gray as the main color, the more reasonable and bold color matching on the original building, making the product more atmospheric and the whole design is more reasonable.

# United Nations Headquarters

联合国总部大楼



Front

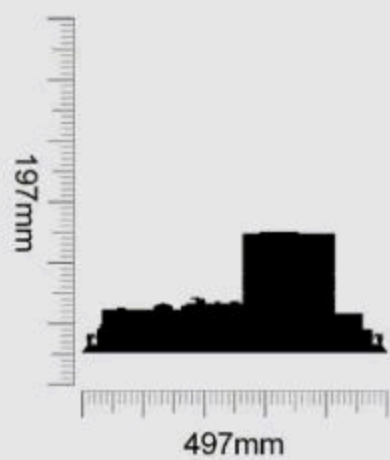

Left

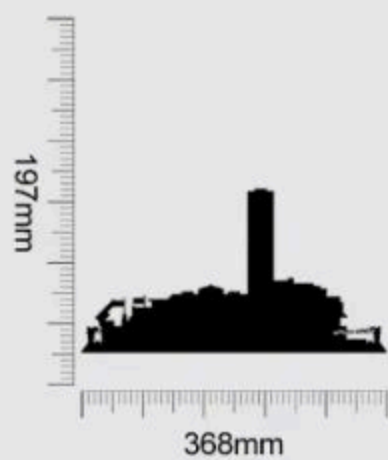

Back

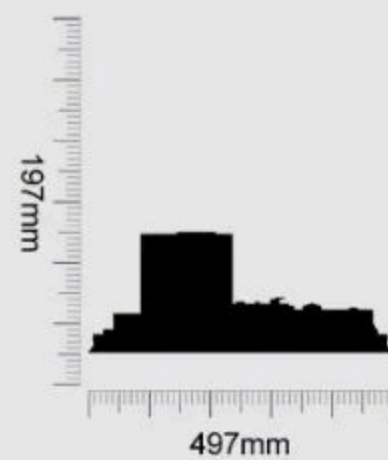

Product Size:497X368x197mm





■ First open the product packaging according to the instructions.

按指导用正确方式拆解产品外包装。



■ Summarize all parts to count the number of familiar accessories.

对照说明书清单确认积木包数量与积木数量。



■ Arranging all accessories by color helps to quickly install the product.

把确认好的积木以类型、颜色进行分类排好以便安装。



■ Carefully install the product and learn about building.

按说明书步骤拼装并完成你的积木模型。



# 1:1 Physical Reference Table

十字棒配件1:1尺寸参照表



Instructions For Use

让安装更简单



**2**  $(1 \times 2) = 2$

**3**  $(1 \times 3) = 3$

**4**  $(1 \times 4) = 4$

**5**  $(1 \times 5) = 5$

**6**  $(1 \times 6) = 6$

**7**  $(1 \times 7) = 7$

**8**  $(1 \times 8) = 8$

**9**  $(1 \times 9) = 9$

**10**  $(1 \times 10) = 10$

**12**  $(1 \times 12) = 12$

**16**  $(1 \times 16) = 16$

# PARTS LIST

配件清单

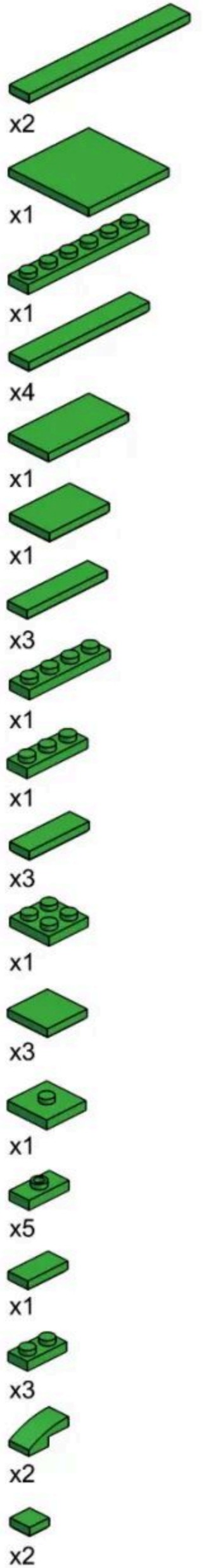
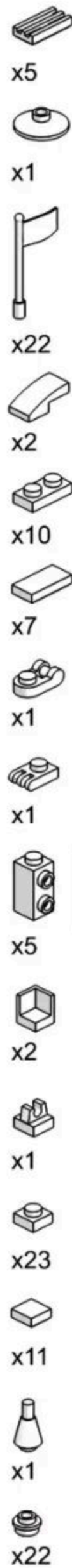
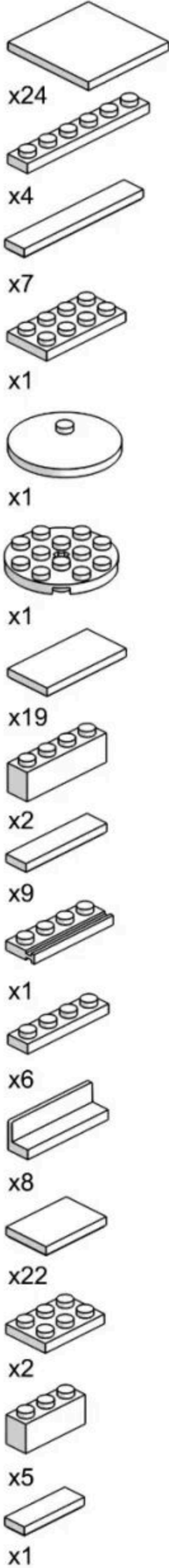
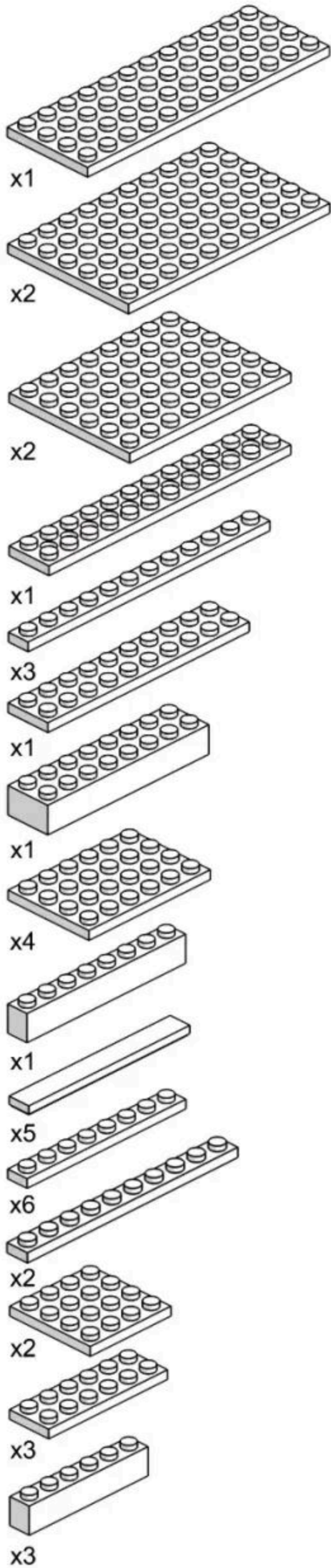

产品有增补件请以实物为准

If product has additional parts, please in kind prevail.





# PARTS LIST

配件清单

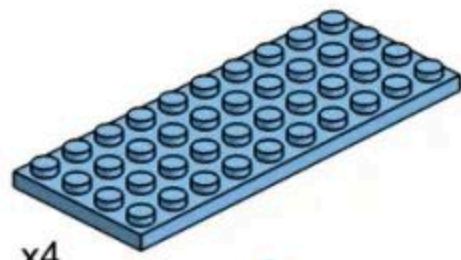

x4

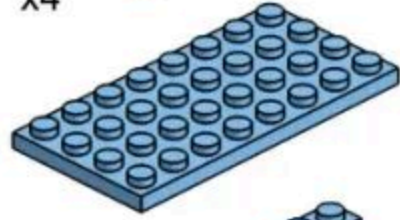

x4

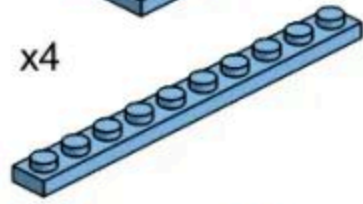

x32

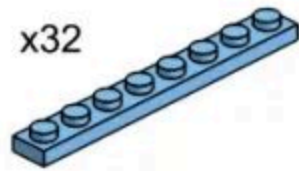

x31

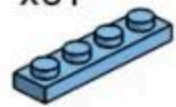

x1



x2



x2



x4

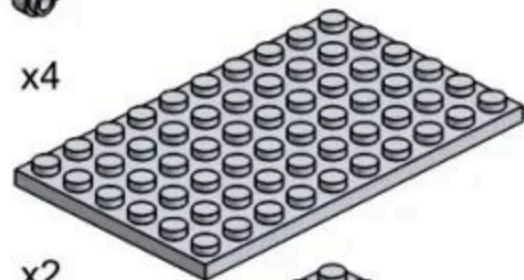

x2

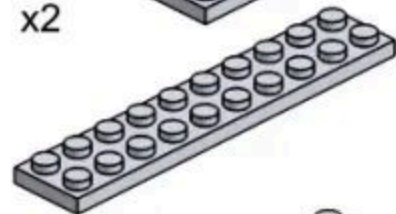

x1

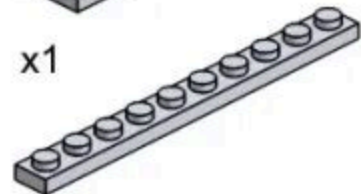

x17



x24

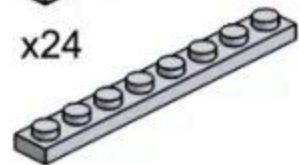

x16



x13



x9



x9

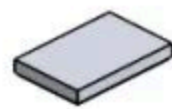

x13



x4



x4



x2



x4



x3



x8



x5



x5



x2



x4



x10

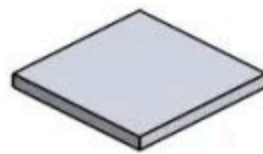

x4

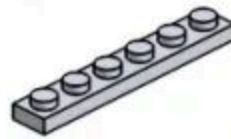

x1

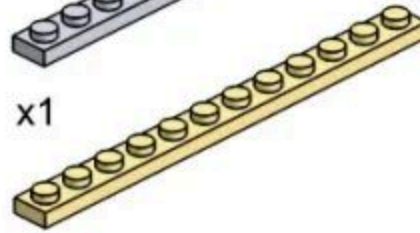

x2

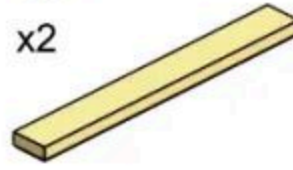

x17

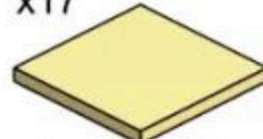

x1

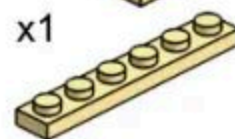

x1

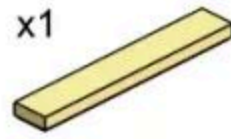

x3



x4

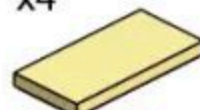

x4



x4

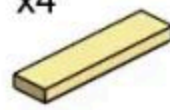

x4

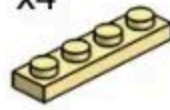

x4



x2



x3



x5



x2



x1



x1



x4



x32



x2



x3



x1



x4

产品有增补件请以实物为准

If product has additional parts, please in kind prevail.



269PCS

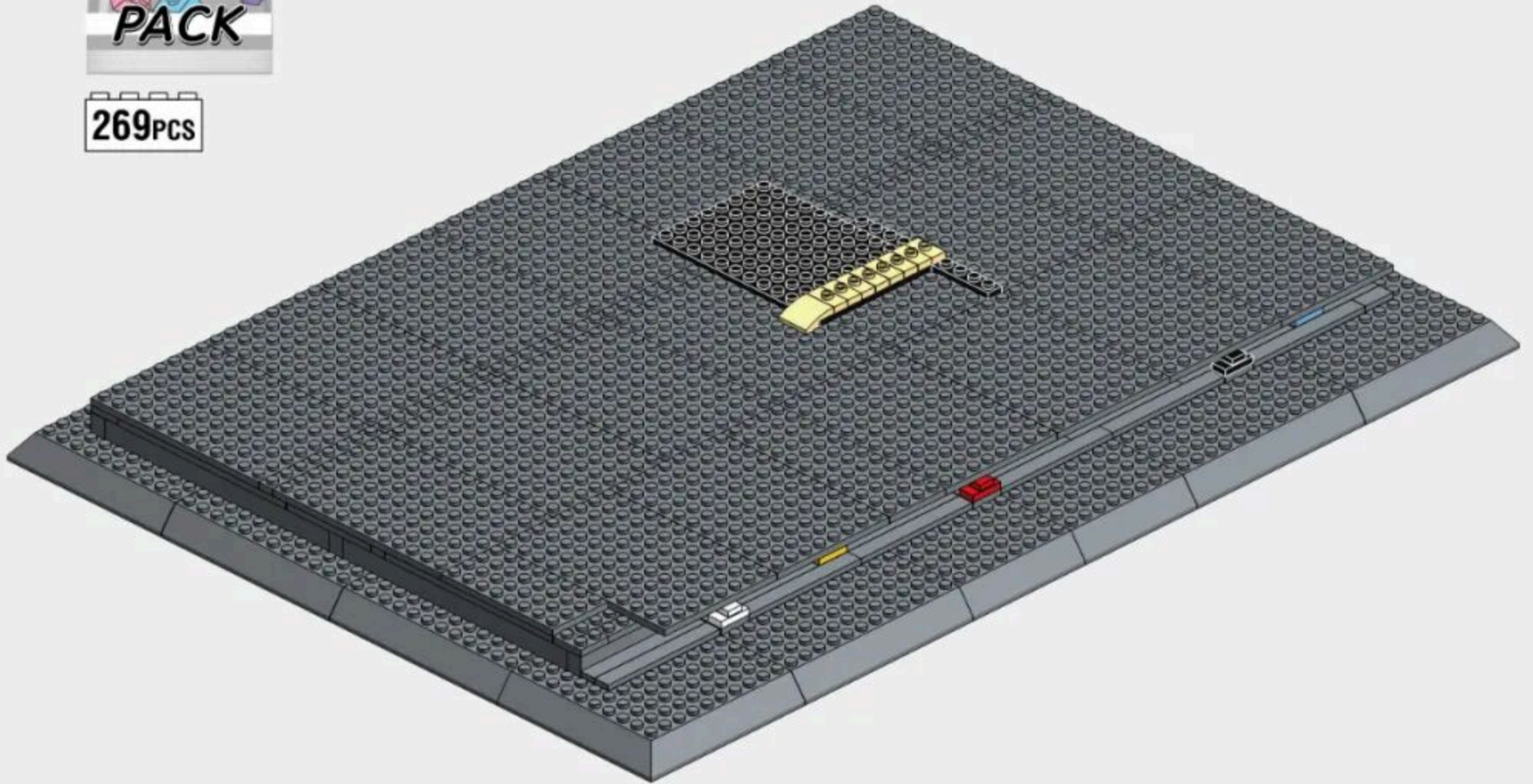

19

1-1

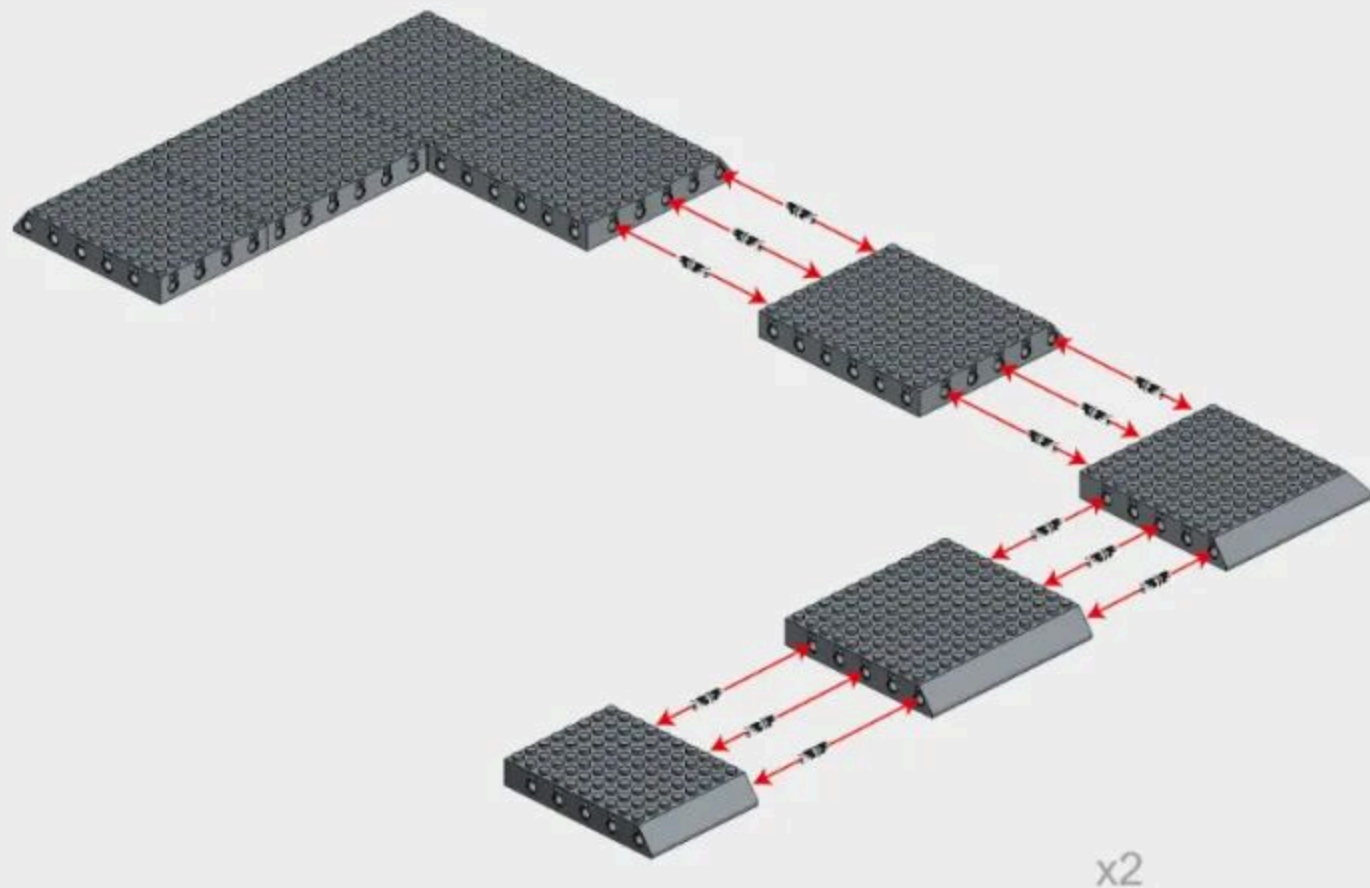
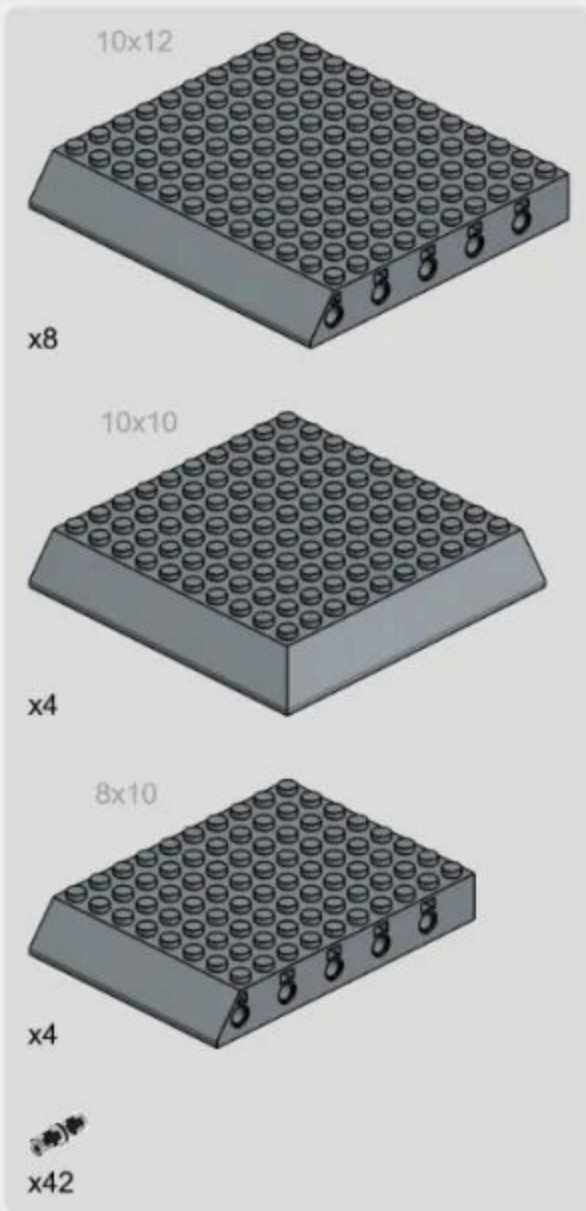

1-2

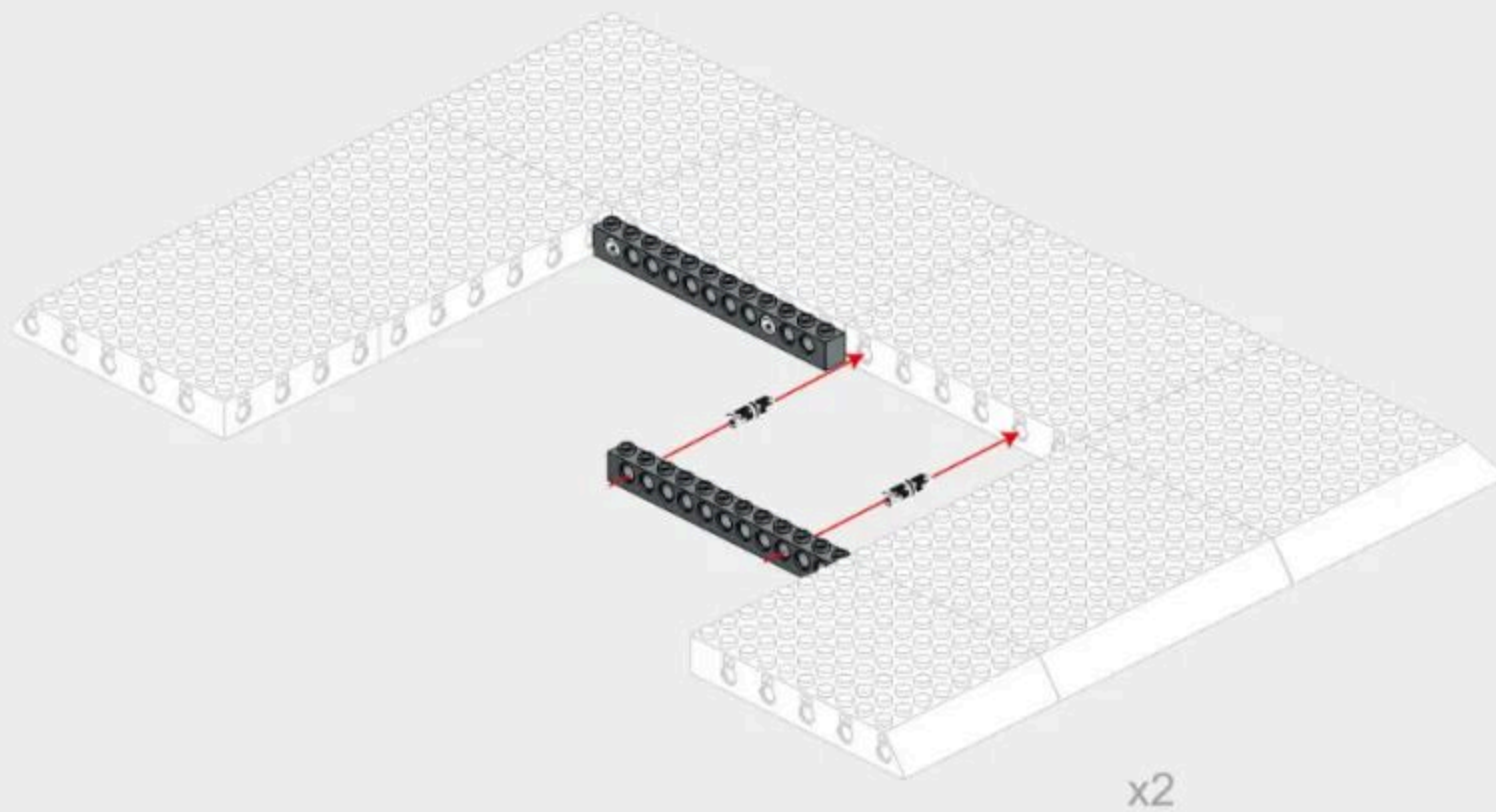
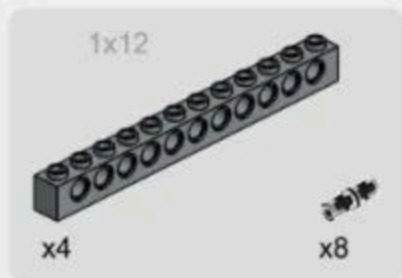

1-3

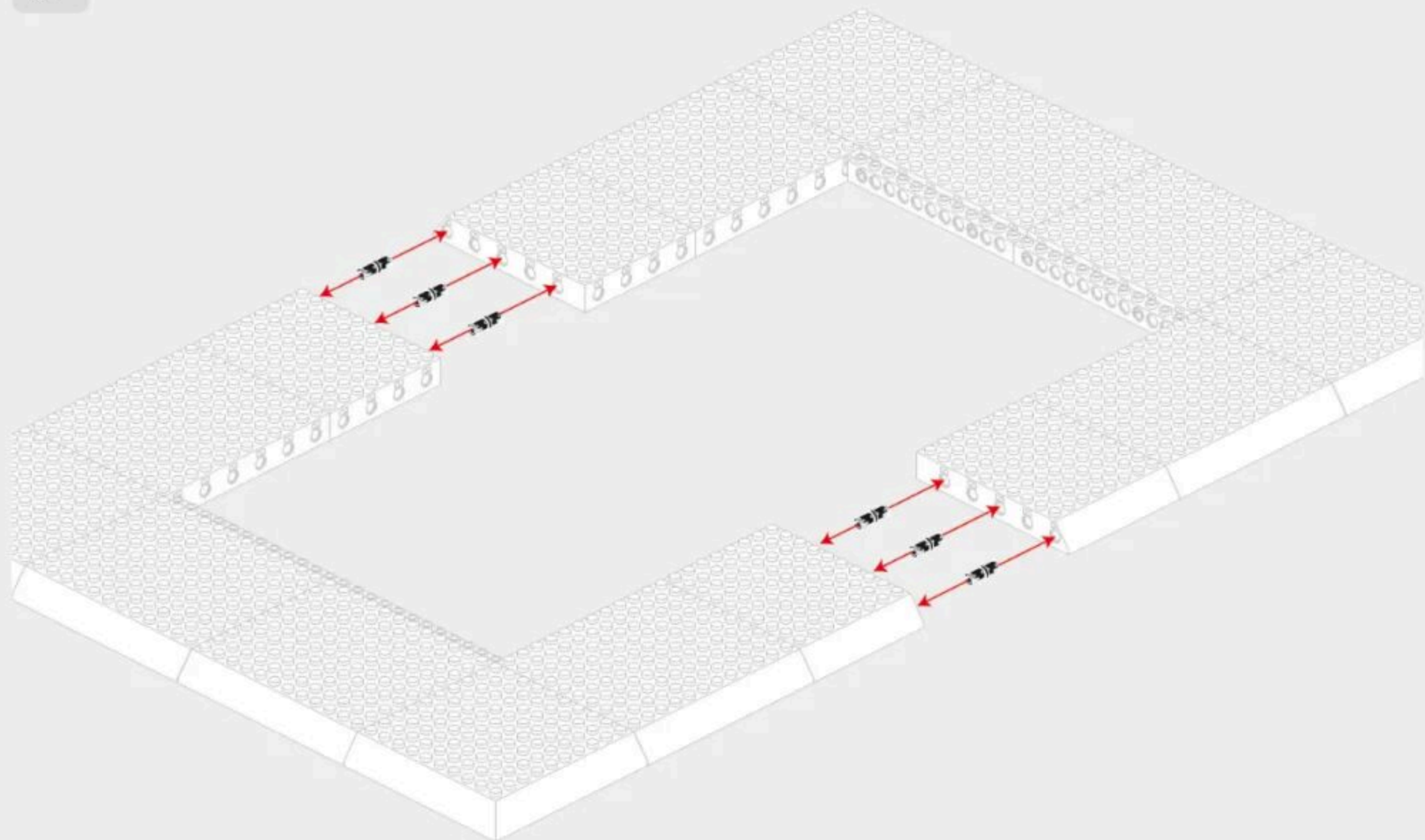

1-4

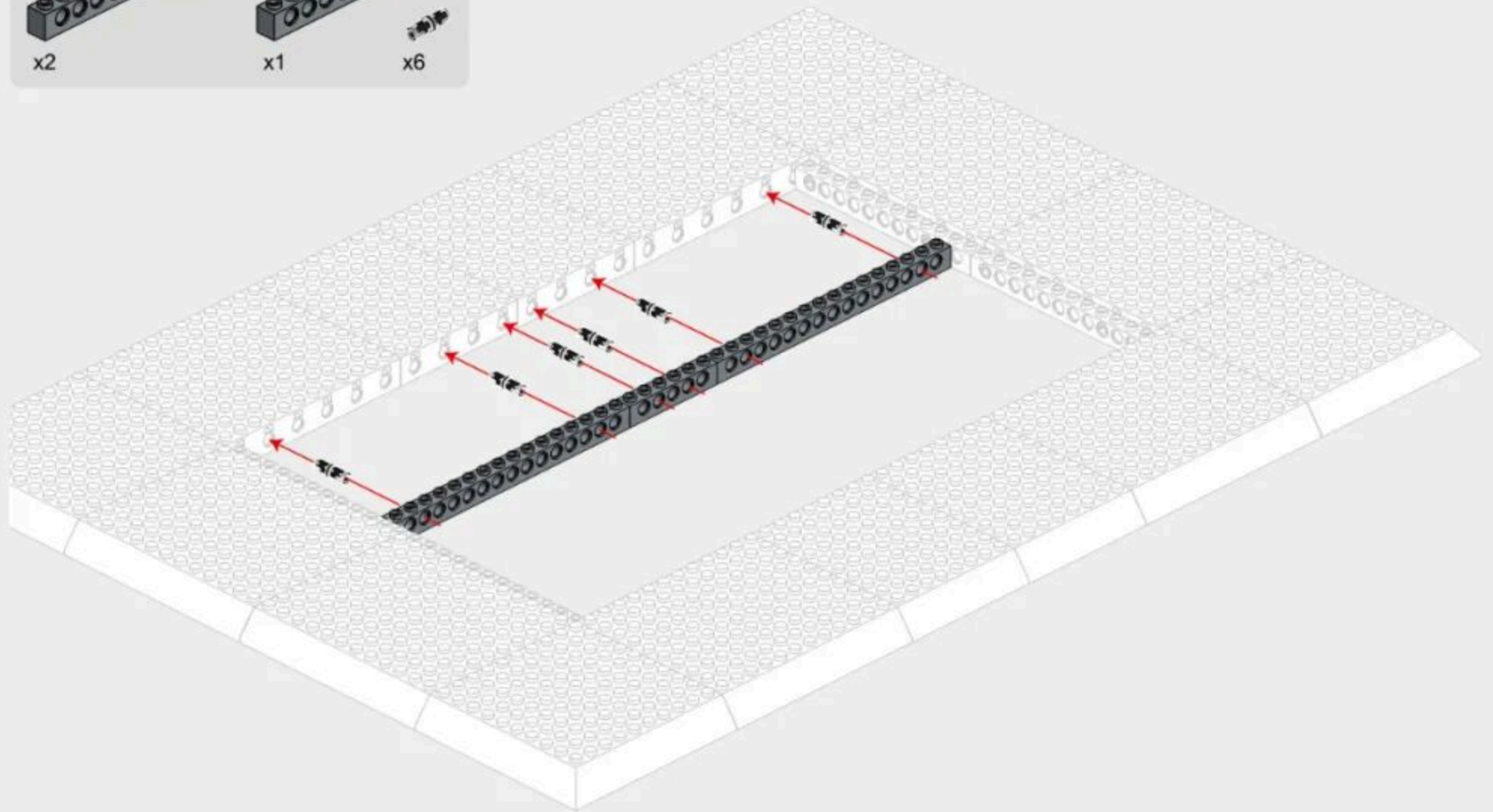
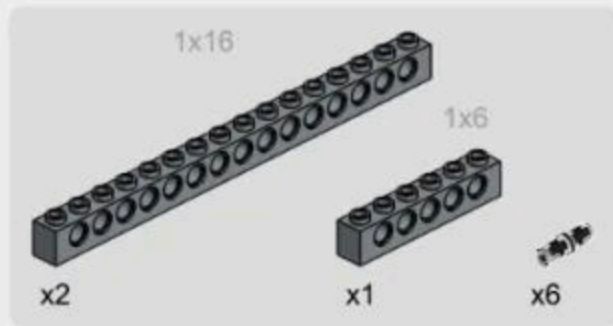

1-5

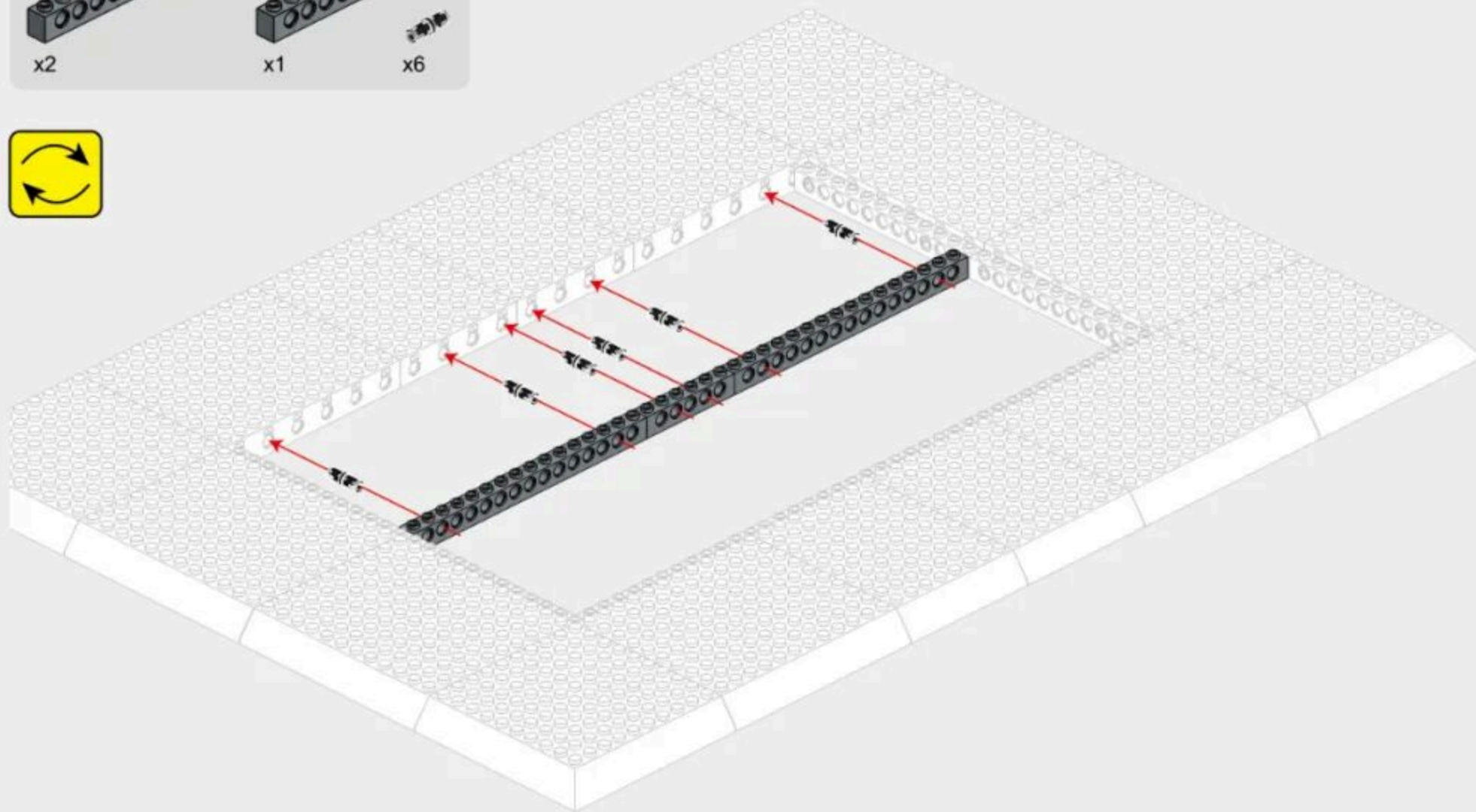
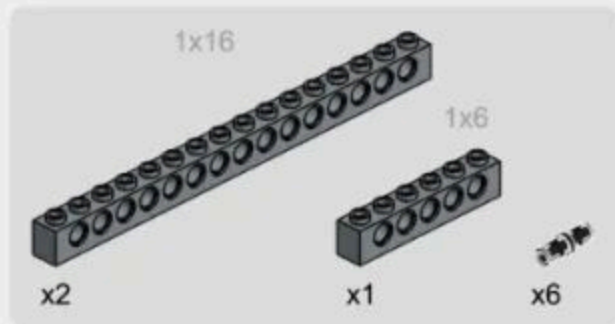



1-7

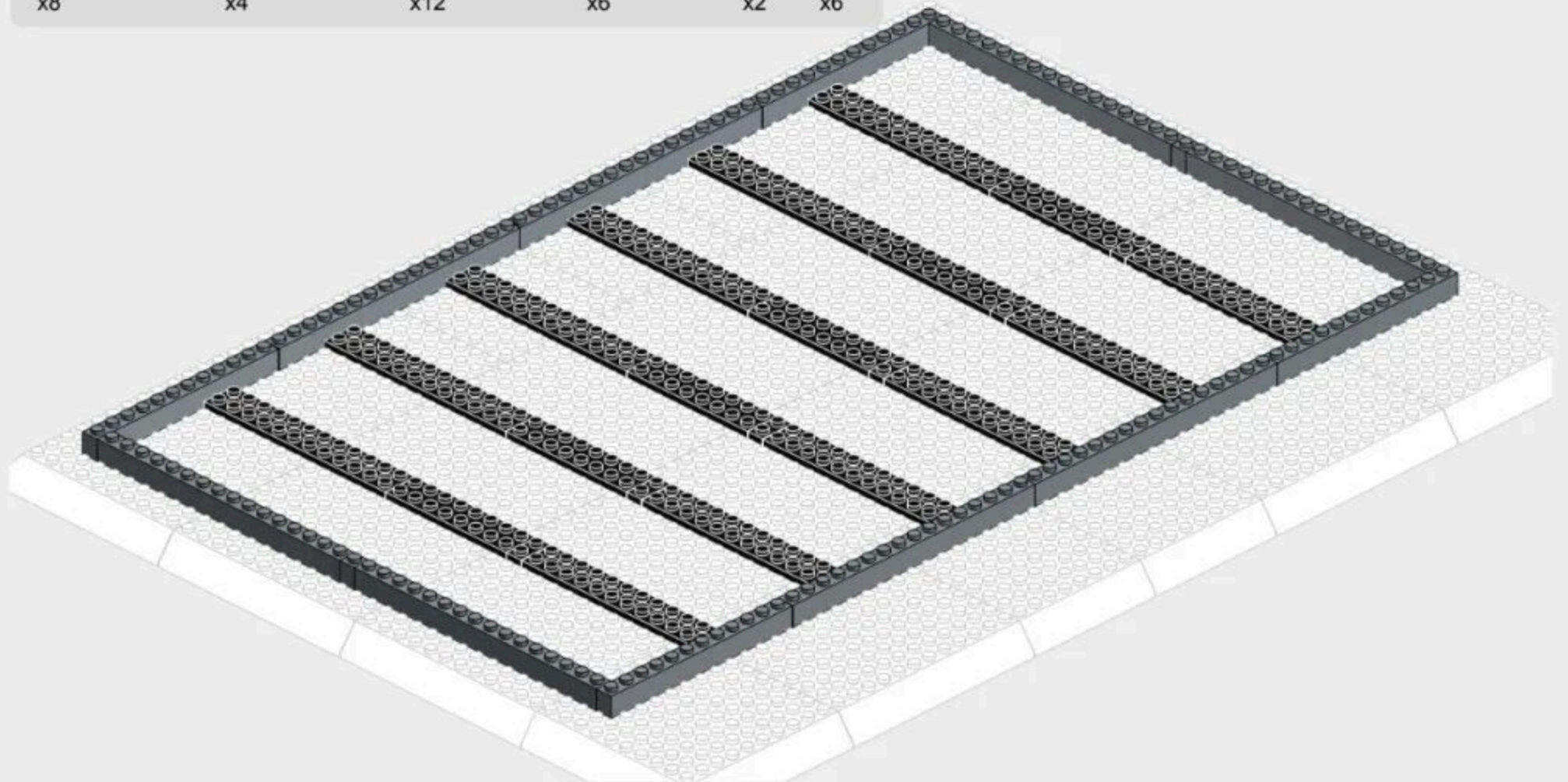
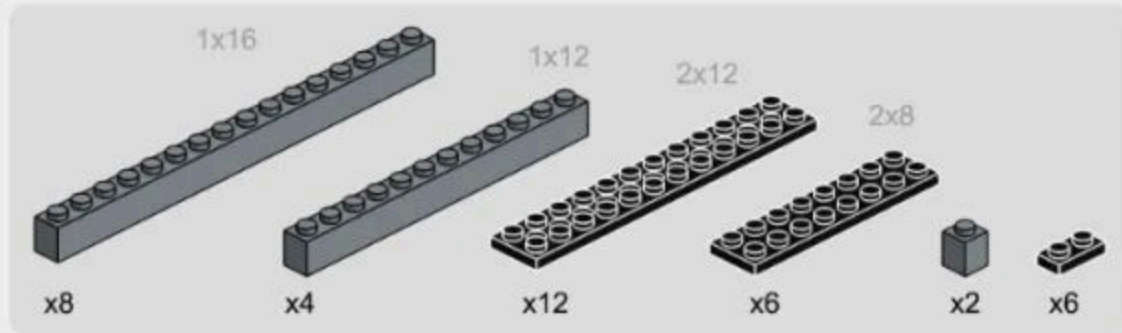

1-8

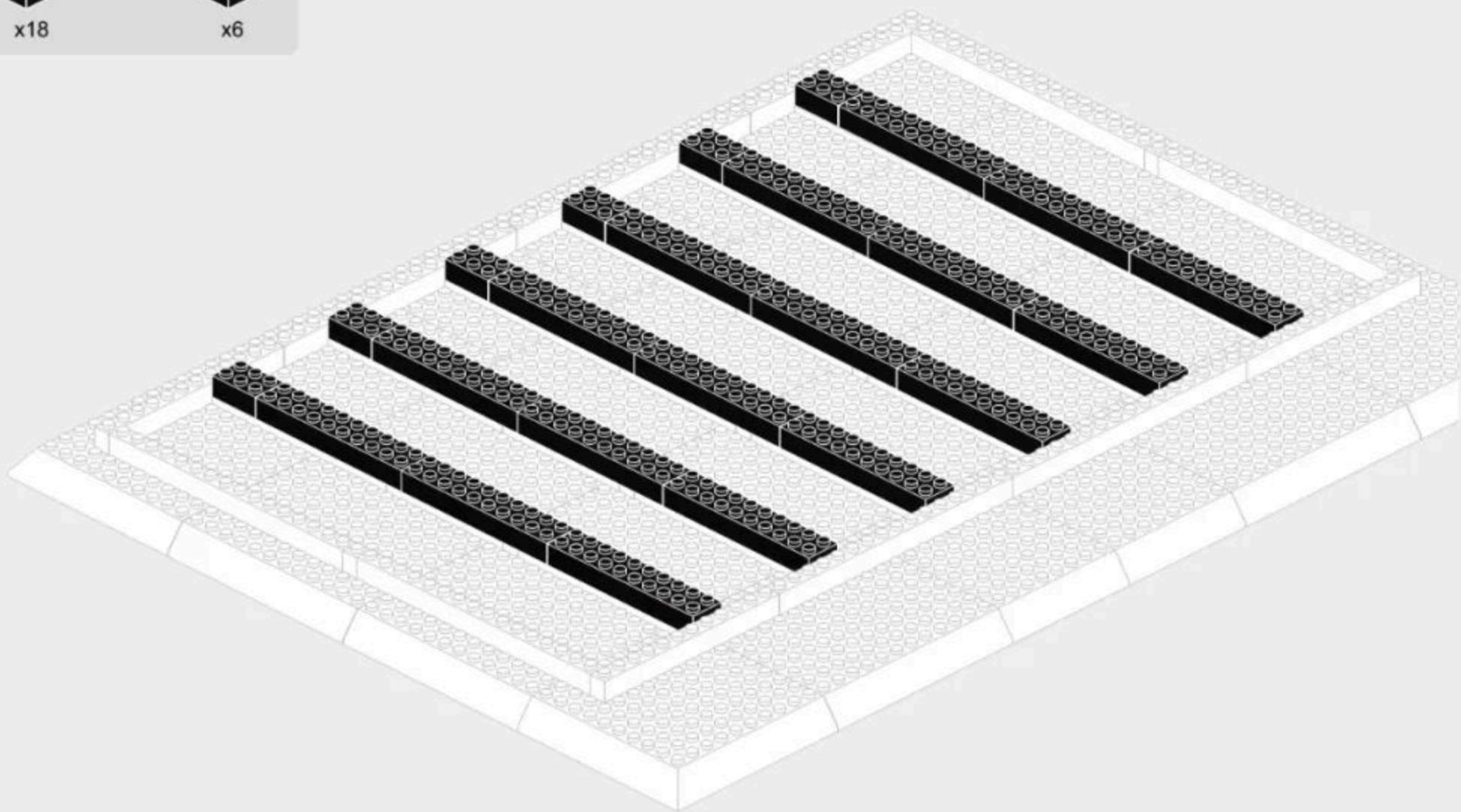
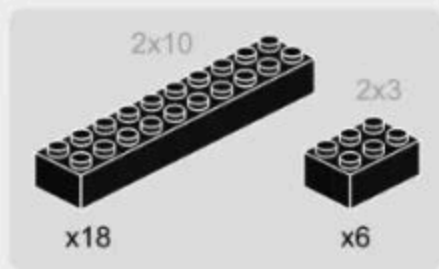

1-9

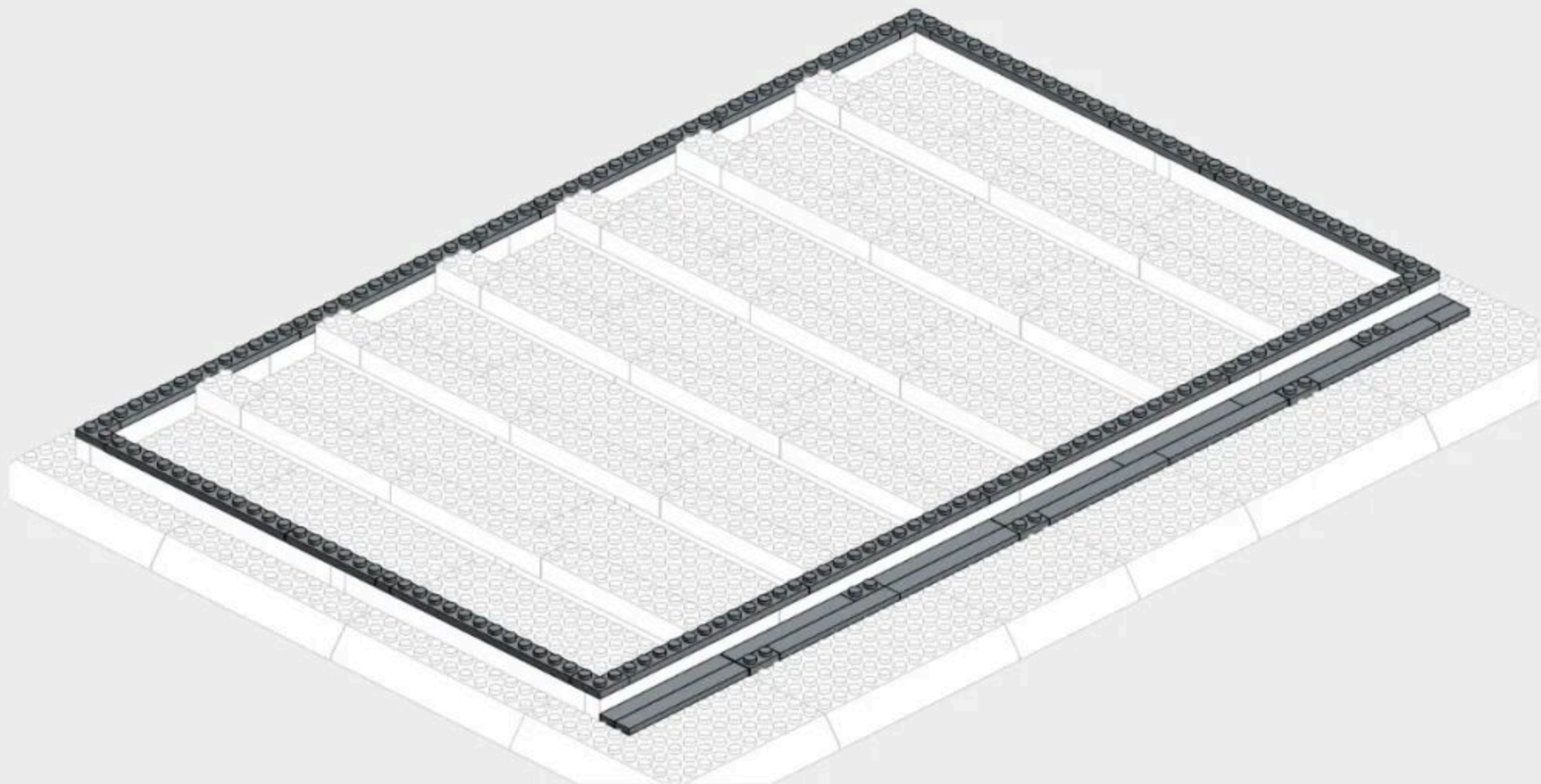
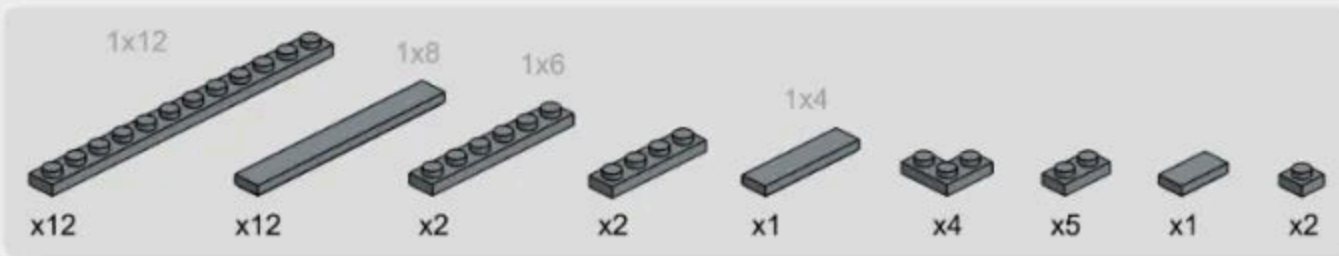



1-11

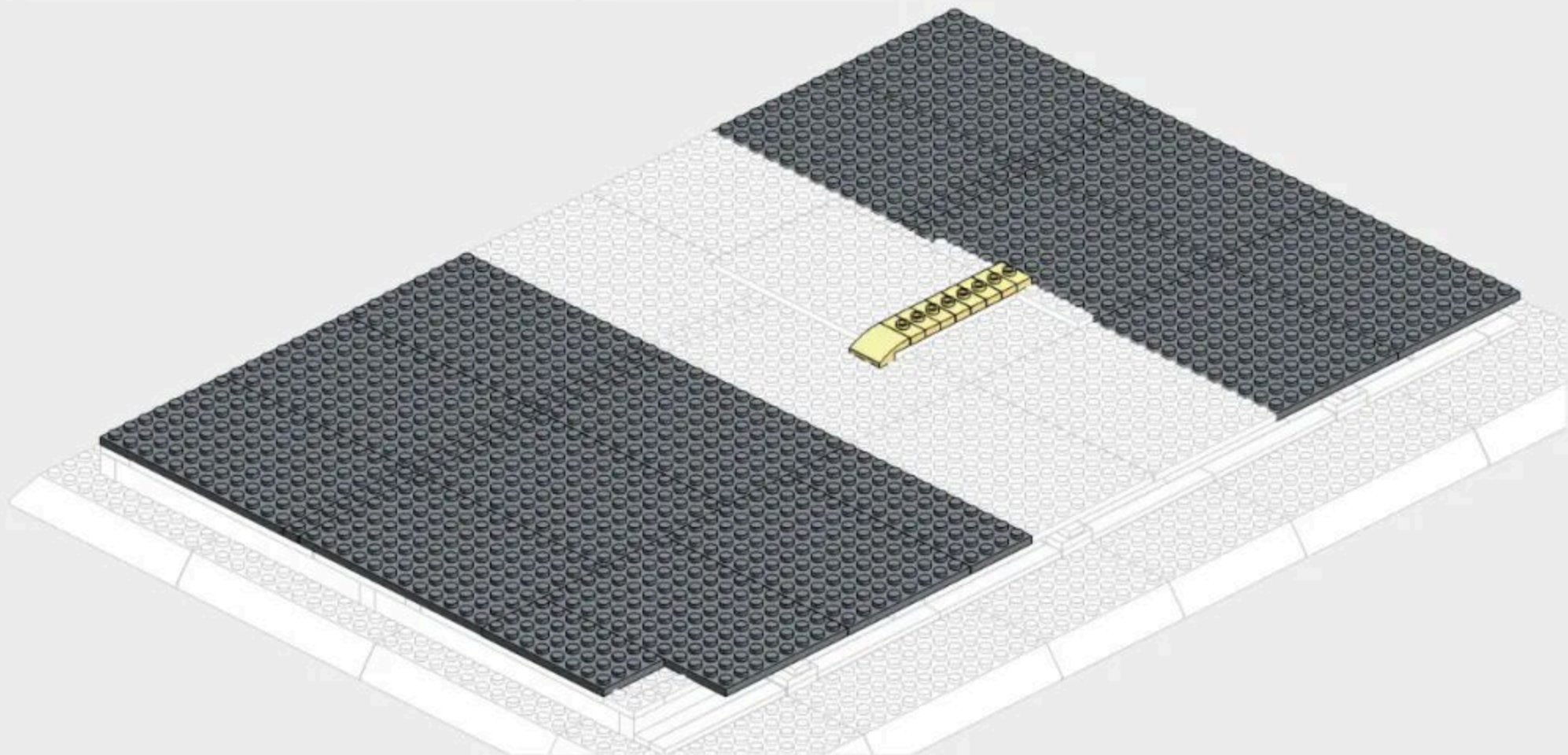
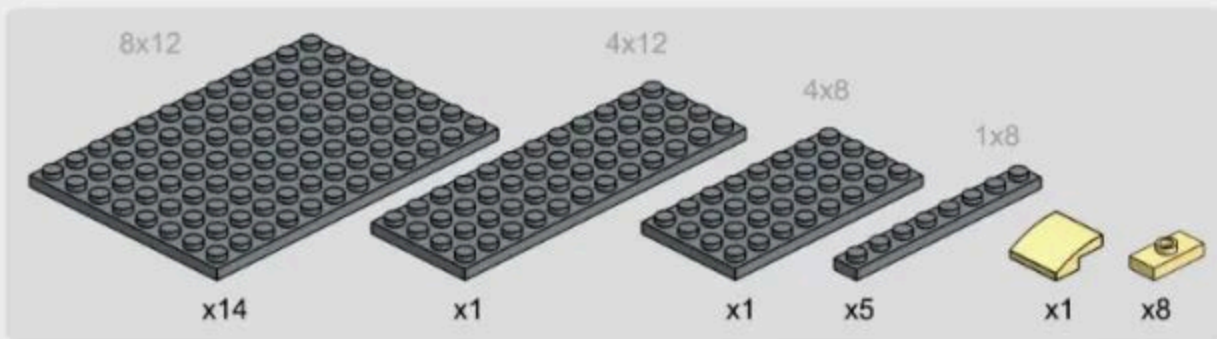



272 PCS

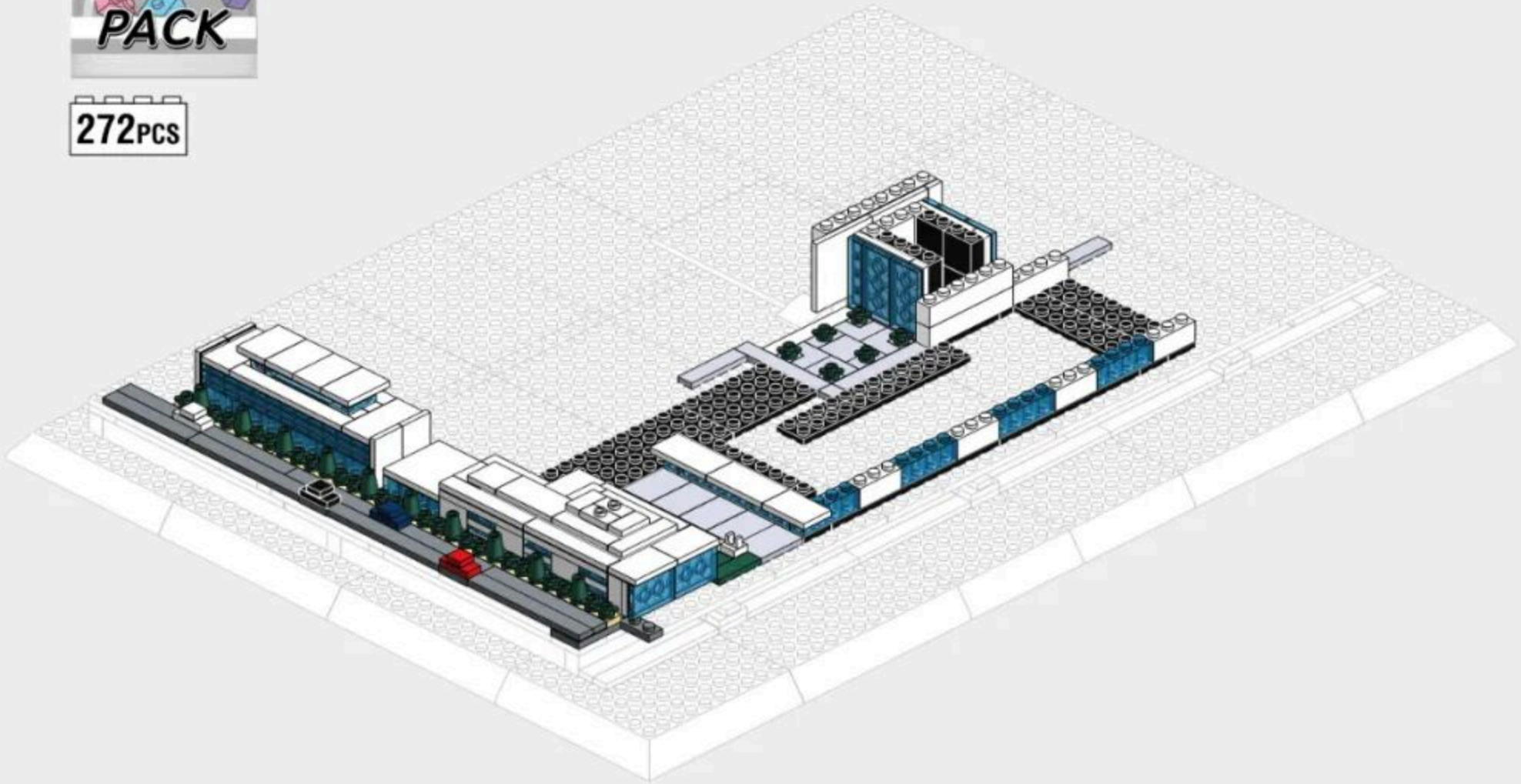



2-2

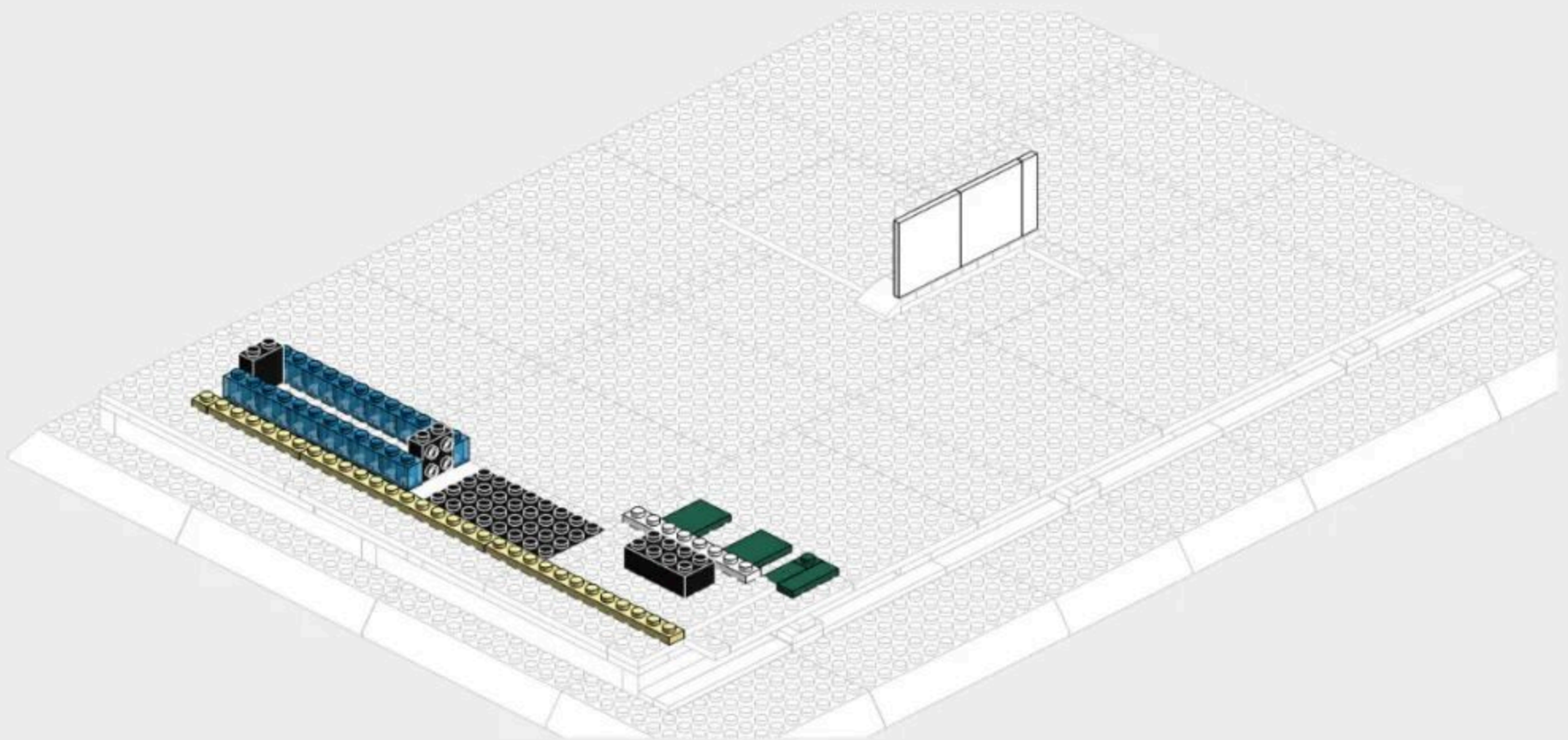
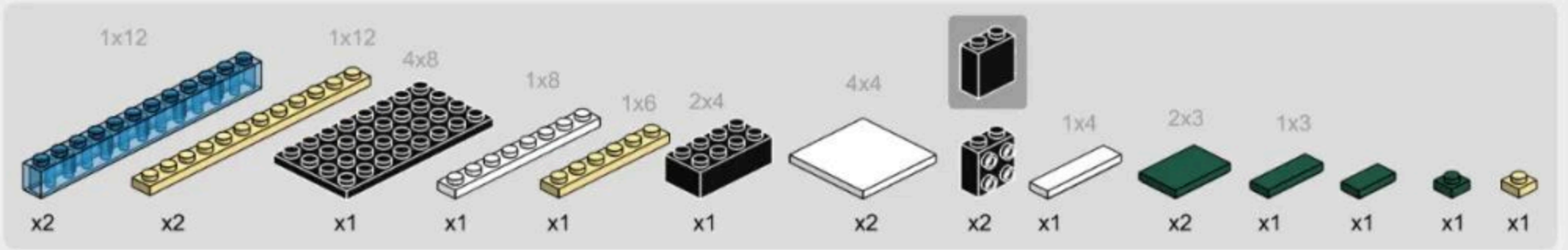

2-3

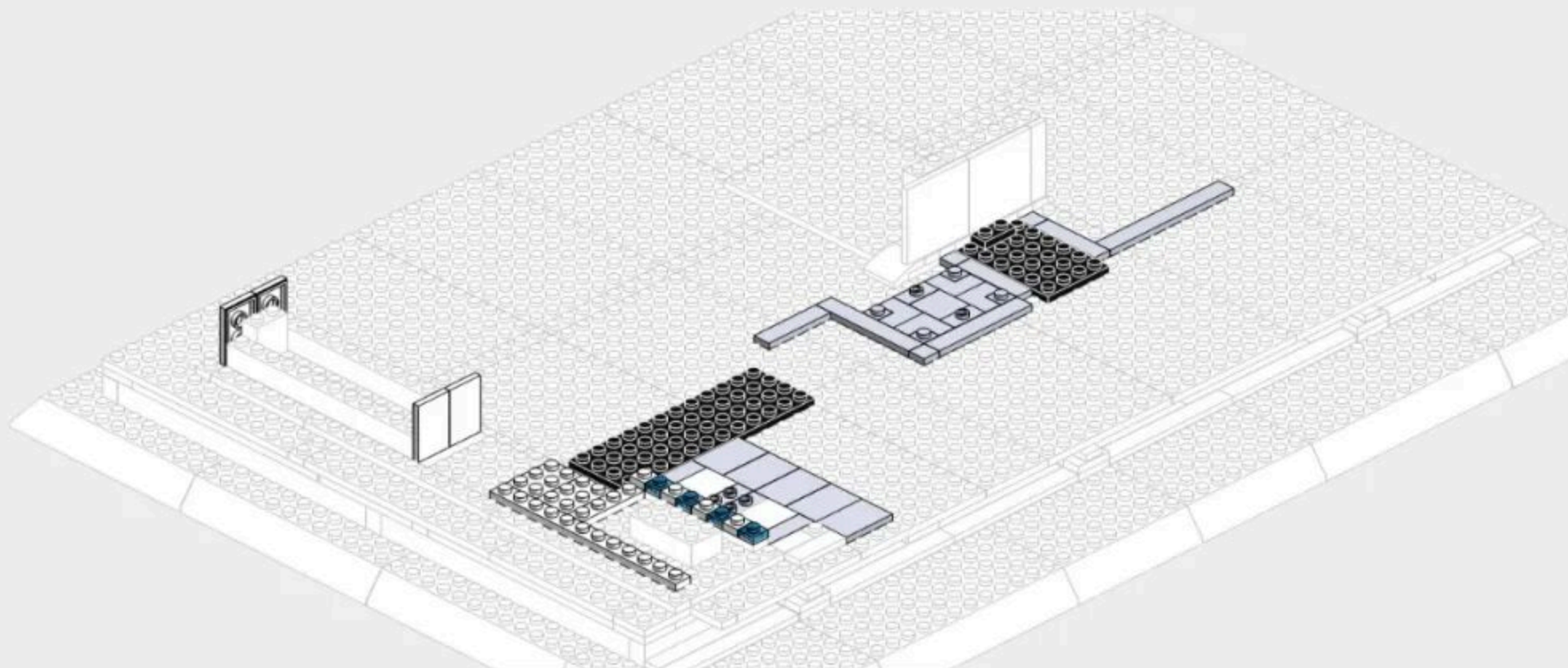
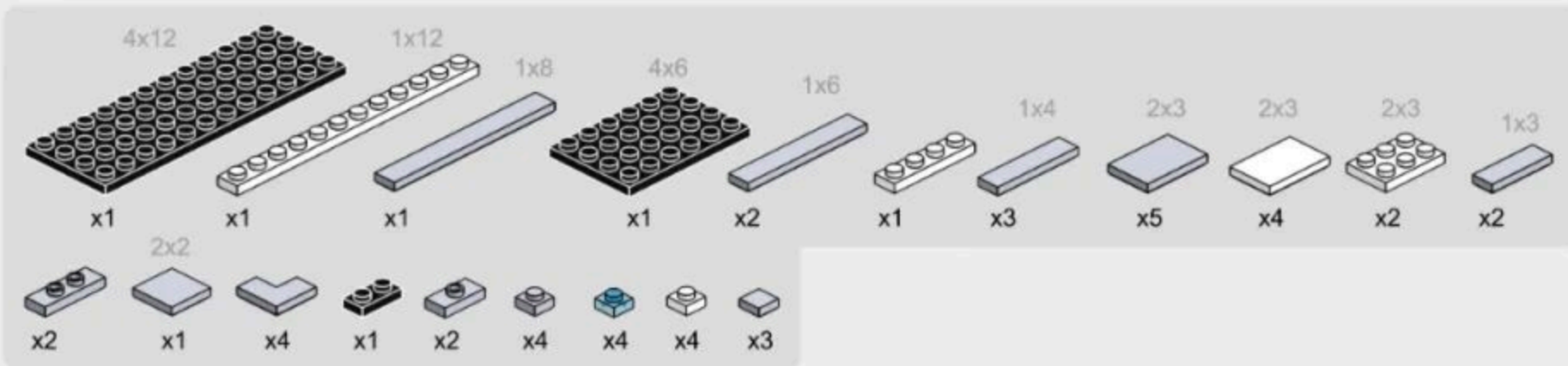



2-5

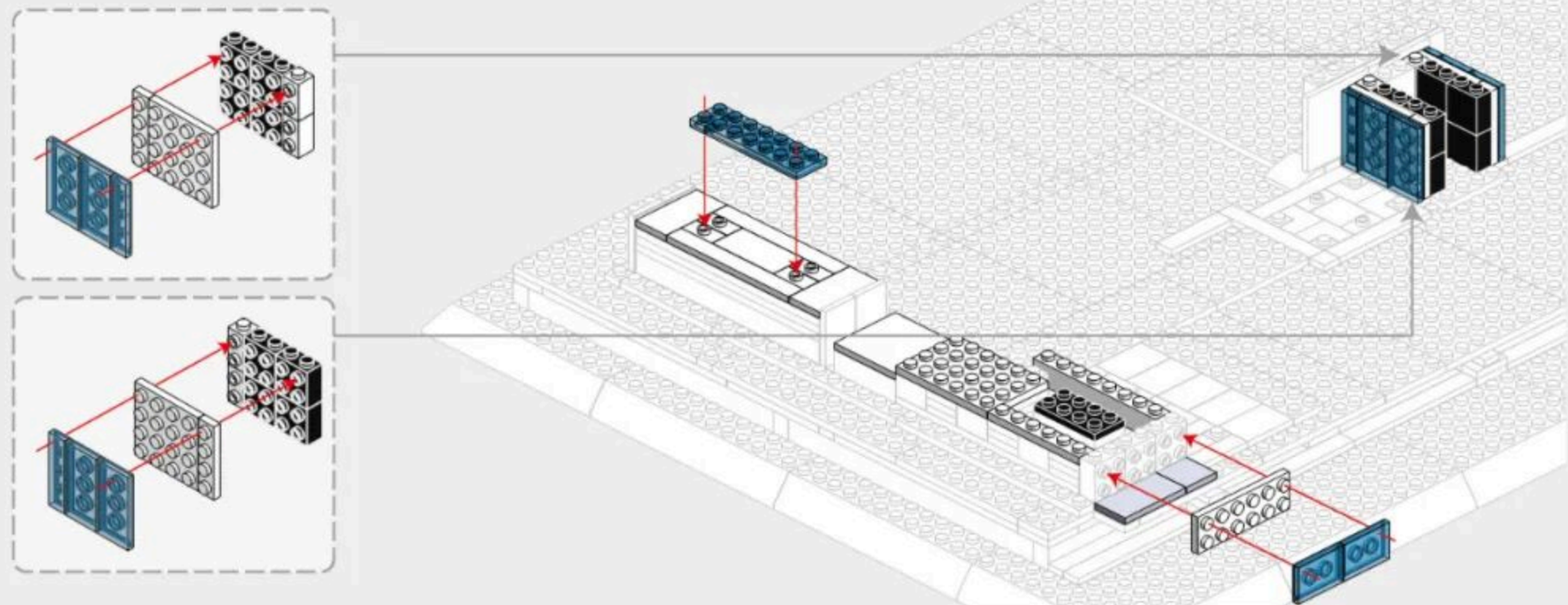
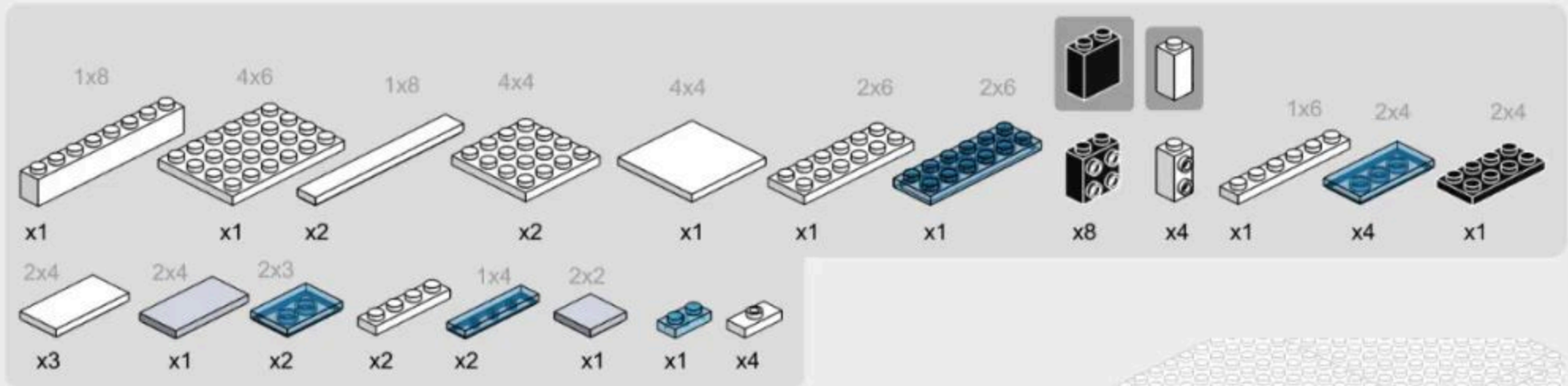



2-7

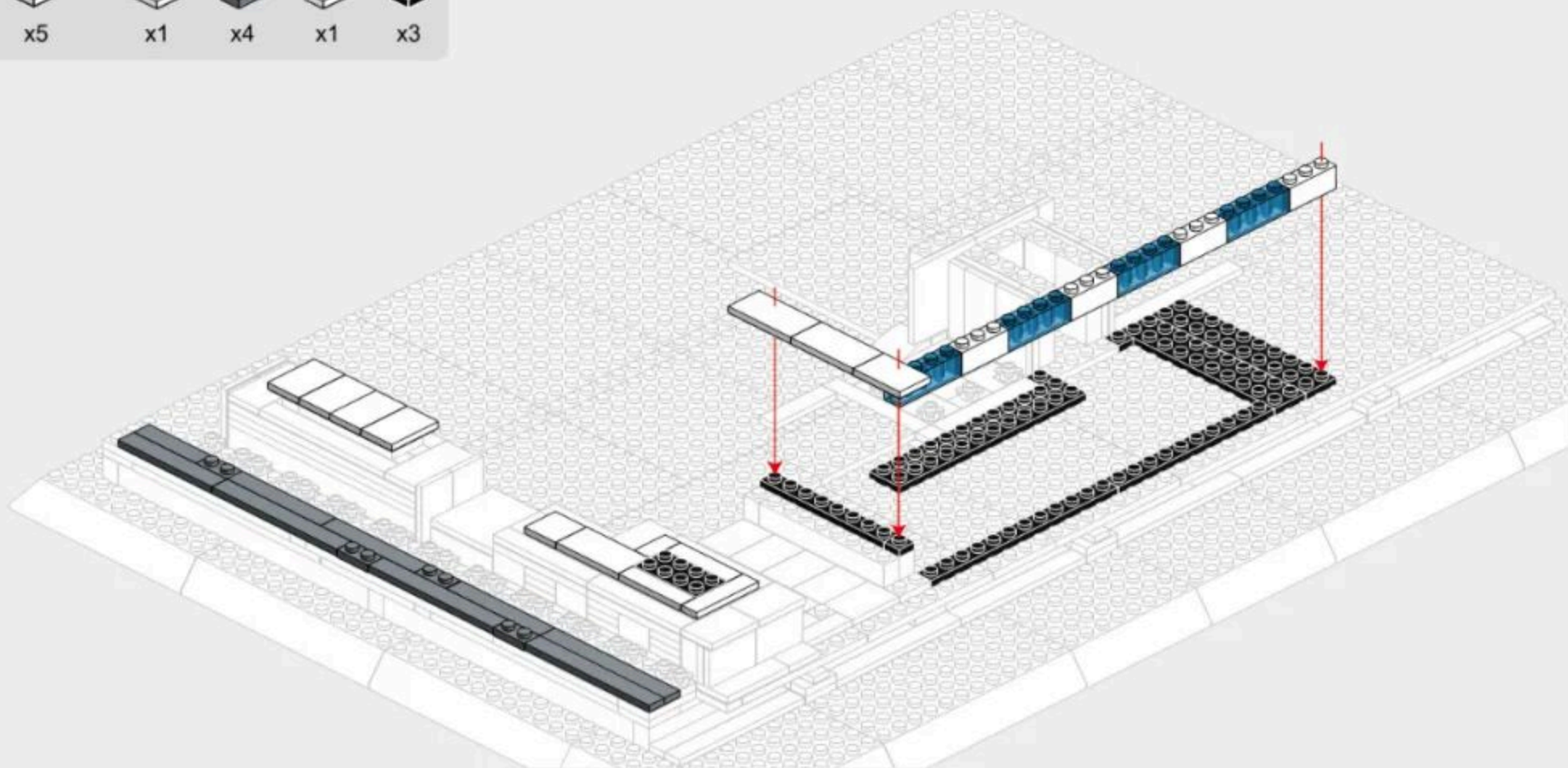
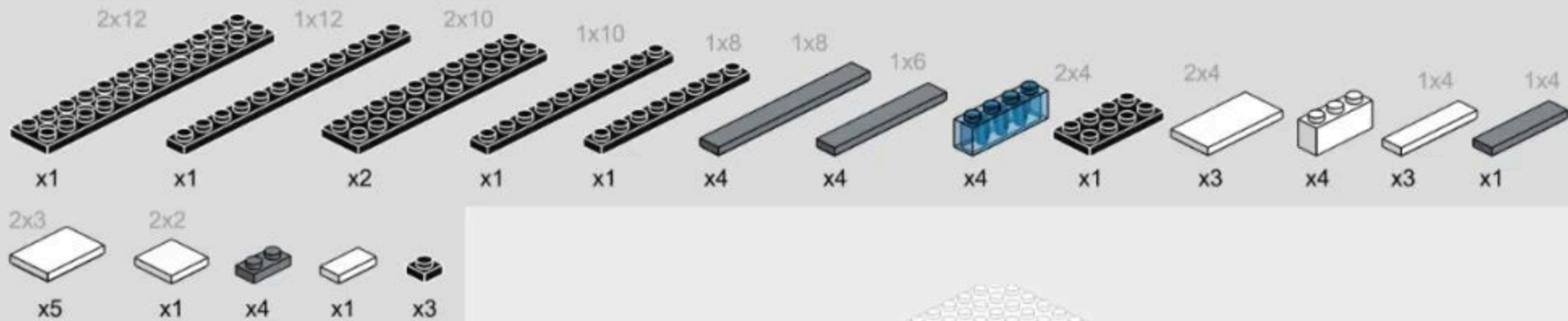

2-8

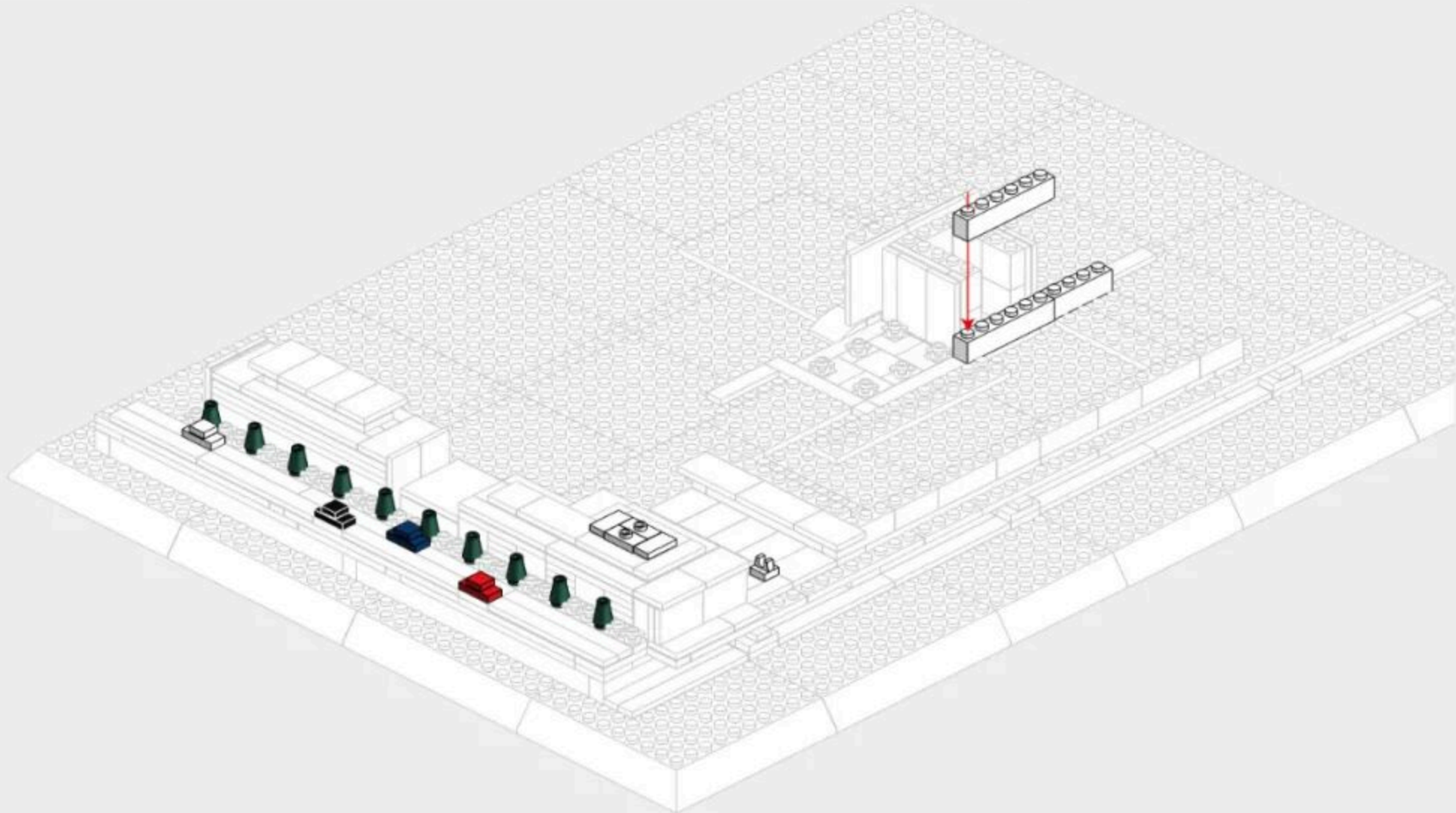



250PCS

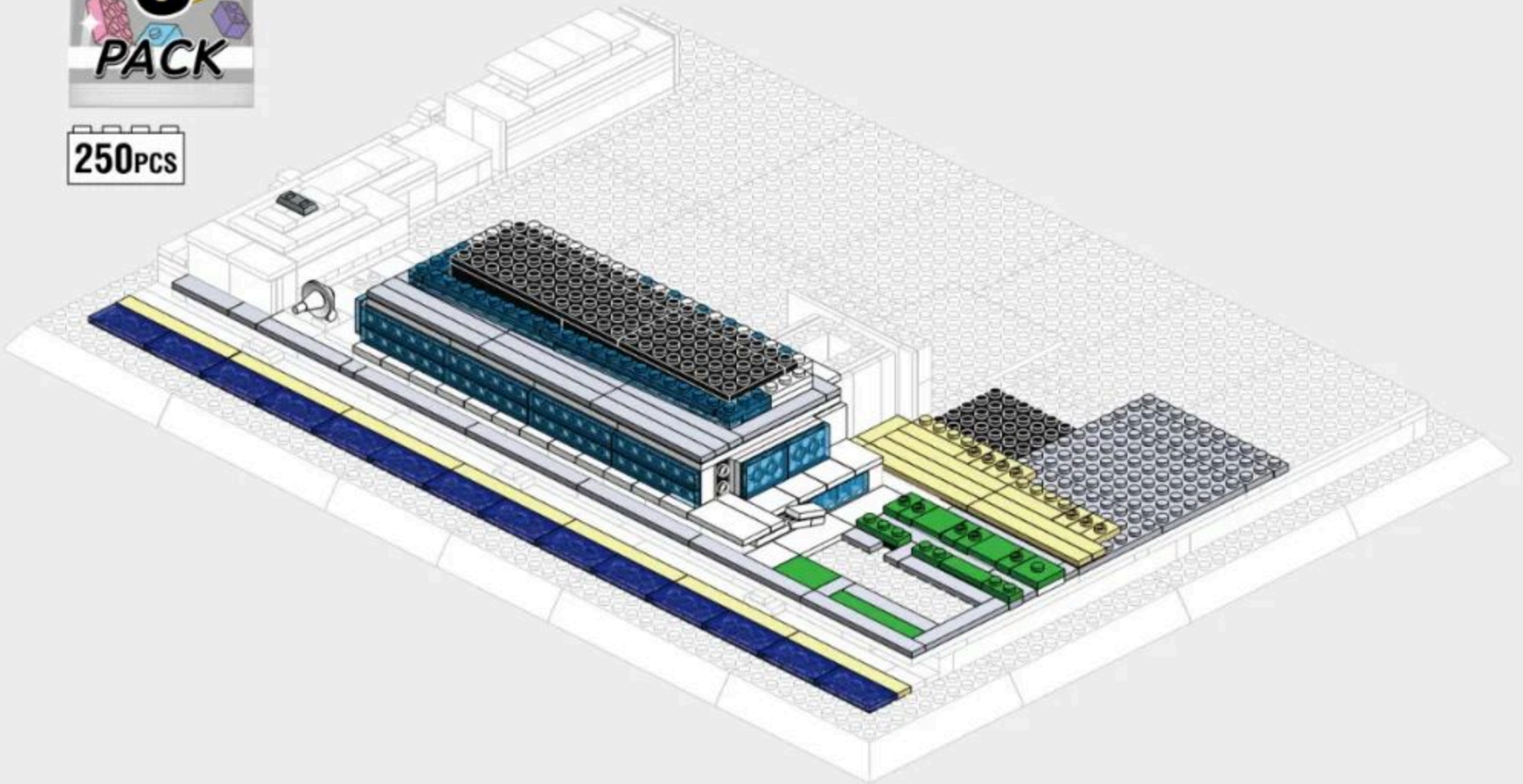

3-1

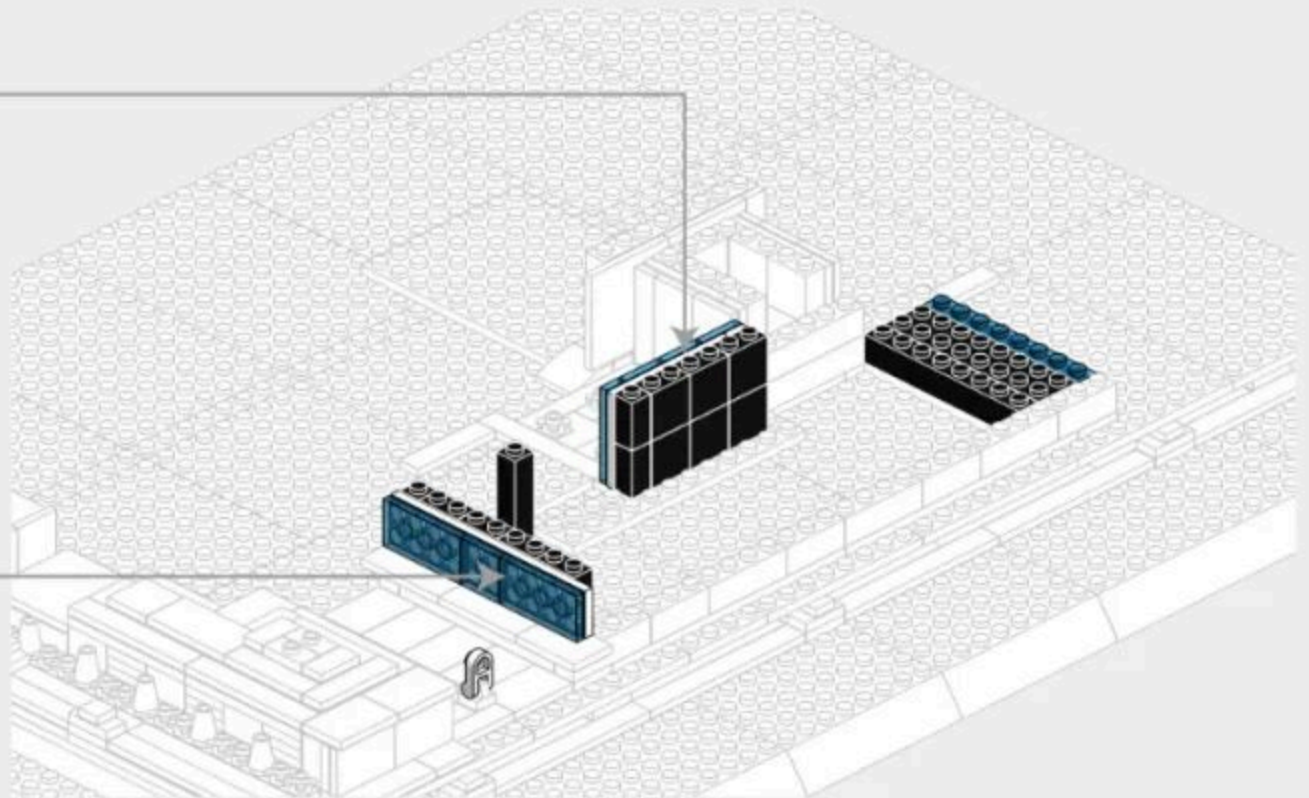
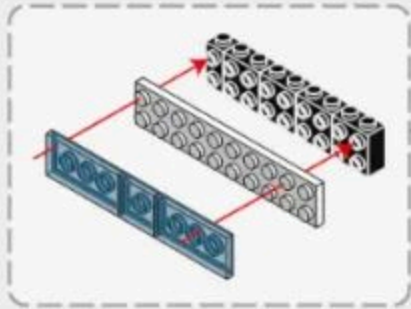
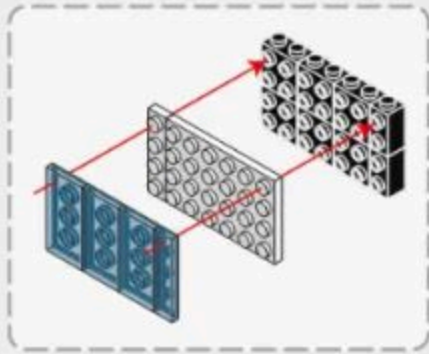
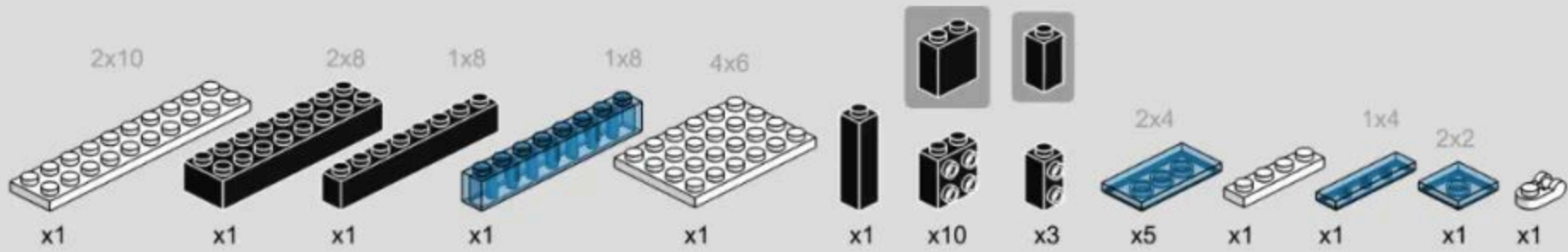



3-3

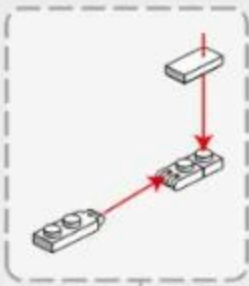
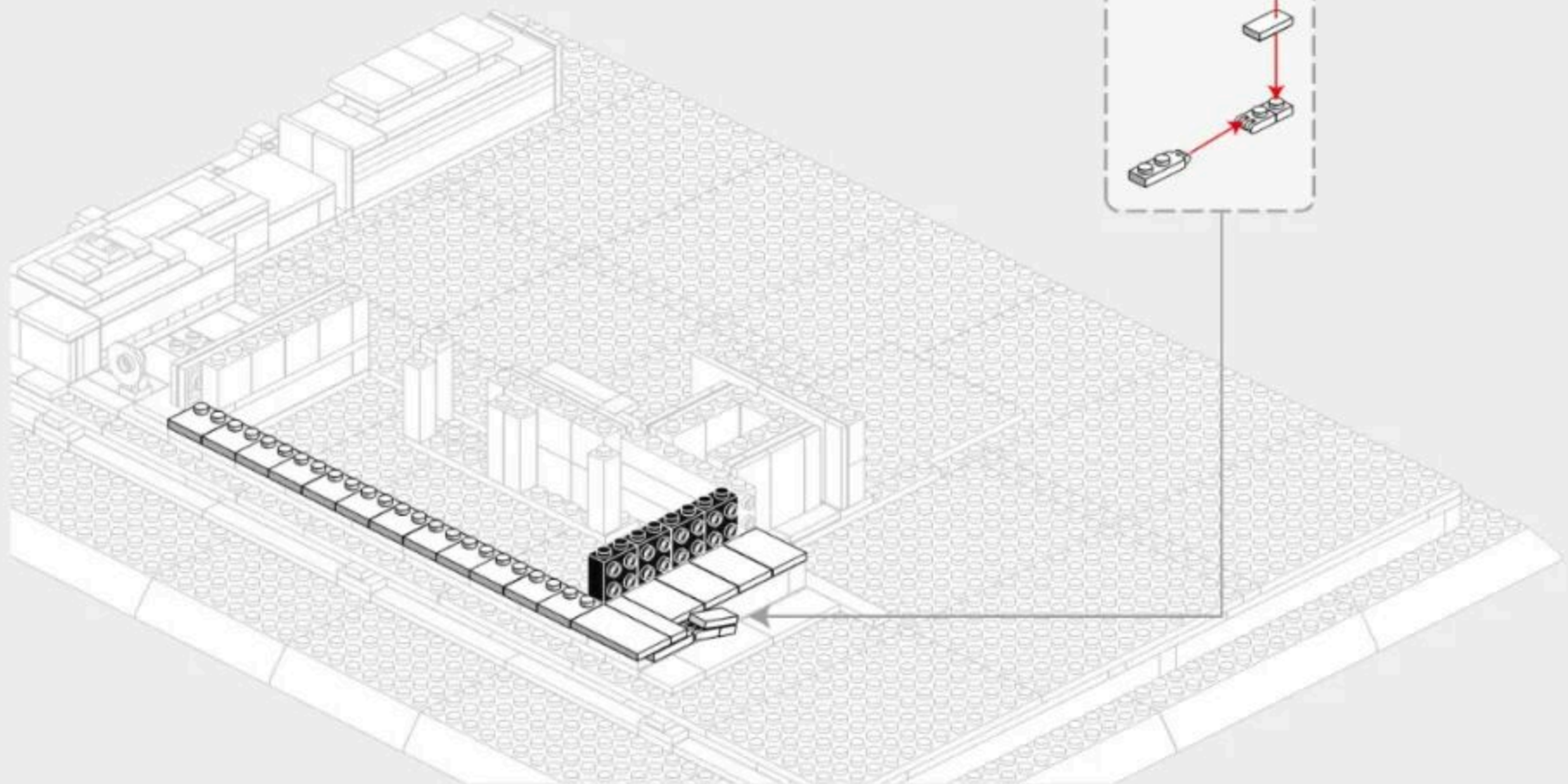
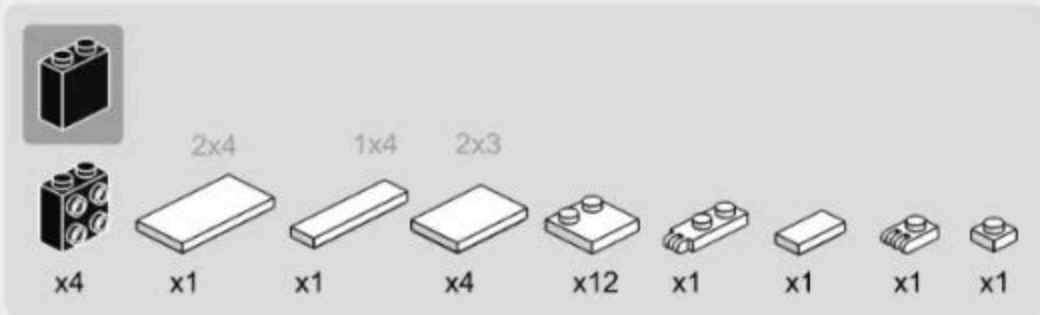

3-4

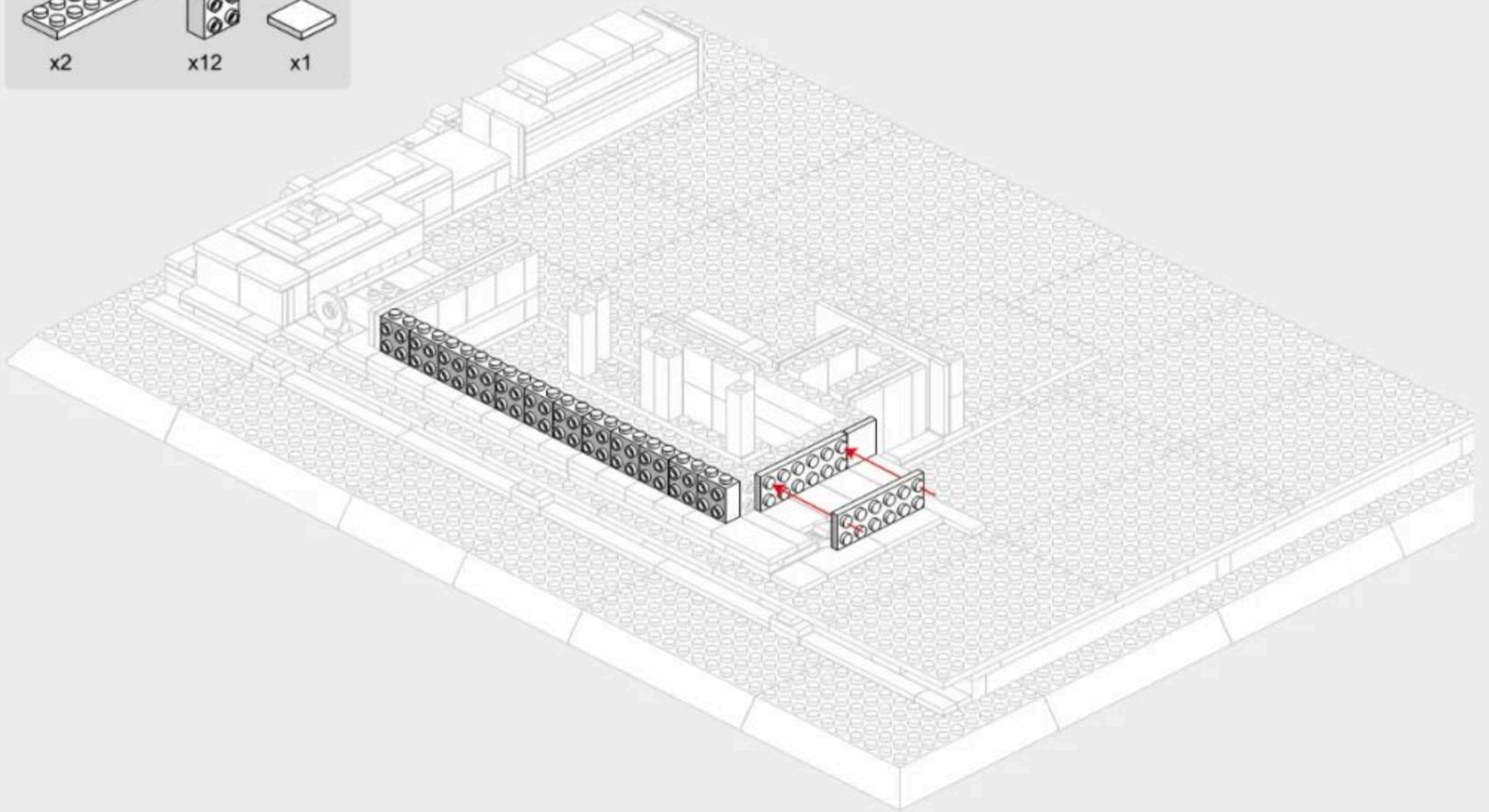
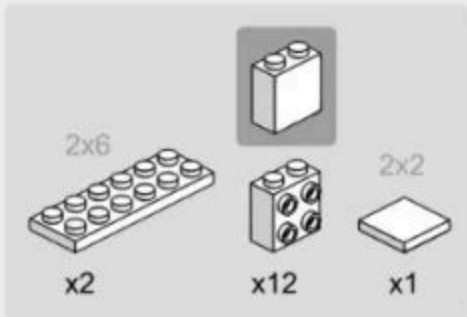





3-7

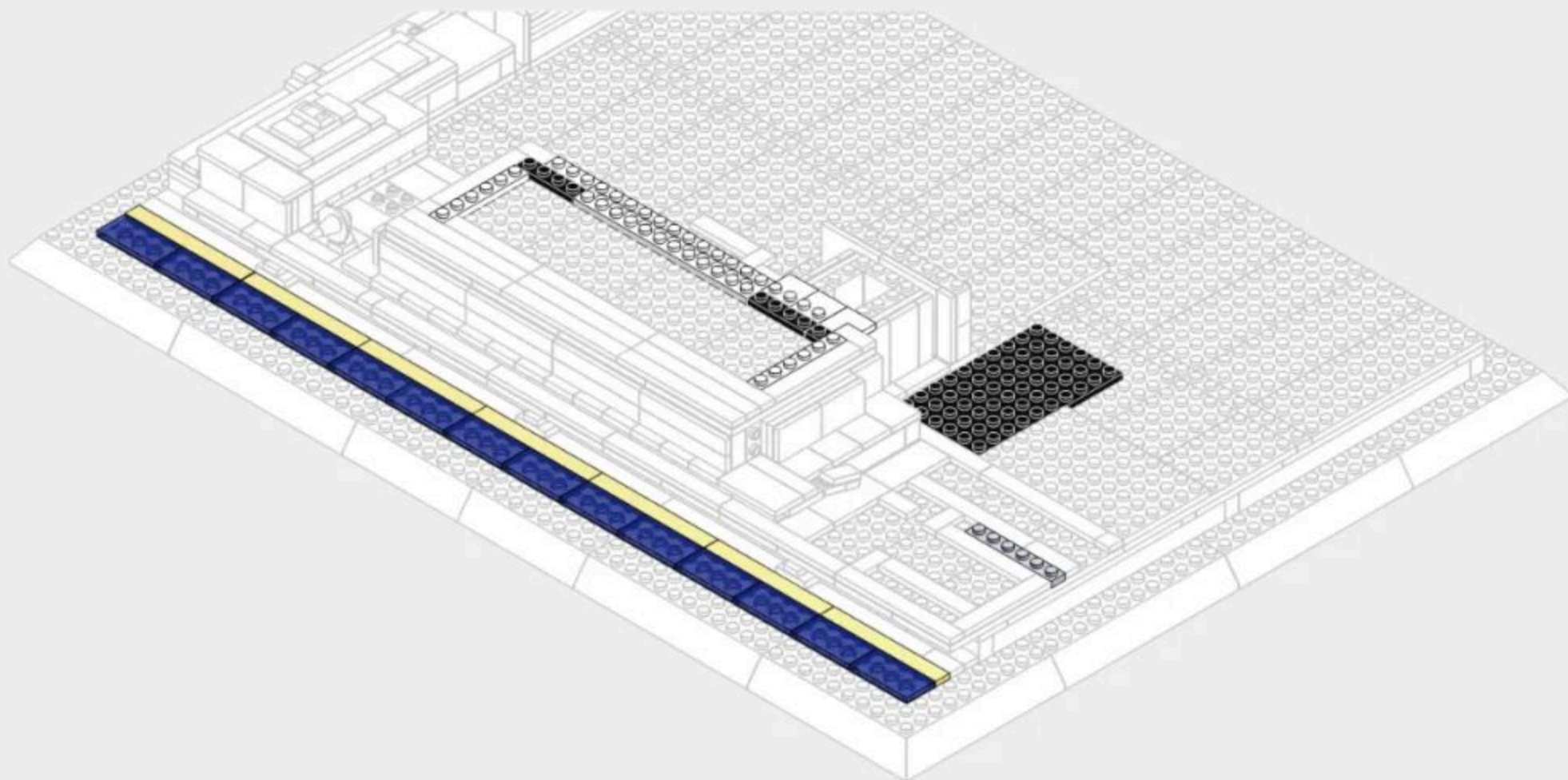
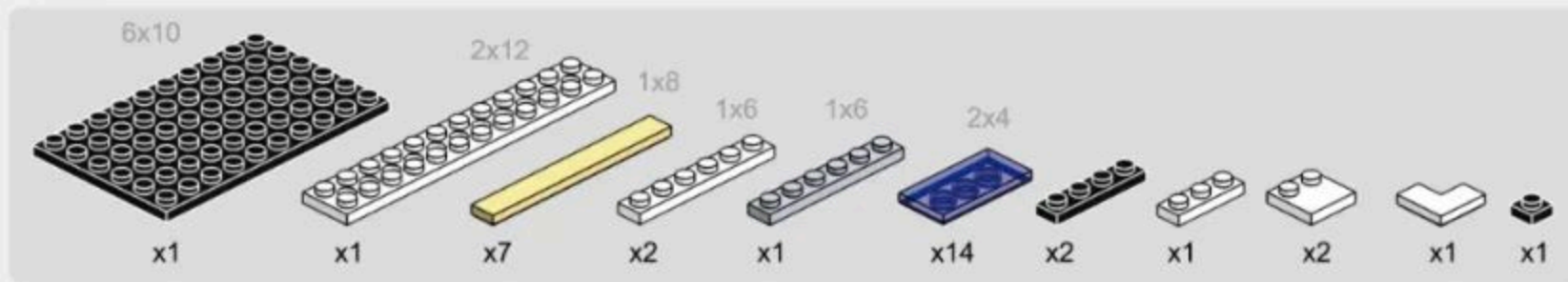

3-8

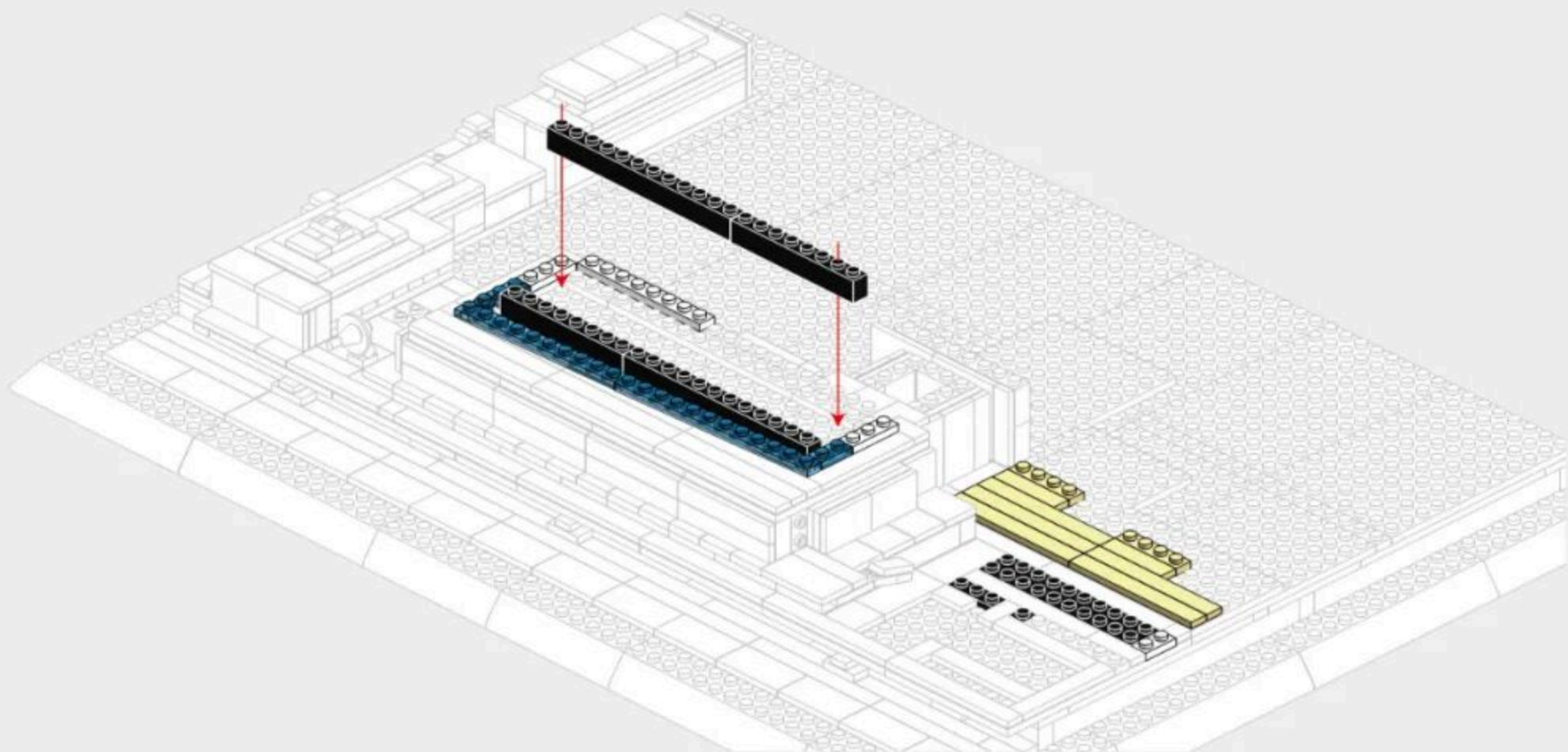
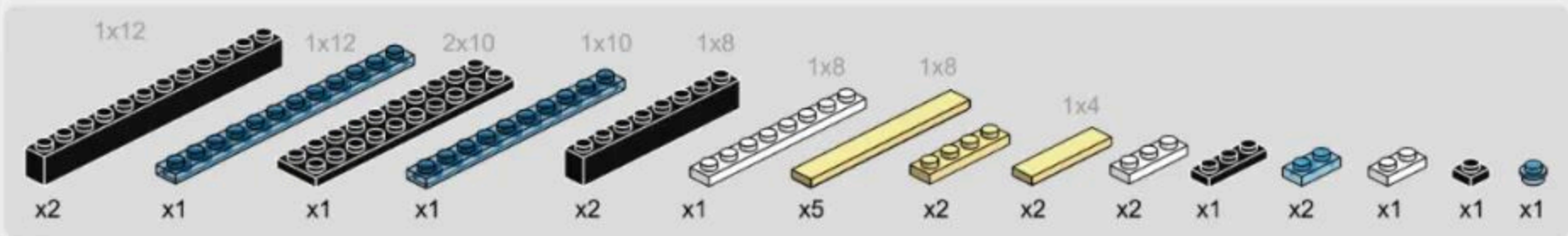

3-9

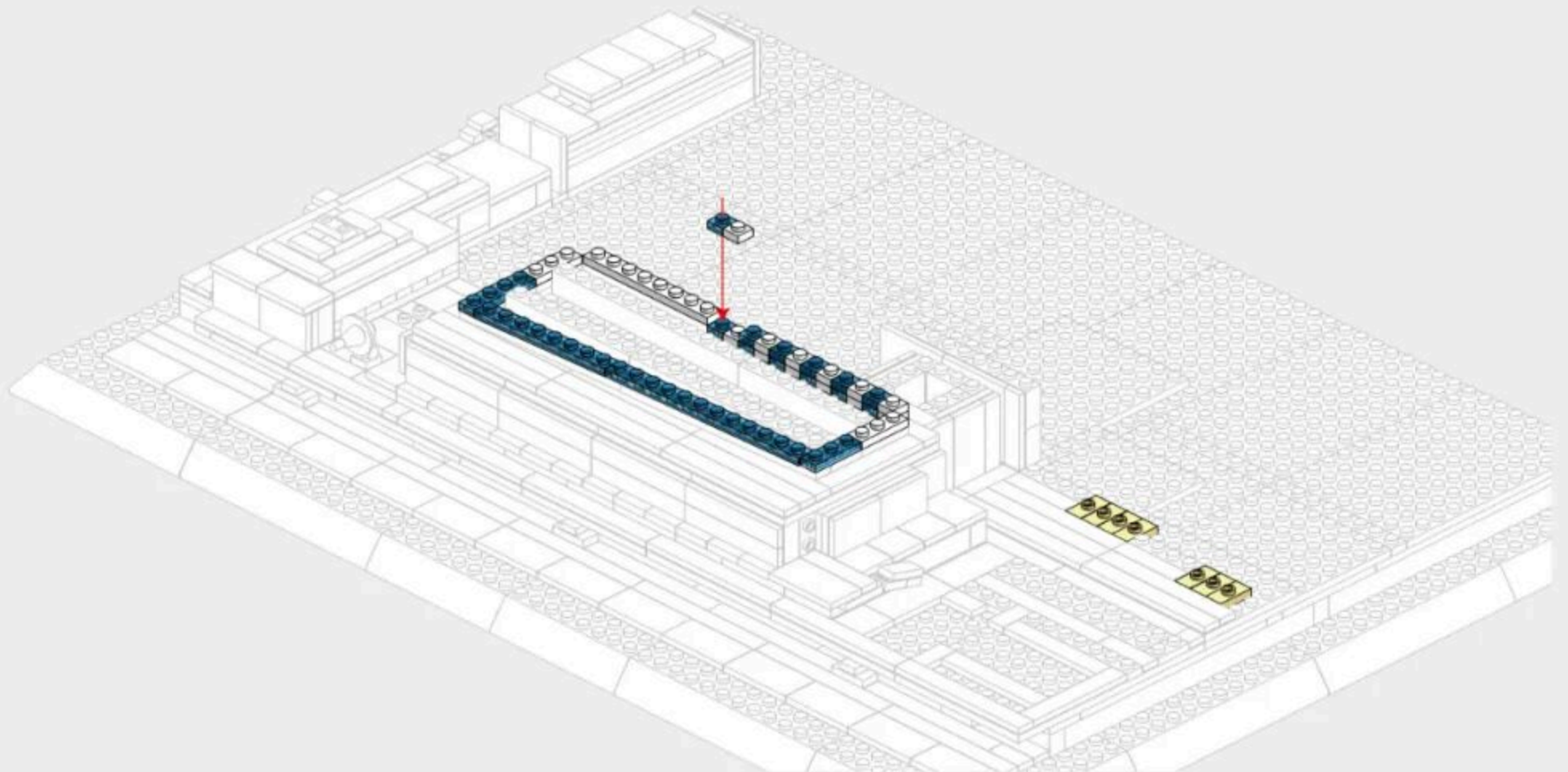
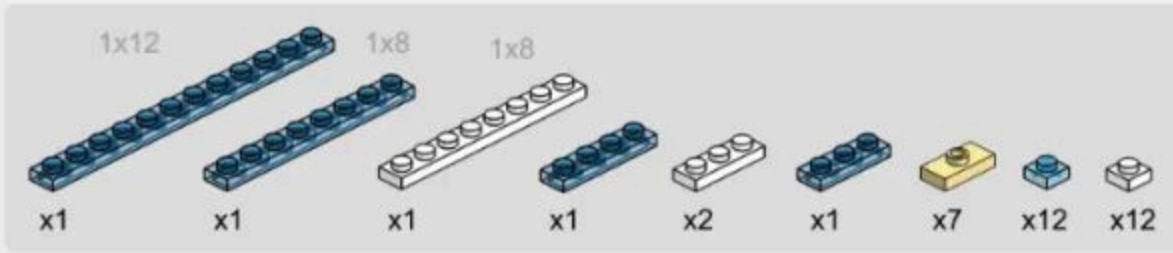

# 3-10

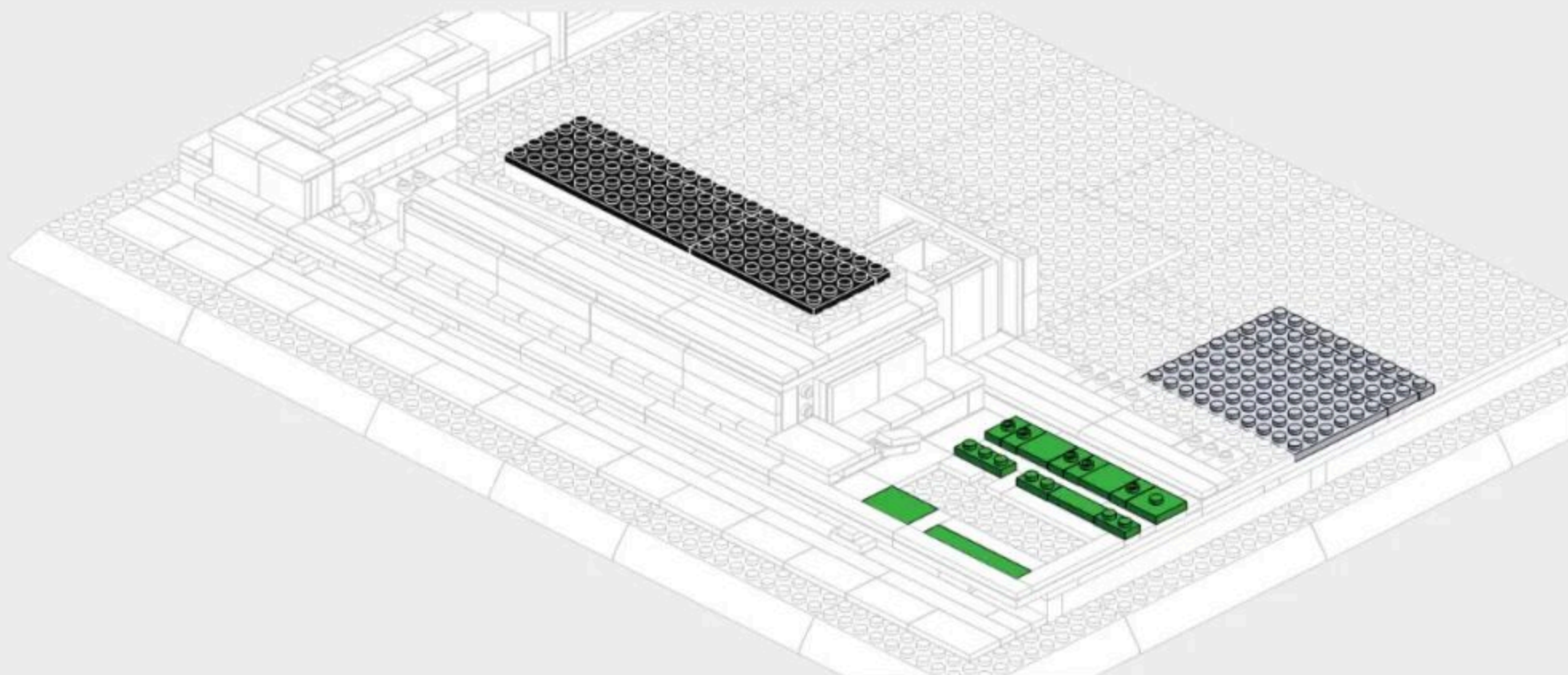
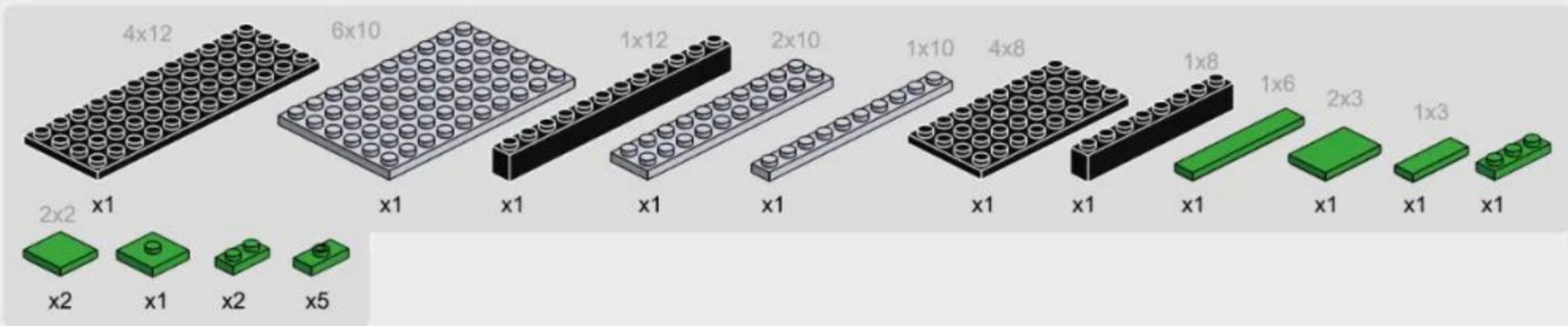



286PCS

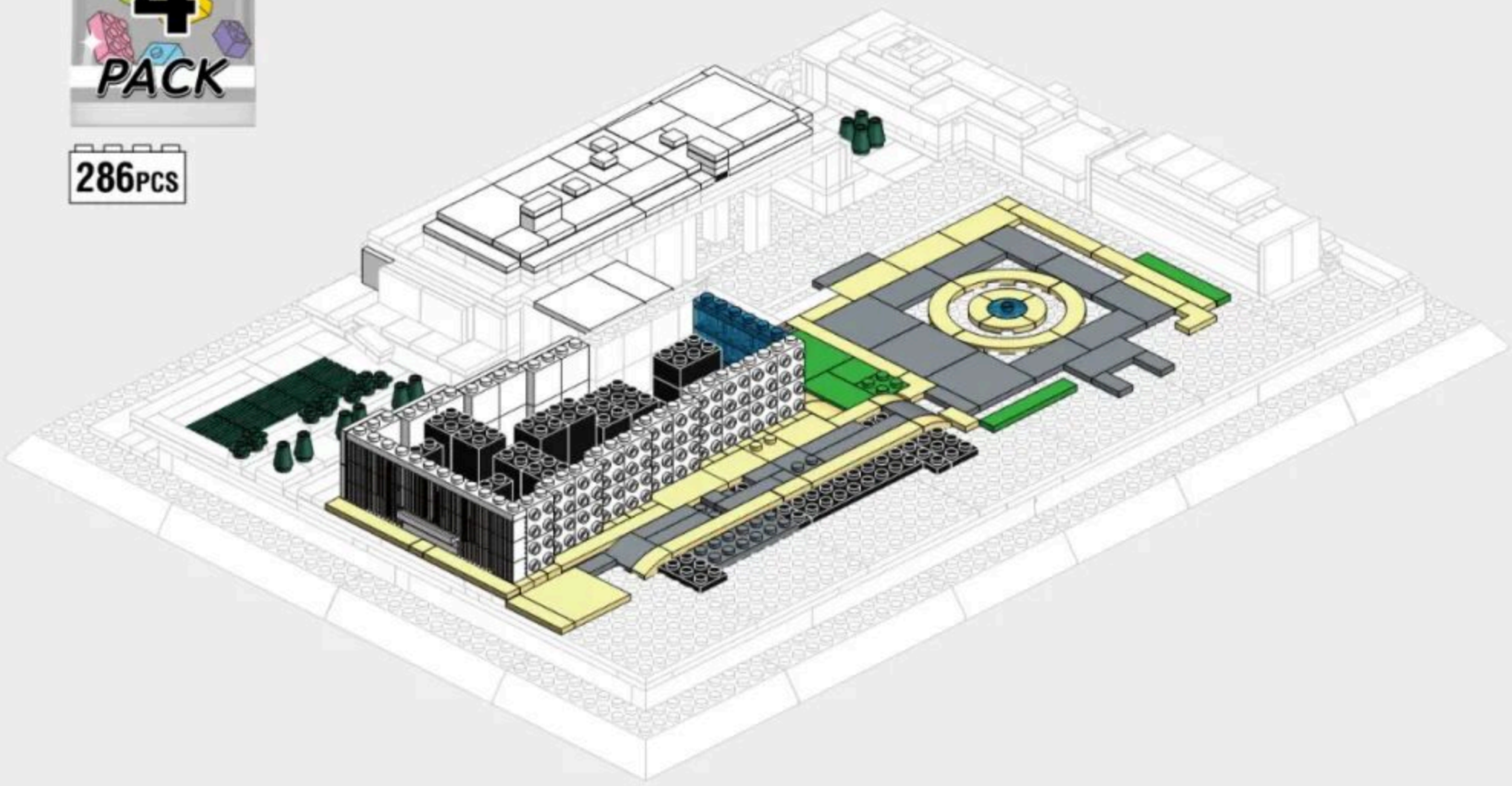



# 4-2

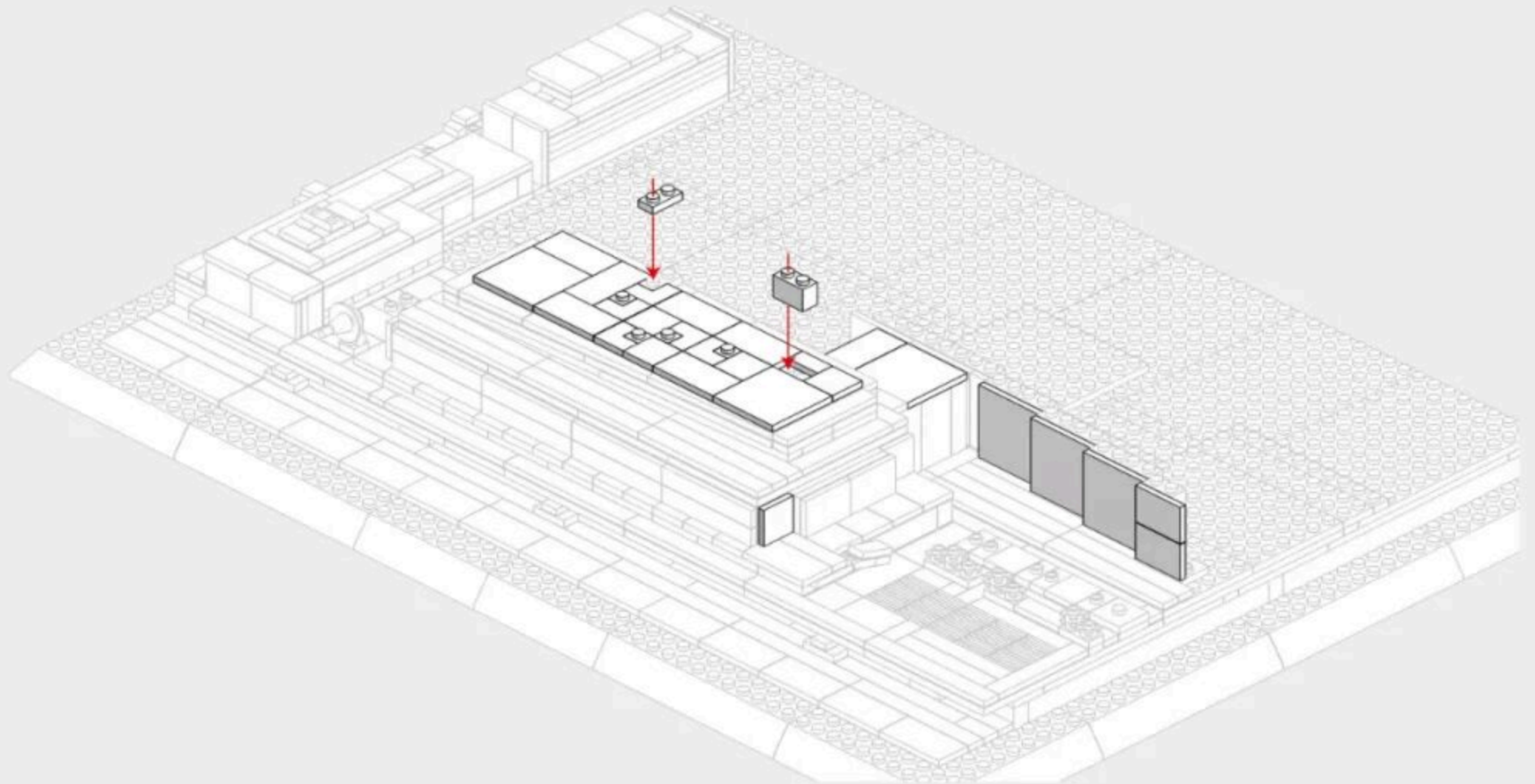
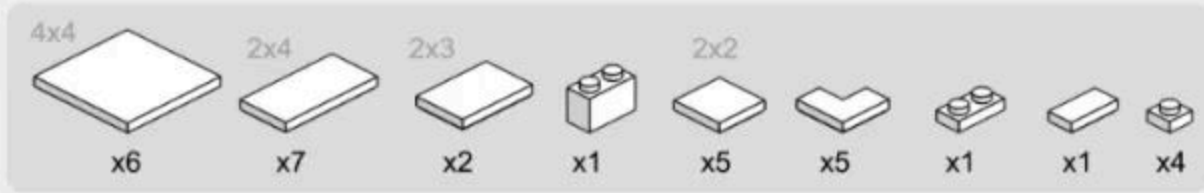

4-3



x10



x2



x4

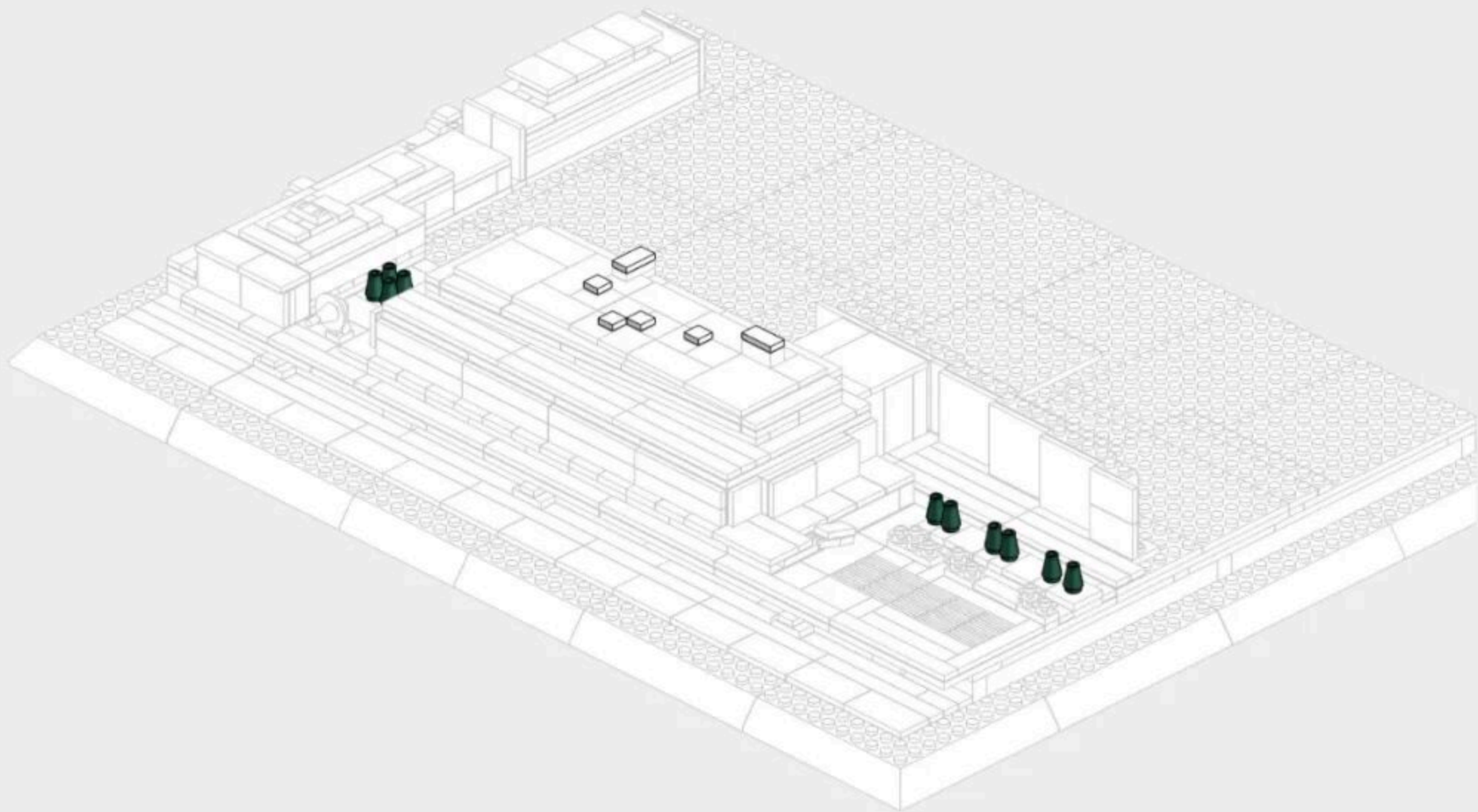

4-4

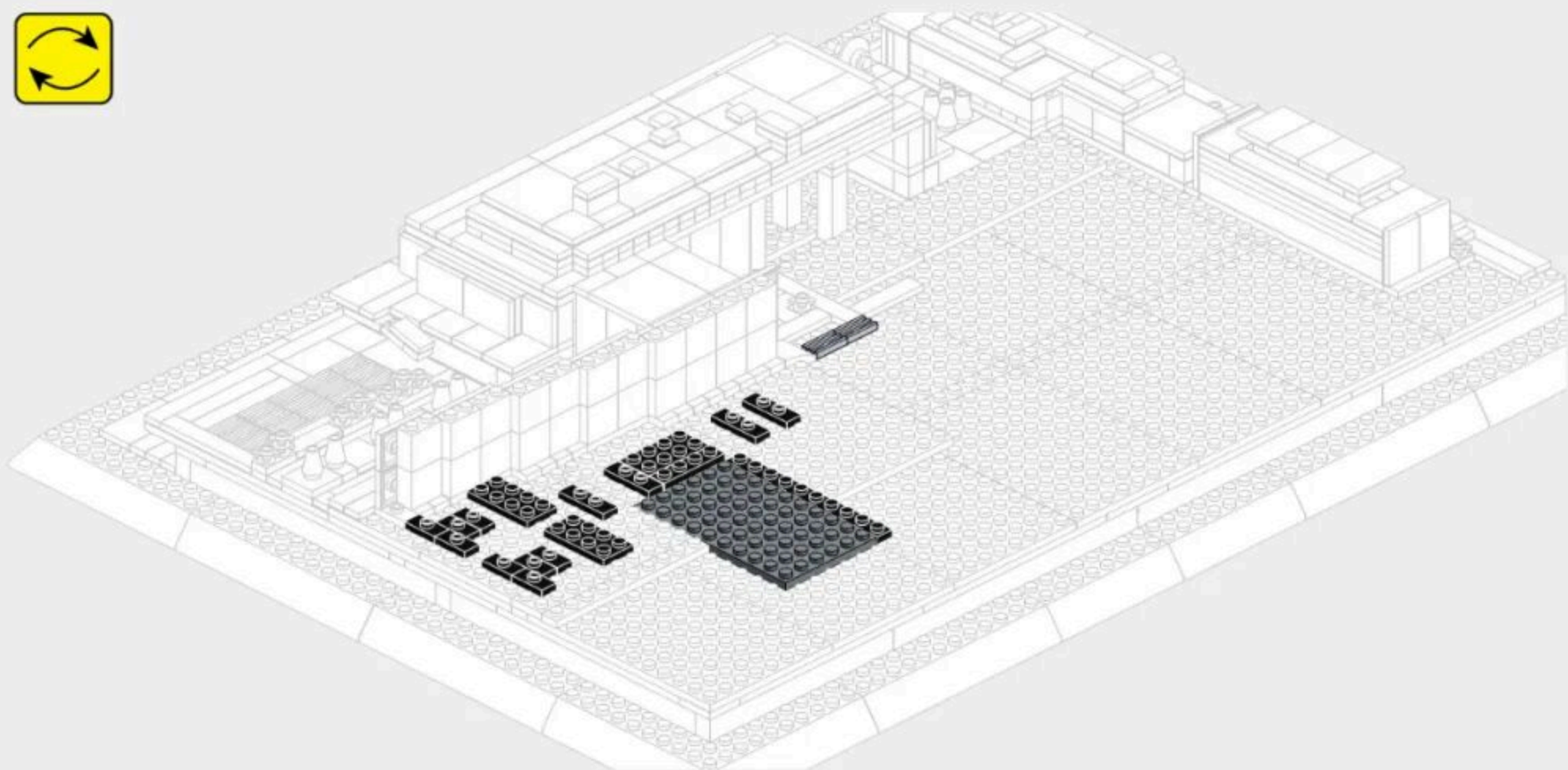
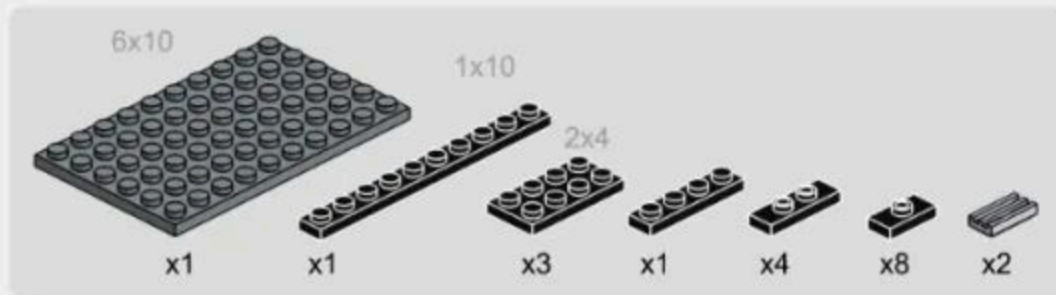

4-5

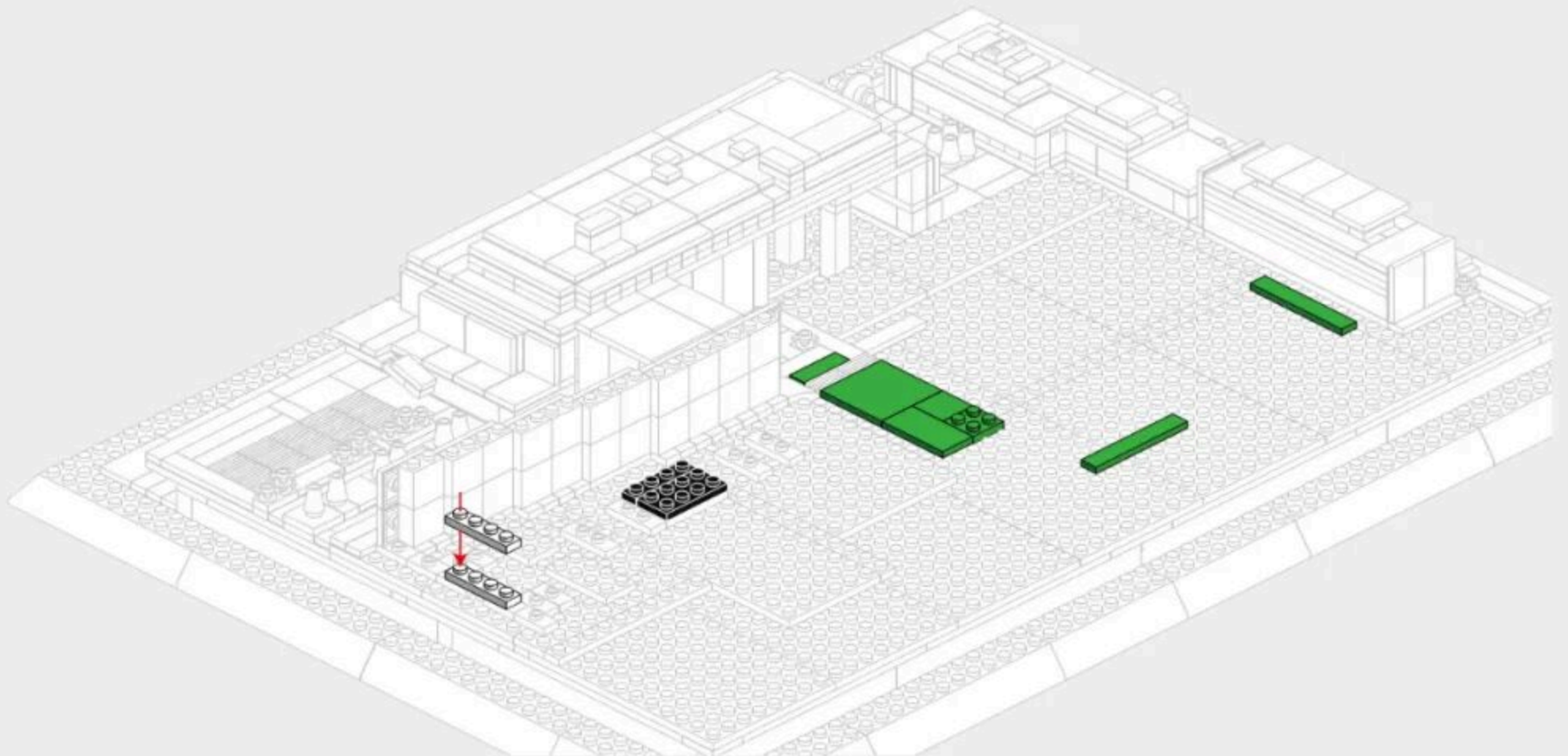
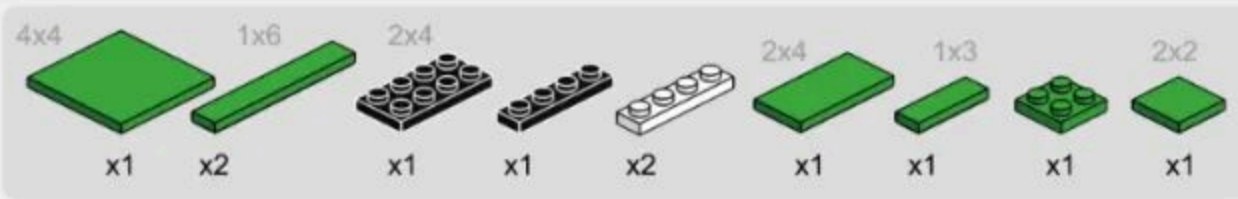



4-7

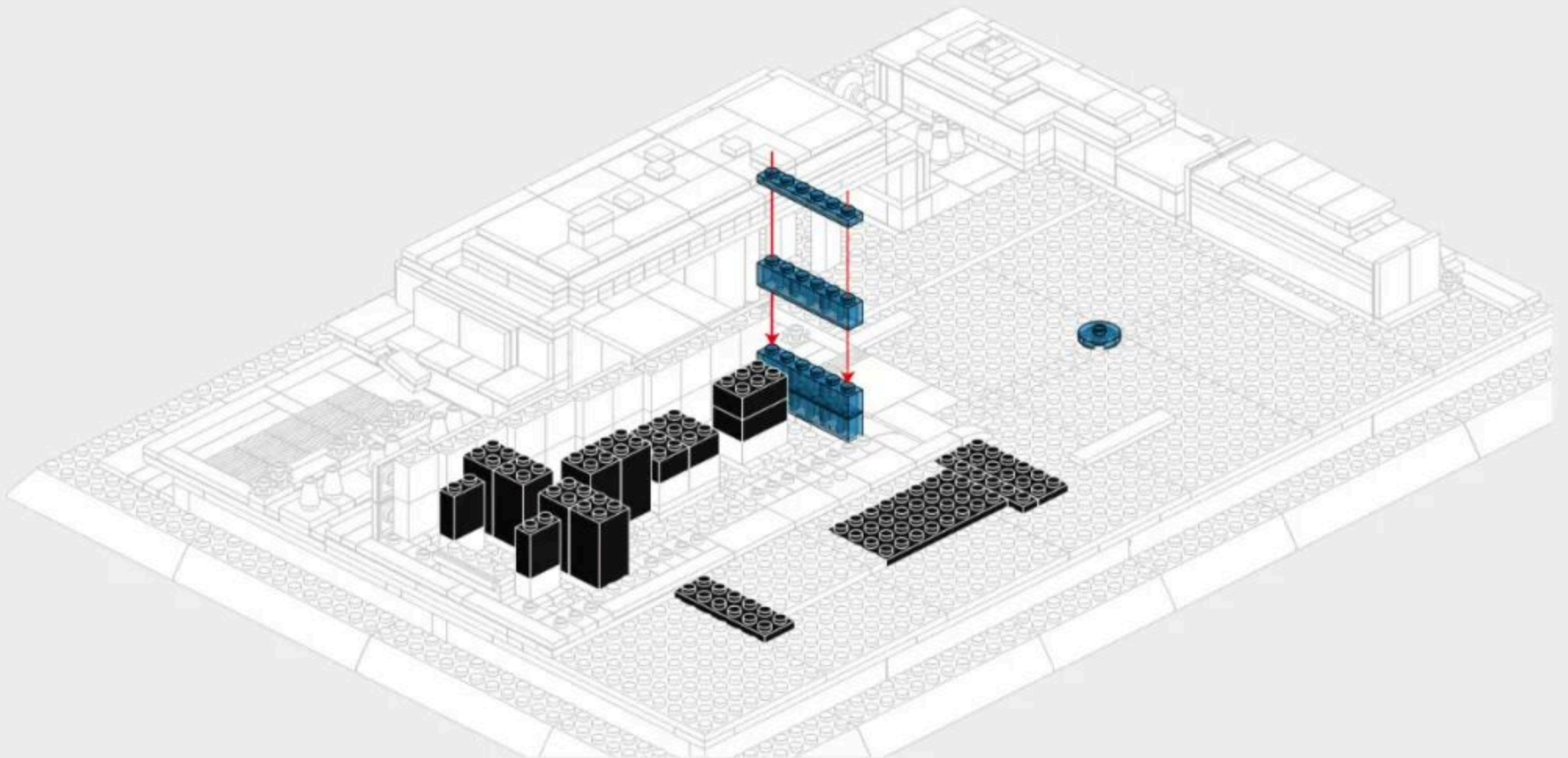
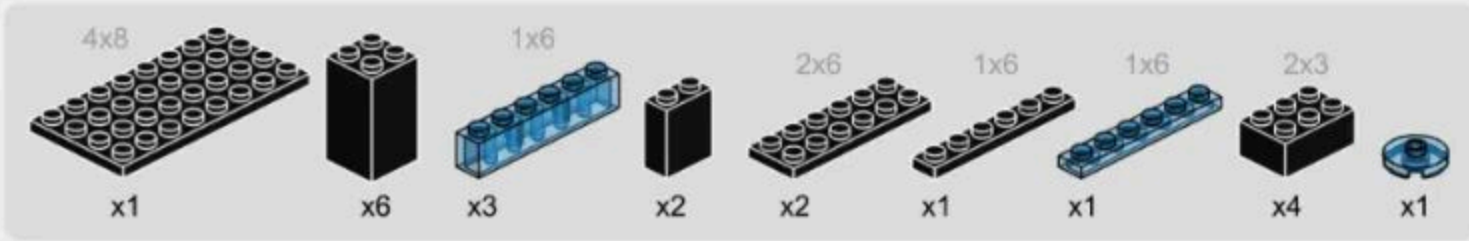

4-8

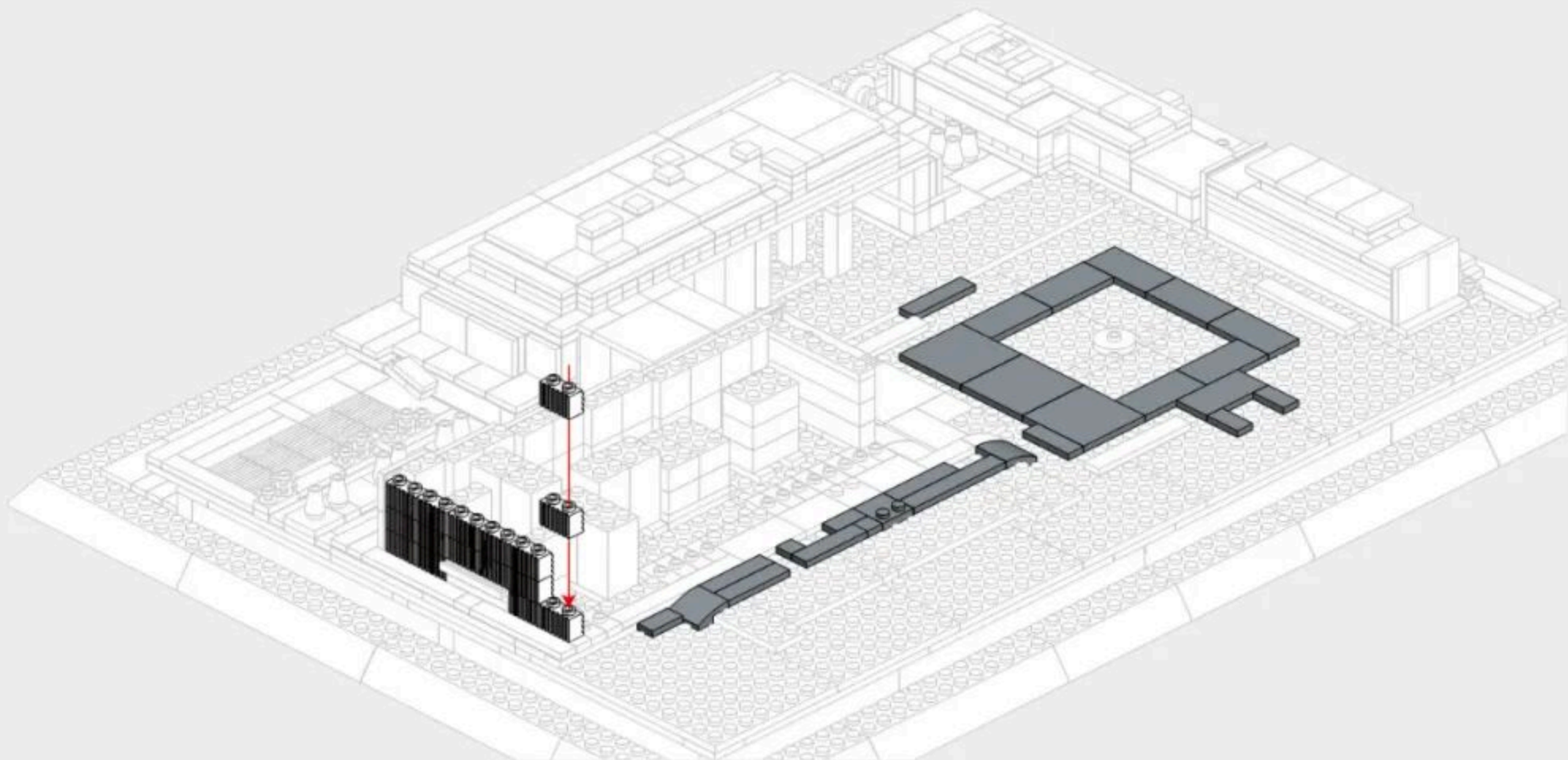

4-9

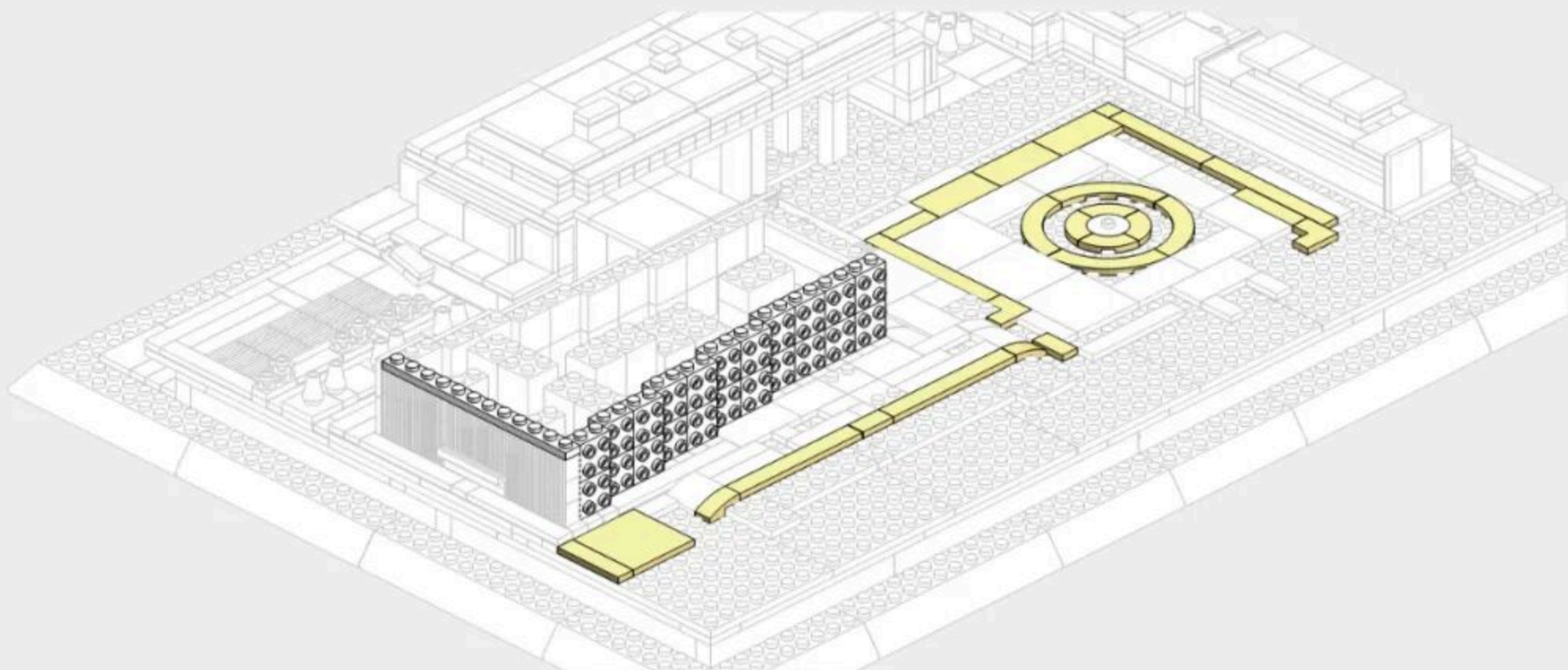
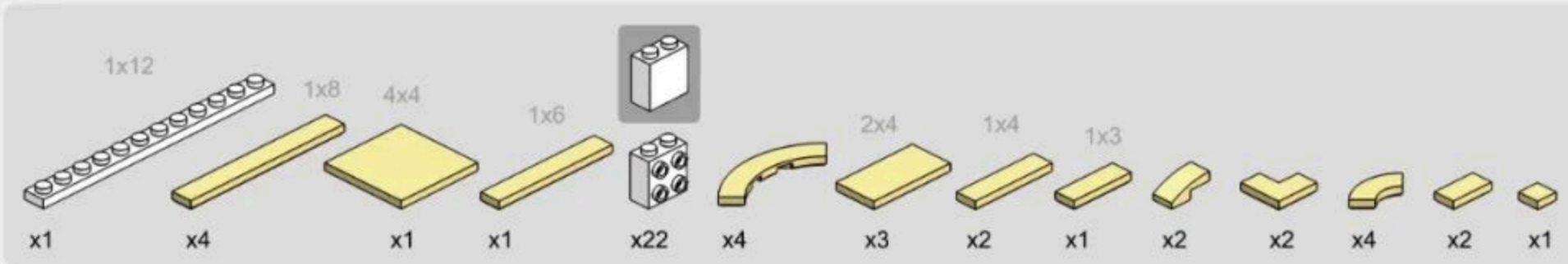



252 PCS

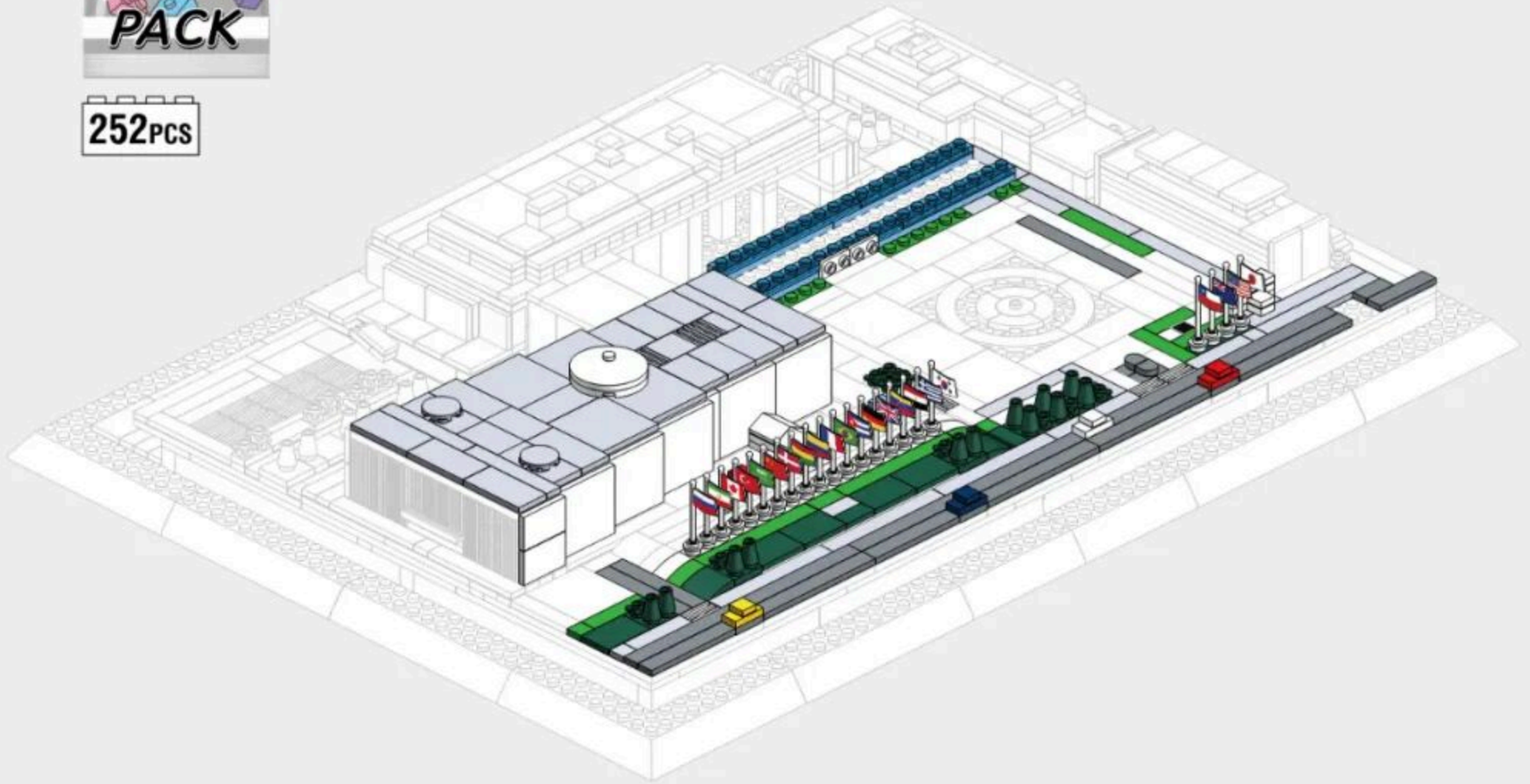

61

# 5-1

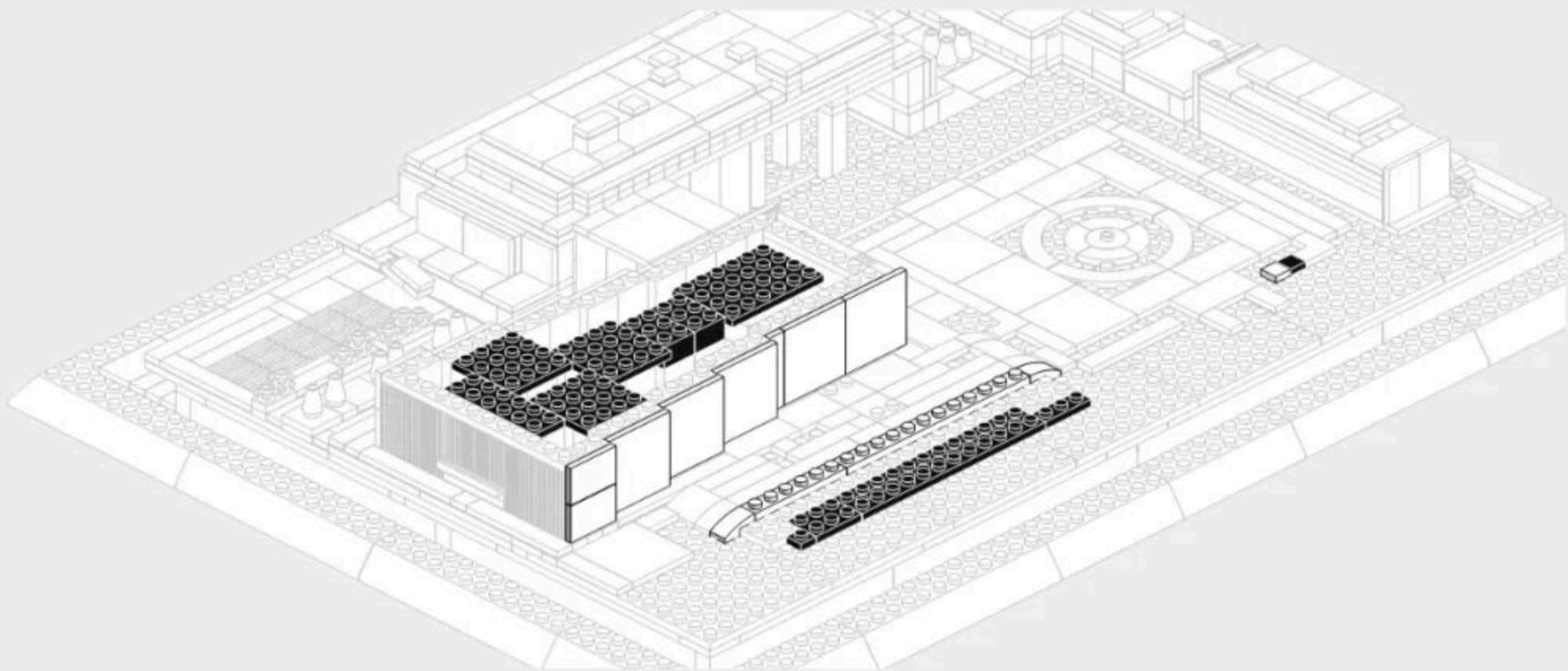
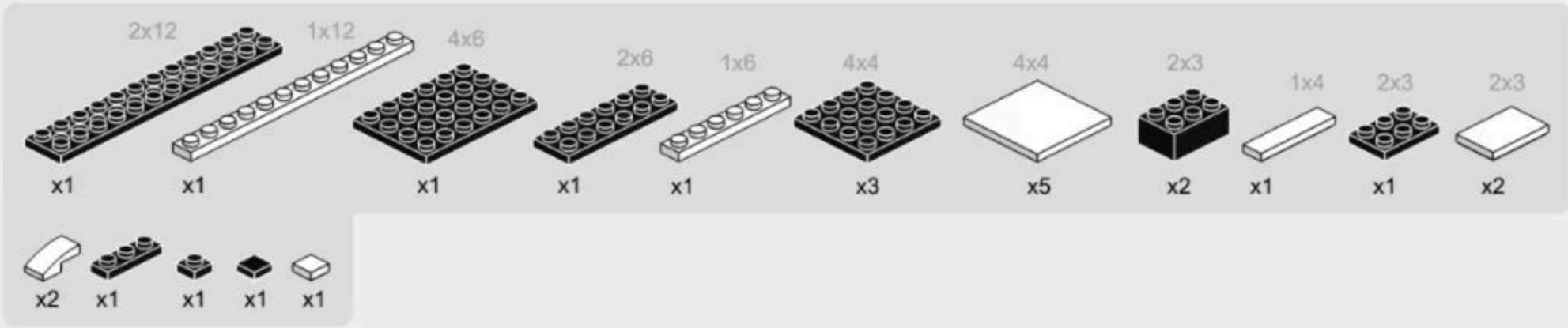

# 5-2

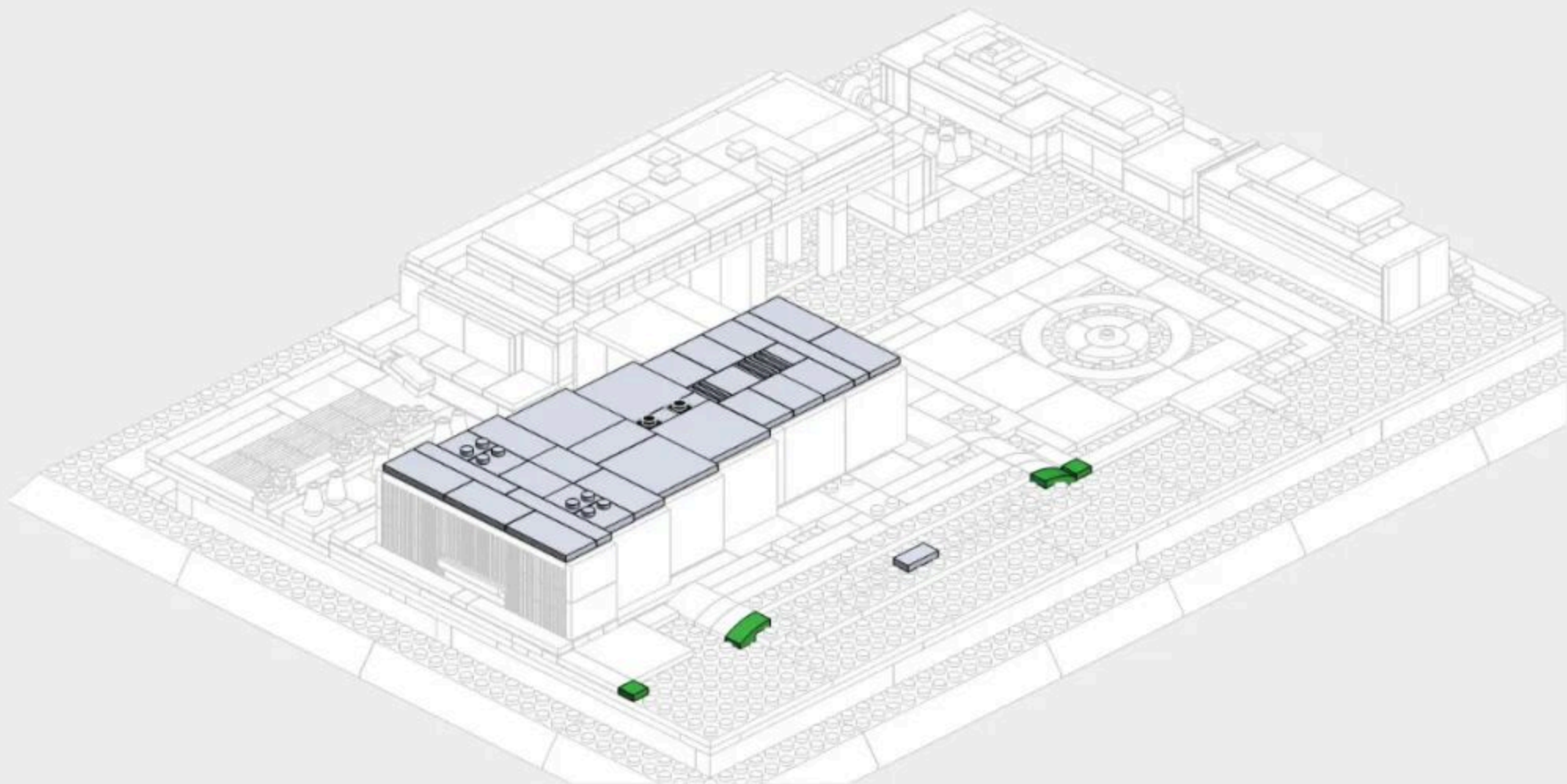
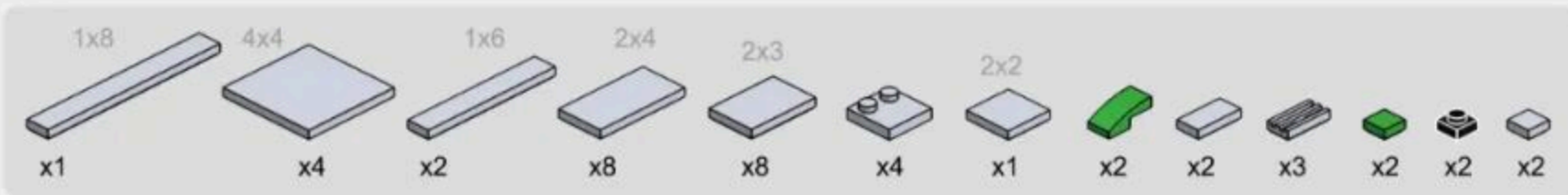

# 5-3

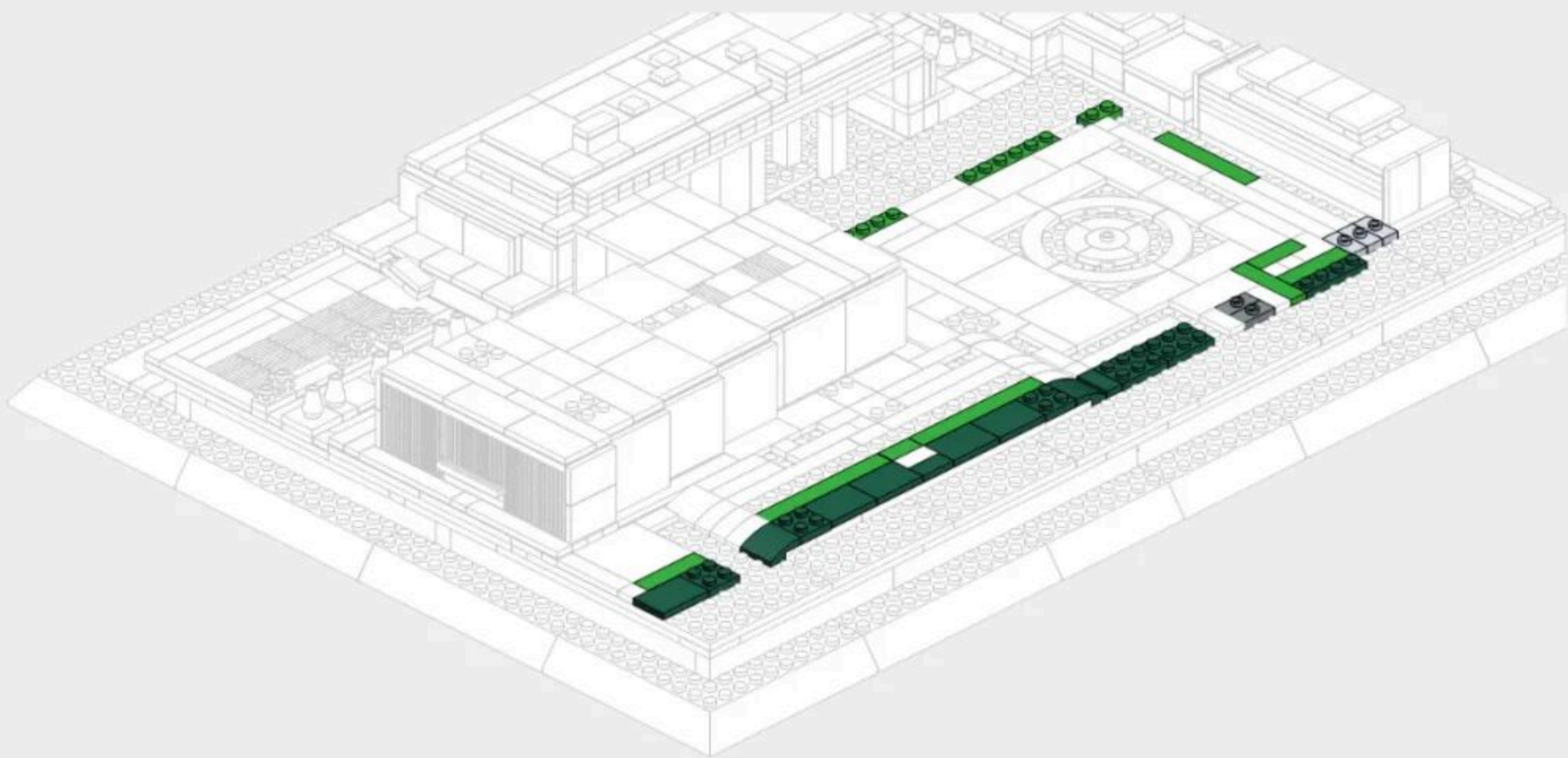
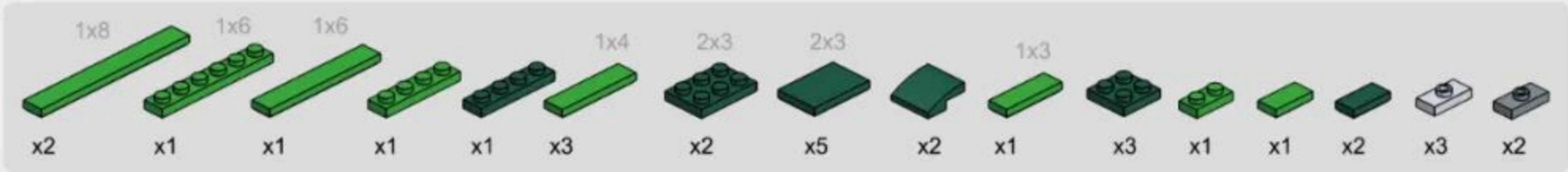

5-4

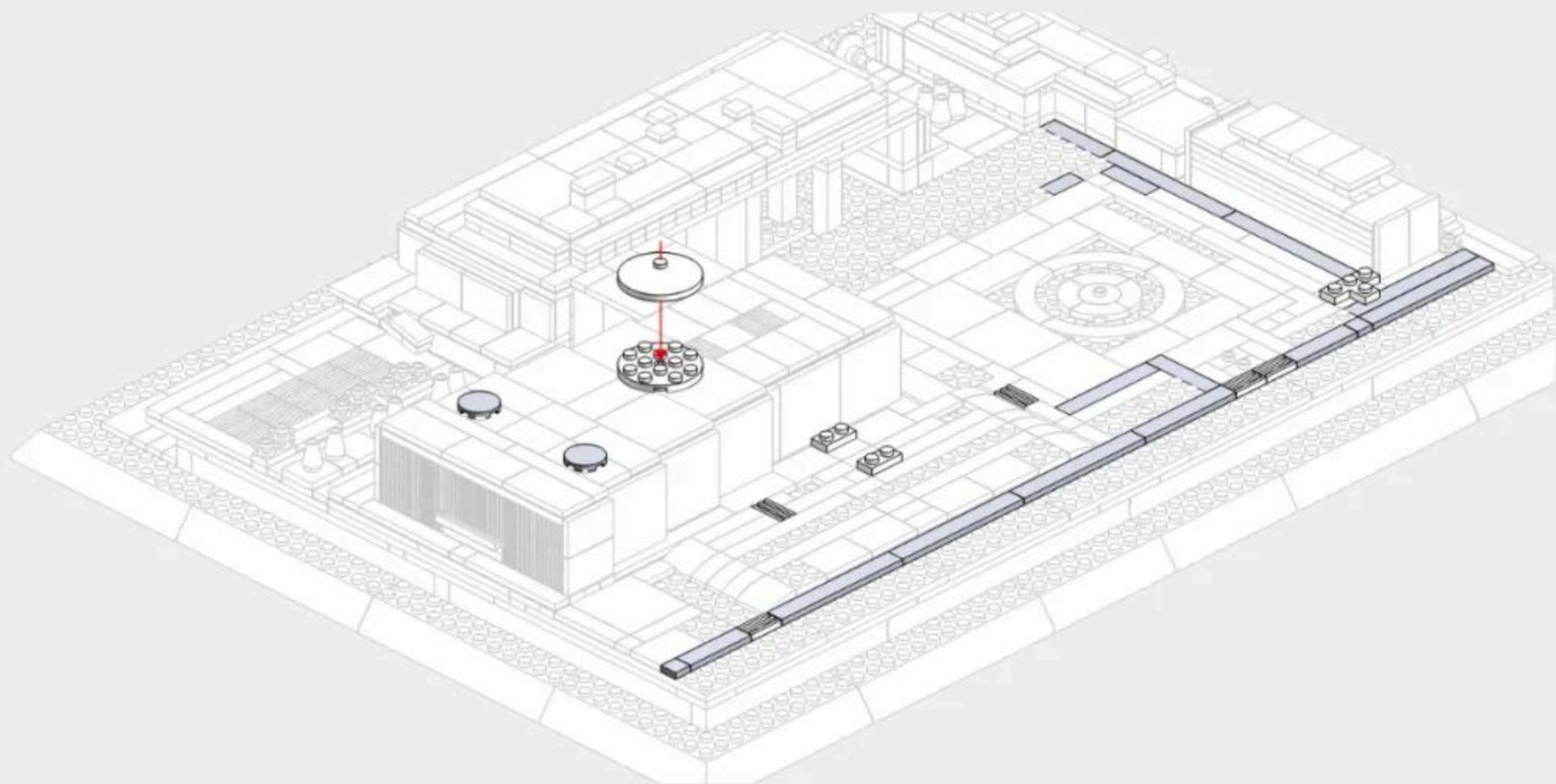
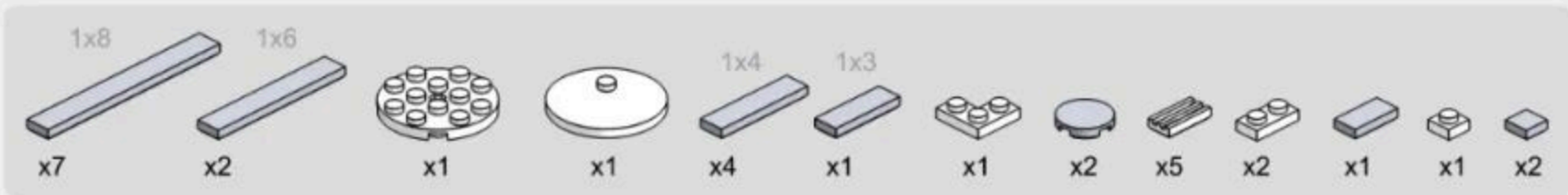

5-5

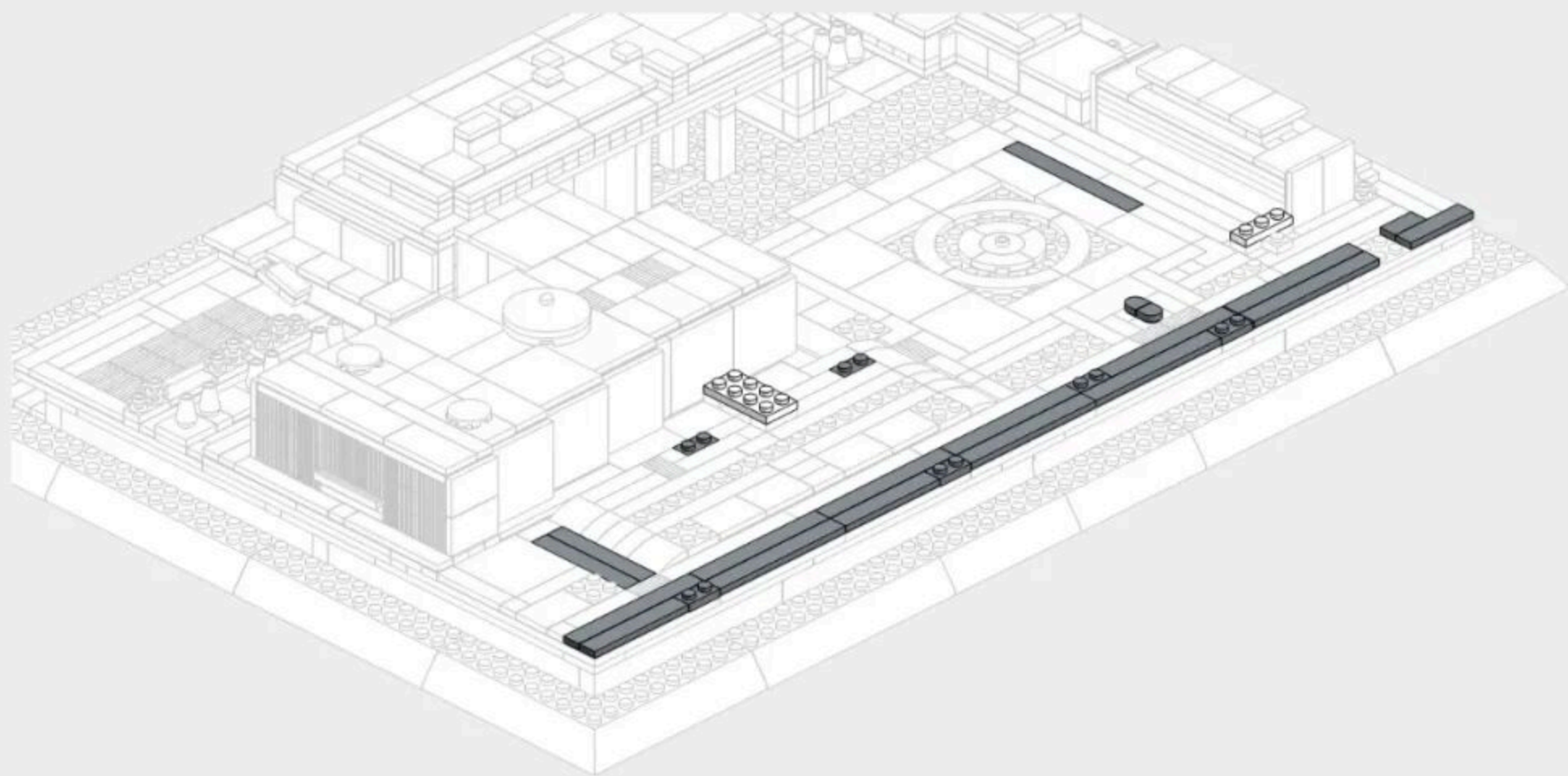
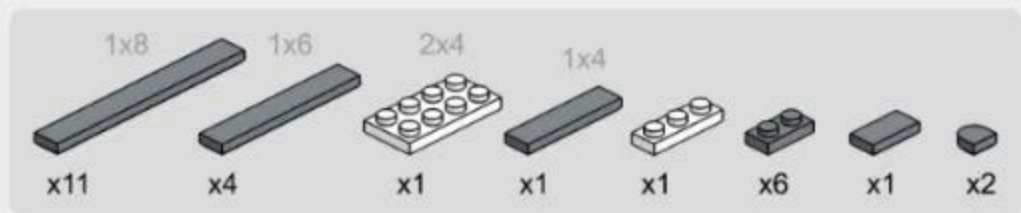

5-6

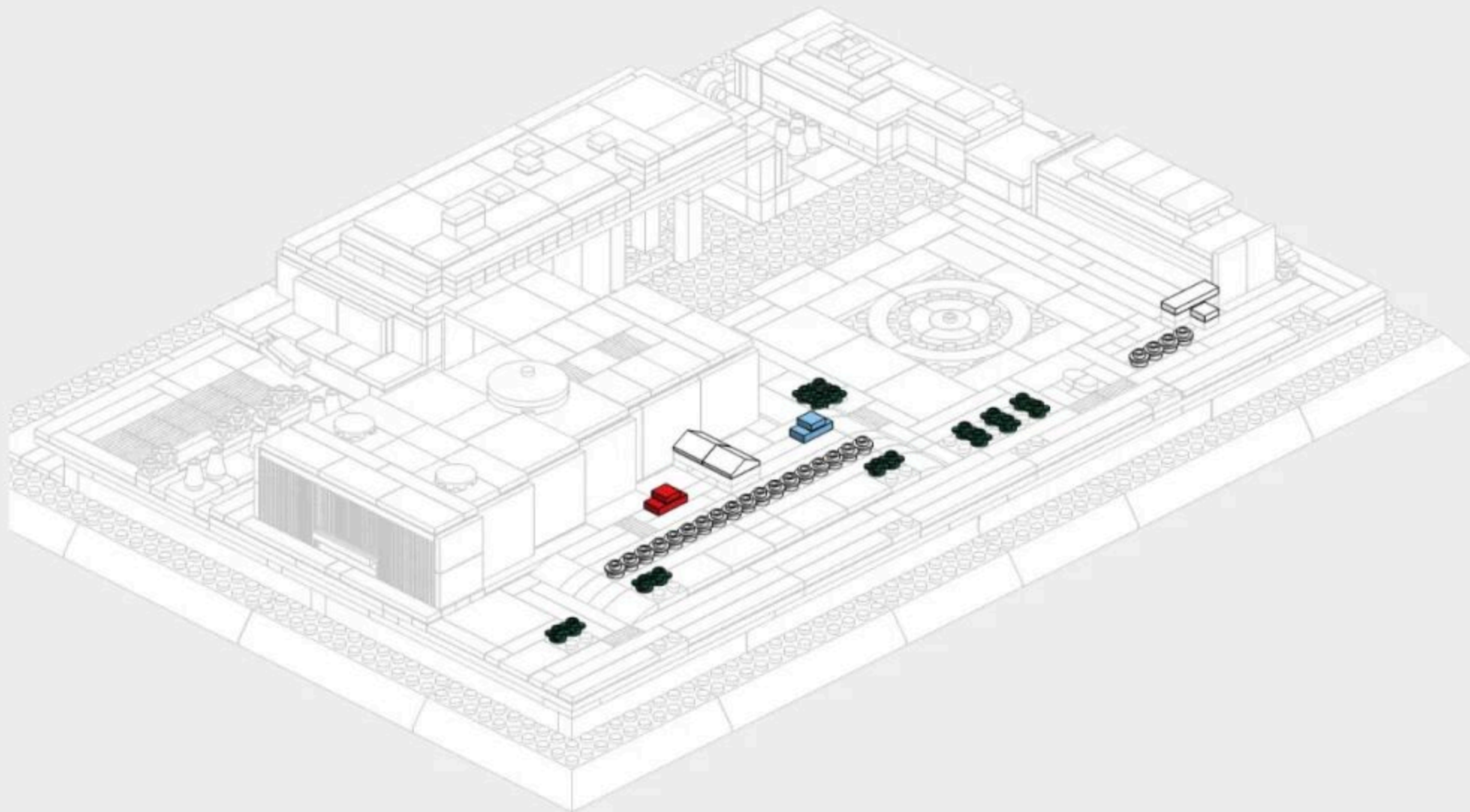
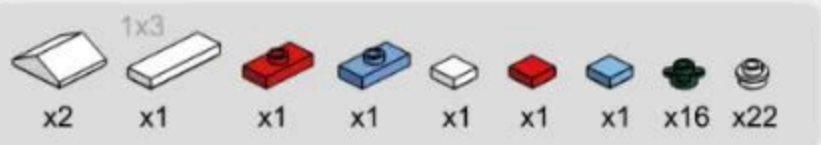



5-8

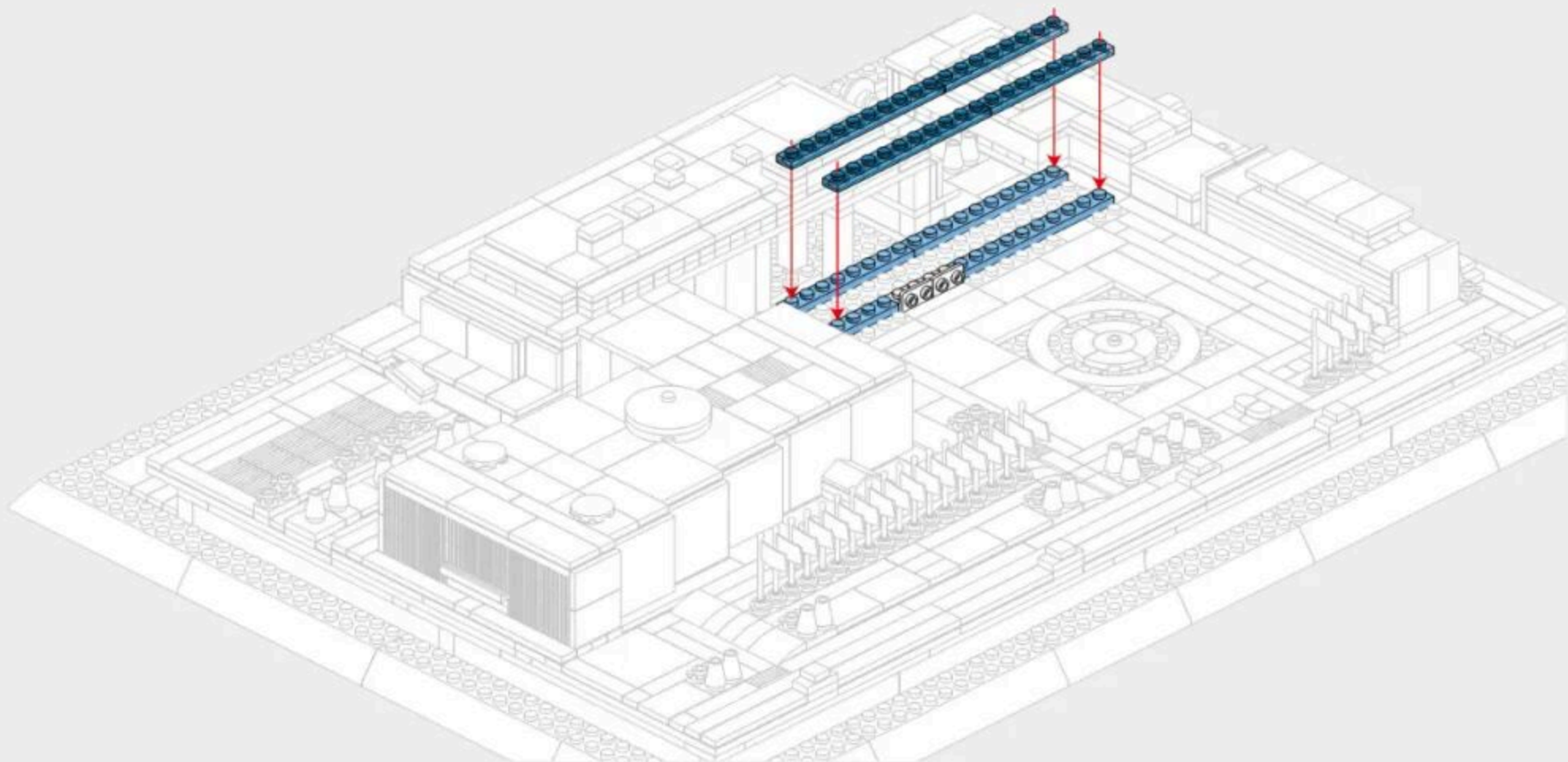
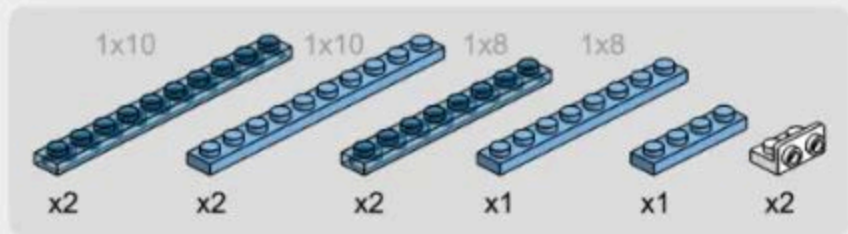



272 PCS

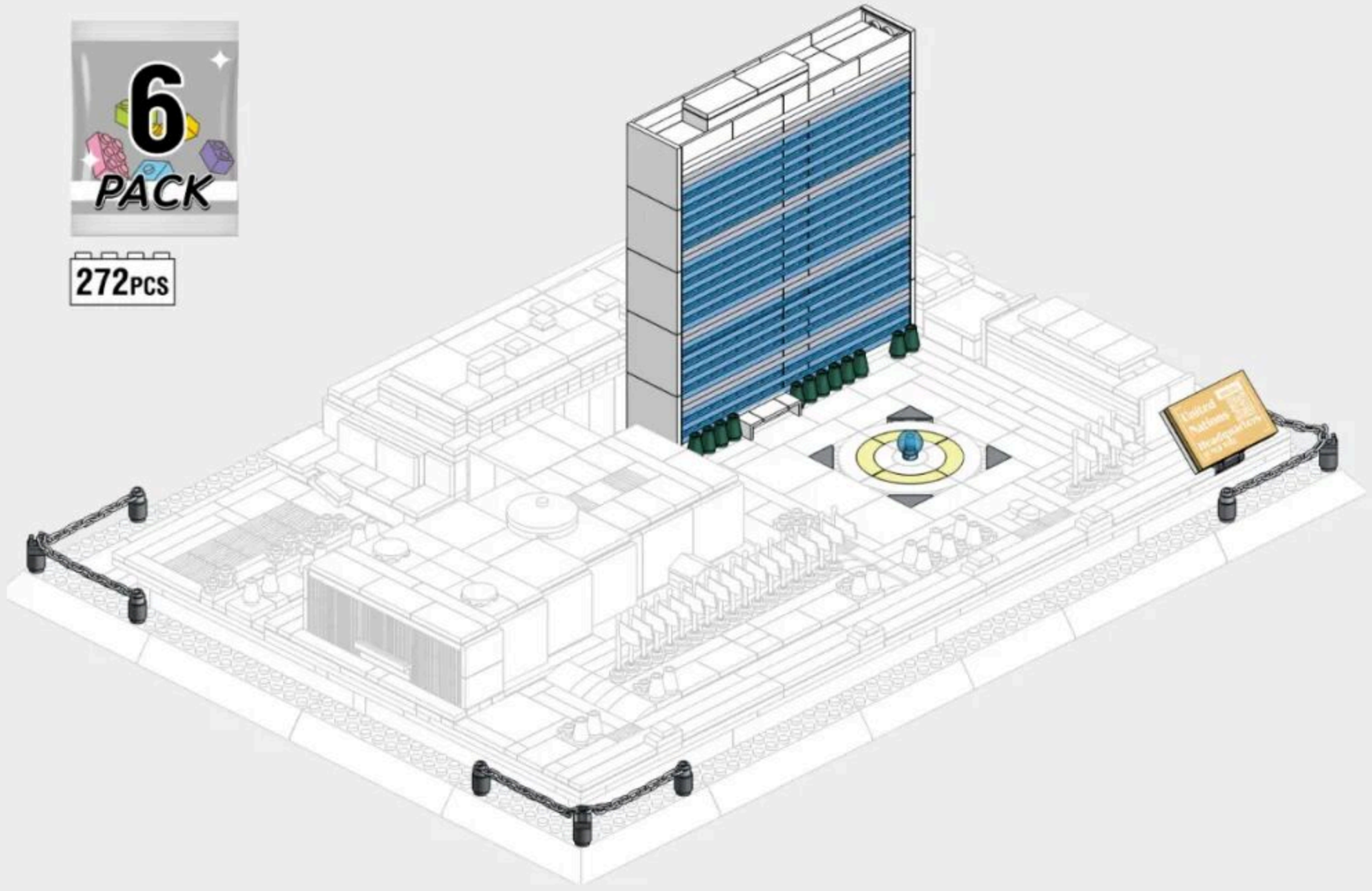

70

6-1

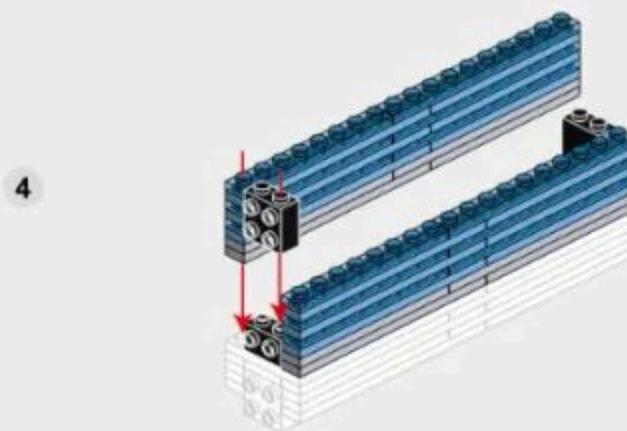
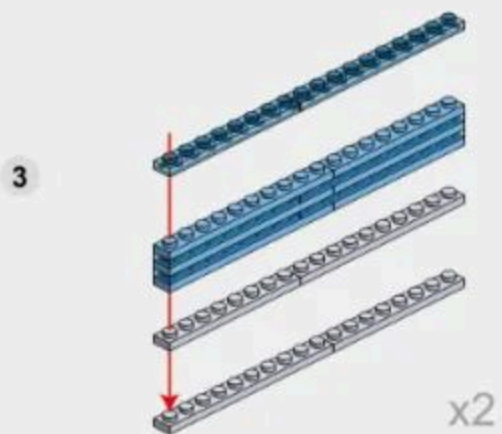
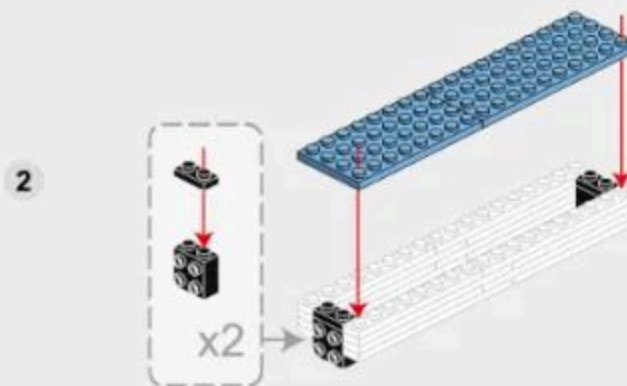
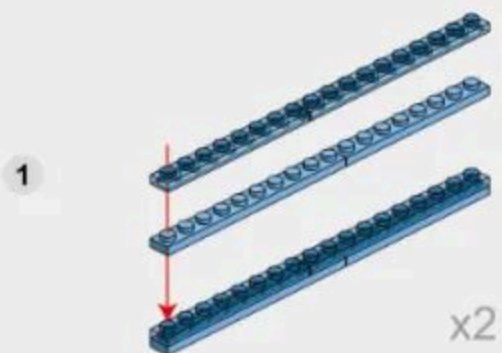
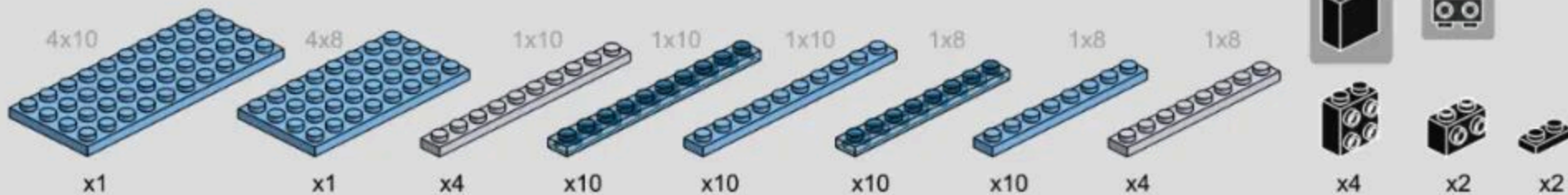

# 6-2

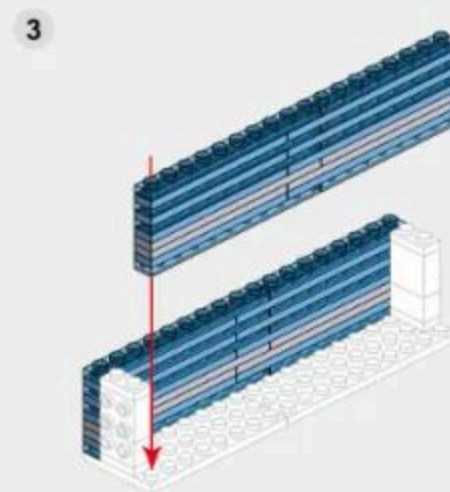
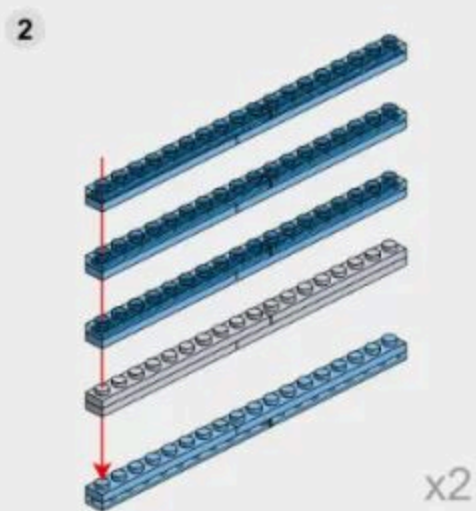
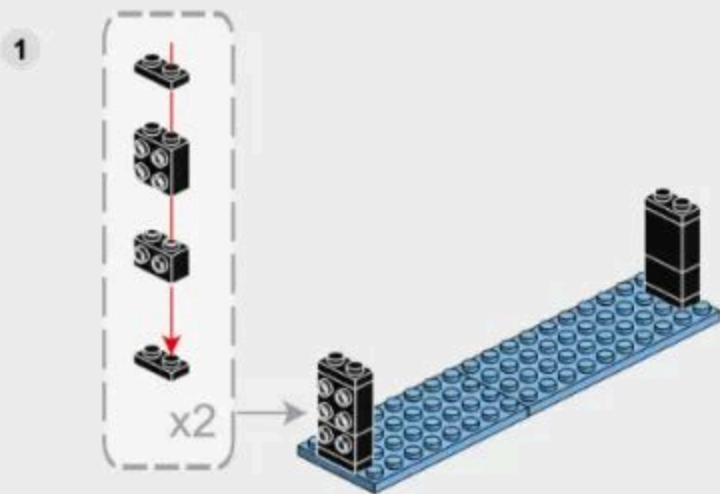
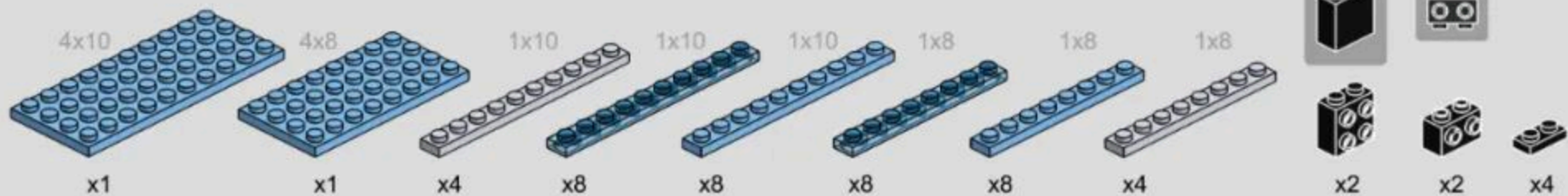

# 6-3

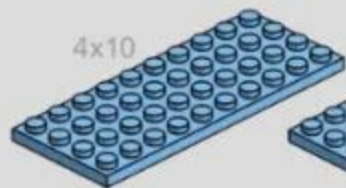

4x10

x1

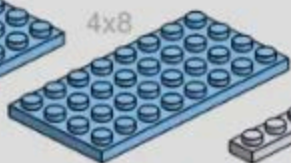

4x8

x1

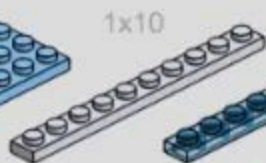

1x10

x4

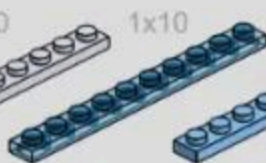

1x10

x8

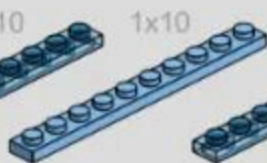

1x10

x6

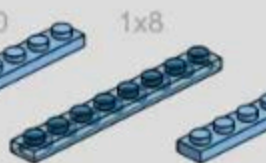

1x8

x8

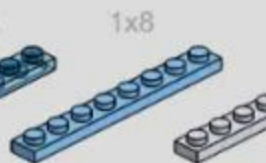

1x8

x6

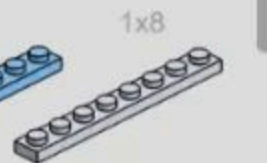

1x8

x4



x2



x2



x2

1



x2

2

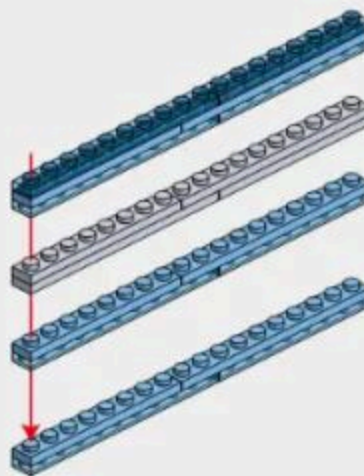

x2

3

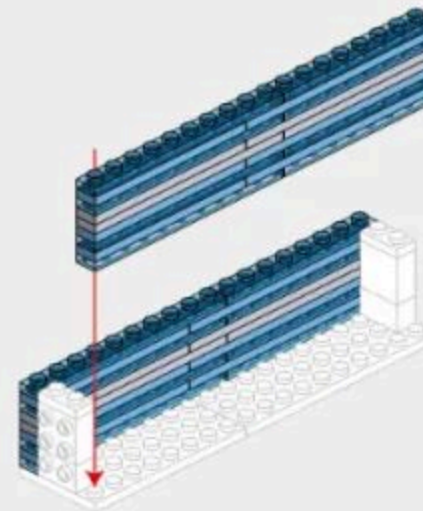

6-4

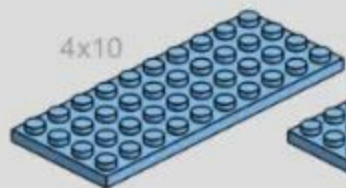

4x10

x1

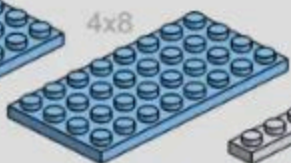

4x8

x1

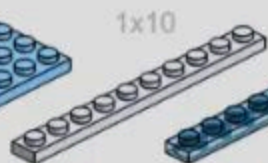

1x10

x4

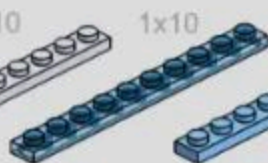

1x10

x6

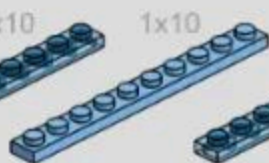

1x10

x6

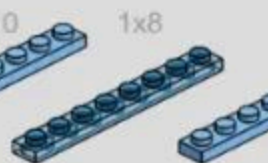

1x8

x6

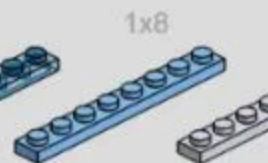

1x8

x6

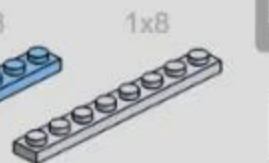

1x8

x4



x2



x2



1x10

x2

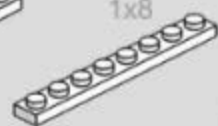

1x8

x2



x2

1

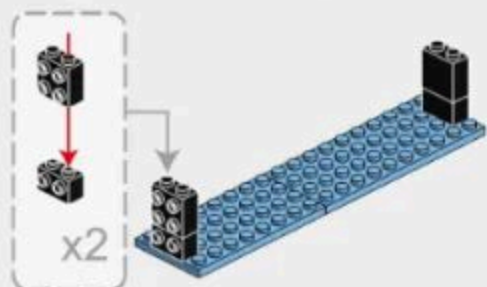

2

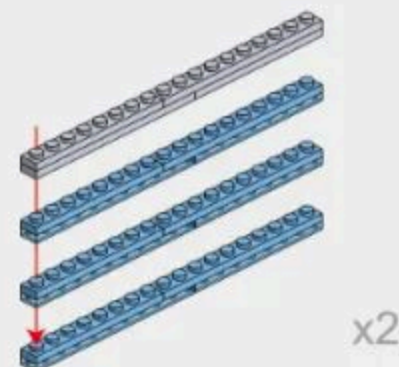

3

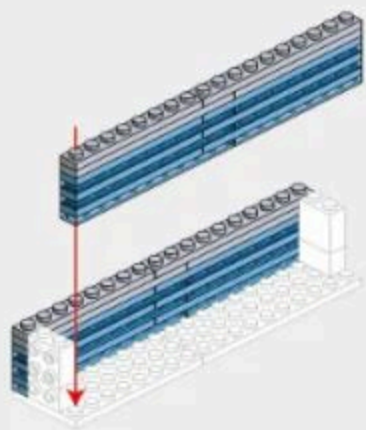

4

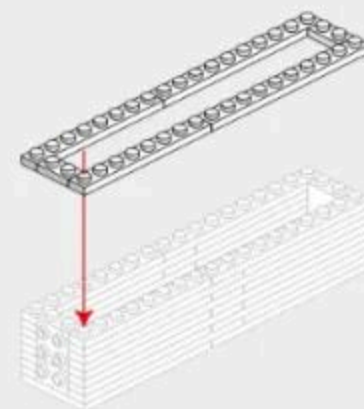

6-5

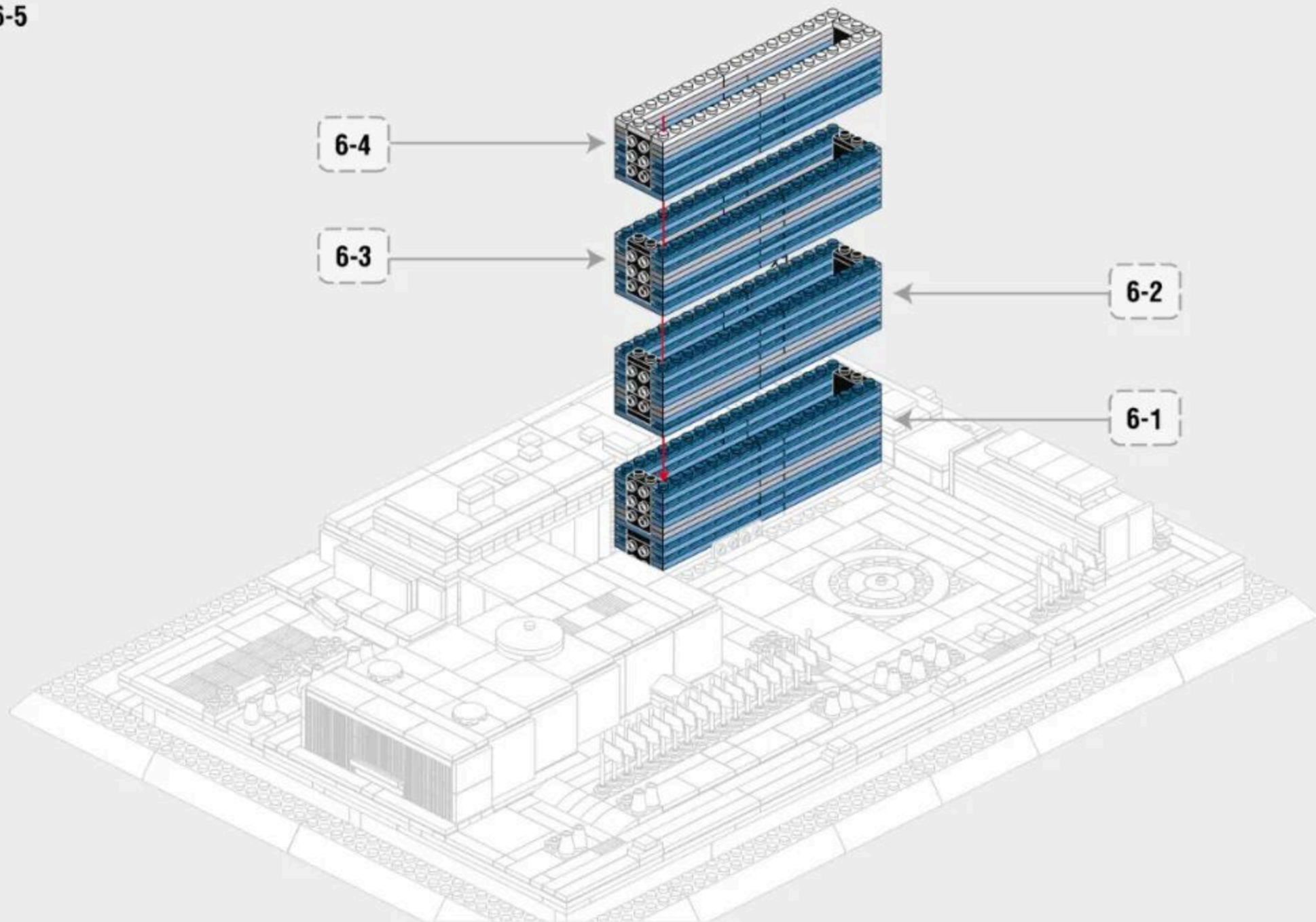

6-4

6-3

6-2

6-1

75

6-6

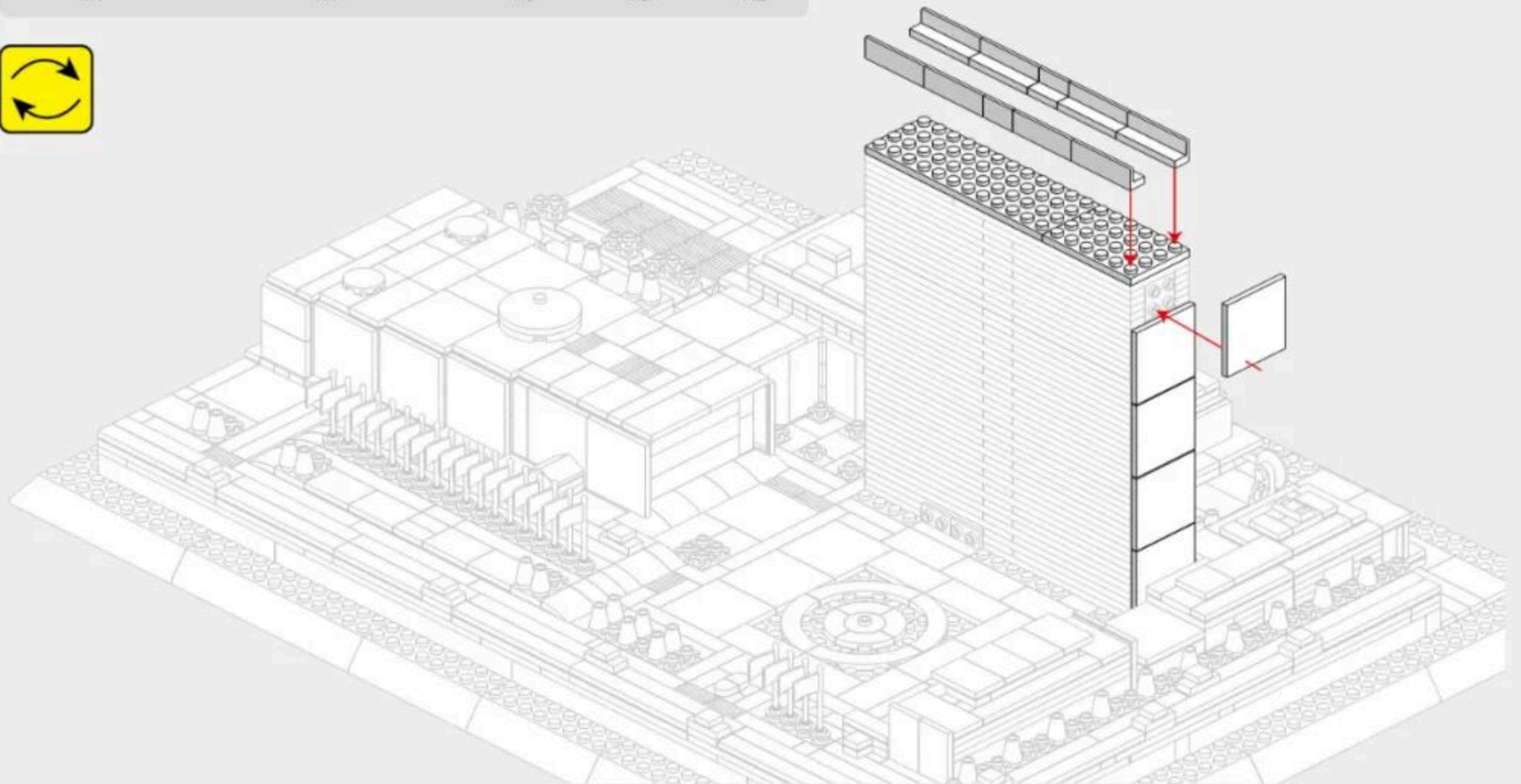
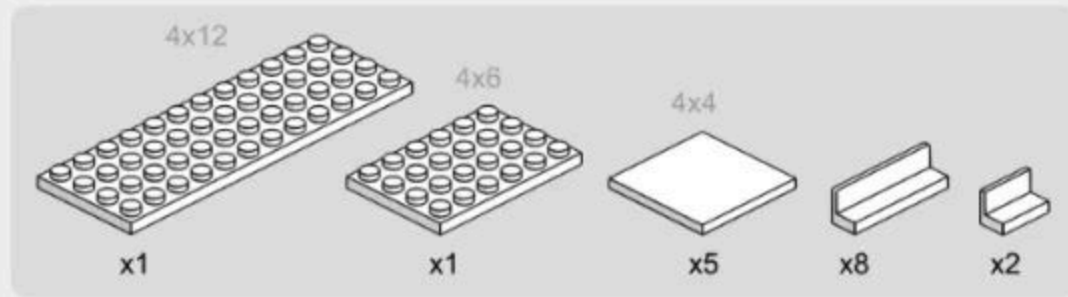

6-7

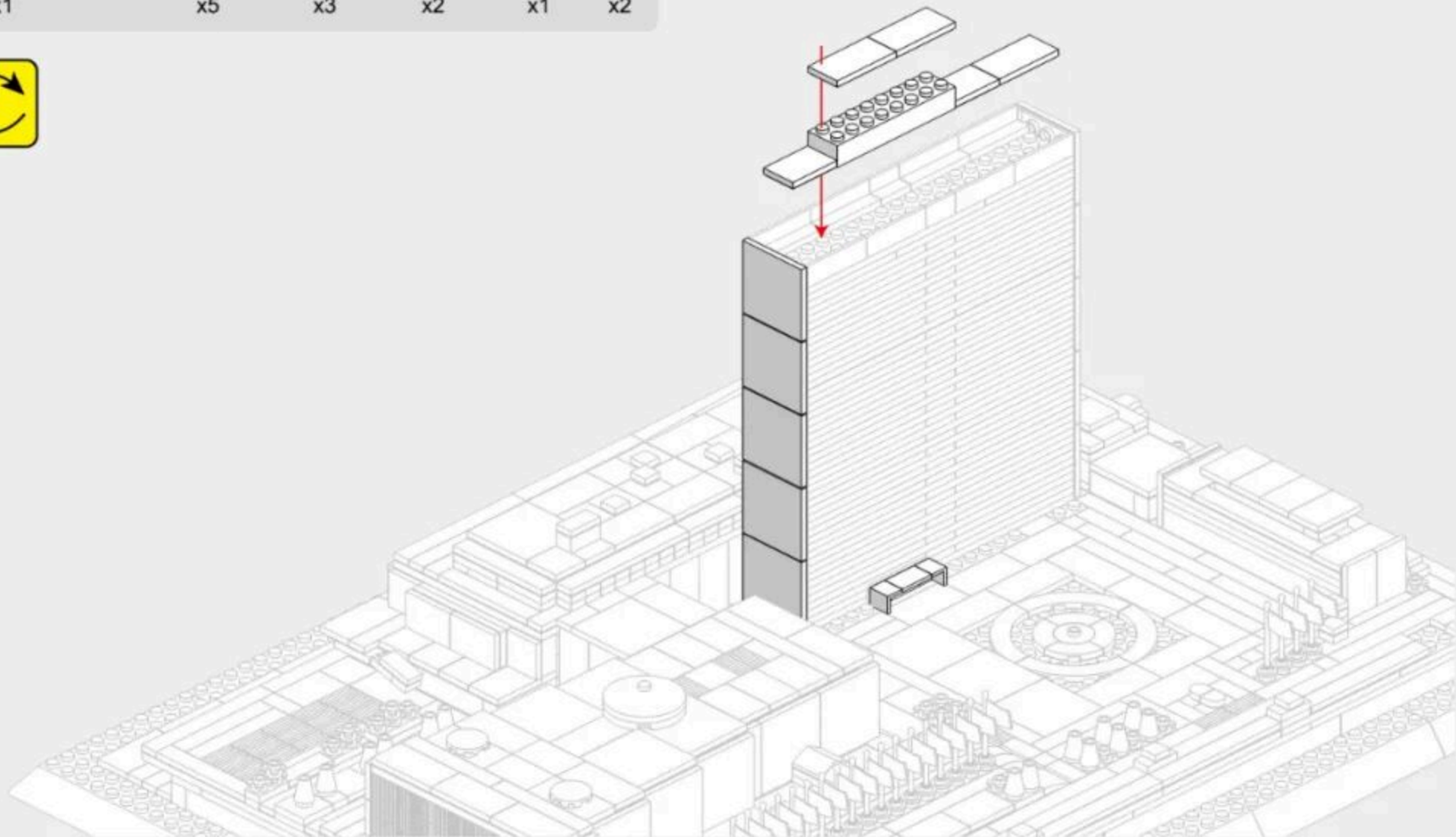
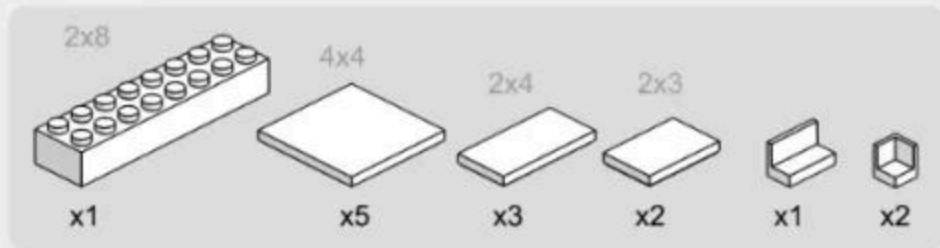

6-8

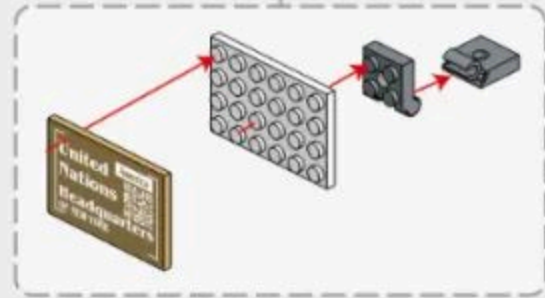
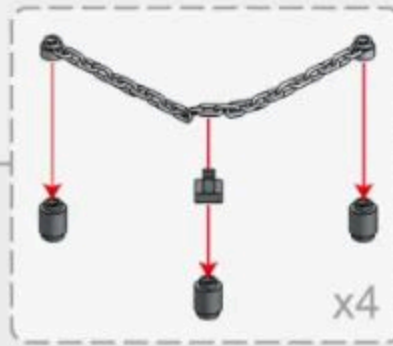
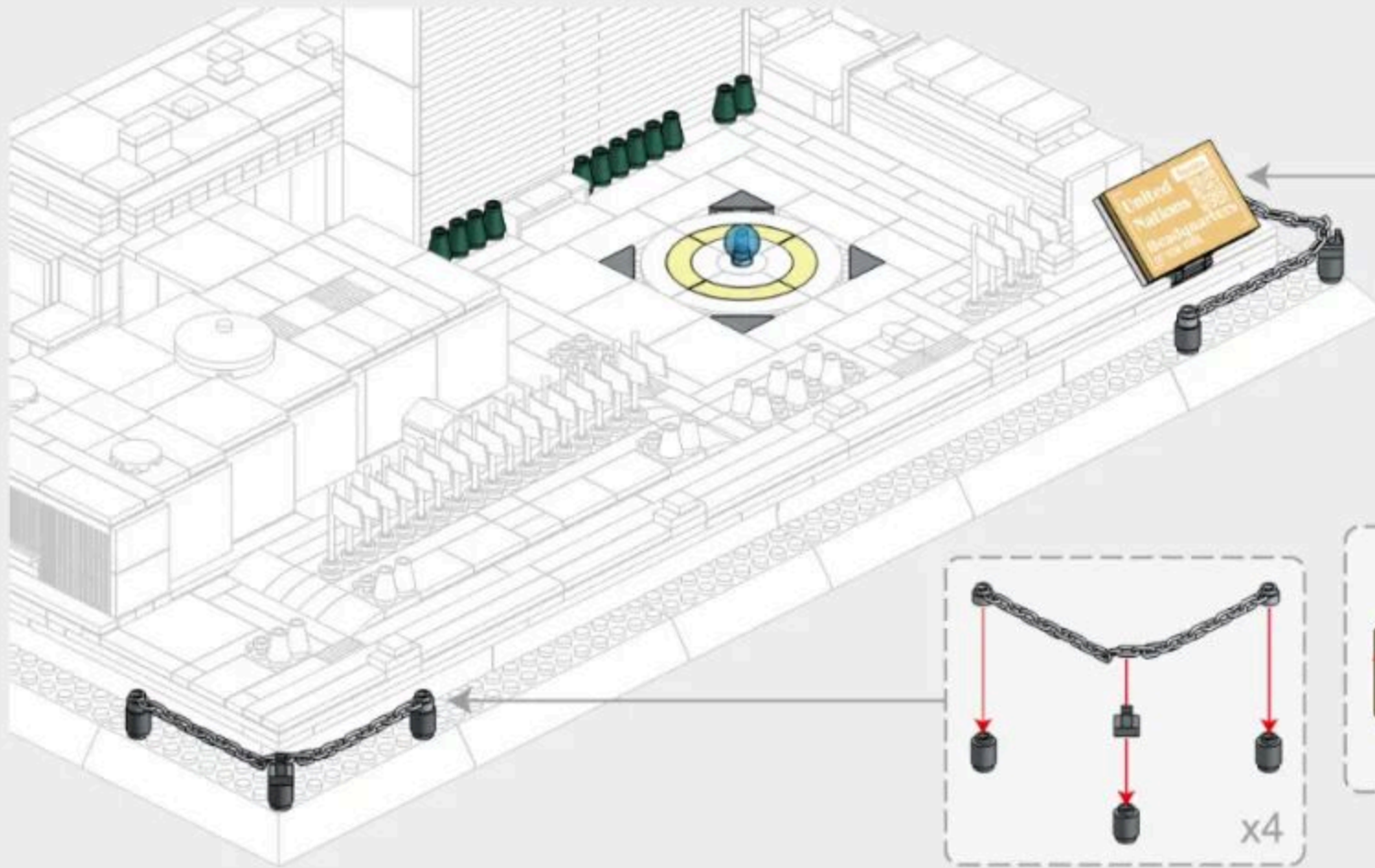
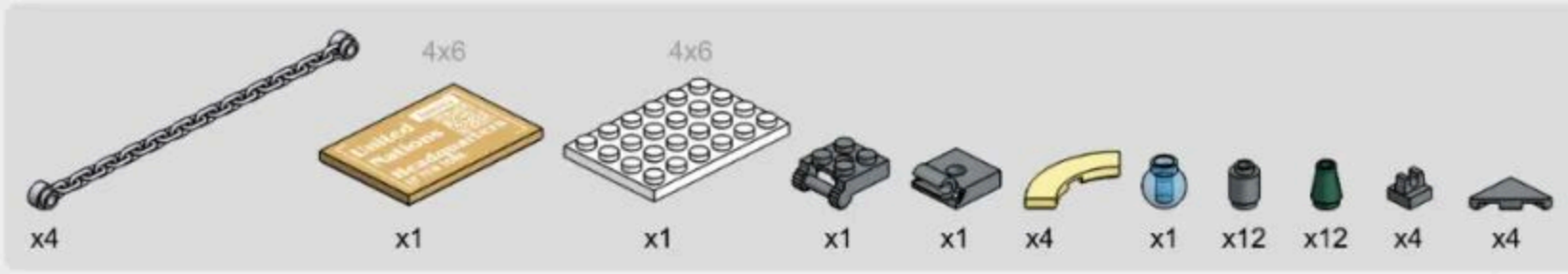

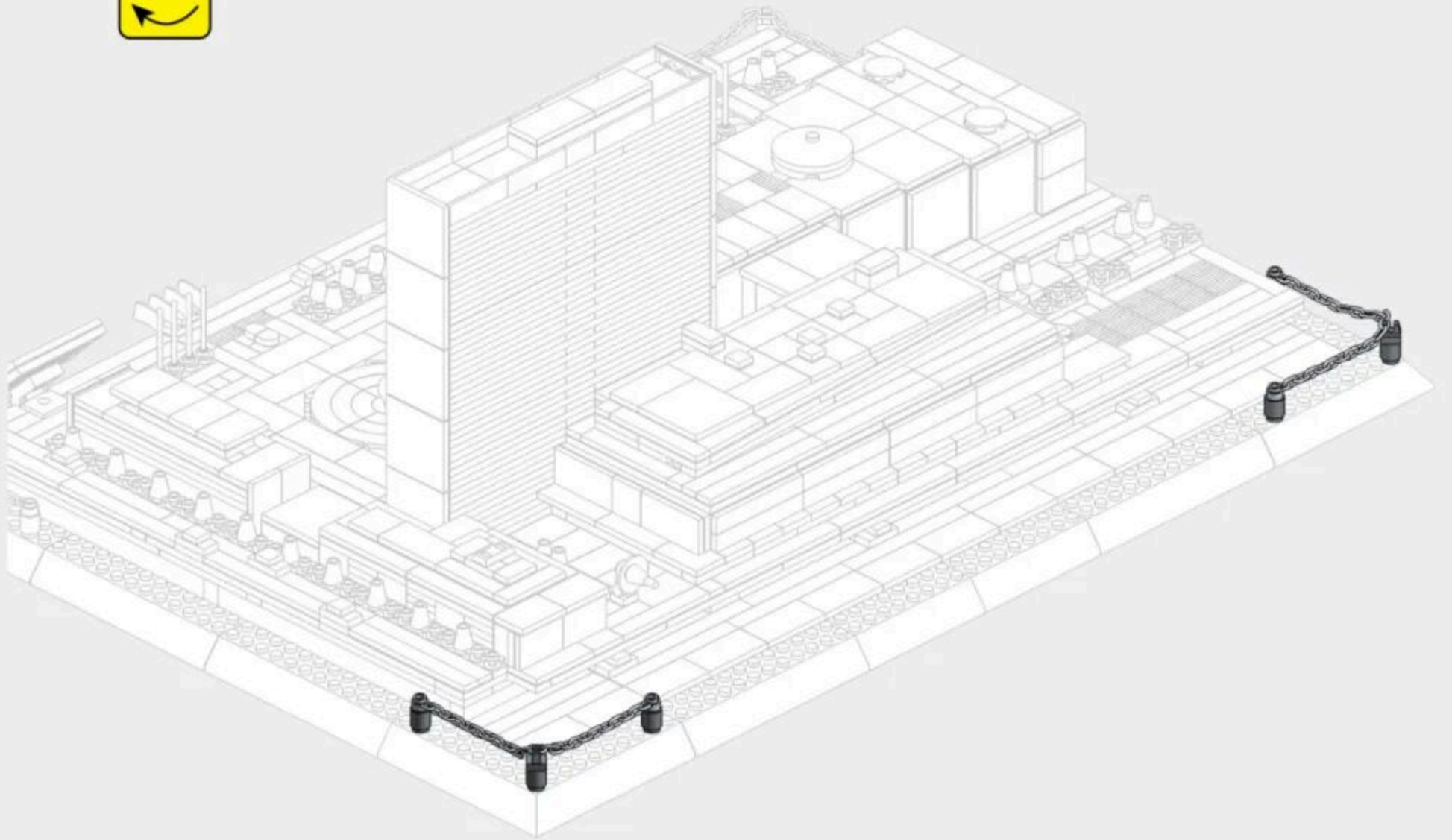



# ARCHITECTURE

The World's great architecture

Shaping Skills   Imagination & Curiosity   Mathematical   Self Discovery & Perception   Parent-Child Interaction   Problem Solving   Creativity



6224 英国伦敦白金汉宫  
BUCKINGHAM PALACE-LONDON,ENGLAND



5225 意大利罗马斗兽场  
COLOSSEUM-ROME,ITALY



5226 日本东京帝国饭店  
IMPERIAL HOTEL-TOKYO,JAPAN



5227 美国纽约自由女神像  
STATUE OF LIBERTY-NEW YORK,AMERICA



6211 德国柏林勃兰登堡门  
BRANDENBURG GATE-BERLIN, GERMANY



6222 中国甘肃长城-嘉峪关  
JIAYU PASS-GANSU,CHINA



6212 日本京都清水寺仁王门  
NOMON GATE OF KIYOMIZU-DERA-KYOTO,JAPAN



6213 俄罗斯莫斯科瓦西里大教堂  
SAINT BASIL'S CATHEDRAL-MOSCOW,RUSSIA



6214 中国武汉黄鹤楼  
YELLOW CRANE TOWER-WUHAN,CHINA



6215 英国伦敦眼  
LONDON EYE-LONDON,ENGLAND



6221 中国北京故宫-太和殿  
HALL OF SUPREME HARMONY-BEIJING,CHINA



6220 沙特阿拉伯麦加大清真寺  
GREAT MOSQUE OF MECCA,SAUDI ARABIA



6219 美国纽约联合国大厦  
UNITED NATIONS HEADQUARTERS-NEW YORK,AMERICA



4214 美国华盛顿白宫  
WHITE HOUSE-WASHINGTON D.C.,AMERICA



4212 意大利罗马许愿池  
TREVI FOUNTAIN-ROME,ITALY



4213 法国巴黎卢浮宫  
MUSÉE DU LOUVRE-PARIS,FRANCE



4218 新加坡-鱼尾狮  
MERLION,SINGAPORE



4219 英国伦敦双子塔桥  
TOWER BRIDGE-LONDON,ENGLAND



4216 美国华盛顿林肯纪念堂  
LINCOLN MEMORIAL-WASHINGTON D.C.,AMERICA



4217 新加坡-金沙酒店  
MARINA BAY SANDS,SINGAPORE



4210 埃及开罗吉萨金字塔  
GREAT PYRAMID OF GIZA-CAIRO,EGYPT



4221 加拿大渥太华国会山庄  
PARLIAMENT BUILDINGS-OTTAWA,CANADA



4211 英国伦敦伊丽莎白塔  
ELIZABETH TOWER-ENGLAND



4215 加拿大多伦多电视塔  
THE CN TOWER-CANADA



4220 美国纽约熨斗大厦  
FLATIRON BUILDING-NEW YORK,AMERICA



**4222** 阿联酋迪拜哈利法塔 **5224** 中国上海东方明珠广播电视塔  
 THE BURJ KHALIFA TOWER-DUBAI, UAE ORIENTAL PEARL TOWER-SHANGHAI, CHINA  
**5212** 美国纽约帝国大厦 **5213** 马来西亚吉隆坡石油双塔 **5214** 意大利托斯卡纳比萨斜塔 **5216** 英国伦敦伊丽莎白塔  
 EMPIRE STATE BUILDING-NEW YORK, AMERICA PETRONAS TWIN TOWERS-KUALA LUMPUR, MALAYSIA LEANING TOWER OF PISA-TUSCANY, ITALY ELIZABETH TOWER-LONDON, ENGLAND



**5219** 俄罗斯莫斯科克里姆林宫钟楼 **5220** 阿联酋迪拜卓美亚帆船酒店 **5217** 法国巴黎埃菲尔铁塔 **5221** 中国台北101大楼 **6223** 中国武汉长江大桥  
 SPASSKAYA TOWER-MOSCOW, RUSSIA BURJAL ARAB HOTEL-DUBAI, UAE EIFFEL TOWER-PARIS, FRANCE TAIPEI 101-TAIPEI, CHINA WUHAN YANGTZE RIVER BRIDGE



**5210** 法国巴黎圣母院大教堂 **5211** 印度阿格拉泰姬陵 **5223** 法国巴黎凯旋门 **5215** 英国伦敦双子塔桥 **5222** 中国北京天坛祈年殿  
 CATHÉDRALE NOTRE DAME DE PARIS-PARIS, FRANCE TAJ MAHAL-AGRA, INDIA ARC DE TRIOMPHE-PARIS, FRANCE TOWER BRIDGE-LONDON, ENGLAND HALL OF PRAYER FOR GOOD HARVESTS-BEIJING, CHINA



**6210** 美国旧金山金门大桥 **6216** 中国北京万里长城（八达岭） **5218** 中国北京天安门 **6217** 中国西藏布达拉宫 **6218** 芬兰罗瓦涅米圣诞老人办公室  
 GOLDEN GATE BRIDGE-SAN FRANCISCO, AMERICA THE GREAT WALL-BEIJING, CHINA TIAN'ANMEN TOWER-BEIJING, CHINA POTALA PALACE-TIBET, CHINA SANTA CLAUS OFFICE-ROVANIEMI, FINLAND

# UNITED NATIONS HEADQUARTERS

COUNTRY: America  
CITY: New York

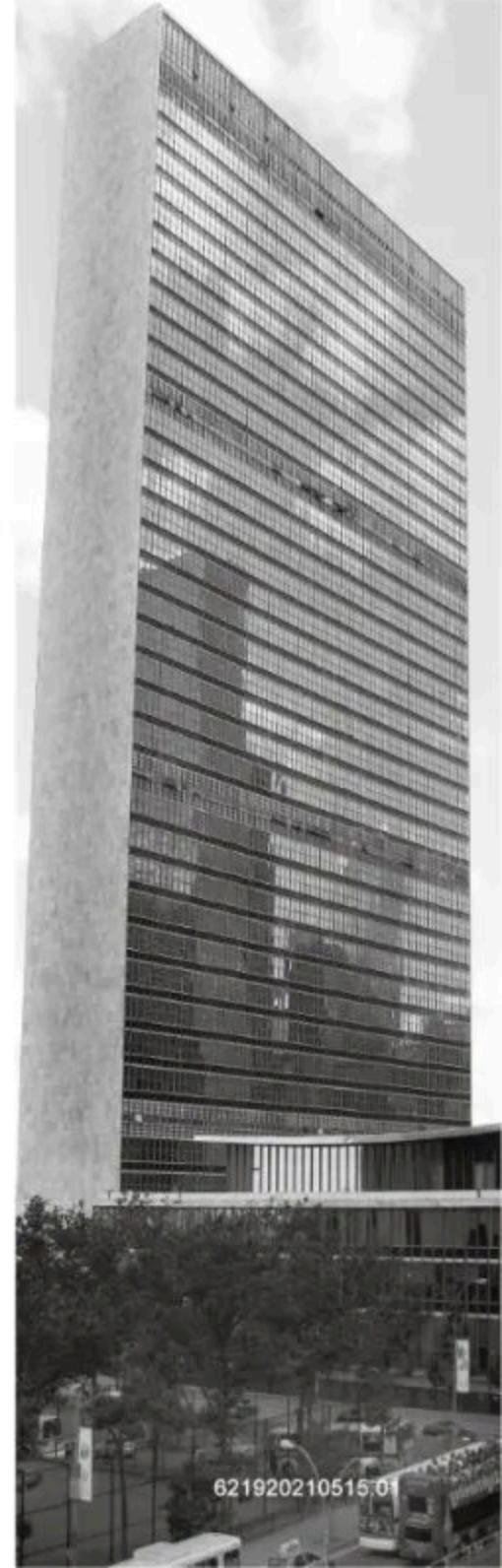

621920210515\_01