



# HALL OF SUPREME HARMONY

中国北京故宫太和殿

Beijing, China

The world's great architecture



6+ / 6221 / 862 PCS  
Suitable Age / Product Number / Parts Total



# Architecture

It will be a city...

这将构成一座城市...

# ABOUT THE PRODUCT

关于产品

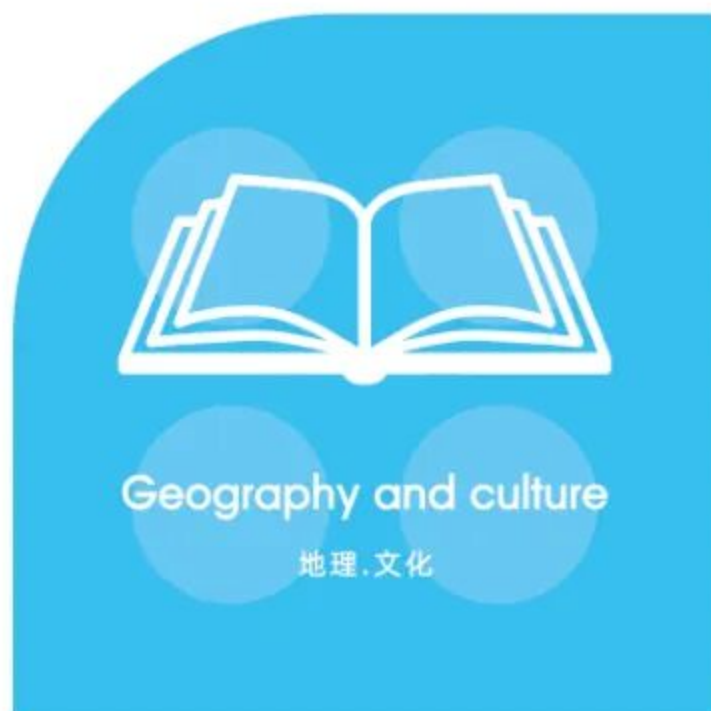

## ARCHITECTURE

WANGE The world's great architect since 1991

# Hall of Supreme Harmony

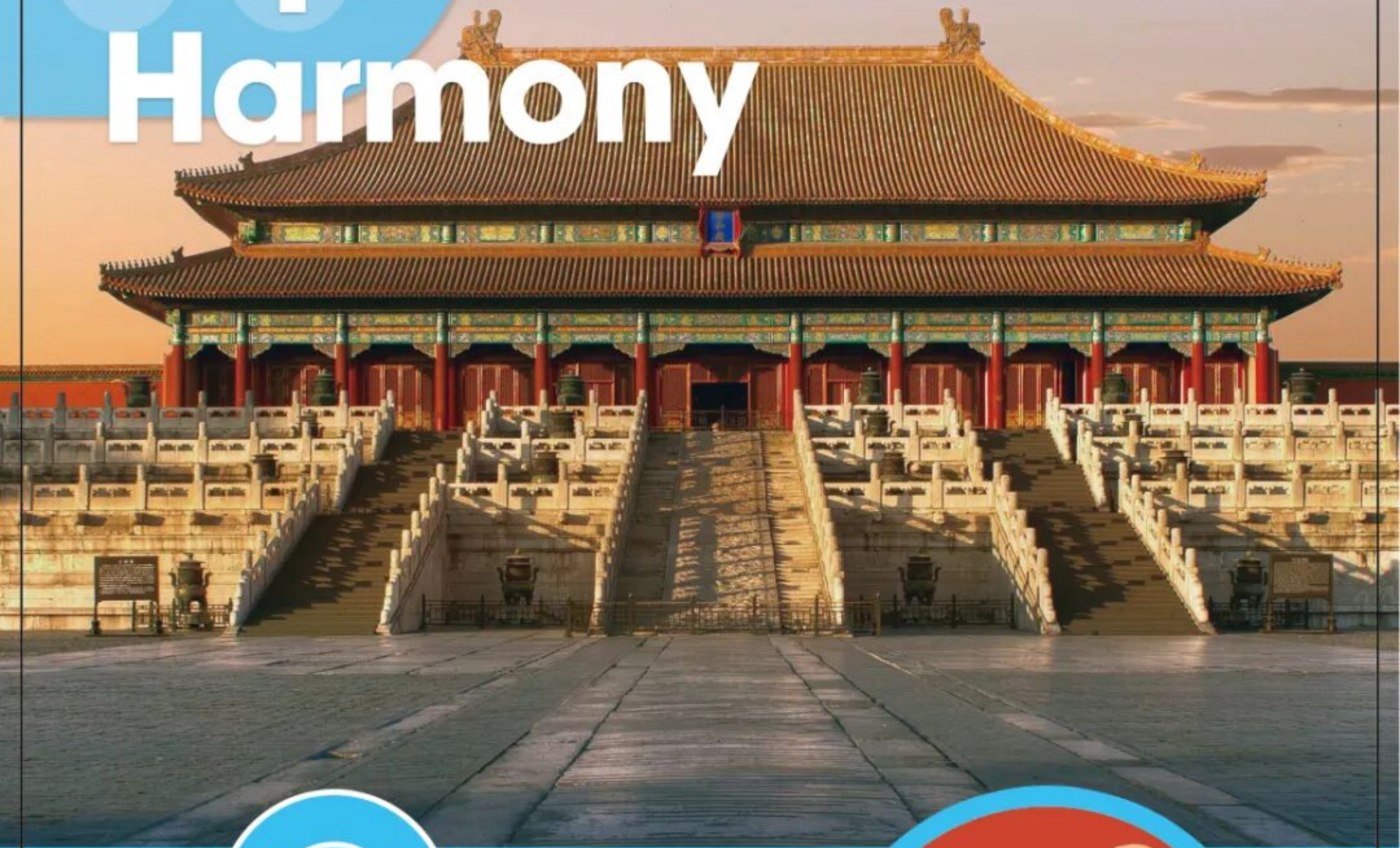

The Hall of Supreme Harmony is the largest hall within the Forbidden City in Beijing, China.

# Hall of Supreme Harmony



## Geography and culture

地理·文化



The Hall of Supreme Harmony is the largest hall within the Forbidden City in Beijing, China. It is located at its central axis, behind the Gate of Supreme Harmony.



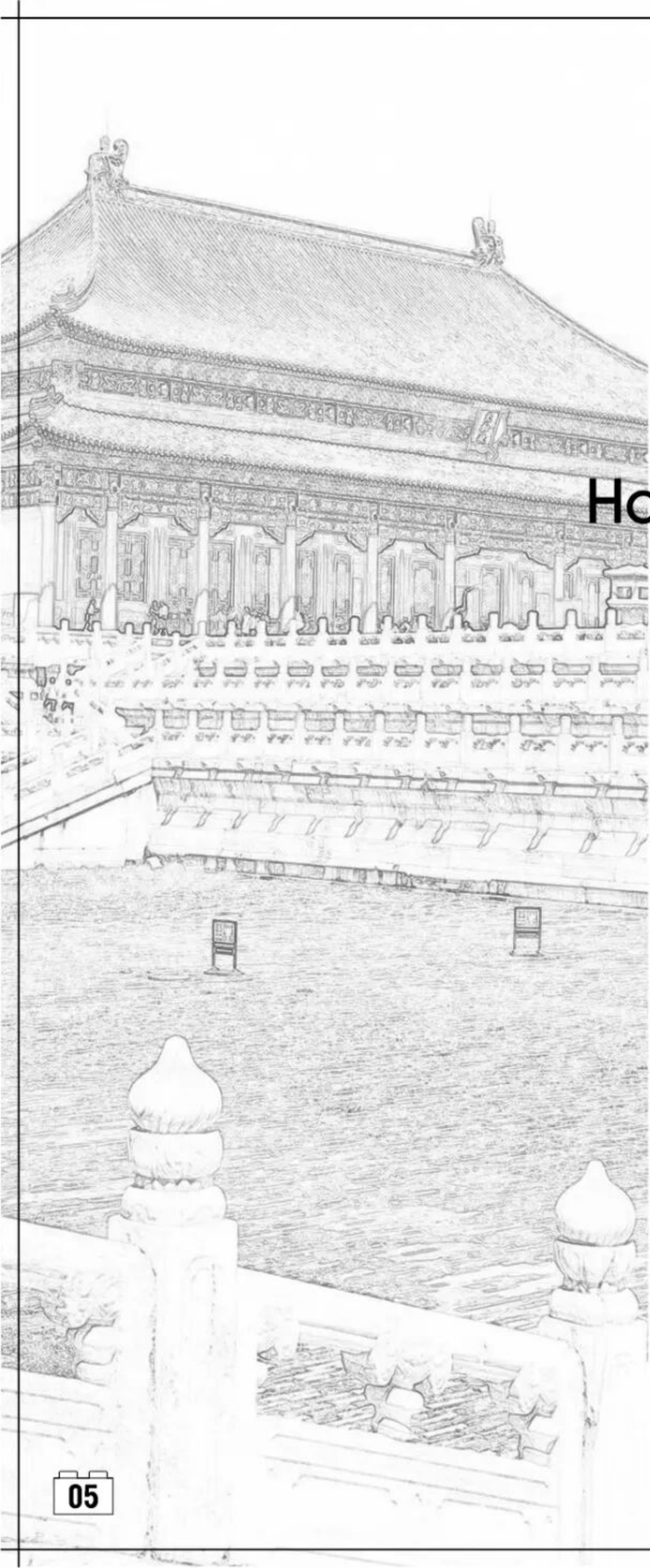

中国北京故宫太和殿

# Hall of Supreme Harmony ■ China

The contents of this chapter refer to the Wikipedia website.

本章内容参考维基百科网站，  
更多资讯可自行查阅。

The world's great architecture

# About The Building



**Hall of Supreme Harmony**, is the largest hall within the Forbidden City in Beijing, China. It is located at its central axis, behind the Gate of Supreme Harmony. Built above three levels of marble stone base, and surrounded by bronze incense burners, the Hall of Supreme Harmony is one of the largest wooden structures within China. It was the location where the emperors of the Ming and Qing dynasties hosted their enthronement and wedding ceremonies.

## 历史与文化

太和殿俗称金銮殿，为北京故宫外朝三大殿中最南面的殿，该殿是明清两朝北京城内最高的建筑，开间最多、进深最大和屋顶最高的大殿，堪称中华第一殿。皇帝登基、册立皇后等大典都在此举行。太和殿是皇权的象征，因而在各种形式上都刻意追求，以示与众不同。

太和殿、中和殿、保和殿建在一座三层汉白玉台基上，合称“三大殿”。“三大殿”和东面的文华殿、西面的武英殿等建筑合称“外朝”。三大殿位于紫禁城中轴线暨北京中轴线上。

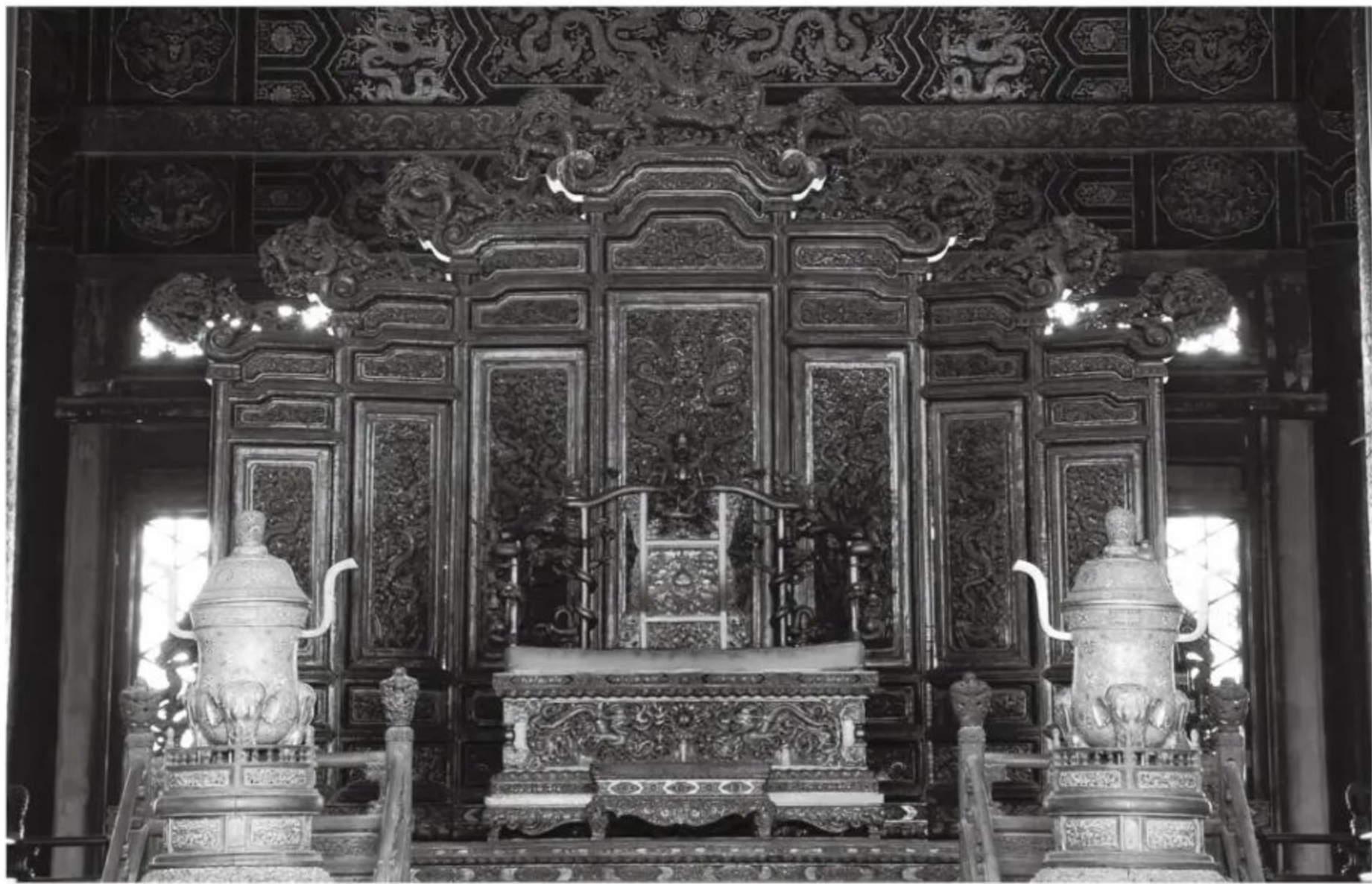

太和殿始建于明朝永乐四年（1406年），建成于永乐十八年（1420年），初名奉天殿。奉天殿初建时的体量，据《明世宗实录》卷四百七十记载：“原旧广三十丈，深十五丈云”，即面阔95米，进深48米，面积达4522平方米。

永乐十九年（1421年），奉天殿遭雷击焚毁，正统元年（1436年）至正统六年（1441年）重建。嘉靖三十六年四月丙申（1557年5月11日），又遭雷击焚毁。嘉靖四十一年（1562年），完成重建，改名为皇极殿，仅为原奉天殿的三分之二大小，所以与原建筑的大基座相比显得小。万历二十五年（1597年）遭遇火灾，天启七年（1627年）重建。

## Design and subsequent history

The Hall of Supreme Harmony rises some 30 metres above the level of the surrounding square. It is the ceremonial center of imperial power, and the largest surviving wooden structure in China. It is eleven bays wide - with the main room being nine bays wide - and five bays deep, the numbers nine and five being symbolically connected to the majesty of the Emperor. The six pillars nearest the imperial throne are covered with gold, and the entire area is decorated with a dragon motif.



The Dragon Throne, in particular, has five dragons coiled around the back and handrests. The screen behind it features sets of nine dragons, again reflecting the "nine-five" symbolism. The Hall of Supreme Harmony features an exquisite throne made of red sandalwood, and formerly used by the emperors of the Qing dynasty. Set into the ceiling directly above the throne is an intricate caisson decorated with a coiled dragon, from the mouth of which issues a chandelier-like set of metal balls, called the "Xuanyuan Mirror", a reference to the Yellow Emperor, a mythological Chinese ruler. According to legend, the metal balls will fall and strike dead any usurper to the throne.

Creation and thinking

创作·思考

# Drawing Design

手绘设计

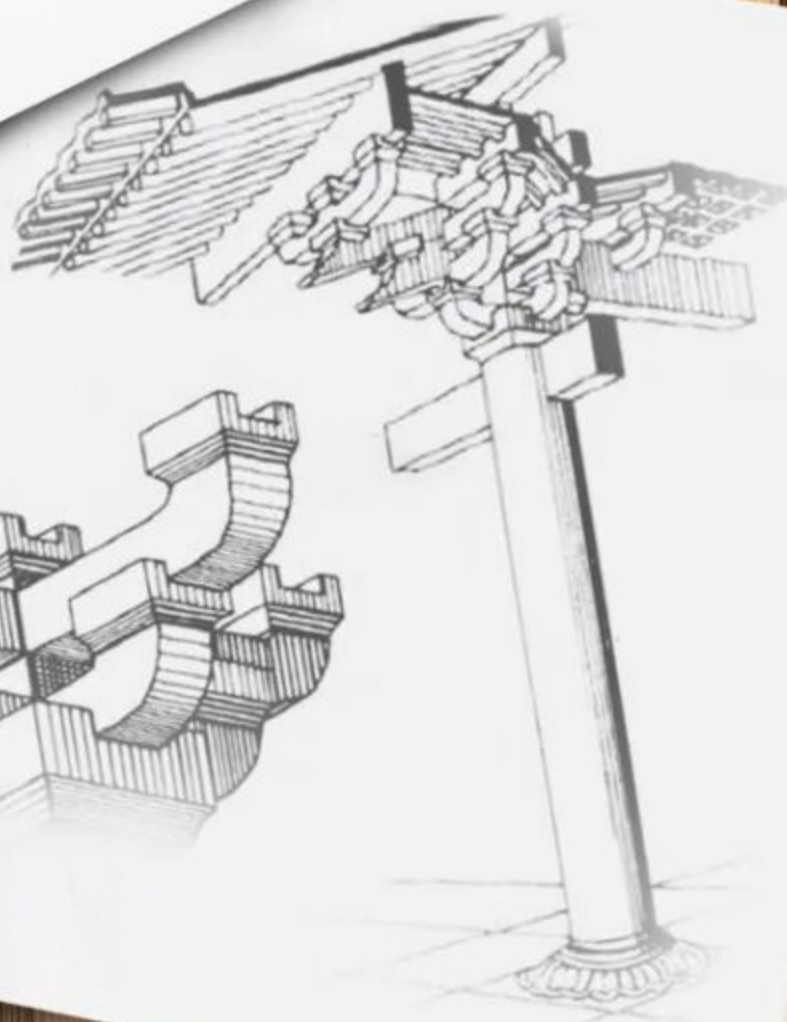

Guangdong Baoge Educational Material Sci-Tech Co., Ltd.  
©2014 Wange / Dubie. All Rights Reserved

Creation and thinking

创作·思考

# Drawing Design

手绘设计

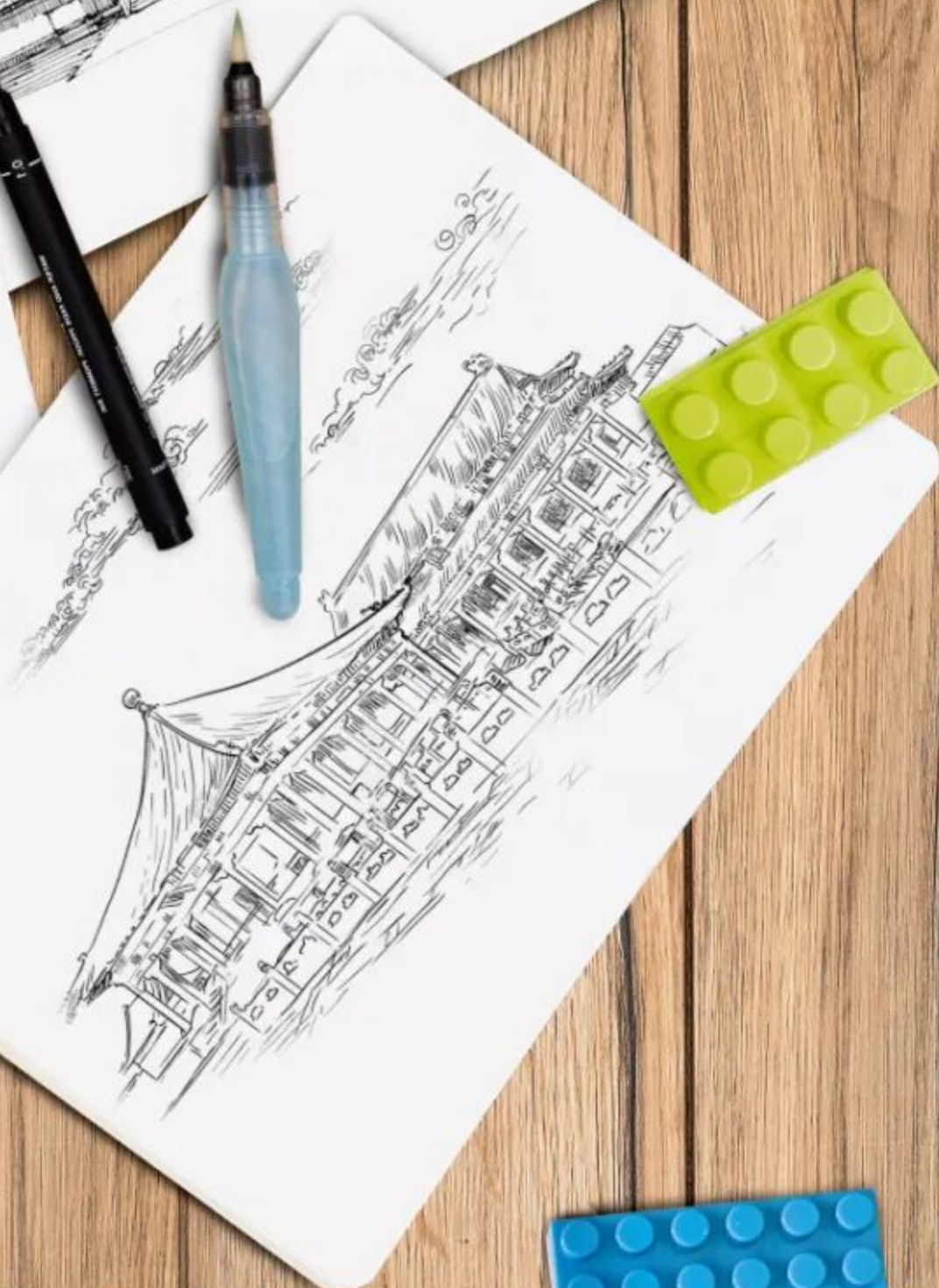

Guangdong Baoge Educational Material Sci-Tech Co., Ltd.  
©2014 Wange / Dubie. All Rights Reserved

# Design Points

结构难点

Angle calculation  
角度的计算

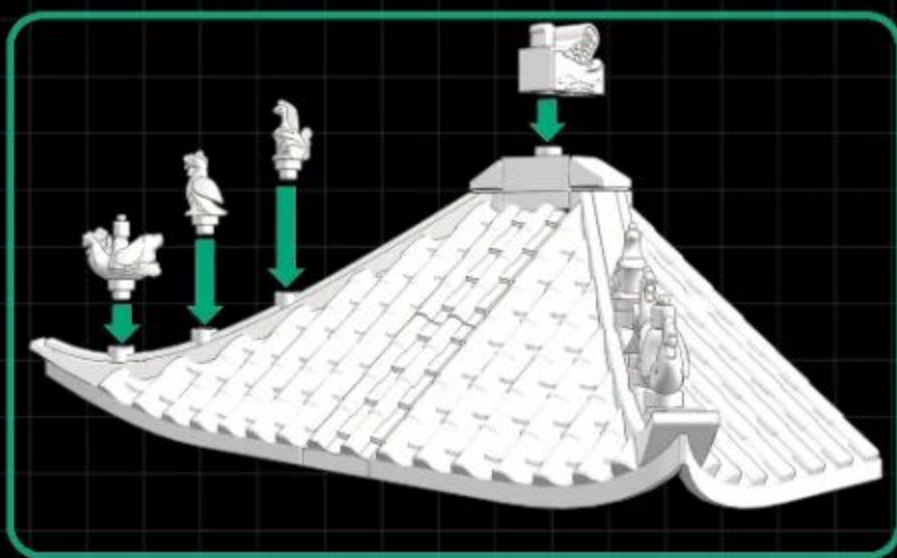

$$S=4\pi\cdot r^2$$

$$a^2+b^2=c^2$$

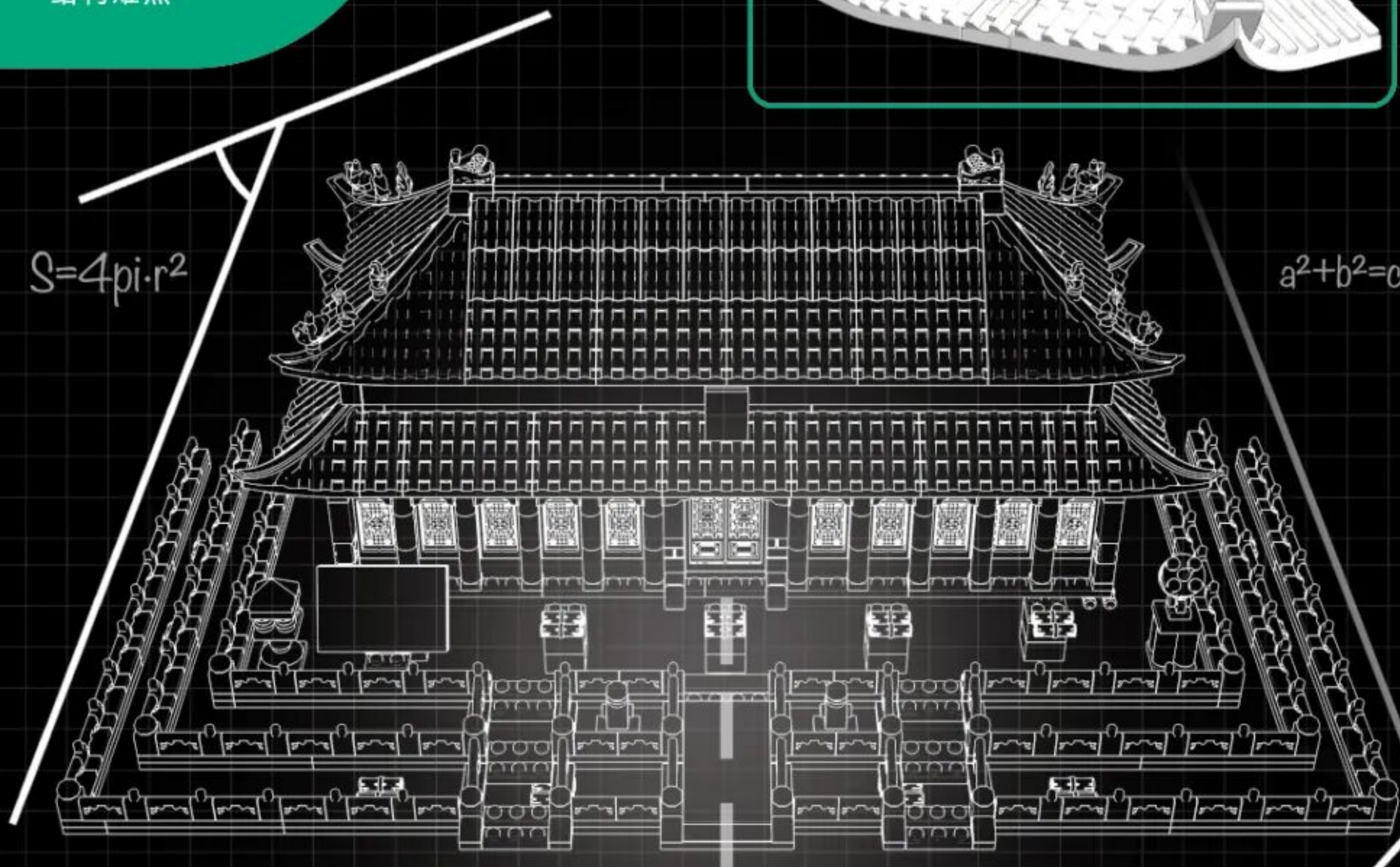

$$\sin^2 a + \cos^2 a = 1$$

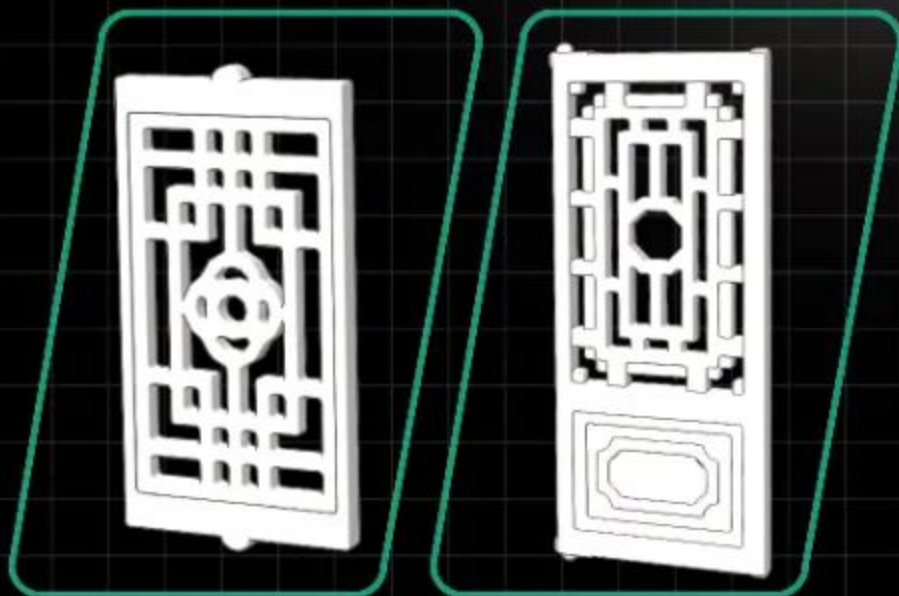

Creation and thinking  
创作·思考

# Force Balance

受力平衡

Scene Matching

场景搭配

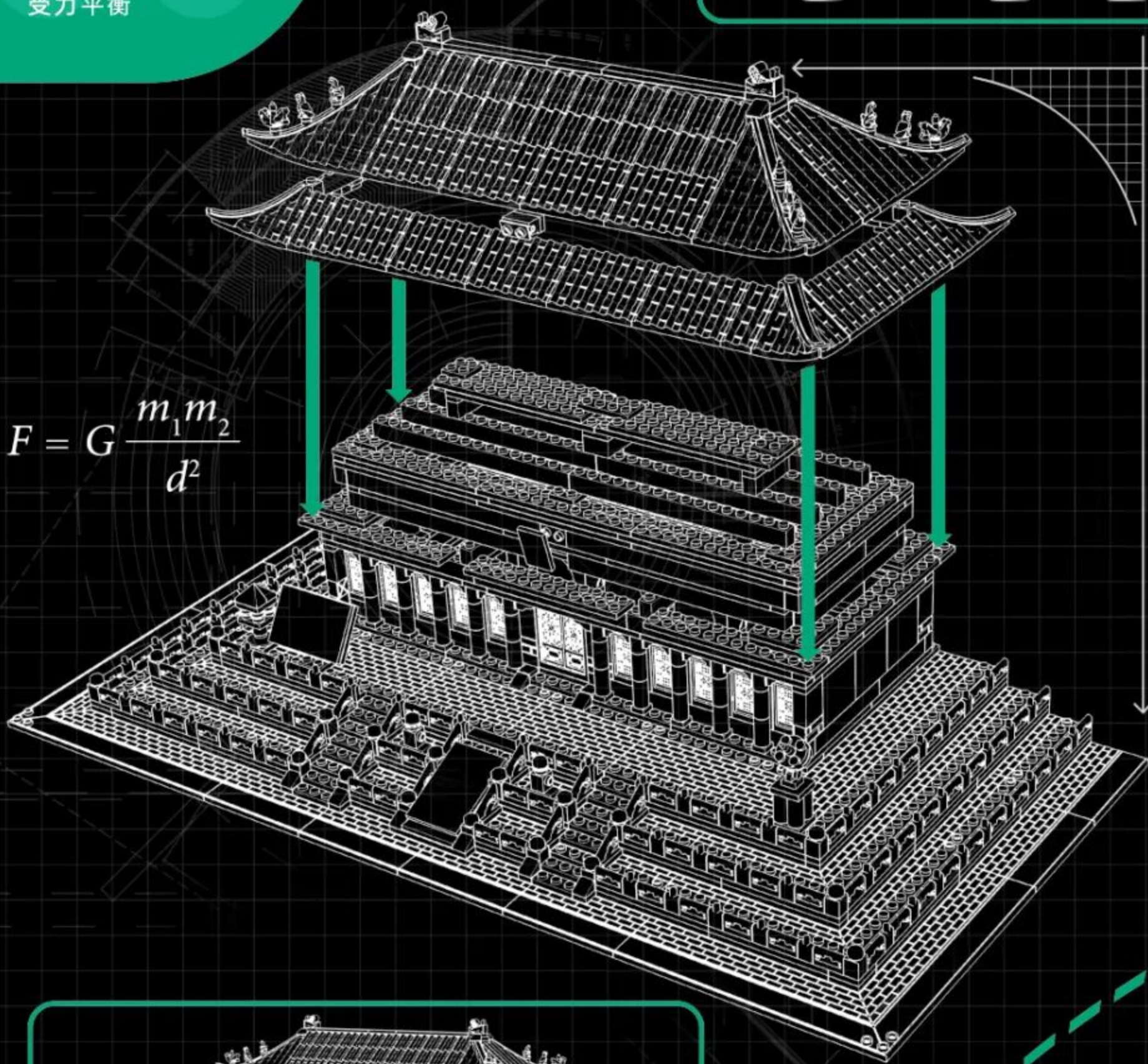
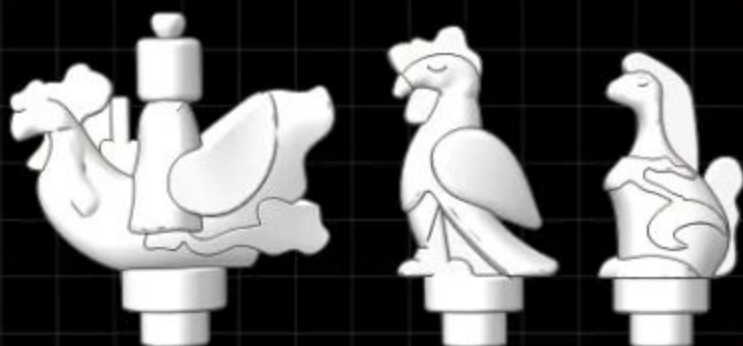

$$F = G \frac{m_1 m_2}{d^2}$$

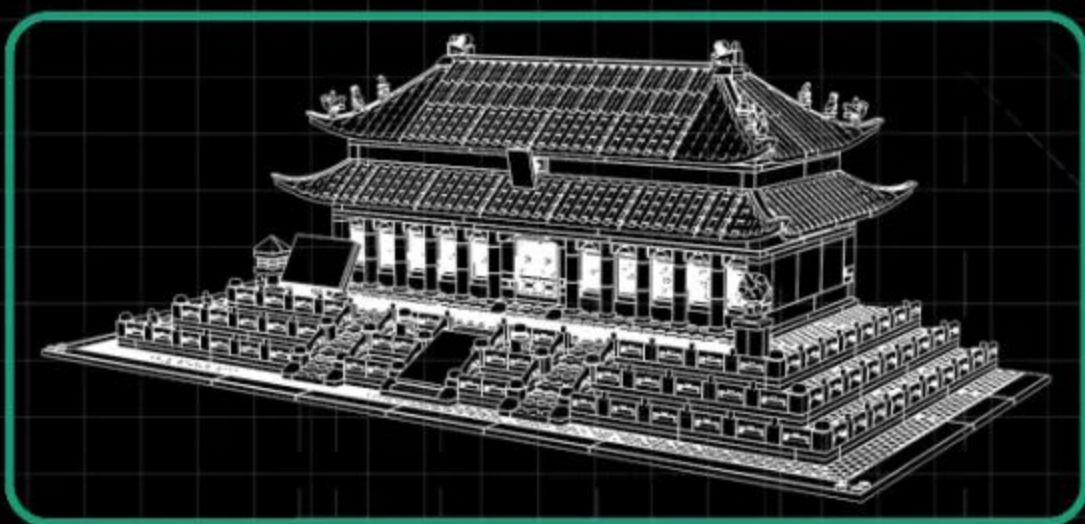

Creation and thinking

创作·思考

# Special parts

特殊零件的开发利用

$$S=4\pi \cdot r^2$$

$$a^2+b^2=c^2$$

**WG1289**

雀替柱



**WG1275**

2孔栏杆



**WG1290**

雀替



**WG1306**

镂空花窗叶



**WG1276**

斜角栏杆



**WG1304**

中式镂空门

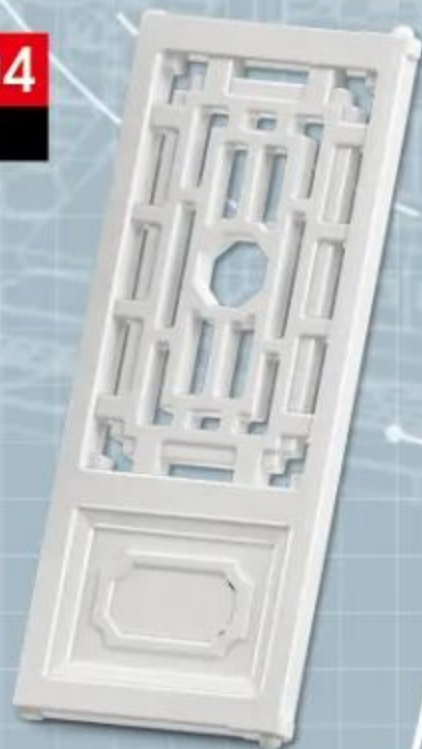

**WG1274**

1孔栏杆



$$\sin^2 a + \cos^2 a = 1$$



features and functions

特点.功能

# Special parts

特殊零件的开发利用

$$S=4\pi \cdot r^2$$

$$a^2+b^2=c^2$$

**WG1308**  
脊兽-骑凤仙人

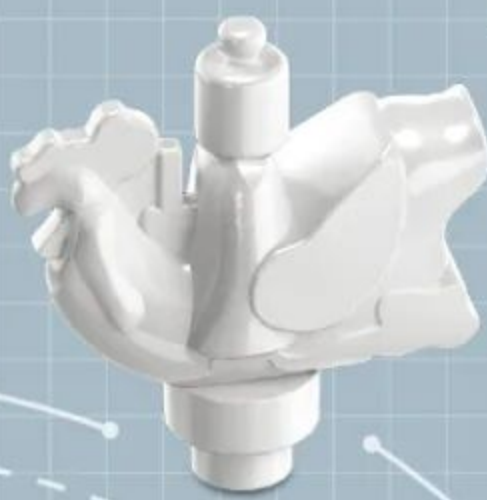

**WG1308**  
脊兽-海马



**WG1307**  
带孔大角瓦片



**WG1308**  
脊兽-凤凰



**WG0533**  
角瓦片

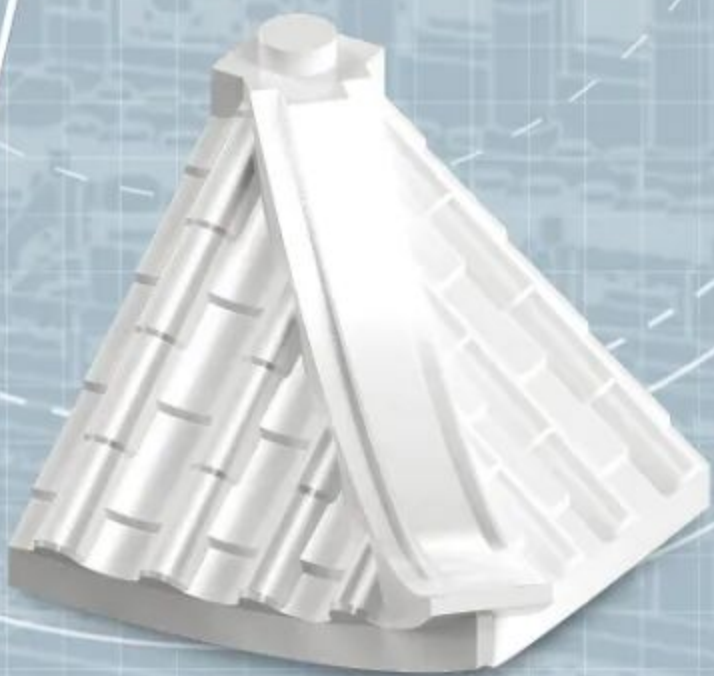

**WG1284**  
2孔龙头砖



$$\sin^2 a + \cos^2 a = 1$$

features and functions

特点.功能



# Special parts

特殊零件的开发利用

$$S=4\pi \cdot r^2$$

**WG1278**

砖纹直底板

$$a^2+b^2=c^2$$

**WG0532**

直瓦片2孔

**WG0534**

直瓦片6孔

**WG1277**

砖纹角底板

**WG1067**

瓦片

$$\sin^2 a + \cos^2 a = 1$$



features and functions

特点.功能

# Main Color Matching

配色方案

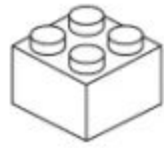

white



Pantone 1575C



Pantone 540C



Pantone 123C



Pantone 7713C



Pantone 7620C



Pantone 7427C



Pantone Cool Gray 6C



## Color matching

Adopting 7 main colors, beige, brown and gray as the main color, the more reasonable and bold color matching on the original building, making the product more atmospheric and the whole design is more reasonable.

# Hall of Supreme Harmony

中国北京故宫太和殿



Front

Left

Back



Product Size:545X293x191mm



# Instructions For Use

积木起件器使用说明  
Brickseparator

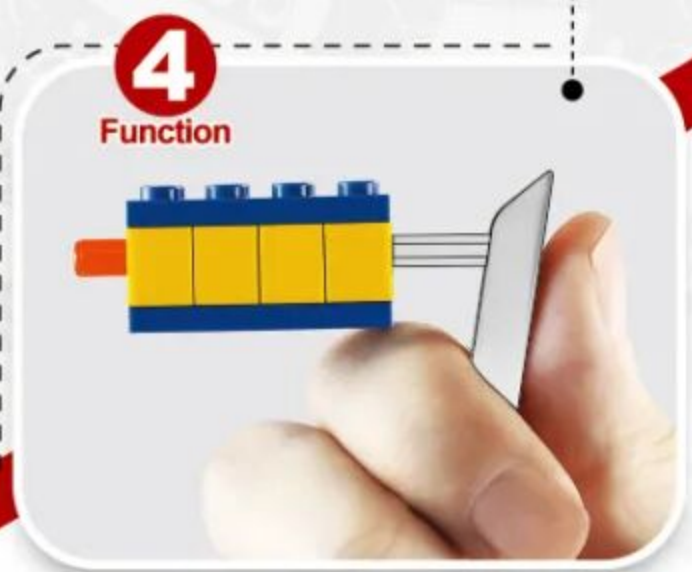
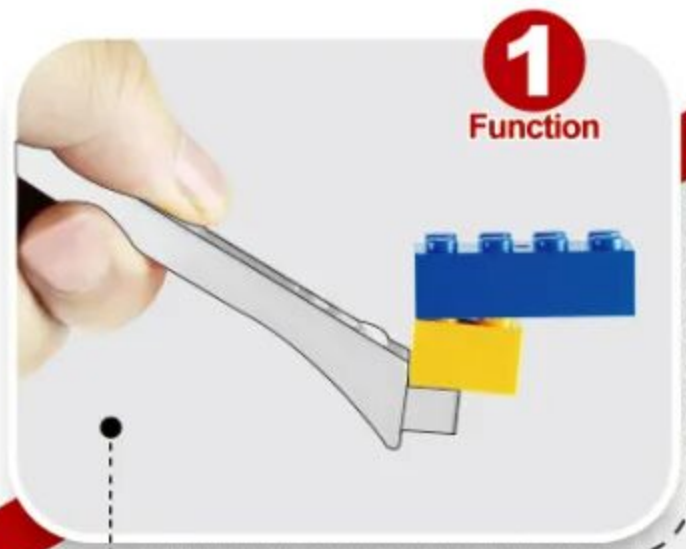

4 ways to make installation easier  
让安装更简单



■ First open the product packaging according to the instructions.

按指导用正确方式拆解产品外包装。



■ Summarize all parts to count the number of familiar accessories.

对照说明书清单确认积木包数量与积木数量。



■ Arranging all accessories by color helps to quickly install the product.

把确认好的积木以类型、颜色进行分类排好以便安装。



■ Carefully install the product and learn about building.

按说明书步骤拼装并完成你的积木模型。



# 1:1 Physical Reference Table

十字棒配件1:1尺寸参照表



Instructions For Use

让安装更简单

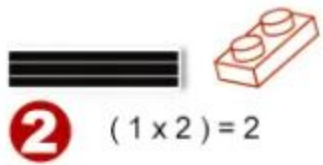

**2** (1x2)=2

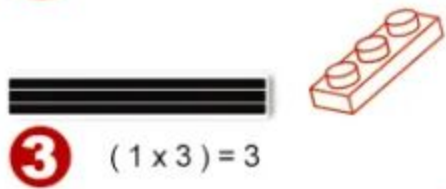

**3** (1x3)=3

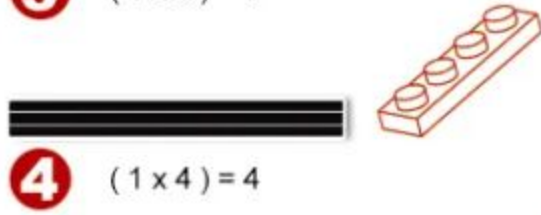

**4** (1x4)=4



**5** (1x5)=5



**6** (1x6)=6

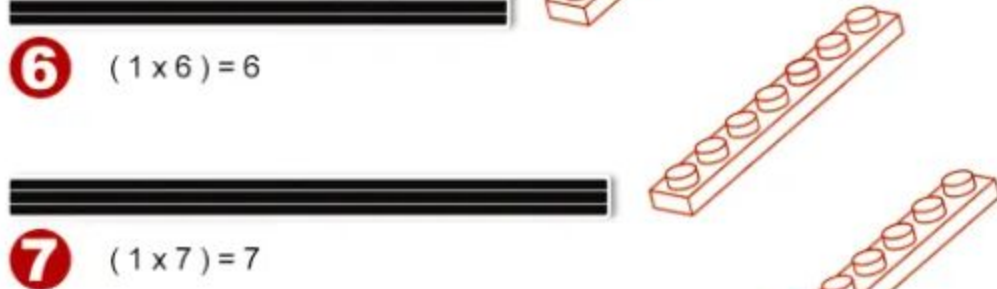

**7** (1x7)=7

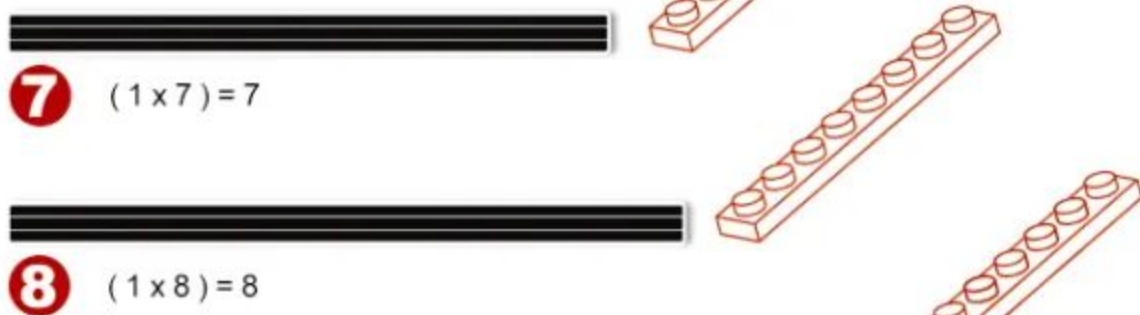

**8** (1x8)=8



**9** (1x9)=9



**10** (1x10)=10



**12** (1x12)=12



**16** (1x16)=16











175PCS

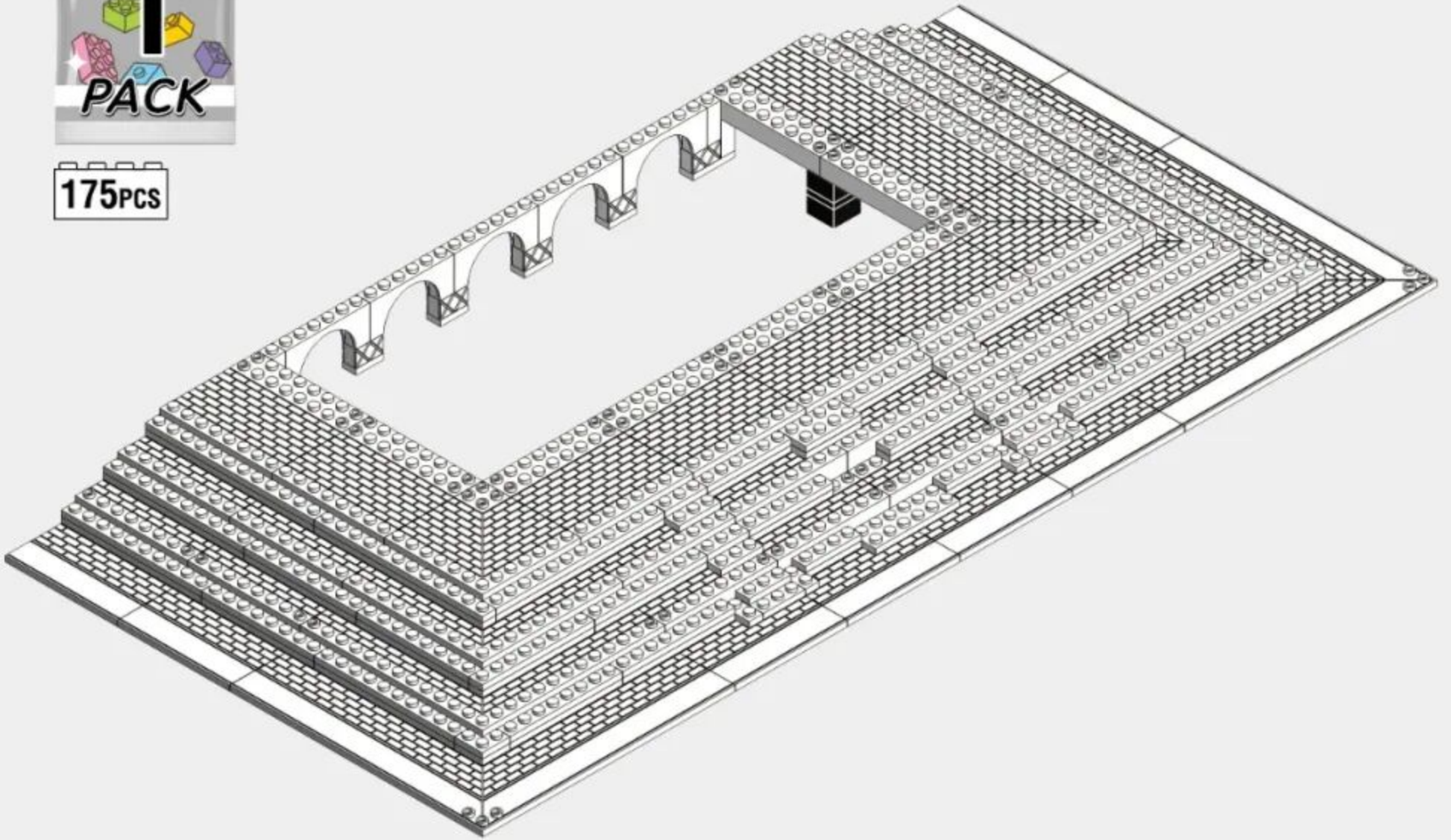

1-1

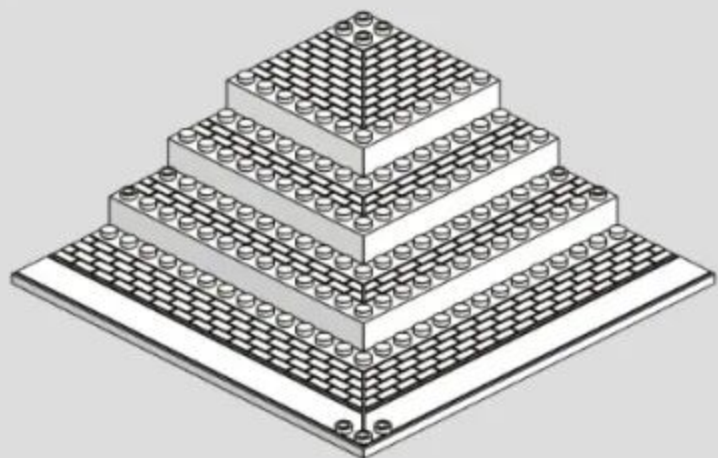

x2

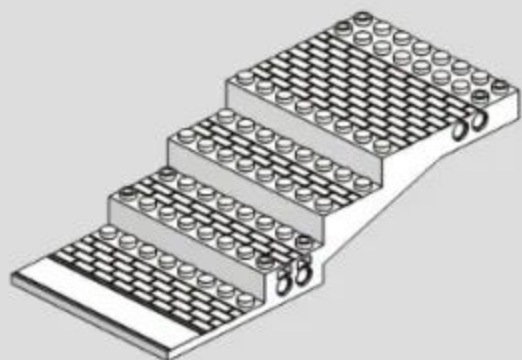

x8



x36

1

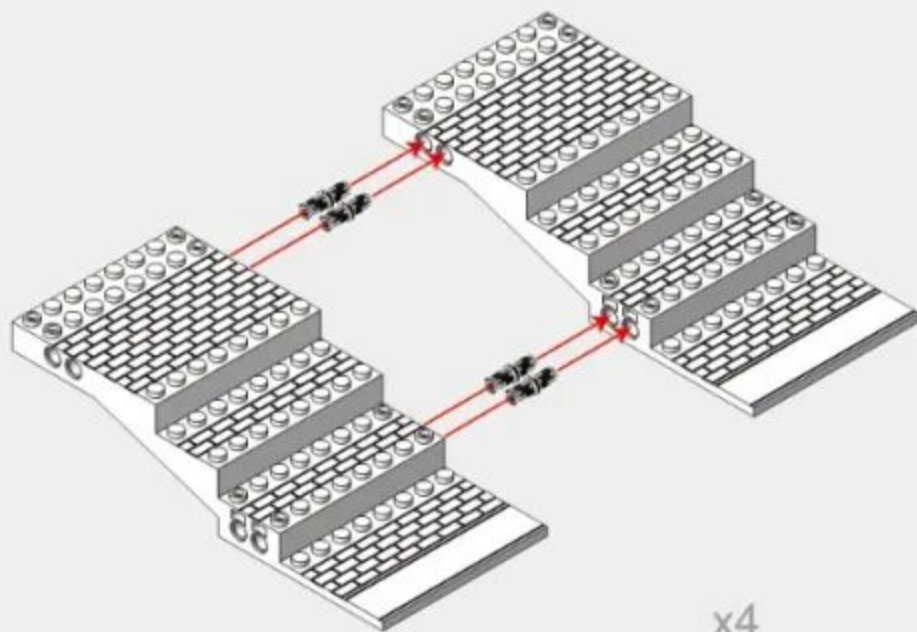

x4



微信扫一扫  
补件更简单

2

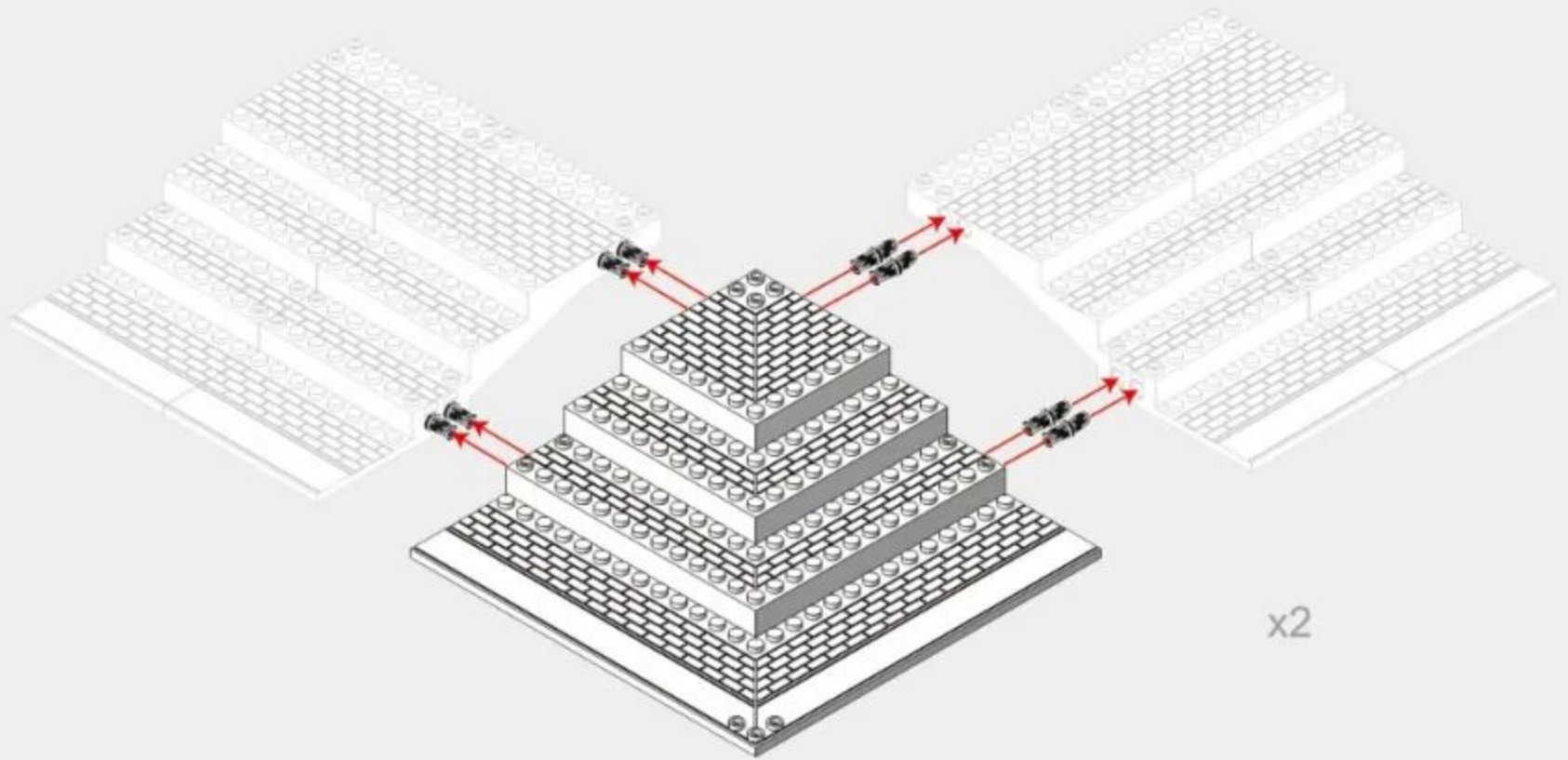

3

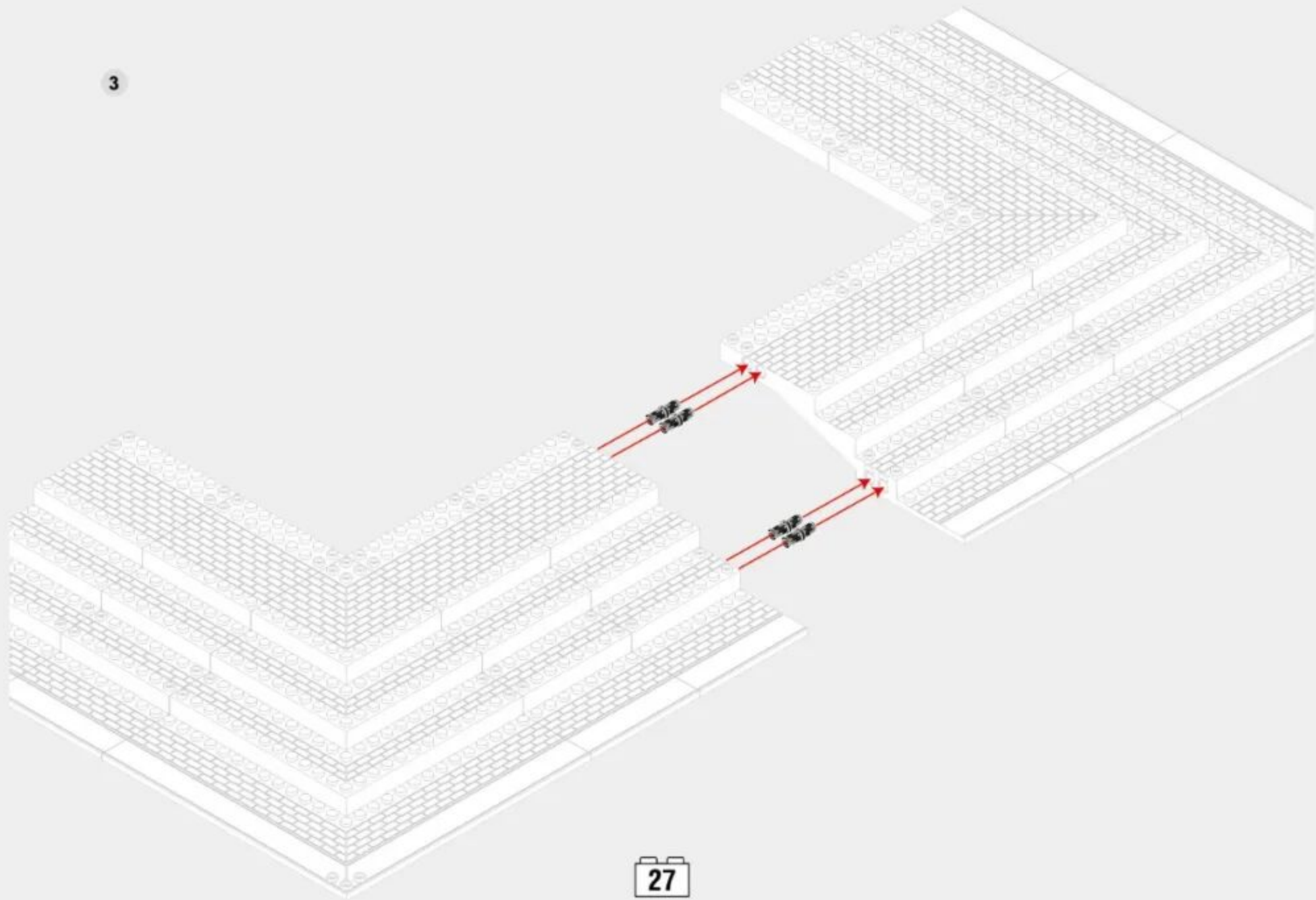



1-3

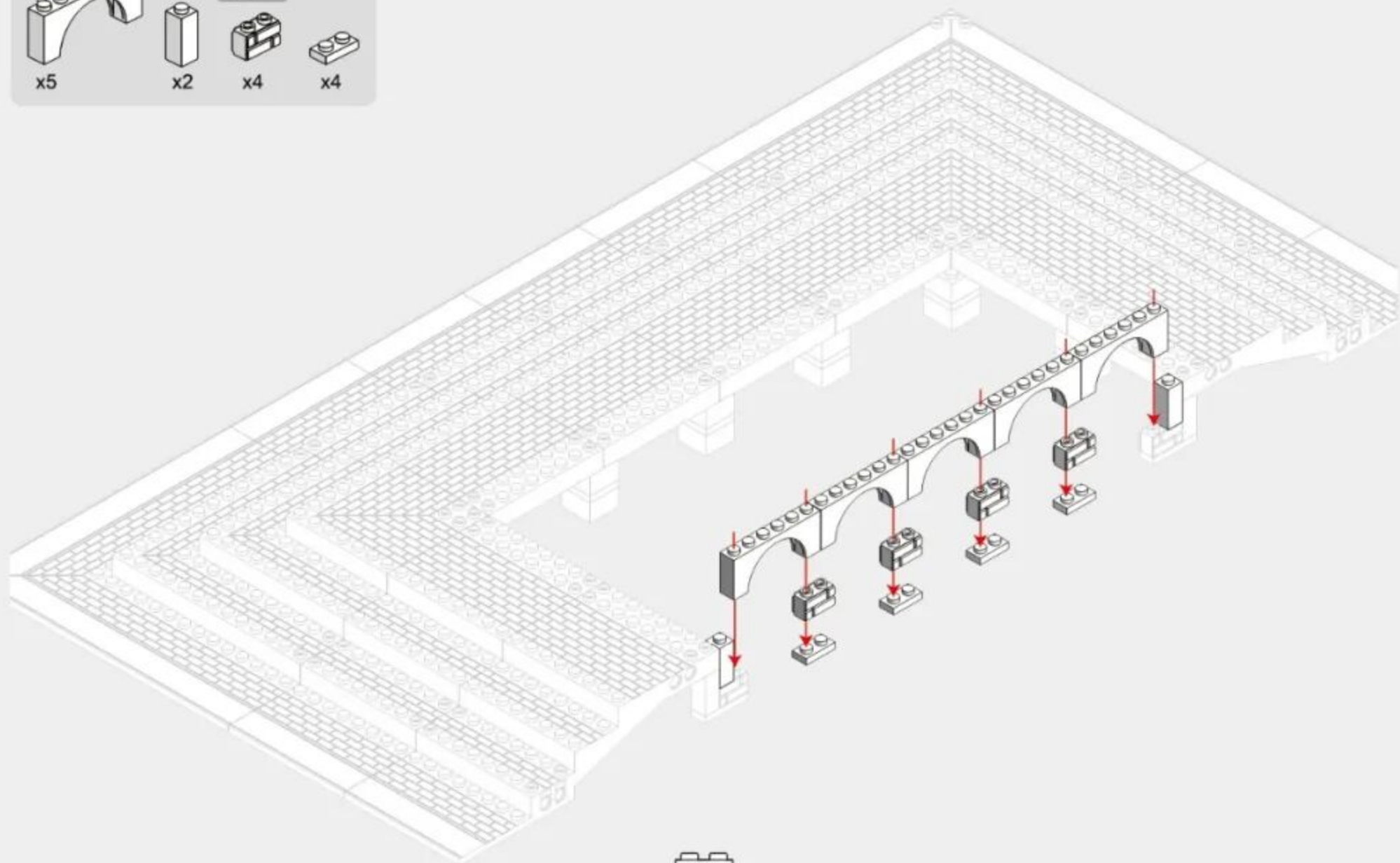
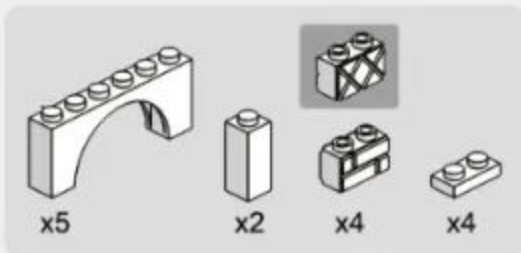

1-4

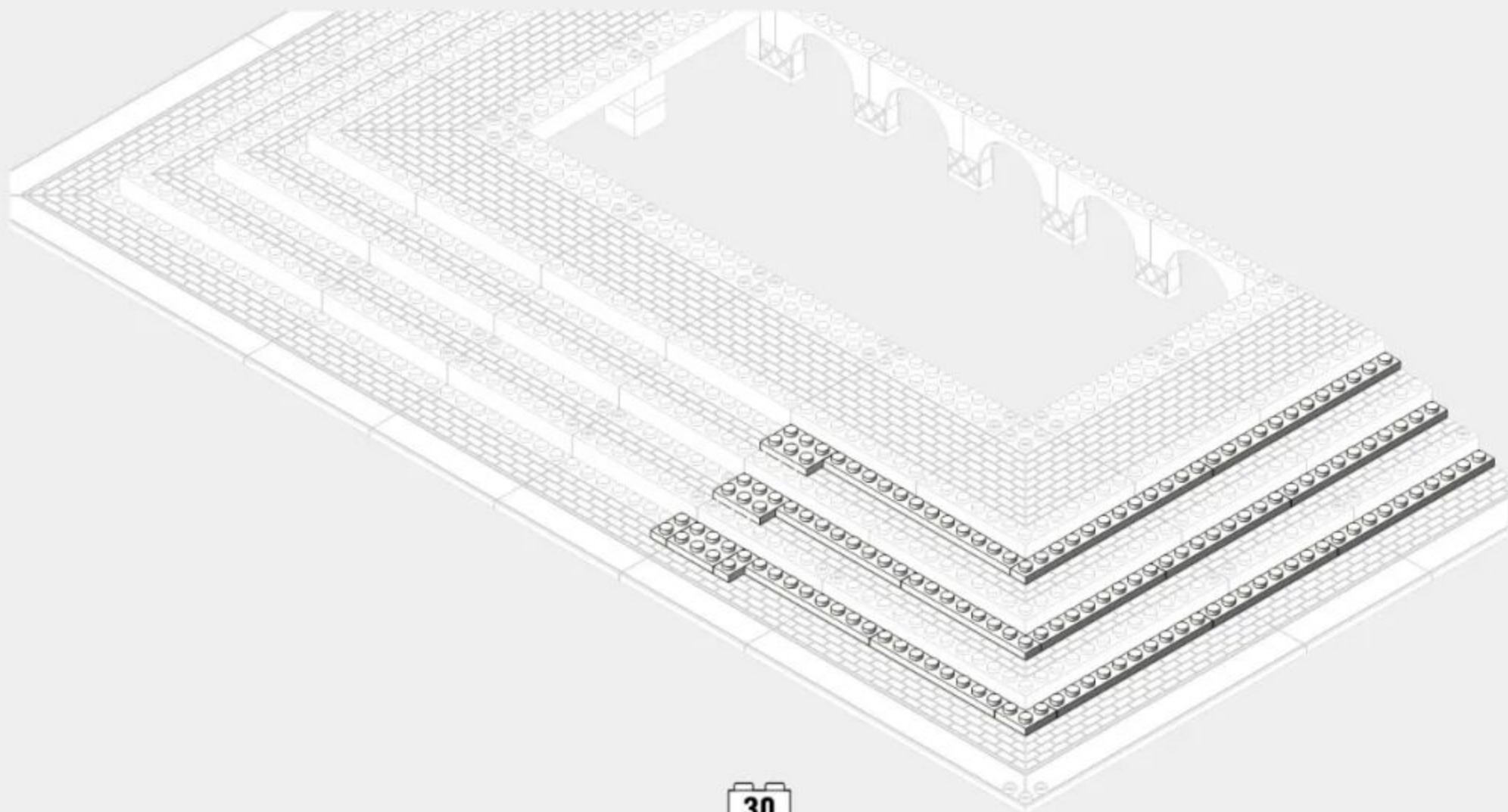
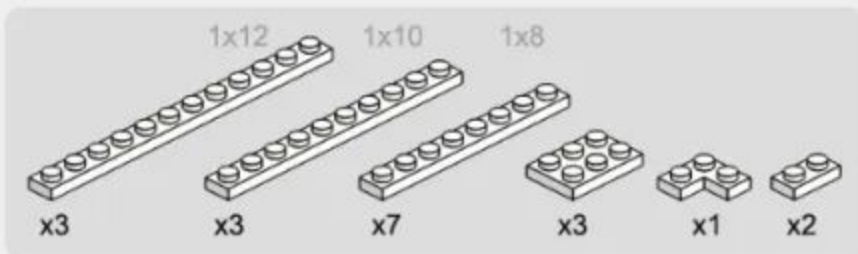

1-5

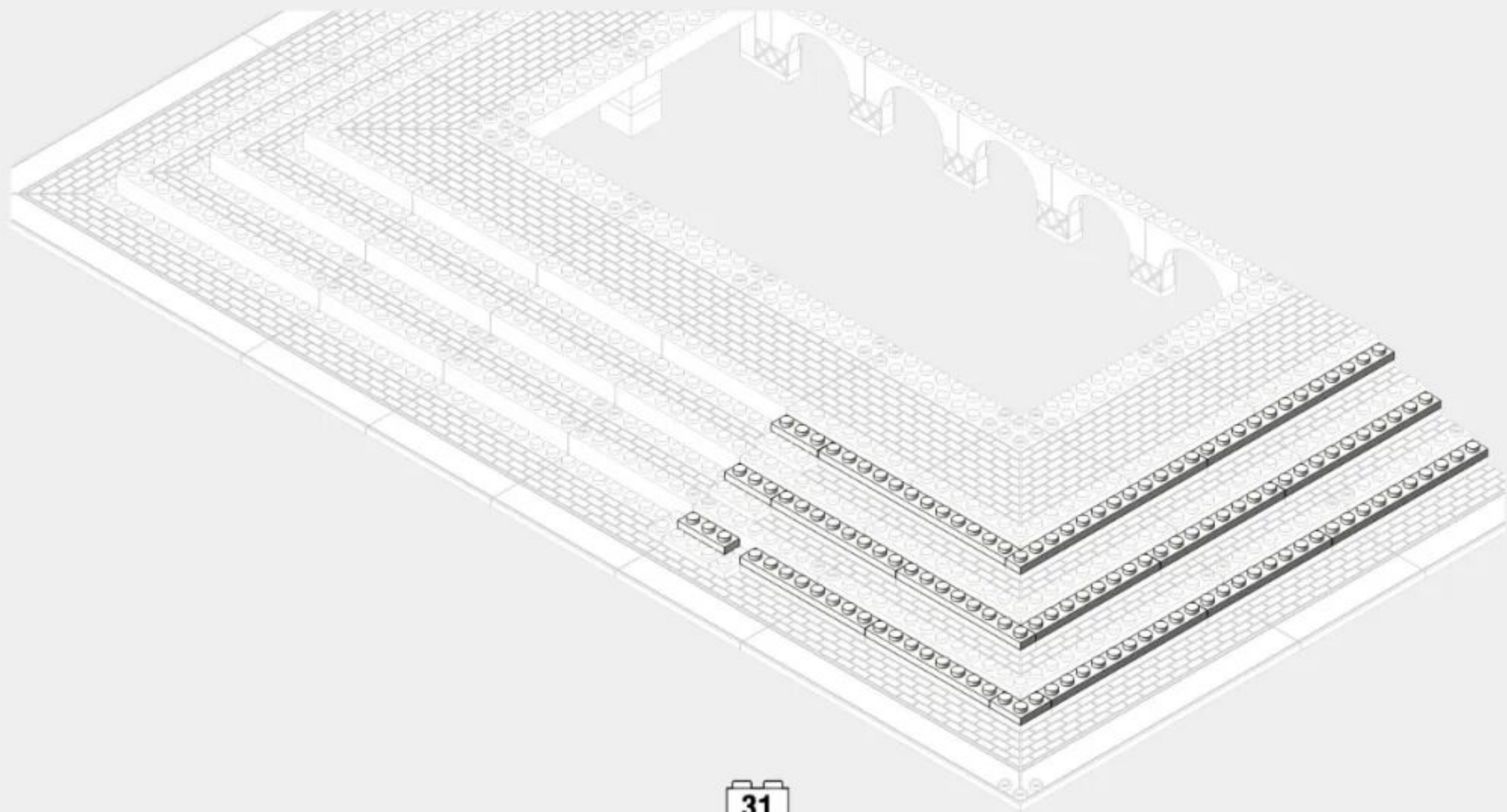
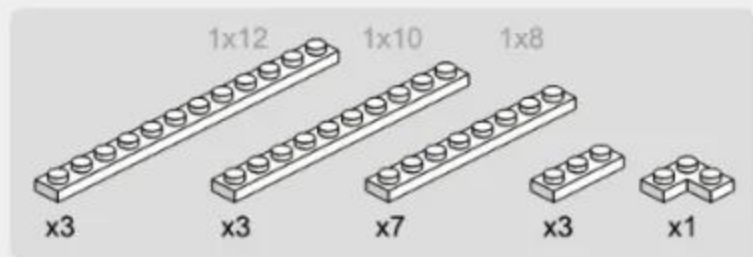

1-6

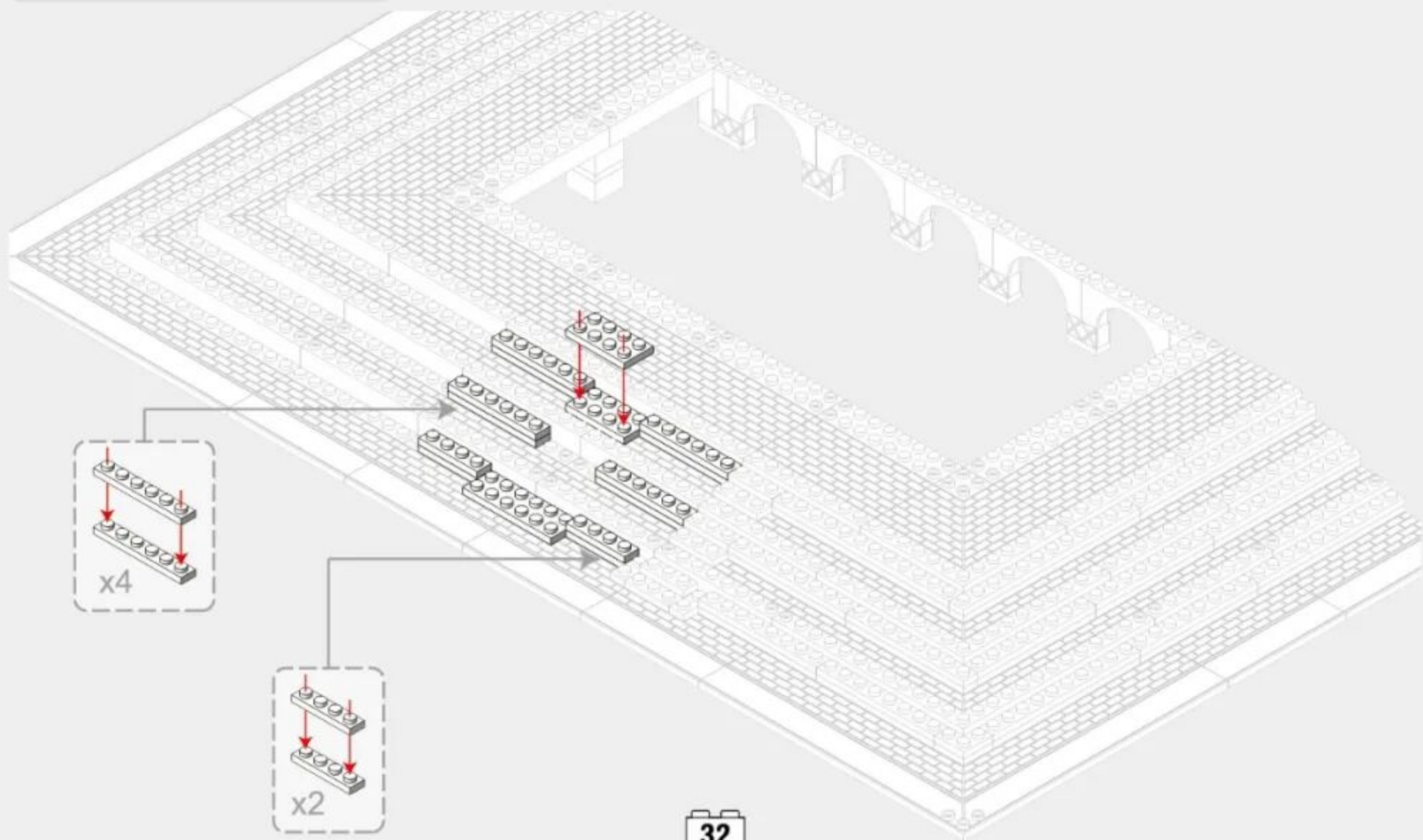
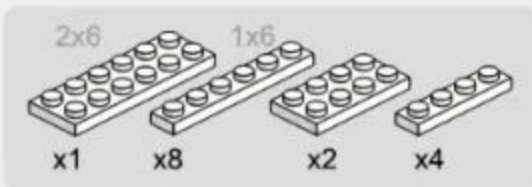

1-7

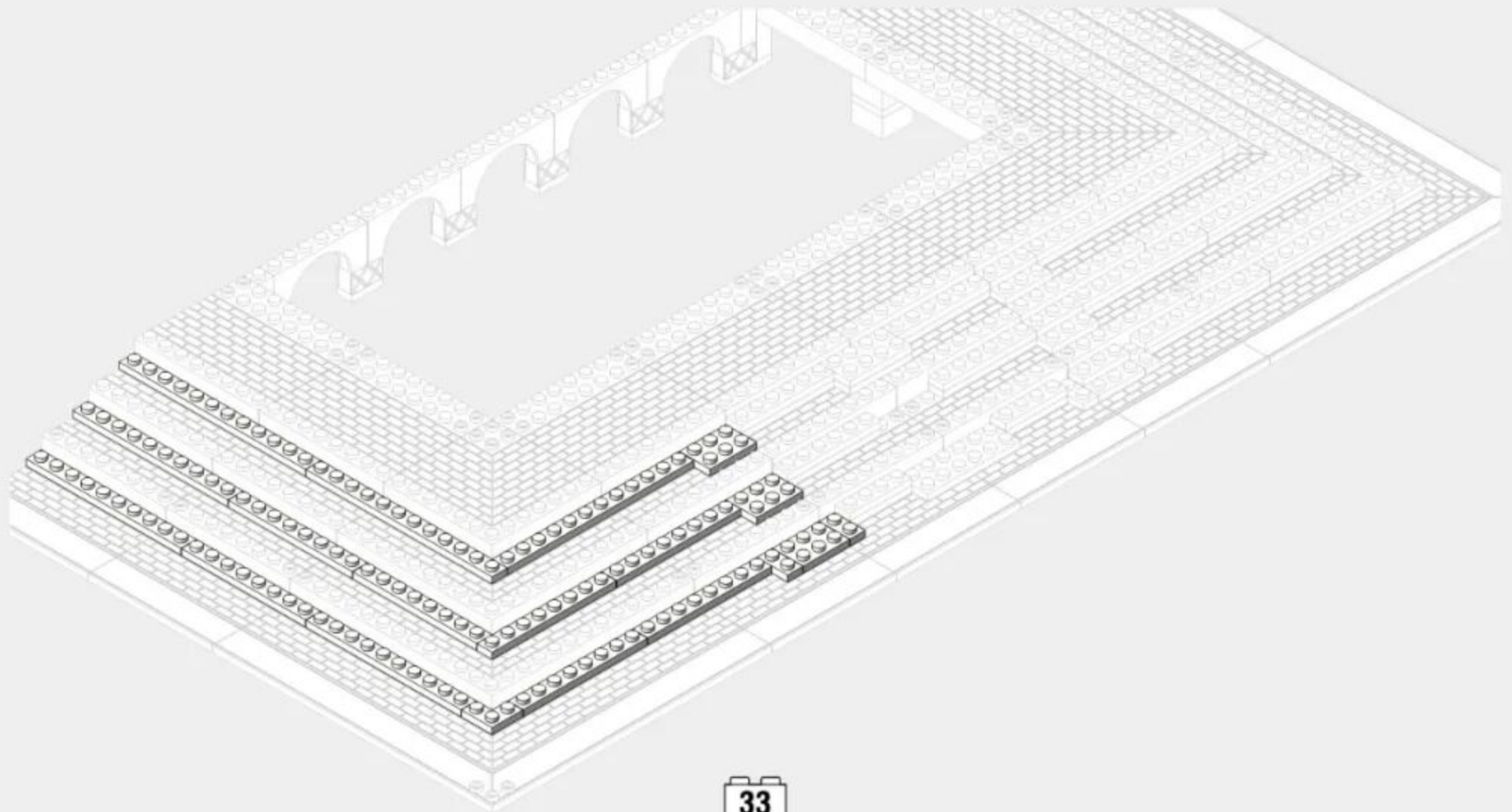
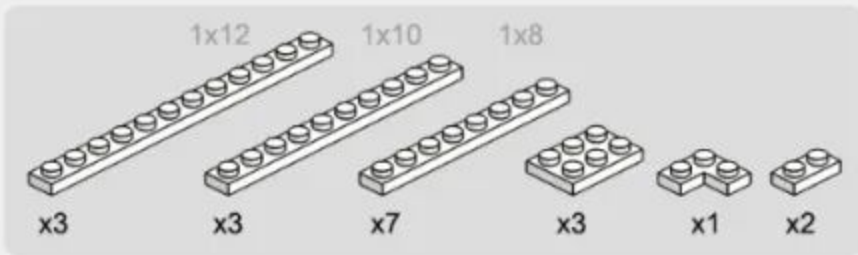

1-8

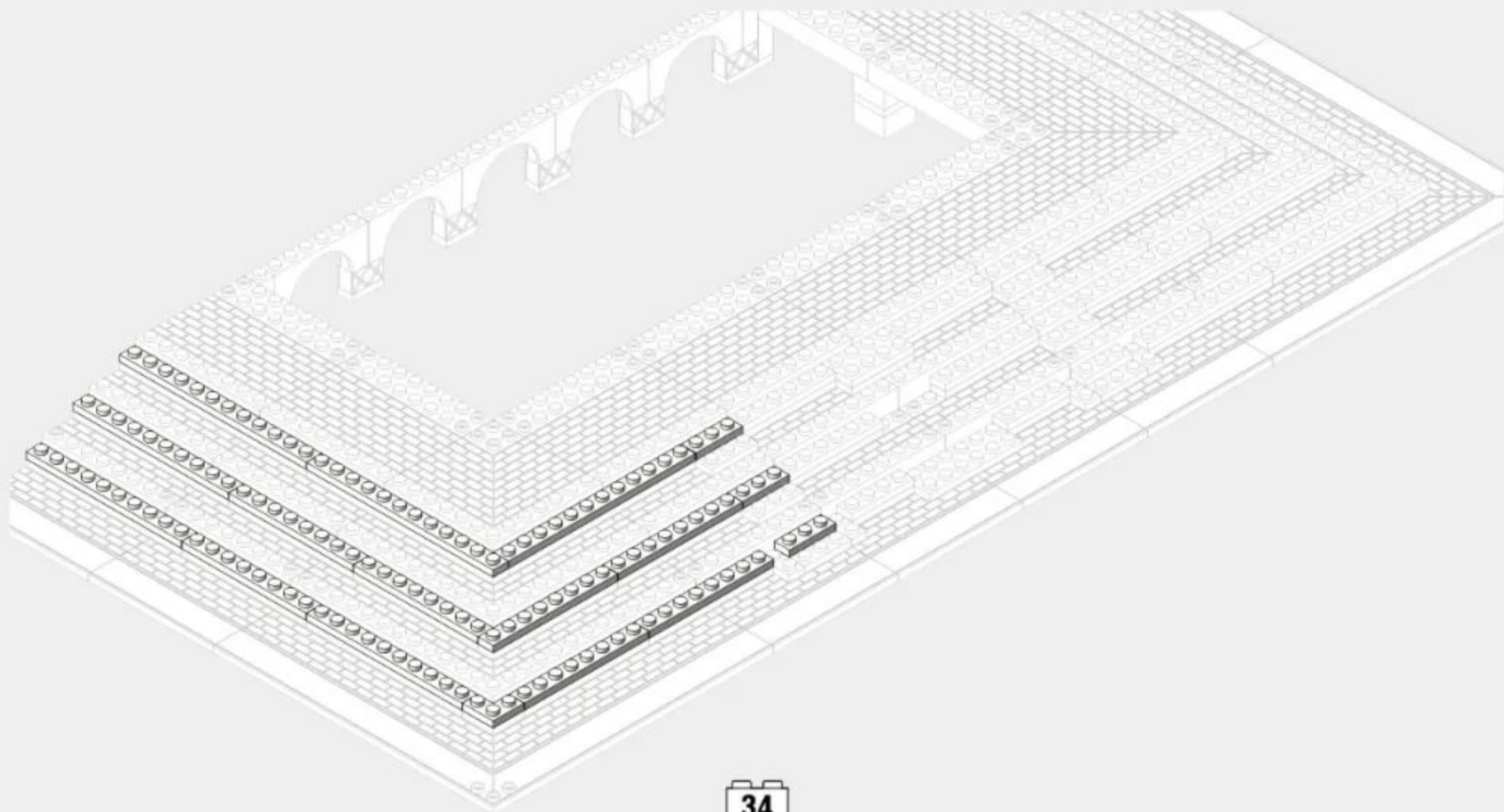
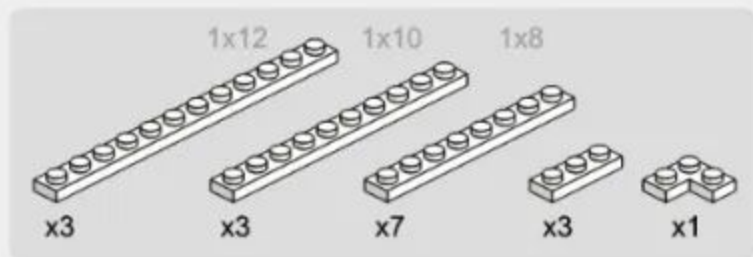



233PCS

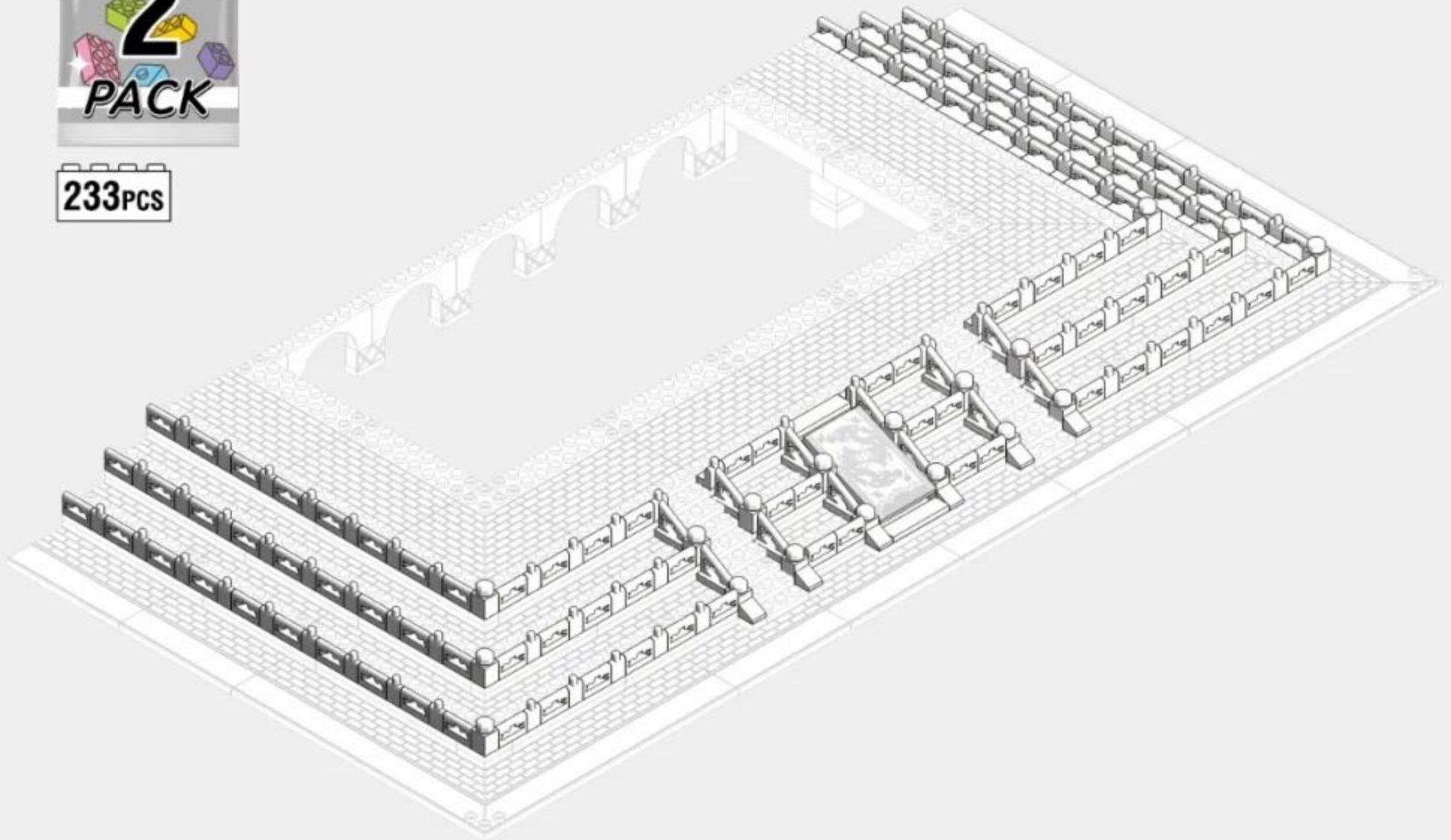



2-2



x6



x6



x2



x9



x3



x9

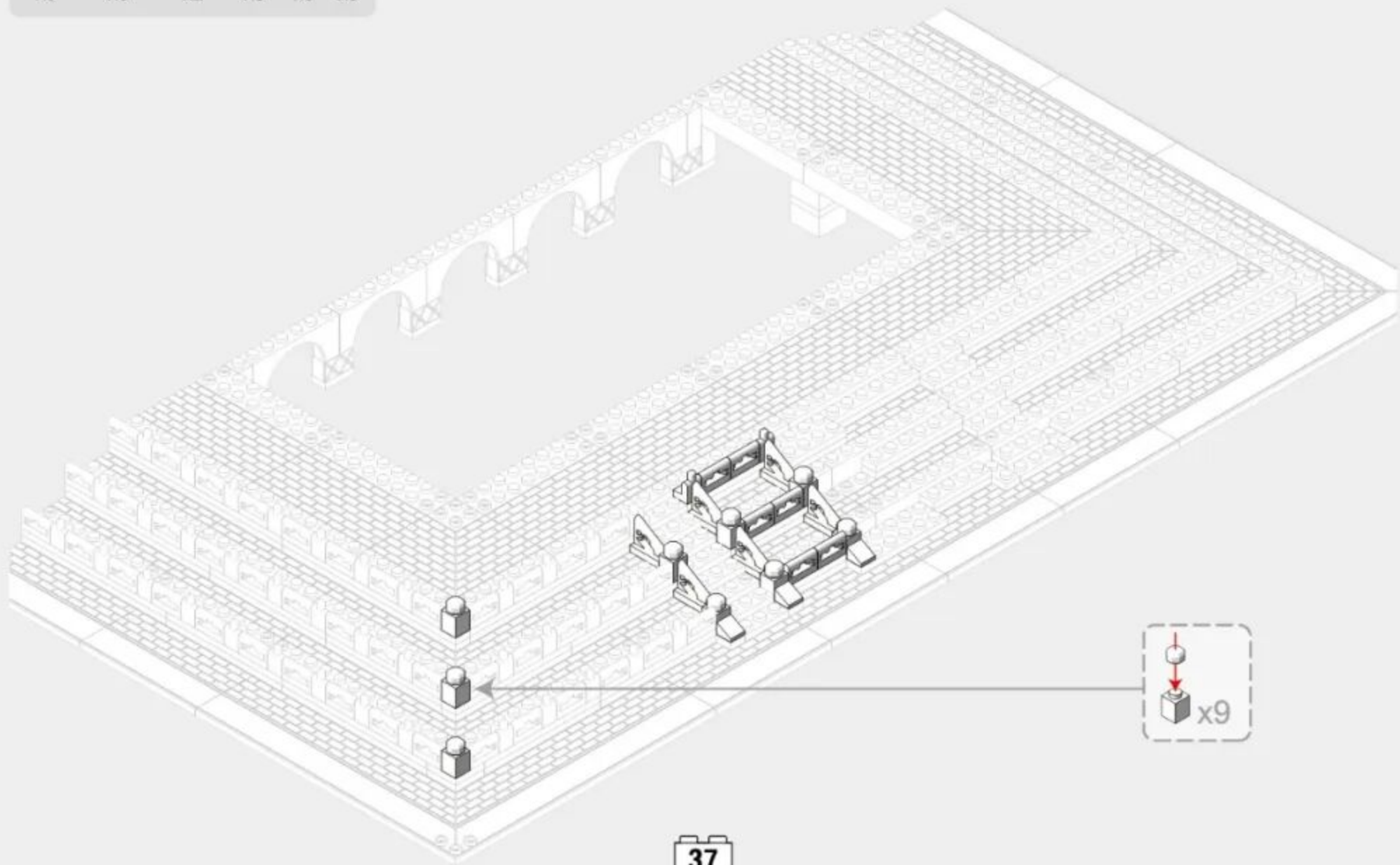

2-3



x42



x37

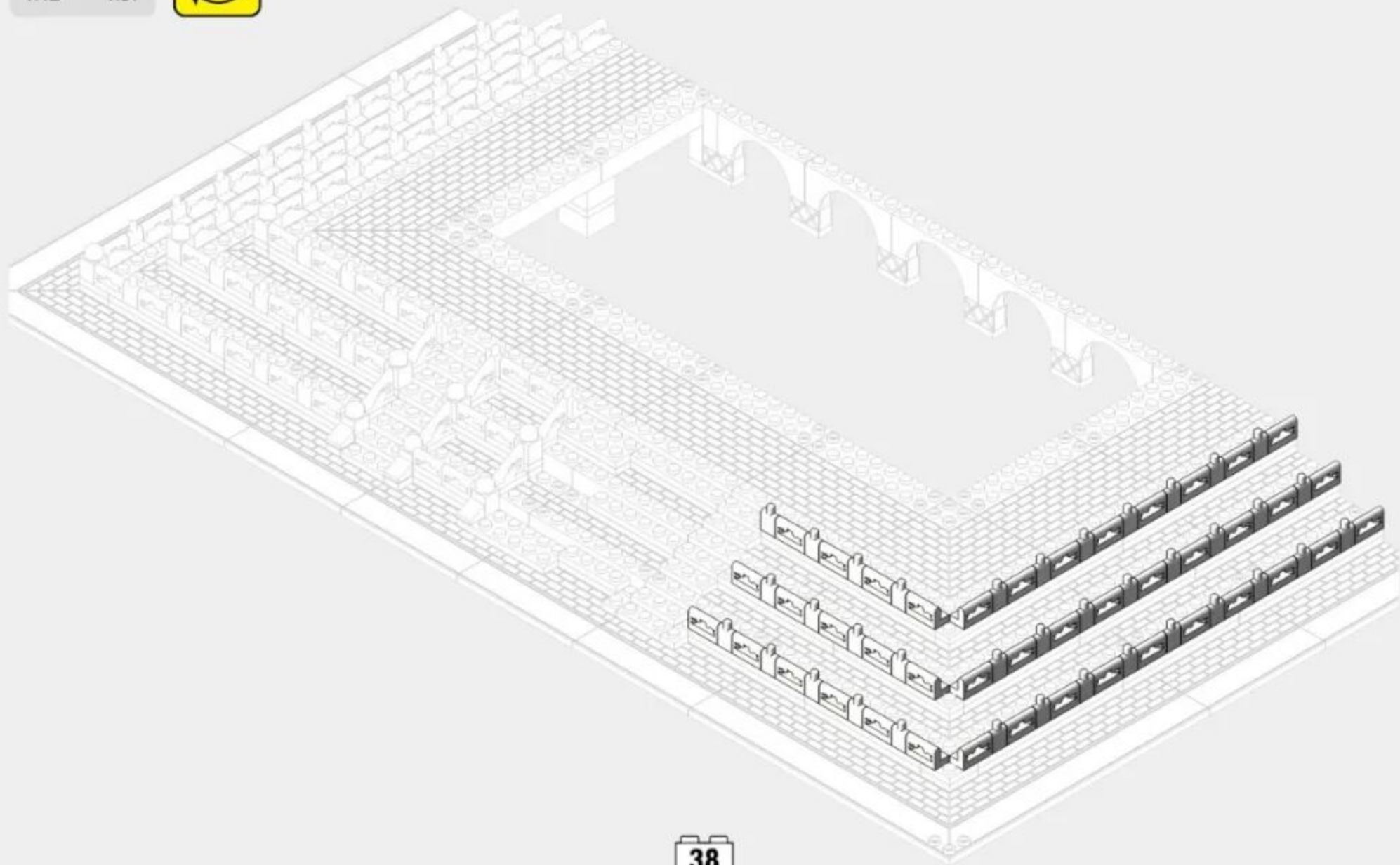

2-4

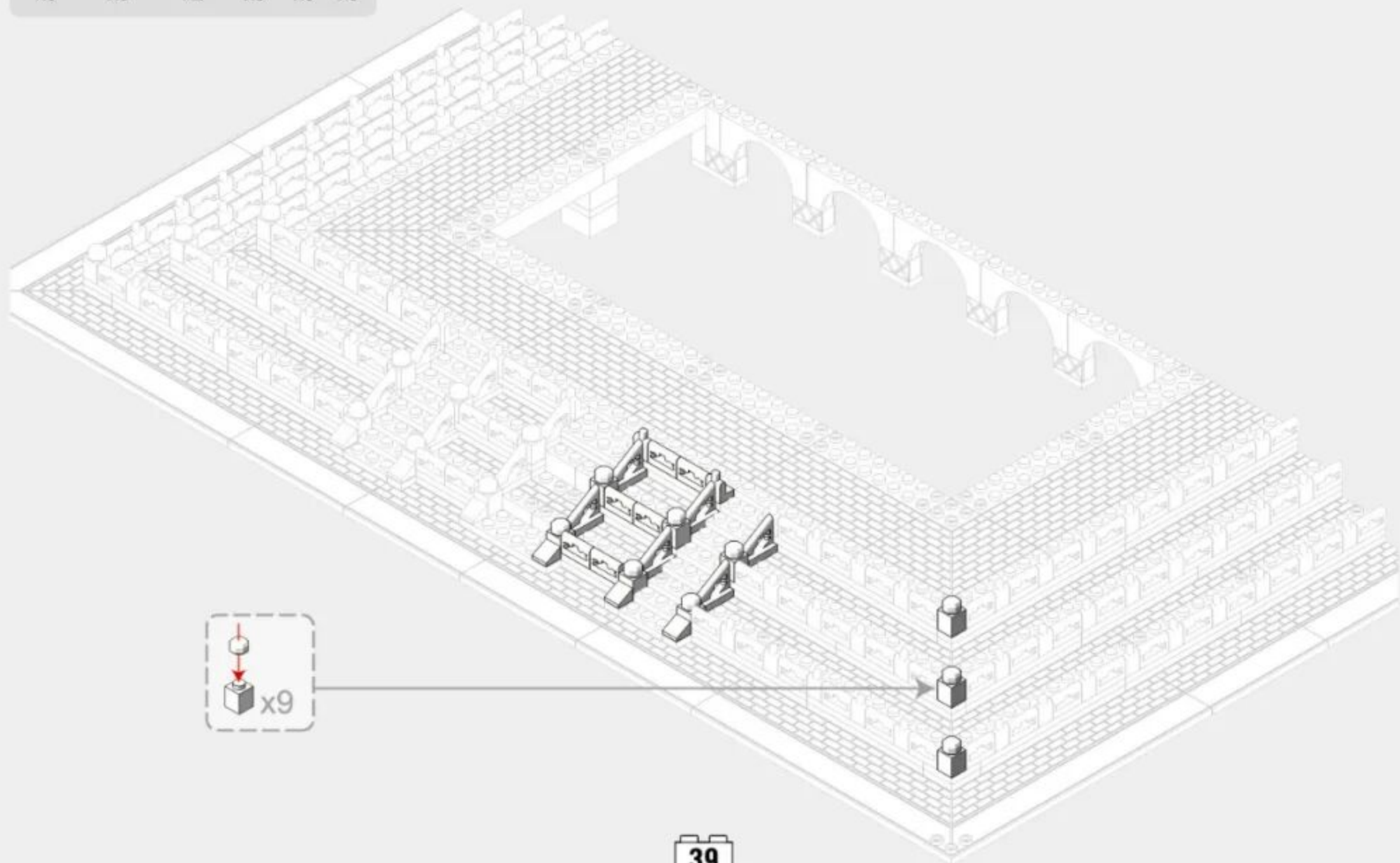

2-5

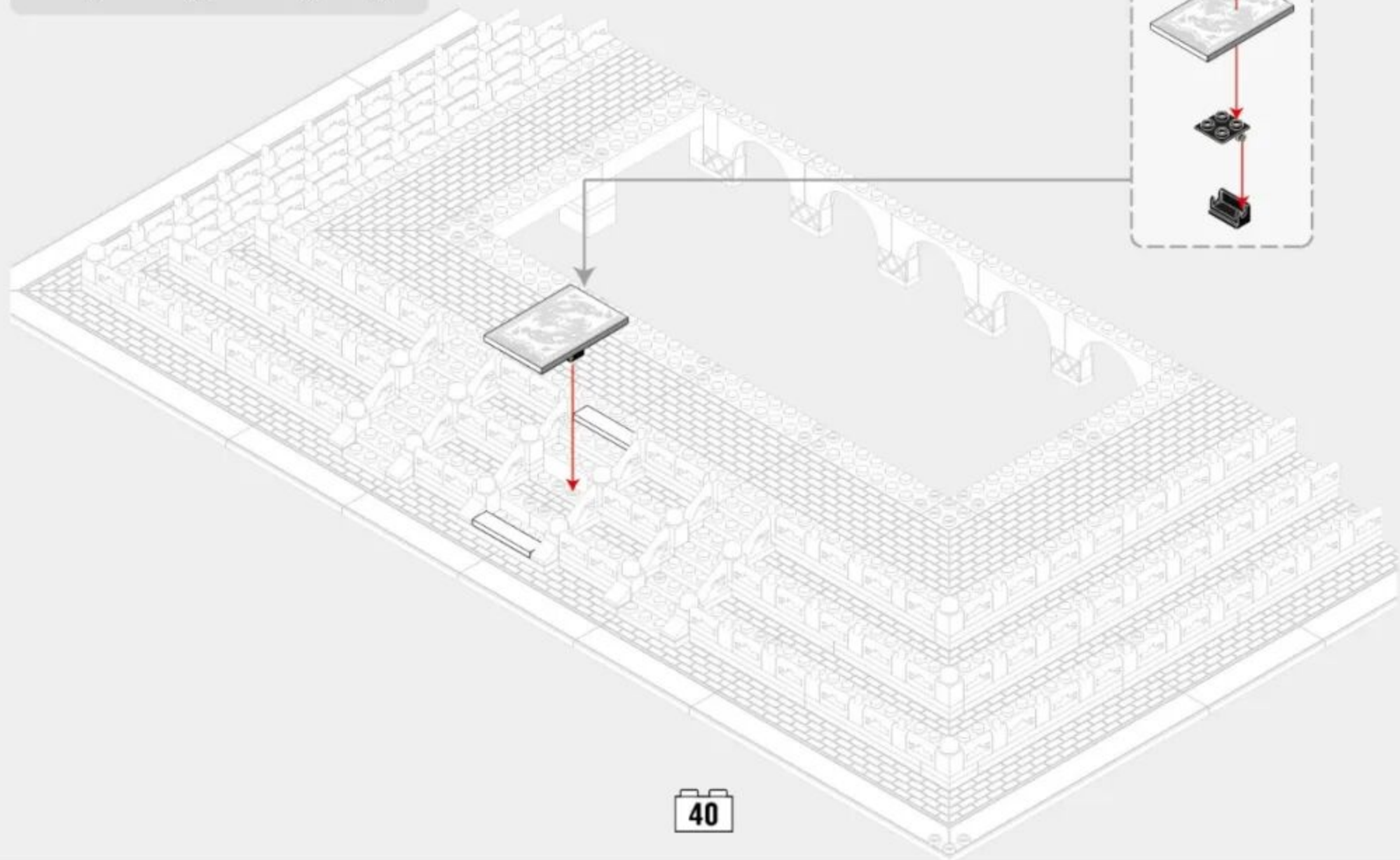
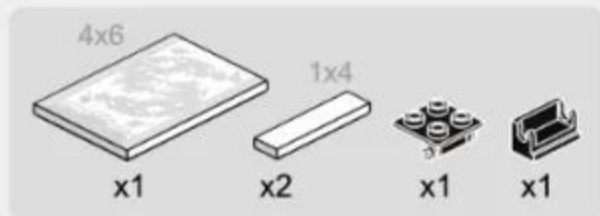

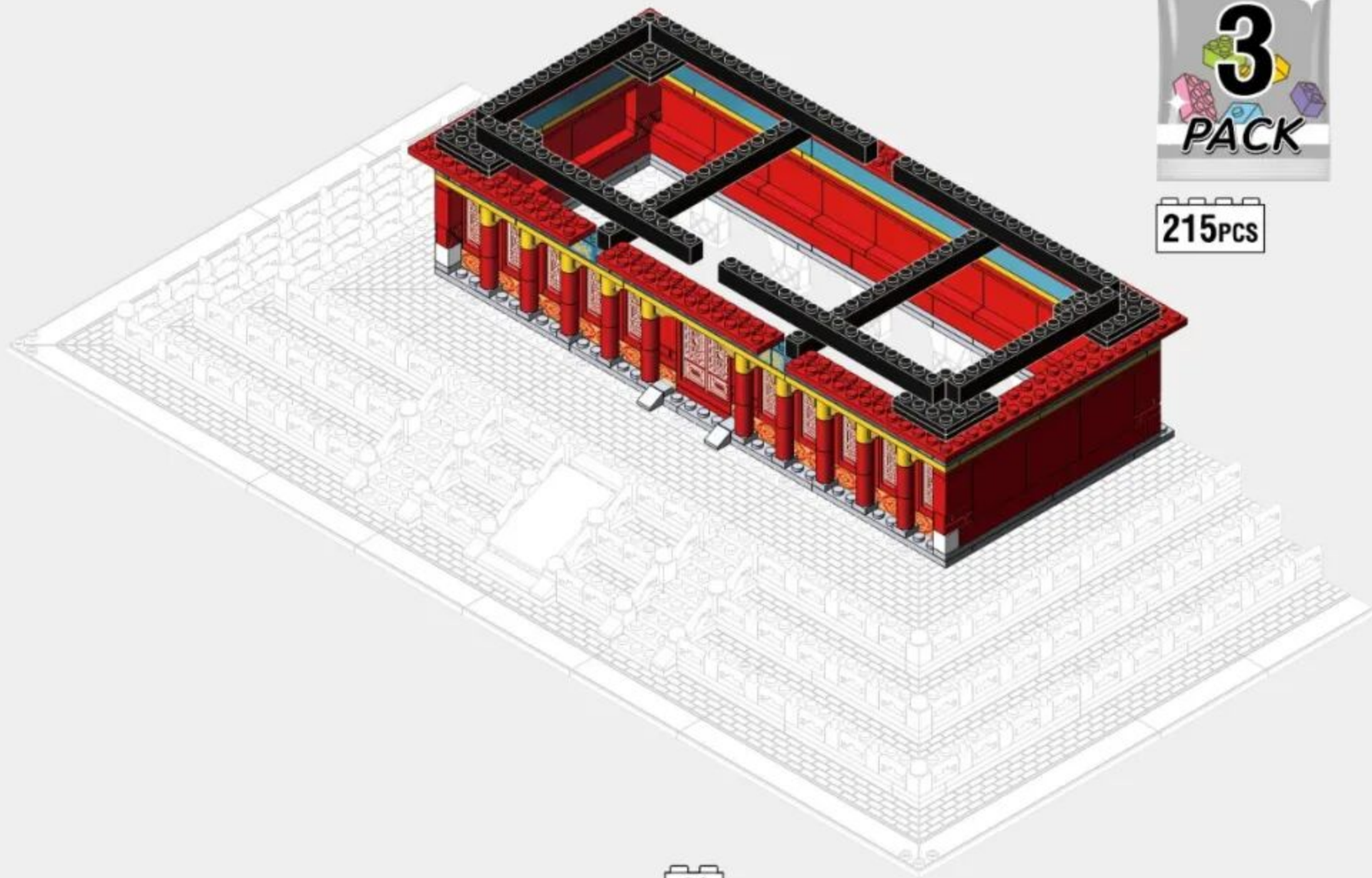

215PCS

3-1

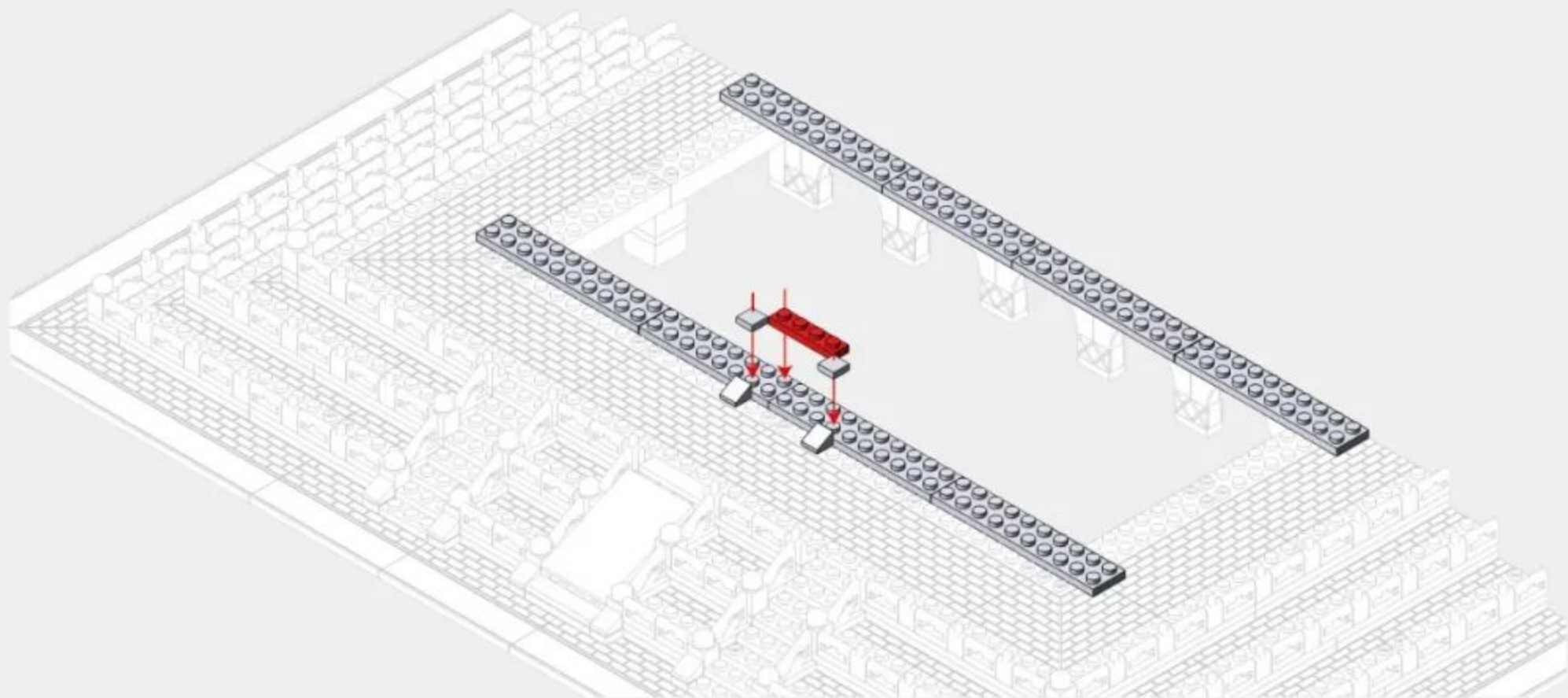
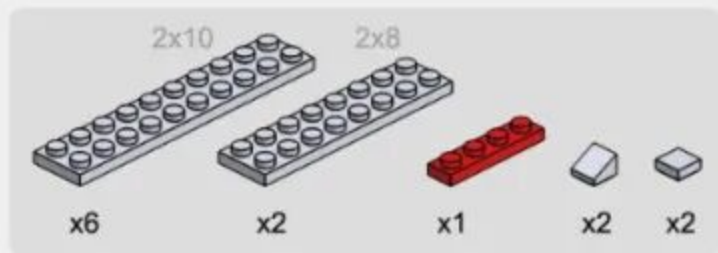

3-2

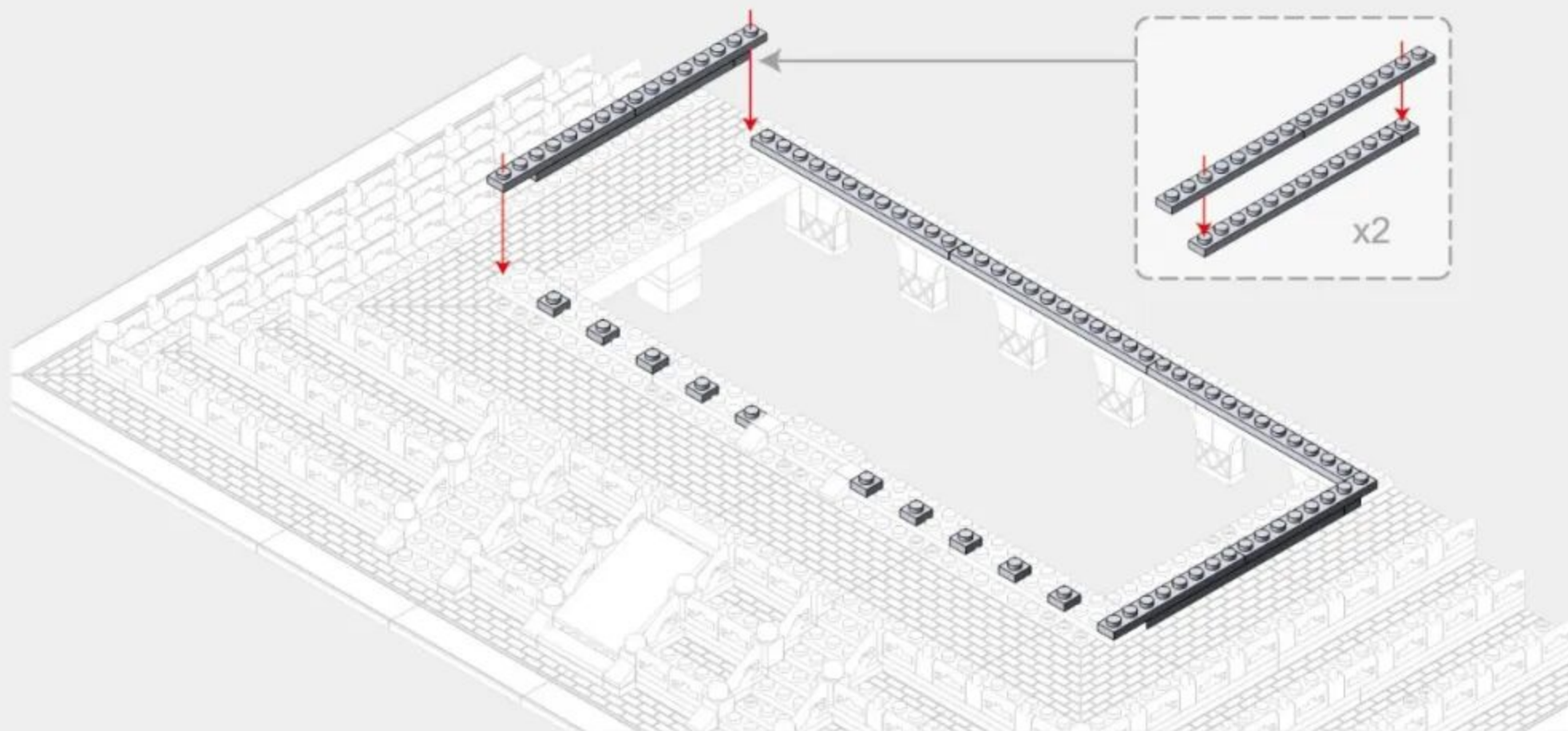
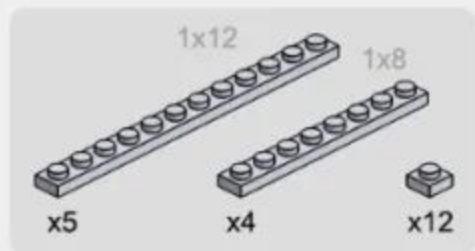

3-3

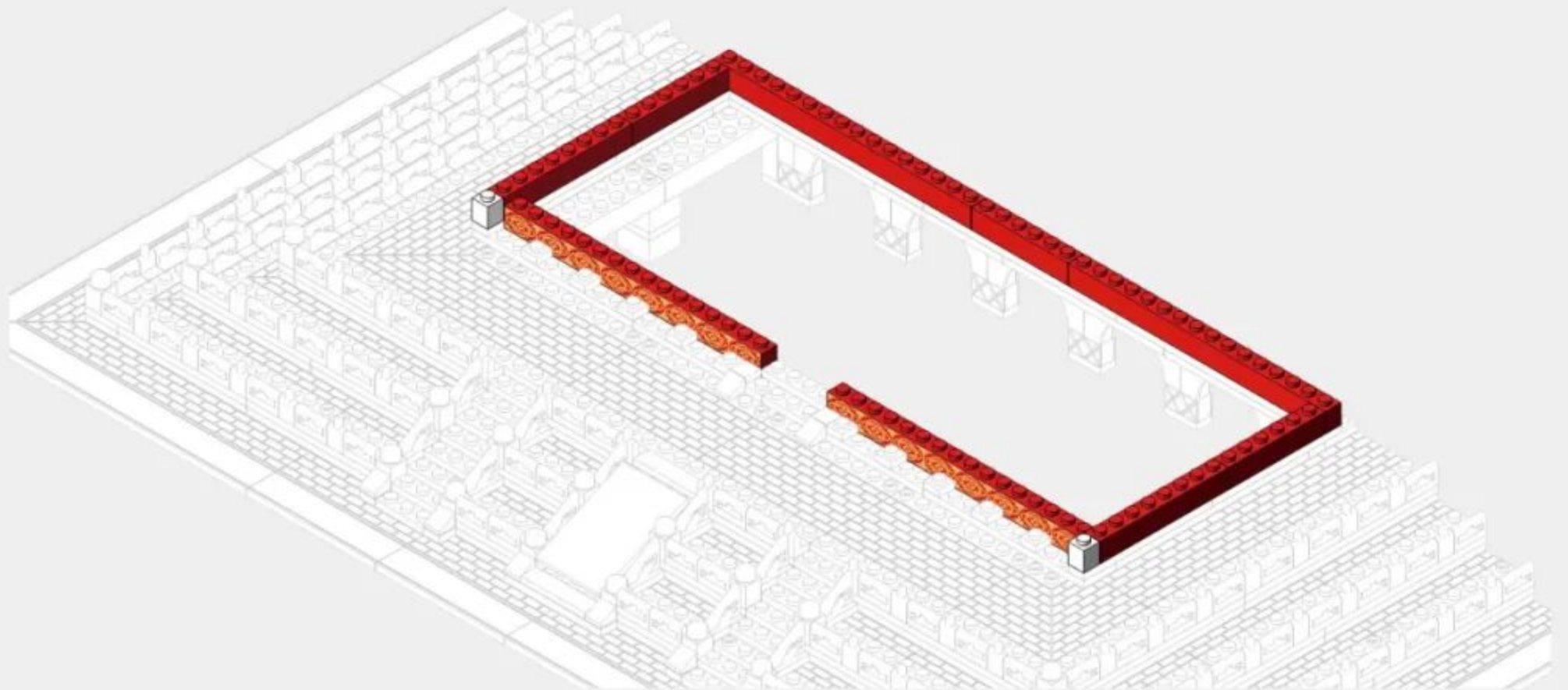
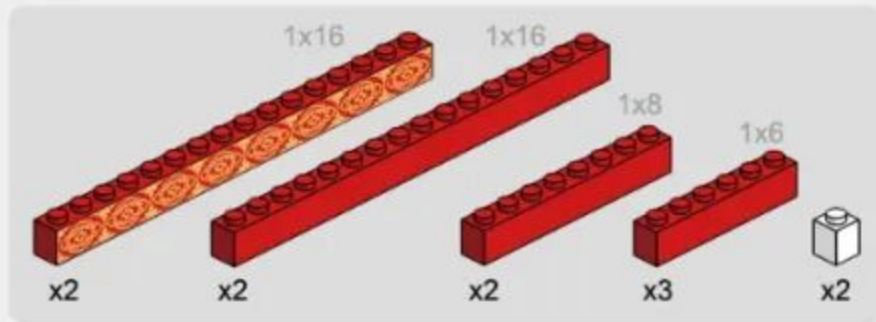

3-4

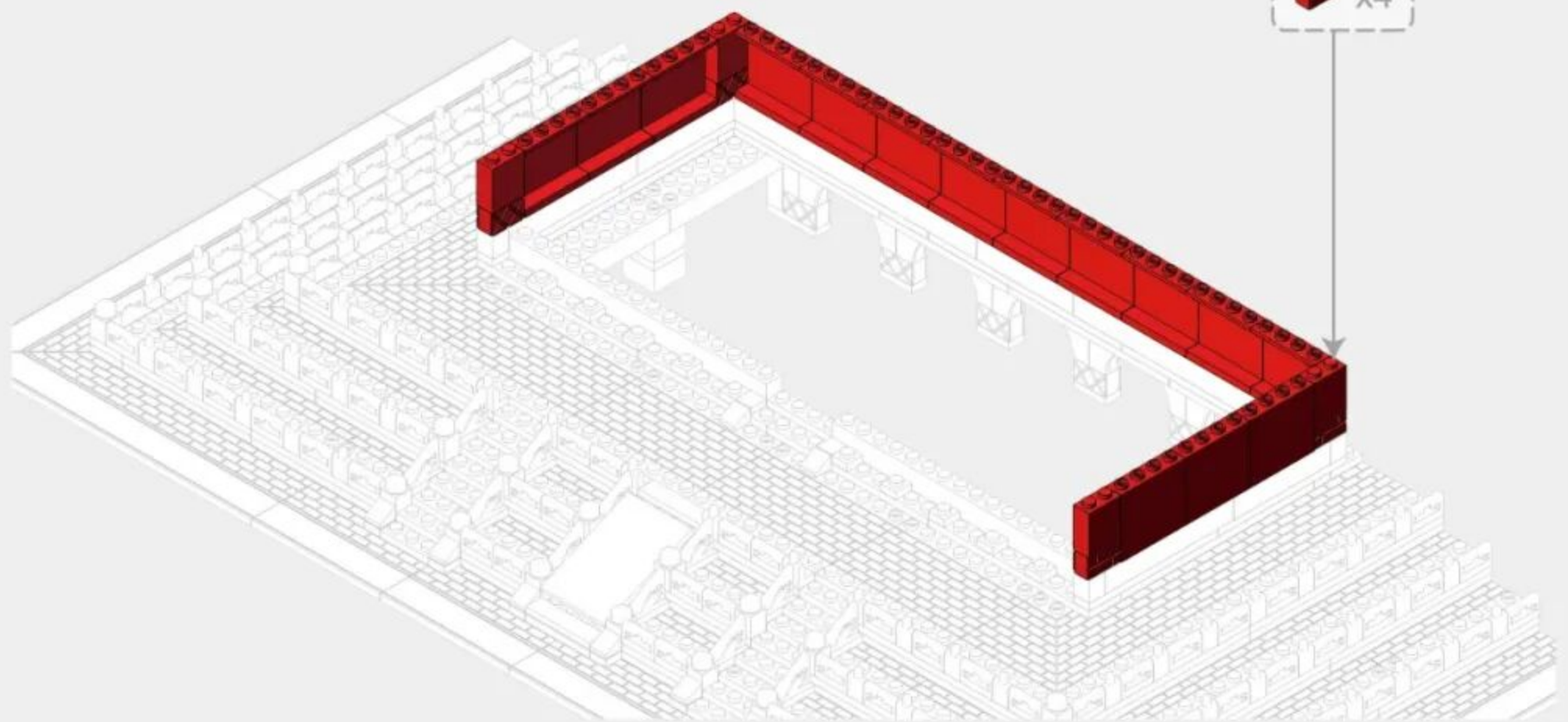
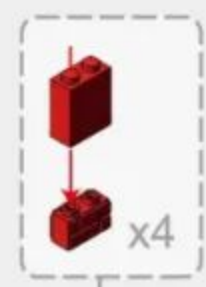
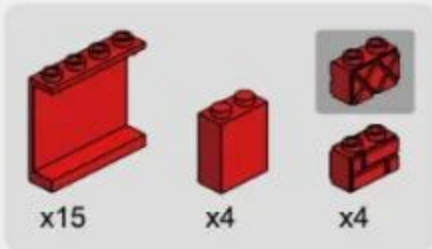

3-5

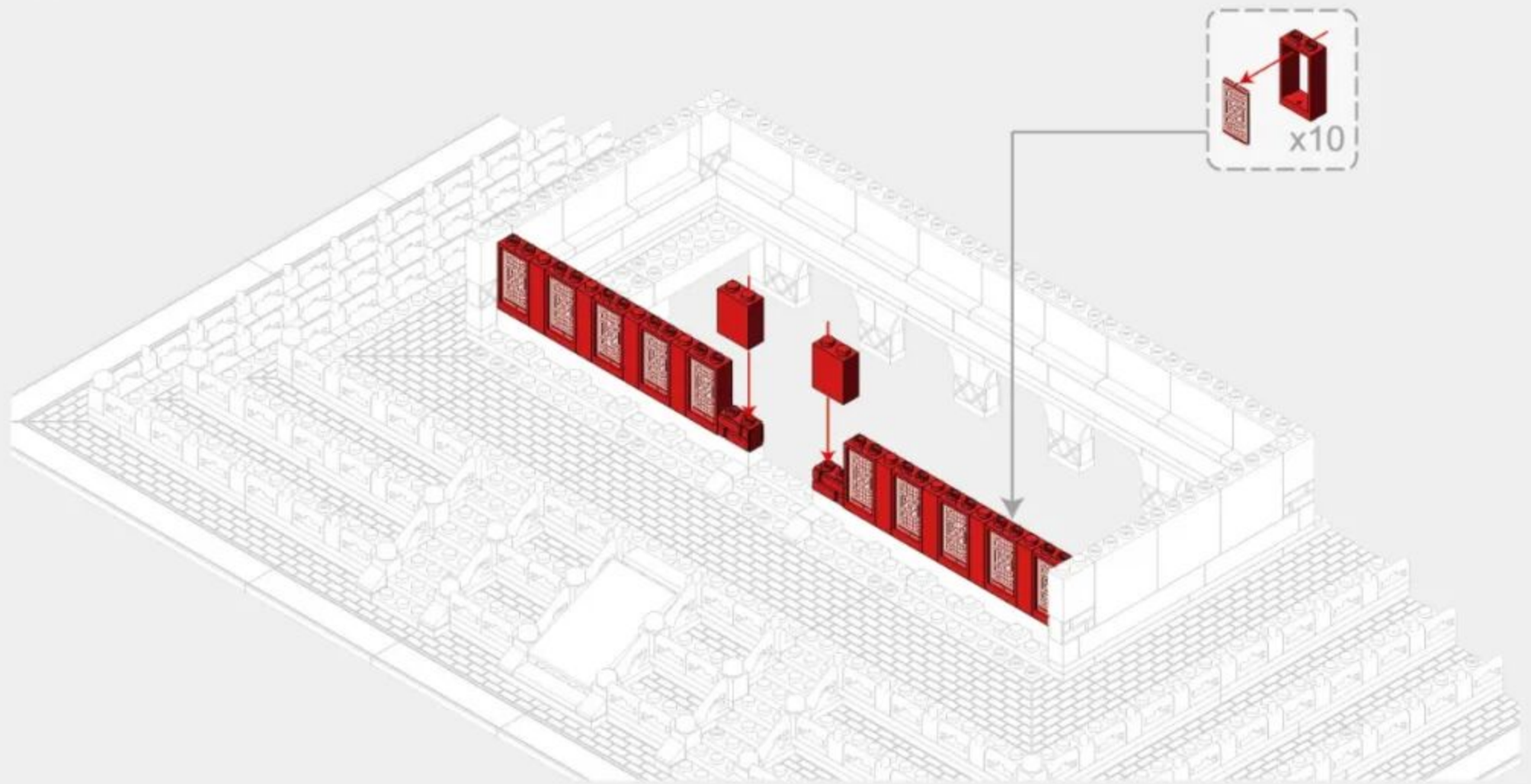
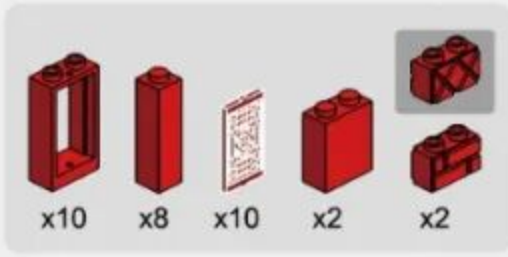

3-6

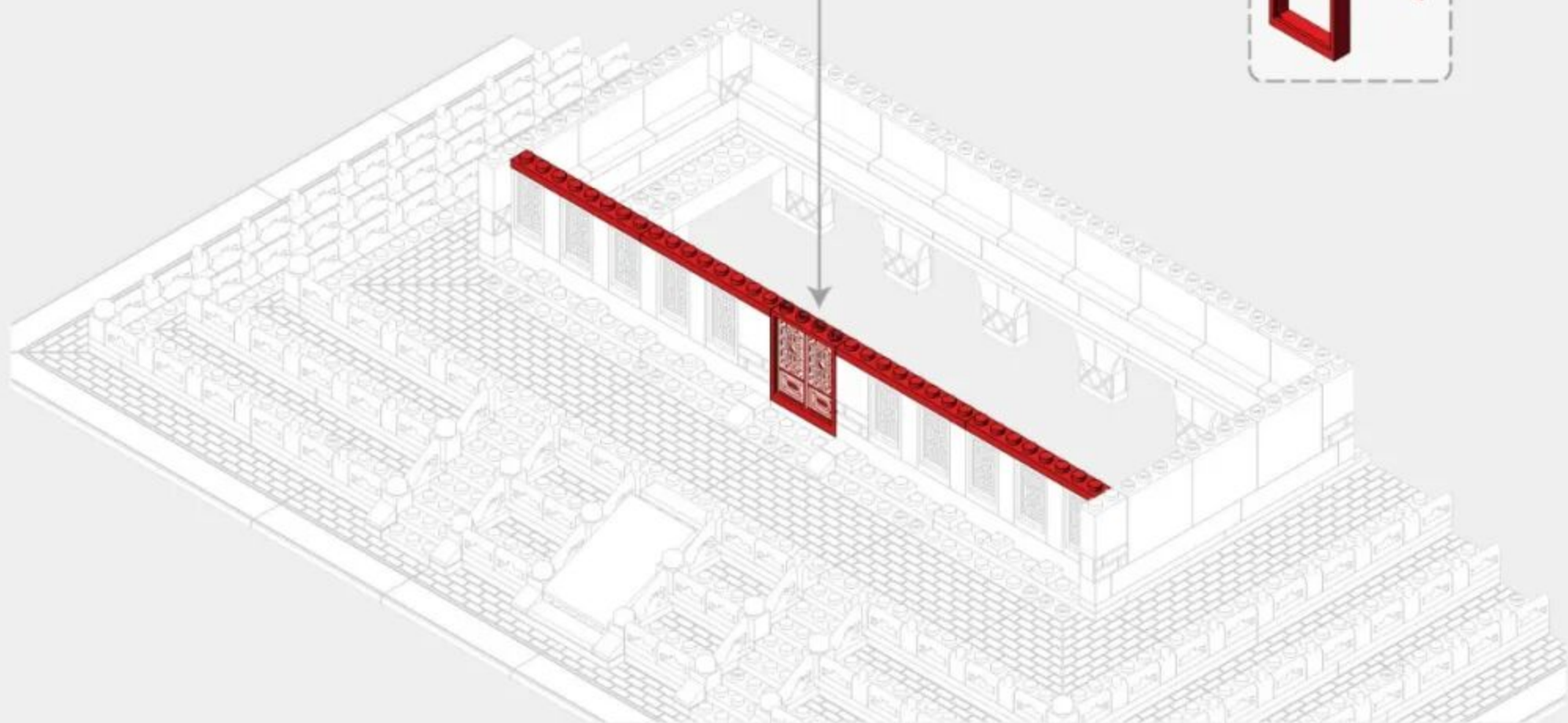
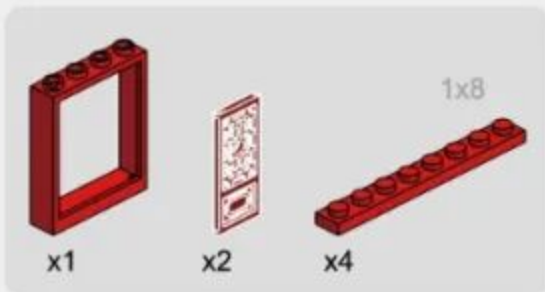

3-7

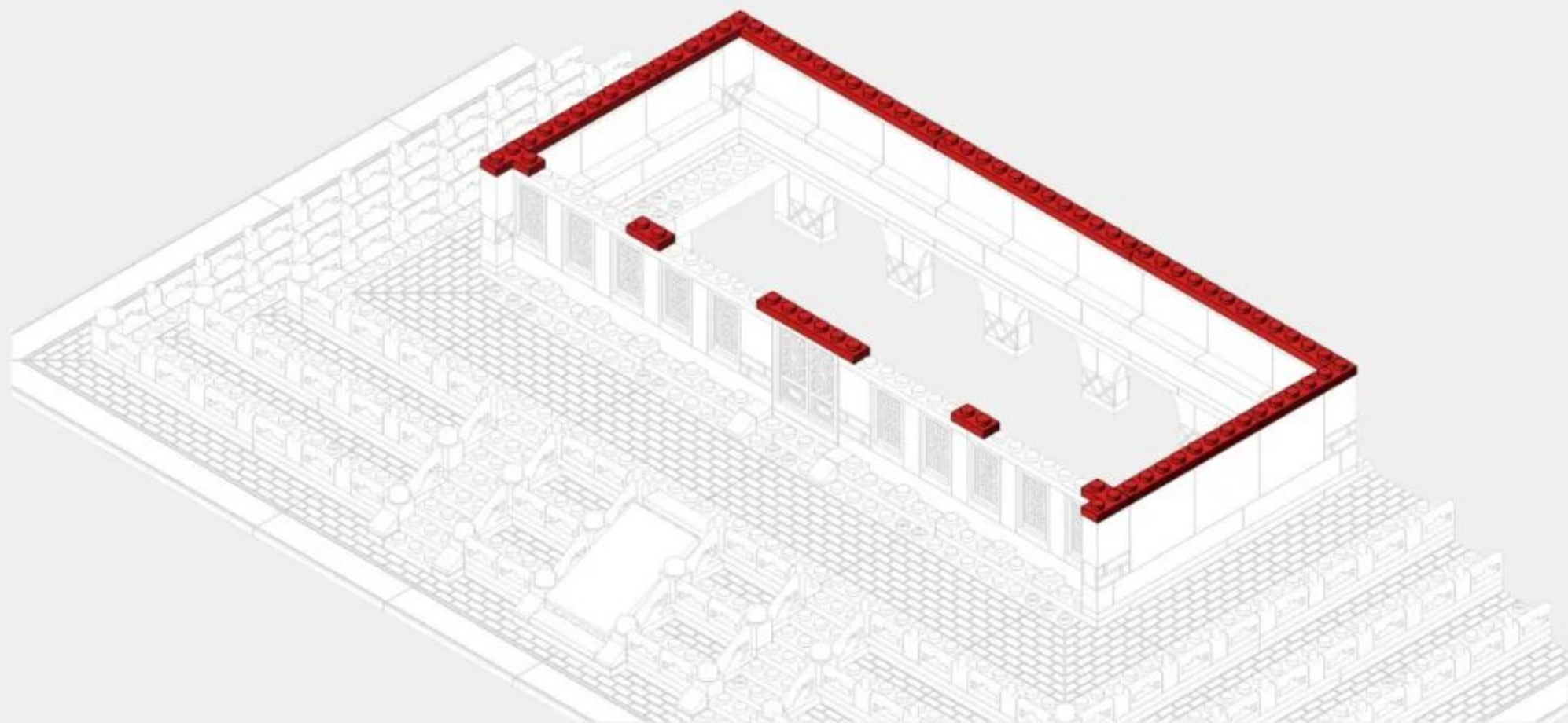
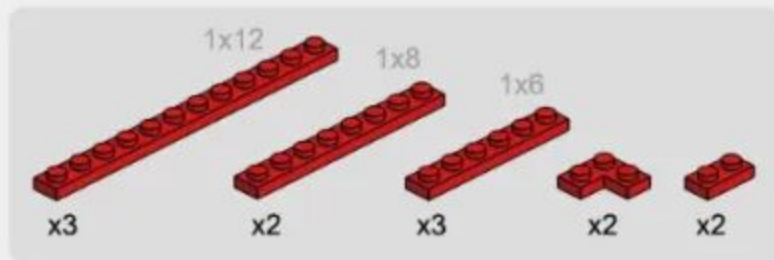

3-8

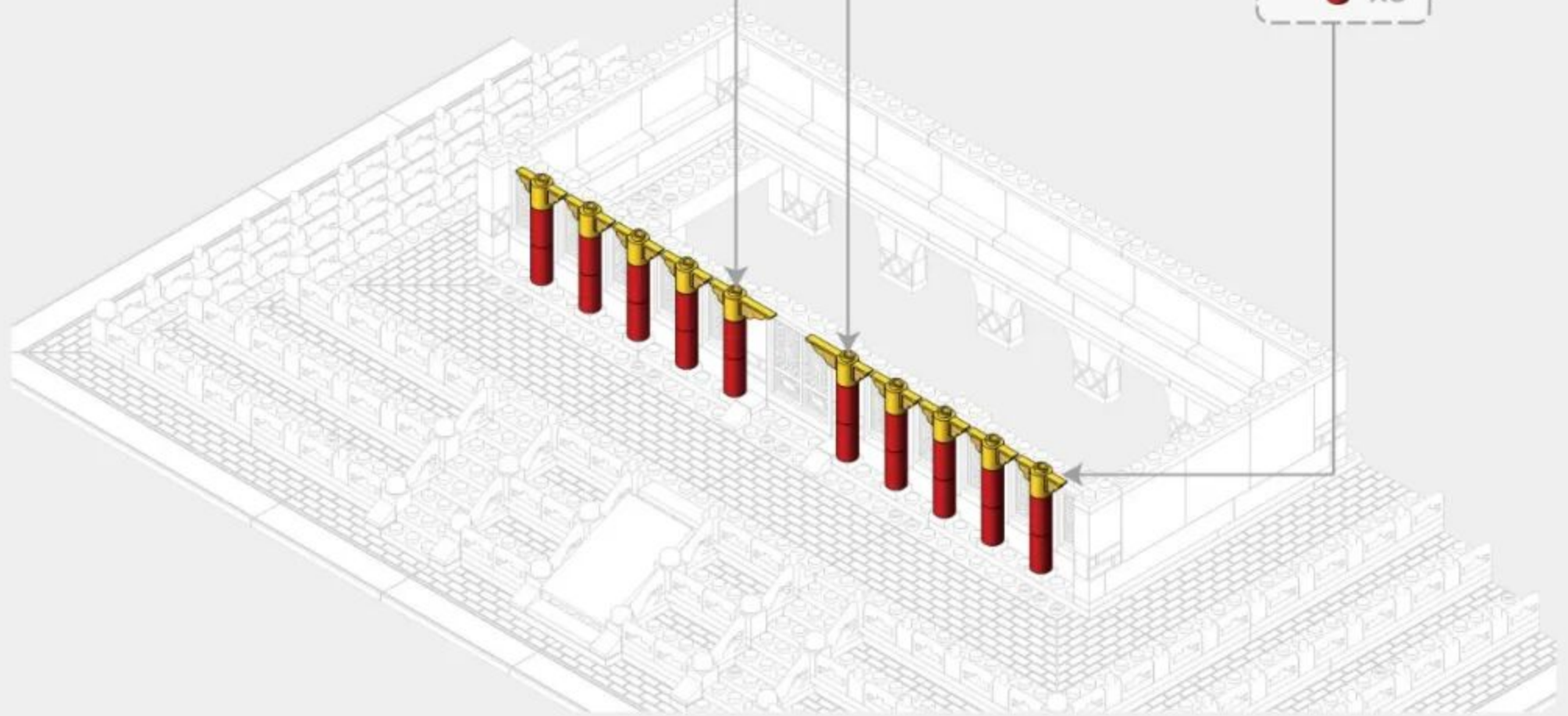
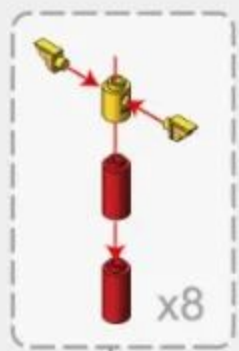
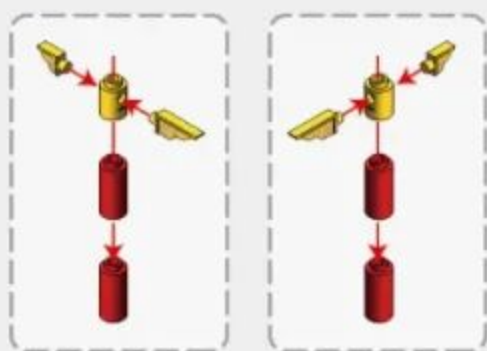

3-9

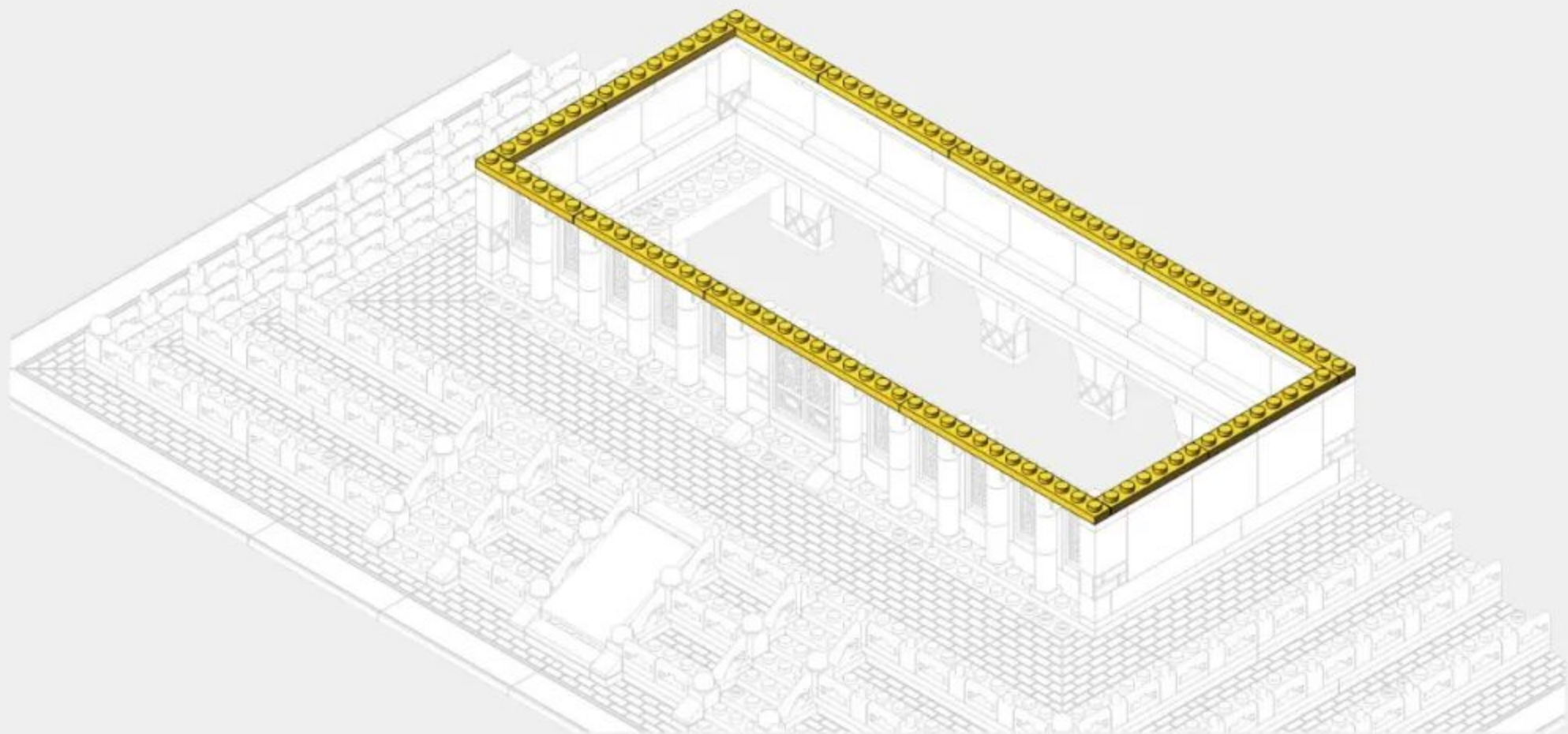
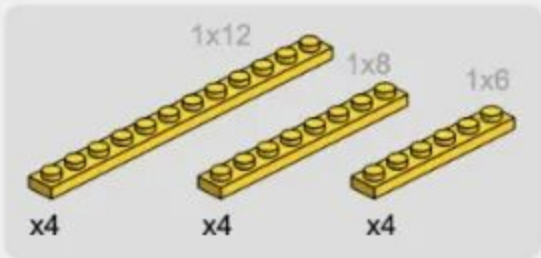

3-10

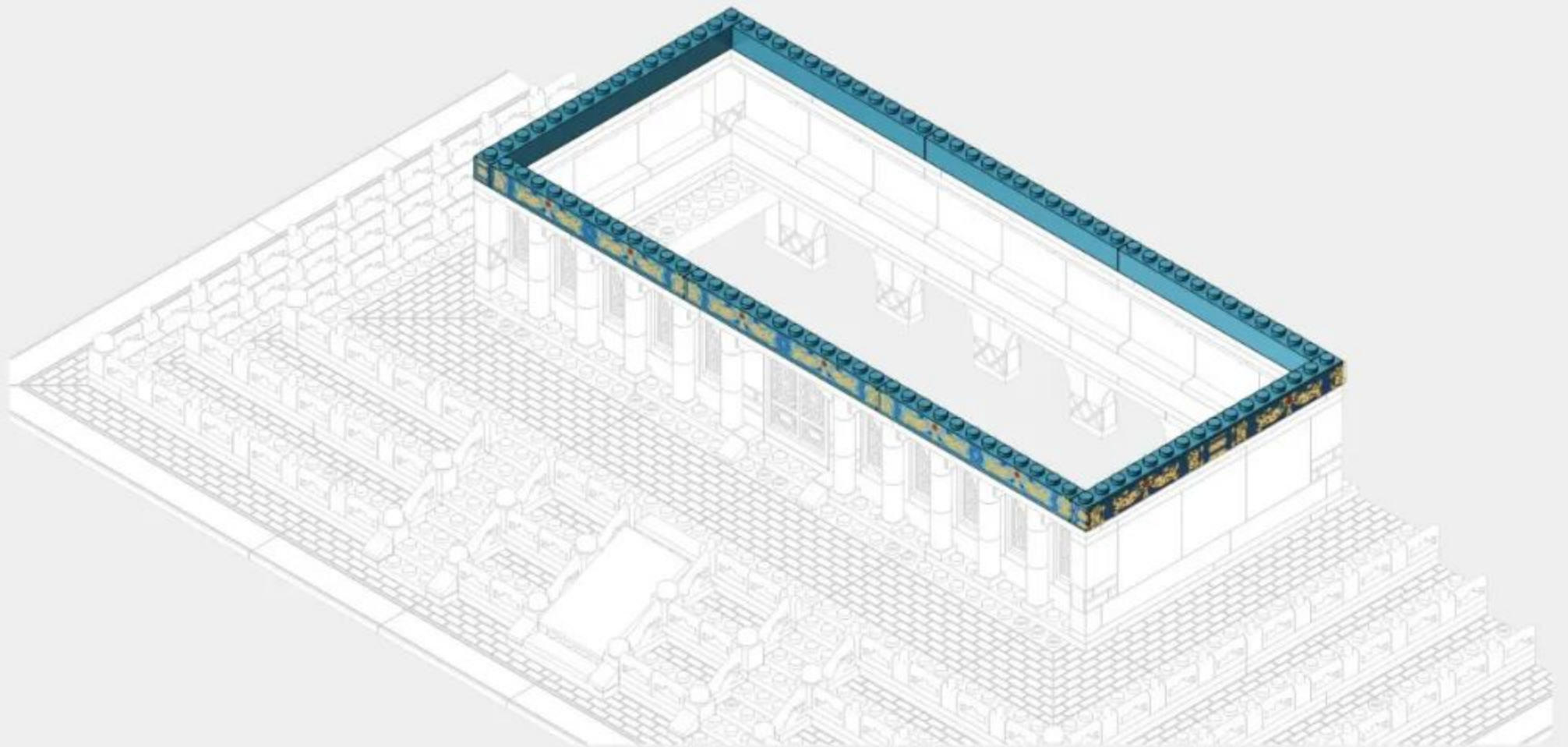
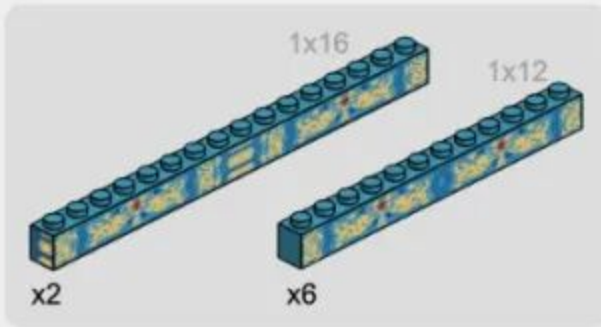

3-11

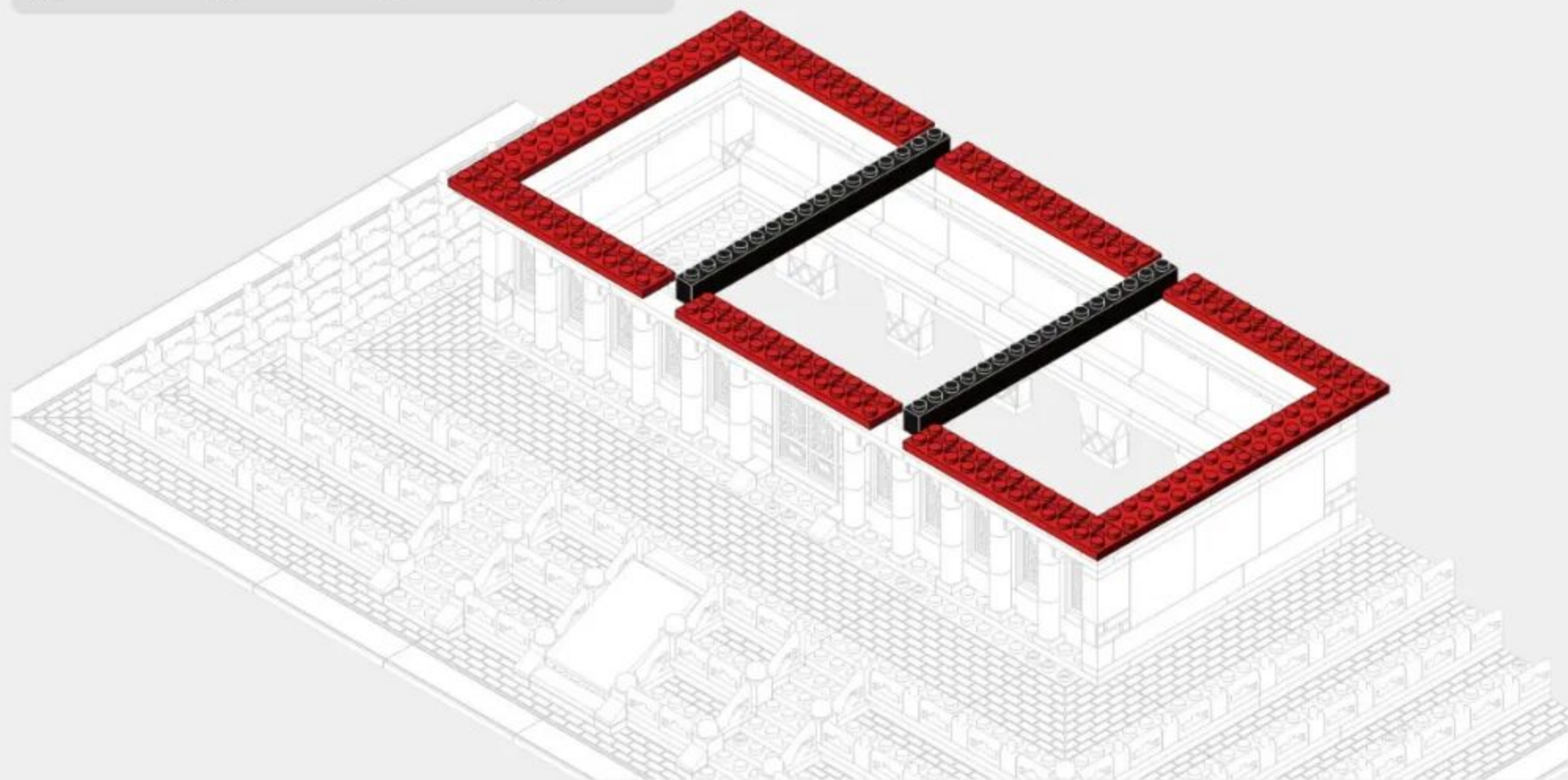
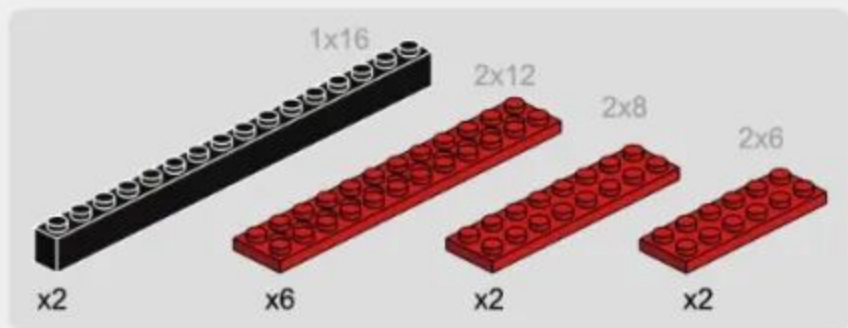

3-12

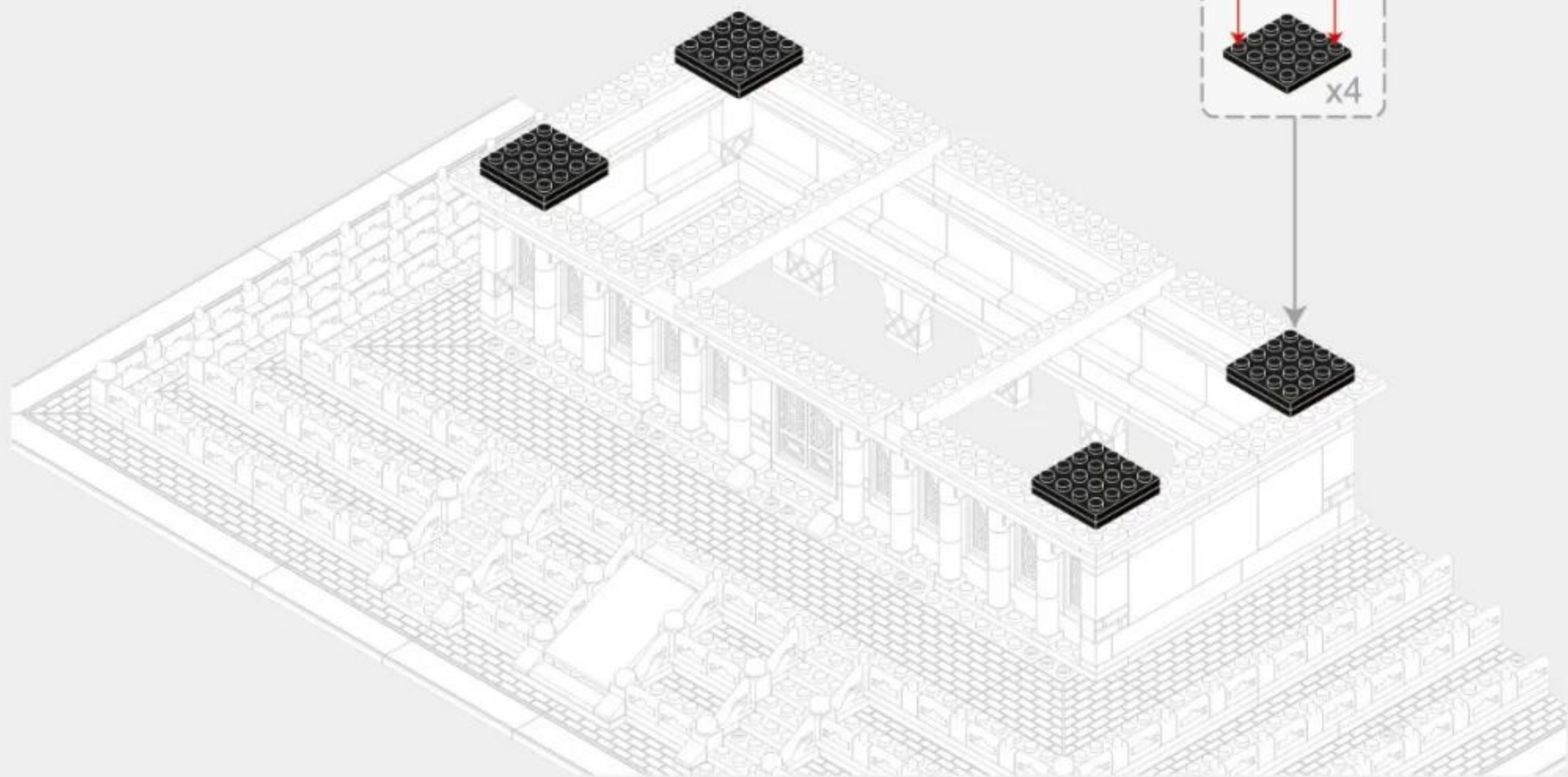
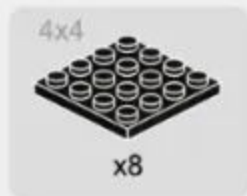

3-13

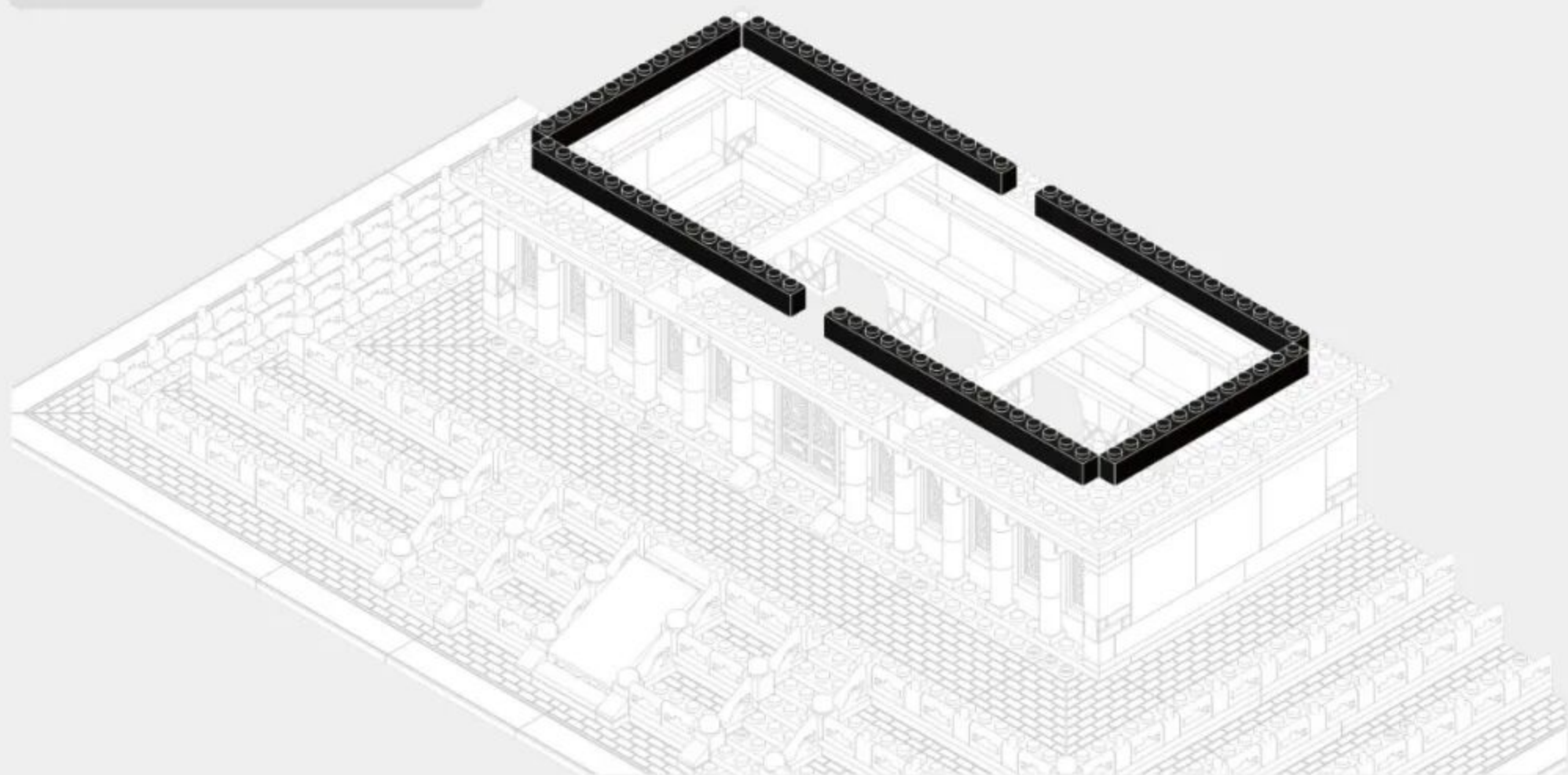
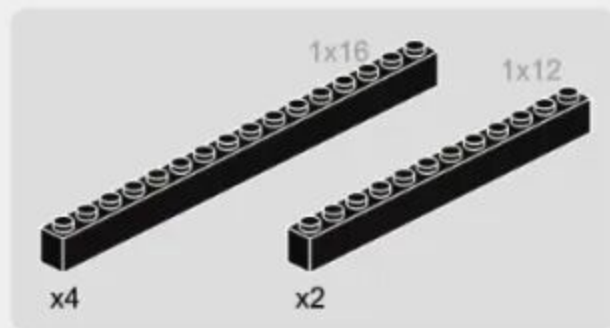



239PCS



55

4-1

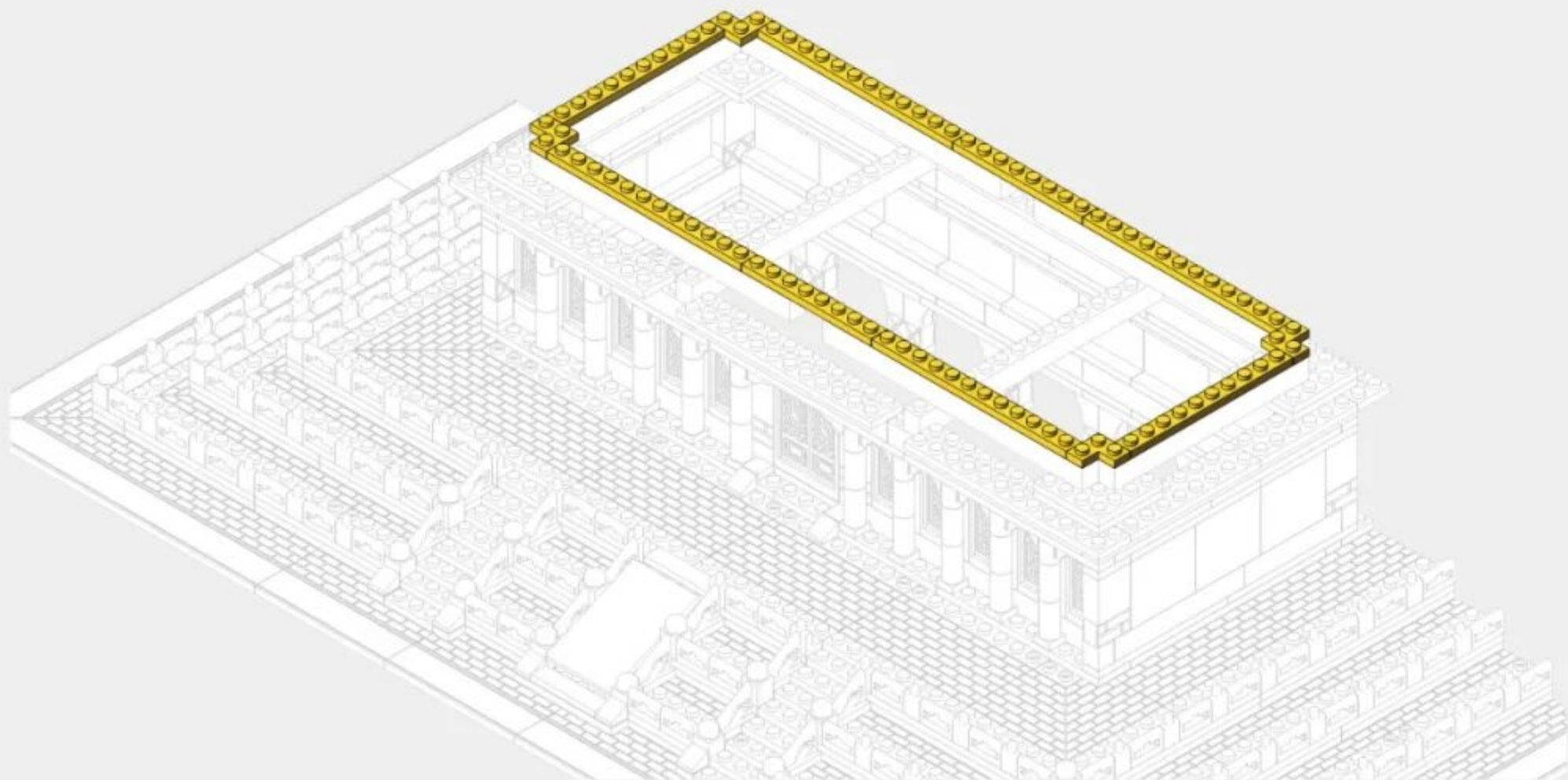
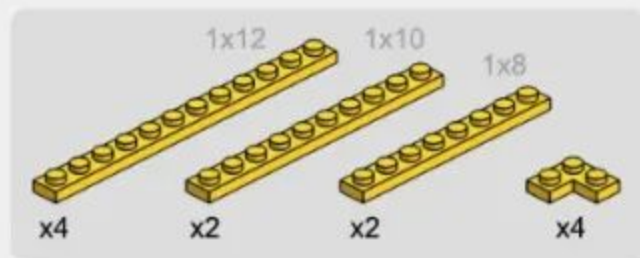

4-2

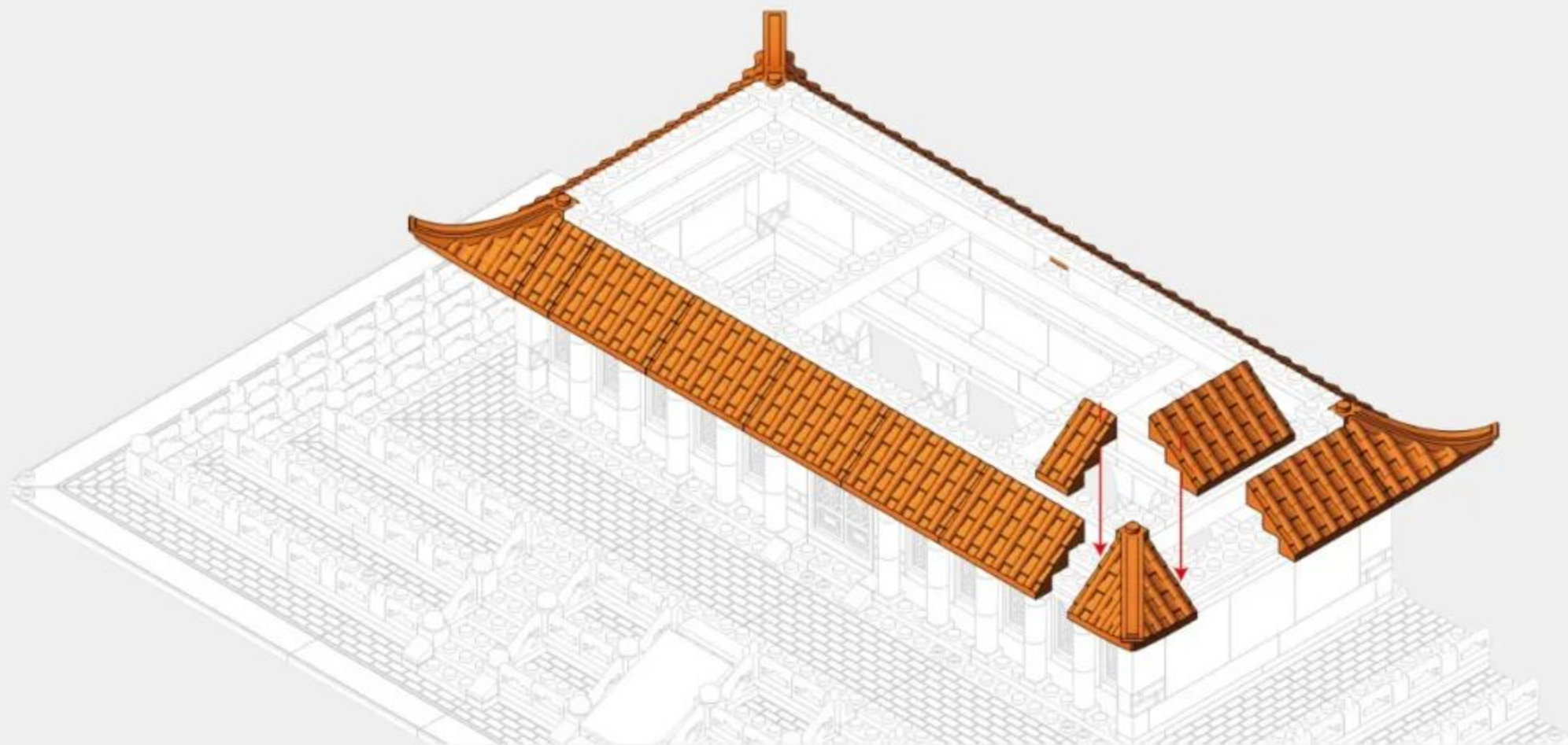
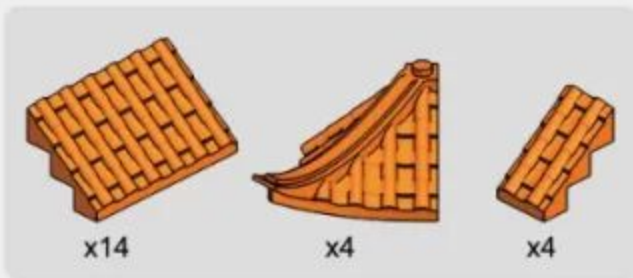

4-3

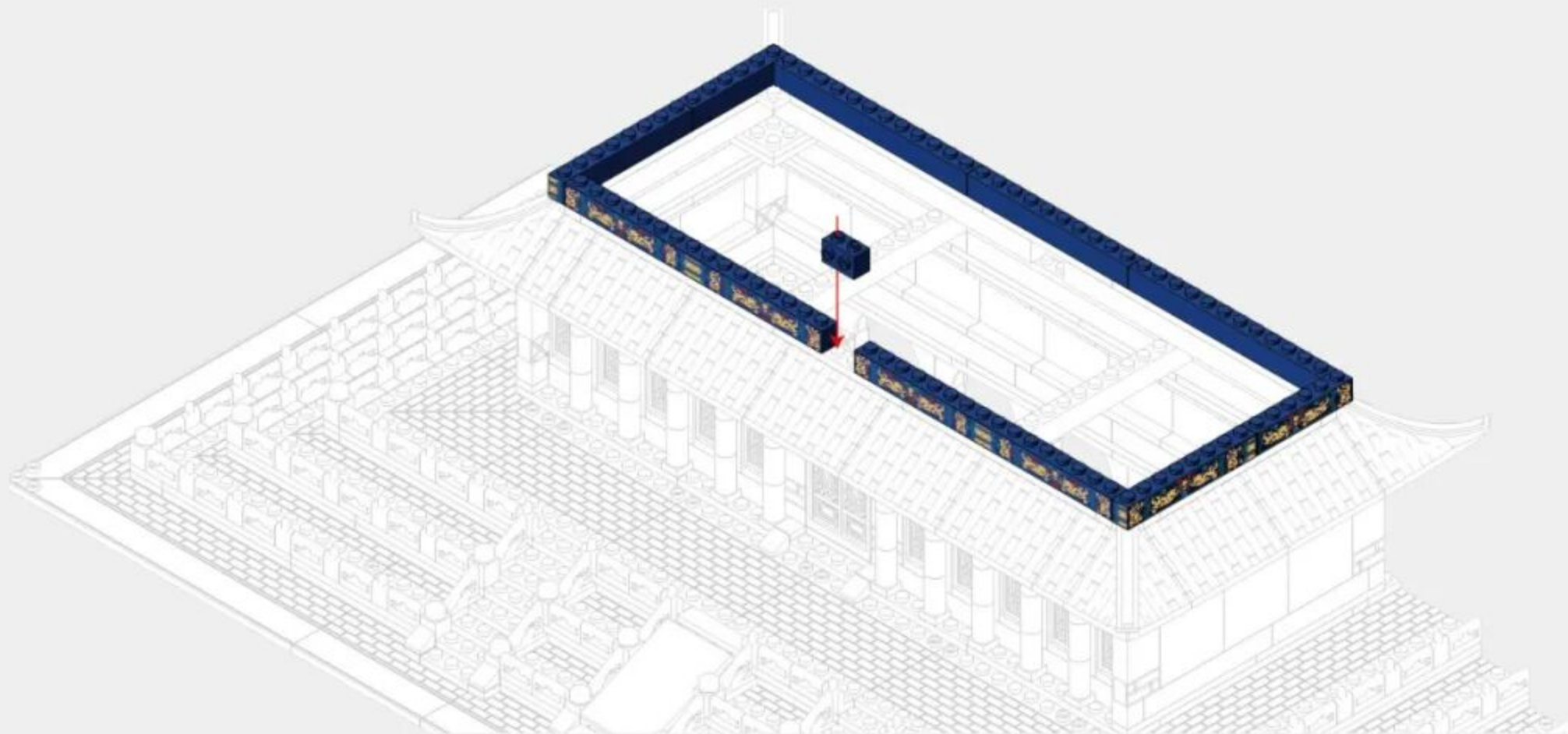

4-4

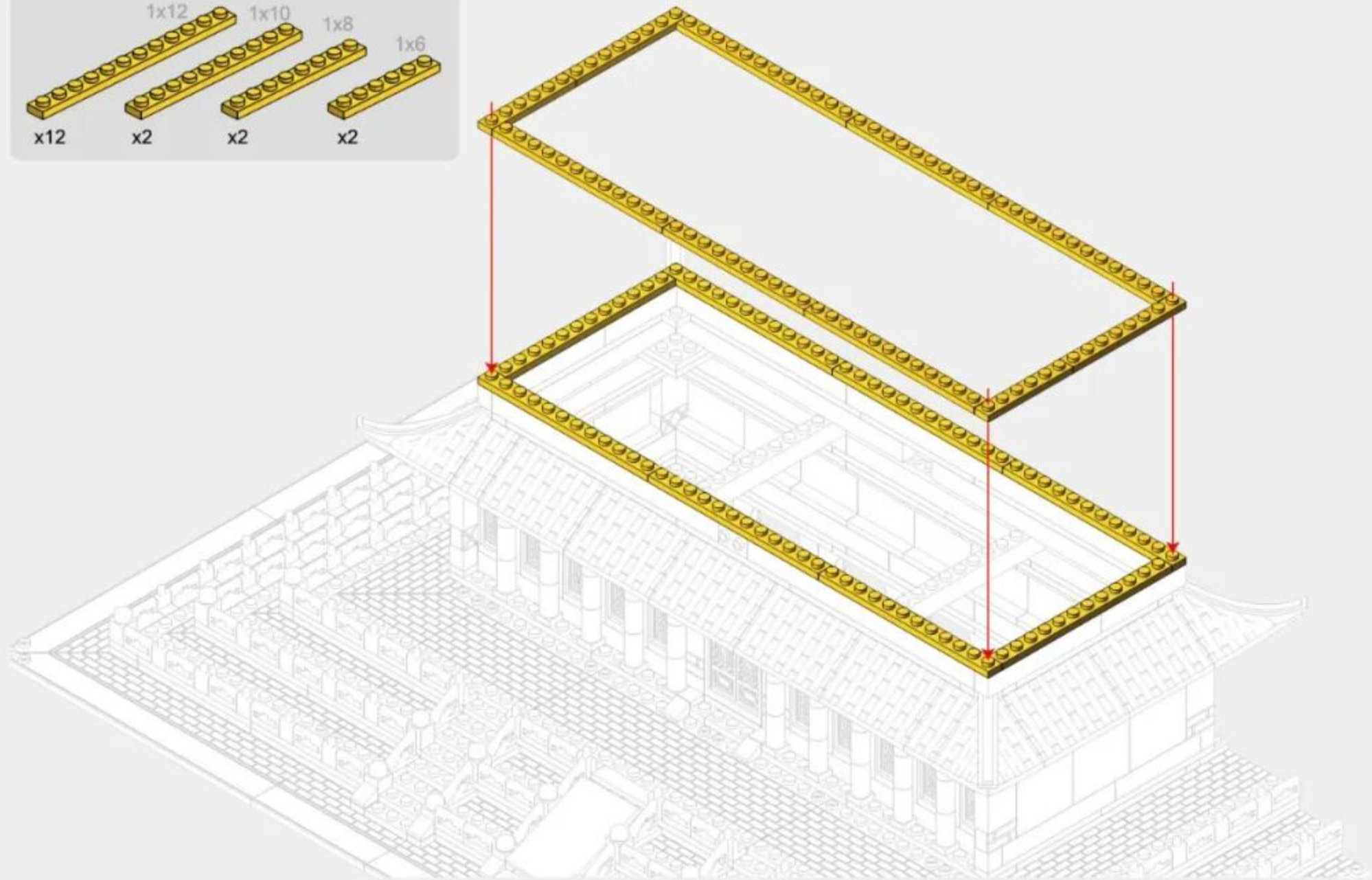
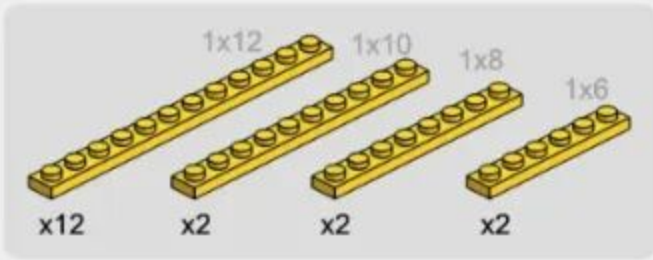

4-5

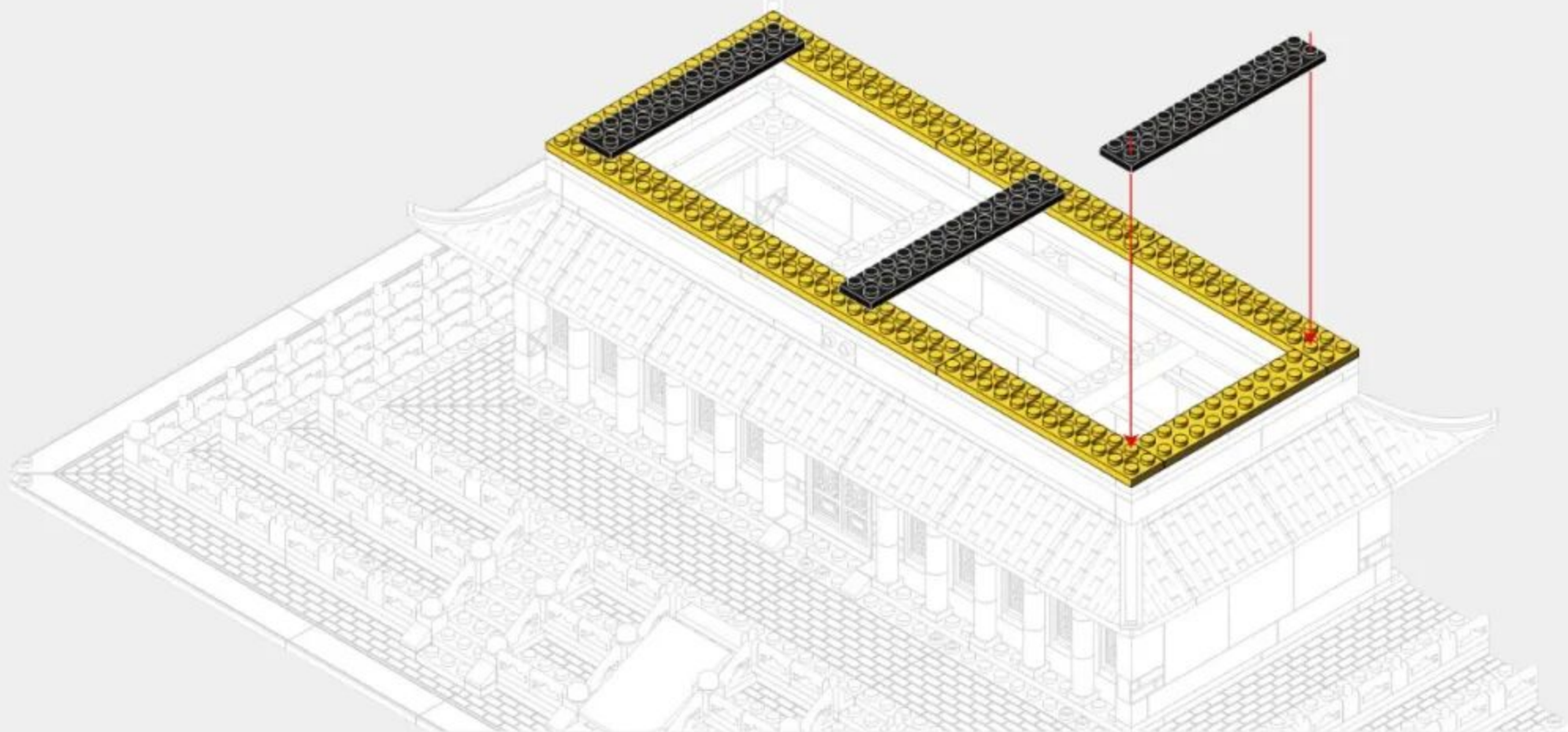
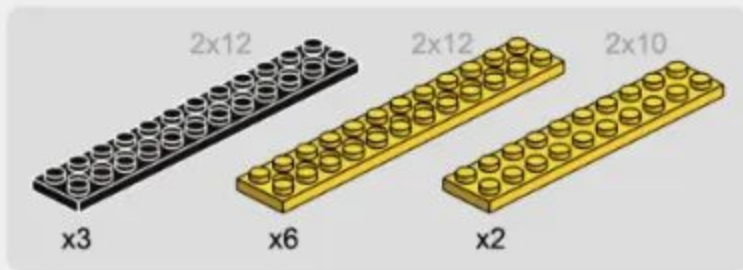

4-6

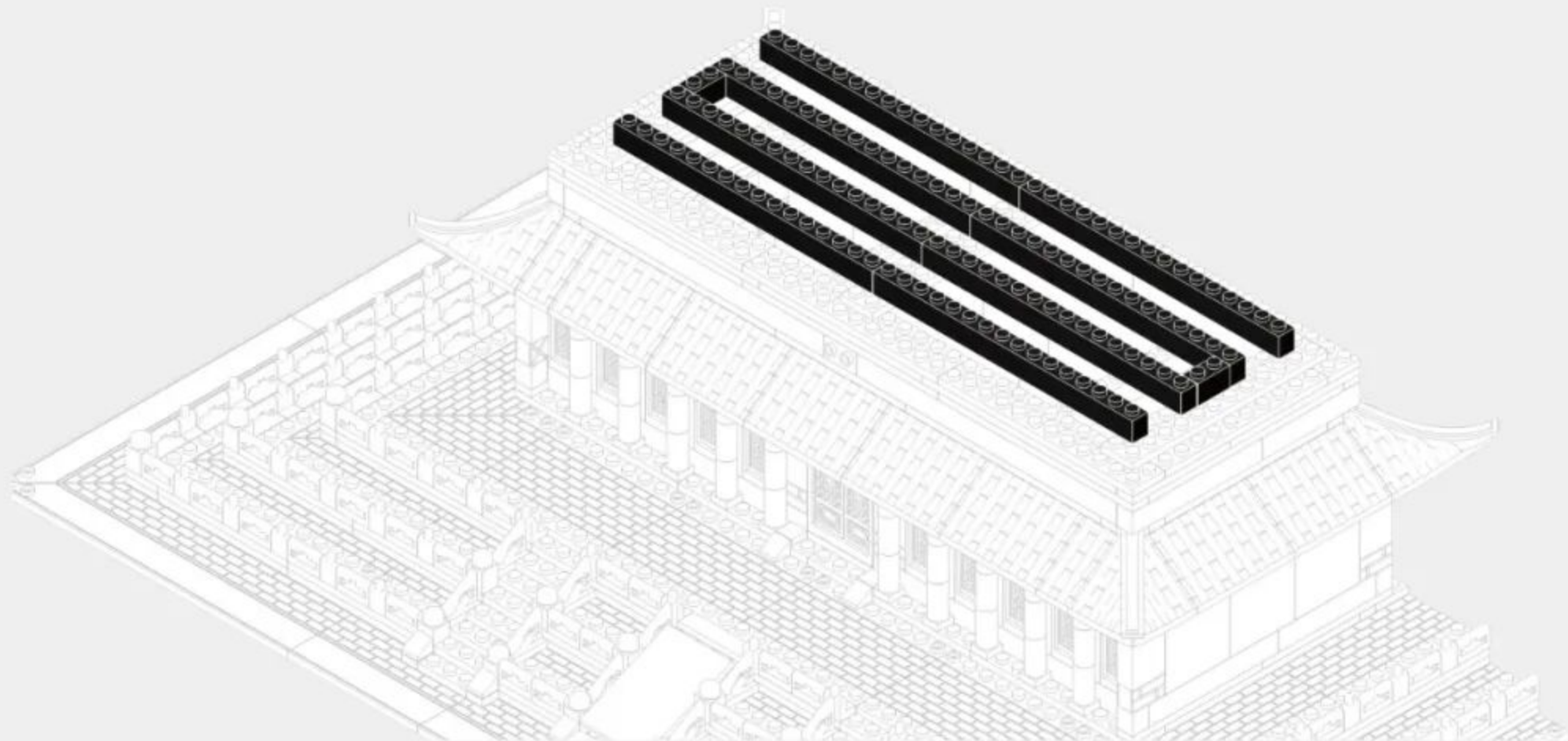
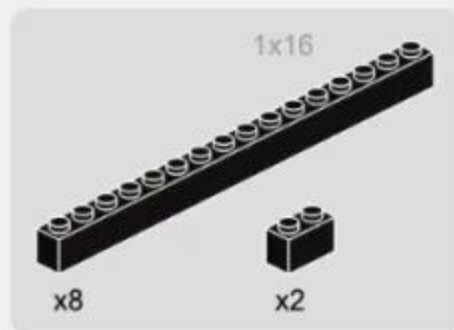

4-7

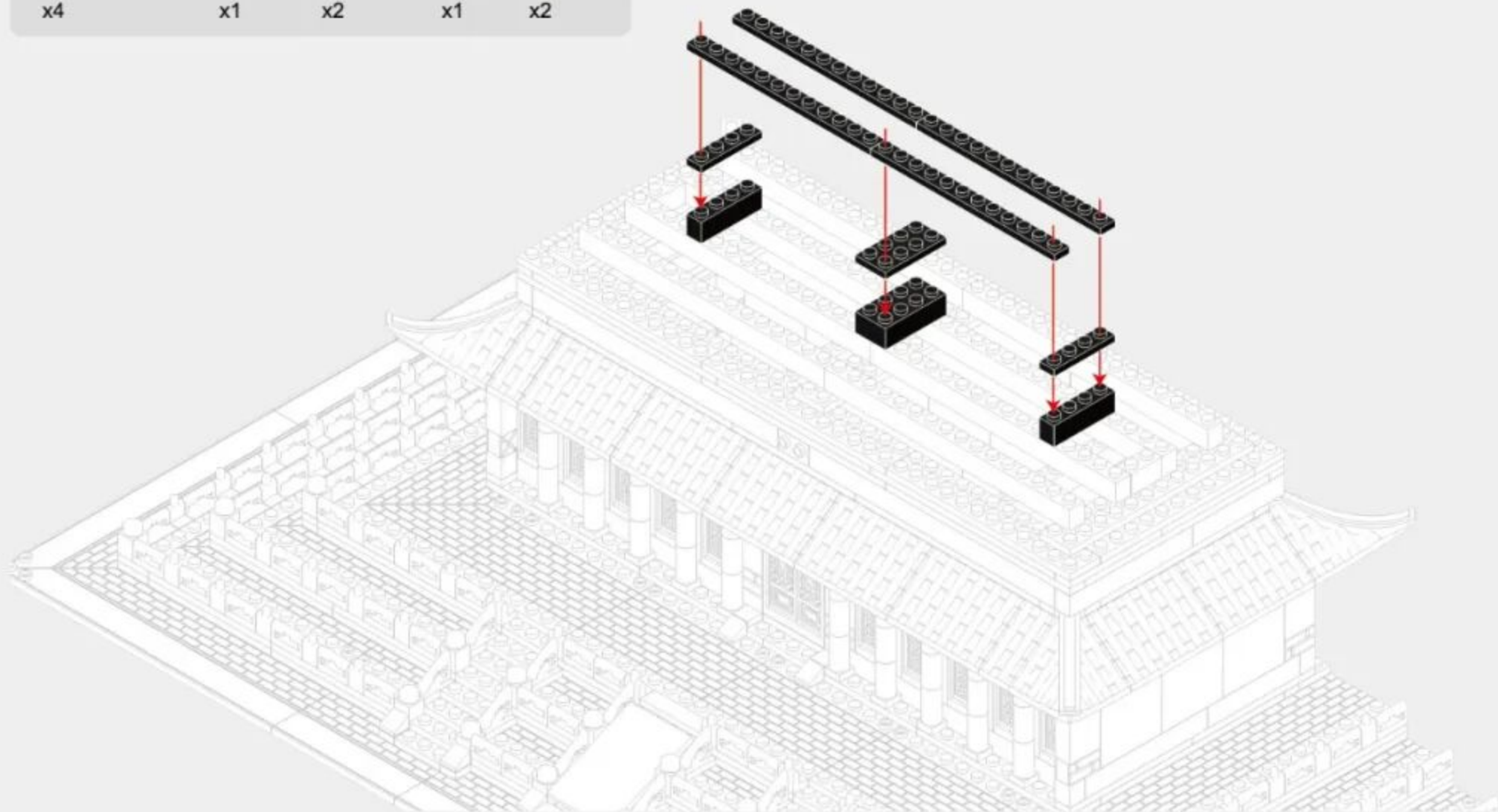
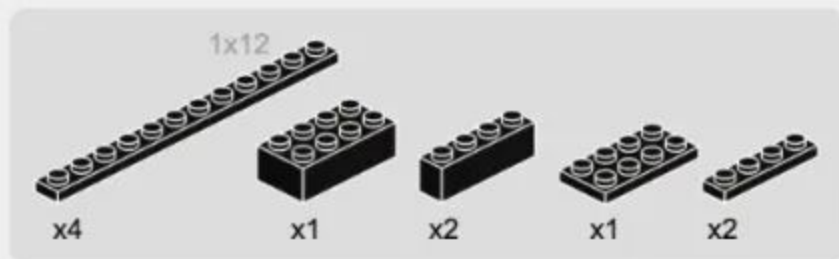

4-8

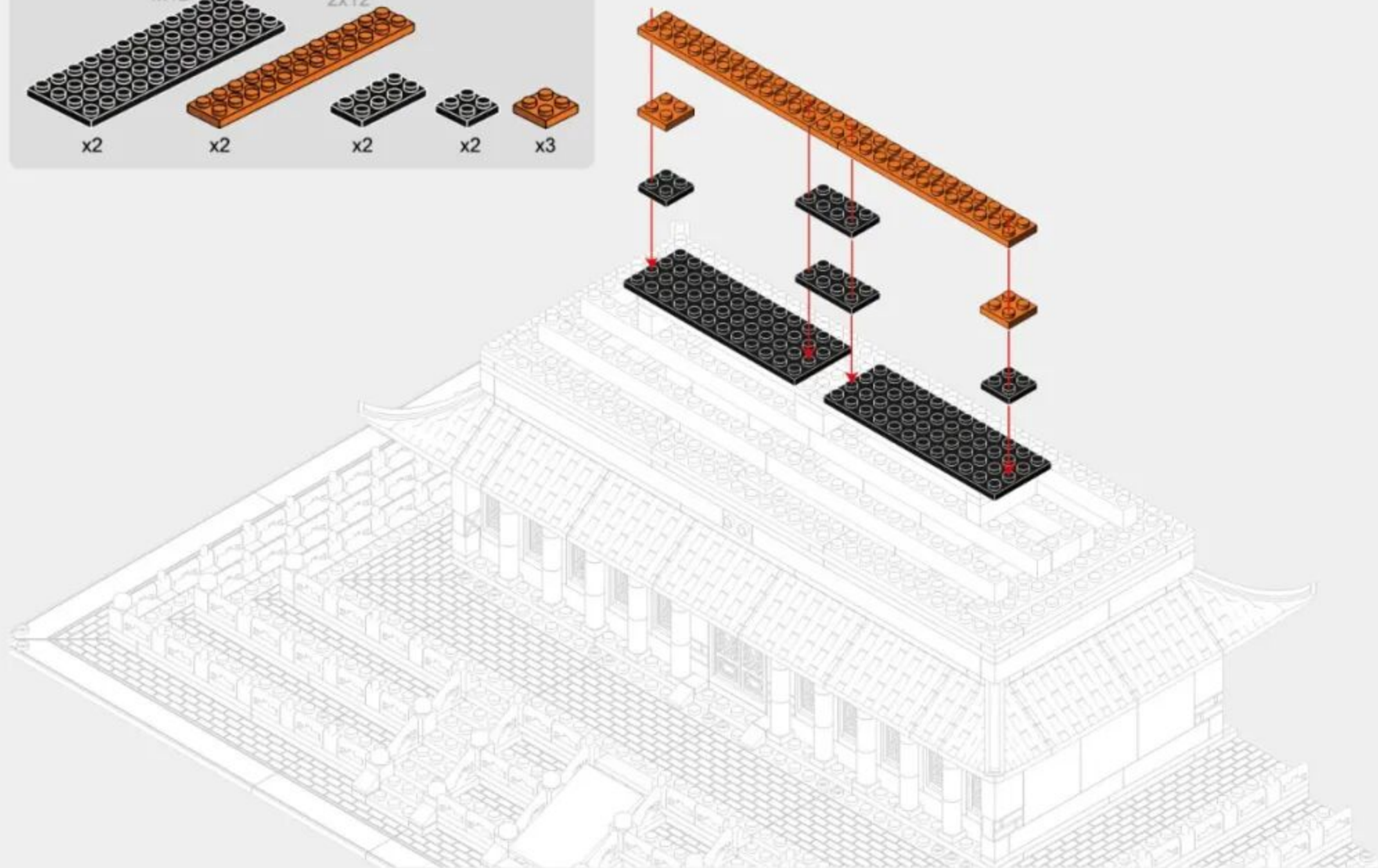
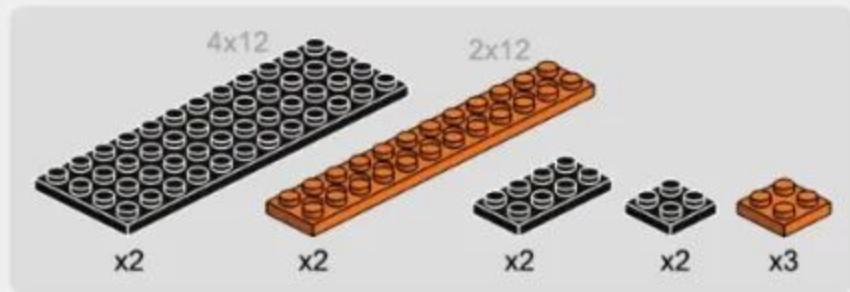

4-9

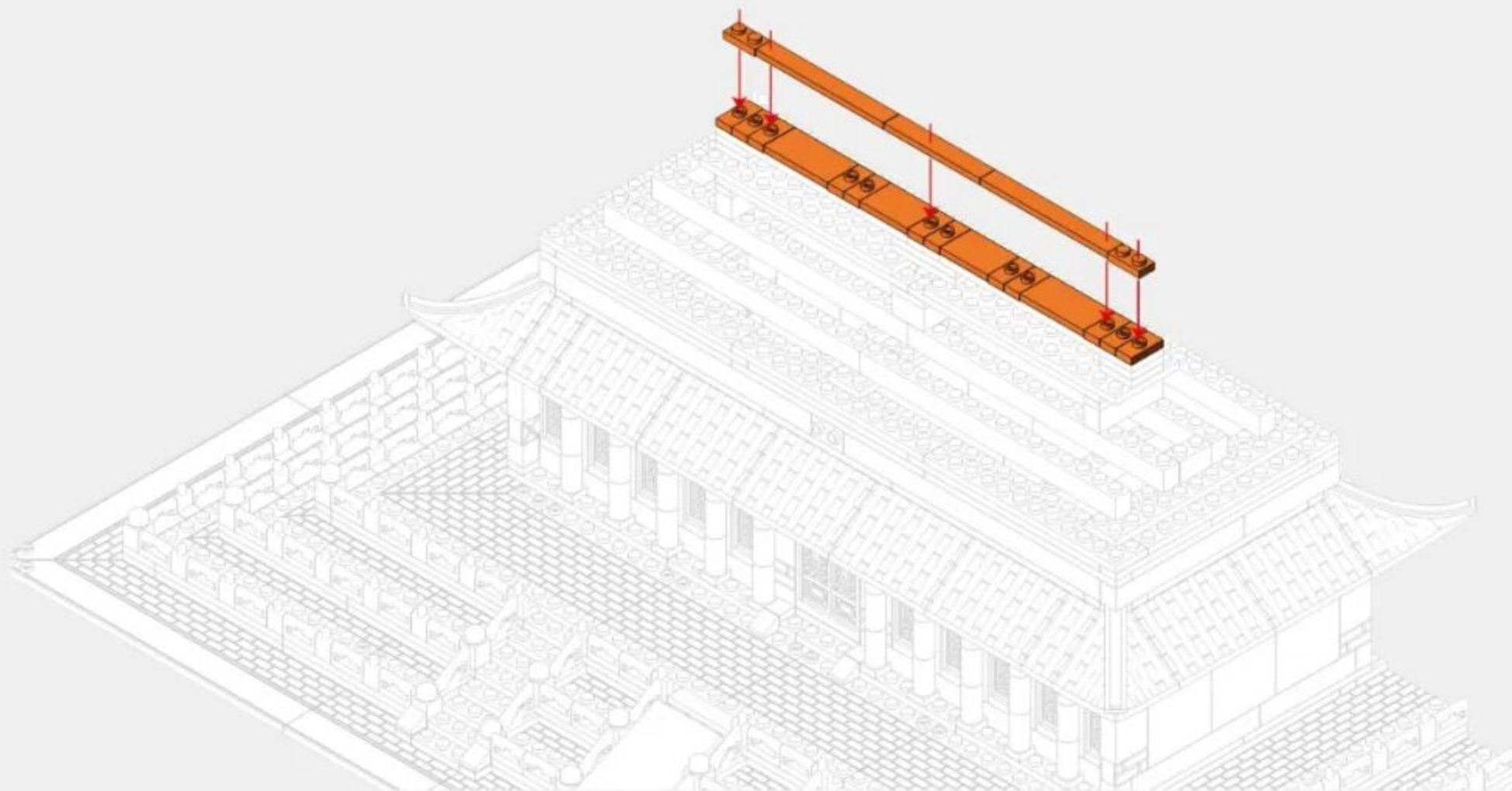
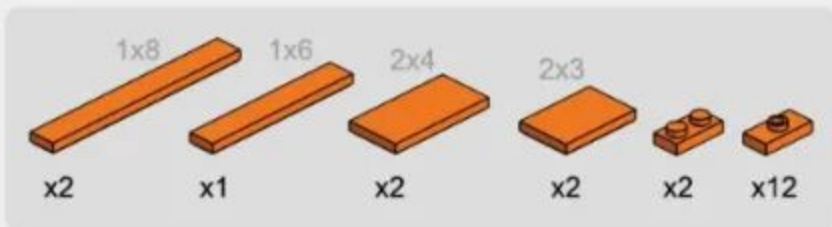

4-10



x8



x4



x48



x2

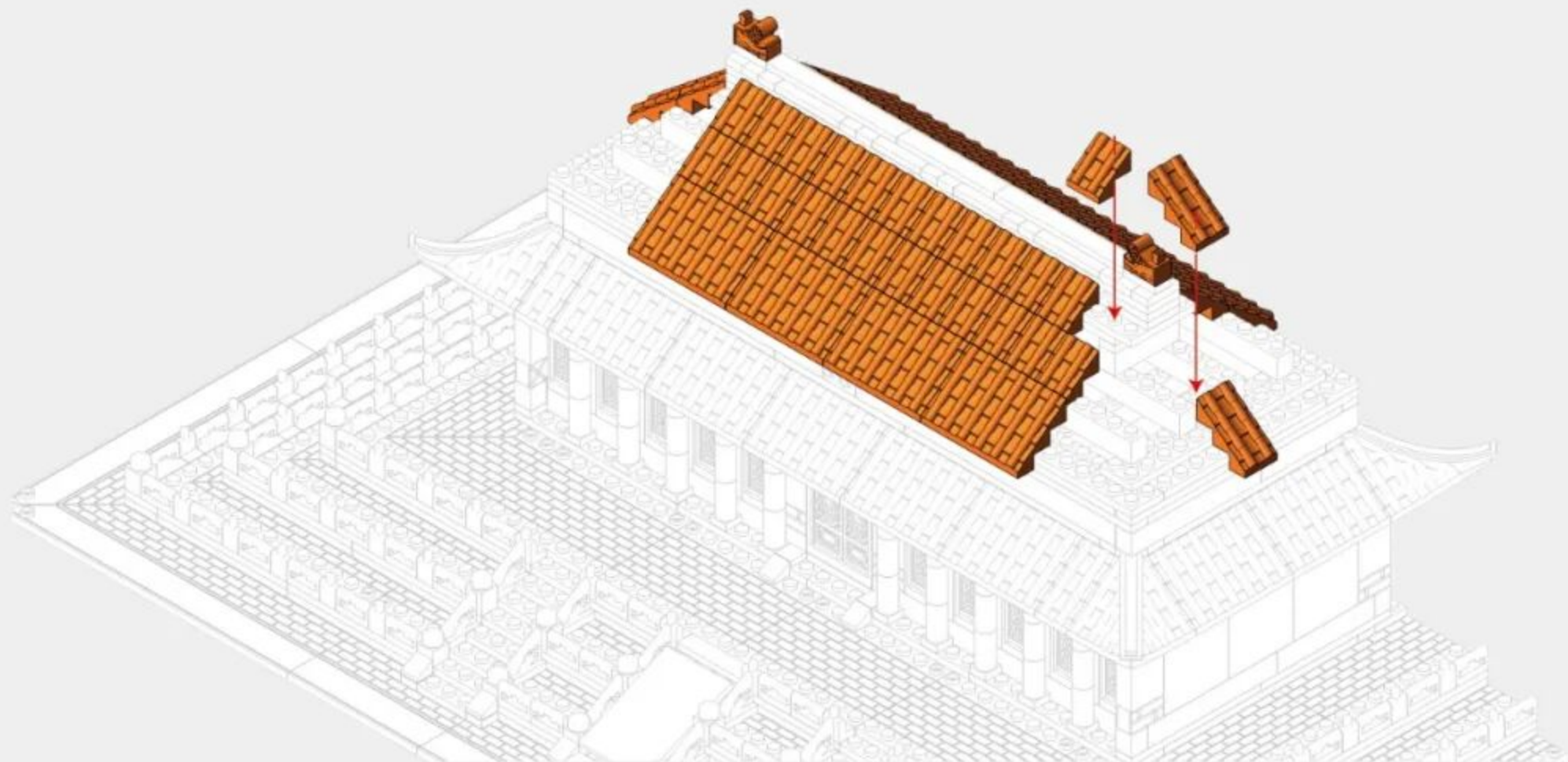

4-11

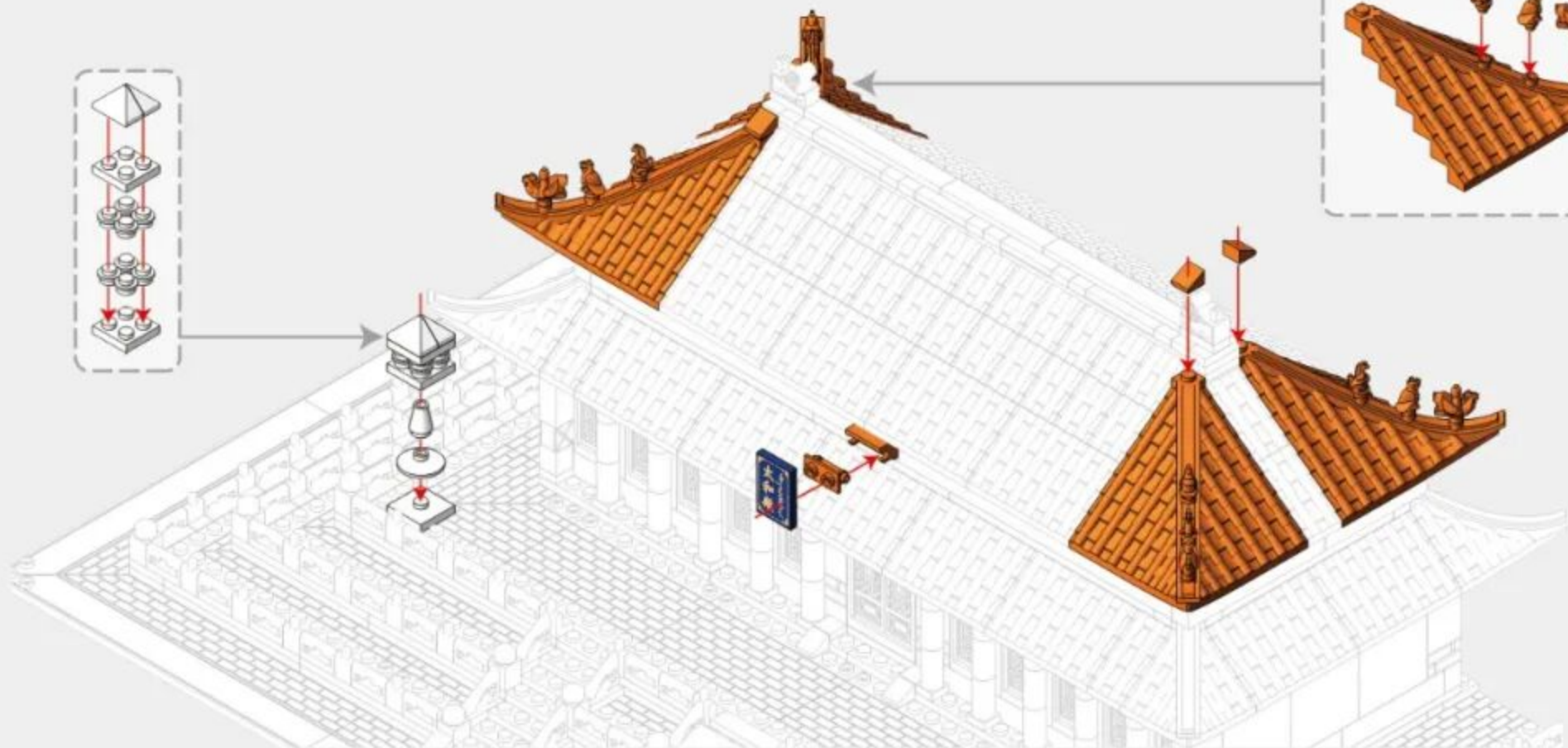
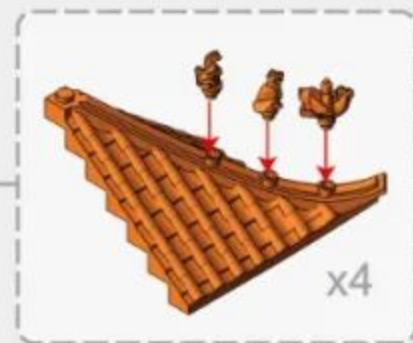
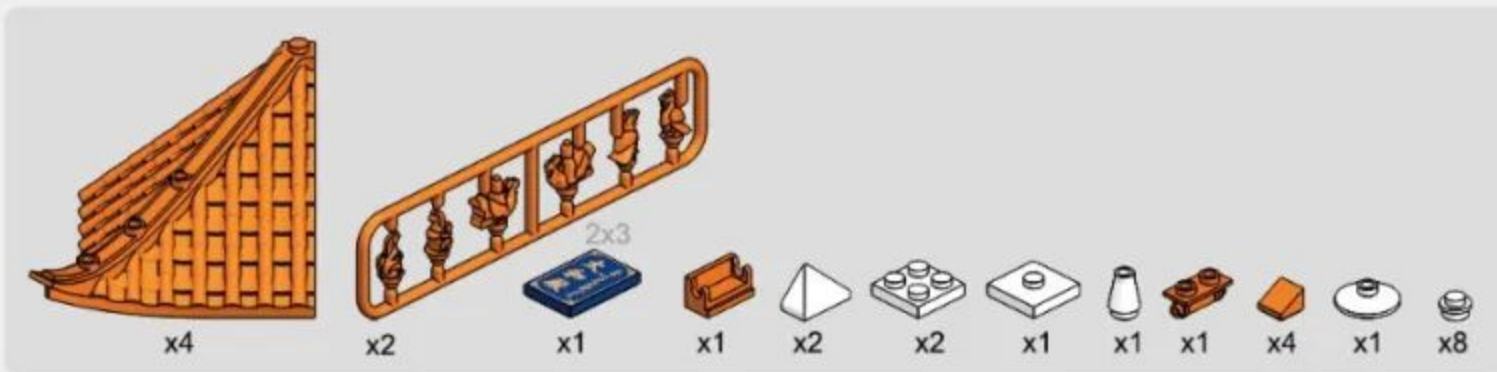

# 4-12

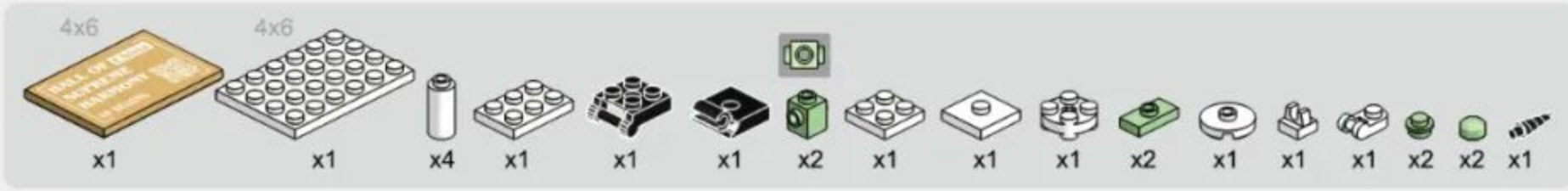

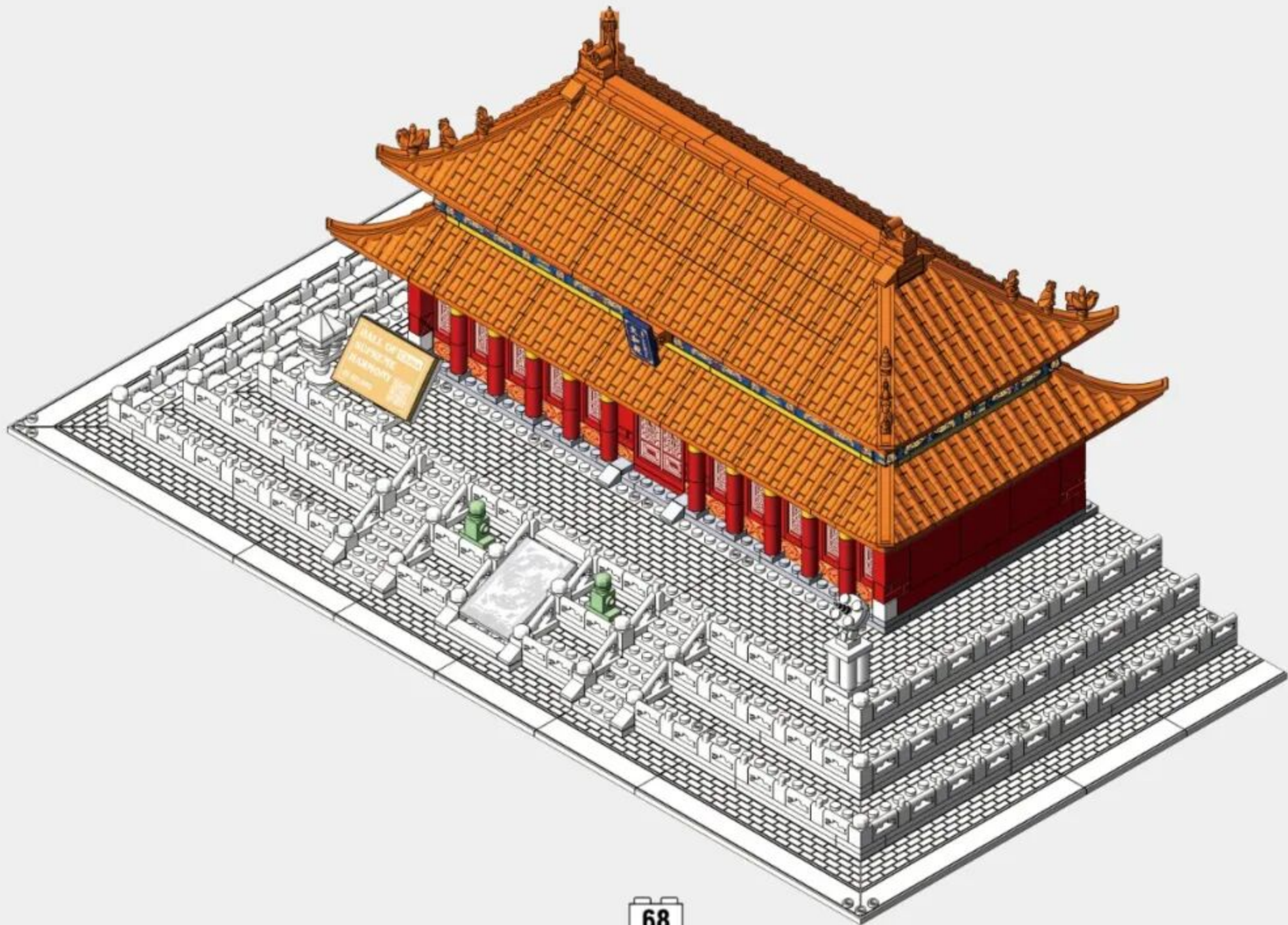

# HALL OF SUPREME HARMONY

COUNTRY: China

CITY: Beijing

