

WUHAN YANGTZE RIVER BRIDGE

武汉长江大桥

Wuhan, China

The world's great architecture



6+ / 6223 / 1454PCS
Suitable Age Product Number Parts Total



Architecture

It will be a city...

这将构成一座城市...

ABOUT THE PRODUCT

关于产品

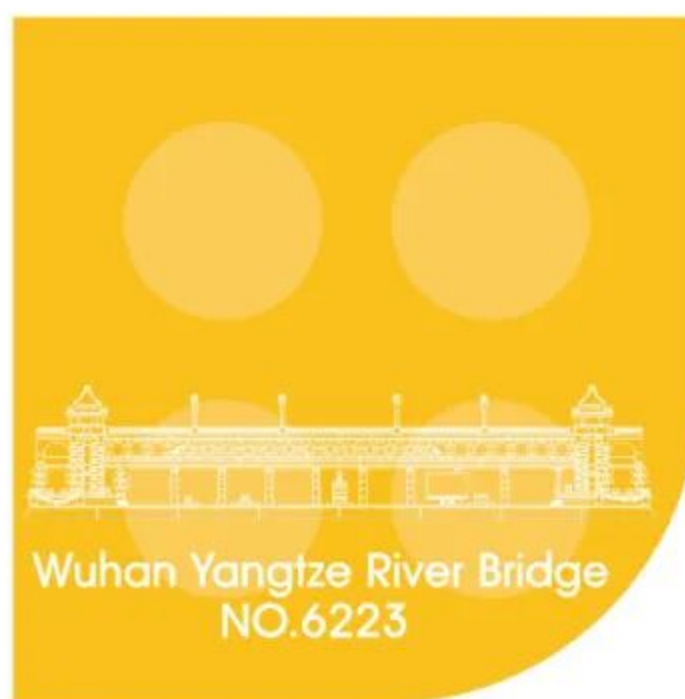

ARCHITECTURE

WANGE The world's great architect since 1991

Wuhan Yangtze River Bridge



Geography and culture

地理.文化



Wuhan Yangtze Bridge, is a double-deck road and rail bridge across the Yangtze River in Wuhan, in Central China.



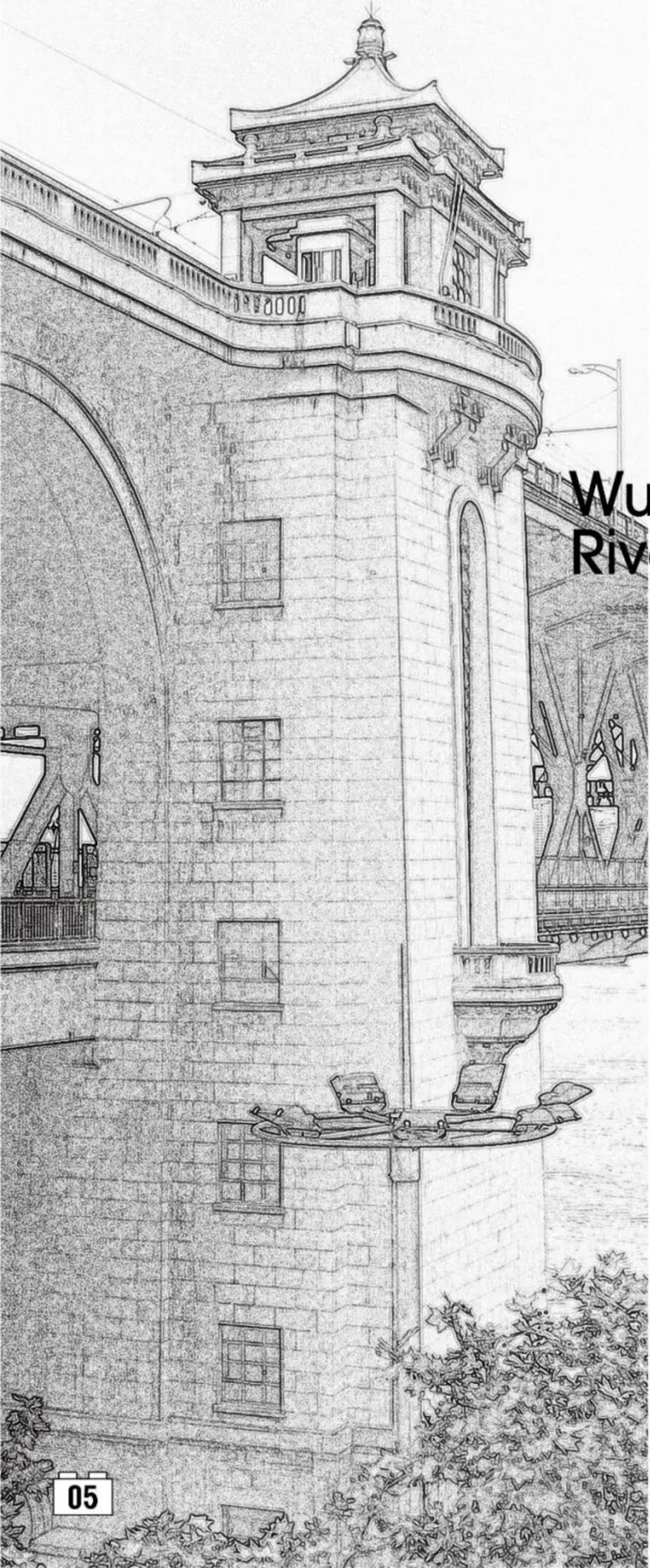

武汉长江大桥

Wuhan Yangtze River Bridge

China

The contents of this chapter refer to the Wikipedia website.

本章内容参考维基百科网站，更多资讯可自行查阅。

The world's great architecture

About The Building



The Wuhan Yangtze Great Bridge, commonly known as Wuhan First Yangtze Bridge, is a double-deck road and rail bridge across the Yangtze River in Wuhan, in Central China. At its completion in 1957, the bridge was the easternmost crossing of the Yangtze, and was often referred to as the "First Bridge of the Yangtze".

历史与文化

武汉长江大桥位于中国湖北省武汉市，横卧于汉阳龟山和武昌蛇山之间的长江江面之上，是长江上第一座铁路、公路两用桥，因此又被称为“万里长江第一桥”。武汉长江大桥的建设规划始于1910年代，由1913年至1948年间曾先后四次进行长江大桥的勘测、选址和设计，但几次规划都因经济、战乱原因而搁置。中华人民共和国成立以后，武汉长江大桥的建设被列入中国第一个五年计划的苏联援华156项工程之一，于1950年起正式开始进行大桥的测量和设计，1955年9月动工建造。由于采用了新的管柱钻孔法取代传统的气压沉箱法，大大加快了大桥的建造速度，使武汉长江大桥竣工日期提前2年，1957年10月正式通车。



武汉三镇位居中国腹地、长江中游，汉水由此汇入长江，拥有重要的地理位置优势，曾被孙中山誉为“内联九省、外通海洋”的大商埠。至清末时期，武昌为湖北省会，汉口为商埠，汉阳也发展了一定的工业基础。1906年，京汉铁路全线通车，而粤汉铁路也在修建当中，建桥跨越长江、汉水连接京汉、粤汉两路的构思即为各方所注意。据历史档案显示，在武汉建第一座长江大桥的设想最早由湖广总督张之洞提出，用以沟通南北铁路。1912年5月，中国铁路工程师詹天佑被北洋政府聘为粤汉铁路会办。詹天佑在进行粤汉铁路复勘定线的过程中，考虑到将来粤汉铁路与京汉铁路会跨江接轨，为此在规划武昌火车站（通湘门车站）时也预留与京汉铁路接轨出岔的位置。

Scene Matching

场景搭配

Force Balance

受力平衡

$$F = G \frac{m_1 m_2}{d^2}$$

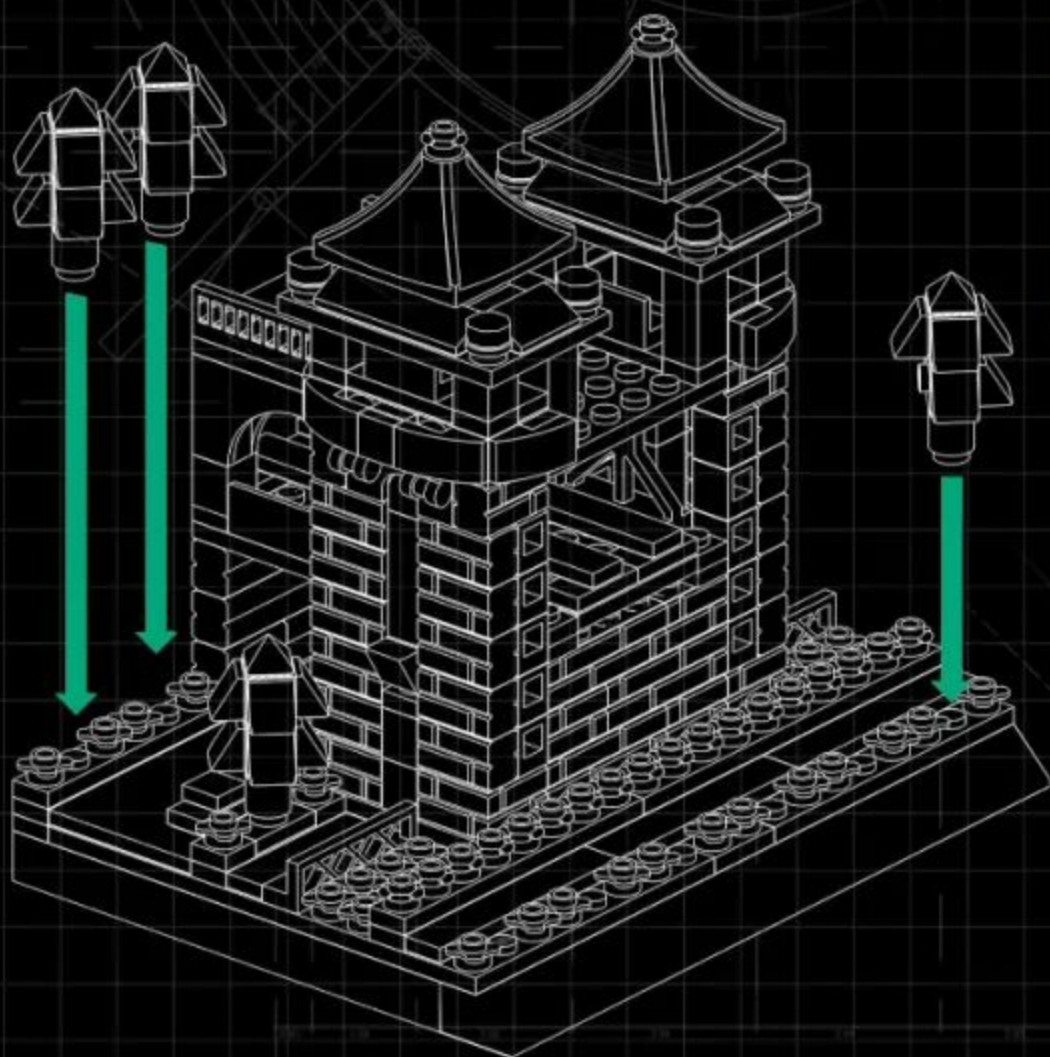
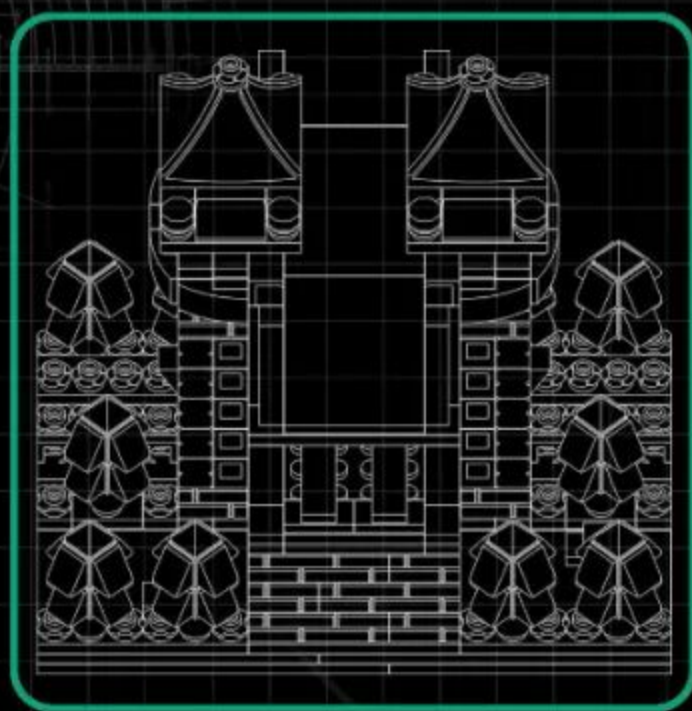
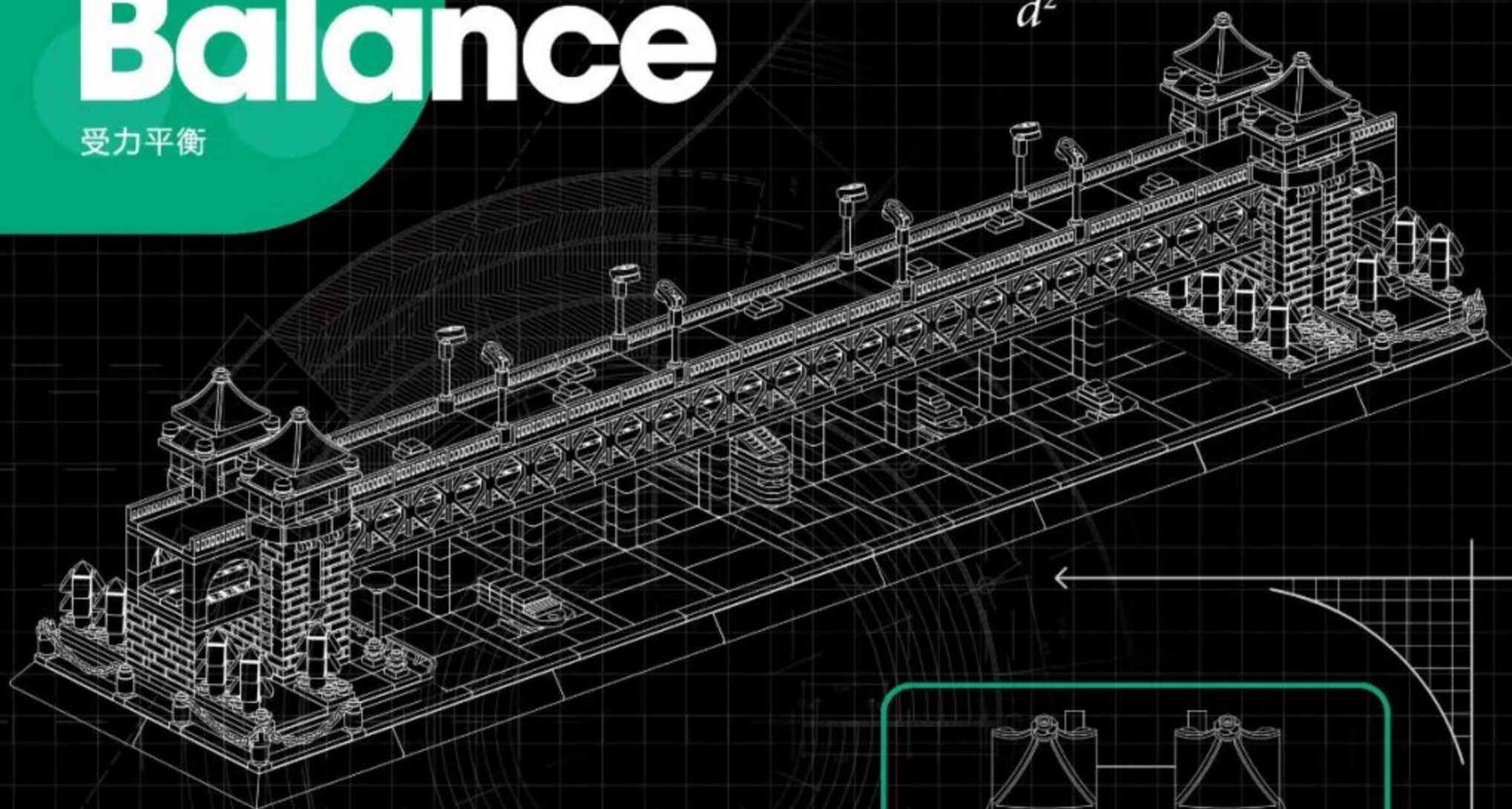

Creation and thinking

创作·思考

Design Points

结构难点

Angle calculation
角度的计算

$$a^2+b^2=c^2$$

$$S=4\pi\cdot r^2$$

$$\sin^2 a + \cos^2 a = 1$$



Creation and thinking

创作·思考

Special parts

特殊零件的开发利用

$$a^2+b^2=c^2$$

WG1344

方形通孔



$$S=4\pi \cdot r^2$$

WG1348

4X4塔顶



WG1342

4孔拱形栏杆



WG1346

矮4X10孔



WG1343

3孔米字栏杆

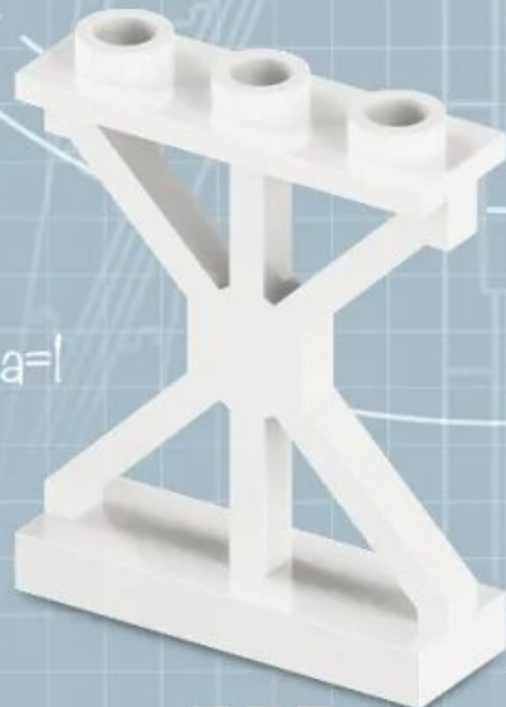

$$\sin^2 a + \cos^2 a = 1$$

features and function

特点.功能

10

Main Color Matching

配色方案



Pantone 7500C



Pantone 431C



Pantone 291C



Pantone Black 6C

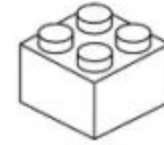

White



Pantone 655C



Pantone 7620C



Pantone 123C



Pantone 347C



Pantone Cool Gray 6C



Color matching

Adopting 7 main colors, beige, brown and gray as the main color, the more reasonable and bold color matching on the original building, making the product more atmospheric and the whole design is more reasonable.

Wuhan Yangtze River Bridge

武汉长江大桥



Front

Left

Back

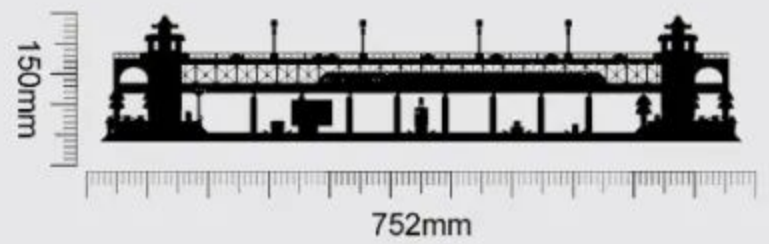
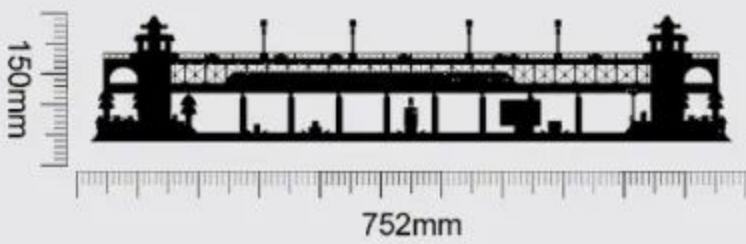

Product Size: 752X176x150mm



Instructions For Use

积木起件器使用说明
Brickseparator

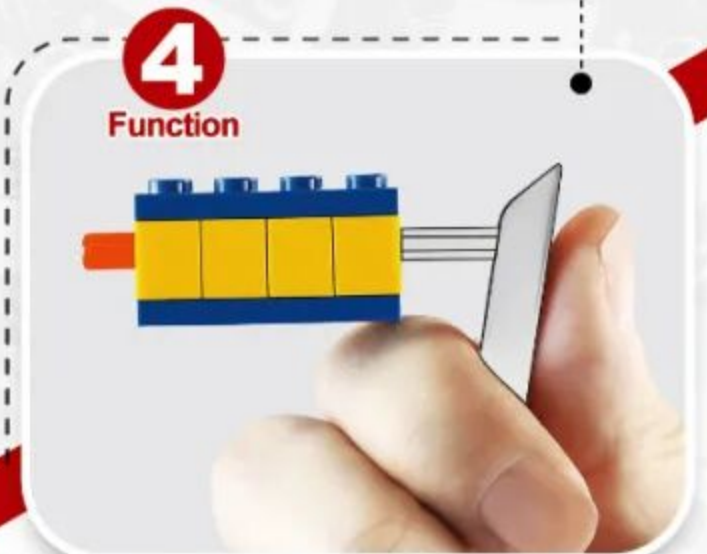
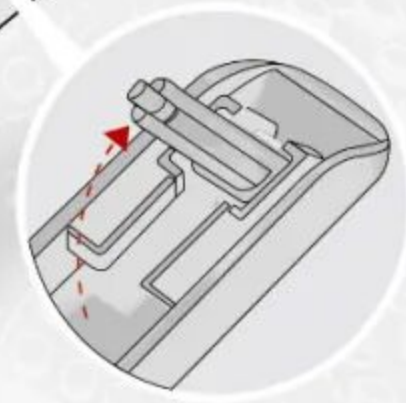
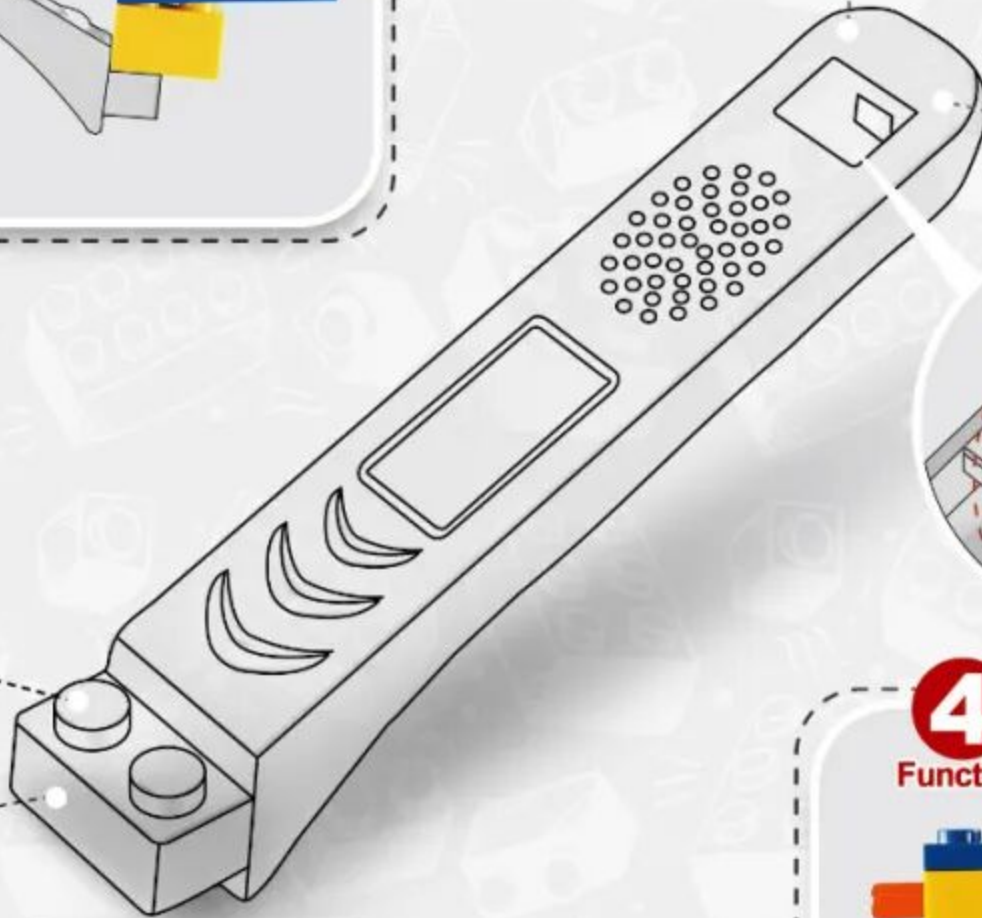
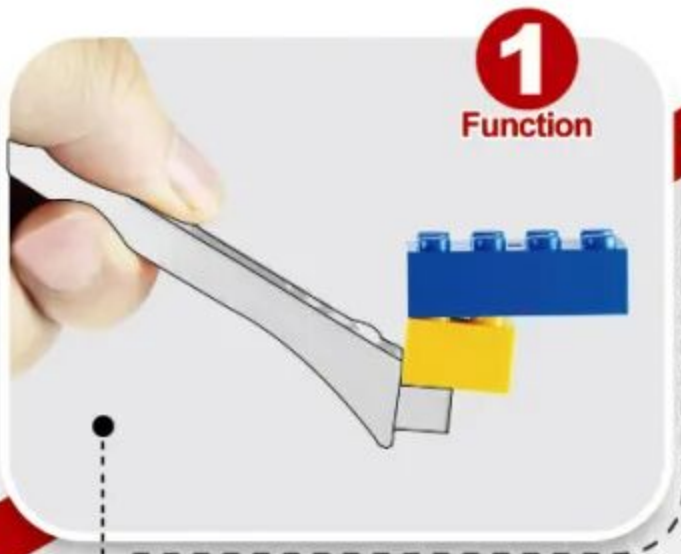

4 ways to make installation easier
让安装更简单



■ First open the product packaging according to the instructions.

按指导用正确方式拆解产品外包装。



■ Summarize all parts to count the number of familiar accessories.

对照说明书清单确认积木包数量与积木数量。



■ Arranging all accessories by color helps to quickly install the product.

把确认好的积木以类型、颜色进行分类排好以便安装。



■ Carefully install the product and learn about building.

按说明书步骤拼装并完成你的积木模型。



1:1 Physical Reference Table

十字棒配件1:1尺寸参照表



Instructions For Use
让安装更简单



2 $(1 \times 2) = 2$

3 $(1 \times 3) = 3$

4 $(1 \times 4) = 4$

5 $(1 \times 5) = 5$

6 $(1 \times 6) = 6$

7 $(1 \times 7) = 7$

8 $(1 \times 8) = 8$

9 $(1 \times 9) = 9$

10 $(1 \times 10) = 10$

12 $(1 \times 12) = 12$

16 $(1 \times 16) = 16$

PARTS LIST

配件清单

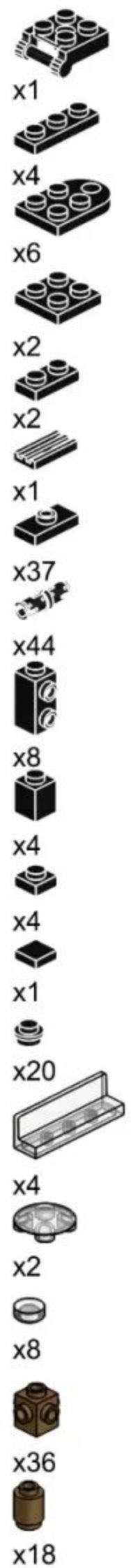
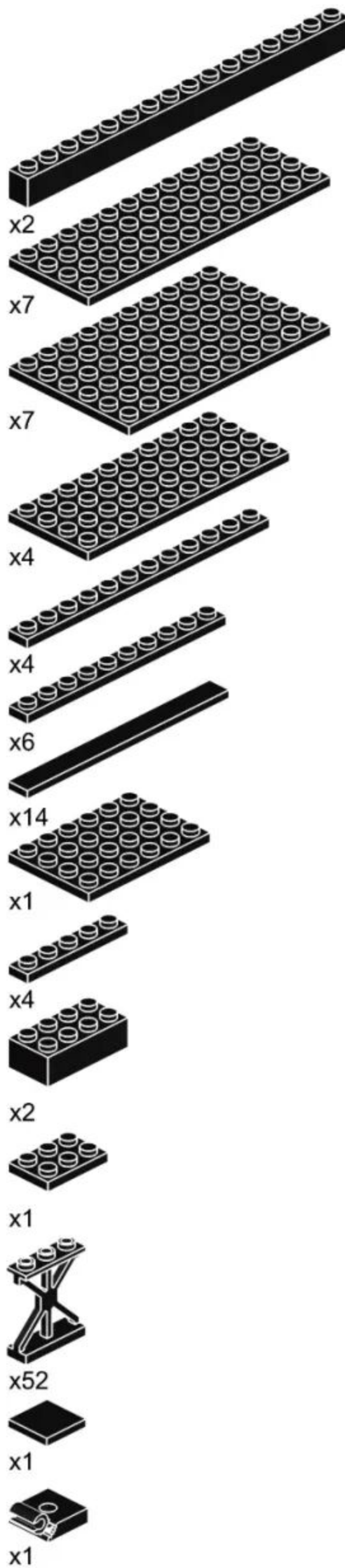
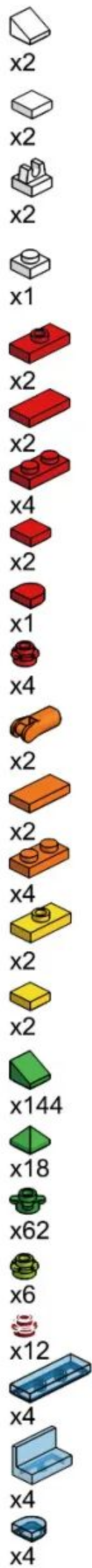
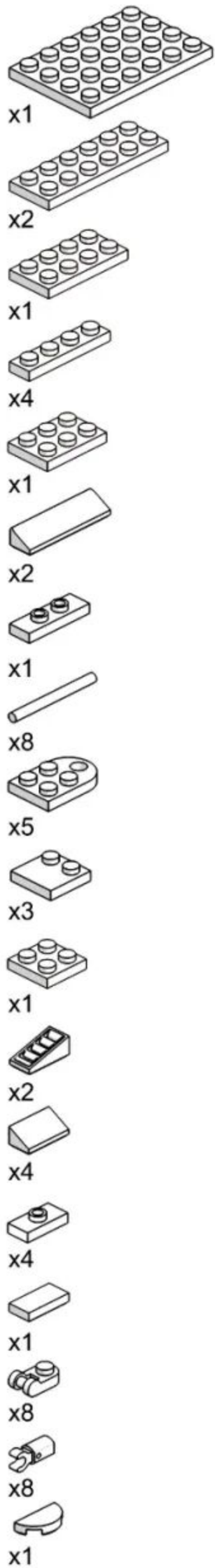

产品有增补件请以实物为准

If product has additional parts, please in kind prevail.

PARTS LIST

配件清单

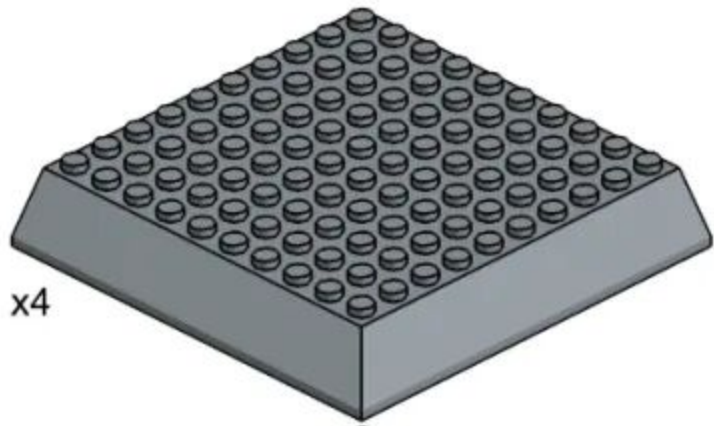

x4

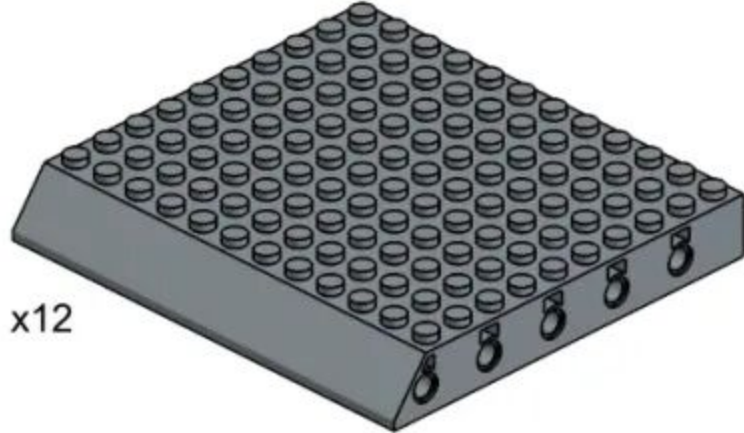

x12



x2

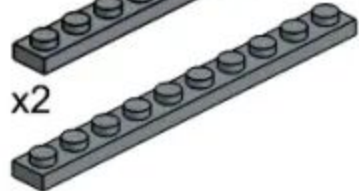

x1



x21



x3



x16



x12



x4



x2

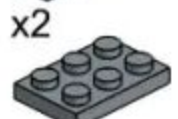

x2



x2

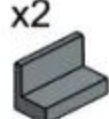

x2



x2



x8



x20



x20



x4

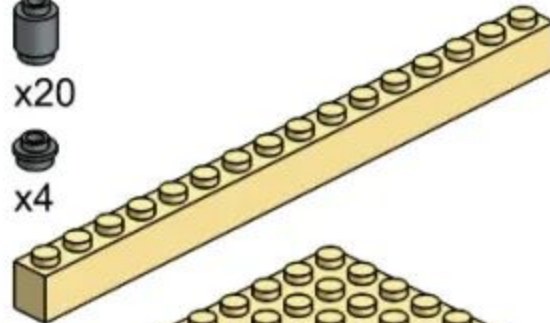

x2

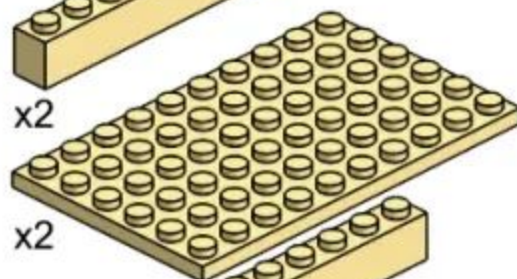

x2

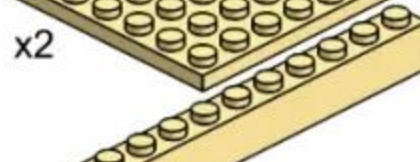

x4

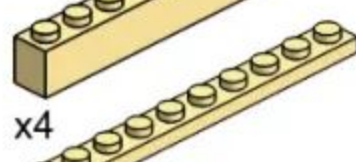

x4



x4



x4



x4

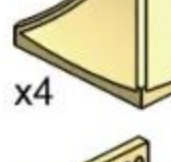

x4

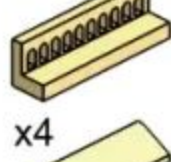

x8

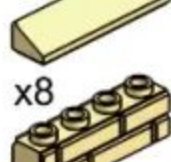

x12



x8

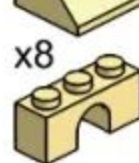

x4



x8



x2



x4



x4



x4



x4



x4



x4



x60



x4



x8



x4



x8



x4



x8

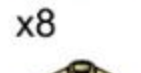

x4



x16



x32



x4



x4



x12



x40



x8



x8



x4



x4



x12



x8



x16



x36



x16



x16



x4



x4



x4



x4



x4



x4



x4



x2



x6



x4



x8



x6



x4



x8



x6



x4



产品有增补件请以实物为准

If product has additional parts, please in kind prevail.

PARTS LIST

配件清单

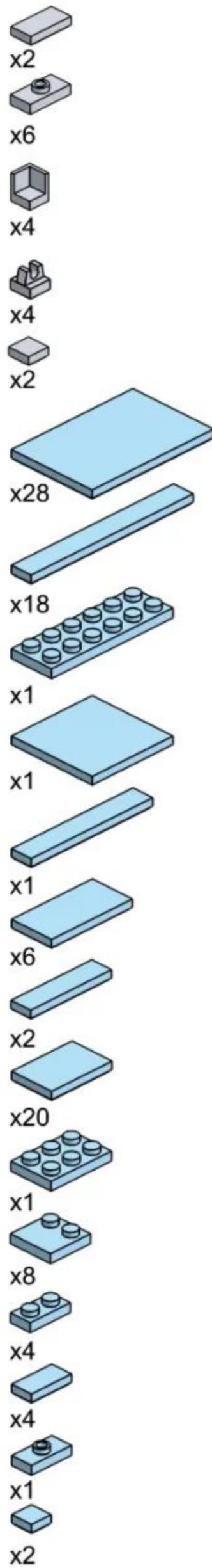
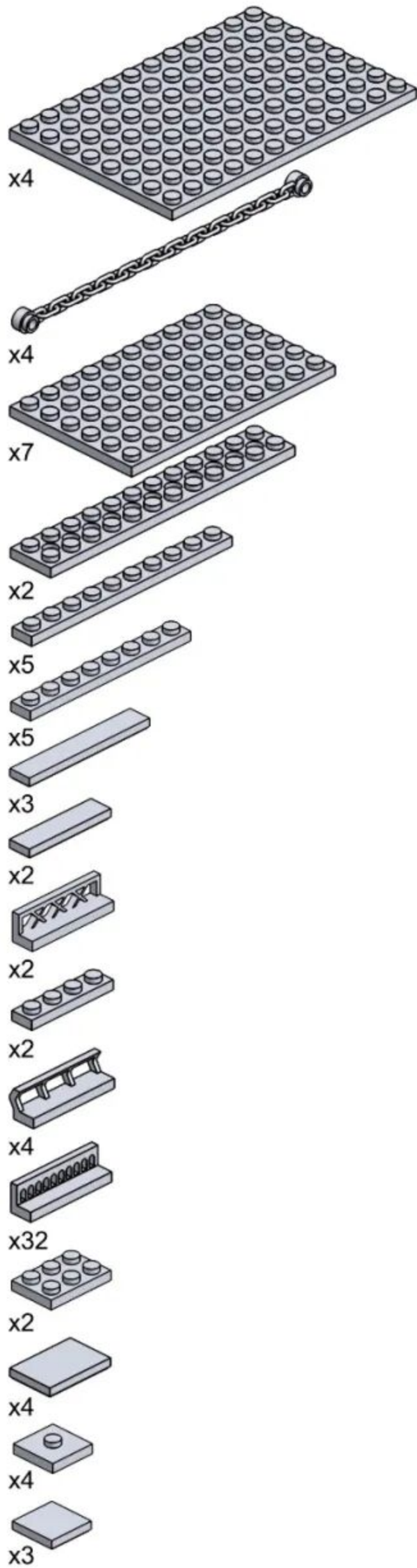

产品有增补件请以实物为准
 If product has additional parts, please in kind prevail.



60PCS

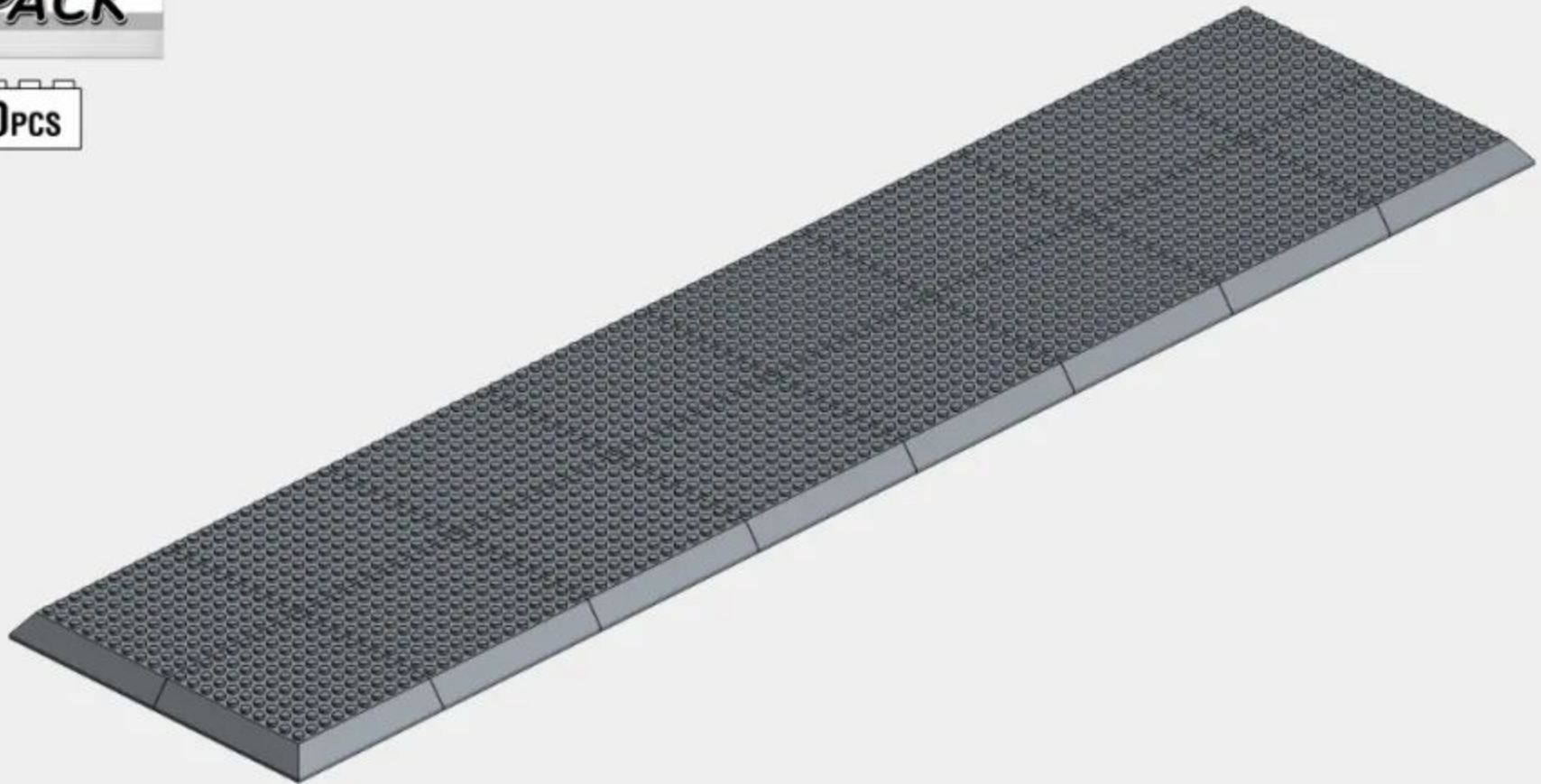

1-1

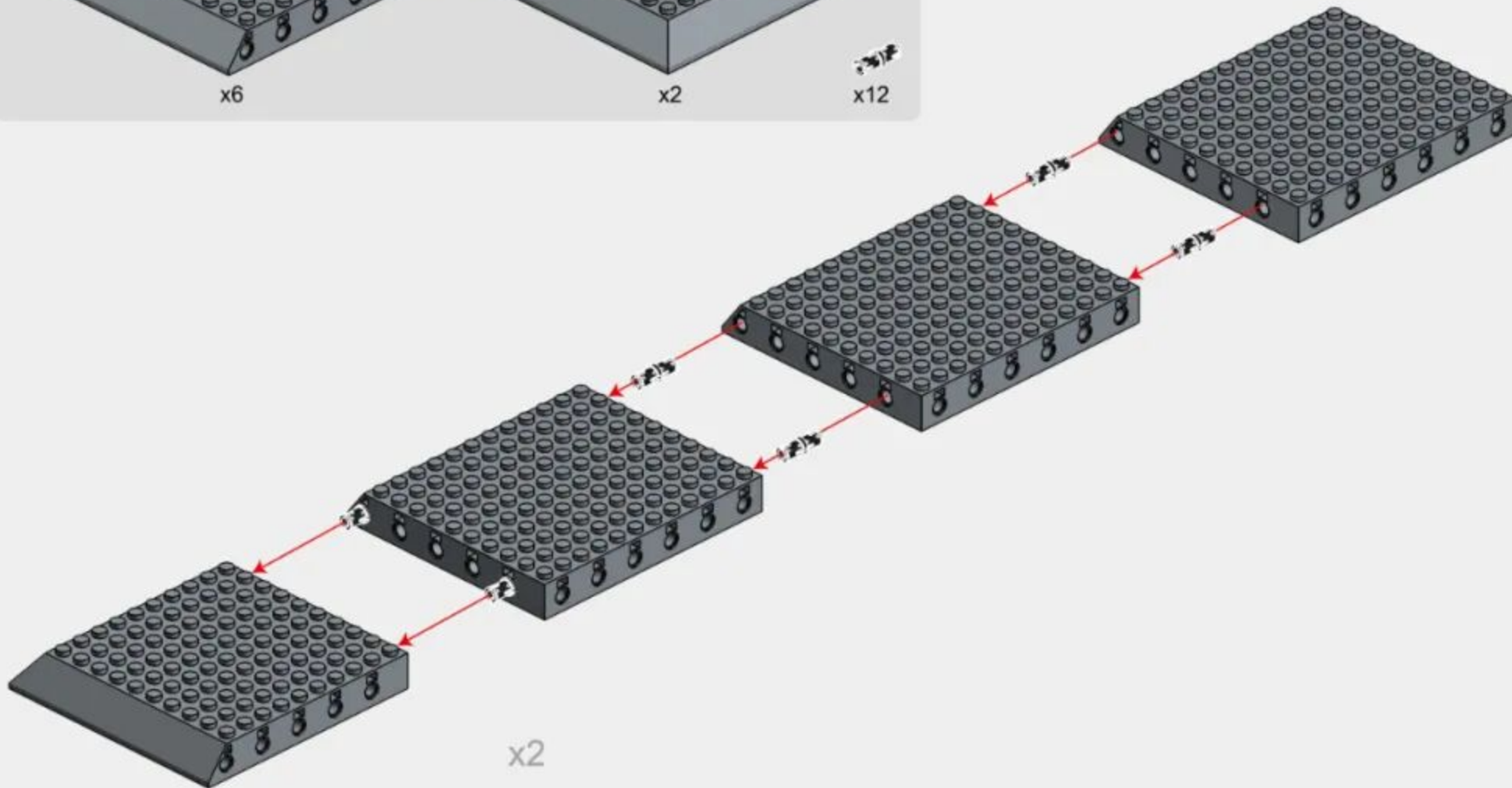
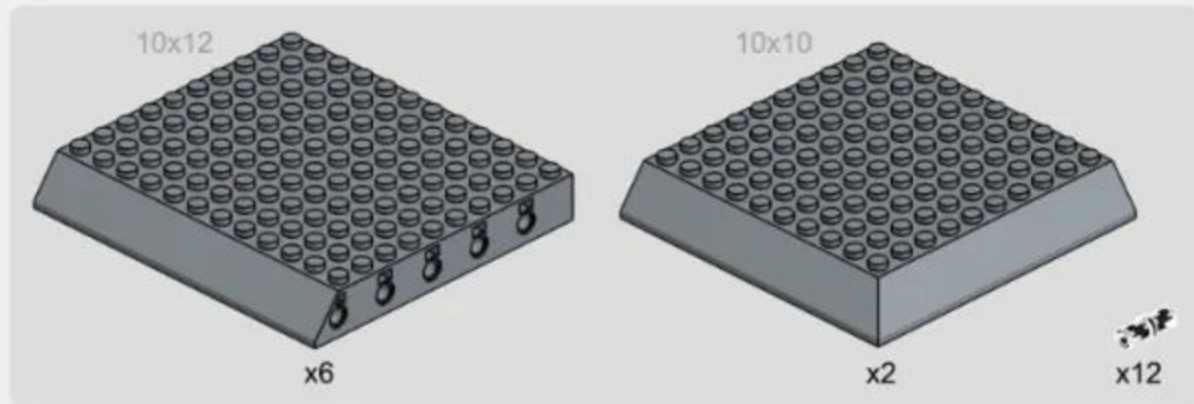

1-2

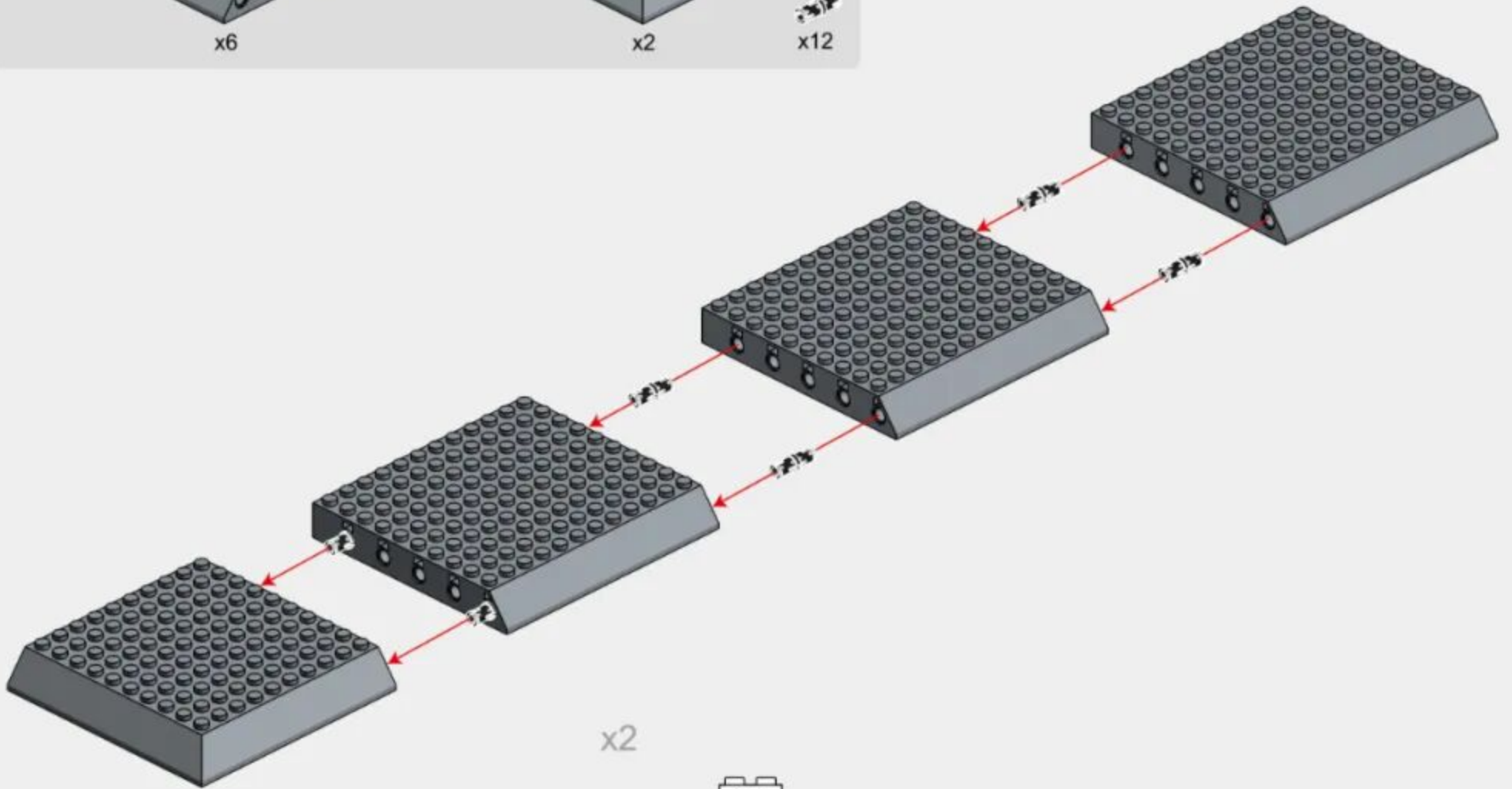
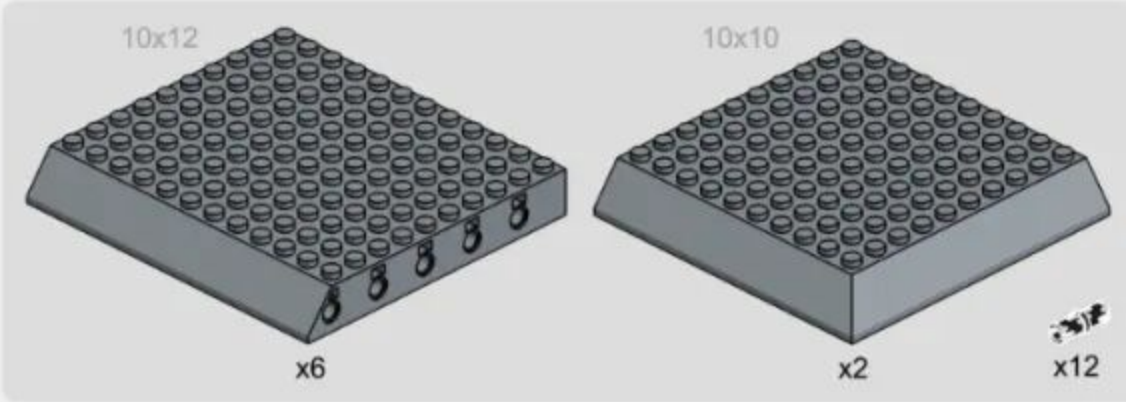

1-3

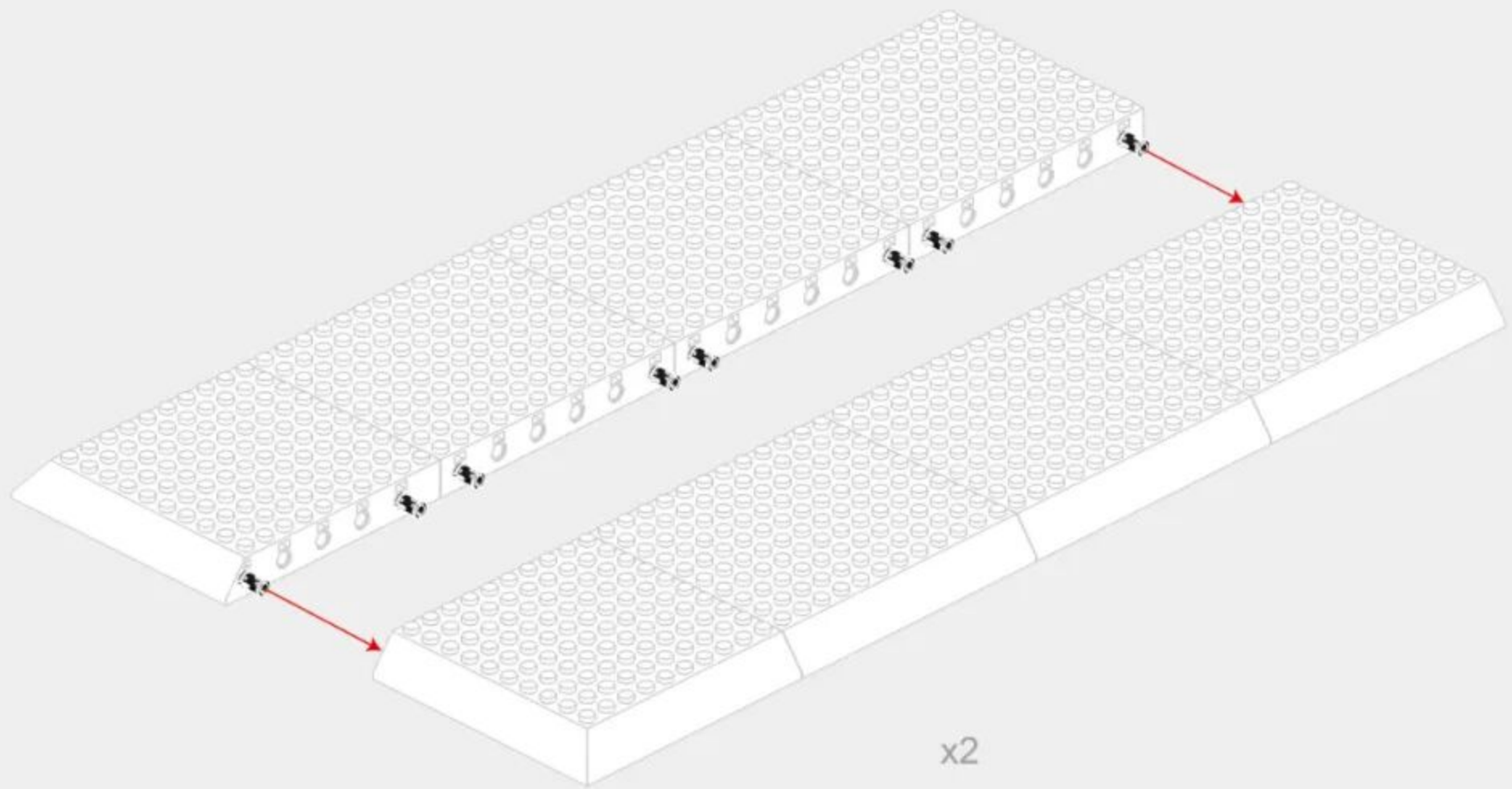

x2



1-4

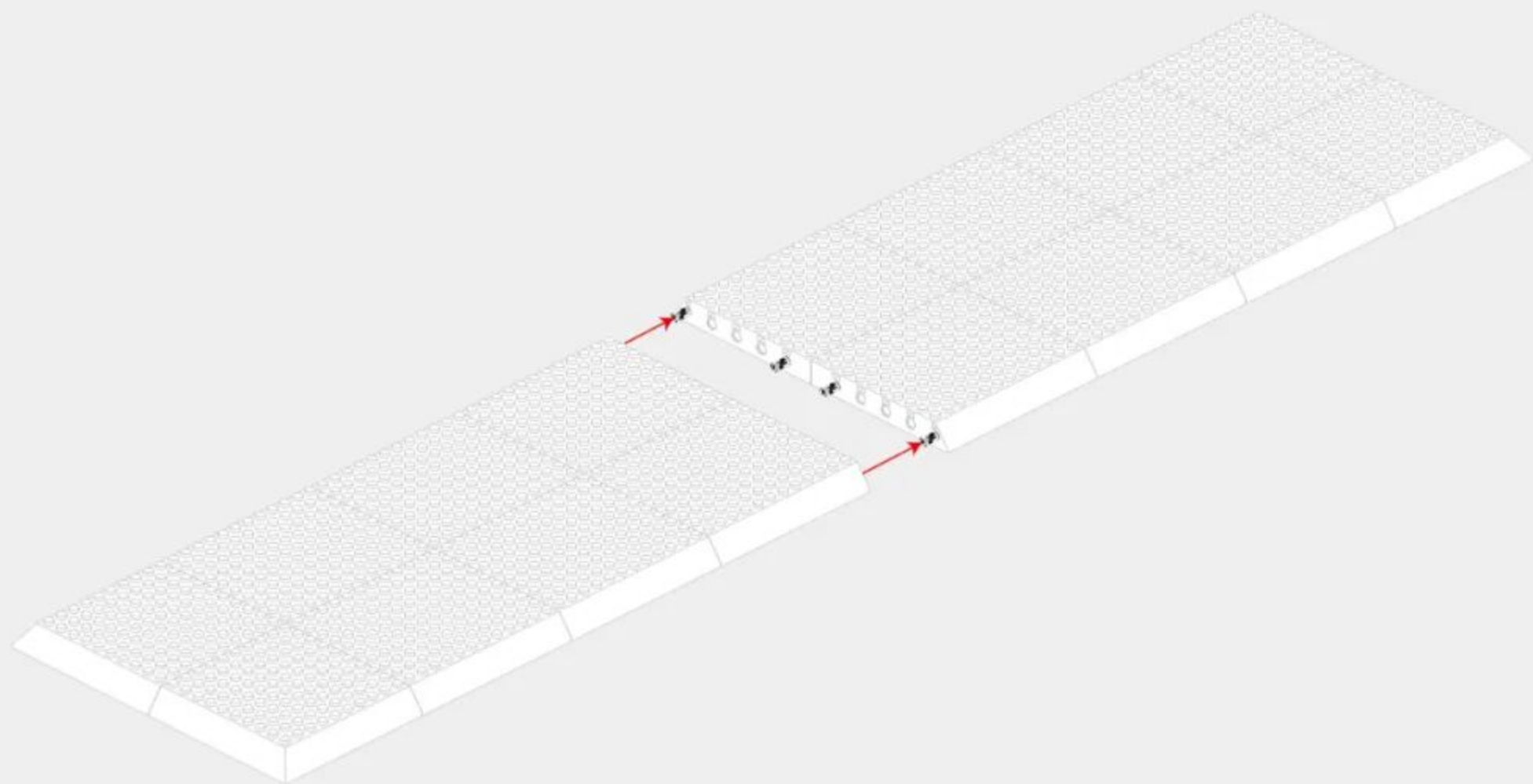



308PCS

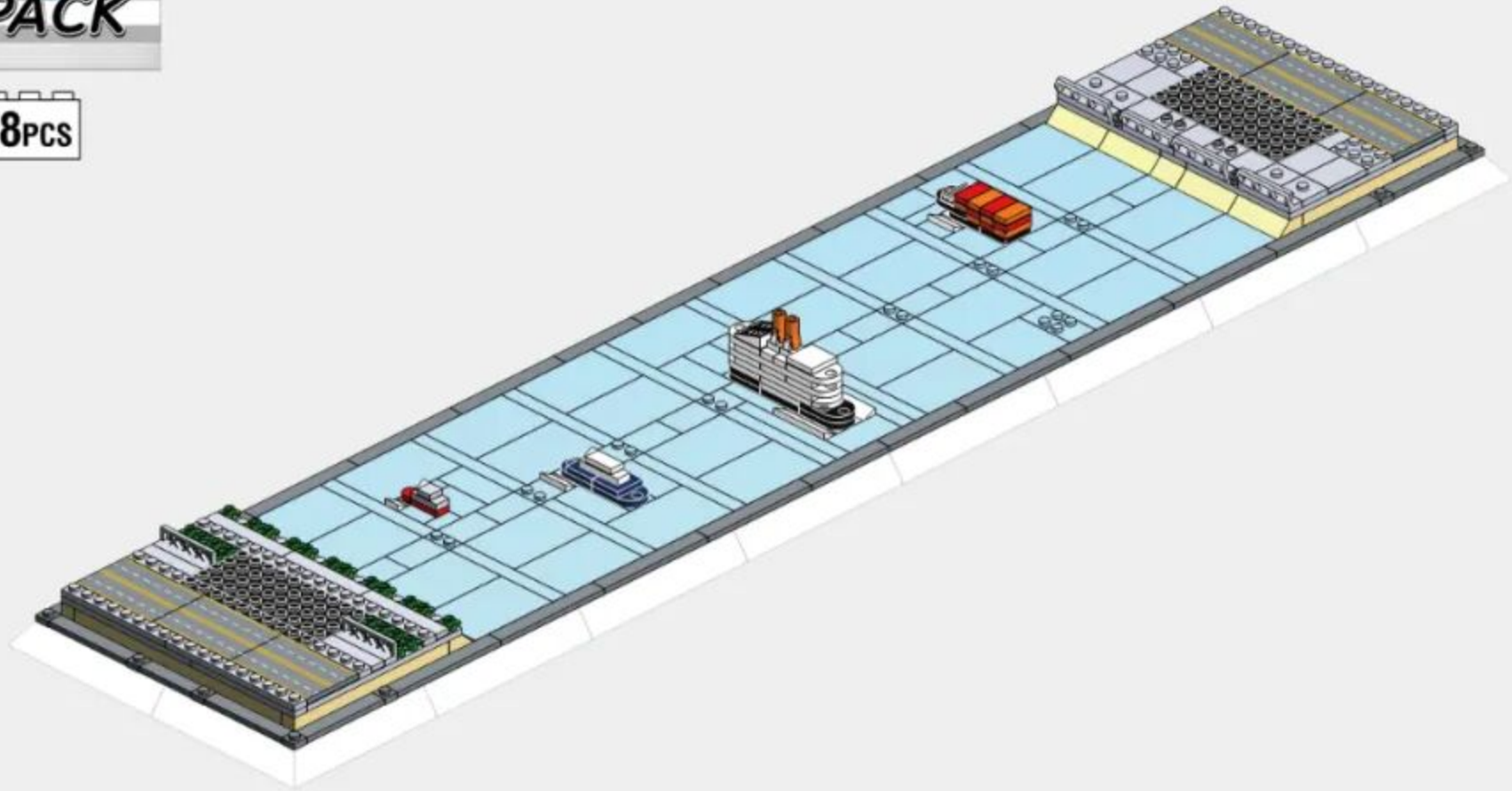

2-1

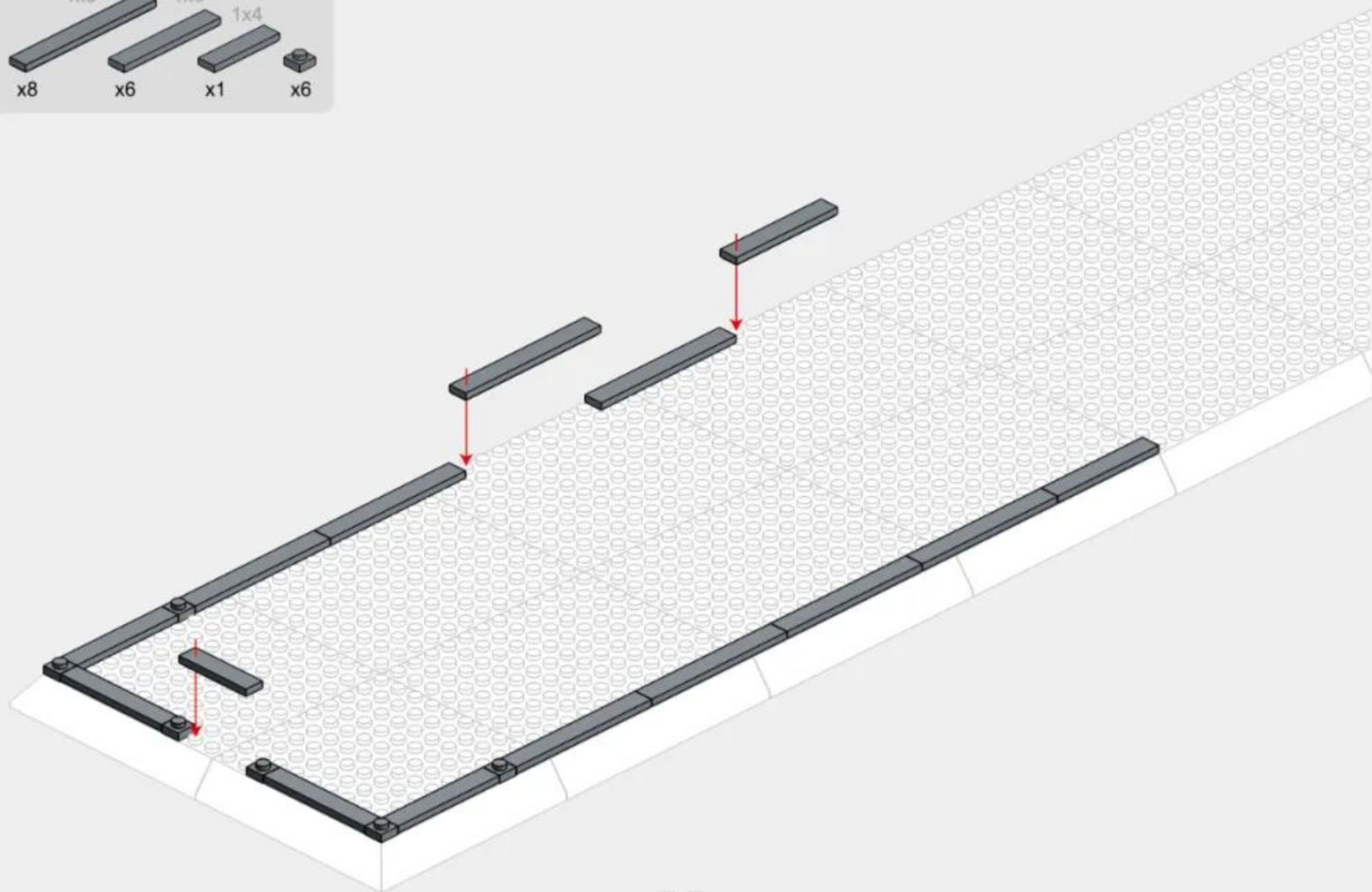
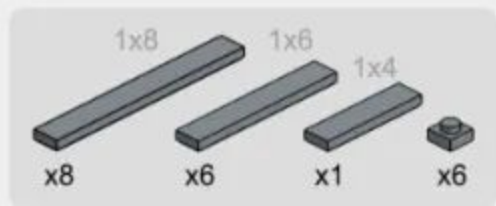

2-2

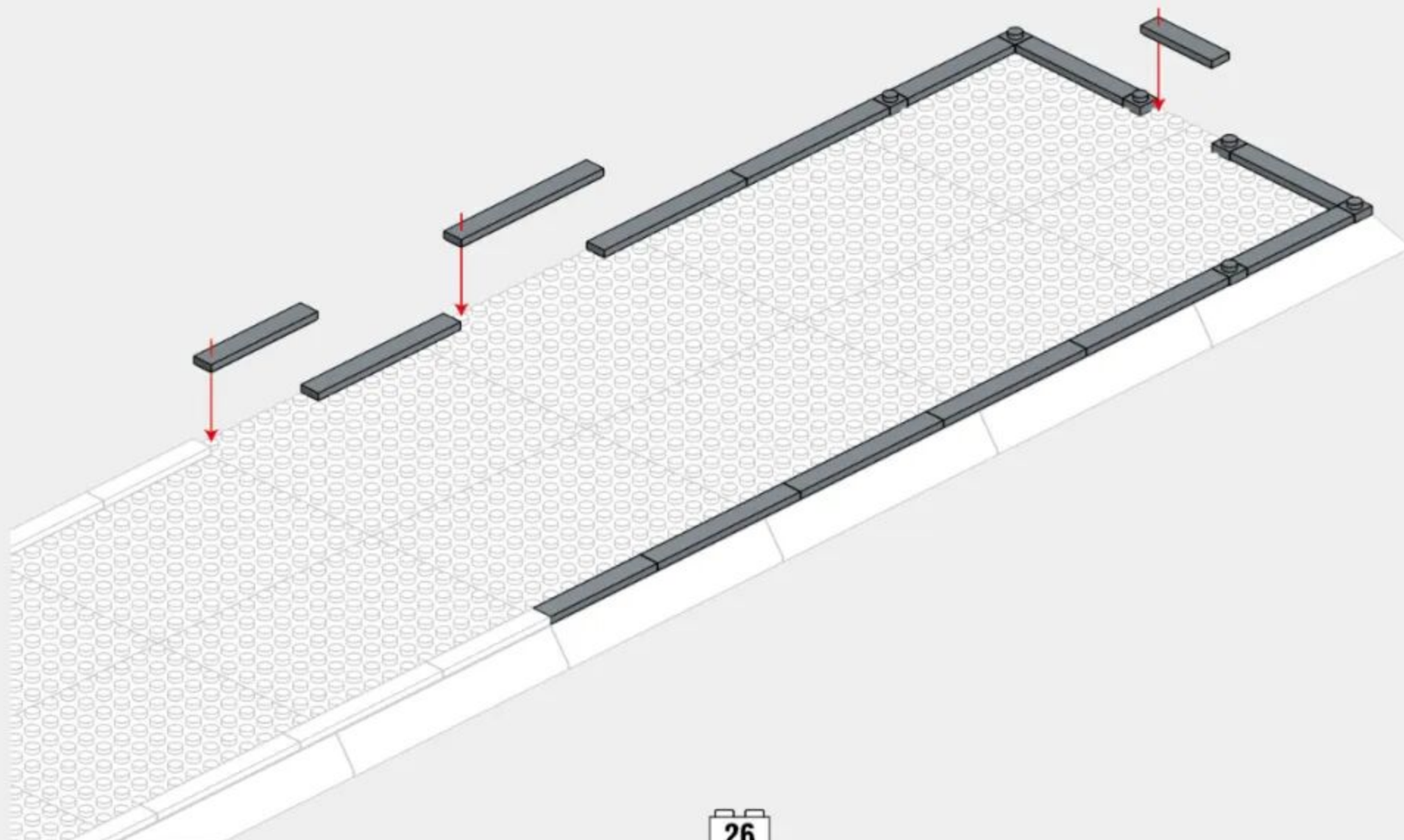
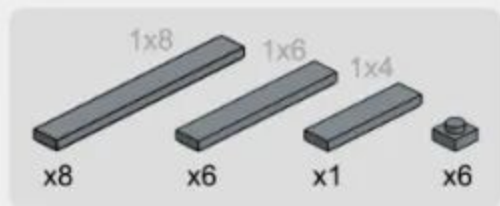

1-3

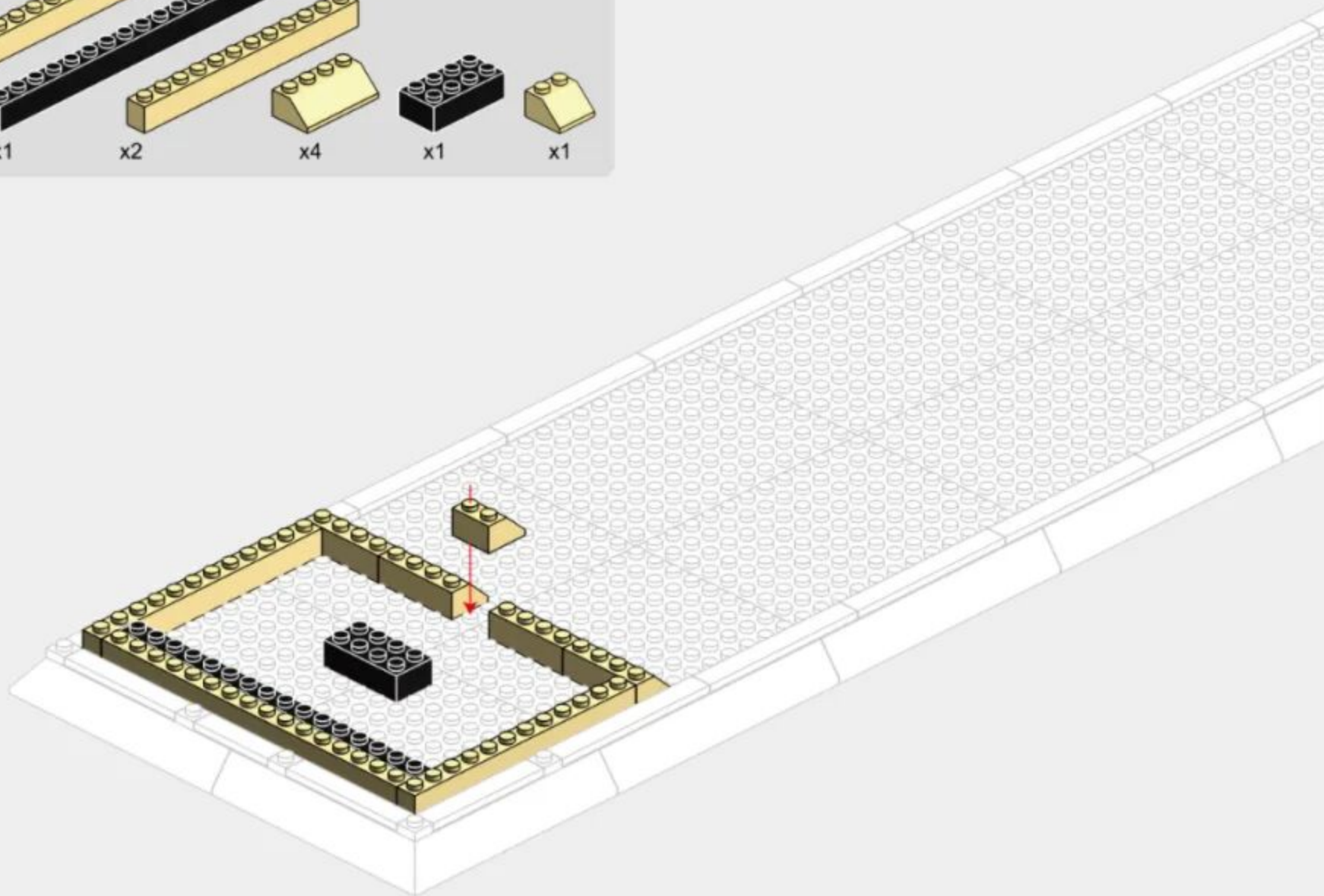
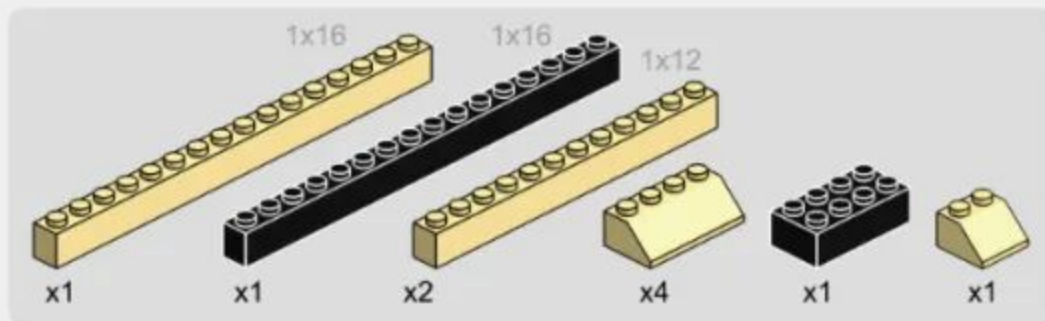

1-4

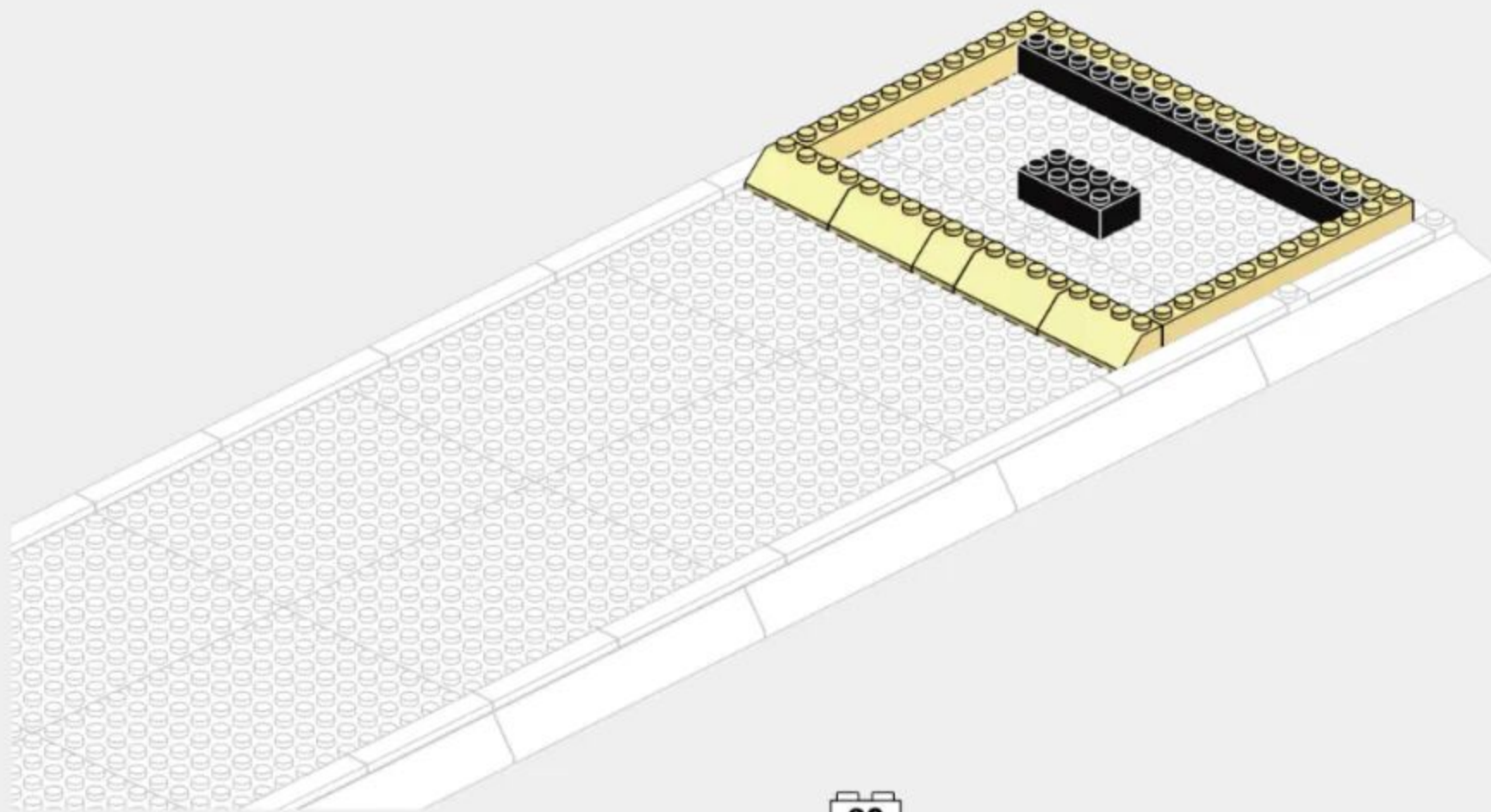
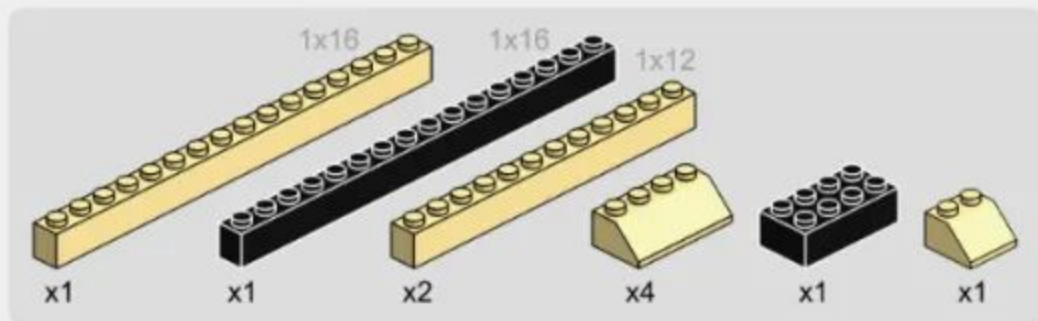

2-5

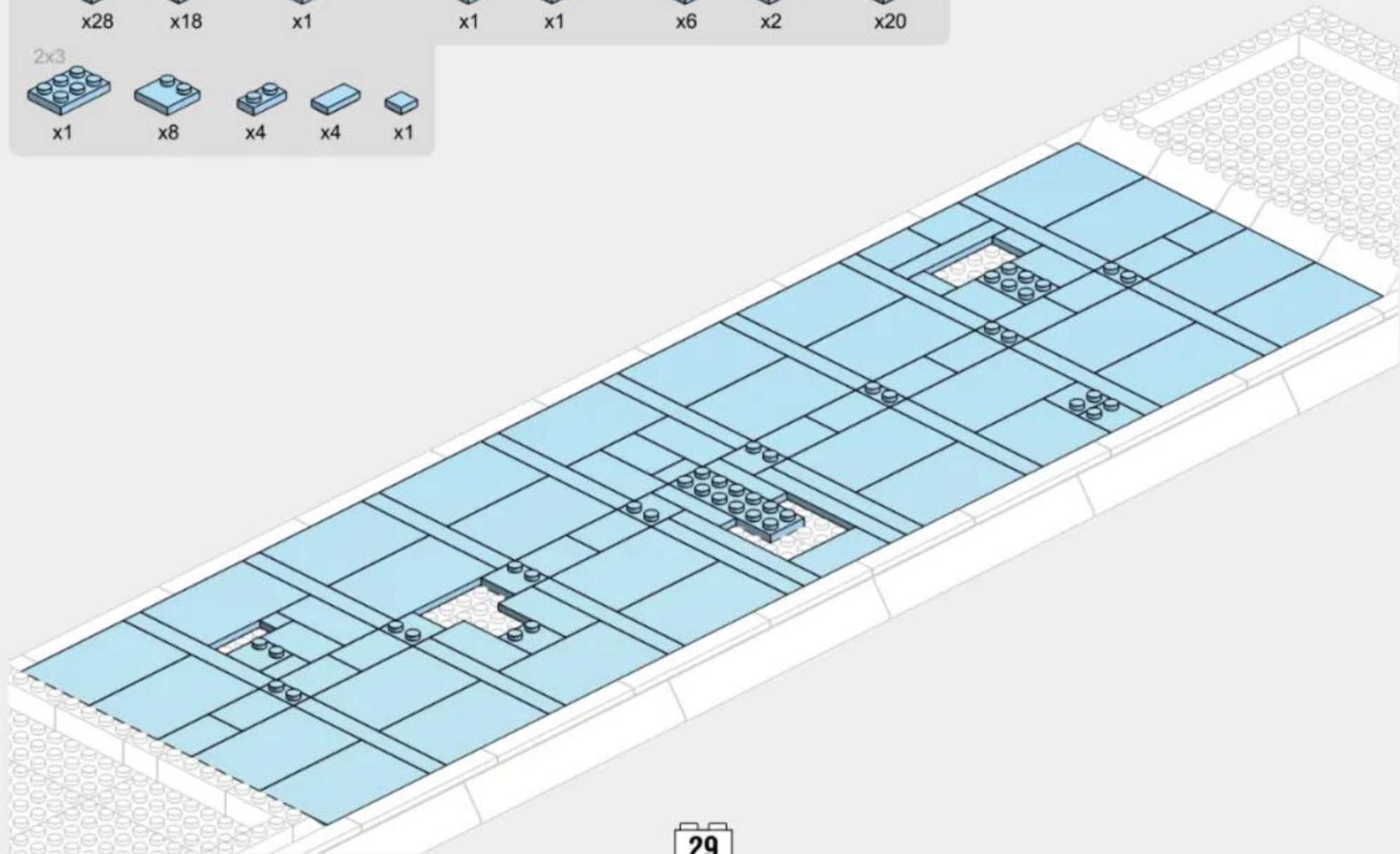
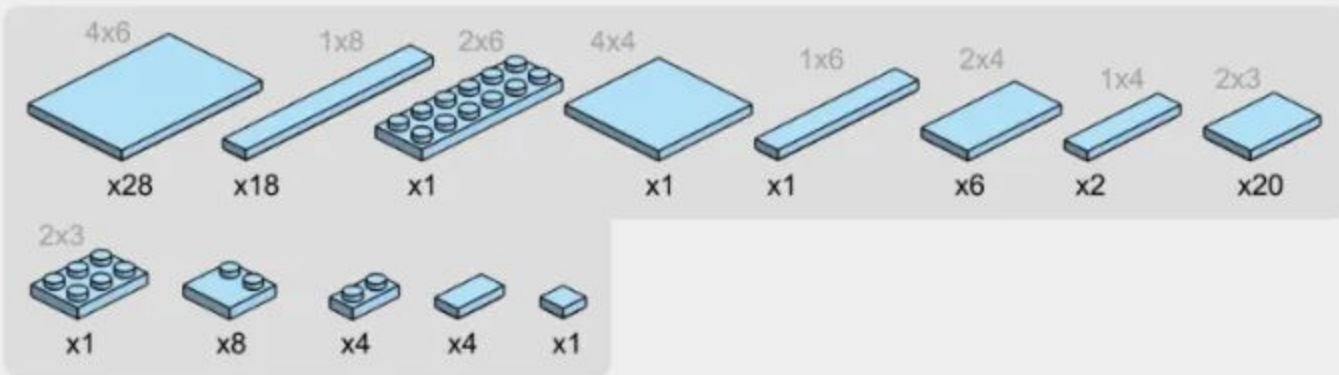

2-6

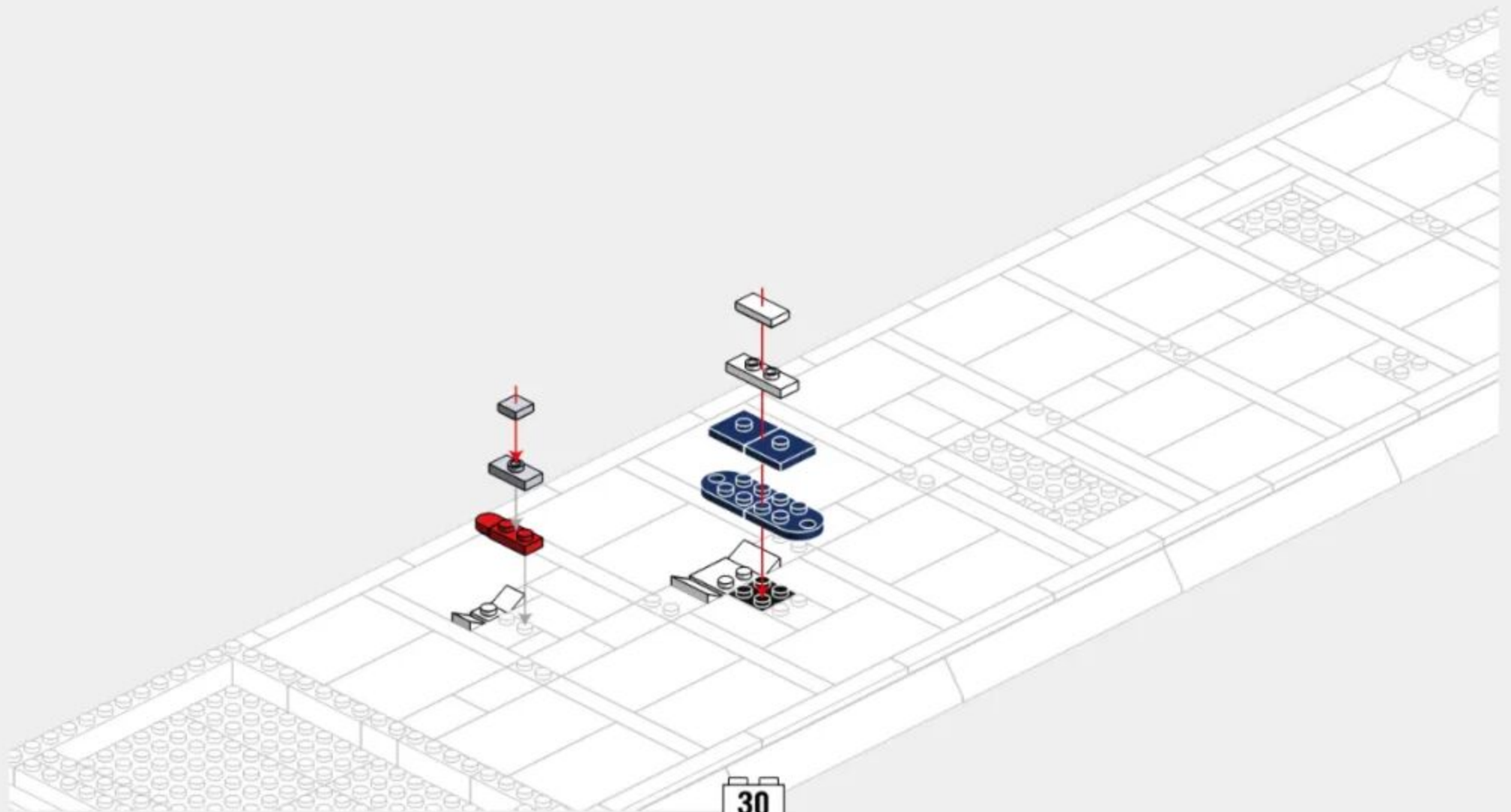
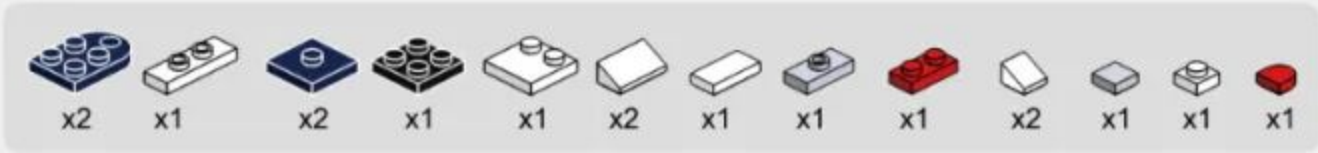

2-7

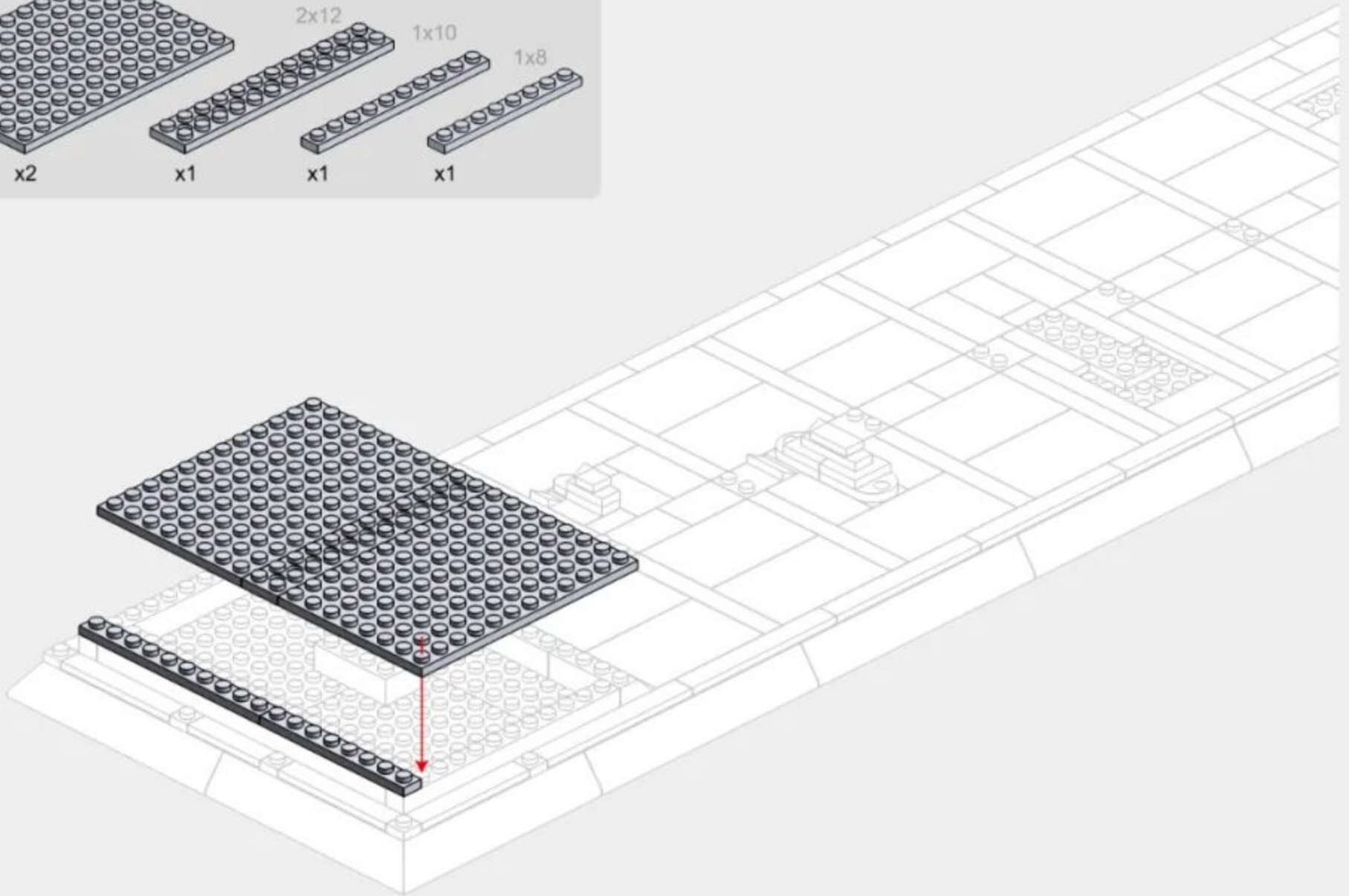
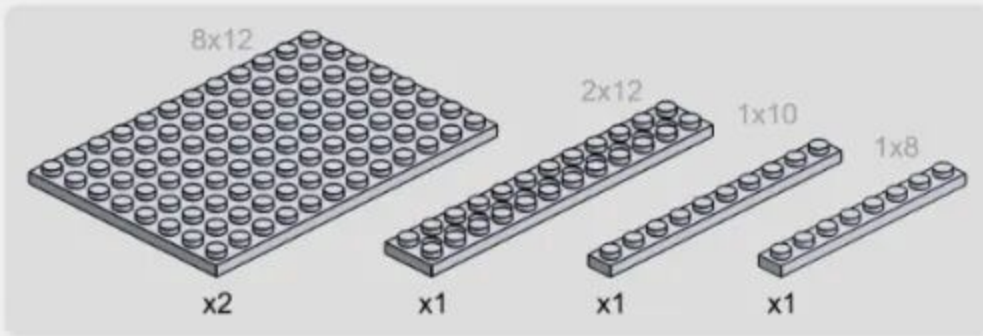

2-8

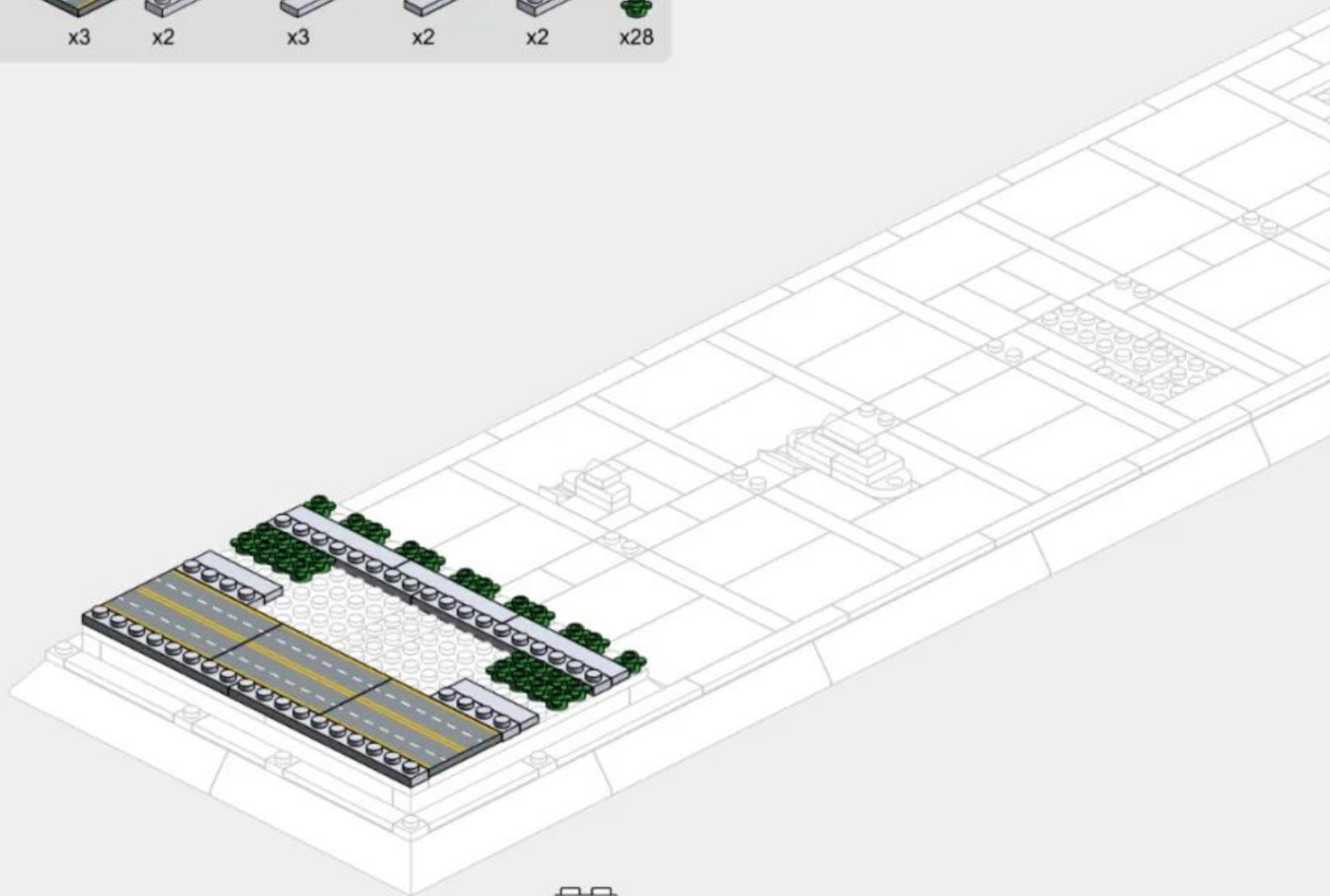
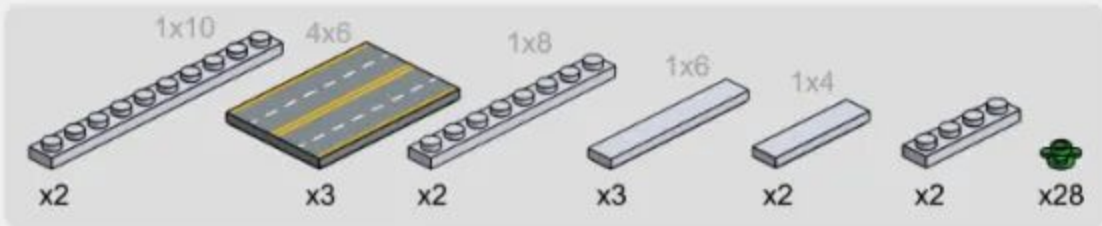

2-9

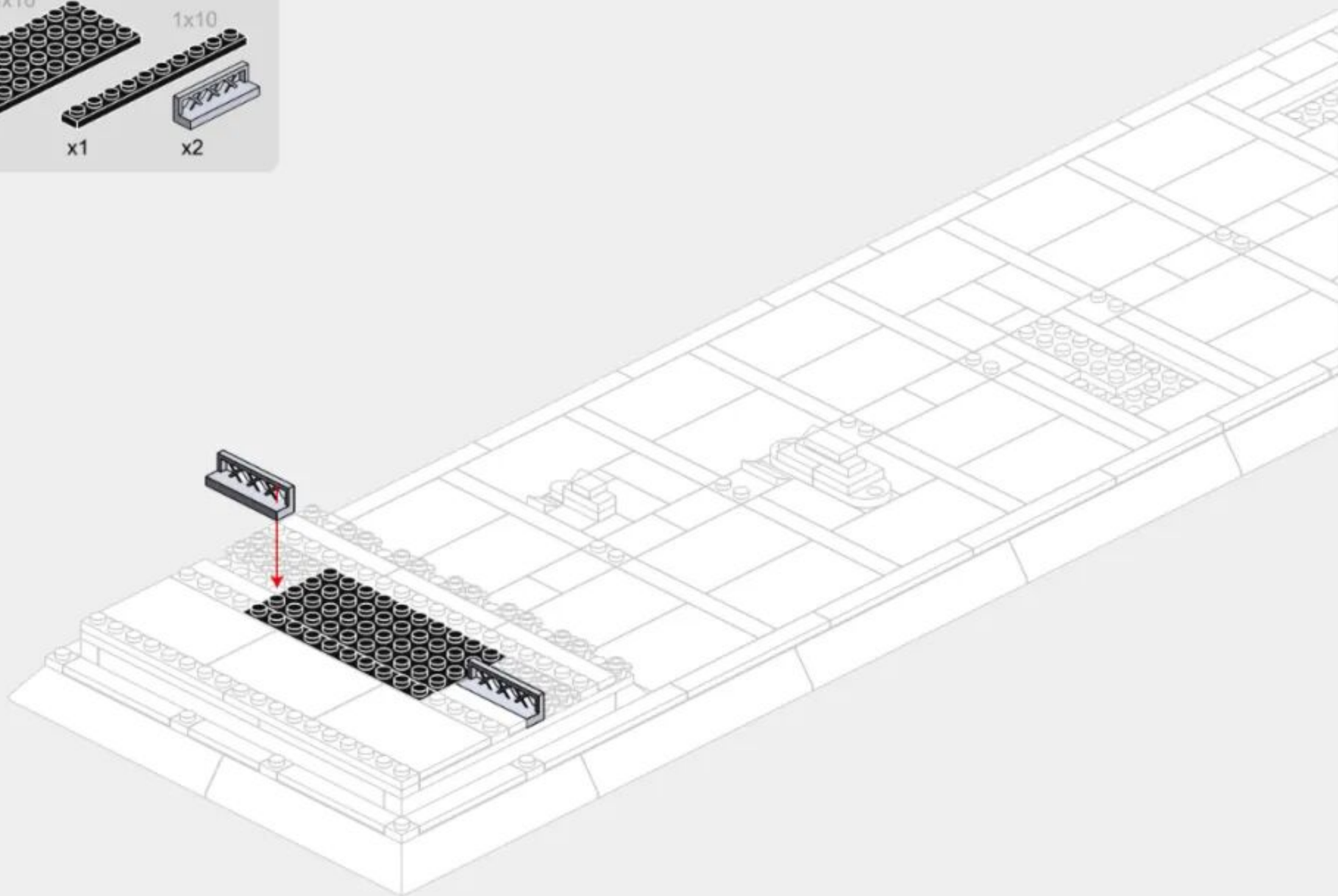
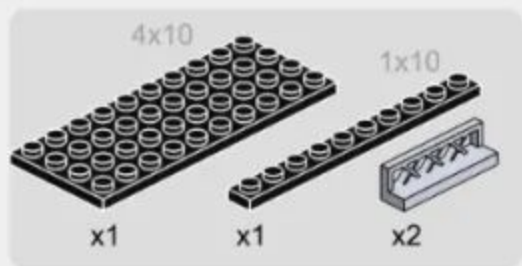

2-10

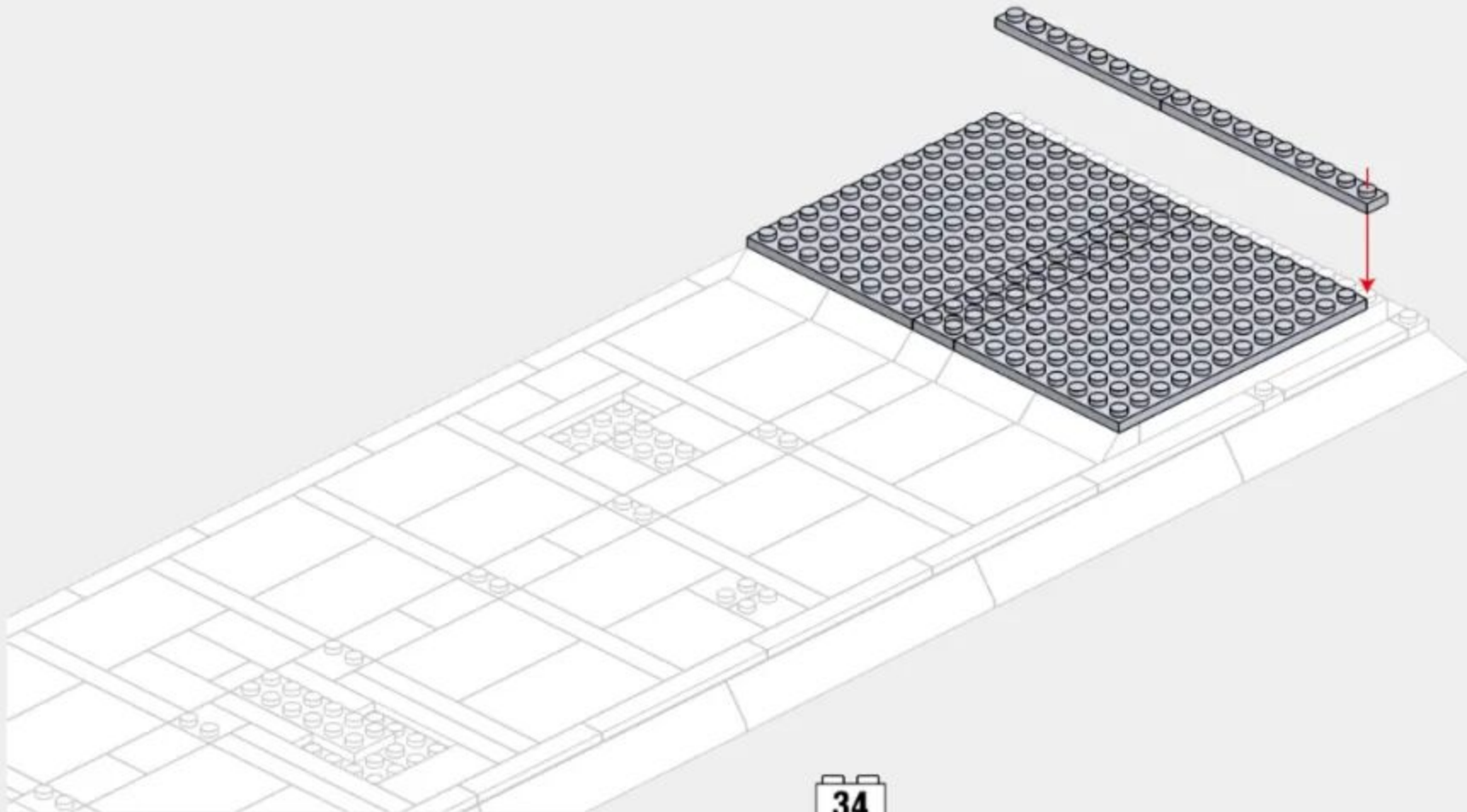
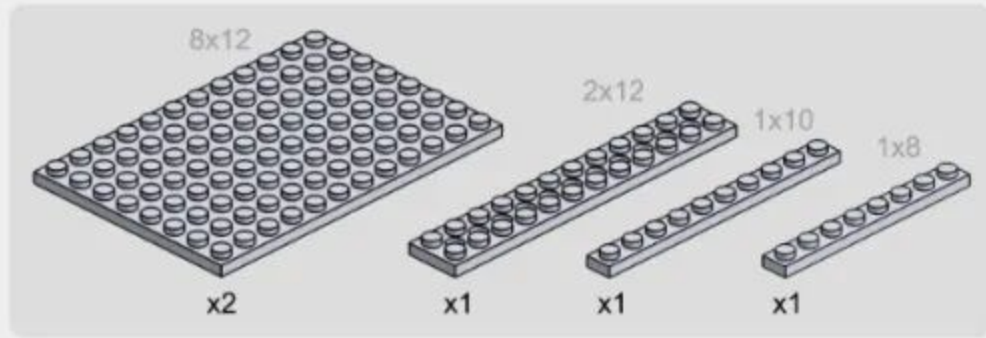

2-11

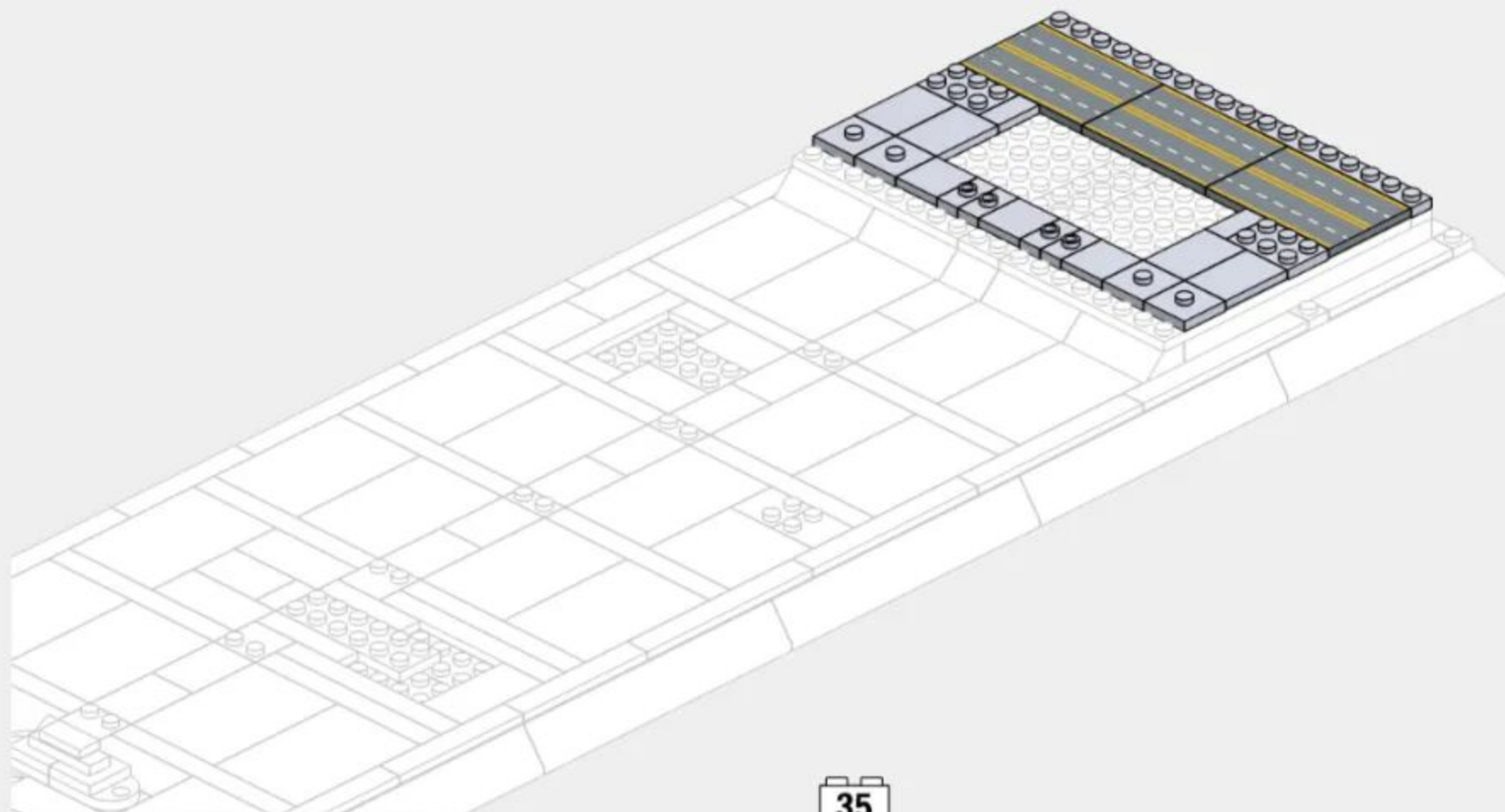
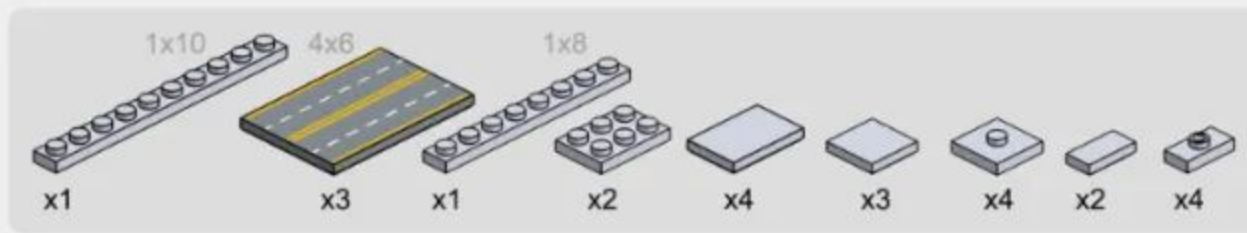

2-12

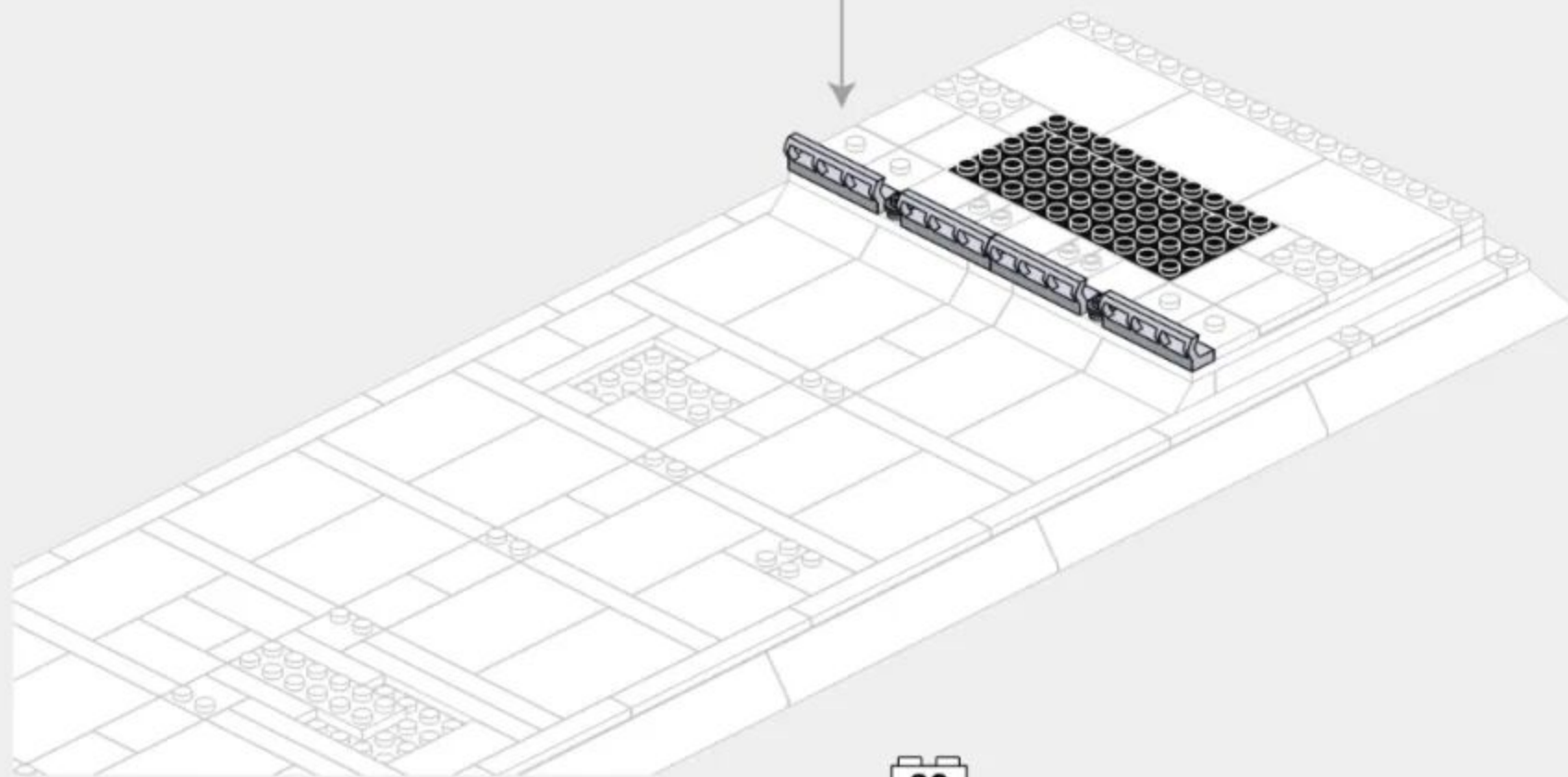
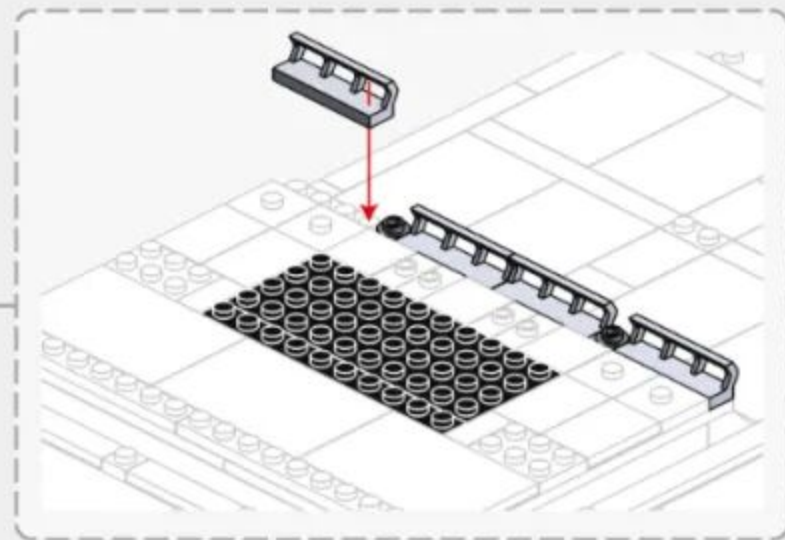
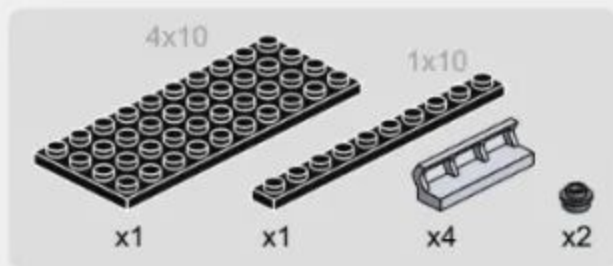

2-13

- x2 (1x5 white Technic brick)
- x1 (1x5 white Technic brick)
- x1 (1x5 black Technic brick)
- x1 (1x5 white Technic brick)
- x5 (1x3 white Technic brick)
- x6 (1x3 black Technic brick)
- x1 (1x3 white Technic brick)
- x1 (1x3 black Technic brick)
- x2 (1x3 white Technic brick)
- x2 (1x2 white Technic brick)
- x1 (1x2 black Technic brick)
- x2 (1x2 white Technic brick)
- x2 (1x2 white Technic brick)
- x2 (1x2 white Technic brick)
- x2 (1x2 white Technic brick)
- x2 (1x2 white Technic brick)
- x2 (1x2 red Technic brick)
- x3 (1x2 red Technic brick)
- x4 (1x2 orange Technic brick)
- x2 (1x2 orange Technic brick)
- x2 (1x2 orange Technic brick)
- x1 (1x2 grey Technic brick)
- x1 (1x2 white Technic brick)

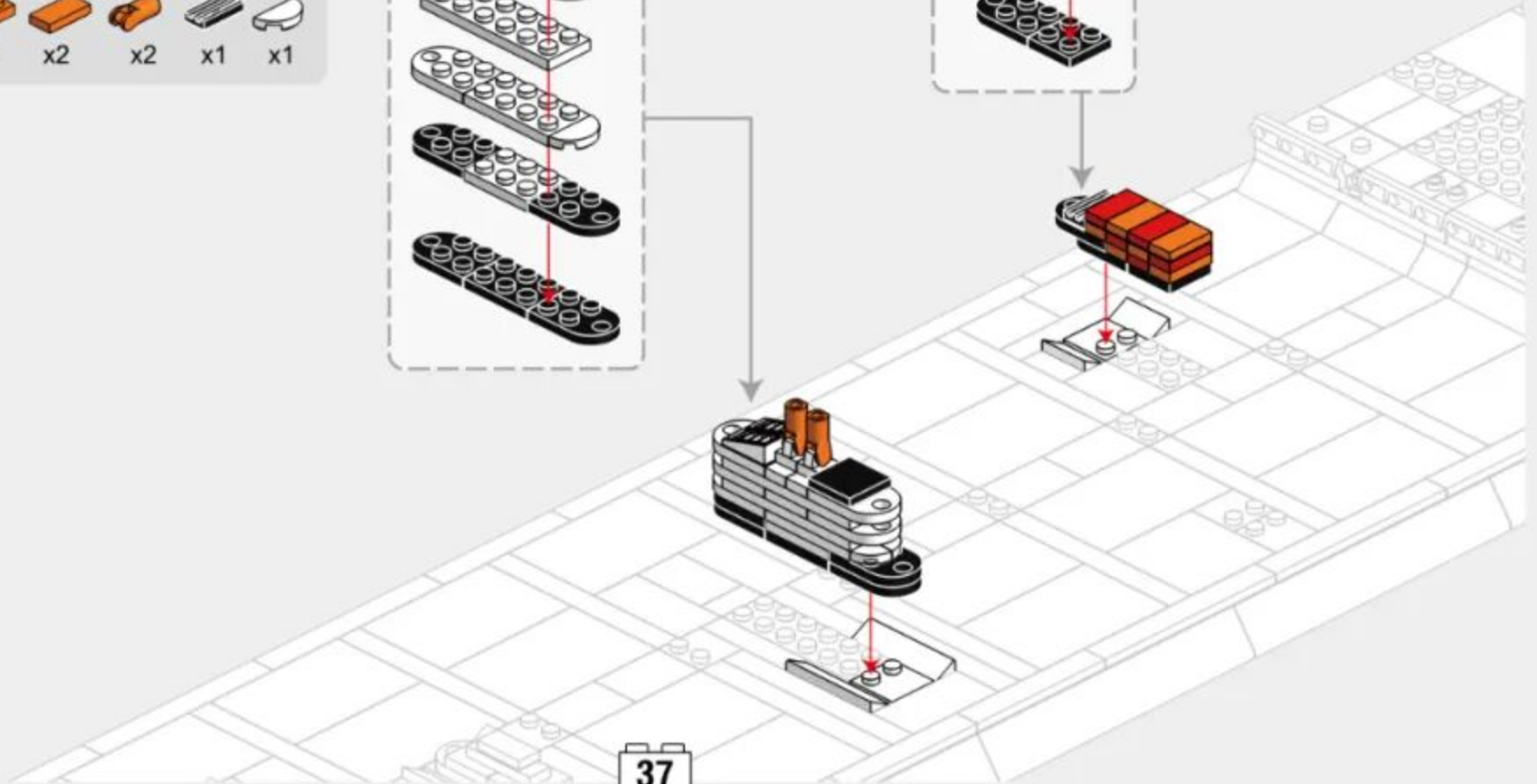
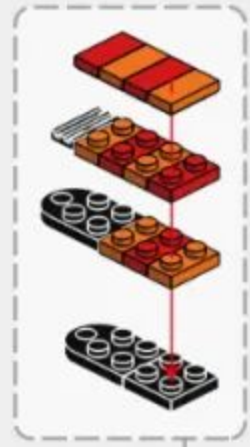
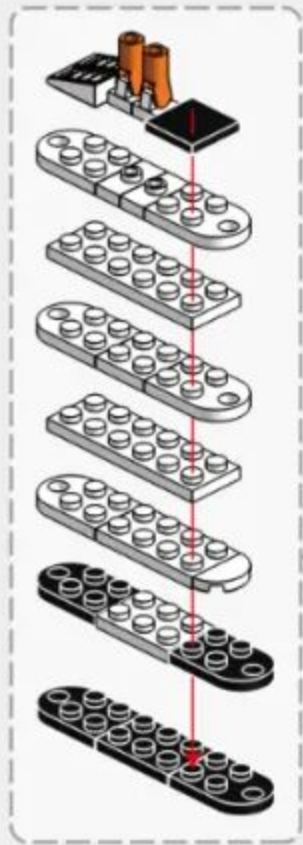



245PCS

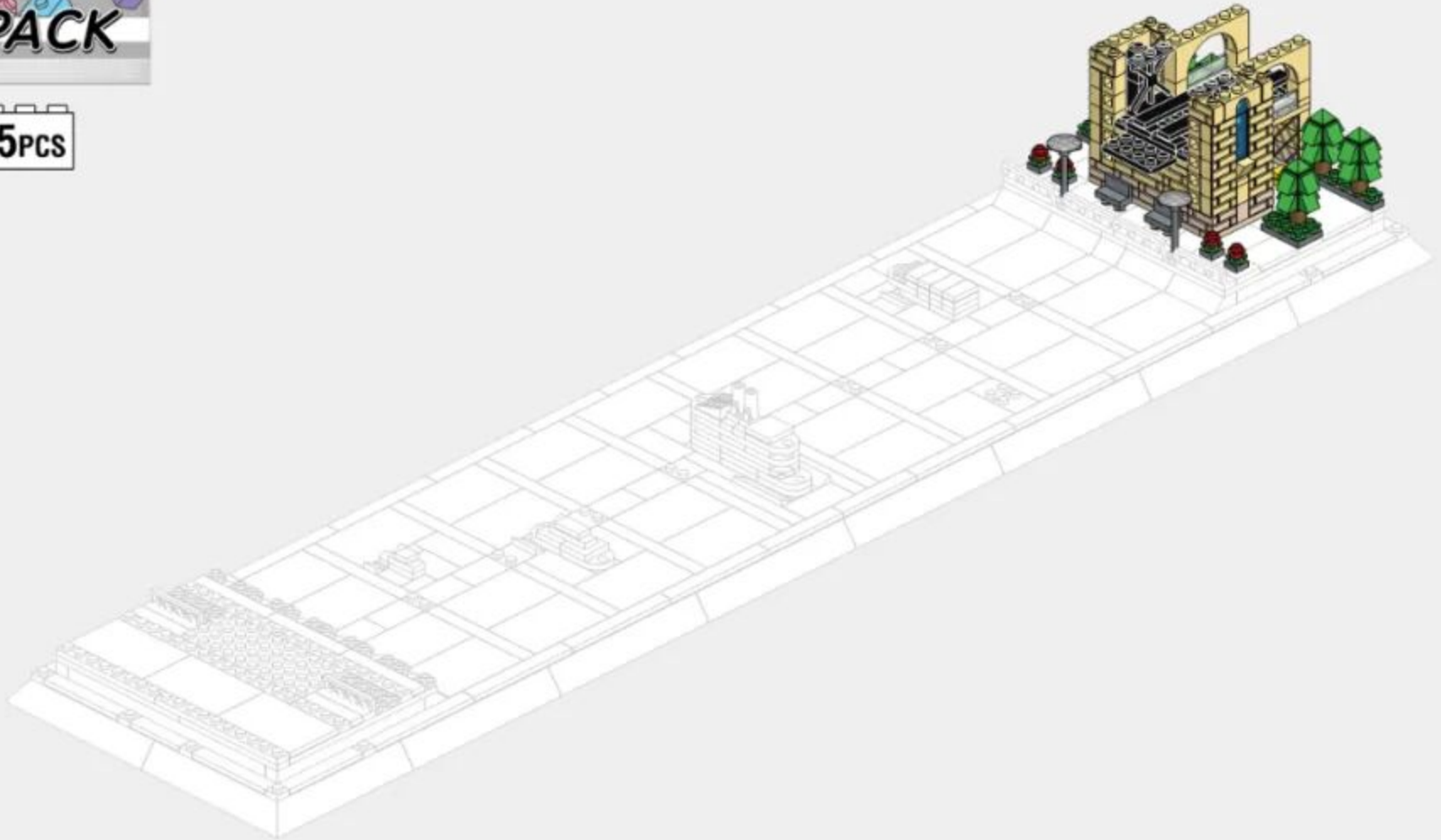

3-13

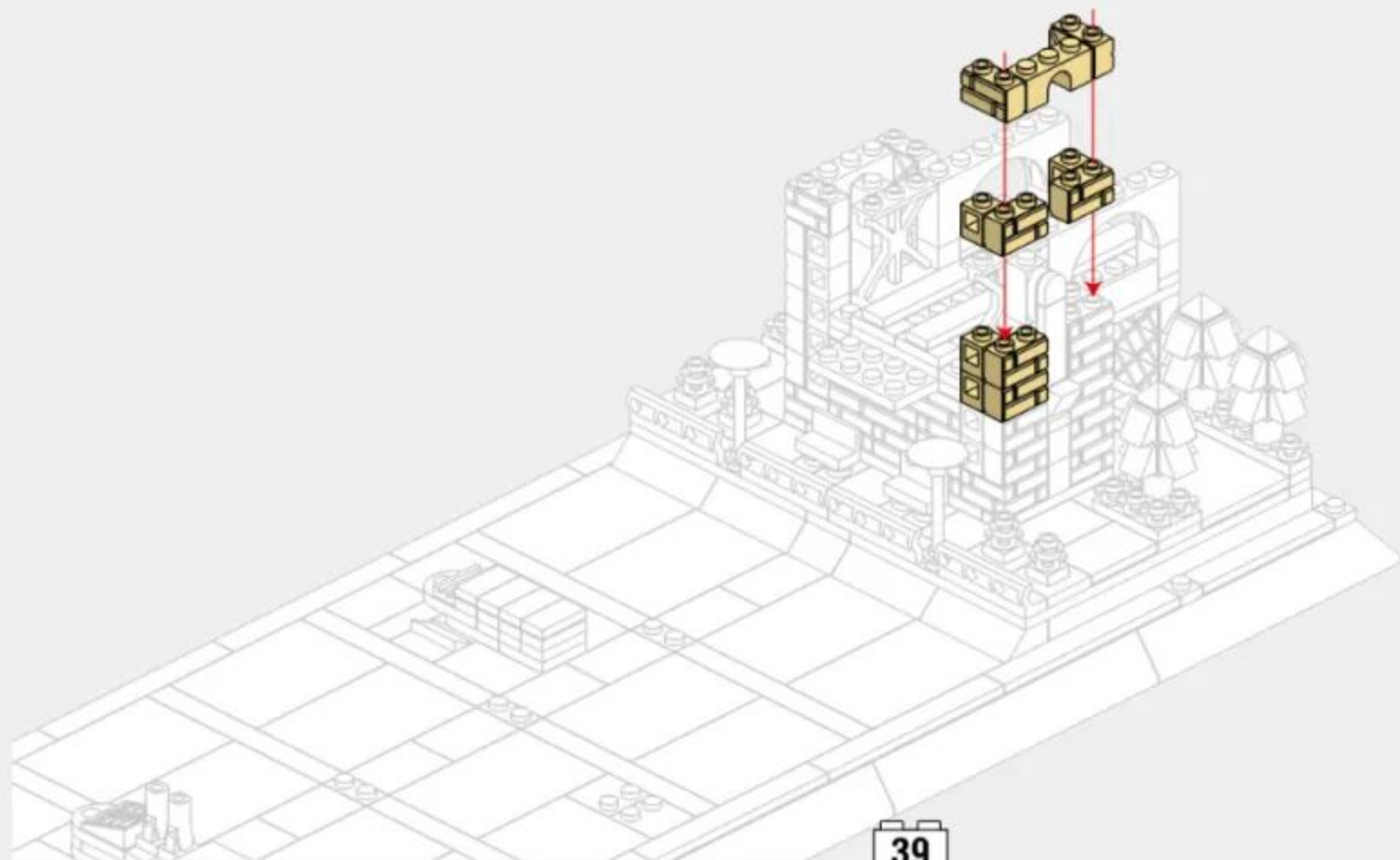

3-1

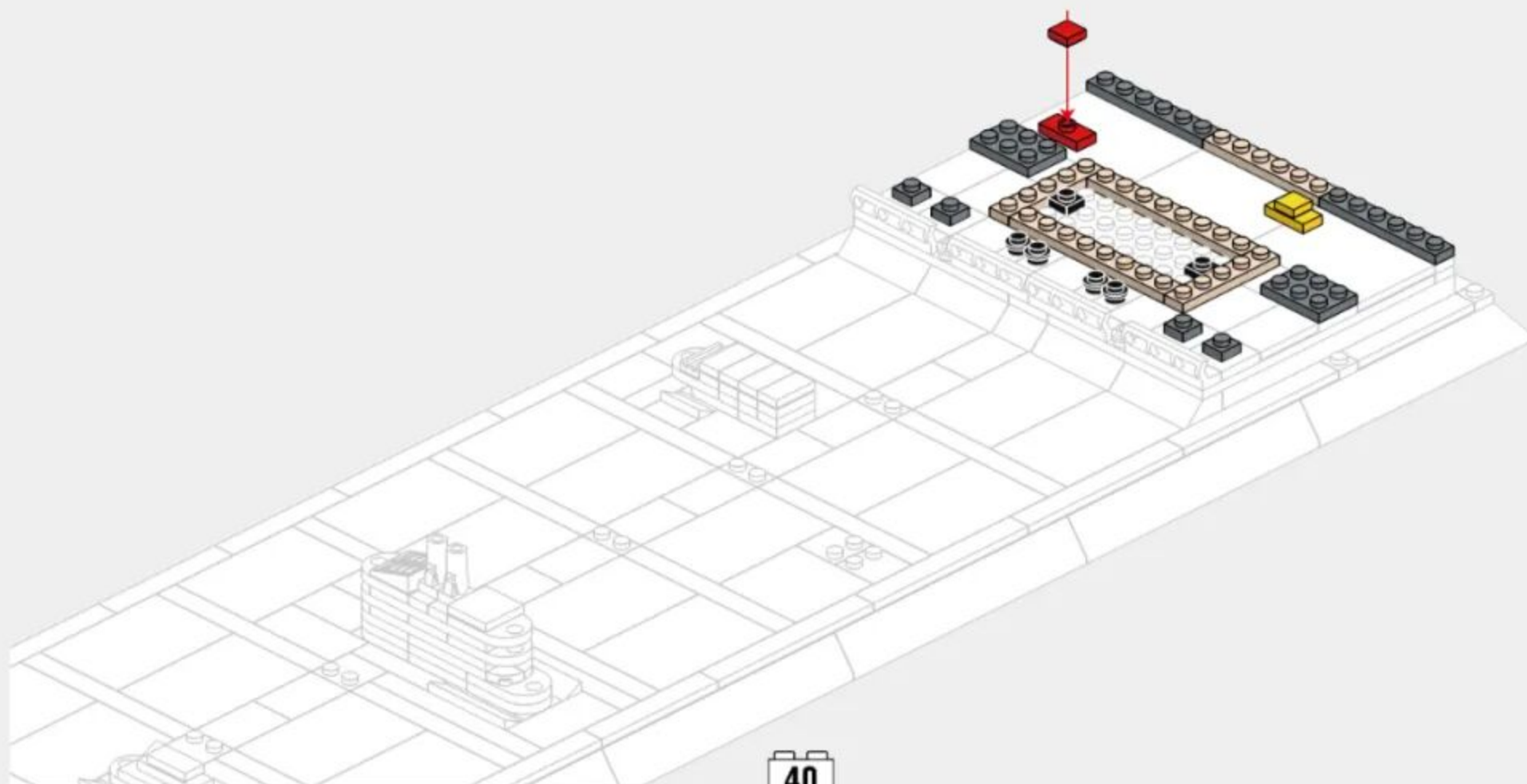

3-2



x3



x4



x3



x2



x22



x4

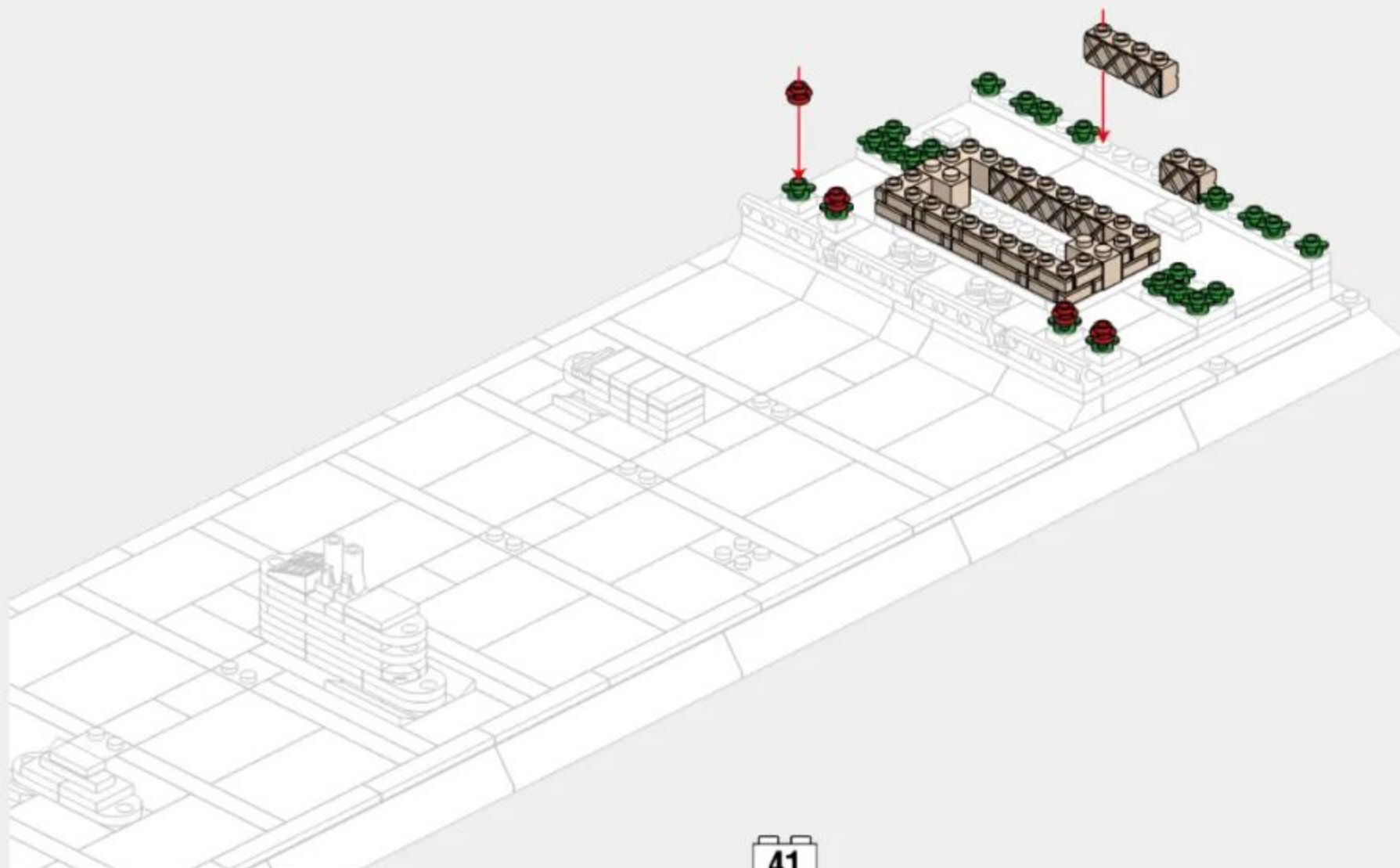

3-3

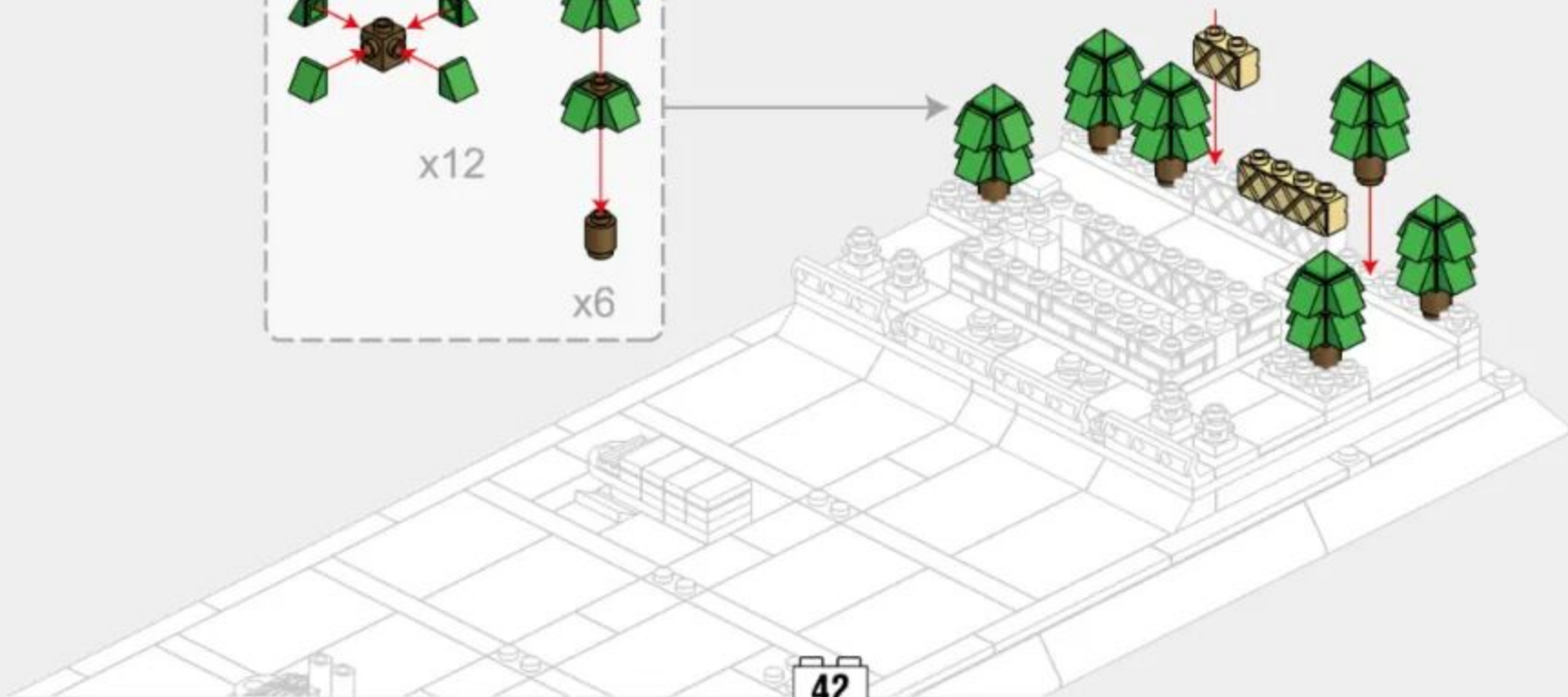
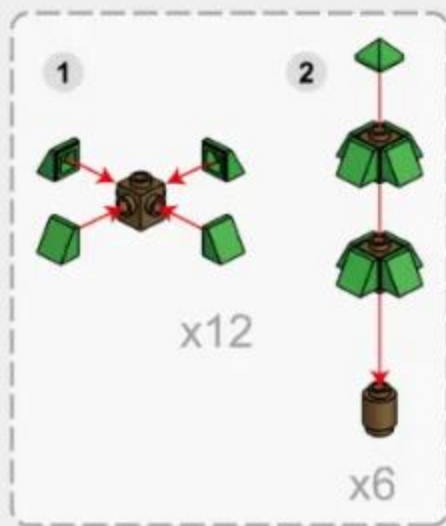
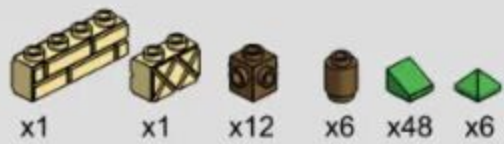

3-4



x2



x6



x2



x4

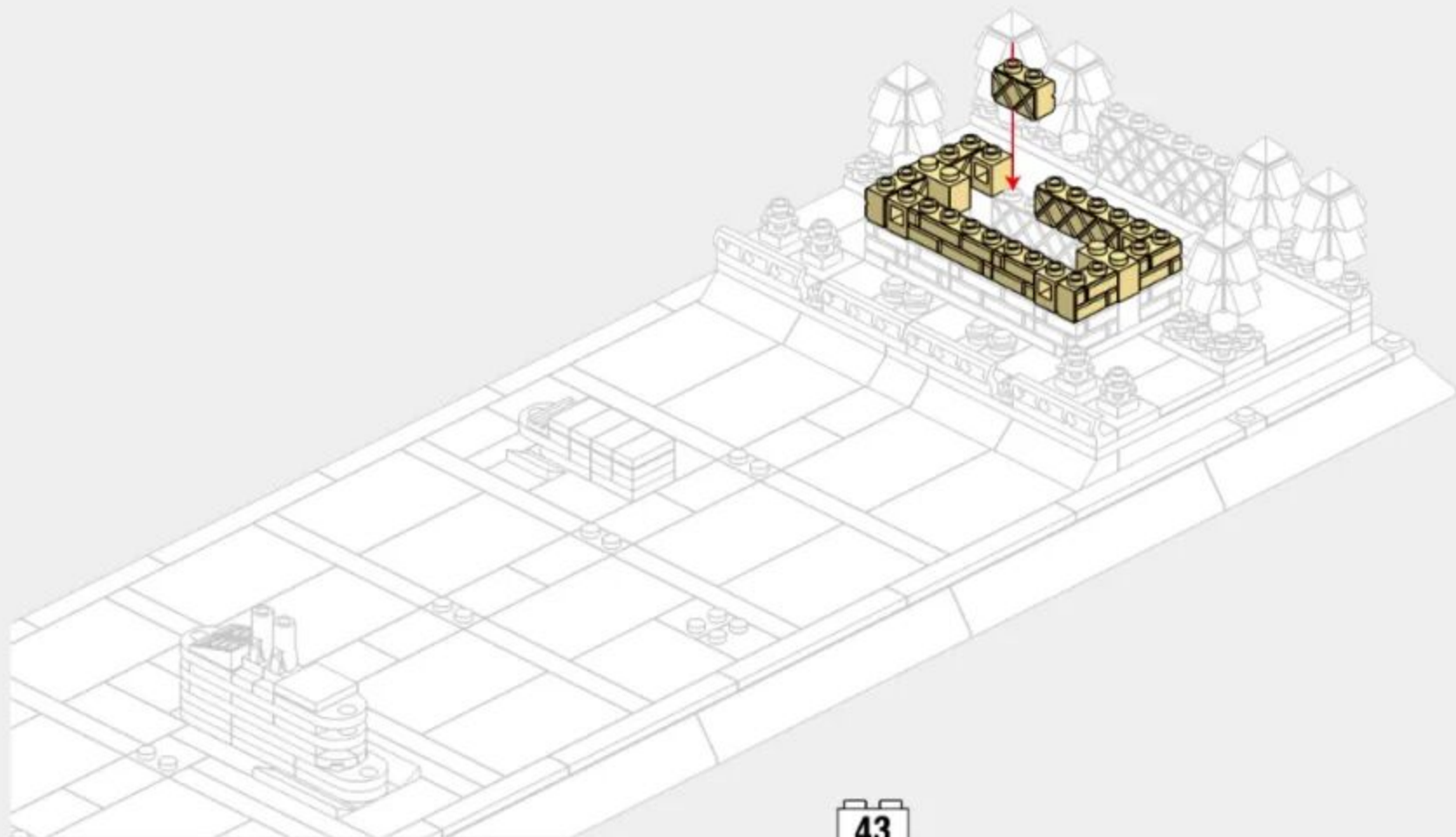

3-5



x2



x4



x2



x2

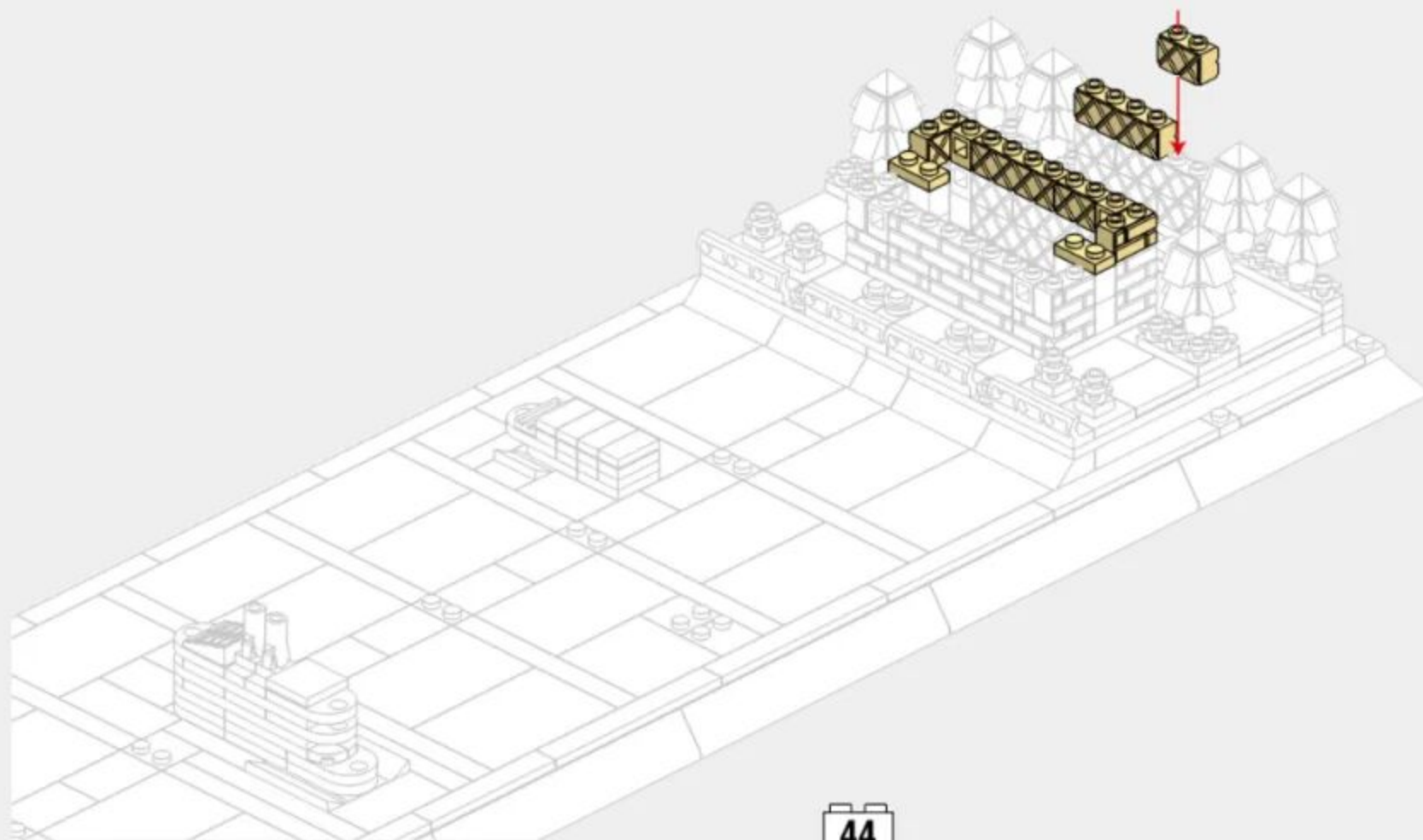

3-6



x2



x2



x2



x2

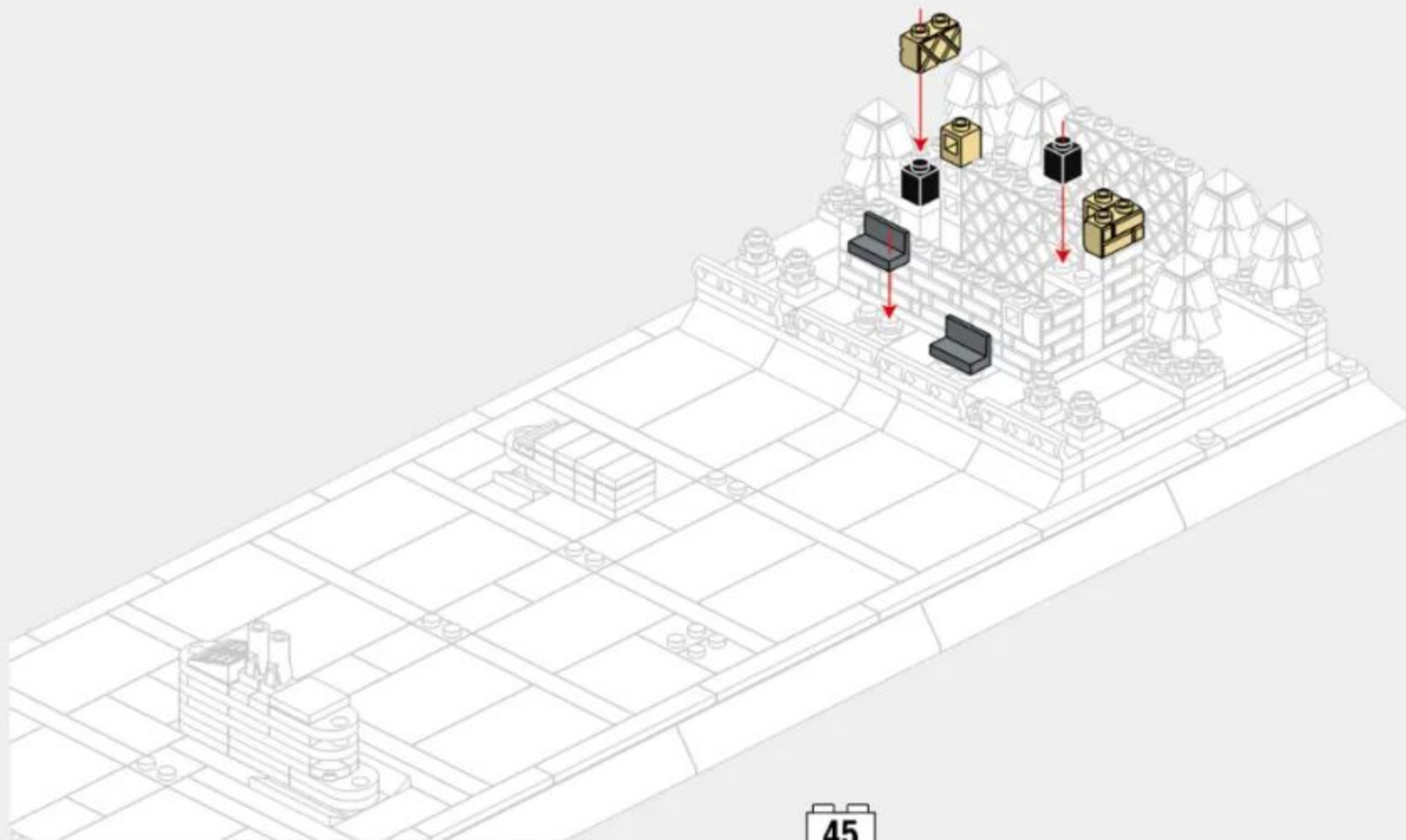

3-7

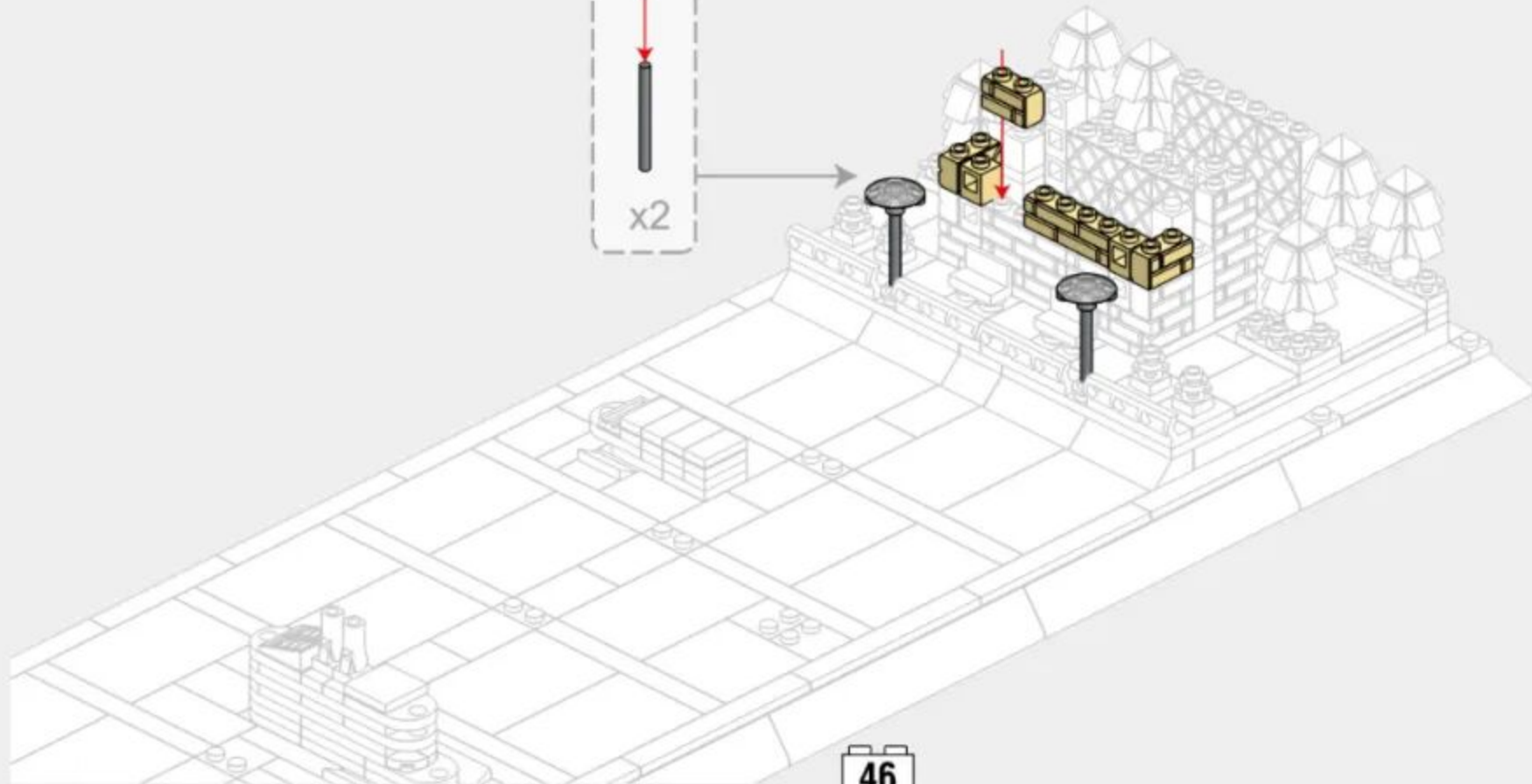

3-8

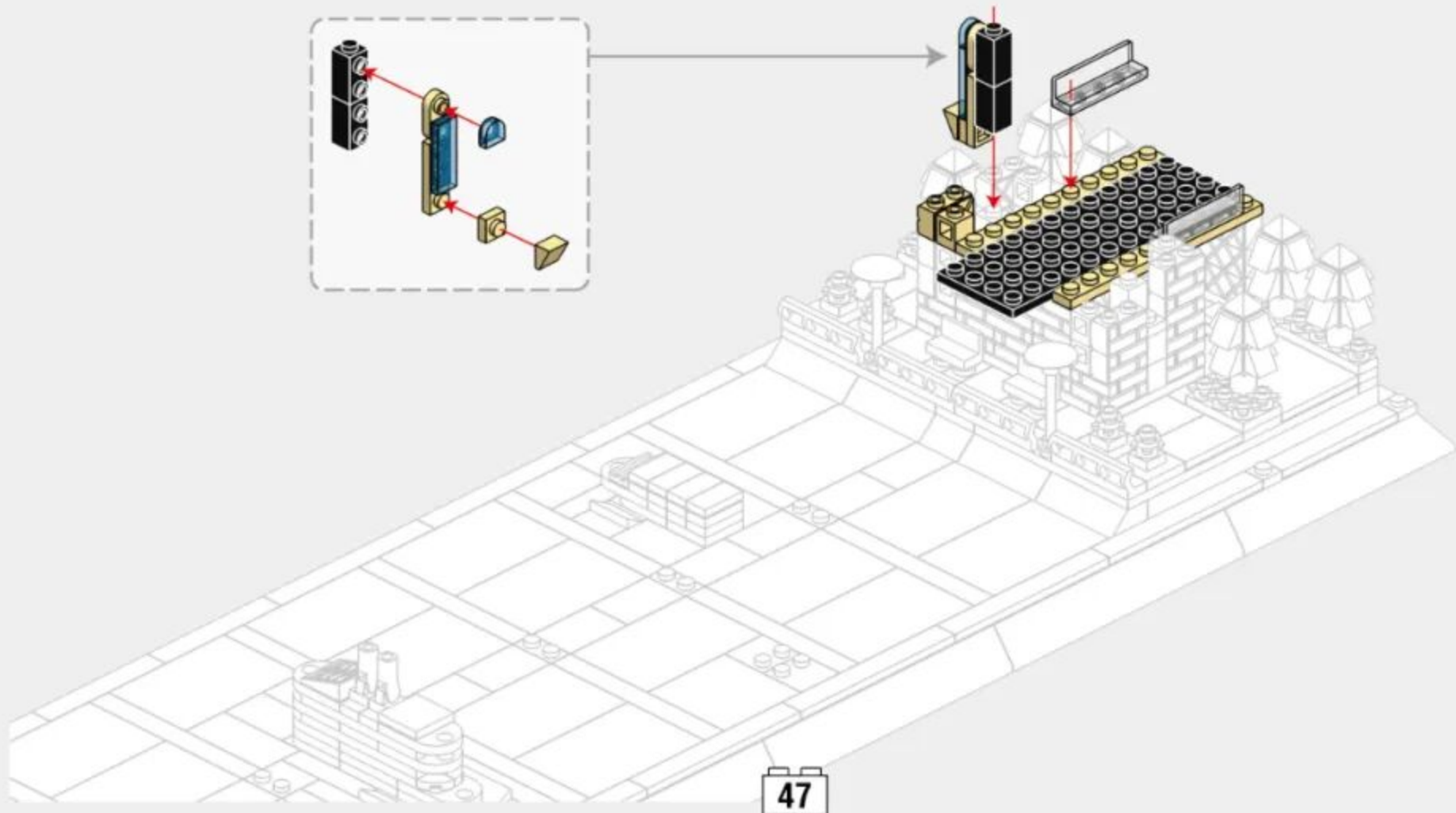
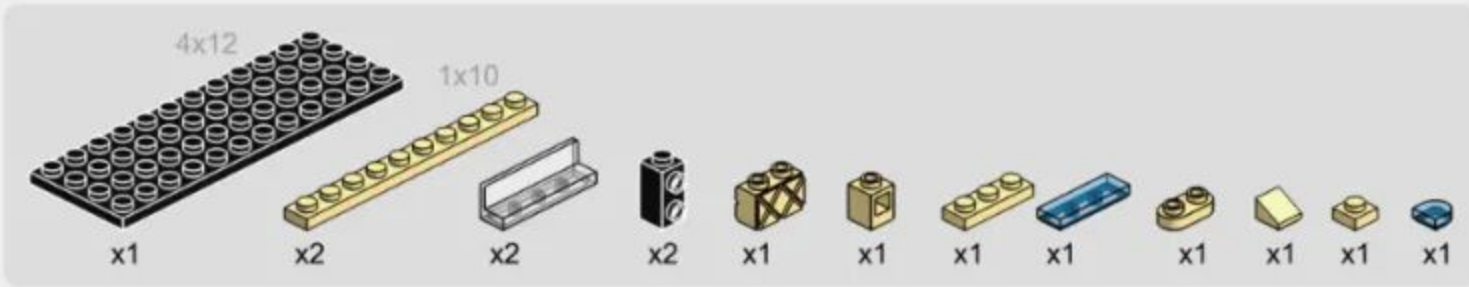

3-9

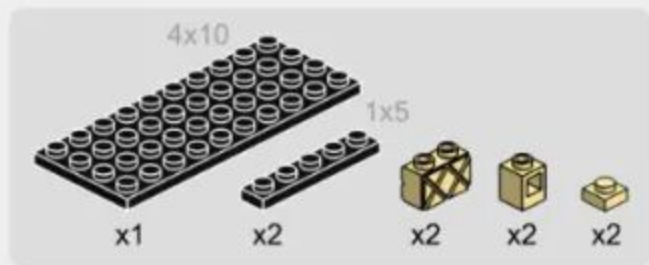

3-10

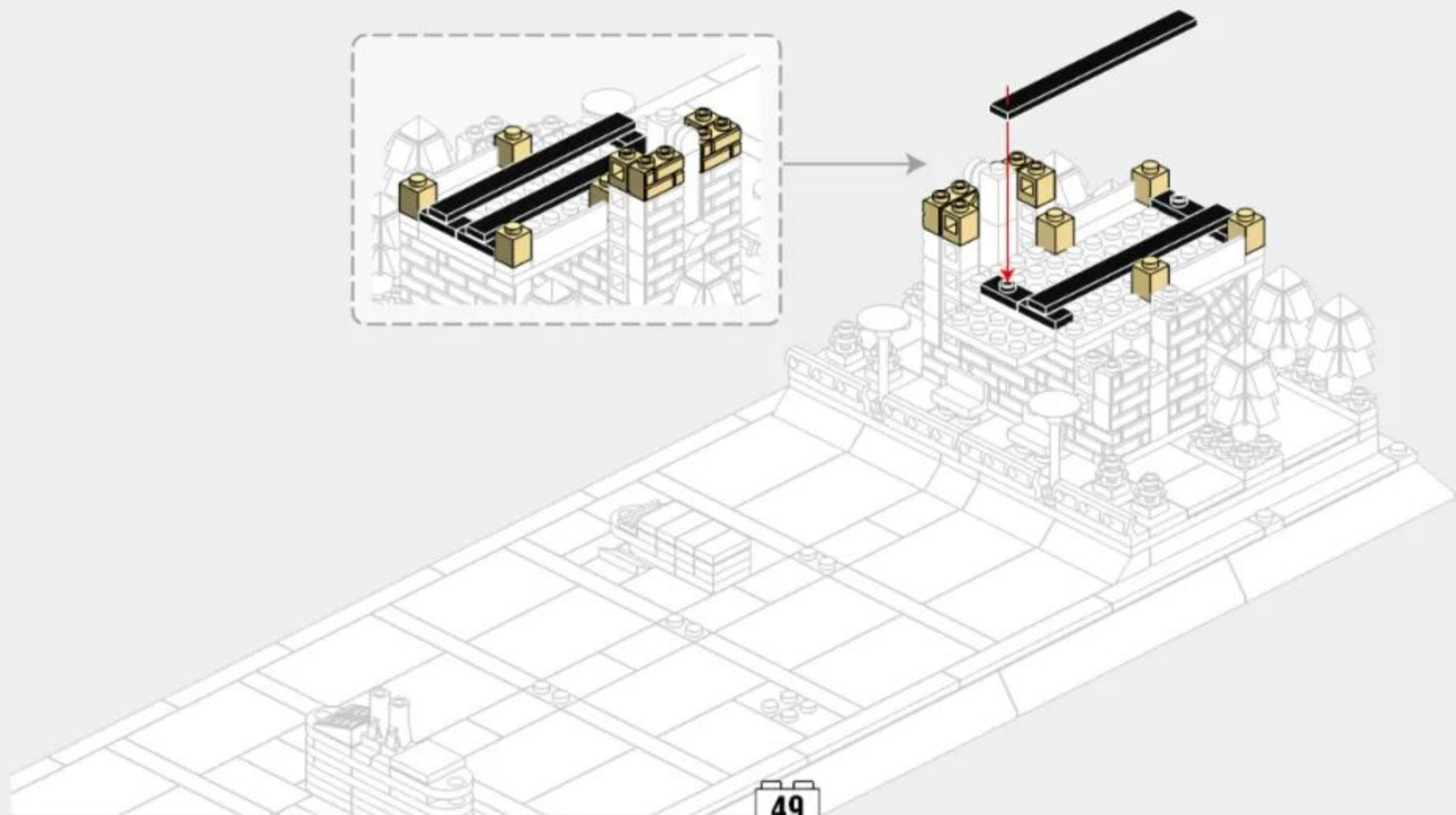

3-11

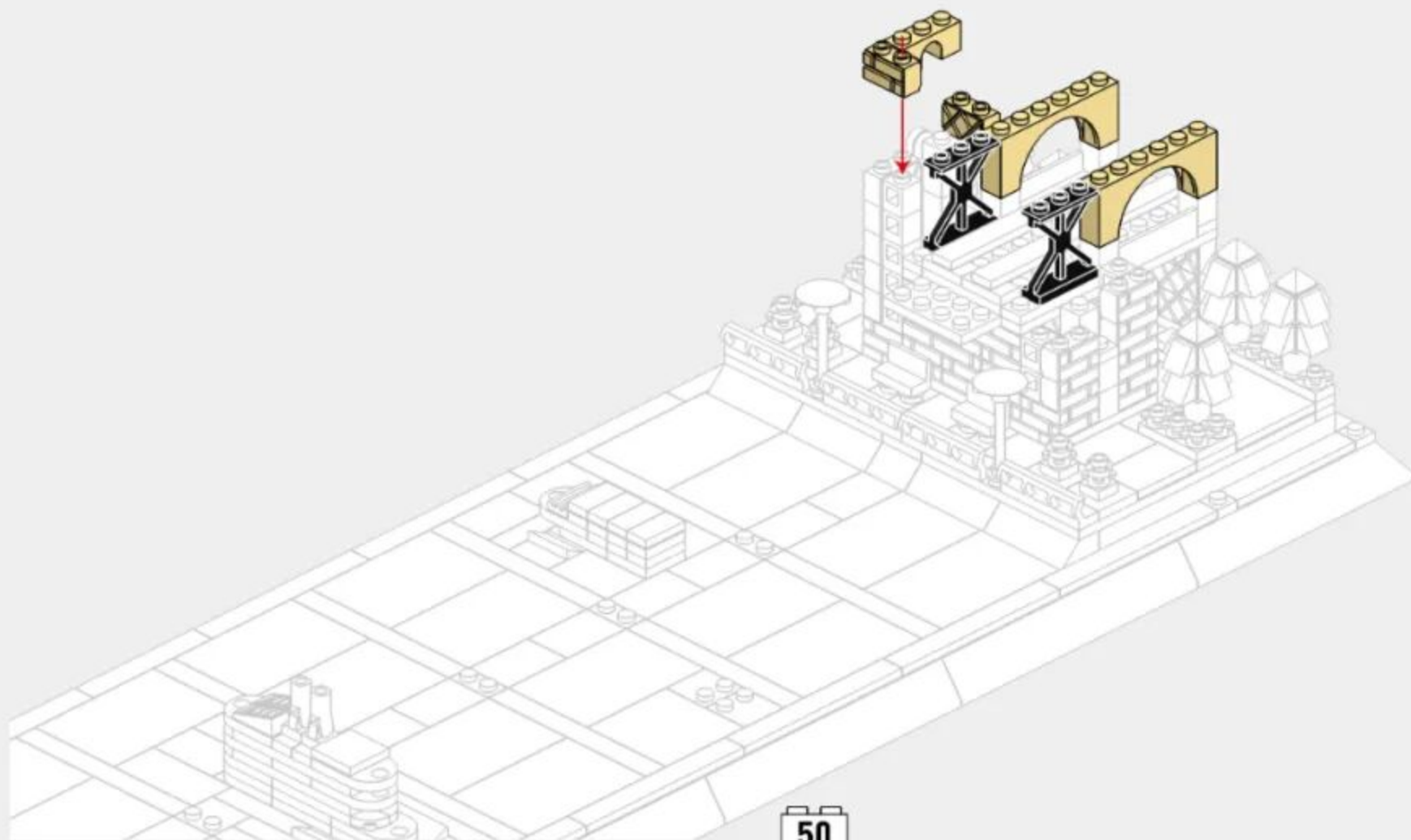

3-12

-  x2
-  x1
-  x1
-  x1
-  x1
-  x1
-  x1
-  x1
-  x1

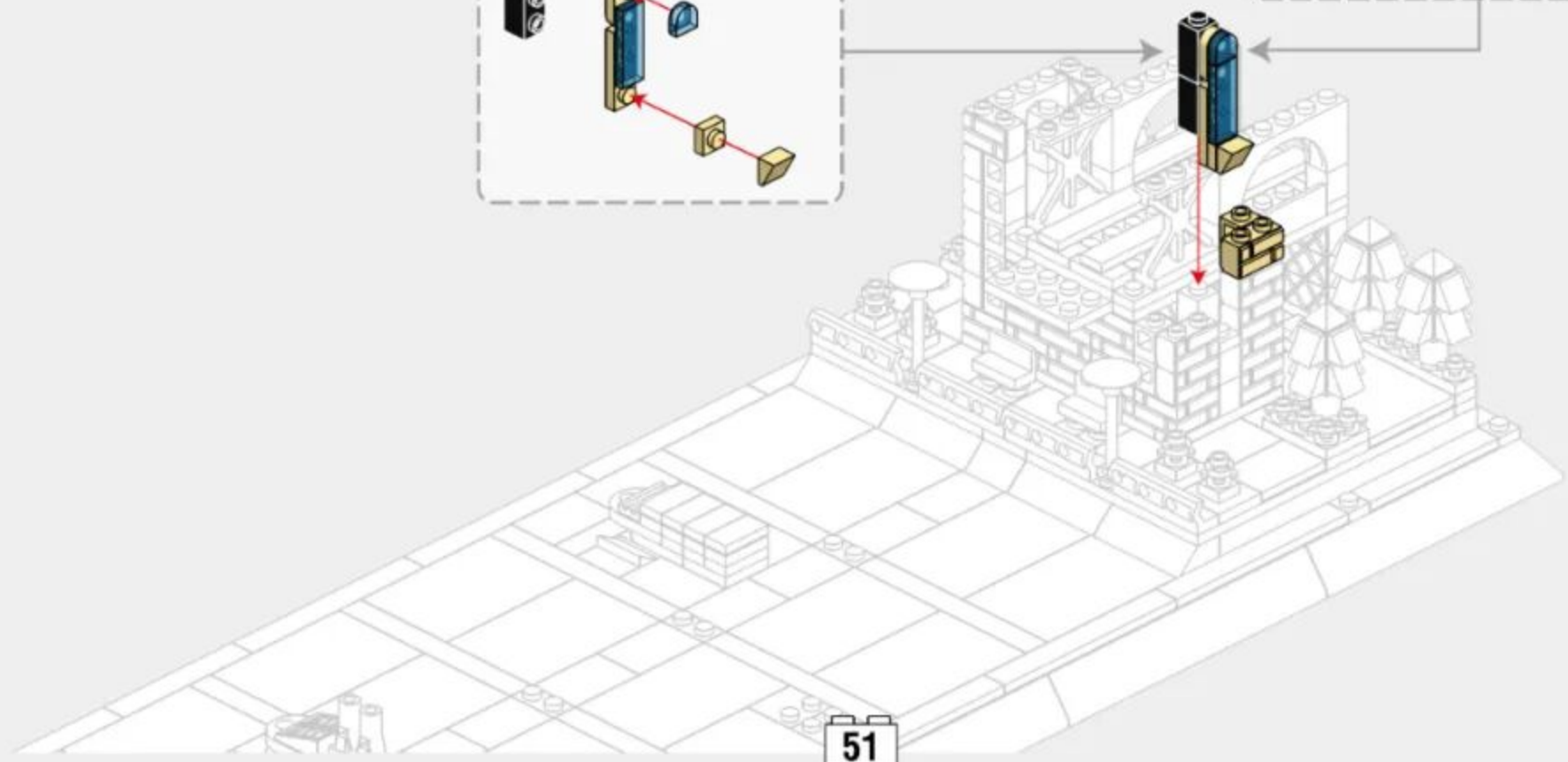
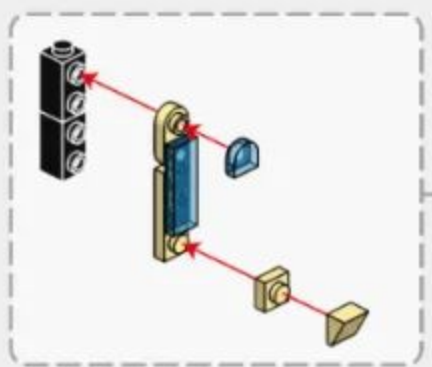



311 PCS

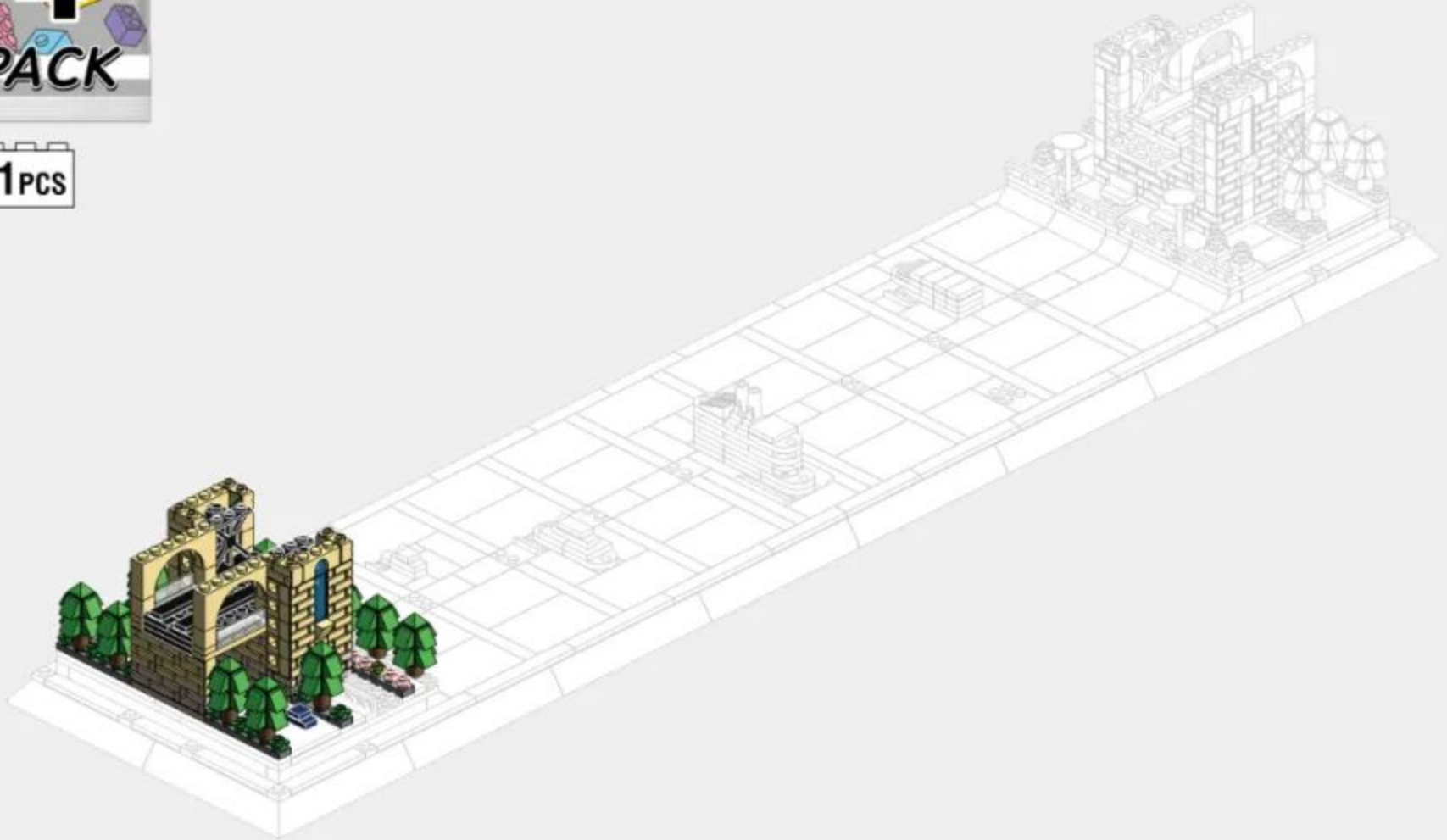

4-1

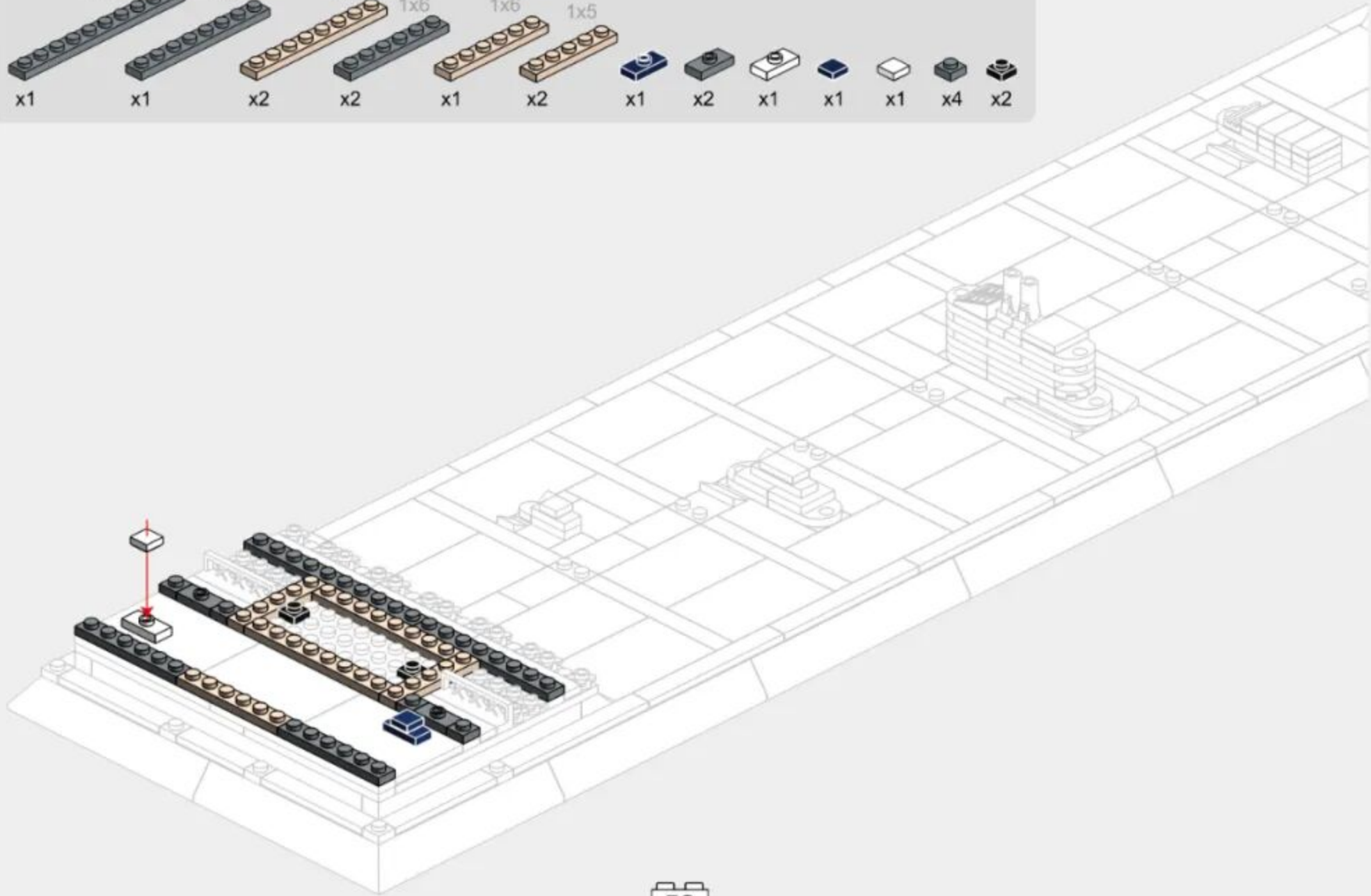
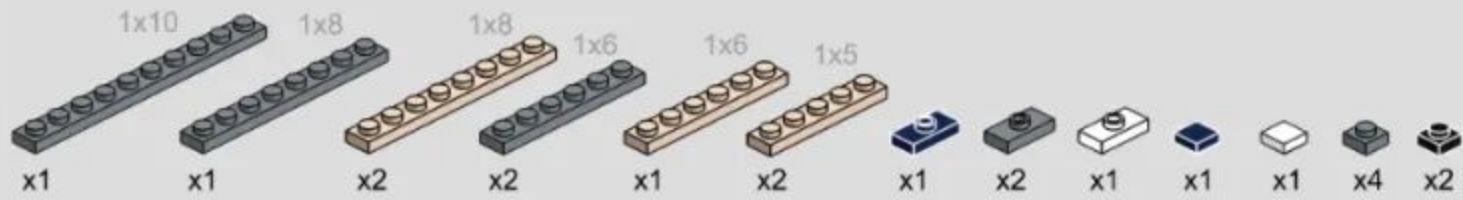

4-2

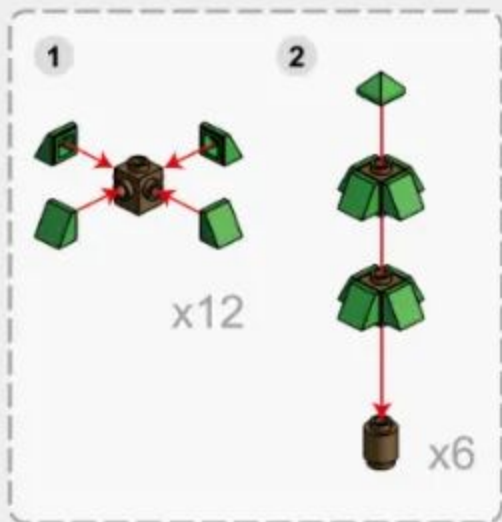

4-3

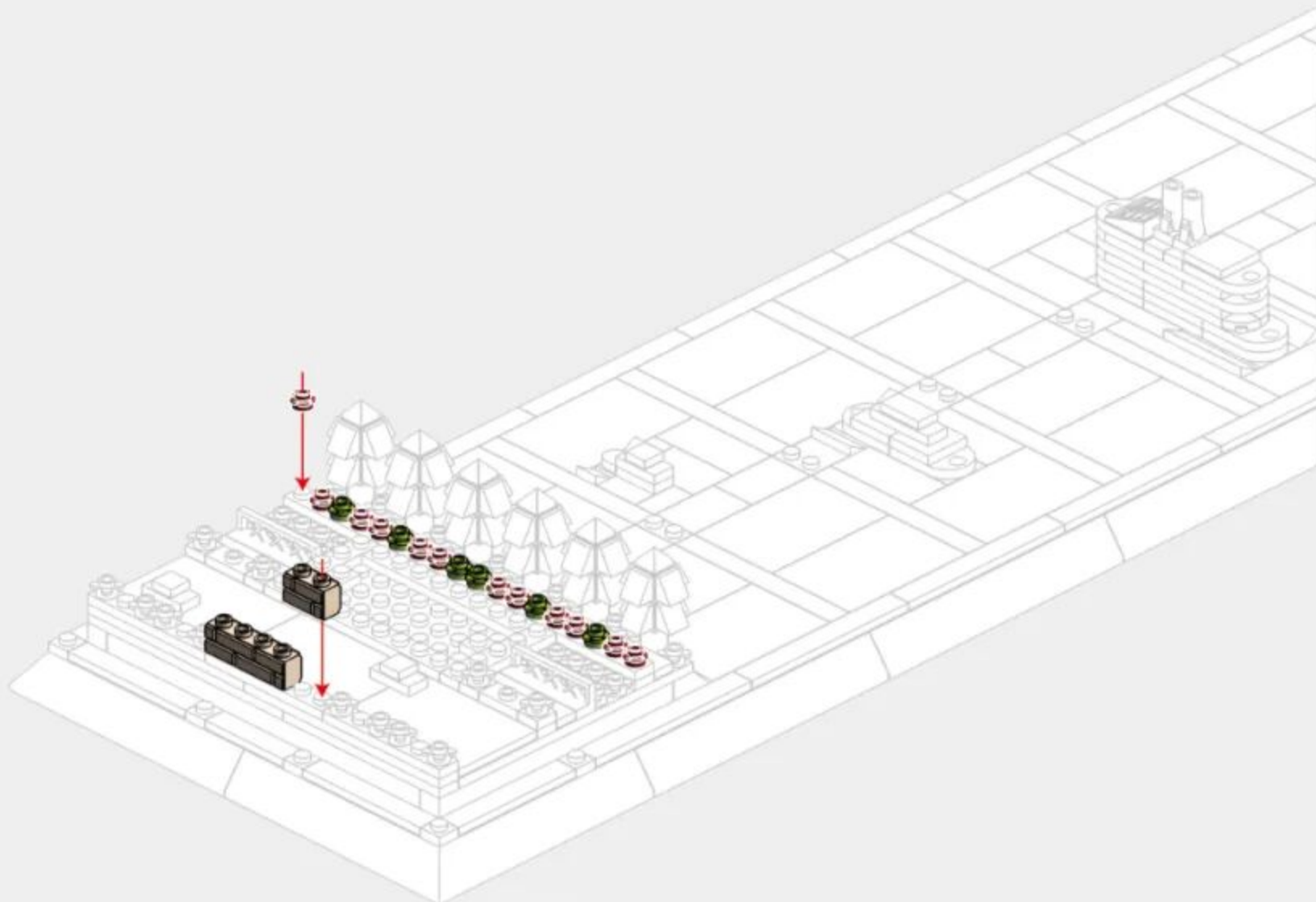

4-4



x1



x2



x4



x2



x2



x1

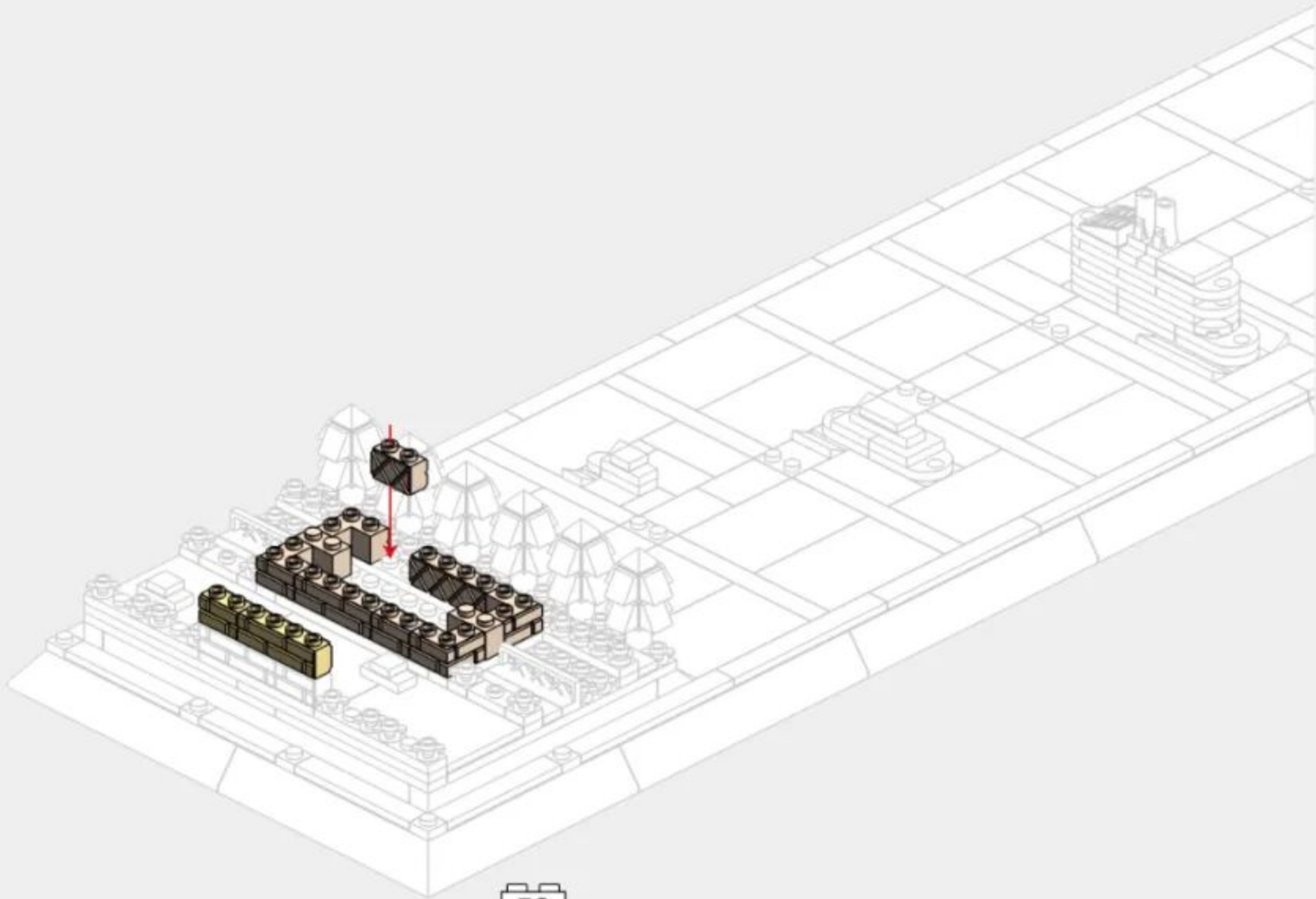

4-5



x2



x6



x2



x4

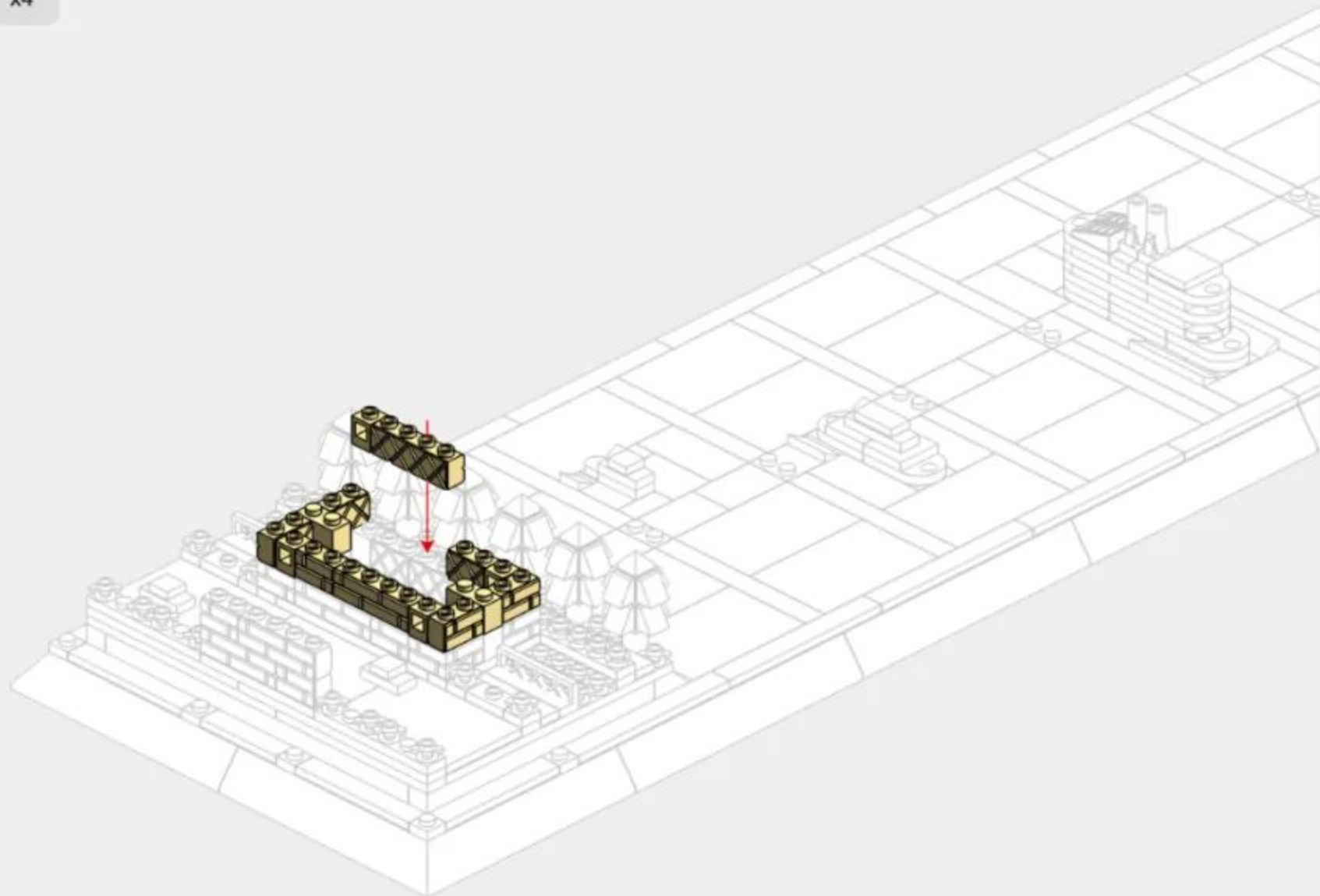

4-6

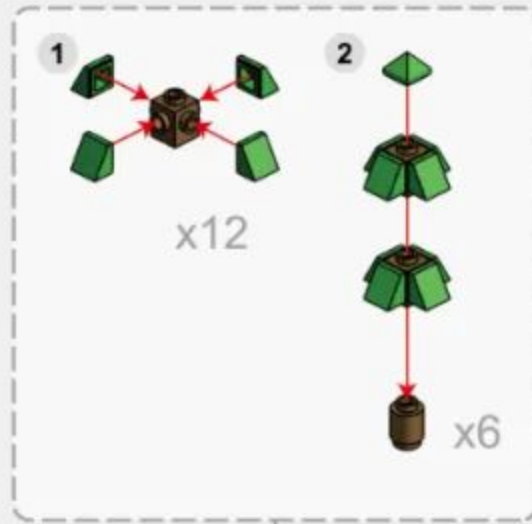

4-7

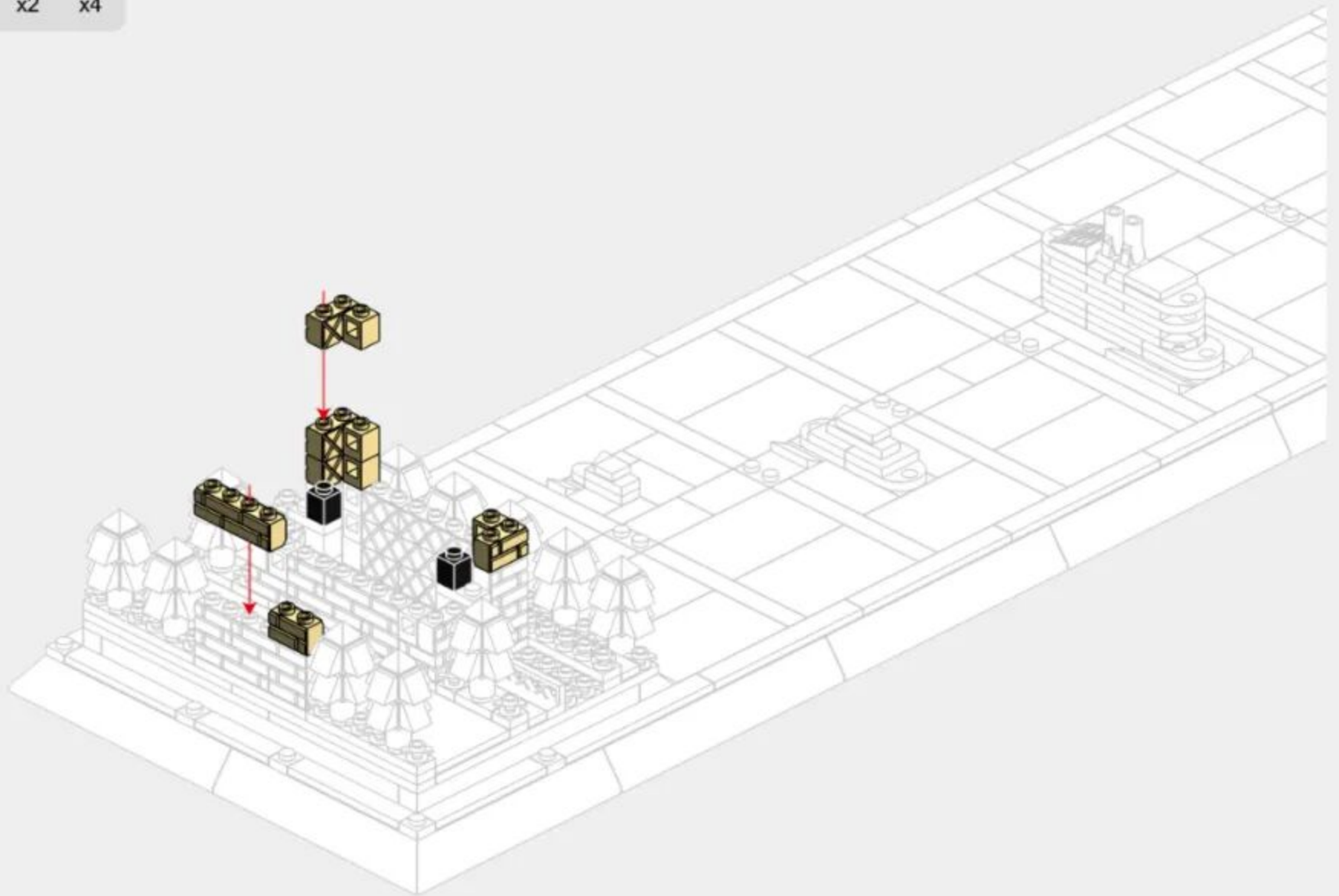

4-8

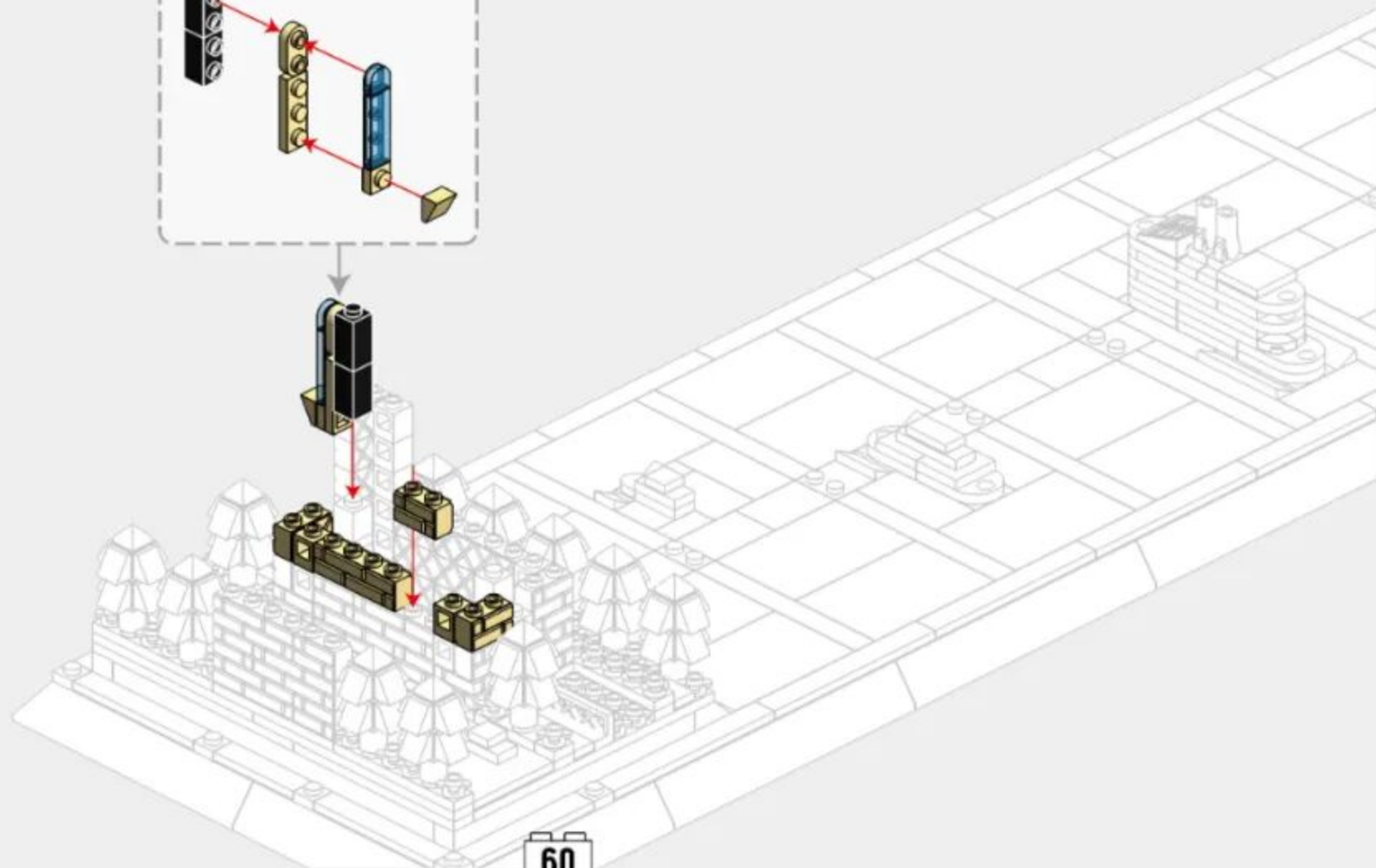
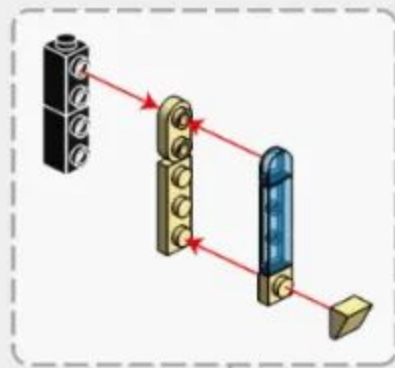

4-9

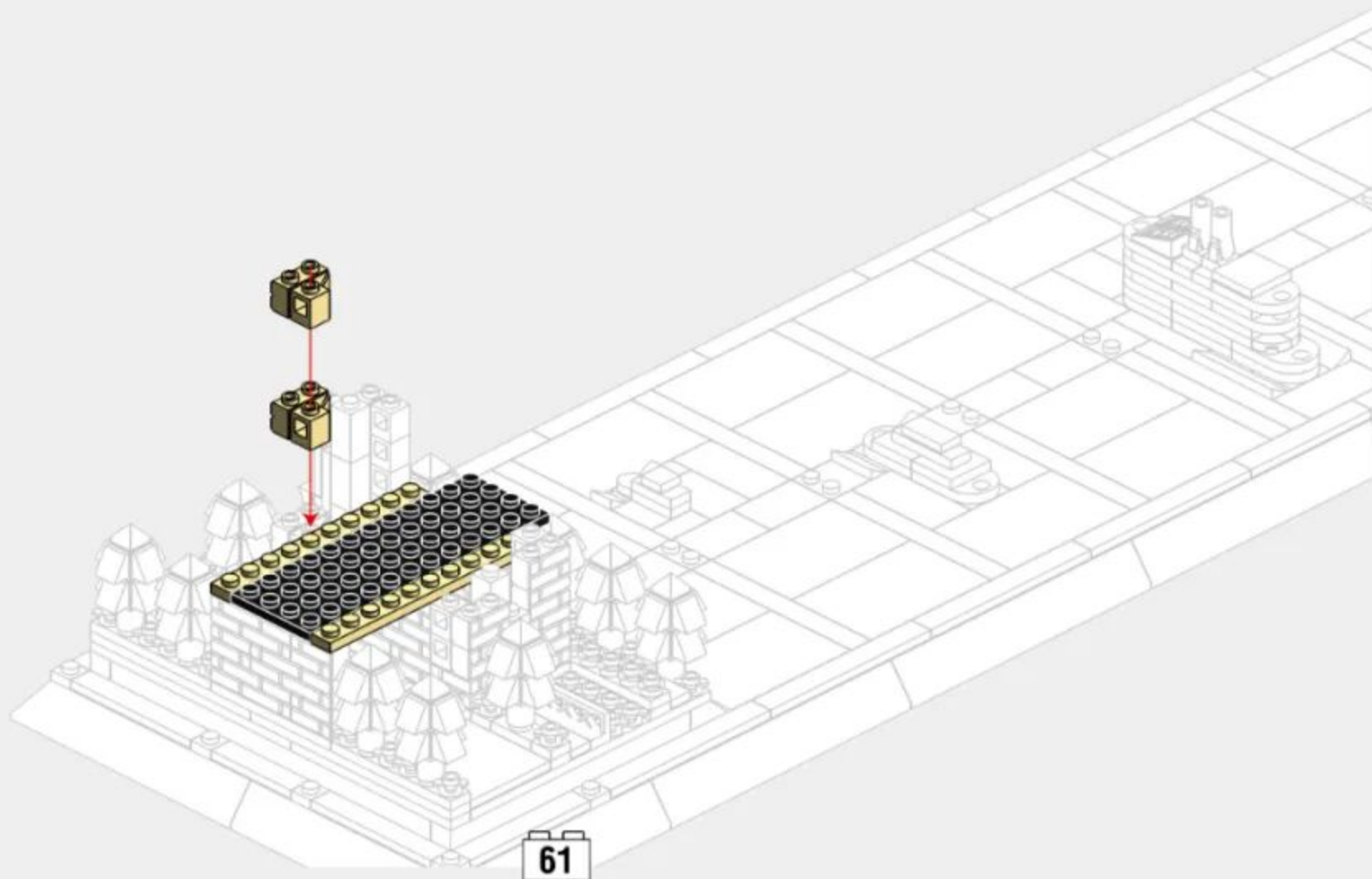
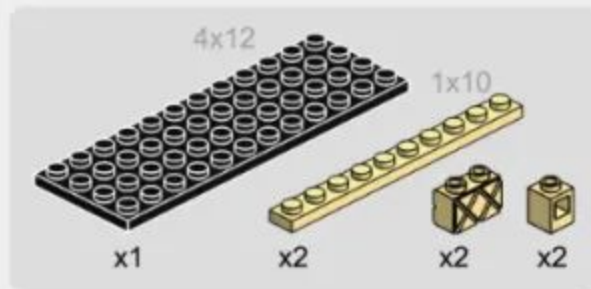

4-10

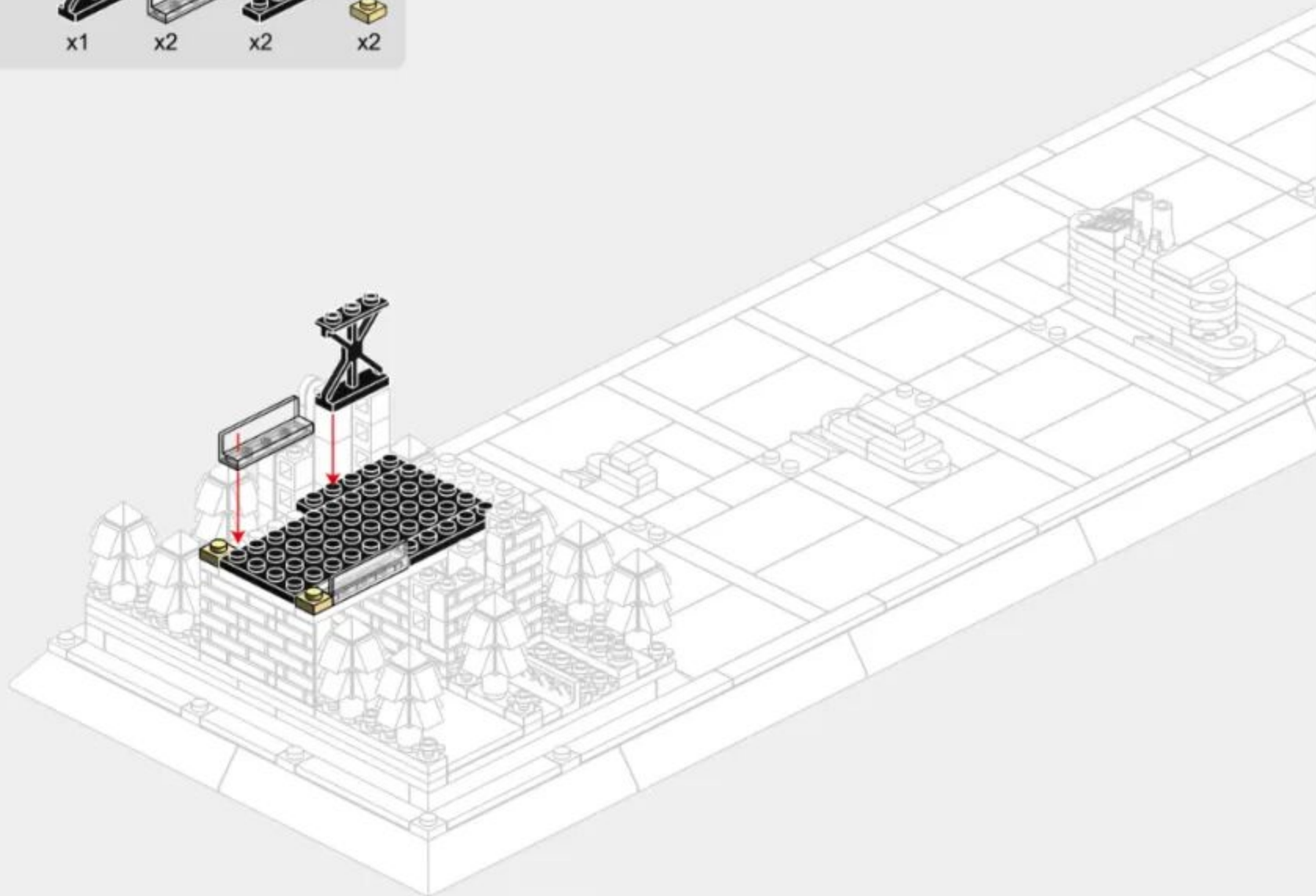
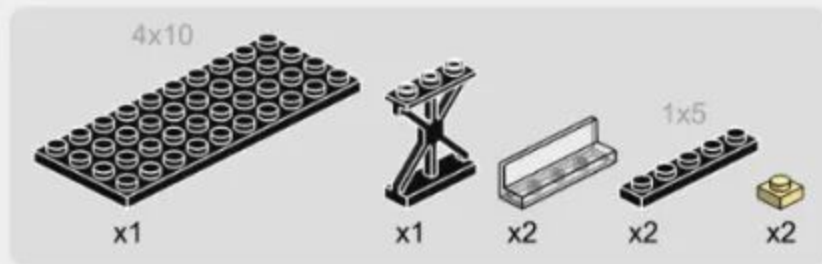

4-11

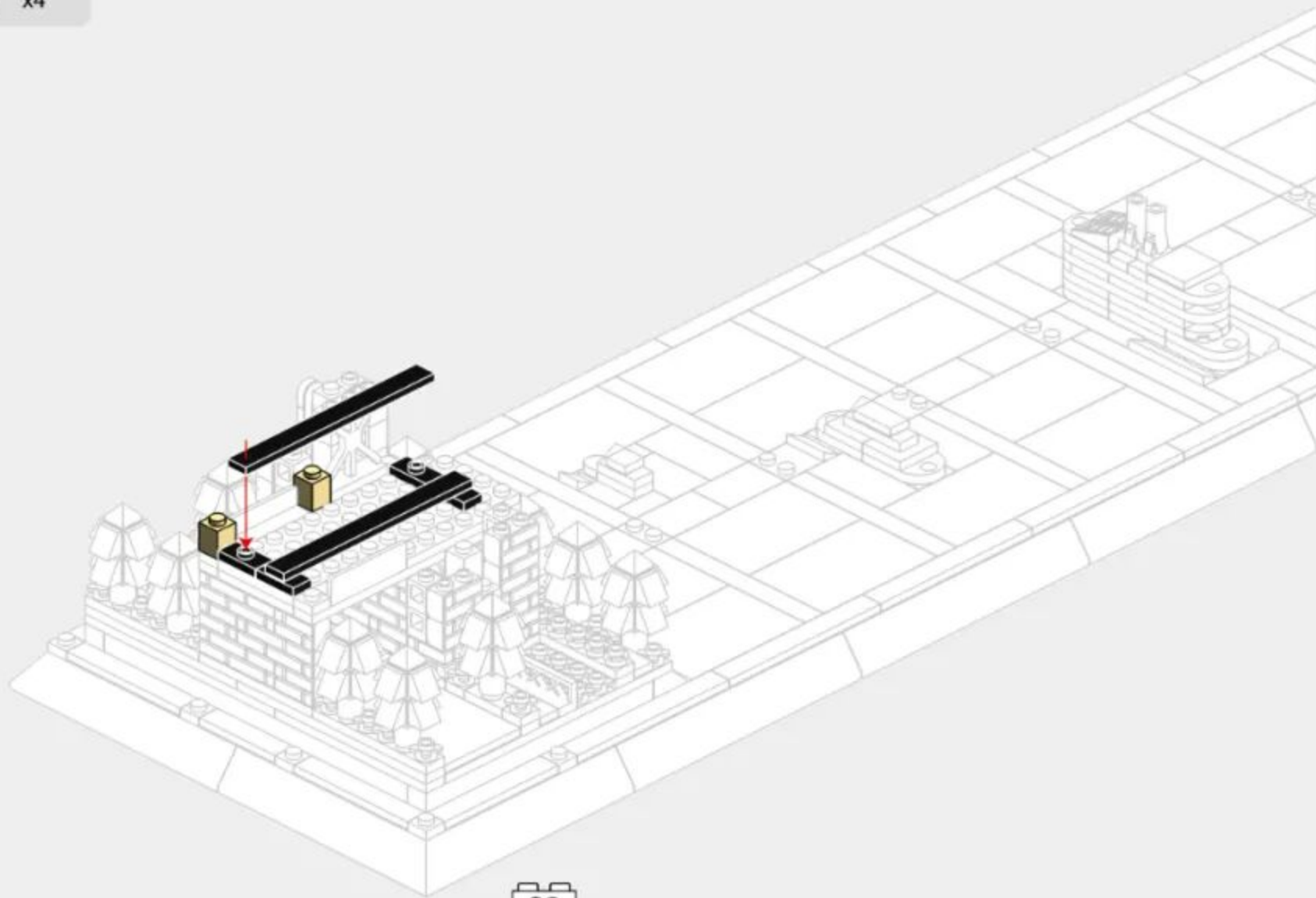

4-12

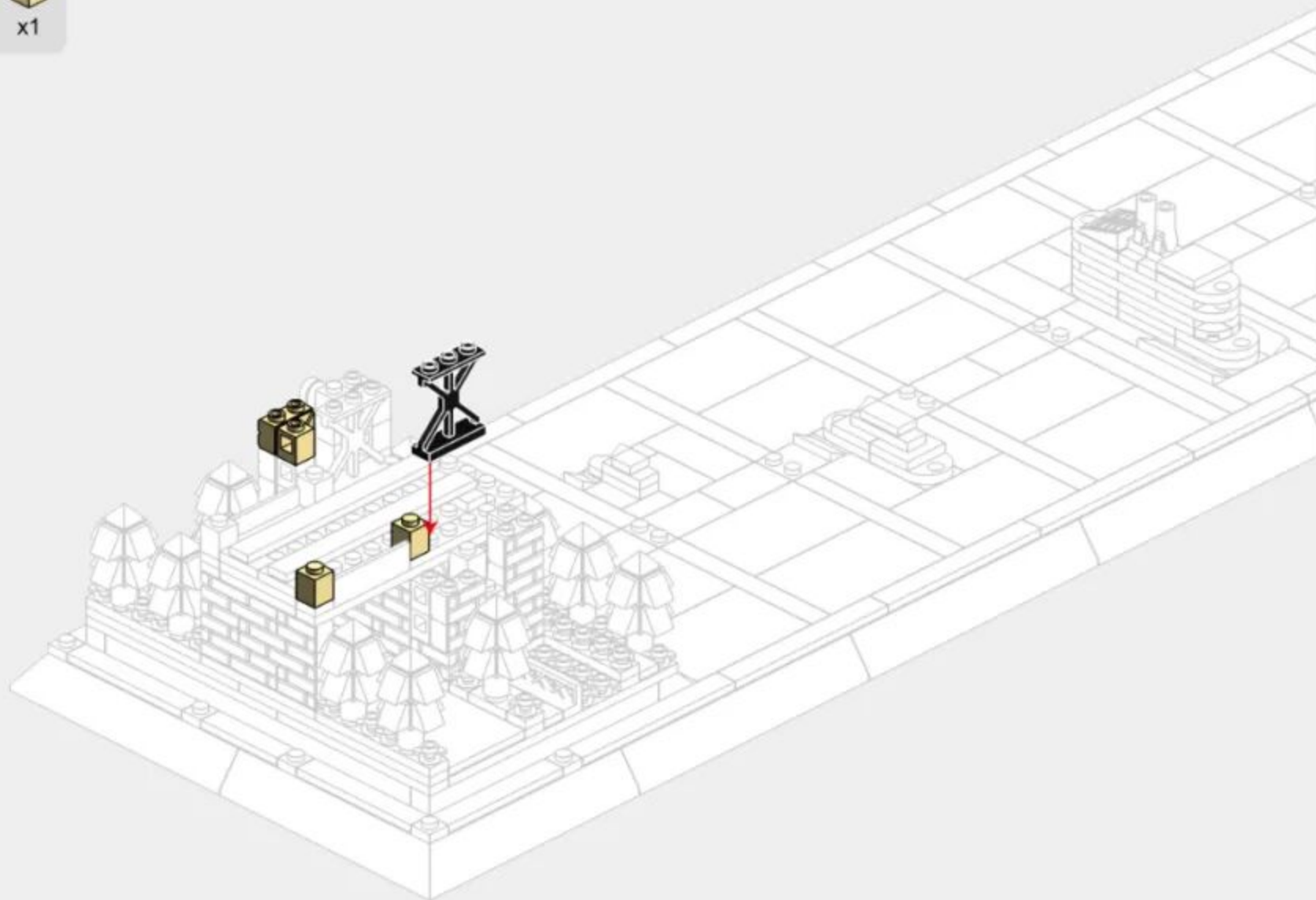

4-13

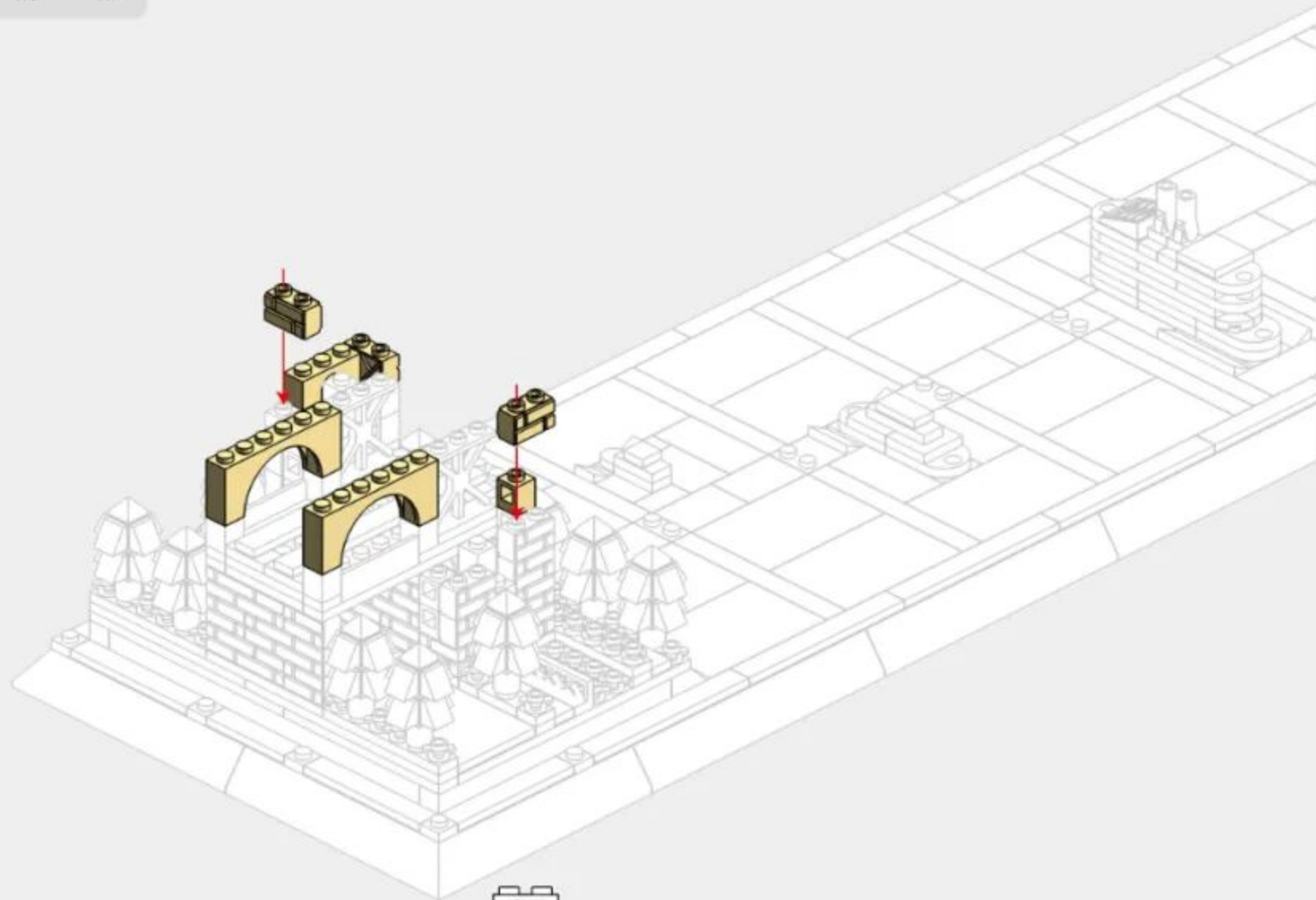
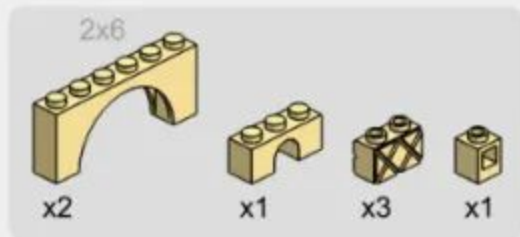

4-14

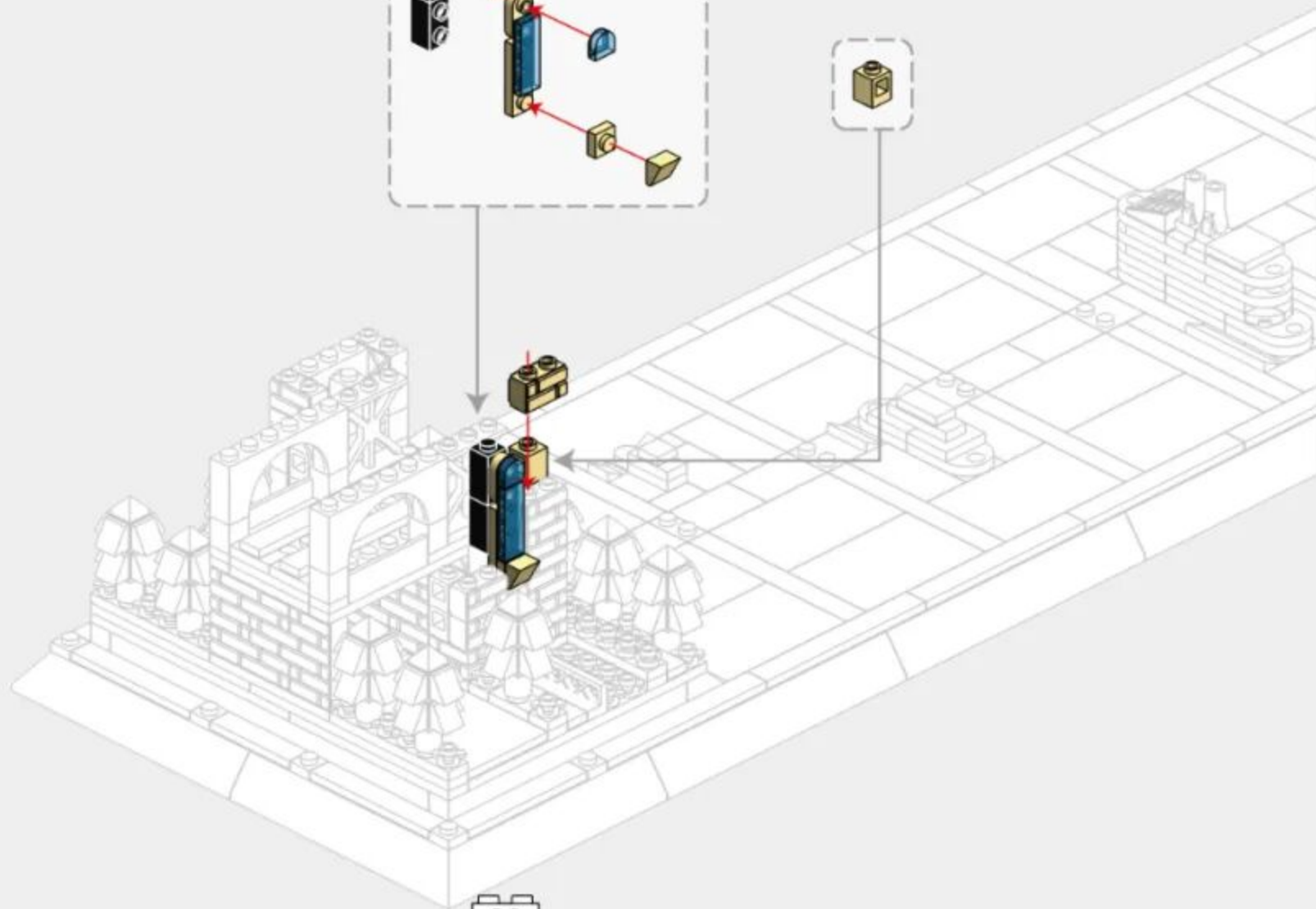
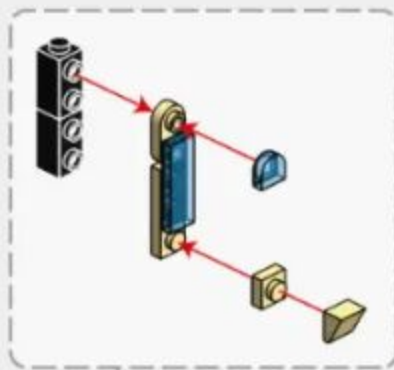
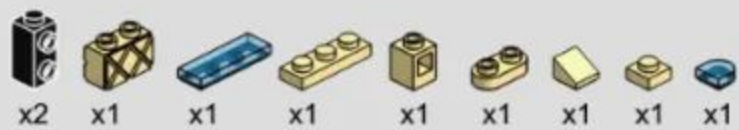

4-15



x1



x5



x3





276PCS

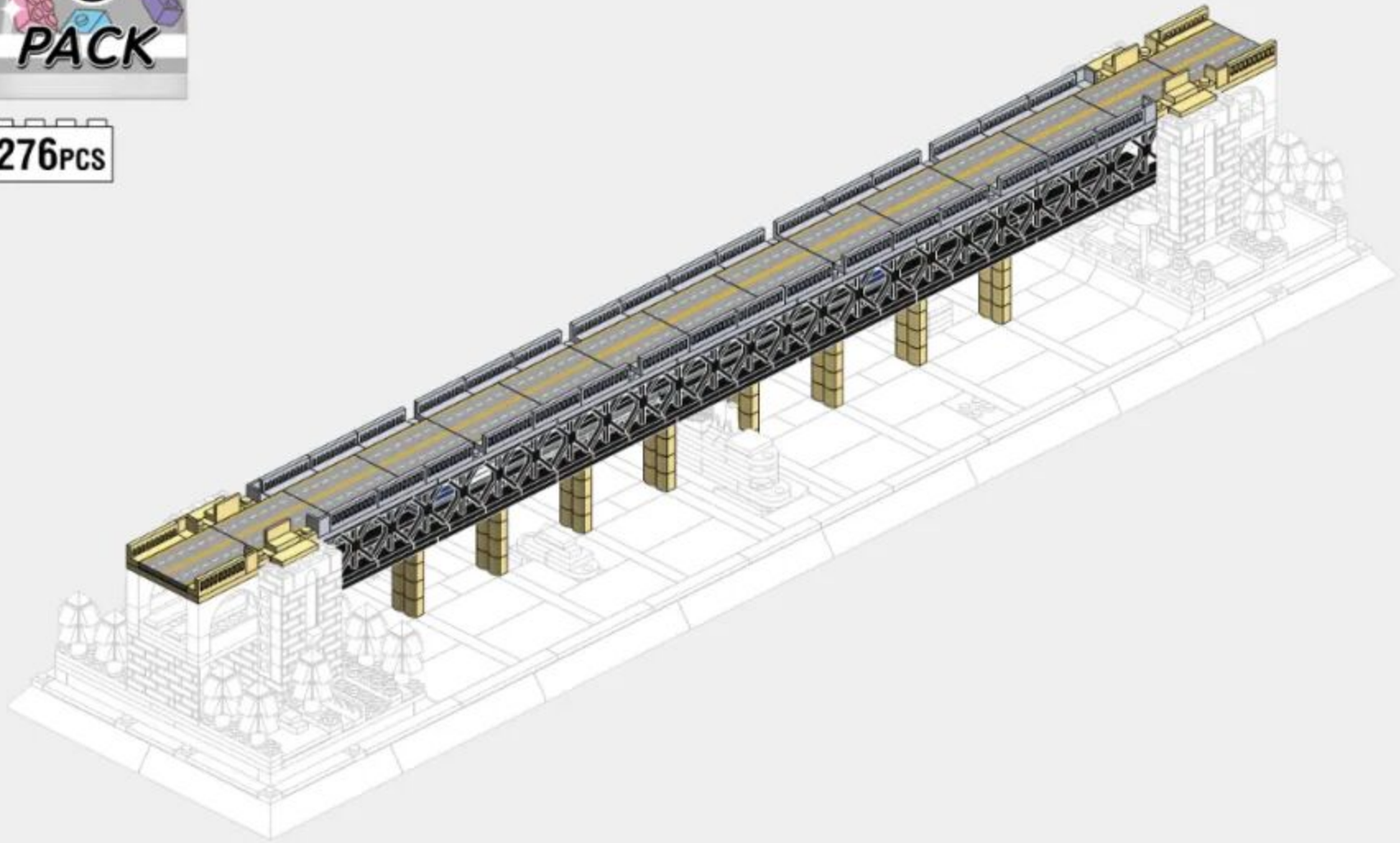

5-1



x32



x8



x16

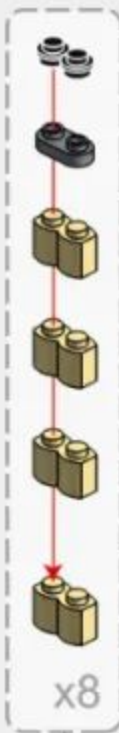

x8

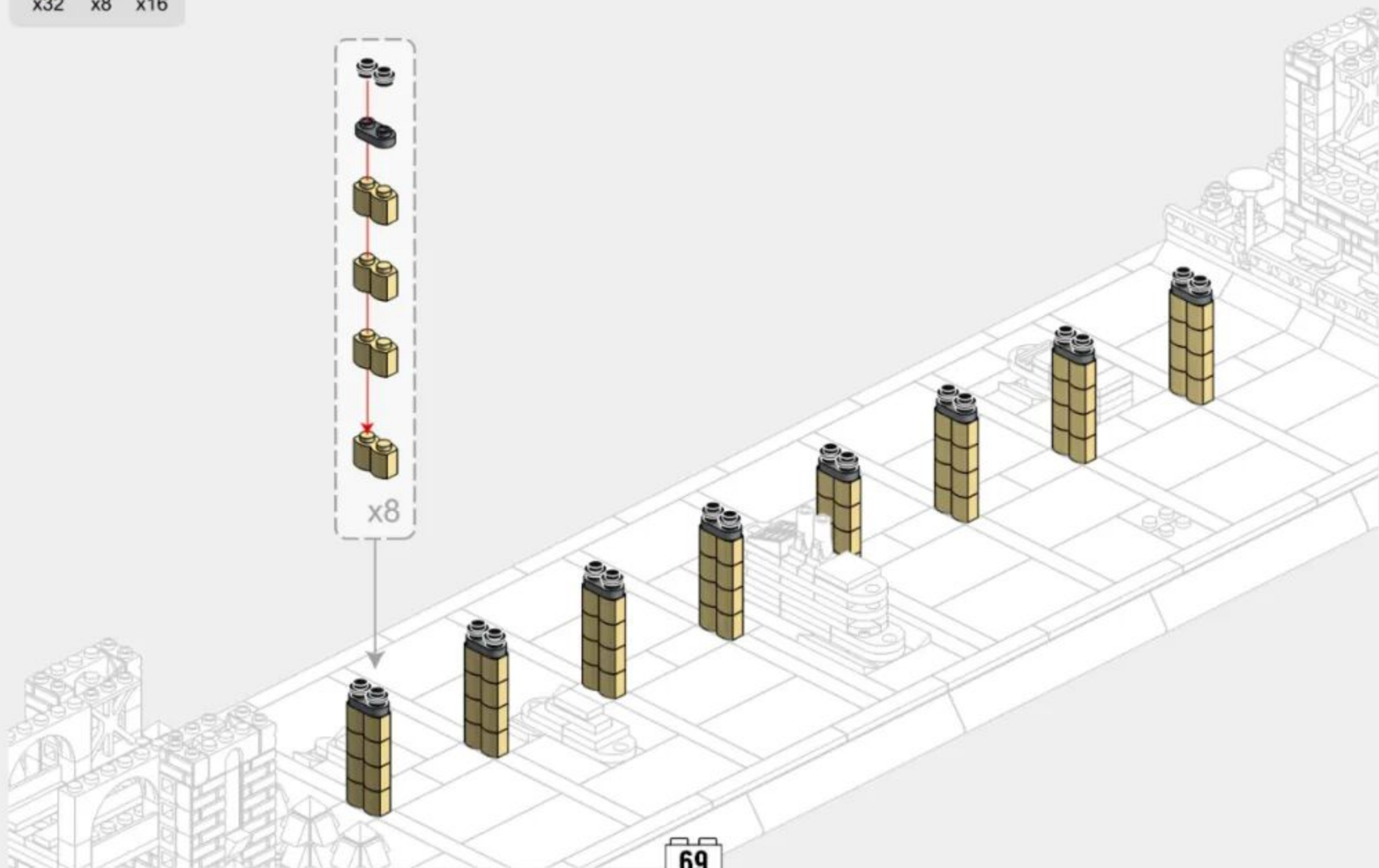

5-2

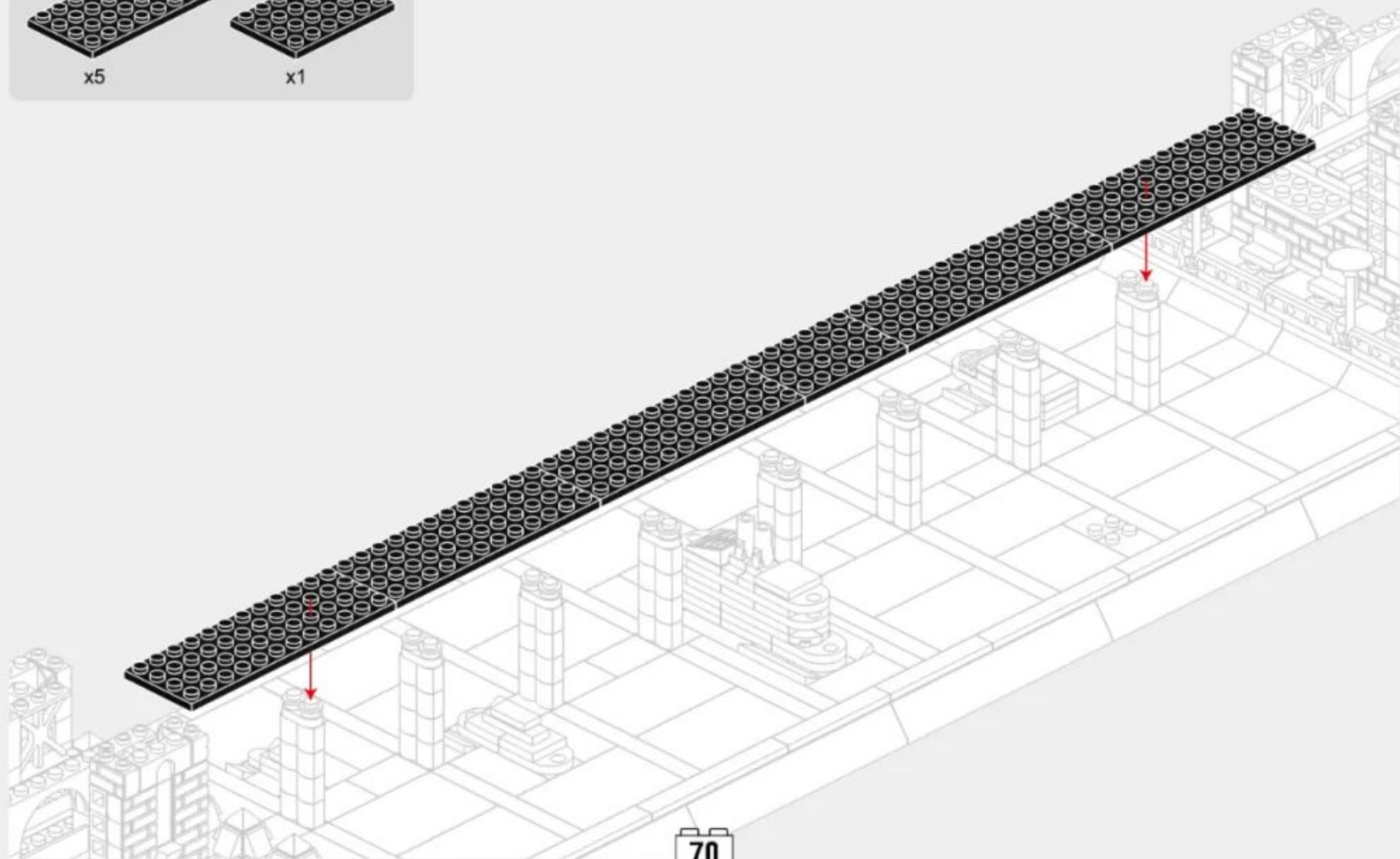
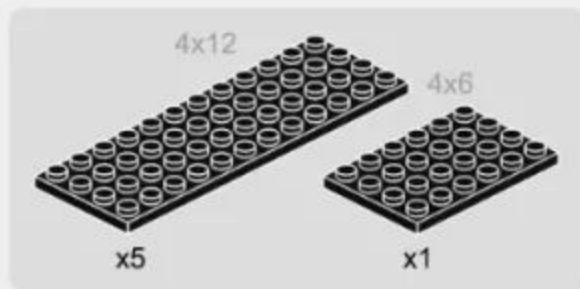

5-3

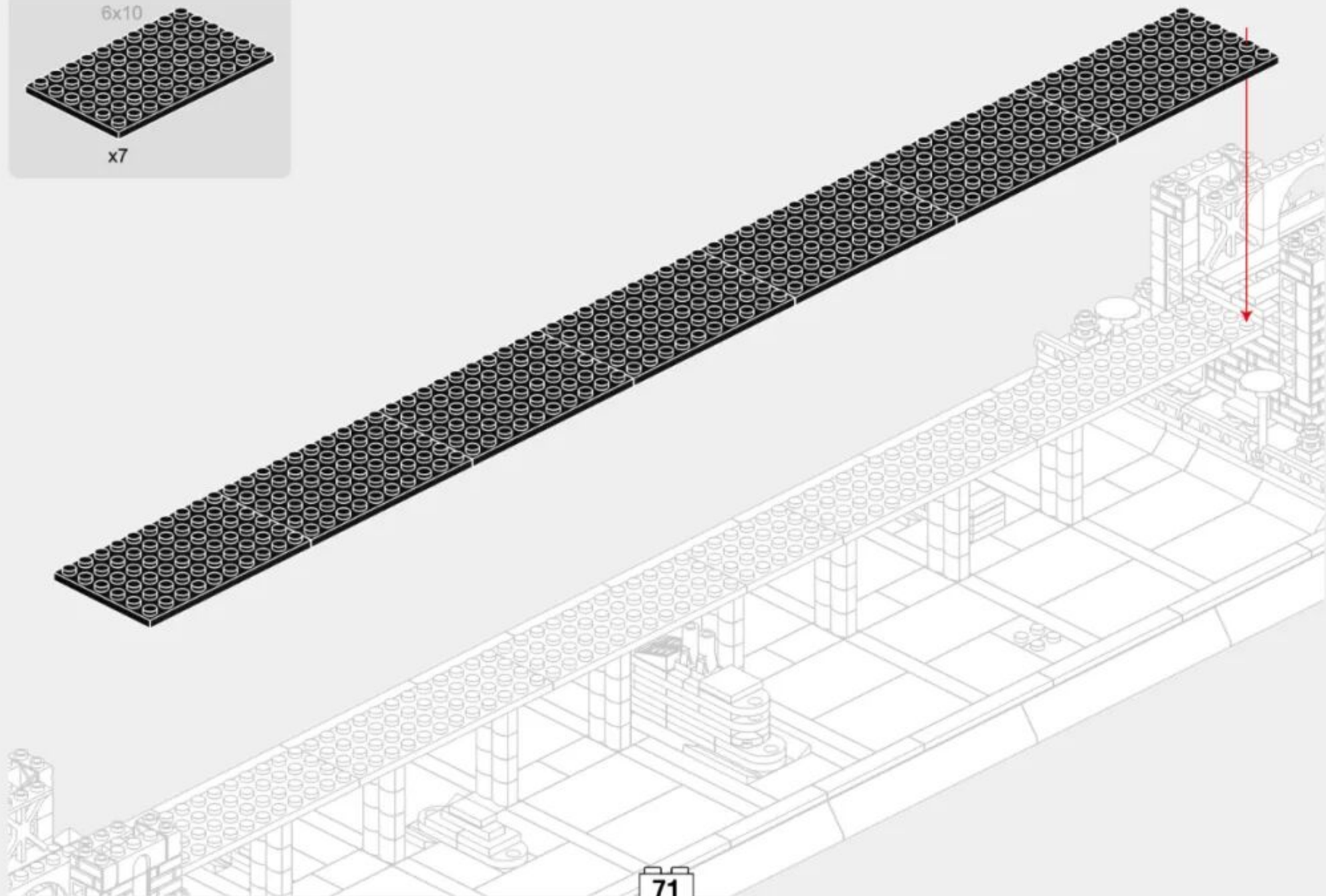
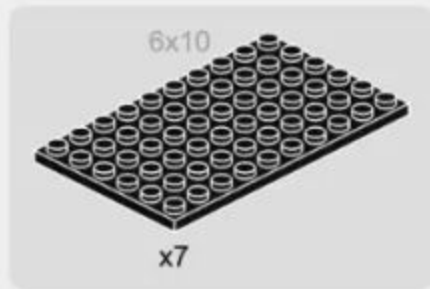

5-4

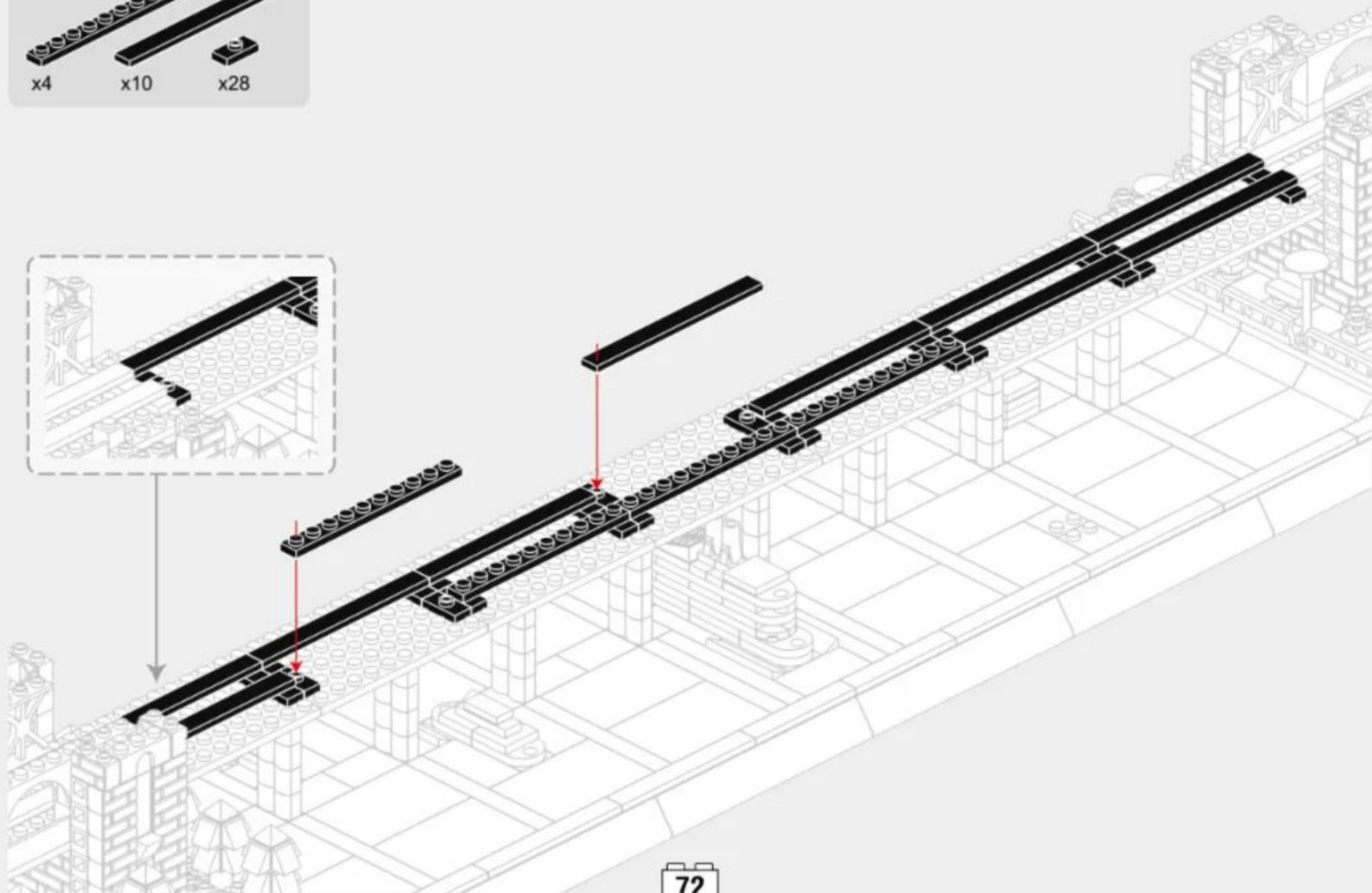
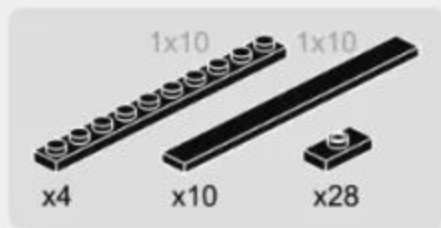

5-5

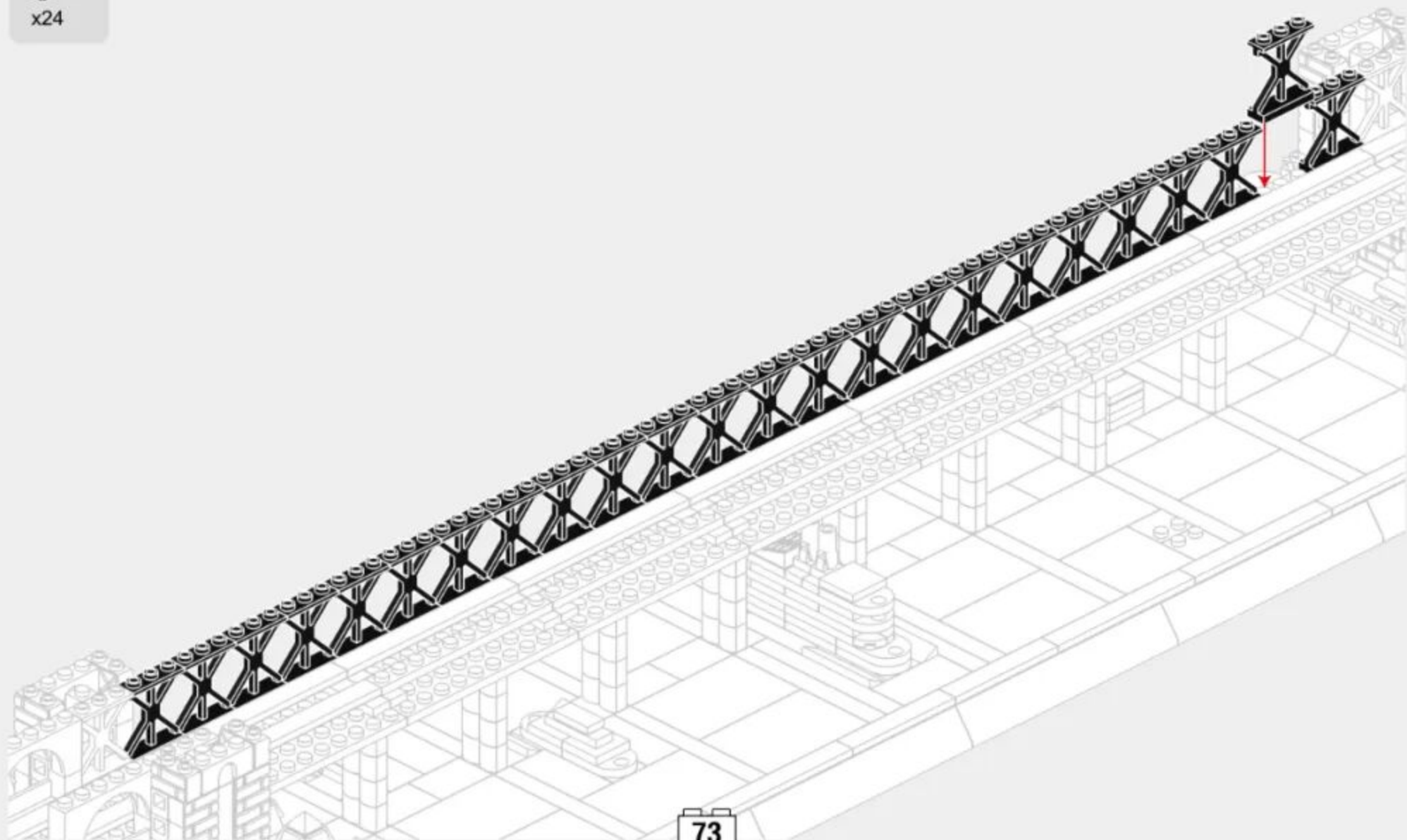

5-6

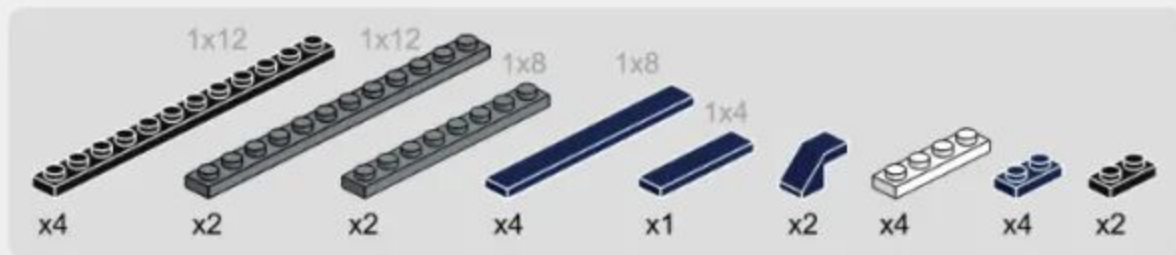

5-7

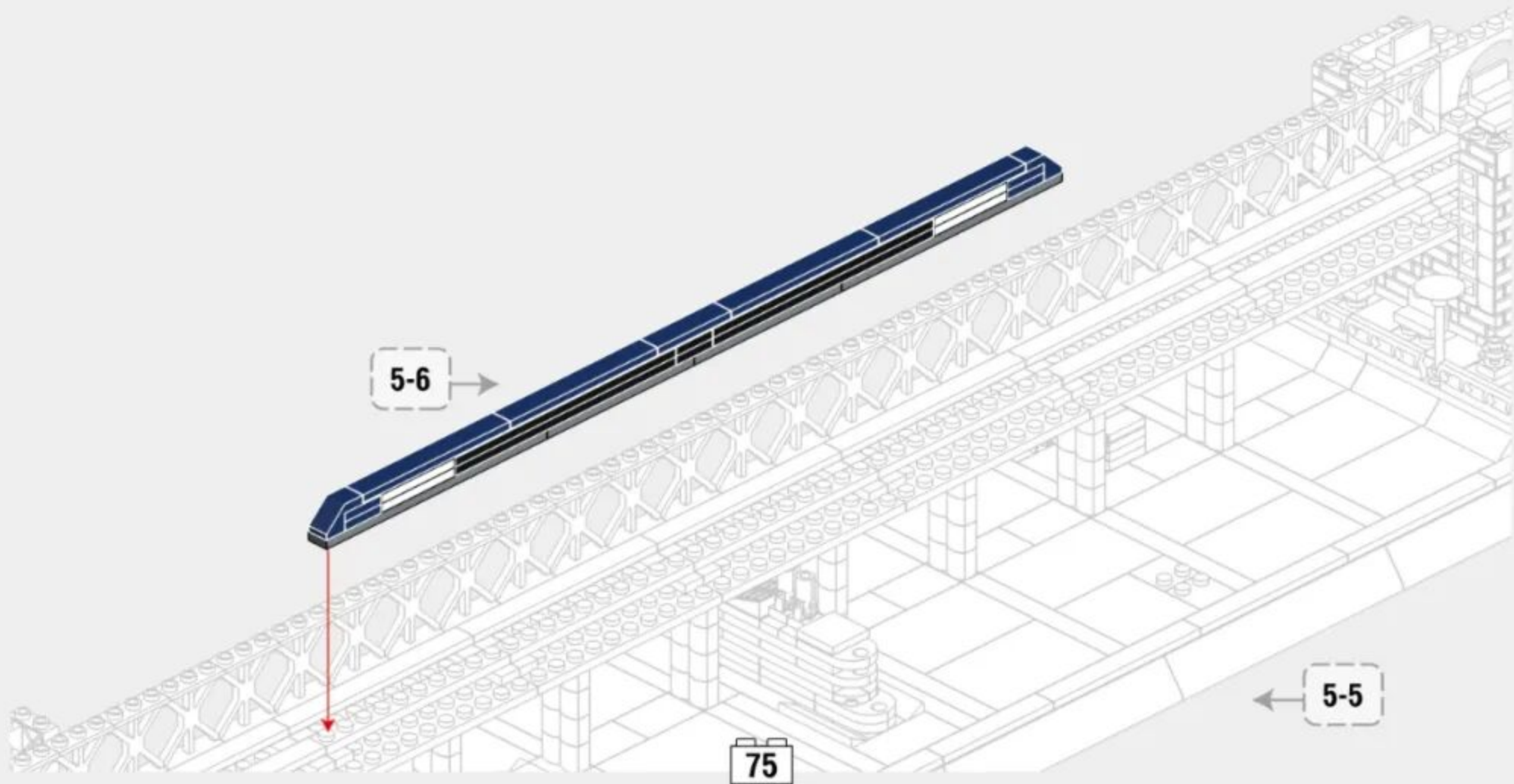

5-8

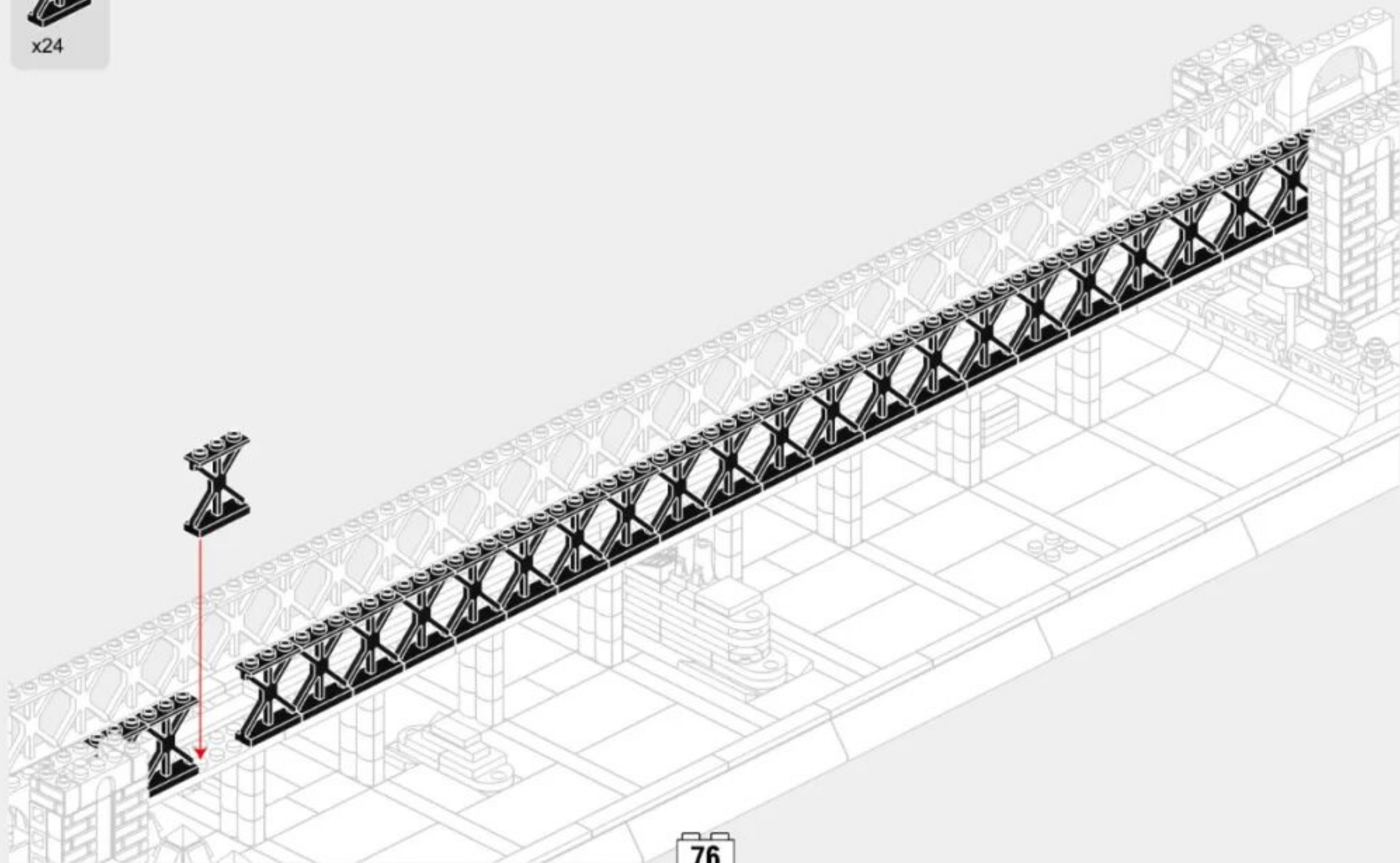

5-9

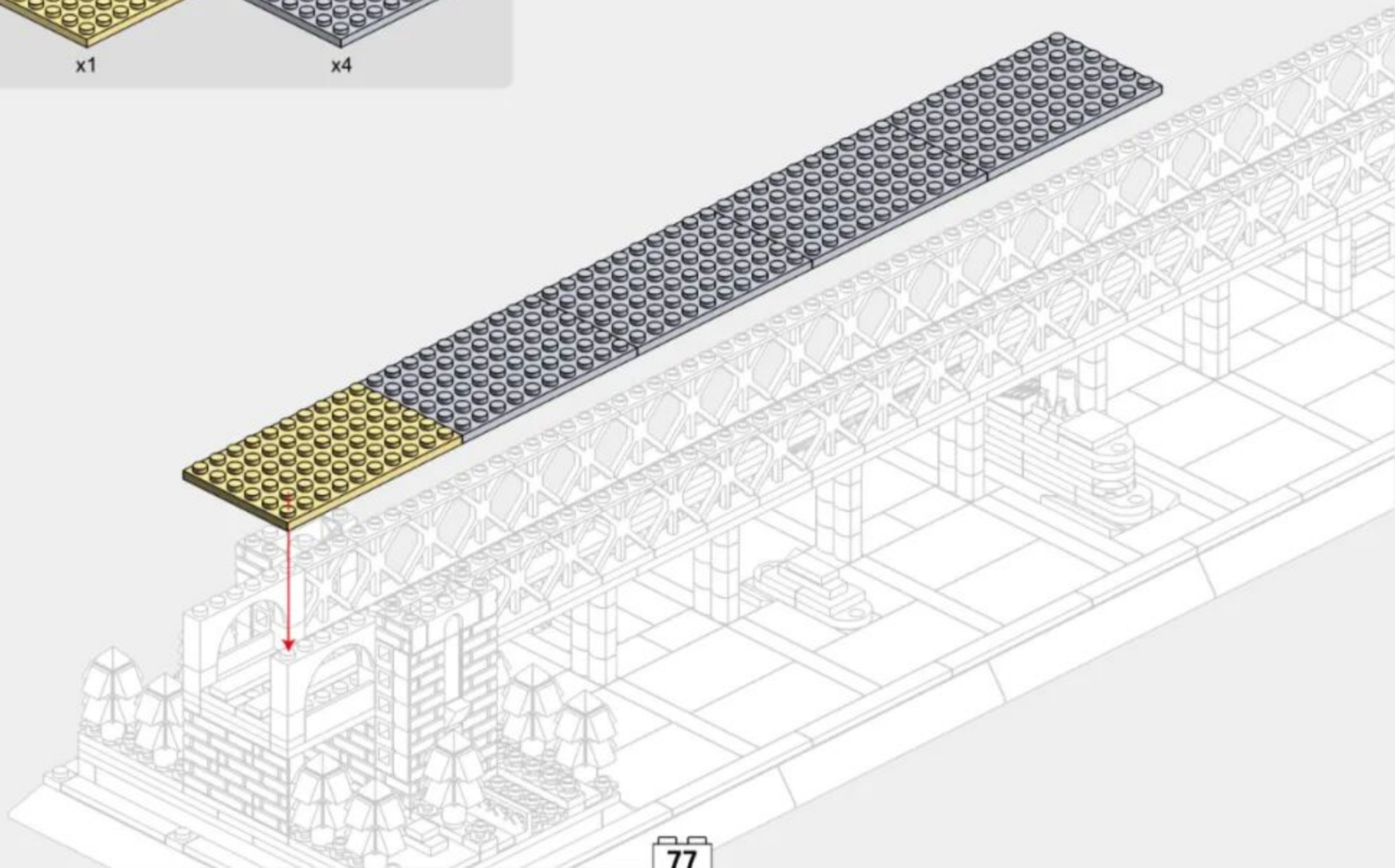
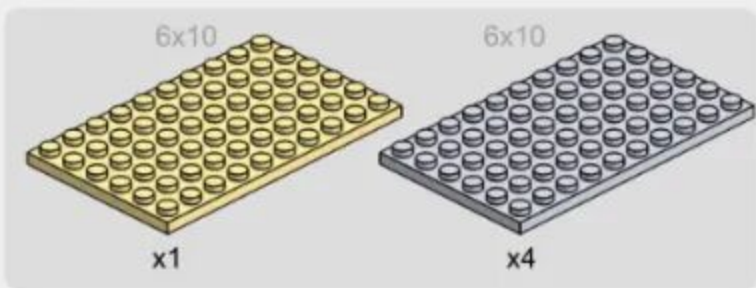

5-10

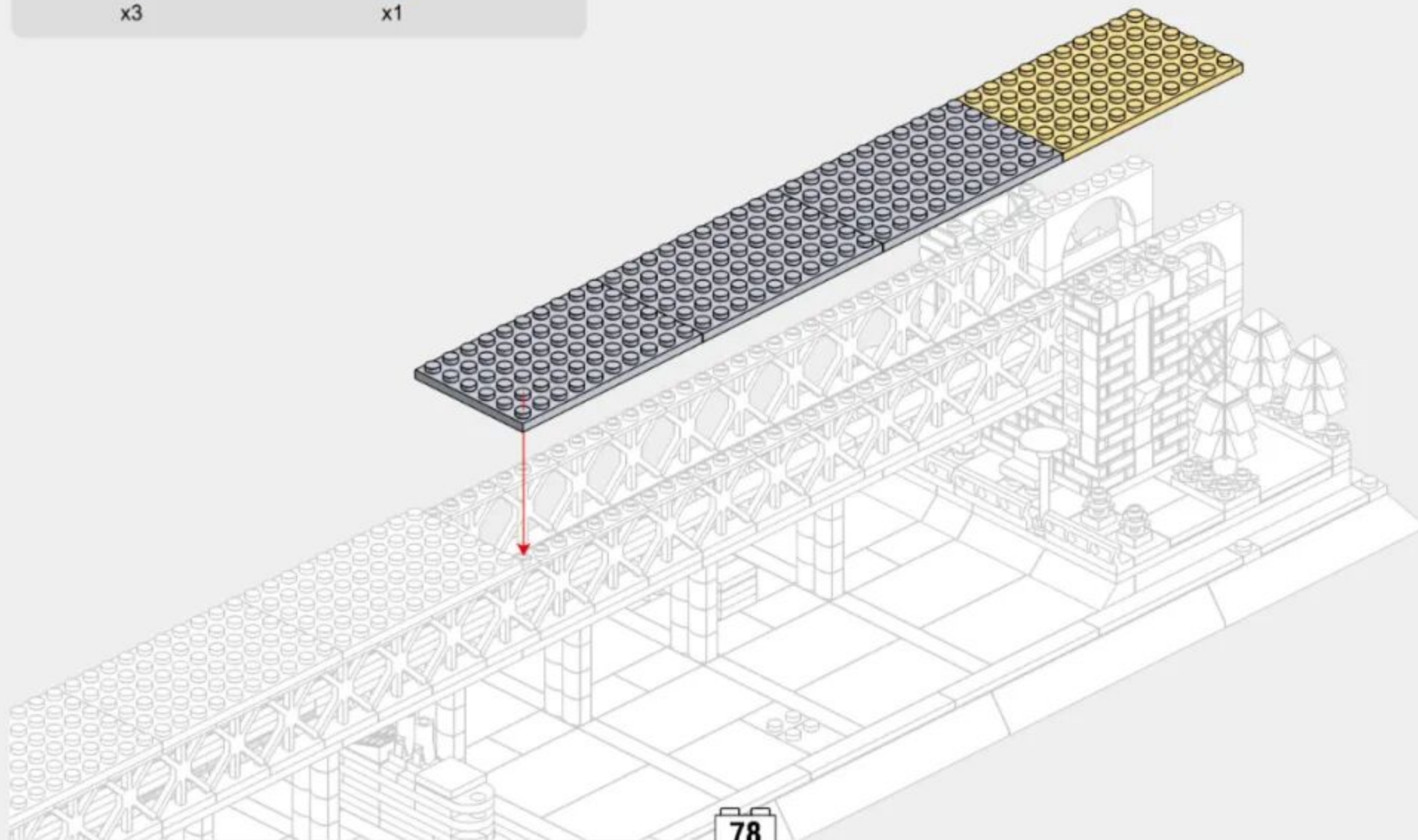
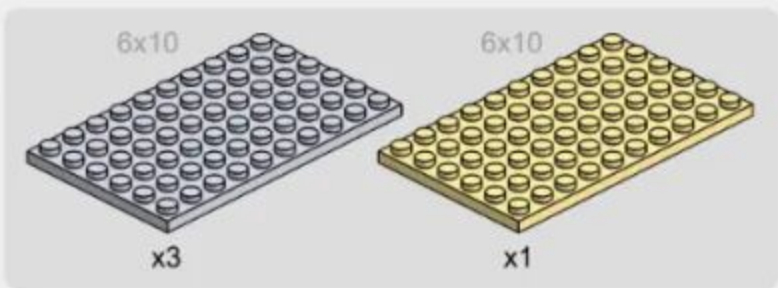

5-11

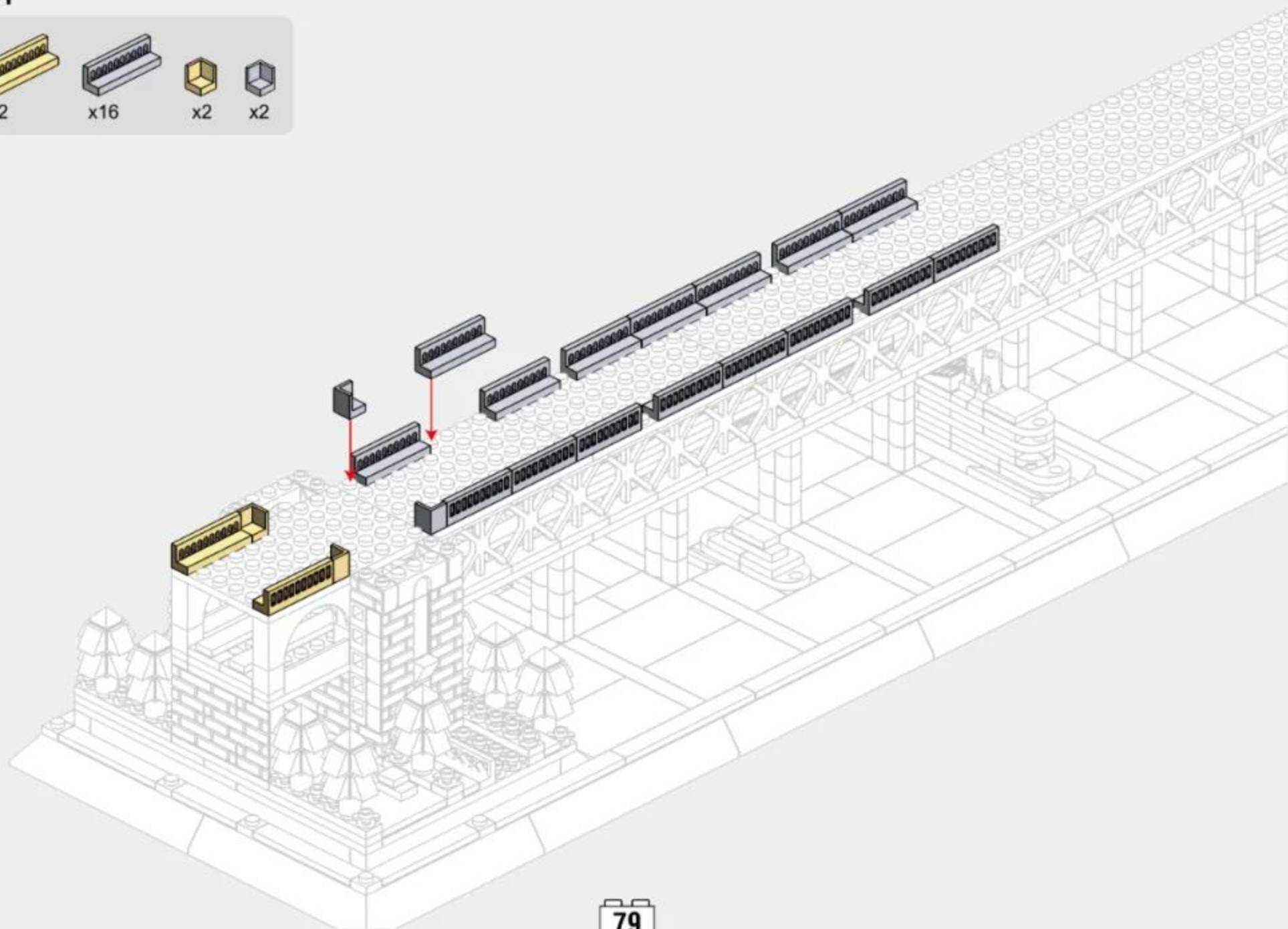

5-12



x16



x2



x2



x2

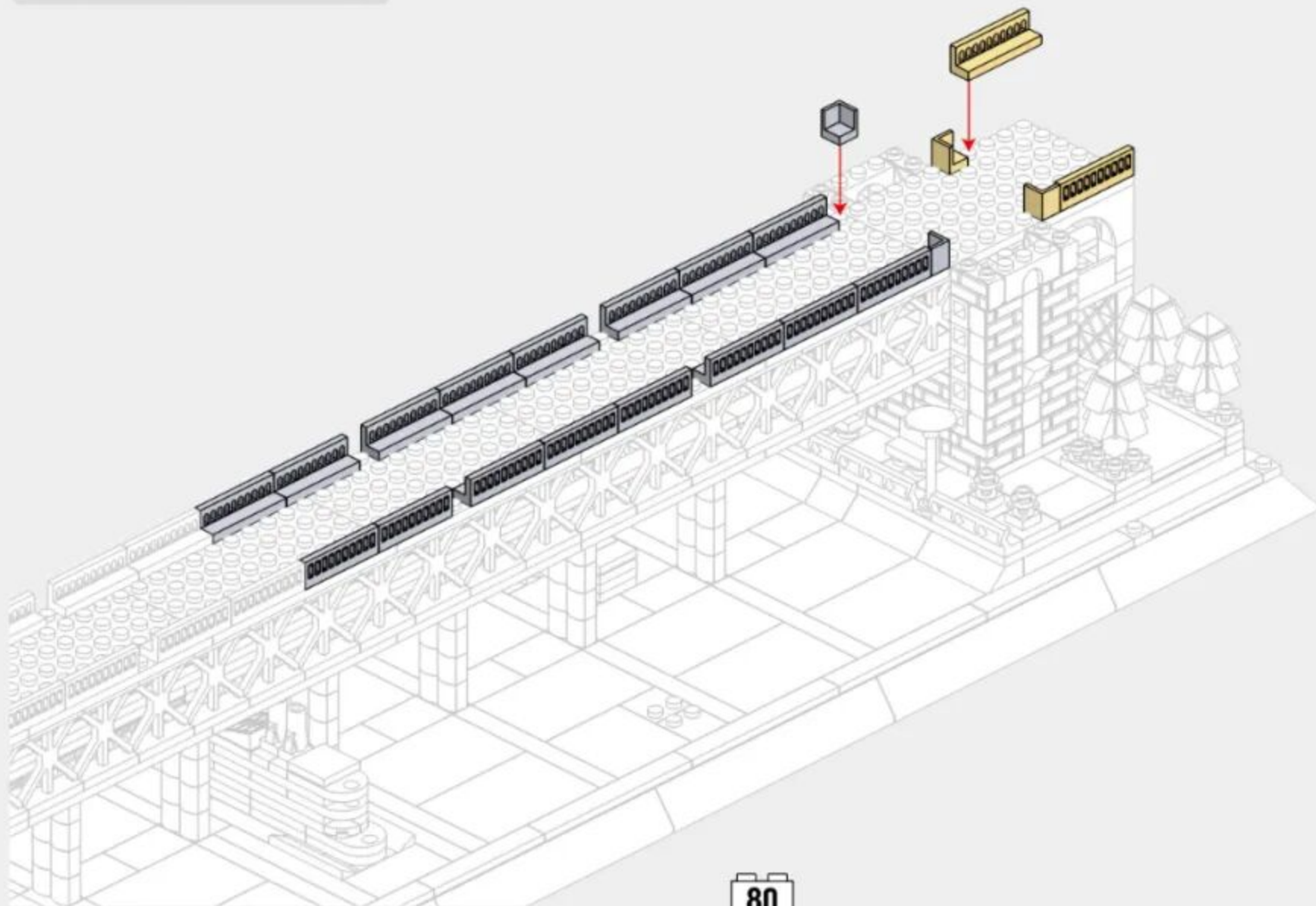

5-13

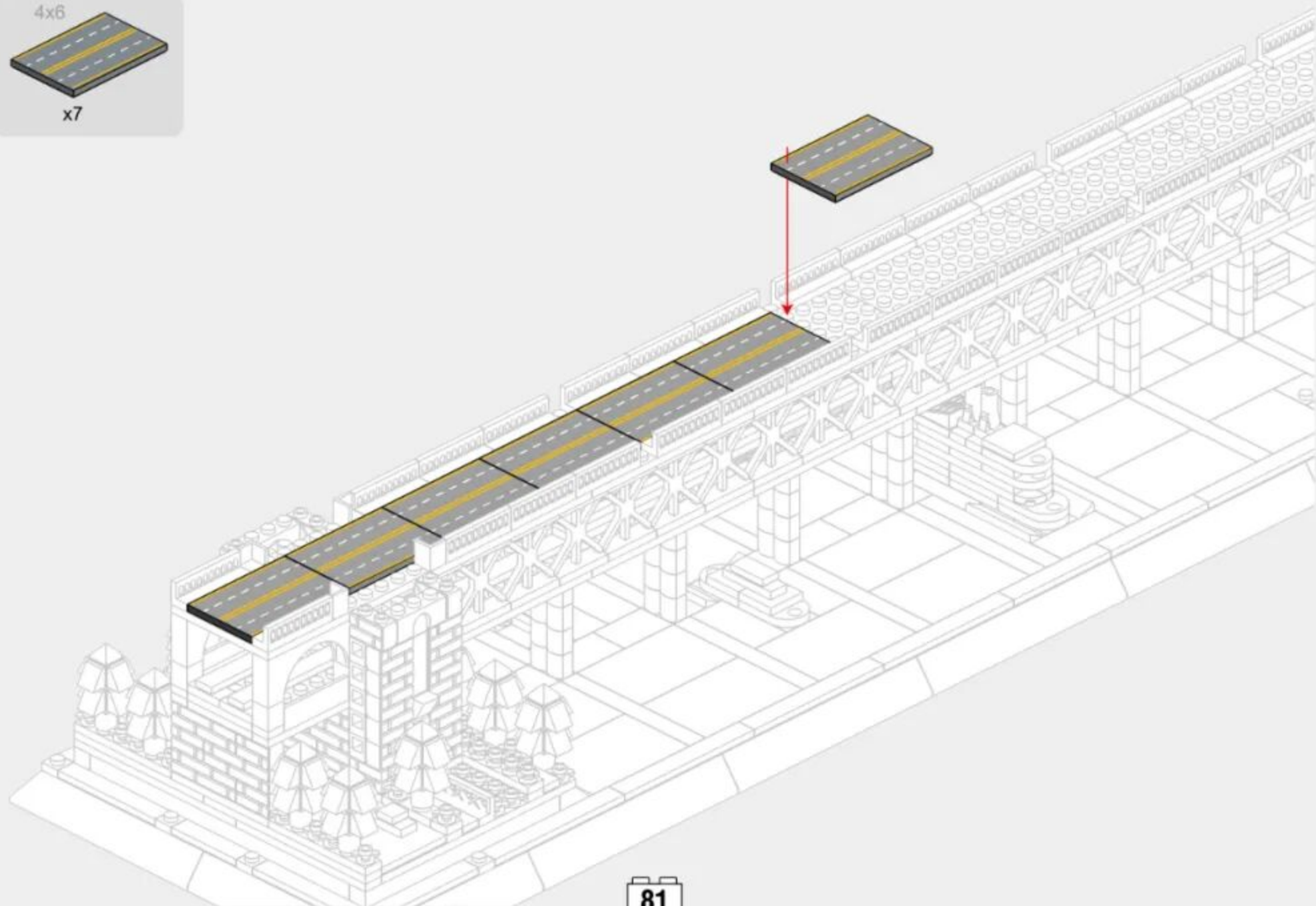
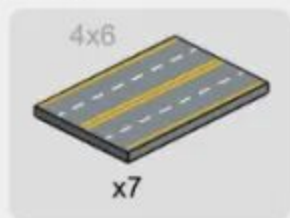

5-14

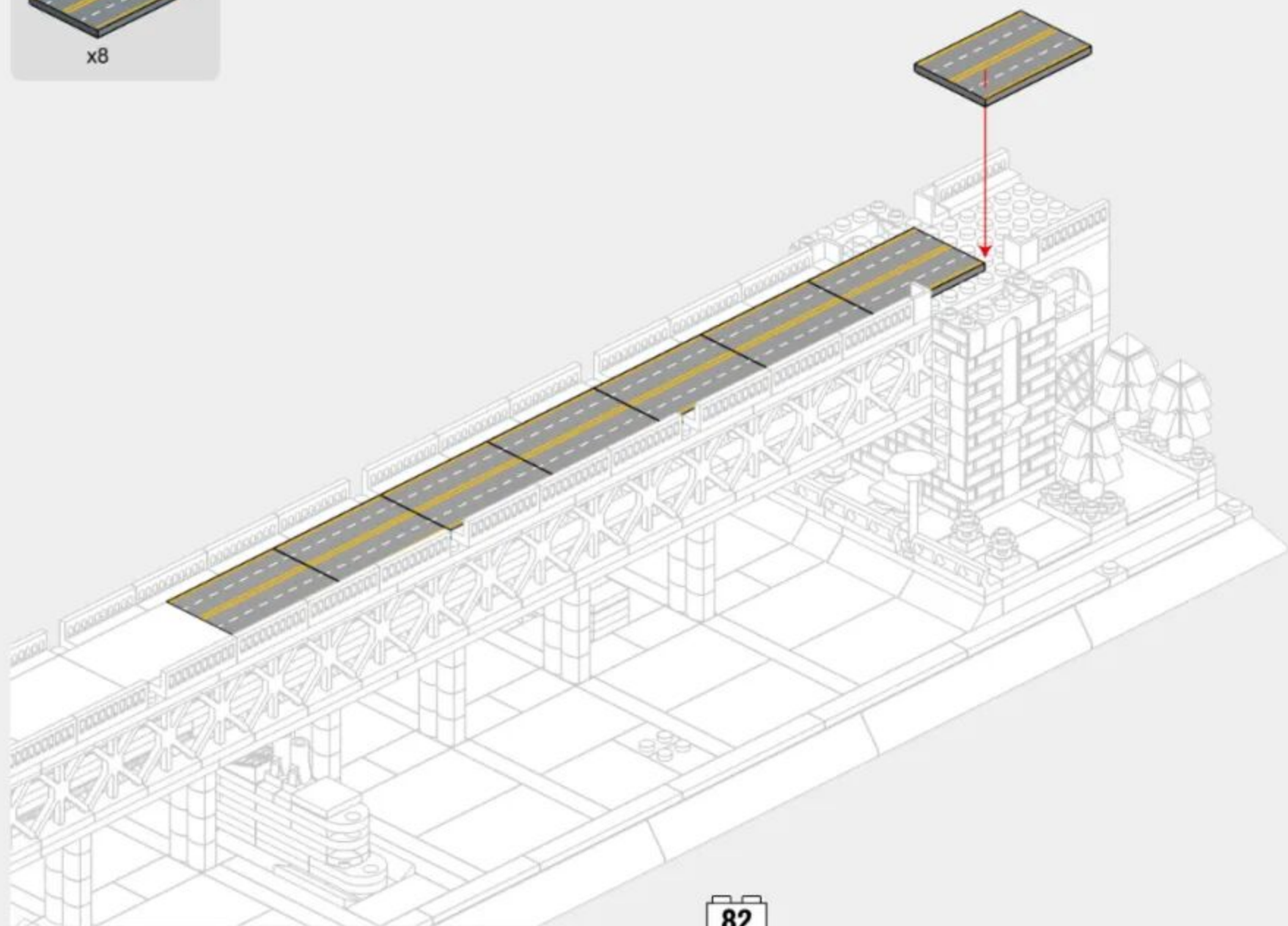
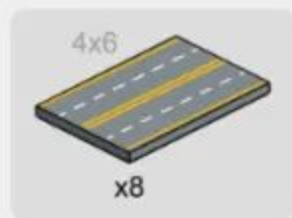

5-15

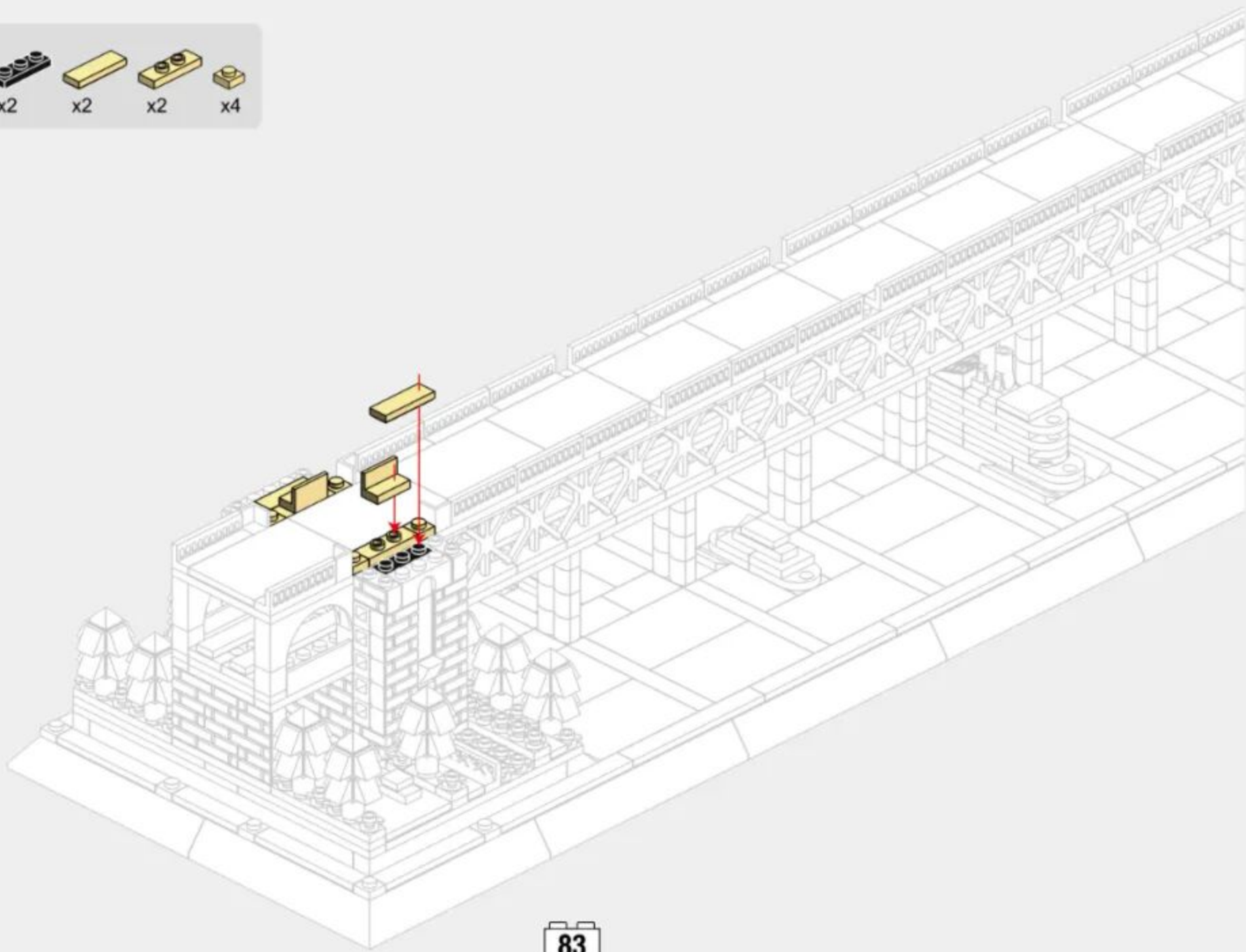
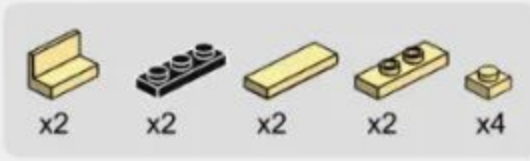

5-16

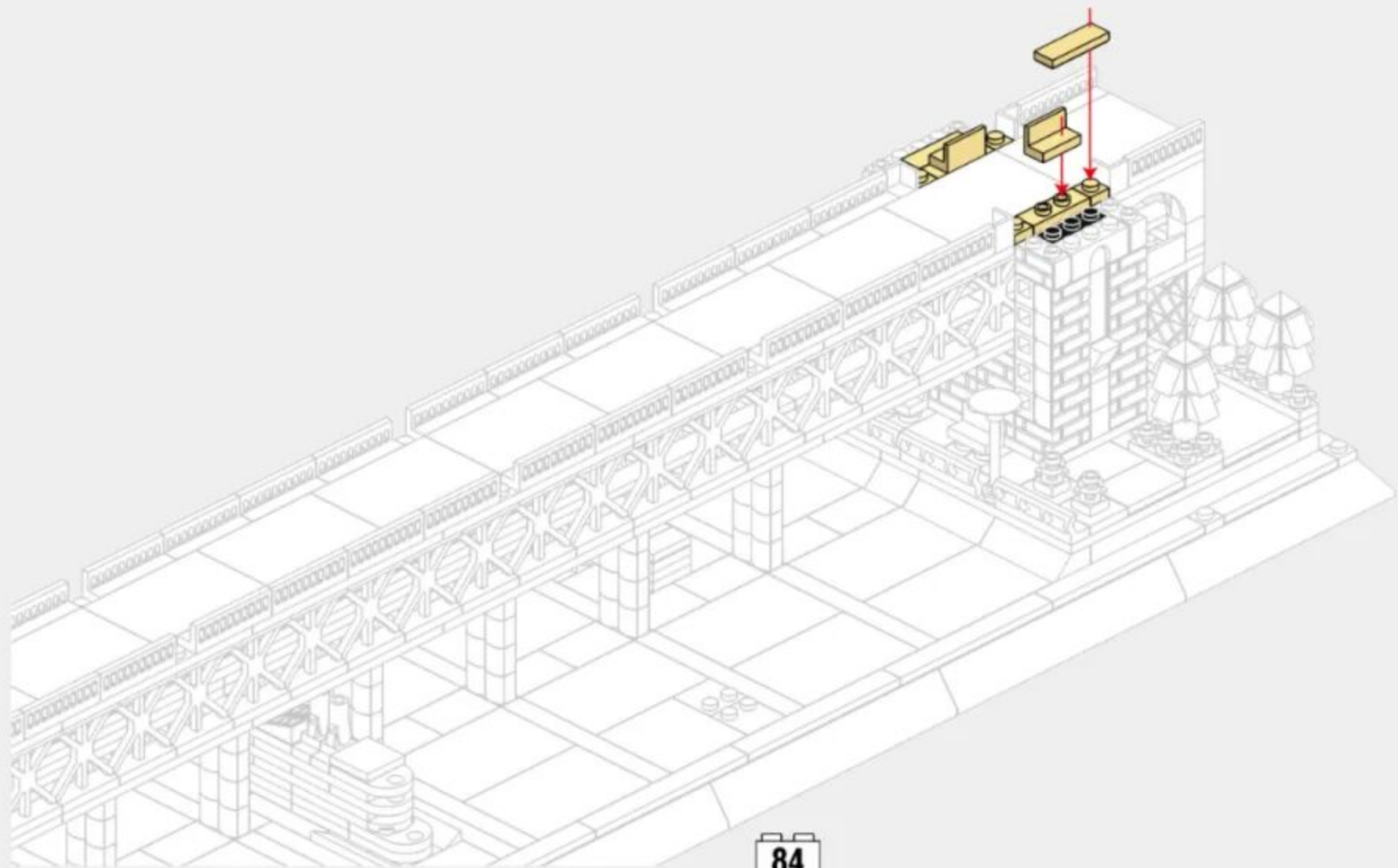
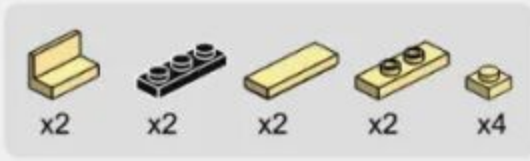



254PCS

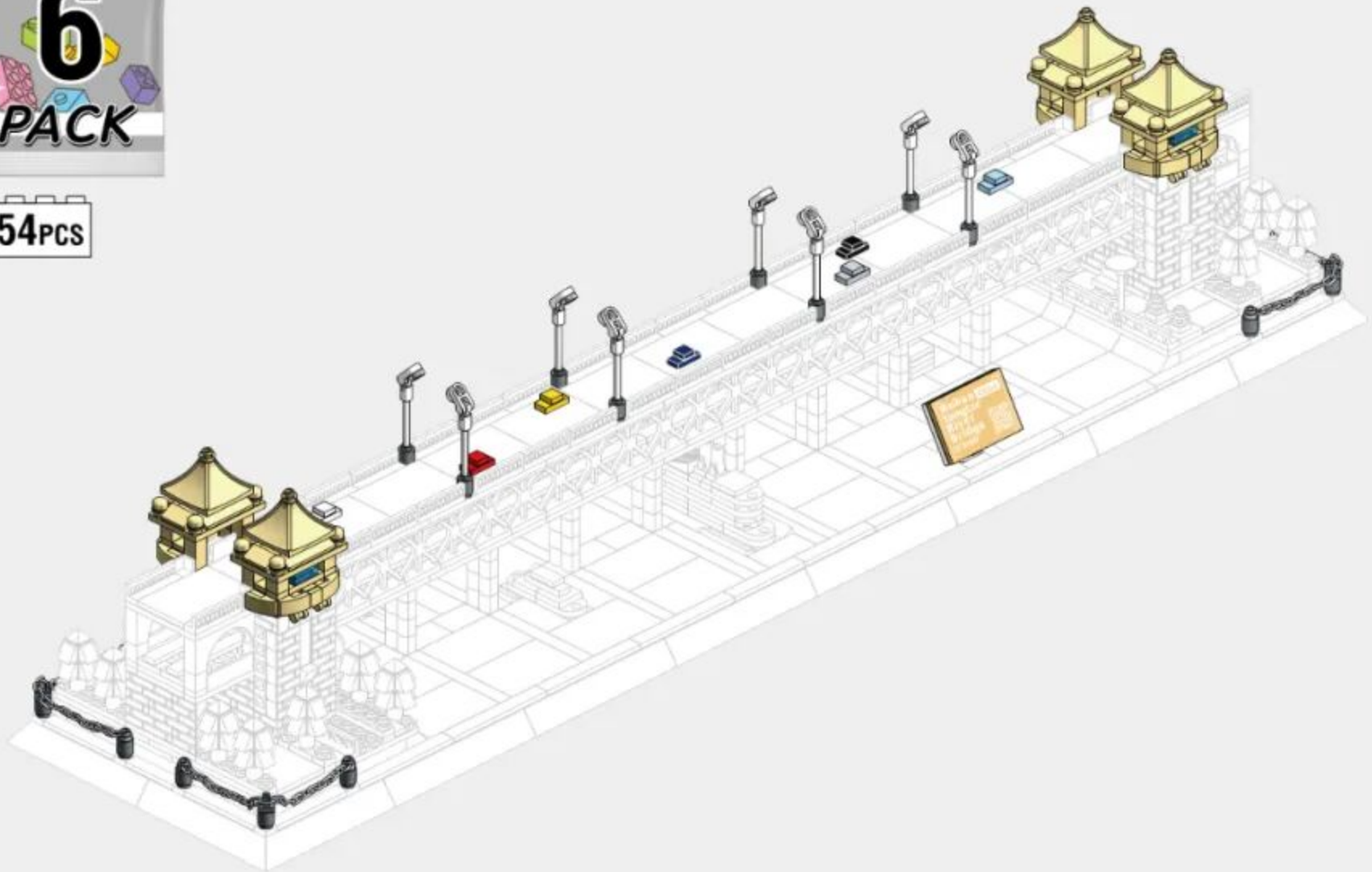

6-1



x2

x4

x6

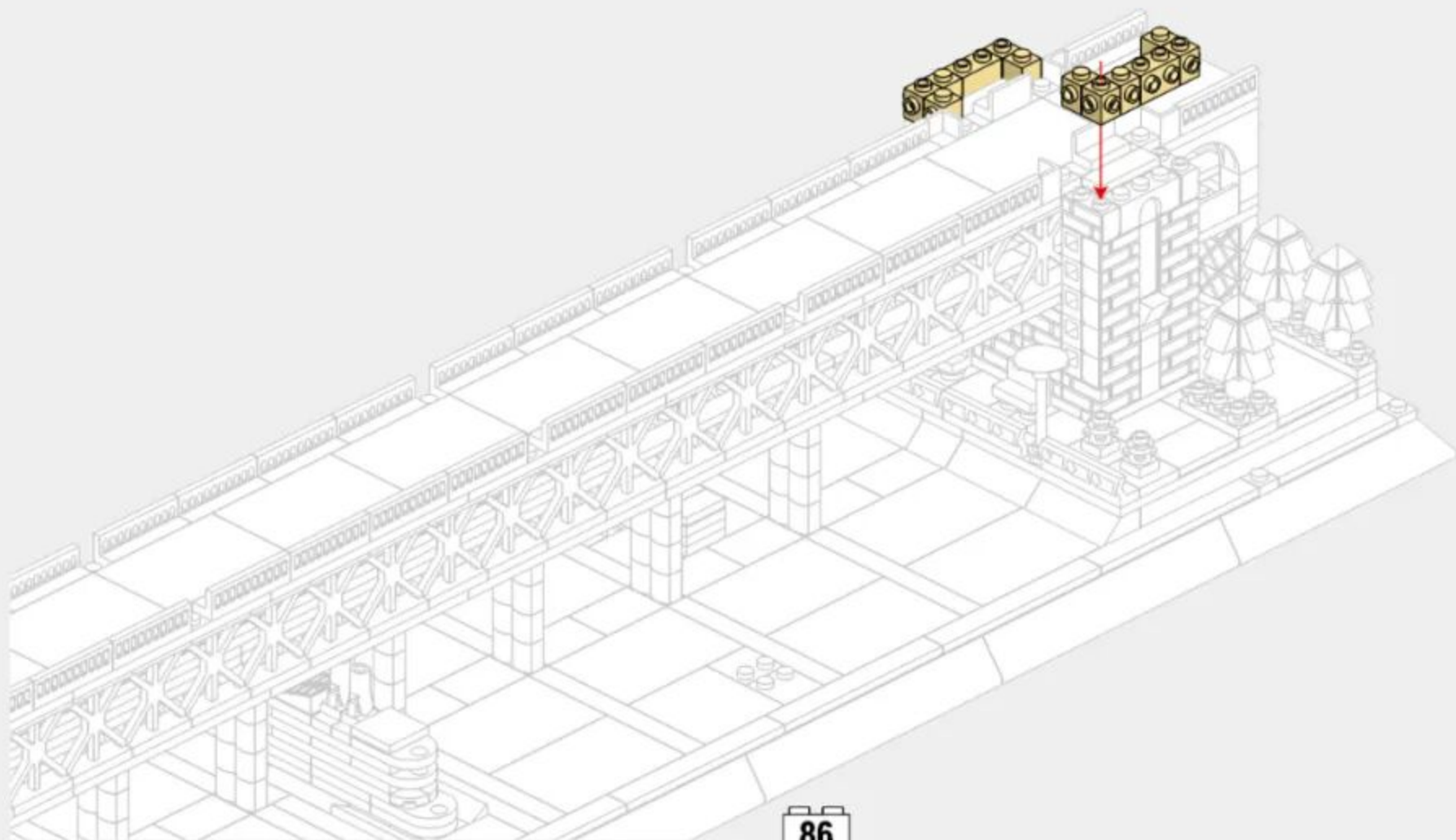

6-2

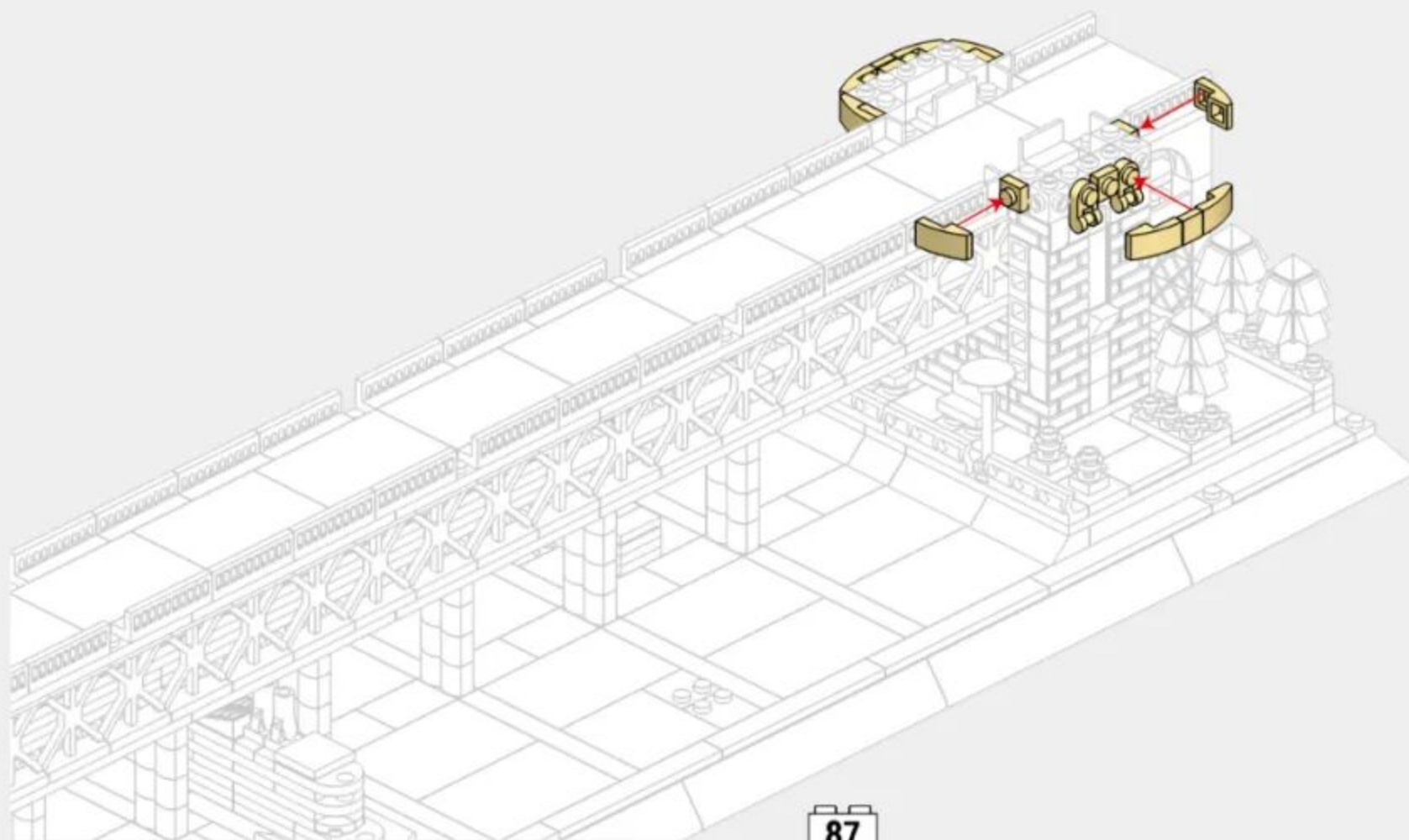

6-3

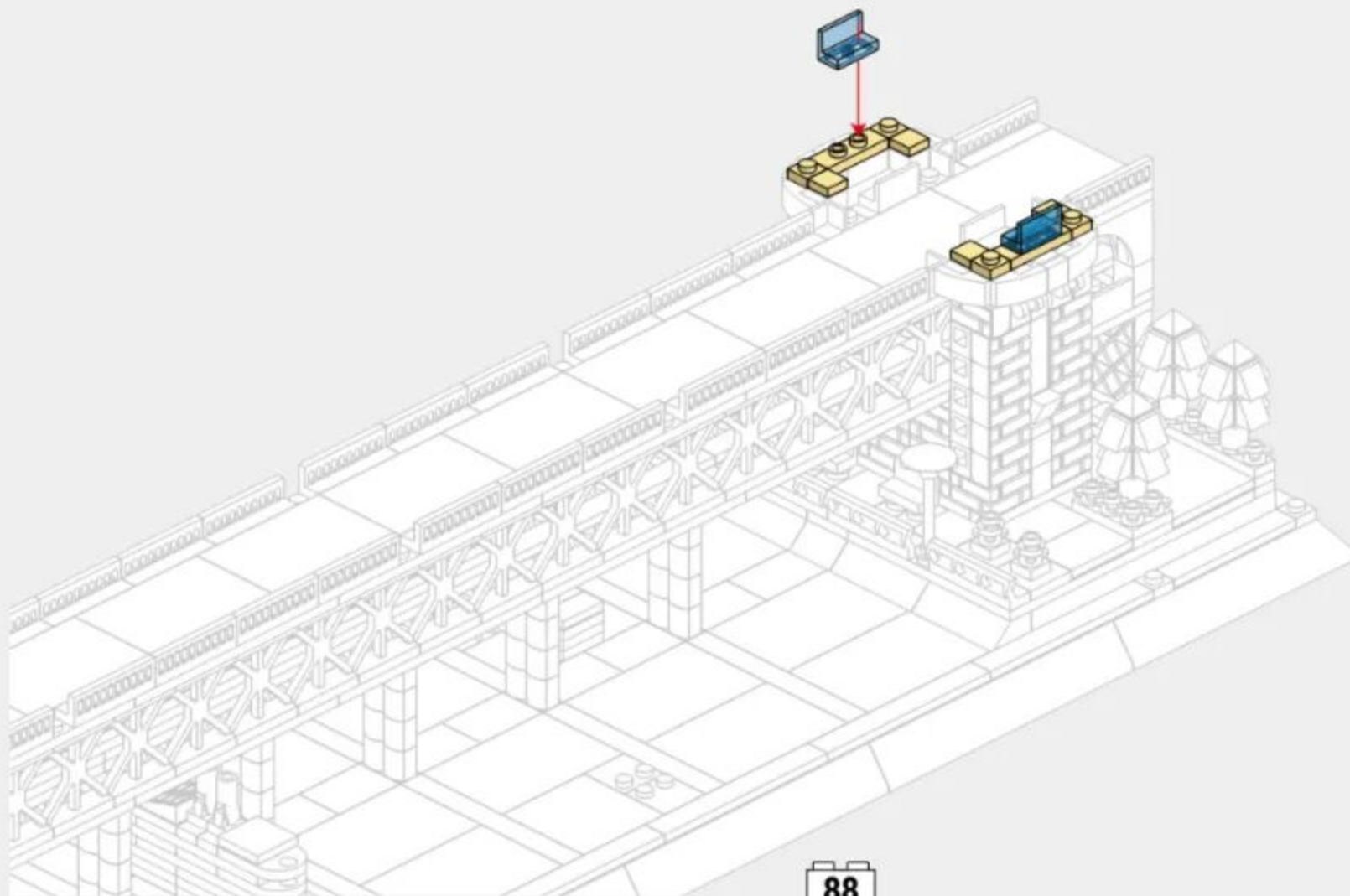

6-4

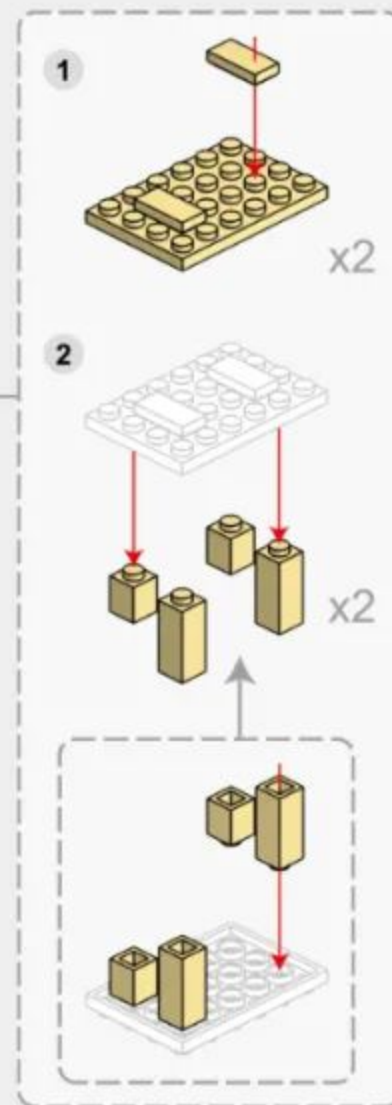
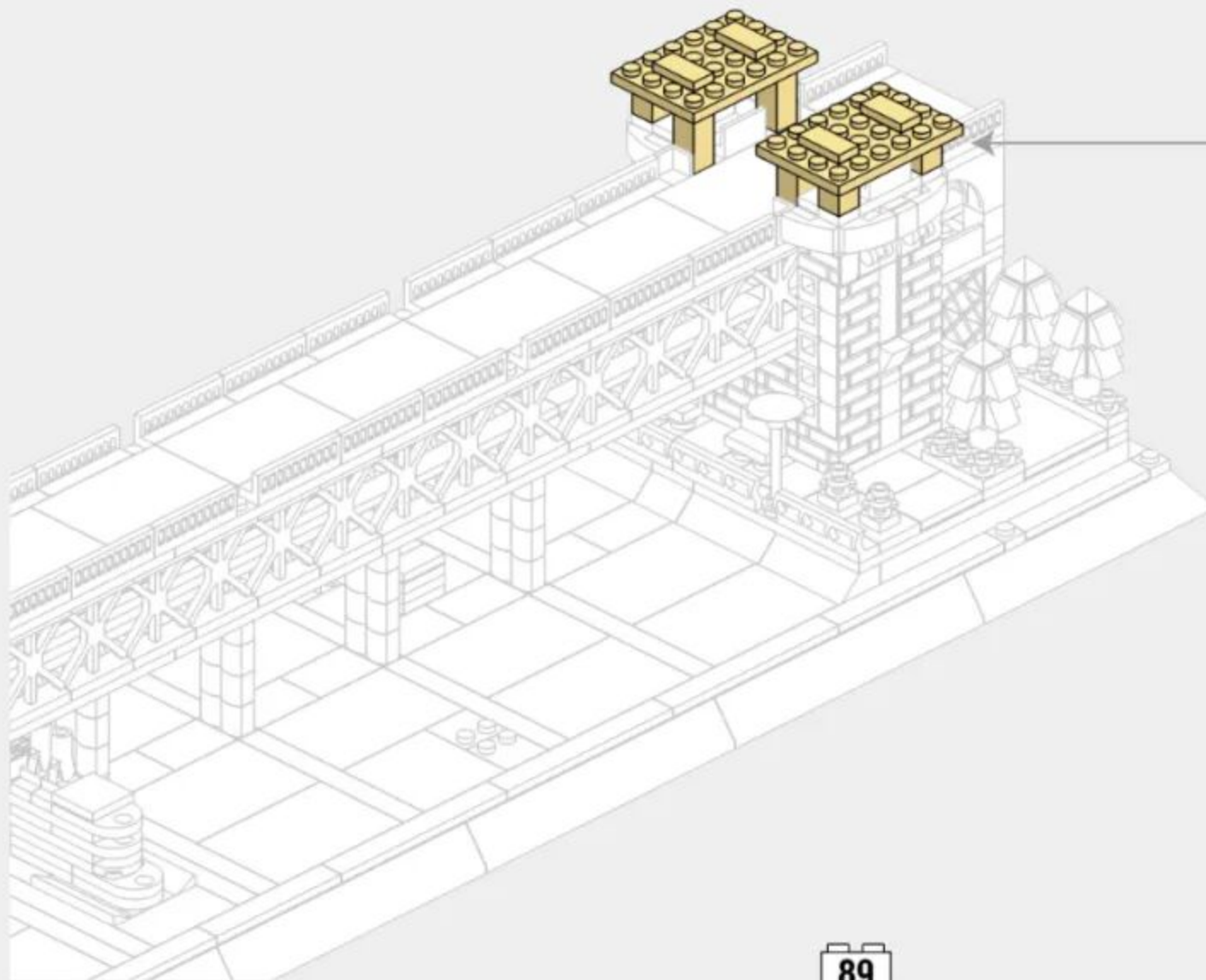
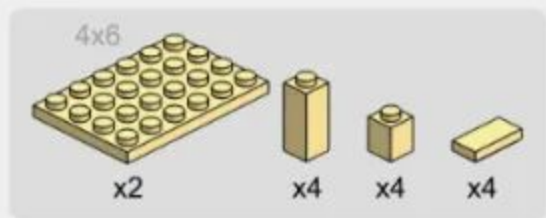

6-5



x2



x4



x4



x8



x8

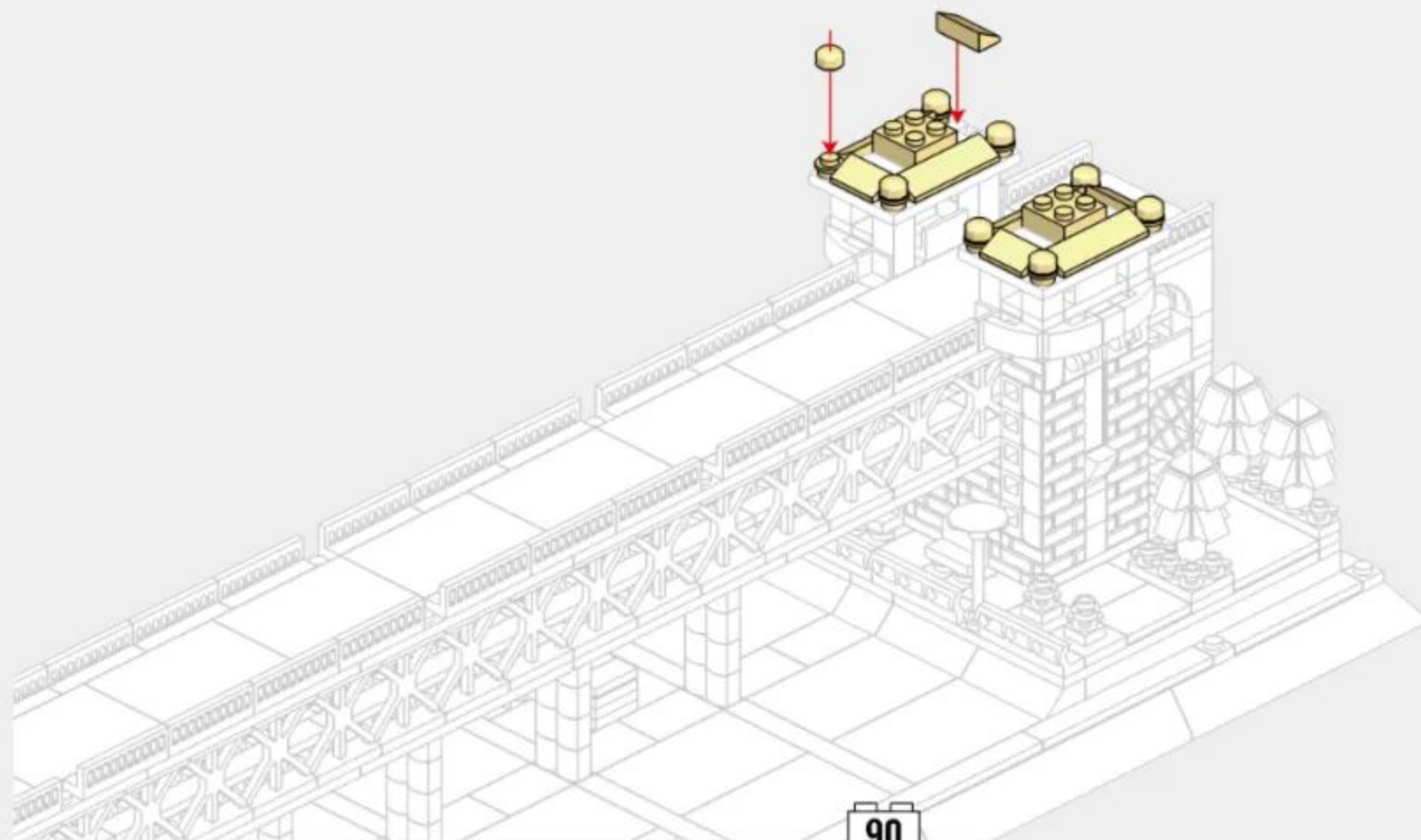

6-6



x2



x6



x4

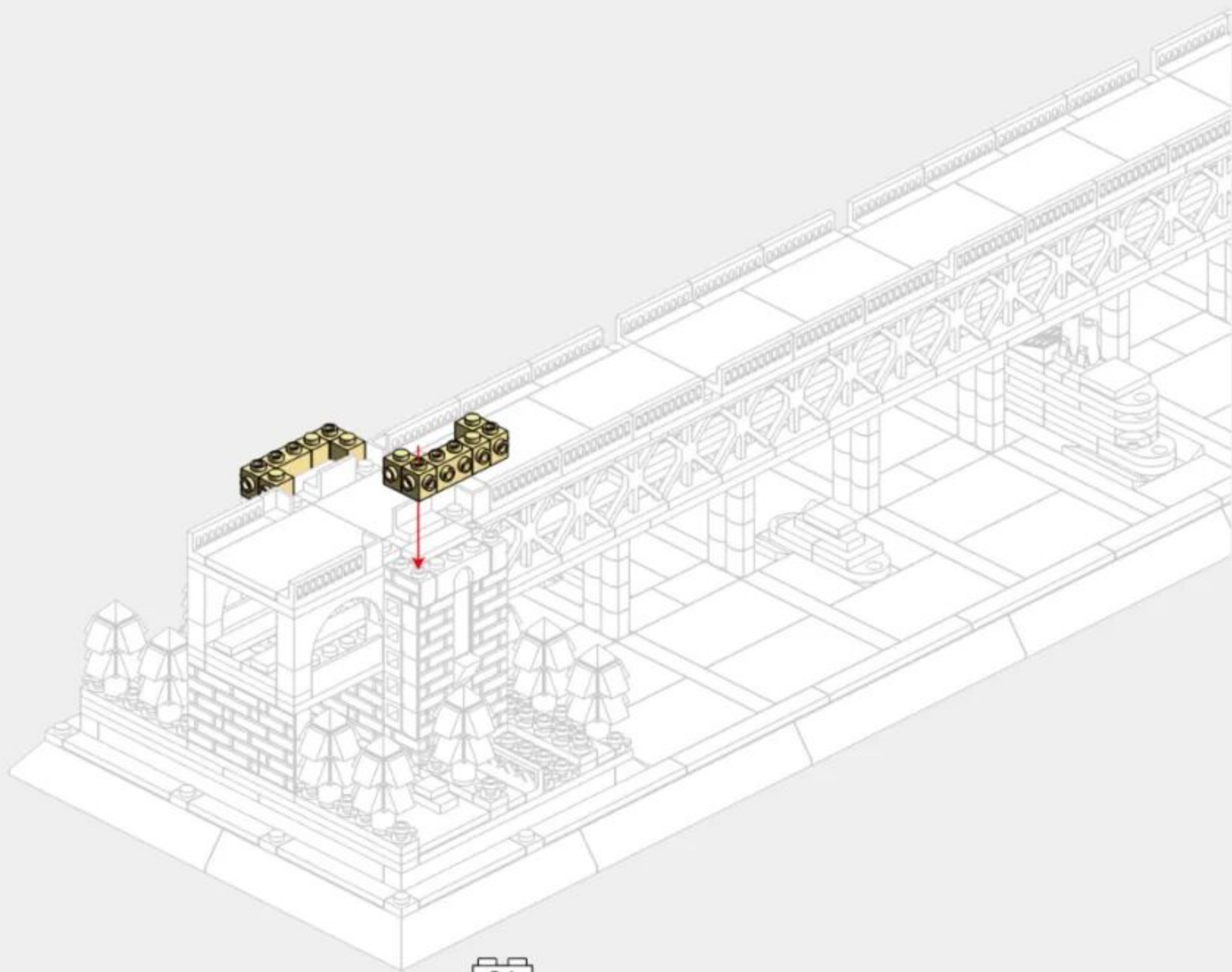

6-7

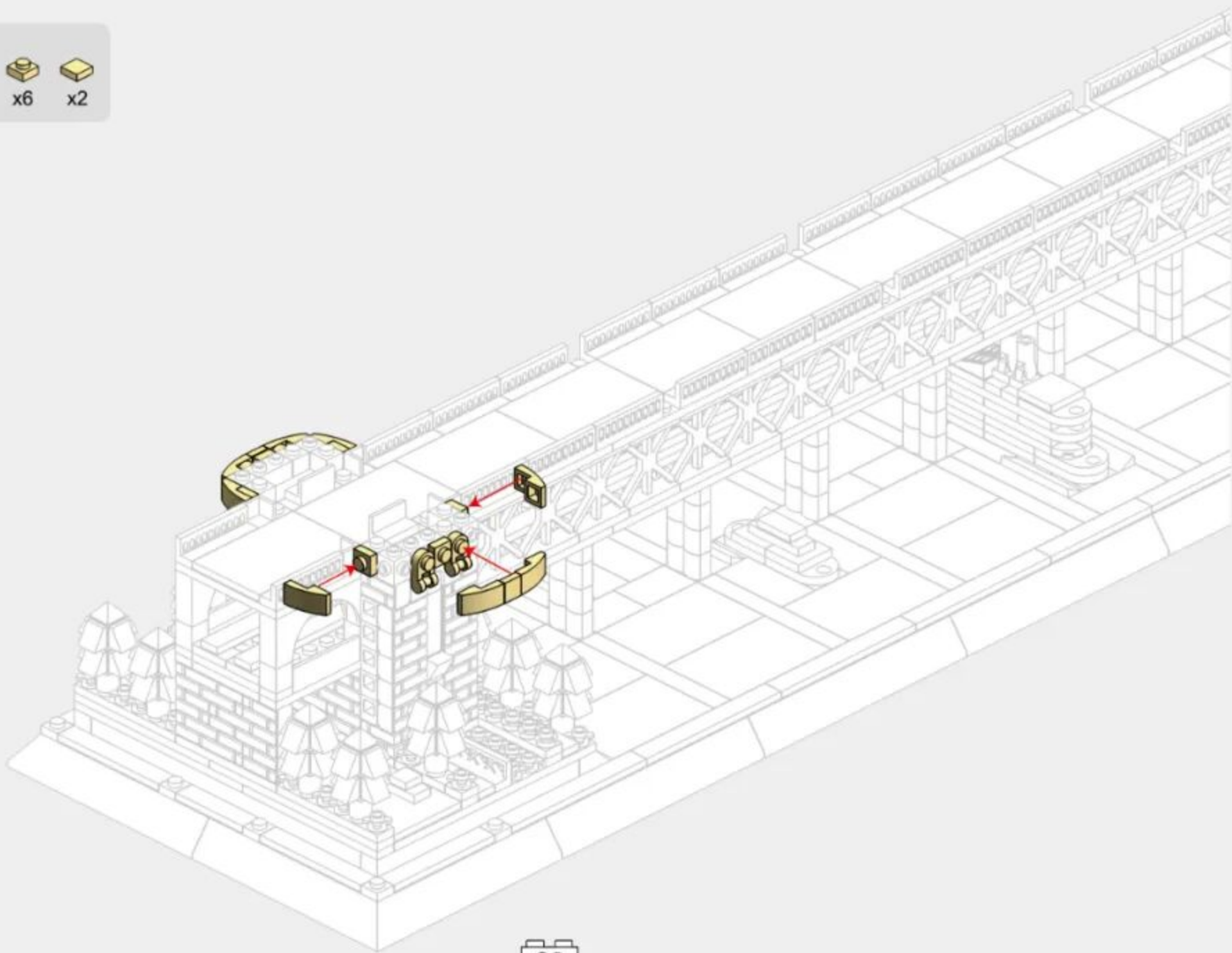

6-8



x2



x2



x4



x4

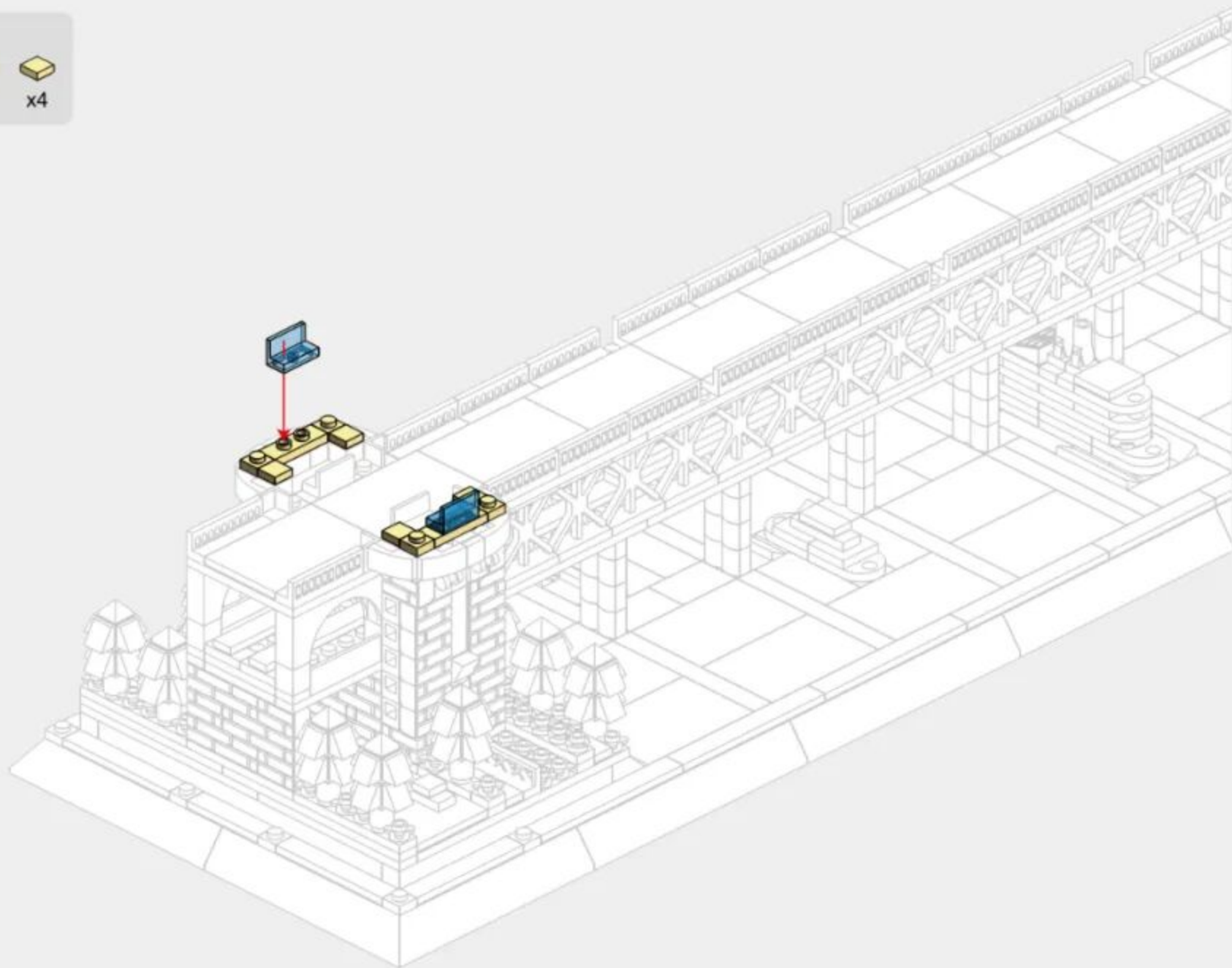

6-9

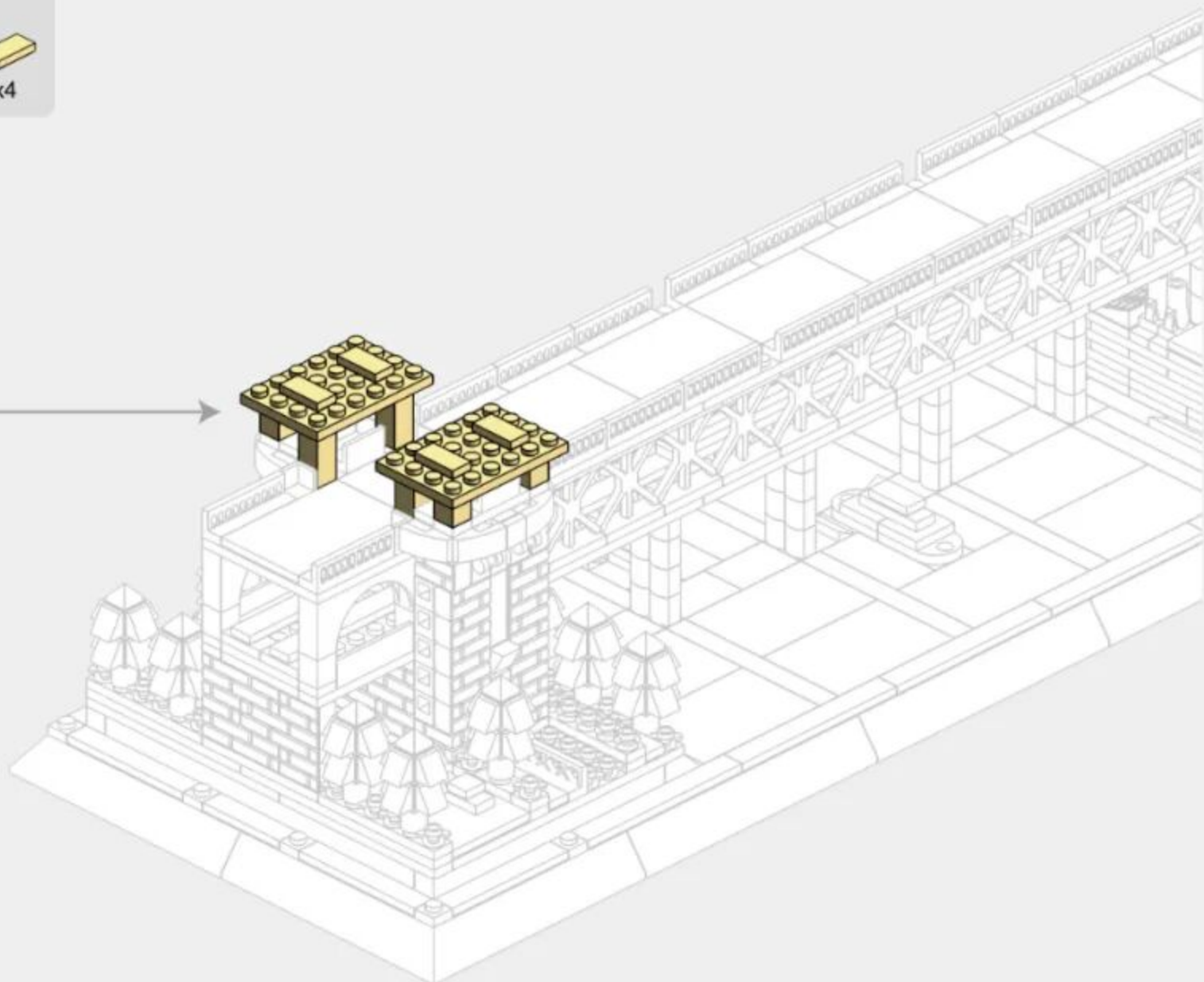
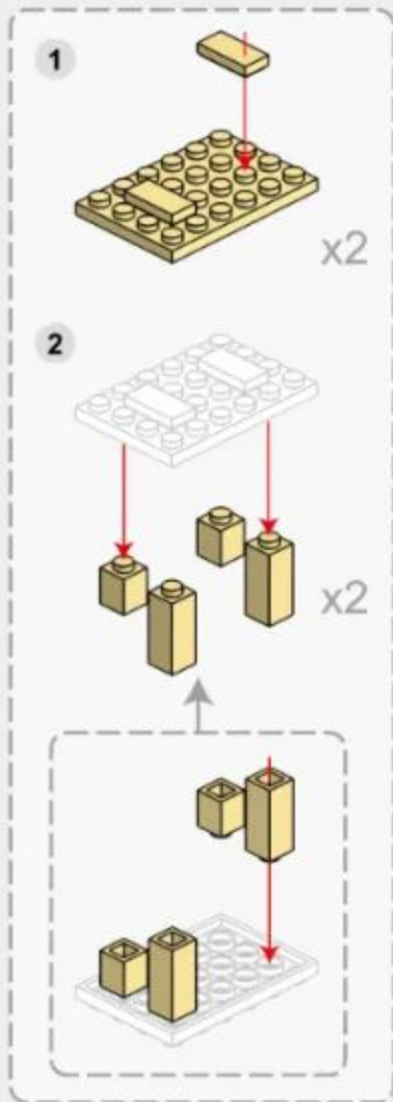
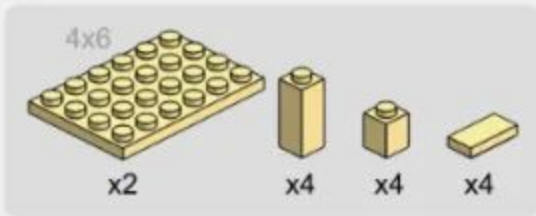

6-10

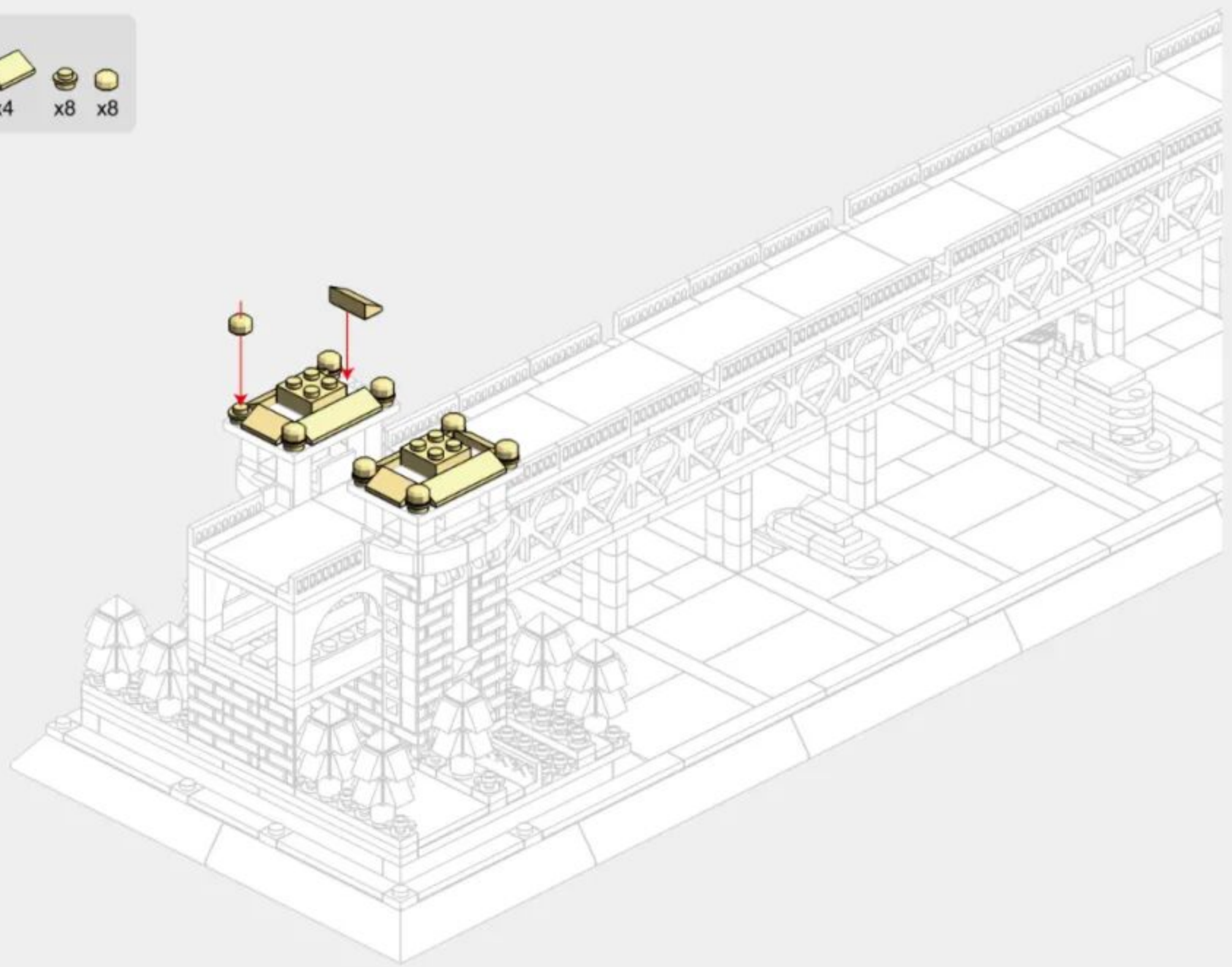
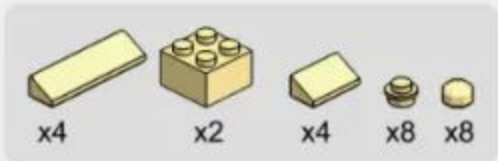

6-11

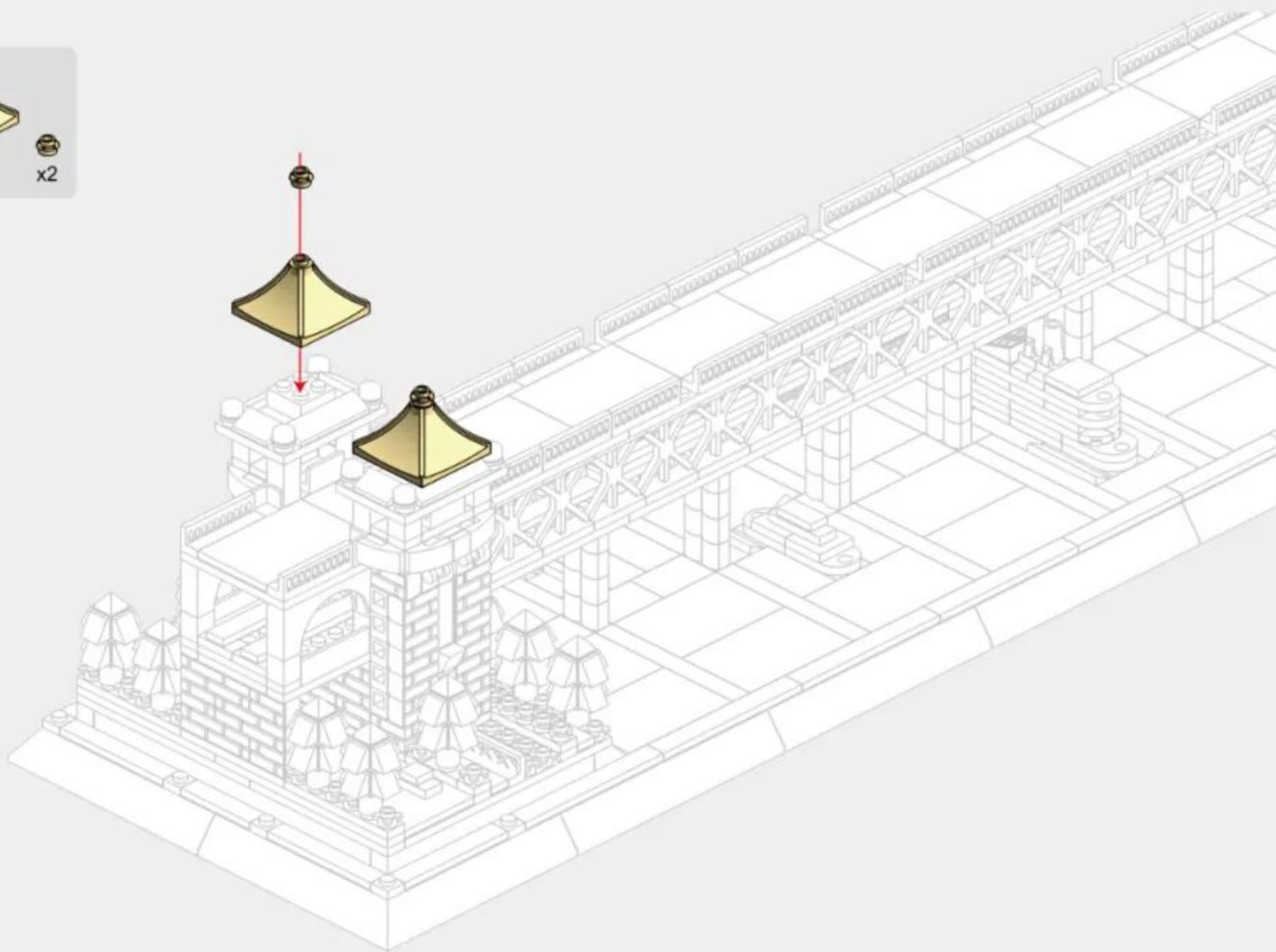

6-12

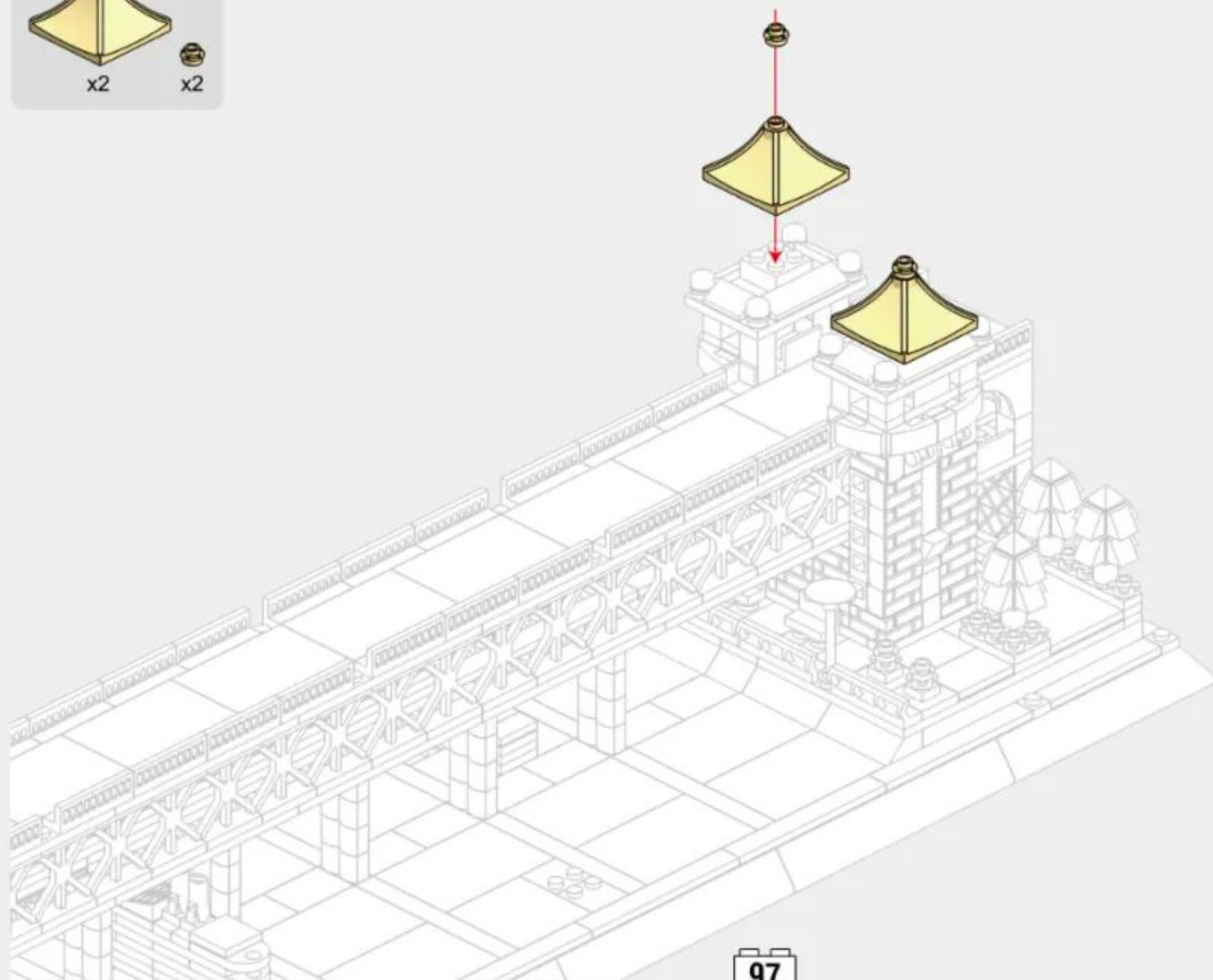

6-13

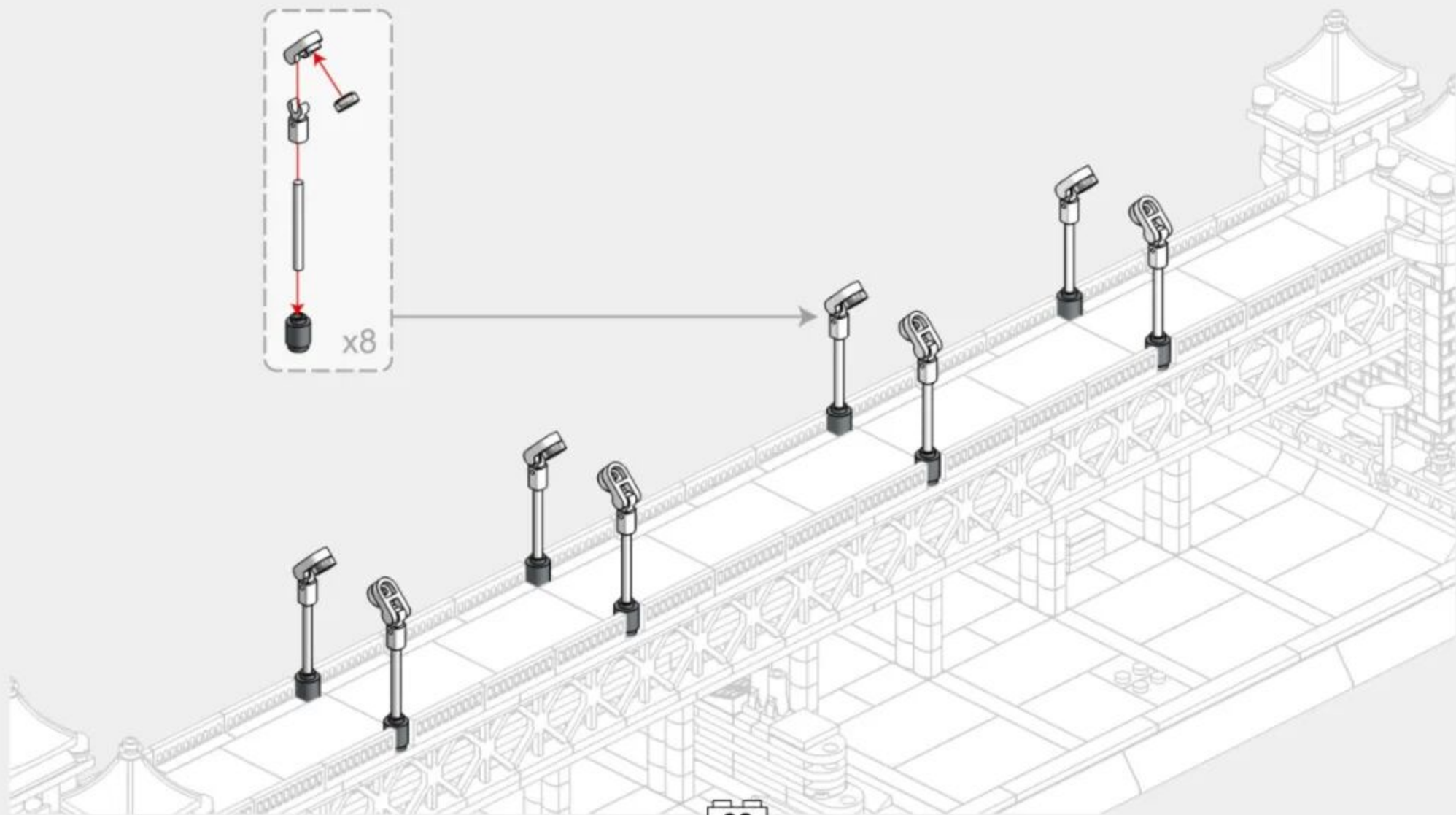

6-14

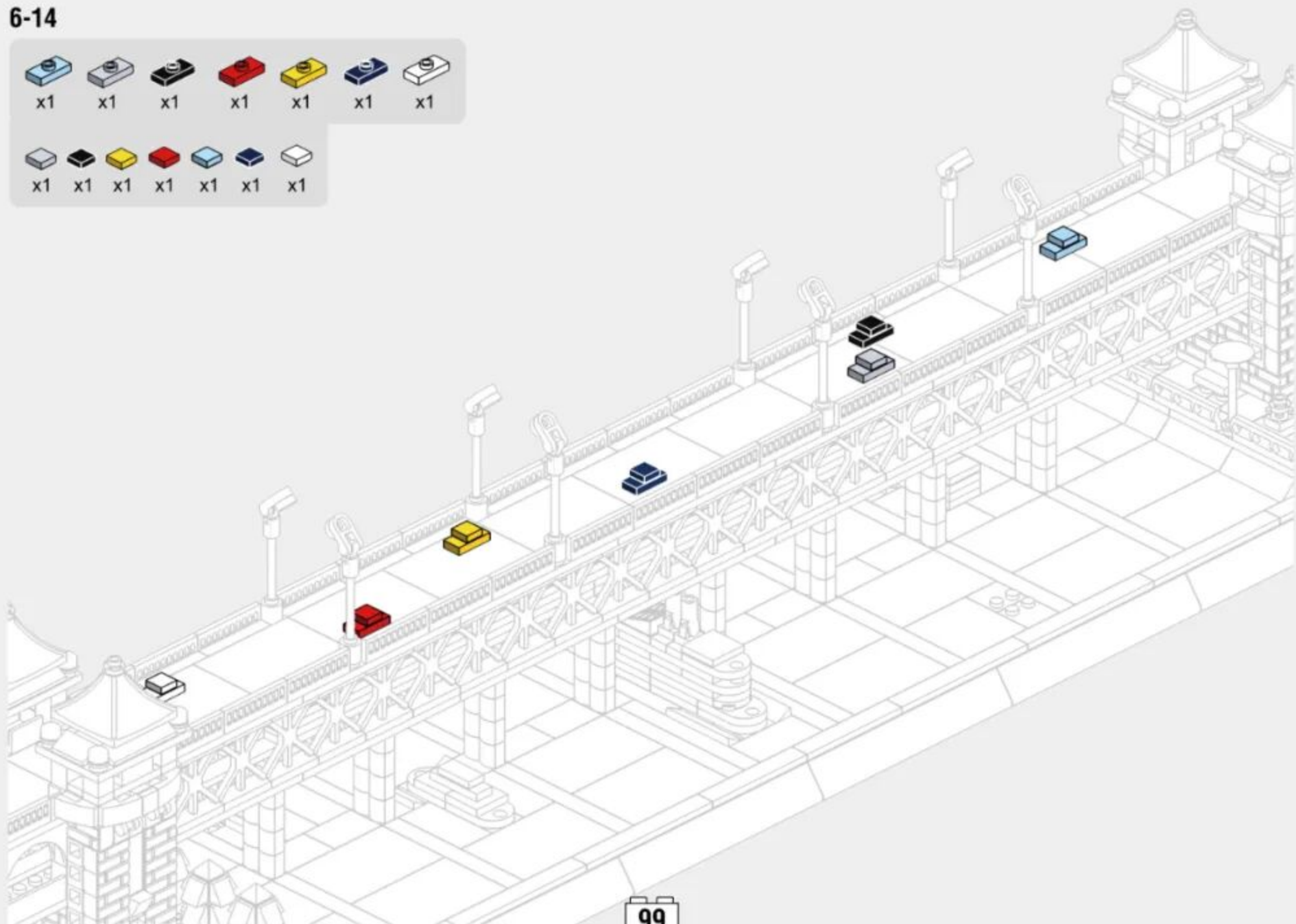

6-15

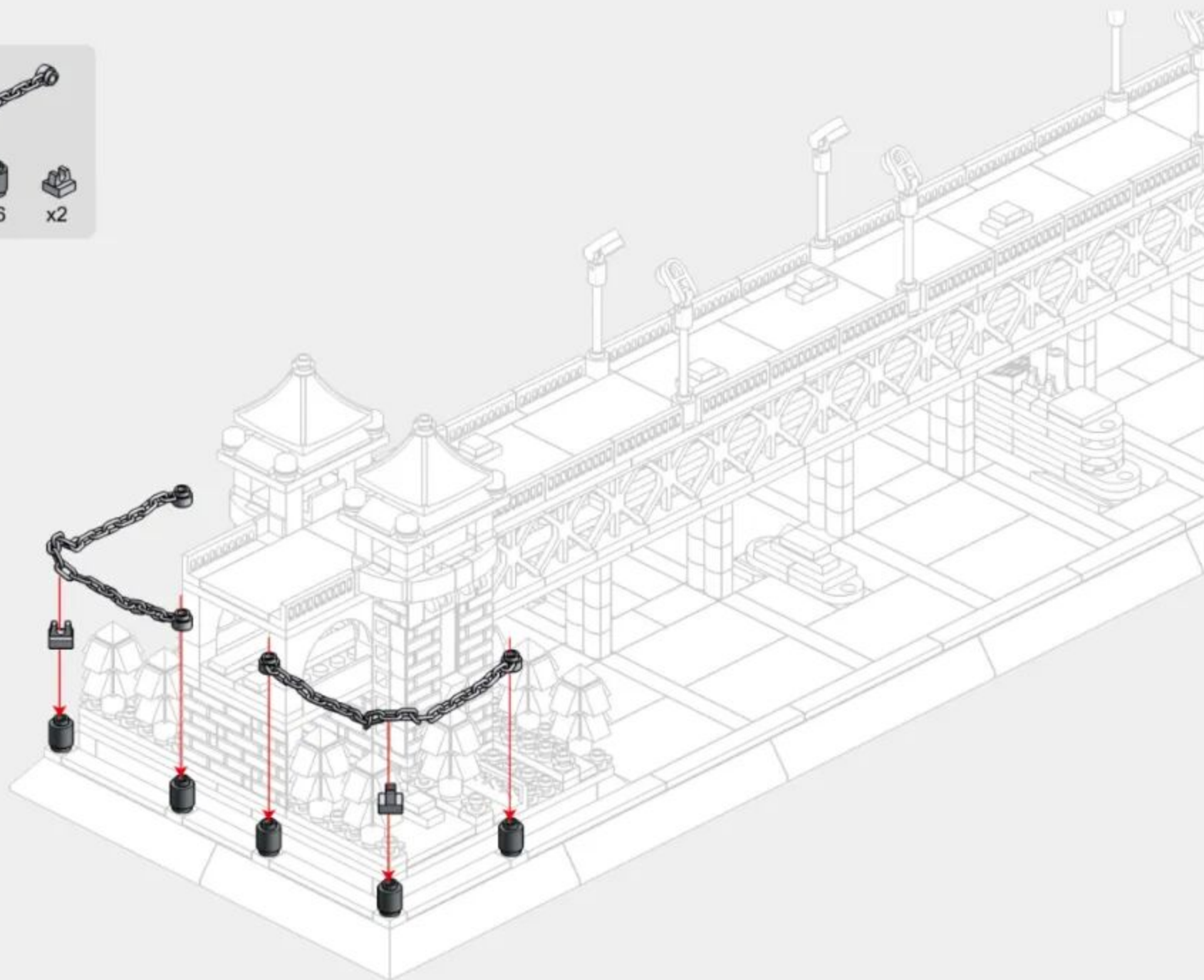

6-16

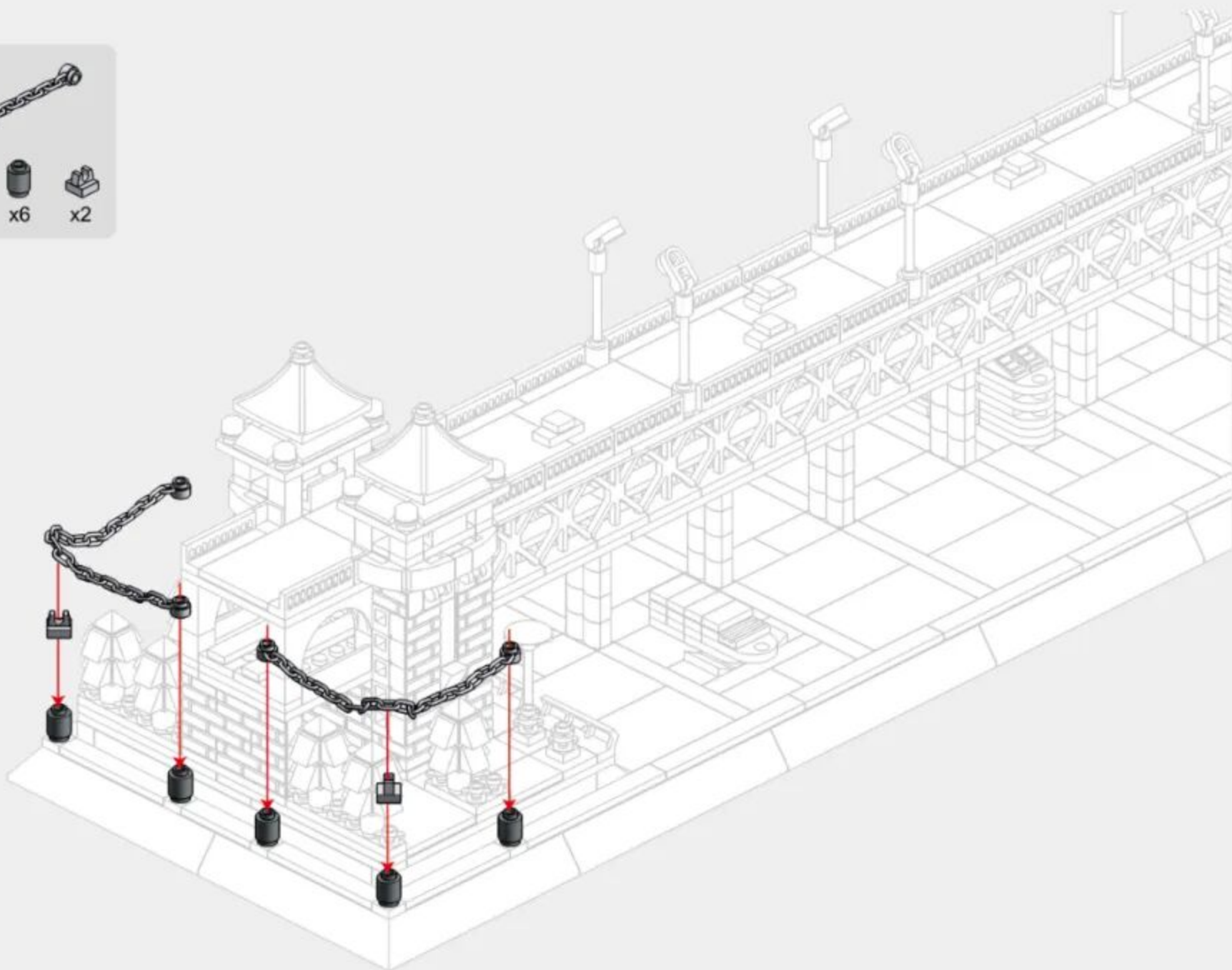

6-17

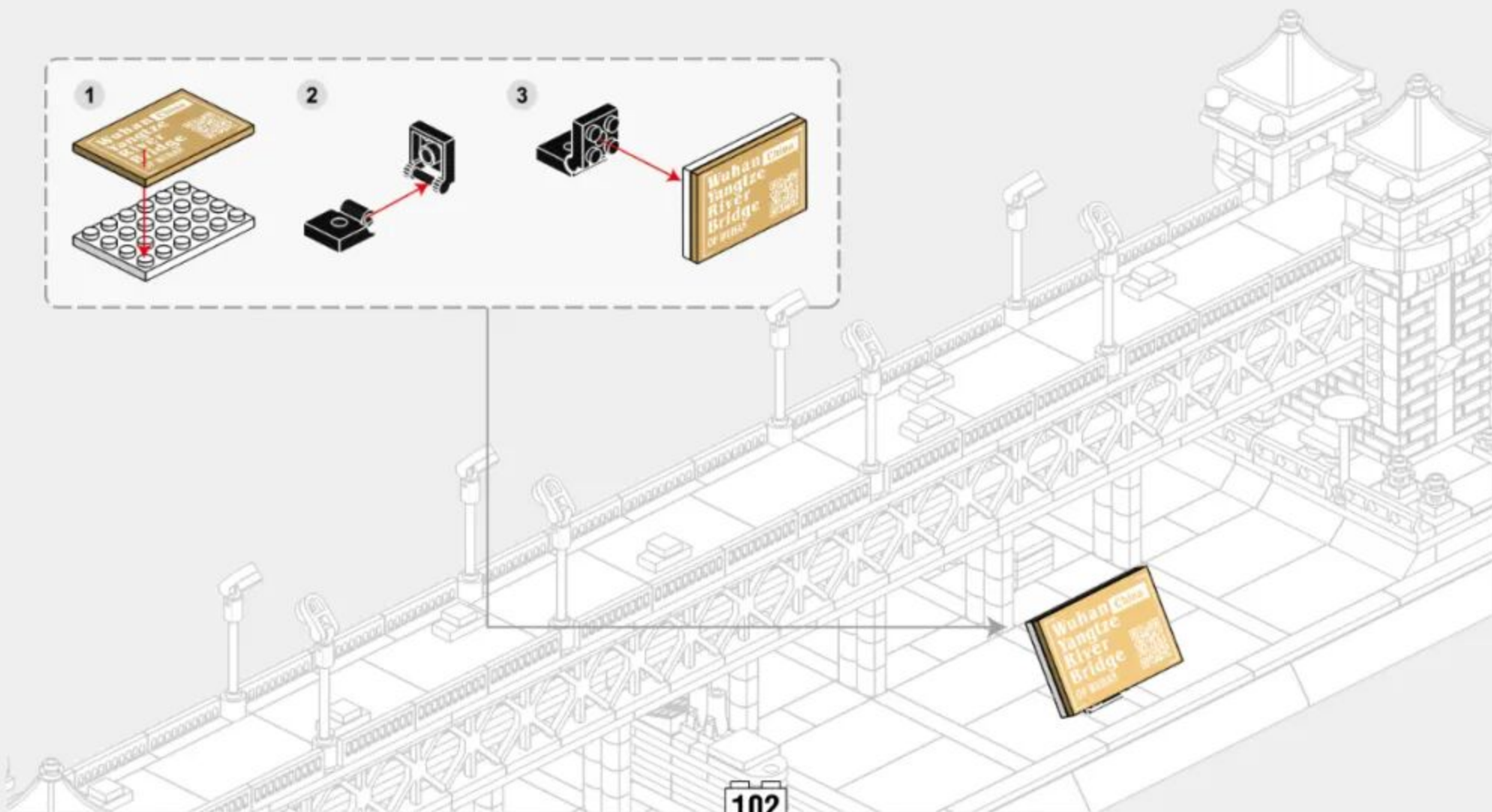
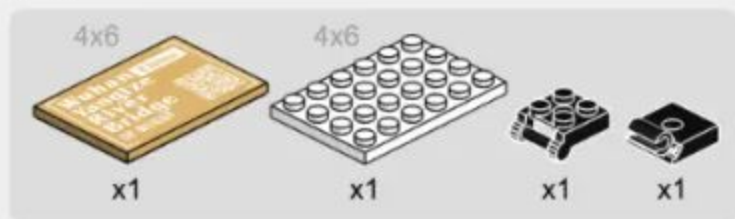

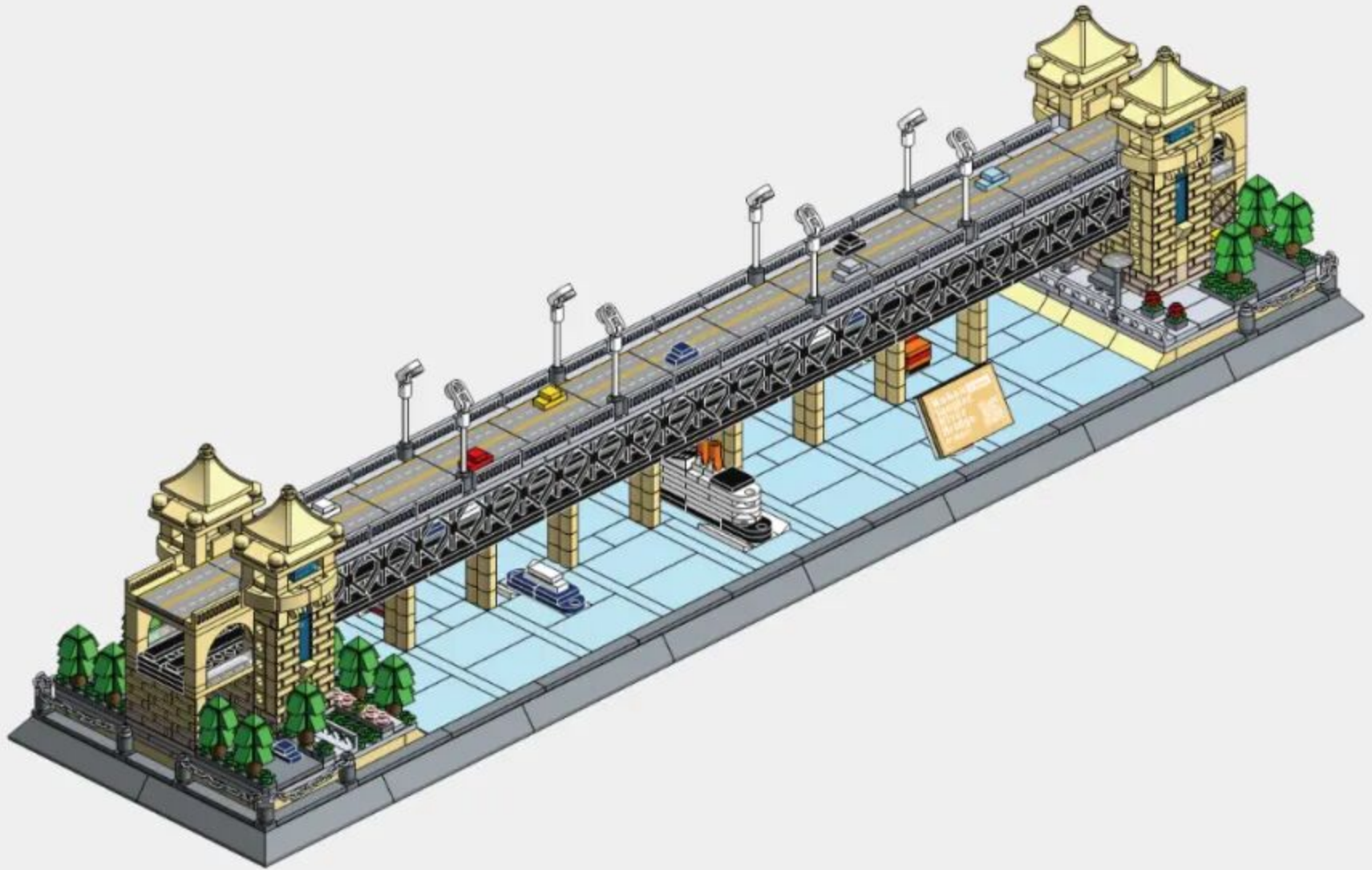

ARCHITECTURE

The World's great architecture



6224 英国伦敦白金汉宫
BUCKINGHAM PALACE-LONDON,ENGLAND



5225 意大利罗马斗兽场
COLOSSEUM-ROME,ITALY



5226 日本东京帝国饭店
IMPERIAL HOTEL-TOKYO,JAPAN



6211 德国柏林勃兰登堡门
BRANDENBURG GATE-BERLIN, GERMANY



6222 中国甘肃长城-嘉峪关
JIAYU PASS-GANSU,CHINA



6212 日本京都清水寺仁王门
NIOMON GATE OF KIYOMIZU-DERA-KYOTO,JAPAN



6214 中国武汉黄鹤楼
YELLOW CRANE TOWER-WUHAN,CHINA



6215 英国伦敦眼
LONDON EYE-LONDON,ENGLAND



6221 中国北京故宫-太和殿
HALL OF SUPREME HARMONY-BEIJING,CHINA



6213 俄罗斯莫斯科瓦西里大教堂
SAINT BASIL'S CATHEDRAL-MOSCOW,RUSSIA



6220 沙特阿拉伯麦加大清真寺
GREAT MOSQUE OF MECCA,SAUDI ARABIA



6219 美国纽约联合国大厦
UNITED NATIONS HEADQUARTERS-NEW YORK,AMERICA



4214 美国华盛顿白宫
WHITE HOUSE-WASHINGTON D.C.,AMERICA



4212 意大利罗马许愿池
TREVI FOUNTAIN-ROME,ITALY



4213 法国巴黎卢浮宫
MUSÉE DU LOUVRE-PARIS,FRANCE



4218 新加坡-鱼尾狮
MERLION,SINGAPORE



4210 埃及开罗吉萨金字塔
GREAT PYRAMID OF GIZA-CAIRO,EGYPT



4219 英国伦敦双子塔桥
TOWER BRIDGE-LONDON,ENGLAND



4216 美国华盛顿林肯纪念堂
LINCOLN MEMORIAL-WASHINGTON D.C.,AMERICA



4217 新加坡-金沙酒店
MARINA BAY SANDS,SINGAPORE



6214 中国武汉黄鹤楼
YELLOW CRANE TOWER-WUHAN,CHINA



4221 加拿大渥太华国会山庄
PARLIAMENT BUILDINGS-OTTAWA,CANADA



4211 英国伦敦伊丽莎白塔
ELIZABETH TOWER-ENGLAND



4220 美国纽约熨斗大厦
FLATIRON BUILDING-NEW YORK,AMERICA



5227 美国纽约自由女神像
STATUE OF LIBERTY-NEW YORK,AMERICA



4215 加拿大多伦多电视塔
THE CN TOWER-CANADA



4222 阿联酋迪拜哈利法塔
THE BURJ KHALIFA TOWER-DUBAI,UAE



5224 中国上海东方明珠广播电视塔
ORIENTAL PEARL TOWER-SHANGHAI,CHINA



5212 美国纽约帝国大厦
EMPIRE STATE BUILDING-NEW YORK,AMERICA



5213 马来西亚吉隆坡石油双塔
PETRONAS TWIN TOWERS-KUALA LUMPUR,MALAYSIA



5214 意大利托斯卡纳比萨斜塔
LEANING TOWER OF PISA-TUSCANY,ITALY



5216 英国伦敦伊丽莎白塔
ELIZABETH TOWER-LONDON ENGLAND



5219 俄罗斯莫斯科克里姆林宫钟楼
SPASSKAYA TOWER-MOSCOW,RUSSIA



5220 阿联酋迪拜卓美亚帆船酒店
BURJ AL ARAB HOTEL-DUBAI,UAE



5217 法国巴黎埃菲尔铁塔
EIFFEL TOWER-PARIS,FRANCE



5221 中国台北101大楼
TAIPEI 101-TAIPEI,CHINA



6223 中国武汉长江大桥
WUHAN YANGTZE RIVER BRIDGE



5210 法国巴黎圣母院大教堂
CATHÉDRALE NOTRE DAME DE PARIS-PARIS, FRANCE



5223 法国巴黎凯旋门
ARC DE TRIOMPHE-PARIS, FRANCE



5211 印度阿格拉泰姬陵
TAJ MAHAL-AGRA, INDIA



5215 英国伦敦双子塔桥
TOWER BRIDGE-LONDON, ENGLAND



5222 中国北京天坛祈年殿
HALL OF PRAYER FOR GOOD HARVESTS-BEIJING, CHINA



6210 美国旧金山金门大桥
GOLDEN GATE BRIDGE-SAN FRANCISCO, AMERICA



6216 中国北京万里长城（八达岭）
THE GREAT WALL-BEIJING, CHINA



5218 中国北京天安门
TIAN'ANMEN TOWER-BEIJING, CHINA



6217 中国西藏布达拉宫
POTALA PALACE-TIBET, CHINA



6218 芬兰罗瓦涅米圣诞老人办公室
SANTA CLAUS OFFICE-ROVANIEMI, FINLAND



6225 墨西哥库库尔坎玛雅金字塔
EL CASTILLO-KUKULKAN, MEXICO



6226 德国巴伐利亚新天鹅堡
SCHLOSS NEUSCHWANSTEIN, BAYERN, DEUTSCHLAND

WUHAN YANGTZE RIVER BRIDGE

COUNTRY: China
CITY: Wuhan



微信扫一扫
补件更简单



Ver: 0223210818