

EL CASTILLO

TEMPLO DE KUKULKÁN

Kukulkan, Mexico

The world's great architecture



6+ / 6225 / 1346 PCS
Suitable Age / Product Number / Parts Total



Architecture

It will be a city...

这将构成一座城市...

ABOUT THE PRODUCT

关于产品

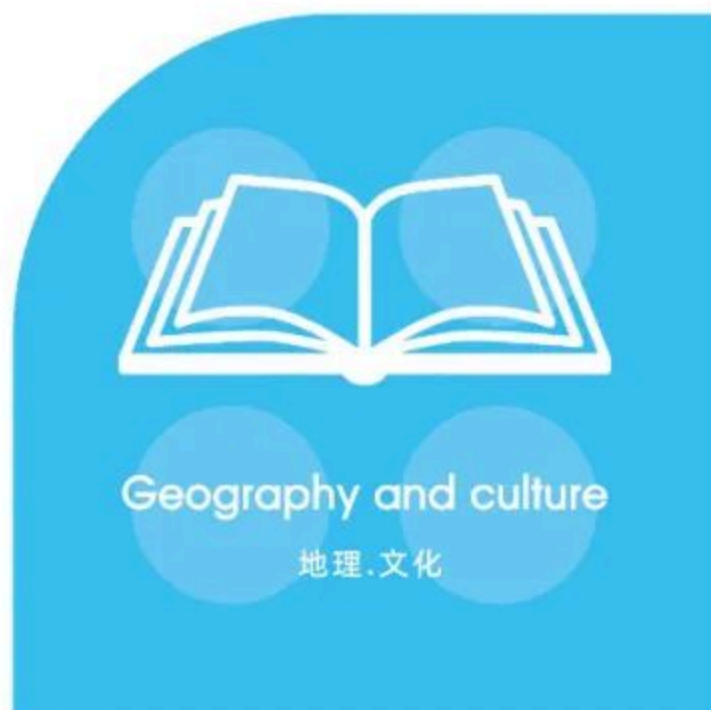

ARCHITECTURE

WANGE The world's great architect since 1991

El Castillo



El Castillo, known as the Temple of Kukulcán (or also just as Kukulcán), is a Mesoamerican step-pyramid that dominates the center of the Chichen Itza archaeological site in the Mexican state of Yucatán.

El Castillo



Geography and culture

地理·文化



Built by the pre-Columbian Maya civilization sometime between the 8th and 12th centuries AD, the pyramid served as a temple to the deity Kukulcán, the Yucatec Maya Feathered Serpent deity closely related to Quetzalcoatl, a deity known to the Aztecs and other central Mexican cultures of the Postclassic period.

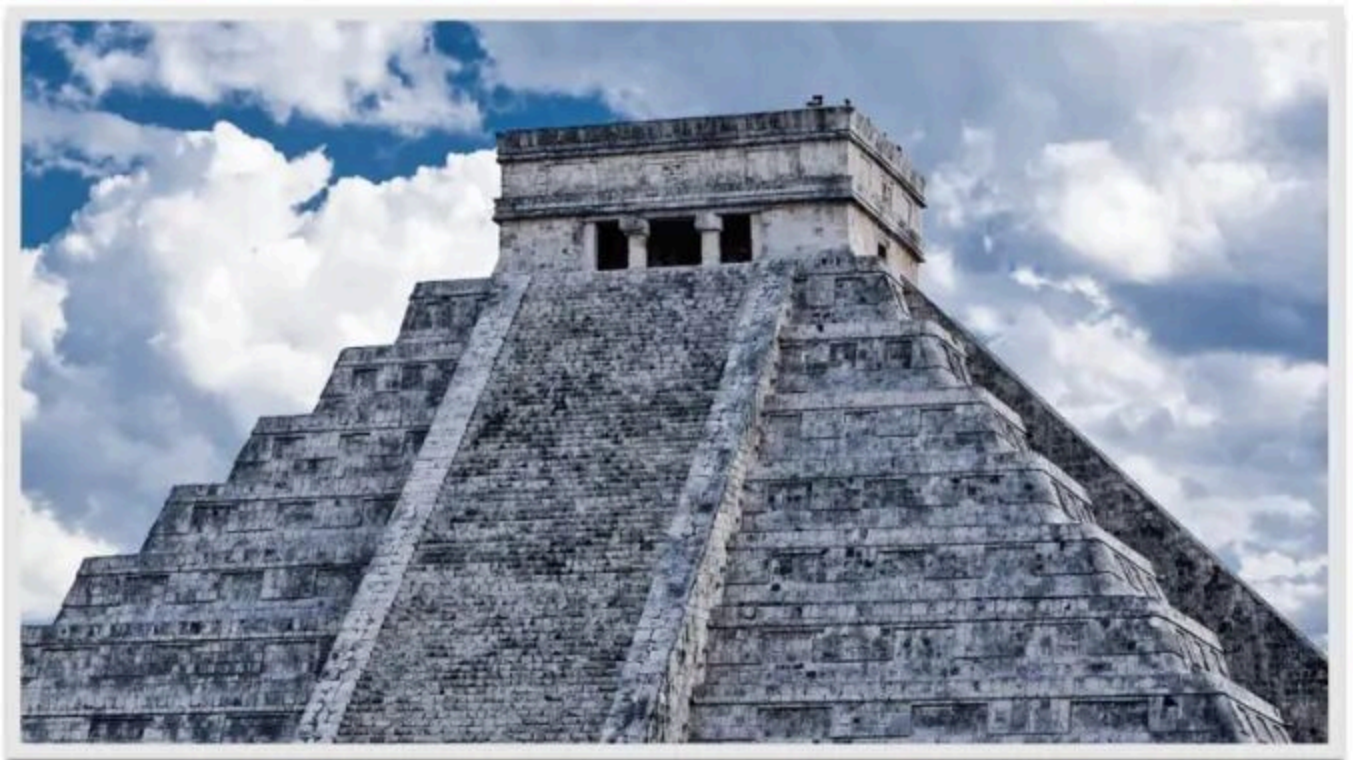



Templo de Kukulcán

El Castillo ■

Mexico

The contents of this chapter refer to the Wikipedia website.

本章内容参考维基百科网站，更多资讯可自行查阅。

The world's great architecture

Buildings and layout

■ 建筑物和布局



El Castillo (estructura también conocida con el nombre de, debido a que los conquistadores españoles en el siglo XVI buscaban alguna similitud arquitectónica con las existentes en el continente europeo), es un edificio prehispánico ubicado en la península de Yucatán, en el actual estado del mismo nombre. El actual templo se construyó en el siglo XII d. por los mayas itzaes en su capital, la ciudad de Chichén Itzá, fundada originalmente en el siglo VI d. Su diseño tiene una forma geométrica piramidal; cuenta con nueve niveles o basamentos, cuatro fachadas principales, cada una con una escalinata central, y una plataforma superior, rematada por un templete.

The pyramid consists of a series of square terraces with stairways up each of the four sides to the temple on top. Sculptures of plumed serpents run down the sides of the northern balustrade. Around the spring and autumn equinoxes, the late afternoon sun strikes off the northwest corner of the pyramid and casts a series of triangular shadows against the northwest balustrade, creating the illusion of the feathered serpent "crawling" down the pyramid.



Symbolism

En comparación con la pirámide de Keops en Egipto, o incluso con la pirámide del Sol de Teotihuacan, las dimensiones de la pirámide de Kukulcán son pequeñas. En cuanto a la altura, la pirámide de Keops mide aproximadamente 147 m y la del Sol, 65 m sin incluir los supuestos 10 metros que tendría su templete; por su parte, la altura de 55,3 m en las bases de sus fachadas.

All four sides of the pyramid have approximately 91 steps which, when added together and including the temple platform on top as the final "step", may produce a total of 365 steps (the steps on the south side of the pyramid are eroded). That number is equal to the number of days of the Haab' year and likely is significantly related to rituals.



Design and construction

Cuatro fachadas principales, cada una con una escalinata central, y una plataforma superior, rematada por un templete. En esta construcción, se rindió culto a la entidad maya Kukulcán (en idioma maya: Serpiente Emplumada), razón por la cual se pueden apreciar motivos serpentinos en la decoración arquitectónica. Por otra parte, también cuenta con simbolismos que hacen alusión a los números más importantes utilizados en el calendario solar agrícola, el calendario Tzolkin (calendario sagrado) y la rueda calendárica. La alineación de la construcción de la pirámide permite que se puedan observar diversos fenómenos de luz y sombra, los cuales se producen en su propio cuerpo durante los equinoccios y solsticios cada año.

El Castillo like other Mesoamerican pyramids, likely reflected the common practice by the Maya of executing several phases of construction for their temples. Based on archaeological research, construction of Kukulcán was based on the concept of axis mundi. Anthropologists think that the site remained sacred regardless of how the structure was positioned on the location.

Force Balance

受力平衡

Physical operations

物理运算

$$F = G \frac{m_1 m_2}{d^2}$$



Creation and thinking

创作·思考

08

Special parts

特殊零件的开发利用

$$S=4\pi \cdot r^2$$



$$a^2+b^2=c^2$$

WG1244

短椅后4孔

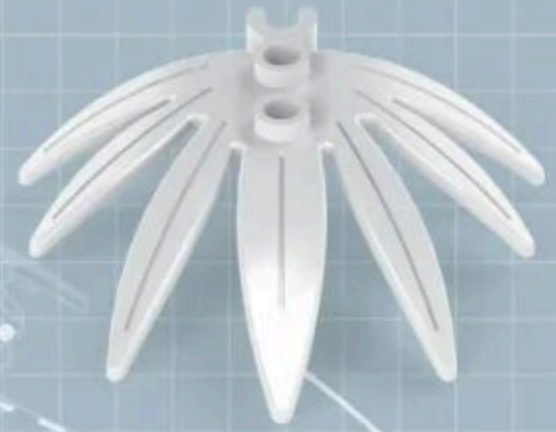

WG1177

大树叶



WG1394

三叶片



WG1604

三叶草



WG1026

竹子



WG1178

海草



WG1508

带槽直角矮3孔



WG1556

2孔3高车窗玻璃1X2X3



WG1371

X架5倍高6孔

$$\sin^2 a + \cos^2 a = 1$$



features and functions

特点.功能

Main Color Matching

配色方案



Pantone 3435C



Pantone 383C



Pantone 2300C



Pantone 348C



Pantone 2422C



Pantone 189C



Pantone 477C



Pantone 7585C



Pantone 2312C



Pantone 1575C



Pantone 109C



Pantone 7500C



Pantone Black 6C



Pantone 431C



Pantone Cool Gray 6C



Color matching

Adopting 4 main colors, Tan, Dark Tan, Light Brown and Bright Green as the main color, the more reasonable and bold color matching on the original building, making the product more atmospheric and the whole design is more reasonable.

El Castillo

Templo de Kukulcán



Front

Left

Back

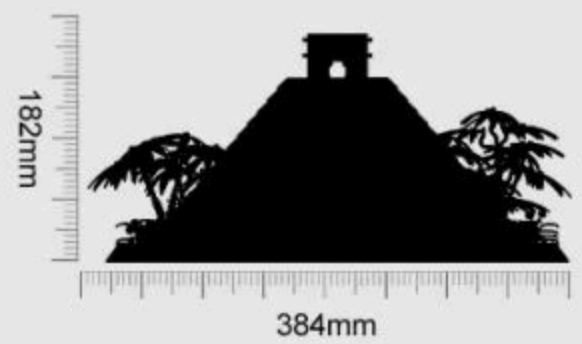
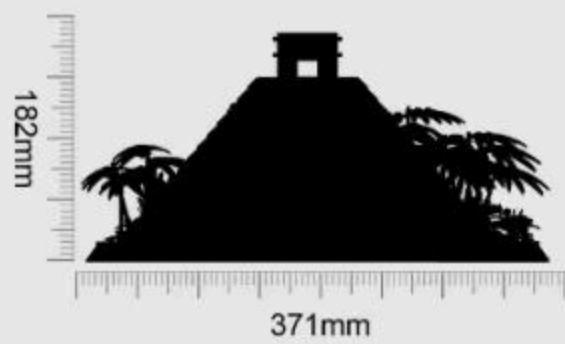
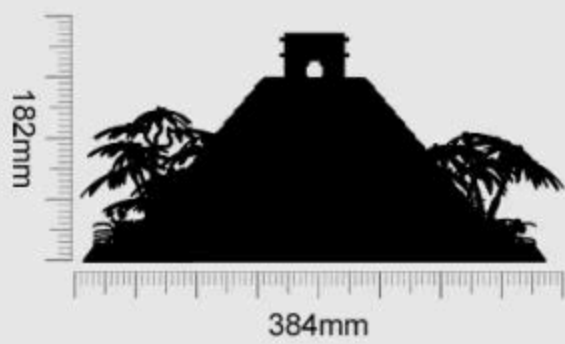

Product Size:384X371X182mm





■ First open the product packaging according to the instructions.

按指导用正确方式拆解产品外包装。



■ Summarize all parts to count the number of familiar accessories.

对照说明书清单确认积木包数量与积木数量。



■ Arranging all accessories by color helps to quickly install the product.

把确认好的积木以类型、颜色进行分类排好以便安装。



■ Carefully install the product and learn about building.

按说明书步骤拼装并完成你的积木模型。



1:1 Physical Reference Table

十字棒配件1:1尺寸参照表



Instructions For Use

让安装更简单

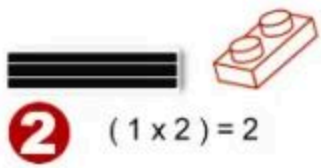

2 $(1 \times 2) = 2$

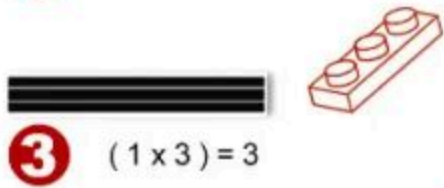

3 $(1 \times 3) = 3$

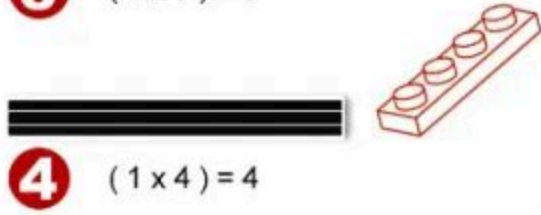

4 $(1 \times 4) = 4$

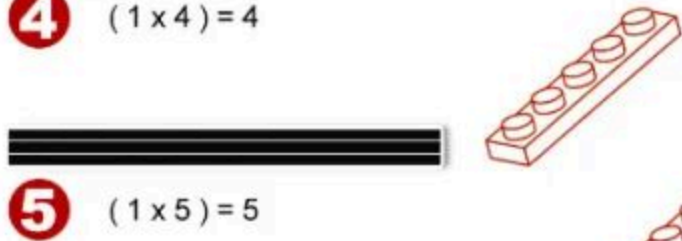

5 $(1 \times 5) = 5$



6 $(1 \times 6) = 6$



7 $(1 \times 7) = 7$



8 $(1 \times 8) = 8$



9 $(1 \times 9) = 9$



10 $(1 \times 10) = 10$



12 $(1 \times 12) = 12$











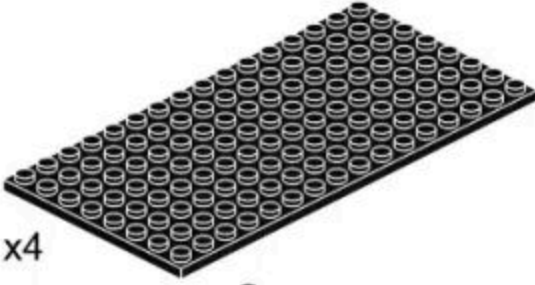





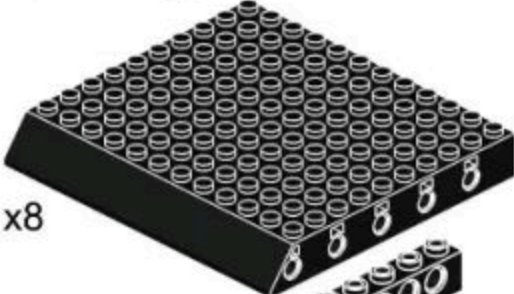











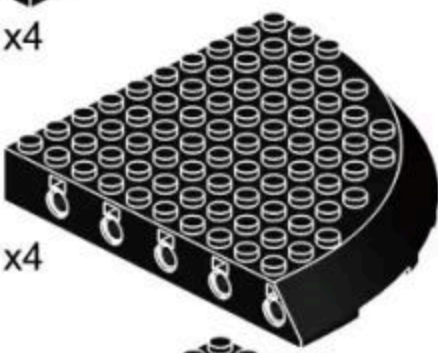



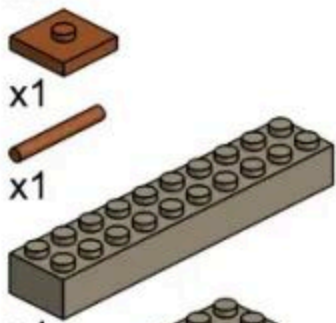
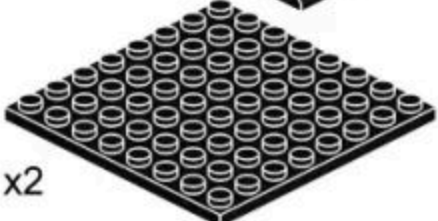

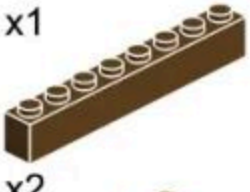

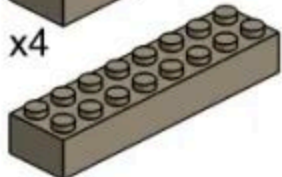
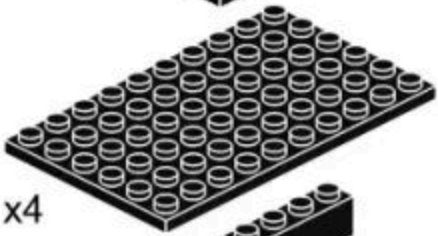

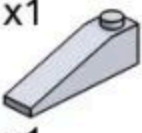

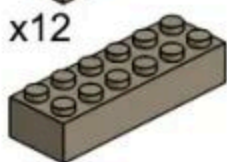

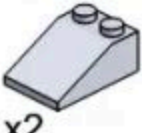

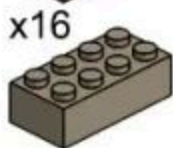







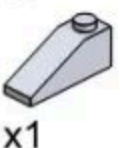

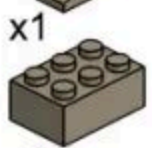
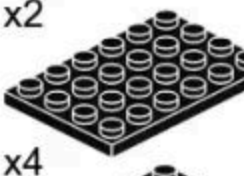



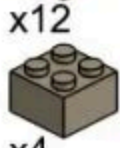



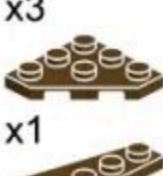

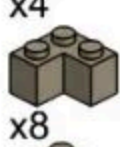

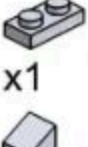
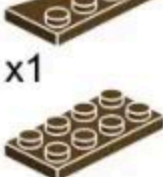

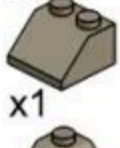











16 $(1 \times 16) = 16$



PARTS LIST

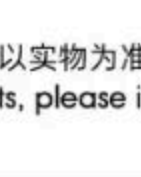









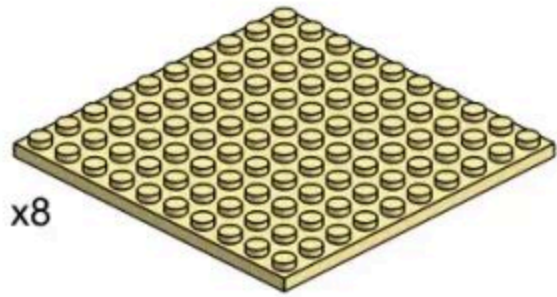
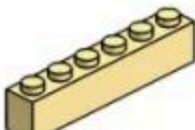

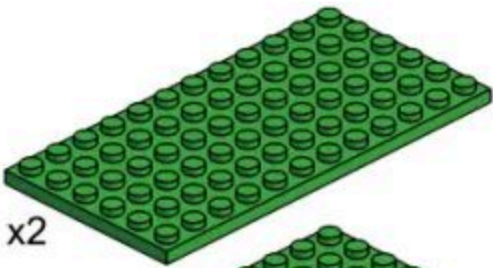

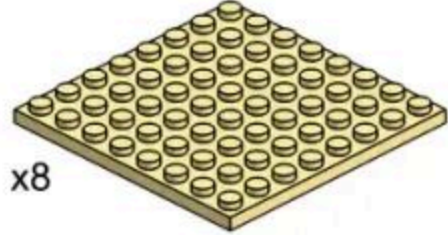
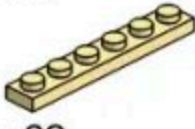



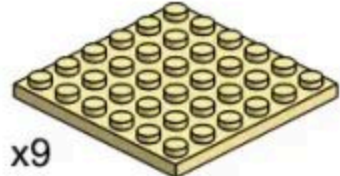

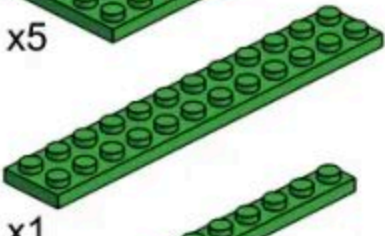

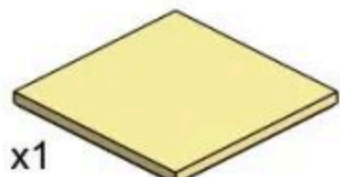

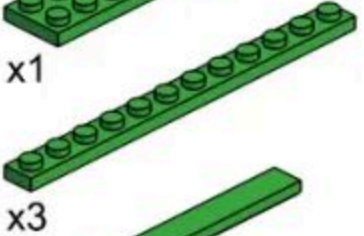

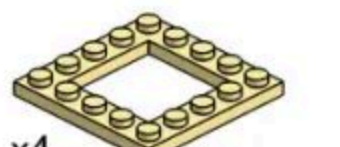

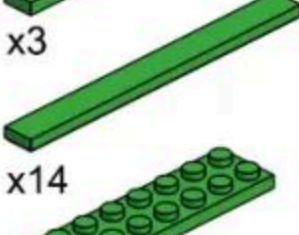

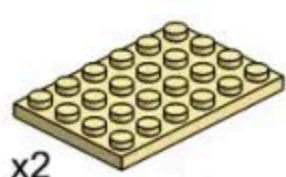

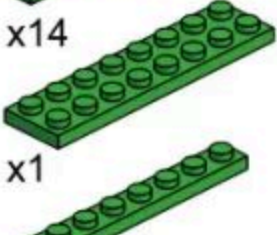

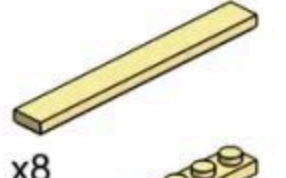

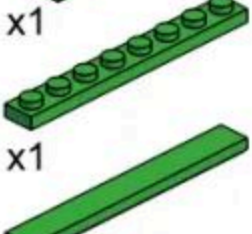
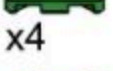

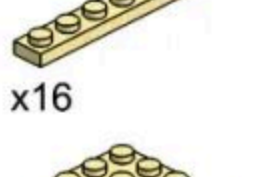

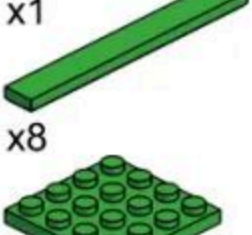

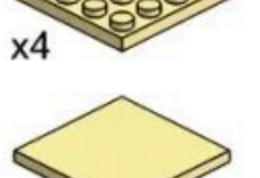

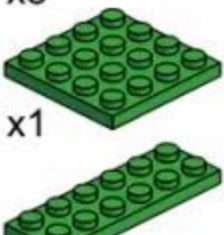

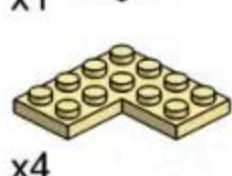

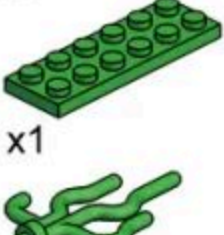

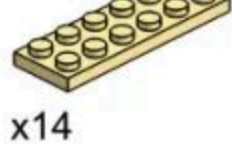

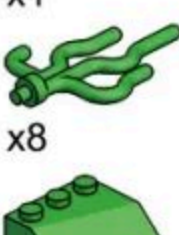





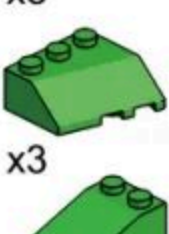





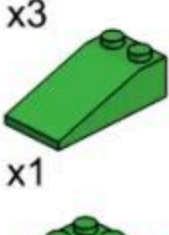

配件清单

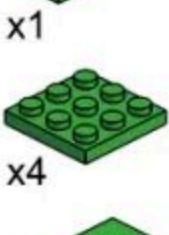
 x4	 x8	 x1	 x1	 x1	 x11
 x8	 x4	 x1	 x2	 x2	 x1
 x4	 x2	 x1	 x1	 x2	 x2
 x4	 x8	 x1	 x1	 x1	 x4
 x2	 x4	 x1	 x2	 x3	 x12
 x4	 x4	 x1	 x2	 x1	 x16
 x3	 x8	 x2	 x1	 x5	 x12
 x4	 x1	 x1	 x2	 x2	 x1
 x3	 x4	 x1	 x3	 x1	 x12
 x4	 x28	 x2	 x1	 x4	 x4
 x2	 x4	 x1	 x1	 x3	 x8
 x4	 x8	 x7	 x1	 x3	 x1
 x14	 x2	 x8	 x3	 x3	 x1
	 x8	 x2	 x2	 x3	 x3
	 x8	 x52	 x2	 x13	 x20
		 x16	 x2	 x3	 x1

产品有增补件请以实物为准
If product has additional parts, please in kind prevail.

PARTS LIST

配件清单

 x8	 x2	 x4	 x2	 x3	 x31
 x8	 x62	 x6	 x5	 x2	 x10
 x9	 x25	 x20	 x1	 x3	 x2
 x1	 x4	 x8	 x3	 x3	 x11
 x4	 x4	 x96	 x14	 x4	 x1
 x4	 x4	 x6	 x1	 x3	 x20
 x2	 x24	 x4	 x1	 x4	 x22
 x8	 x2	 x2	 x8	 x5	 x10
 x16	 x48	 x7	 x1	 x4	 x1
 x4	 x3	 x2	 x8	 x2	 x3
 x1	 x22	 x2	 x3	 x3	 x1
 x4	 x8	 x2	 x1	 x1	 x8
 x14	 x2	 x32	 x4	 x4	 x4
	 x8	 x21	 x1	 x4	 x1
	 x11	 x2		 x4	
		 x2		 x9	

产品有增补件请以实物为准

If product has additional parts, please in kind prevail.



274PCS

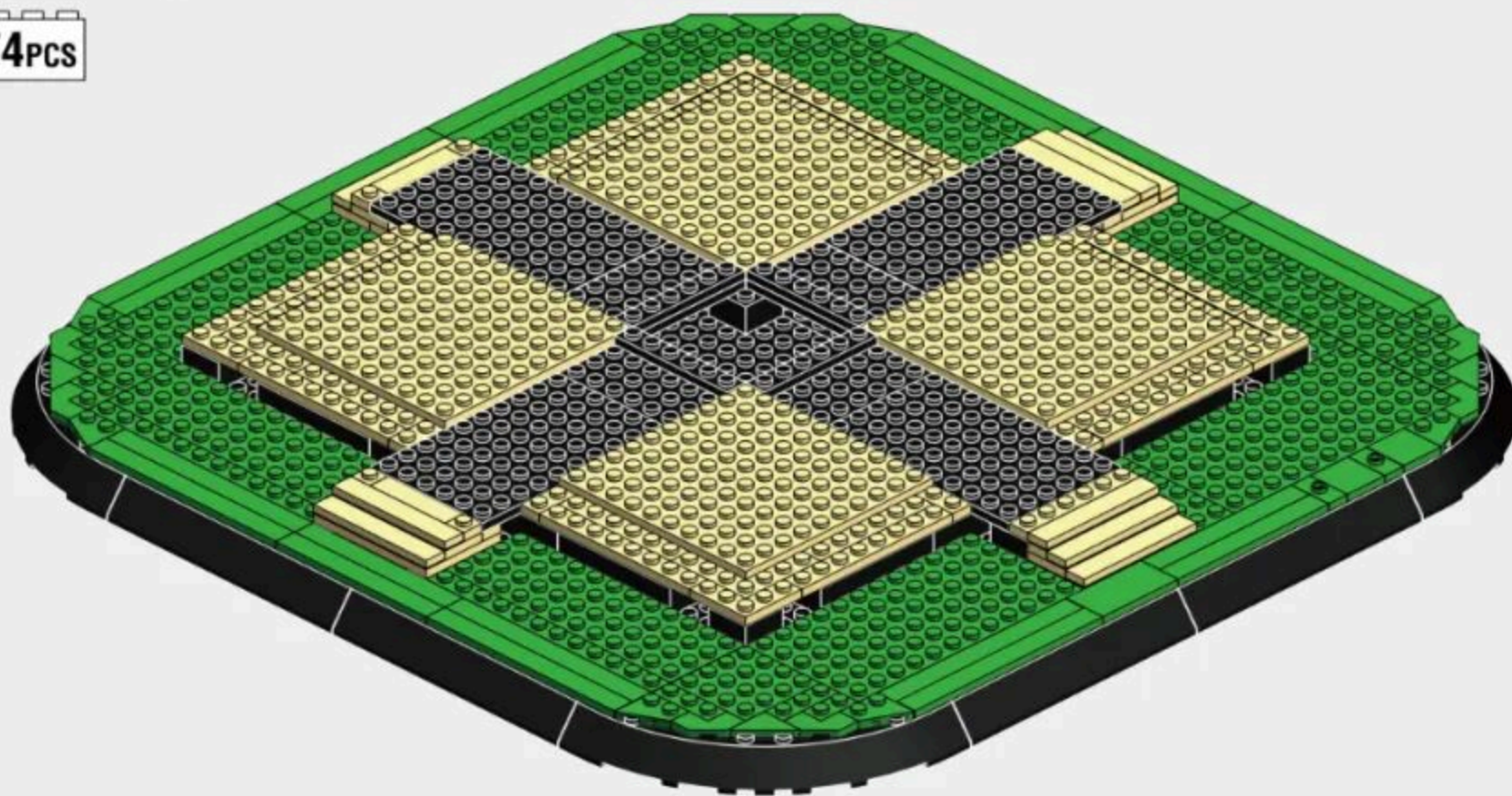

1-1

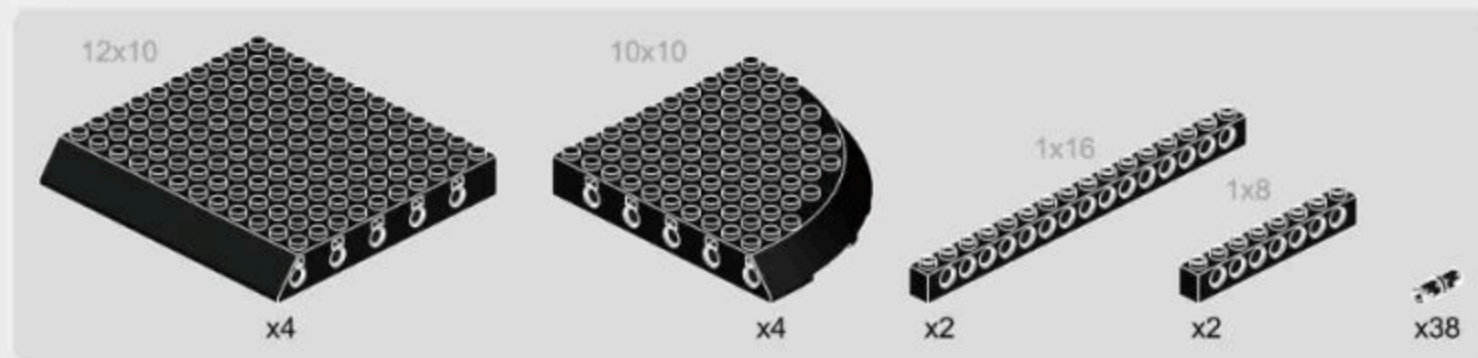

微信扫一扫
补件更简单

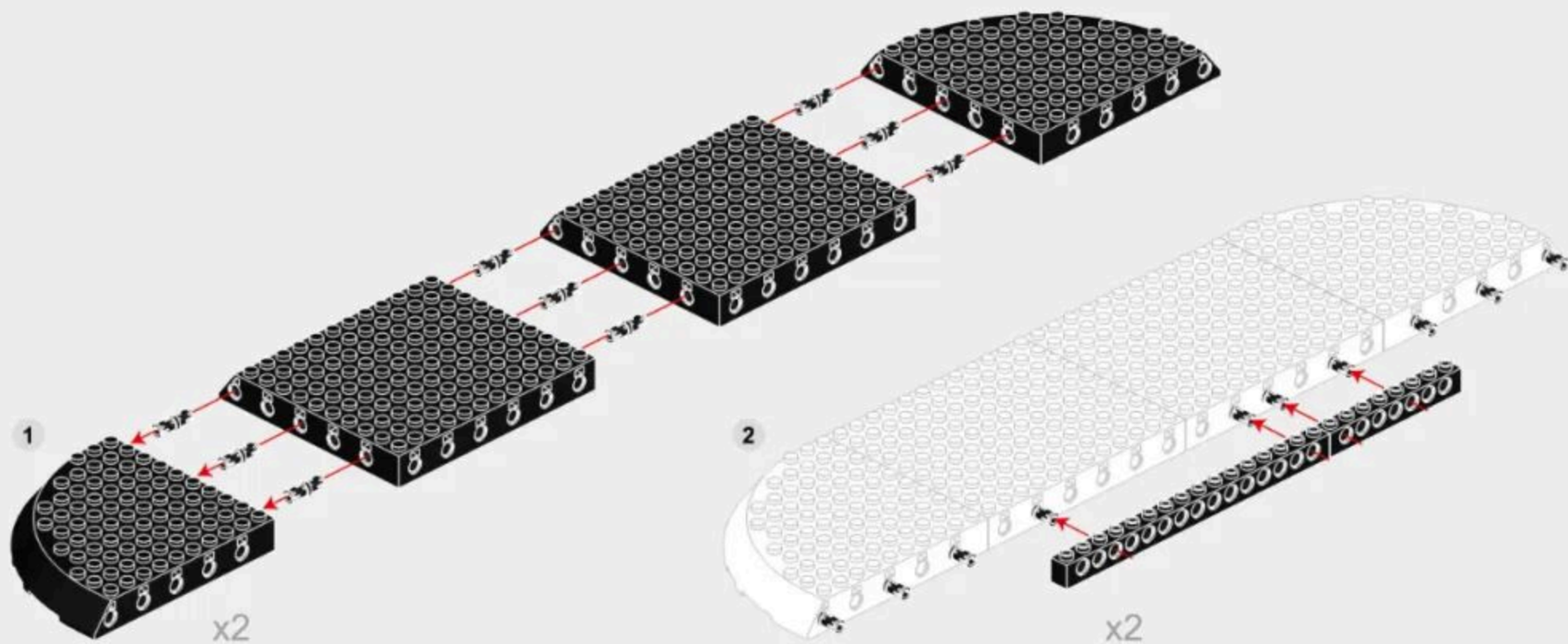

1-2

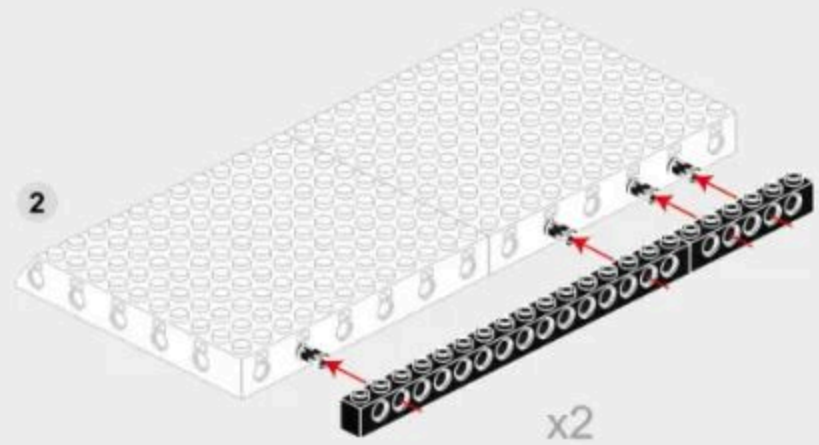
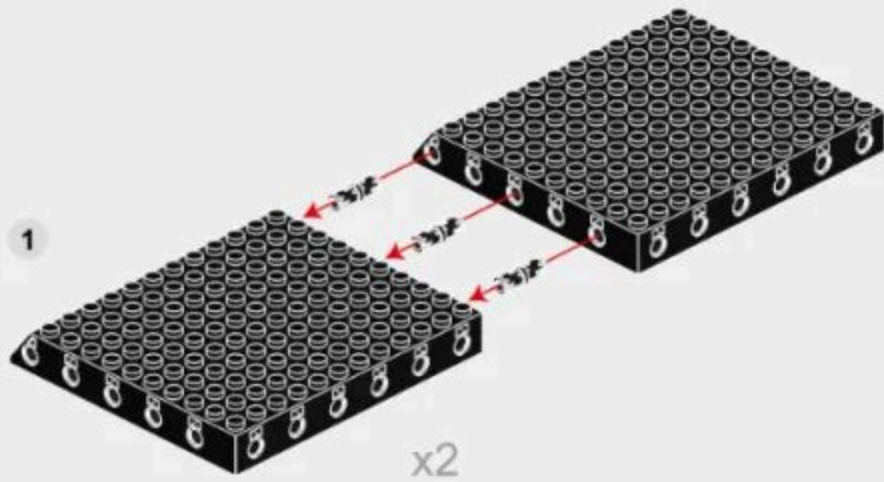
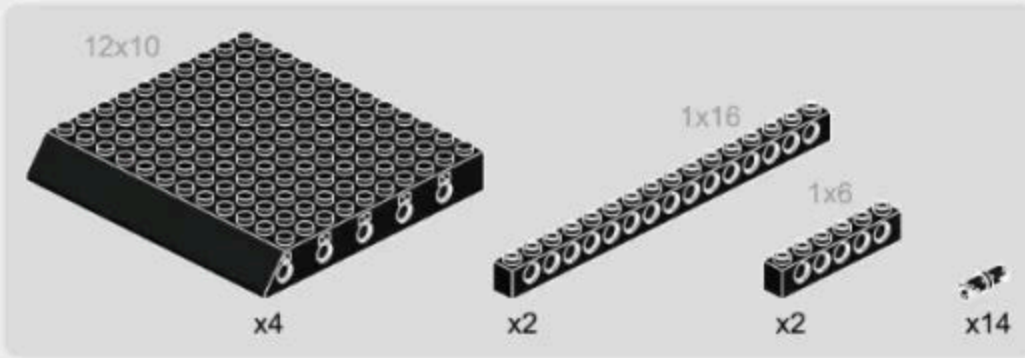

1-3

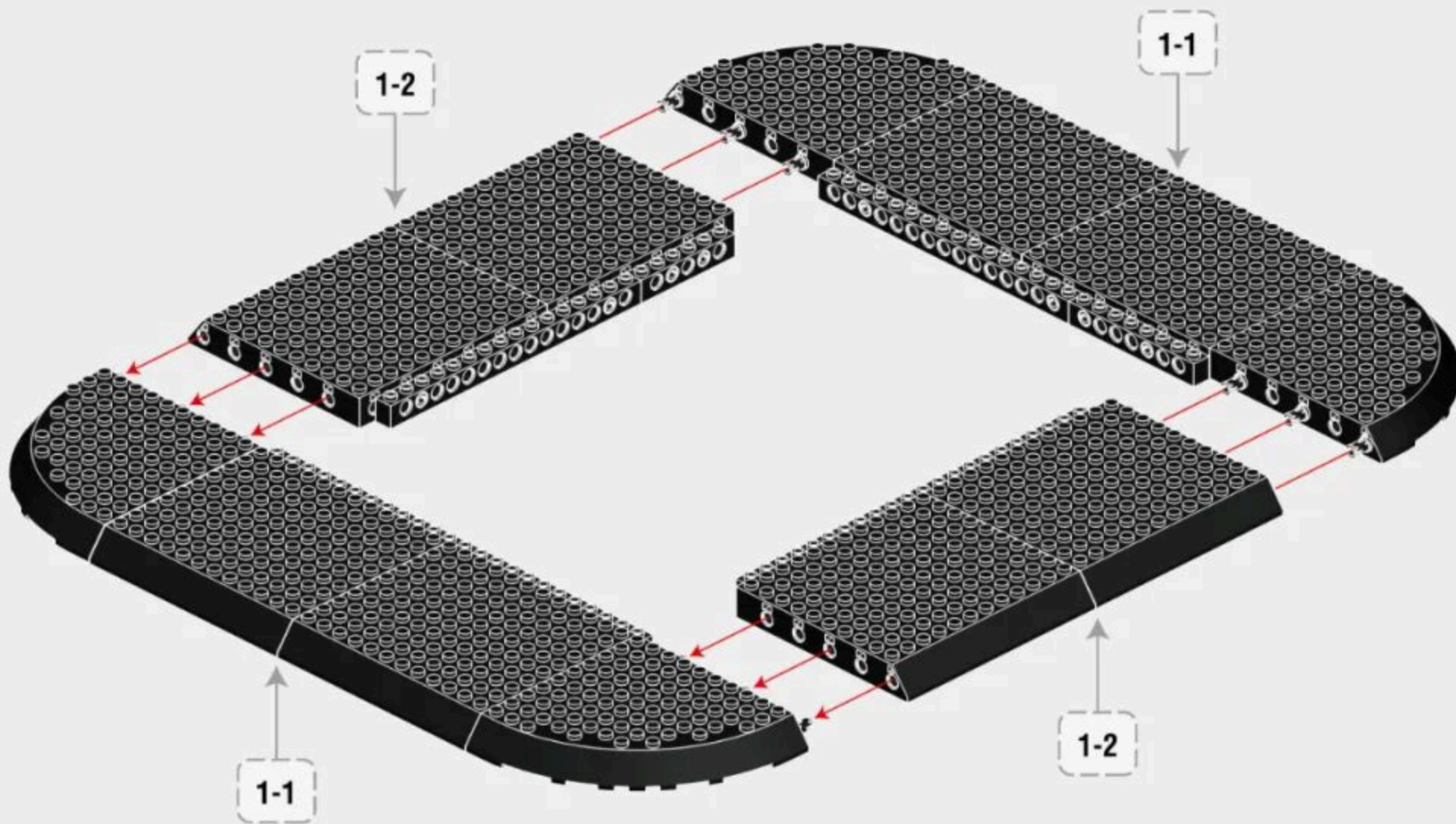

1-4

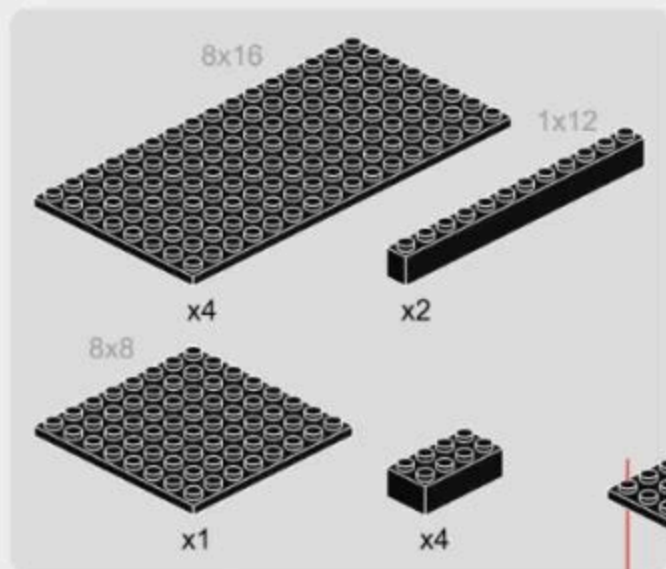

Back Side of Installation Drawing
安装图背面

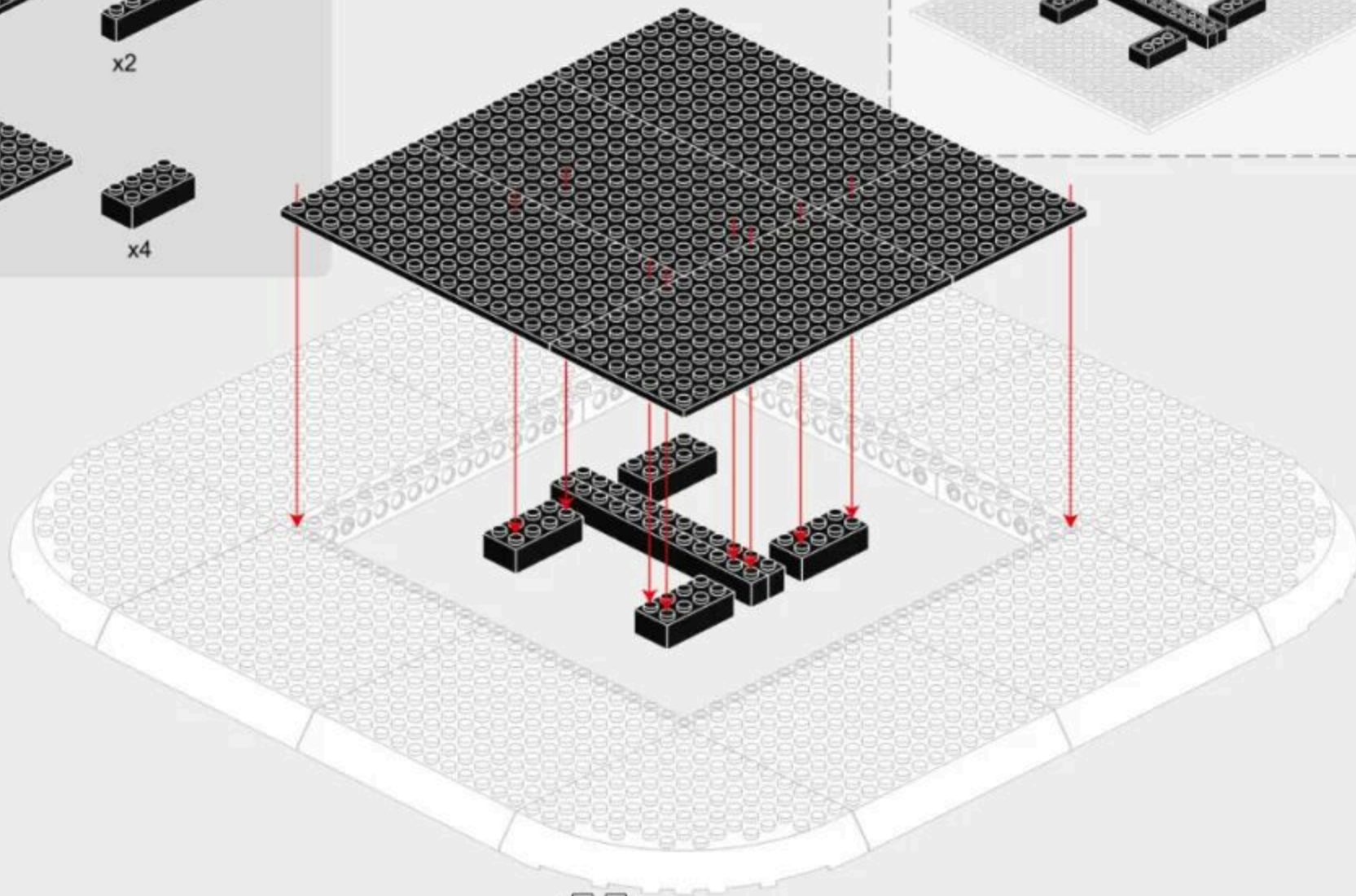
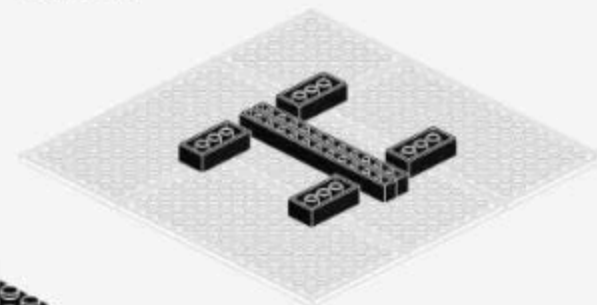

1-5

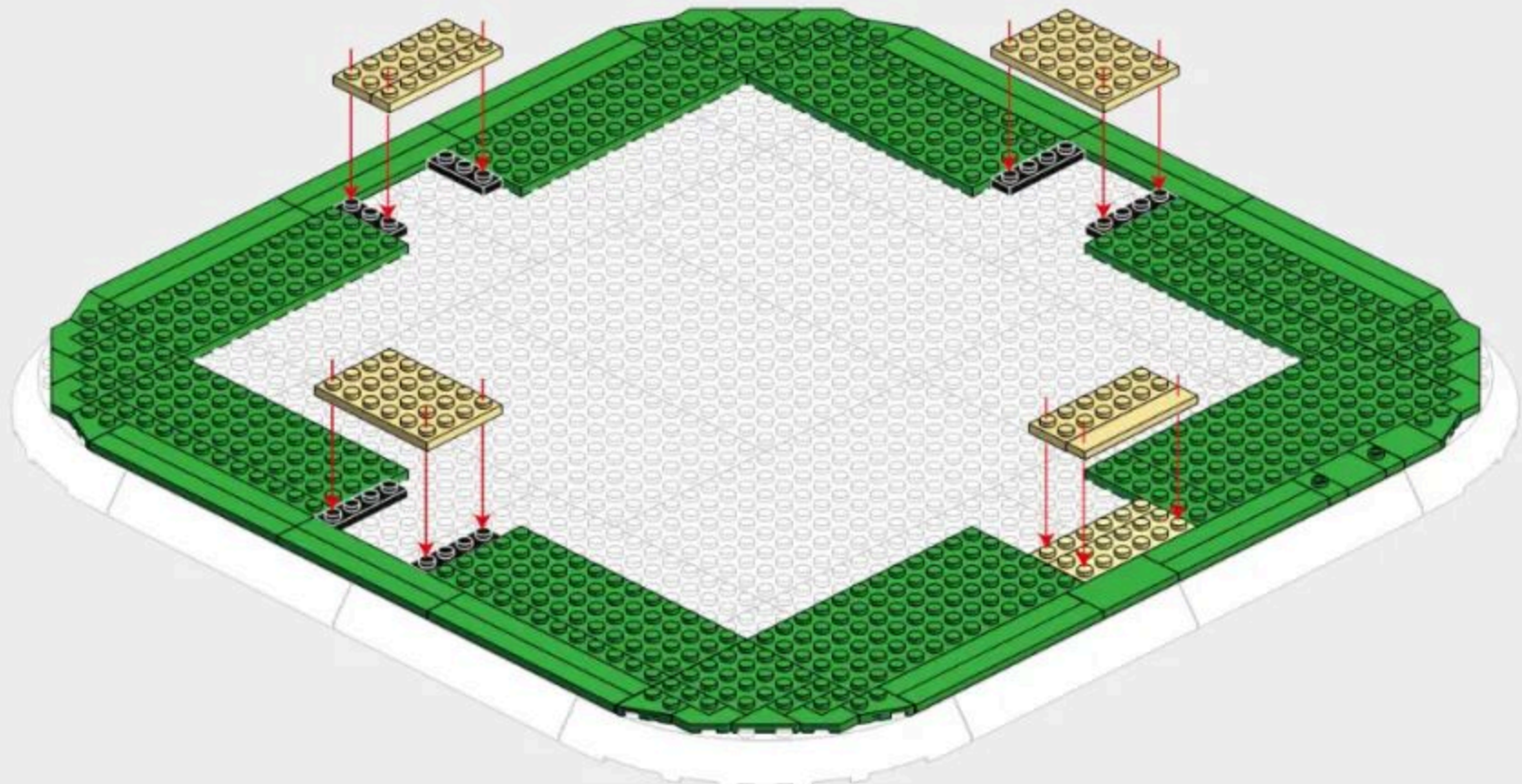
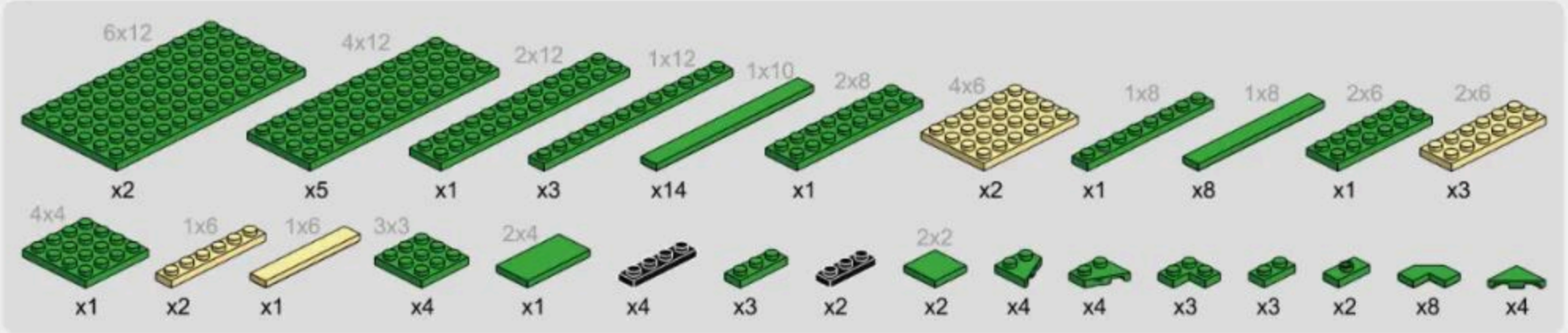

1-6

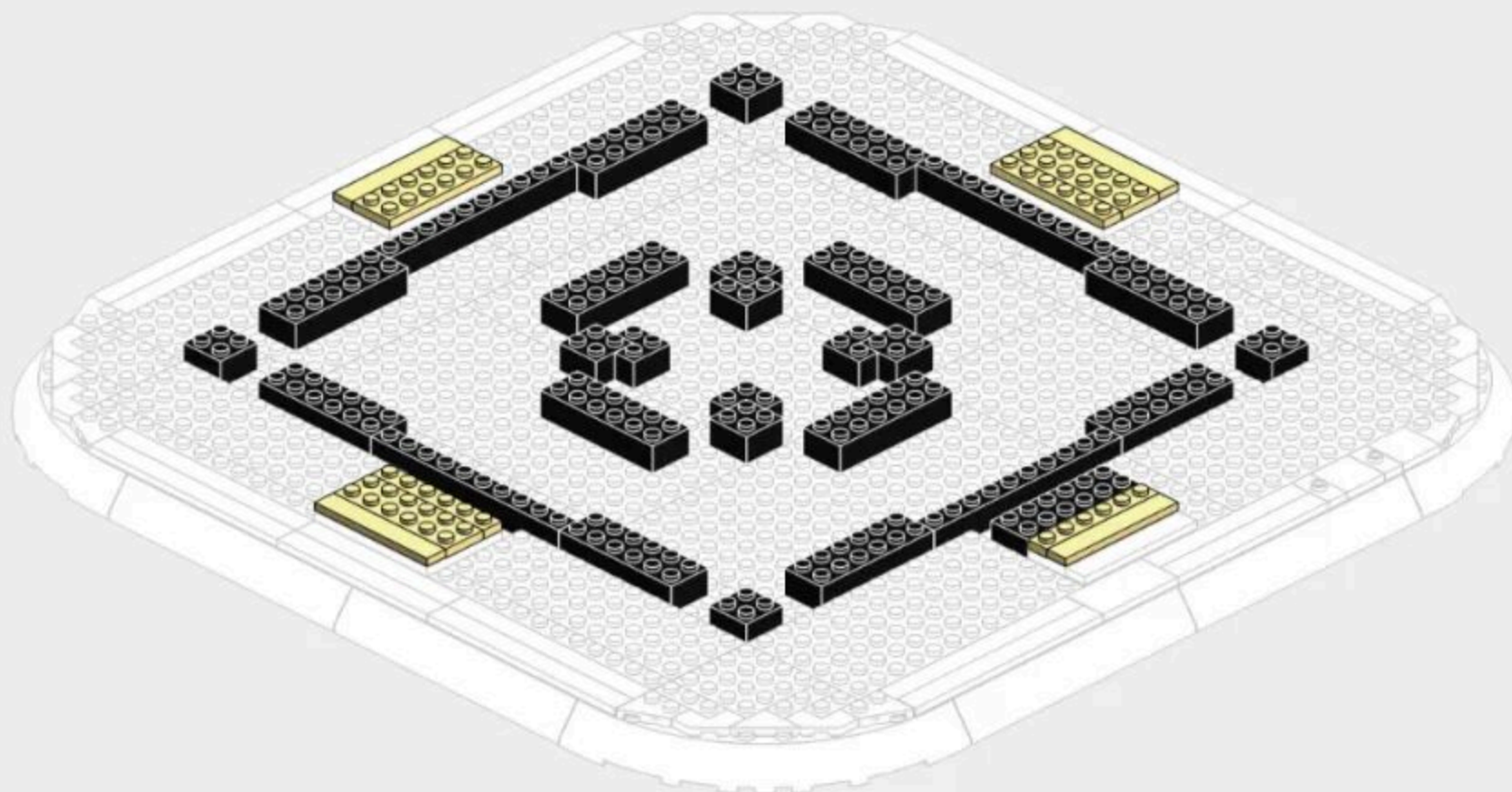
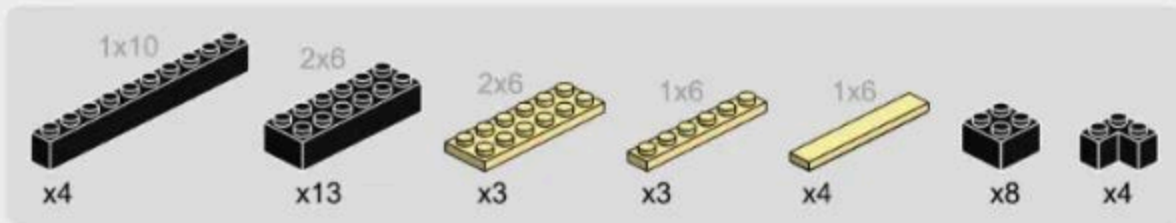

1-7

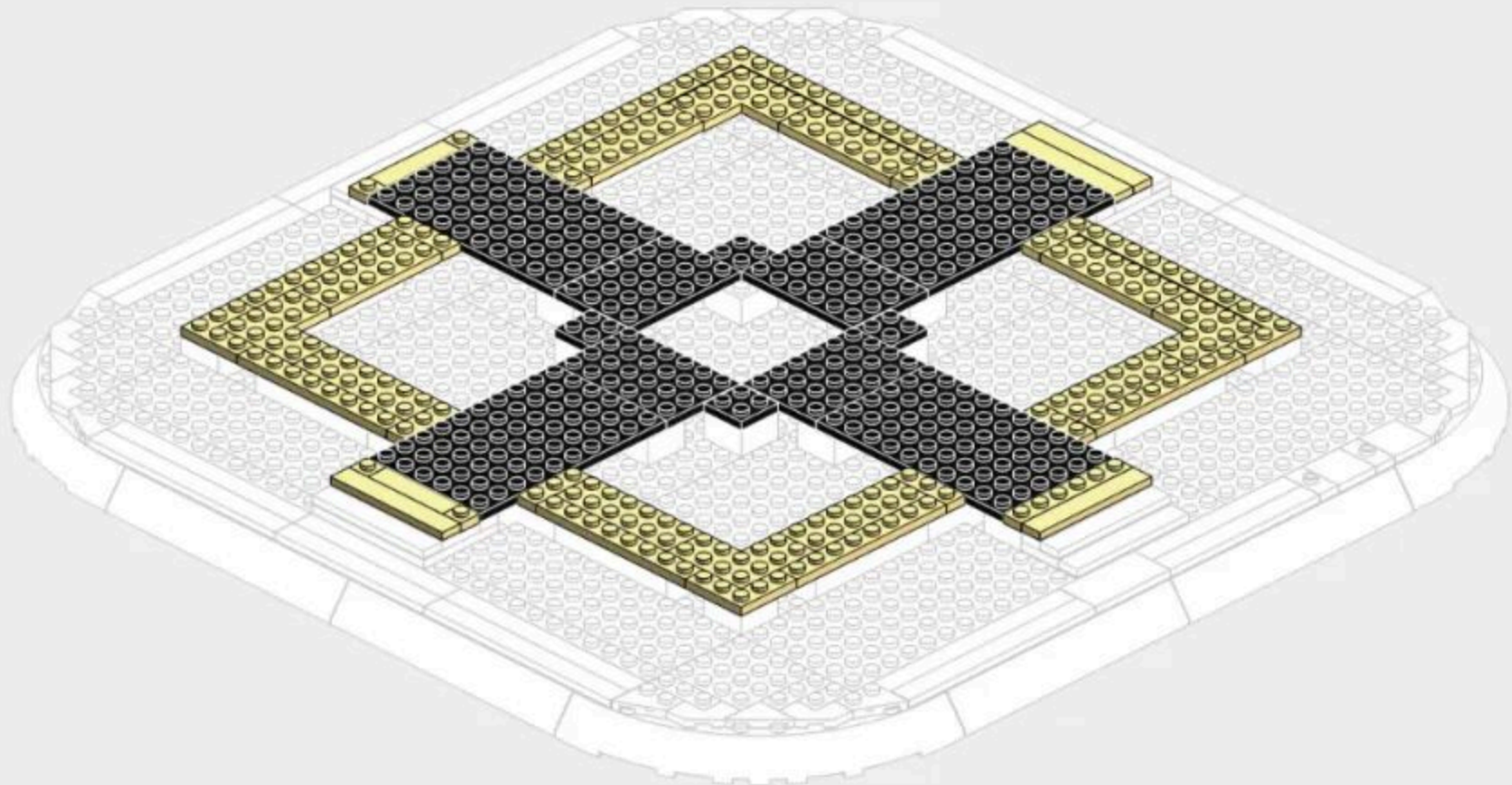
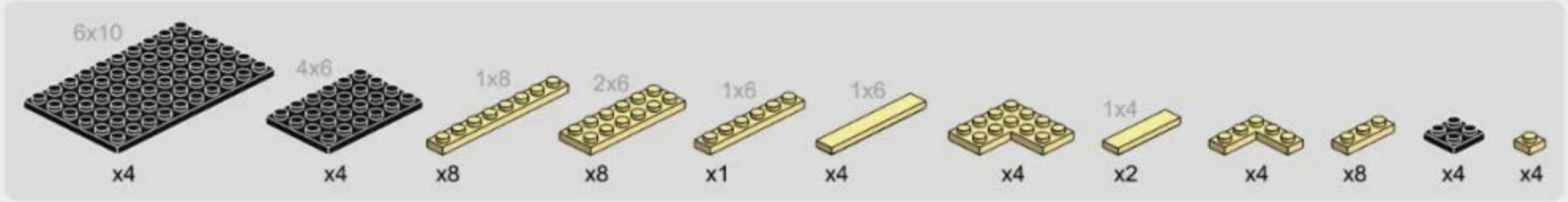

1-8

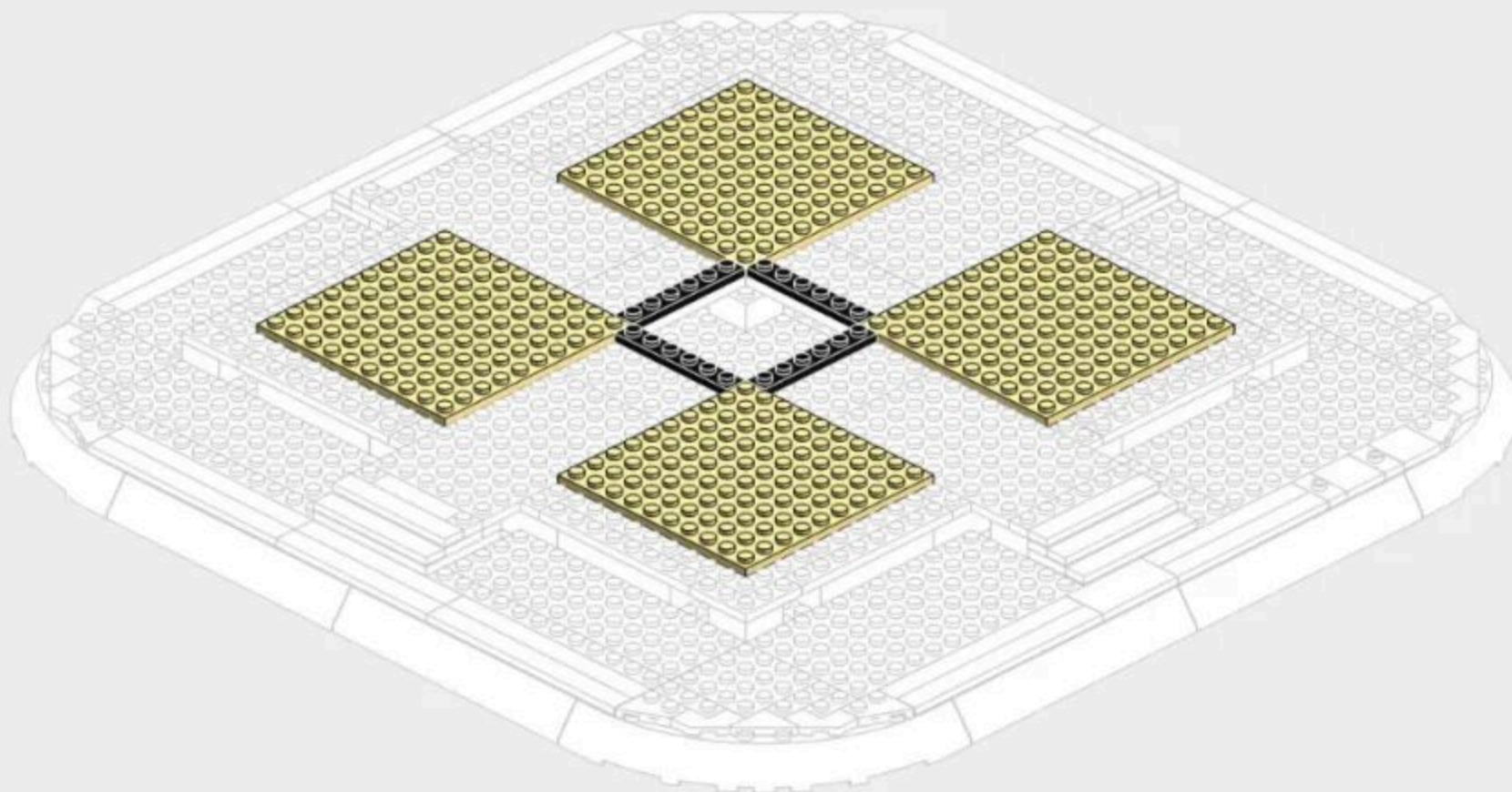
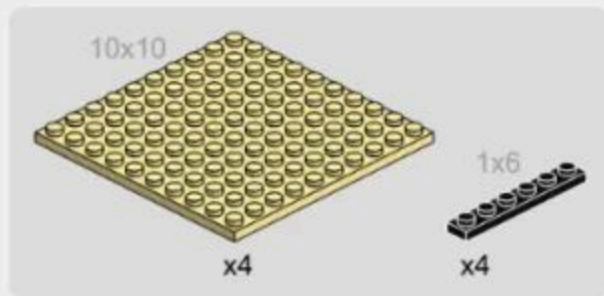



262 PCS

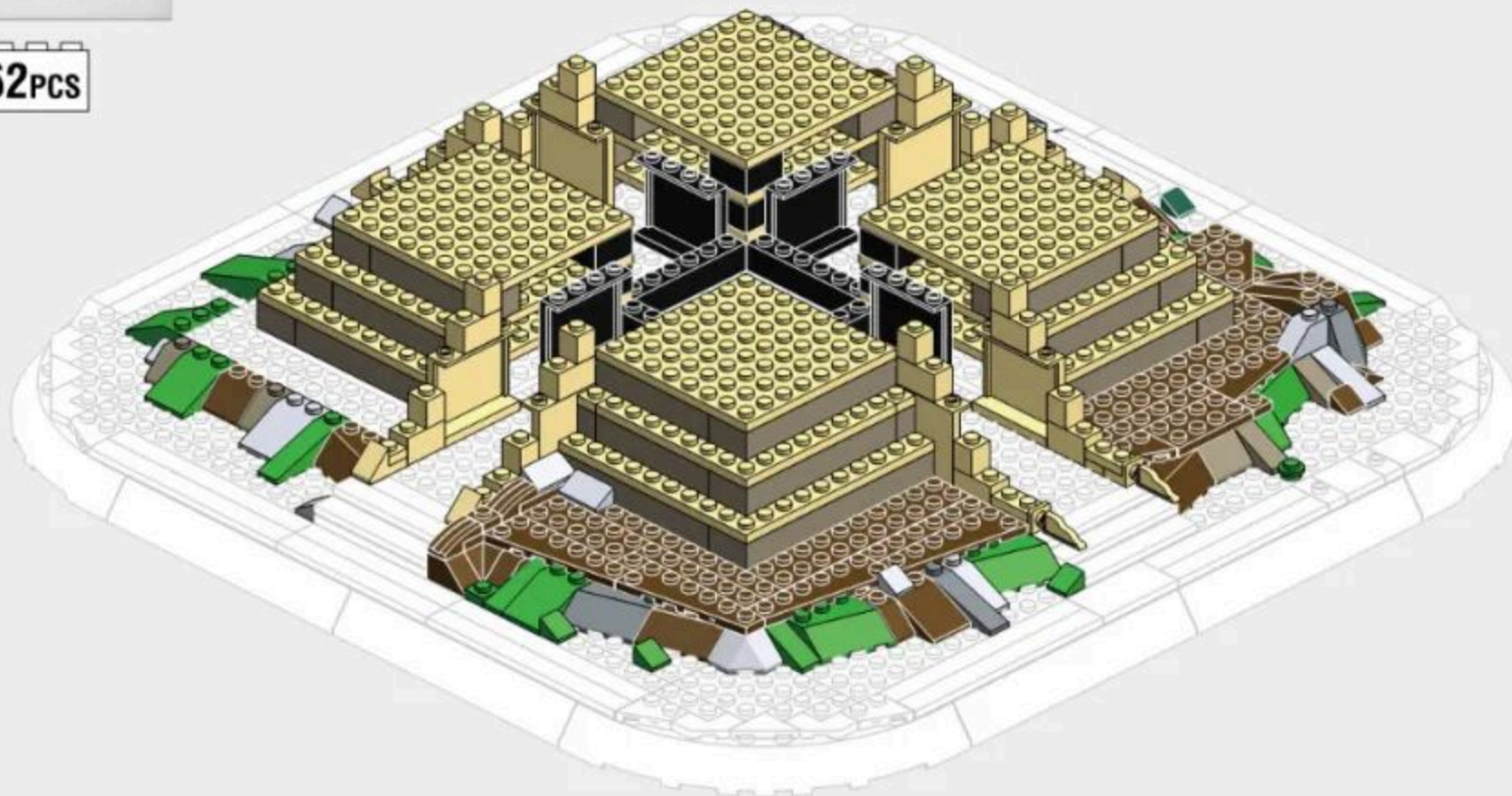

2-1

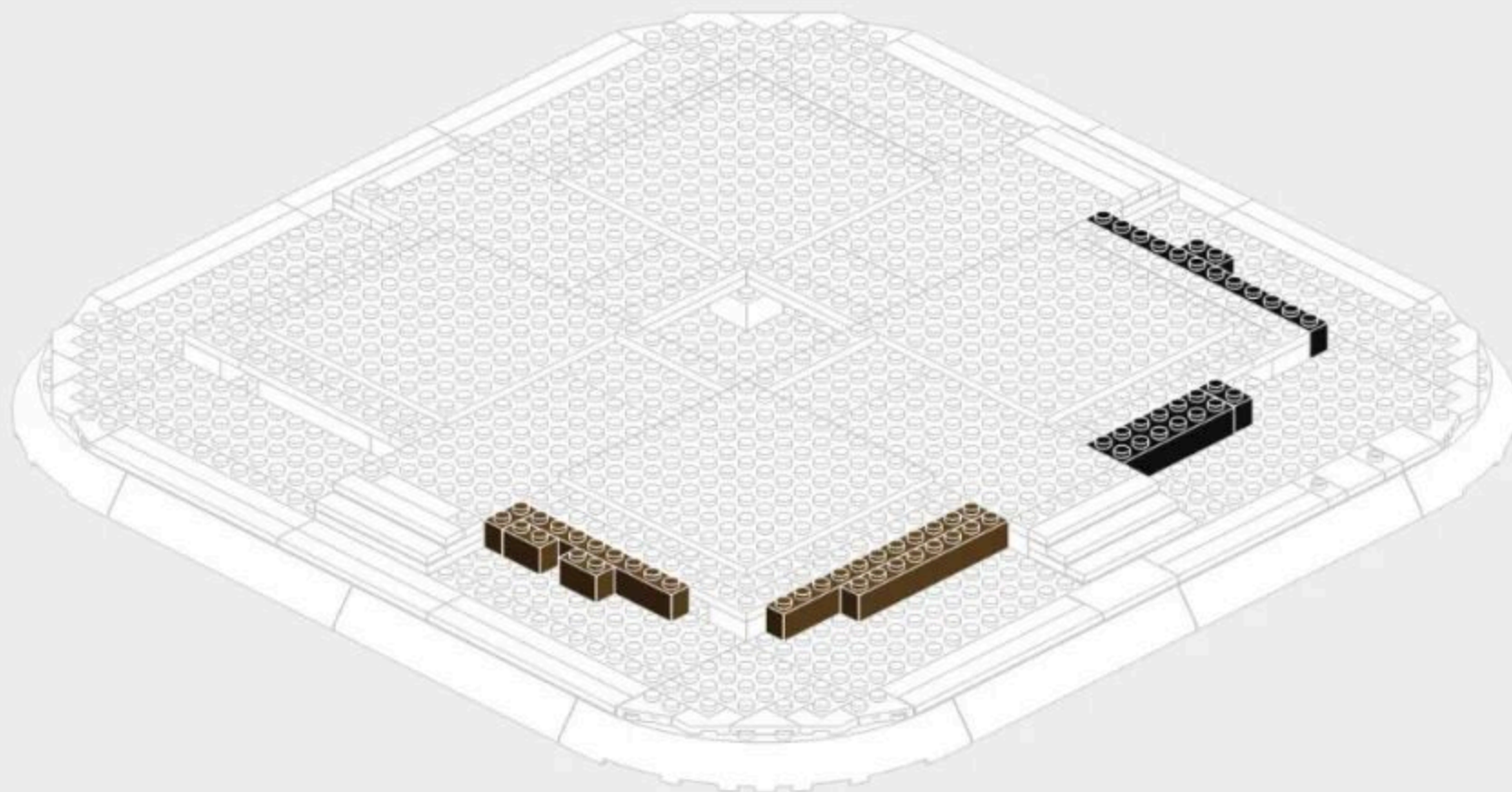
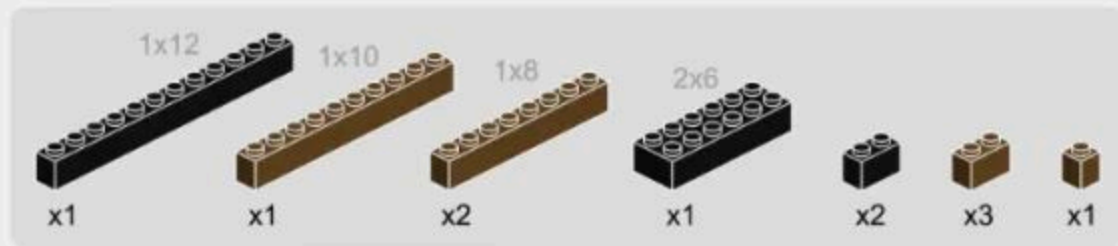

2-2



2-3

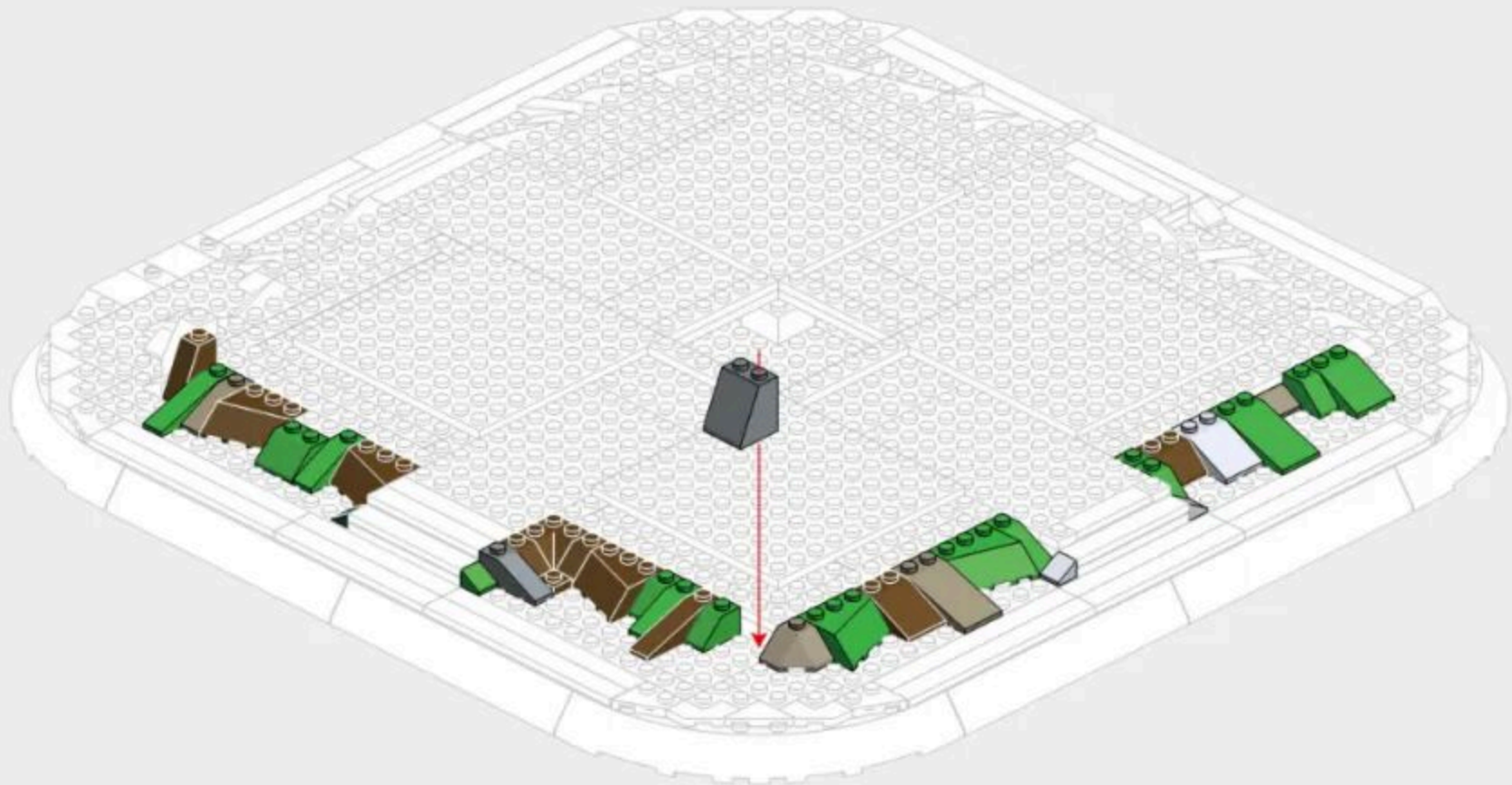

2-4

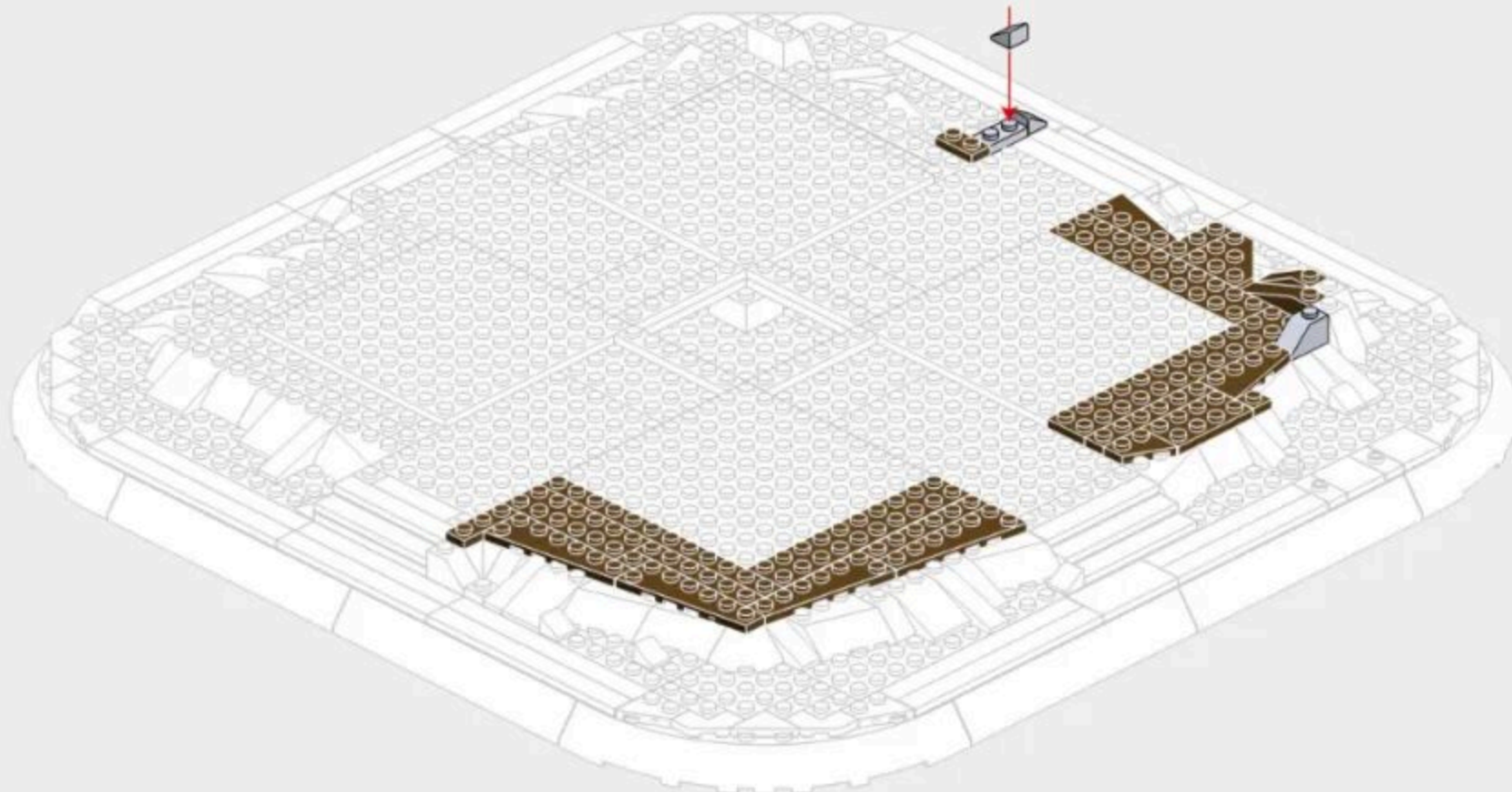
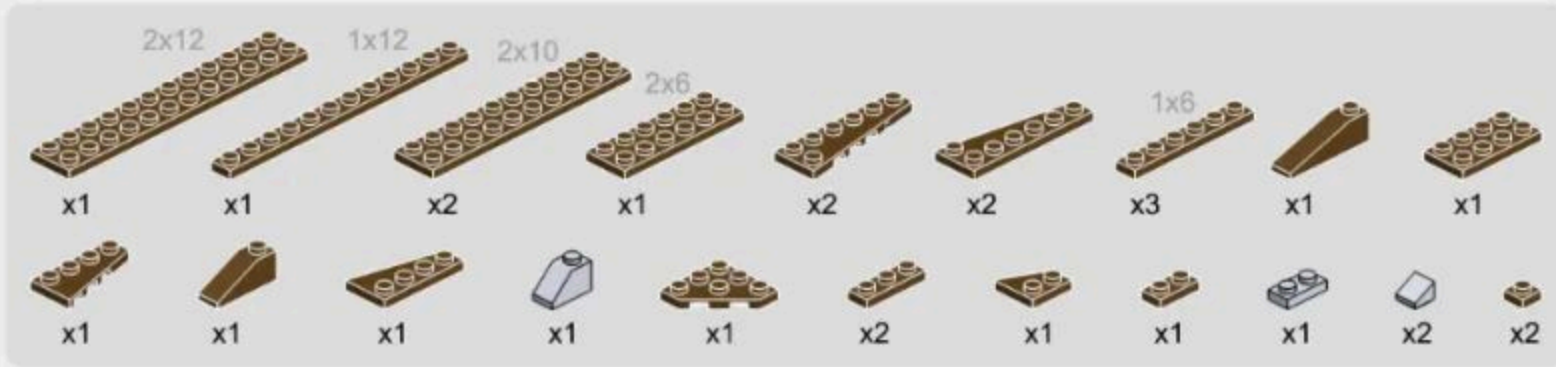

2-5

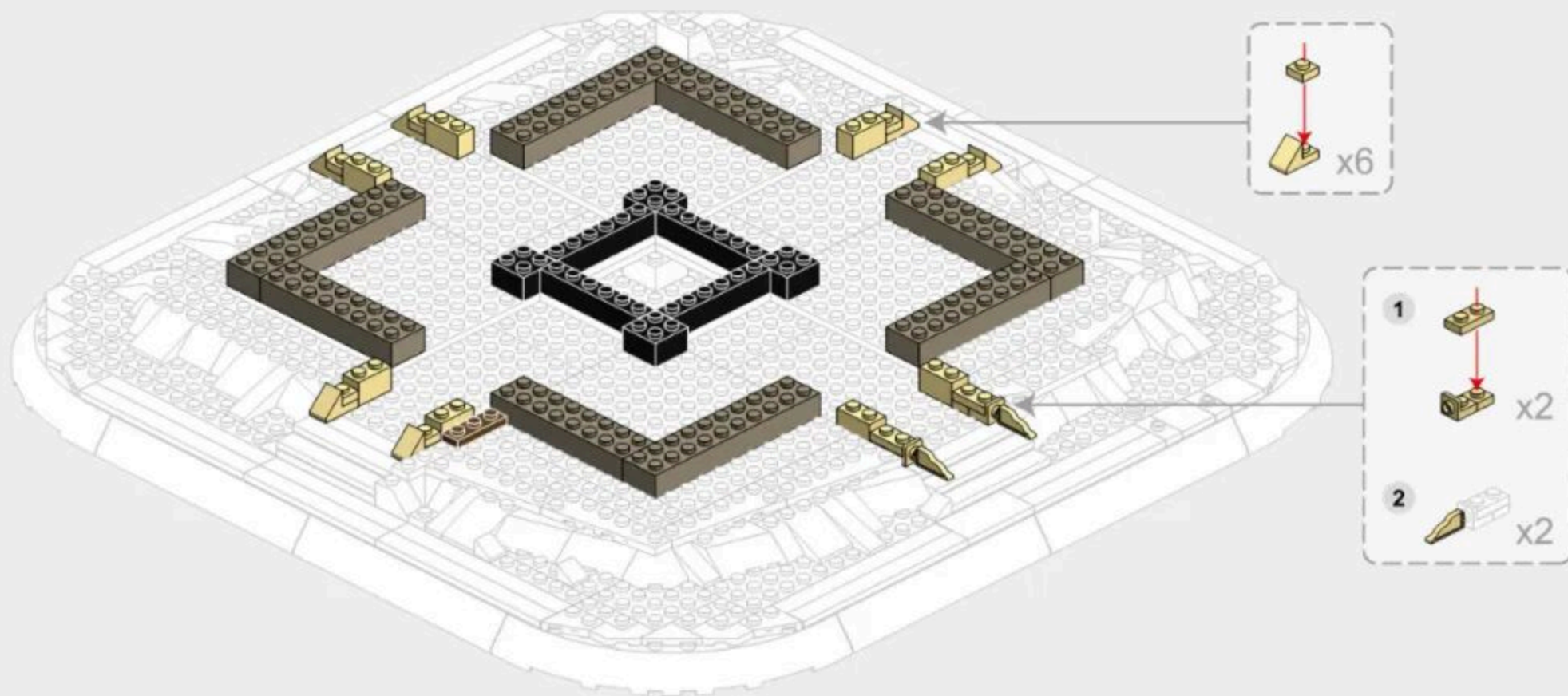

2-6

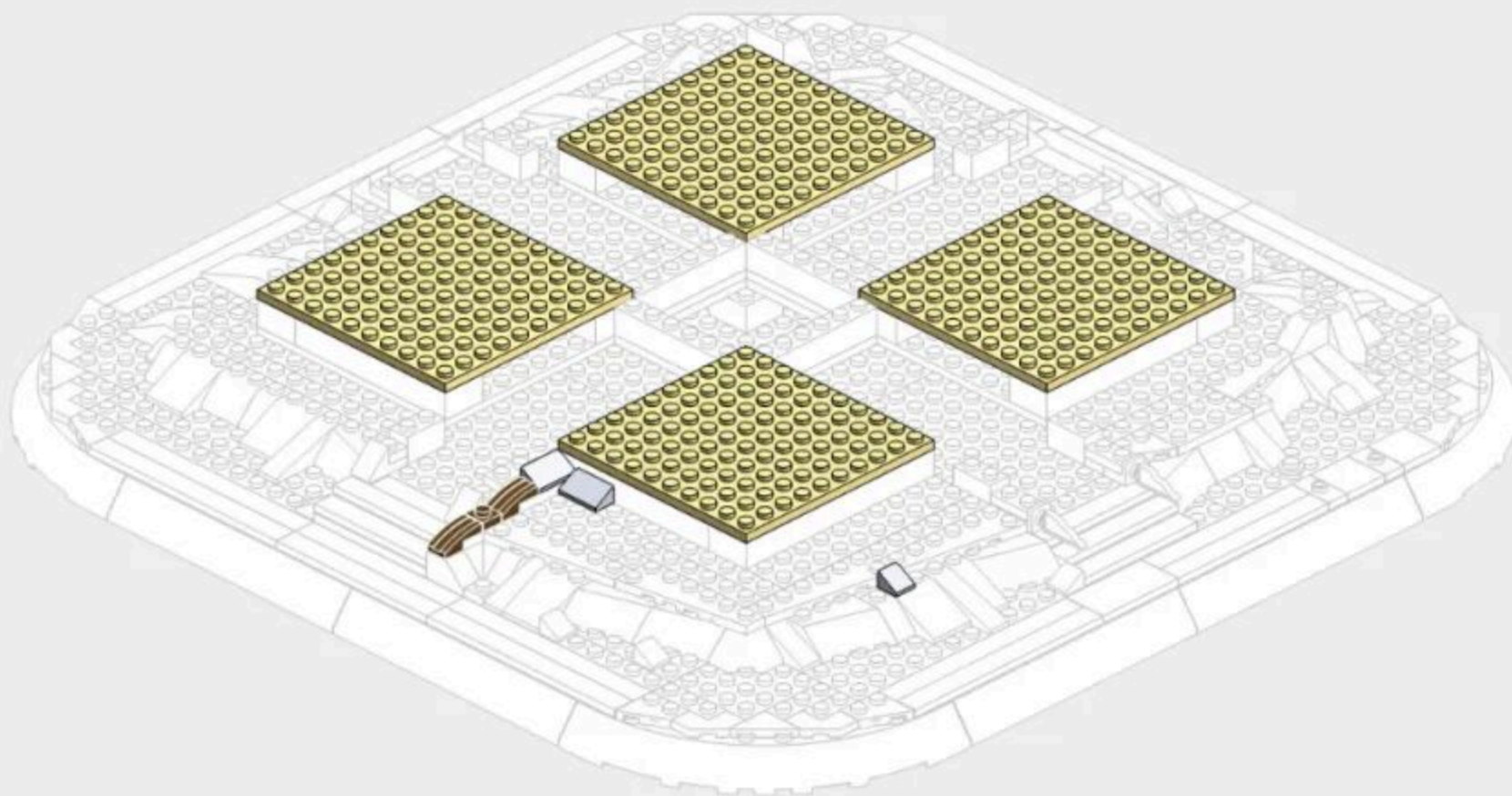
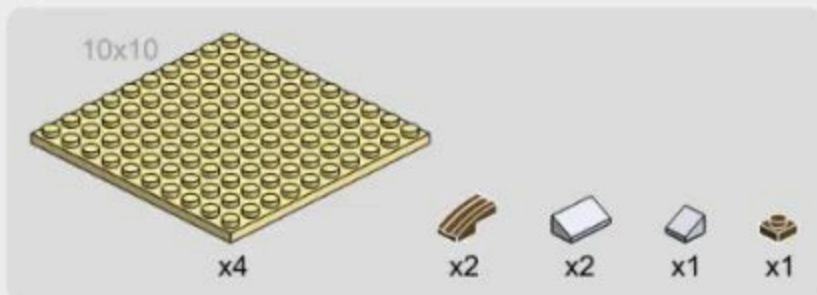

2-7

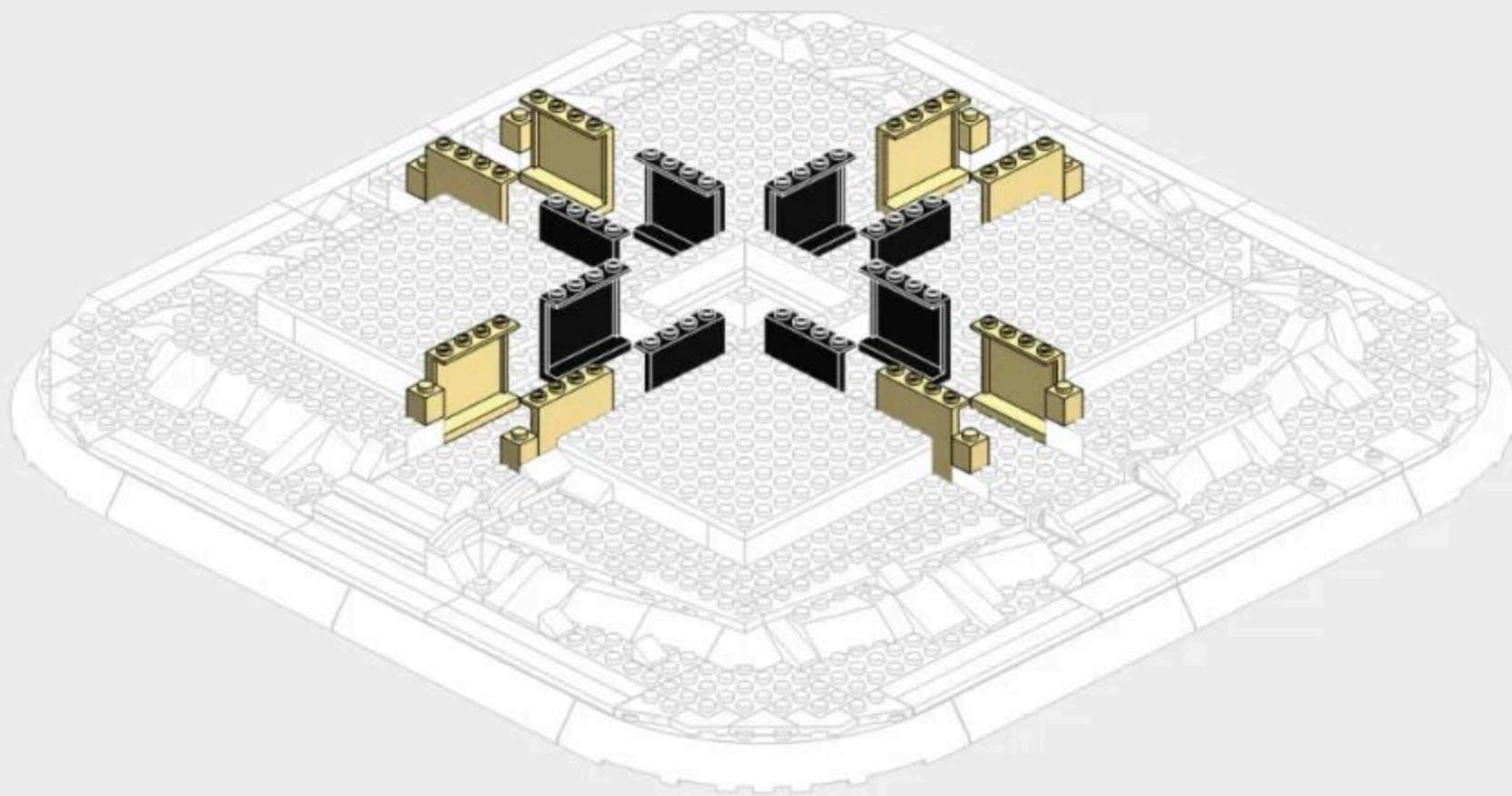

2-8

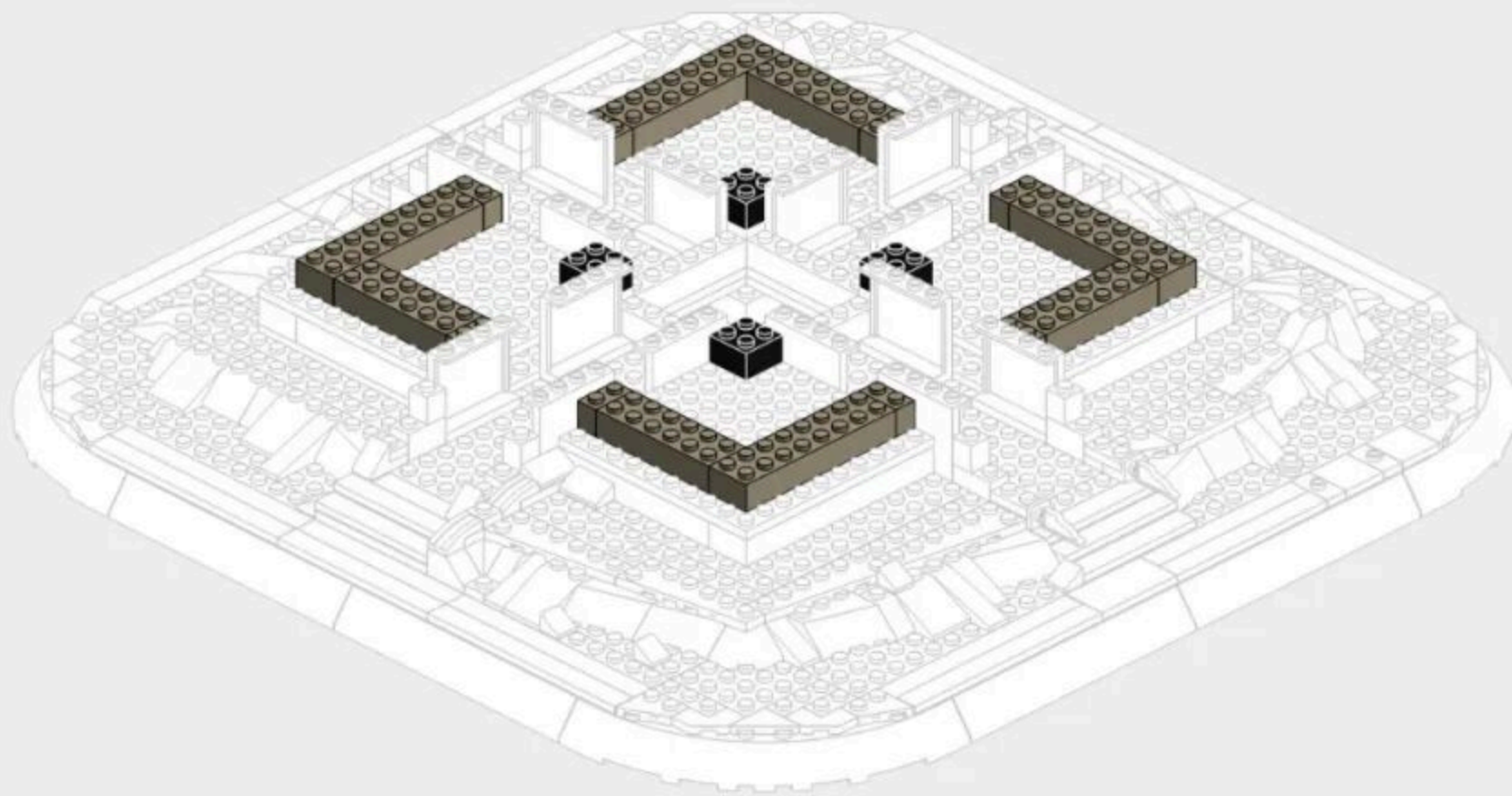

2-9

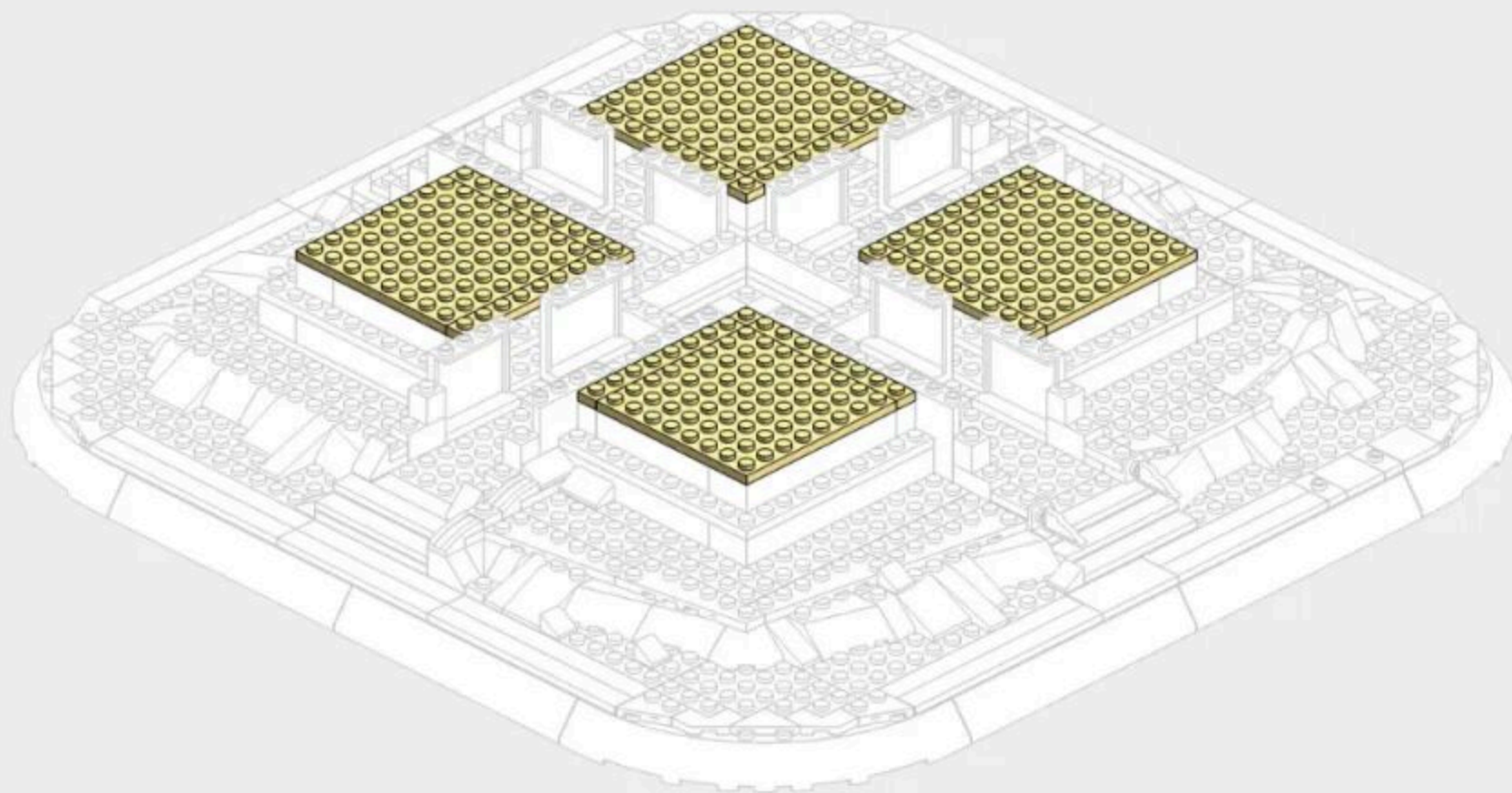
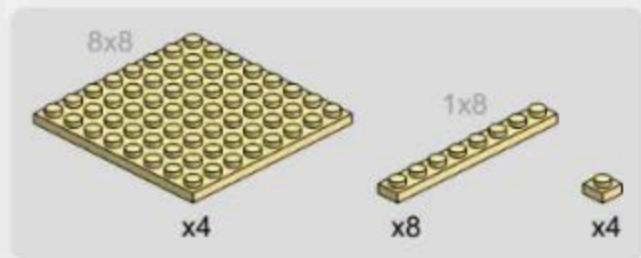

2-10

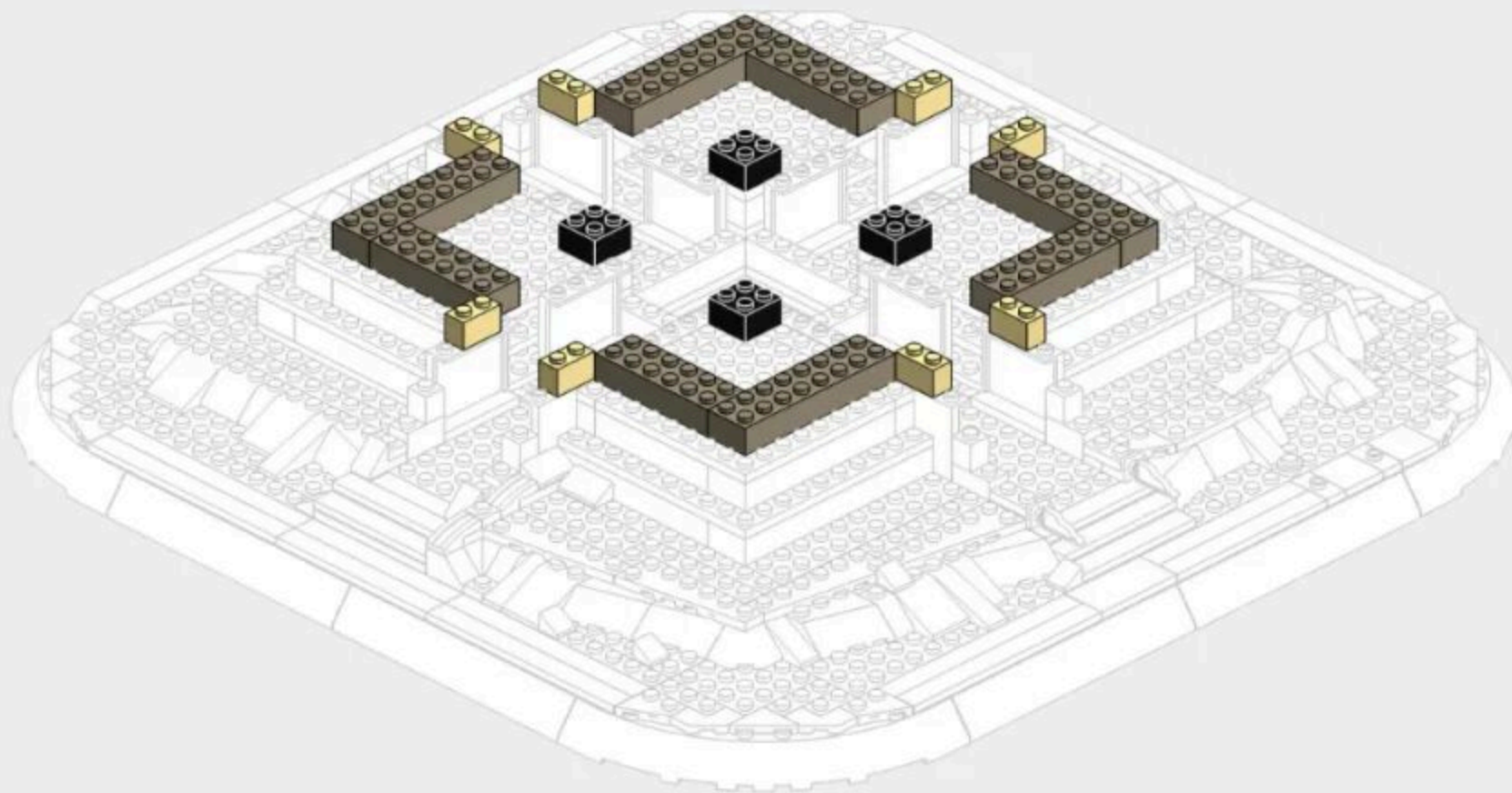

2-11

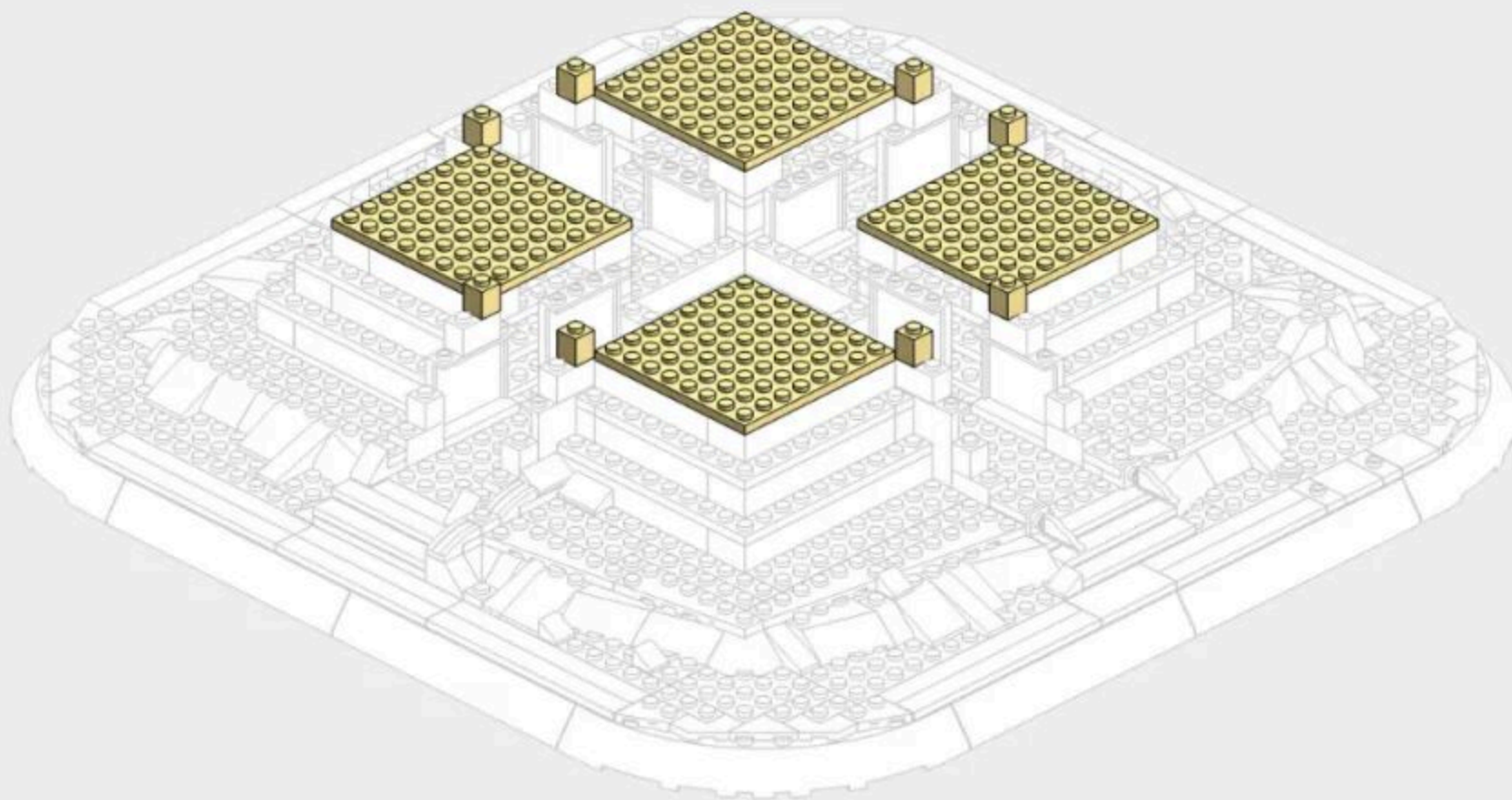
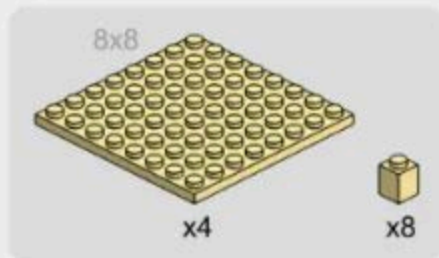



279PCS

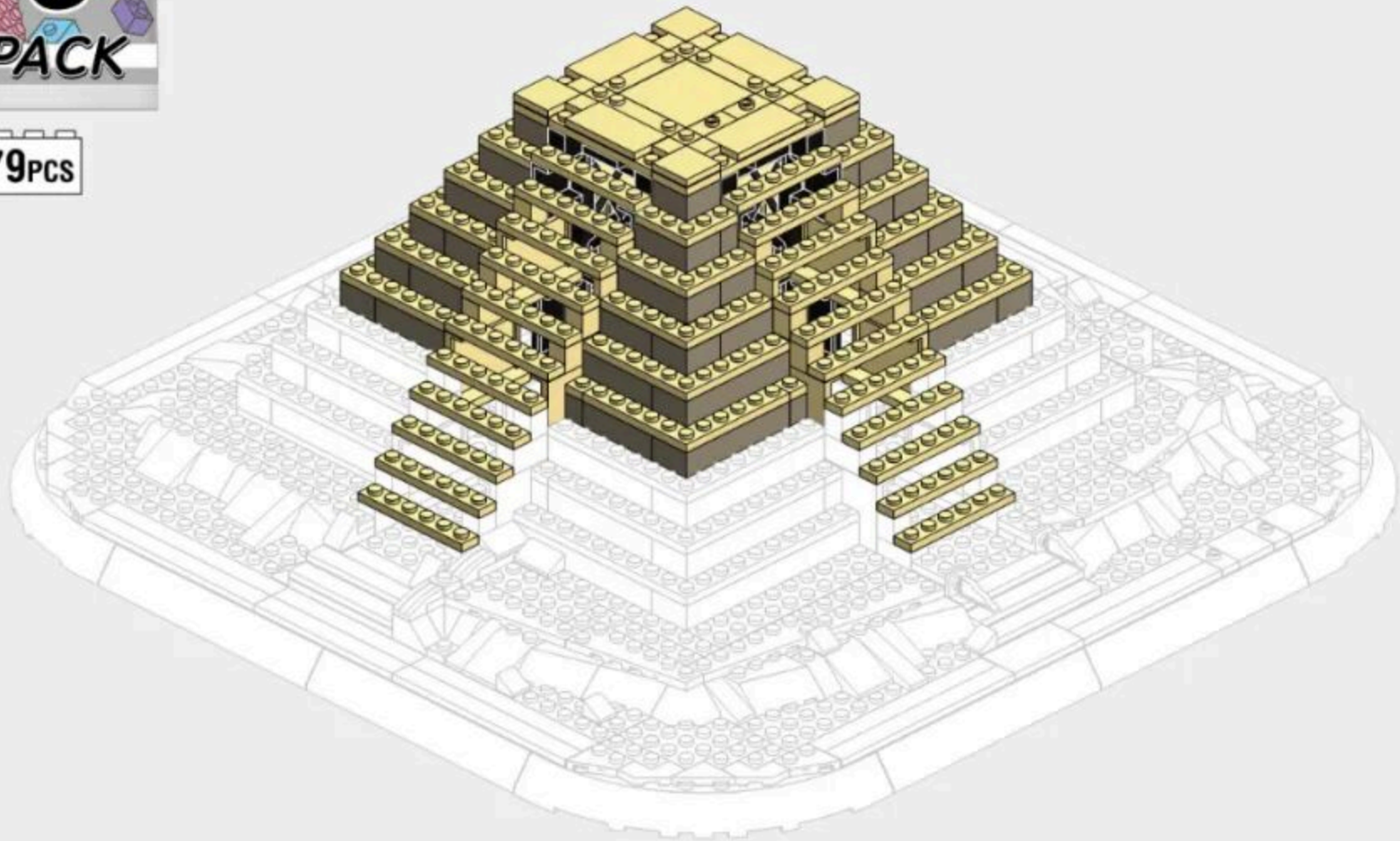

3-1

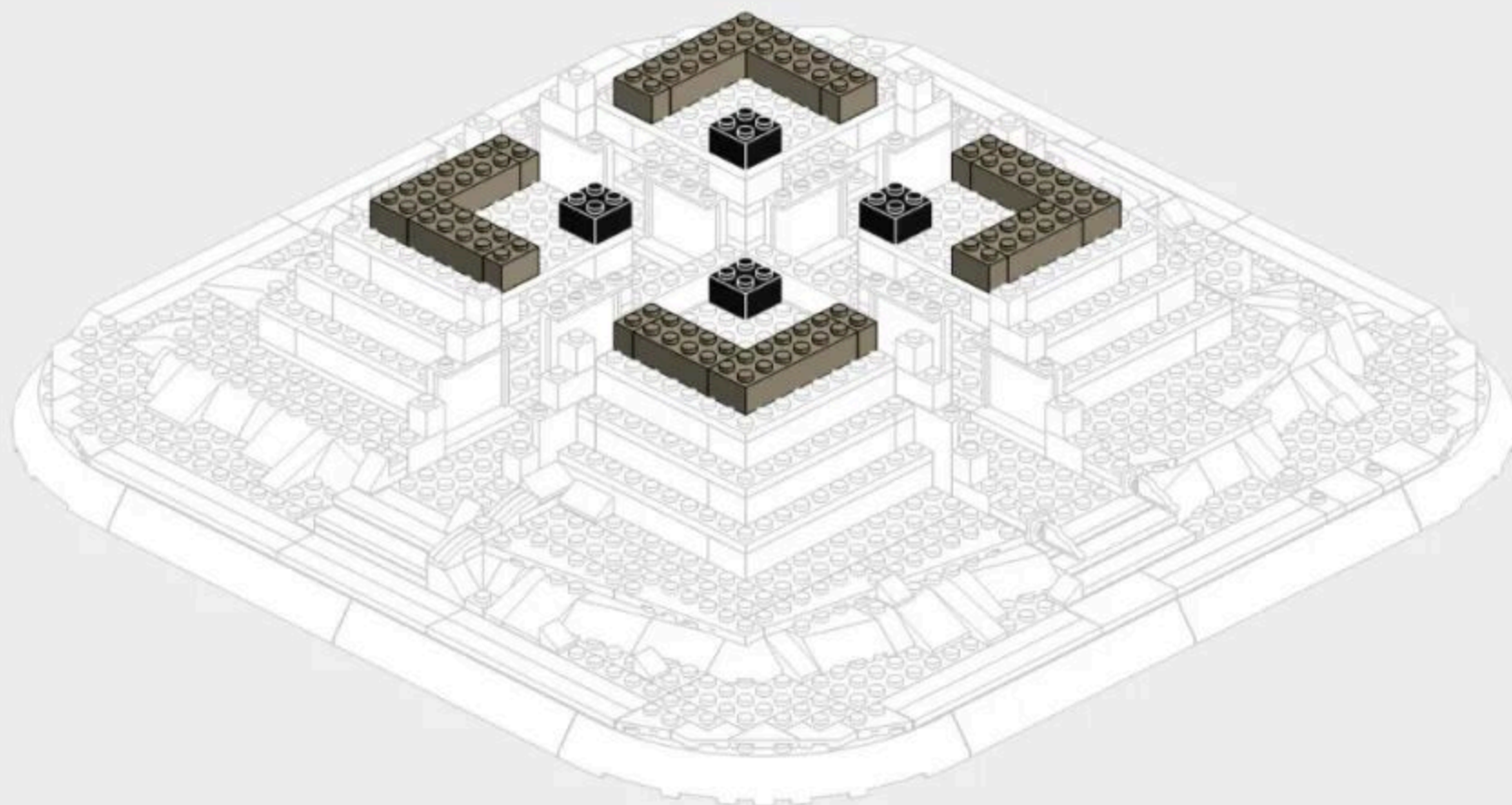

3-2

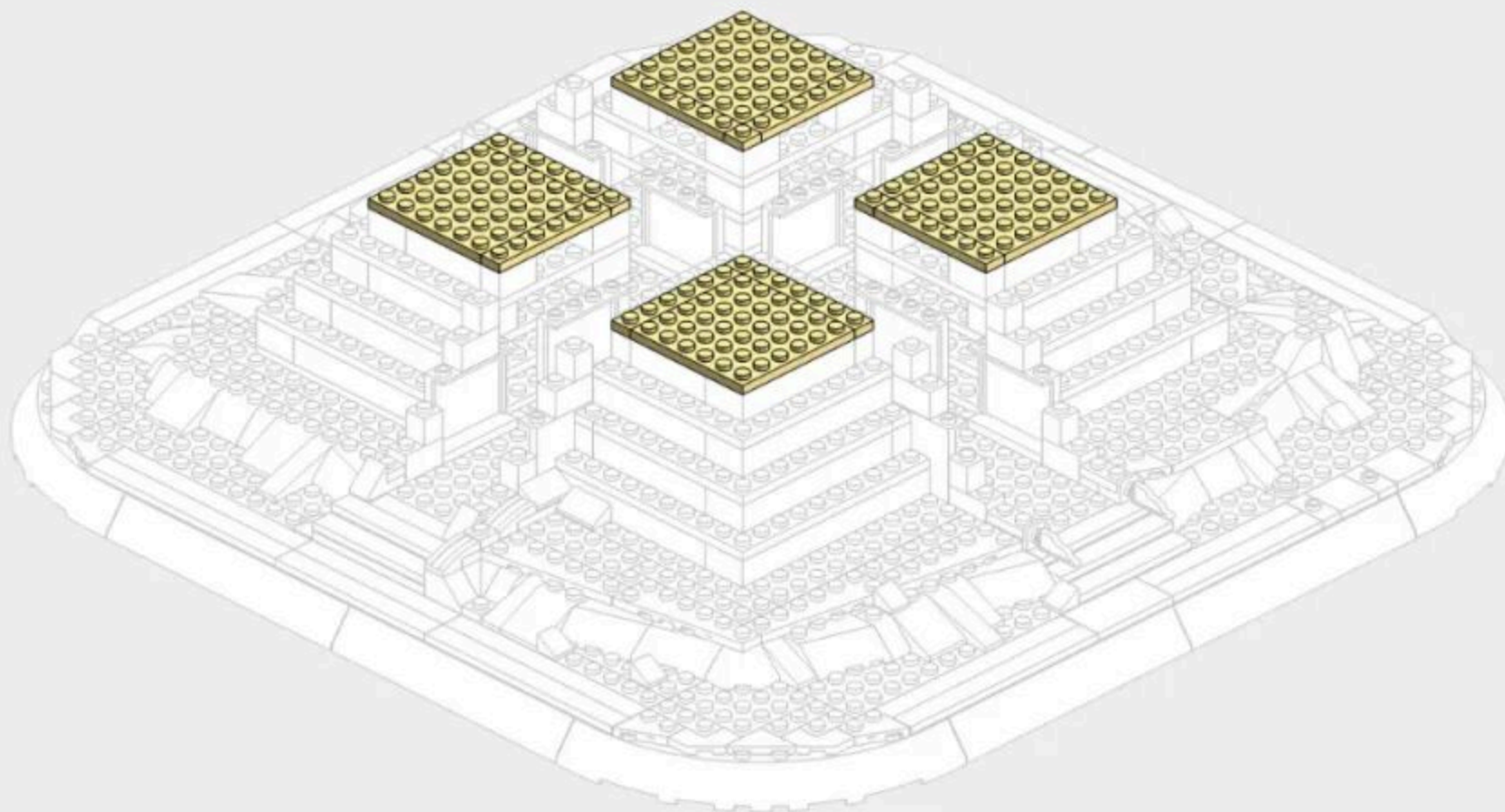
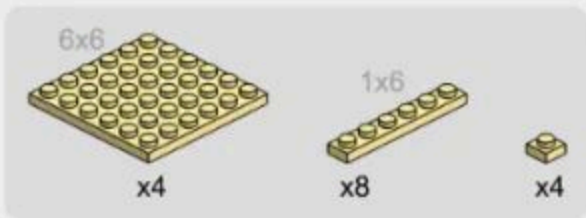

3-4

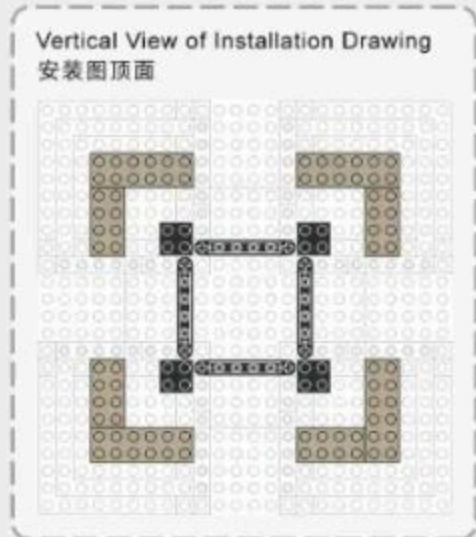
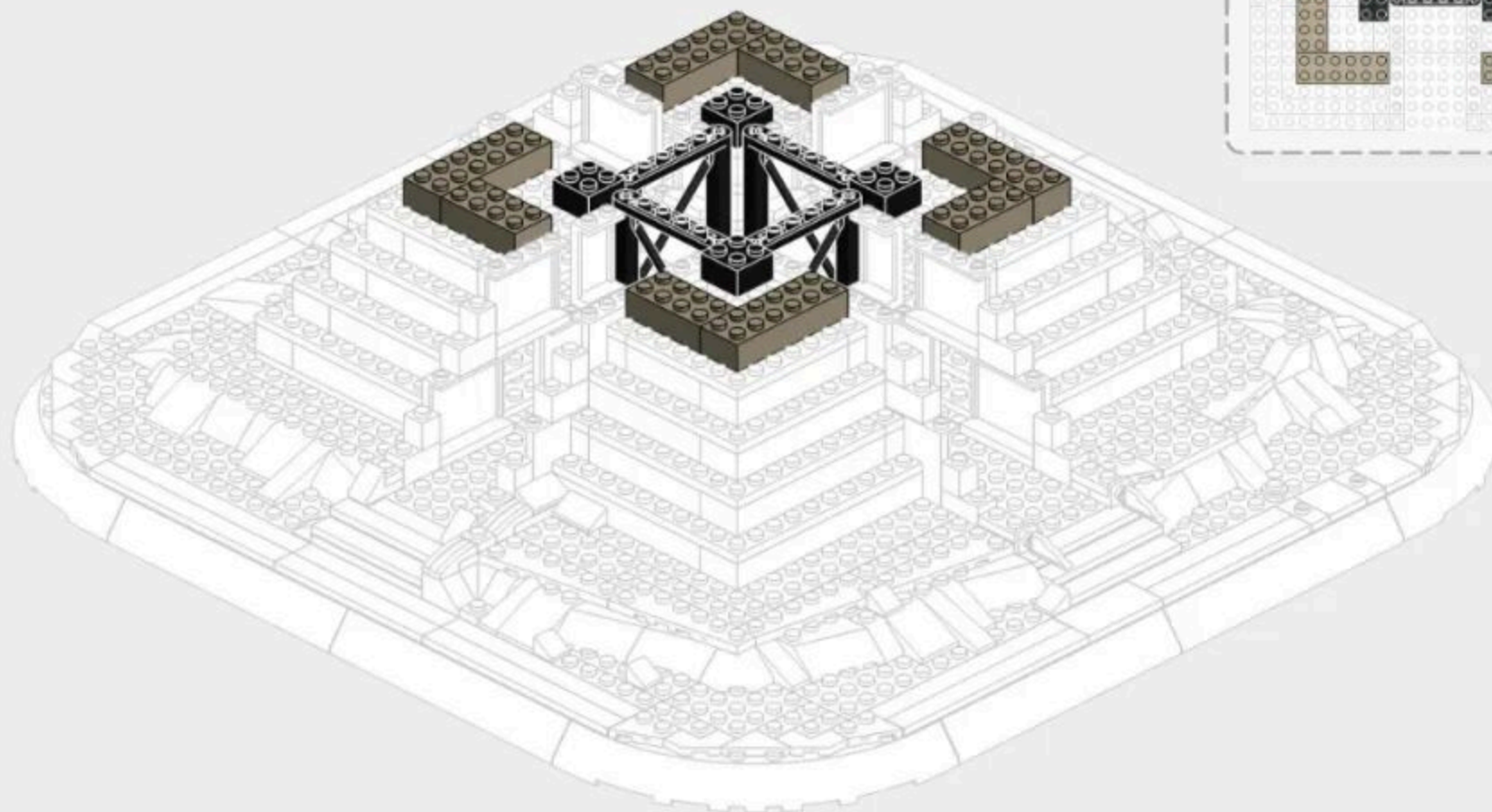
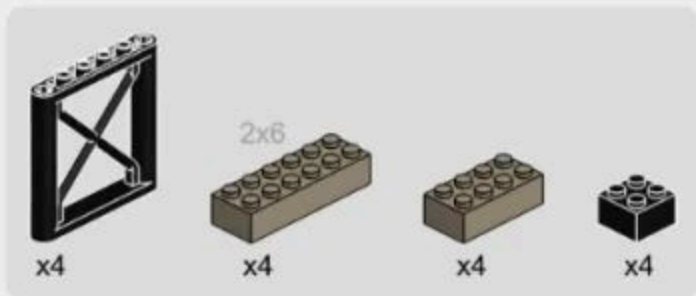

3-5

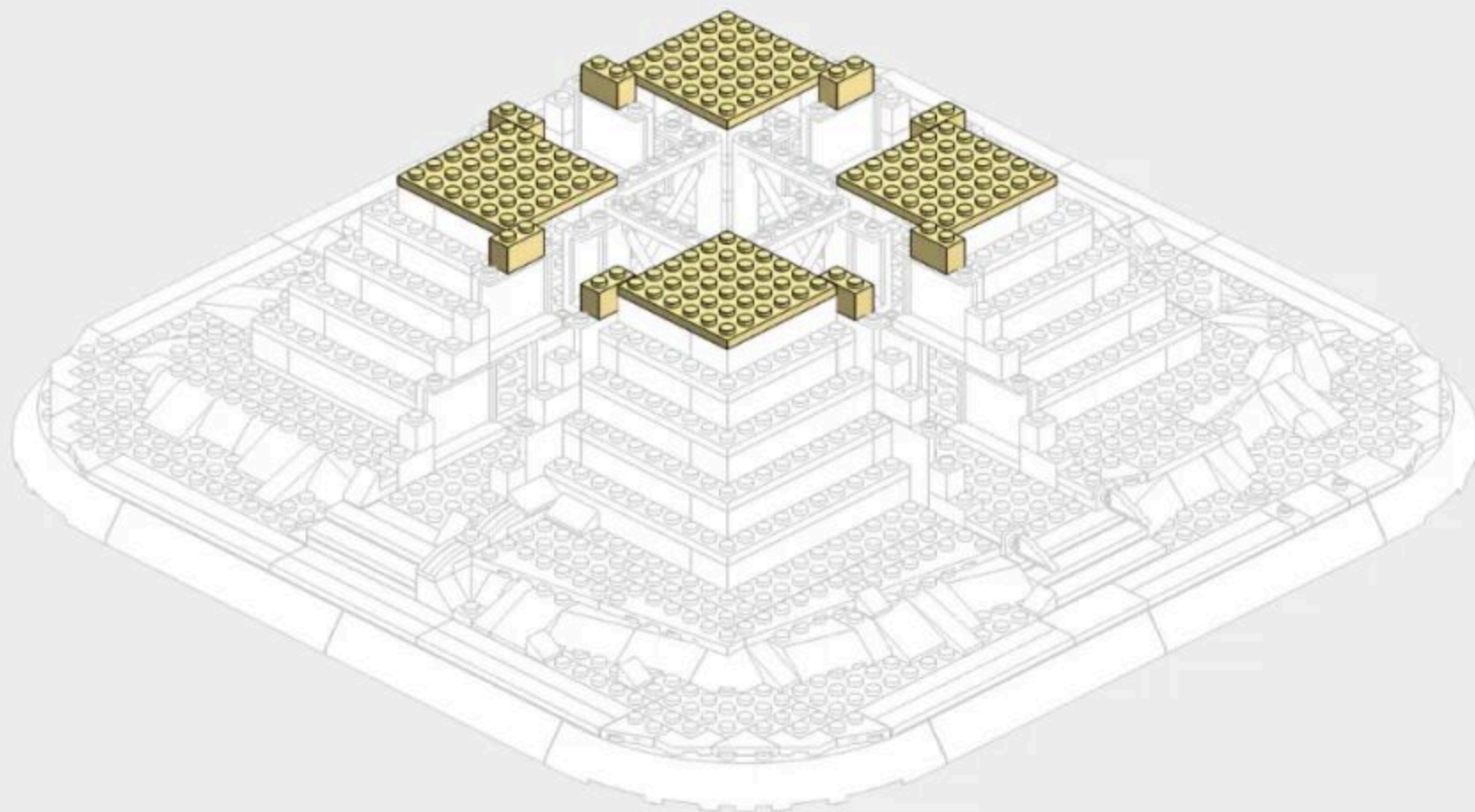
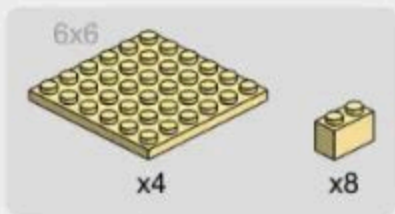

3-6



x8



x4



x4



x8

3-7

5x5



x4

3x3



x4

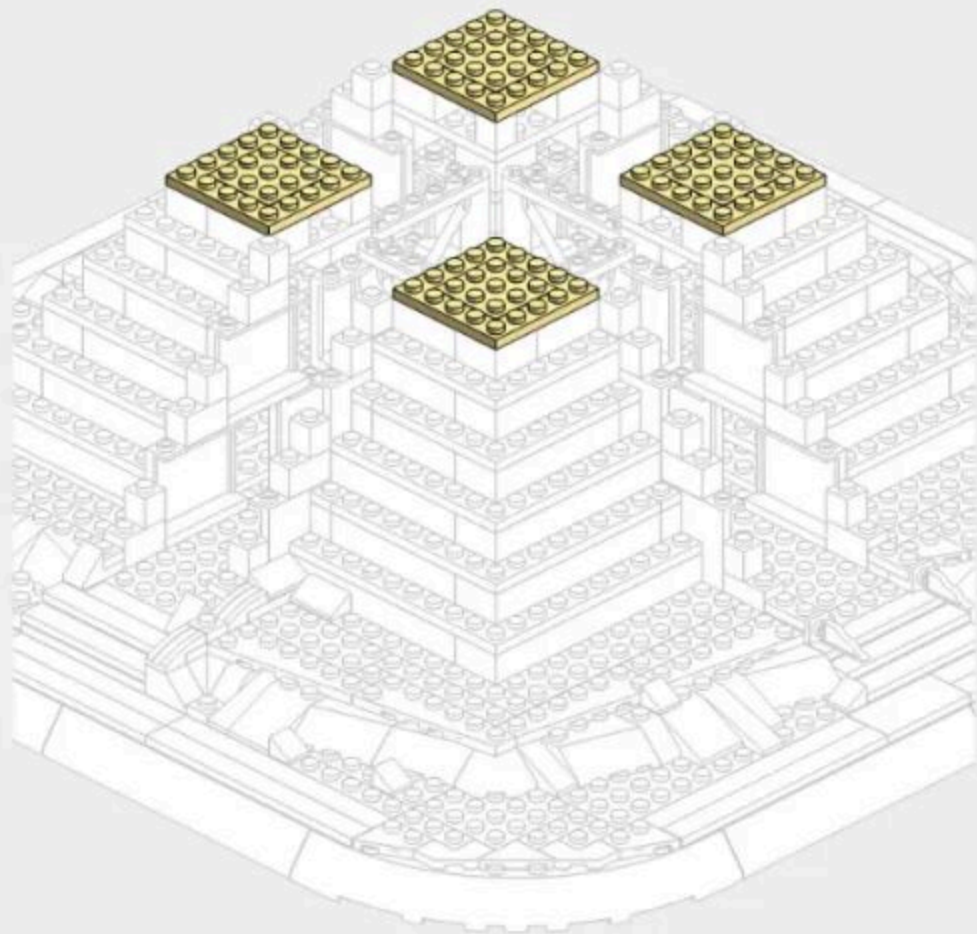
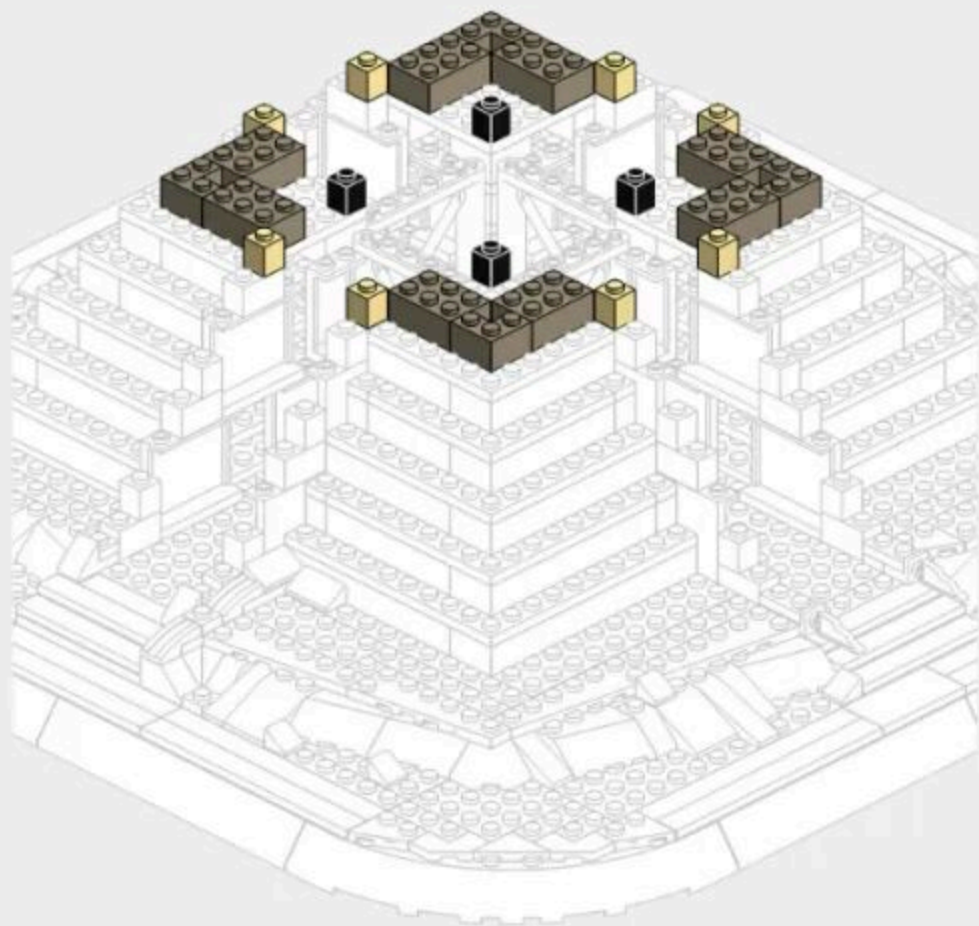

3-8



3-9

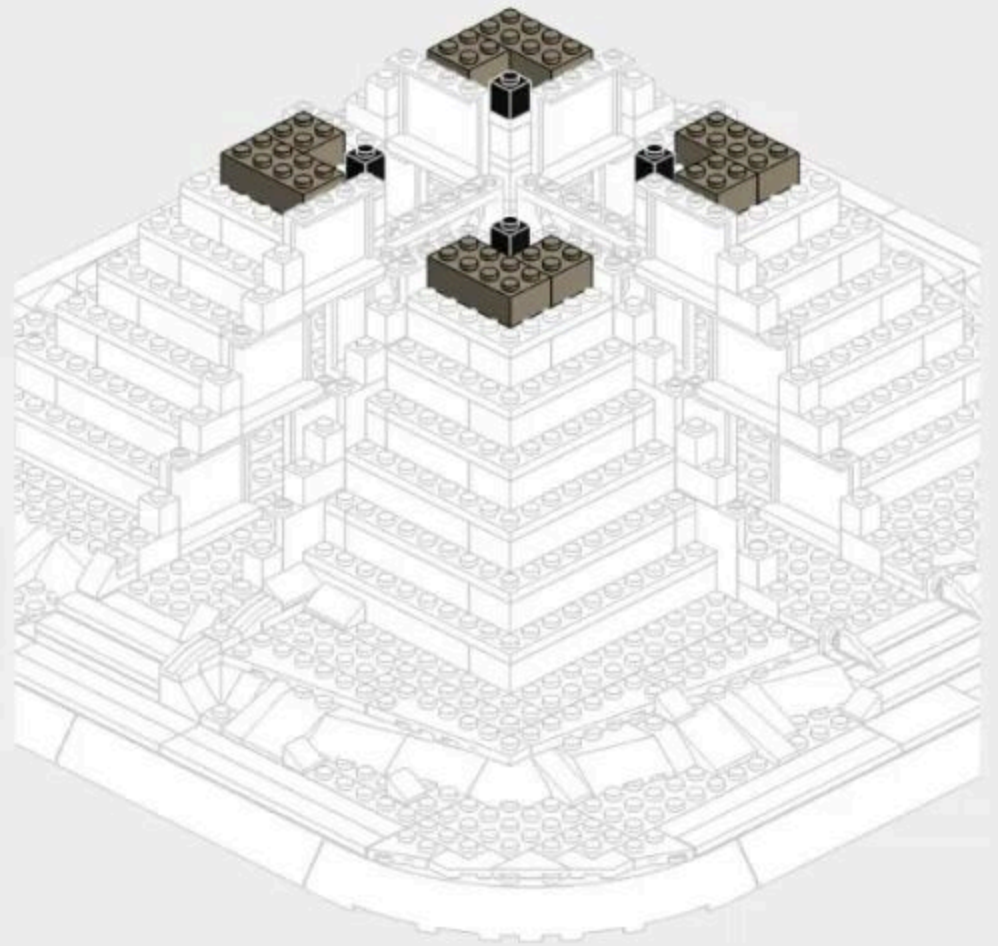
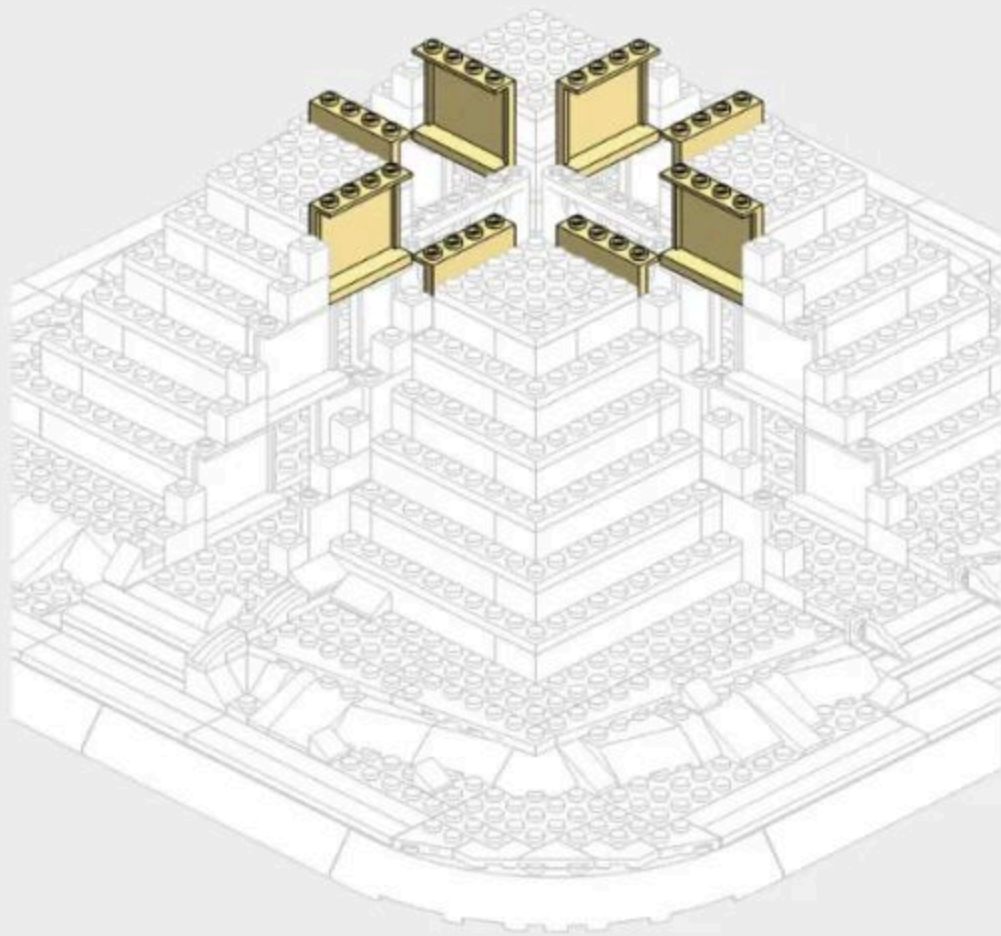
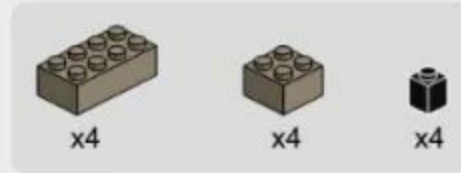

3-10

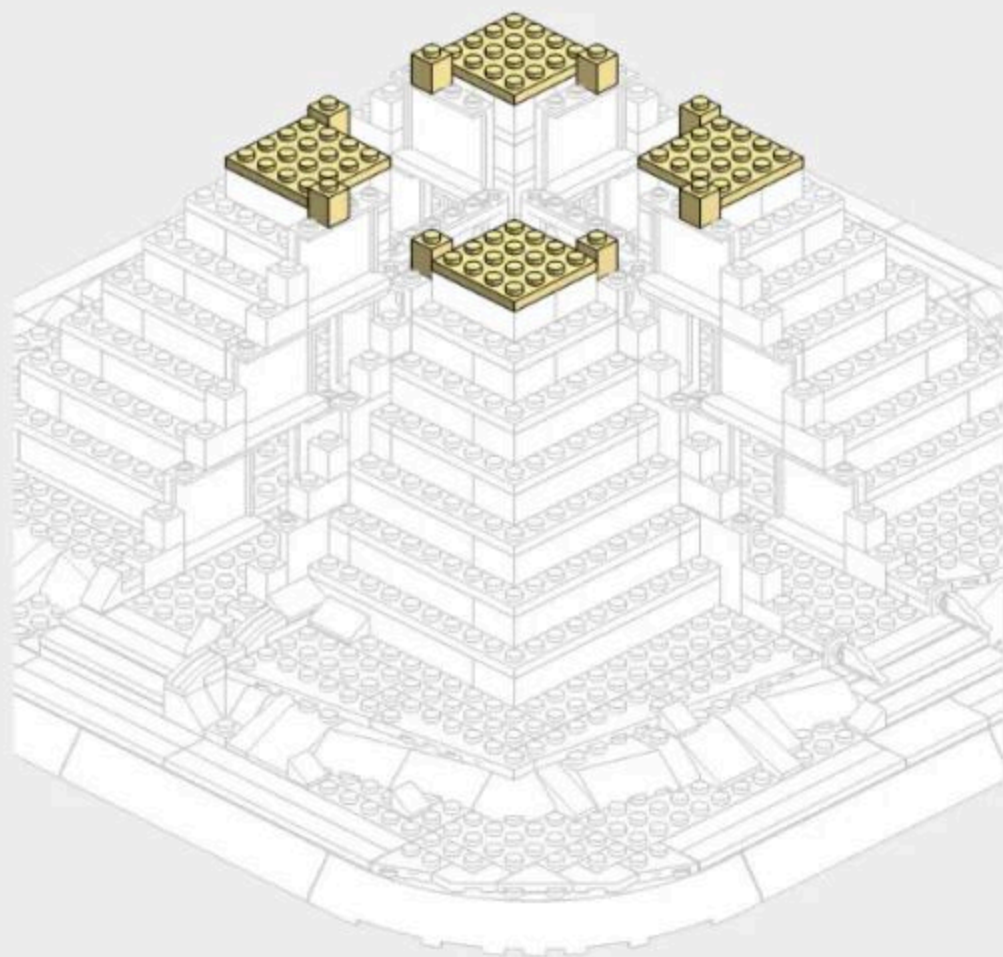

3-11

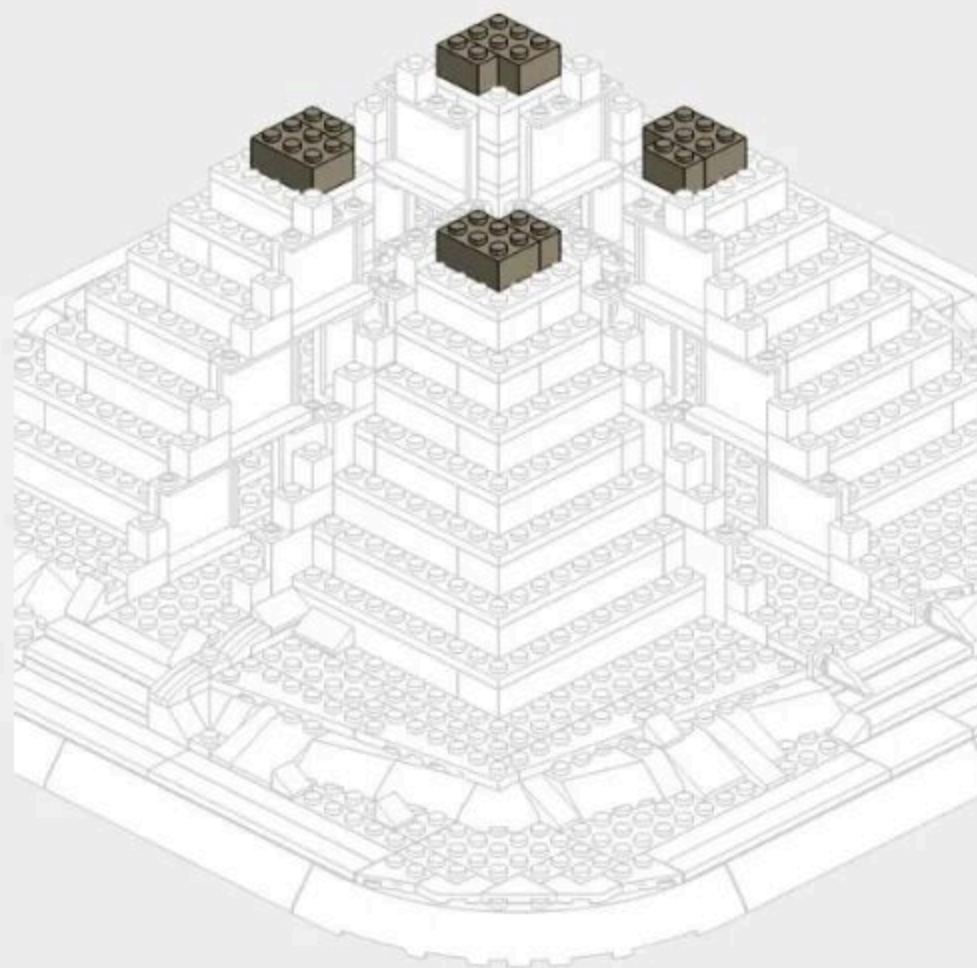

3-12

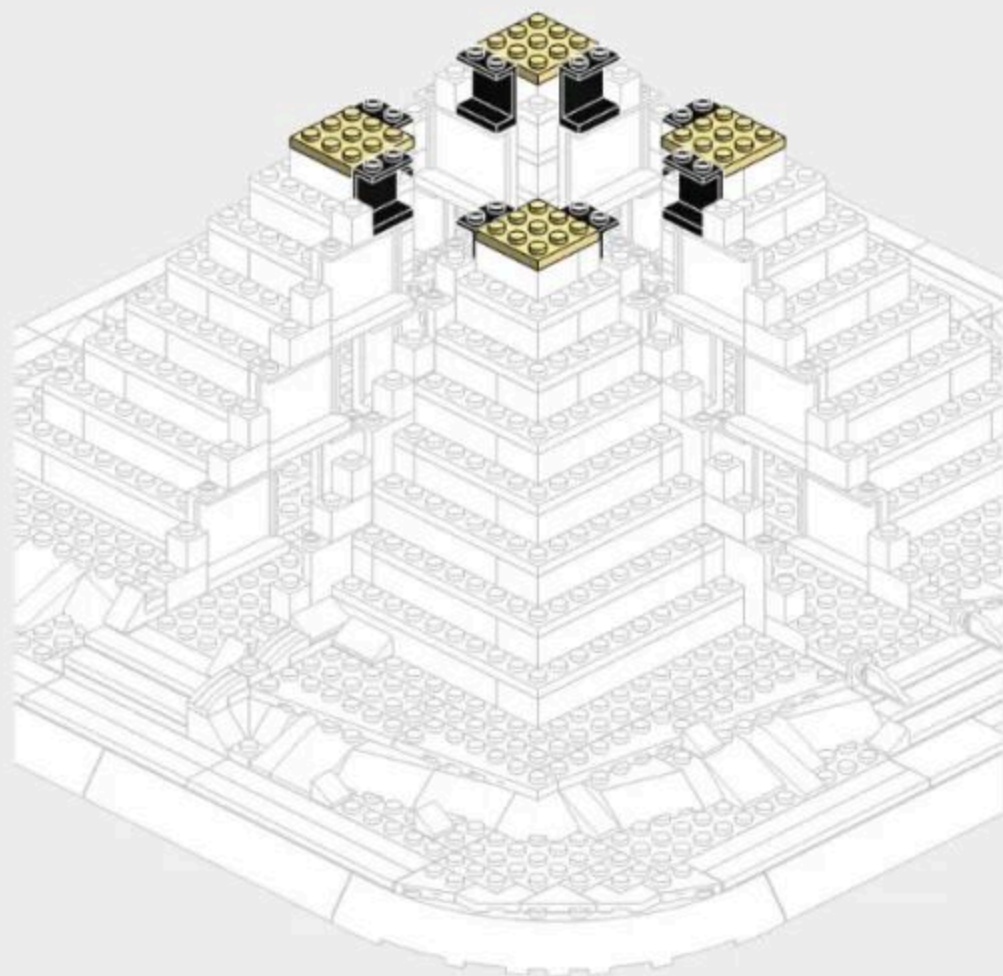

3-13

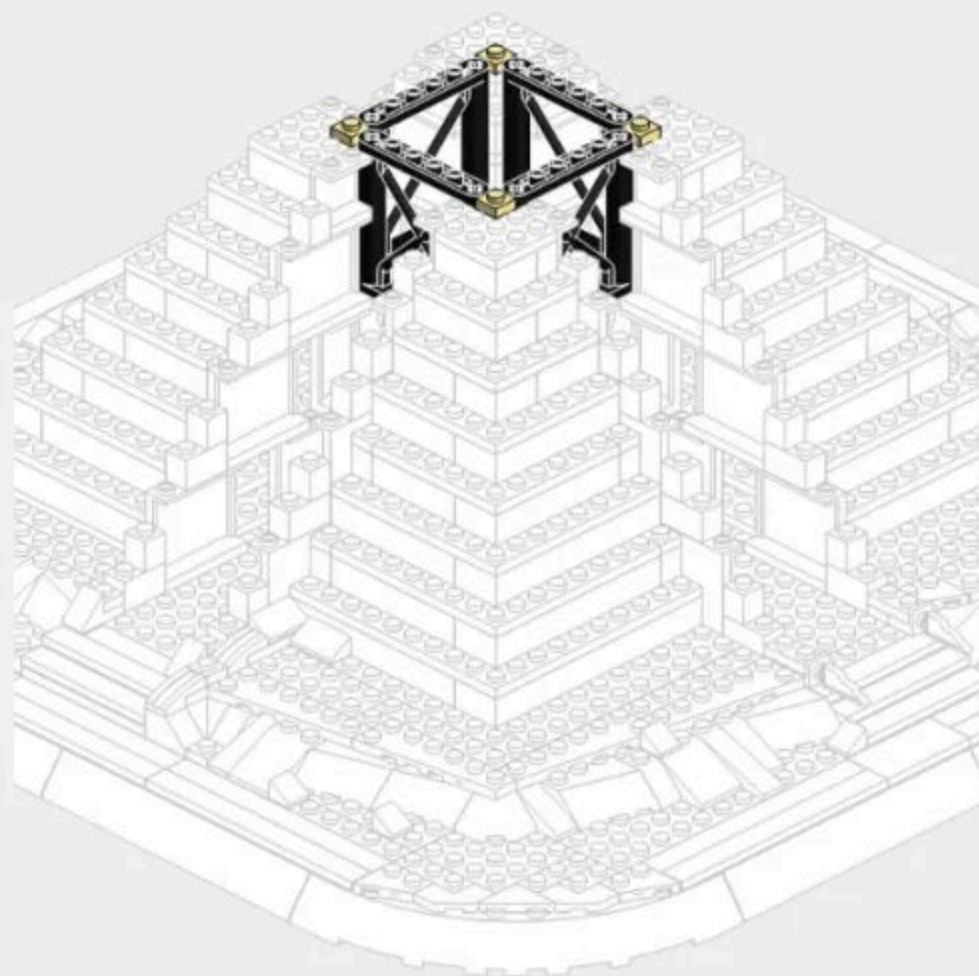

3-14

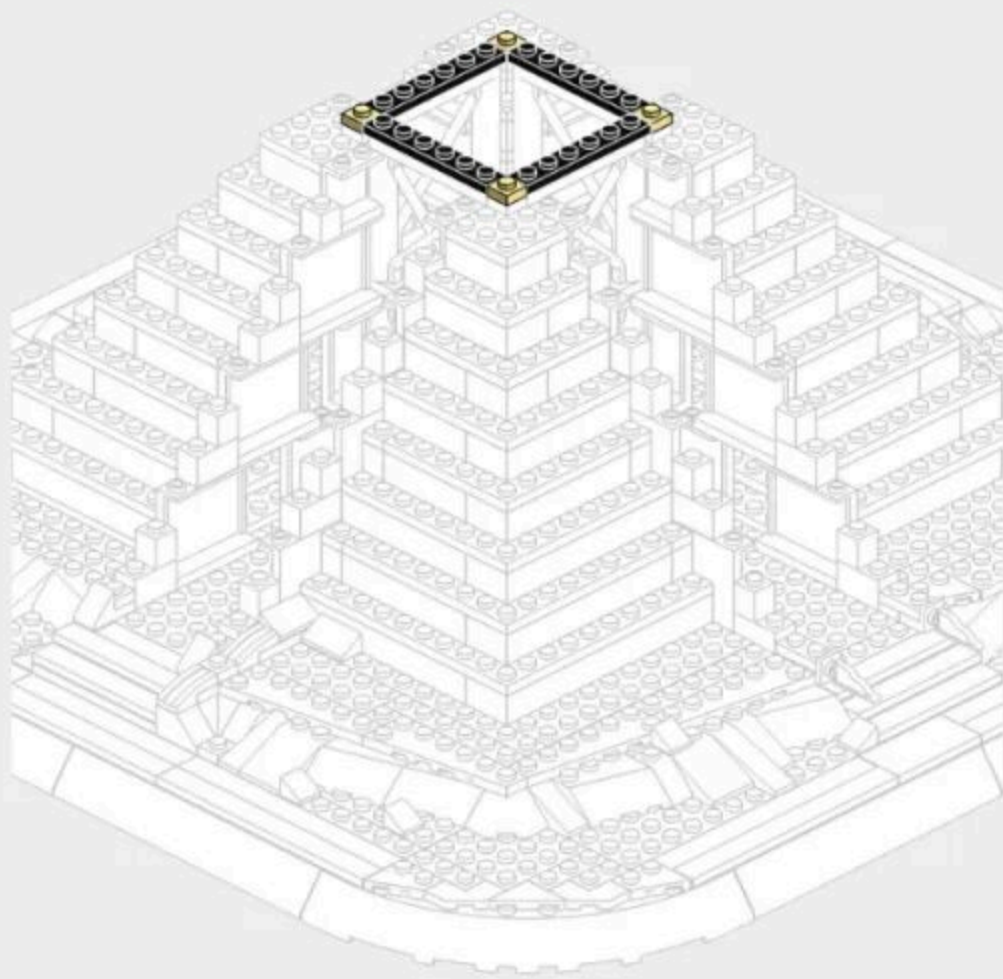

3-15

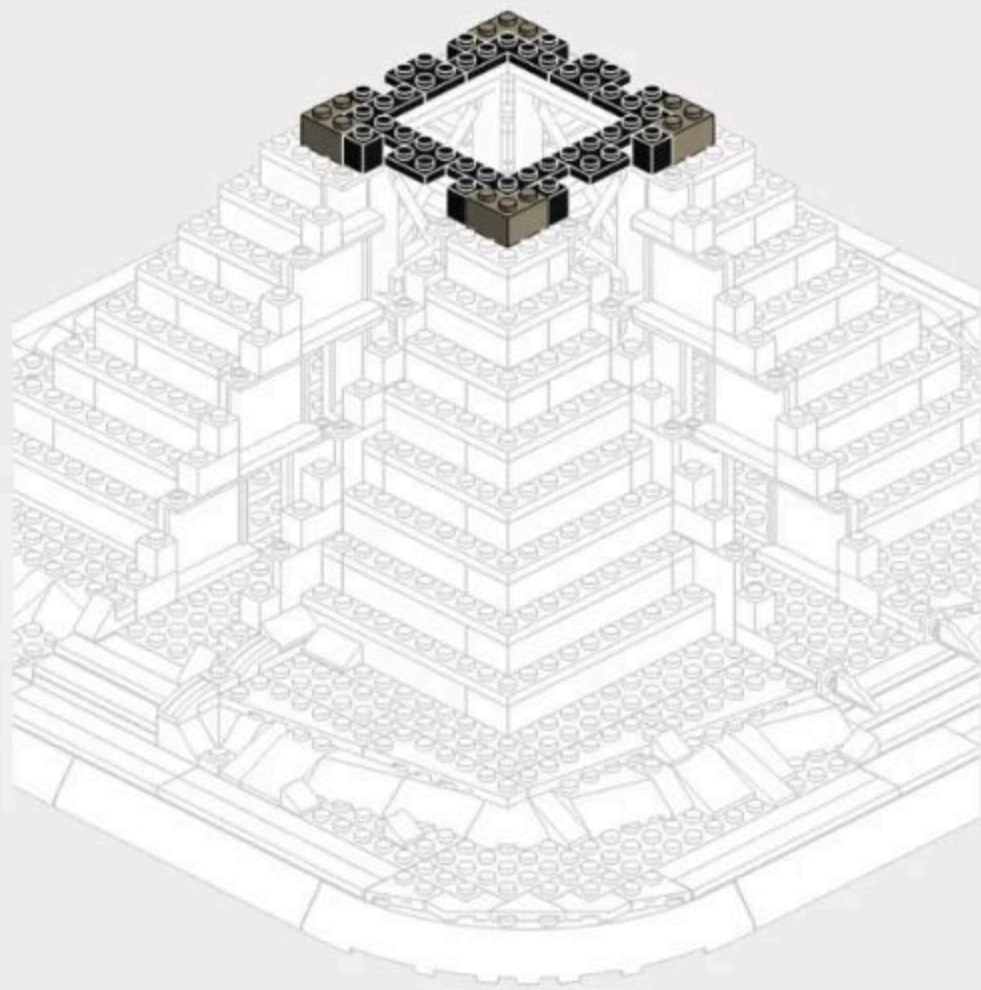

3-16

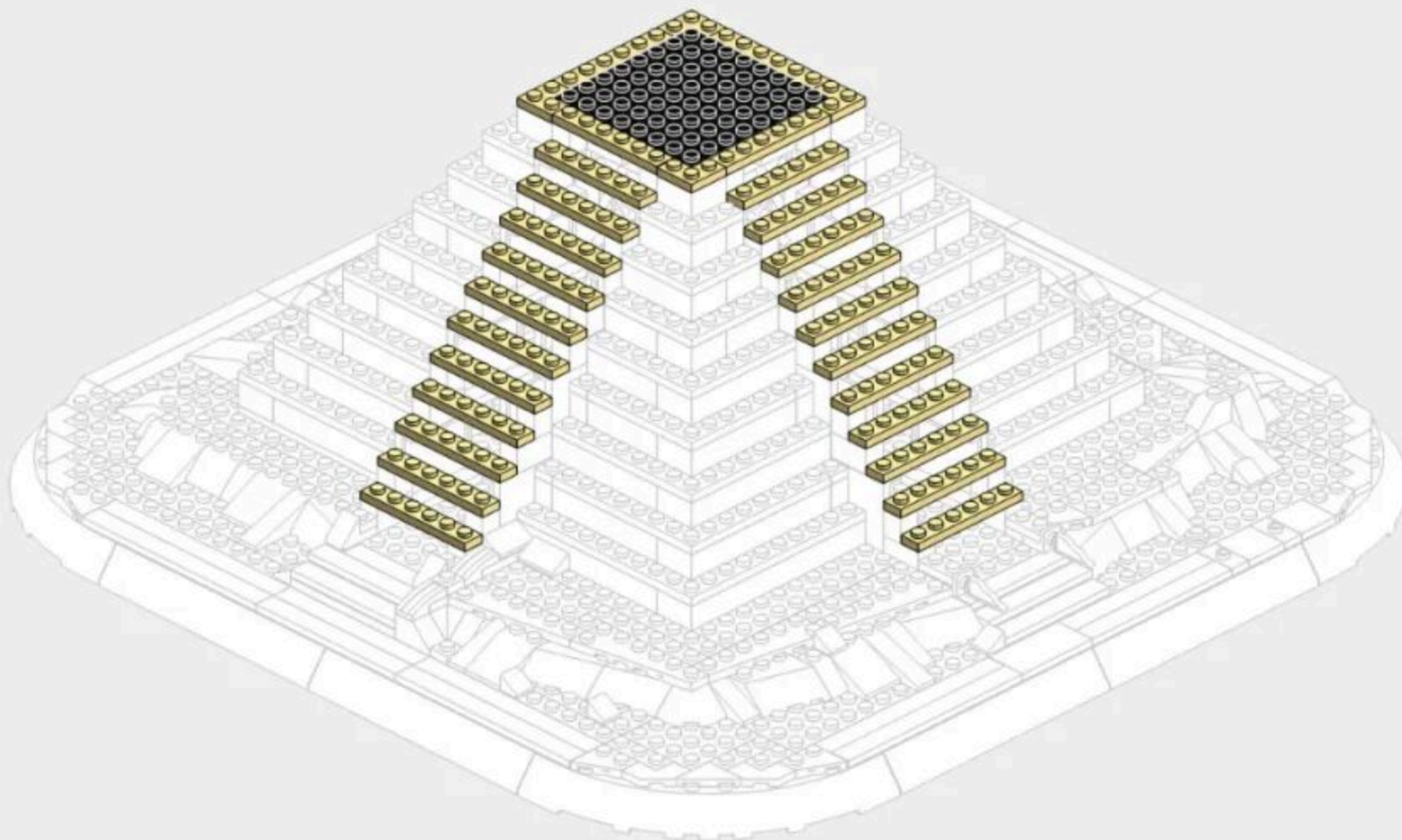
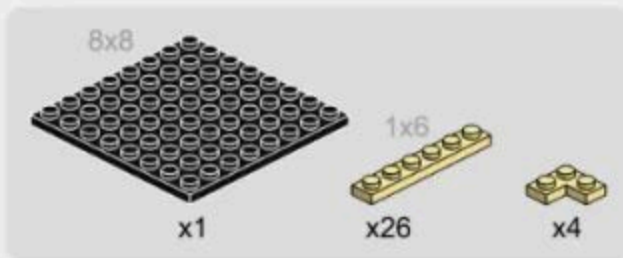

3-17

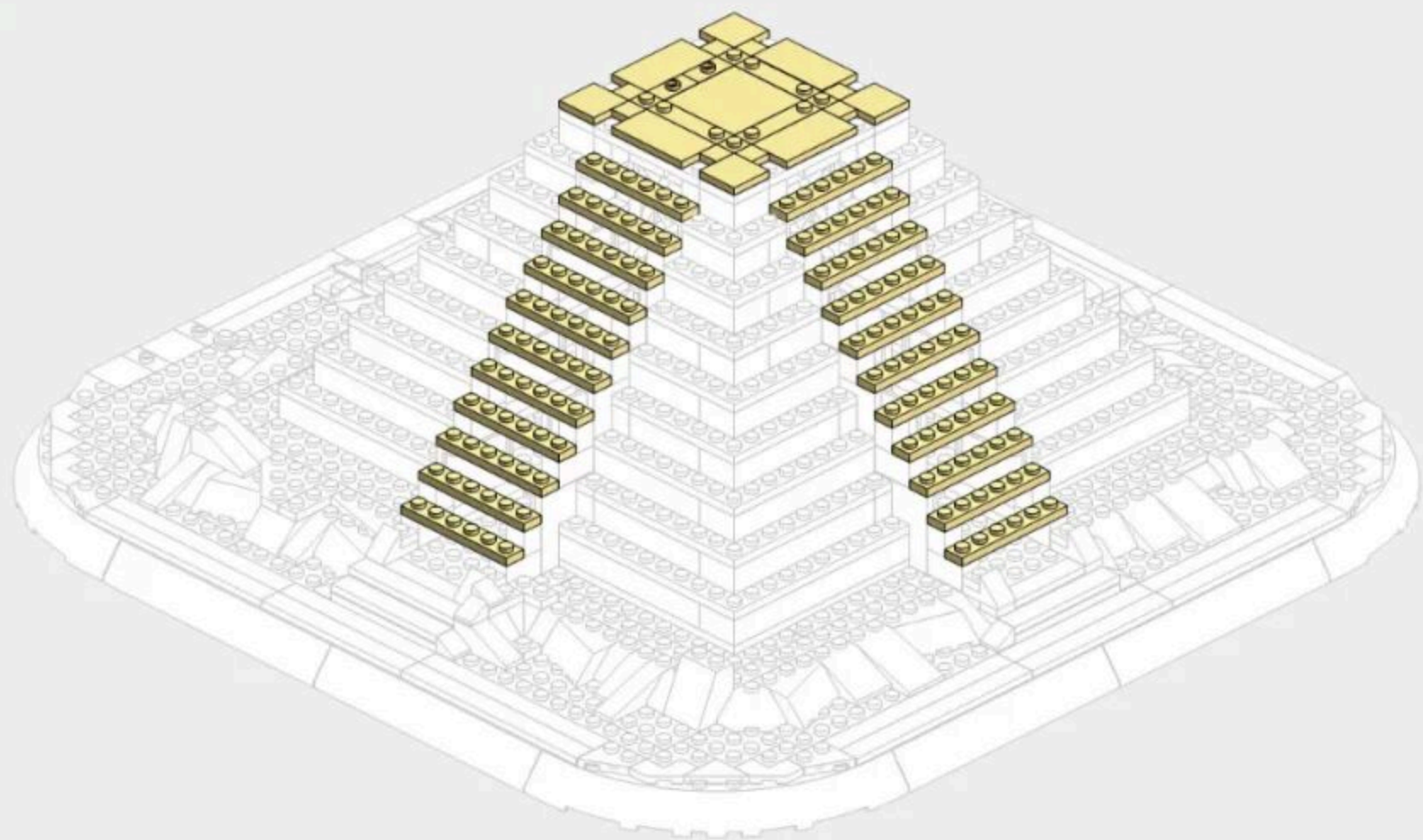
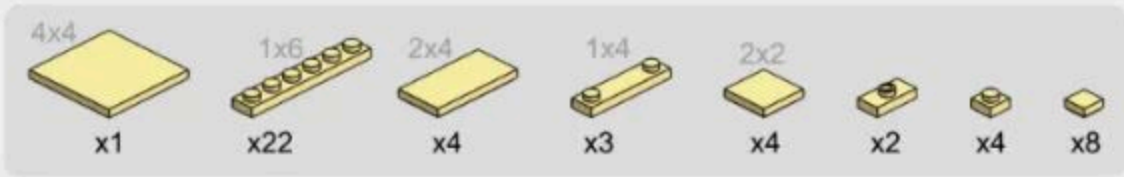



267 PCS

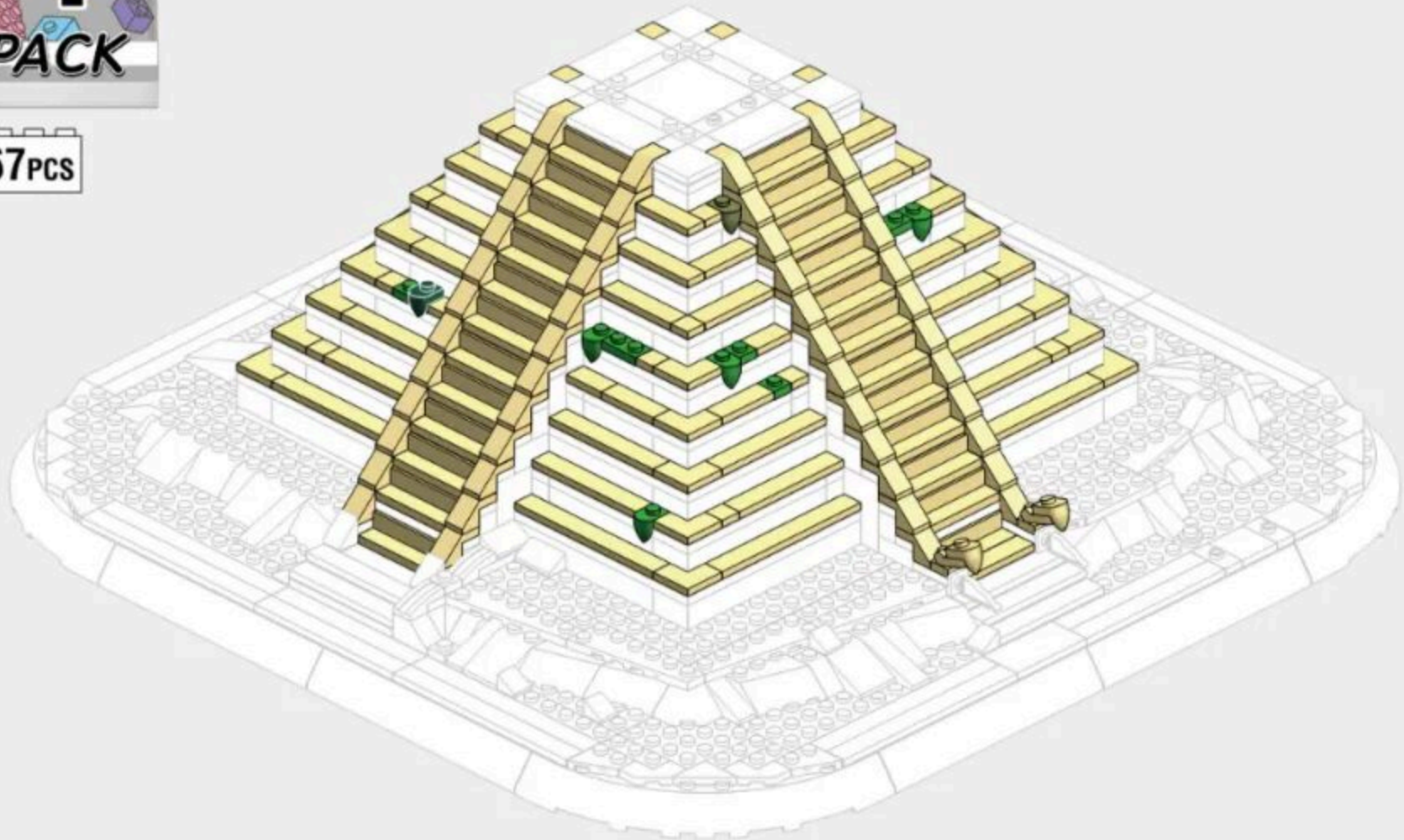

4-1

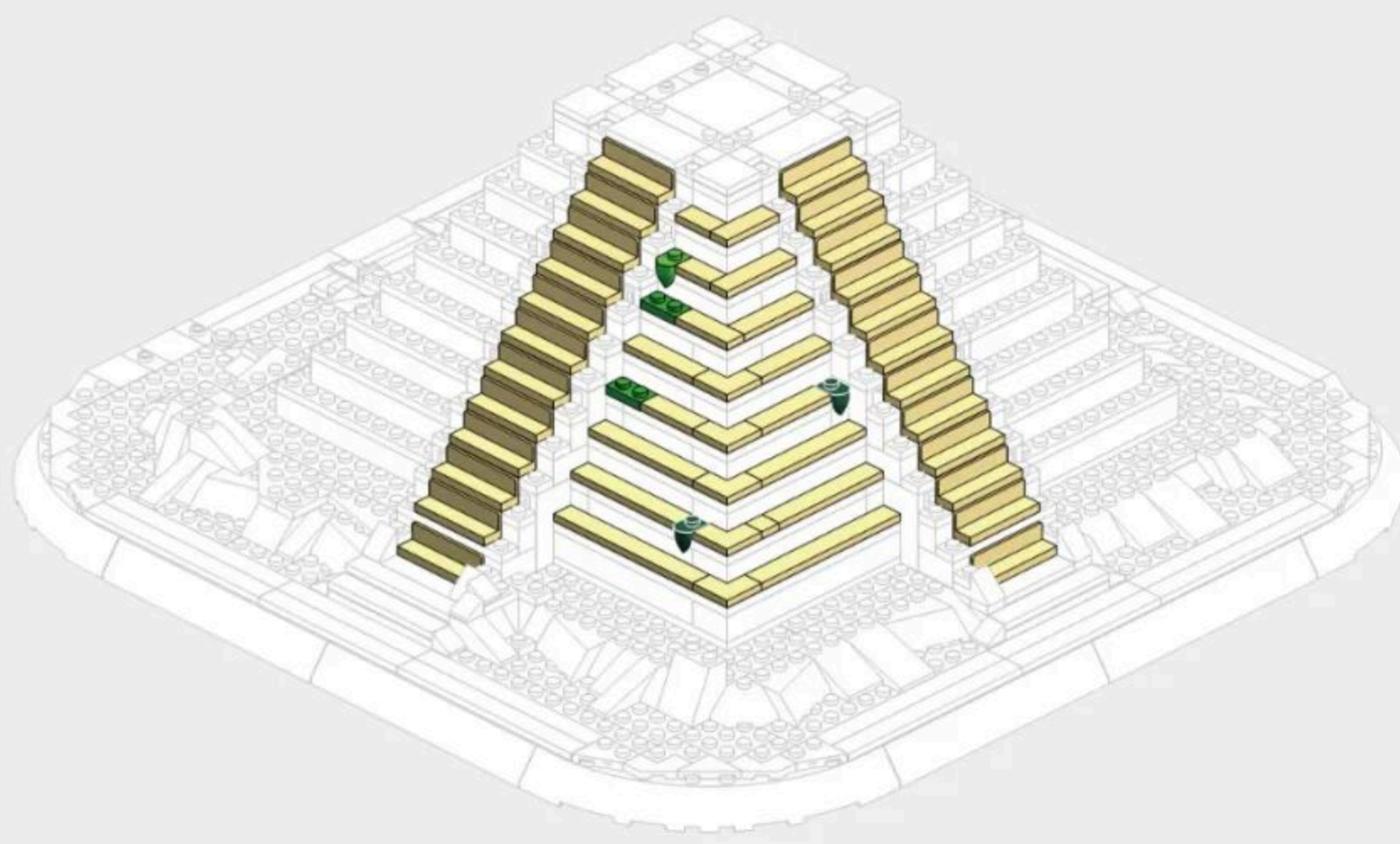
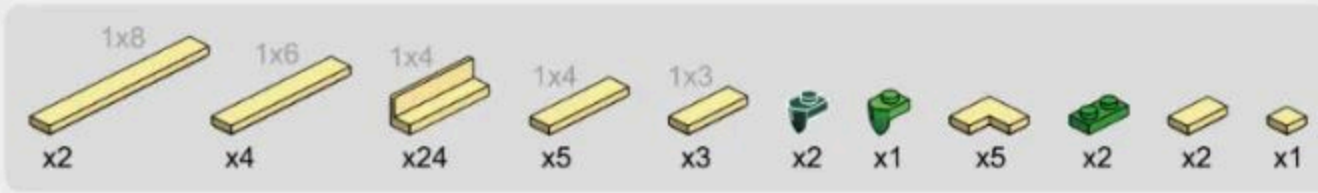

4-2

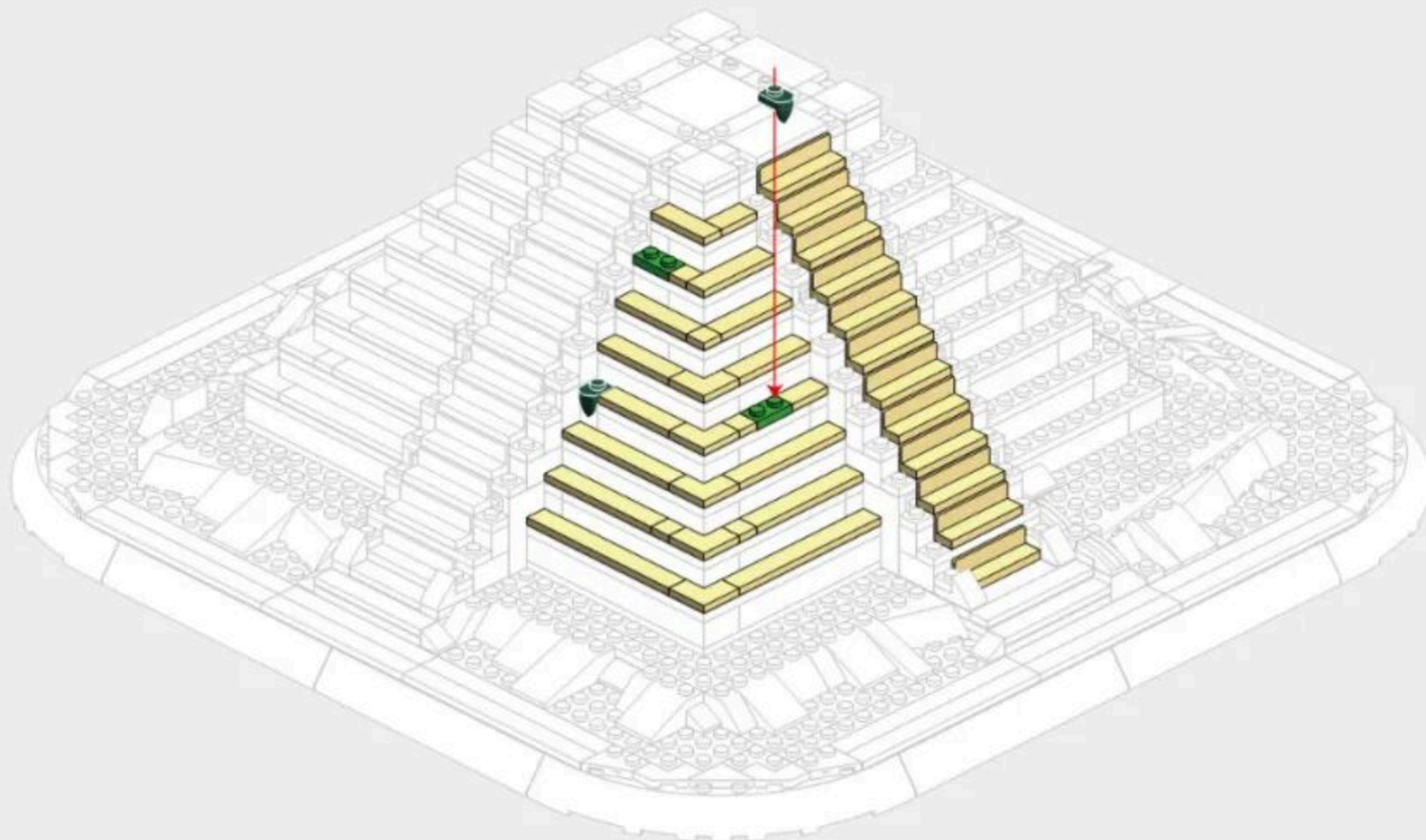
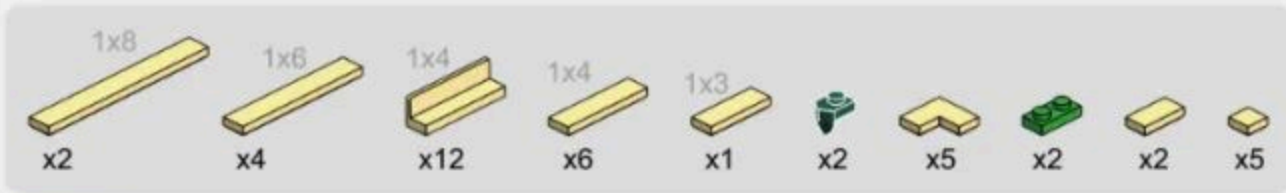

4-3

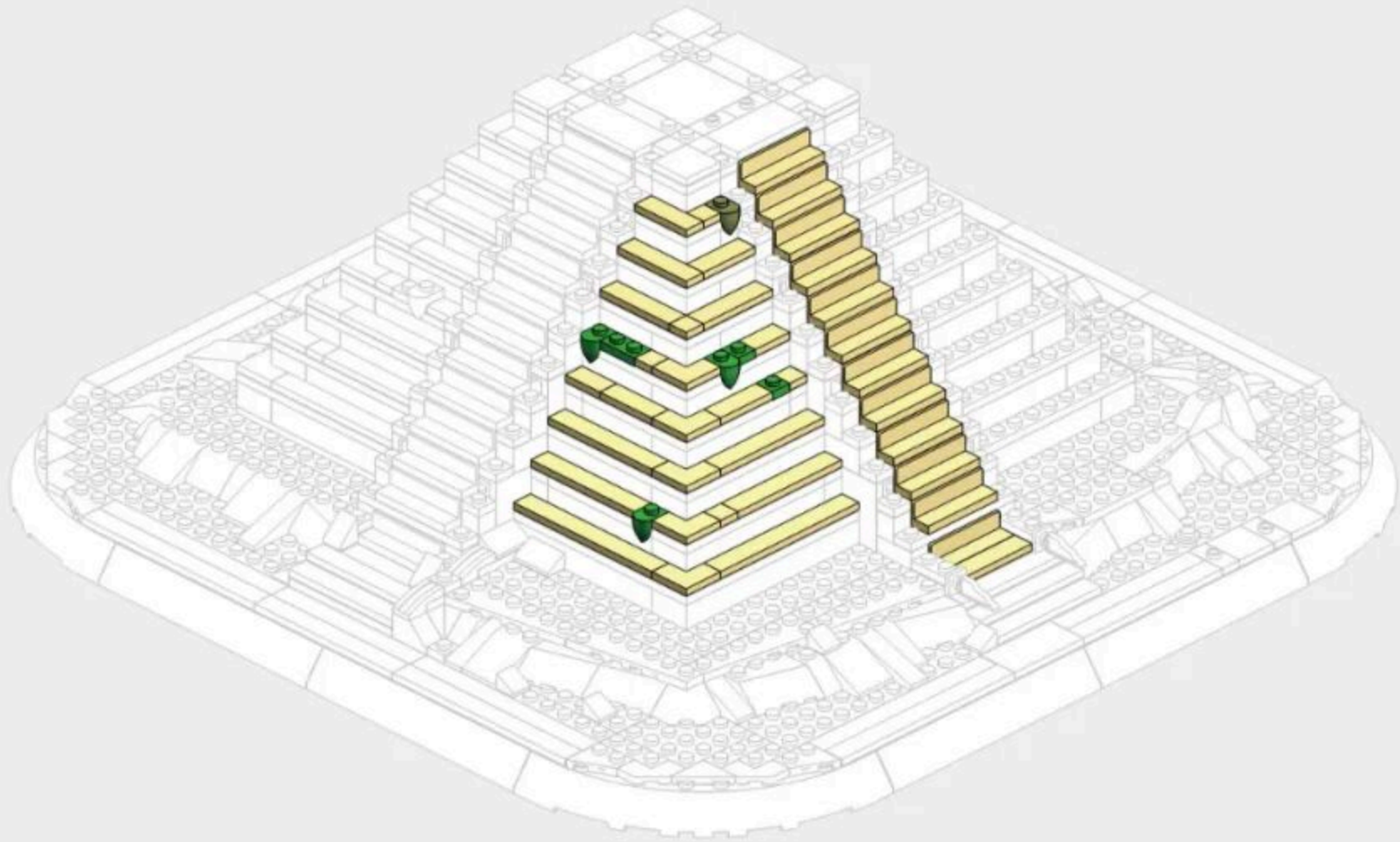
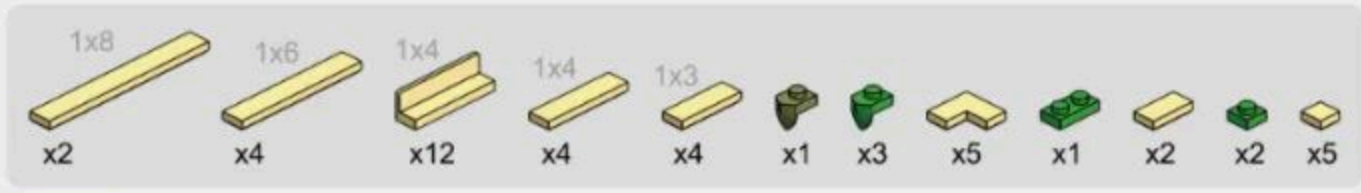

4-5

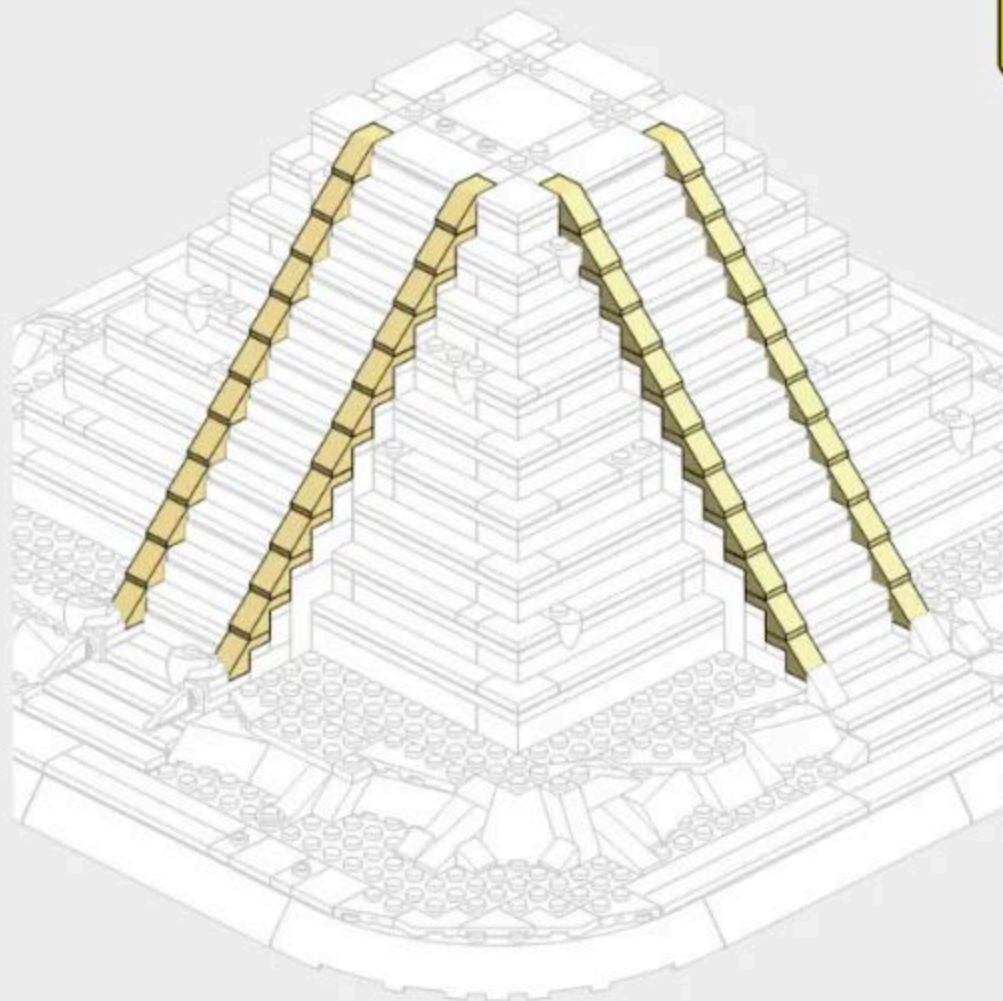

4-6

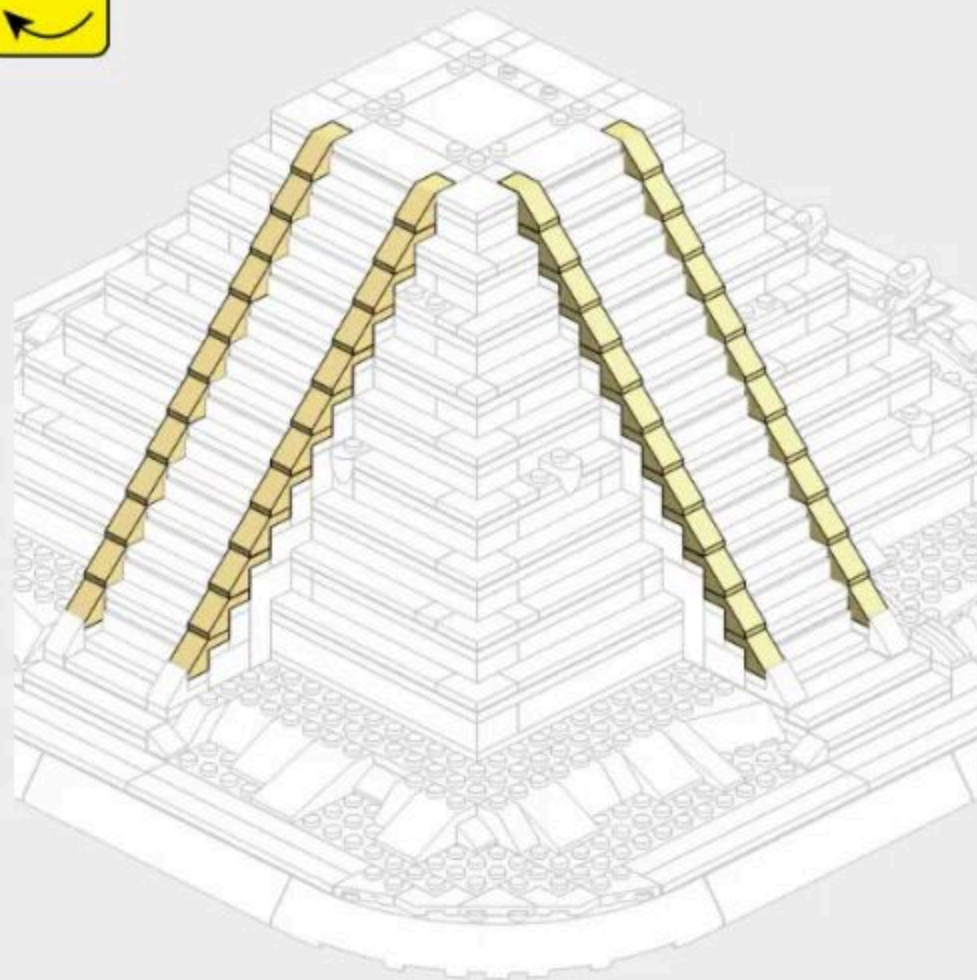



264PCS



56

5-1

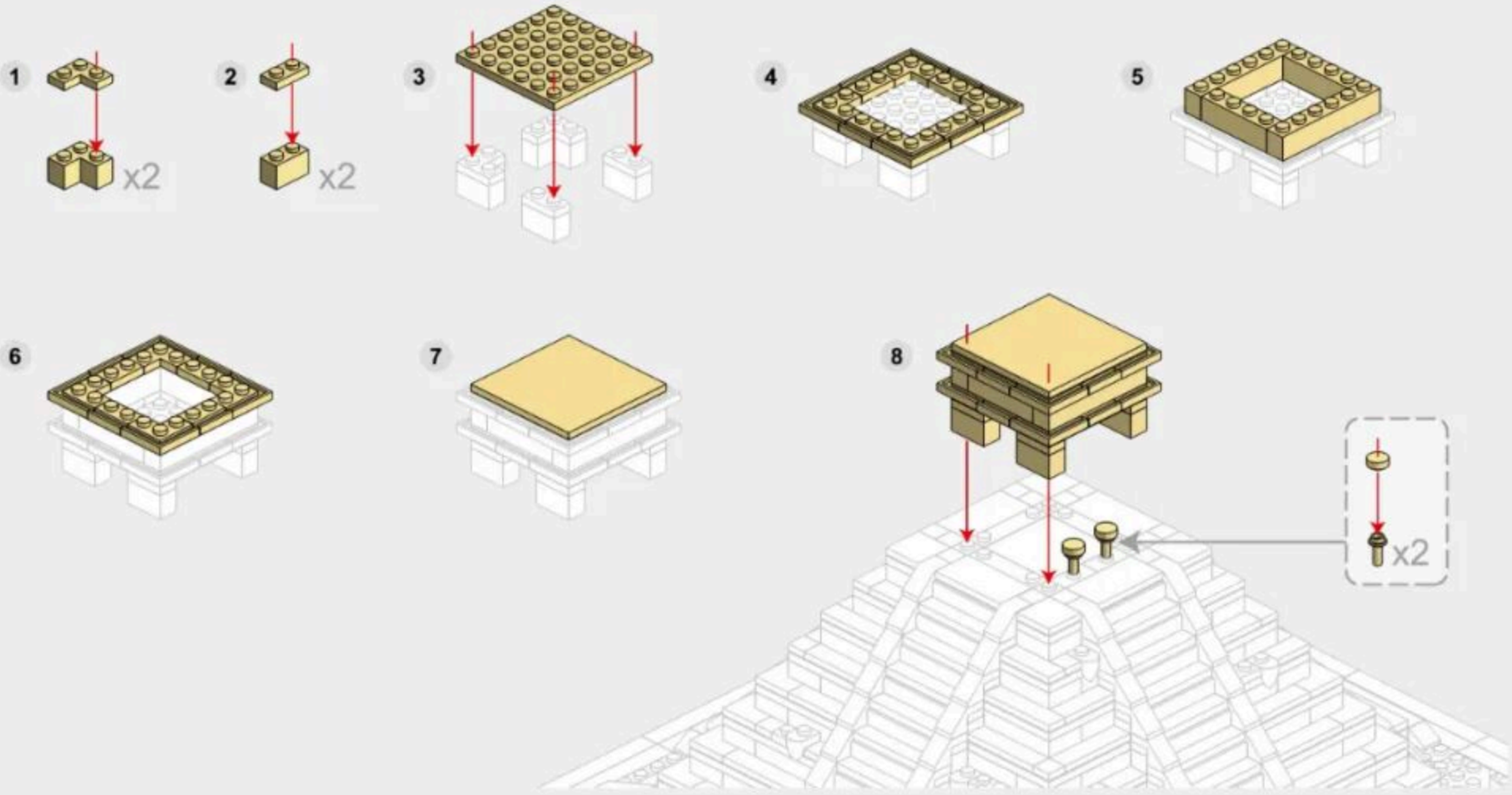
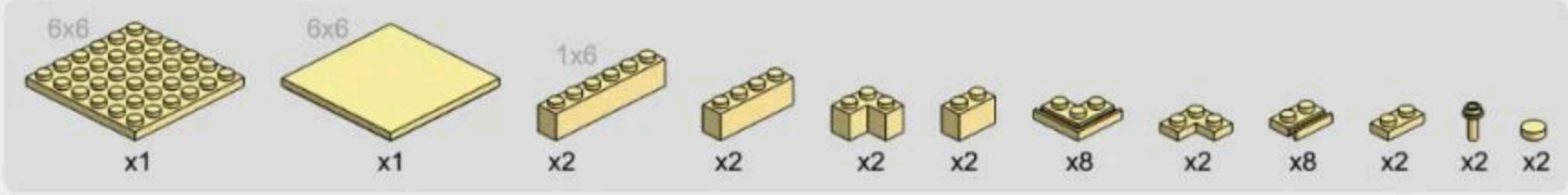

5-2

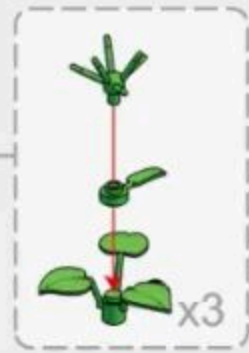
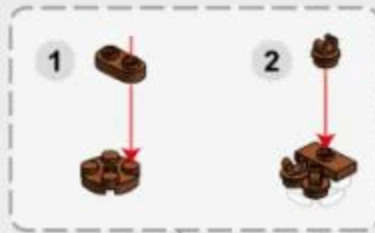

5-3



Vertical View of Installation Drawing
安装图顶面

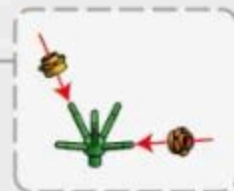

5-4



x3



x5



x2



x1



x8



x4



x3



x1



x2



x3



x1

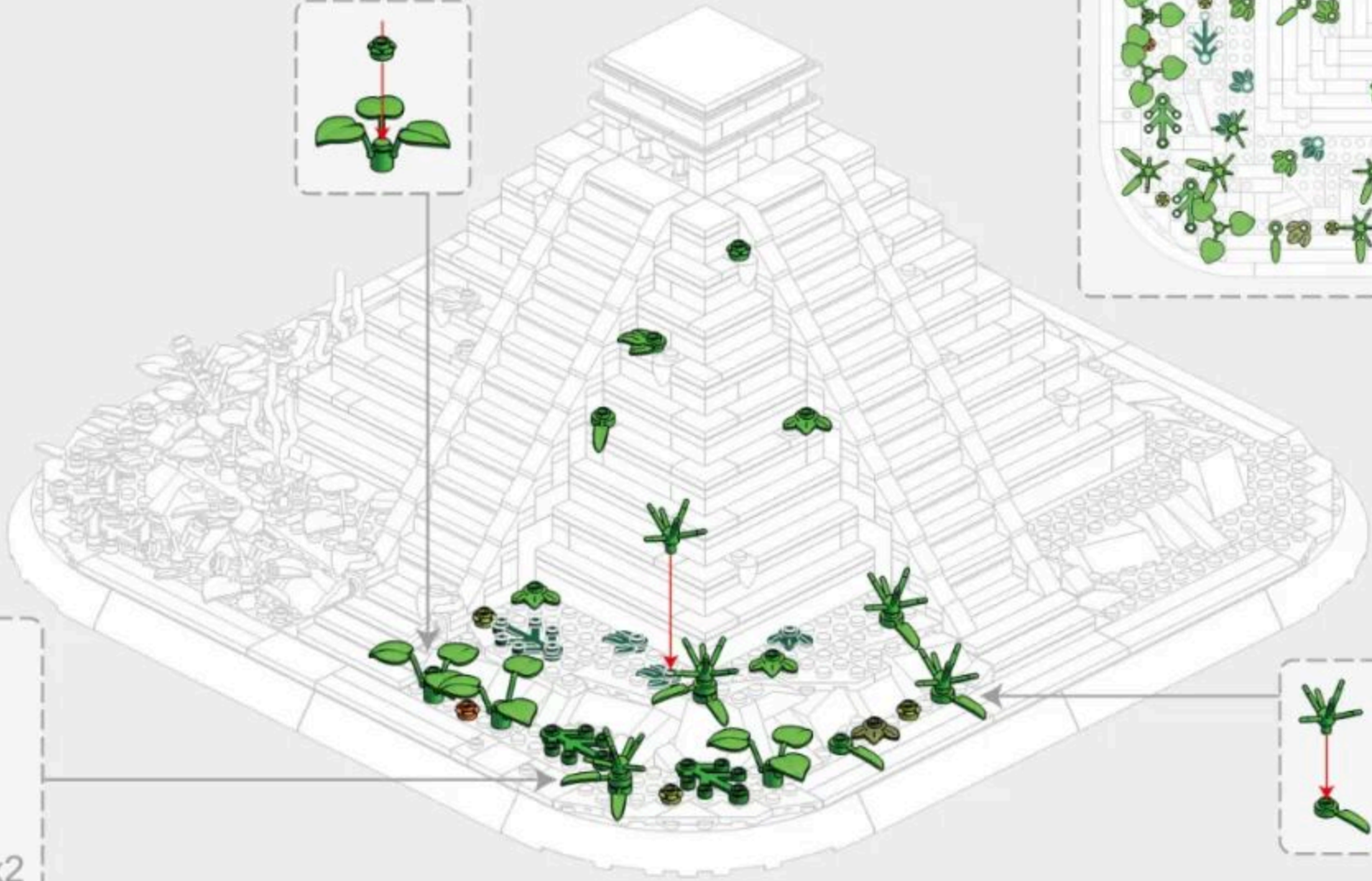

Vertical View of Installation Drawing
安装图顶面

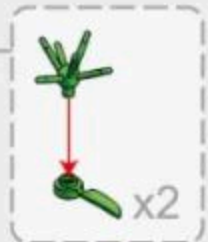
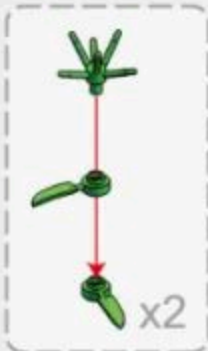

5-5



5-6



5-7

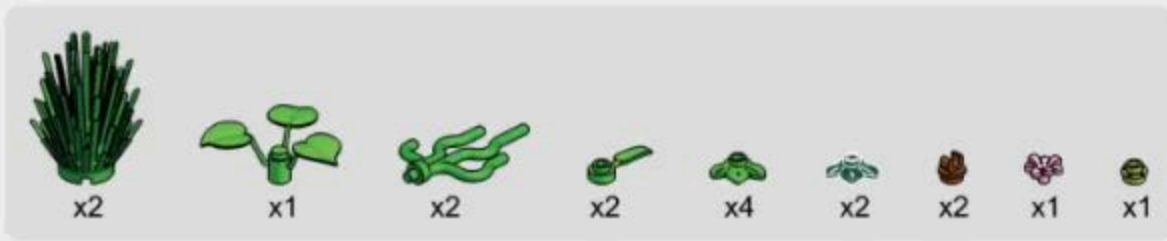

5-8



x6



x2



x1



x2

1



2



5-9

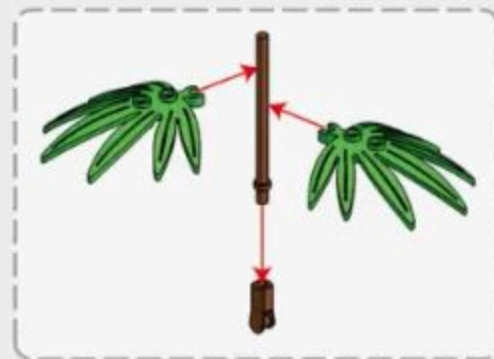
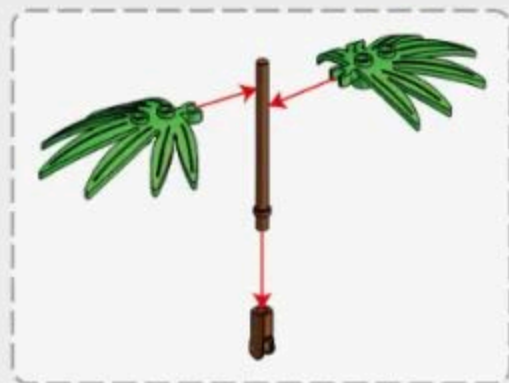

5-10



x6



x1



x1



x3



x1



x1

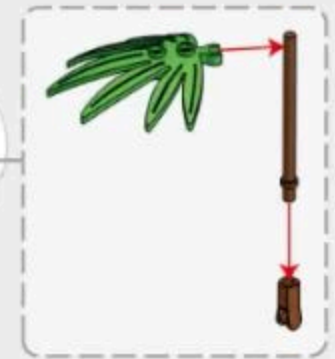

5-11

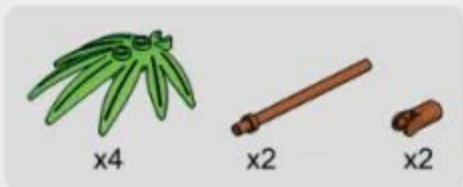

5-12

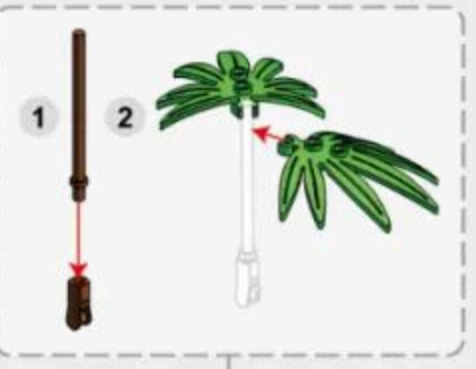
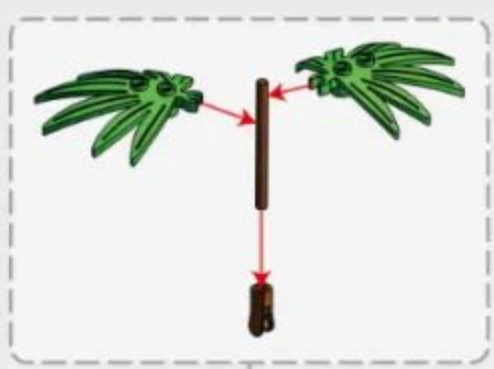

5-13





扫一扫
了解产品更多信息



ARCHITECTURE

The World's great architecture



Shaping Skills



Imagination & Curiosity



Mathematical



Self Discovery & Perception



Parent-Child Interaction



Problem Solving



Creativity



6224 英国伦敦白金汉宫
BUCKINGHAM PALACE-LONDON,ENGLAND



5225 意大利罗马斗兽场
COLOSSEUM-ROME,ITALY



5226 日本东京帝国饭店
IMPERIAL HOTEL-TOKYO,JAPAN



5227 美国纽约自由女神像
STATUE OF LIBERTY-NEW YORK,AMERICA



6211 德国柏林勃兰登堡门
BRANDENBURG GATE-BERLIN, GERMANY

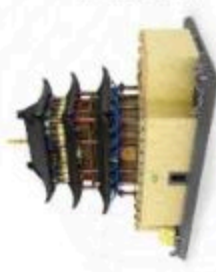

6222 中国甘肃长城-嘉峪关
JIAYU PASS-GANSU, CHINA



6212 日本京都清水寺仁王门
NISHINOMIYA GATE OF NINOMIYA-DERA-AYOTOJAPAN



6213 俄罗斯莫斯科瓦西里大教堂
SAINT BASIL'S CATHEDRAL-MOSCOW,RUSSIA



6214 中国武汉黄鹤楼
YELLOW CRANE TOWER-WUHAN,CHINA



6215 英国伦敦眼
LONDON EYE-LONDON,ENGLAND



6221 中国北京故宫-太和殿
HALL OF SUPREME HARMONY-BEIJING,CHINA



6220 沙特阿拉伯麦加大清真寺
GREAT MOSQUE OF MECCA-SALDAH ARABIA



6219 美国纽约联合国大厦
UNITED NATIONS SECRETARIAT BLDG-NEW YORK,AMERICA



4214 美国华盛顿白宫
WHITE HOUSE-WASHINGTON DC,AMERICA



4212 意大利罗马许愿池
TREVII FOUNTAIN-ROME,ITALY



4213 法国巴黎卢浮宫
MUSEE DU LOUVRE-PARIS,FRANCE



4218 新加坡-鱼尾狮
MERLION,SINGAPORE



4219 英国伦敦双子塔桥
TOWER BRIDGE-LONDON,ENGLAND



4216 美国华盛顿林肯纪念馆
LINCOLN MEMORIAL-WASHINGTON DC,AMERICA



4217 新加坡-金沙酒店
MARINA BAY SANDS,SINGAPORE



4210 埃及开罗吉萨金字塔
GREAT PYRAMID OF GIZA-CAIRO,EGYPT



4221 加拿大渥太华国会山庄
PARLIAMENT BUILDING-SOTTAWA,CANADA



4211 英国伦敦伊丽莎白塔
ELIZABETH TOWER-ENGLAND



4215 加拿大多伦多电视塔
THE CN TOWER-CANADA



4220 美国纽约熨斗大厦
FLATIRON BUILDING-NEW YORK,AMERICA



4222 阿联酋迪拜哈利法塔
THE BURJ KHALIFA TOWER-DUBAI, U.A.E.



5224 中国上海东方明珠广播电视塔
ORIENTAL PEARL TOWER-SHANGHAI, CHINA



5212 美国纽约帝国大厦
EMPIRE STATE BUILDING-NEW YORK, AMERICA



5213 马来西亚吉隆坡石油双塔
PETRONAS TWIN TOWERS-KUALA LUMPUR, MALAYSIA



5214 意大利托斯卡纳比萨斜塔
LEANING TOWER OF PISA-TUSCANY, ITALY



5216 英国伦敦伊丽莎白塔
BIG BEN-TOWER-LONDON, ENGLAND



5219 俄罗斯莫斯科克里姆林宫钟楼
SPASSKAYA TOWER-MOSCOW, RUSSIA



5220 阿联酋迪拜卓美亚帆船酒店
BURJ AL ARAB HOTEL-DUBAI, U.A.E.



5217 法国巴黎埃菲尔铁塔
EIFFEL TOWER-PARIS, FRANCE



5221 中国台北101大楼
TAIPEI 101-TAIPEI, CHINA



5228 美国芝加哥威利斯大厦
WILLIS TOWER-CHICAGO, AMERICA



5231 巴西里约热内卢基督救世像
CRISTO REDENTOR-RIO DE JANEIRO, BRASIL



6223 中国武汉长江大桥
WUHAN YANGTZE RIVER BRIDGE



5210 法国巴黎圣母院大教堂
CATHÉDRALE NOTRE-DAME DE PARIS-PARIS, FRANCE



5211 印度阿格拉泰姬陵
TAJ MAHAL-AGRA, INDIA



5223 法国巴黎凯旋门
ARC DE TRIOMPHE-PARIS, FRANCE



5215 英国伦敦双子塔桥
TOWER BRIDGE-LONDON, ENGLAND



5222 中国北京天坛祈年殿
HALL OF PRAYER FOR GOOD HARVESTS-BEIJING, CHINA



6210 美国旧金山金门大桥
GOLDEN GATE BRIDGE-SAN FRANCISCO, AMERICA



6216 中国北京万里长城（八达岭）
THE GREAT WALL-BEIJING, CHINA



5218 中国北京天安门
TIAN'ANMEN TOWER-BEIJING, CHINA



6217 中国西藏布达拉宫
POTALA PALACE-TIBET, CHINA



6218 芬兰罗瓦涅米圣诞老人办公室
SANTA CLAUS OFFICE-ROVANIEMI, FINLAND



6225 墨西哥库库尔坎玛雅金字塔
EL CASTILLO-KUKULKAN, MEXICO



6226 德国巴伐利亚新天鹅堡
SCHLOSS NEUSCHWANSTEIN-BAYERN, DEUTSCHLAND



5229 土耳其伊斯坦布尔少女塔
MAIDEN TOWER-ISTANBUL, TURKEY



5230 中国湖南长沙爱晚亭
AWANTING PAVILION-HUNAN, CHINA



7210 中国上海世博会中国馆
CHINA PAVILION AT EXPO-SHANGHAI/CHINA



5232 美国宾夕法尼亚州流水别墅
FALLINGWATER-PENNSYLVANIA, AMERICA



5233 美国芝加哥范斯沃斯住宅
FARNSWORTH HOUSE-CHICAGO, AMERICA



5234 美国华盛顿唐人街
CHINA TOWN-WASHINGTON, D.C., AMERICA



3210 美国纽约自由女神像
STATUE OF LIBERTY-NEW YORK/AMERICA



4223 中国北京清华园
TINGHUA CAMPUS-BEIJING, CHINA



7211 中国湖南岳阳楼
YUEYANG TOWER-HUNAN, CHINA



8210 澳大利亚悉尼歌剧院
SYDNEY OPERA HOUSE-EDMUNDELONG POINT-AUSTRALIA



7212 中国江西南昌滕王阁
PAVILION OF PRINCE TENG-JIANGXI/CHINA



6227 中国河南郑州嵩山少林寺
SHAOLIN TEMPLE-HENAN, CHINA



7213 中国重庆洪崖洞
HONGJIADONG-CHONGQING, CHINA



5235 美国华盛顿国会大厦
UNITED STATES CAPITOL-WASHINGTON, D.C./AMERICA



5236 中国安徽滁州醉翁亭
ZUIHENG PAVILION-ANHUI/CHINA



6228 中国陕西西安钟楼
XIAN BELL TOWER-SHAANXI/CHINA



5238 美国西雅图太空针塔
SPACE NEEDLE-SEATTLE-AMERICA



5237 法国巴黎萨伏伊别墅
VILLA SAVOYE-PARIS, FRANCE



6229 中国山西运城鹳雀楼
STORK TOWER-SHANXI/CHINA



6230 希腊爱琴海圣托里尼岛
SANTORINI-PIRAEUS, GREECE



6231 中国上海海关大楼
SHANGHAI CUSTOMS HOUSE-SHANGHAI/CHINA



5239 中国北京紫禁城角楼
TURRET OF PALACE MUSEUM-BEIJING, CHINA



5240 韩国首尔崇礼门
NANDAEMUN-SEOUL, KOREA



5241 中国江苏南京夫子庙
CONFUCIUS TEMPLE-JIANGSU, CHINA



5242 美国纽约古根海姆博物馆
GUGGENHEIM MUSEUM-NEW YORK, AMERICA



6232 中国江苏南京秦淮河画舫
QIONGLAI RIVER PAINTED BOAT-JIANGSU, CHINA



6233 法国诺曼底圣米歇尔山
SAINT MICHAEL'S MOUNT-NORMANDY, FRANCE



6234 中国河南洛阳老君山
THE LAOJUN MOUNTAIN-HENAN, CHINA



5243 耶路撒冷岩石圆顶
DOME OF THE ROCK-JERUSALEM



6235 中国江苏苏州寒山寺 (普明宝塔)
HANSHAN TEMPLE-JIANGSU, CHINA



4224 英国威尔特郡巨石阵
STONEHENGE-WILTSHIRE, ENGLAND



4225 中国内蒙古自治区蒙古包
MONGOLIAN YURT-INNER MONGOLIA, CHINA



8211 中国福建土楼(承启楼)
CHENGQI EARTH BUILDING-FUJIAN, CHINA



4226 沙特阿拉伯麦加大清真寺(克尔白)
KERBAL GREAT MOSQUE OF MECCA, SAUDI ARABIA



5244 俄罗斯圣彼得堡冬宫
WINTER PALACE-ST. PETERSBURG, RUSSIA



7214 中国陕西西安鼓楼
XIAN DRUM TOWER-SHAANXI, CHINA



5245 中国重庆李子坝站
LIZIBA STATION-CHONGQING, CHINA



4227 俄罗斯莫斯科国立大学
MOSCOW STATE UNIVERSITY- MOSCOW, RUSSIA



4228 沙特阿拉伯麦地那先知清真寺
PROPHETS MOSQUE-E- MEDINA, SAUDI ARABIA



EL CASTILLO

COUNTRY: Mexico
CITY: Kukulcan

