



XI'AN BELL TOWER

中国陕西西安钟楼

Shaanxi, China

The world's great architecture



6+
Suitable Age

6228
Product Number

1116 PCS
Parts Total

XI'AN BELL TOWER

COUNTRY: China

CITY: Xi'an



Ver 622820230227



Architecture

It will be a city...

这将构成一座城市...

ABOUT THE PRODUCT

关于产品

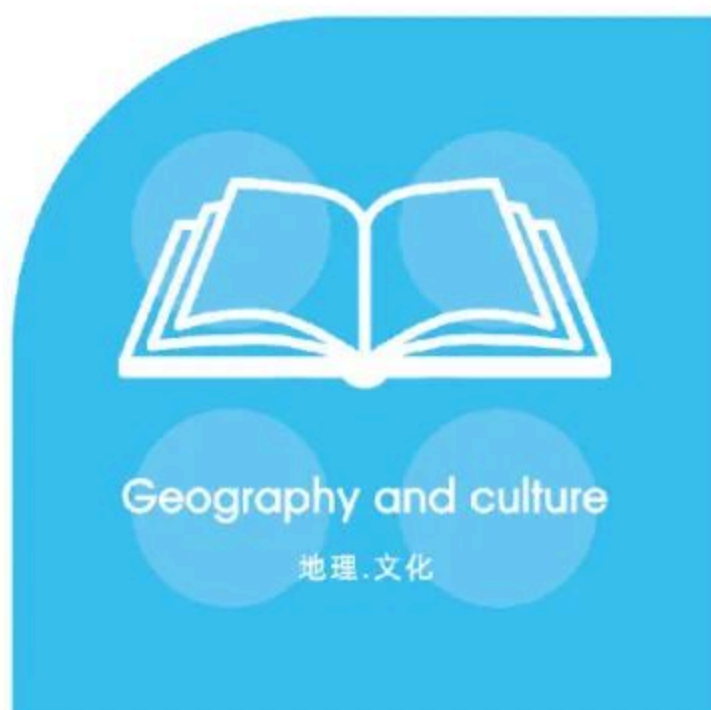

ARCHITECTURE

WANGE The world's great architect since 1991

Xi'an Bell Tower



Xi'an Bell Tower is located in the center of Xi'an, at the intersection of the east, west, north, south, and four avenues within the Ming city wall. It is the largest and best-preserved bell tower in China.

Xi'an Bell Tower



Geography and culture

地理·文化



Xi'an Bell Tower was built in the seventeenth year of Hongwu in Ming Dynasty (1384). In the past, there was a big clock hanging upstairs to tell the time, hence the name "Bell Tower".



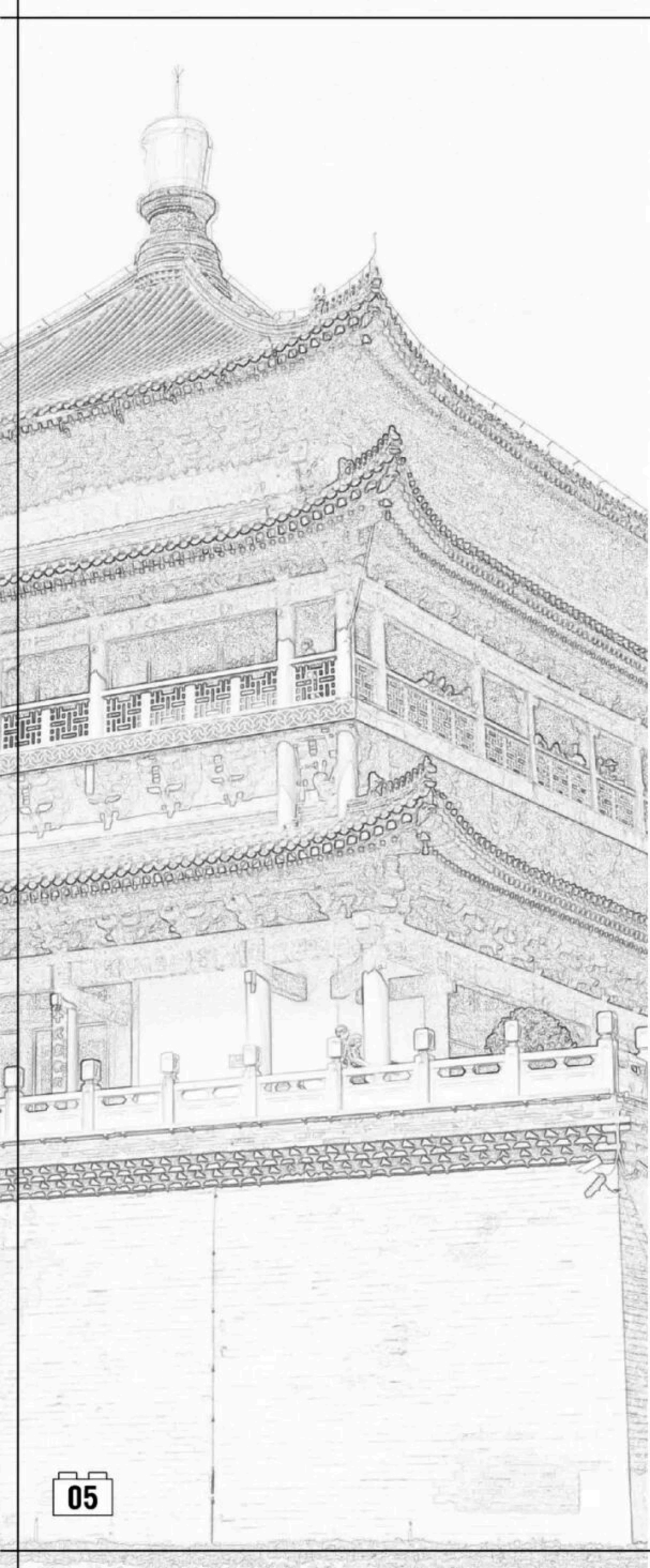

中国陕西西安钟楼

Xi'an Bell Tower

China

The contents of this chapter refer to the Wikipedia website.

本章内容参考维基百科网站，
更多资讯可自行查阅。

The world's great architecture

Buildings and layout

■ 建筑物和布局



西安钟楼始建于明初，建于1384年，是西安市的象征，也是中国同类钟楼中最宏伟的钟楼之一。钟楼内还藏有数座唐代大型青铜铸钟。塔基为方形，占地面积1,377平方米（14,820平方英尺）。该塔为砖木结构，高近40 m（130 ft）。位于西安市中心，东、西、南、北四街交汇处。它是中国古代遗留下来的众多钟楼中规模最大、保存最完好的一座。

The Bell Tower of Xi'an, built in 1384 during the early Ming Dynasty, is a symbol of the city of Xi'an and one of the grandest of its kind in China. The Bell Tower also contains several large bronze-cast bells from the Tang Dynasty. The tower base is square and it covers an area of 1,377 m² (14,820 sq ft). The tower is a brick and timber structure and close to 40 m (130 ft) high. It is located in the center of Xi'an, at the intersection of the four streets of the east, west, south and north. It is the largest and most preserved one amongst the many bell towers left over from ancient China.



Structure

钟楼构建于用青砖、白灰砌成的方形基座上，为砖木结构，重楼三层檐，四角攒顶的形式。自地面至楼顶总高36米，由基座、楼身和楼顶三部分组成。下部砖石结构的正方形基座高8.6米，每边长35.5米，面积约1377.4平方米，内有楼梯可盘旋而上，基座之上为两层木结构楼体，由四面空透的圆柱回廊和迭起的飞檐等组成，高27米。

The bell tower is built on a square base made of blue brick and white ash. It is a brick and wood structure, with three-storey eaves and a roof at the corners. From the ground to the roof of the total height of 36 meters, by the base, building and roof of three parts. The square base of the lower brick structure is 8.6 meters high and 35.5 meters long on each side, covering an area of 1,377.4 square meters. There are stairs that can spiral up. Above the base is a two-story wooden building, which is 27 meters high and consists of cylindrical corridors and cascading eaves on all sides.



History

西安钟楼始建于明洪武十七年（1384年），钟楼初建时的位置在西大街以北广济街口的迎祥观，与南北城门正对，是城市的中心。其后的二百年间，西安城不断扩建，在原来的基础上，向东、向北各扩建了近四分之一的面积，随着城市中心东移，城门改建，新的东、南、西、北四条大街形成，位于迎祥观的钟楼便日益显得偏离城市中心。1956年8月6日，陕西省人民委员会公布钟楼为省级文物保护单位。1996年11月20日，西安钟楼被国务院公布为全国重点文物保护单位。

Xi'an Bell Tower was built in the seventeenth year of Hongwu in Ming Dynasty (1384). When the Bell Tower was first built, it was located at the front view of Guangji Street, north of West Street, opposite the north and south gates, and was the center of the city. In the following two hundred years, the city of Xi'an continued to expand. On the basis of the original, it expanded by nearly a quarter of the area to the east and north. With the formation of four avenues in the south, west and north, the Bell Tower at Yingxianguan is increasingly deviated from the city center. On August 6, 1956, the Shaanxi Provincial People's Committee announced the Bell Tower as a provincial-level cultural relics protection unit. On November 20, 1996, Xi'an Bell Tower was announced by the State Council as a national key cultural relics protection unit.

Force Balance

受力平衡

Physical operations

物理运算

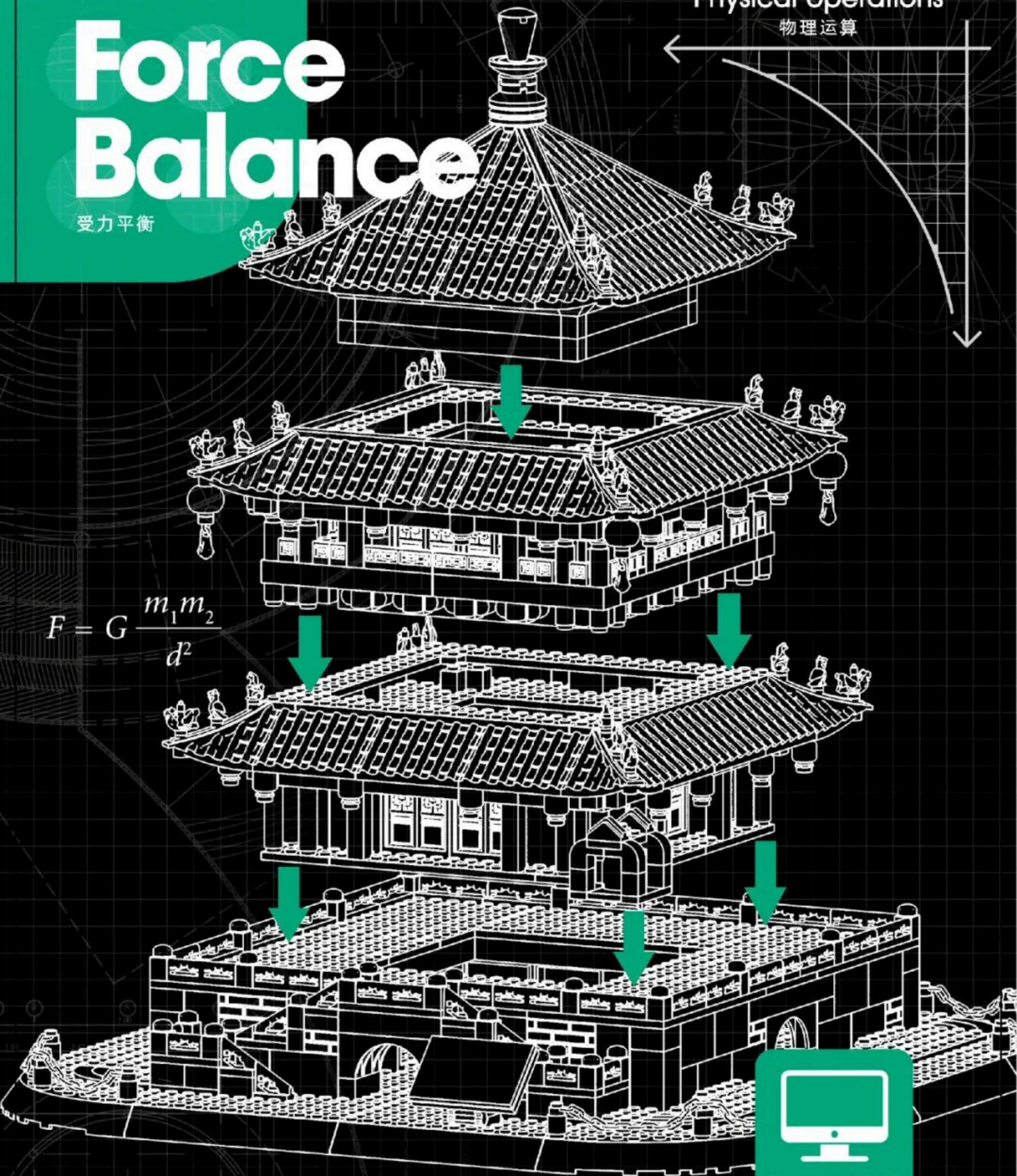

$$F = G \frac{m_1 m_2}{d^2}$$



Creation and thinking

创作·思考

08

$$S=4\pi \cdot r^2$$

Special parts

特殊零件的开发利用

$$a^2+b^2=c^2$$

WG1439

1孔回纹栏杆



WG0534

直瓦片6孔

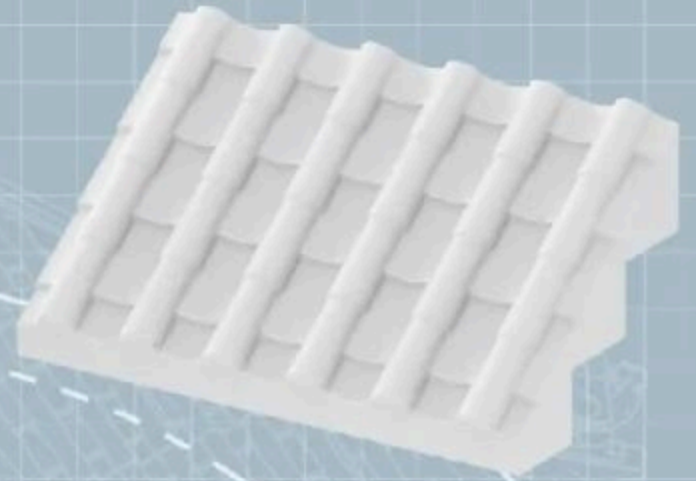

WG1275

2孔栏杆



WG1345

竖纹2倍2孔



WG1389

4孔回纹栏杆



WG1519

带孔弯角瓦片



WG1275

2孔栏杆

$$\sin^2 a + \cos^2 a = 1$$



WG1316

2高4孔墙砖



WG1434

斜面瓦片



features and functions

特点.功能

Main Color Matching

配色方案



Pantone 7427C



Pantone 7620C



Pantone 218C



Pantone 7509C



Pantone 7500C



Pantone 3435C



Pantone 2422C



Pantone 383C



Pantone 123C



Pantone 7717C



Pantone Black 6C



Pantone 540C



Pantone 431C



Pantone Cool Gray 6C

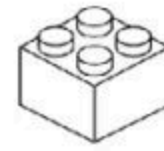

White



Color matching

Adopting 3 main colors, Blue-green, light grey and red as the main color, the more reasonable and Green color matching on the original building, making the product more atmospheric and the whole design is more reasonable.

Xi'an Bell Tower

中国陕西西安钟楼



Front

Left

Back

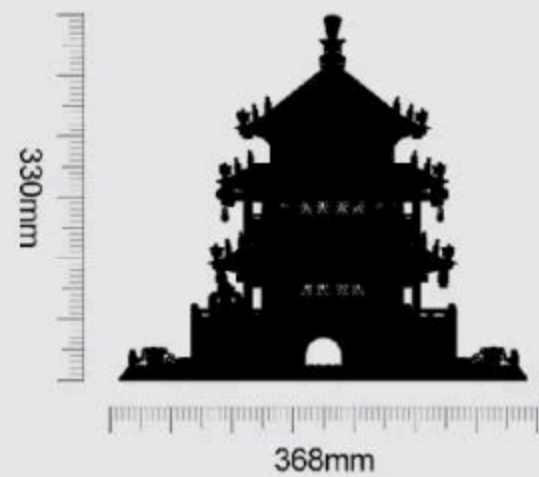
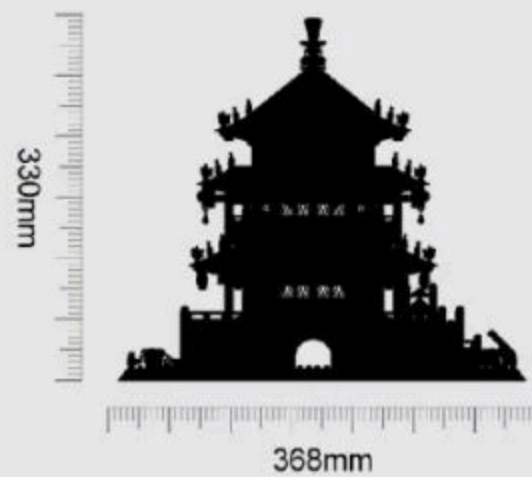
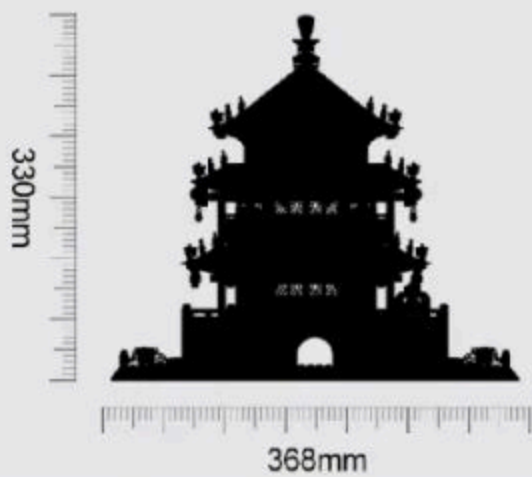

Product Size: 368X368X330mm



Instructions For Use

积木起件器使用说明
Brickseparator

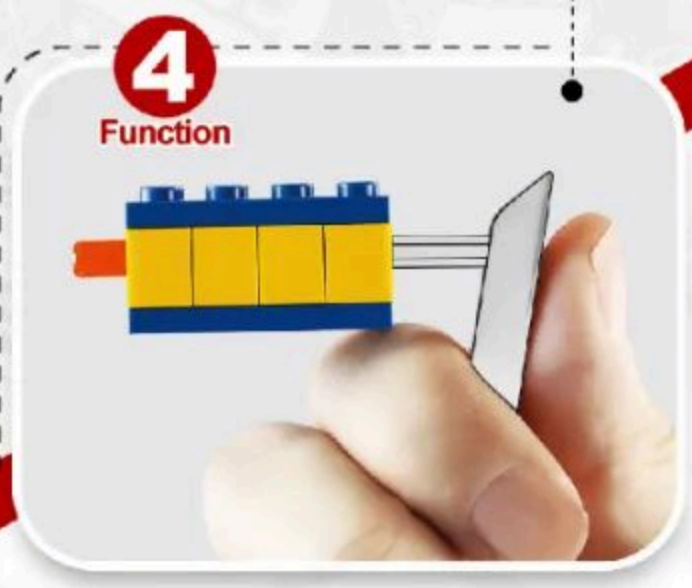
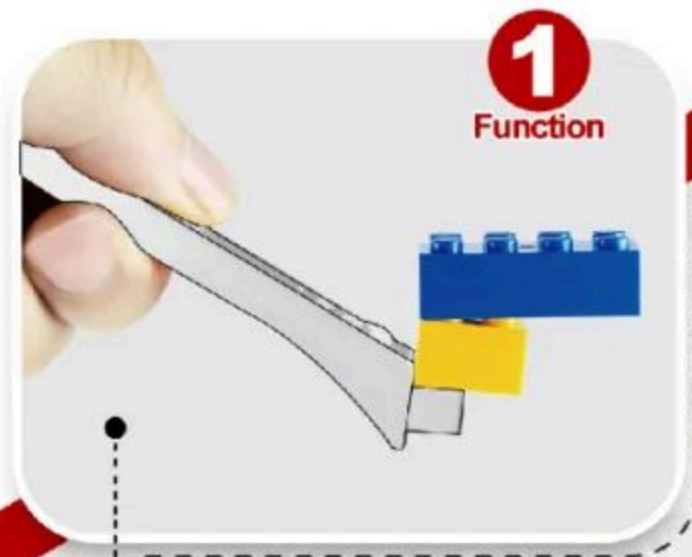

4 ways to make installation easier
让安装更简单



■ First open the product packaging according to the instructions.

按指导用正确方式拆解产品外包装。



■ Summarize all parts to count the number of familiar accessories.

对照说明书清单确认积木包数量与积木数量。



■ Arranging all accessories by color helps to quickly install the product.

把确认好的积木以类型、颜色进行分类排好以便安装。



■ Carefully install the product and learn about building.

按说明书步骤拼装并完成你的积木模型。



1:1 Physical Reference Table

十字棒配件1:1尺寸参照表



Instructions For Use

让安装更简单



2 (1x2)=2



3 (1x3)=3



4 (1x4)=4



5 (1x5)=5



6 (1x6)=6



7 (1x7)=7



8 (1x8)=8



9 (1x9)=9



10 (1x10)=10



12 (1x12)=12

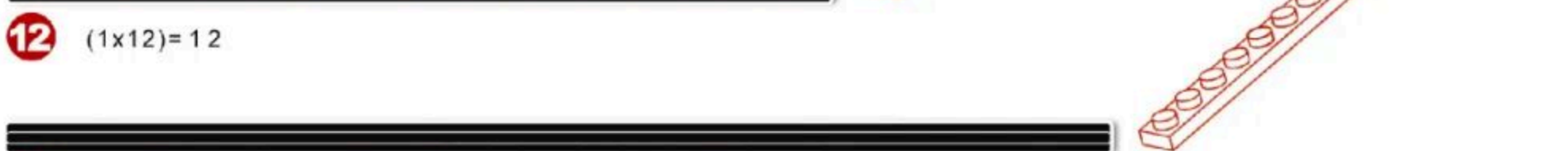

16 (1x16)=16



PARTS LIST

配件清单



x2



x2



x2



x2



x16



x8



x4



x6



x8



x1



x1



x12



x8



x12



x12



x16



x12

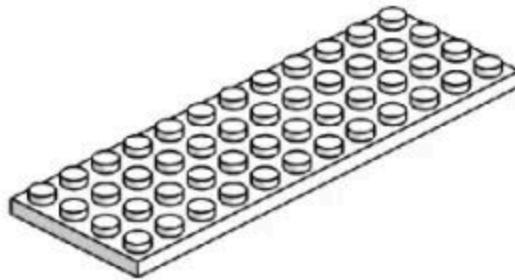

x4

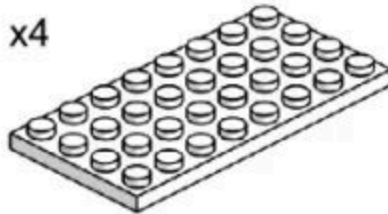

x2

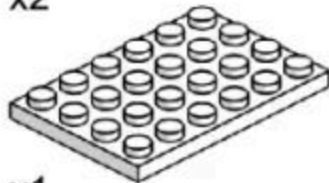

x1



x1

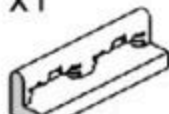

x23

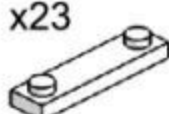

x2

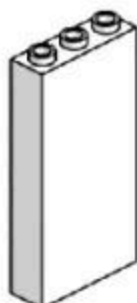

x8



x9



x8



x26



x2



x26



x4

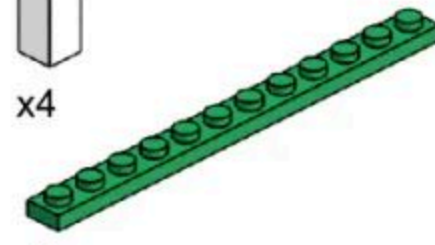

x6



x4



x6



x2



x12

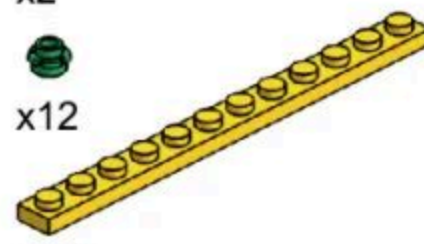

x12



x4



x4



x1



x1

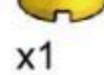

x4



x4



x4



x32



x4



x6



x1



x4



x1



x2



x2



x8



x4



x4



x4



x32



x4



x32

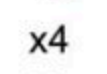

x1



x12



x6



x8



x24

产品有增补件请以实物为准

If product has additional parts, please in kind prevail.

PARTS LIST

配件清单

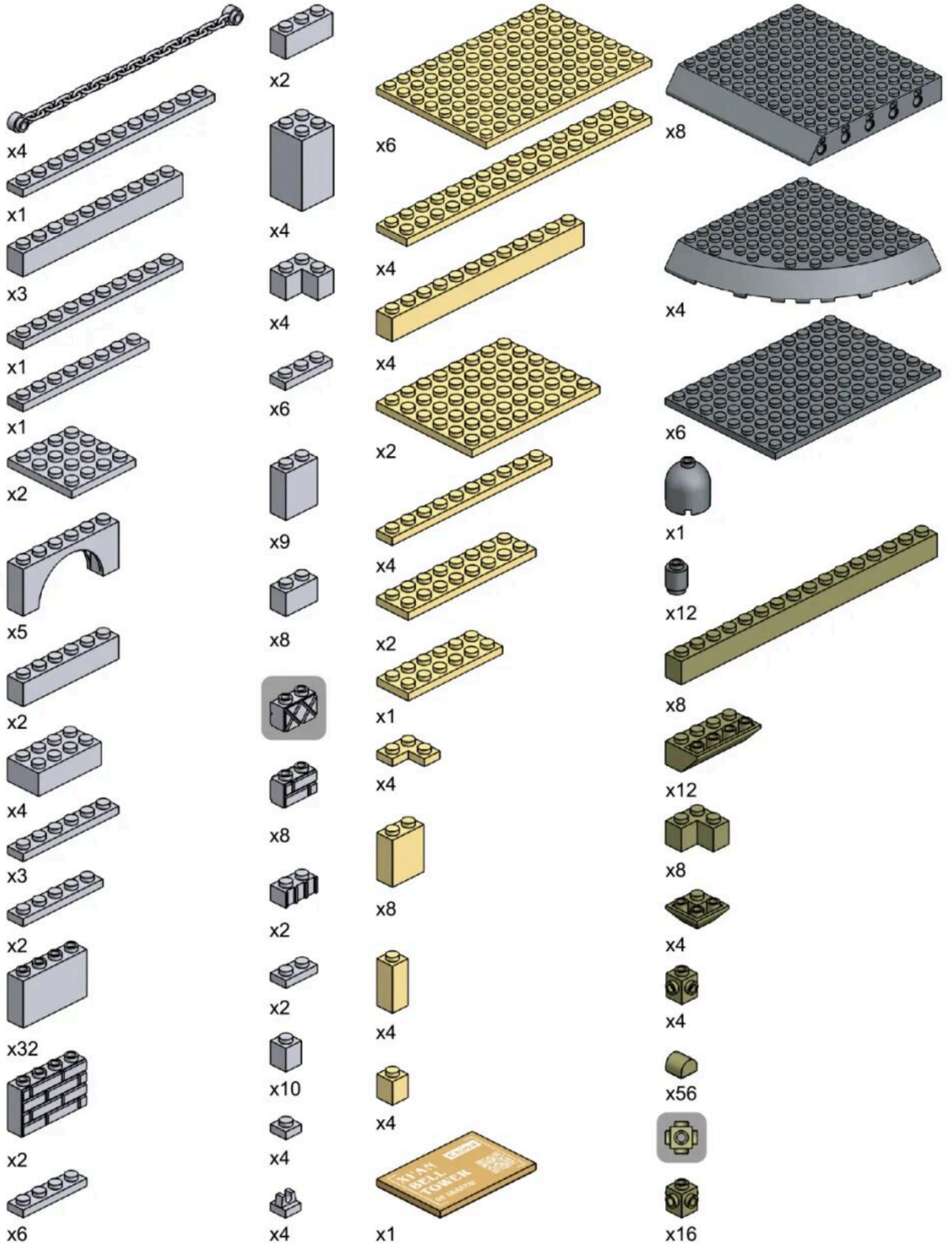

产品有增补件请以实物为准

If product has additional parts, please in kind prevail.

PARTS LIST

配件清单

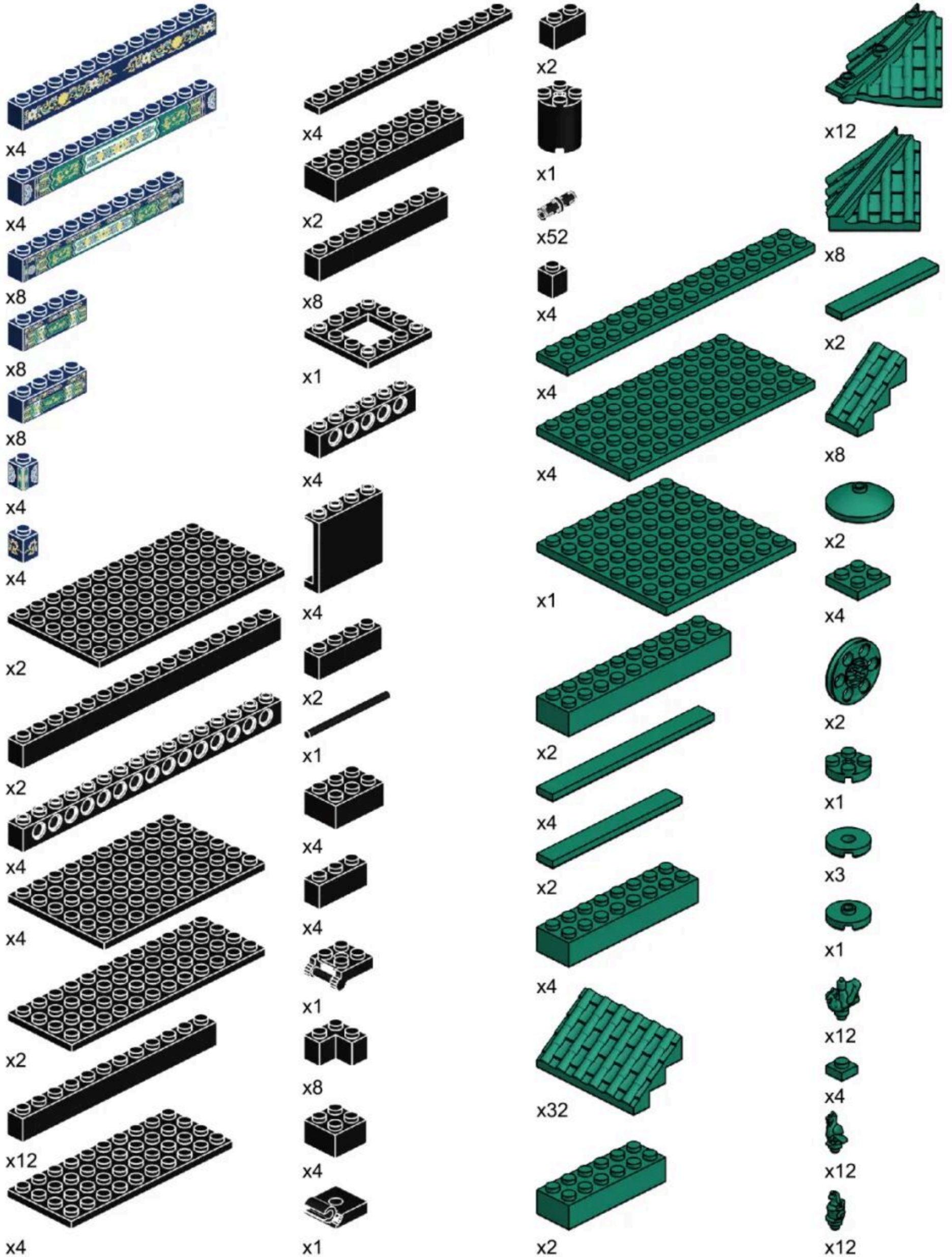



278PCS

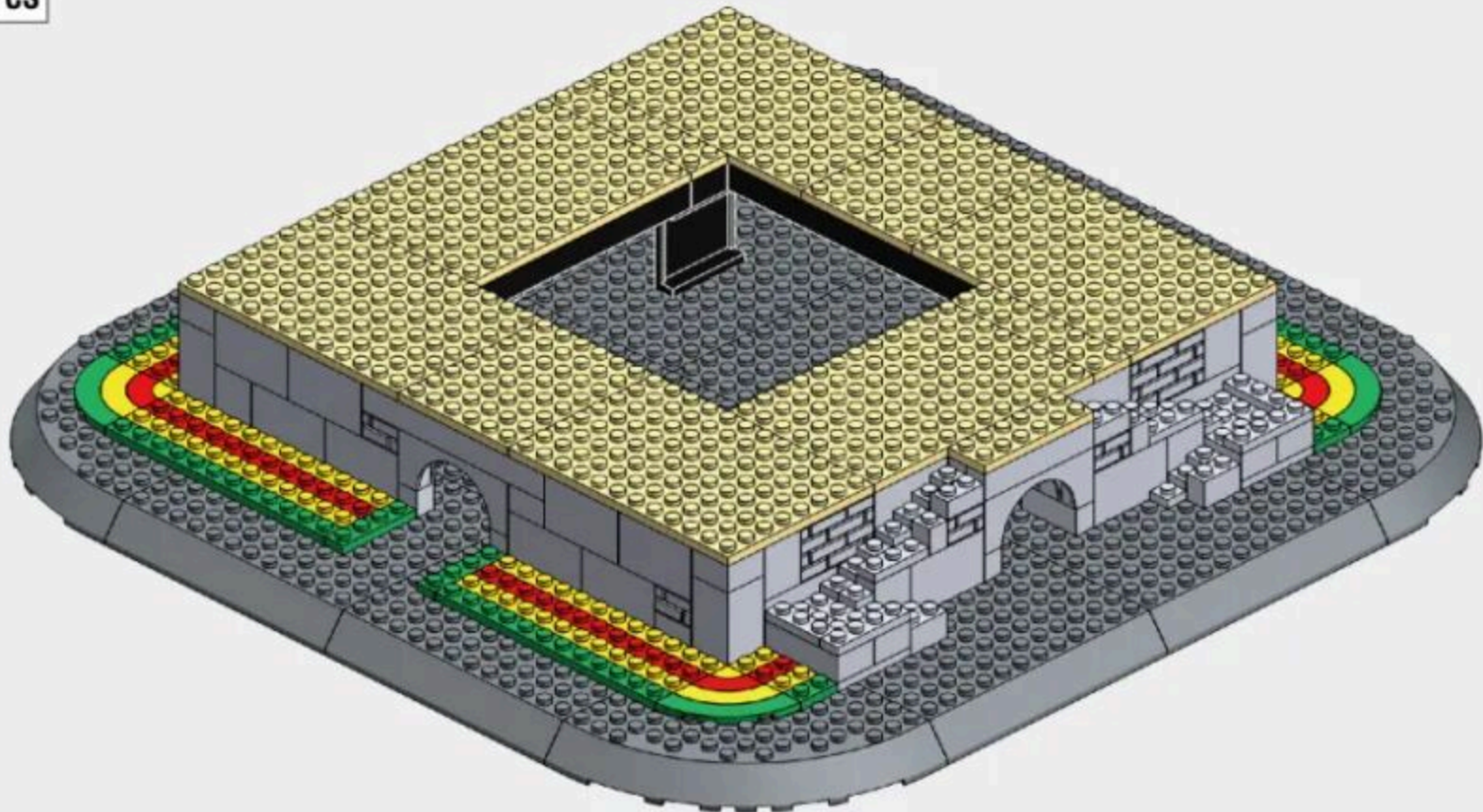

18

1-1

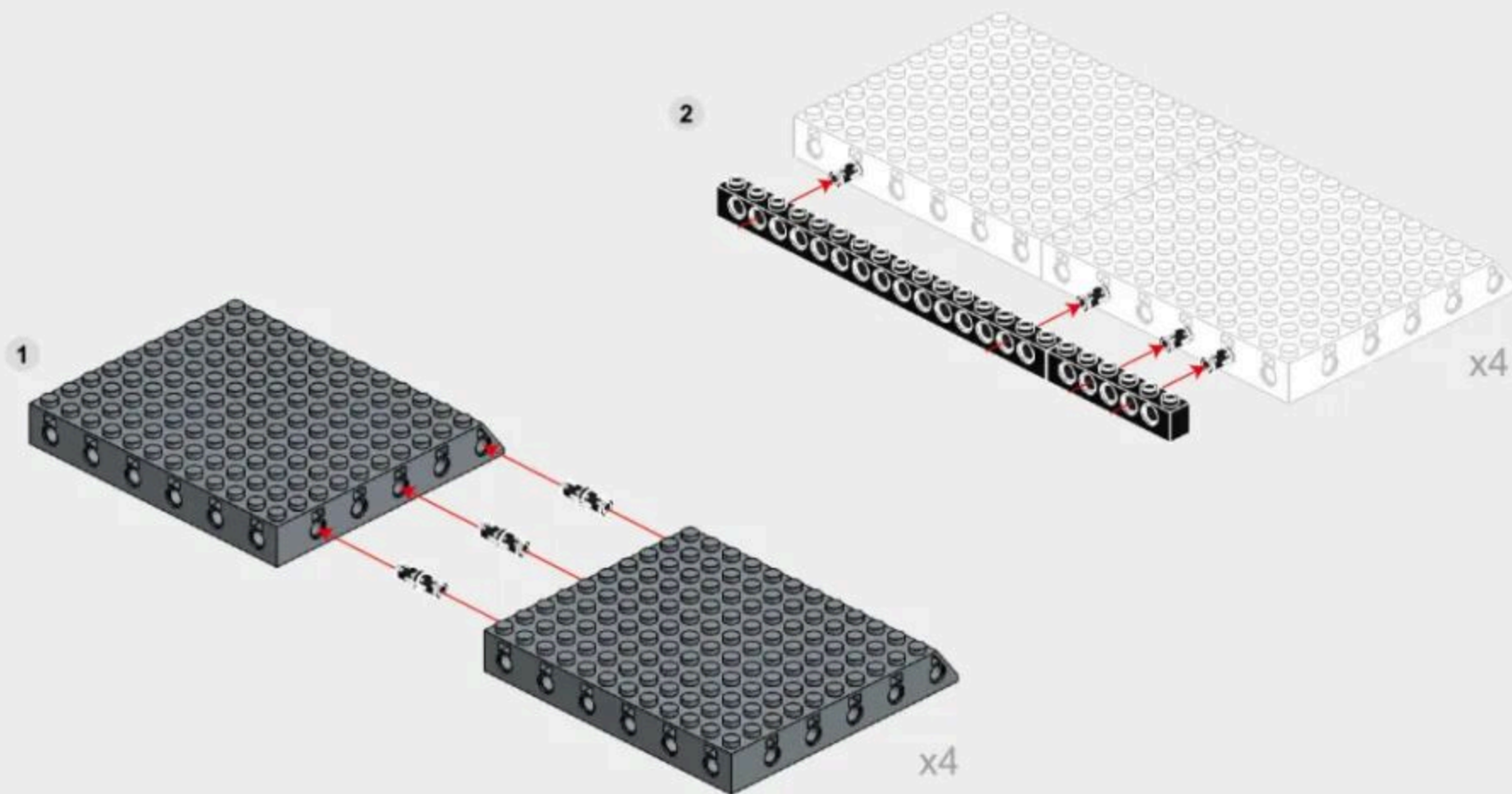
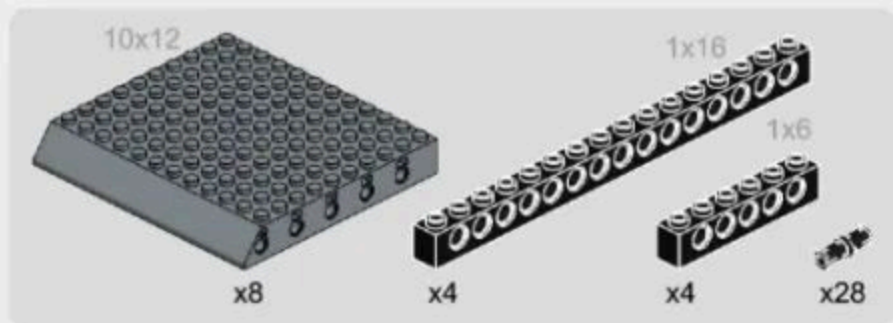

1-2

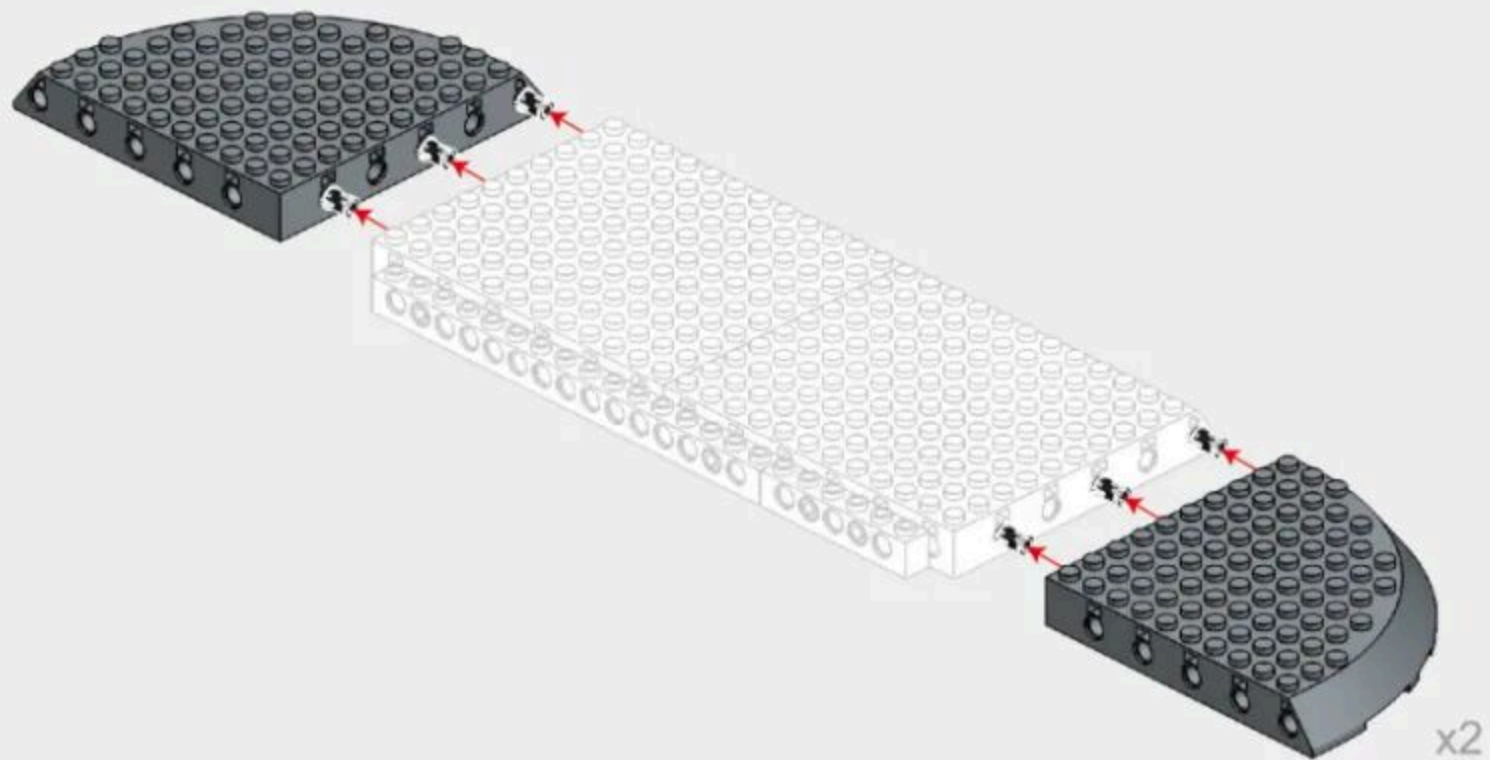
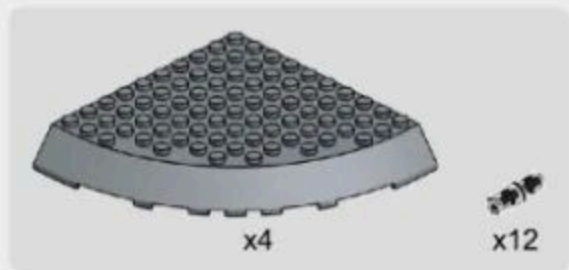

1-3

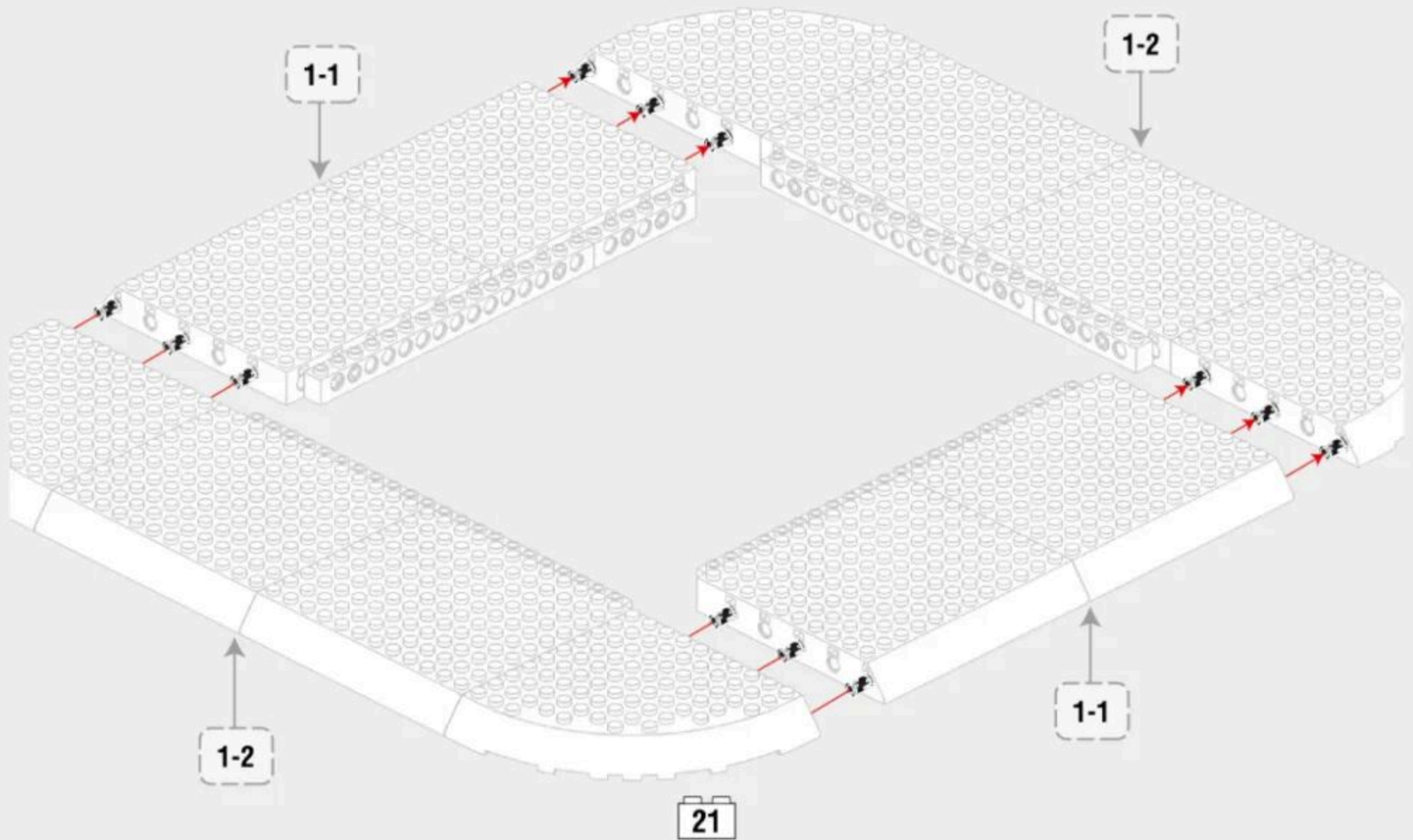

1-4

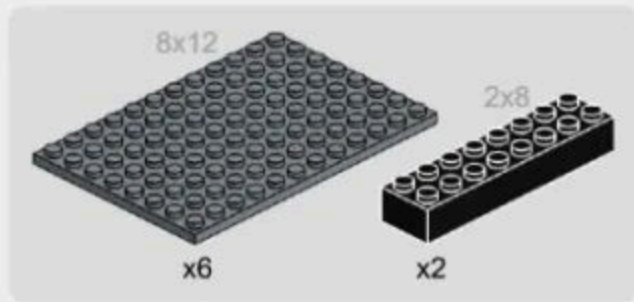

1

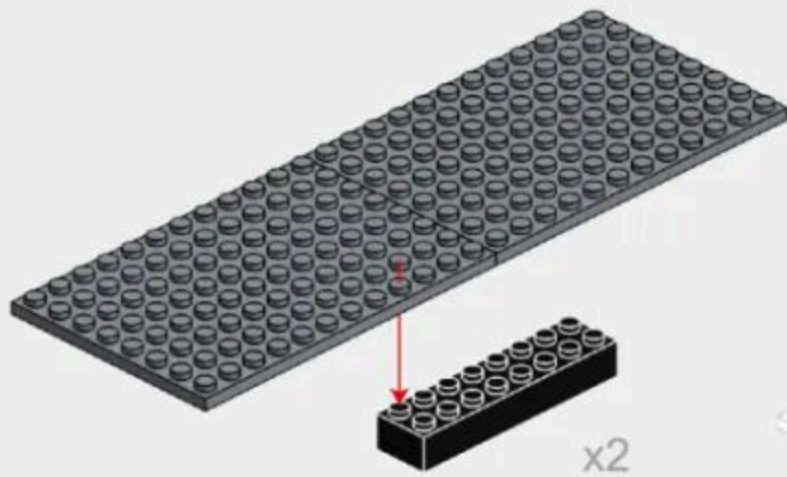

2

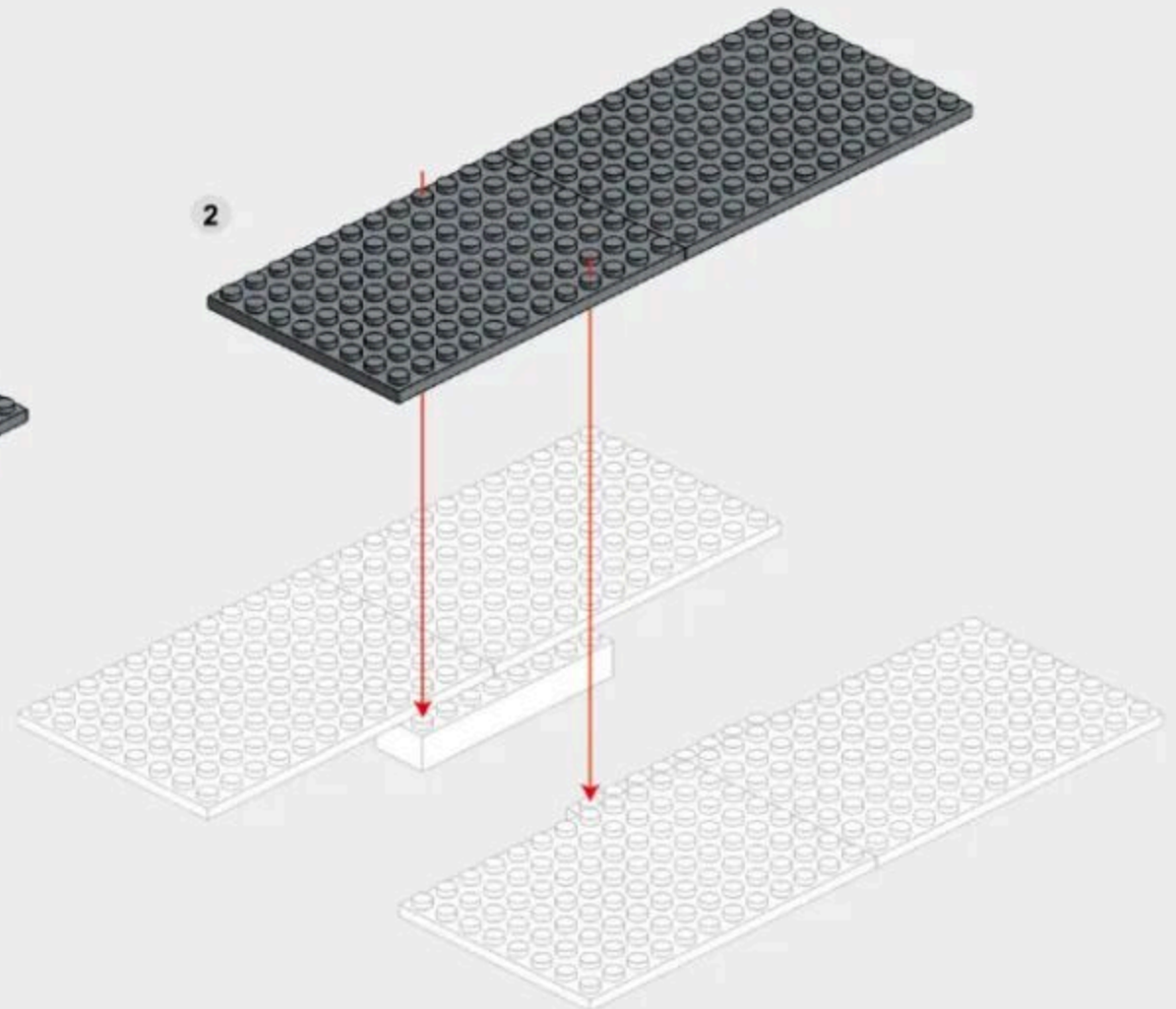

1-5

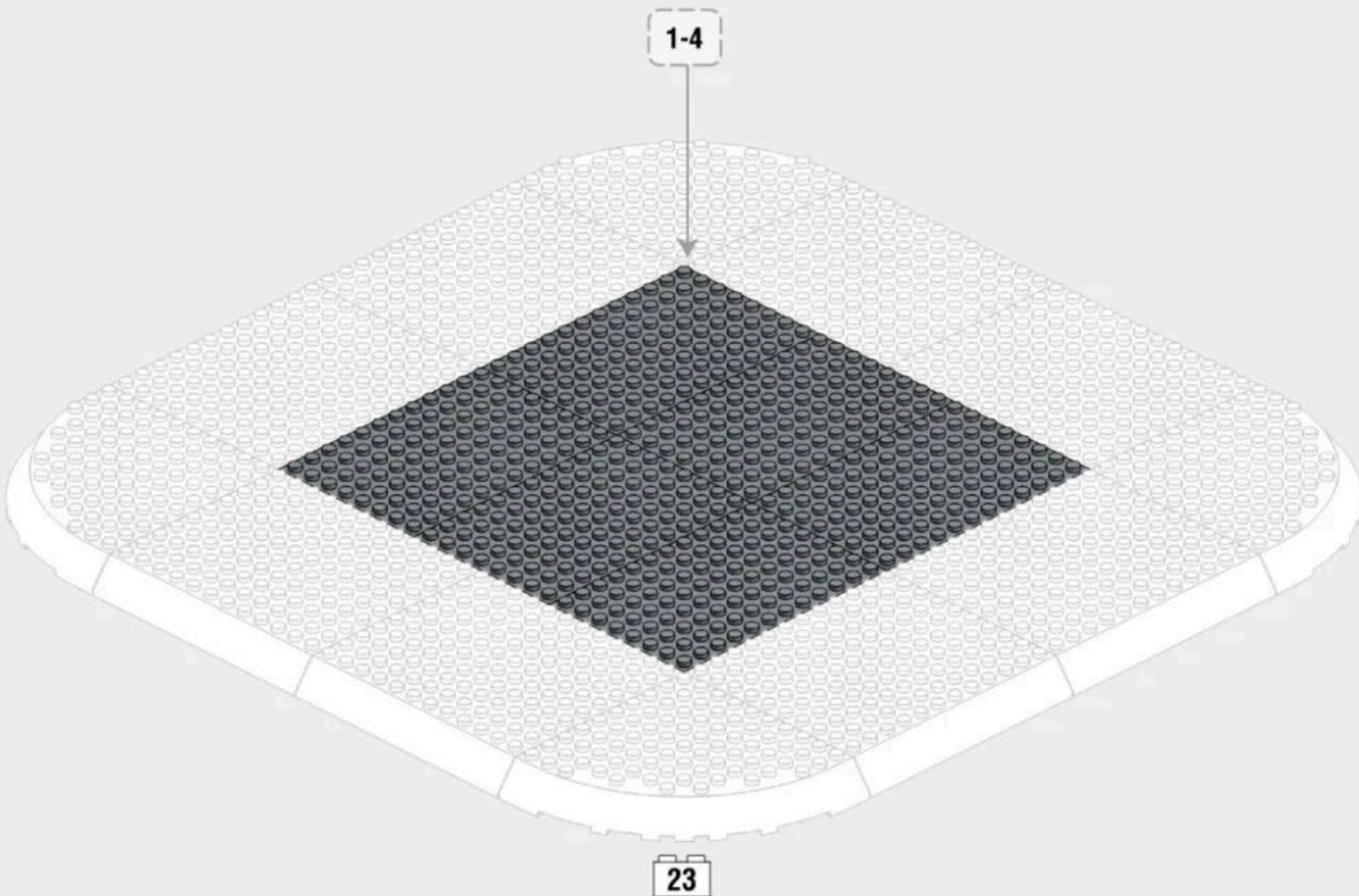

1-6

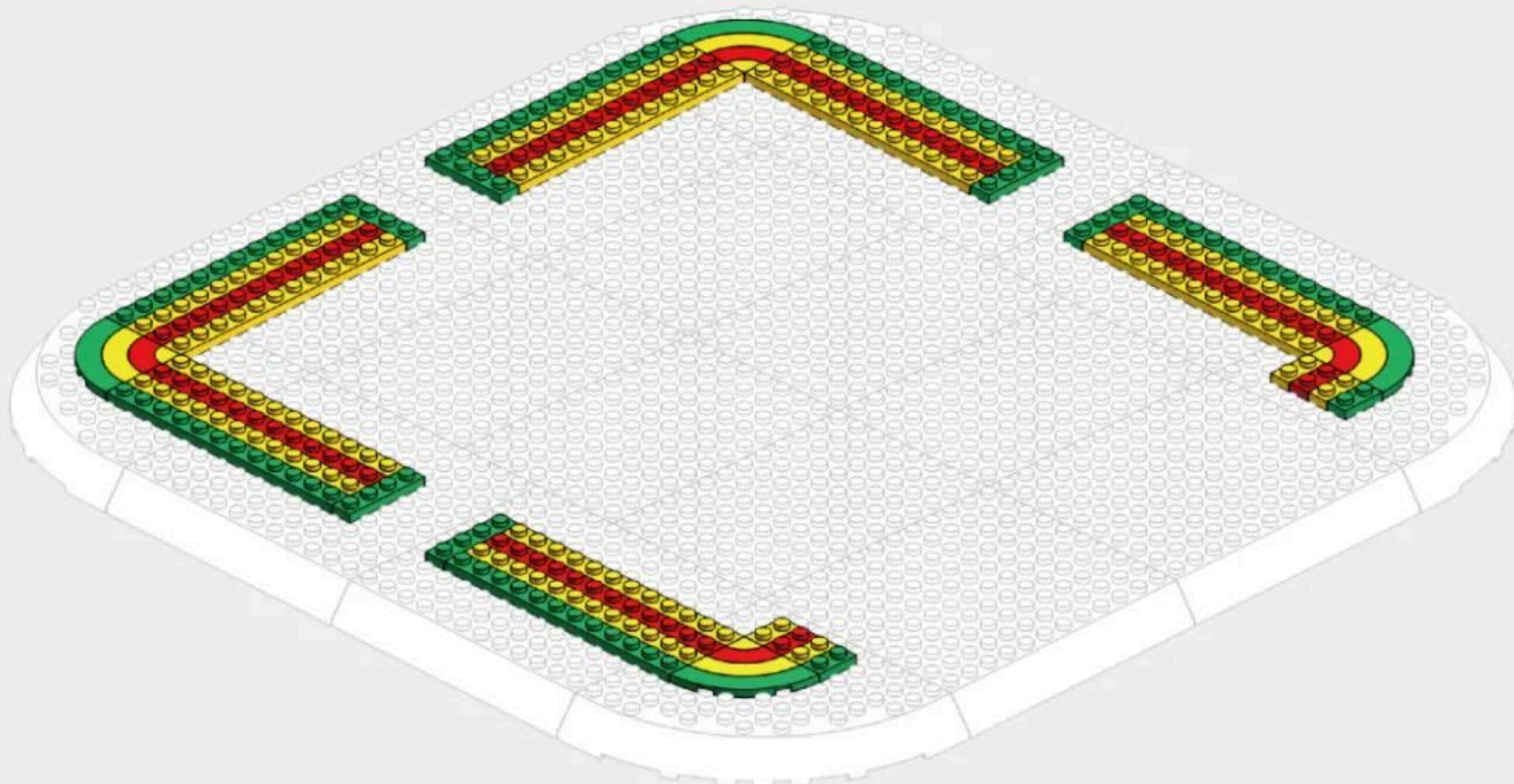
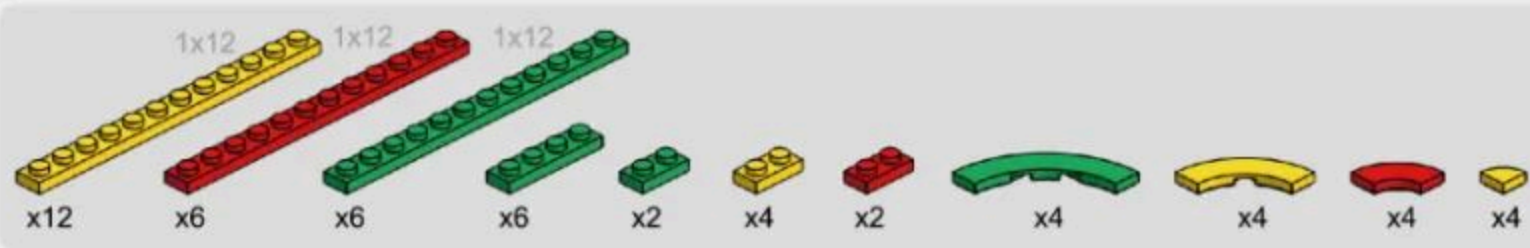

1-7

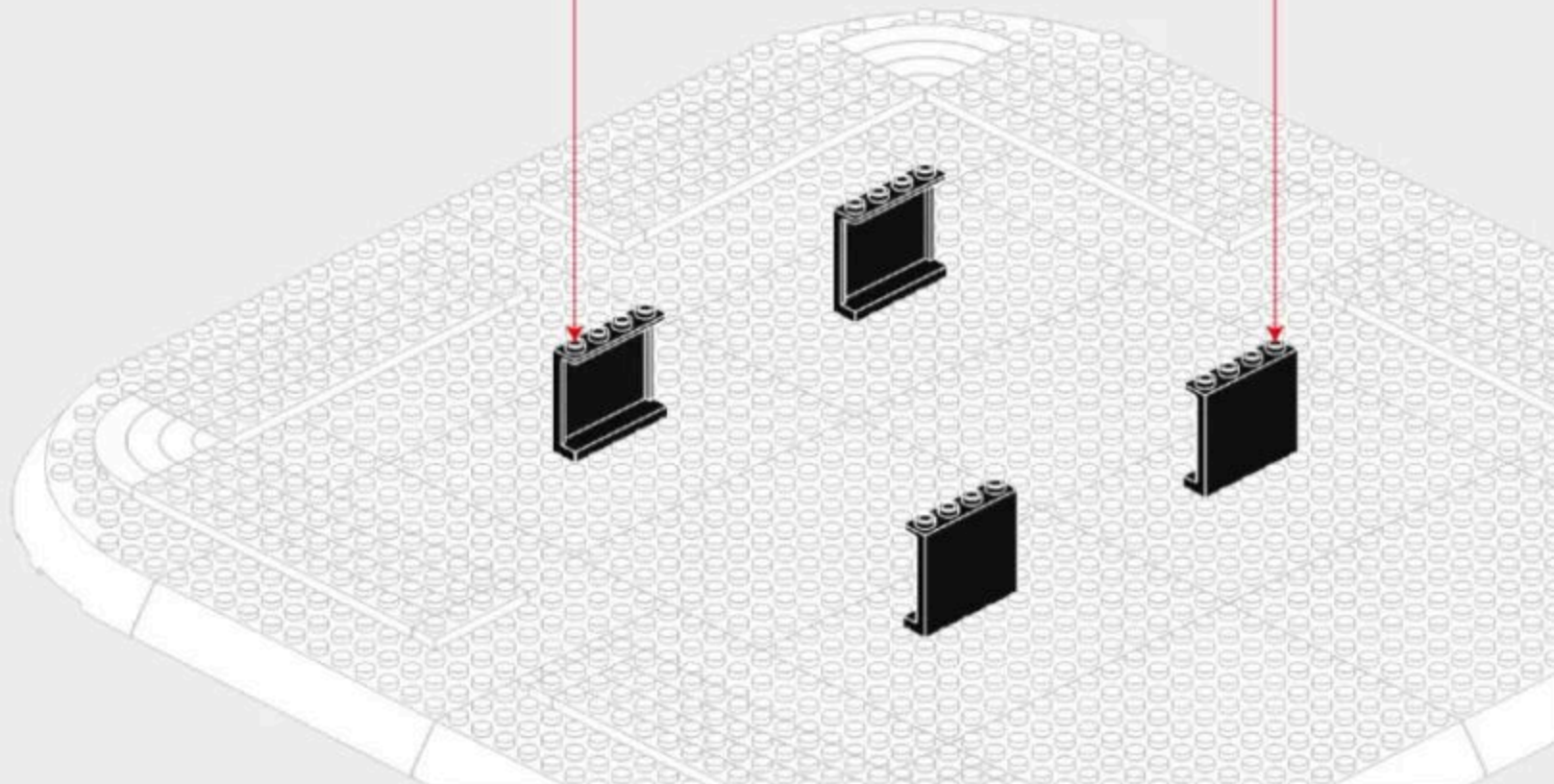
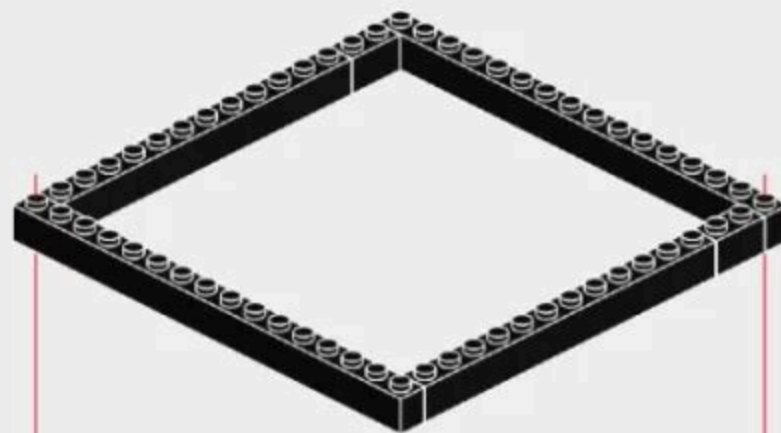
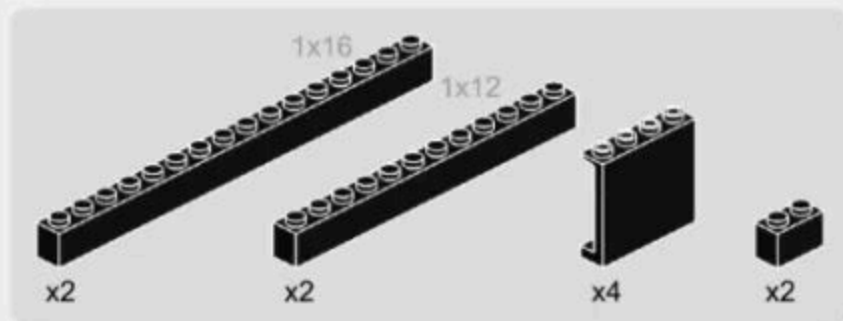

1-8

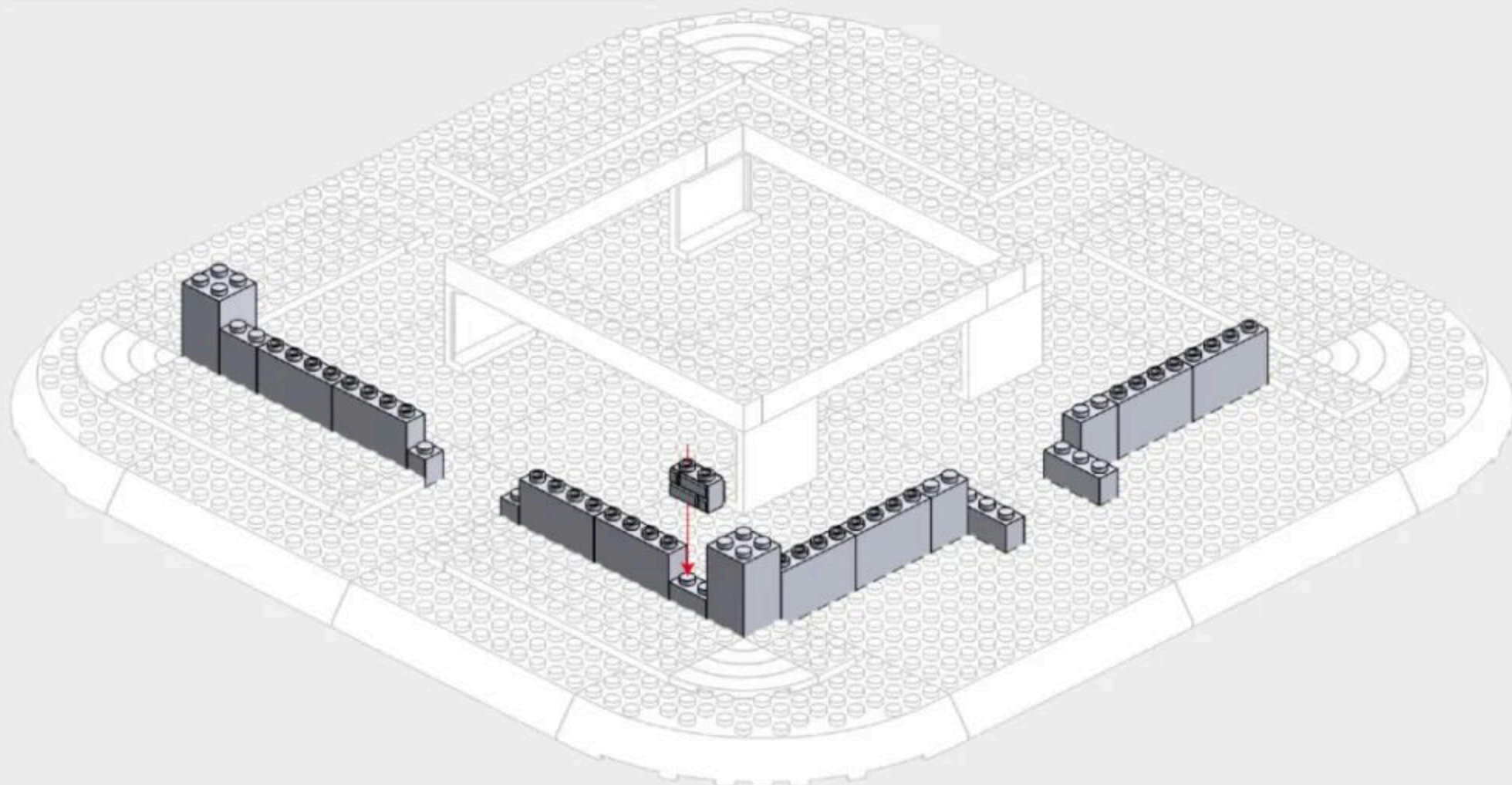
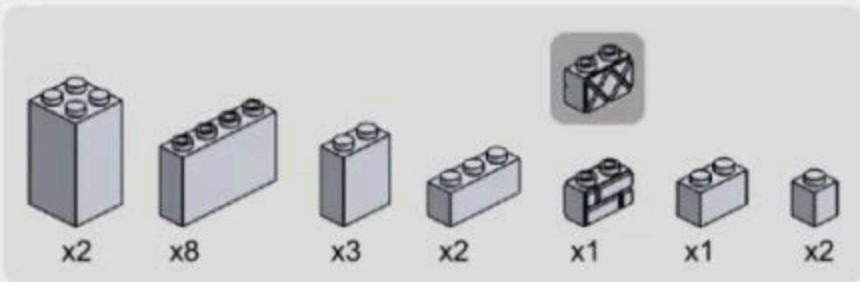

1-9

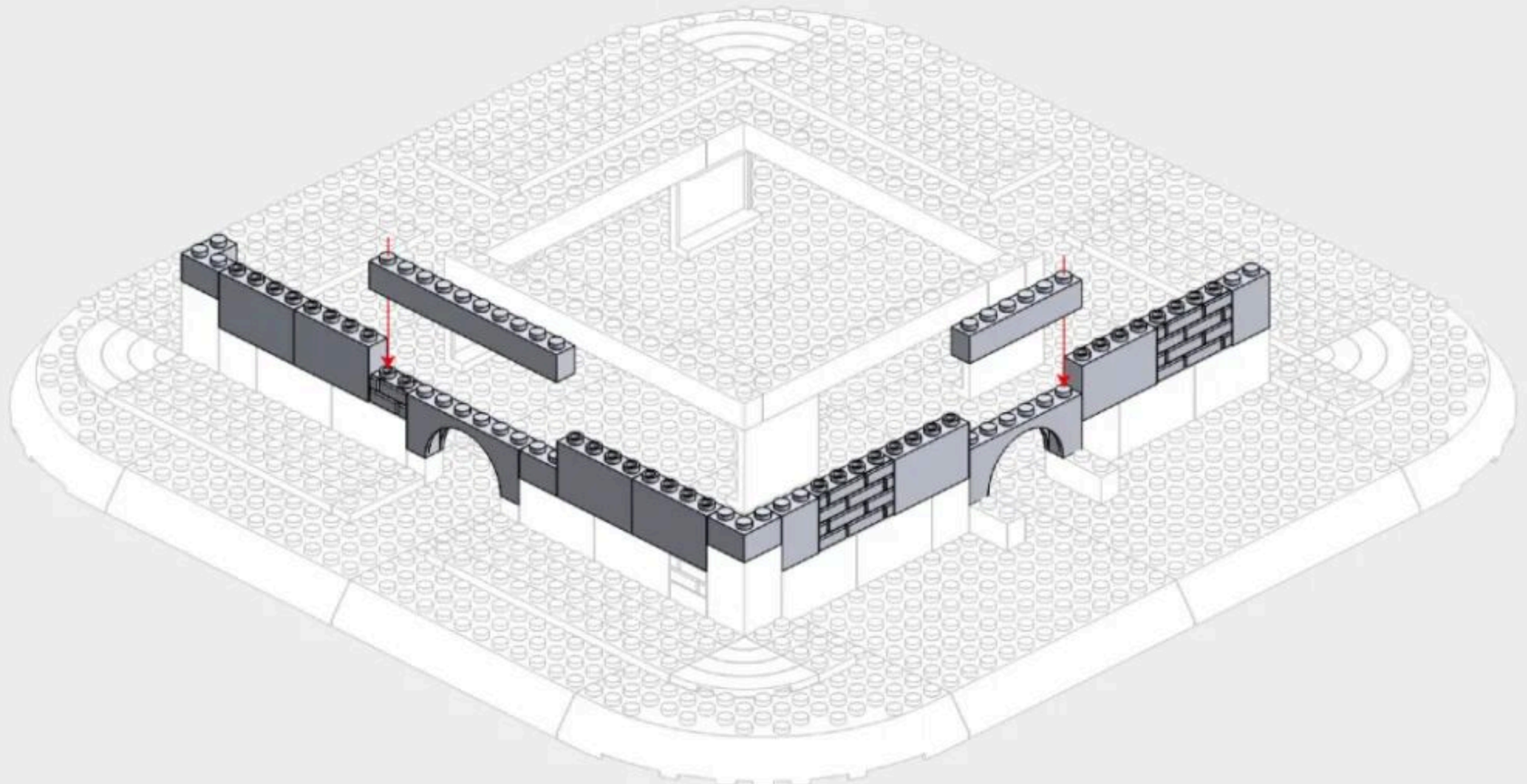
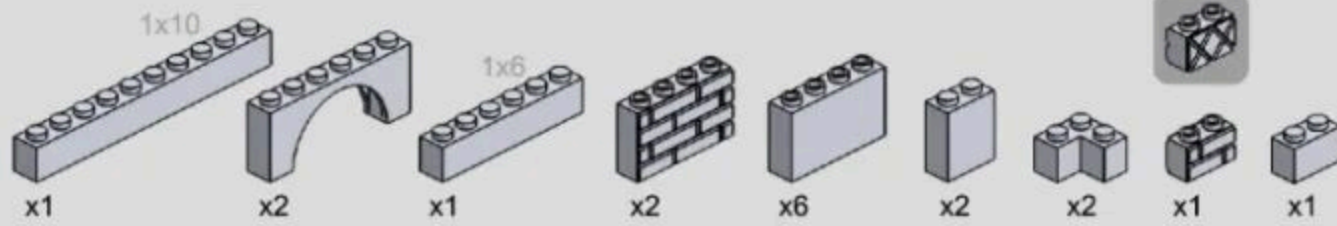

1-10

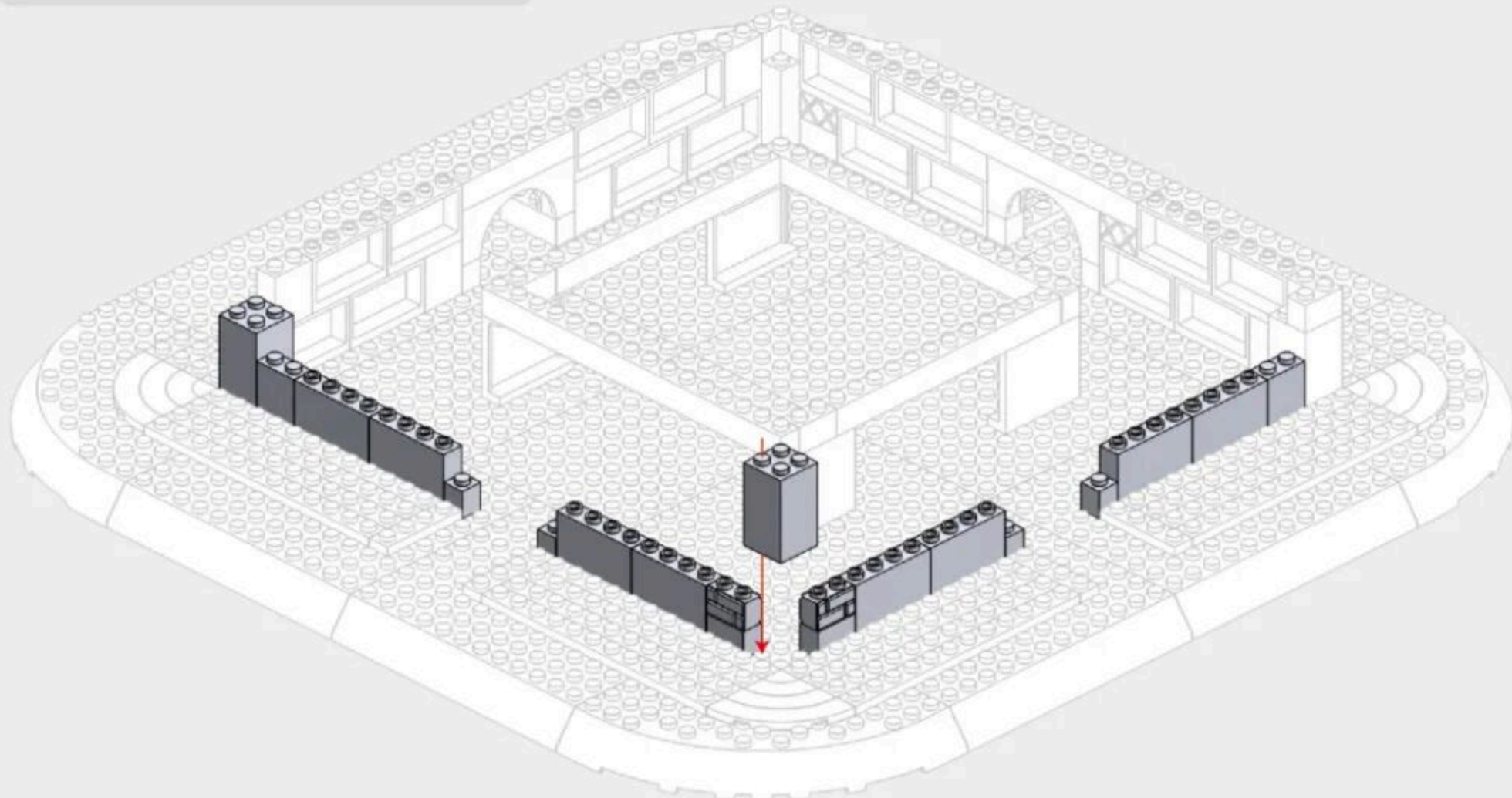
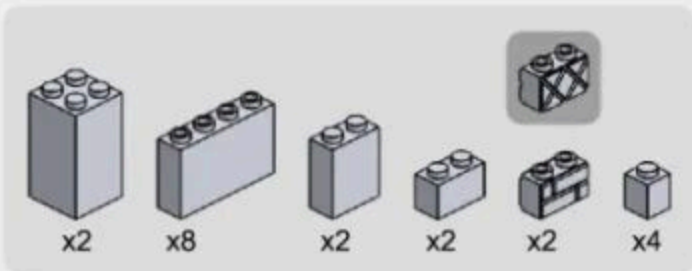

1-11

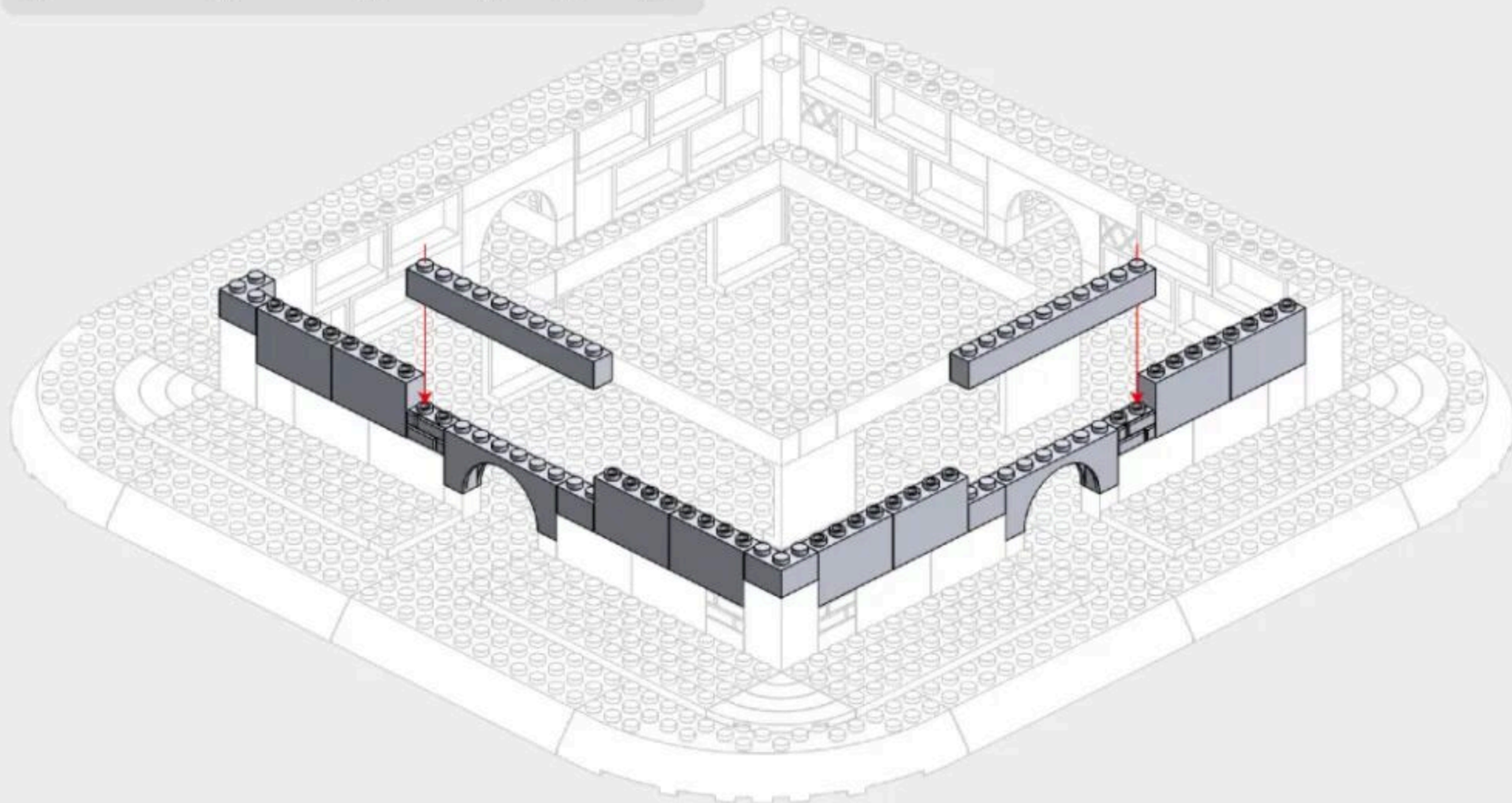
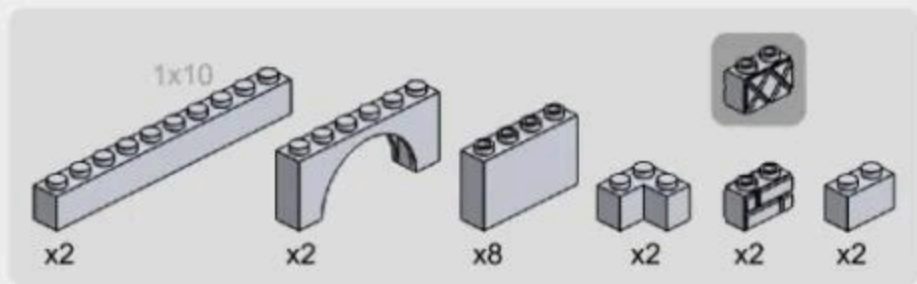

1-12

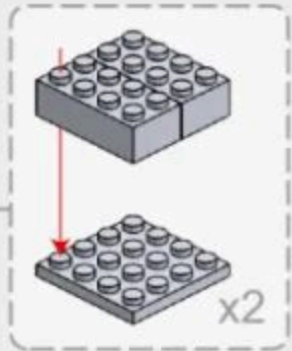
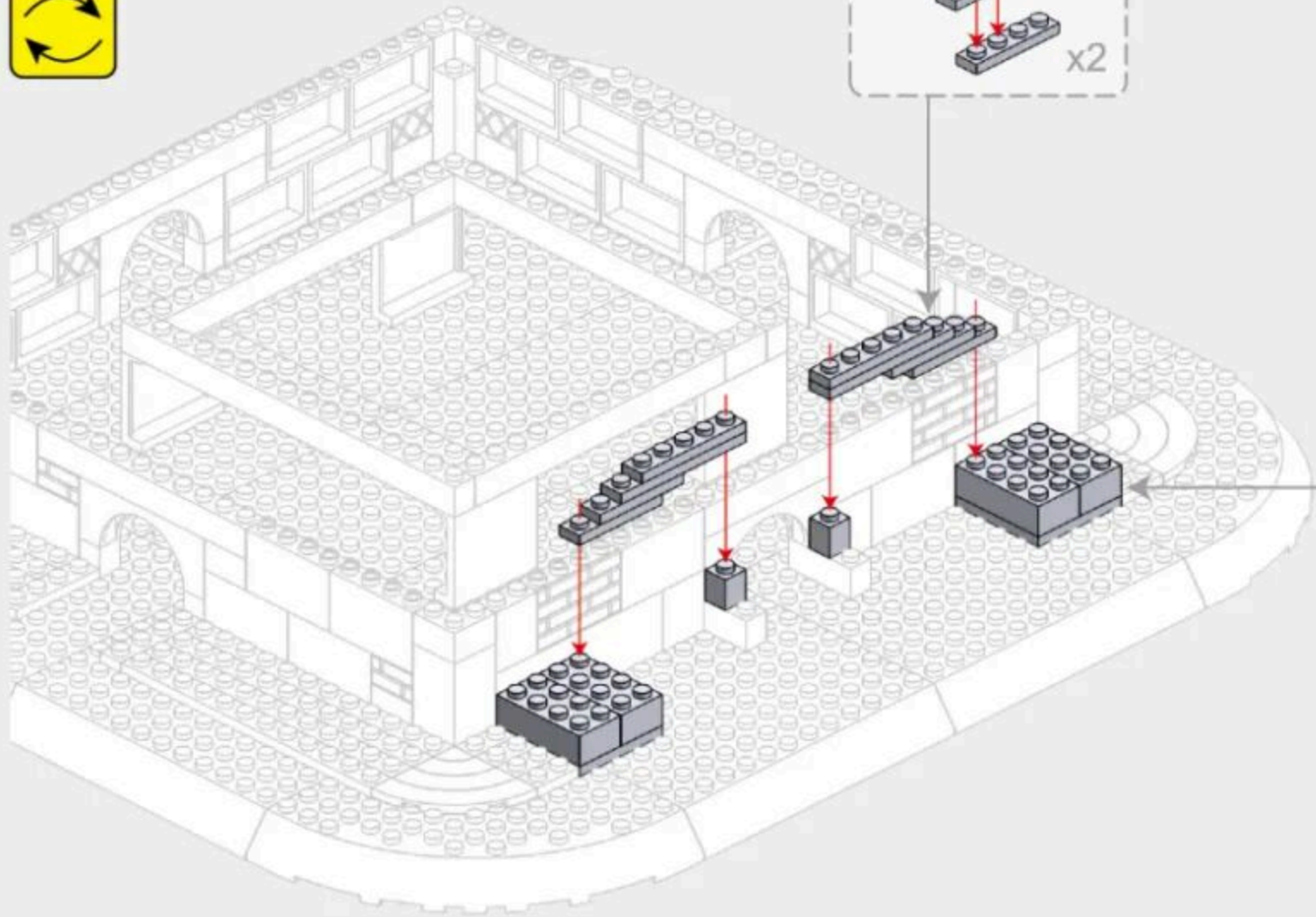
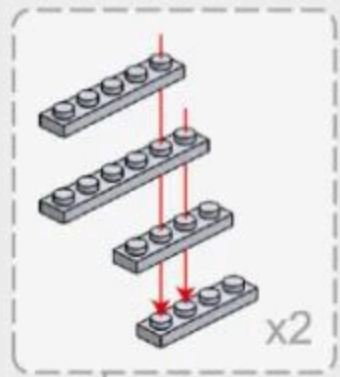
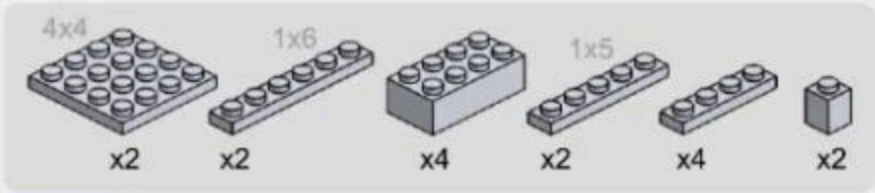

1-13

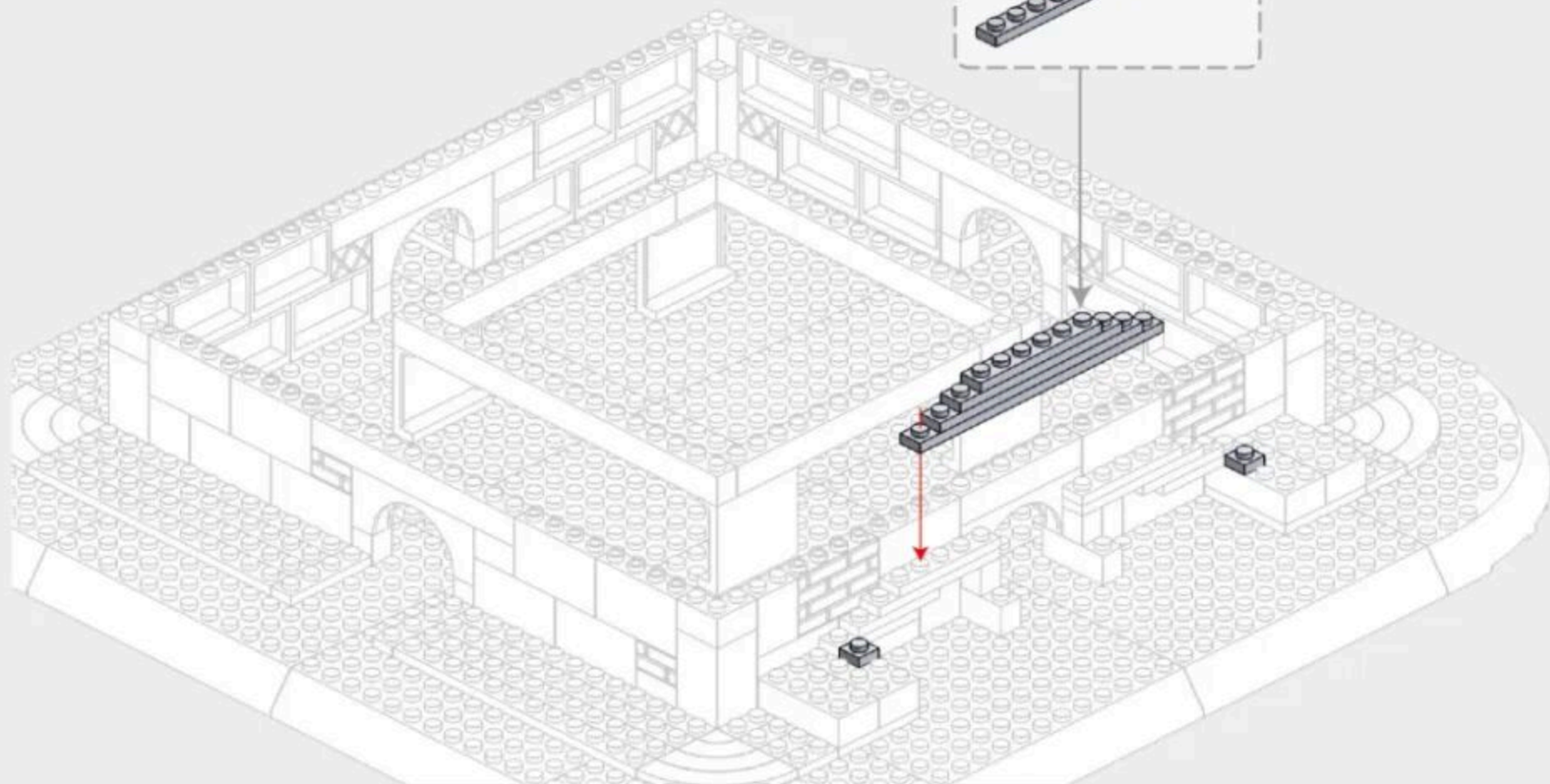
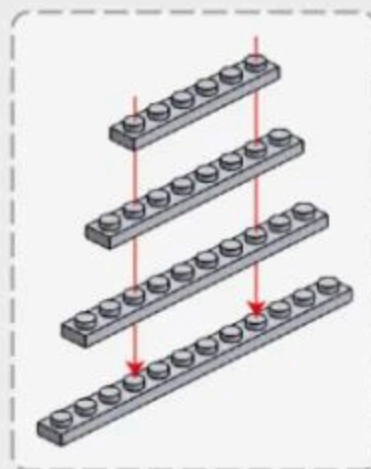
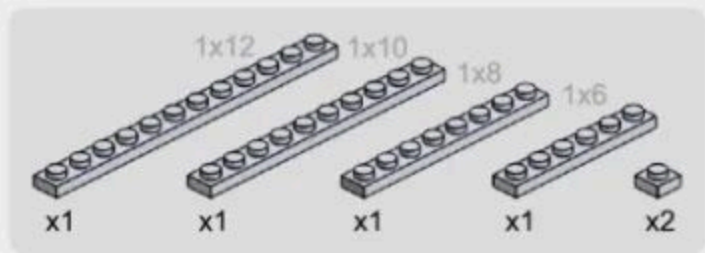

1-14

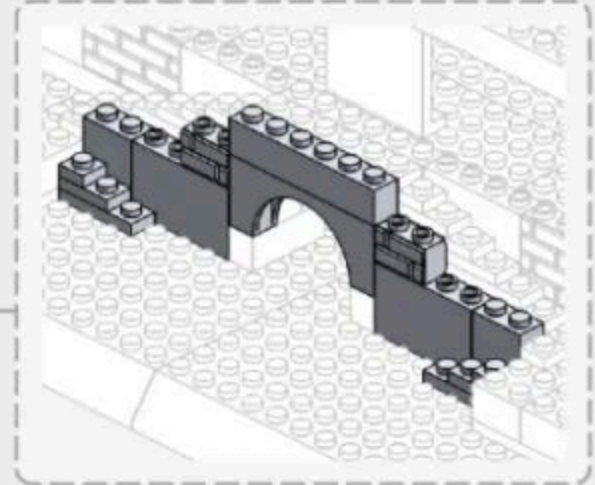
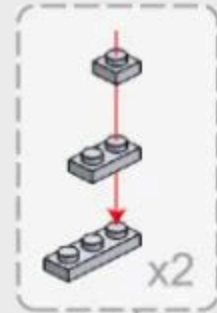
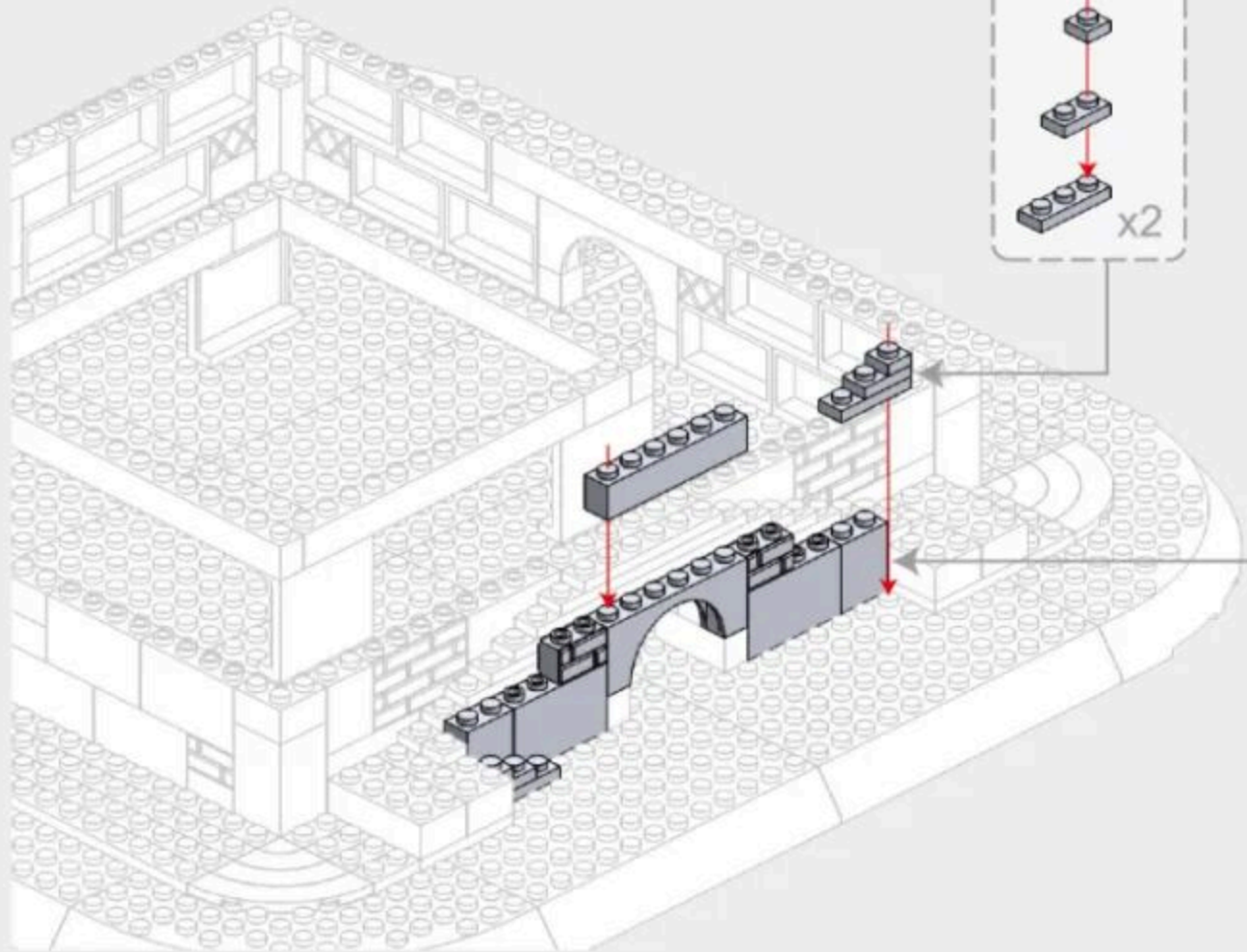
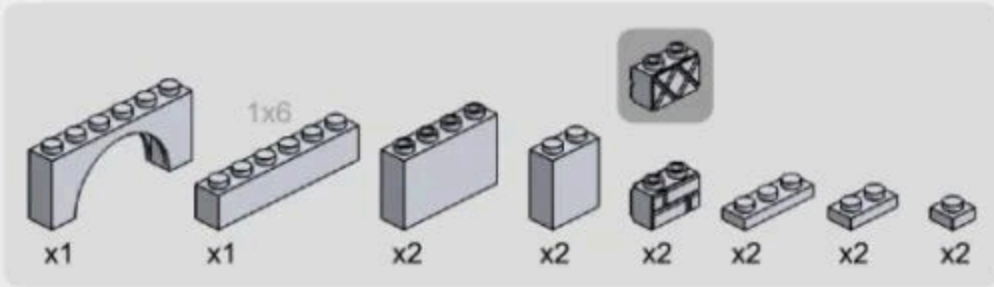

1-15

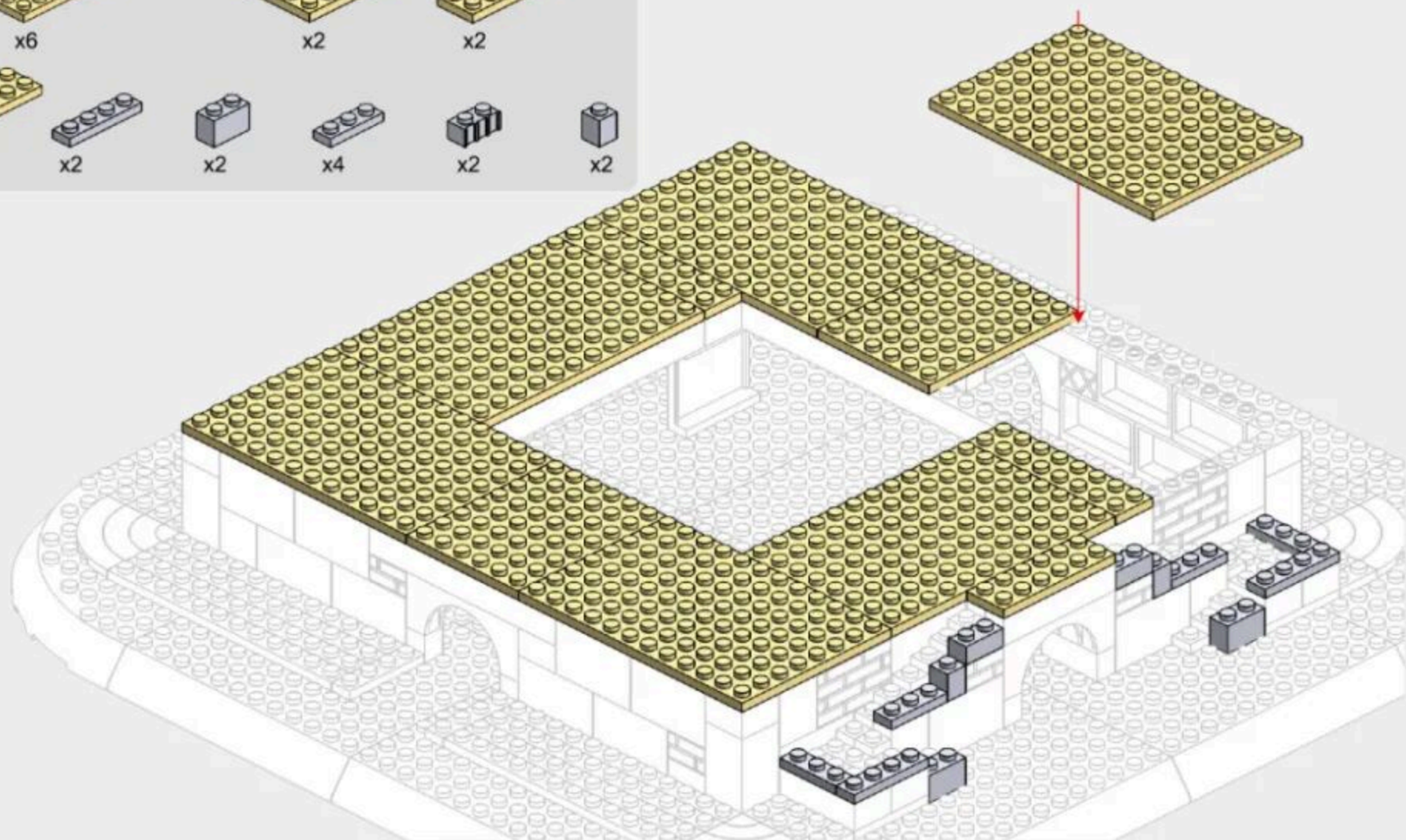
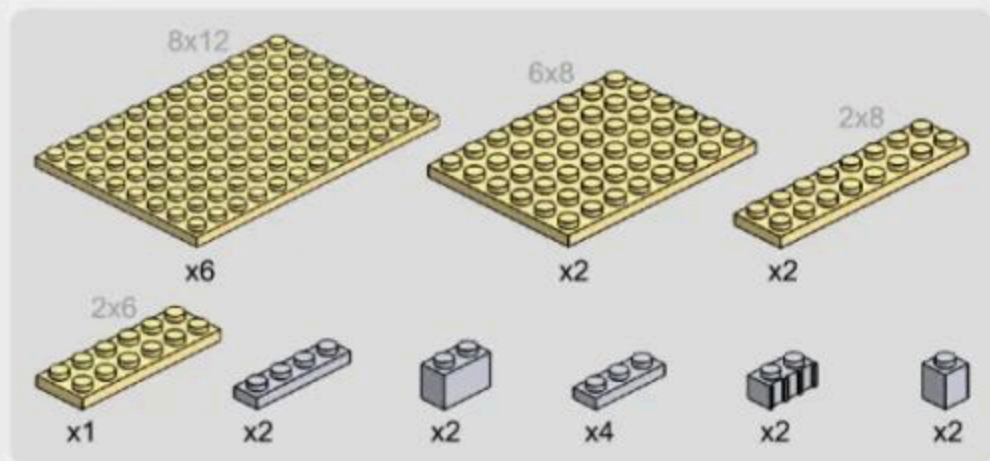



269PCS

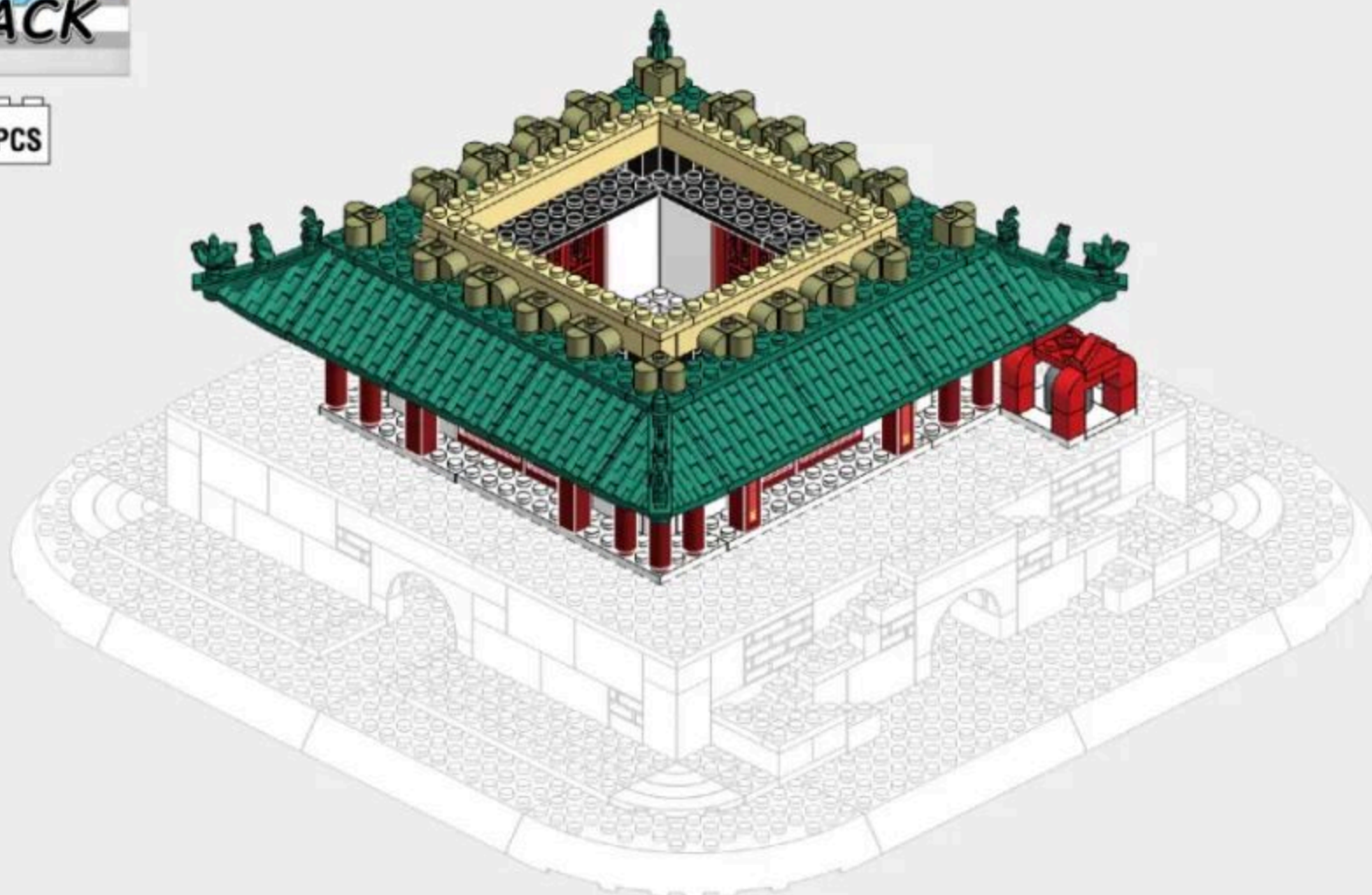

2-1

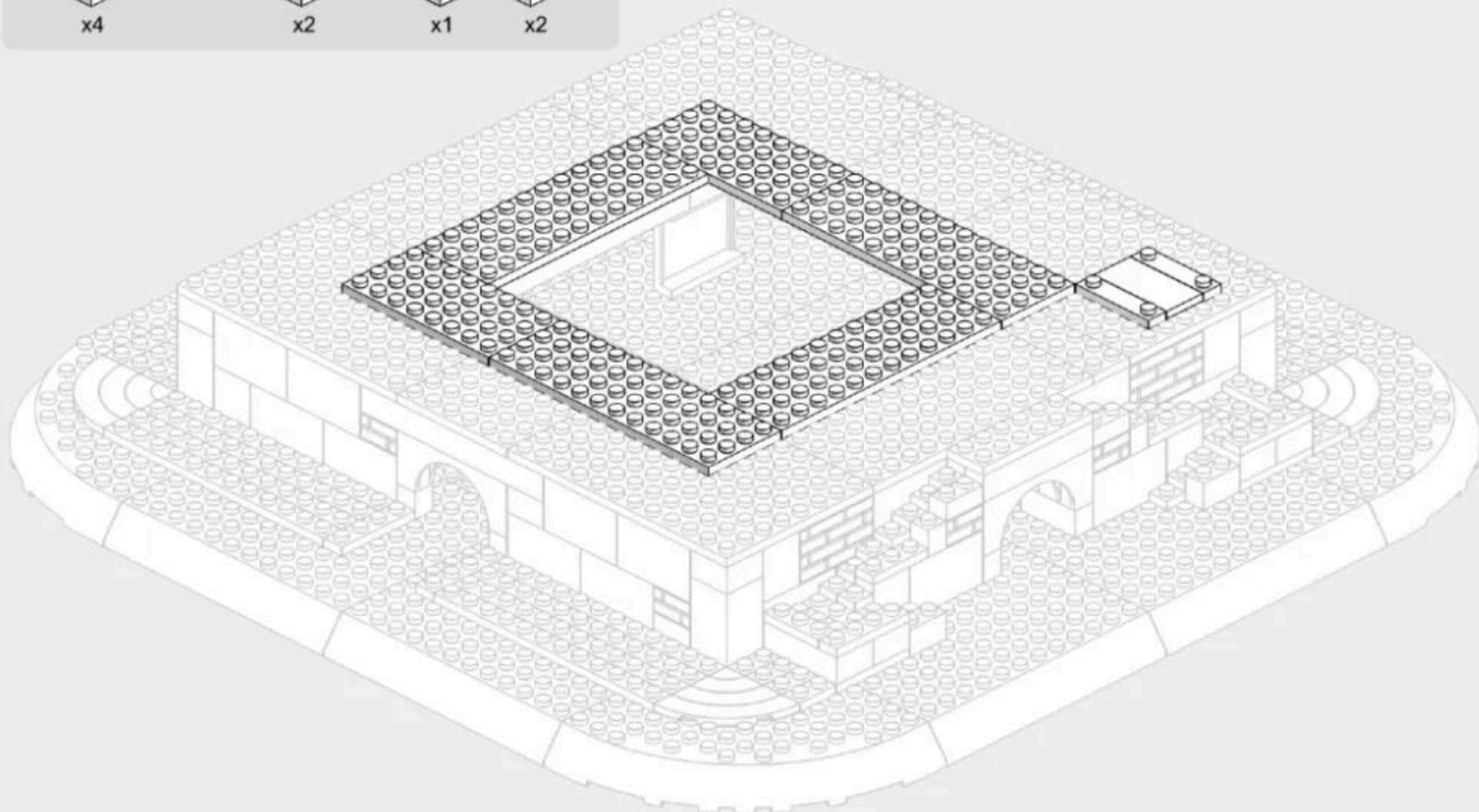
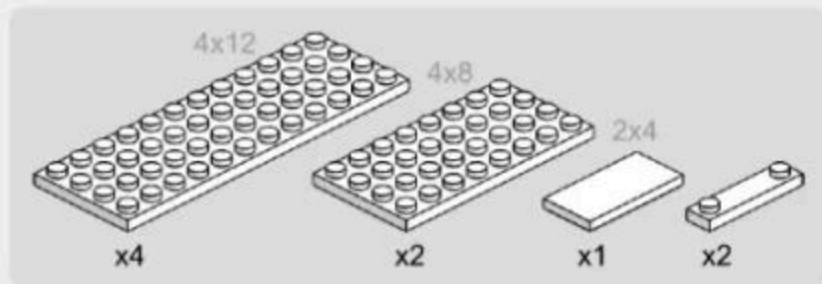

2-2

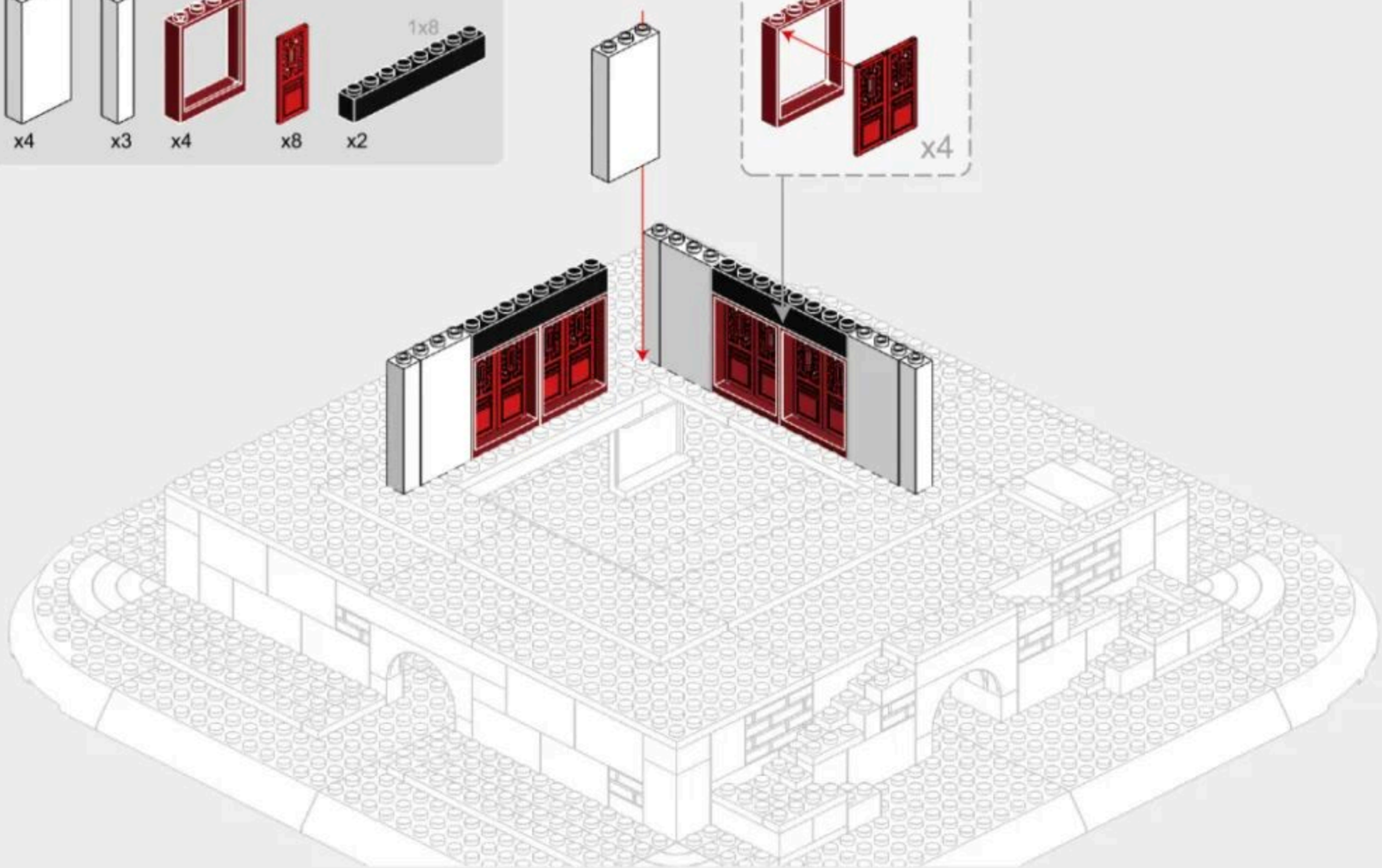
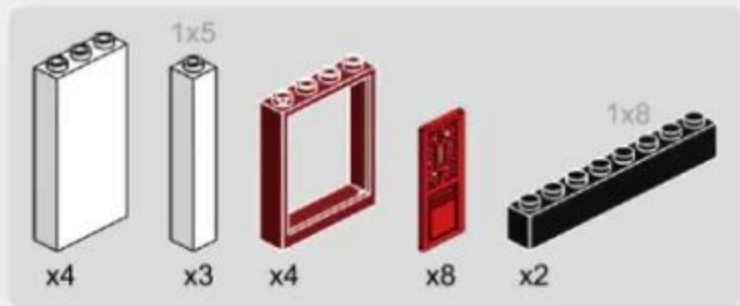

2-3

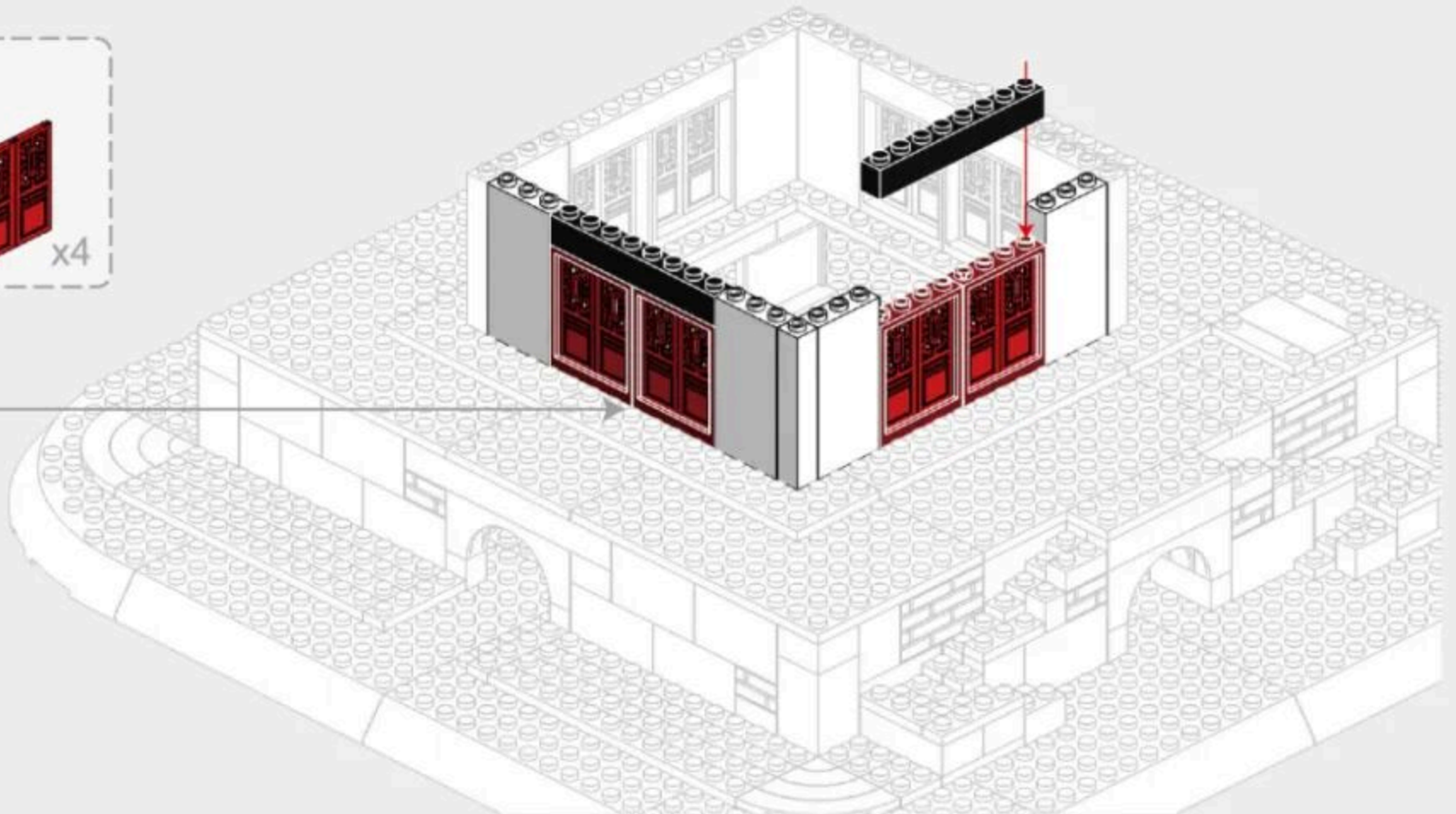
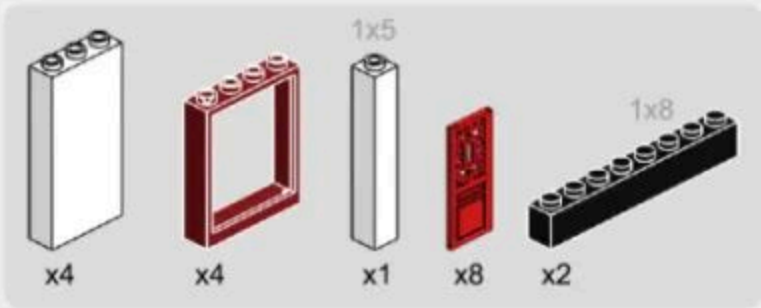

2-4

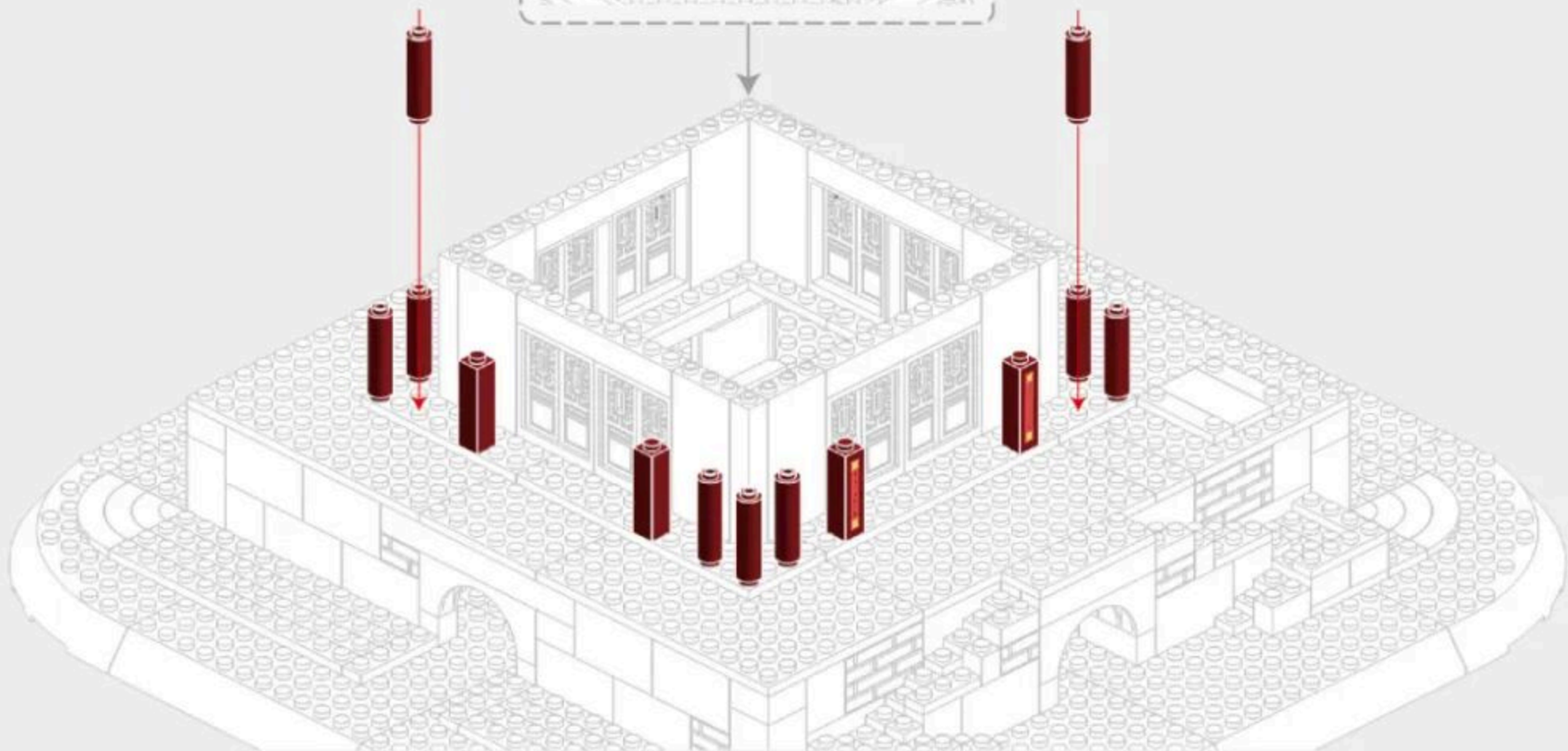
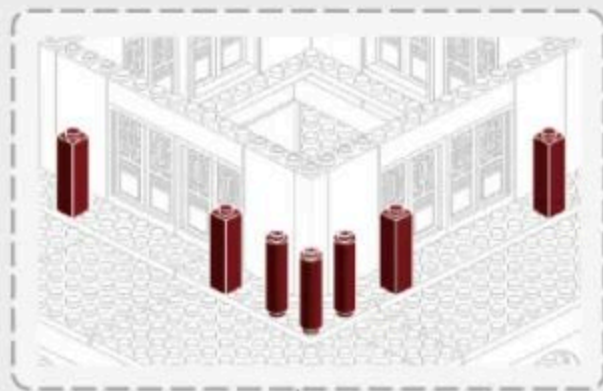

2-5

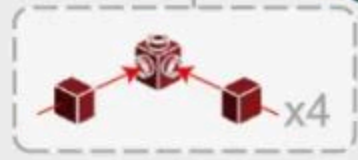
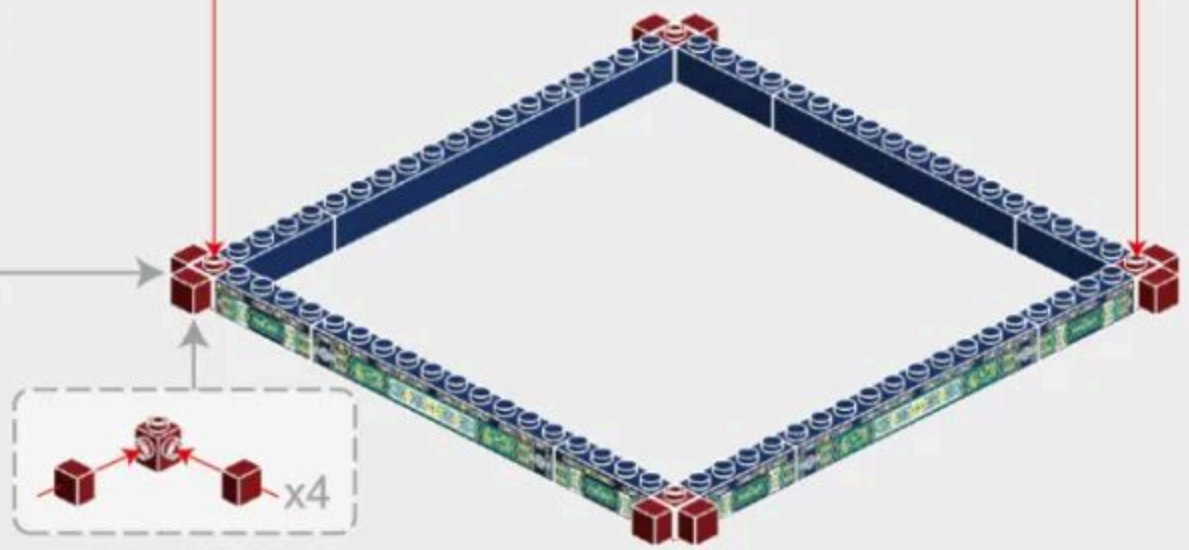
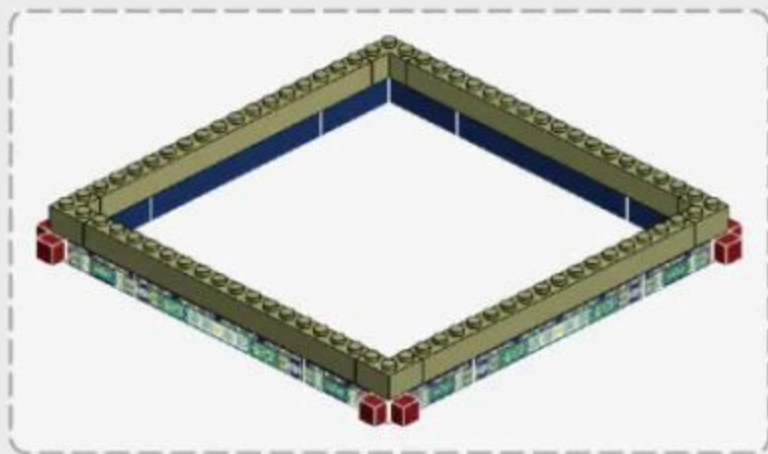
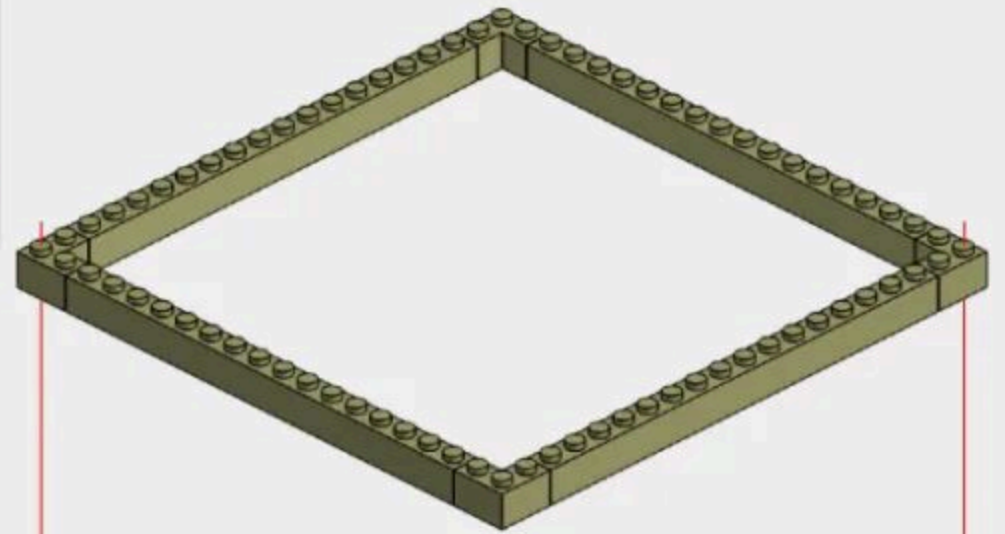
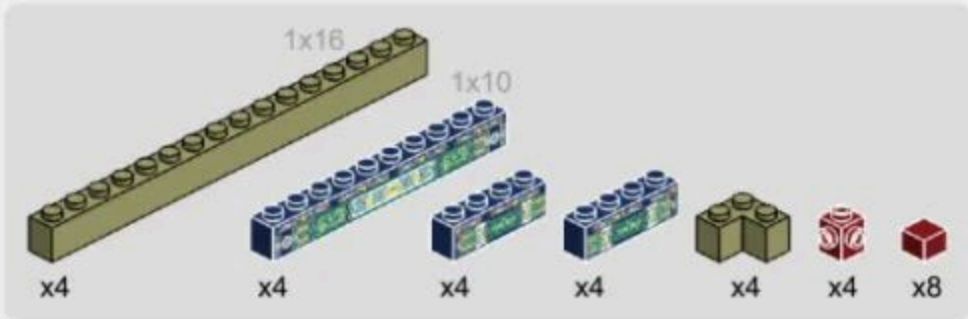

2-6

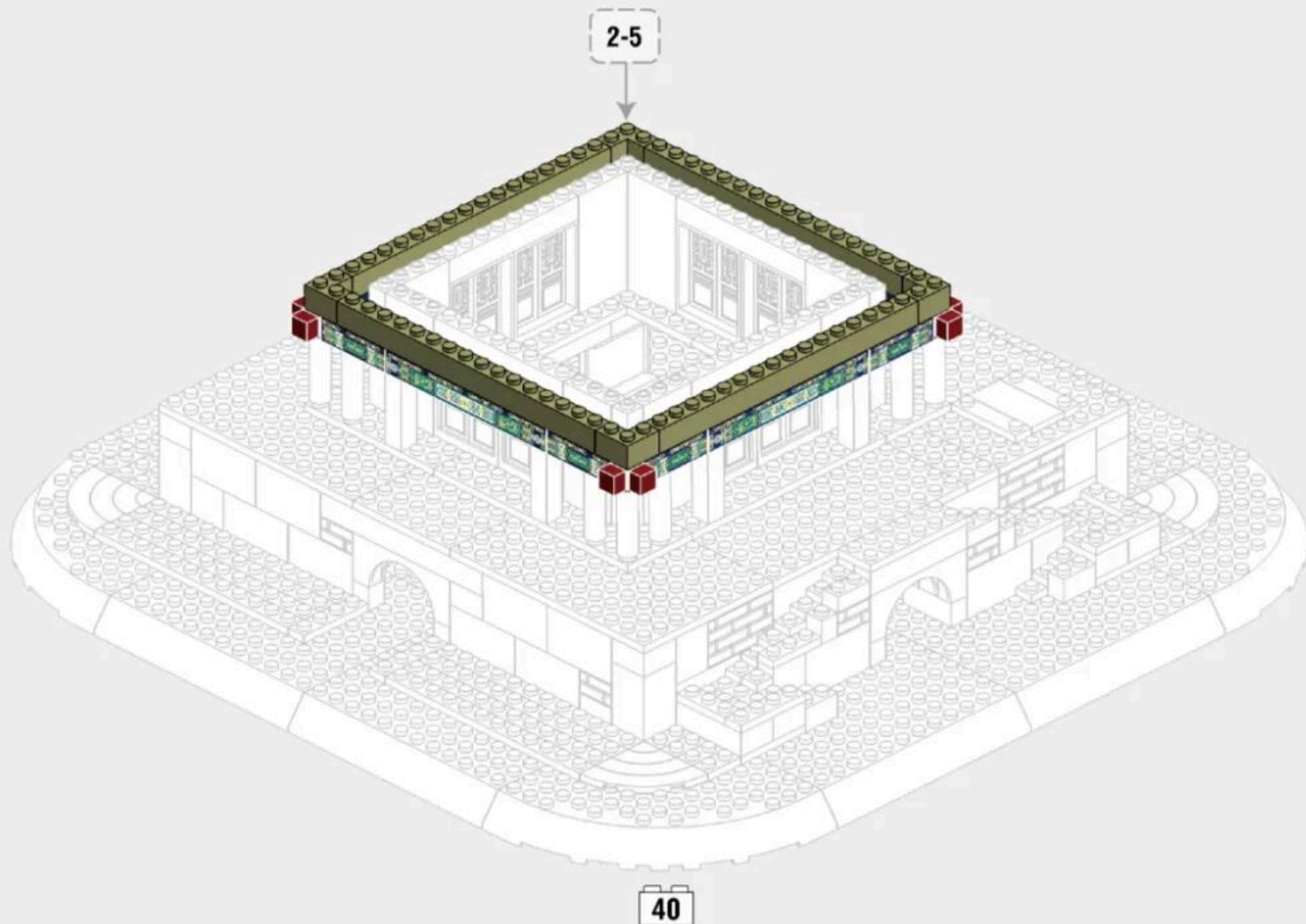

2-7

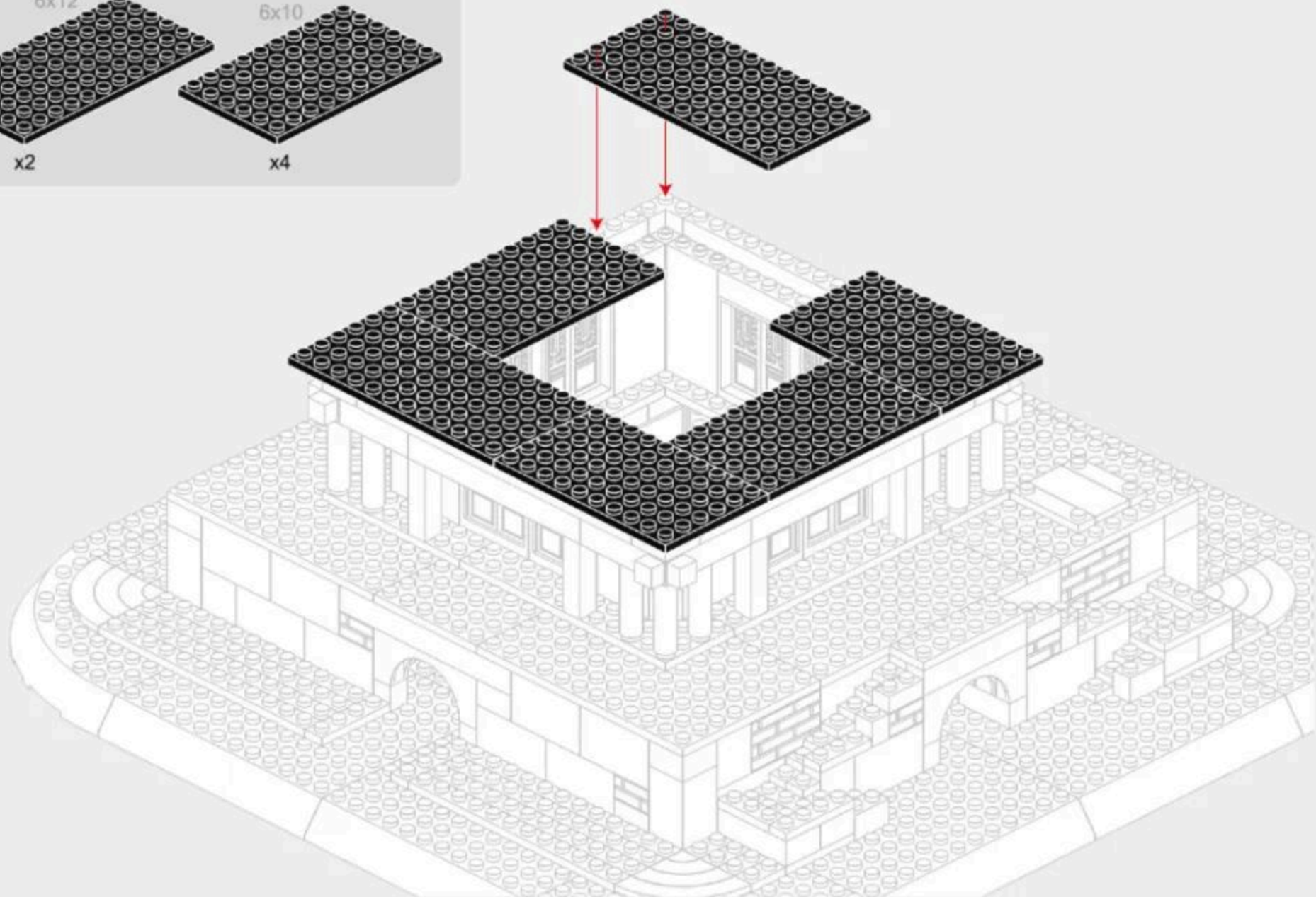
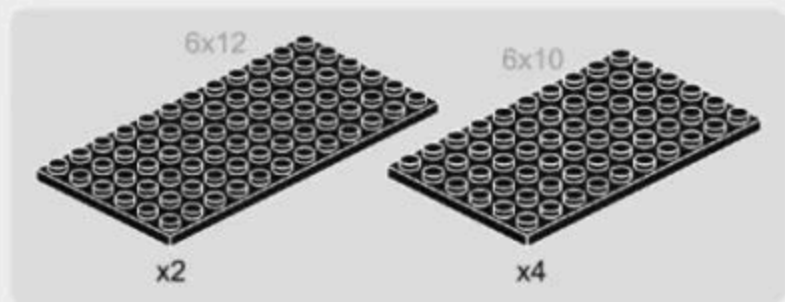

2-8

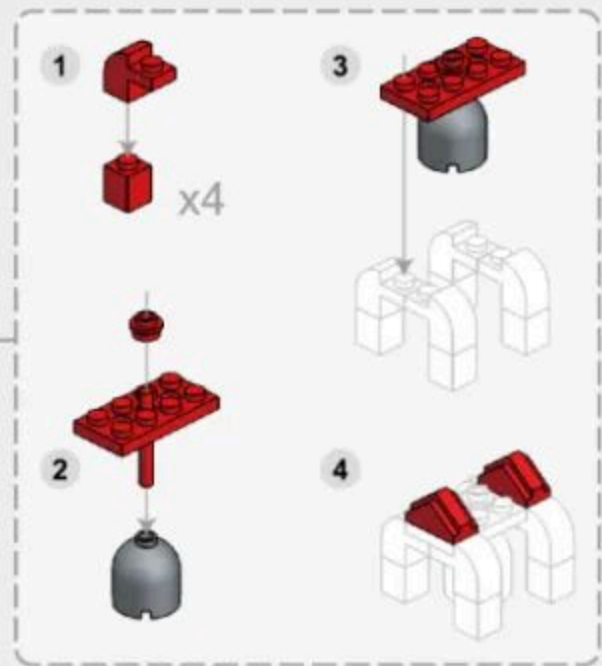
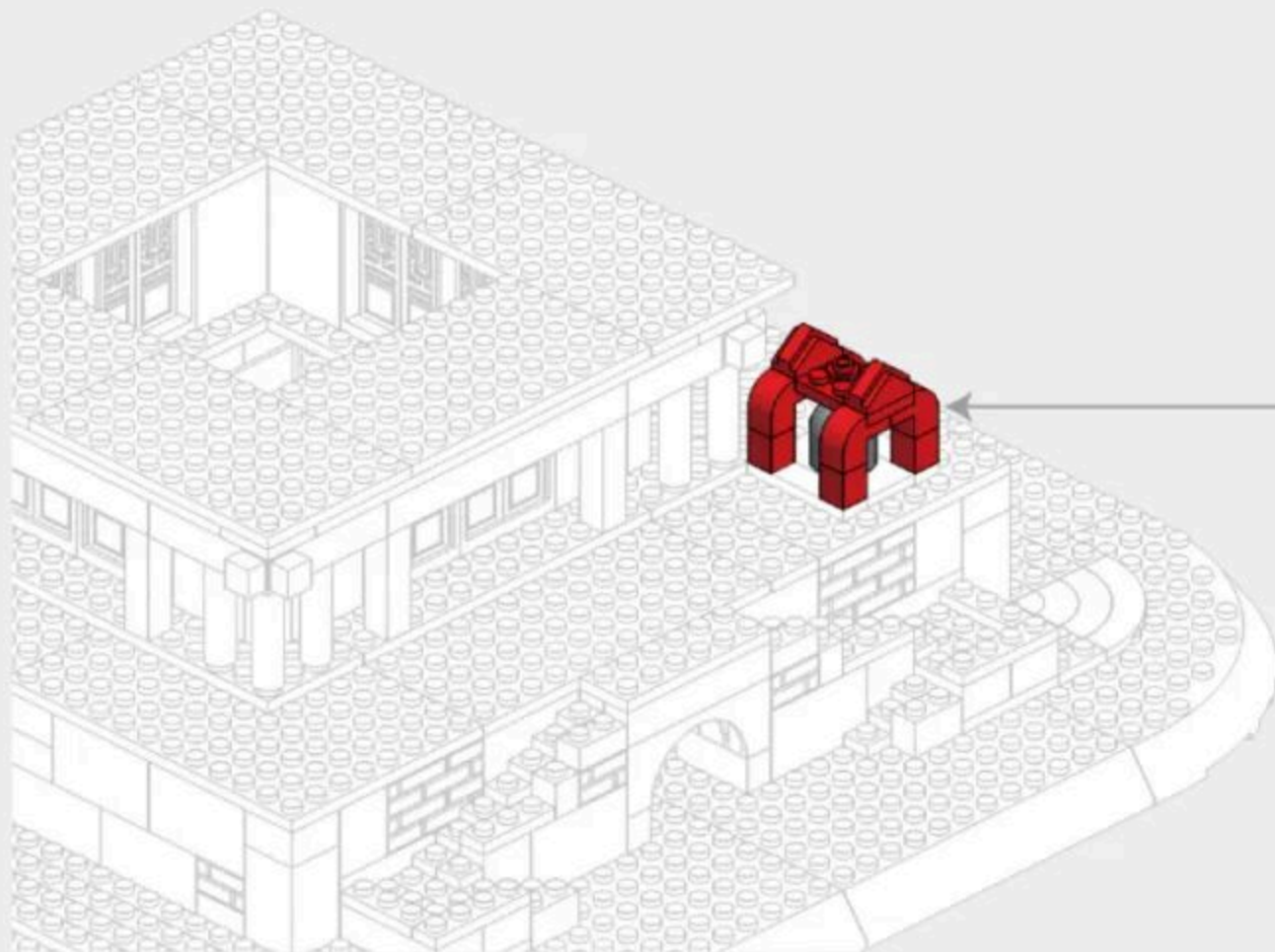

2-9



x4



x4



x4



x4

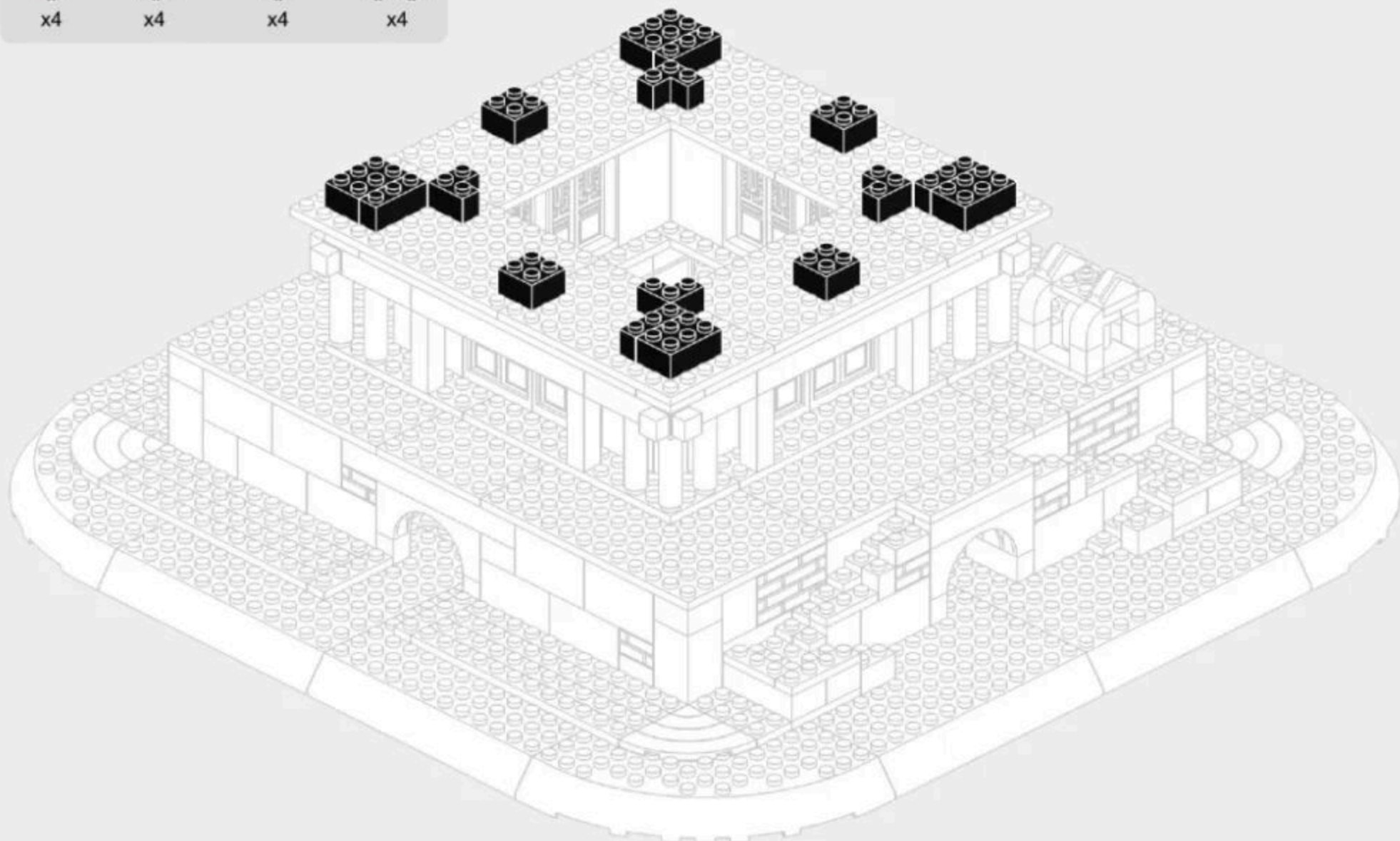

2-10

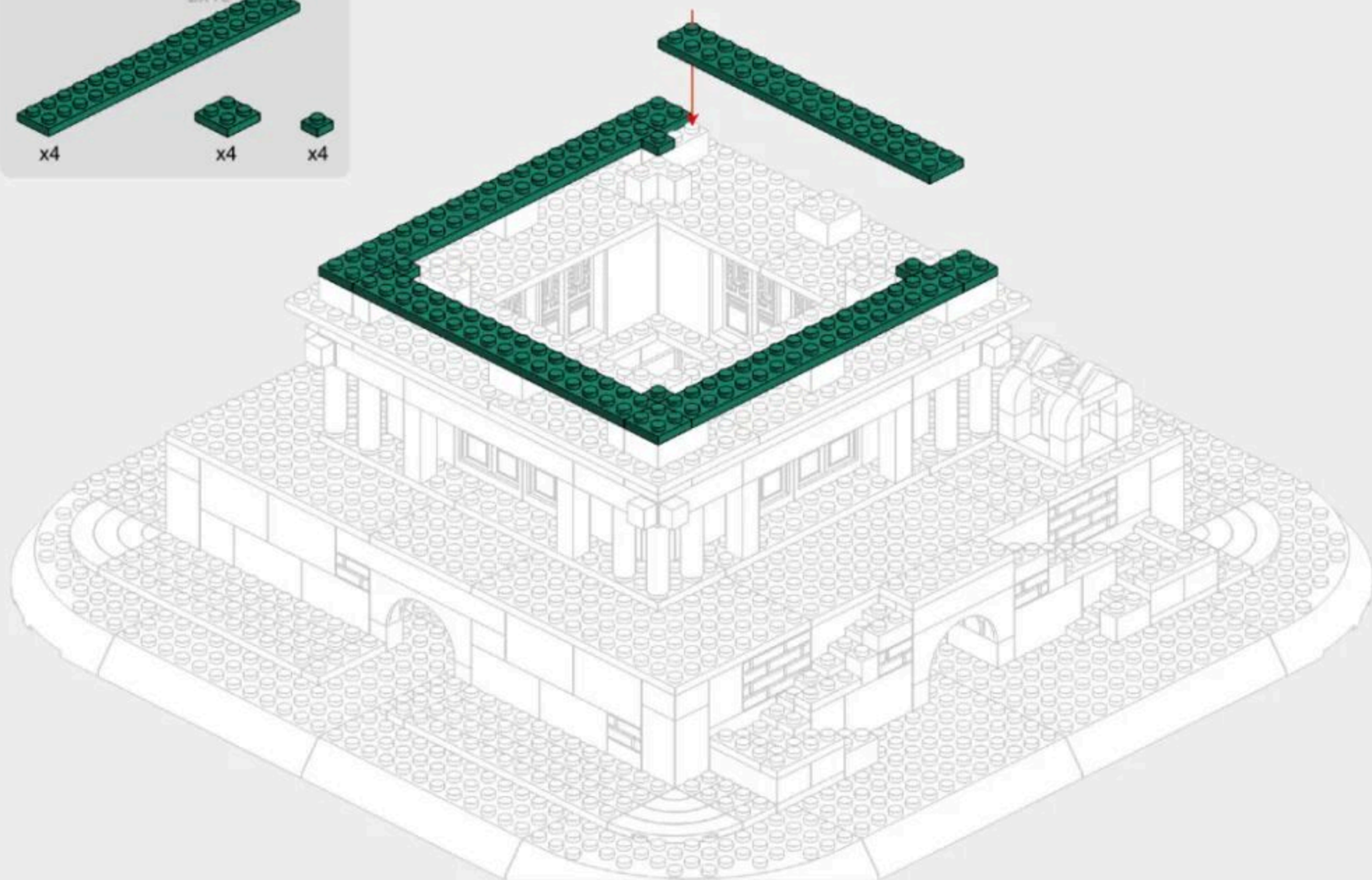
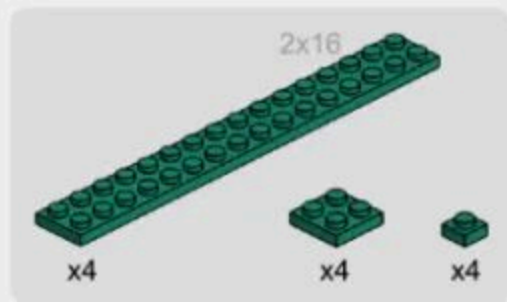

2-11

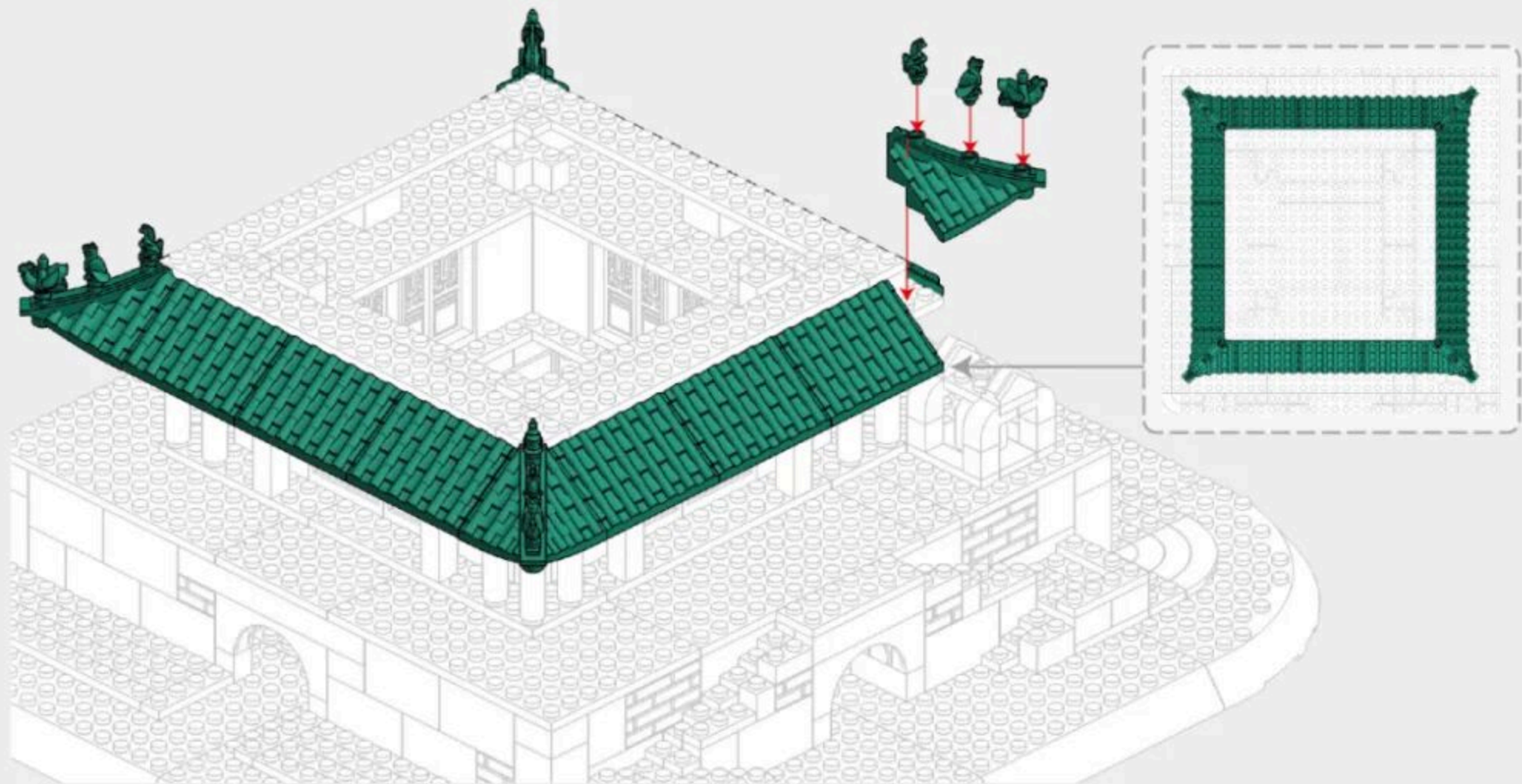
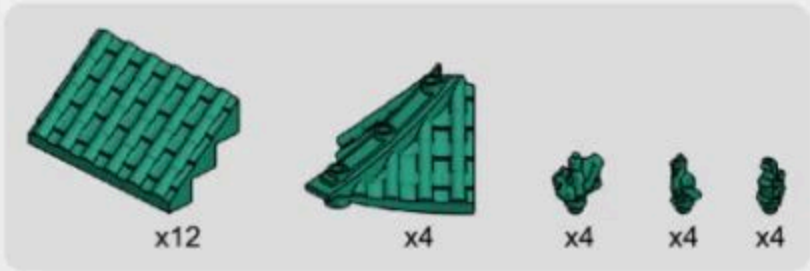

2-12

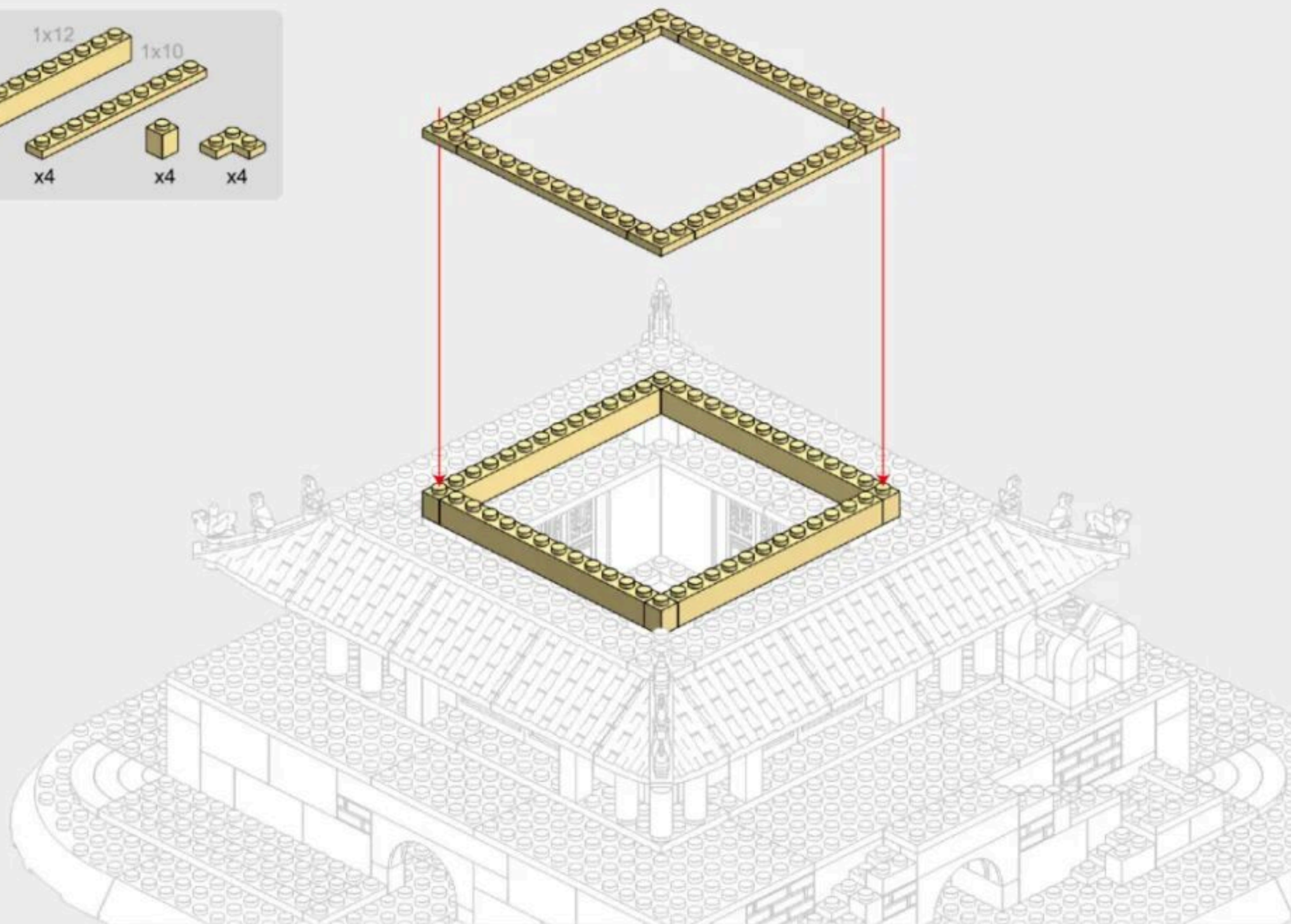
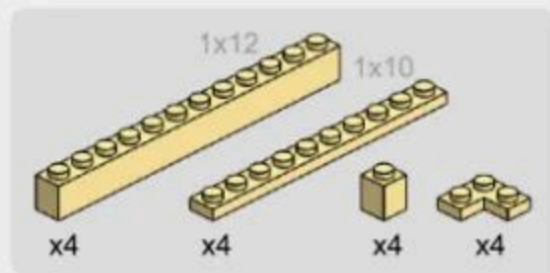

2-13

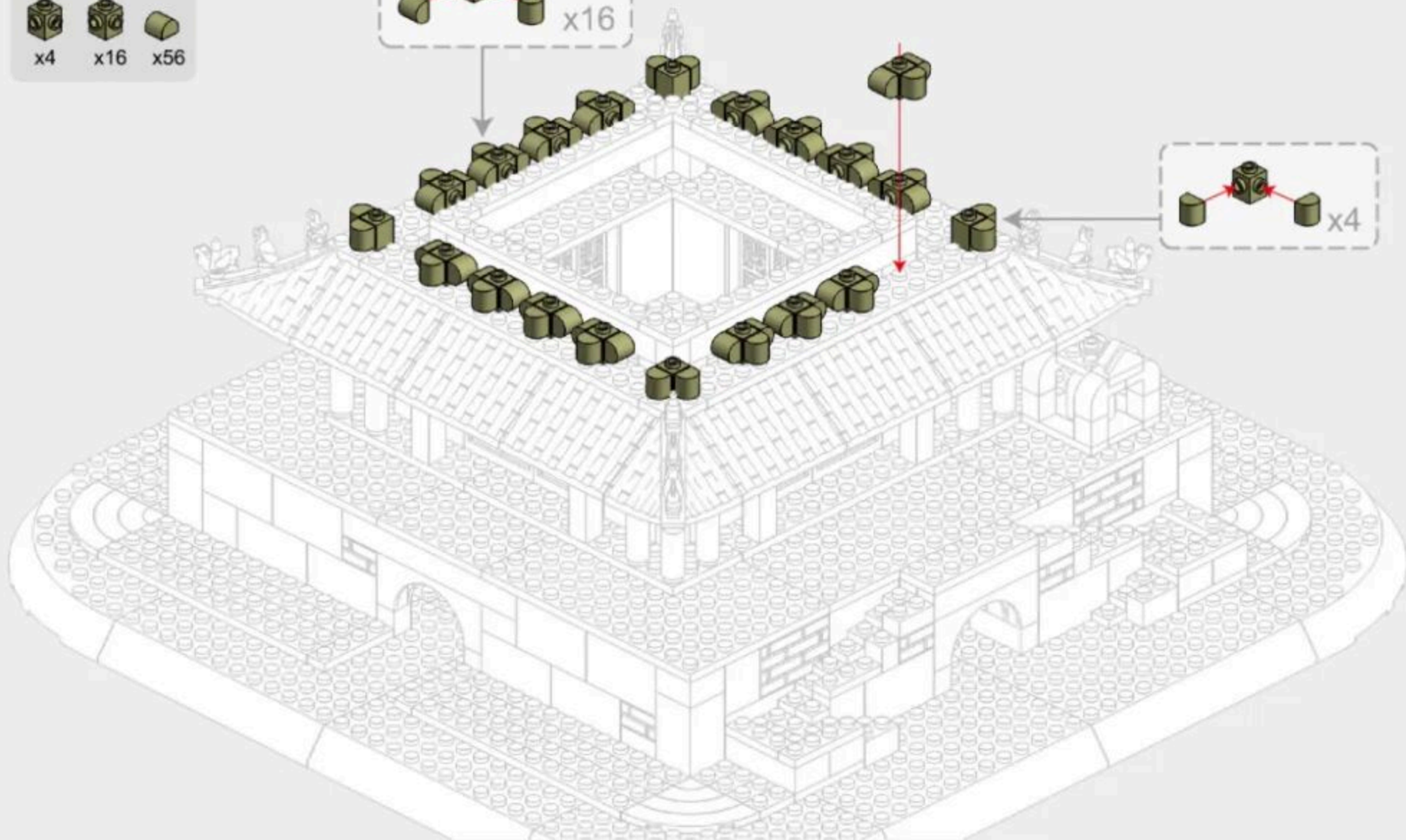
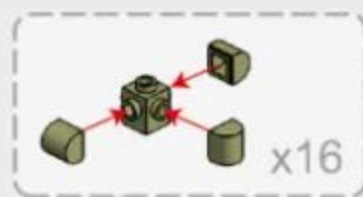



186PCS

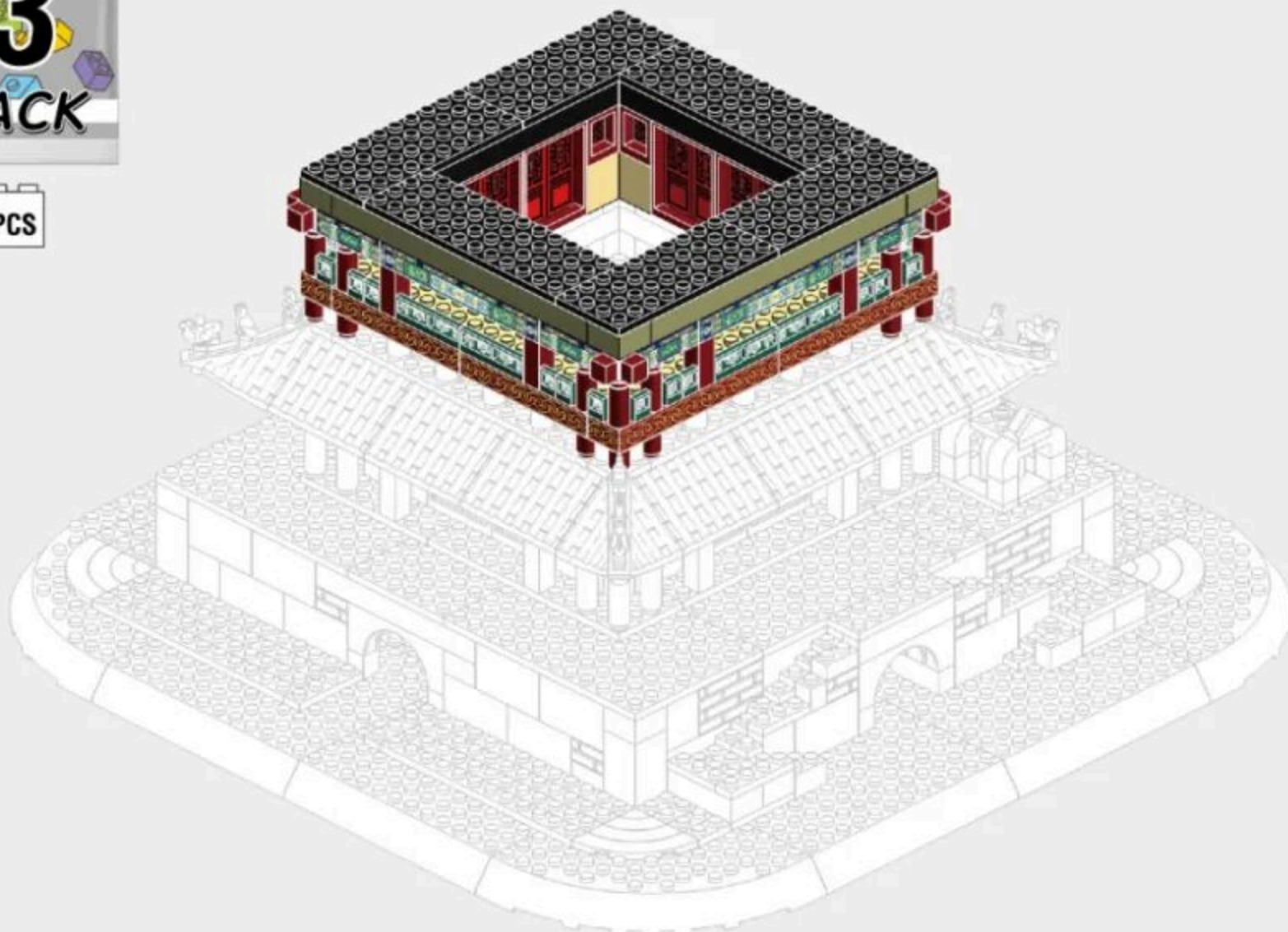

48

3-1

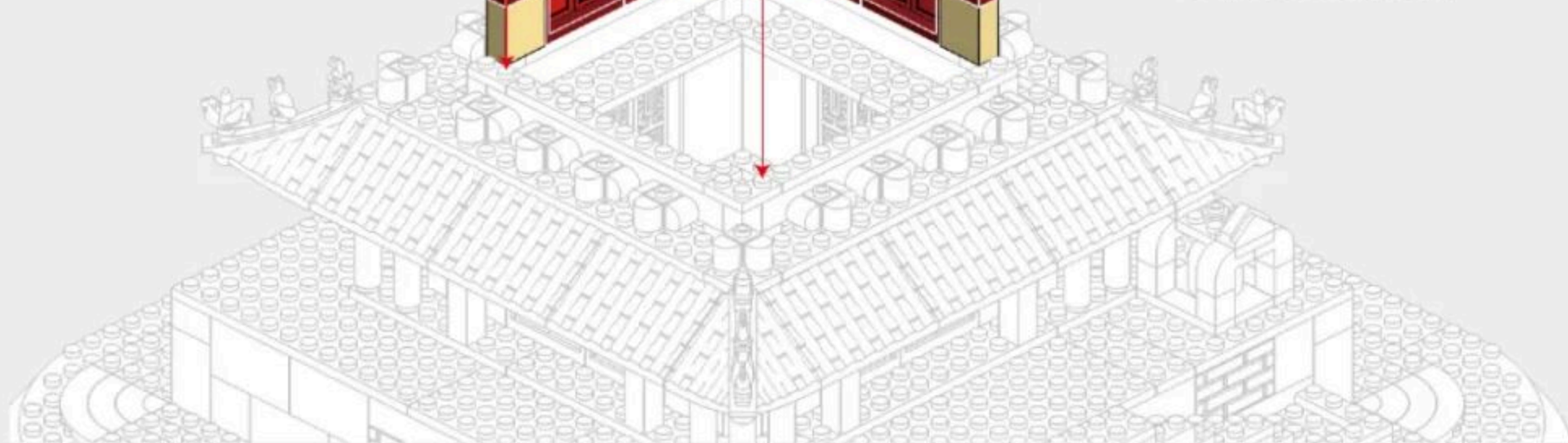
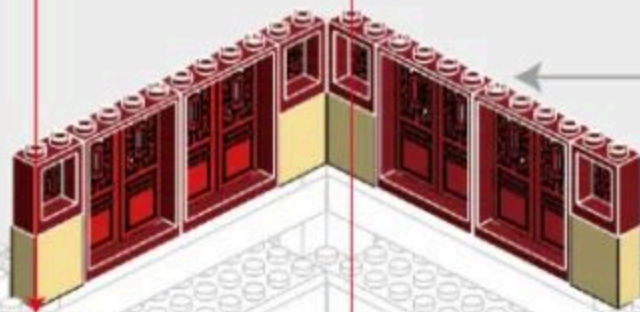

3-2

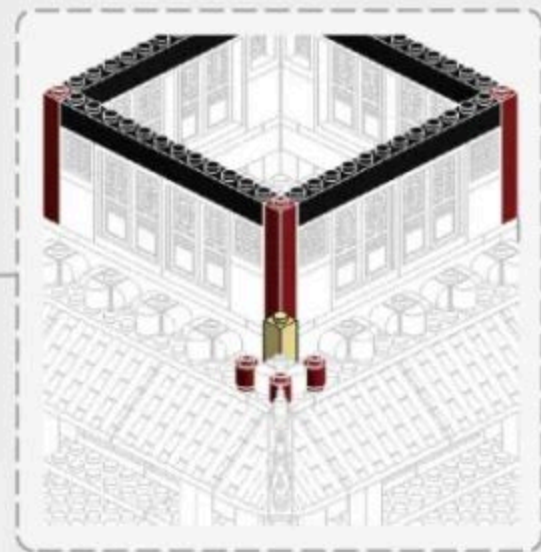
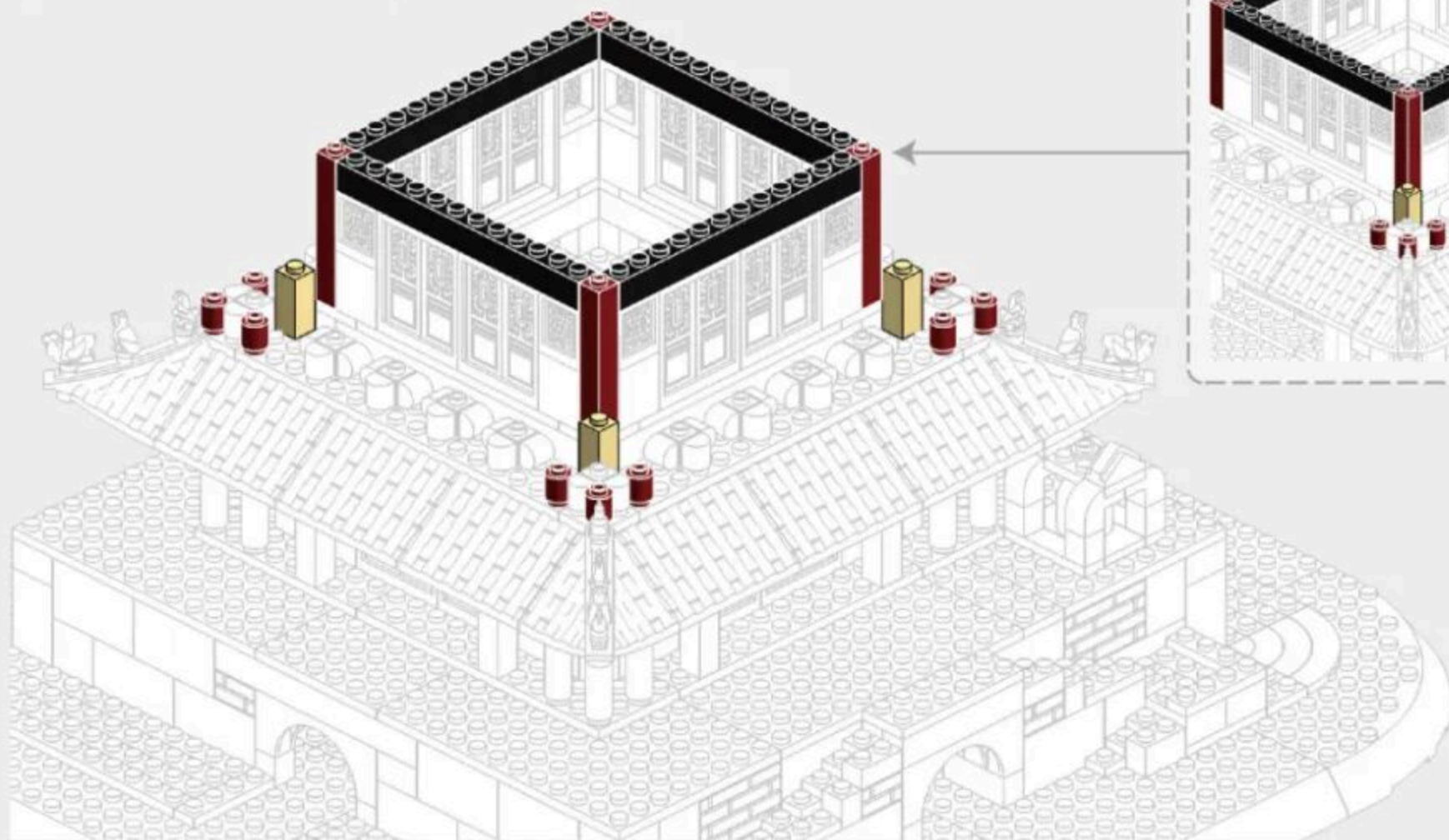
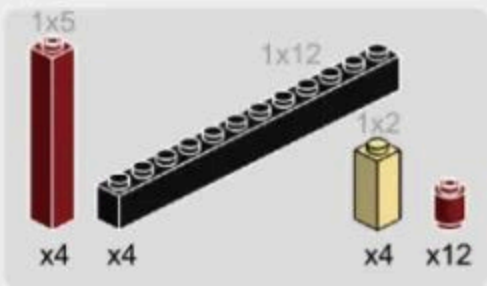

3-3

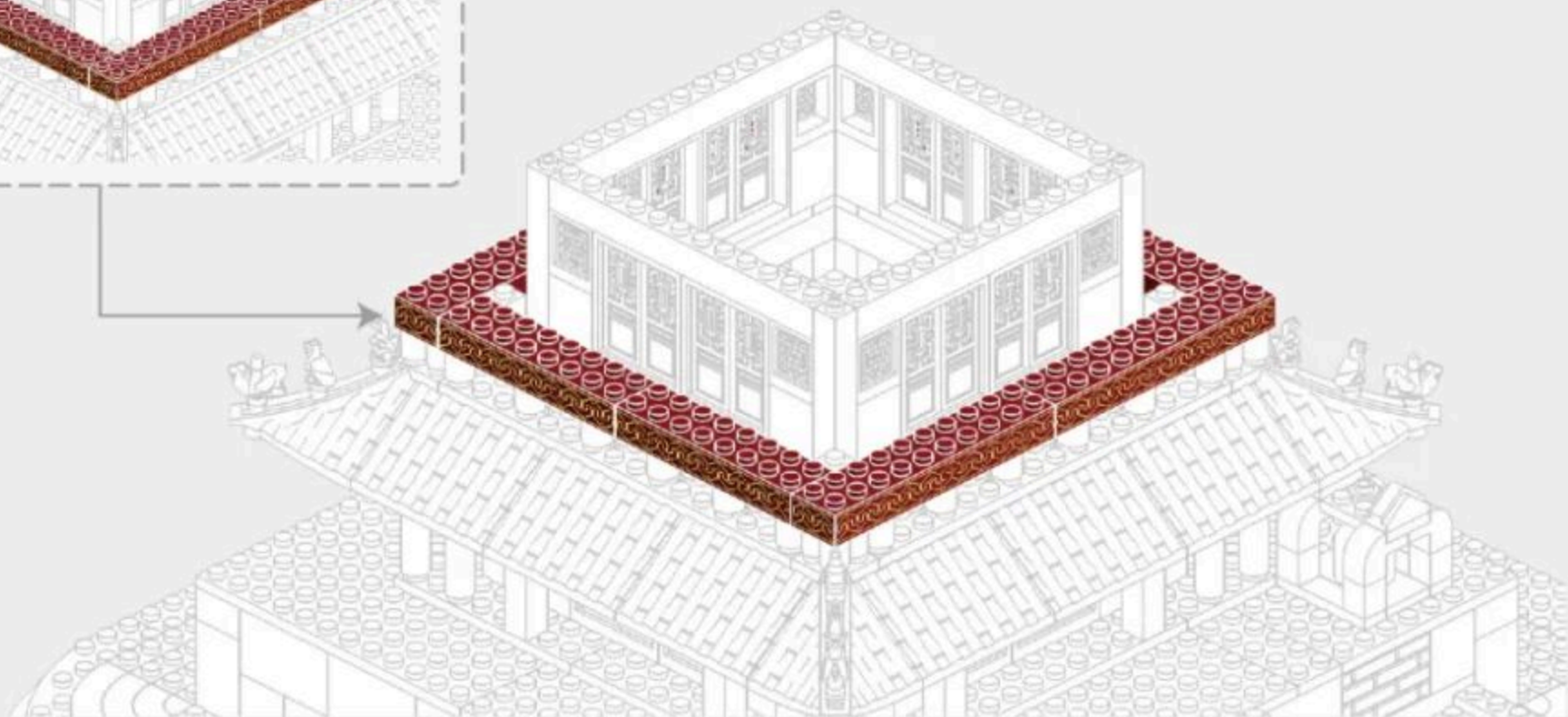
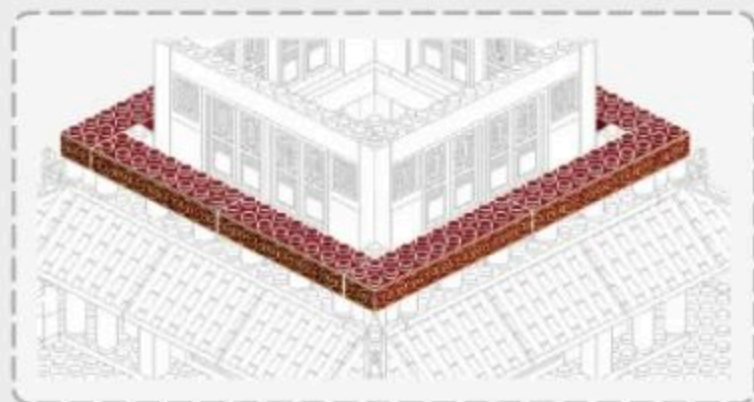
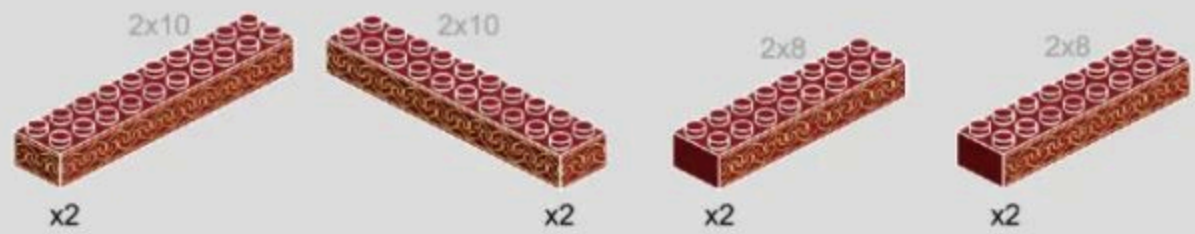

3-4

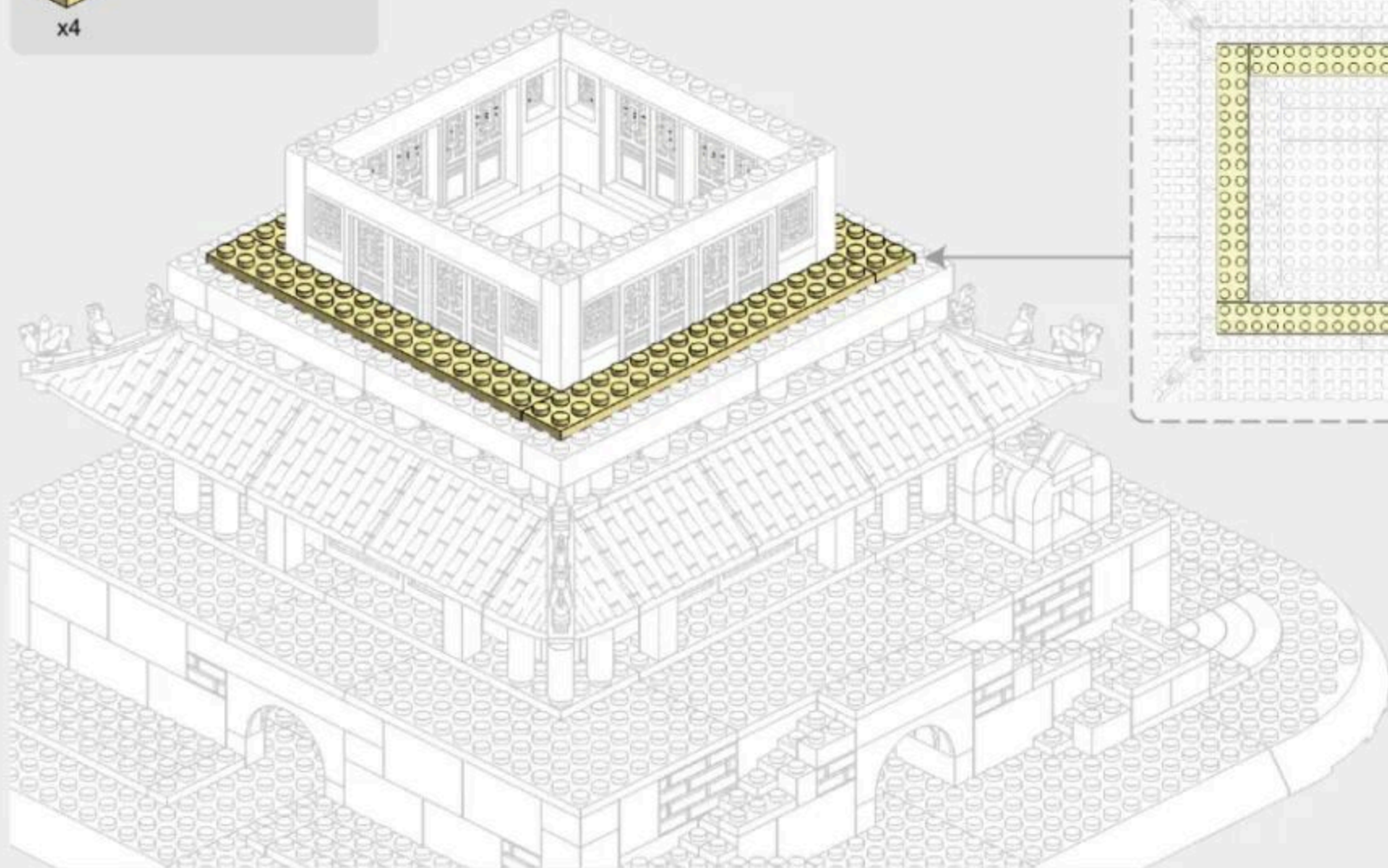
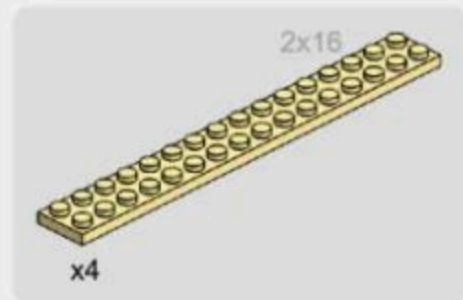

3-5

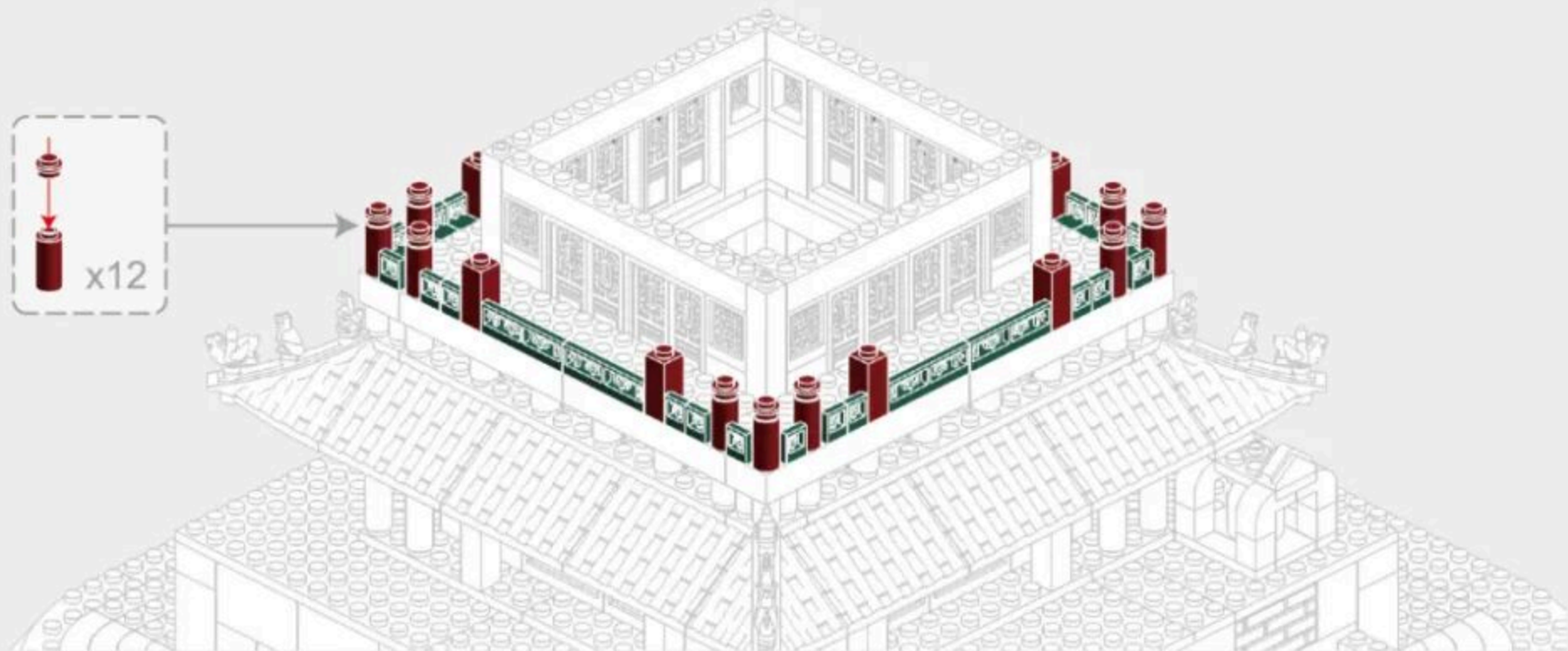
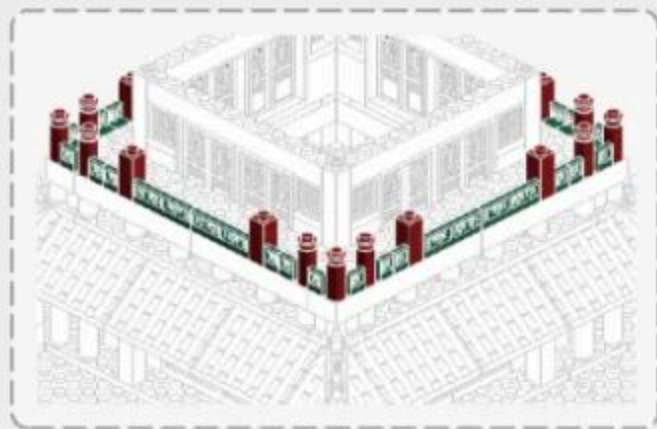

3-6

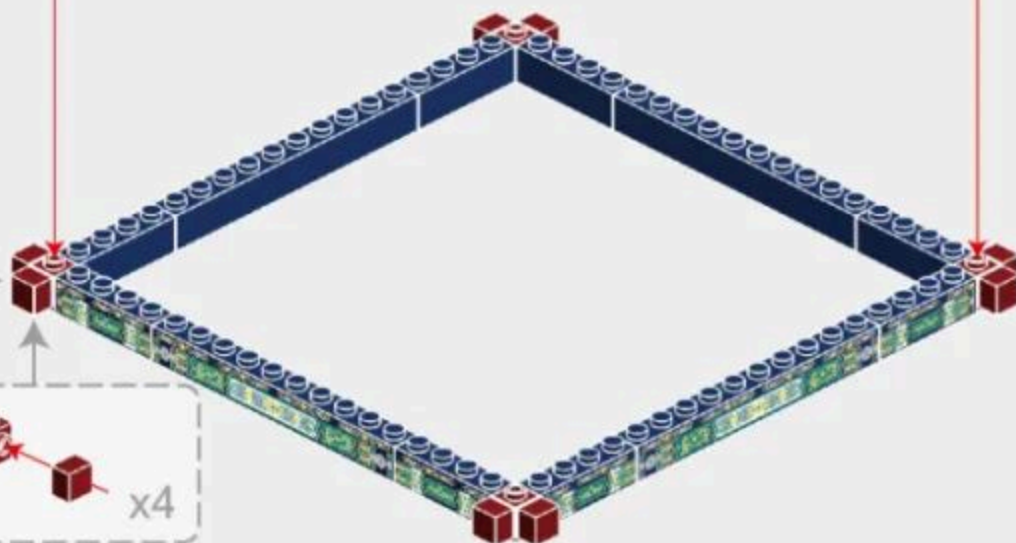
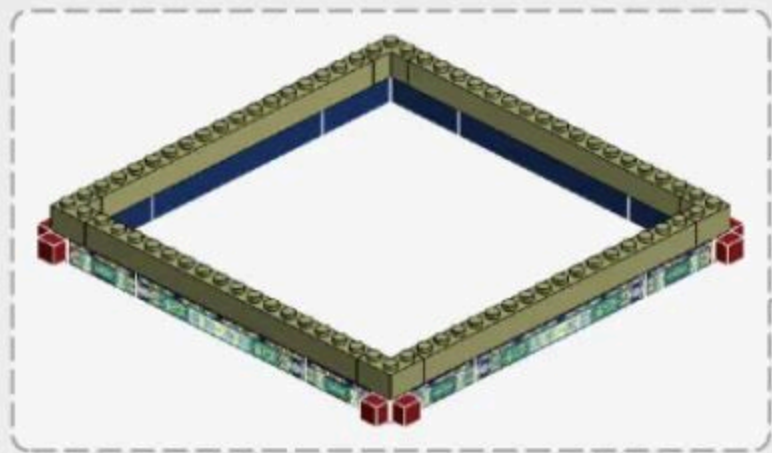
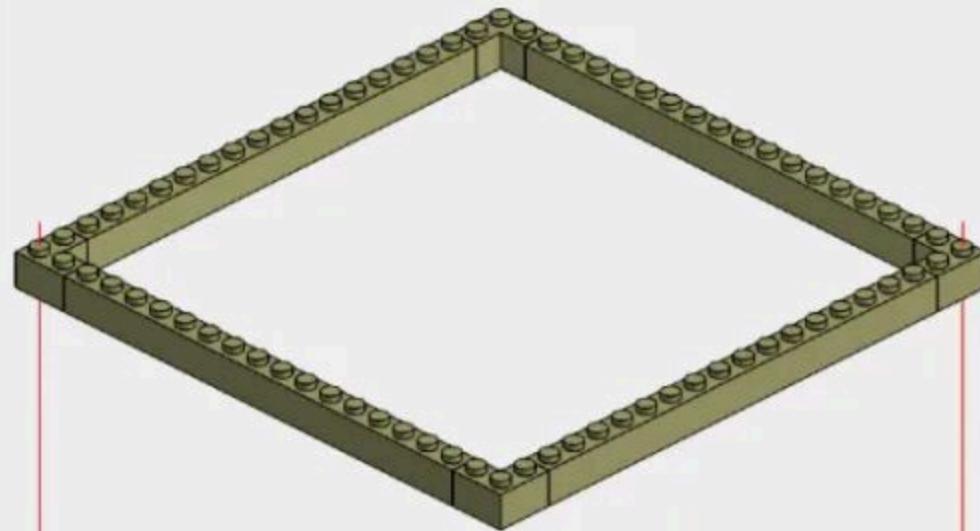
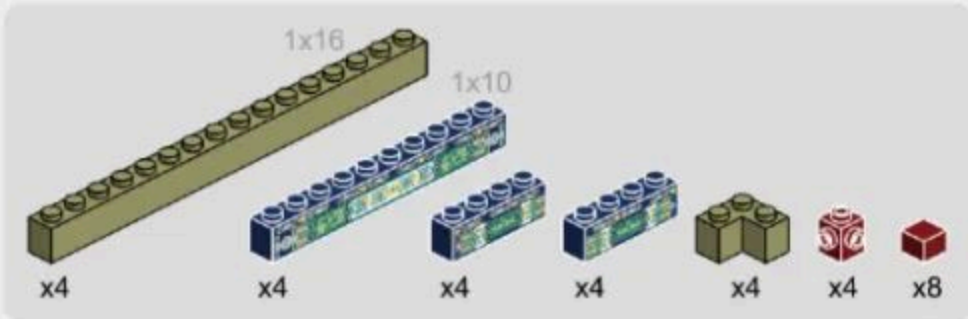

3-7

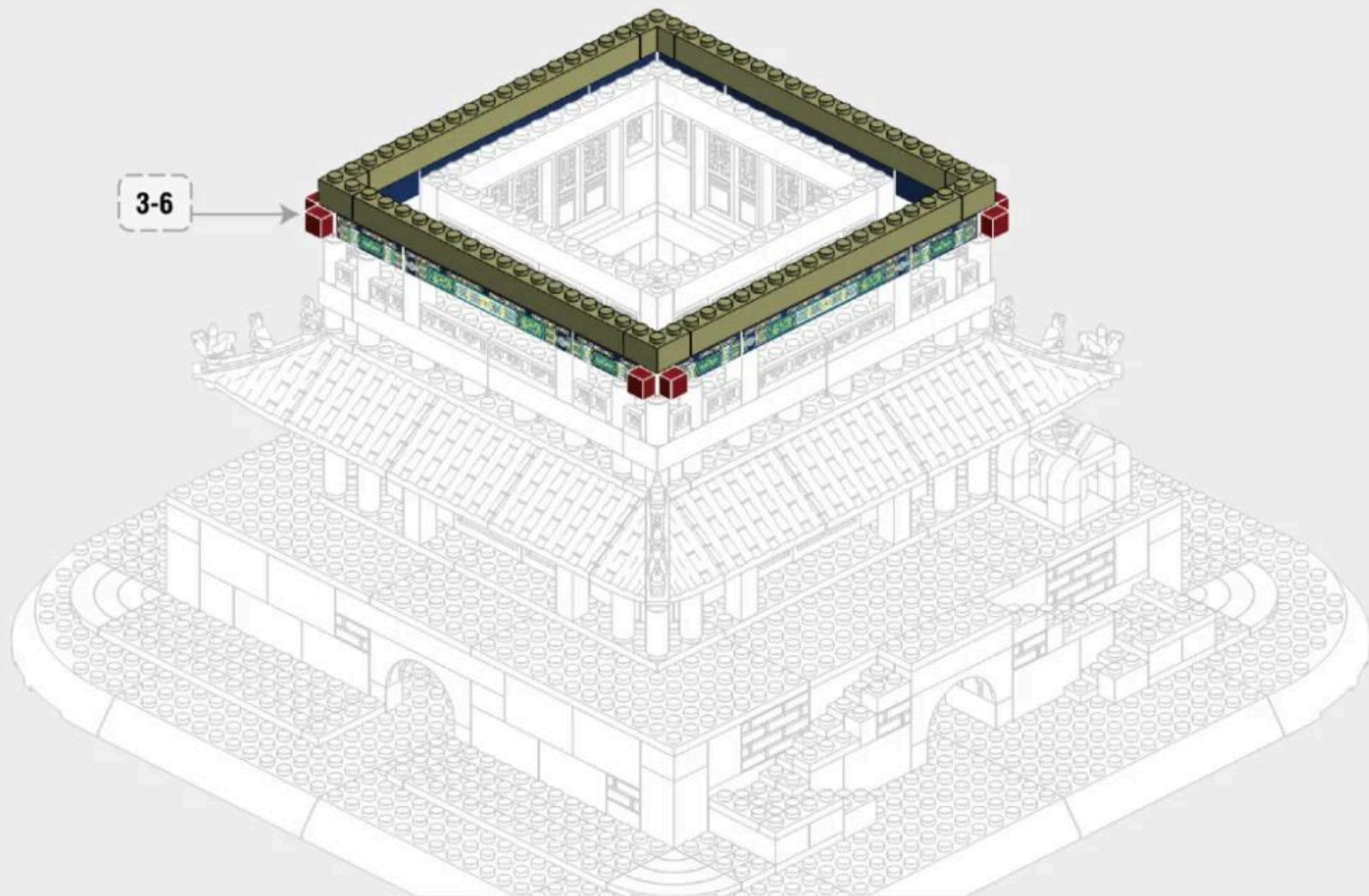

3-6

3-8

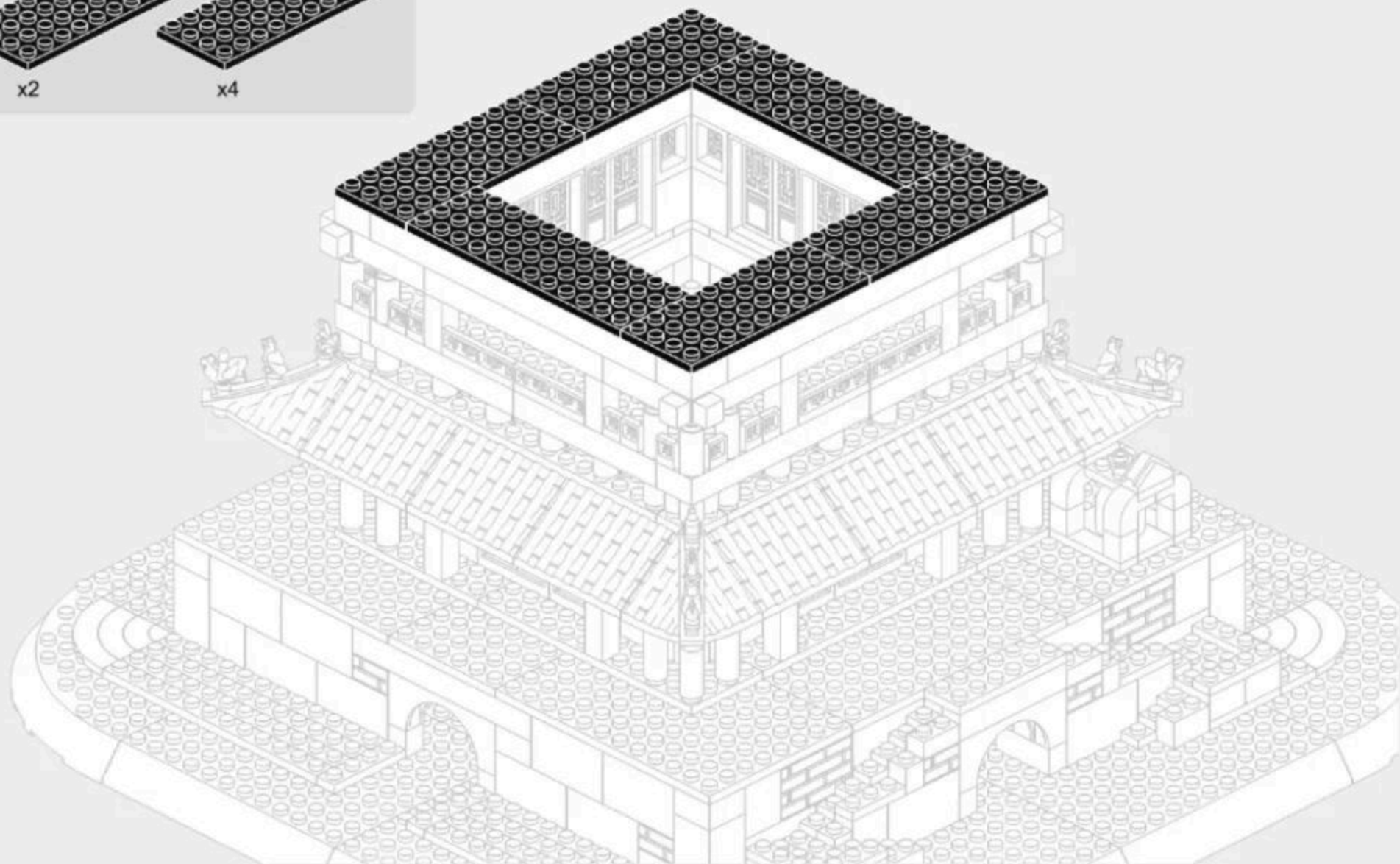
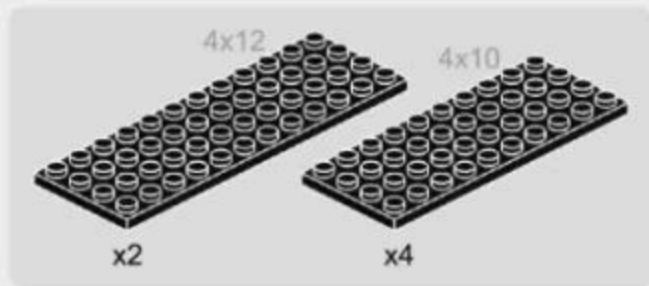



235PCS

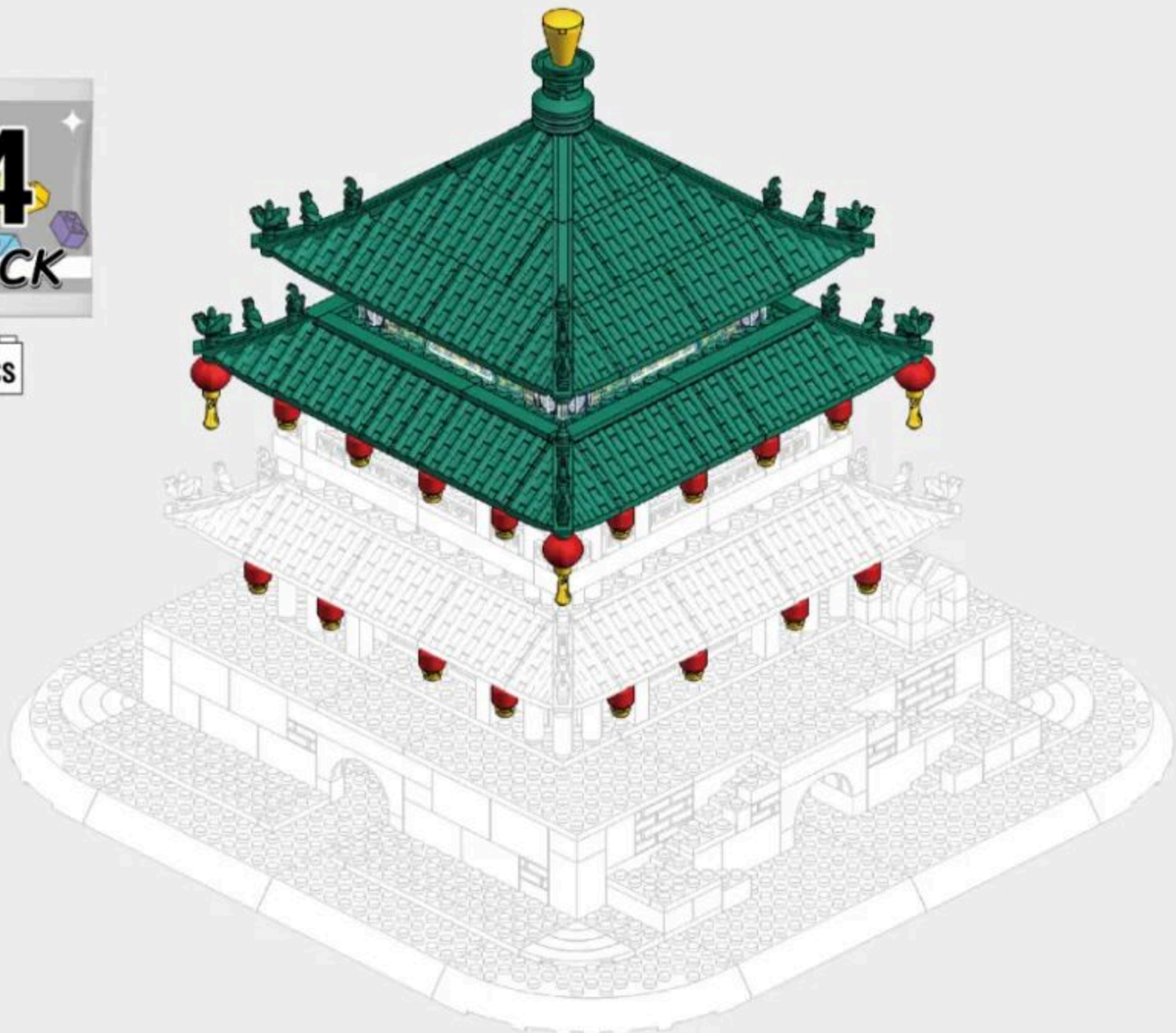

57

4-1

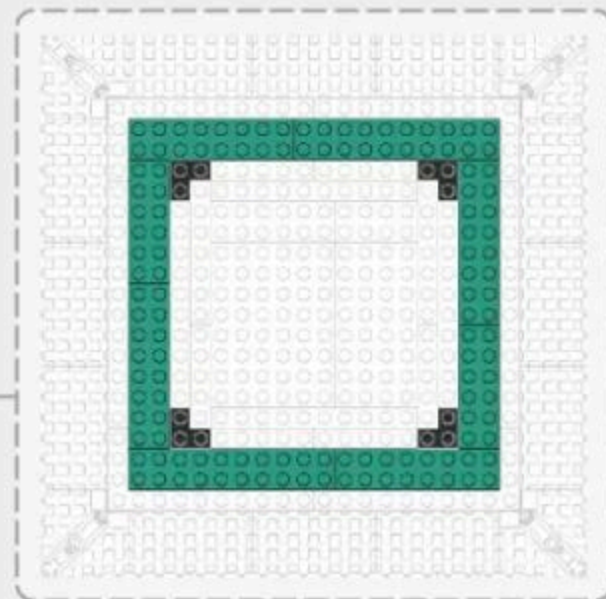
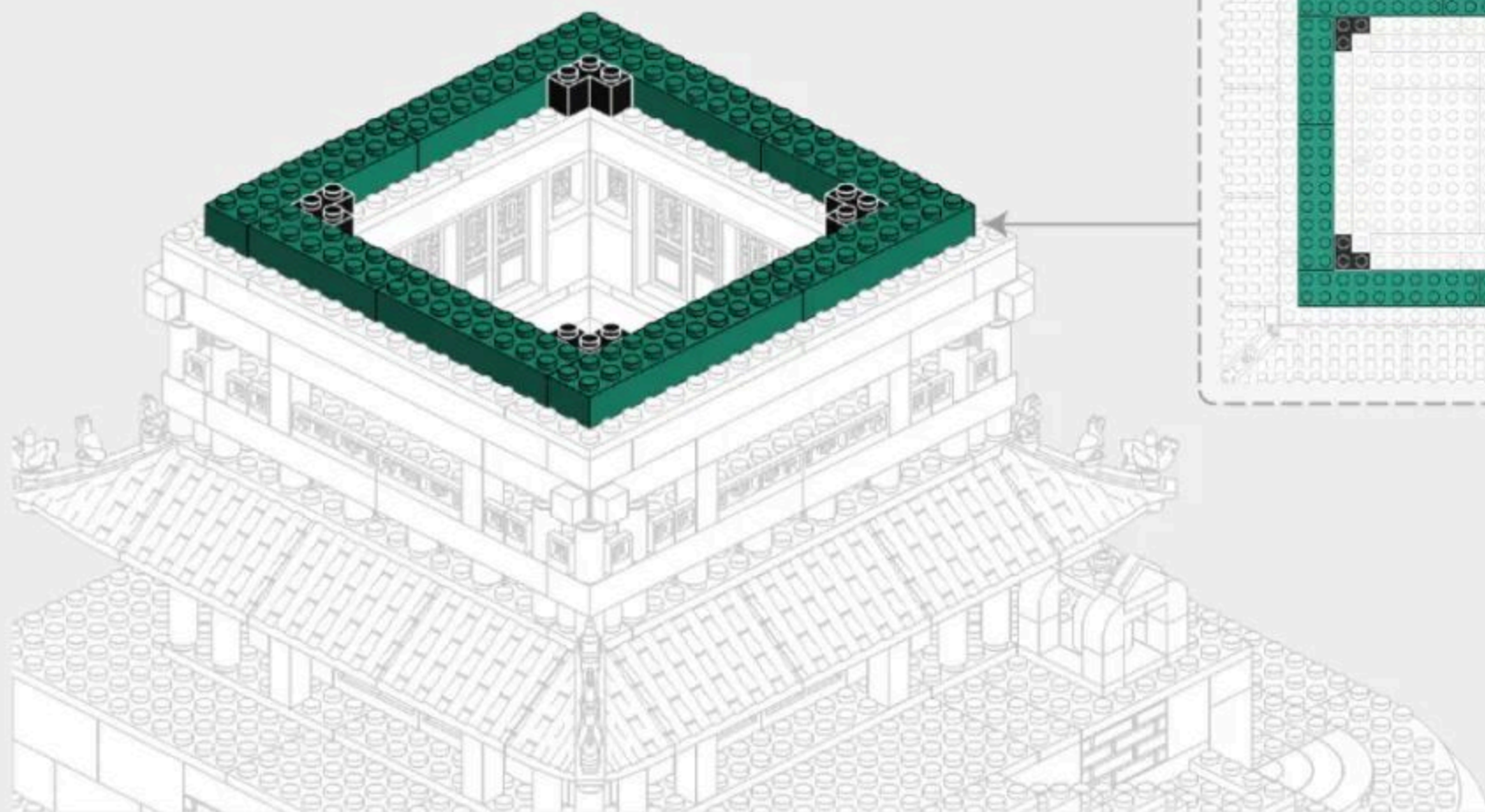
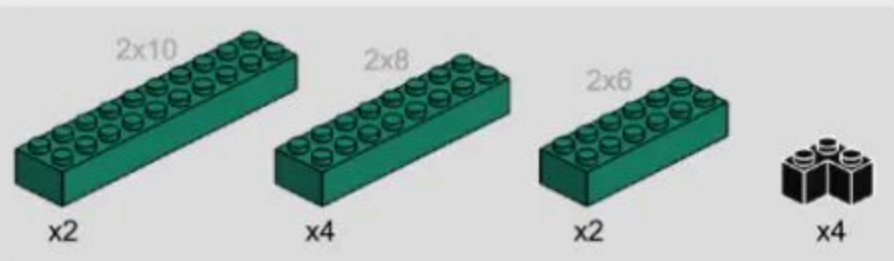

4-2

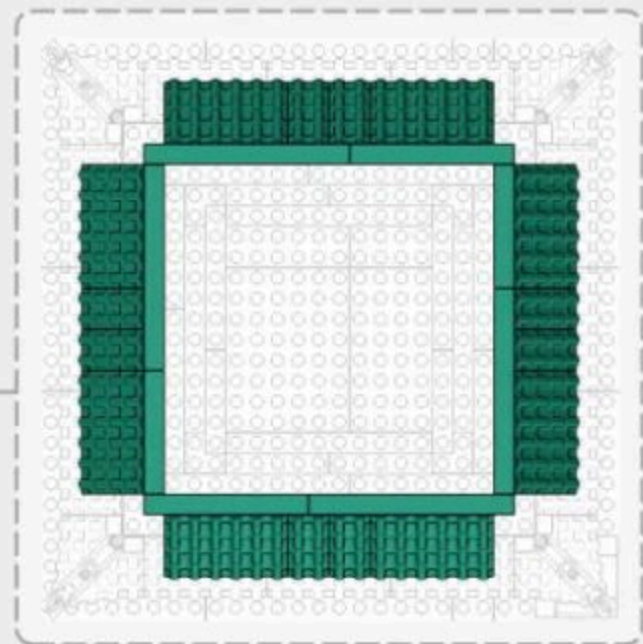
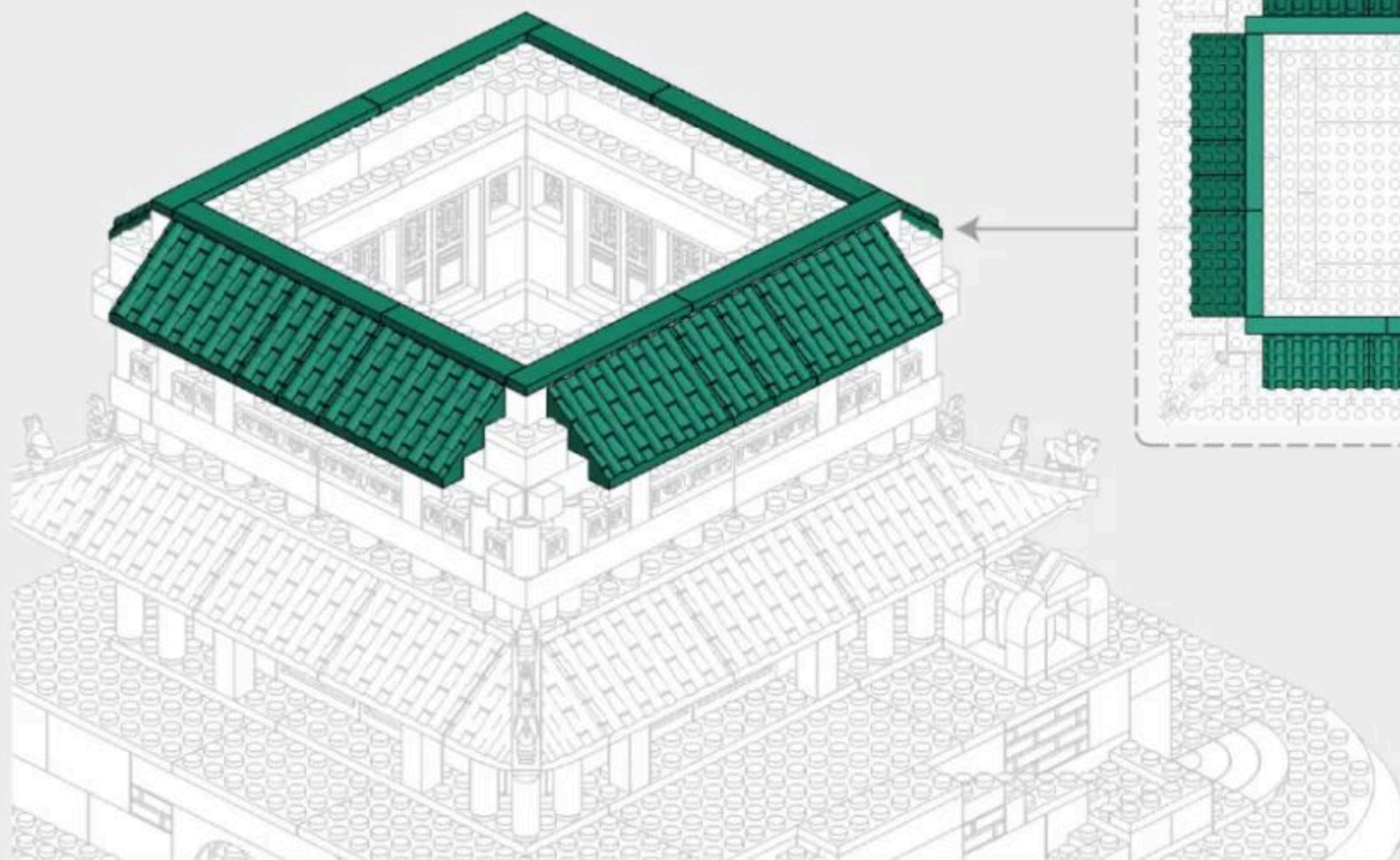
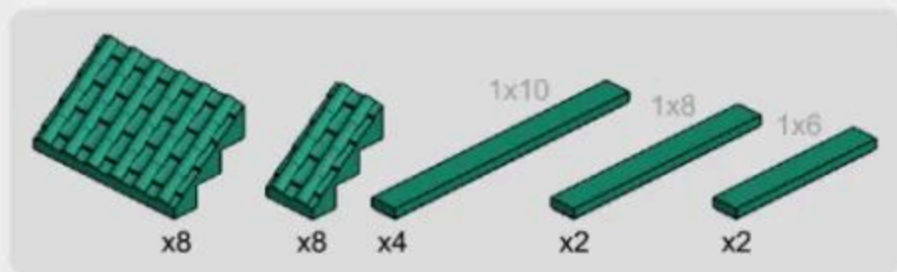

4-3

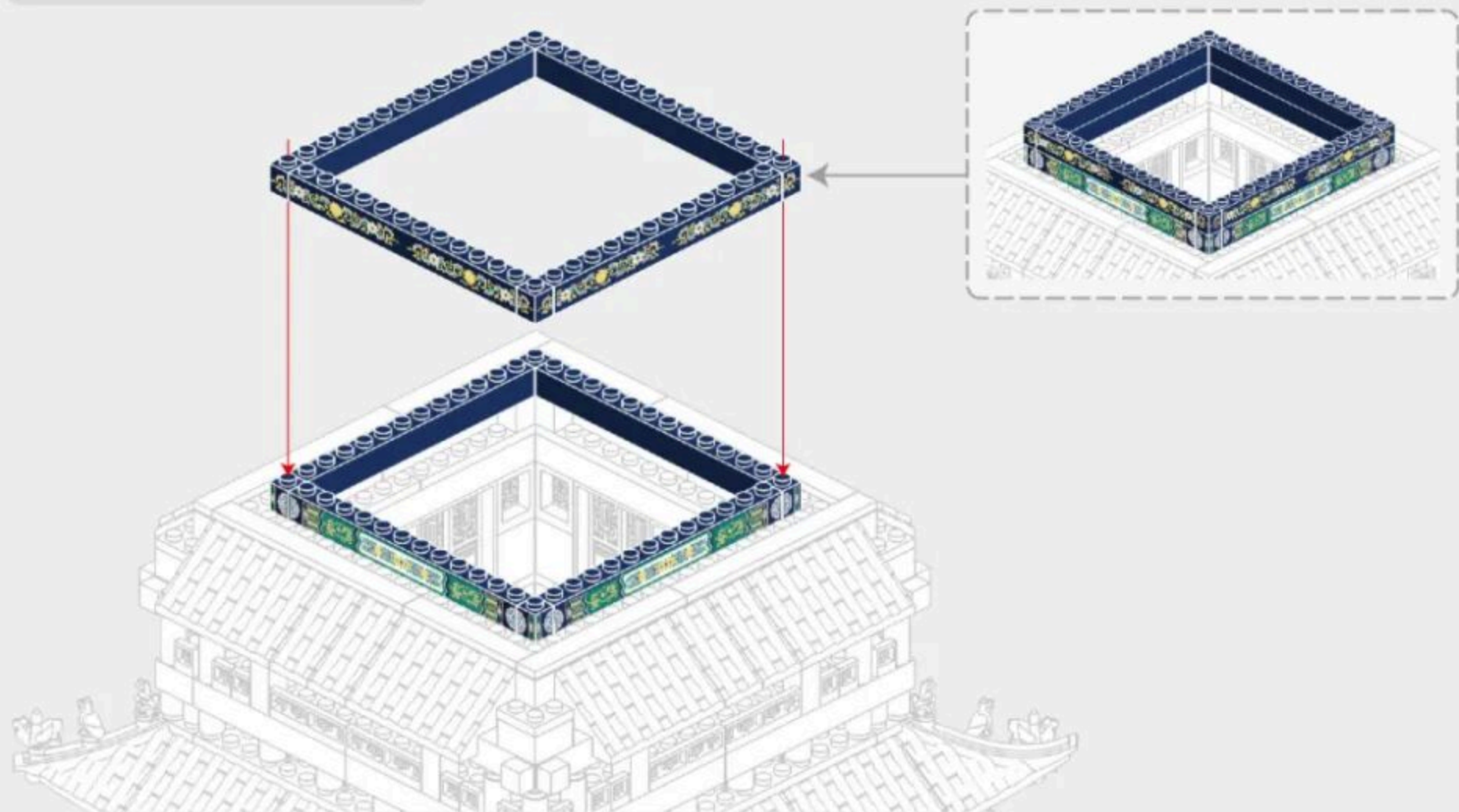

4-4



x4



x4



x4



x4



x32



x4



x4



x4



x32

1



x4

2

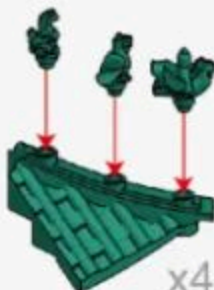

x4

3



x4

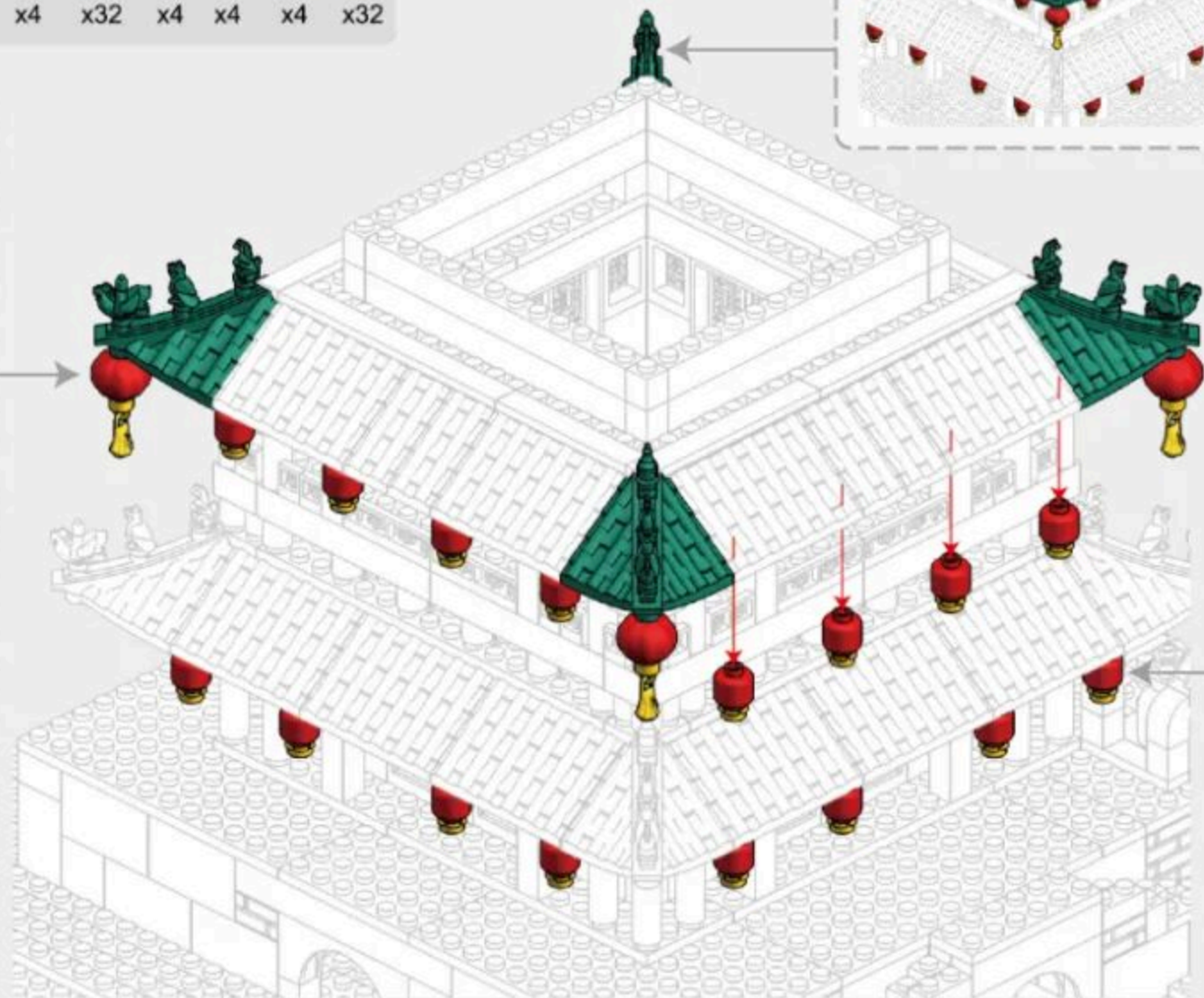

x32

4-5



x12

x4

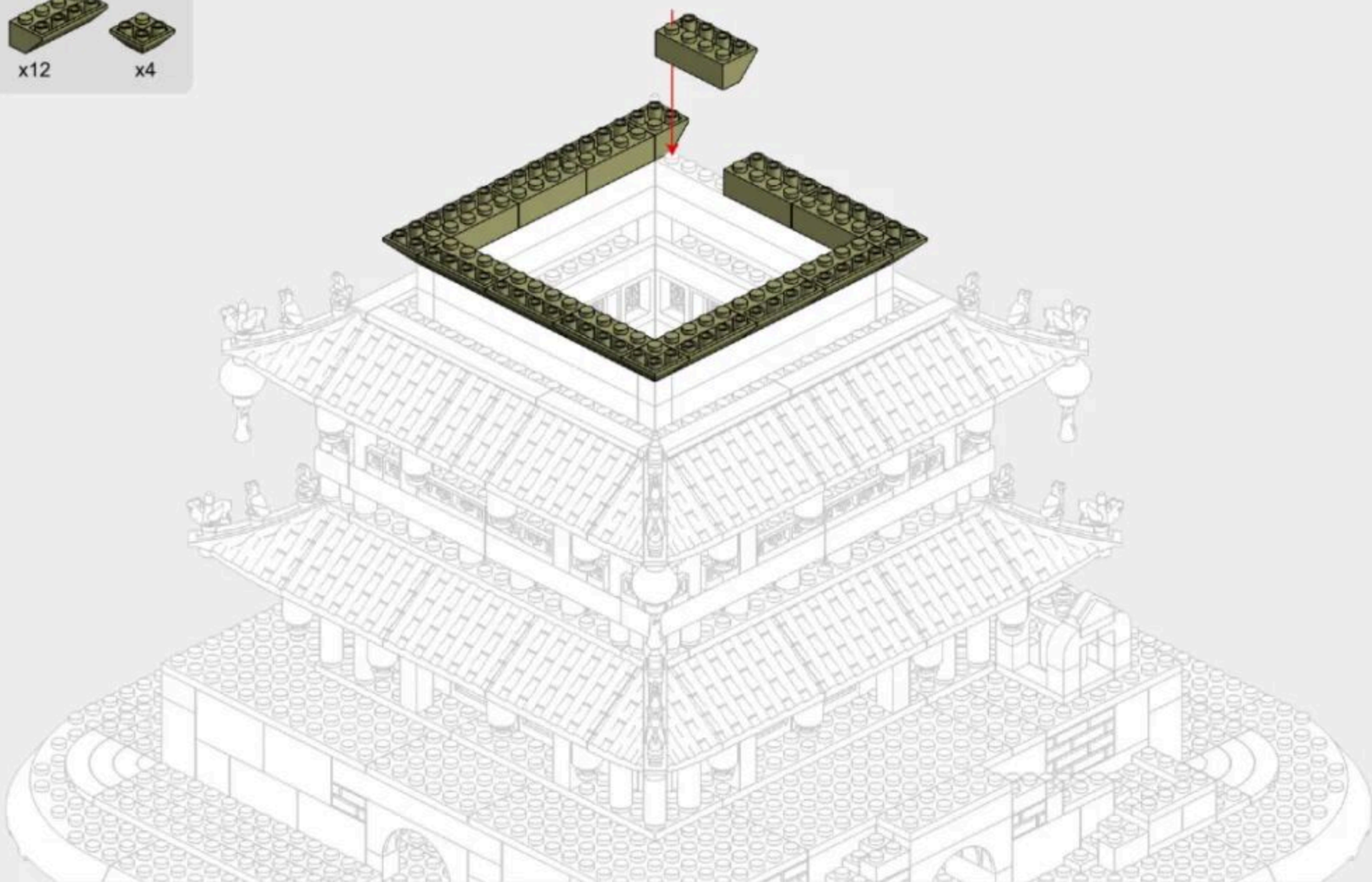

4-6

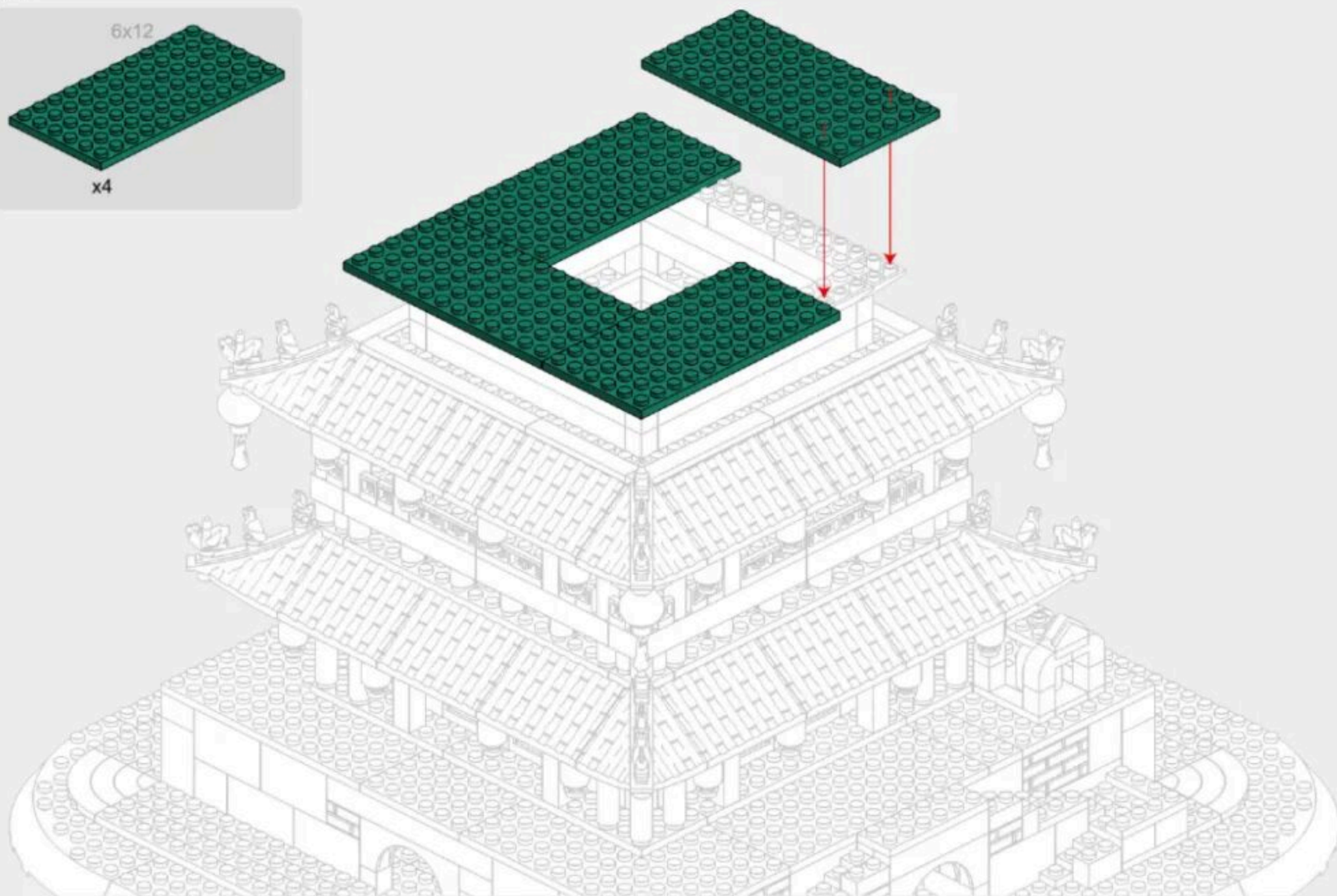
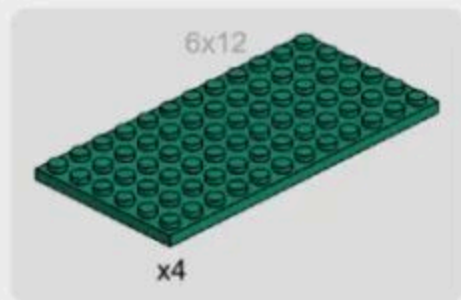

4-7

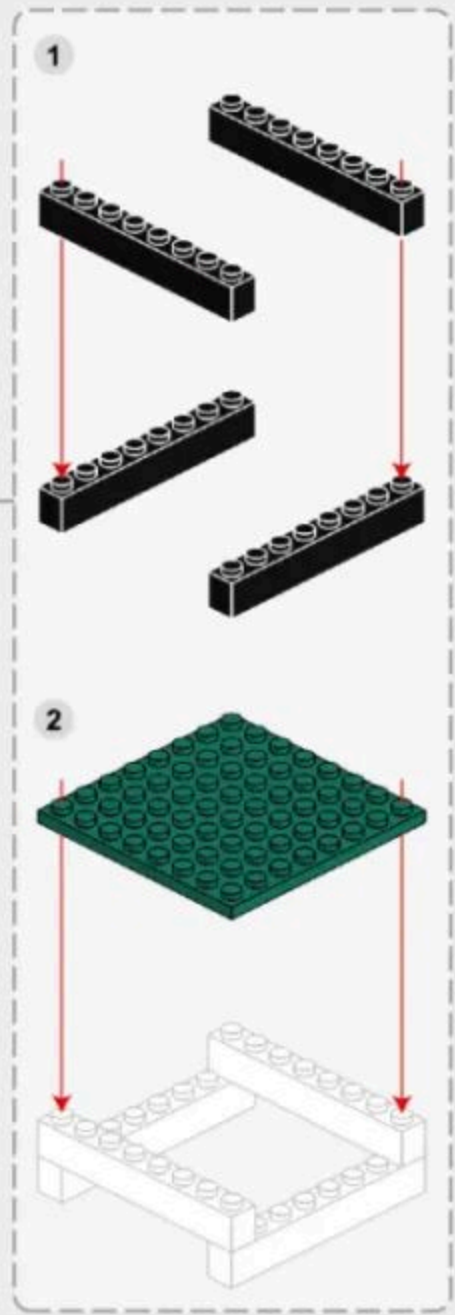
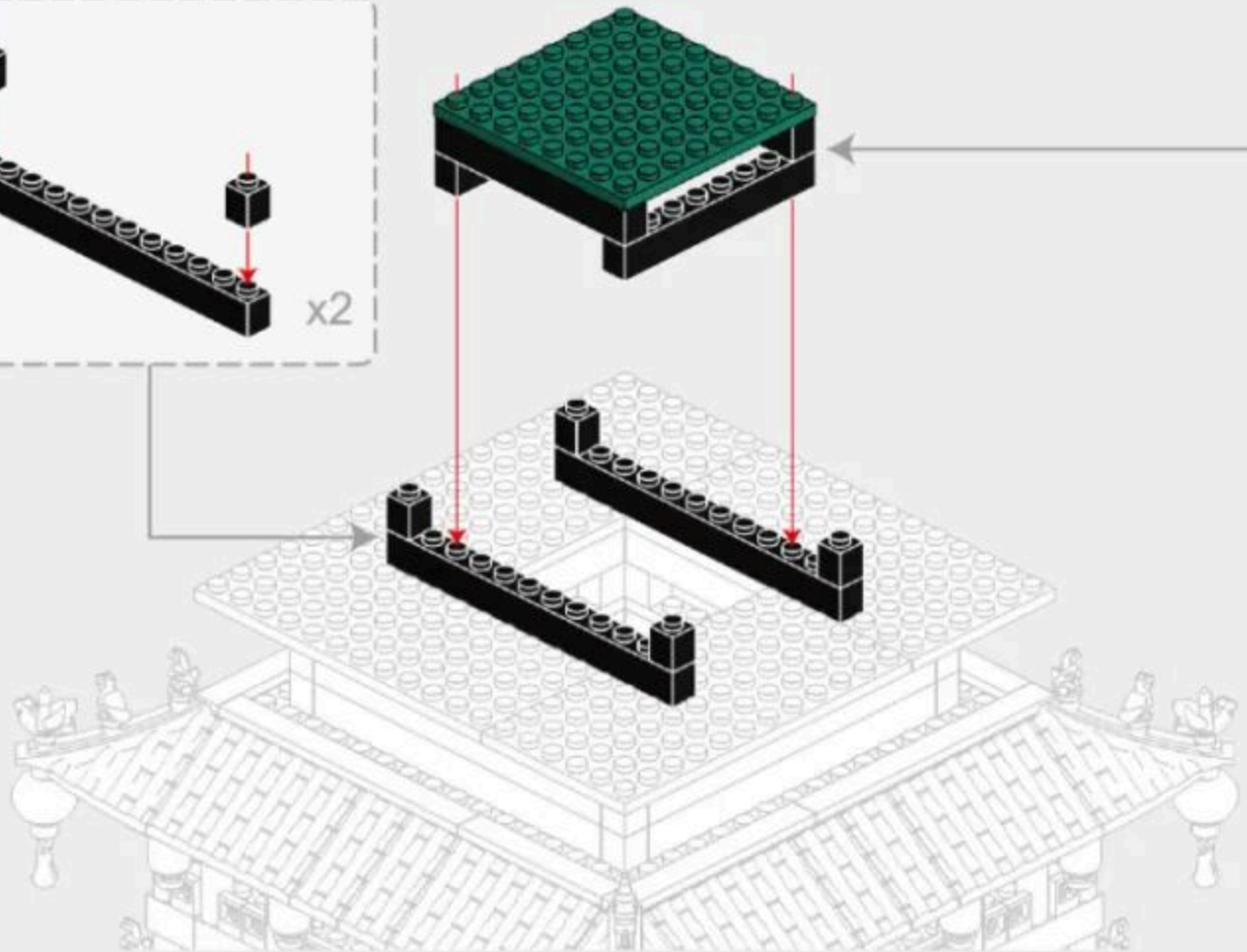
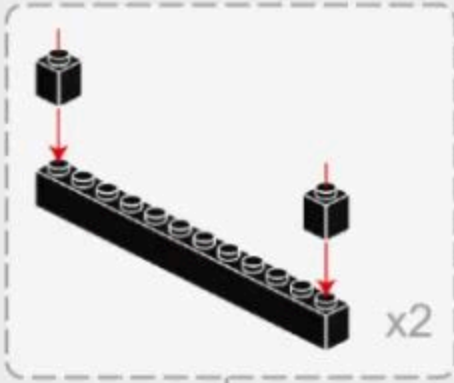
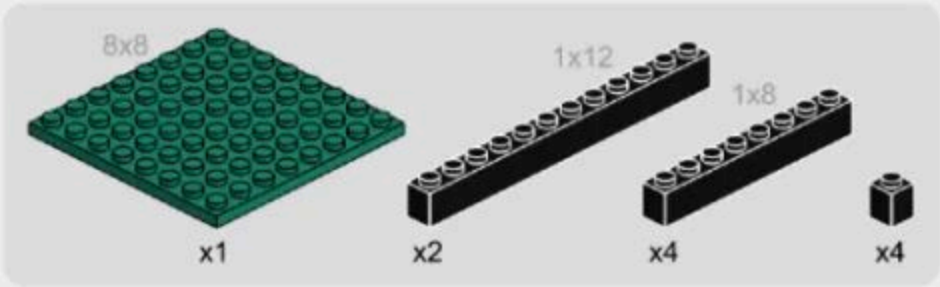

4-8

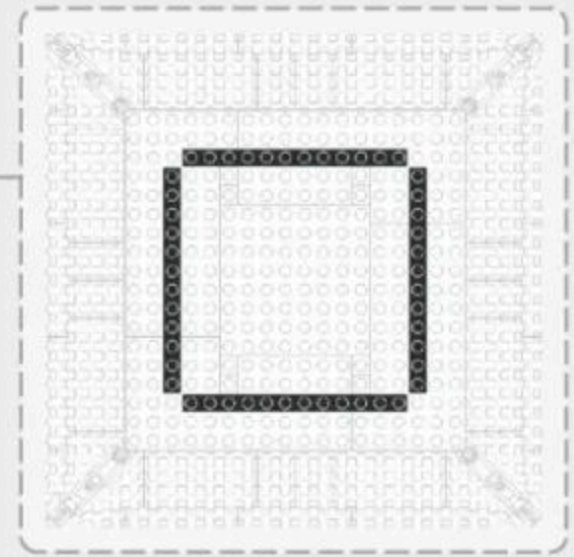
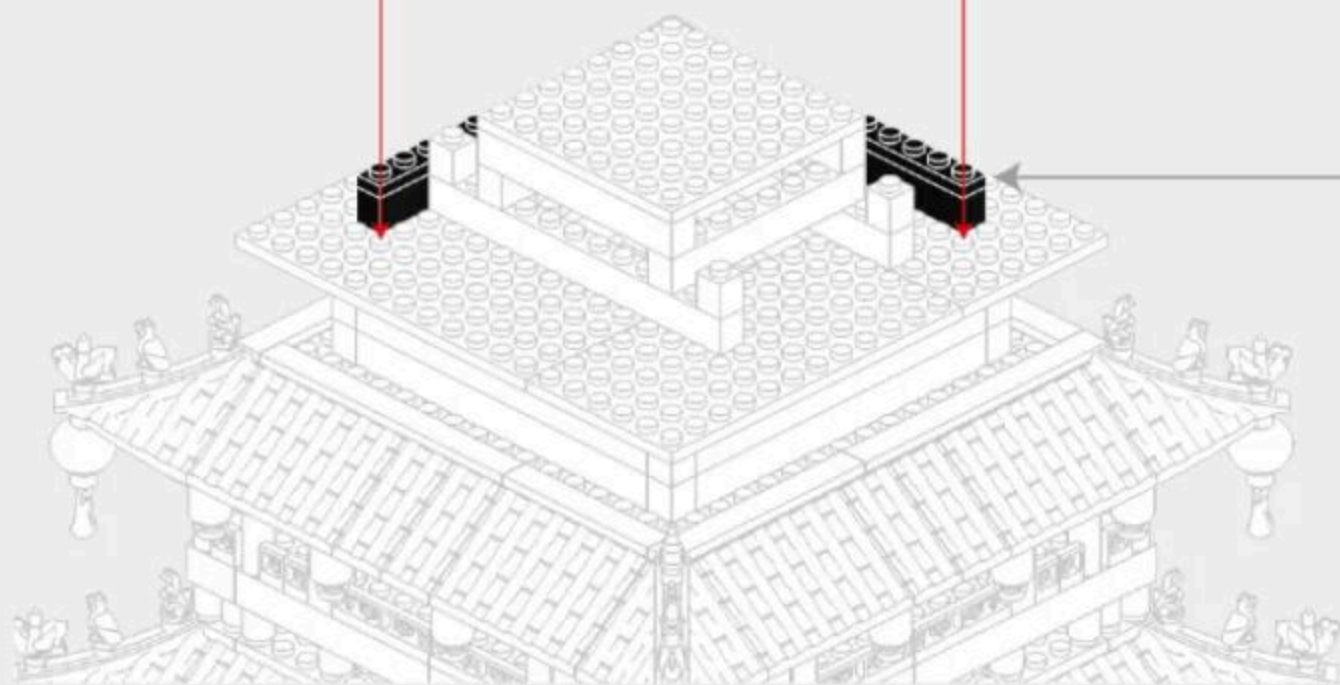
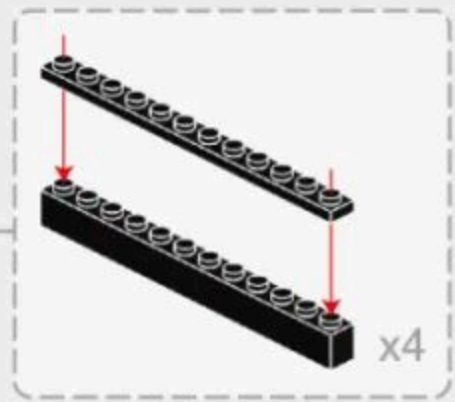
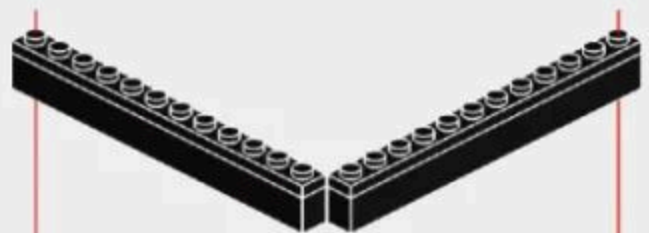
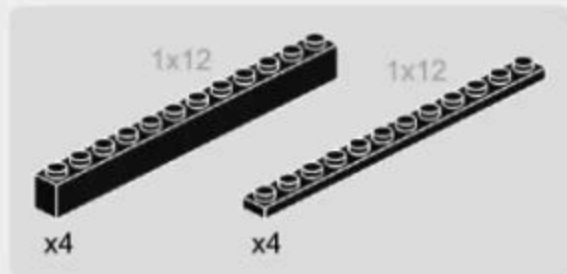

4-9

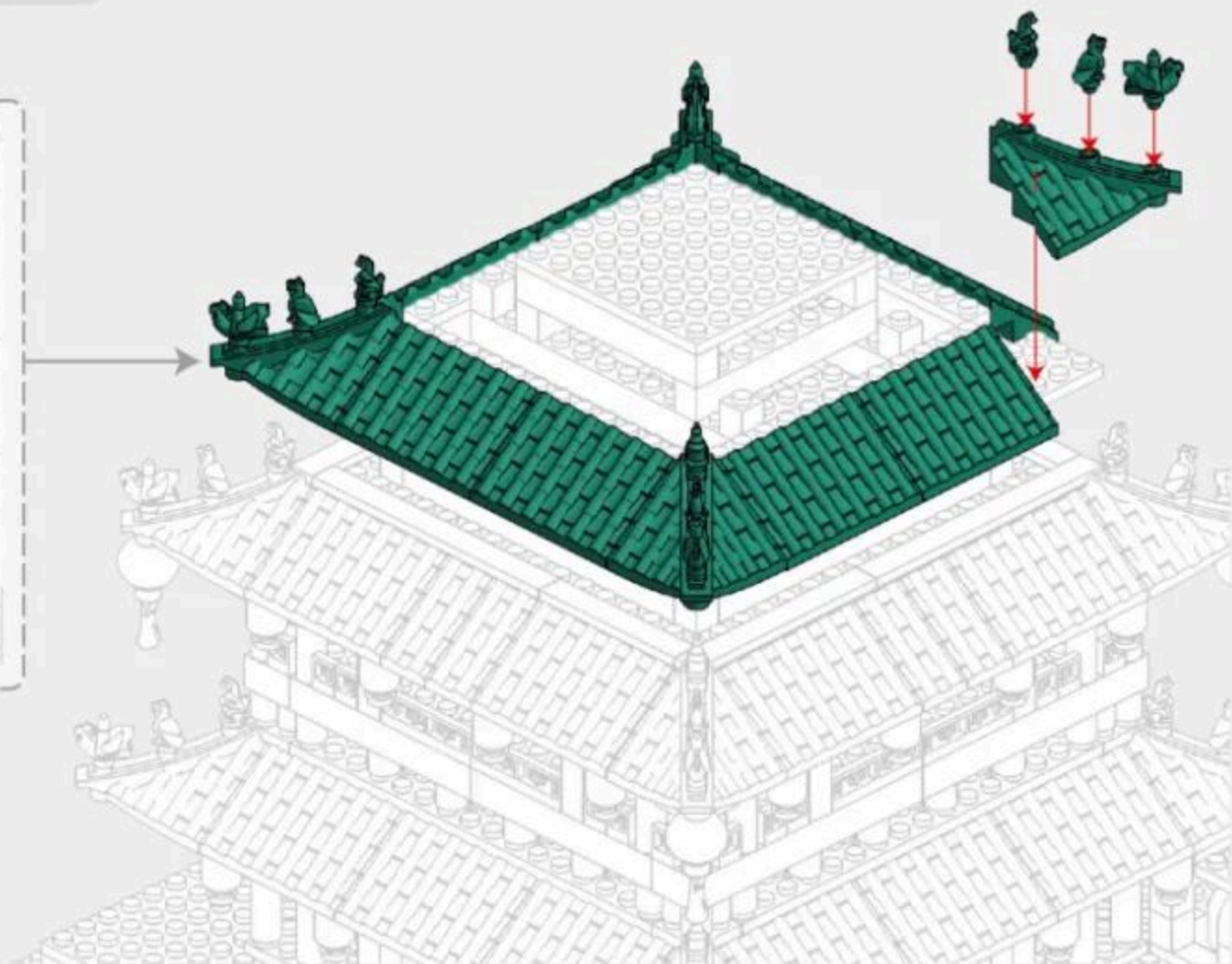
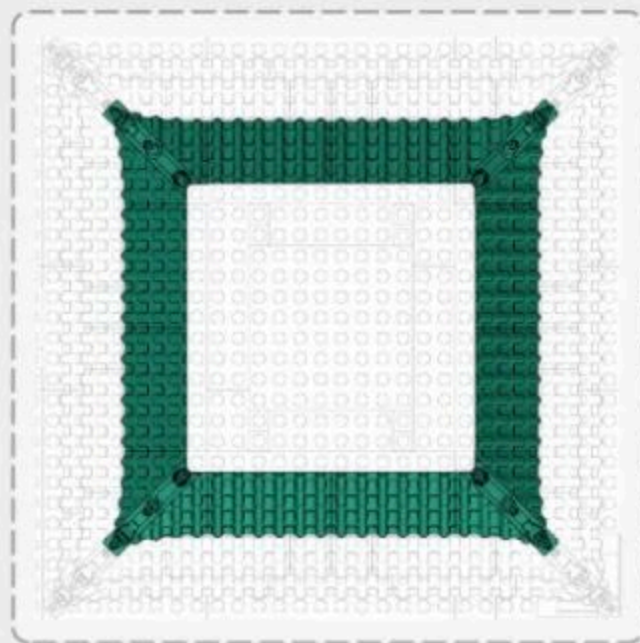
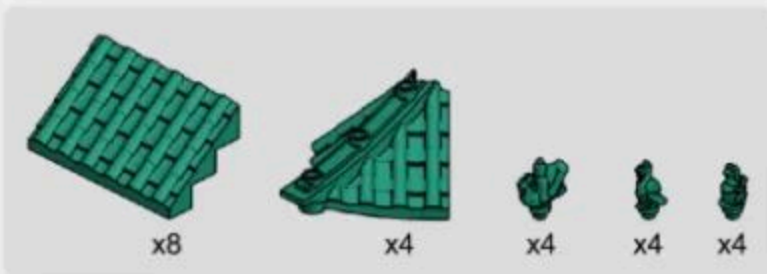

4-10

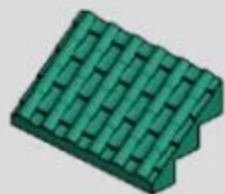

x4



x4



x1



x2

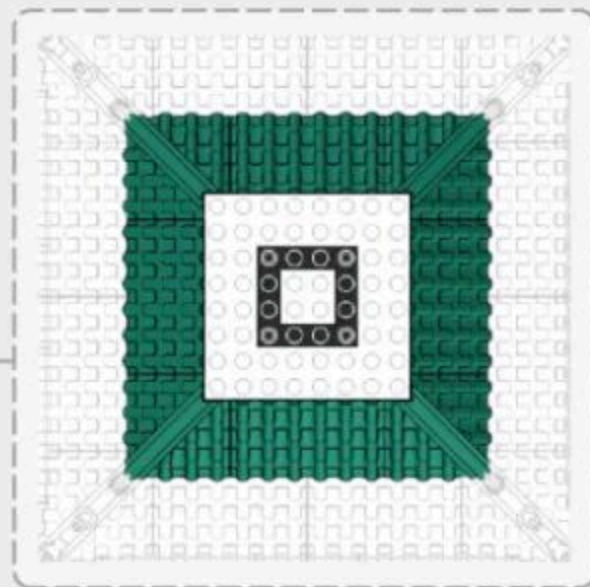
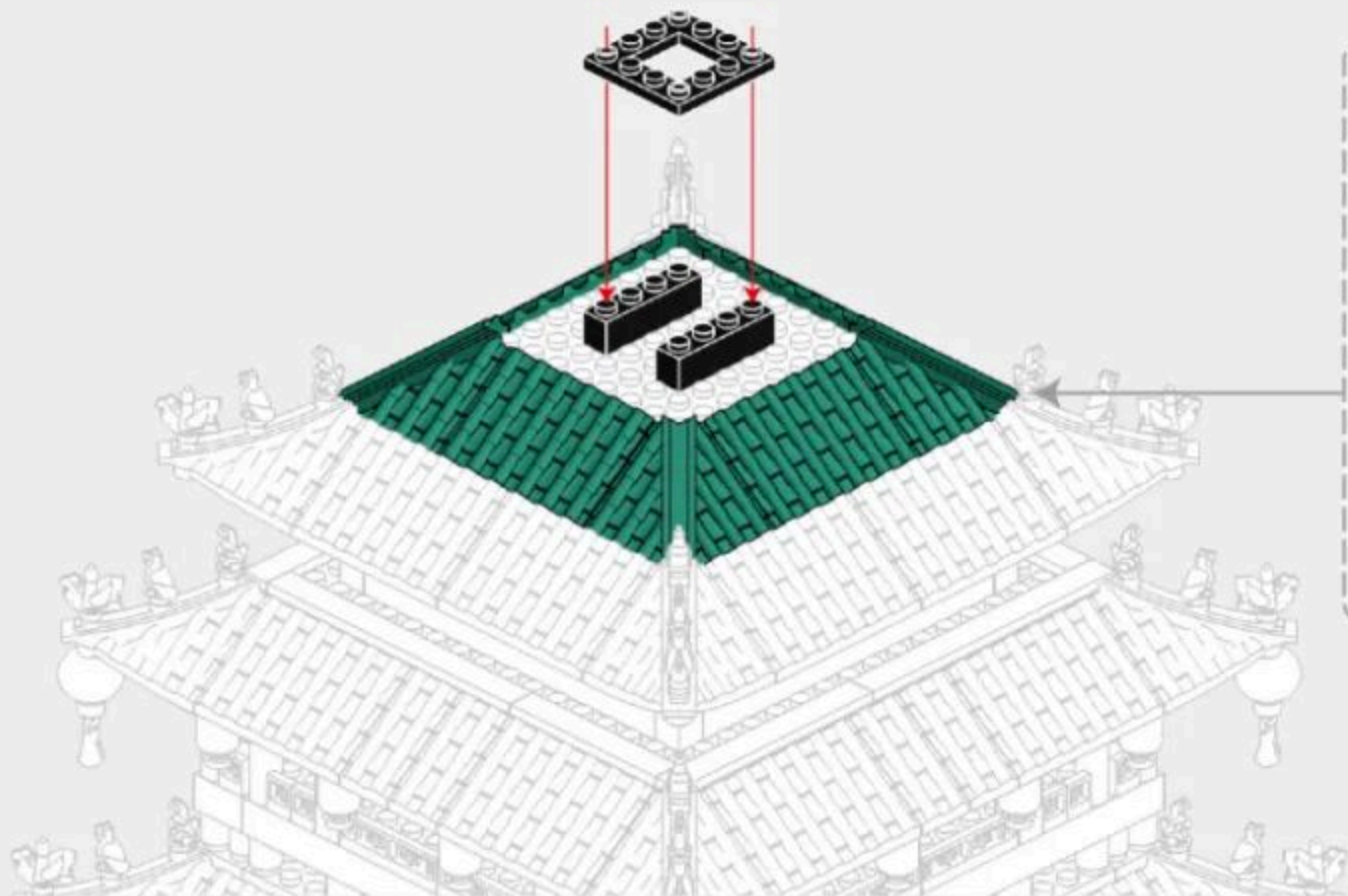

4-11

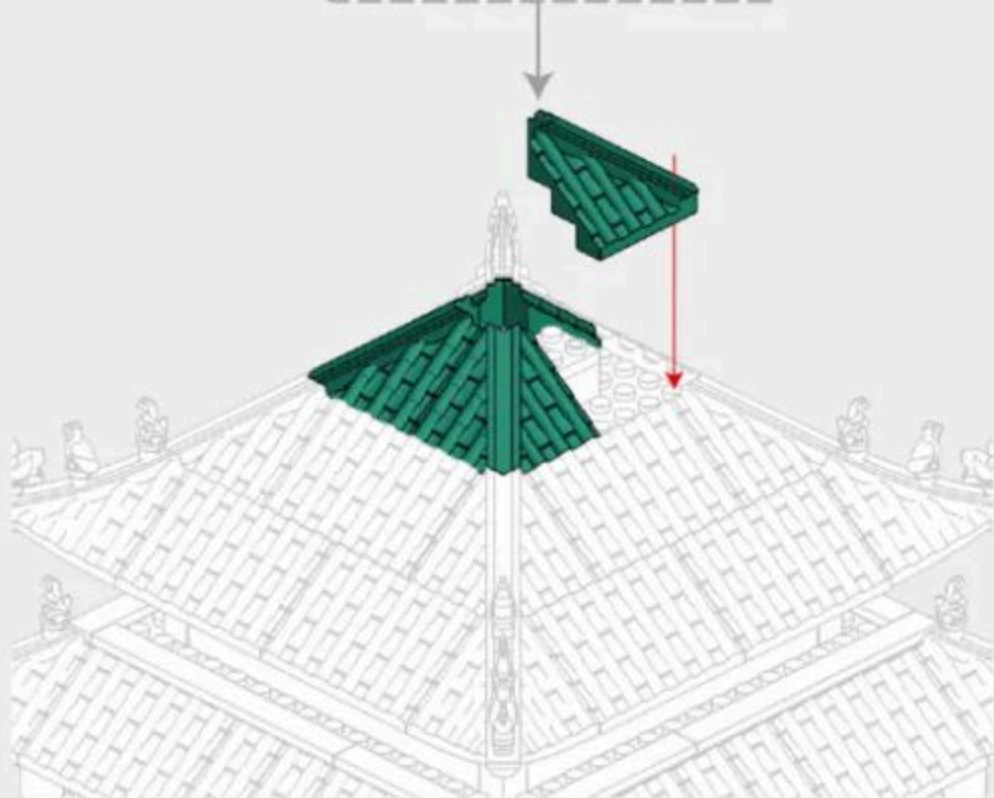
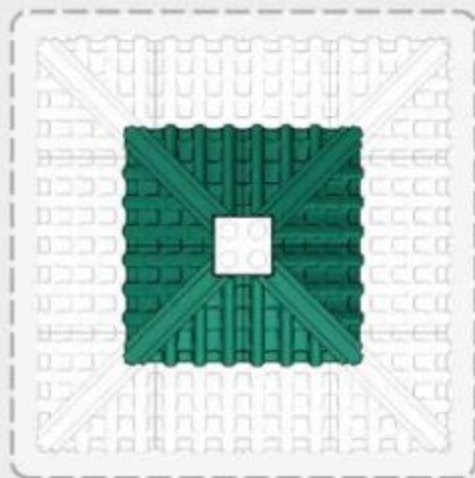

4-12

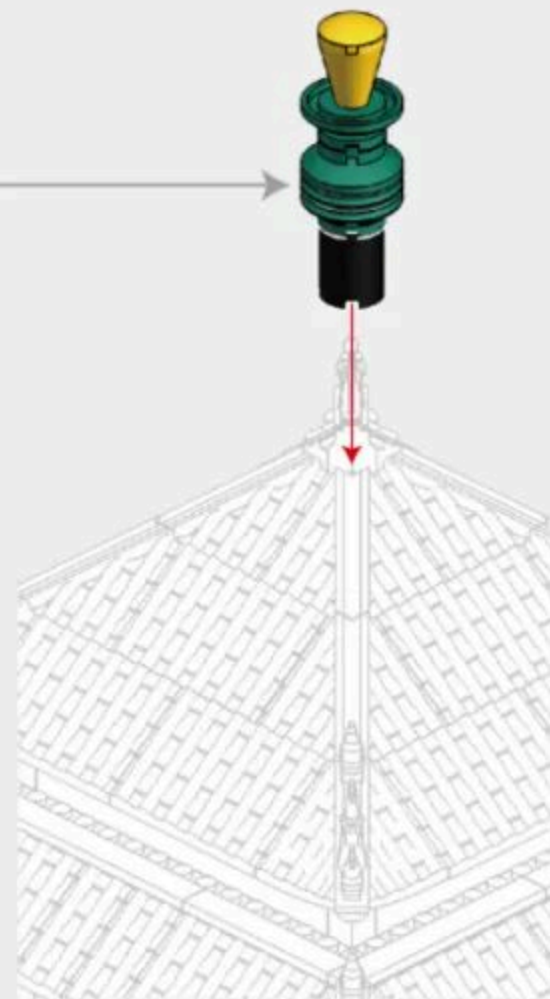
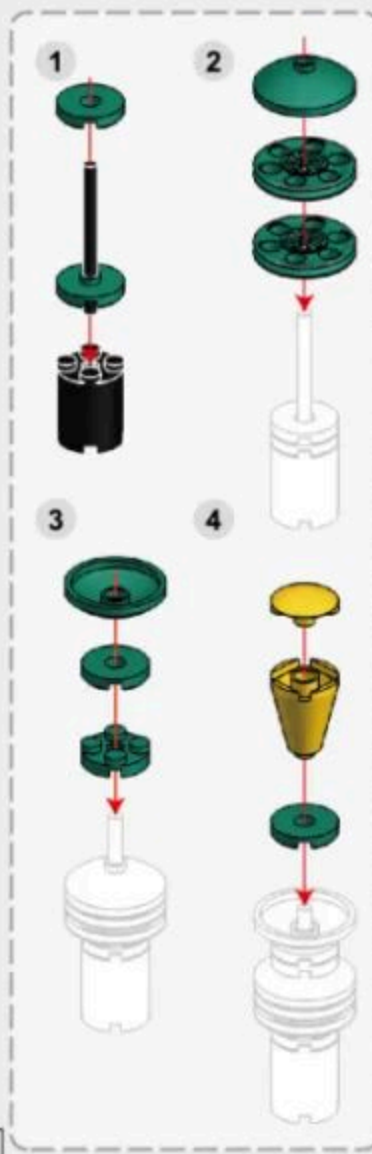



148PCS

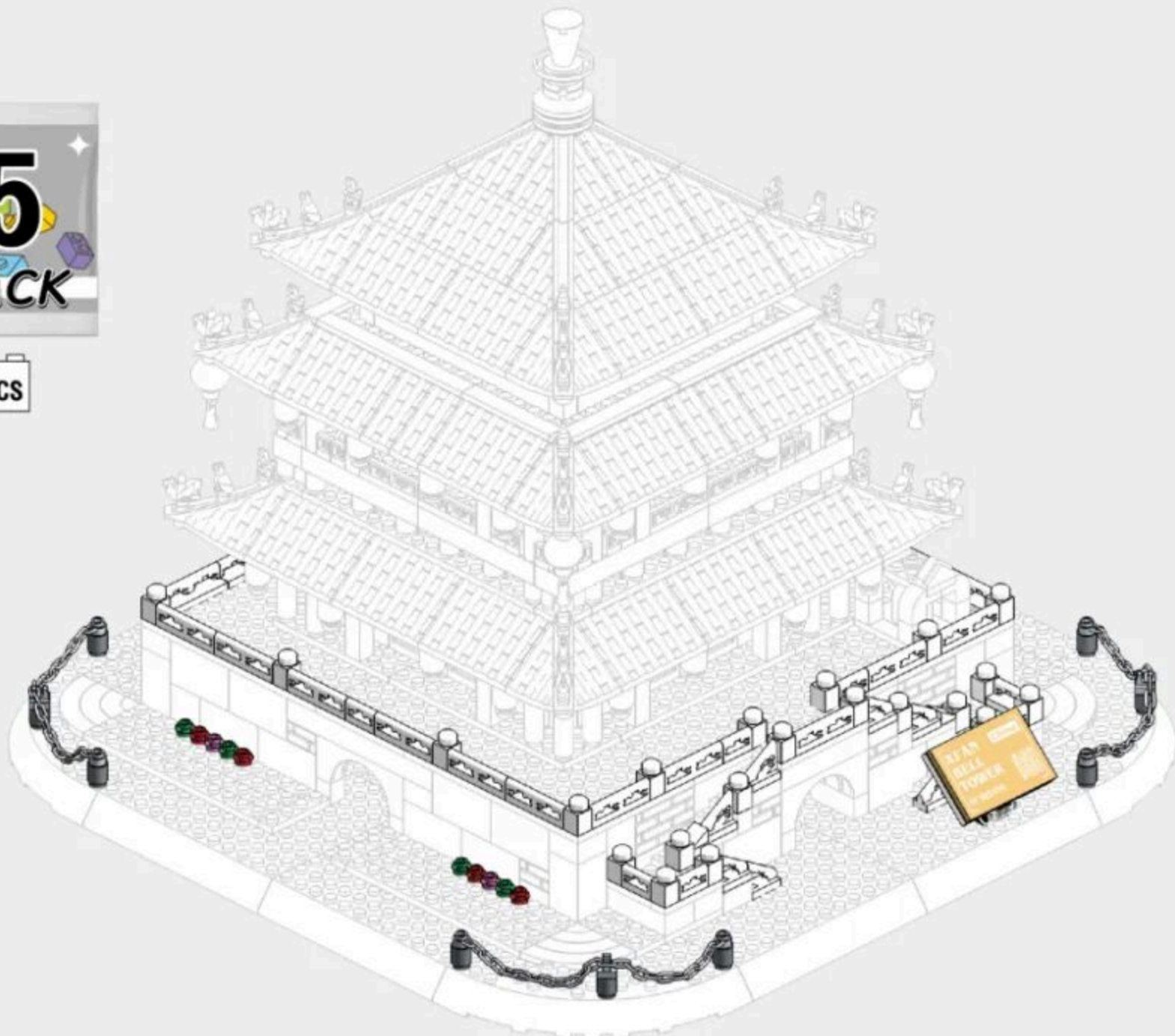

69

5-1

- 1x4 (grey) x11
- 1x2 (grey) x7
- 1x2 (grey) x8
- 1x1 (white) x21
- 1x1 (white) x2
- 1x1 (purple) x2
- 1x1 (red) x4
- 1x1 (green) x4
- 1x1 (white) x21

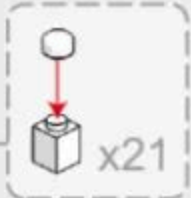
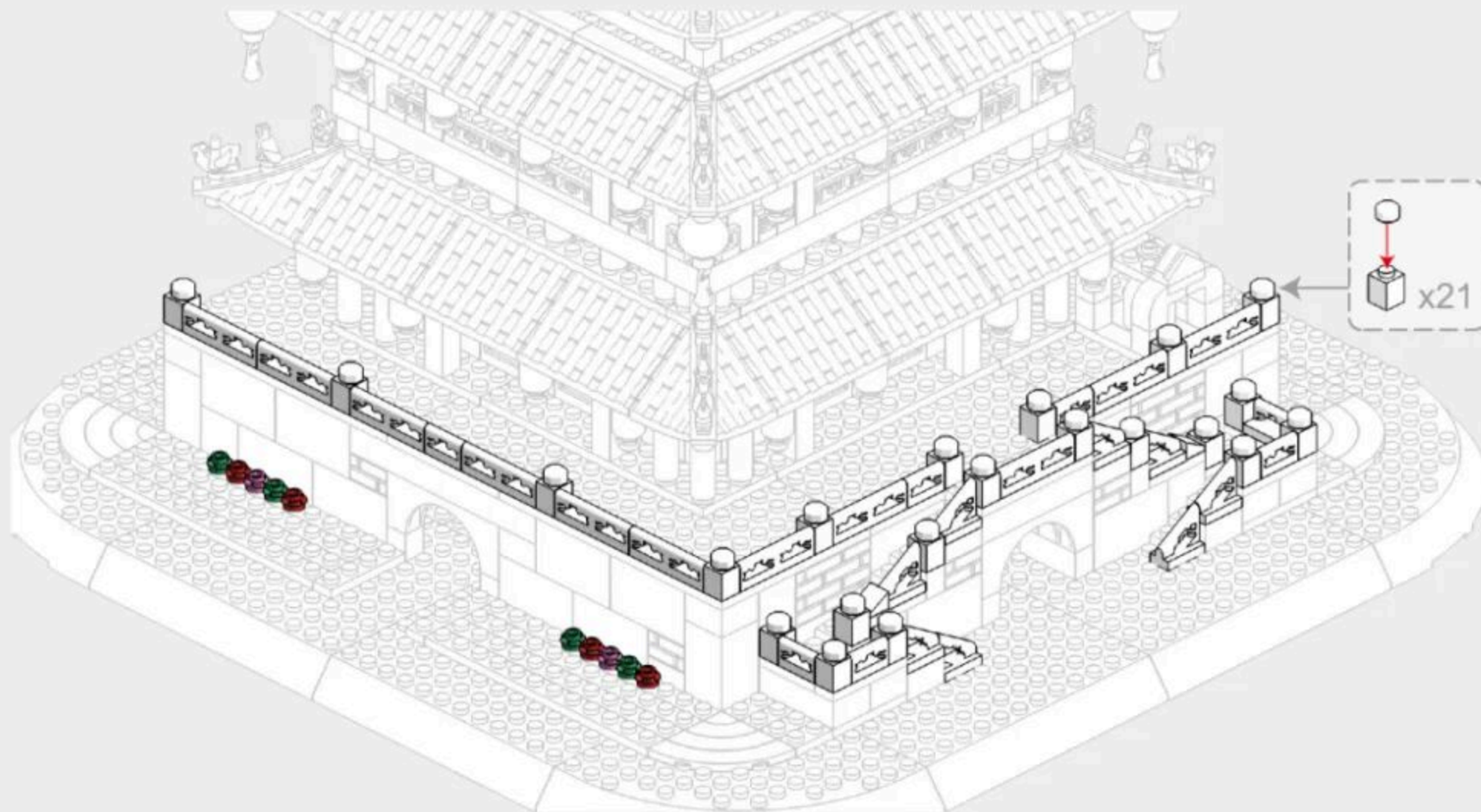

5-2

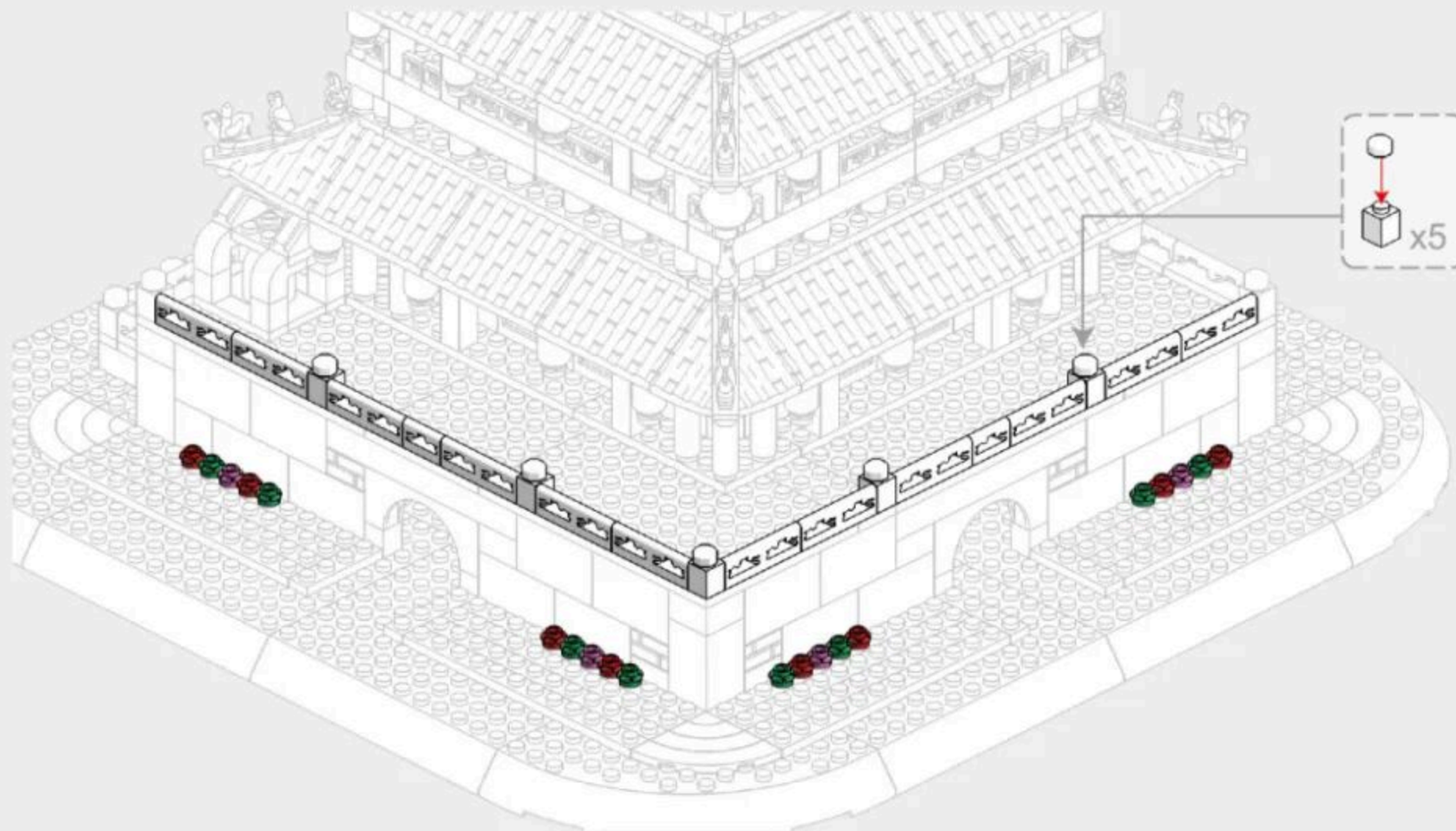

5-3

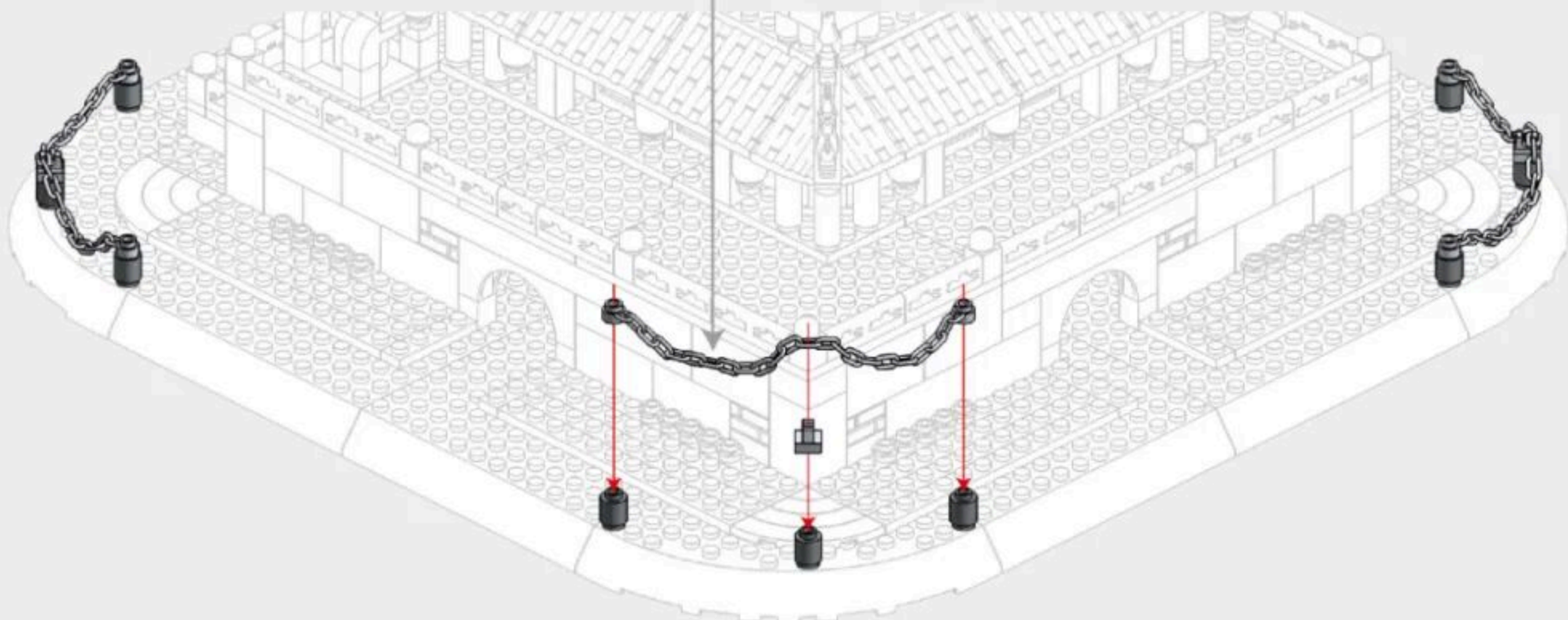
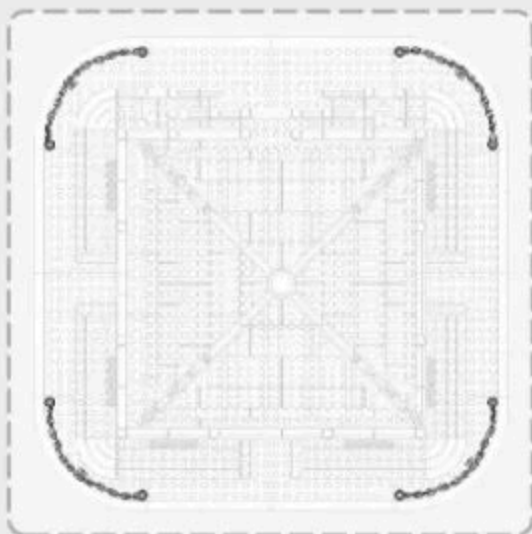
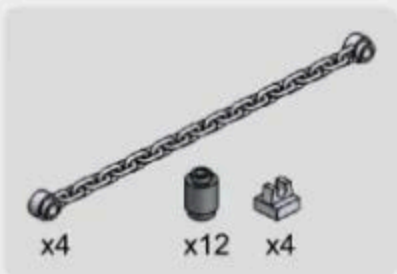

5-4

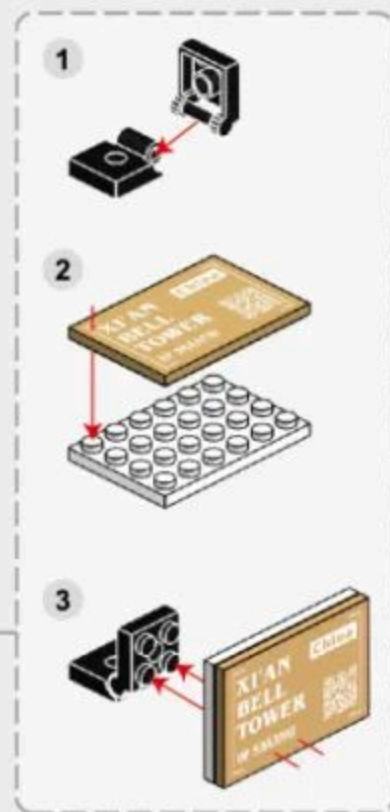
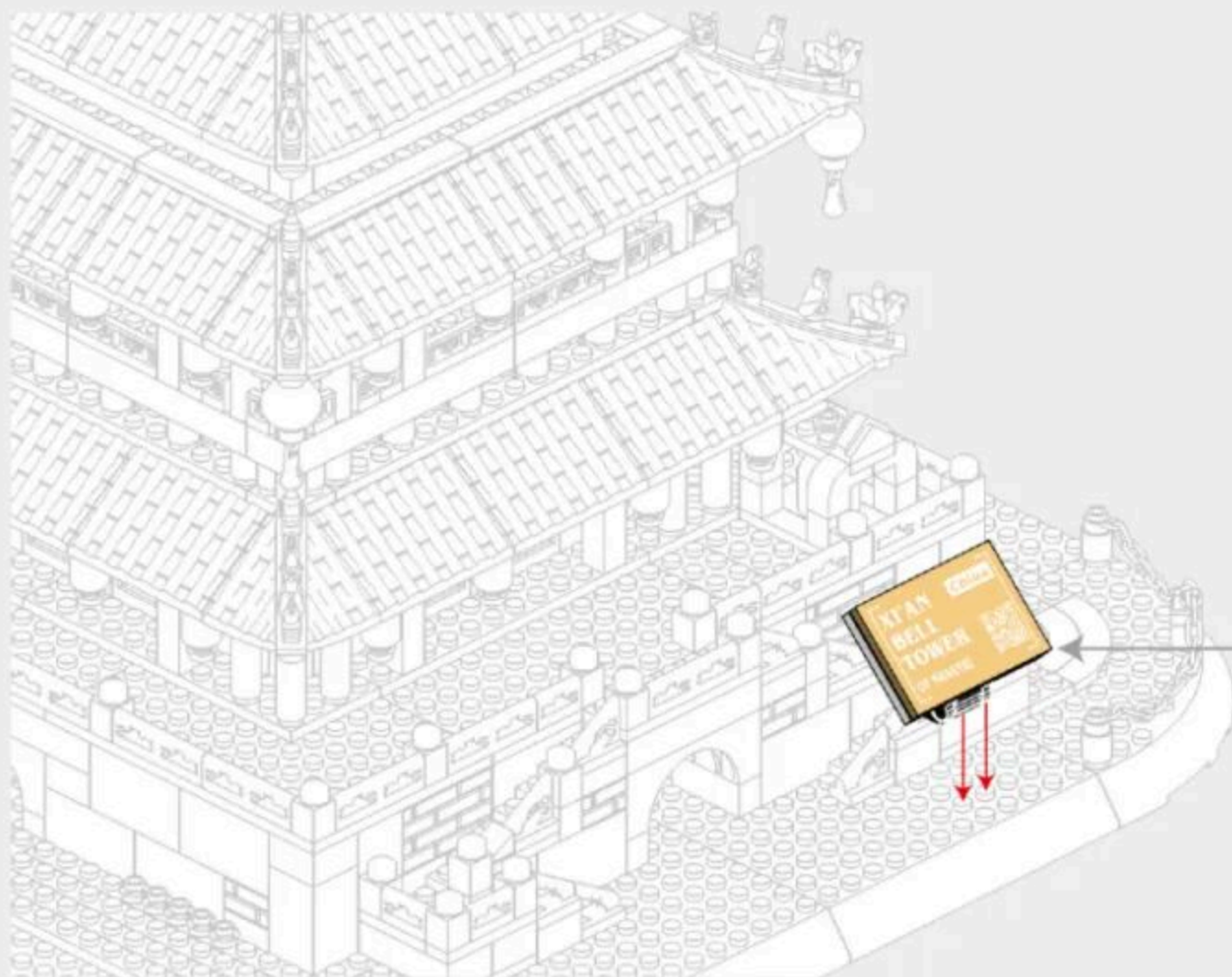
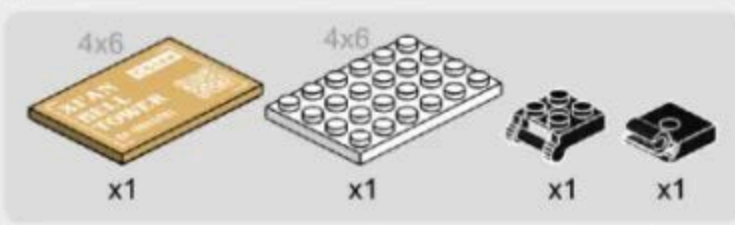



ARCHITECTURE

The World's great architecture



6224 英国伦敦白金汉宫
BUCKINGHAM PALACE-LONDON,ENGLAND

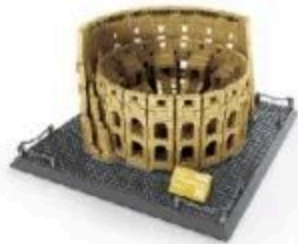

5225 意大利罗马斗兽场
COLOSSEUM-ROME,ITALY



5226 日本东京帝国饭店
IMPERIAL HOTEL-TOKYO,JAPAN



6211 德国柏林勃兰登堡门
BRANDENBURG GATE-BERLIN, GERMANY



6222 中国甘肃长城-嘉峪关
JIAYU PASS-GANSU,CHINA



6212 日本京都清水寺仁王门
NIOMON GATE OF KIYOMIZU-DERA-KYOTO,JAPAN



6214 中国武汉黄鹤楼
YELLOW CRANE TOWER-WUHAN,CHINA



6215 英国伦敦眼
LONDON EYE-LONDON,ENGLAND



6221 中国北京故宫-太和殿
HALL OF SUPREME HARMONY-BEIJING,CHINA



6213 俄罗斯莫斯科瓦西里大教堂
SAINT BASIL'S CATHEDRAL-MOSCOW,RUSSIA



6220 沙特阿拉伯麦加大清真寺
GREAT MOSQUE OF MECCA,SAUDI ARABIA



6219 美国纽约联合国大厦
UNITED NATIONS HEADQUARTERS-NEW YORK,AMERICA



4214 美国华盛顿白宫
WHITE HOUSE-WASHINGTON D.C.,AMERICA



4212 意大利罗马许愿池
TREVI FOUNTAIN-ROME,ITALY



4213 法国巴黎卢浮宫
MUSÉE DU LOUVRE-PARIS,FRANCE



4218 新加坡-鱼尾狮
MERLION,SINGAPORE



4210 埃及开罗吉萨金字塔
GREAT PYRAMID OF GIZA-CAIRO,EGYPT



4219 英国伦敦双子塔桥
TOWER BRIDGE-LONDON,ENGLAND



4216 美国华盛顿林肯纪念堂
LINCOLN MEMORIAL-WASHINGTON D.C.,AMERICA



4217 新加坡-金沙酒店
MARINA BAY SANDS,SINGAPORE



7210 中国上海世博会中国馆
CHINA PAVILION AT EXPO-SHANGHAI, CHINA



4221 加拿大渥太华国会山庄
PARLIAMENT BUILDINGS-OTTAWA, CANADA



4211 英国伦敦伊丽莎白塔
ELIZABETH TOWER-ENGLAND



4220 美国纽约熨斗大厦
FLATIRON BUILDING-NEW YORK, AMERICA



5227 美国纽约自由女神像
STATUE OF LIBERTY-NEW YORK, AMERICA



4215 加拿大多伦多电视塔
THE CN TOWER-CANADA



4222 阿联酋迪拜哈利法塔
THE BURJ KHALIFA TOWER-DUBAI, UAE



5224 中国上海东方明珠广播电视塔
ORIENTAL PEARL TOWER-SHANGHAI, CHINA



5212 美国纽约帝国大厦
EMPIRE STATE BUILDING-NEW YORK, AMERICA



5213 马来西亚吉隆坡石油双塔
PETRONAS TWIN TOWERS-KUALA LUMPUR, MALAYSIA



5214 意大利托斯卡纳比萨斜塔
LEANING TOWER OF PISA-TUSCANY, ITALY



5216 英国伦敦伊丽莎白塔
ELIZABETH TOWER-ENGLAND



5219 俄罗斯莫斯科克里姆林宫钟楼
SPASSKAYA TOWER-MOSCOW, RUSSIA



5220 阿联酋迪拜卓美亚帆船酒店
BURJ AL ARAB HOTEL-DUBAI, UAE



5217 法国巴黎埃菲尔铁塔
EIFFEL TOWER-PARIS, FRANCE



5221 中国台北101大楼
TAIPEI 101-TAIPEI, CHINA



6223 中国武汉长江大桥
WUHAN YANGTZE RIVER BRIDGE



5210 法国巴黎圣母院大教堂
CATHEDRALE NOTRE DAME DE PARIS-PARIS, FRANCE



5223 法国巴黎凯旋门
ARC DE TRIOMPHE-PARIS, FRANCE



5211 印度阿格拉泰姬陵
TAJ MAHAL-AGRA, INDIA



5215 英国伦敦双子塔桥
TOWER BRIDGE-LONDON,ENGLAND



5222 中国北京天坛祈年殿
HALL OF PRAYER FOR GOOD HARVESTS-BEIJING,CHINA



6210 美国旧金山金门大桥
GOLDEN GATE BRIDGE-SAN FRANCISCO,AMERICA



6216 中国北京万里长城（八达岭）
THE GREAT WALL-BEIJING,CHINA



5218 中国北京天安门
TIANANMEN TOWER-BEIJING,CHINA



6217 中国西藏布达拉宫
POTALA PALACE-TIBET,CHINA



6218 芬兰罗瓦涅米圣诞老人办公室
SANTA CLAUS OFFICE-ROVANIEMI,FINLAND



6225 墨西哥库库尔坎玛雅金字塔
EL CASTILLO-KUKULKAN,MEXICO



6226 德国巴伐利亚新天鹅堡
SCHLOSS NEUSCHWANSTEIN, BAYERN, DEUTSCHLAND



5228 美国芝加哥威利斯大厦
WILLIS TOWER-CHICAGO, AMERICA



5229 土耳其伊斯坦布尔少女塔
MAIDEN TOWER-ISTANBUL,TURKEY



5230 中国湖南长沙爱晚亭
AIWAN TING PAVILION-HUNAN,CHINA



5231 巴西里约热内卢救世基督像
CRISTO REDENTOR-RIO DE JANEIRO, BRASIL



5232 美国宾夕法尼亚州流水别墅
FALLINGWATER-PENNSYLVANIA, AMERICA



5233 美国芝加哥范斯沃斯住宅
FARNSWORTH HOUSE-CHICAGO, AMERICA



5234 美国华盛顿唐人街
CHINA TOWN-WASHINGTON, D.C., AMERICA



3210 美国纽约自由女神像
STATUE OF LIBERTY-NEW YORK,AMERICA



4223 中国北京清华园
TSINGHUA CAMPUS-BEIJING,CHINA



7211 中国湖南岳阳楼
YUEYANG TOWER-HUNAN,CHINA



8210 澳大利亚悉尼歌剧院
SYDNEY OPERA HOUSE-BENNELONG POINT,AUSTRALIA



7212 中国江西南昌滕王阁
PAVILION OF PRINCE TENG-JIANGXI, CHINA



6227 中国河南郑州嵩山少林寺
SHAOLIN TEMPLE-HENAN, CHINA



7213 中国重庆洪崖洞
HONGYADONG-CHONGQING, CHINA



5235 美国华盛顿国会大厦
UNITED STATES CAPITOL-WASHINGTON D.C., AMERICA



5236 中国安徽滁州醉翁亭
ZUIWENG PAVILION-ANHUI, CHINA



6228 中国陕西西安钟楼
XIAN BELL TOWER-SHAANXI, CHINA



5238 美国西雅图太空针塔
SPACE NEEDLE-SEATTLE, AMERICA



5237 法国巴黎普瓦西萨伏伊别墅
VILLA SAVOYE-POISSY, PARIS, FRANCE



6229 中国山西运城鹳雀楼
STORK TOWER-SHANXI, CHINA



6230 希腊爱情海圣托里尼岛
SANTORINI-FIRA, GREECE



6231 中国上海海关大楼
SHANGHAI CUSTOMS HOUSE-SHANGHAI, CHINA



5239 中国北京紫禁城角楼
TURRET OF PALACE MUSEUM-BEIJING, CHINA



5240 韩国首尔崇礼门
NAMDAEMUN-SEOUL, KOREA



5241 中国江苏南京夫子庙
CONFUCIUS TEMPLE-JIANGSU, CHINA



5242 美国纽约古根海姆博物馆
GUGGENHEIM MUSEUM-NEW YORK, AMERICA



6232 中国江苏南京秦淮河画舫
QINHUAI RIVER PAINTED BOAT-JIANGSU, CHINA



6233 法国诺曼底圣米歇尔山
SAINT MICHAEL'S MOUNT-NORMANDY, FRANCE



6234 中国河南洛阳栾川老君山
THE LAOJUN MOUNTAIN-HENAN, CHINA