



STORK TOWER

中国山西运城鹤雀楼

Shanxi, China

The world's great architecture

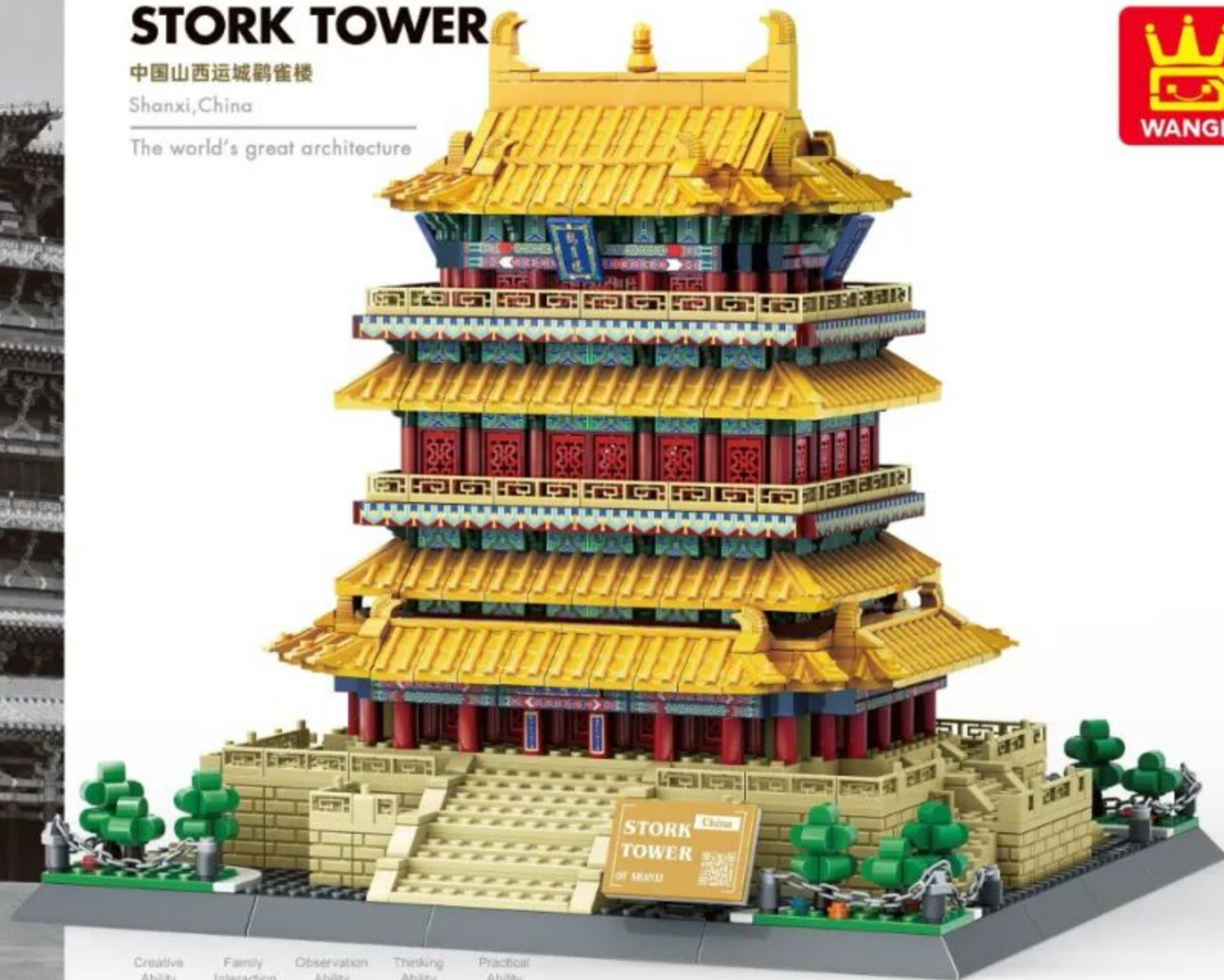

6+ / 6229 / 1557 PCS
Suitable Age / Product Number / Parts Total



Architecture

It will be a city...

这将构成一座城市...

ABOUT THE PRODUCT

关于产品



ARCHITECTURE

WANGE The world's great architect since 1991

Guangdong Baoge Educational Material Sci-Tech Co., Ltd.
©2014 Wange / Dubie. All Rights Reserved

Stork Tower



The Stork Tower or Guanque Tower is an ancient Chinese tower in Puzhou Town, Yongji, Shanxi, China. It was located in the southwest outside the Puzhou ancient city, and near to the Pujin Ferry .

Stork Tower



Geography and culture

地理·文化



The Stork Tower had reached unprecedented heyday in the Tang dynasty (618-907) due to an eternally famous poem "On the Stork Tower" written by poet Wang Zhihuan (688-742). Alongside the Pavilion of Prince Teng, Yueyang Tower and Yellow Crane Tower, it is one of the Four Great Towers of China.



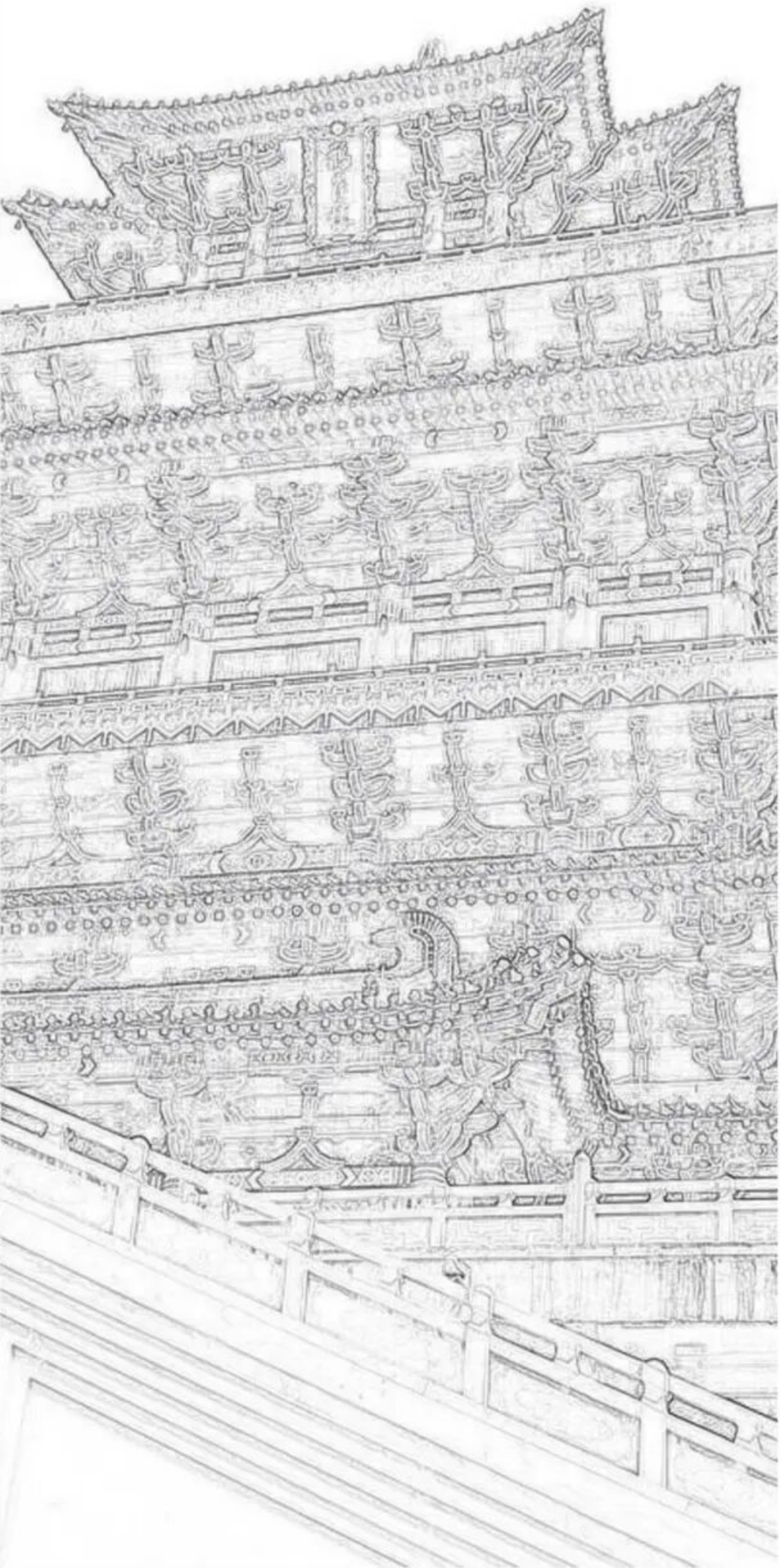

中国山西运城鹤雀楼

Stork Tower ■

China

The contents of this chapter refer to the Wikipedia website.

本章内容参考维基百科网站，更多资讯可自行查阅。

The world's great architecture

Buildings and layout

■ 建筑物和布局



鹤雀楼，又名鹤鹑楼，位于山西省运城市永济市蒲州镇，在东经110°15'00"~110°45'33"和北纬34°44'50"~35°04'50"之间，总建筑面积33206平方米，总重量58000吨。鹤雀楼始建于北周时期，在金元光元年（1222年）遭大火焚毁，1997年12月，鹤雀楼重修，2002年10月1日，鹤雀楼正式对游客开放。鹤雀楼为高台式十字歇山顶楼阁，外观3层4檐，内部为9层使用空间，并设置电梯、楼梯组织垂直交通。整座楼阁分为台基和楼身两部分，总高度达73.9米，是四大名楼中最高的一座，是中国仿造楼中较为精致的。鹤雀楼整个的油漆彩画，是国内失传的唐代彩画艺术，经过国家文物局的专家多方考察抢救，重新创作设计，故鹤雀楼是国内唯一采用唐代彩画艺术恢复的唐代建筑。

The Stork Tower or Guanque Tower is an ancient Chinese tower in Puzhou Town, Yongji, Shanxi, China. It was located in the southwest outside the Puzhou ancient city, and near to the Pujin Ferry. The Stork Tower had reached unprecedented heyday in the Tang dynasty (618-907) due to an eternally famous poem "On the Stork Tower" written by poet Wang Zhihuan (688-742). Alongside the Pavilion of Prince Teng, Yueyang Tower and Yellow Crane Tower, it is one of the Four Great Towers of China.



Construction

鹤雀楼的柱梁皆采用钢筋混凝土仿古建筑作法设计建造。楼身底层柱网布置形式参照宋《营造法式》及五台山唐代古建筑佛光寺东大殿“金箱斗底槽”的作法，楼身用柱40根（檐柱一周24根和内柱一周16根）；外围回廊和四向抱厦用柱52根（廊柱一周32根和抱厦柱4组20根），合计使用立柱92根，每面柱网均呈凸字形排列，以求在规整中得到变化。

The Stork Tower, has a total height of 73.9-metre , which is equivalent to the height of a building with over 20 stories now, being a typical Tang-style stories building with a high base . With three stories and four eaves, it has a circle corridor on the first floor and four backrooms. The inside layout and beautiful colored decoration both contain the style of the Tang dynasty. The present Stork Tower isn't located beside the Puzhou ancient city, but is about 3-kilometre away from it. The tower is rebuilt, majestic and splendid, it sets off green trees and facing the rising sun, looking loftier.



History

北周时，宇文护为了镇守蒲州，在蒲州西面的黄河东岸建造了一座戍楼，作军事瞭望之用，这便是后世所称的鹤雀楼。金元光元年（1222年），蒙古攻打蒲州古城。为延缓敌兵攻城，金军守将侯小叔下令焚毁鹤雀楼及附近的蒲州浮桥等军事设施。至明初时，鹤雀楼故基犹存，后因黄河泛滥，故址淹没。改革开放以来，重修鹤雀楼的呼声日益强烈。1992年7月，永济县召开了鹤雀楼复建方案论证会。会议由国家建筑学家郑孝燮、文物局专家组组长罗哲文主持。论证会肯定了规划方案，初步选定楼址。同年9月，山西省计委、旅游局将“关于申请复全国四大名楼之一鹤雀楼项目建议书的报告”上报国家计委和旅游局。

According to the historical records, the Stork Tower was first built in the Northern and Southern dynasties (420-589) by Yuwen Hu (513-572), a powerful minister of the Northern Zhou dynasty (557-581). Arrogating all powers to himself, Yuwen Hu presided over state affairs of the Northern Zhou dynasty for over ten years. During his reign, he went in for large-scale construction to build many palaces and towers. Back then, Puzhou was the only way from Chang'an, the capital of the Northern Zhou dynasty, to Jinyang, the political center of the neighboring state Northern Qi dynasty (550-577). Guarding Puzhou, Yuwen Hu had Puzhou city reinforced to make it impregnable. Meanwhile, in order to keep a lookout for the enemy's situation, he also had a three-story tower built outside the city. It's said that after the tower was built, storks often perched on the tower, so it was named the Stork Tower.

Design Points

结构难点

$$F = G \frac{m_1 m_2}{d^2}$$

Physical operations

物理运算

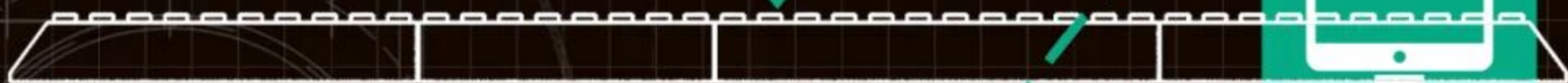
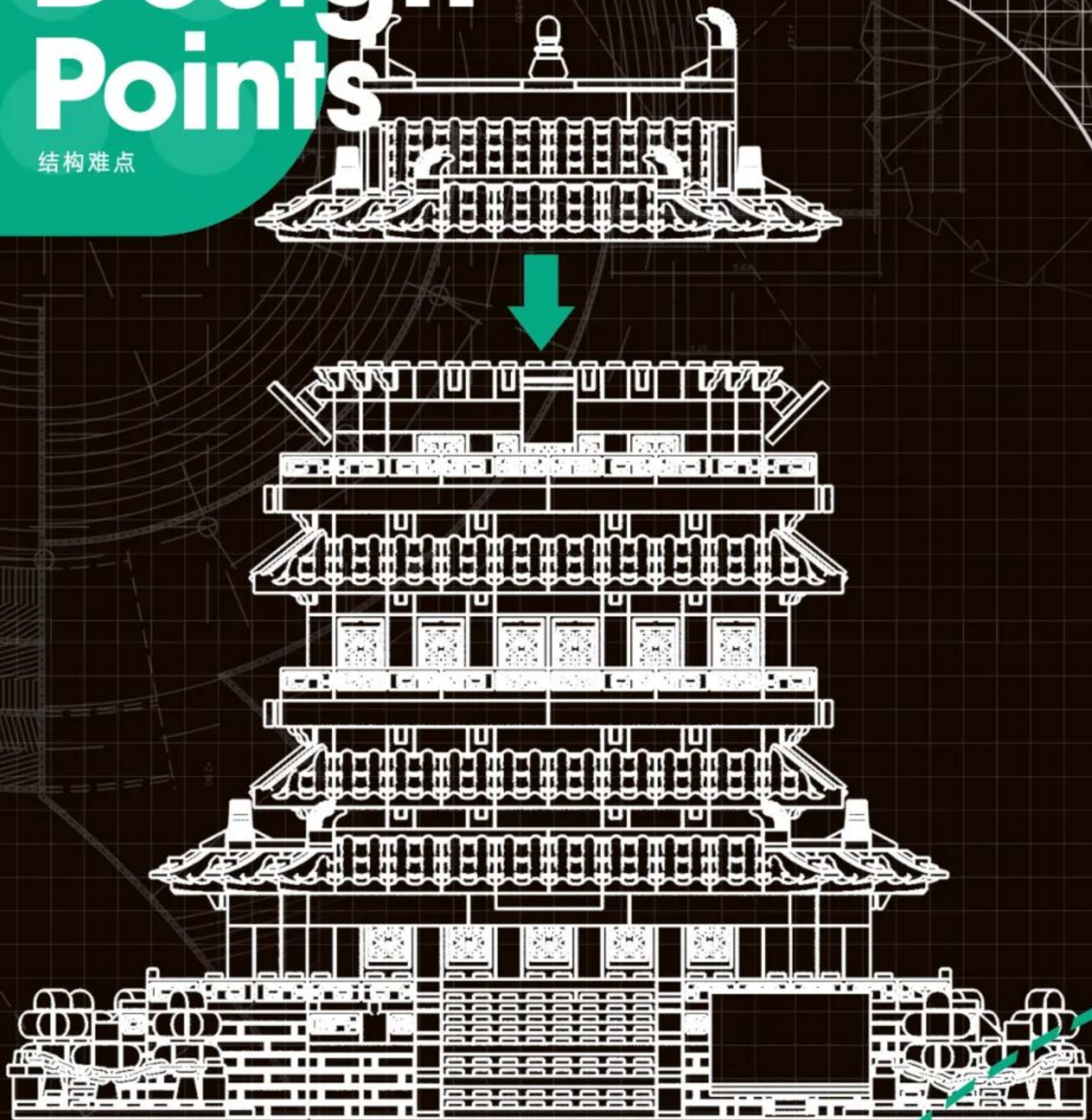

Creation and thinking

创作·思考

Special parts

特殊零件的开发利用

$$S=4\pi \cdot r^2$$

$$a^2+b^2=c^2$$



WG1505

弯脊装饰



WG1403

中式回纹窗叶



WG1316

2高4孔墙砖



WG1067

瓦片



WG1442

转角回纹栏杆

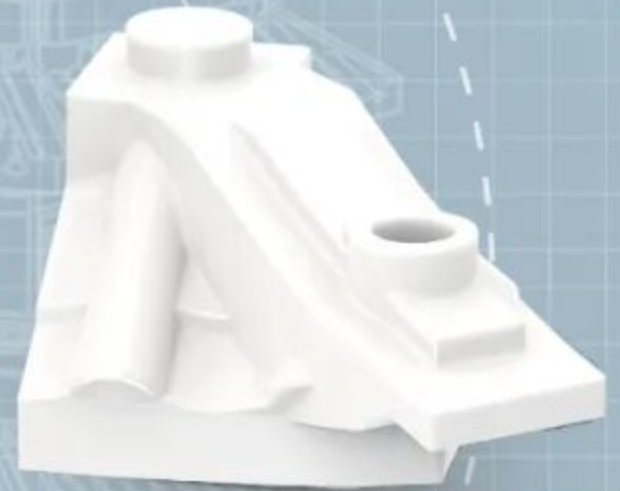

WG1504

带孔小角瓦片



WG1389

4孔回纹栏杆



WG1441

回纹小窗叶



WG534

直瓦片6孔

$$\sin^2 a + \cos^2 a = 1$$



features and function

特点.功能

Main Color Matching

配色方案



Color matching Adopting 3 main colors, Gold, Beige and Jujube red as the main color, the more reasonable and Dark blue color matching on the original building, making the product more atmospheric and the whole design is more reasonable.

Stork Tower

中国山西运城鹤雀楼



Front

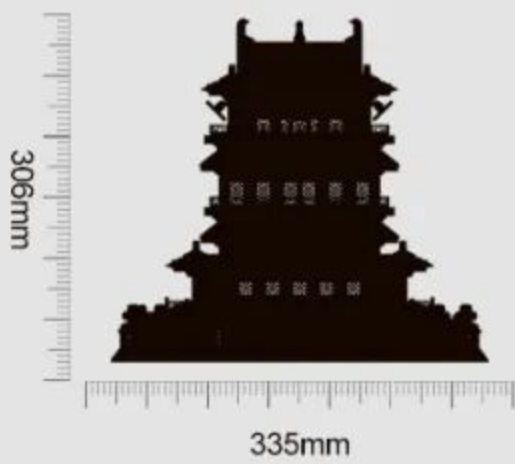

Left

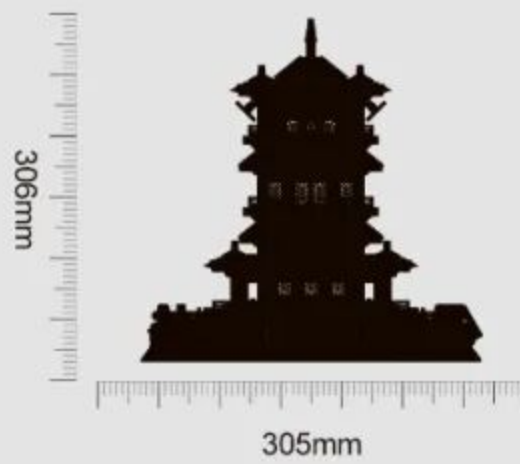

Back

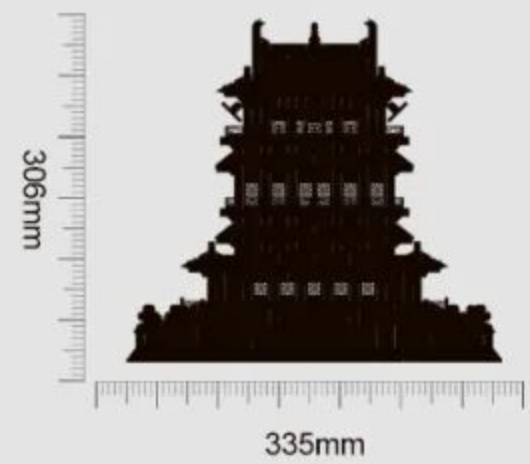

Product Size: 335X305X306mm



Instructions For Use

积木起件器使用说明
Brickseparator

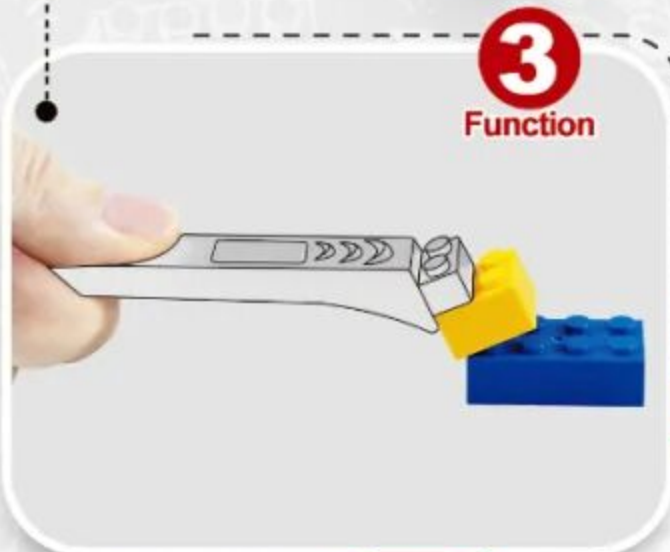
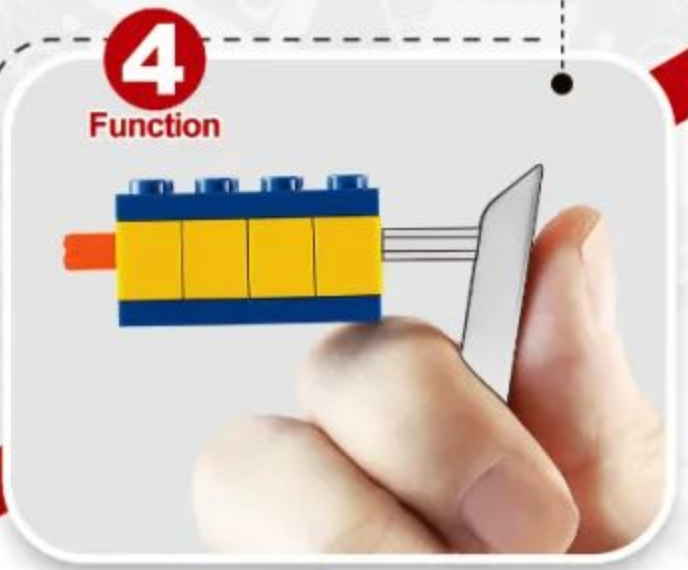
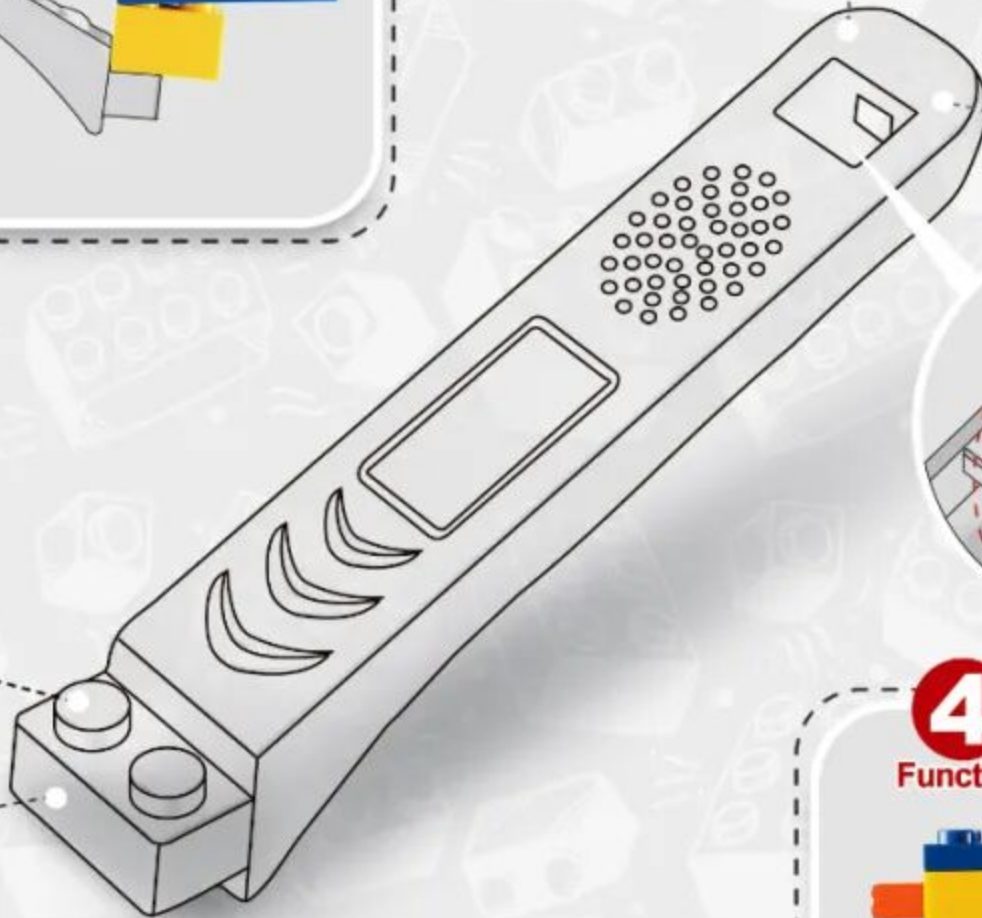
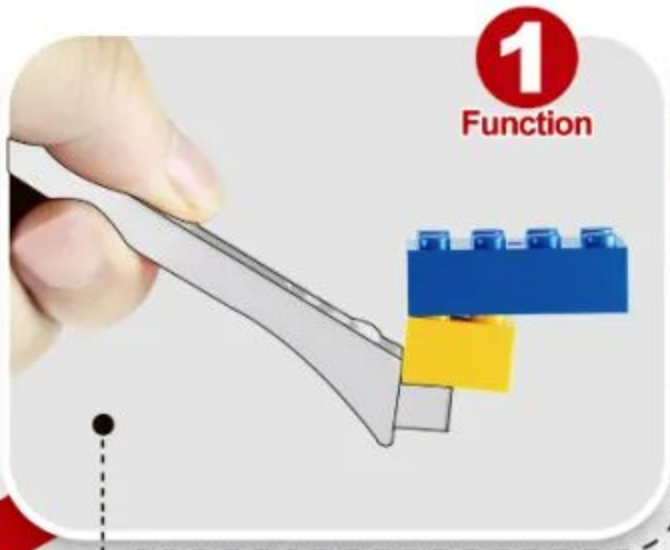

4 ways to make installation easier
让安装更简单



1

- First open the product packaging according to the instructions.

按指导用正确方式拆解产品外包装。



2

- Summarize all parts to count the number of familiar accessories.

对照说明书清单确认积木包数量与积木数量。



3

- Arranging all accessories by color helps to quickly install the product.

把确认好的积木以类型、颜色进行分类排好以便安装。



4

- Carefully install the product and learn about building.

按说明书步骤拼装并完成你的积木模型。



1:1 Physical Reference Table

十字棒配件1:1尺寸参照表



Instructions For Use

让安装更简单



2 (1x2)=2



3 (1x3)=3



4 (1x4)=4



5 (1x5)=5



6 (1x6)=6



7 (1x7)=7



8 (1x8)=8



9 (1x9)=9



10 (1x10)=10



12 (1x12)=12



16 (1x16)=16













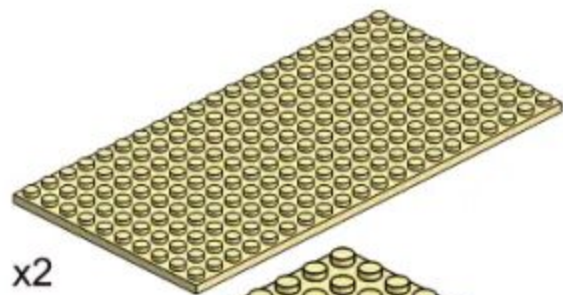
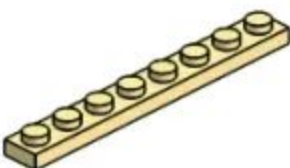



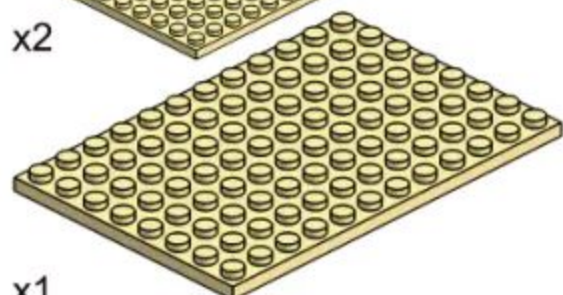
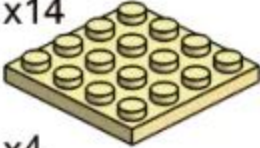



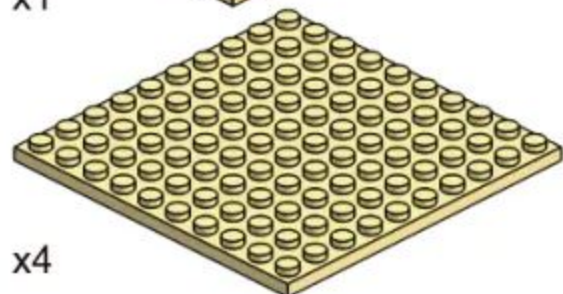
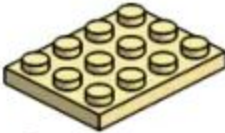



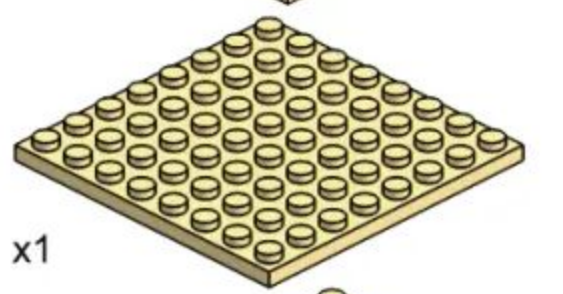
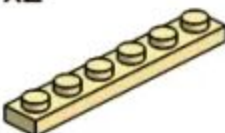



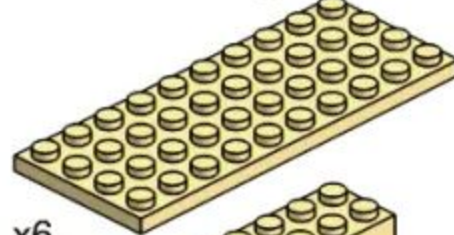
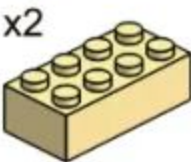

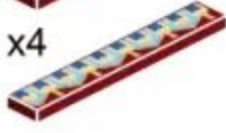

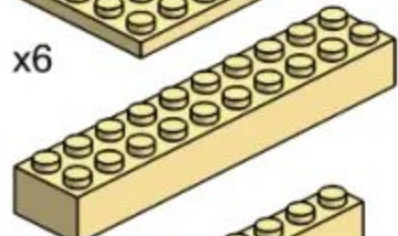
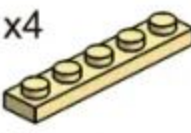



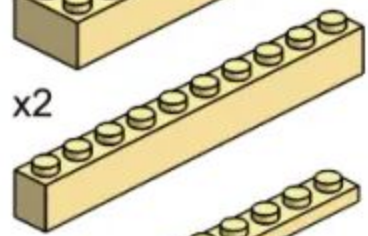
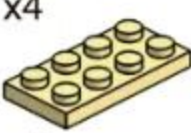



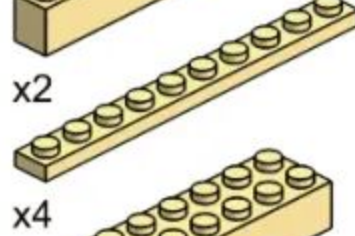



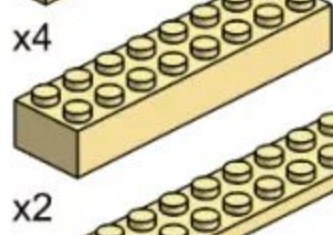
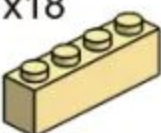



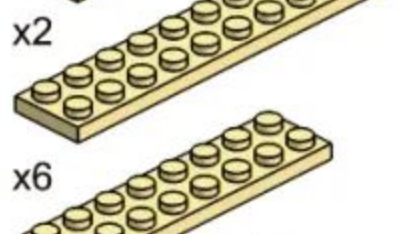



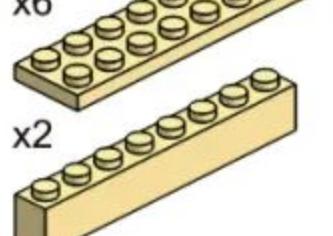
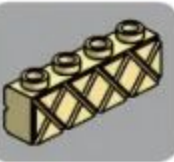



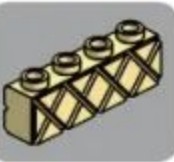

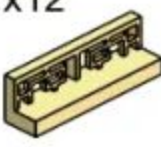

PARTS LIST

配件清单

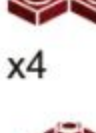
x2	x8	x5	x1	x1
x2	x24	x8	x2	x2
x4	x4	x2	x3	x1
x1	x4	x18	x2	
x2	x90			
x6	x16	x1		
x4	x2	x30		
x1	x4	x12		
x1	x2	x1		
x1	x4	x1		
x2	x4	x3		
x28	x4	x3		
x4	x4	x4		
x1	x2			
x1	x2	x36		
x1	x2	x16		
x1	x2	x16		
x1	x2	x16		
x1	x2	x16		
x1	x2	x16		
x1	x2	x16		
x1	x2	x16		
x1	x2	x16		
x1	x2	x16		
x1	x2	x16		
x1	x2	x16		
x1	x2	x16		
x1	x2	x16		
x1	x2	x16		
x1	x2	x16		
x1	x2	x16		
x1	x2	x16		
x1	x2	x16		
x1	x2	x16		
x1	x2	x16		
x1	x2	x16		
x1	x2	x16		
x1	x2	x16		
x1	x2	x16		
x1	x2	x16		
x1	x2	x16		
x1	x2	x16		
x1	x2	x16		
x1	x2	x16		
x1	x2	x16		
x1	x2	x16		
x1	x2	x16		
x1	x2	x16		
x1	x2	x16		
x1	x2	x16		
x1	x2	x16		
x1	x2	x16		
x1	x2	x16		
x1	x2	x16		
x1	x2	x16		
x1	x2	x16		
x1	x2	x16		
x1	x2	x16		
x1	x2	x16		
x1	x2	x16		
x1	x2	x16		
x1	x2	x16		
x1	x2	x16		
x1	x2	x16		
x1	x2	x16		
x1	x2	x16		
x1	x2	x16		
x1	x2	x16		
x1	x2	x16		
x1	x2	x16		
x1	x2	x16		
x1	x2	x16		
x1	x2	x16		
x1	x2	x16		
x1	x2	x16		

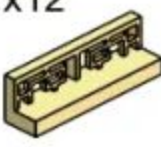
PARTS LIST

配件清单

				
x2	x14	x28	x4	x4
				
x1	x4	x16	x8	x4
				
x4	x2	x8	x6	x52
				
x1	x2	x4	x4	x36
				
x6	x4	x16	x24	x16
				
x2	x4		x4	x2
				
x2	x2	x20	x4	x2
				
x2	x18	x12	x1	x2
				
x4	x2	x4	x1	x2
				
x2	x4	x24	x8	x4
				
x6		x20	x4	x2
				
x2	x12	x4	x36	x2
				
x4	x38	x8	x16	x2
				
		x2		x4

产品有增补件请以实物为准
If product has additional parts, please in kind prevail.



263PCS

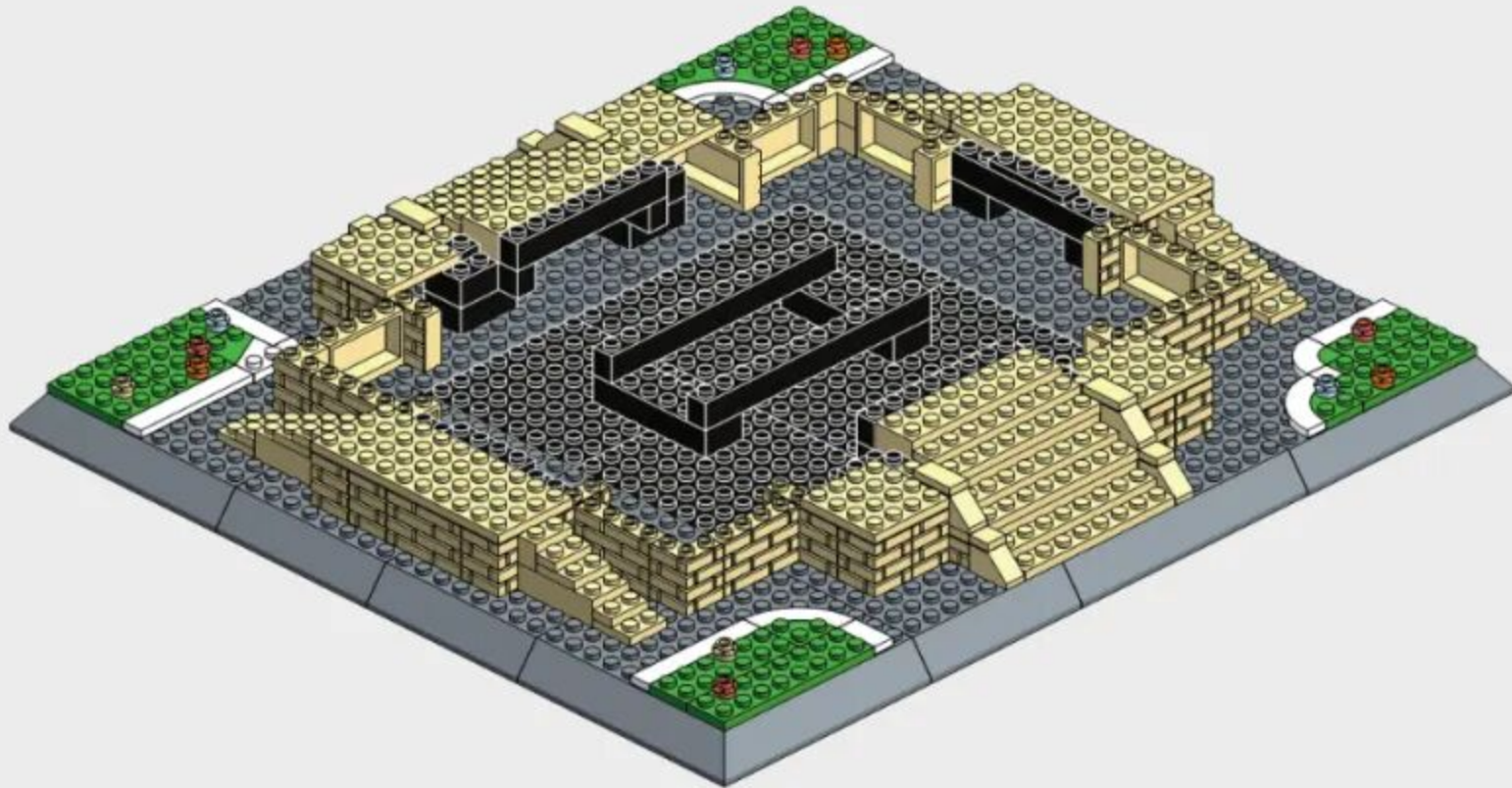

18

1-1

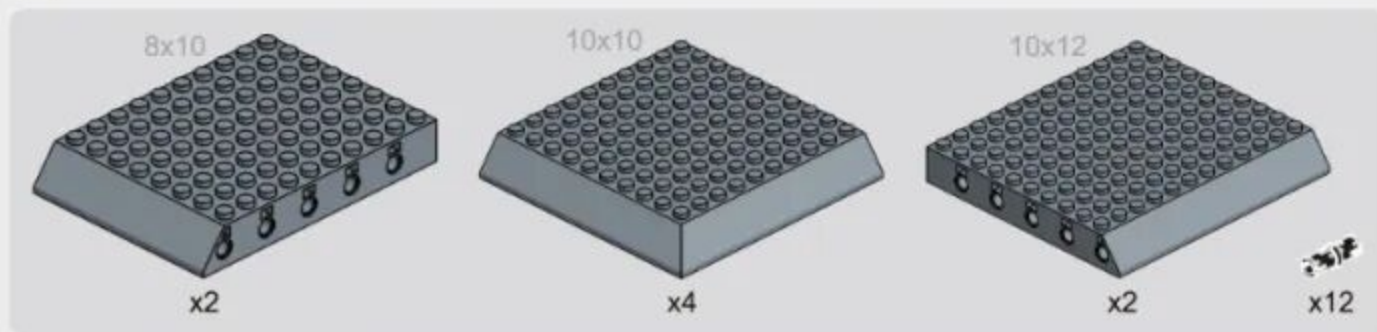

微信扫一扫
补件更简单

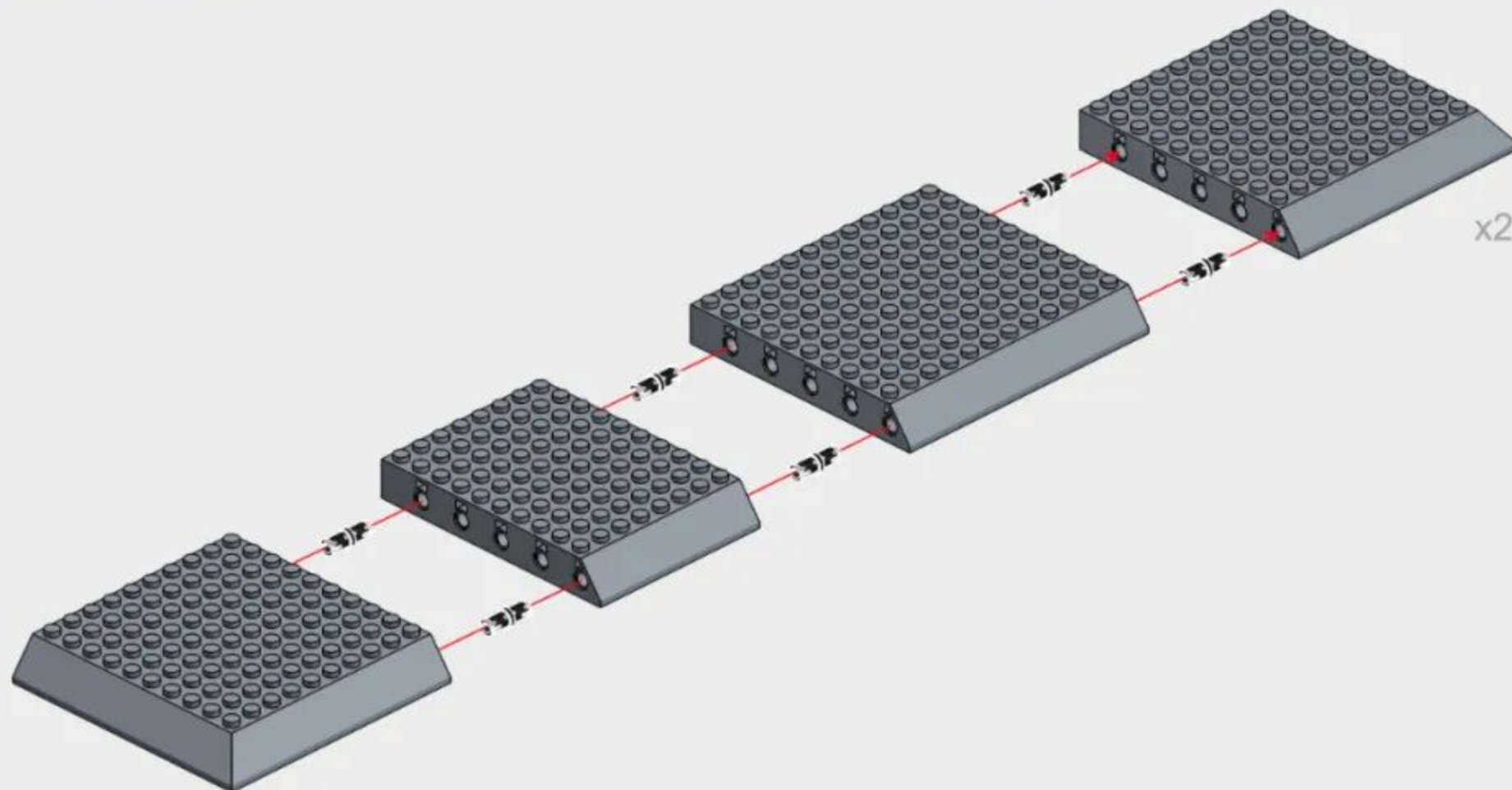

1-2

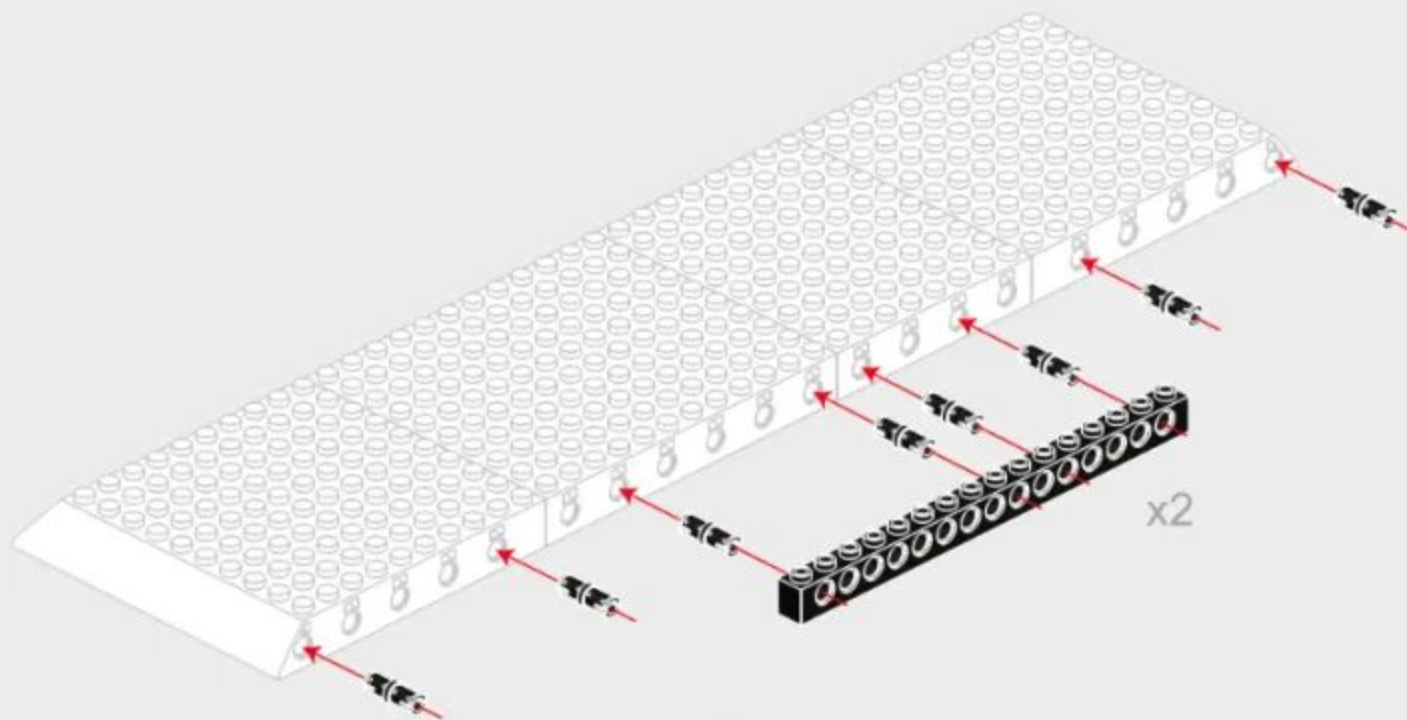
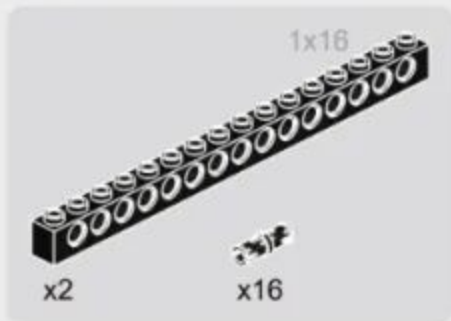

1-3

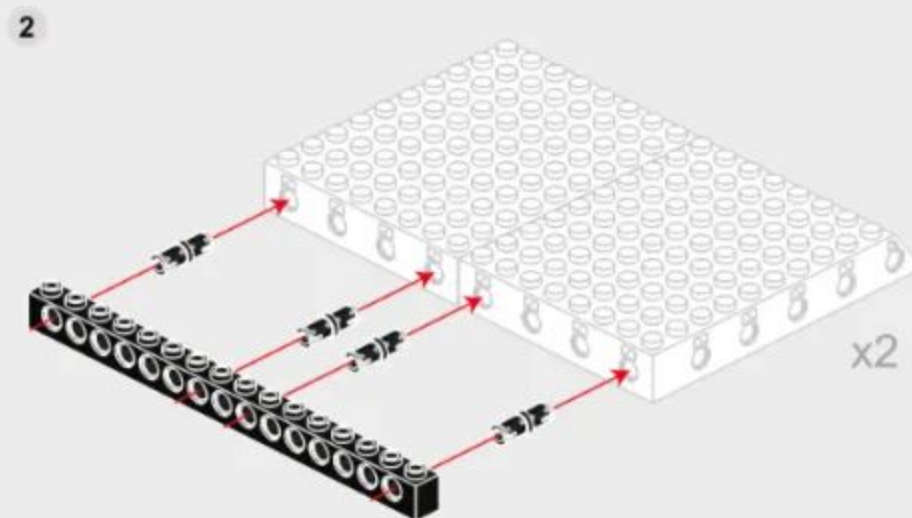
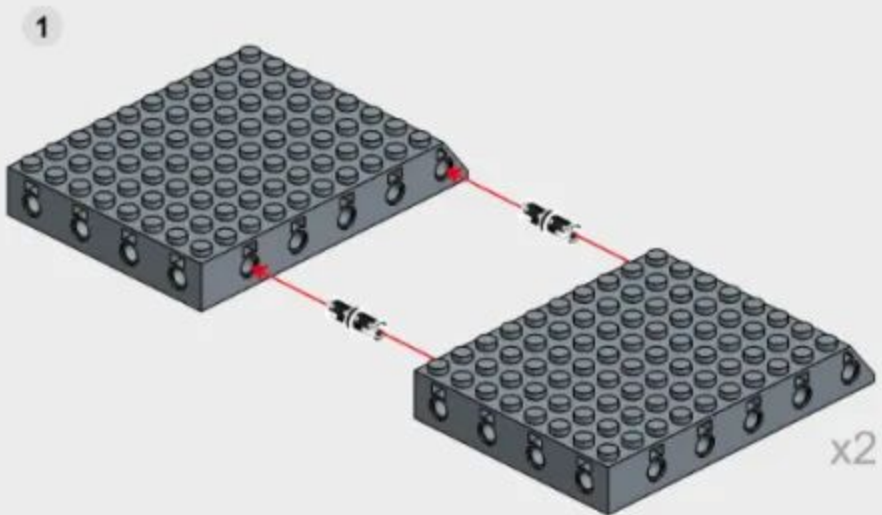
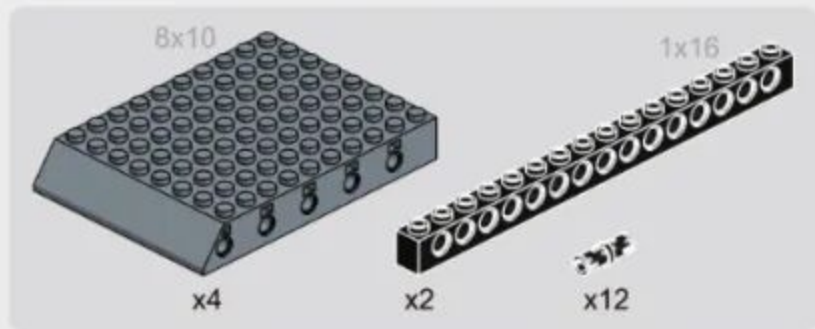

1-4

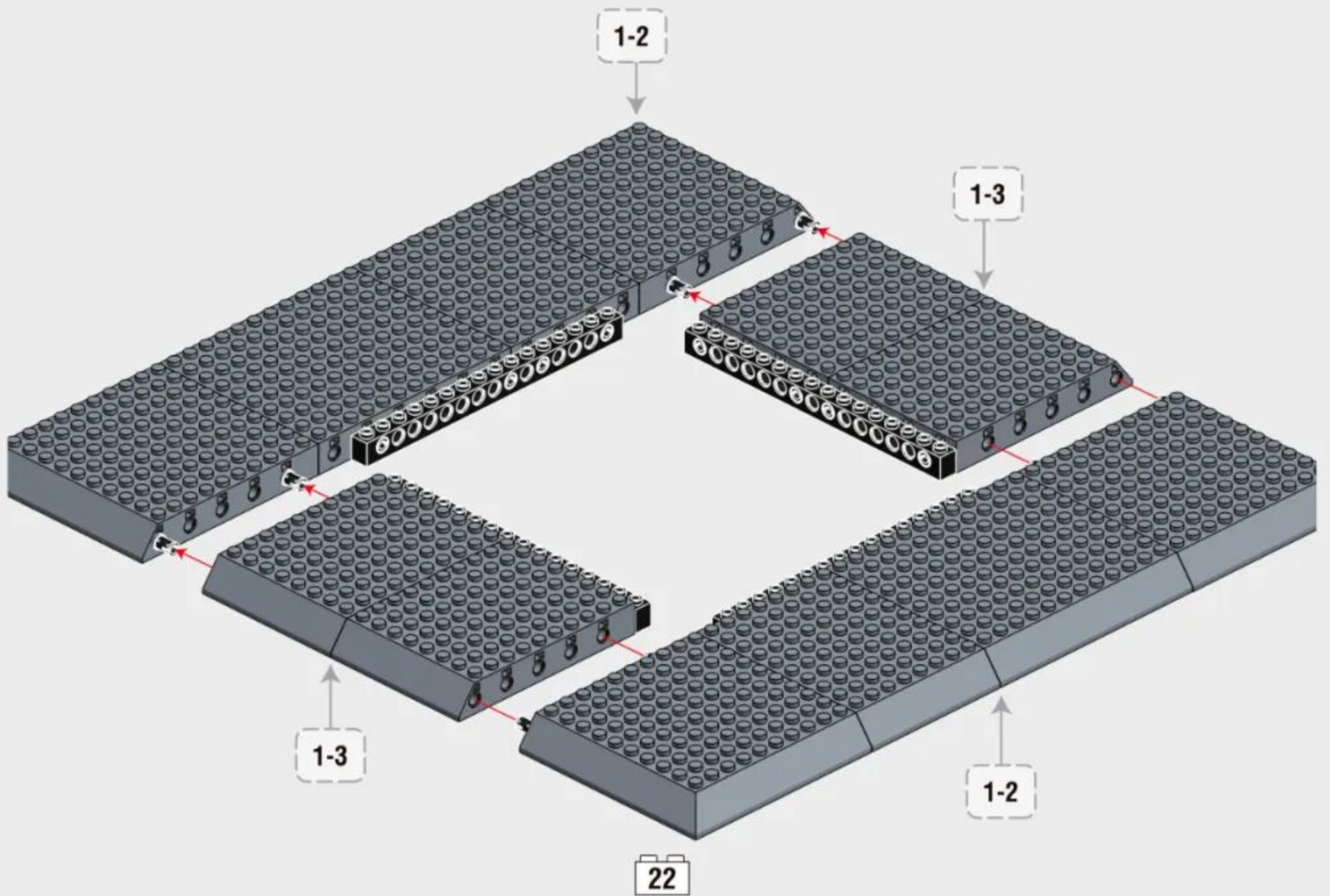

1-5

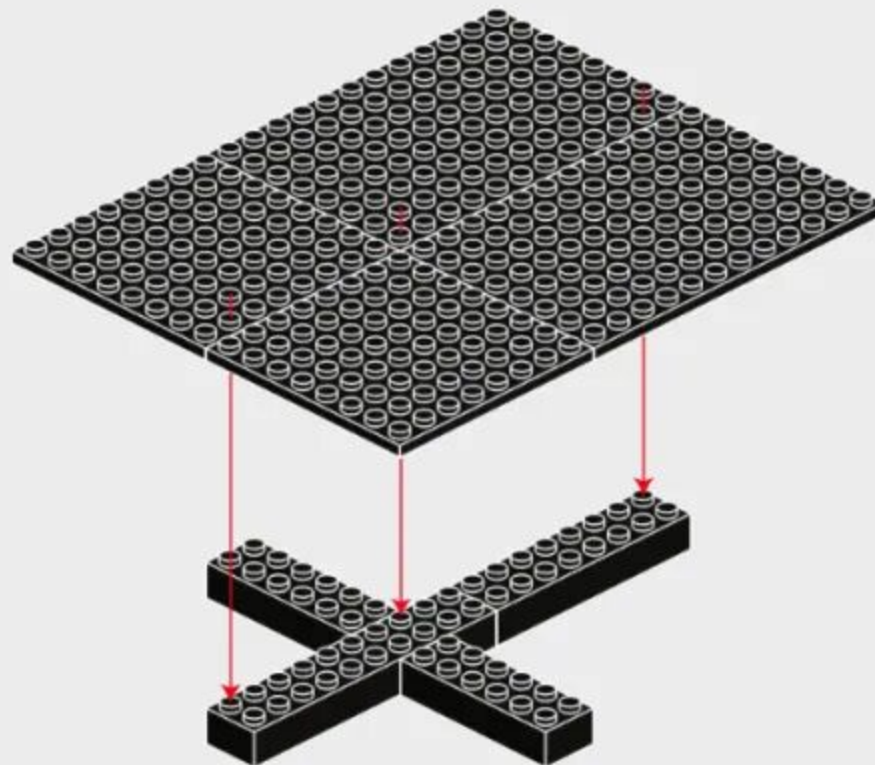
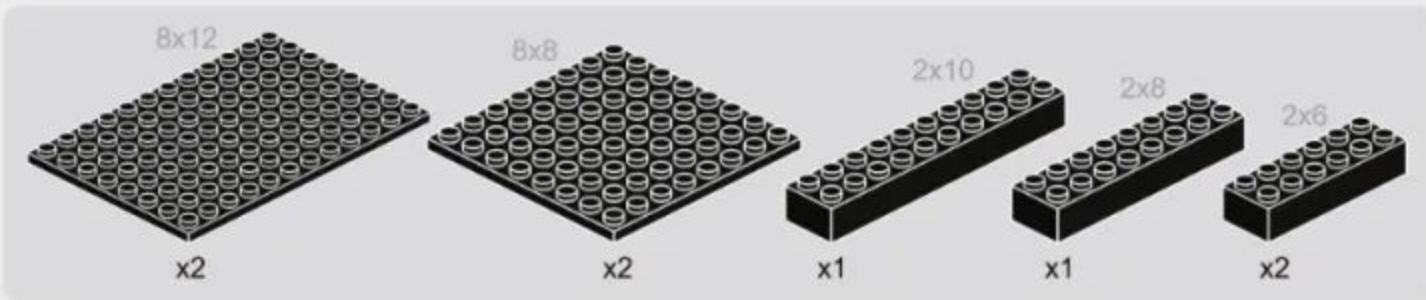

1-6

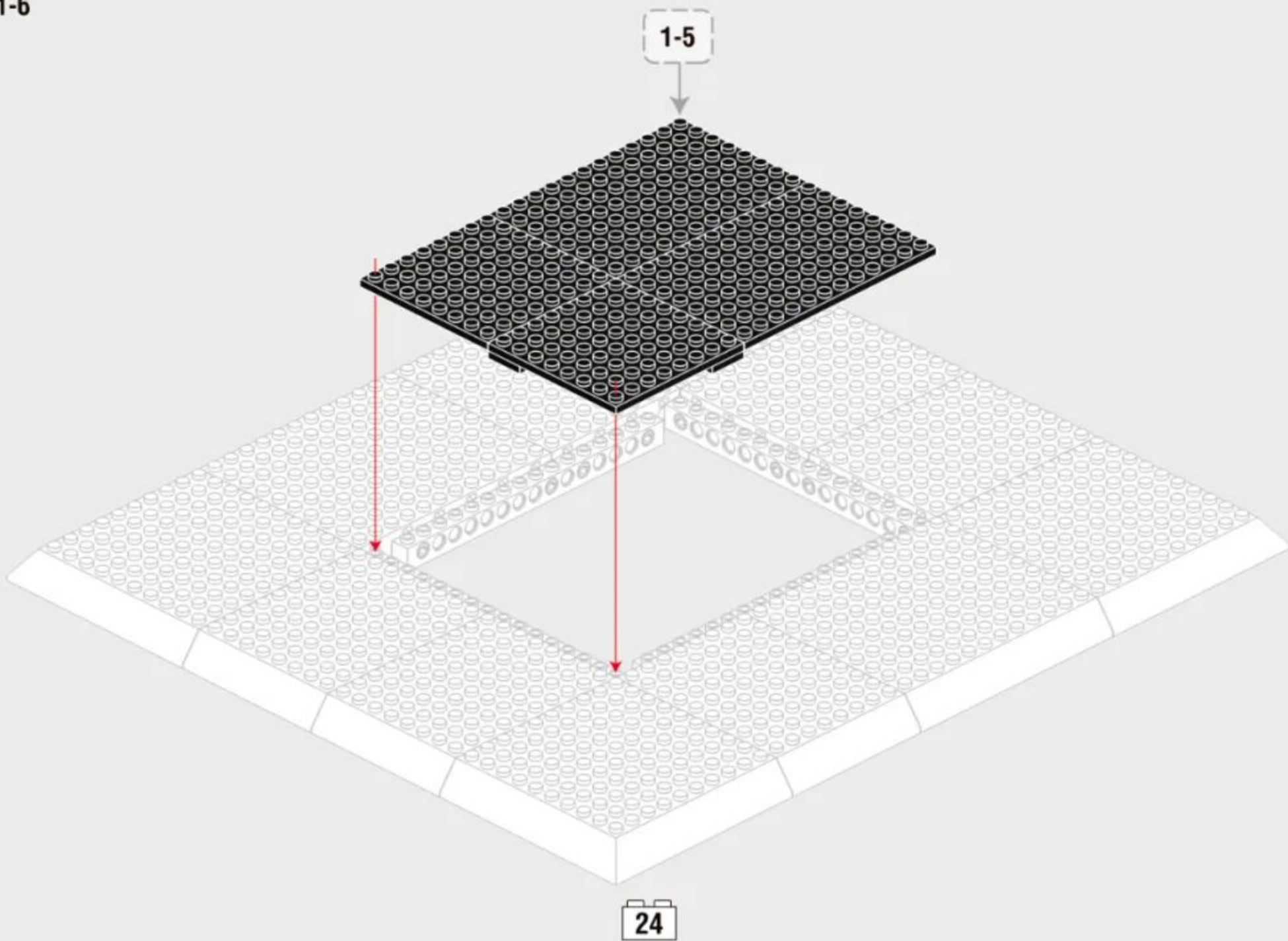

1-8

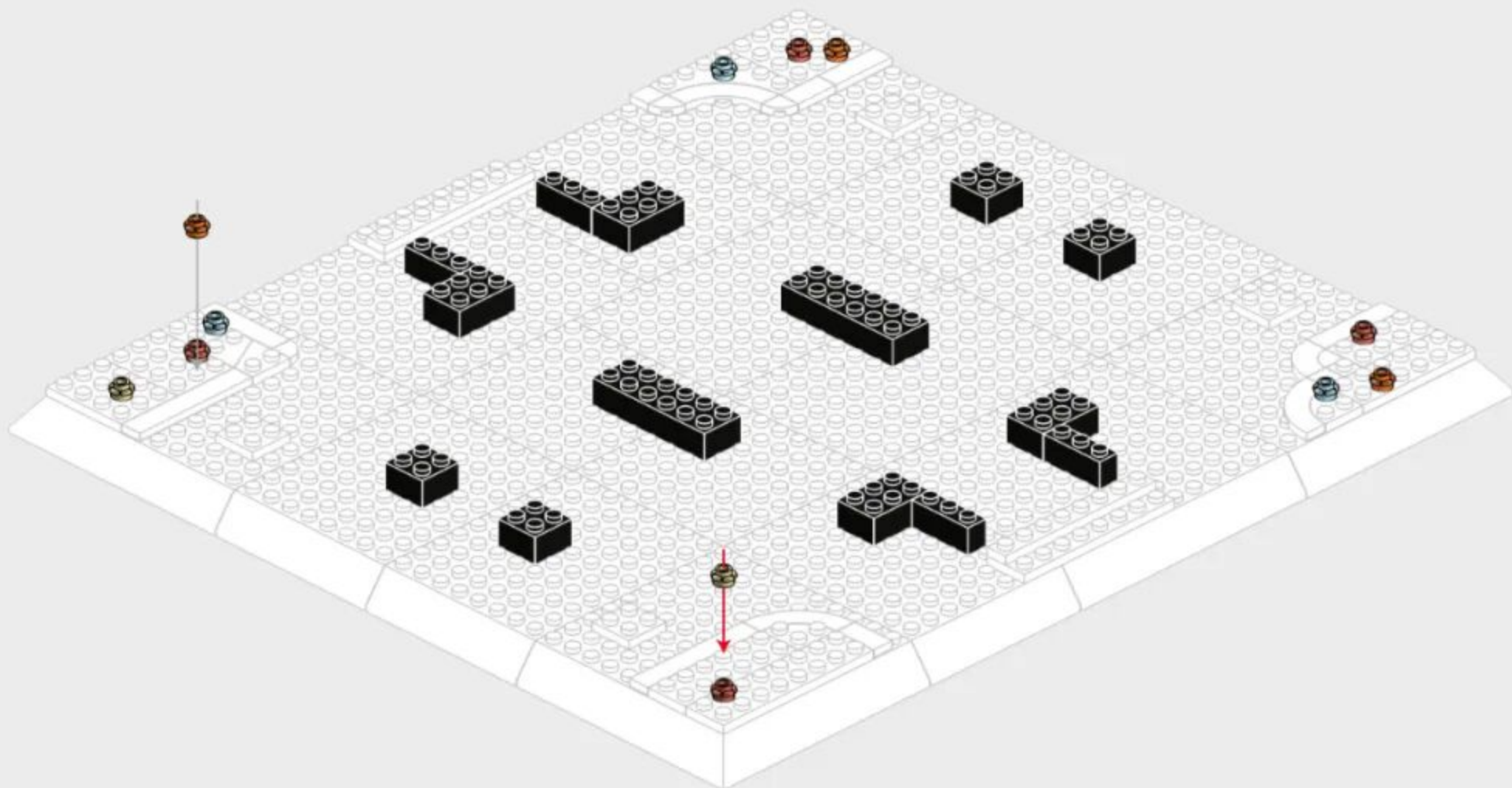

1-9

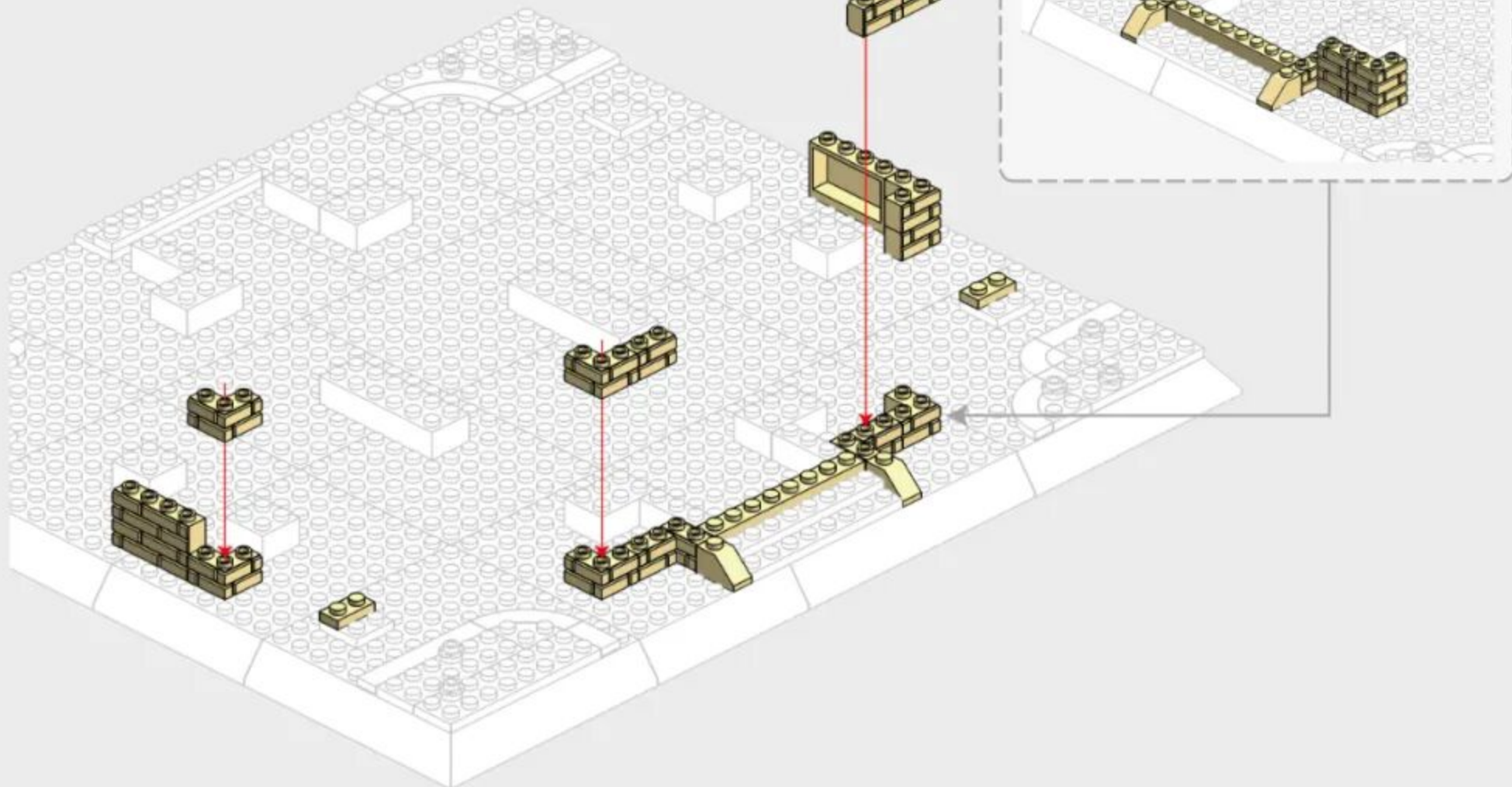
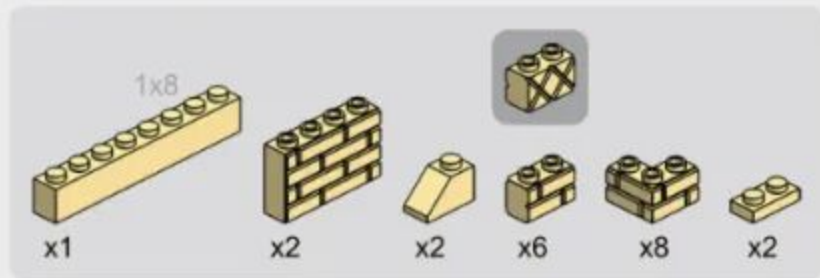

1-10

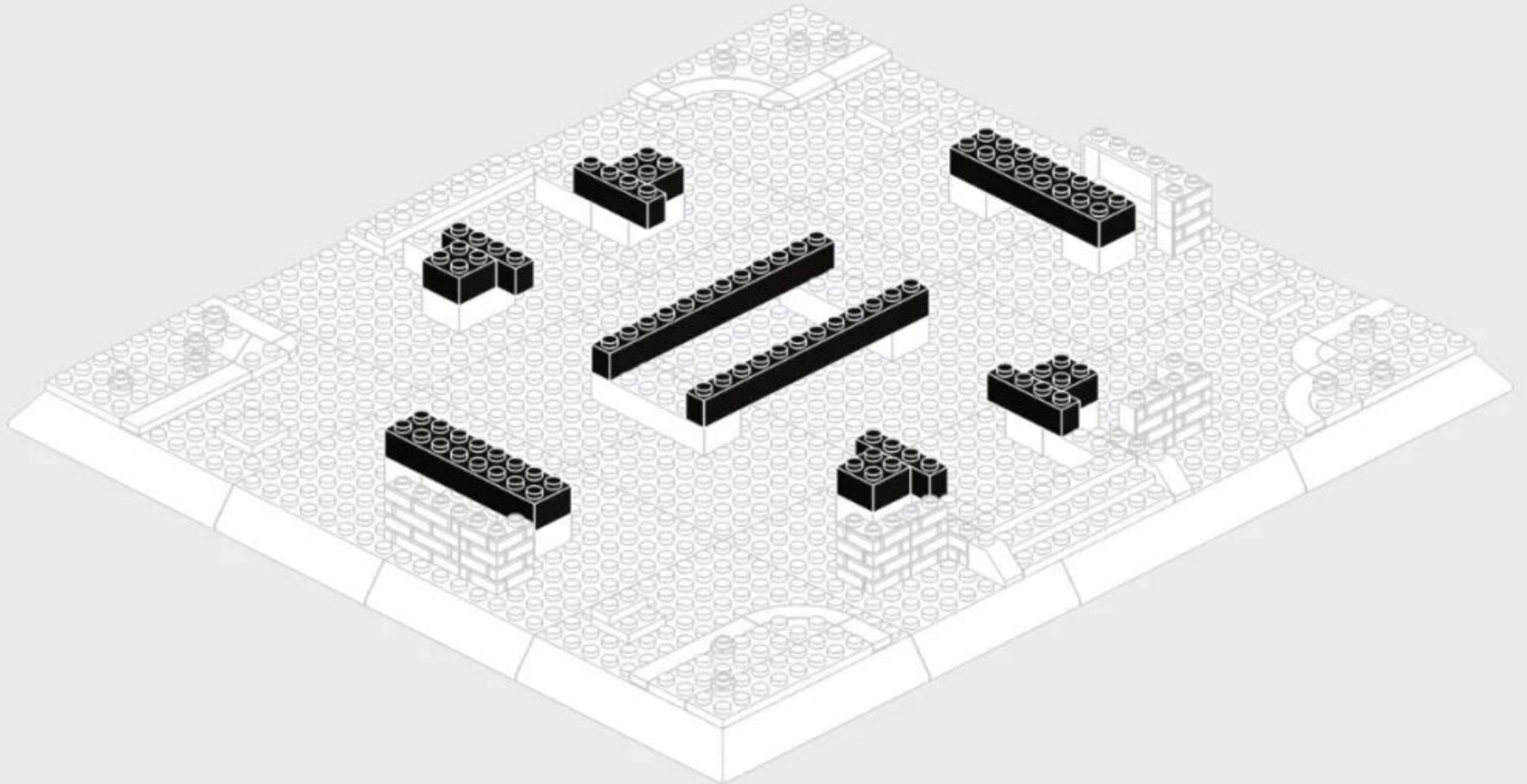
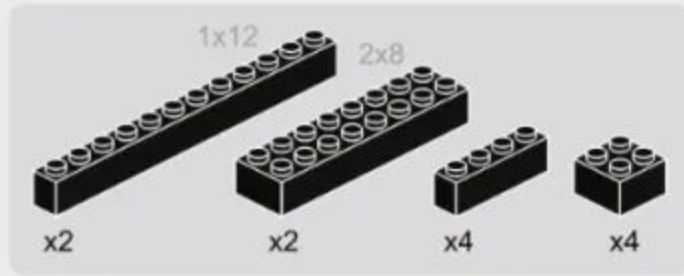

1-11

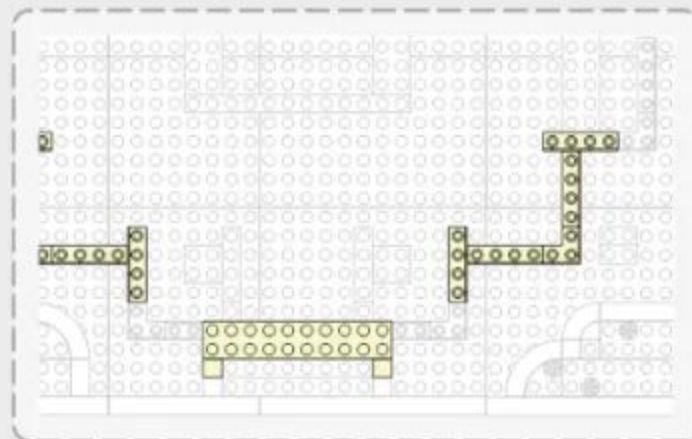
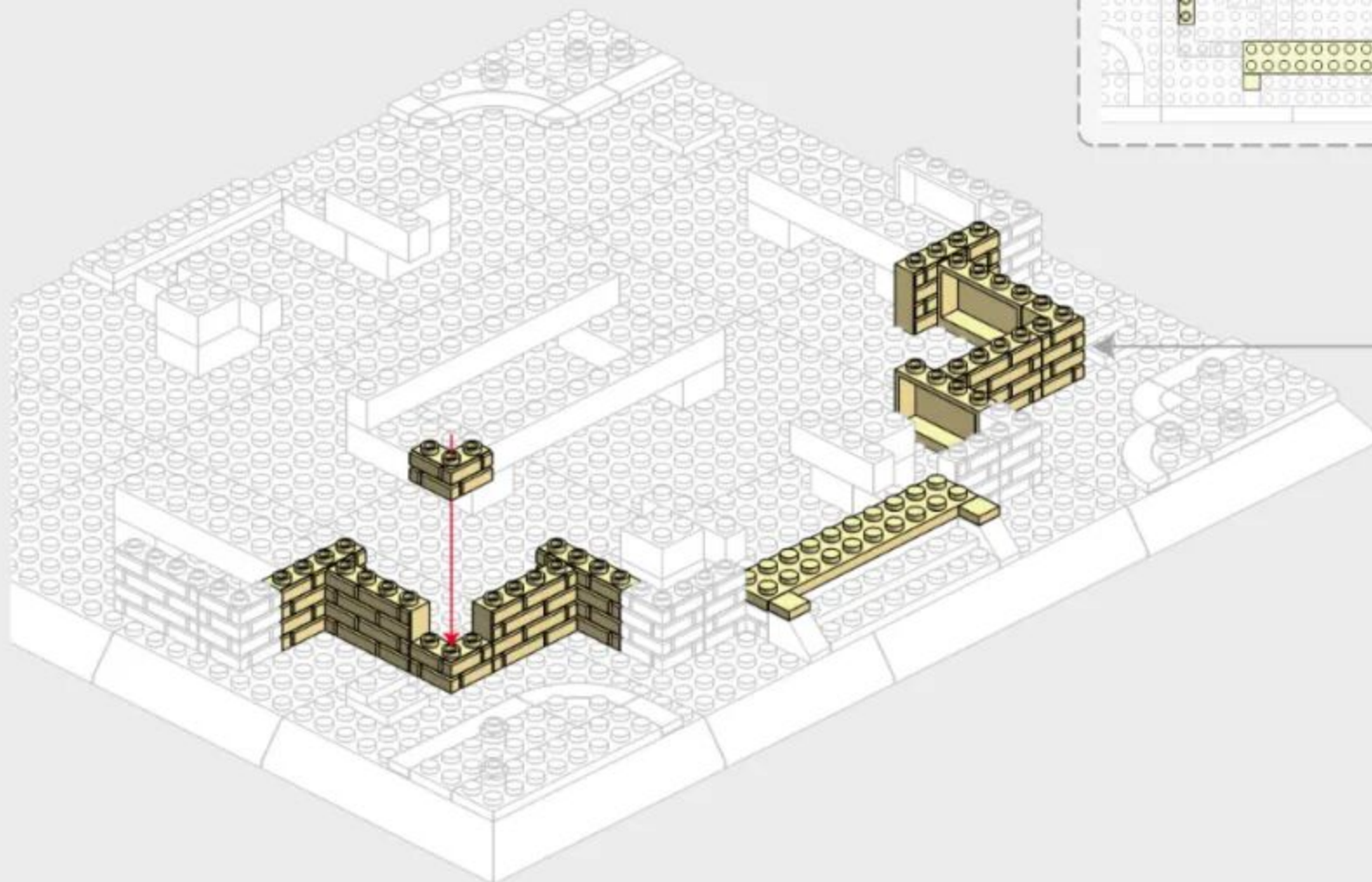

1-12

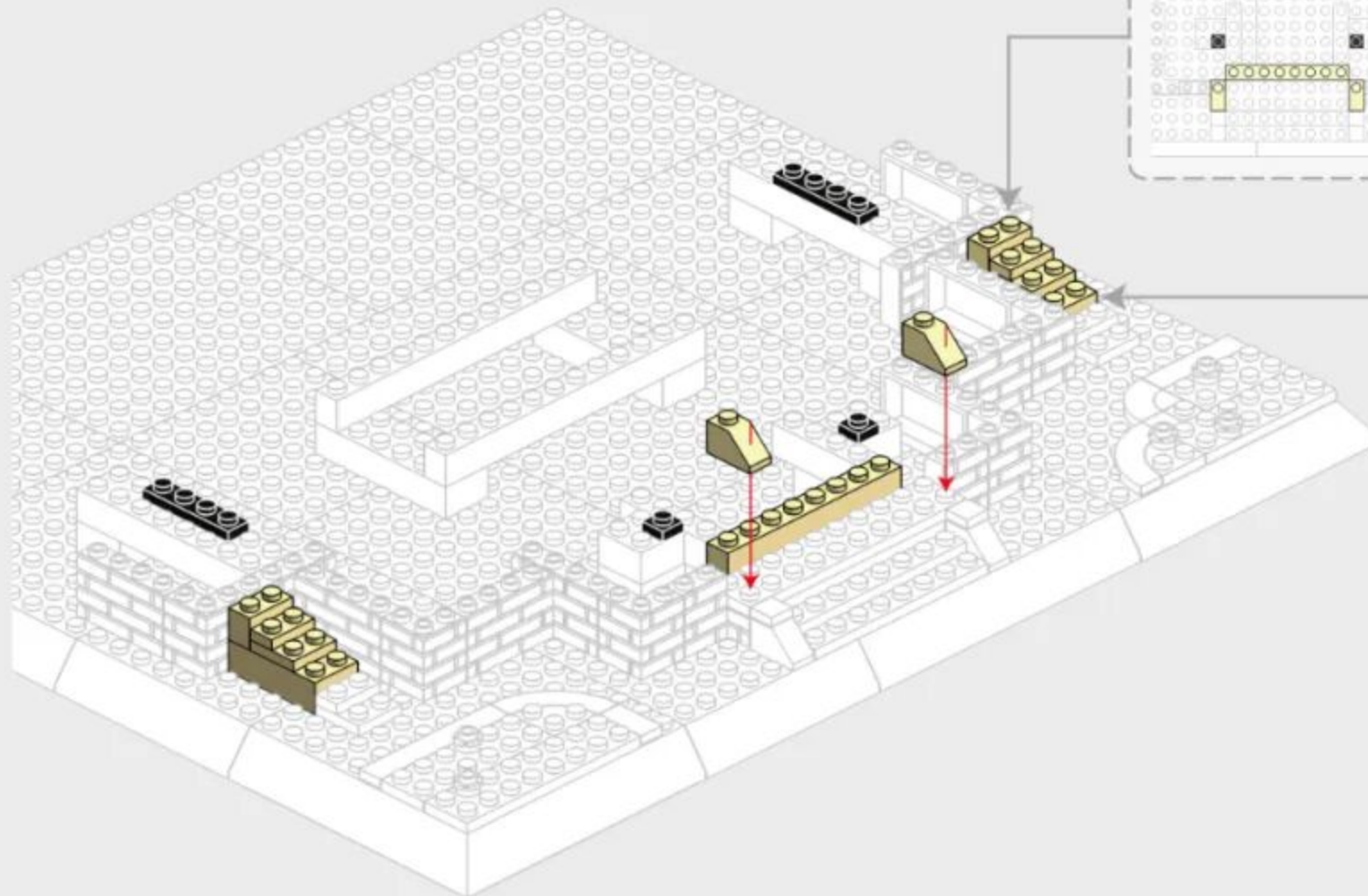

1-13

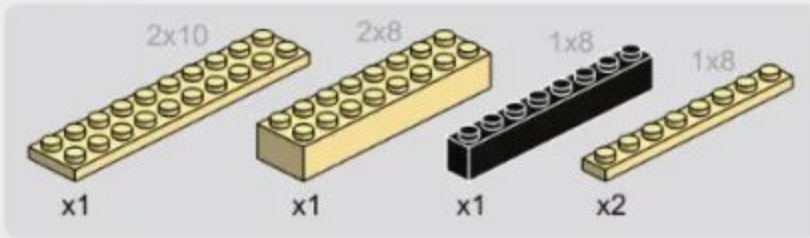

1-14

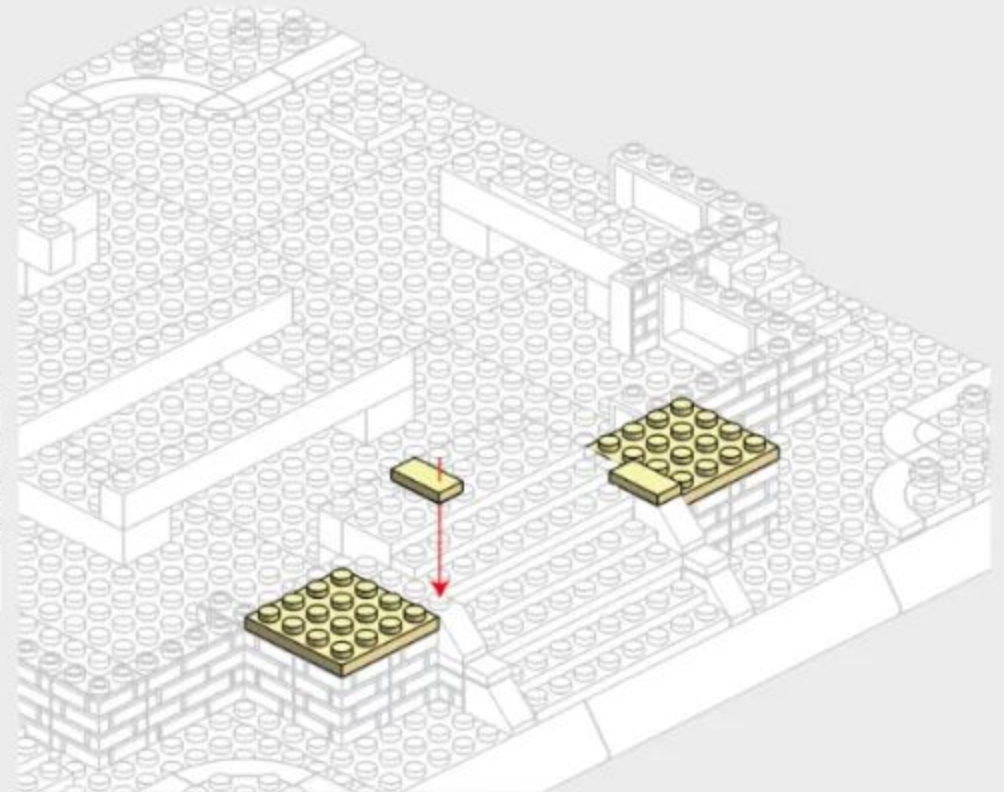
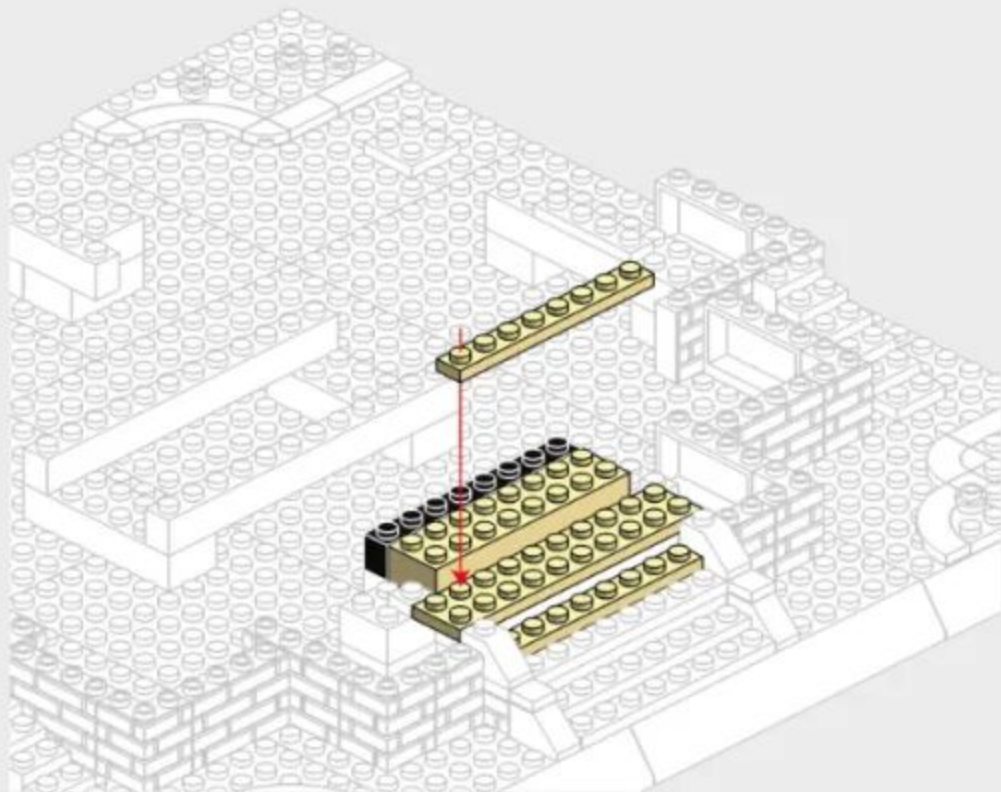
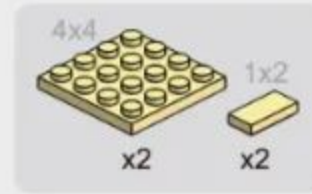

1-15

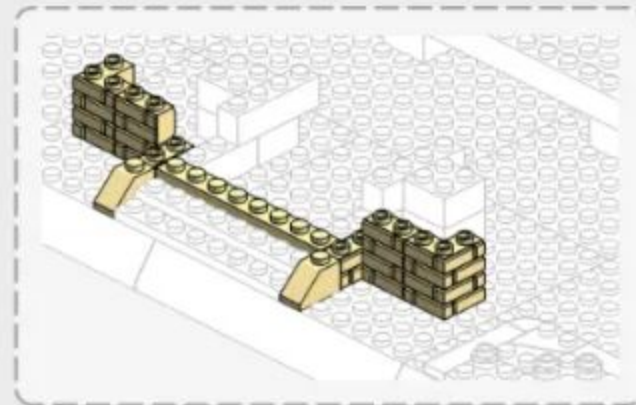
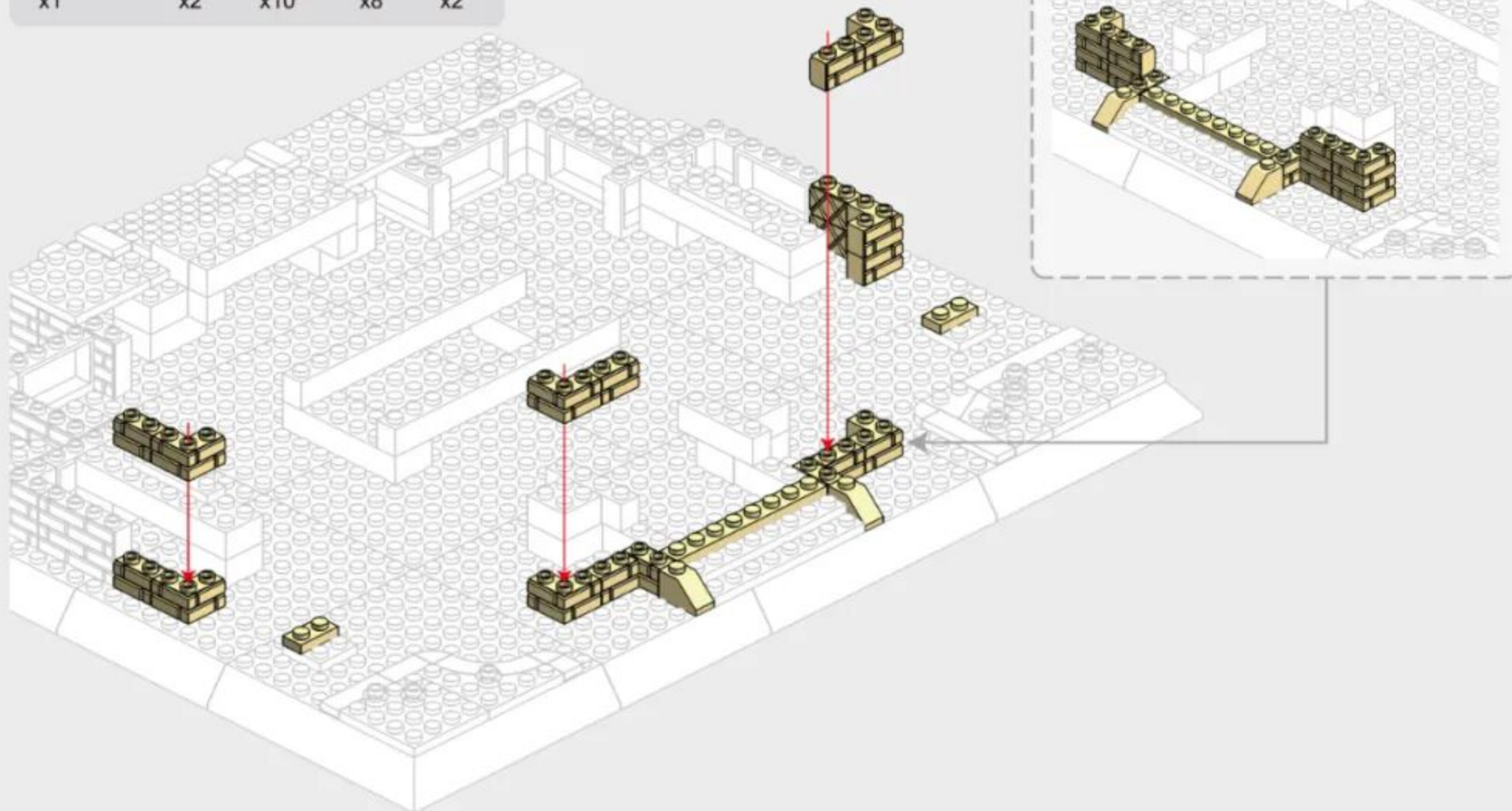
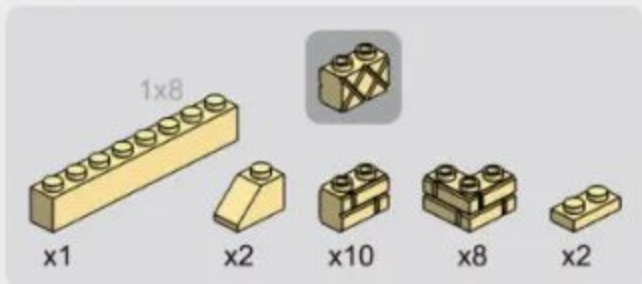

1-16

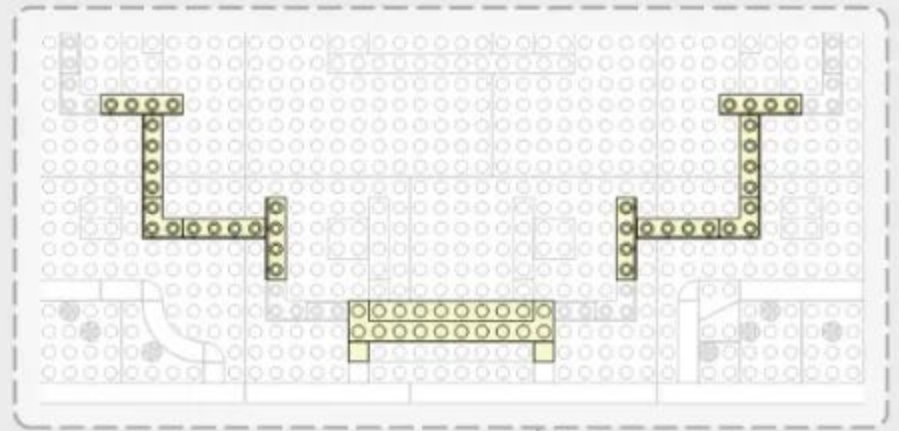
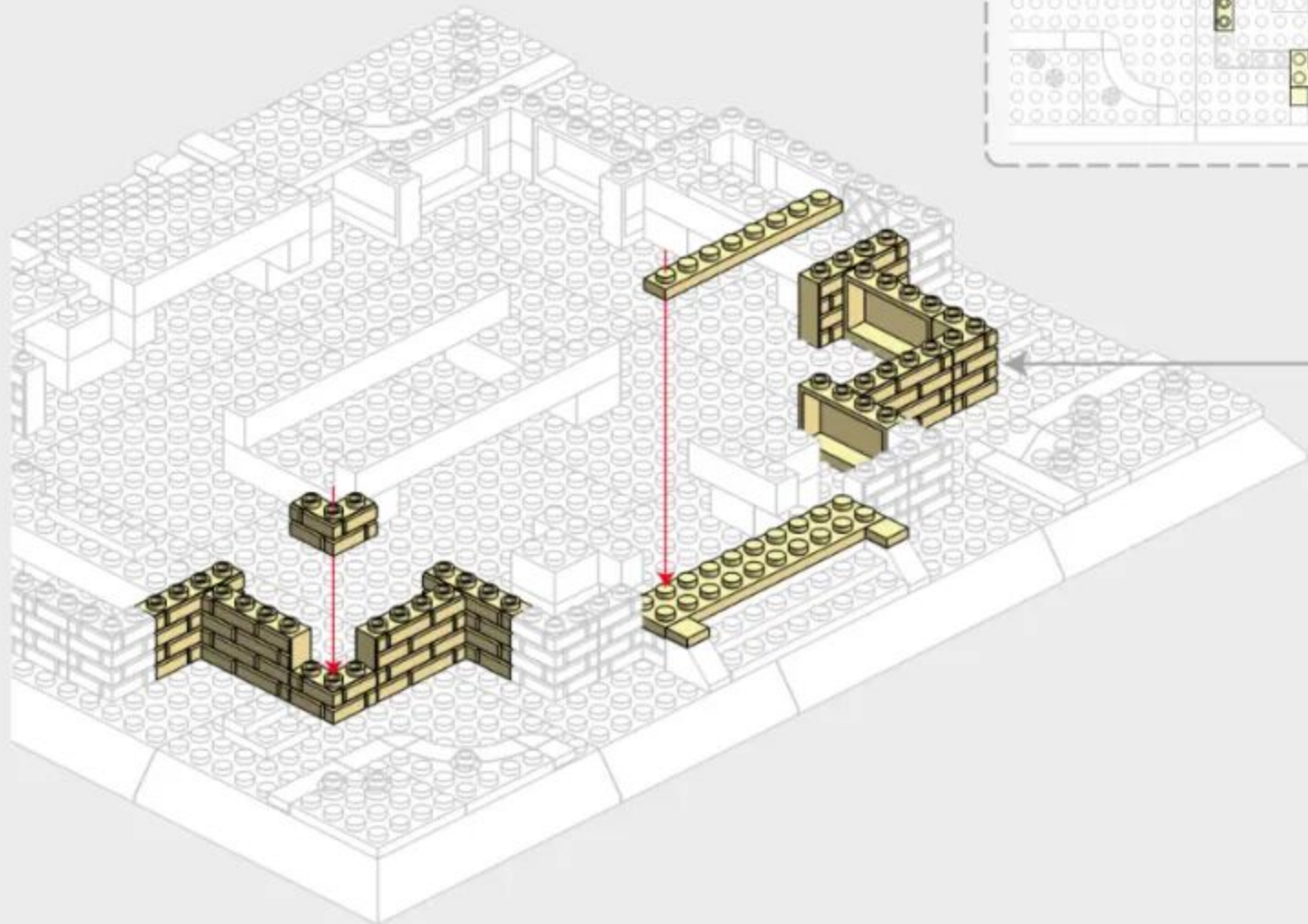
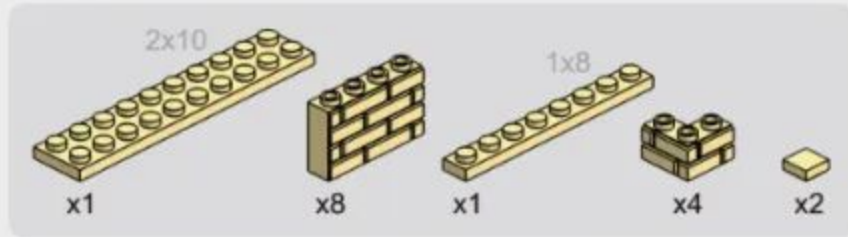

1-17

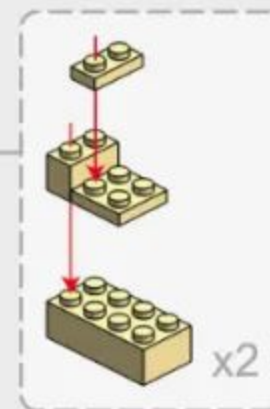
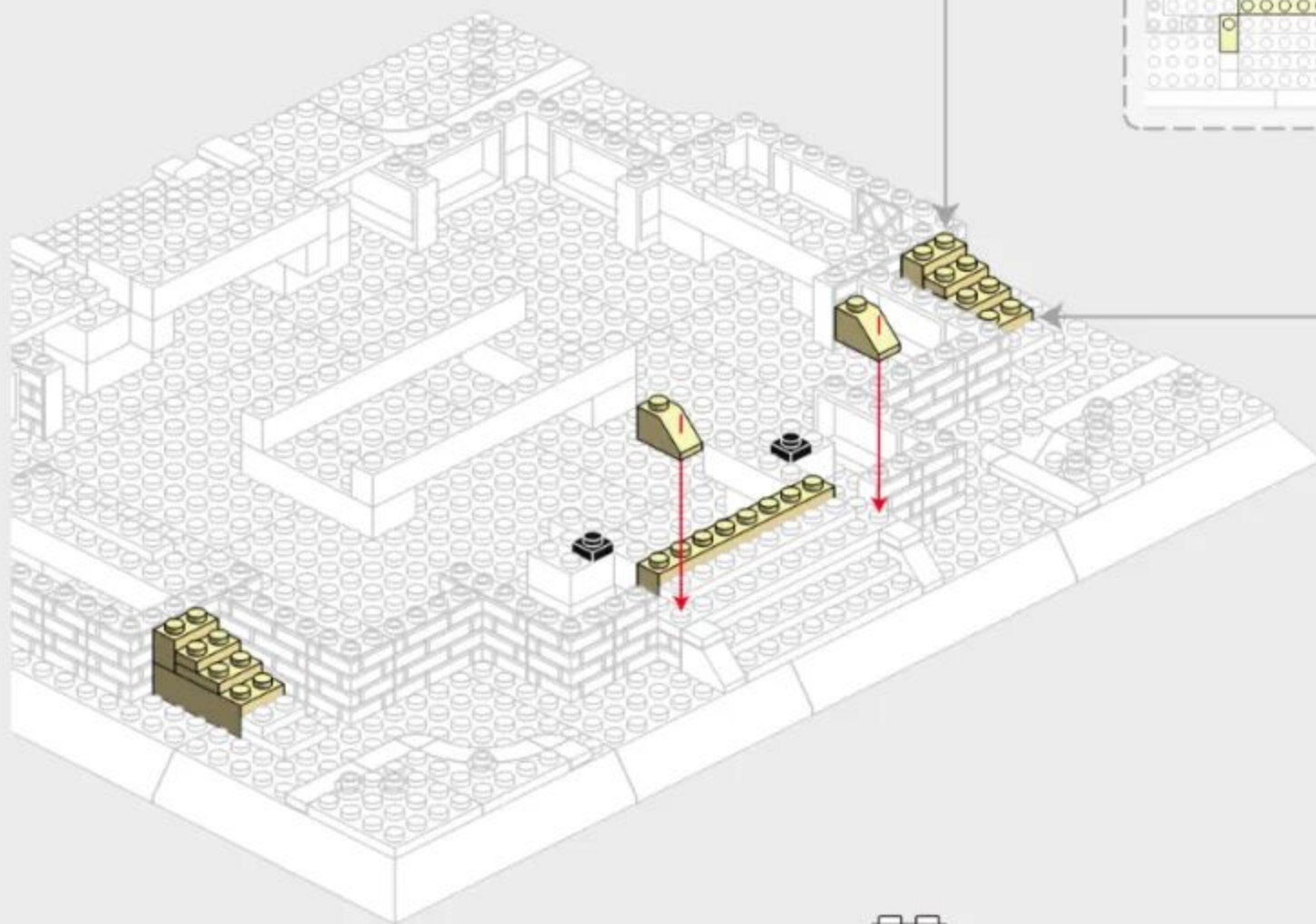
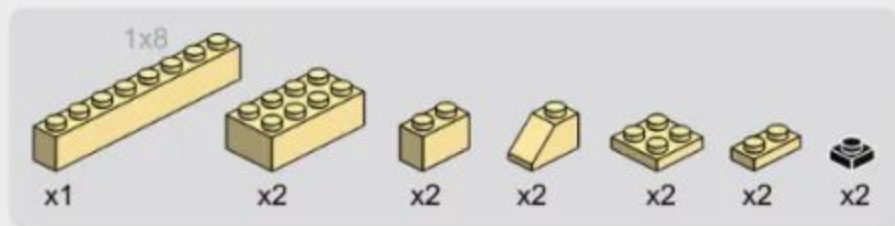

1-18

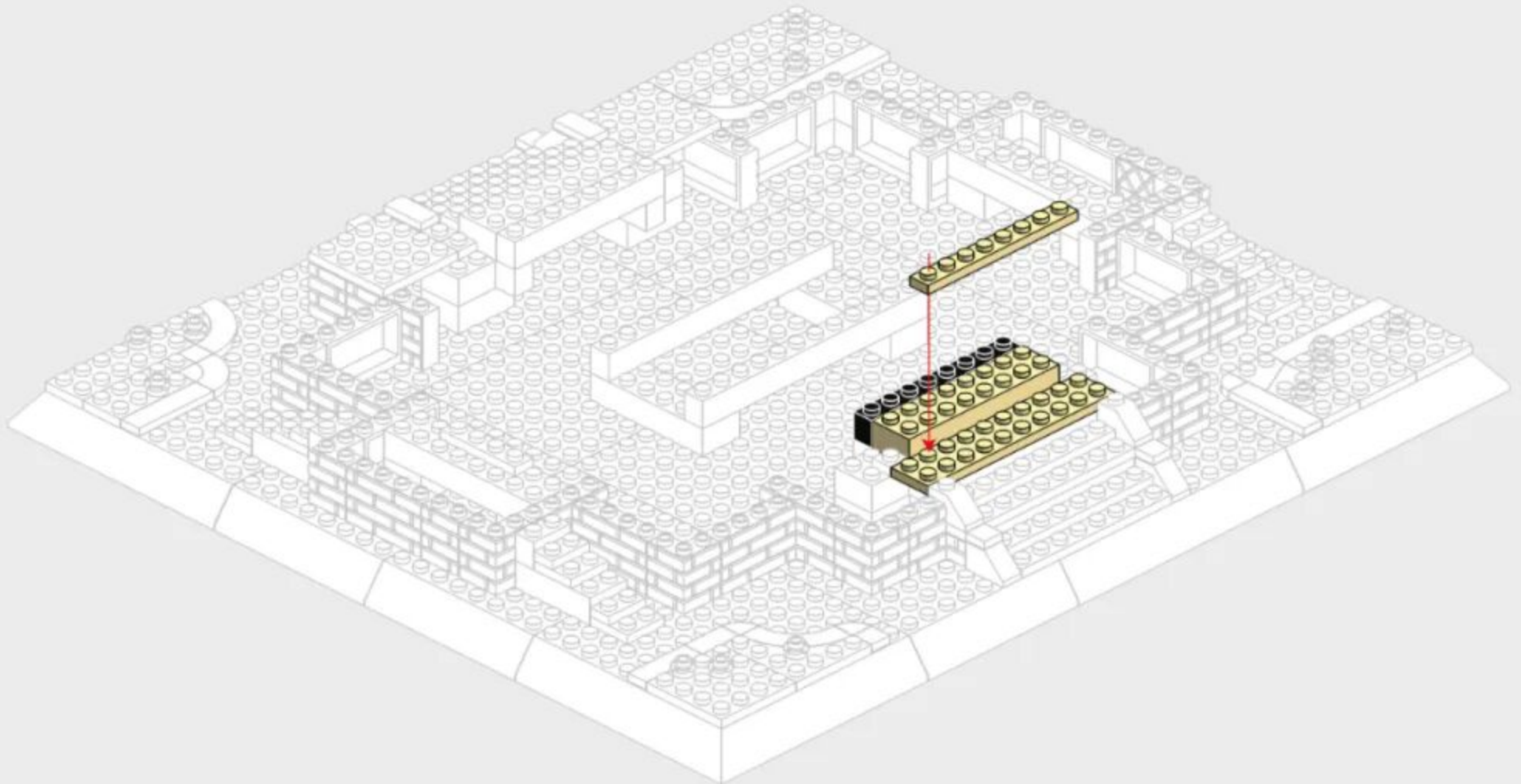
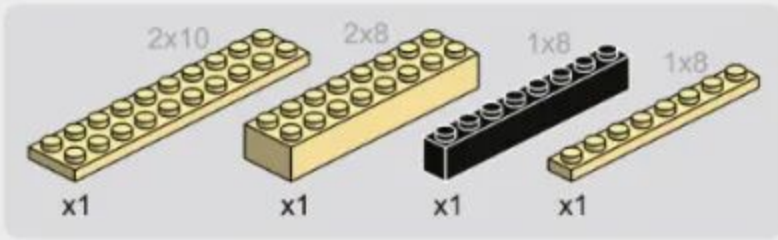

1-19

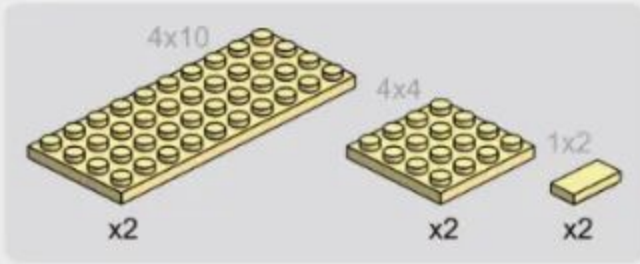



269PCS



2-1

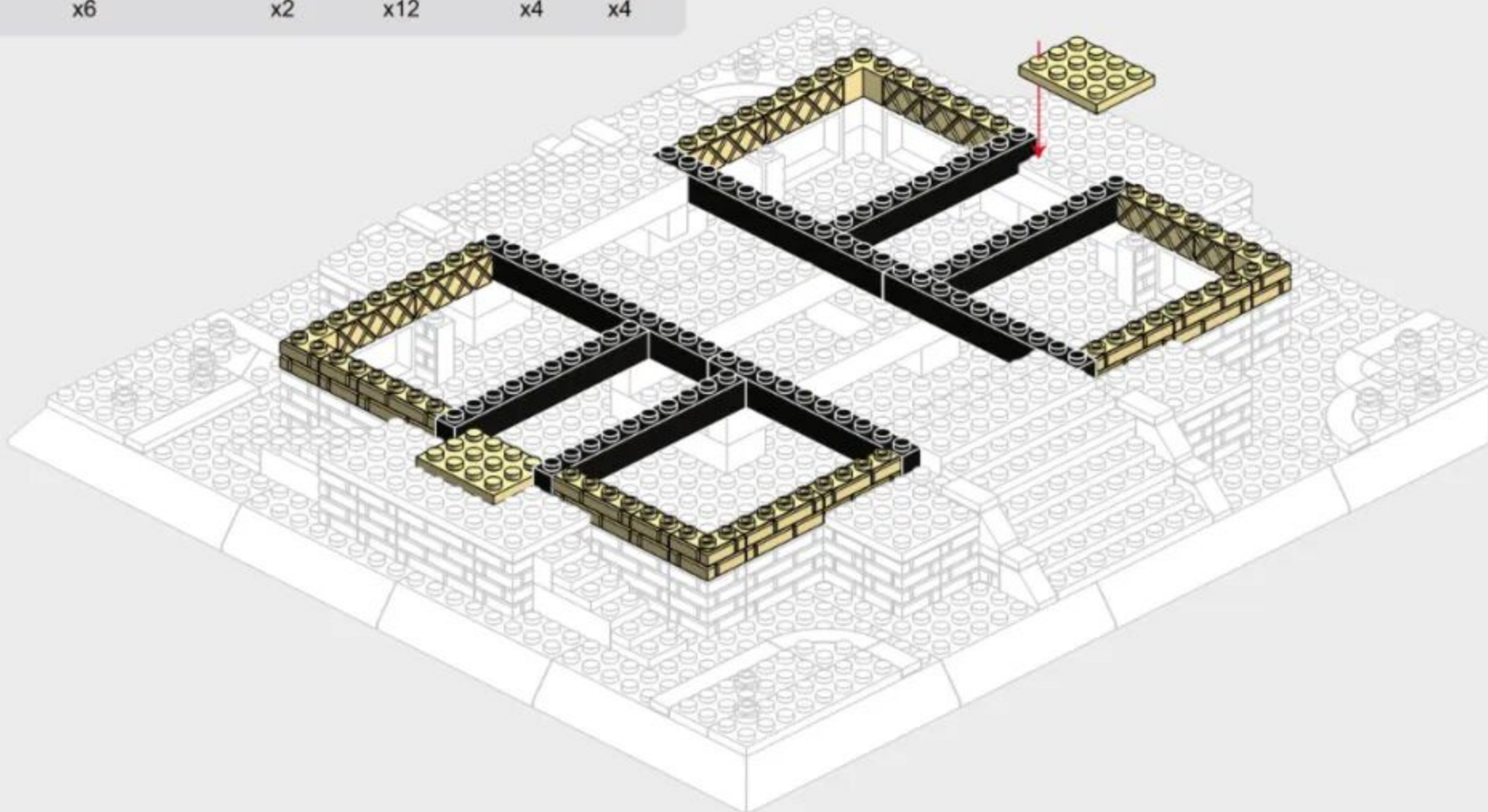
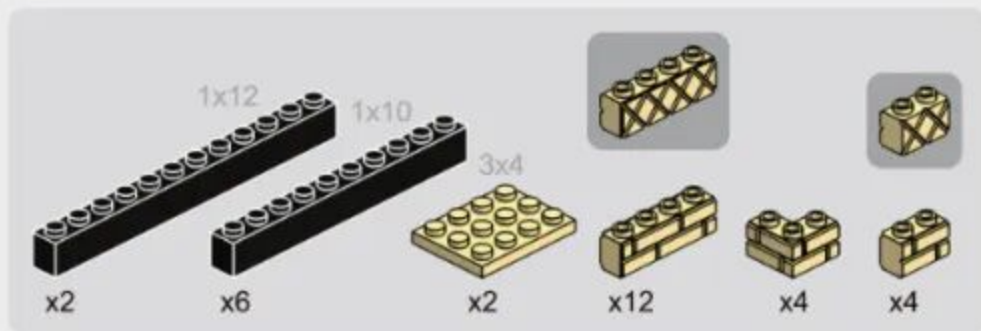

2-2



x2



x8

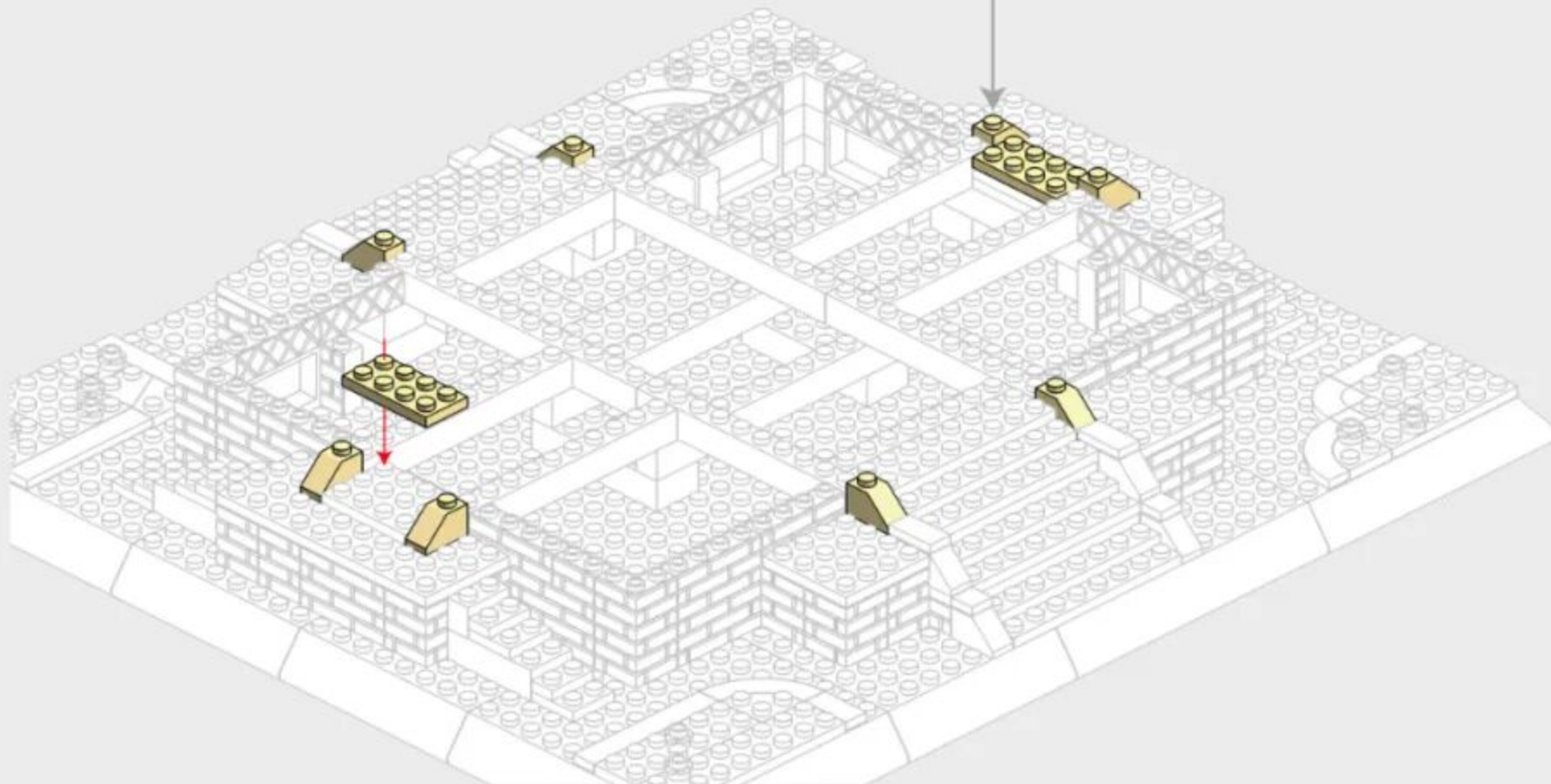
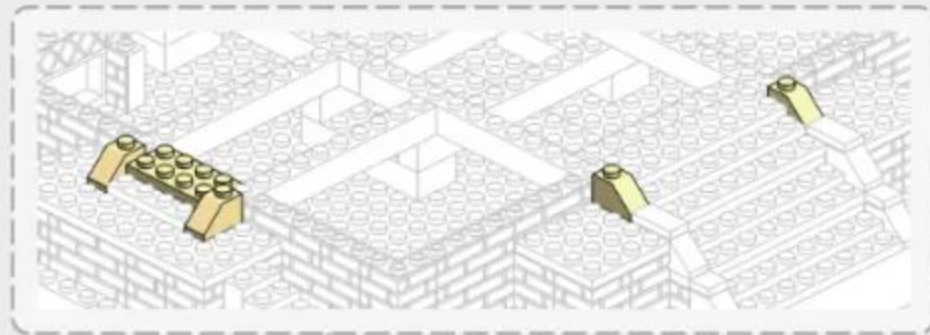

2-3

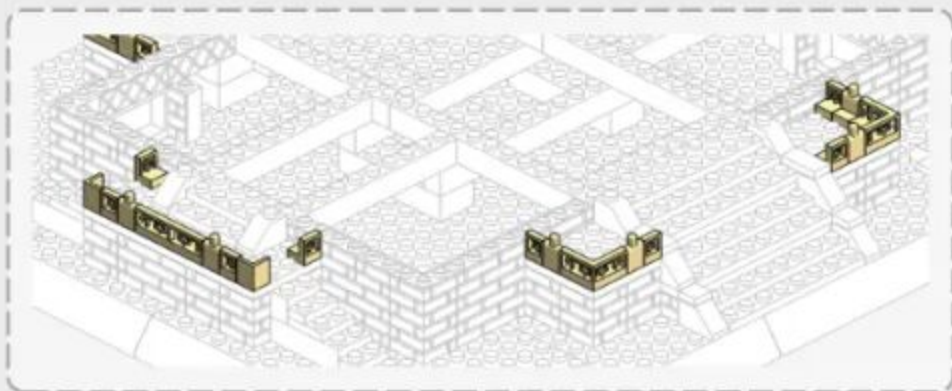

2-4

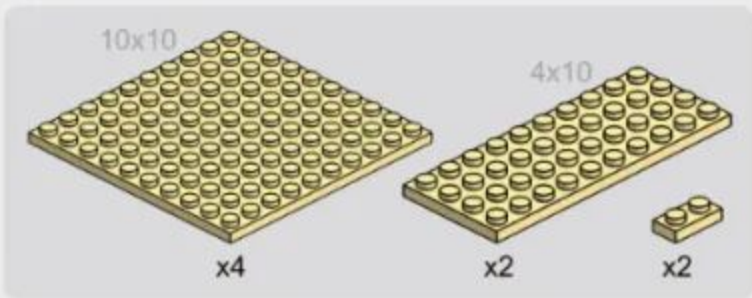

2-5

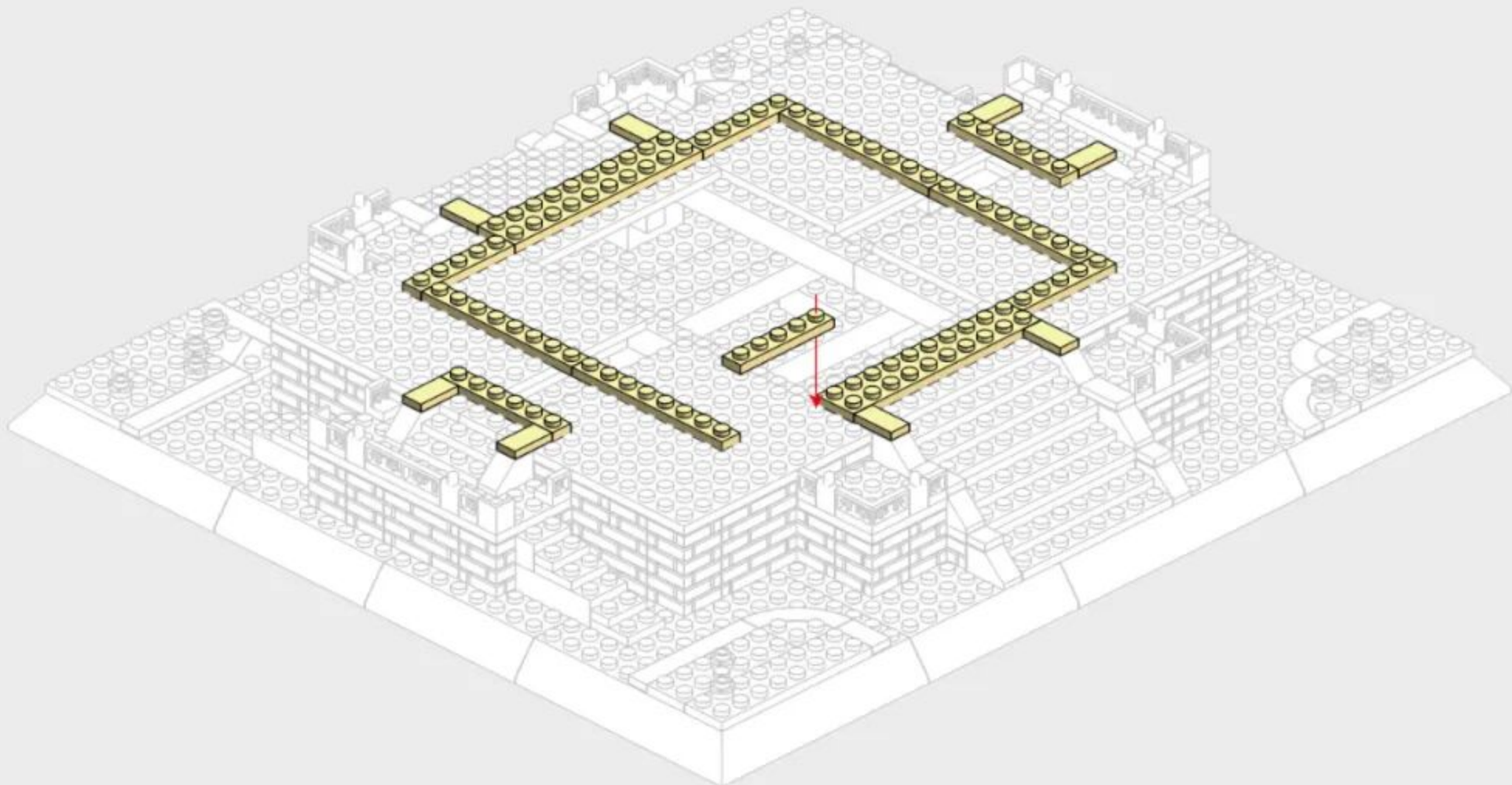
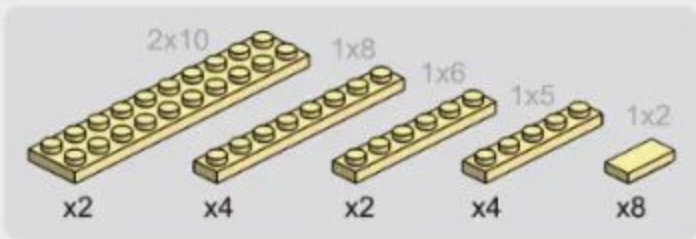

2-6

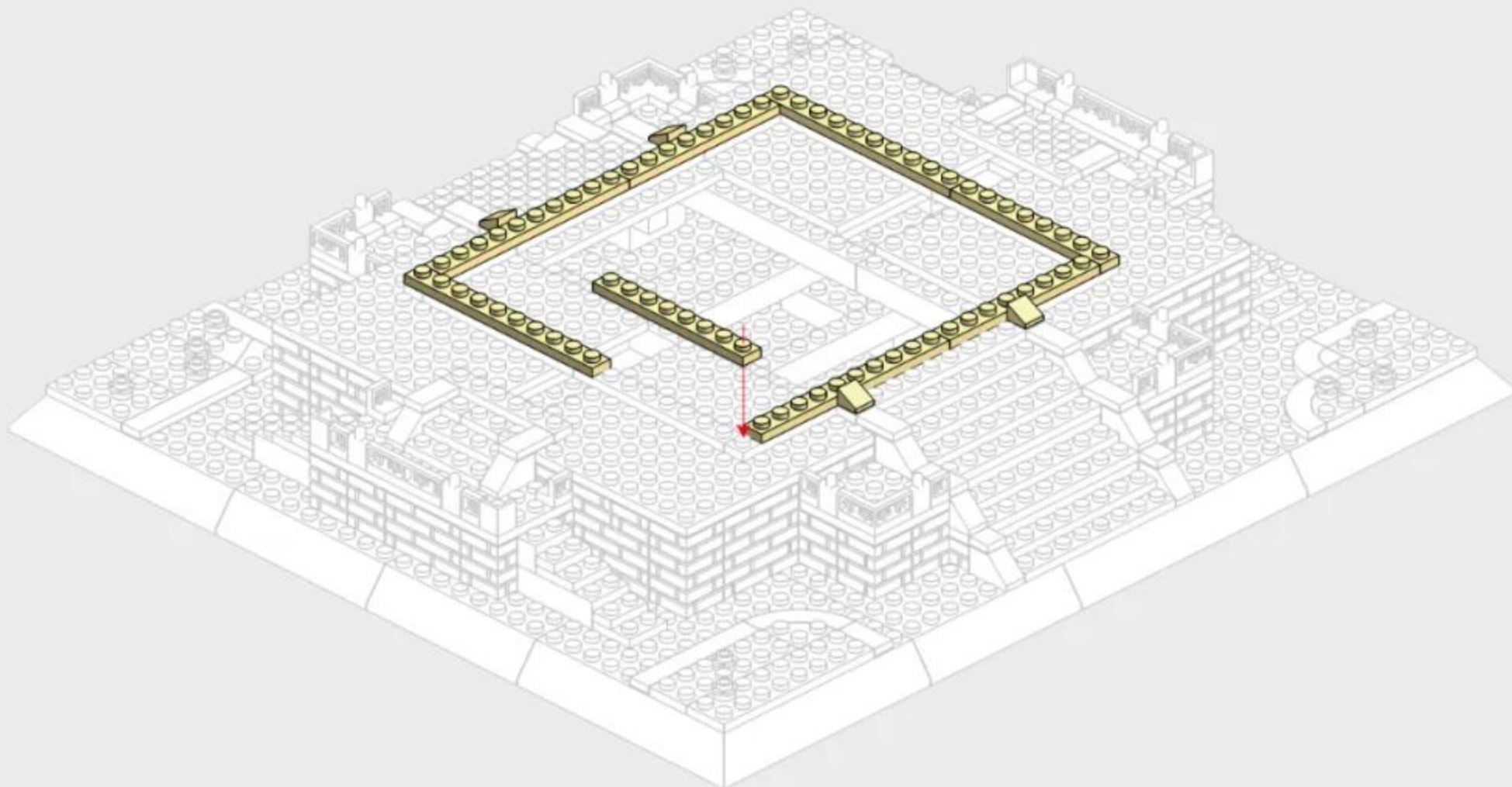
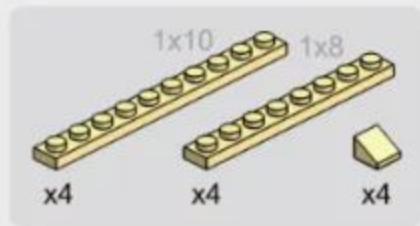

2-7

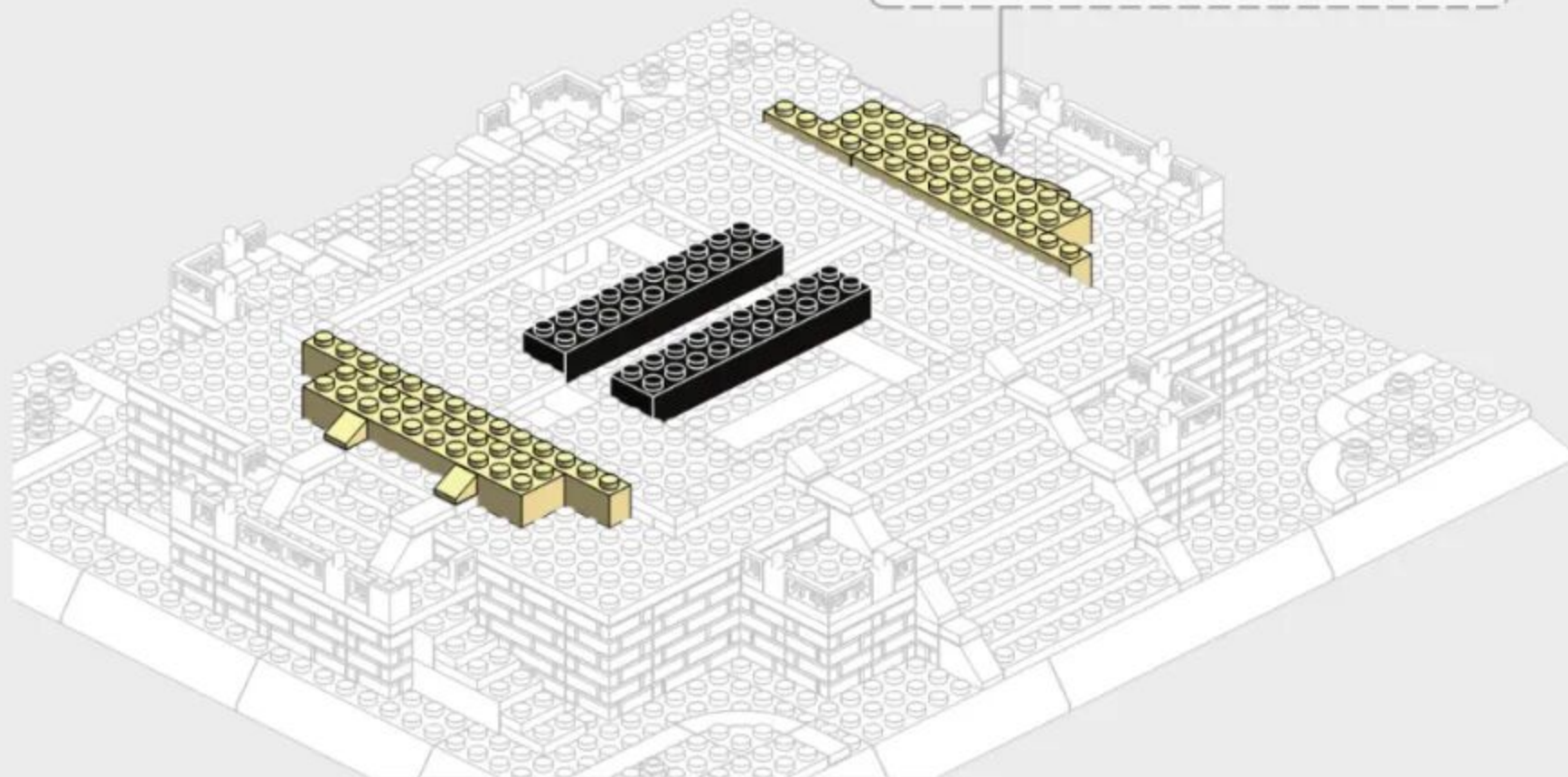
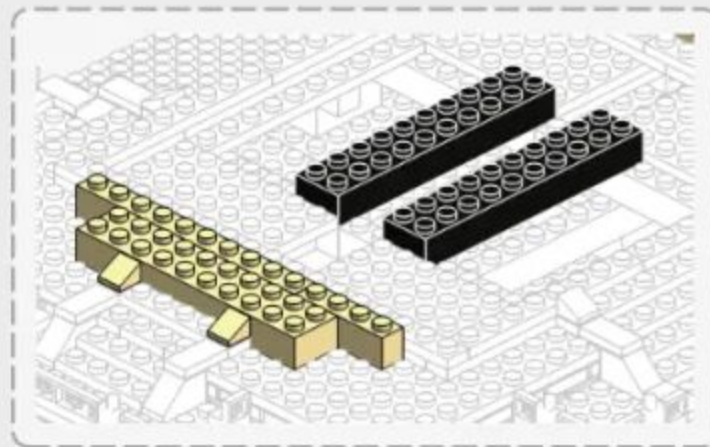
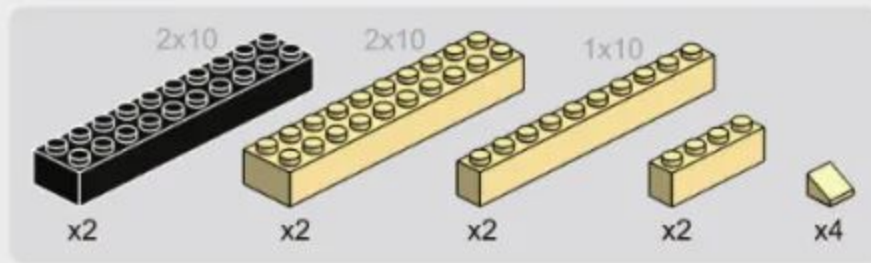

2-8

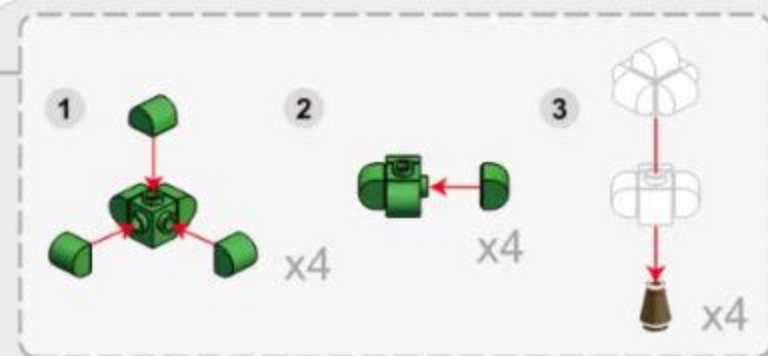
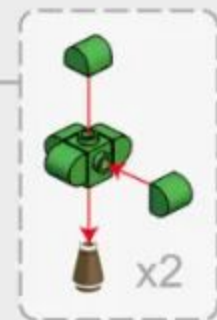
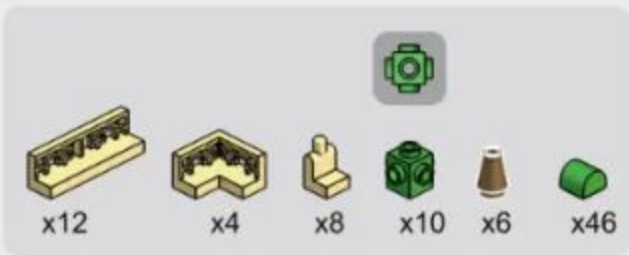

2-9

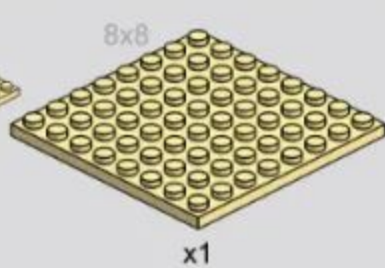
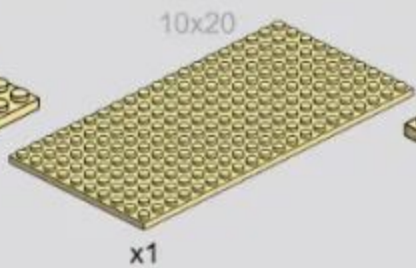
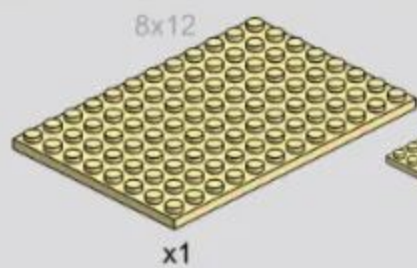

x8

x5

x37

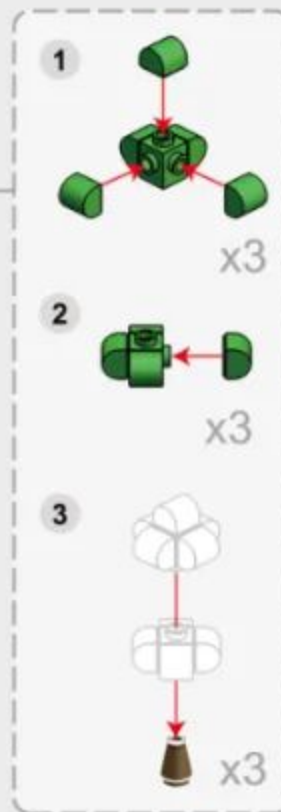
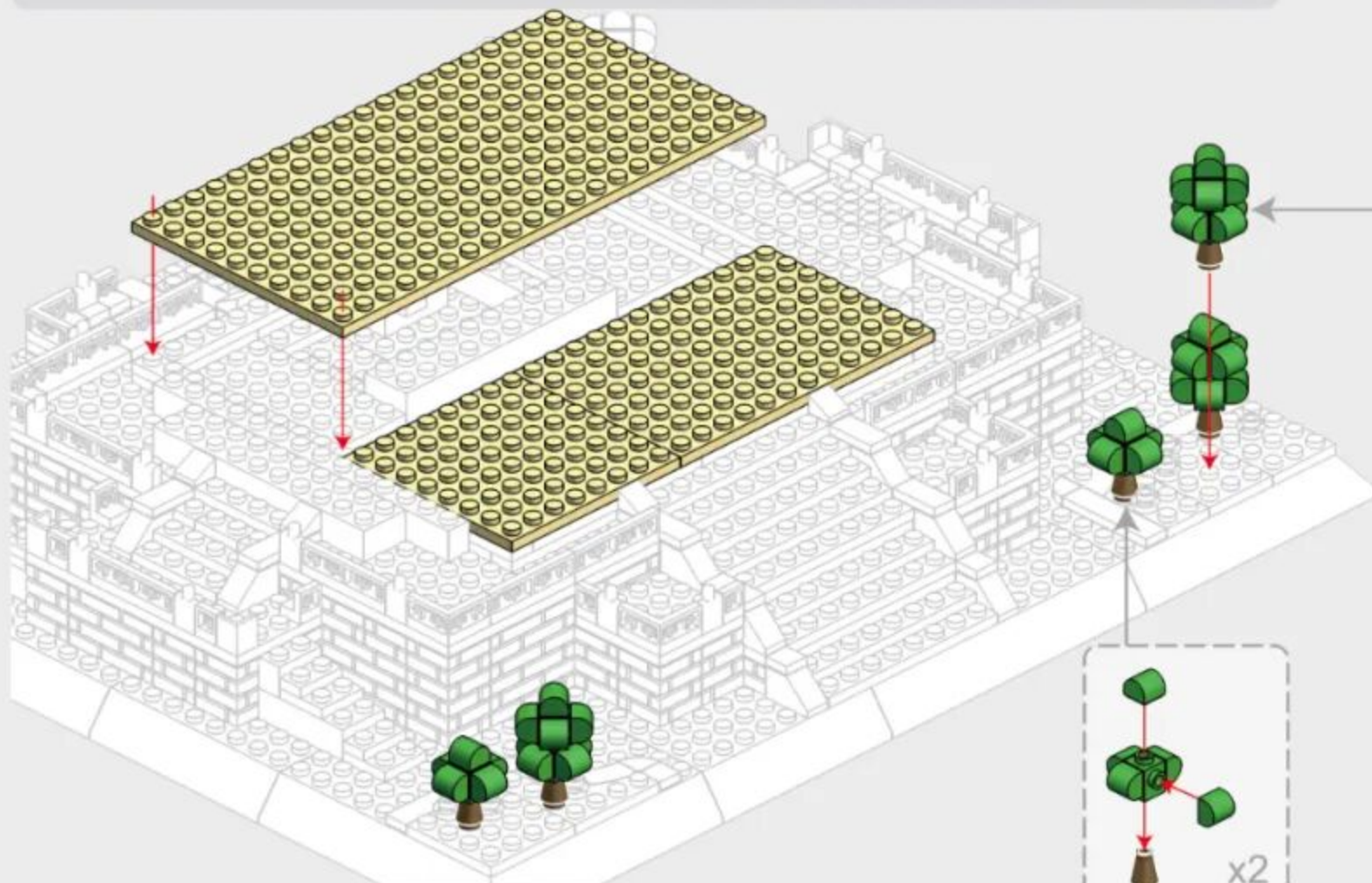



250PCS

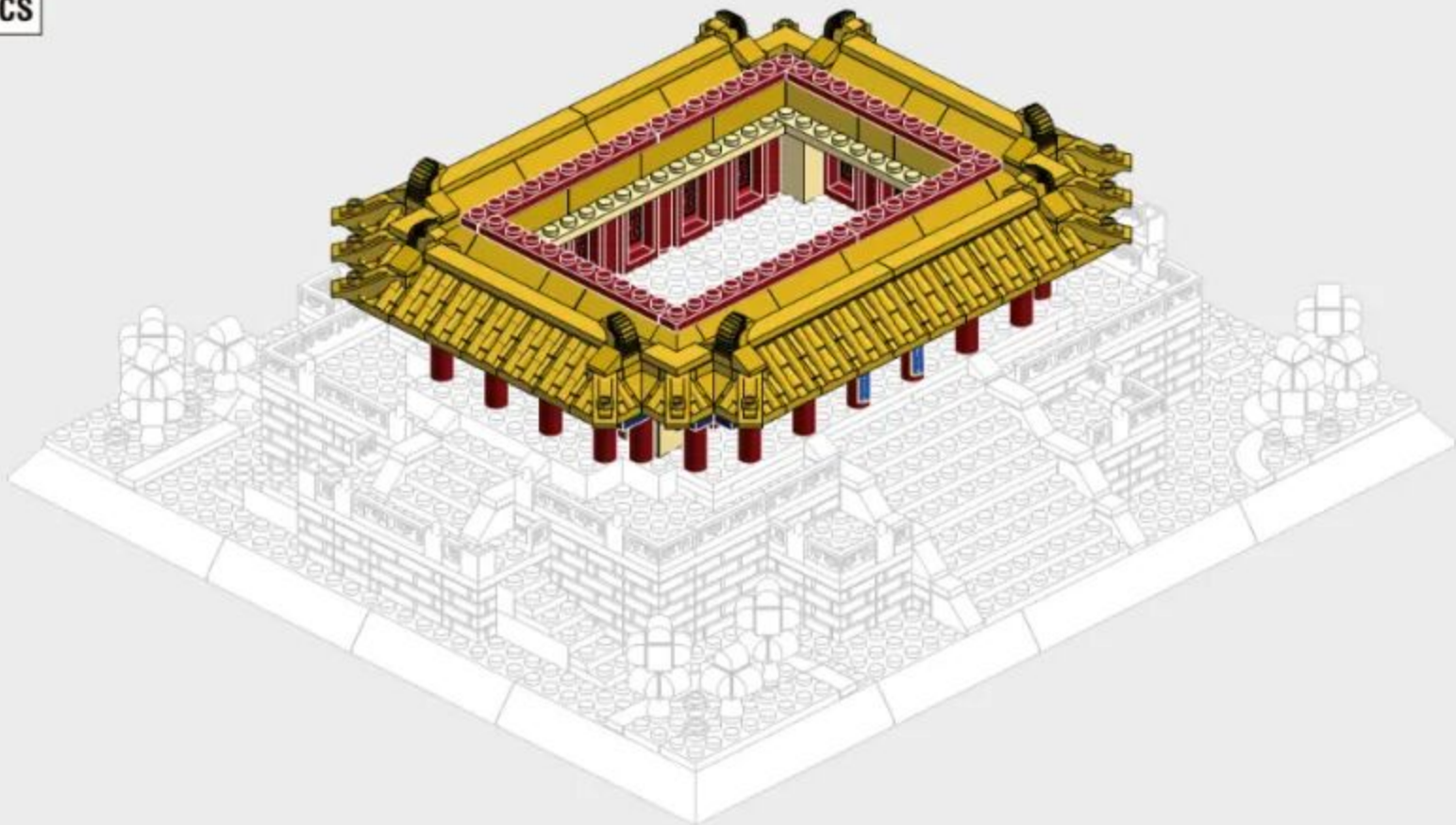

47

3-1

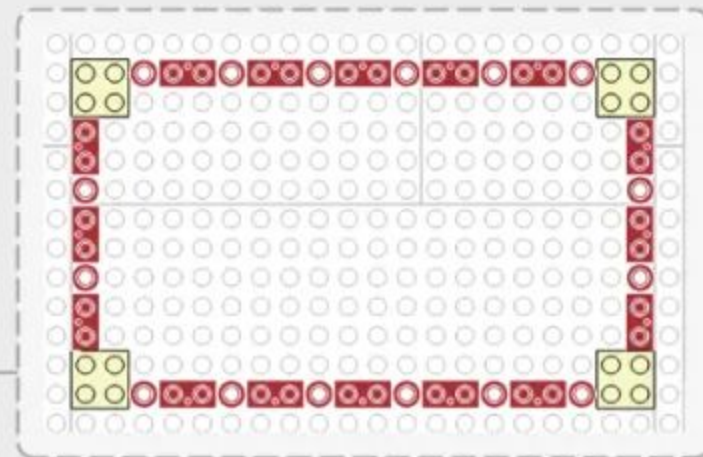
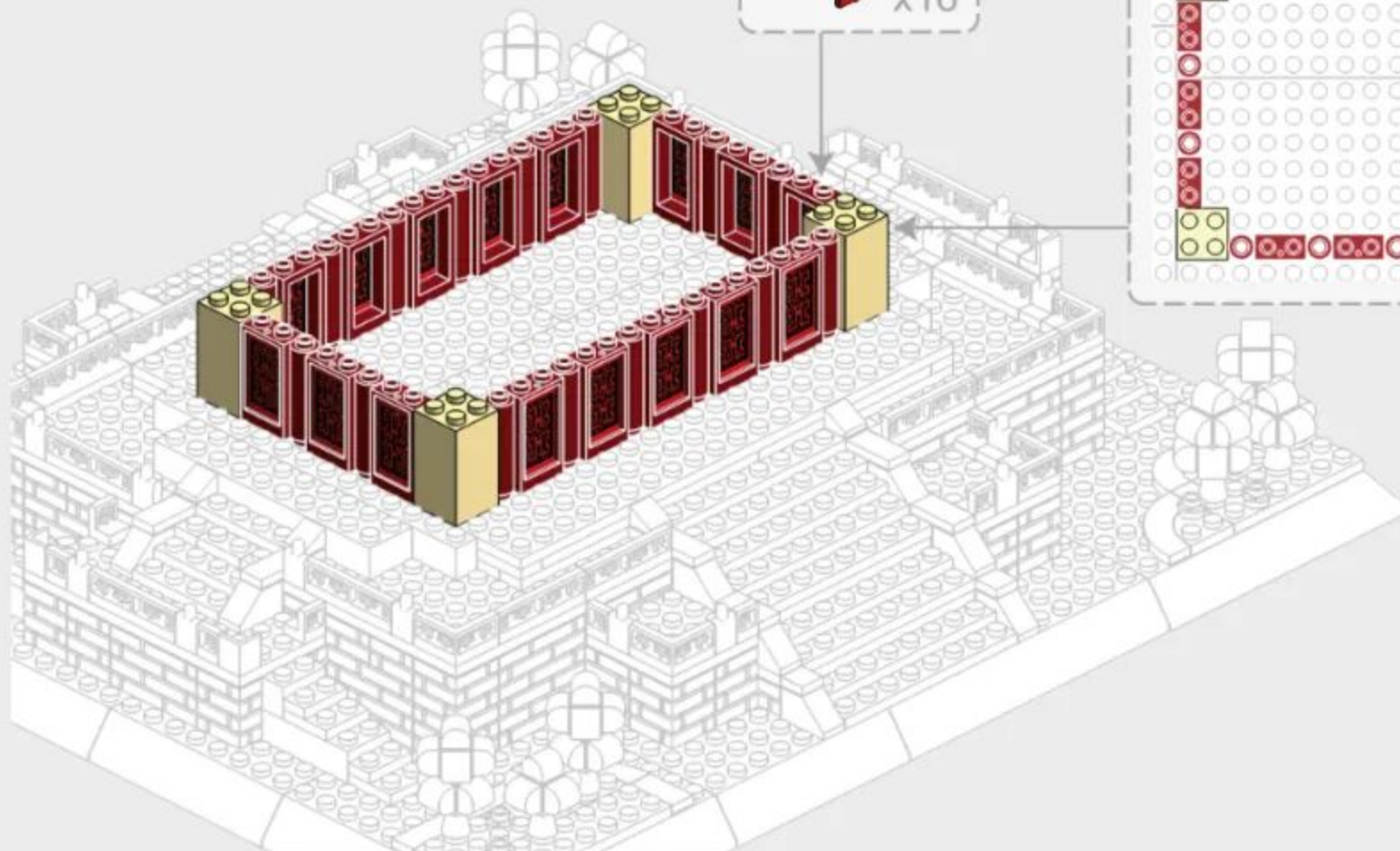

3-2



x28

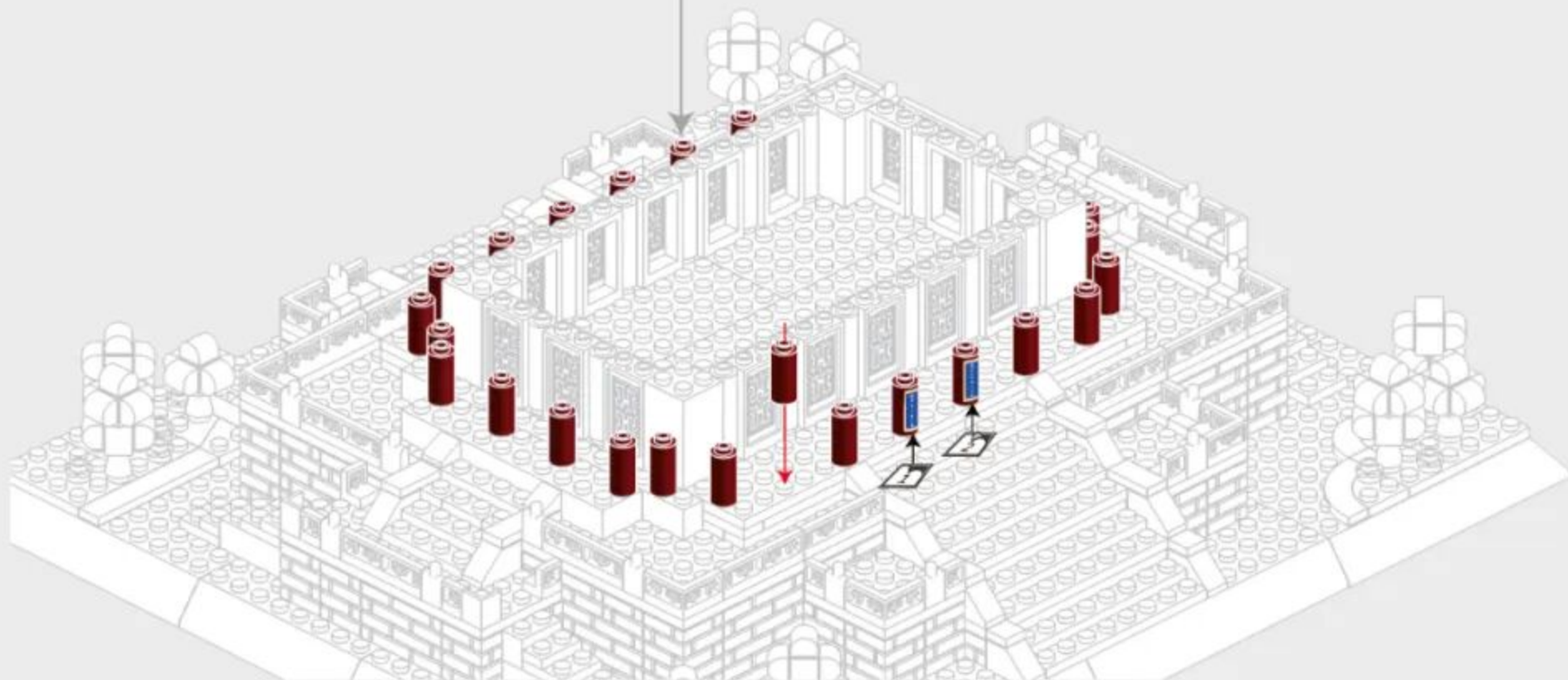
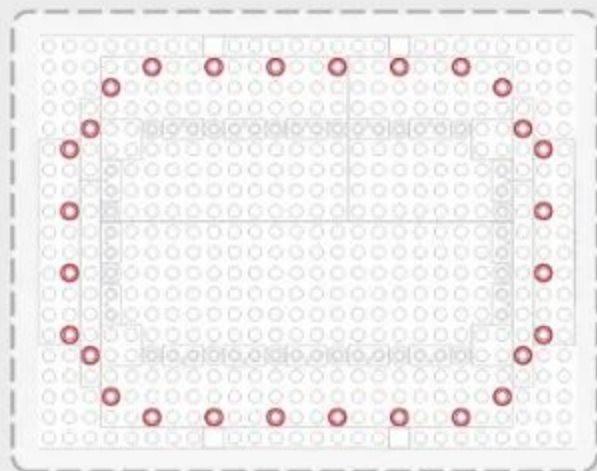

3-3

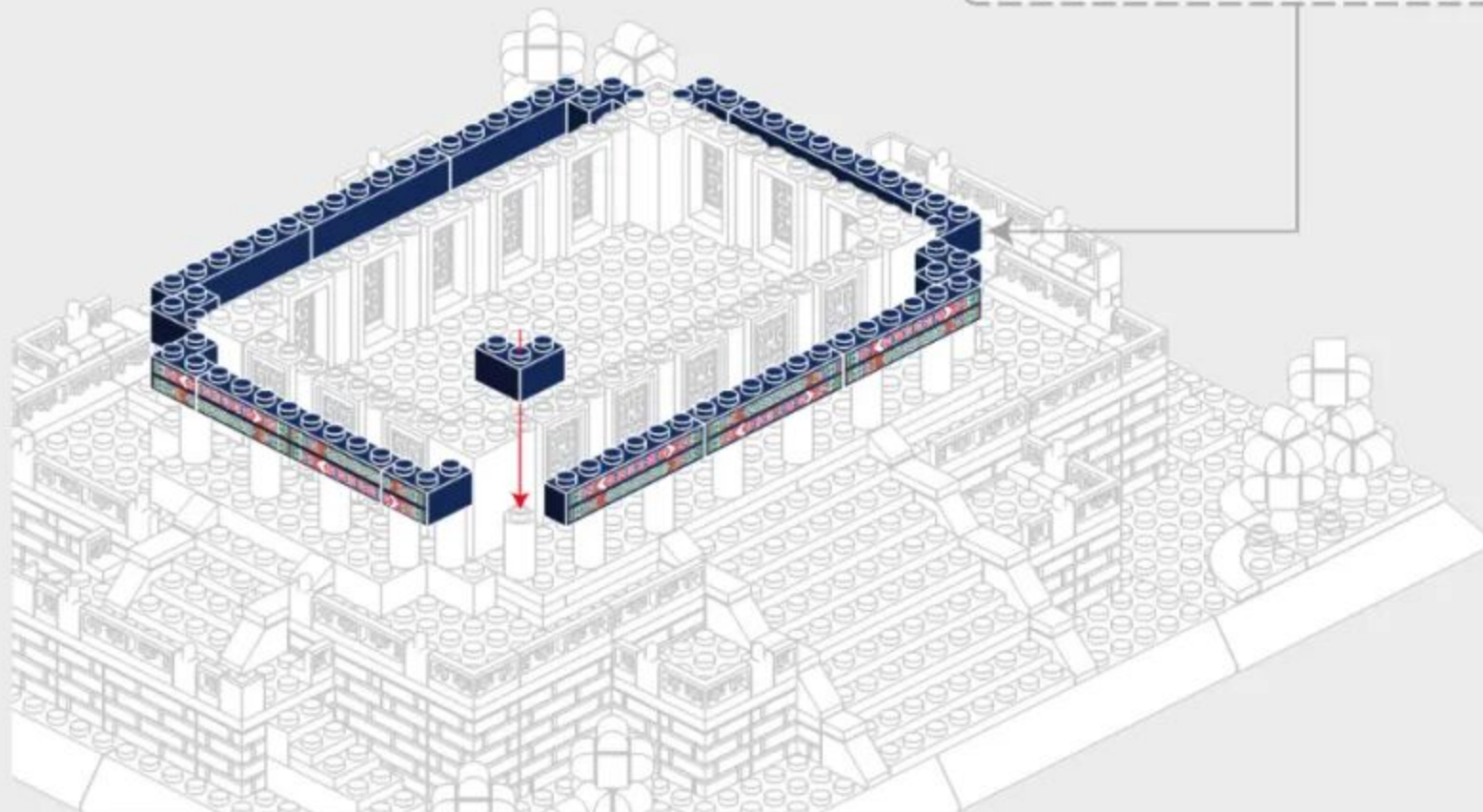
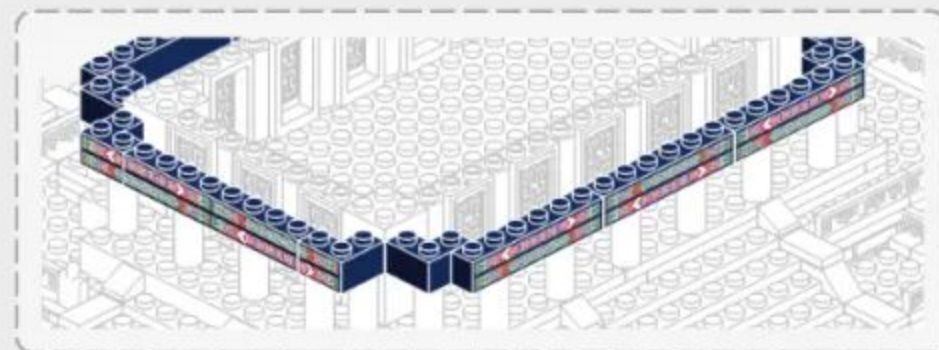

3-4

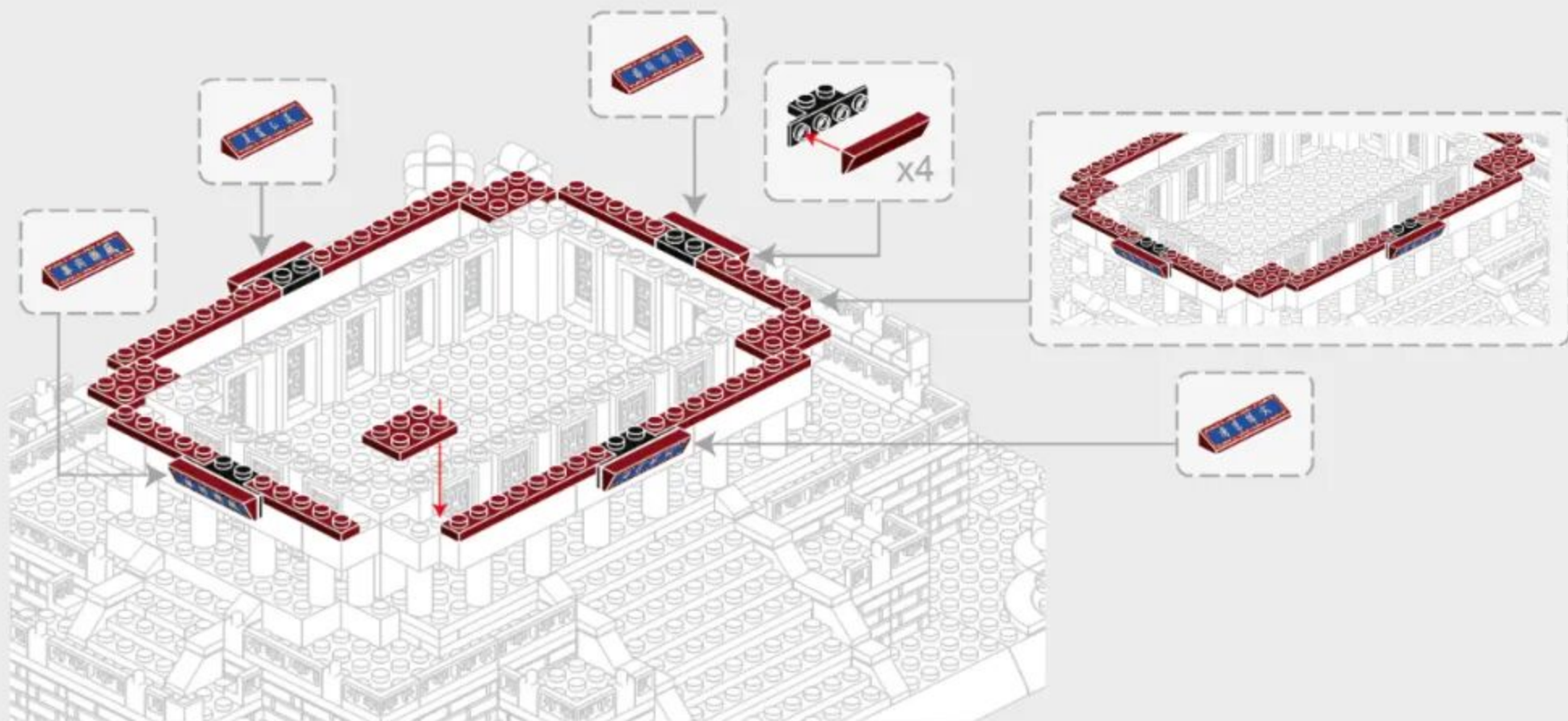

3-5

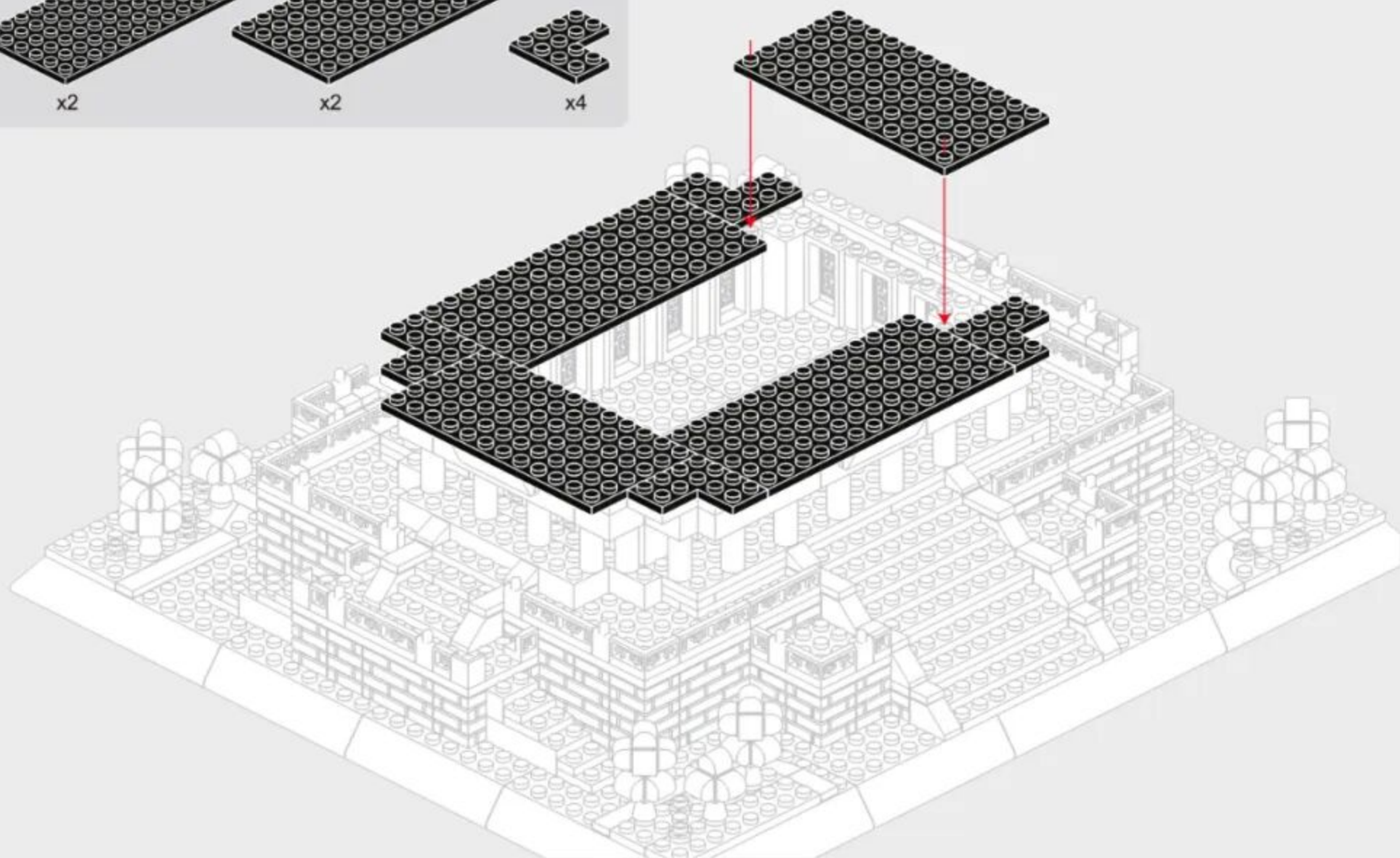
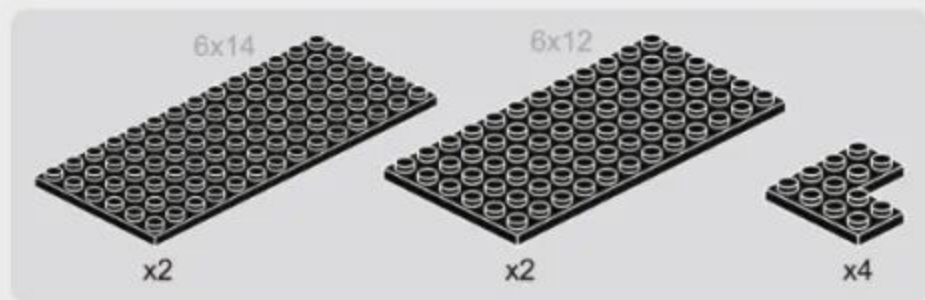

3-6

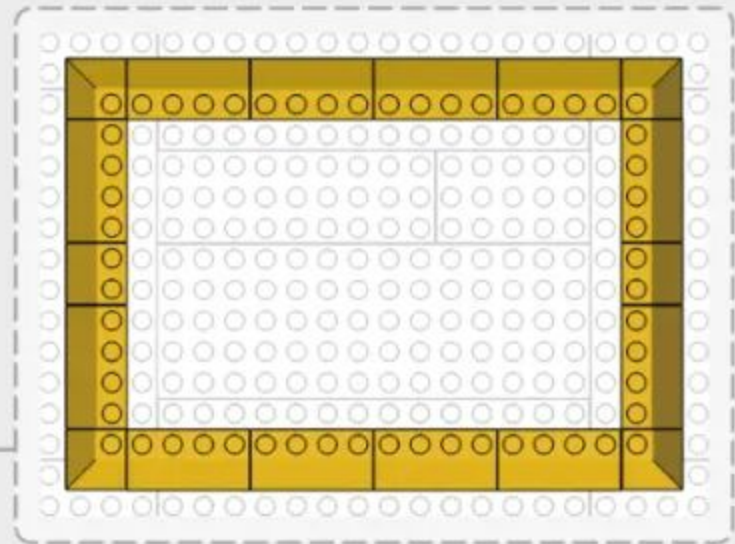
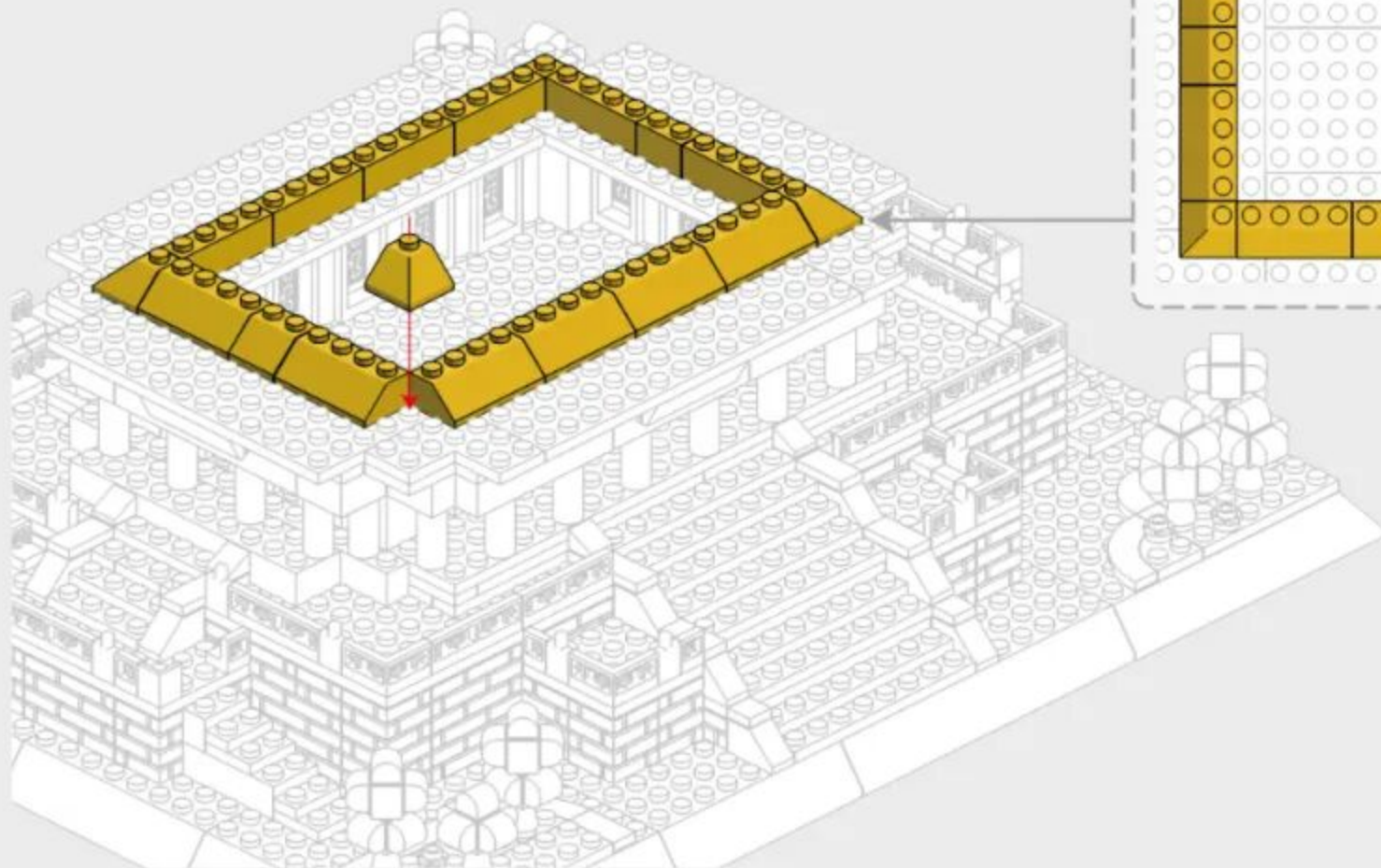

3-7



x12



x2

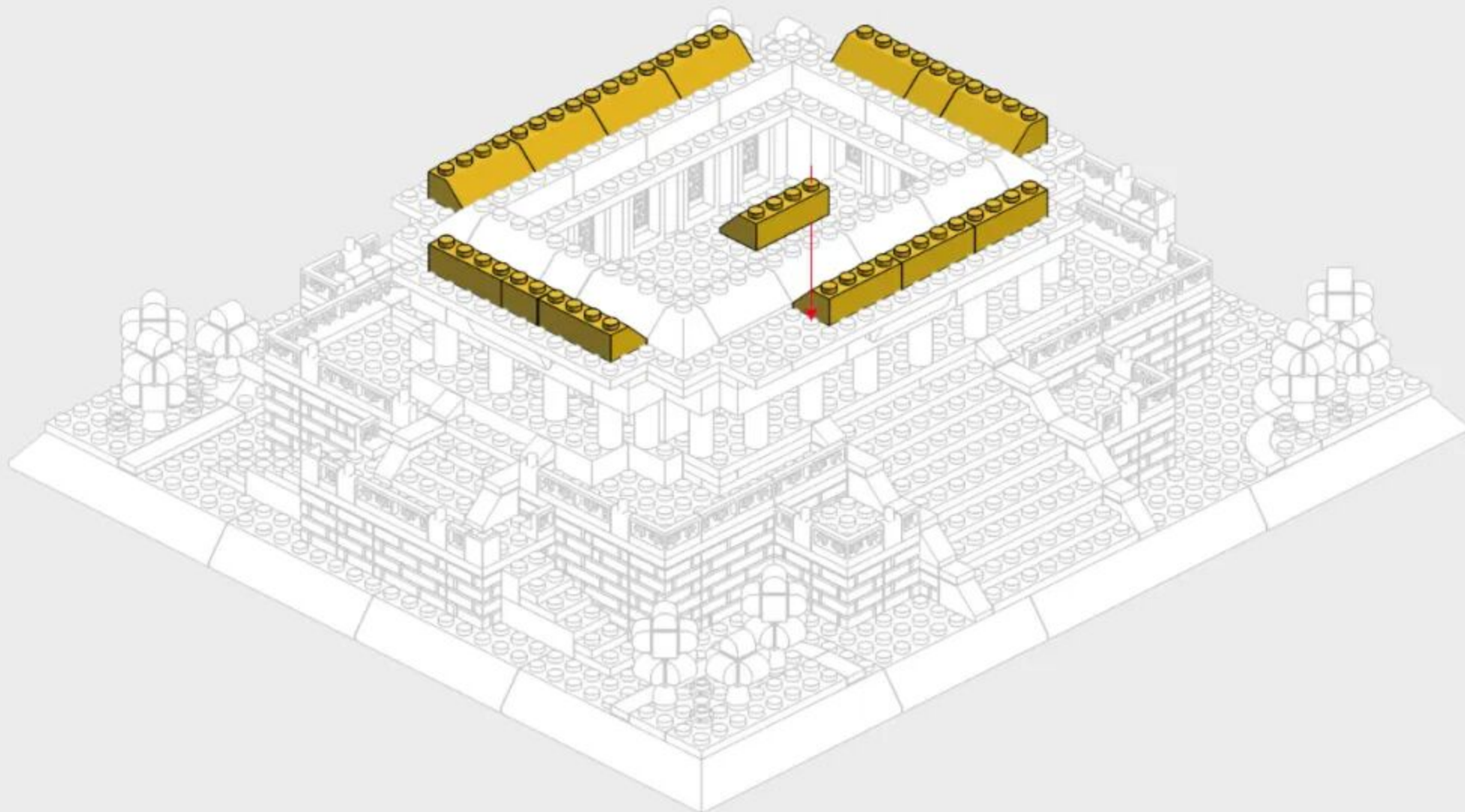

3-8



x8



x12

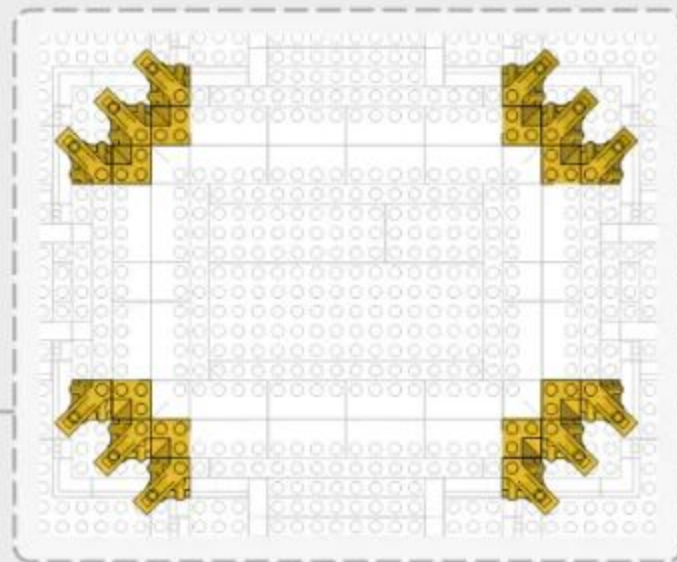
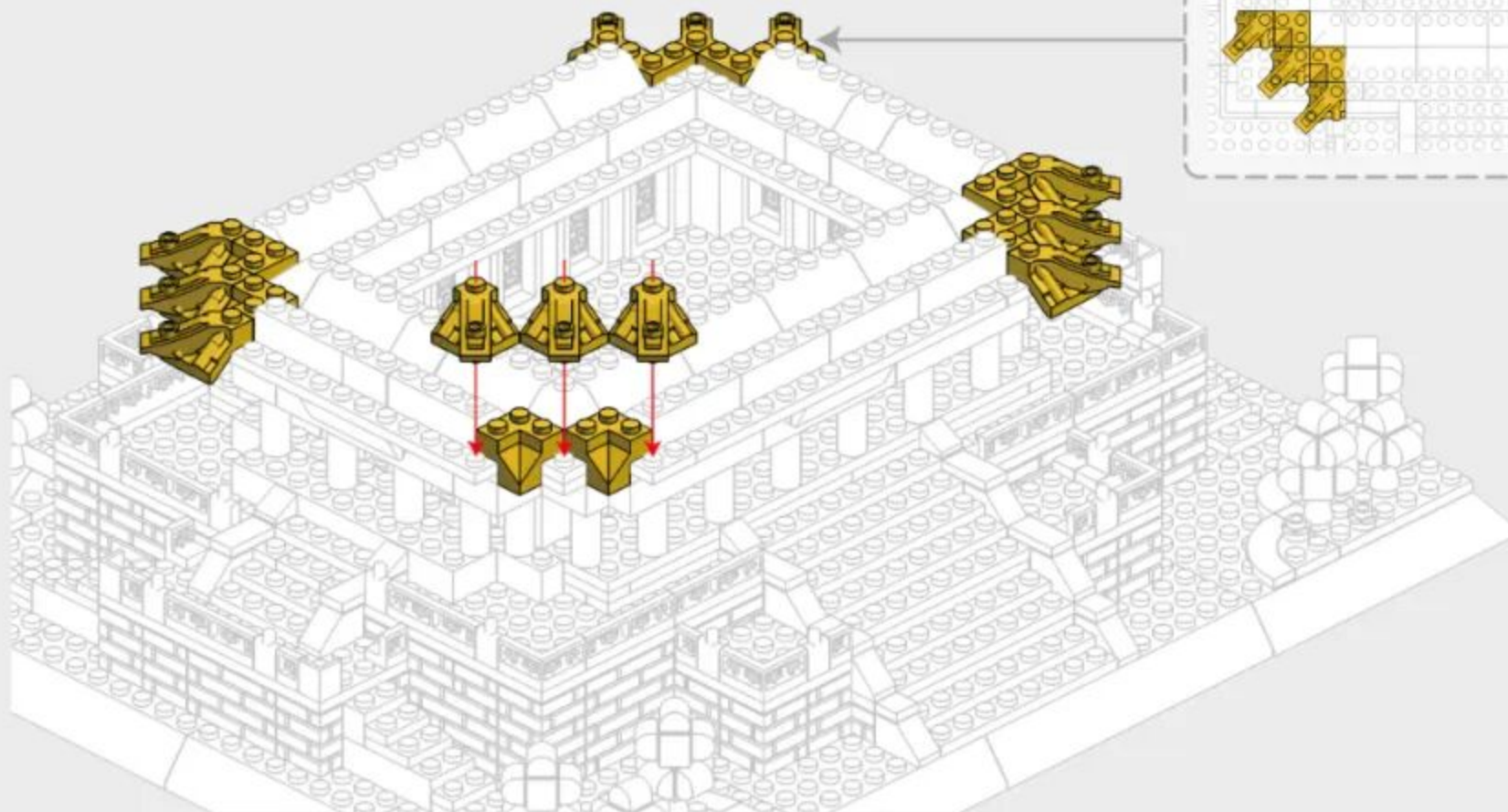

3-9

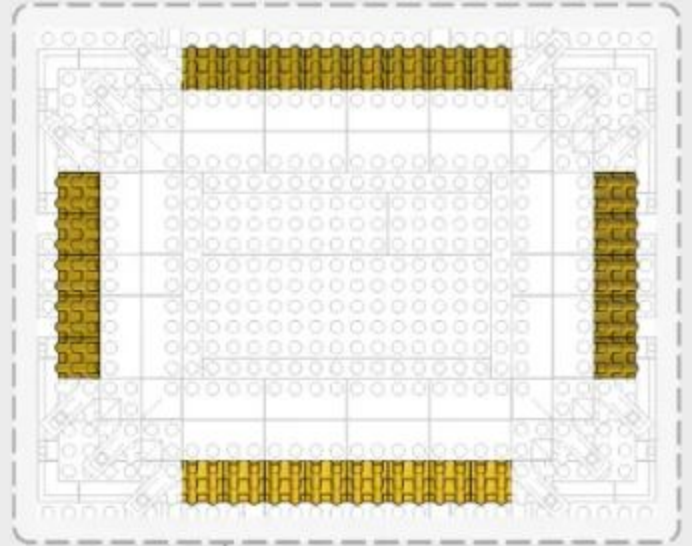

3-11



x8



x16

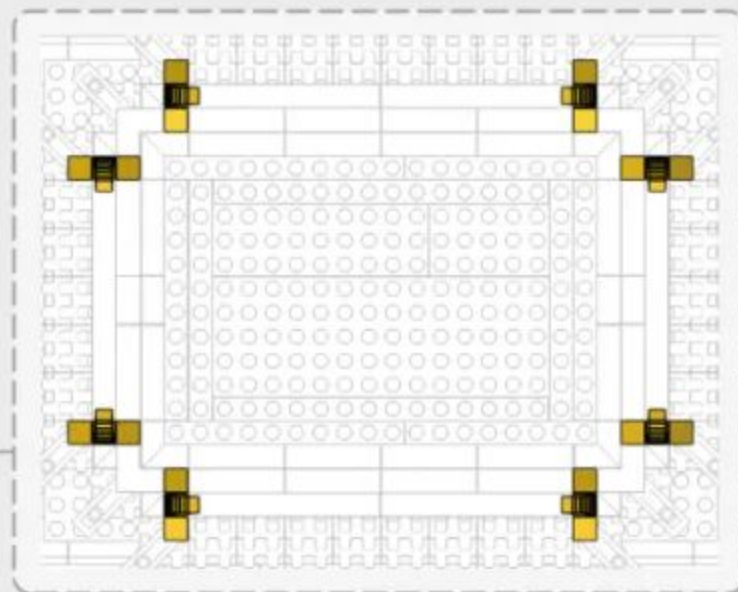
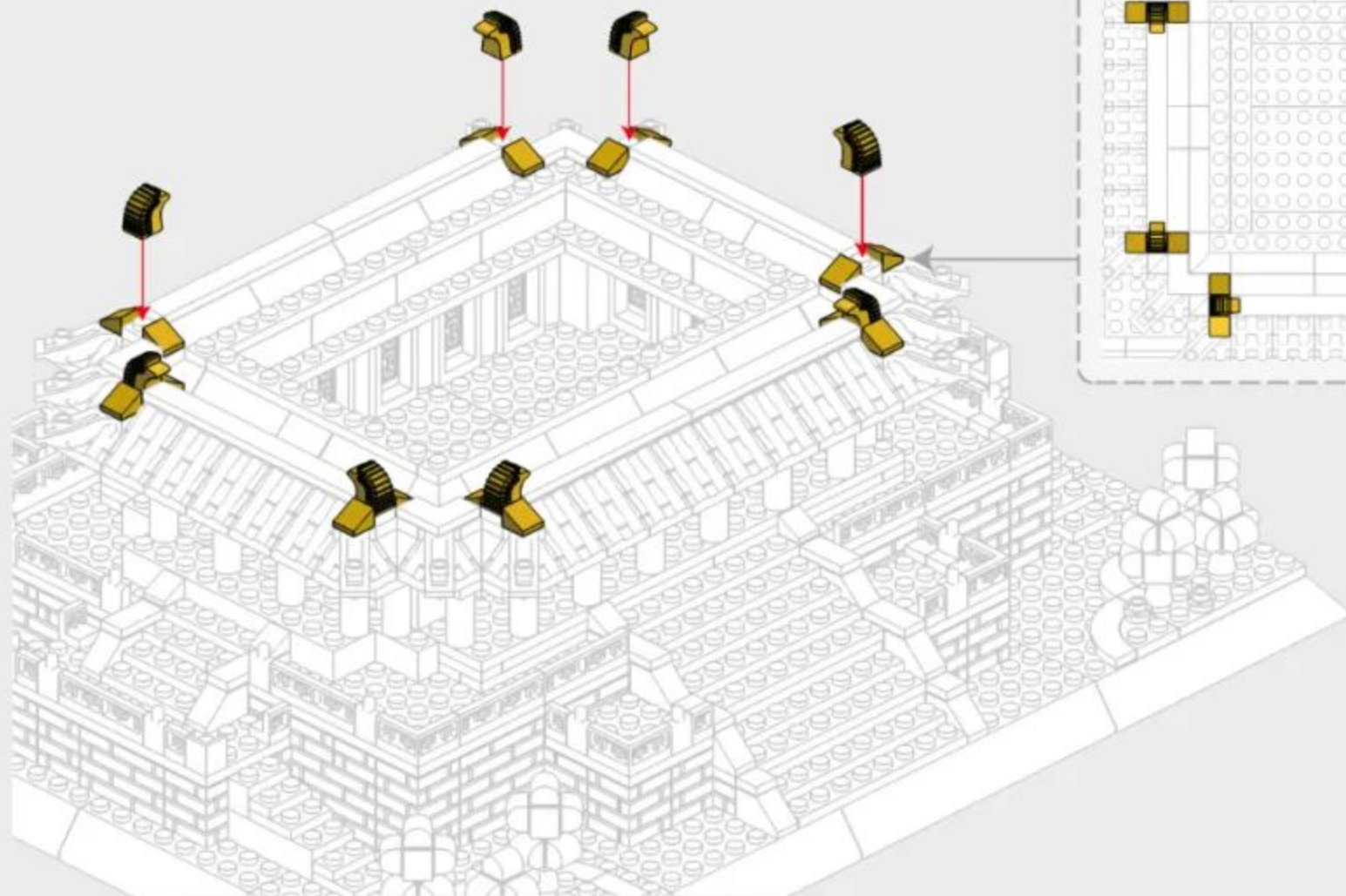



254PCS

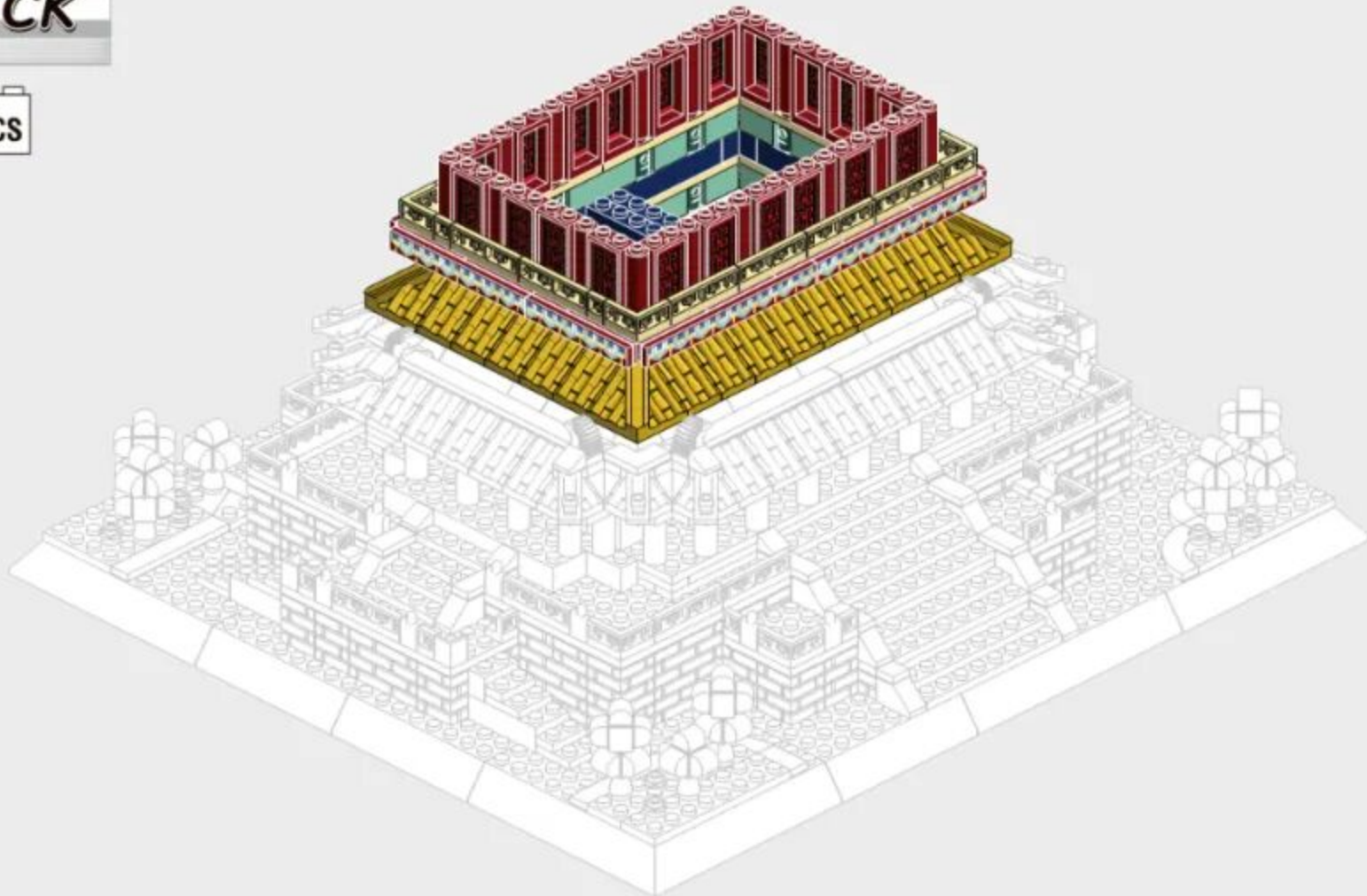

59

4-1

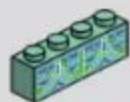

x4



x12



x16



x16

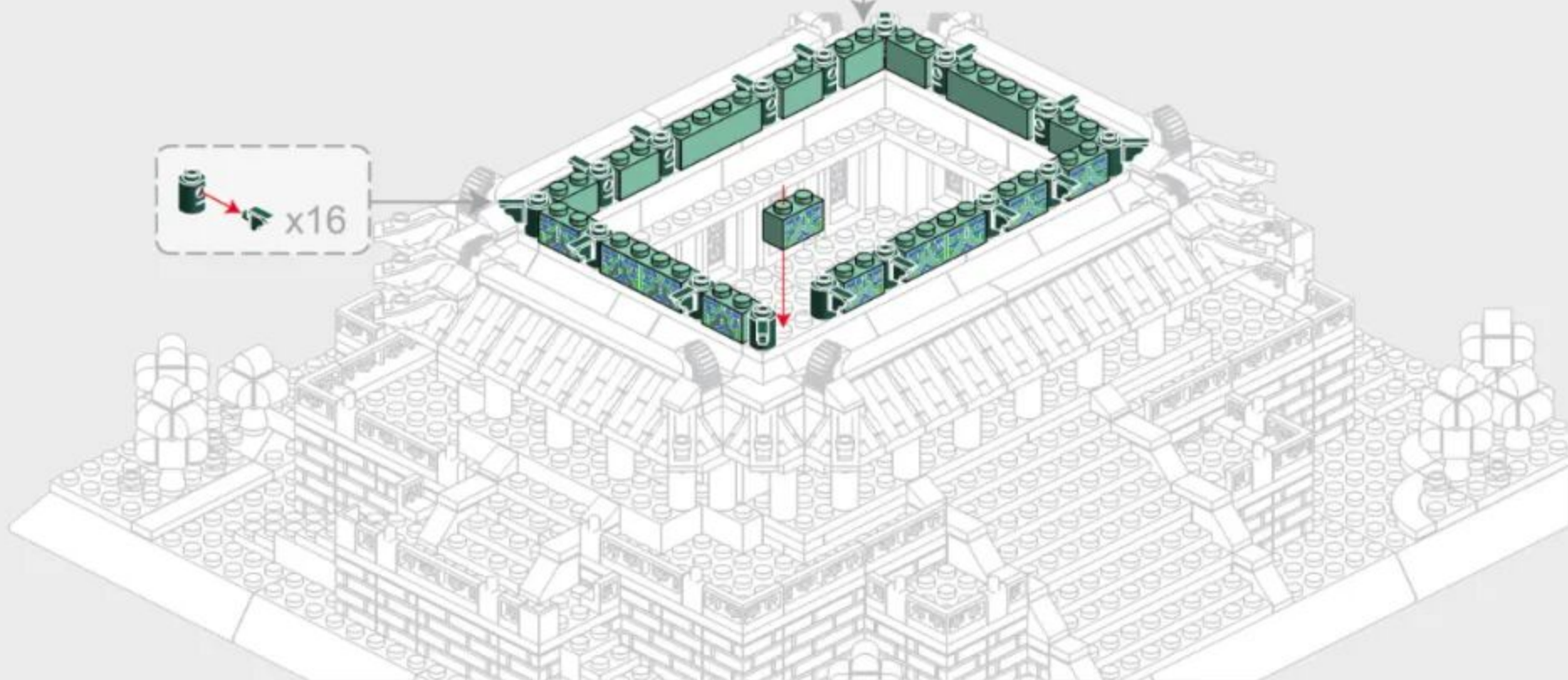
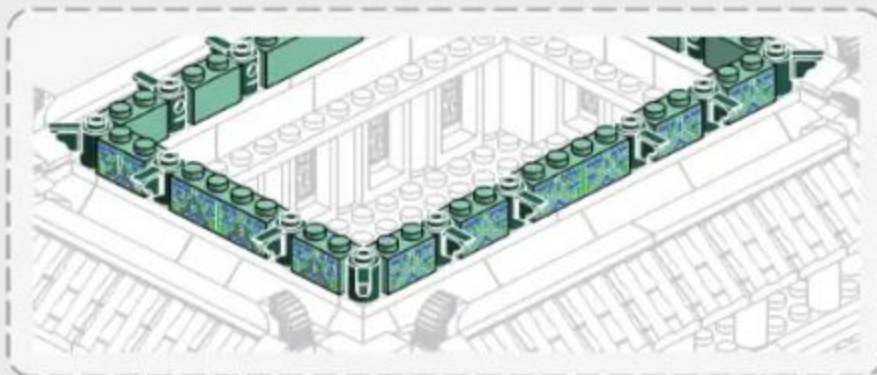

4-2

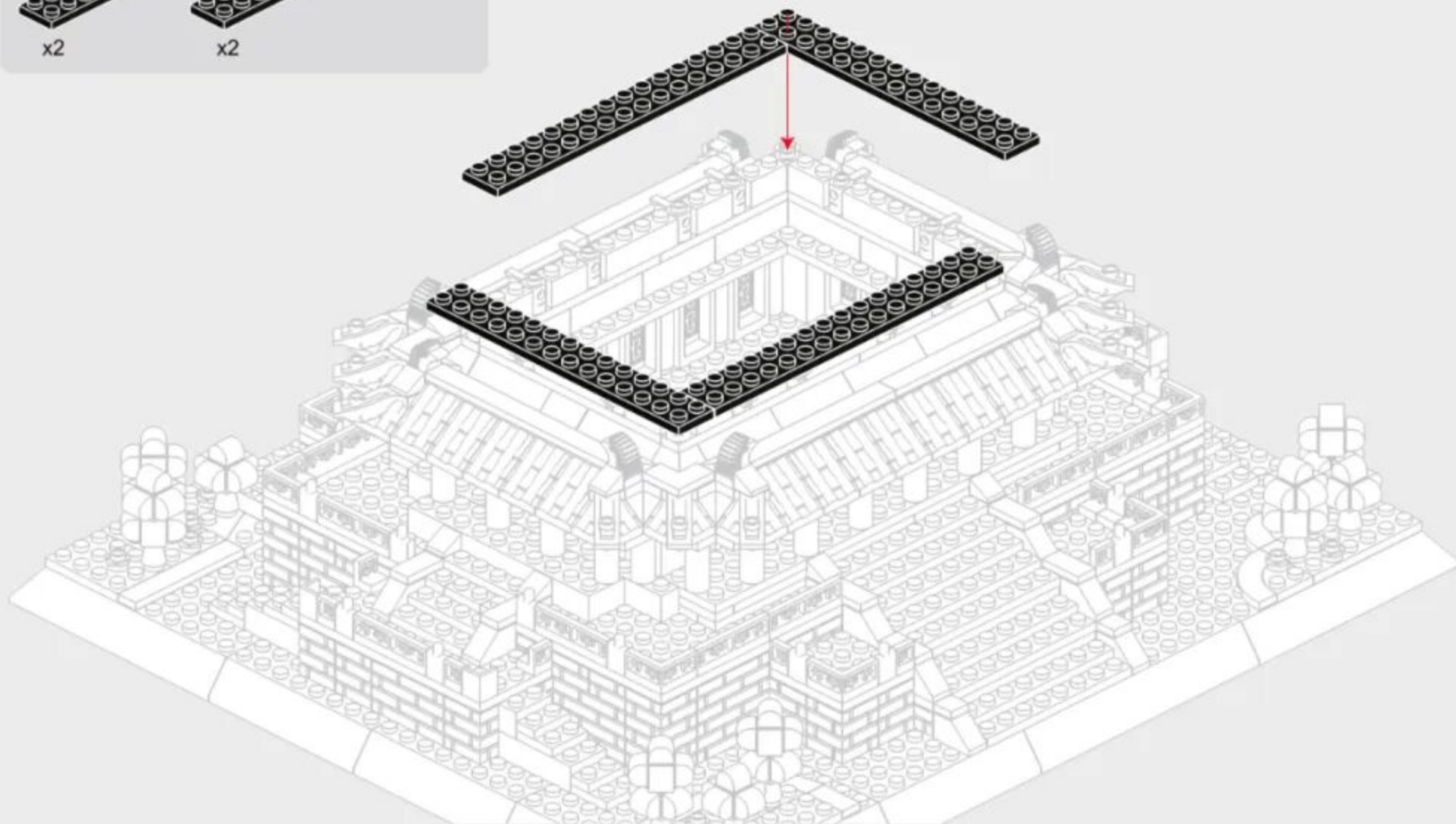
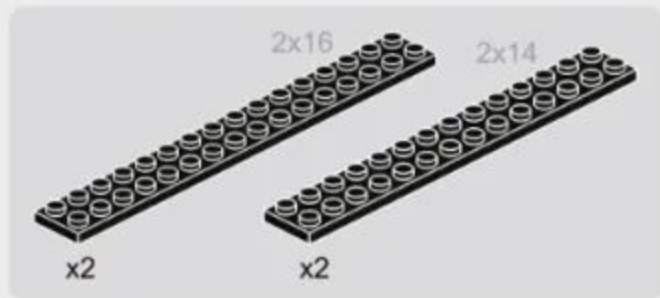

4-3

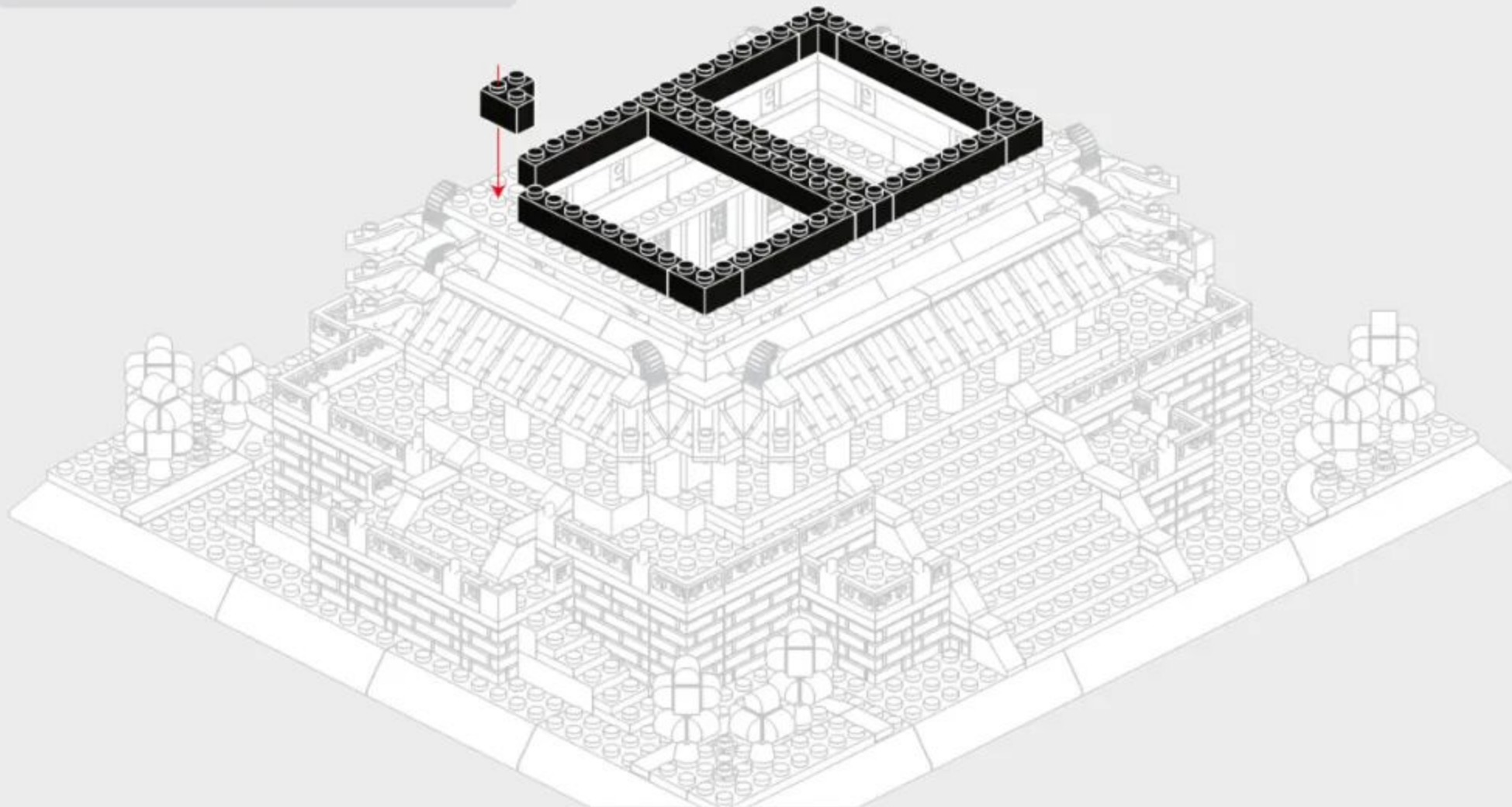
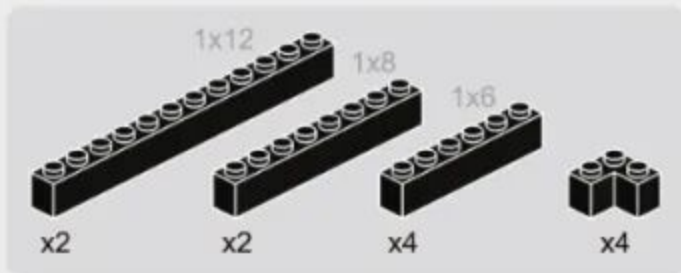

4-4



x4



x26

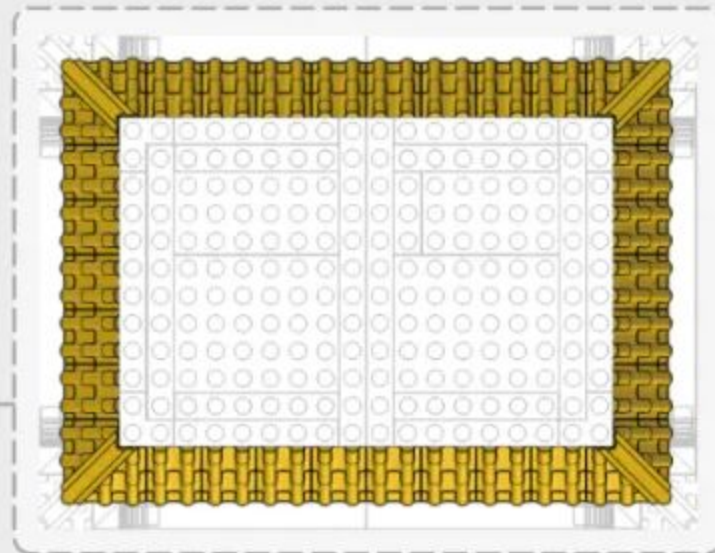
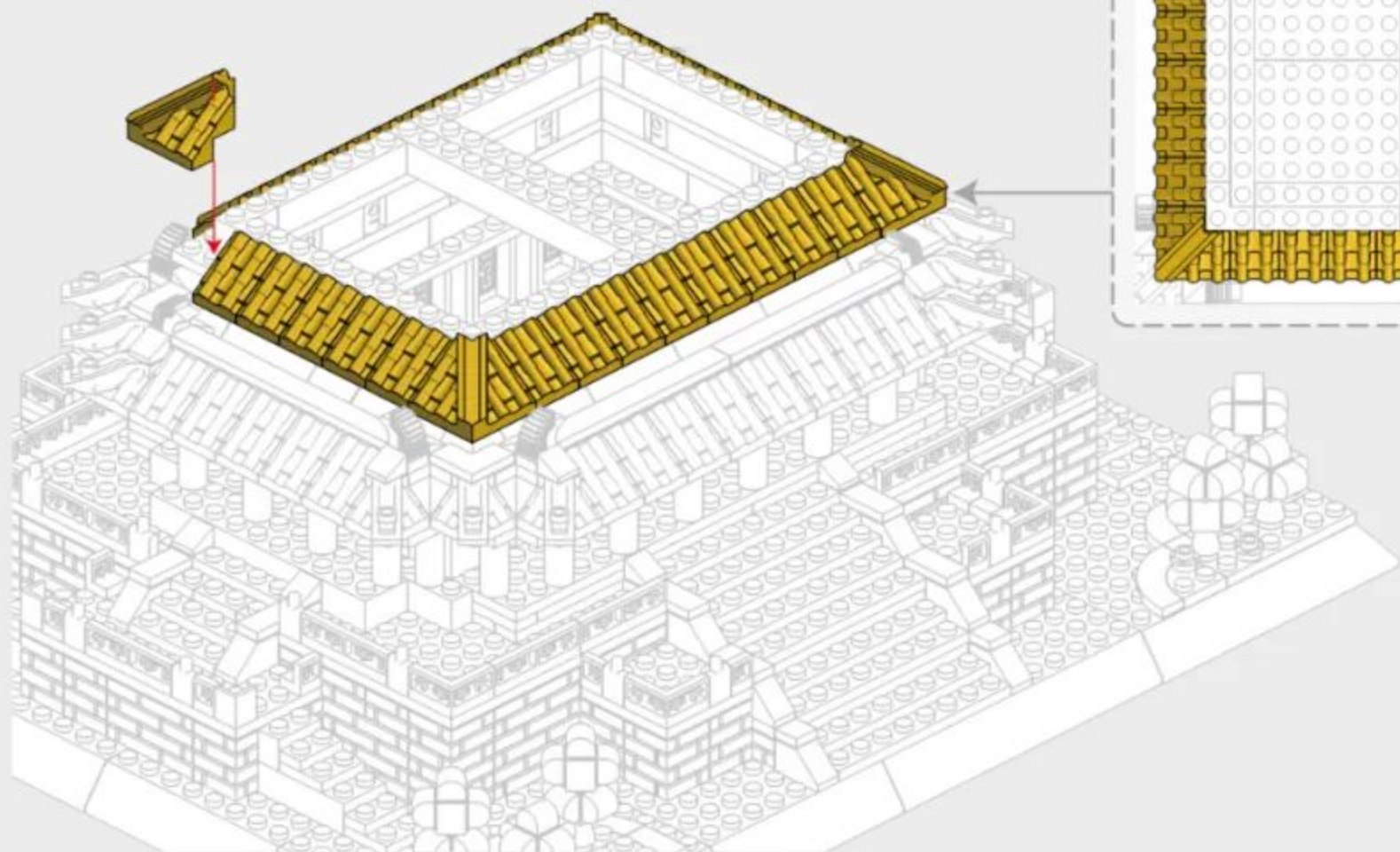

4-5

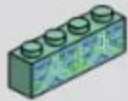

x4



x12



x16



x16

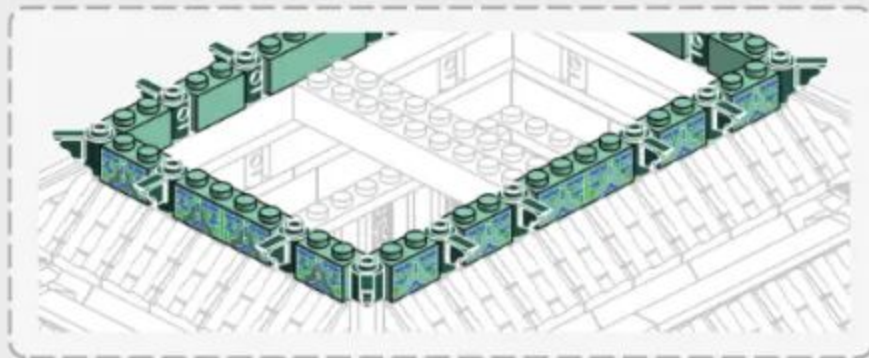

x16

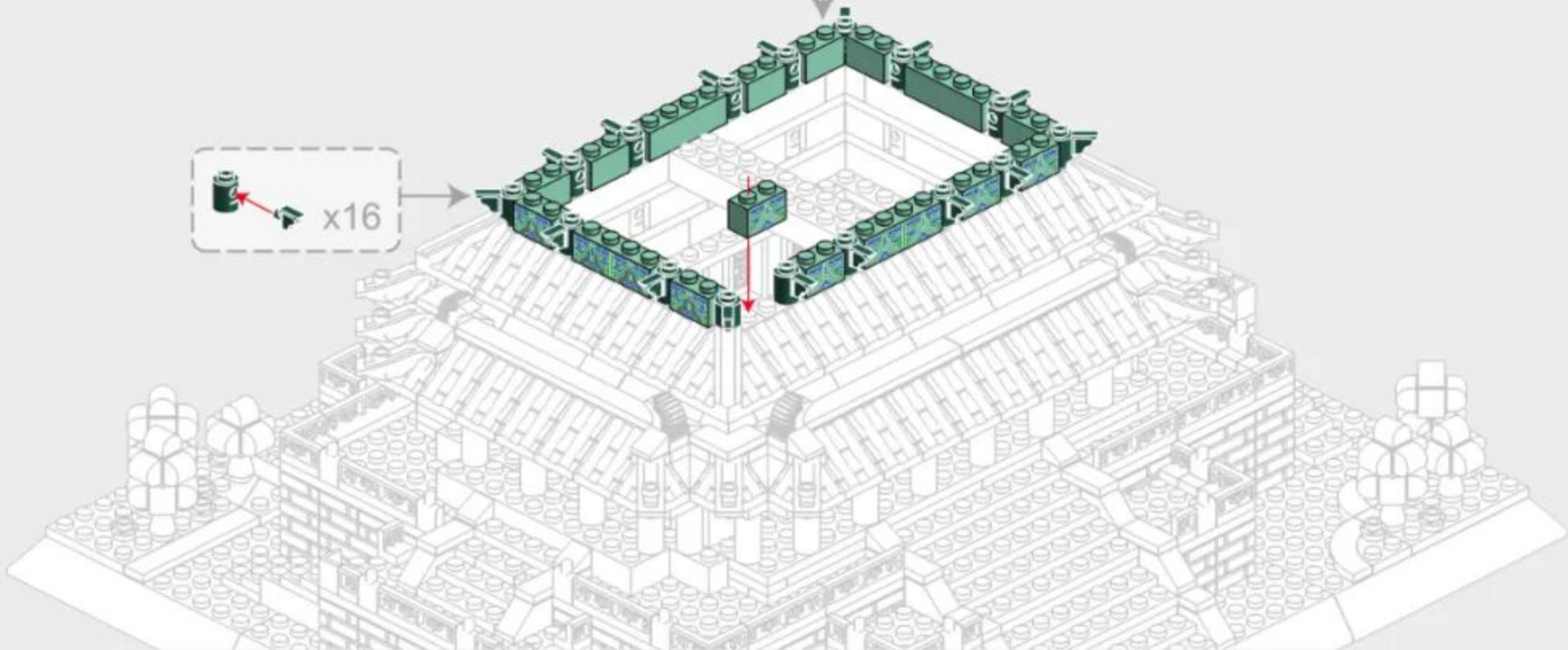

4-6

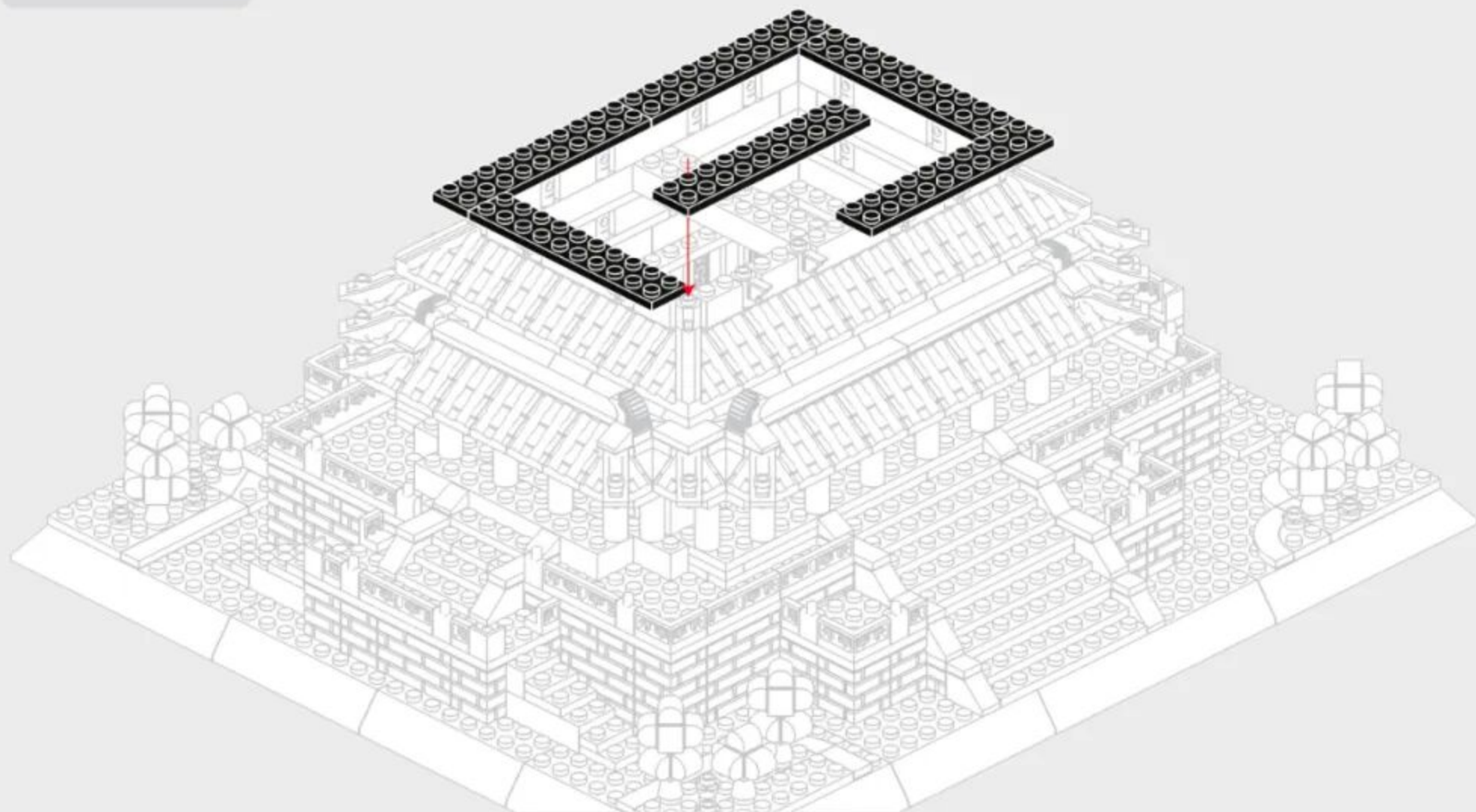
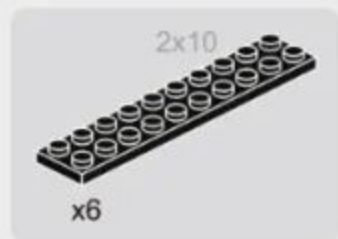

4-7

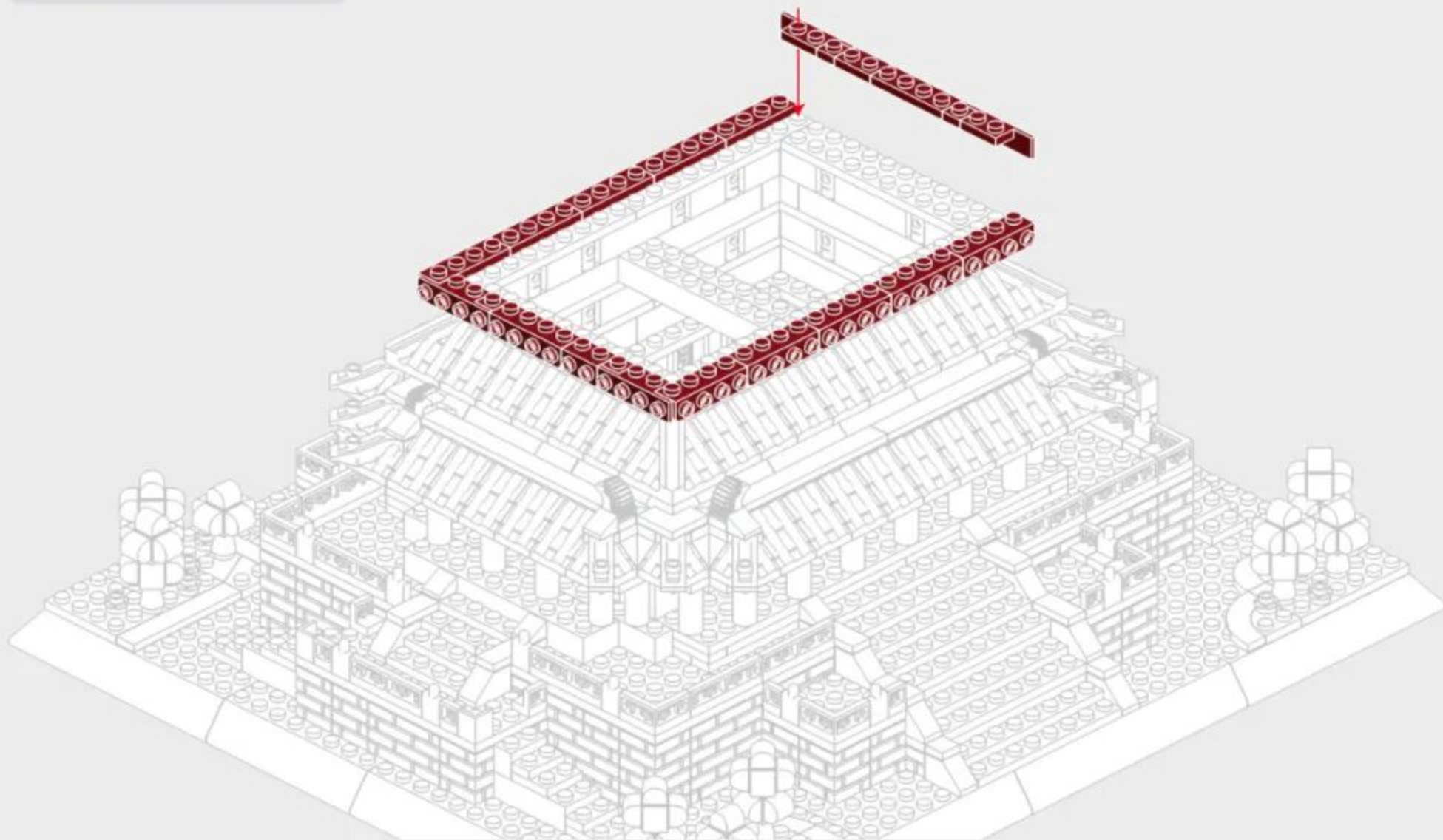

4-8

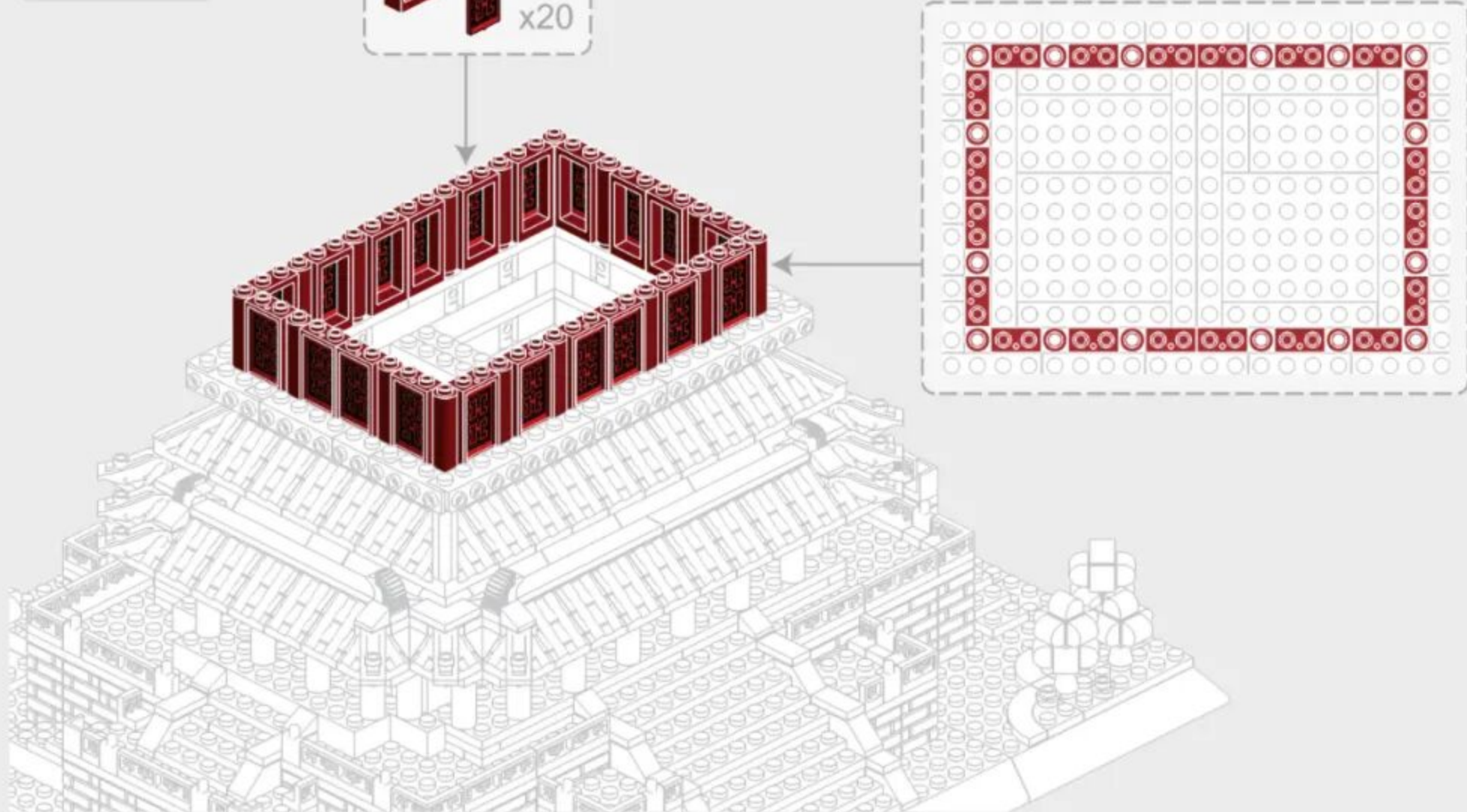

4-9

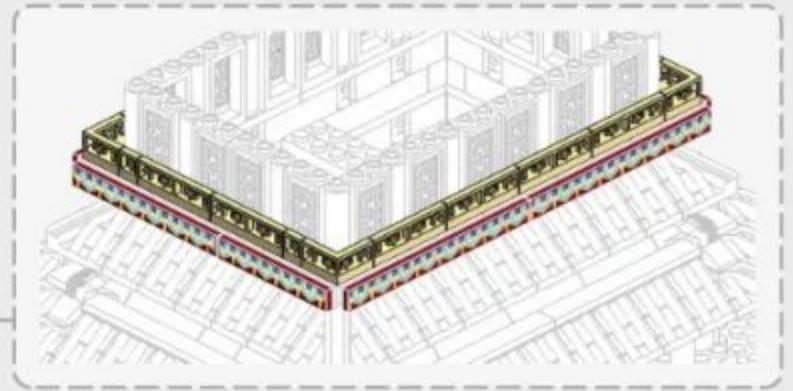
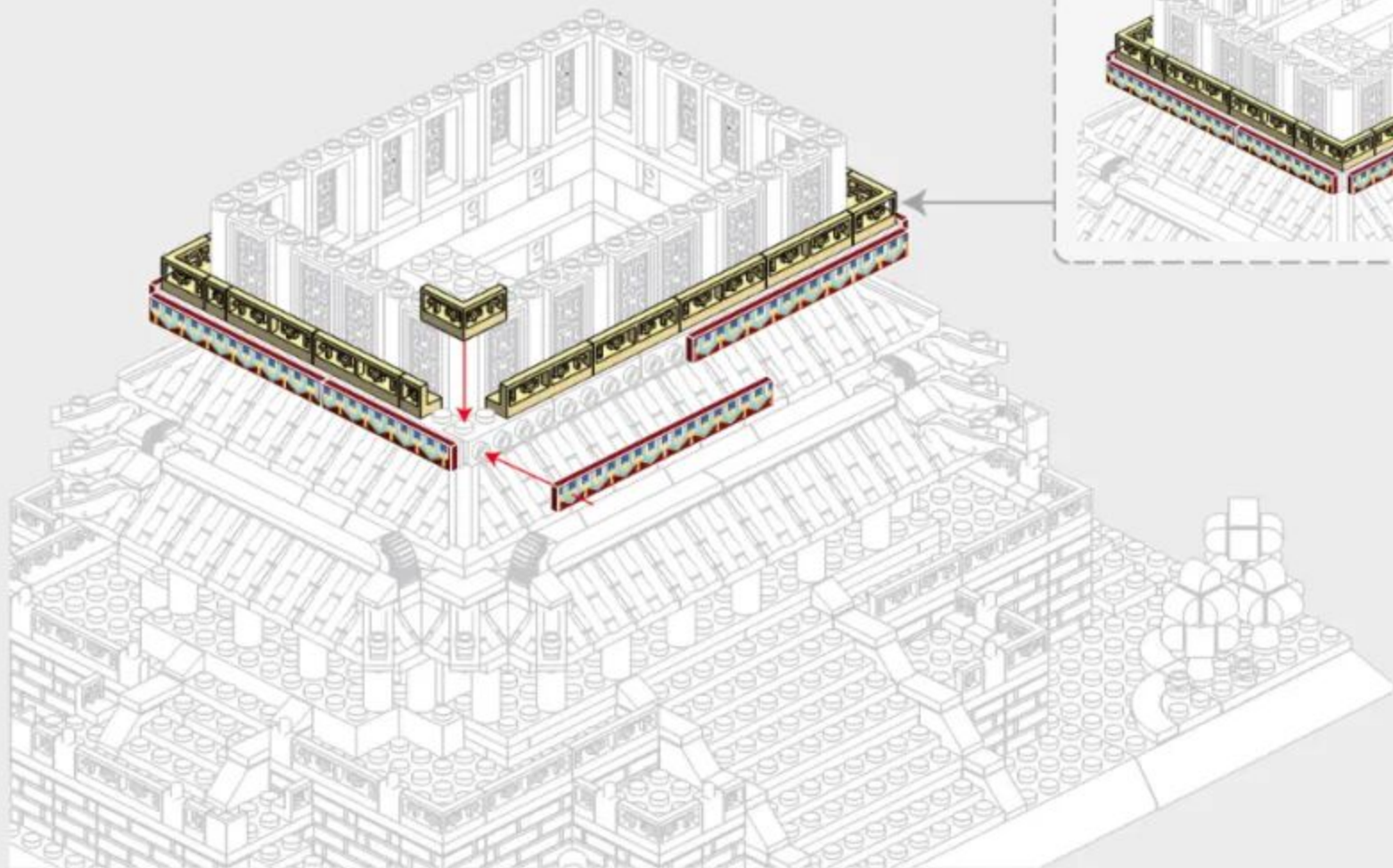
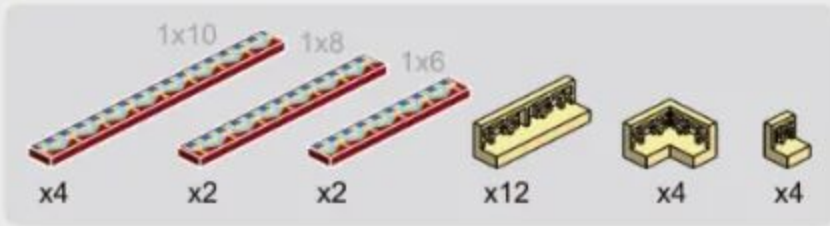



281 PCS

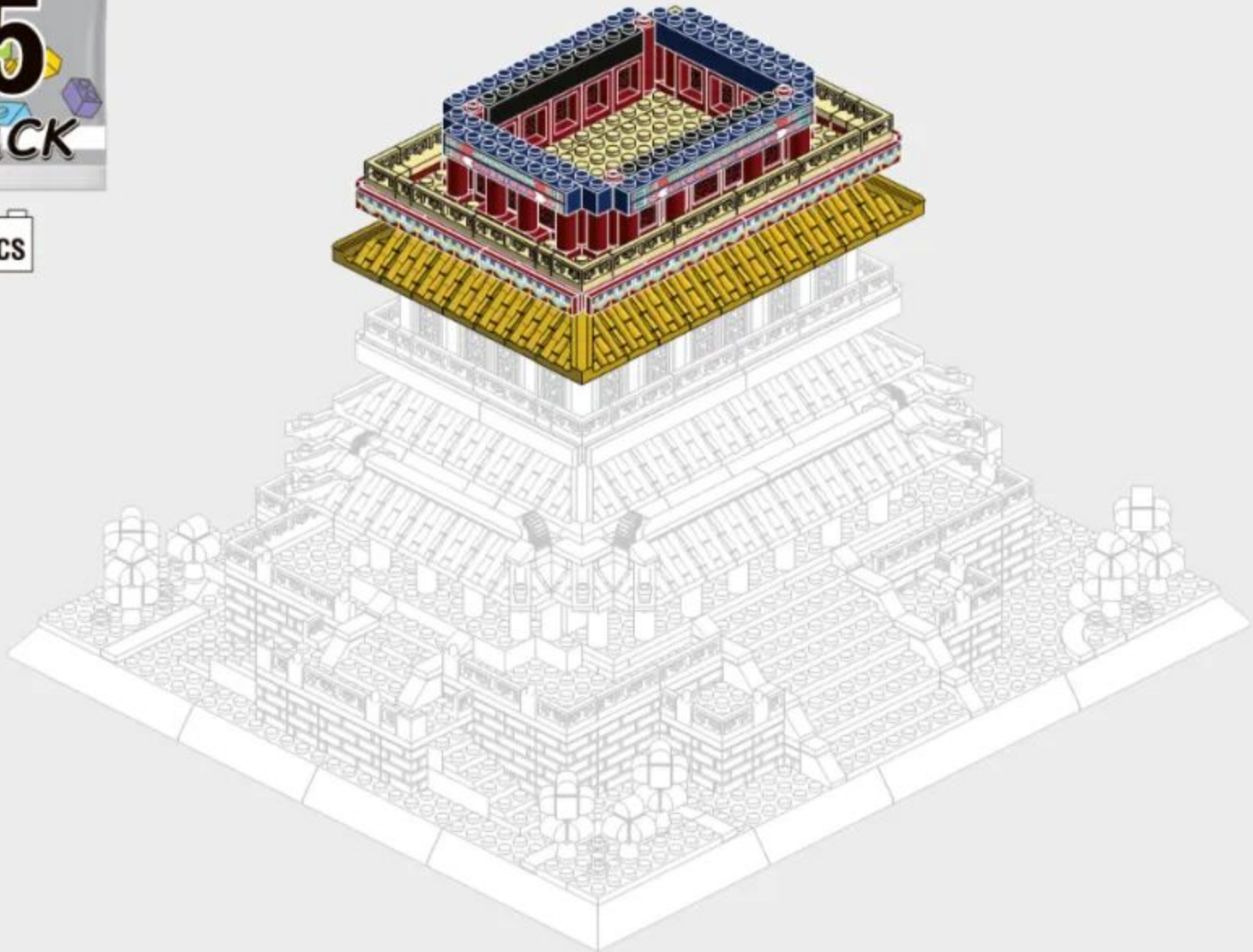

69

5-1



x4



x12



x16



x16

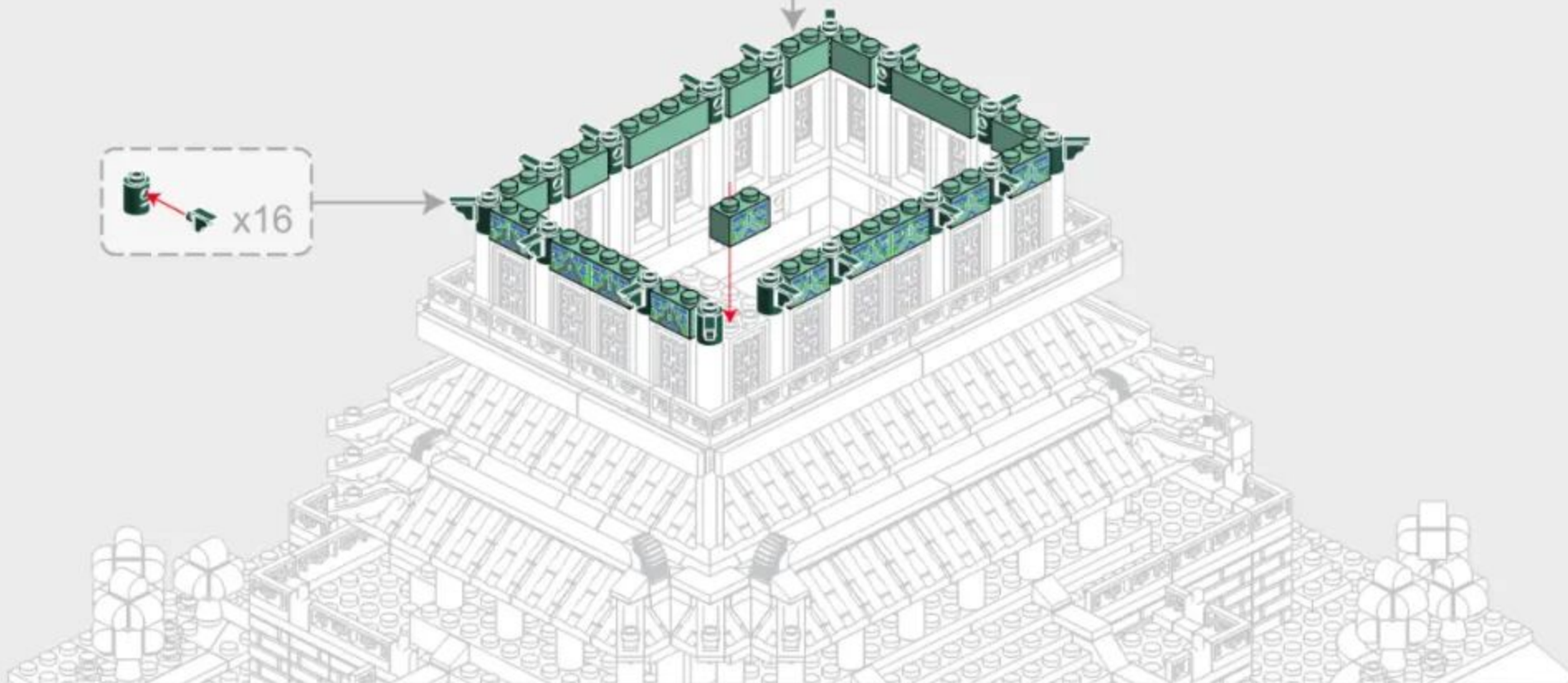
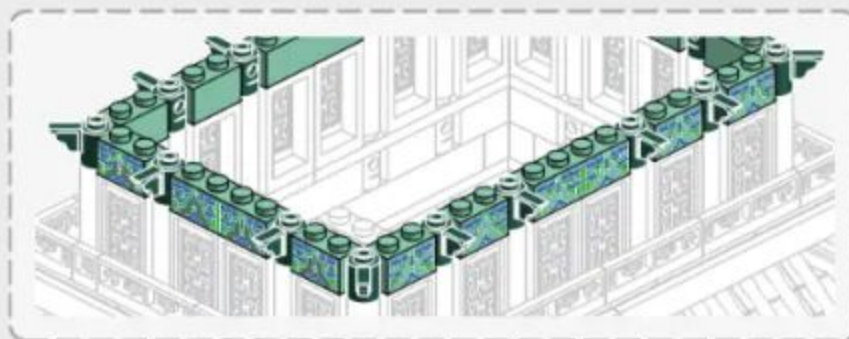

5-2

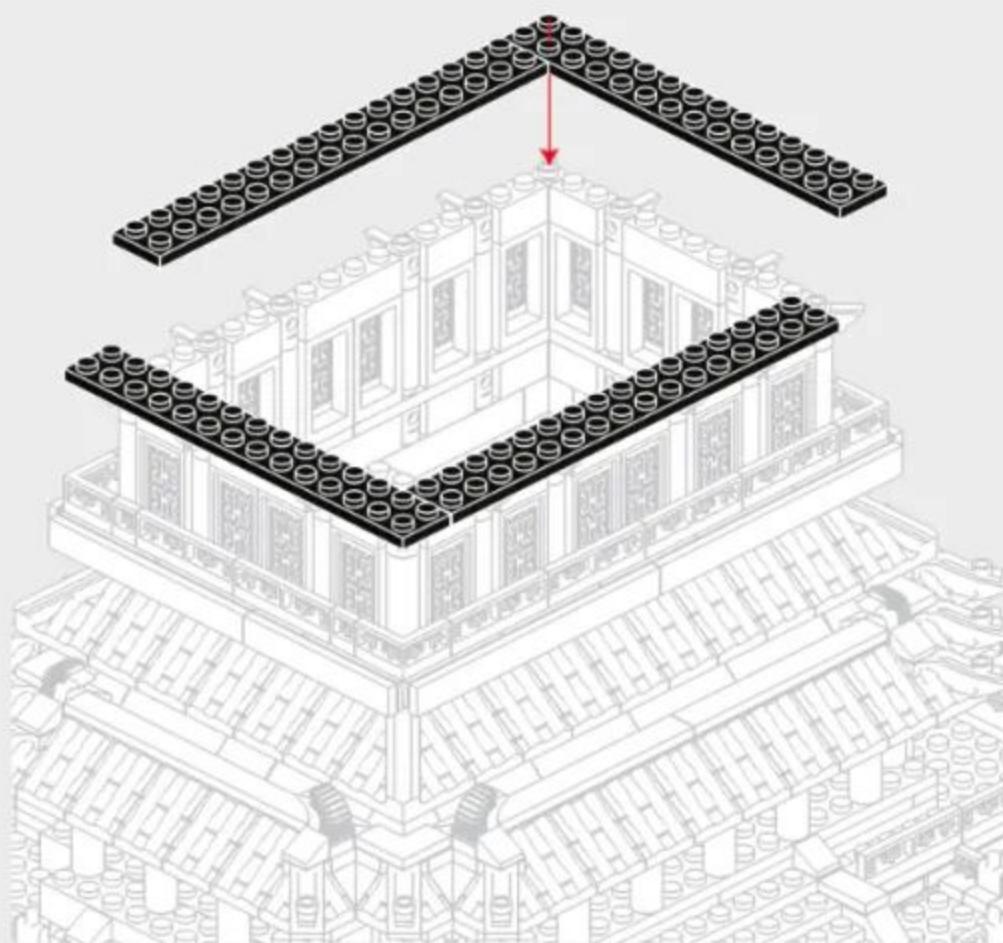
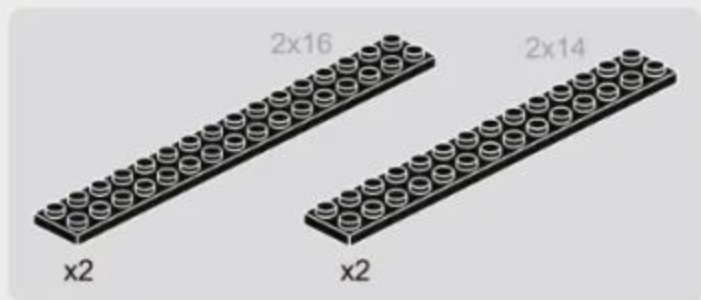

5-3

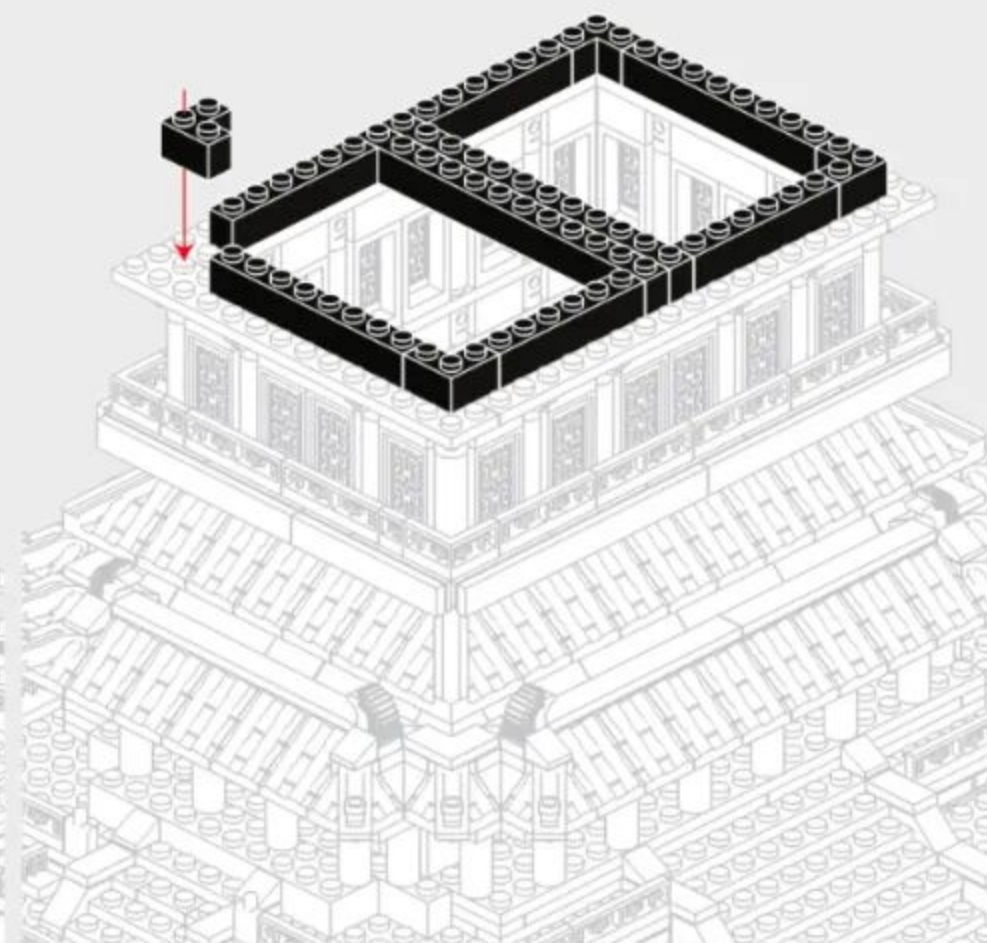
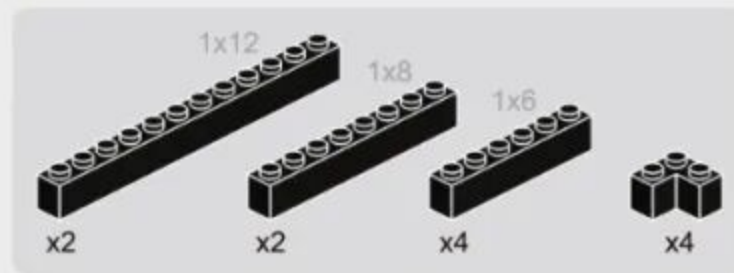

5-4

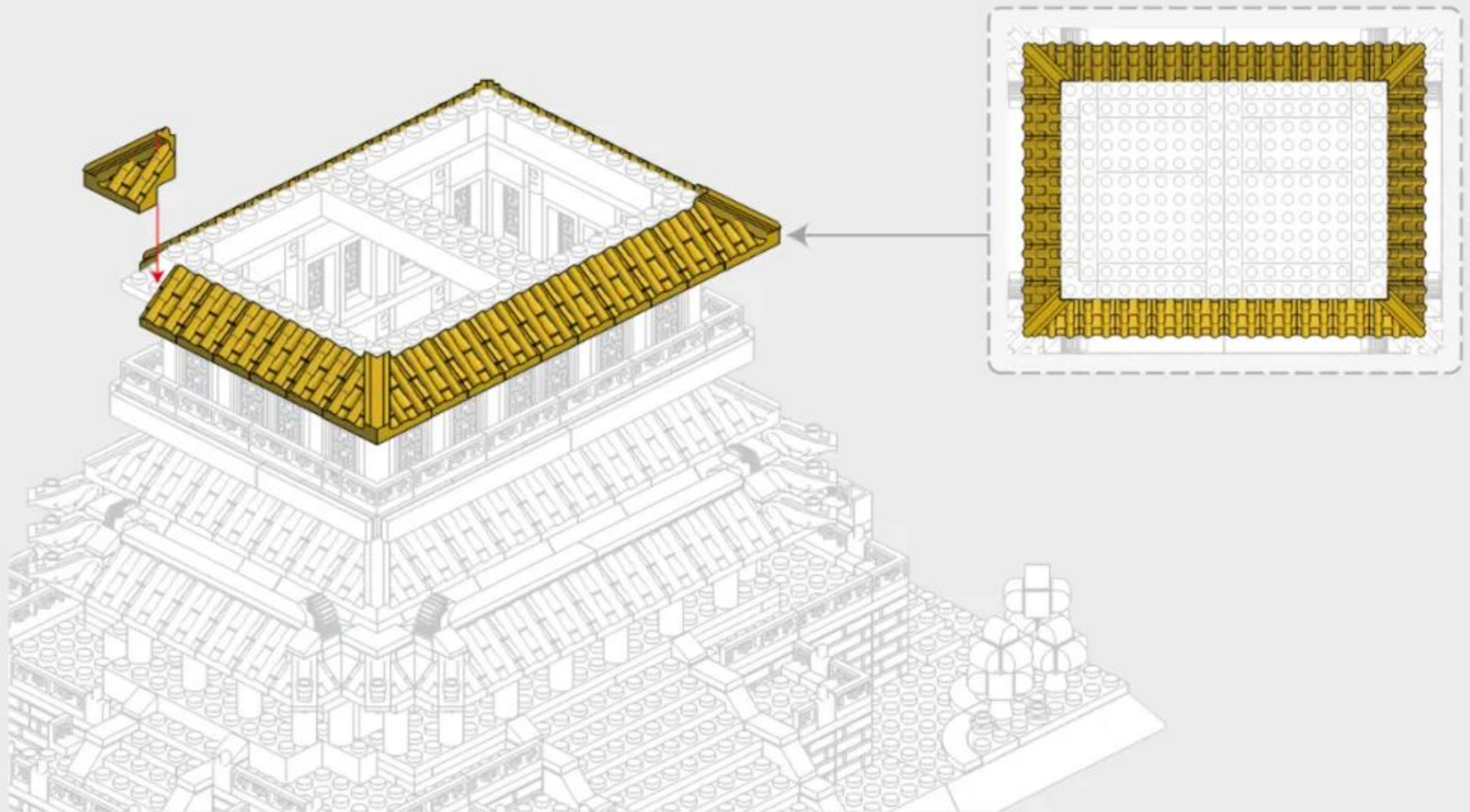

5-5

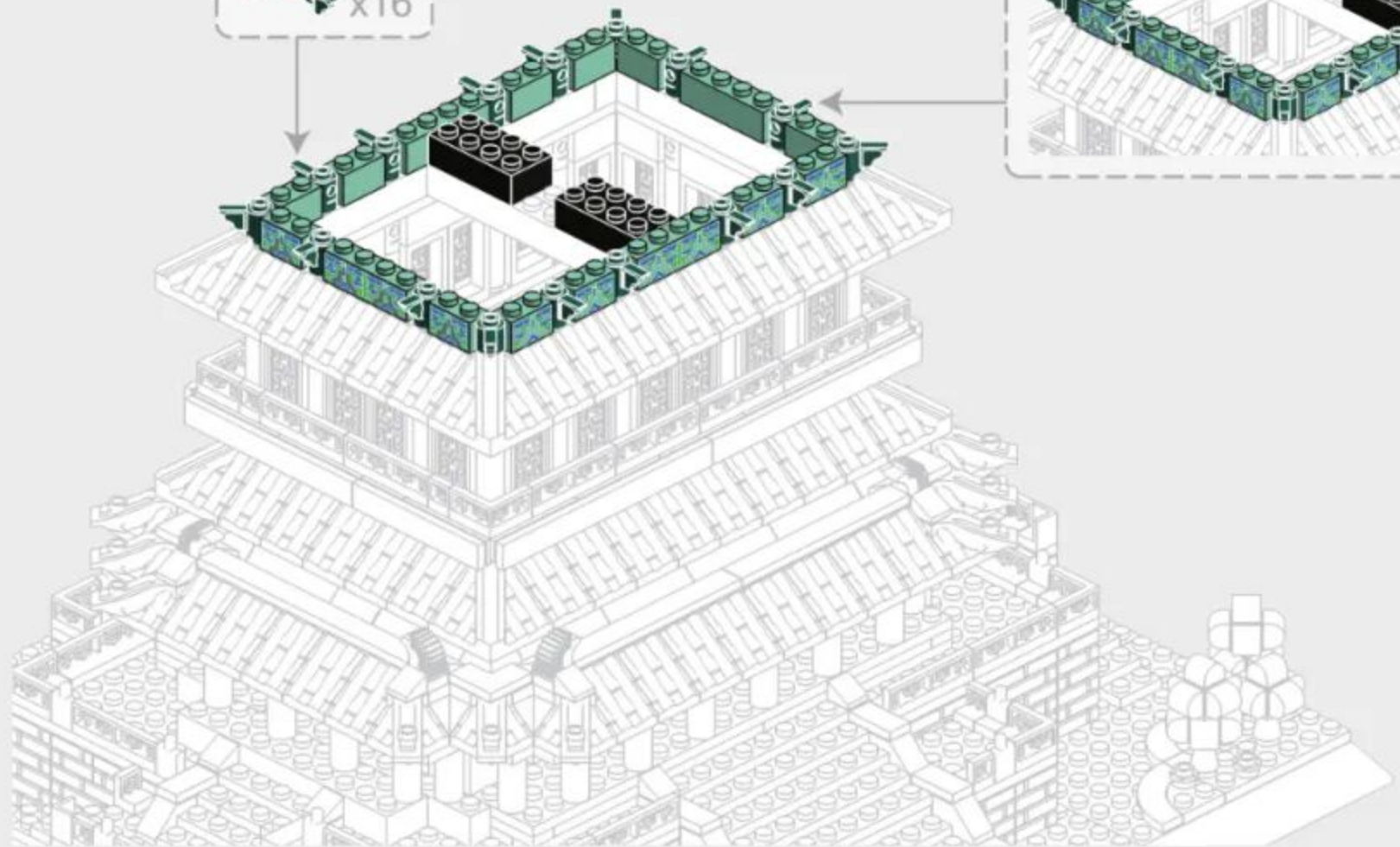
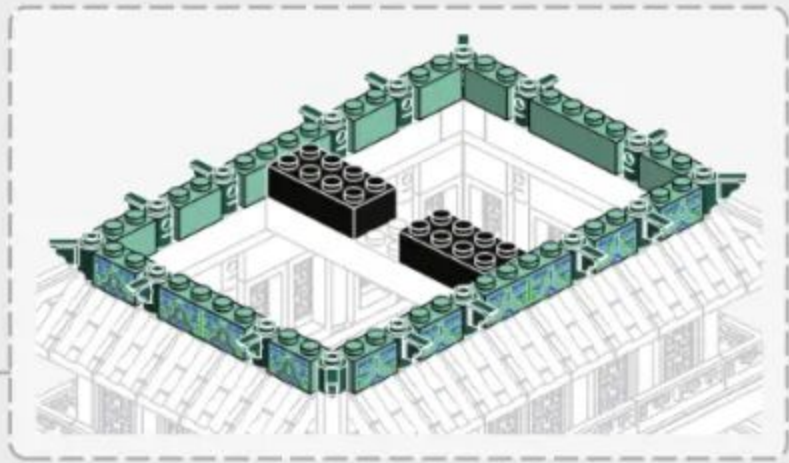

5-6

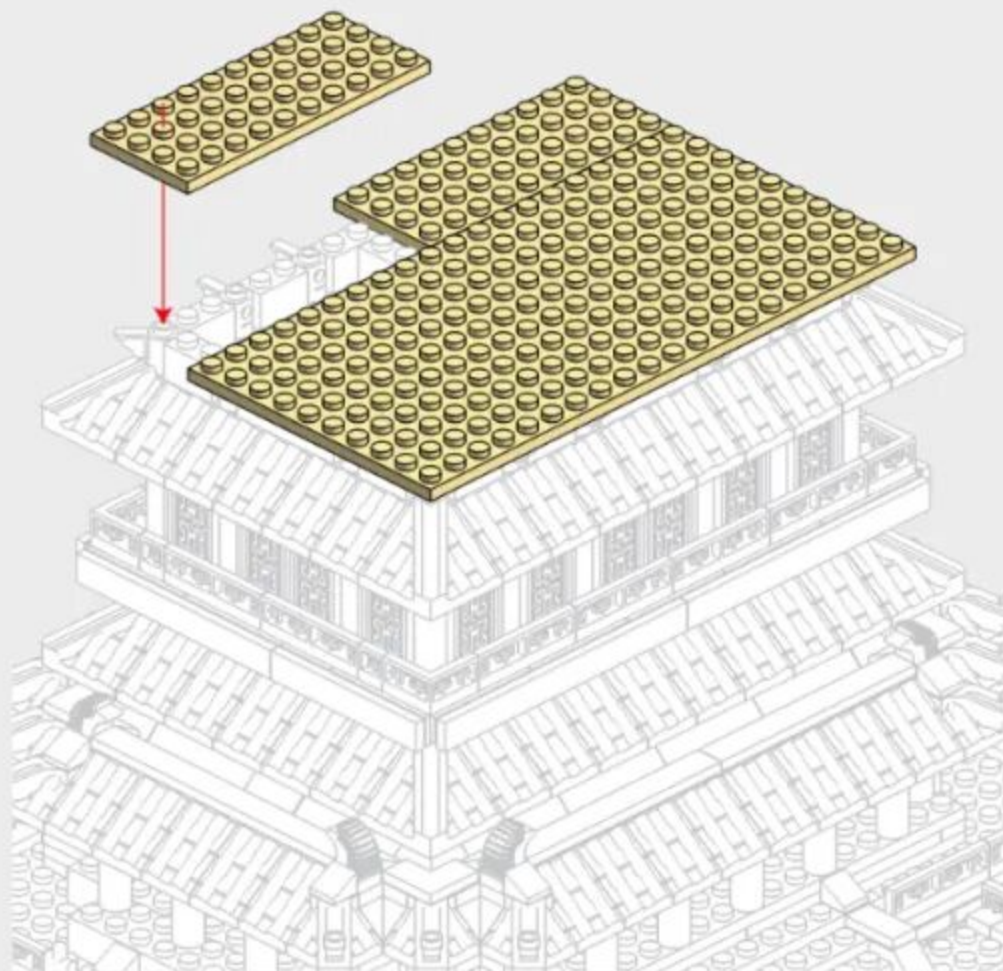
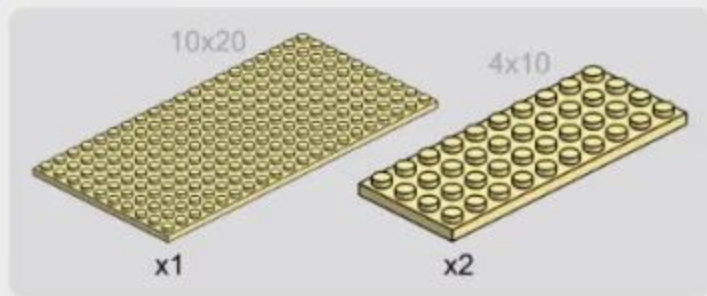

5-7

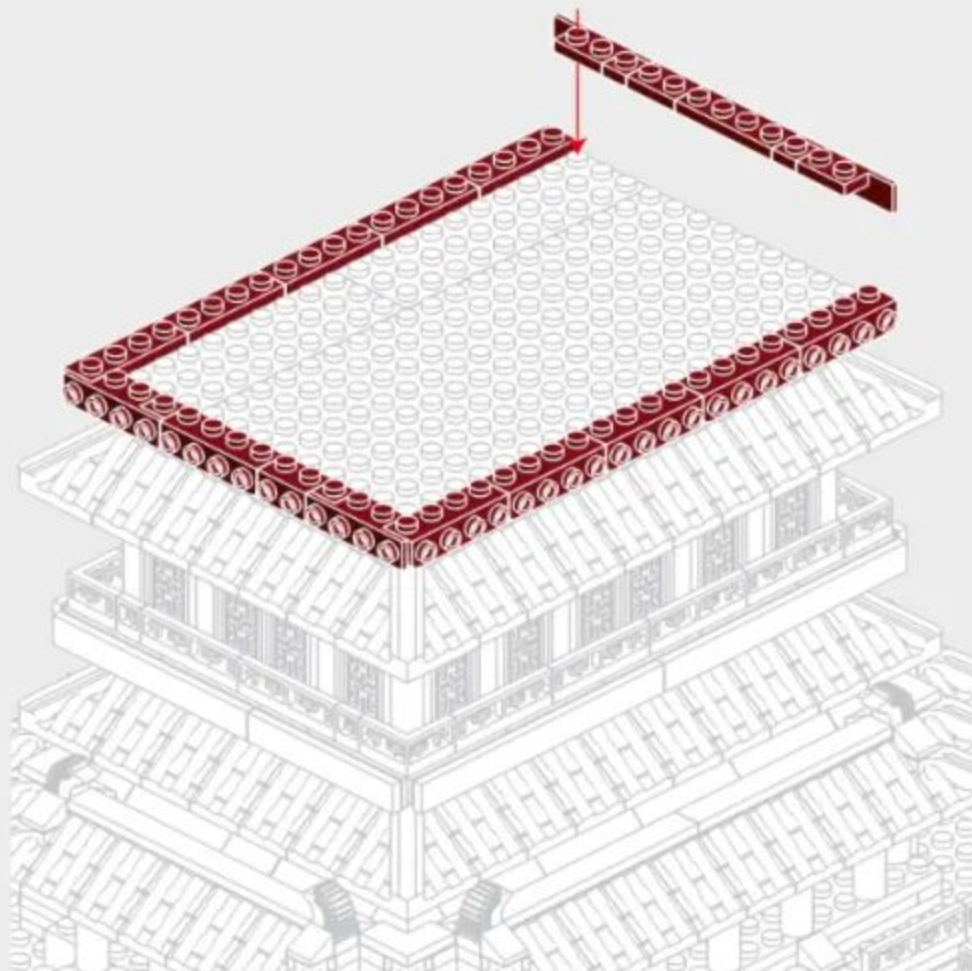

5-8

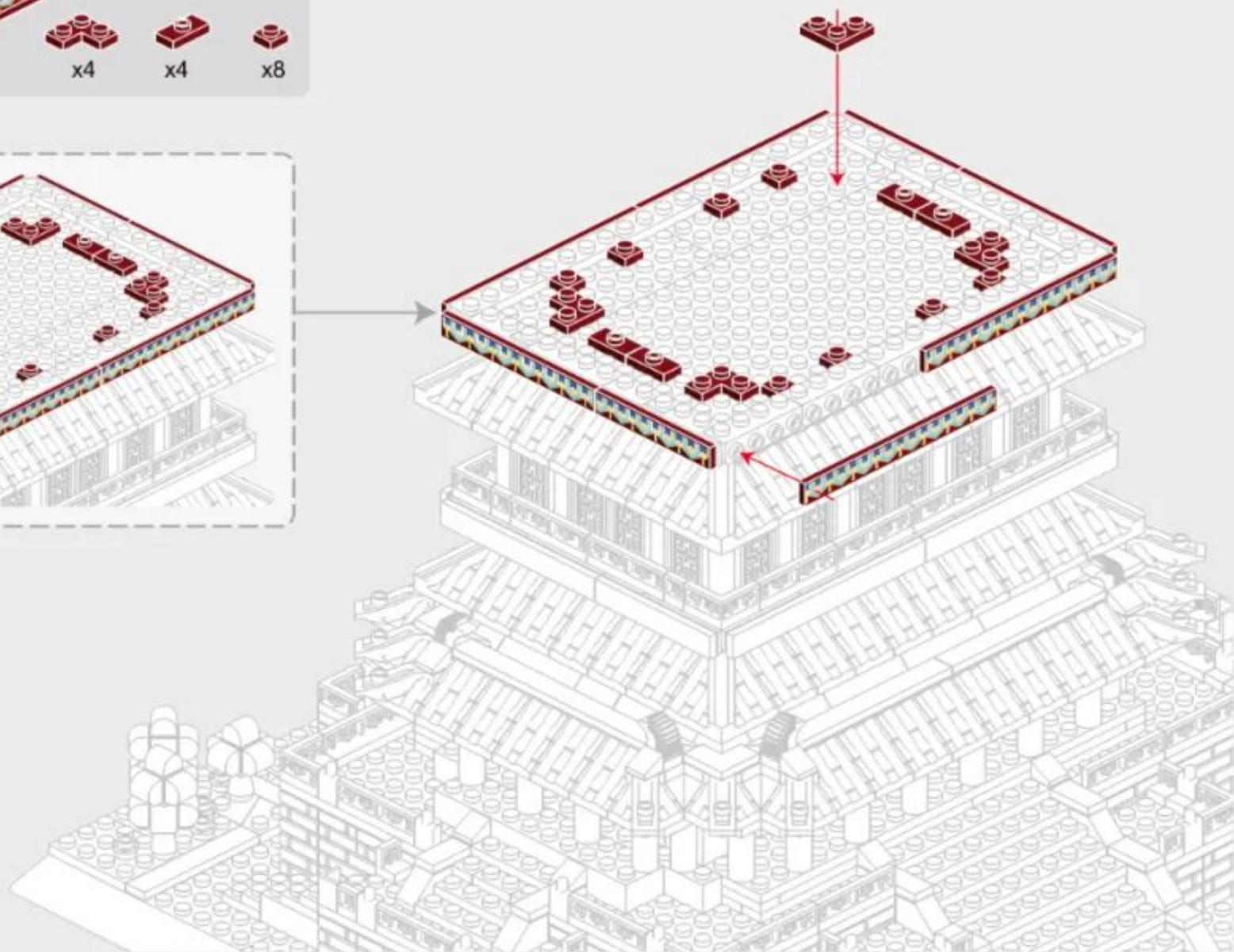
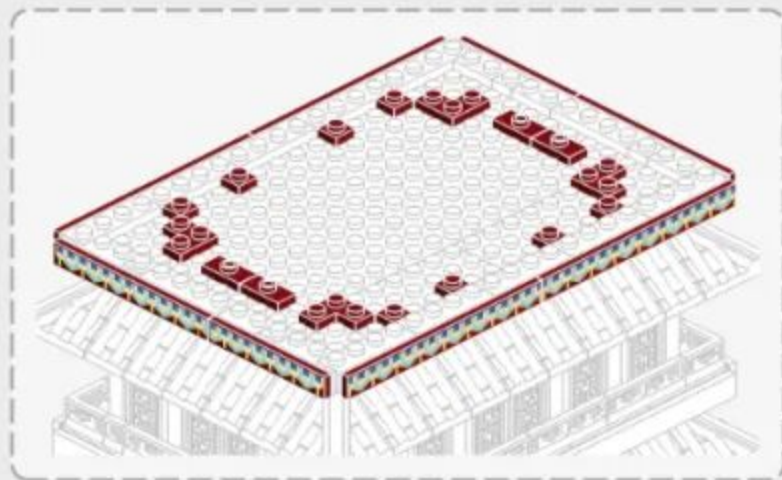
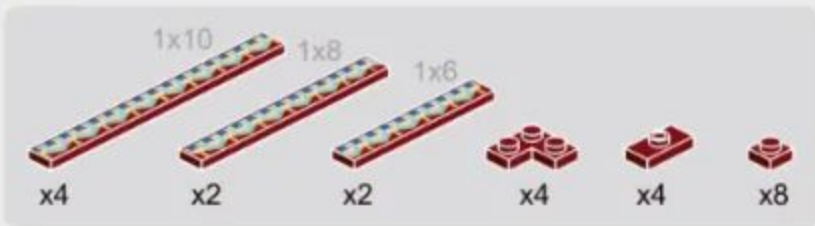

5-9

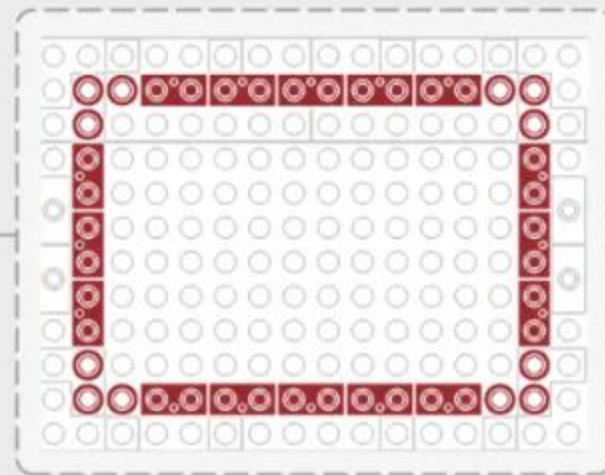
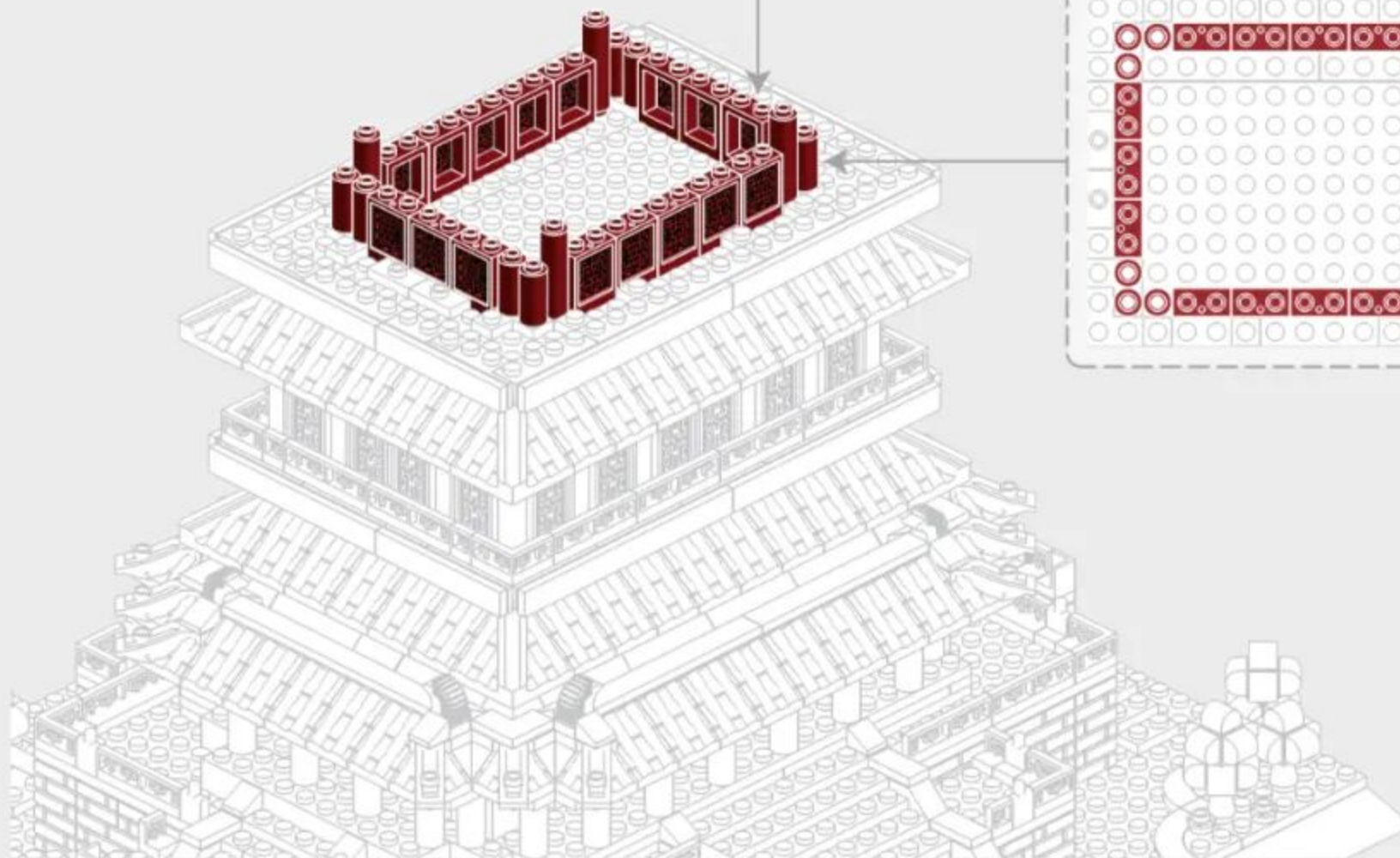

5-10



x16

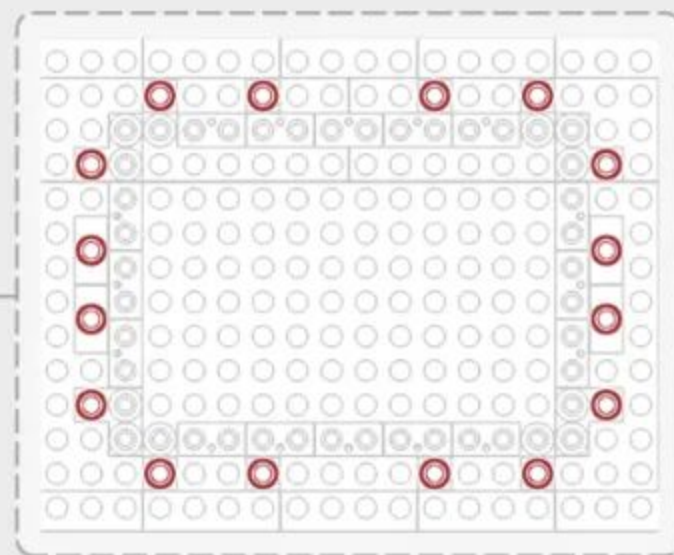
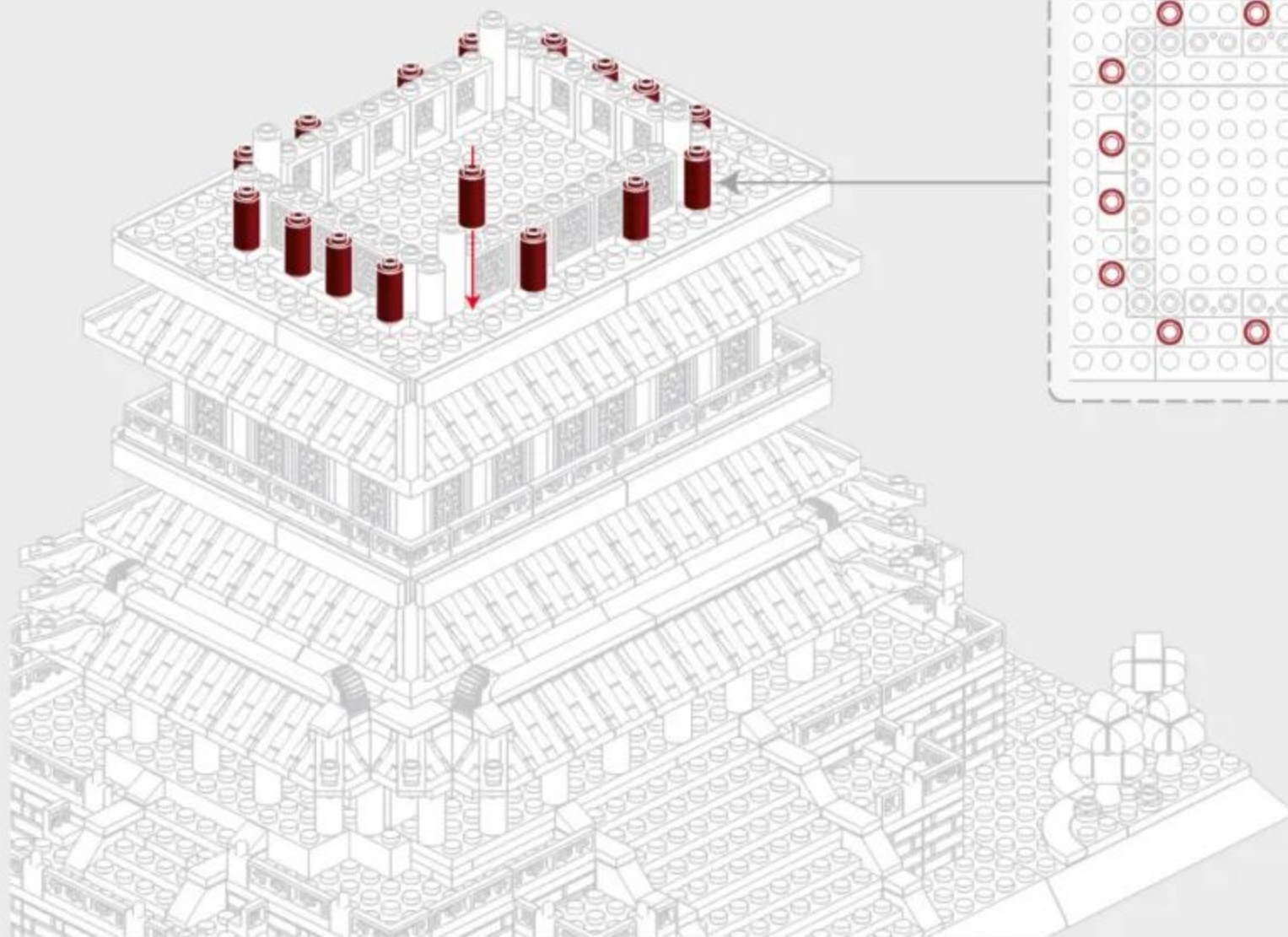

5-11



x12



x4



x4

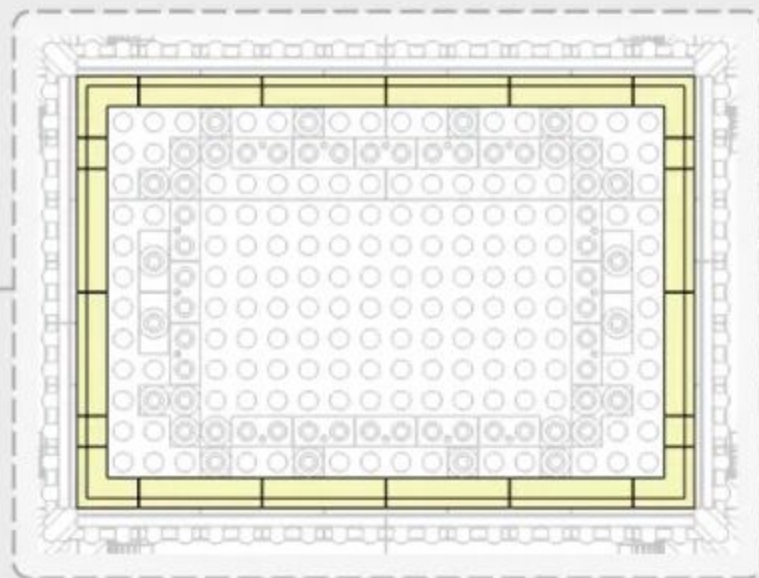
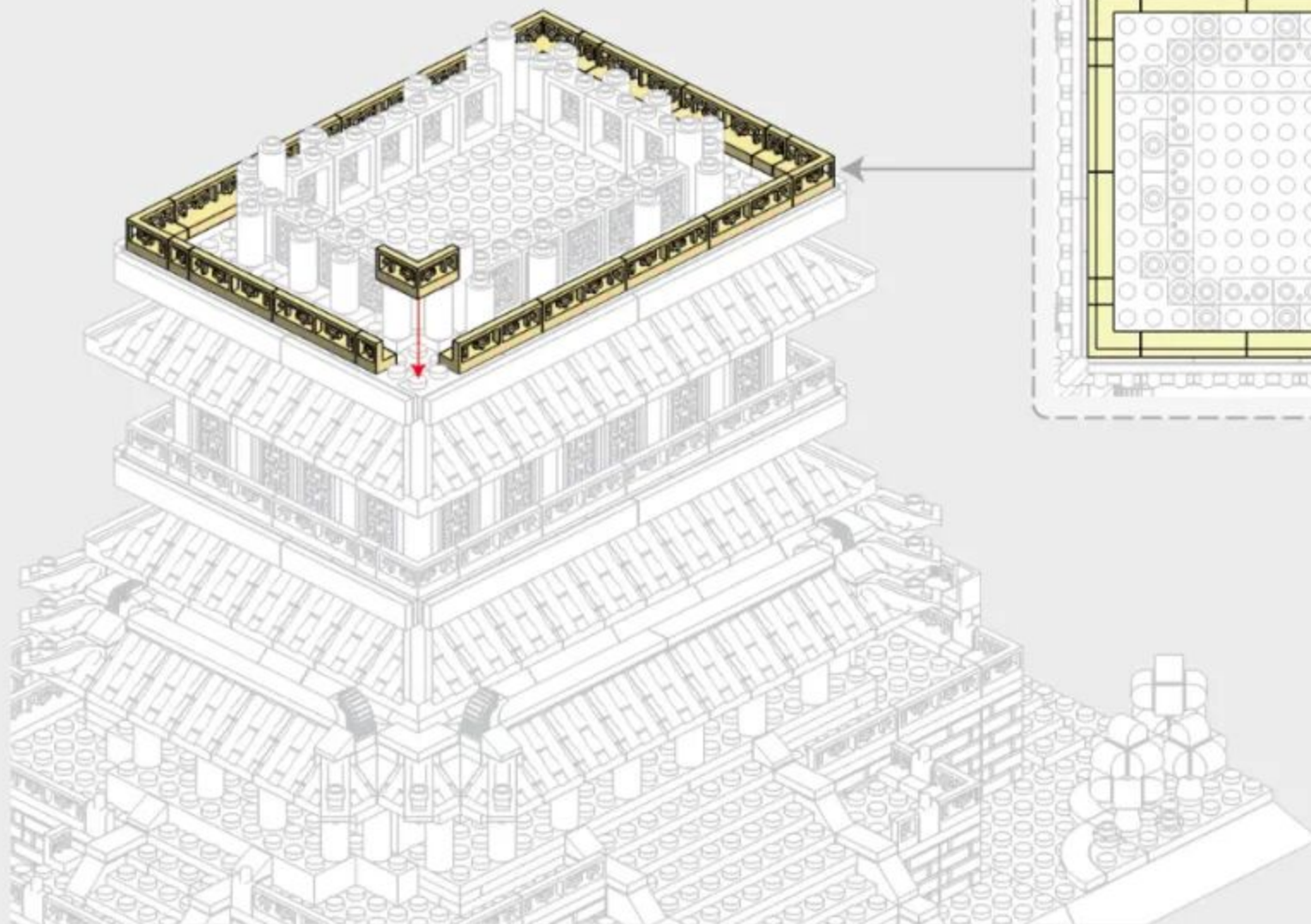

5-12

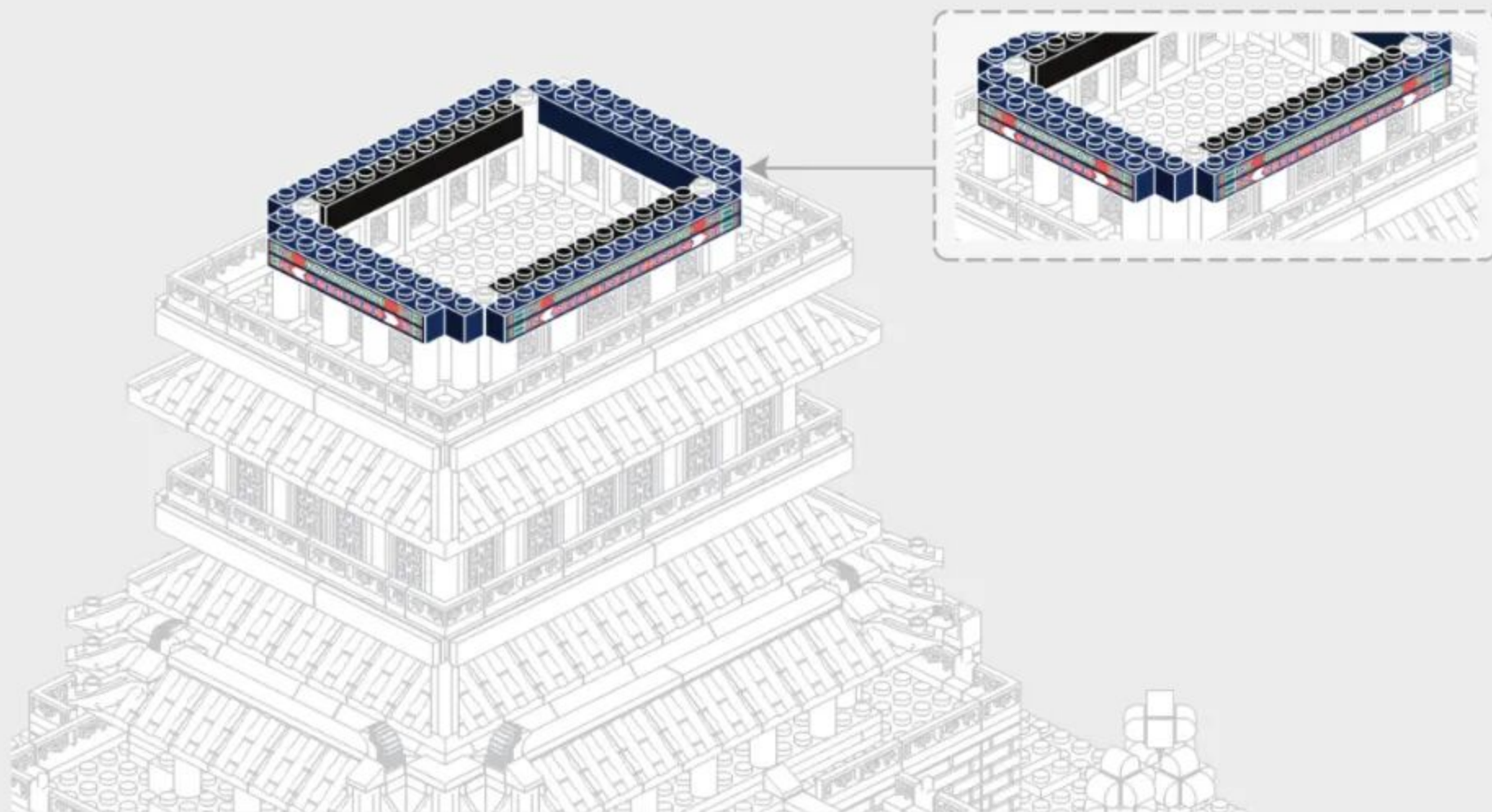
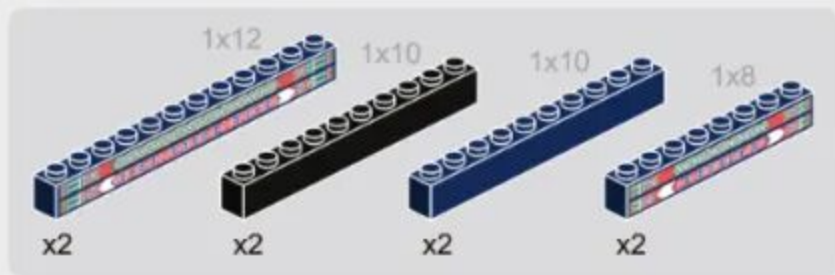



240PCS

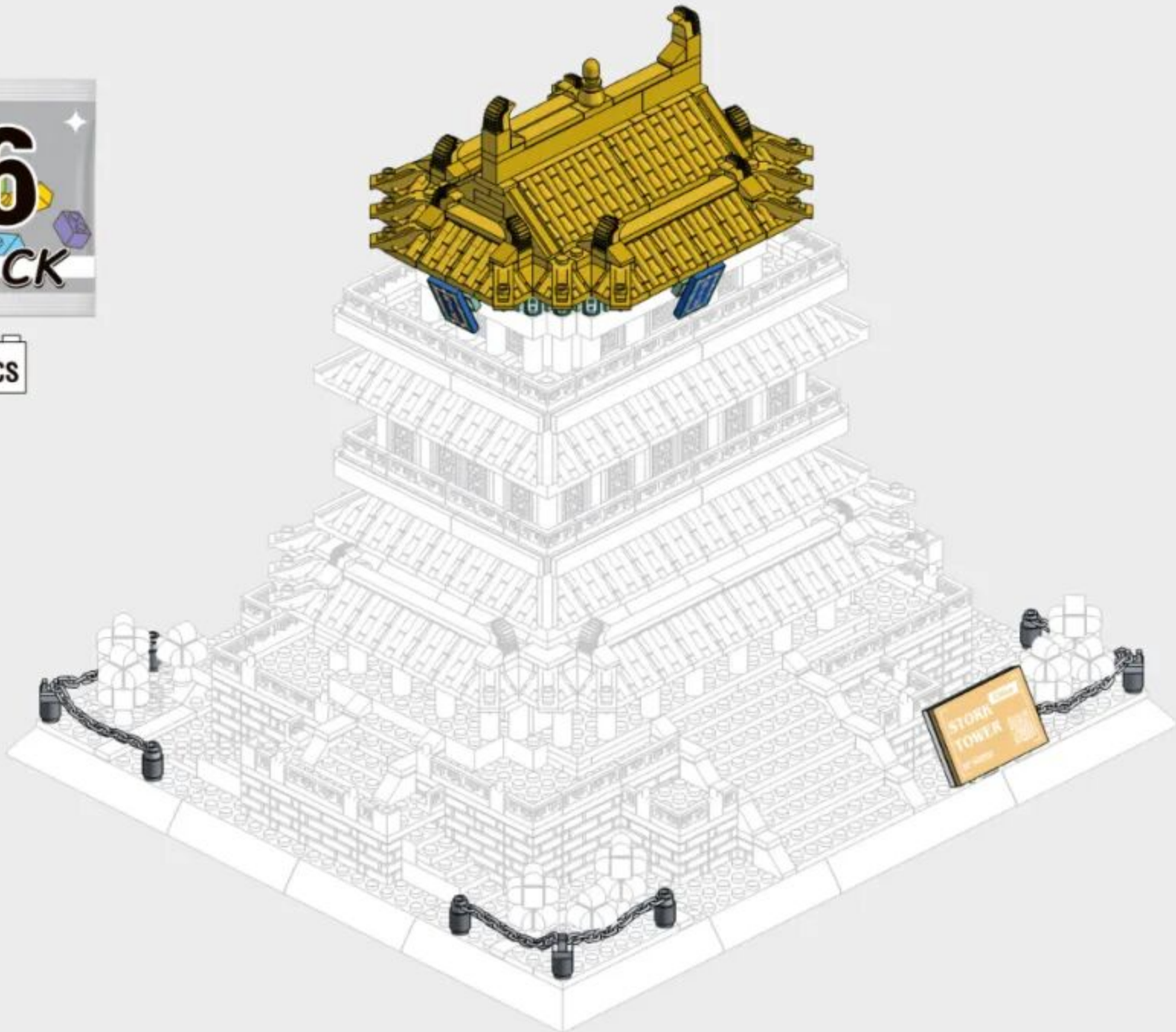

80

6-1



x4



x4

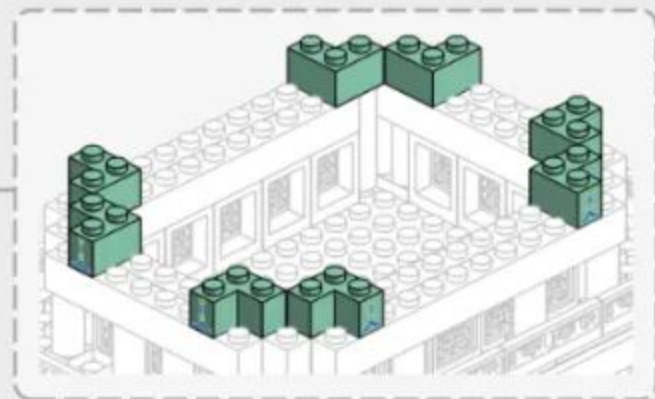
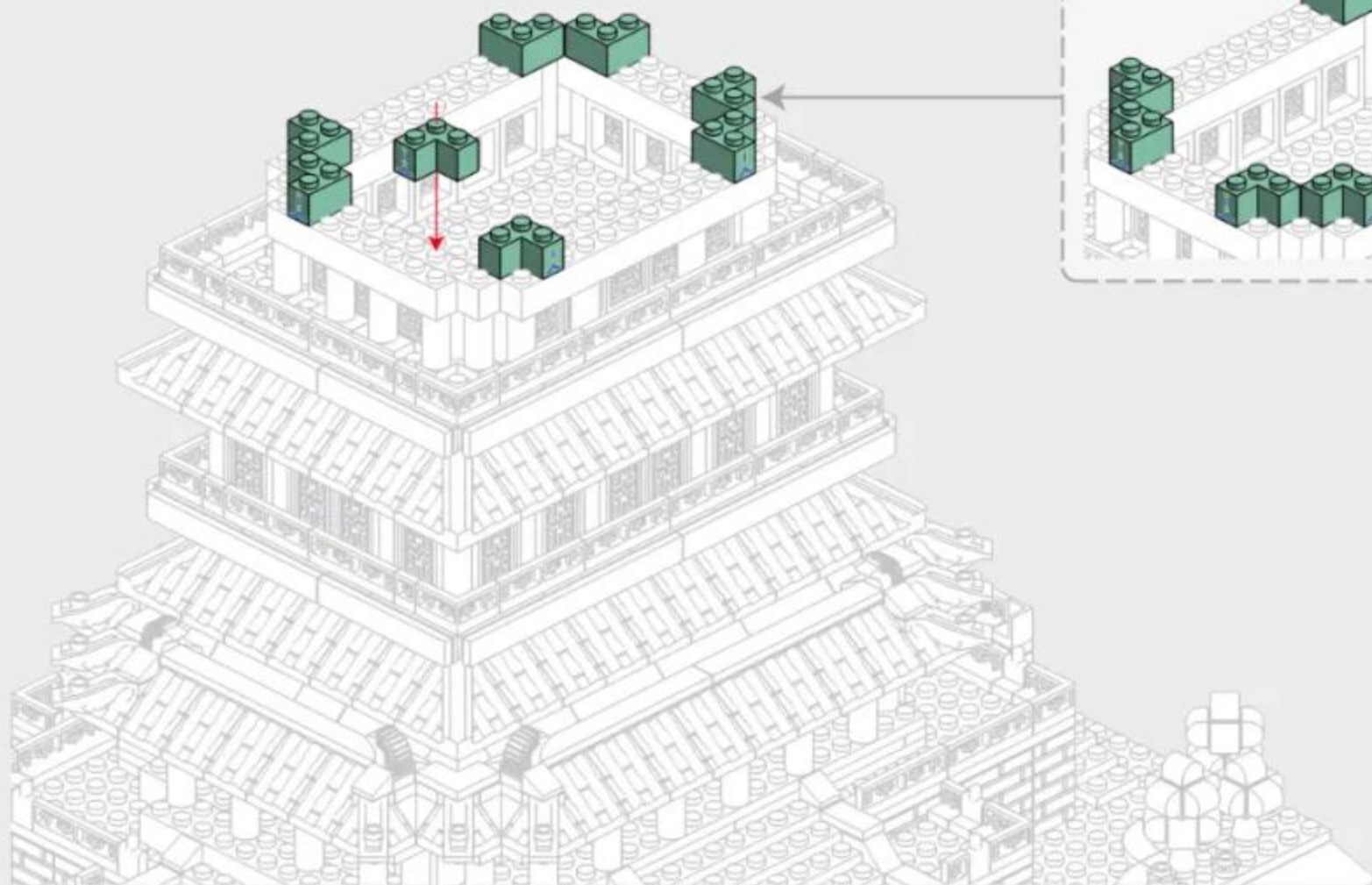

6-2

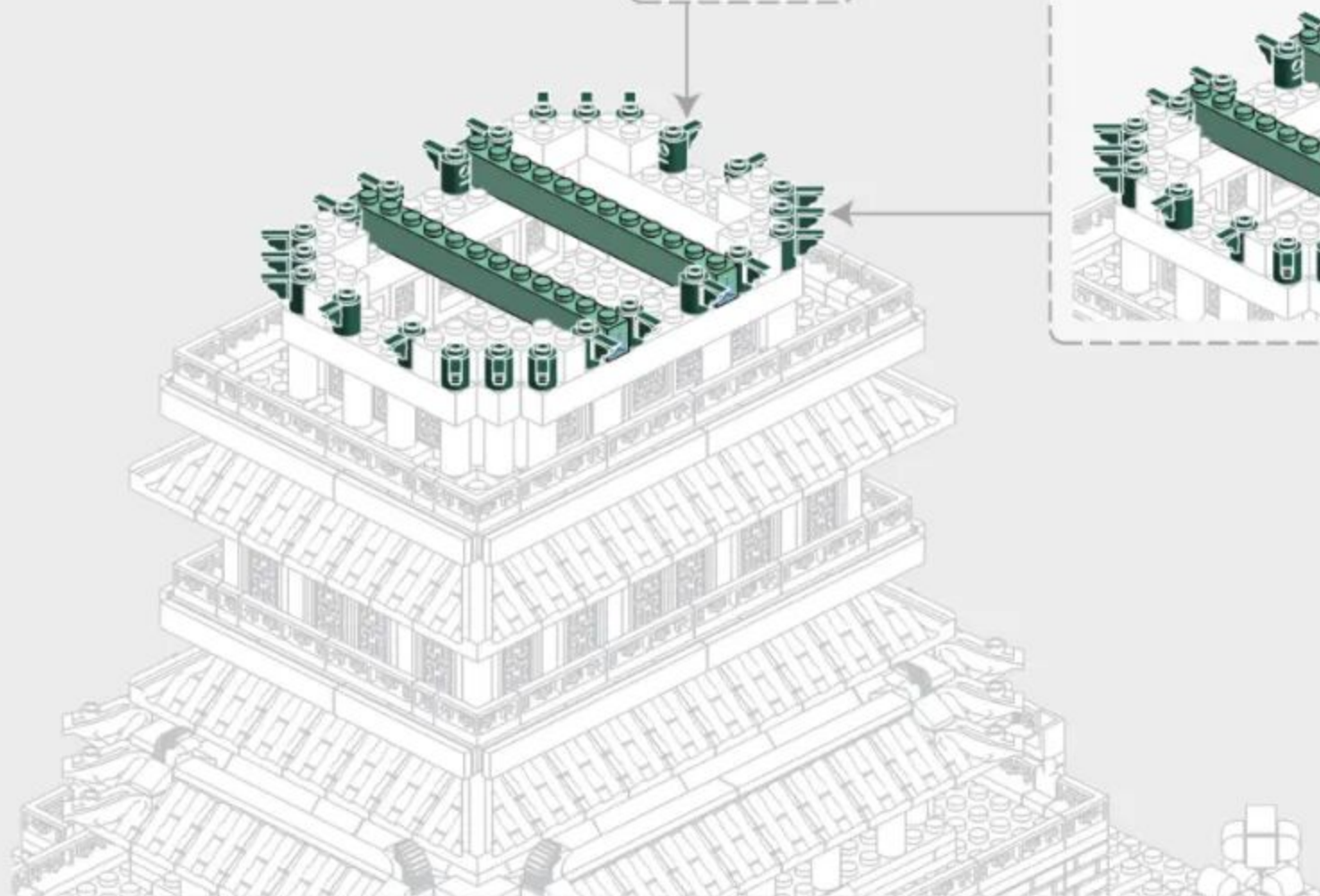
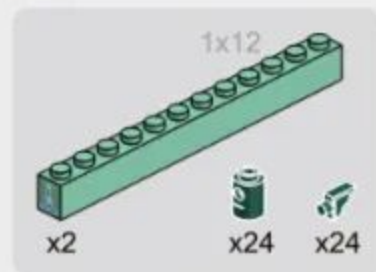

6-3

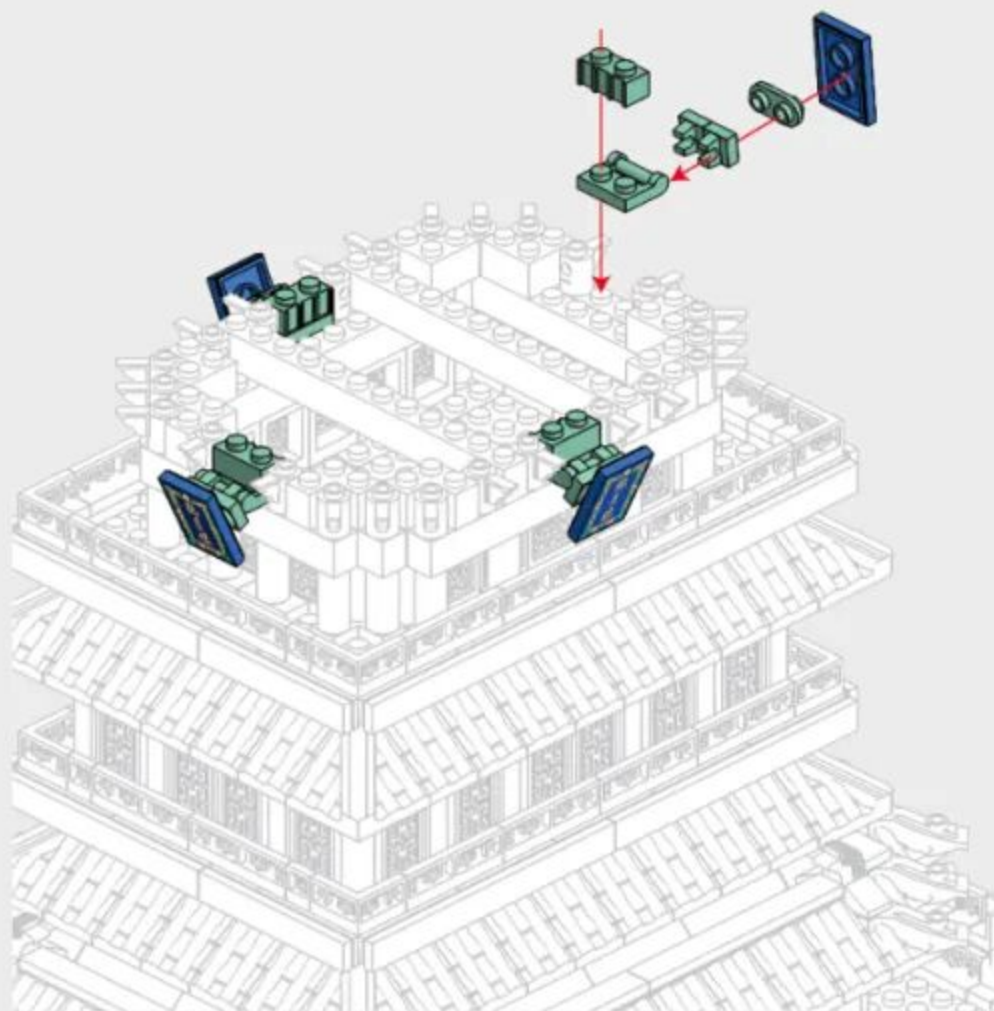

6-4

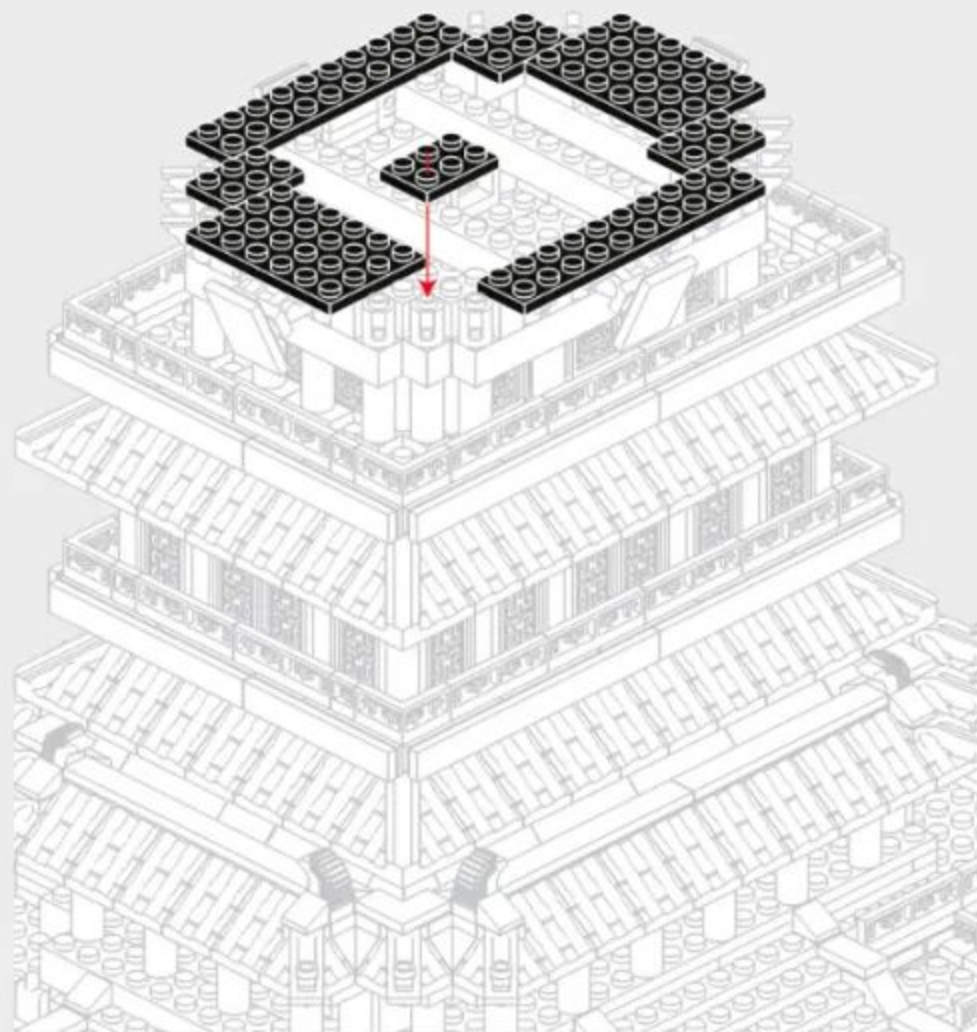
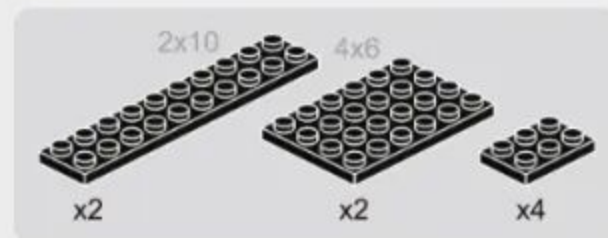

6-5

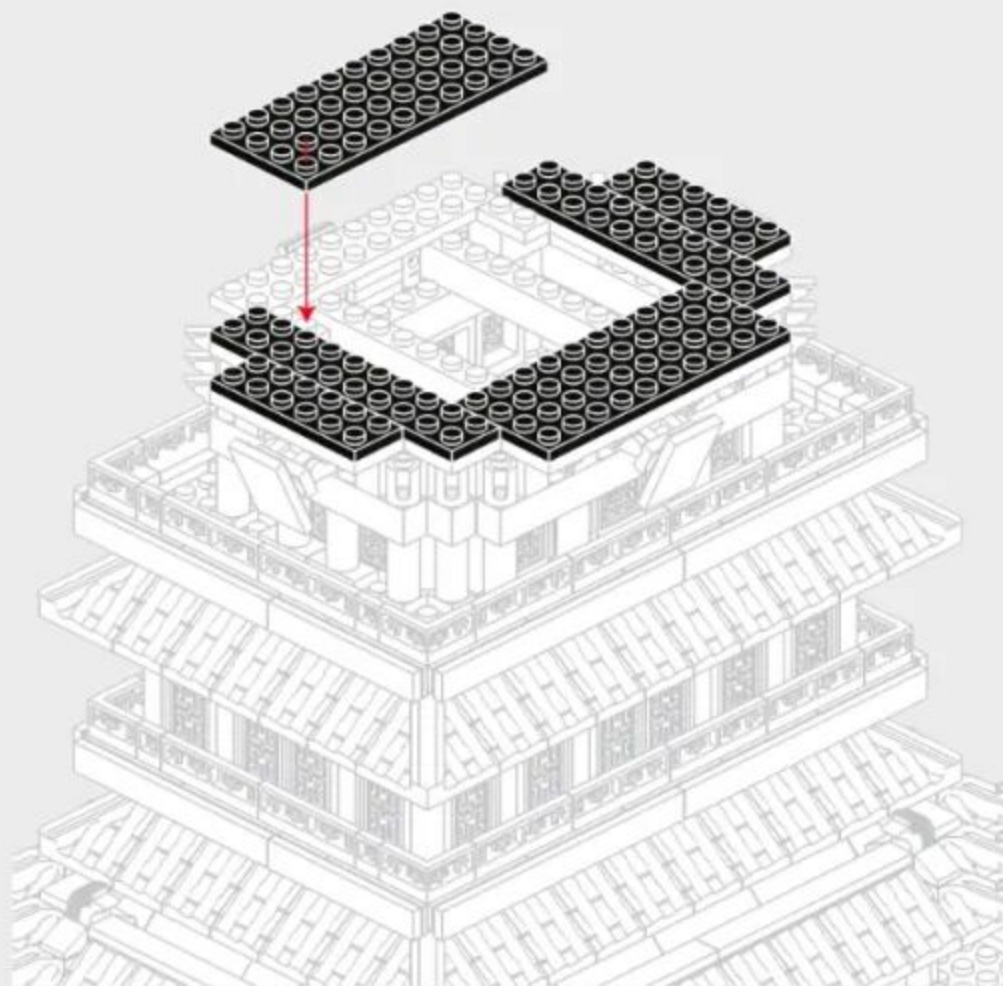
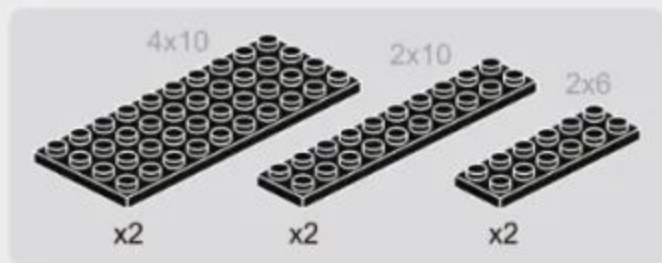

6-6

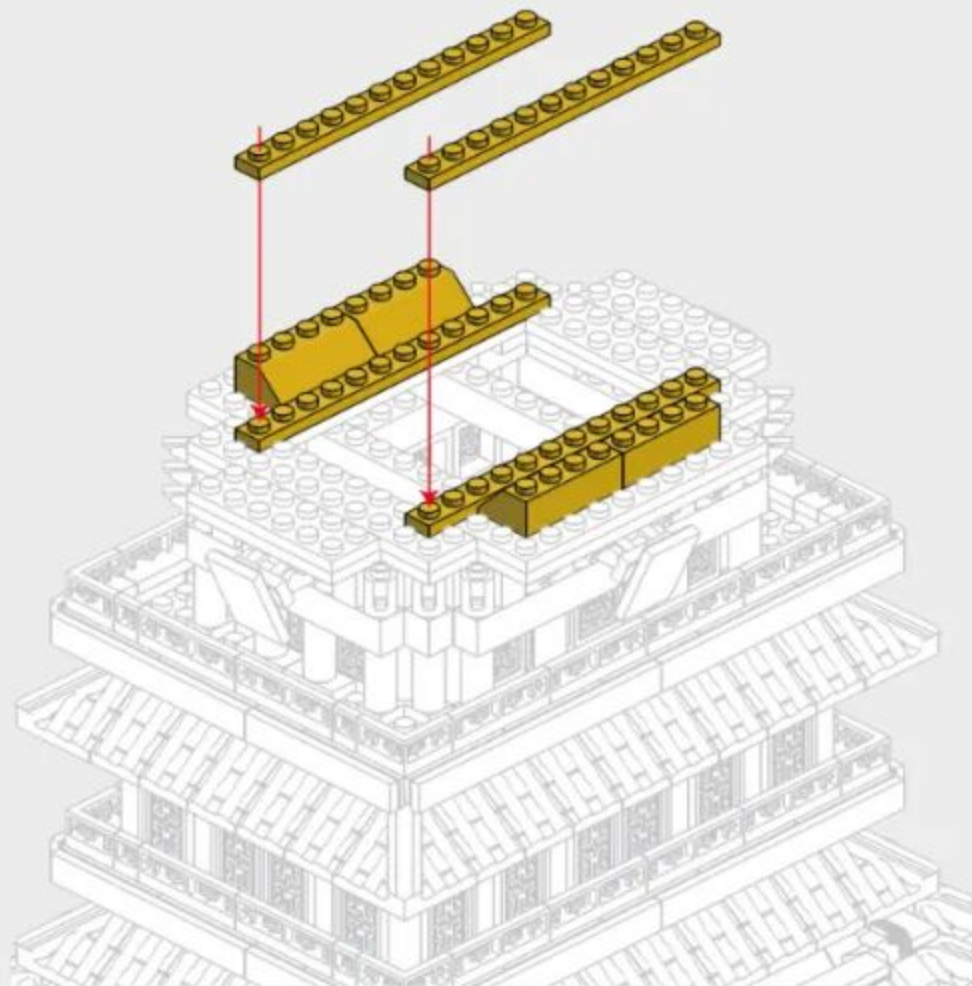
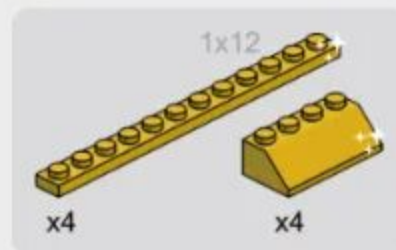

6-7

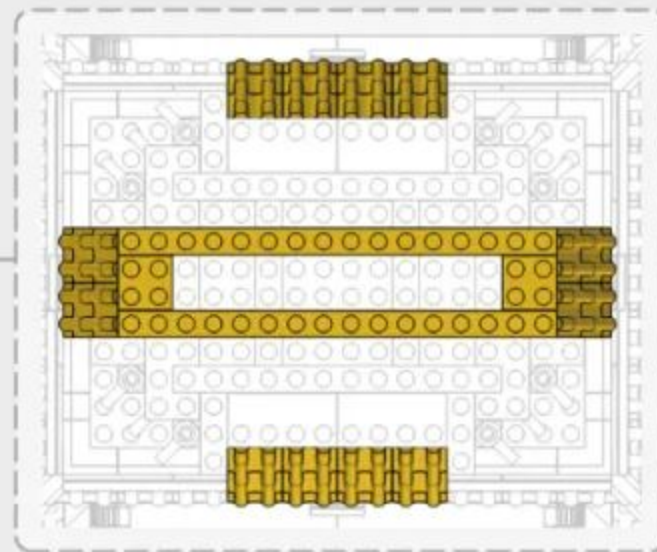
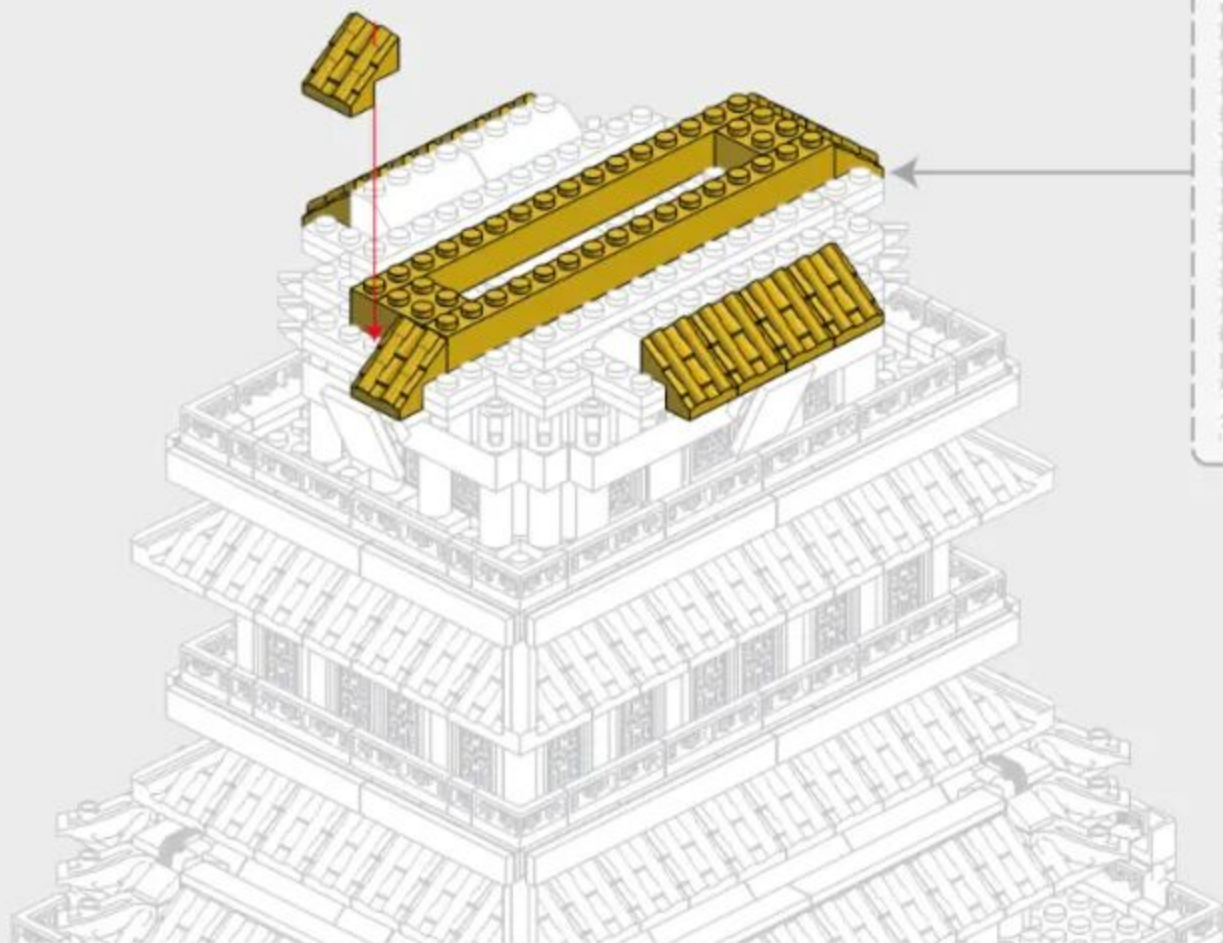
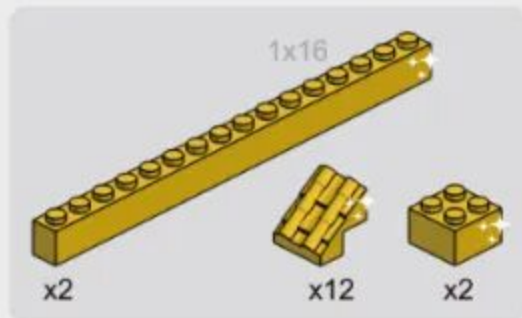

6-8



x8



x12

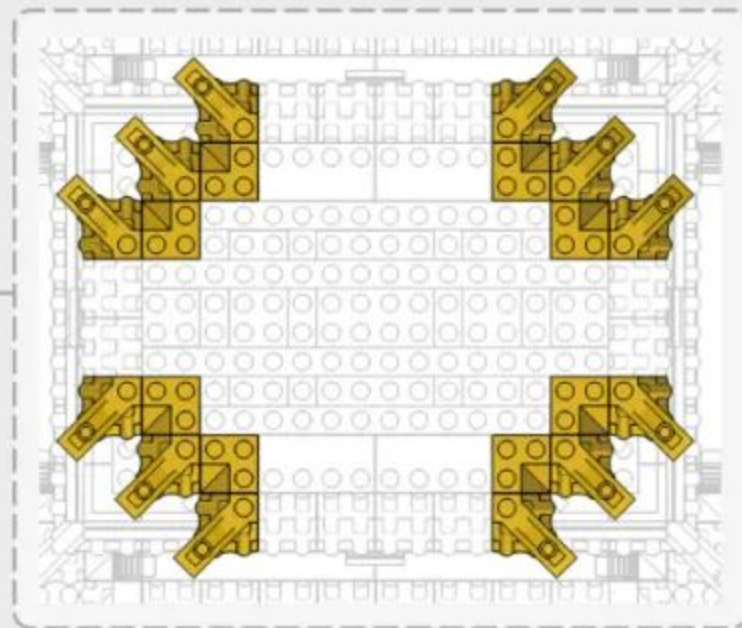
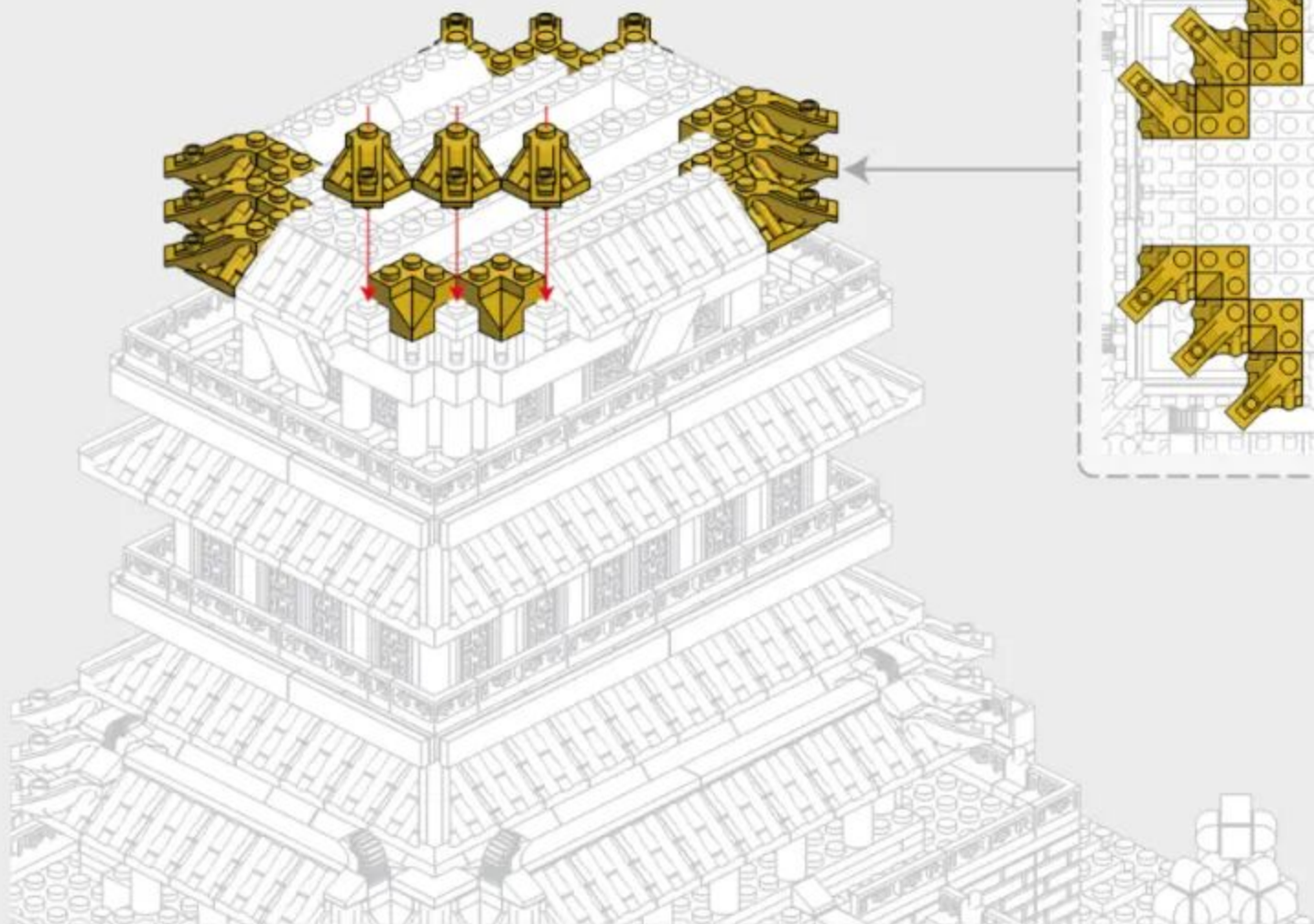

6-9

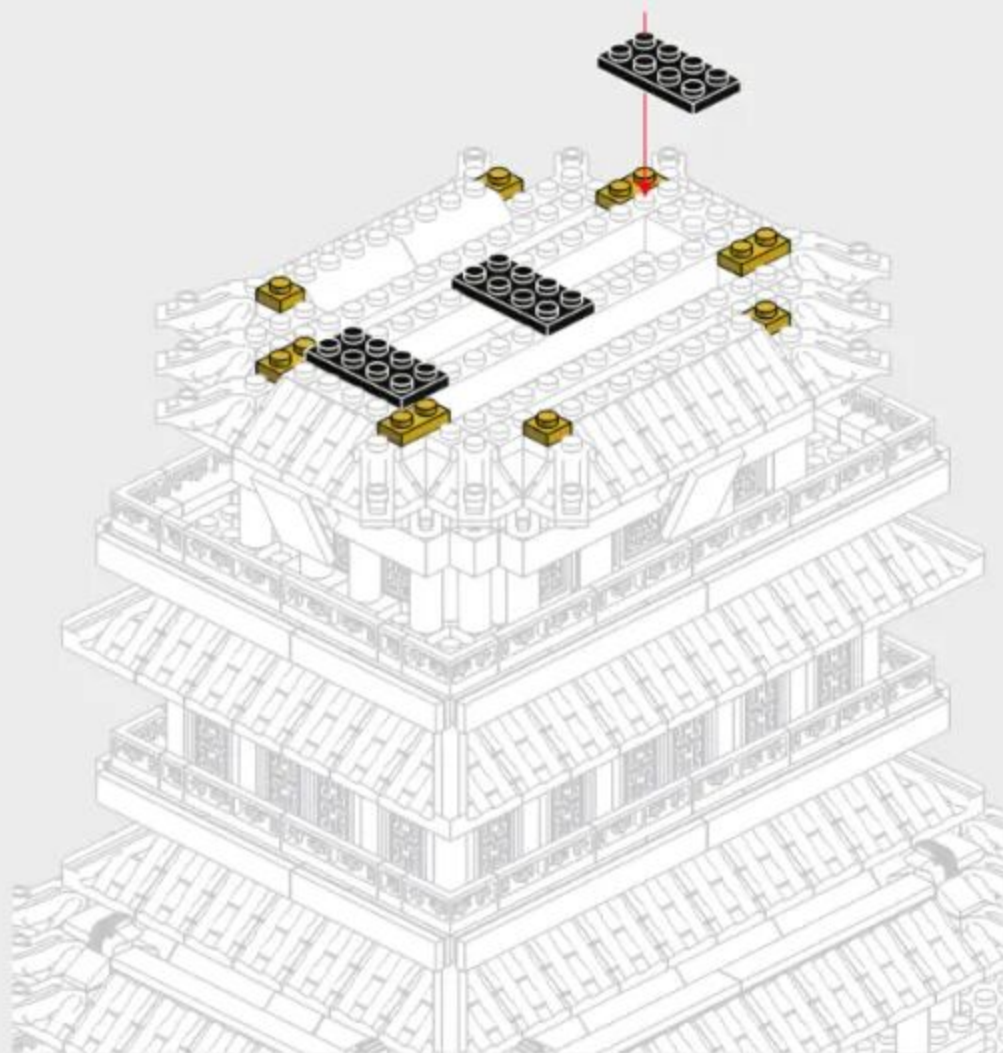

6-10

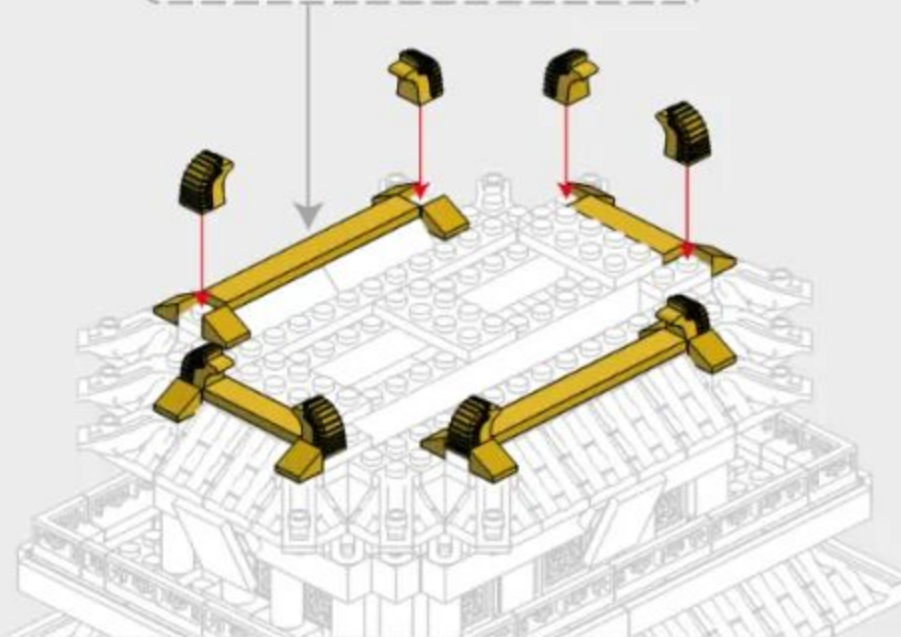
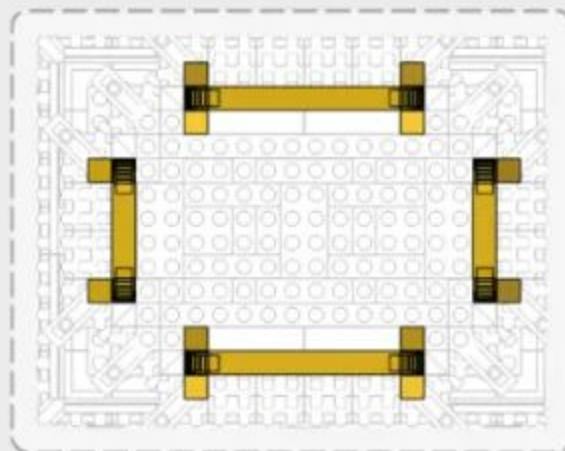

6-11

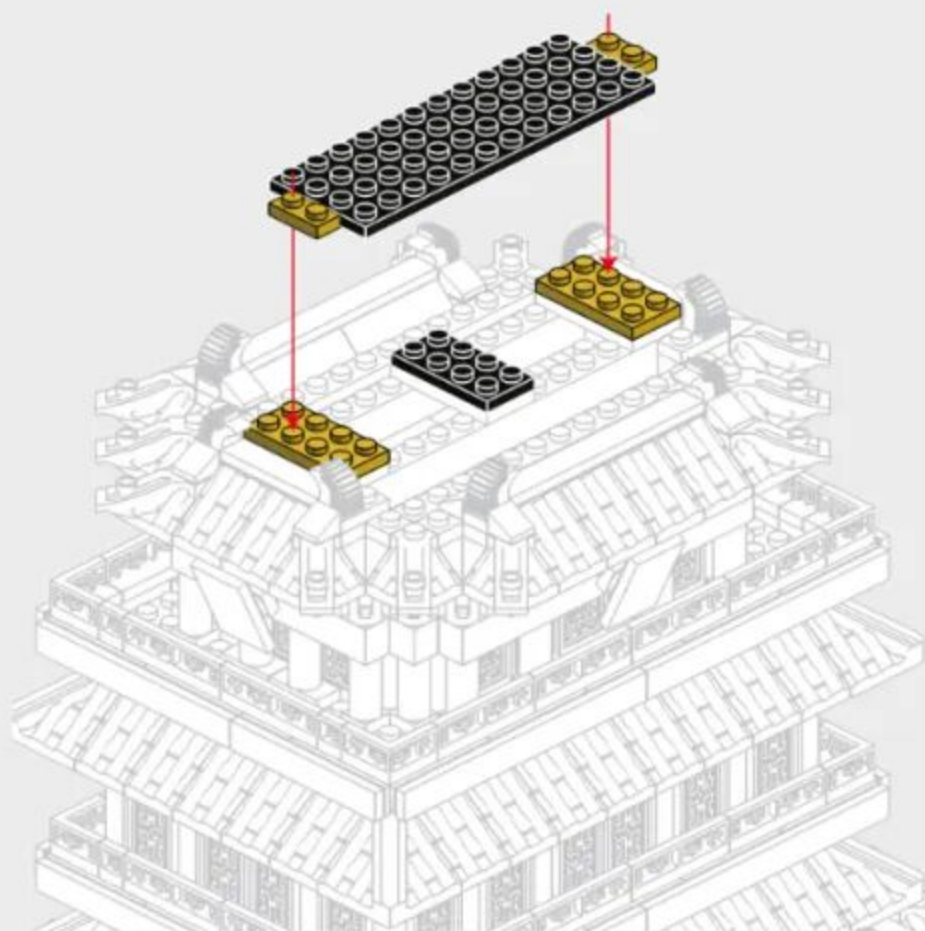
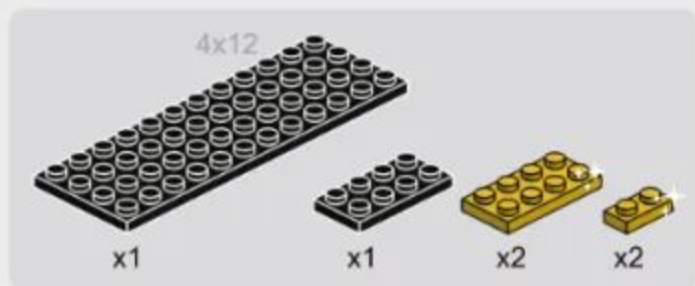

6-12

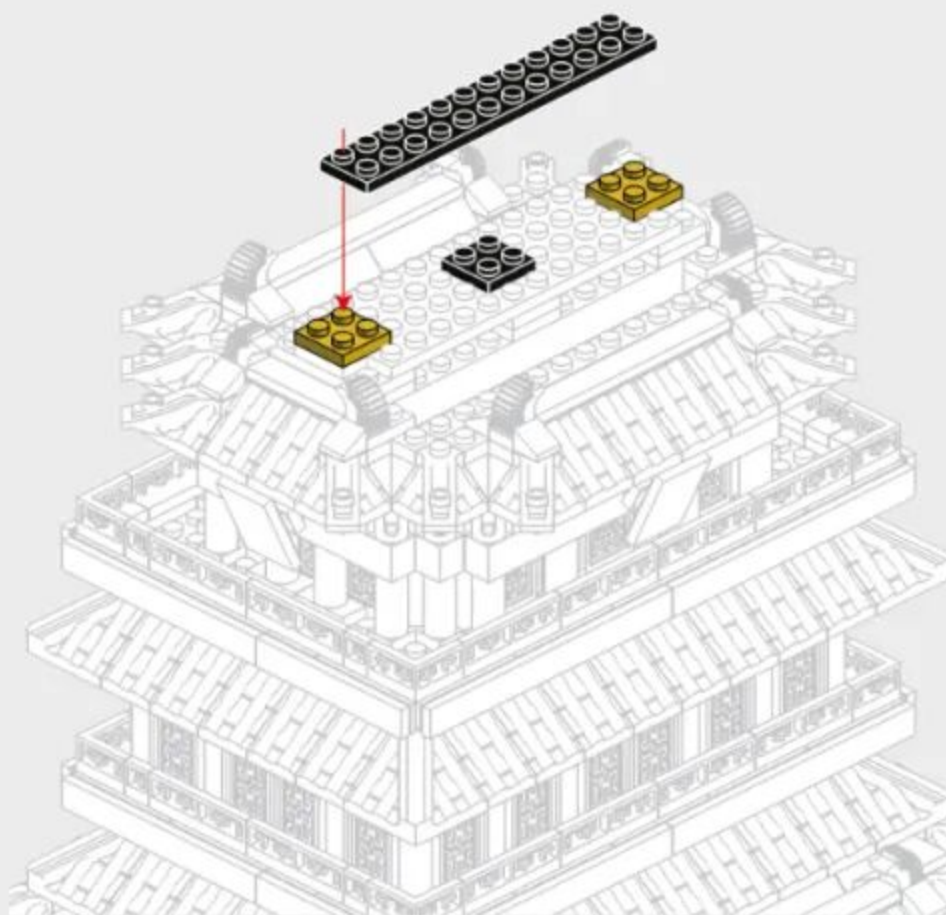
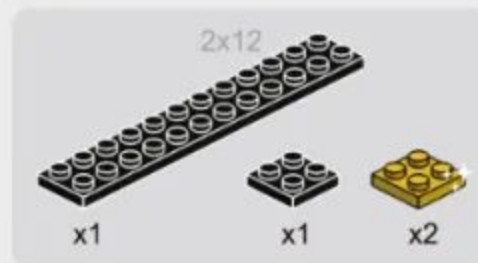

6-13

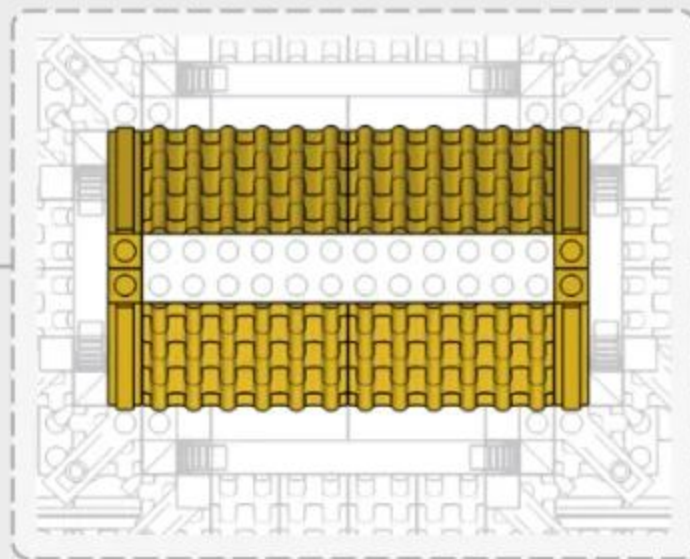
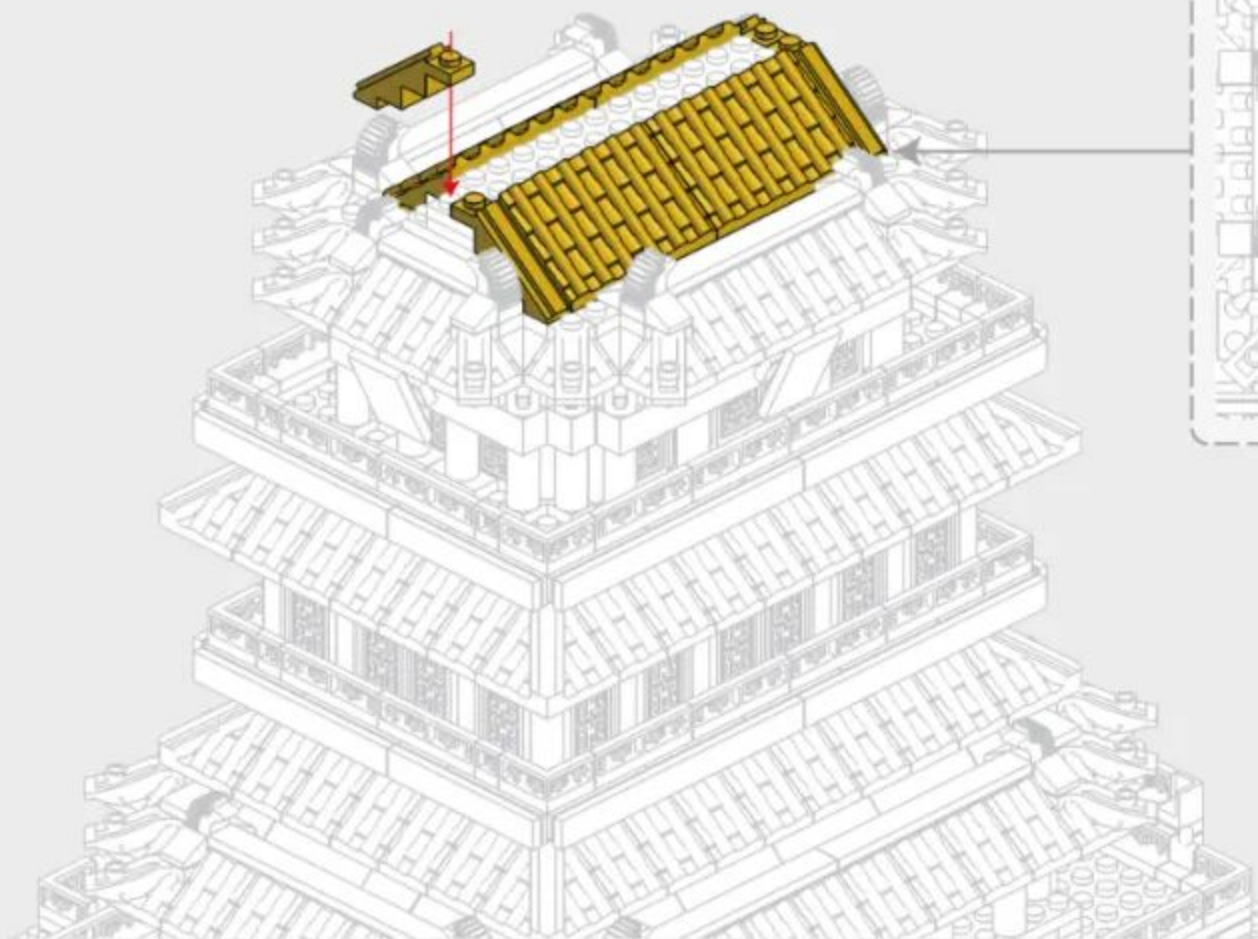
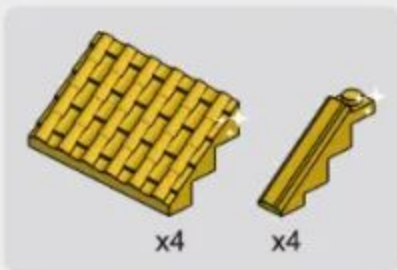

6-14

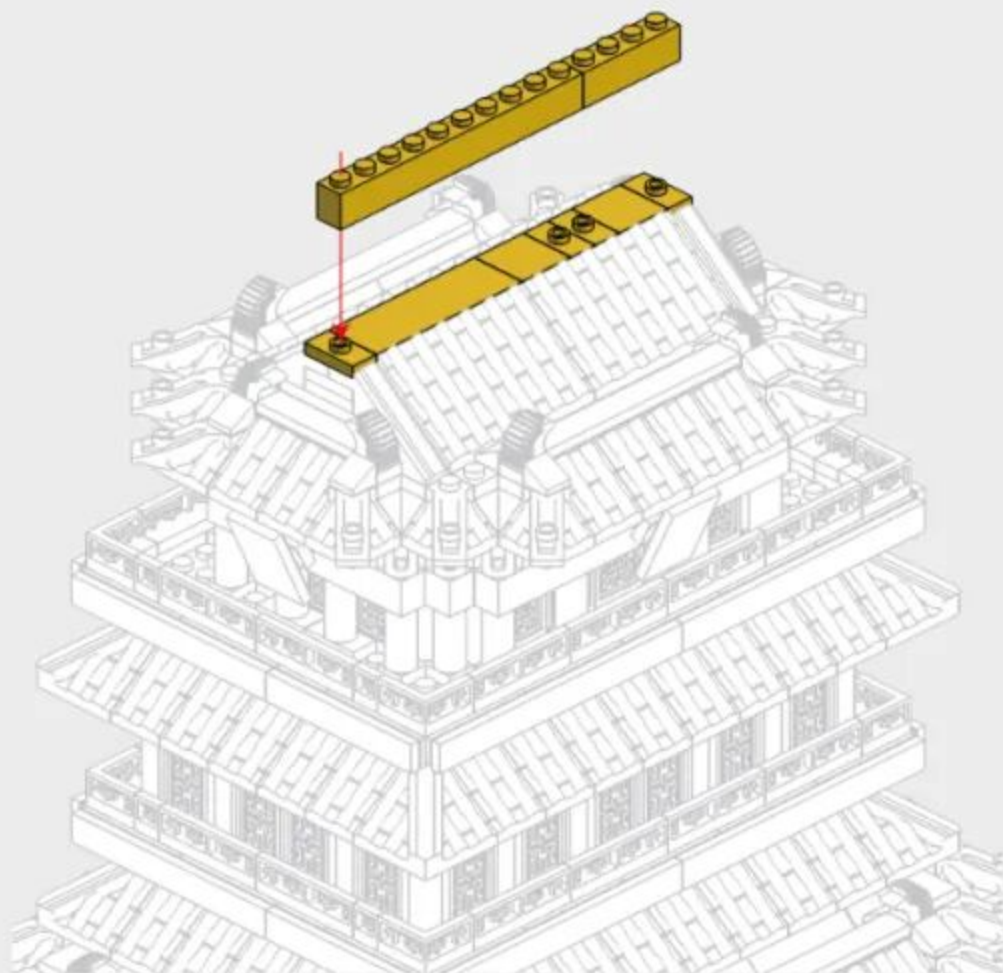
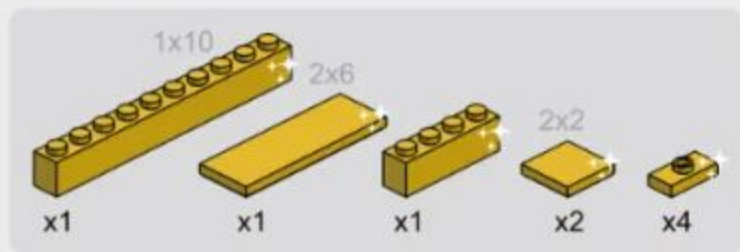

6-15

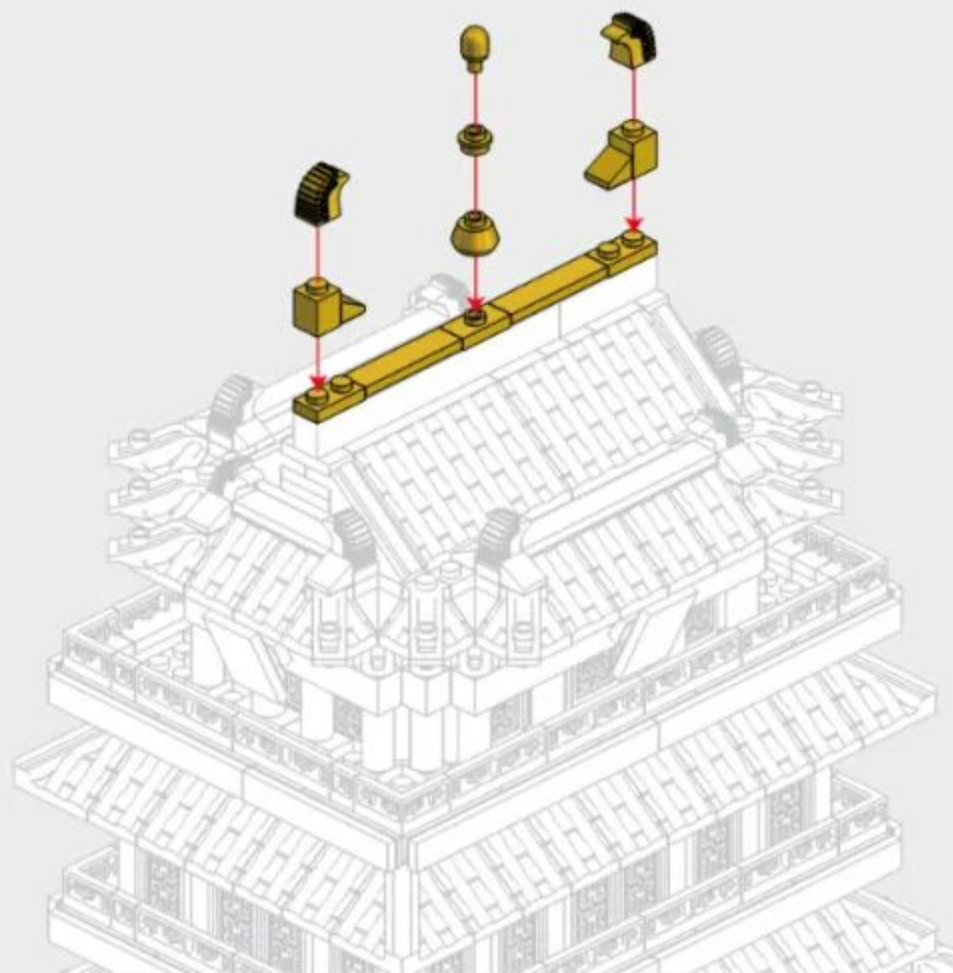

6-16

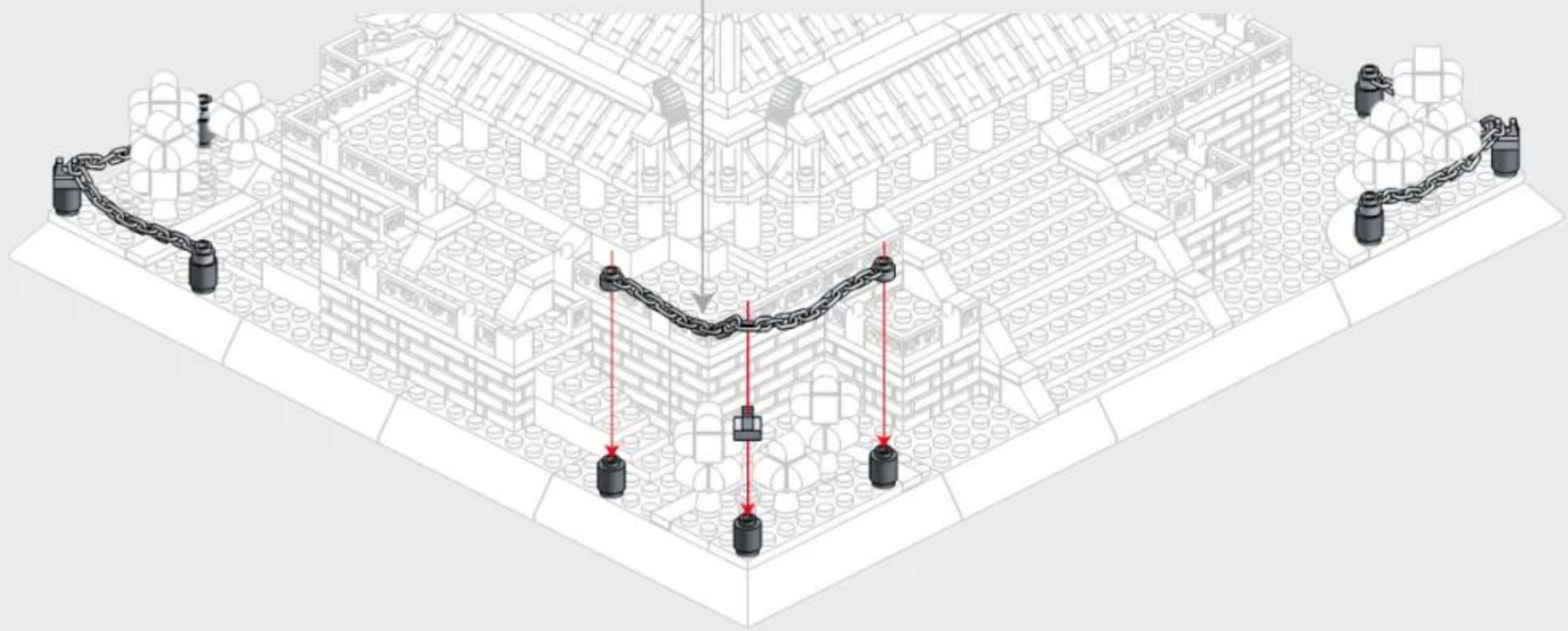
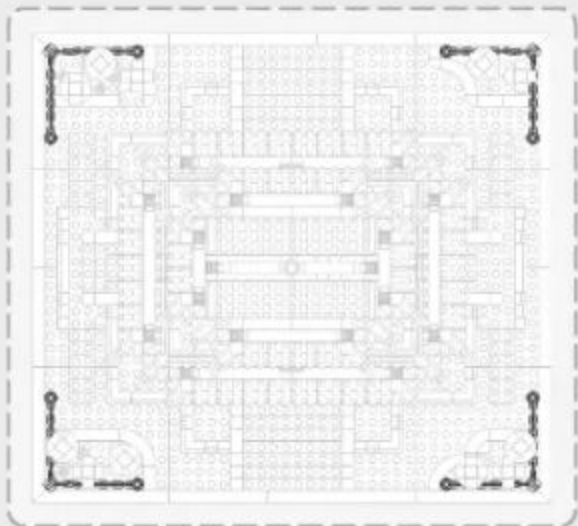
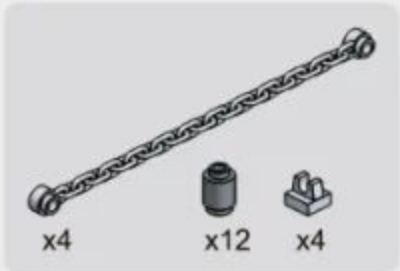

6-17

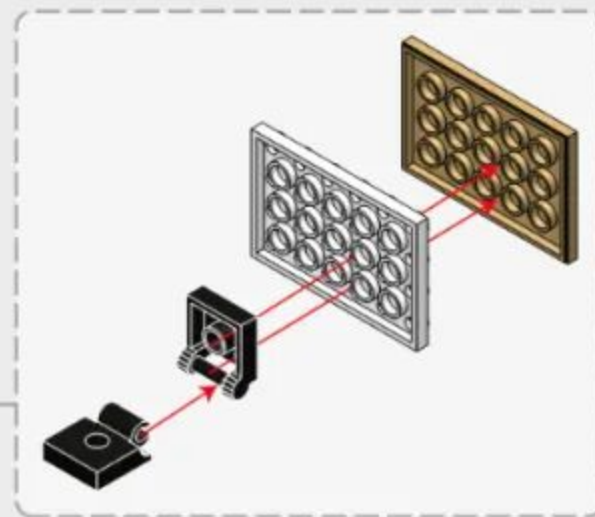
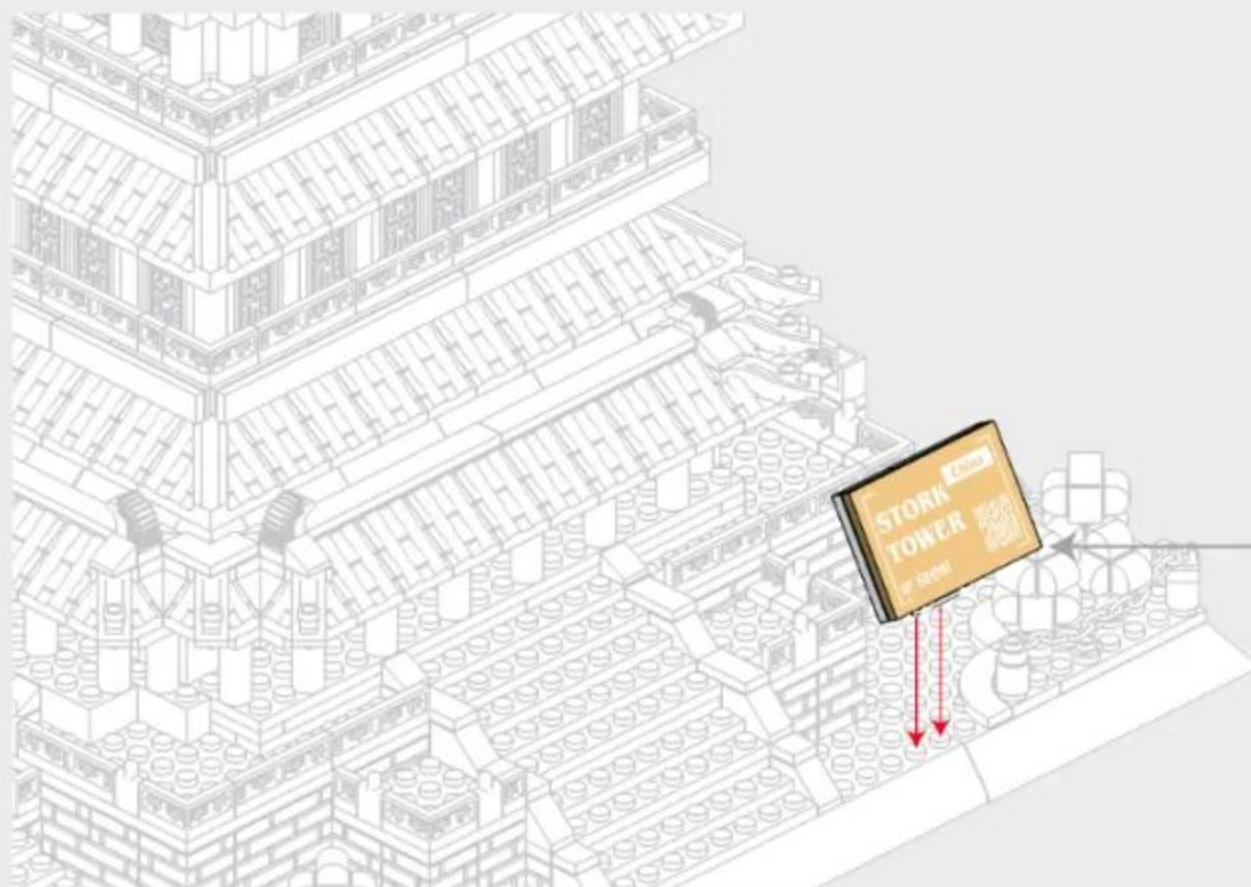
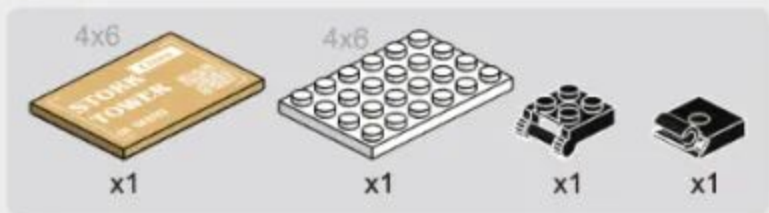



ARCHITECTURE

The World's great architecture

Shaping Skills Imagination & Curiosity Mathematical Self Discovery & Perception Parent-Child Interaction Problem Solving Creativity



6224 英国伦敦白金汉宫
BUCKINGHAM PALACE-LONDON,ENGLAND



5225 意大利罗马斗兽场
COLOSSEUM-ROME,ITALY



5226 日本东京帝国饭店
IMPERIAL HOTEL-TOKYO,JAPAN



5227 美国纽约自由女神像
STATUE OF LIBERTY-NEW YORK,AMERICA



6211 德国柏林勃兰登堡门
BRANDENBURG GATE-BERLIN, GERMANY



6222 中国甘肃长城-嘉峪关
JIAYU PASS-GANSU,CHINA



6212 日本京都清水寺仁王门
NIMON GATE OF KIYOMIZU-DERA-KYOTO,JAPAN



6213 俄罗斯莫斯科瓦西里大教堂
SAINT BASIL'S CATHEDRAL-MOSCOW,RUSSIA



6214 中国武汉黄鹤楼
YELLOW CRANE TOWER-WUHAN,CHINA



6215 英国伦敦眼
LONDON EYE-LONDON,ENGLAND



6221 中国北京故宫-太和殿
HALL OF SUPREME HARMONY-BEIJING,CHINA



6220 沙特阿拉伯麦加大清真寺
GREAT MOSQUE OF MECCA,SAUDI ARABIA



6219 美国纽约联合国大厦
UNITED NATIONS HEADQUARTERS-NEW YORK,AMERICA



4214 美国华盛顿白宫
WHITE HOUSE-WASHINGTON D.C.,AMERICA



4212 意大利罗马许愿池
TREVI FOUNTAIN-ROME,ITALY



4213 法国巴黎卢浮宫
MUSÉE DU LOUVRE-PARIS,FRANCE

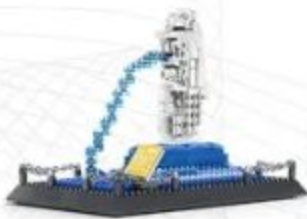

4218 新加坡-鱼尾狮
MERLION,SINGAPORE



4219 英国伦敦双子塔桥
TOWER BRIDGE-LONDON,ENGLAND



4216 美国华盛顿林肯纪念馆
LINCOLN MEMORIAL-WASHINGTON D.C.,AMERICA



4217 新加坡-金沙酒店
MARINA BAY SANDS,SINGAPORE



4210 埃及开罗吉萨金字塔
GREAT PYRAMID OF GIZA-CAIRO,EGYPT



4221 加拿大渥太华国会山庄
PARLIAMENT BUILDINGS-OTTAWA,CANADA



4211 英国伦敦伊丽莎白塔
ELIZABETH TOWER-ENGLAND



4215 加拿大多伦多电视塔
THE CN TOWER-CANADA



4220 美国纽约熨斗大厦
FLATIRON BUILDING-NEW YORK,AMERICA



4222 阿联酋迪拜哈利法塔 THE BURJ KHALIFA TOWER-DUBAI, UAE
 5224 中国上海东方明珠广播电视塔 ORIENTAL PEARL TOWER-SHANGHAI, CHINA
 5212 美国纽约帝国大厦 EMPIRE STATE BUILDING-NEW YORK, AMERICA
 5213 马来西亚吉隆坡石油双塔 PETRONAS TWIN TOWERS-KUALA LUMPUR, MALAYSIA
 5214 意大利托斯卡纳比萨斜塔 LEANING TOWER OF PISA-TUSCANY, ITALY
 5216 英国伦敦伊丽莎白塔 ELIZABETH TOWER-LONDON, ENGLAND



5219 俄罗斯莫斯科克里姆林宫钟楼 SPASSKAYA TOWER-MOSCOW, RUSSIA
 5220 阿联酋迪拜卓美亚帆船酒店 BURJ AL ARAB HOTEL-DUBAI, UAE
 5217 法国巴黎埃菲尔铁塔 EIFFEL TOWER-PARIS, FRANCE
 5221 中国台北101大楼 TAIPEI 101-TAIPEI, CHINA
 5228 美国芝加哥威利斯大厦 WILLIS TOWER-CHICAGO, AMERICA
 5231 巴西里约热内卢救世基督像 CRISTO REDENTOR-RIO DE JANEIRO, BRASIL



6223 中国武汉长江大桥 WUHAN YANGTZE RIVER BRIDGE
 5210 法国巴黎圣母院大教堂 CATHÉDRALE NOTRE DAME DE PARIS-PARIS, FRANCE
 5211 印度阿格拉泰姬陵 TAJ MAHAL-AGRA, INDIA
 5223 法国巴黎凯旋门 ARC DE TRIOMPHE-PARIS, FRANCE
 5215 英国伦敦双子塔桥 TOWER BRIDGE-LONDON, ENGLAND



5222 中国北京天坛祈年殿 HALL OF PRAYER FOR GOOD HARVESTS-BEIJING, CHINA
 6210 美国旧金山金门大桥 GOLDEN GATE BRIDGE-SAN FRANCISCO, AMERICA
 6216 中国北京万里长城(八达岭) THE GREAT WALL-BEIJING, CHINA
 5218 中国北京天安门 TIANANMEN TOWER-BEIJING, CHINA
 6217 中国西藏布达拉宫 POTALA PALACE-TIBET, CHINA



6218 芬兰罗瓦涅米圣诞老人办公室 SANTA CLAUS OFFICE-ROVANIEMI, FINLAND
 6225 墨西哥库库尔坎玛雅金字塔 EL CASTILLO-KUKULKAN, MEXICO
 6226 德国巴伐利亚新天鹅堡 SCHLOSS NEUSCHWANSTEIN-BAYERN, DEUTSCHLAND
 5229 土耳其伊斯坦布尔其少女塔 MAIDEN TOWER-ISTANBUL, TURKEY
 5230 中国湖南长沙爱晚亭 AIWANTING PAVILION-HUNAN, CHINA



7210 中国上海世博会中国馆
CHINA PAVILION AT EXPO-SHANGHAI, CHINA



5232 美国宾夕法尼亚州流水别墅
FALLINGWATER-PENNSYLVANIA, AMERICA



5233 美国芝加哥范斯沃斯住宅
FARNSWORTH HOUSE-CHICAGO, AMERICA



5234 美国华盛顿唐人街
CHINA TOWN-WASHINGTON, D.C., AMERICA



3210 美国纽约自由女神像
STATUE OF LIBERTY-NEW YORK, AMERICA



4223 中国北京清华园
TSINGHUA CAMPUS-BEIJING, CHINA



7211 中国湖南岳阳楼
YUEYANG TOWER-HUNAN, CHINA



8210 澳大利亚悉尼歌剧院
SYDNEY OPERA HOUSE-BENNELONG POINT, AUSTRALIA



7212 中国江西南昌滕王阁
PAVILION OF PRINCE TENG-JIANGXI, CHINA



6227 中国河南郑州嵩山少林寺
SHAOLIN TEMPLE-HENAN, CHINA



7213 中国重庆洪崖洞
HONGYADONG-CHONGQING, CHINA



5235 美国华盛顿哥伦比亚特区国会大厦
UNITED STATES CAPITOL-WASHINGTON, D.C., AMERICA



5236 中国安徽滁州醉翁亭
ZUIWENG PAVILION-ANHUI, CHINA



6228 中国陕西西安钟楼
XI'AN BELL TOWER-SHAANXI, CHINA



5238 美国华盛顿州西雅图太空针塔
SPACE NEEDLE-SEATTLE, WASHINGTON, AMERICA



5237 法国巴黎普瓦西萨伏伊别墅
VILLA SAVOYE-POISSY, PARIS, FRANCE



6229 中国山西运城鹳雀楼
STORK TOWER-SHANXI, CHINA

STORK TOWER

COUNTRY: China
CITY: Shanxi

