



# SHANGHAI CUSTOMS HOUSE

中国上海海关大楼

Shanghai, China

The world's great architecture





# Architecture

It will be a city...

这将构成一座城市...

# ABOUT THE PRODUCT

关于产品

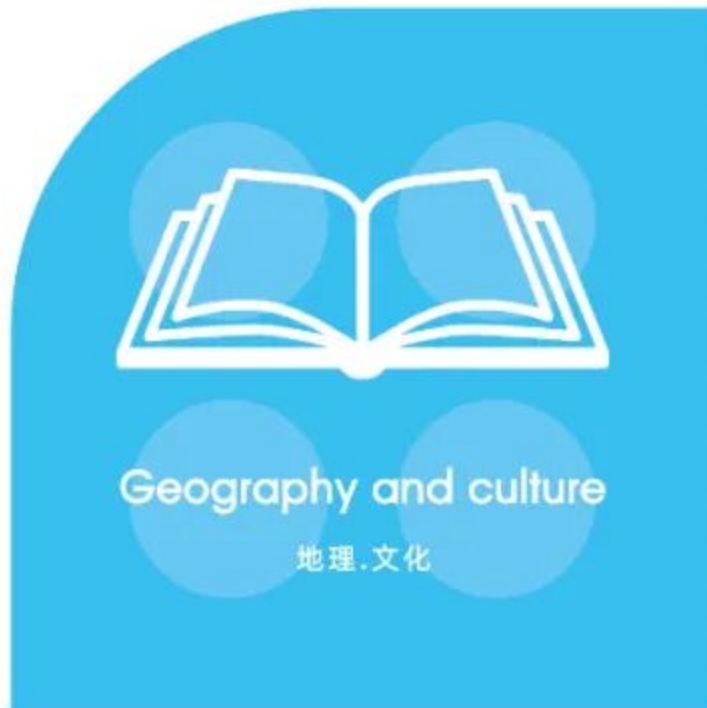

## ARCHITECTURE

WANGE The world's great architect since 1991

Geography and culture

地理·文化

# Shanghai Customs House



Shanghai Customs House is located at No. 13, Zhongshan East 1st Road, Huangpu District, Shanghai, China.

# Shanghai Customs House



## Geography and culture

地理·文化



The Custom House is an eight story building on the Bund, Shanghai. Built in 1927, the building remains a customs house today. Together with the neighboring HSBC Building, the Custom House is seen as one of the symbols of the Bund and Shanghai.





中国上海海关大楼

# Shanghai ■ Customs House China

The contents of this chapter refer to the Wikipedia website.

本章内容参考维基百科网站，  
更多资讯可自行查阅。

The world's great architecture

# Buildings and layout

■ 建筑物和布局



**上海海关大楼** 位于上海黄浦区中山东一路 13 号，外滩海关建筑。最早是由中国人造的一座宫衙式房屋。三进楼房正檐翘角，歇山顶，屋面上又有一座小阁。海关大楼于 1893 年竣工，砖木结构。中间有五层高的哥特式方形钟楼，钟楼两面各有三层楼房相对，大门两旁围墙上加铁栏杆，入门为广场。大楼占地面积为 5722 平方米，建筑面积为 32680 平方米。钟楼旗杆位置北纬 31 度 14' 20.38"，东经 121 度 29' 0.02"，为上海地理位置的标志点，同时也外滩建筑中上最气派最大者。上海海关大楼最著名的是它高耸的钟楼和大钟。这座大钟是亚洲第一大钟，也是世界著名大钟之一。海关大楼巍然屹立在浦江之滨，它那铿锵、激昂的钟声象征着庄严，象征着使命。

The Custom House is an eight story building on the Bund, Shanghai. Built in 1927, the building remains a customs house today. Together with the neighboring HSBC Building, the Custom House is seen as one of the symbols of the Bund and Shanghai. The present Custom House occupies an area of 5,722 square meters (61,590 sq ft), with 32,680 square meters (351,800 sq ft) of floor space. The building is in two section: the eastern section is eight stories tall and faces the Huangpu River. It is topped by a clock tower, which is eleven stories or 90 meters (300 ft) tall. The western section is five stories tall and faces onto Sichuan Road. A reinforced concrete core was used while the exterior follows a Greek-revival Neo-Classical design. The most noted feature of the Custom House is the clock tower and clock. The clock tower offers views over the entire Bund and Shanghai city centre. It remains the largest mechanical clock in Asia.



## Layout

大楼面临外滩的一端高8层，上冠三层高的四面钟楼，西部5层，均为钢架结构。主楼高度约120英尺（合36.2米），钟楼高度约140英尺（合43米），大楼总高度约260英尺（合79.2米），是20世纪20年代上海外滩最高的建筑物。外墙用金山石砌筑，东部墙面用花岗石砌筑，西部1、2层石砌，3、4层镶褐色面砖。正面1、2层处理似底座，粗石墙面。7层上方又挑出高大檐口。顶部的钟楼为整幢建筑的纵轴线，两边门窗及雕刻图案对称、和谐。东立面大门由4根粗壮的多立克柱子支撑，显得庄重有力。正门入口有4根希腊多立克式柱，形成门廊。入口大厅藻井以彩色马赛克相拼的帆影海事图案为饰，甚为精美。

The building is in two section: the eastern section is eight stories tall and faces the Huangpu River. It is topped by a clock tower, which is eleven stories or 90 meters (300 ft) tall. The western section is five stories tall and faces onto Sichuan Road. A reinforced concrete core was used while the exterior follows a Greek-revival Neo-Classical design.



## History

1891年，此屋已十分陈旧，上海的道台请得上级拨款，翻造新署，这时海关已有赫德掌权，遂请了英国工程师设计，施工由浦东人杨斯盛的营造厂主持。当年替外国人造房子，必须有一定的技术力量，并由洋人监工。十分挑剔。杨斯盛建成海关后，庄严的外表在上海建筑行业中获得了一定的地位。1925年，这座楼房又显得陈旧且不敷应用，于是再一次重建新楼，规模又扩大了。新楼由公和洋行设计，英国建筑公司承建。是年12月奠基，1927年12月19日落成，花去白银430万两，较预算增加一倍多。1893年建造的海关大楼是当时外滩最高建筑物，海关大楼顶部为逐级收拢的四面钟楼，每日准确、悠扬的报钟声使之与南侧原汇丰银行大楼一起成为当时年代外滩建筑群的核心建筑之一。钟楼旗杆位置北纬31°14'20.38，东经121°29'0.02，成为20世纪20年代上海地理位置的标志点，同时也是外滩建筑中最高、气派最大者。

As rebuilt in 1857, the New Custom House was in the traditional Chinese Yamen style. It was fronted with a monumental arch or pailou and two flag poles. By 1859, the building had become outdated. The governor of Shanghai then applied for funding to rebuild it. Robert Hart chose a Gothic design, with a five-story rectangular clock tower in the center, and two three-story wings beside it, surrounding a quadrangle. This was built in 1891. This building was again demolished in 1925 to make way for the current structure designed by architects Palmer and Turner. The new building was completed on 19 December 1927, and cost 4.3 million taels of silver, twice the budget. It was the tallest building on the Bund at the time of construction. The building remains a customs house today.

# Force Balance

受力平衡

$$F = G \frac{m_1 m_2}{d^2}$$

Physical operations

物理运算

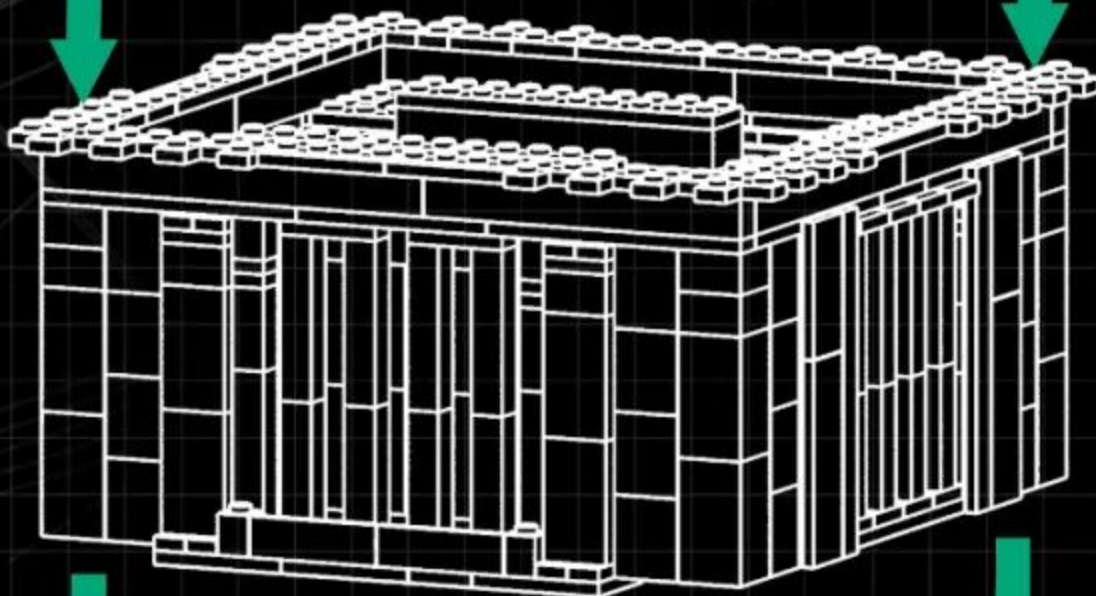

Creation and thinking

创作·思考

08

$$S=4\pi \cdot r^2$$

# Special parts

特殊零件的开发利用

$$a^2+b^2=c^2$$

**WG1218**  
5倍圆棒

**WG1337**  
无孔3x4

**WG1506**  
1孔拱形栏杆

**WG1507**  
转角拱形栏杆

**WG1342**  
4孔拱形栏杆

**WG0379**  
带槽矮长4孔

**WG1508**  
带槽直角矮3孔

$$\sin^2 a + \cos^2 a = 1$$

**WG1498**  
短椅后6孔

**WG1330**  
带槽矮长6孔



features and functions

特点.功能

# Main Color Matching

配色方案



**Color matching** Adopting 3 main colors, Cream-colored, Gray and Green as the main color, the more reasonable and bold color matching on the original building, making the product more atmospheric and the whole design is more reasonable.

# Shanghai Customs House

中国上海海关大楼

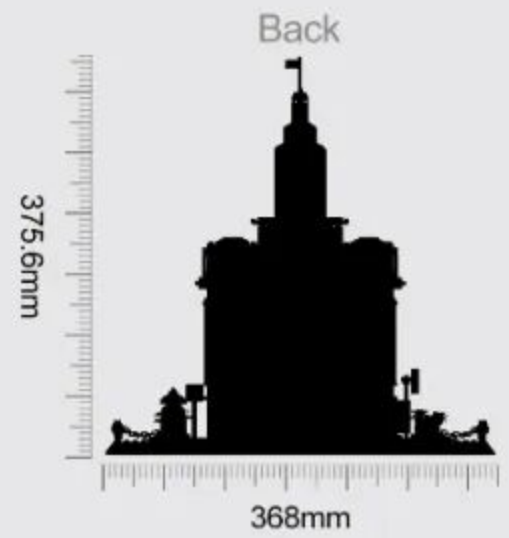
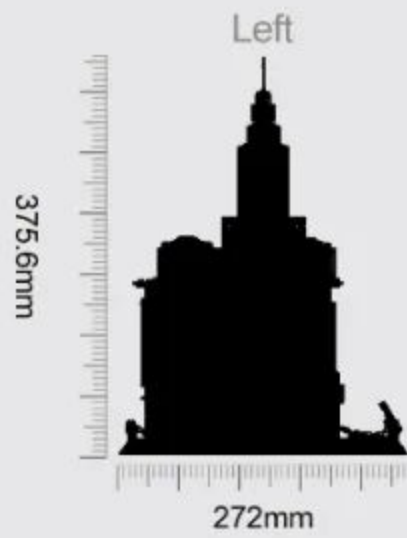
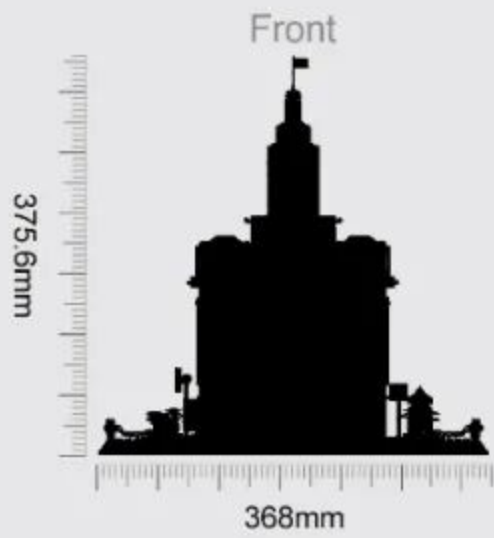

Product Size:368X272X375.6mm



# Instructions For Use

积木起件器使用说明  
Brickseparator

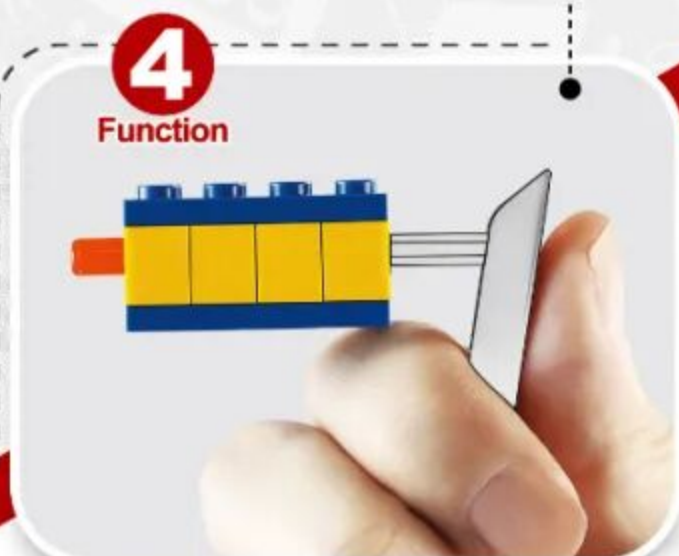
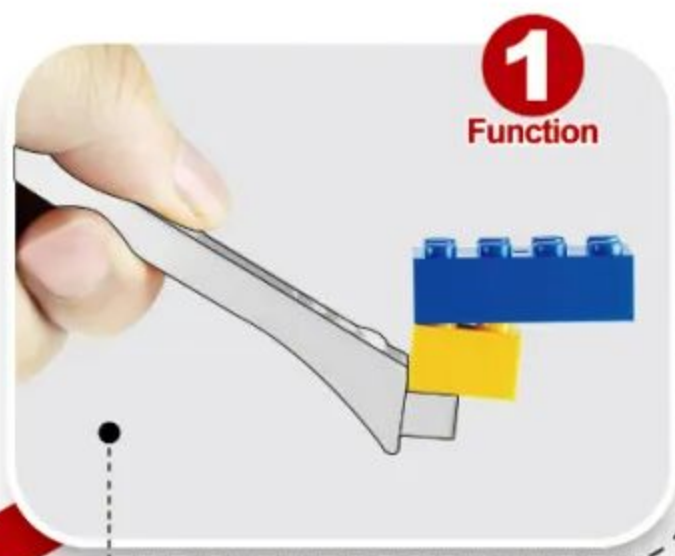

4 ways to make installation easier  
让安装更简单



■ First open the product packaging according to the instructions.

按指导用正确方式拆解产品外包装。



■ Summarize all parts to count the number of familiar accessories.

对照说明书清单确认积木包数量与积木数量。



■ Arranging all accessories by color helps to quickly install the product.

把确认好的积木以类型、颜色进行分类排好以便安装。



■ Carefully install the product and learn about building.

按说明书步骤拼装并完成你的积木模型。



# 1:1 Physical Reference Table

十字棒配件1:1尺寸参照表



Instructions For Use

让安装更简单

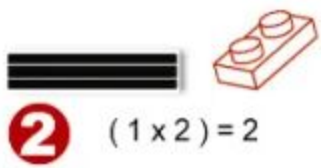

**2** (1x2)=2

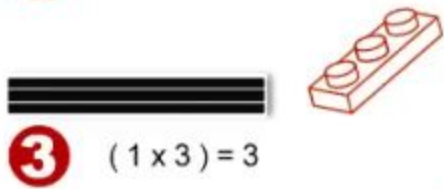

**3** (1x3)=3

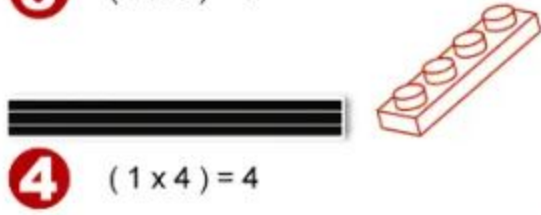

**4** (1x4)=4



**5** (1x5)=5



**6** (1x6)=6

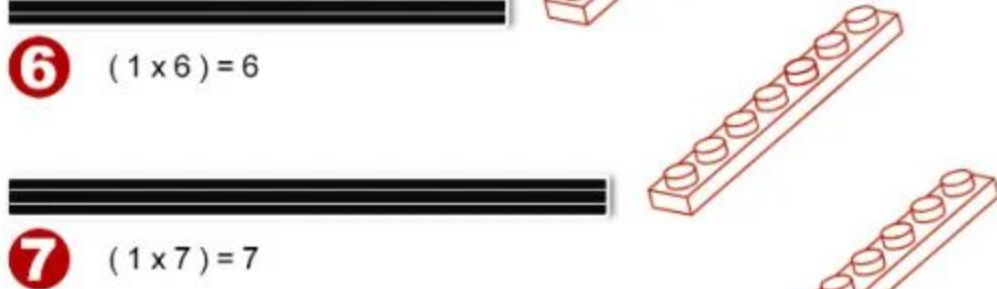

**7** (1x7)=7



**8** (1x8)=8



**9** (1x9)=9



**10** (1x10)=10



**12** (1x12)=12











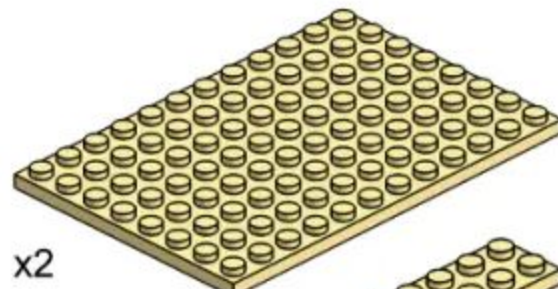



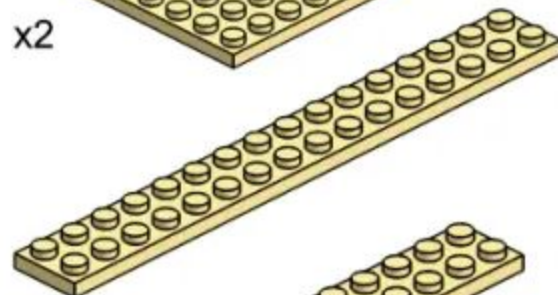
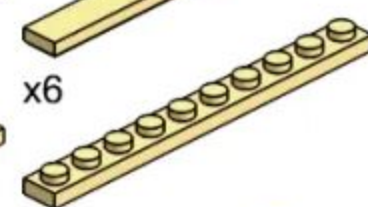



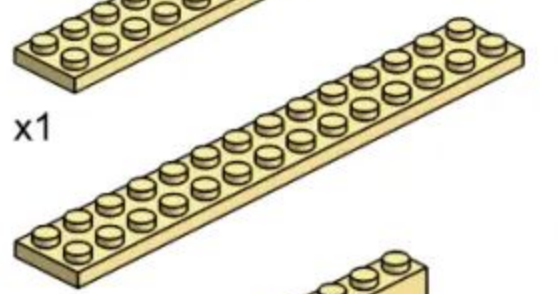
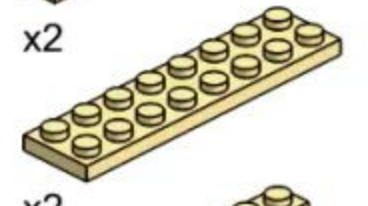



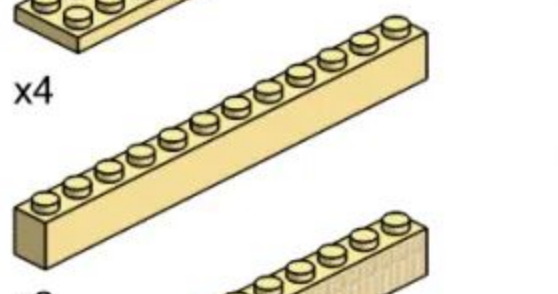
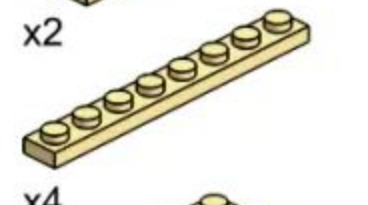



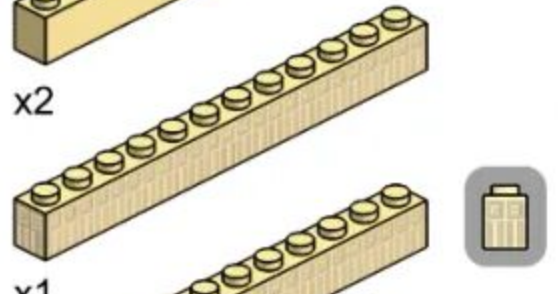
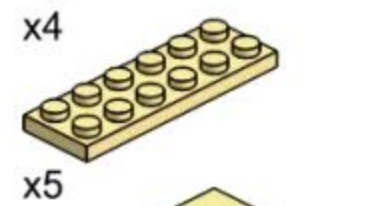
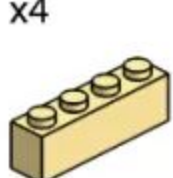

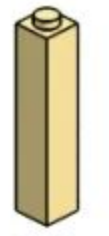
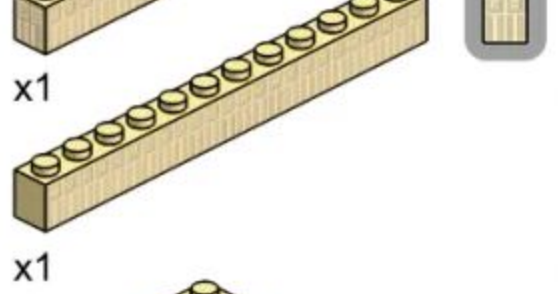
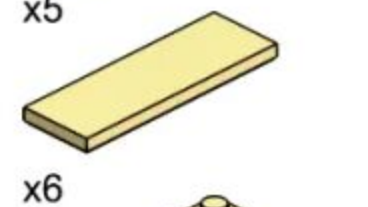
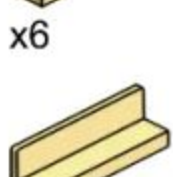
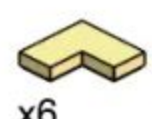
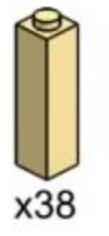
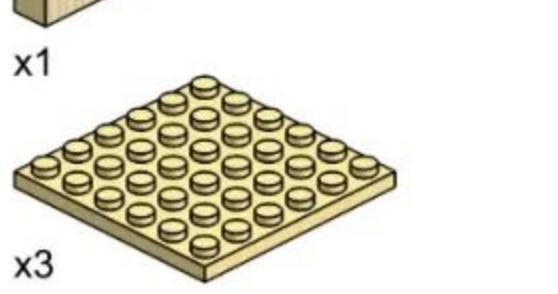
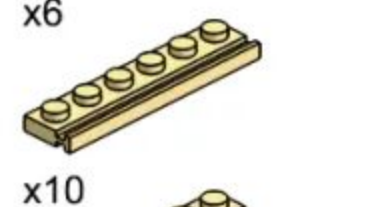
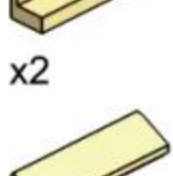

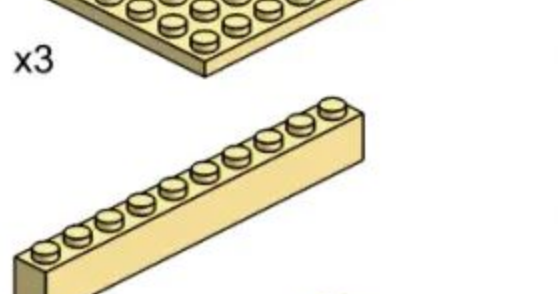
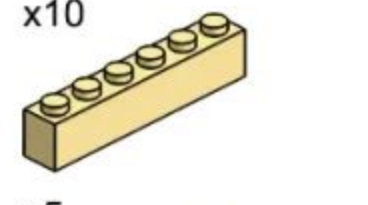
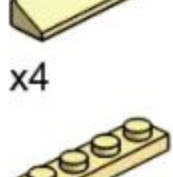

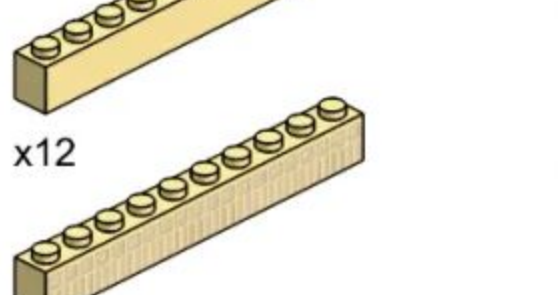

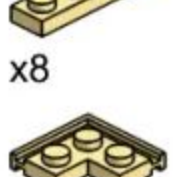

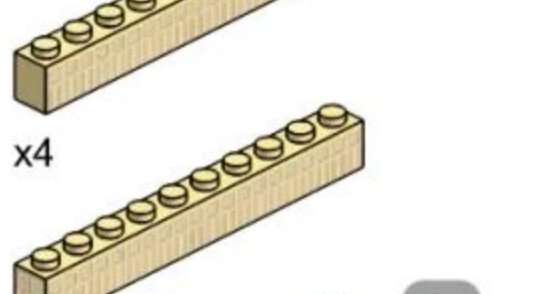
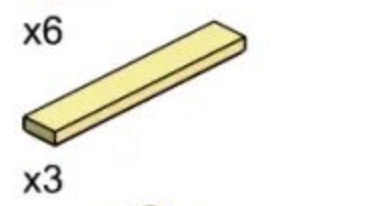
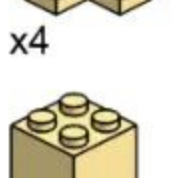

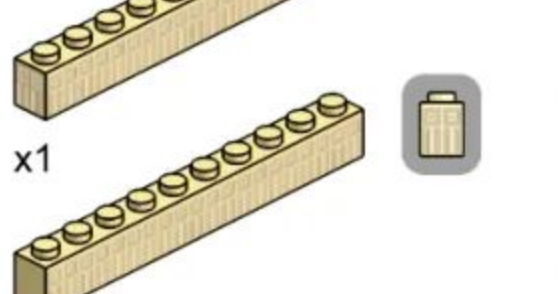
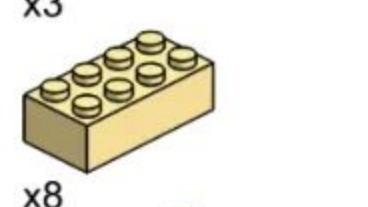



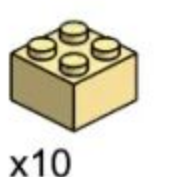

**16** (1x16)=16

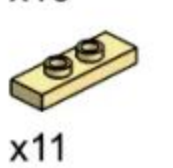

# PARTS LIST

配件清单

 x2	 x6	 x4	 x10	 x24
 x1	 x2	 x15	 x2	 x36
 x4	 x2	 x4	 x10	 x1
 x2	 x4	 x4	 x36	 x1
 x1	 x5	 x4	 x2	 x20
 x1	 x6	 x6	 x6	 x38
 x1	 x10	 x2	 x12	 x10
 x3	 x5	 x4	 x2	 x4
 x12	 x6	 x8	 x2	 x12
 x4	 x3	 x4	 x32	 x12
 x1	 x8	 x24	 x14	 x18
 x1	 x4	 x10	 x19	 x28
	 x6	 x11	 x2	
	 x1		 x2	

产品有增补件请以实物为准

If product has additional parts, please in kind prevail.

# PARTS LIST



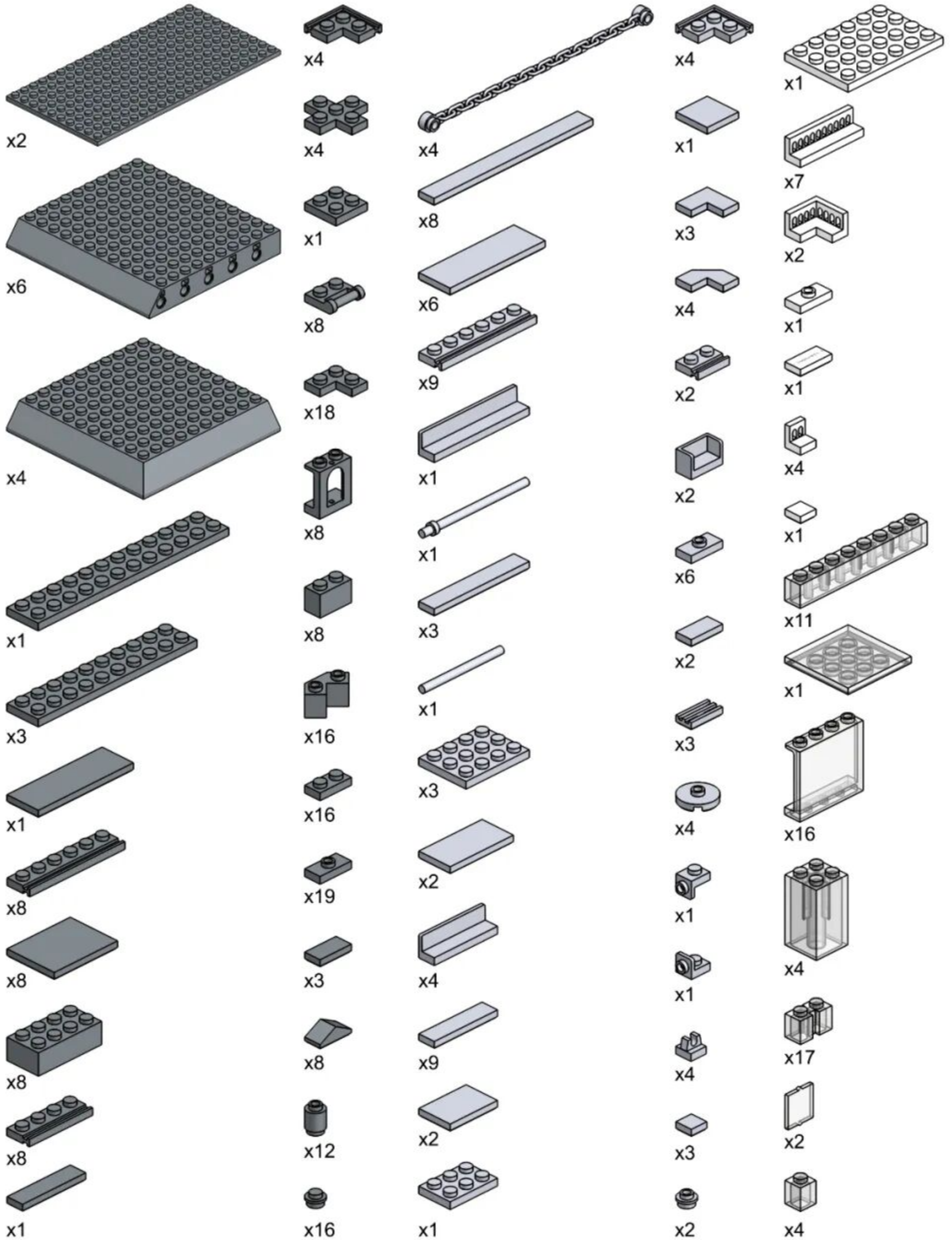







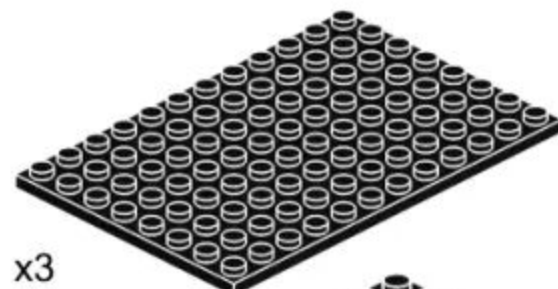



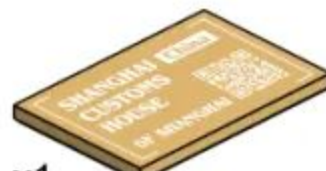



















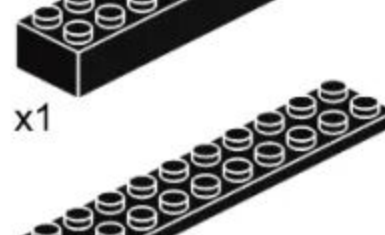

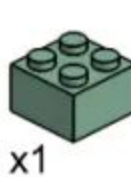









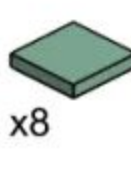

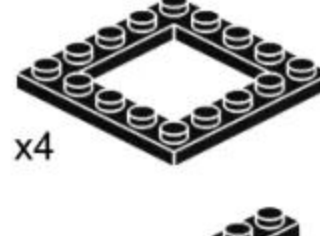

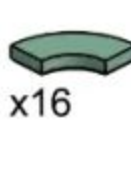

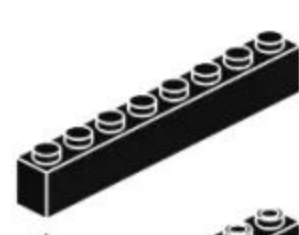



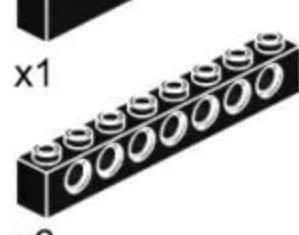





配件清单



产品有增补件请以实物为准  
If product has additional parts, please in kind prevail.

# PARTS LIST

配件清单

 x3	 x6	 x4	 x2	 x1
 x2	 x1	 x2	 x1	 x1
 x2	 x3	 x6	 x2	 x1
 x3	 x6	 x4	 x4	 x2
 x3	 x1	 x5	 x2	 x4
 x1	 x1	 x2	 x1	 x1
 x1	 x2	 x4	 x8	 x2
 x2	 x14	 x14	 x8	 x2
 x4	 x6	 x20	 x16	 x2
 x1	 x2	 x2	 x20	 x1
 x6	 x6	 x2	 x4	 x2
 x6	 x4	 x1	 x4	 x12
	 x46	 x4	 x16	 x1
	 x8	 x4		
		 x12		

产品有增补件请以实物为准

If product has additional parts, please in kind prevail.



262PCS

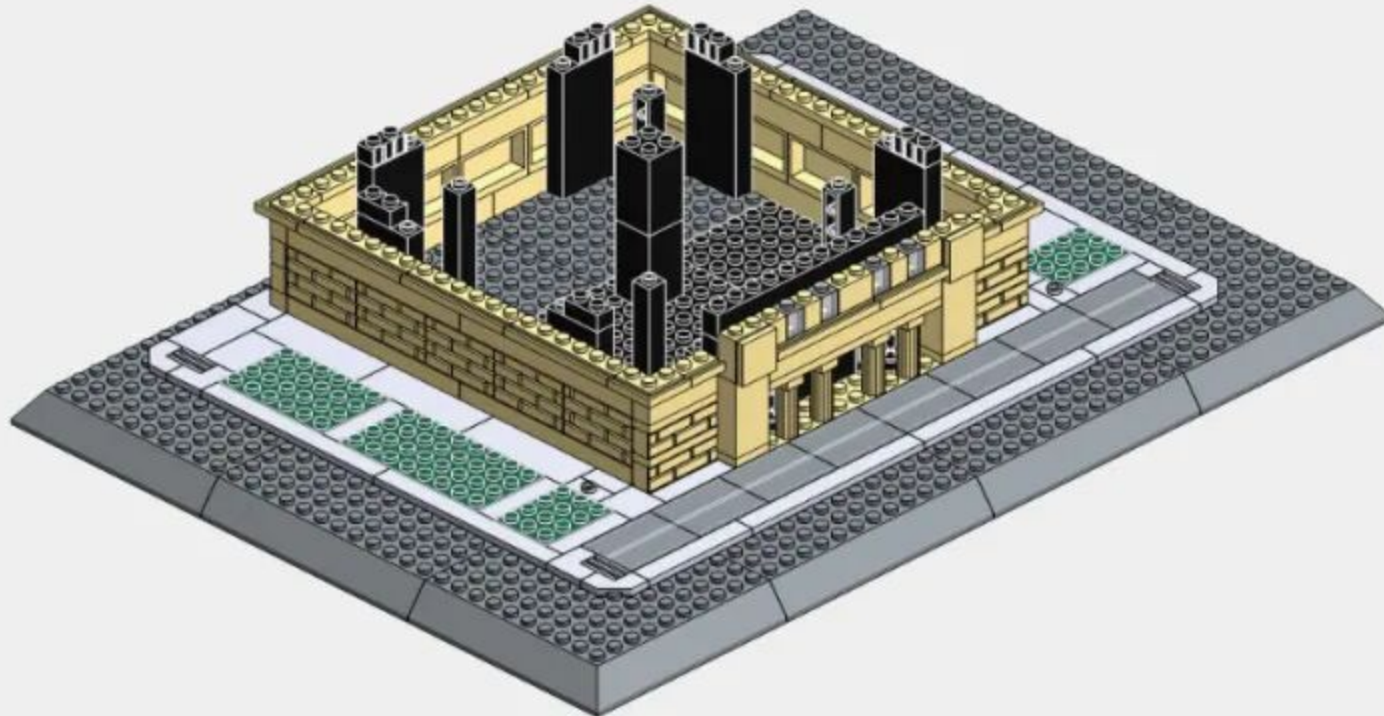

18

1-1

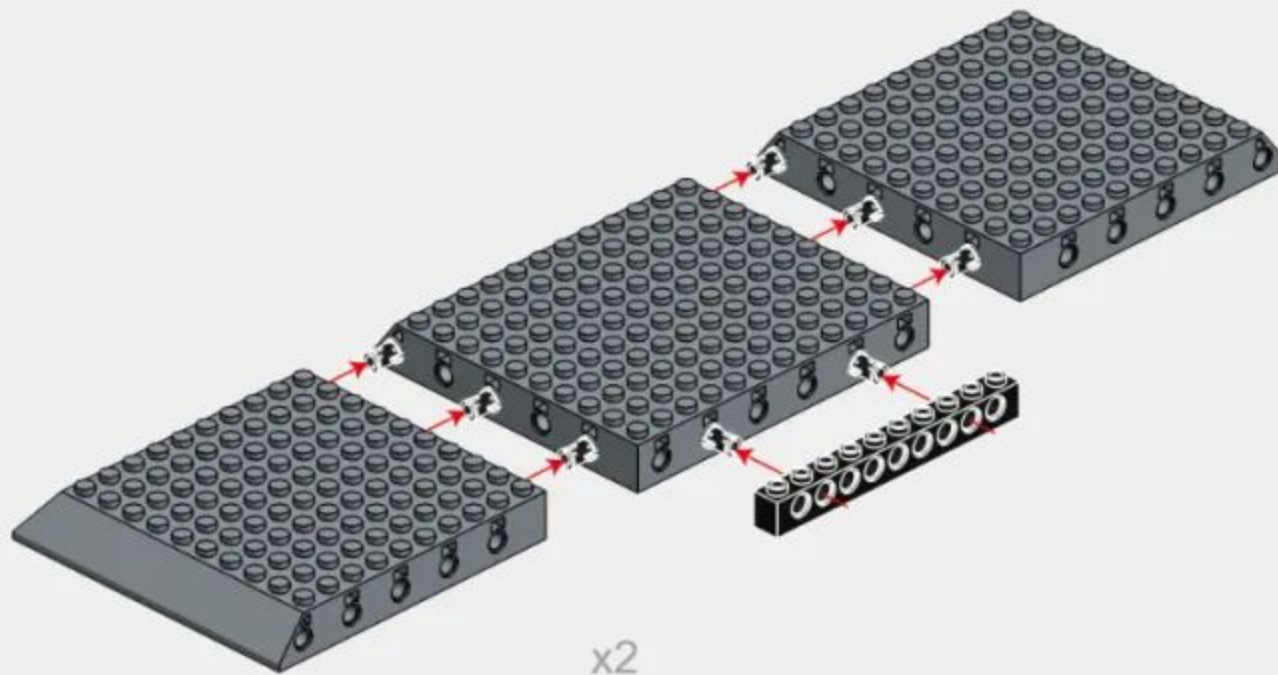
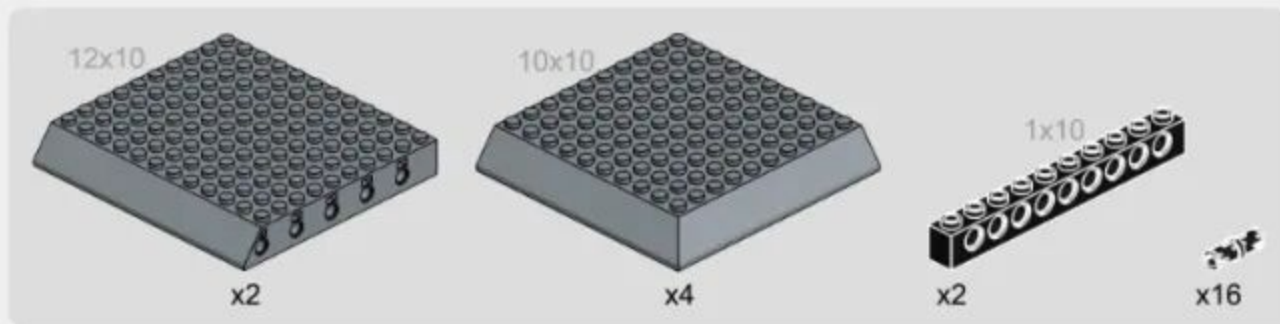

1-2

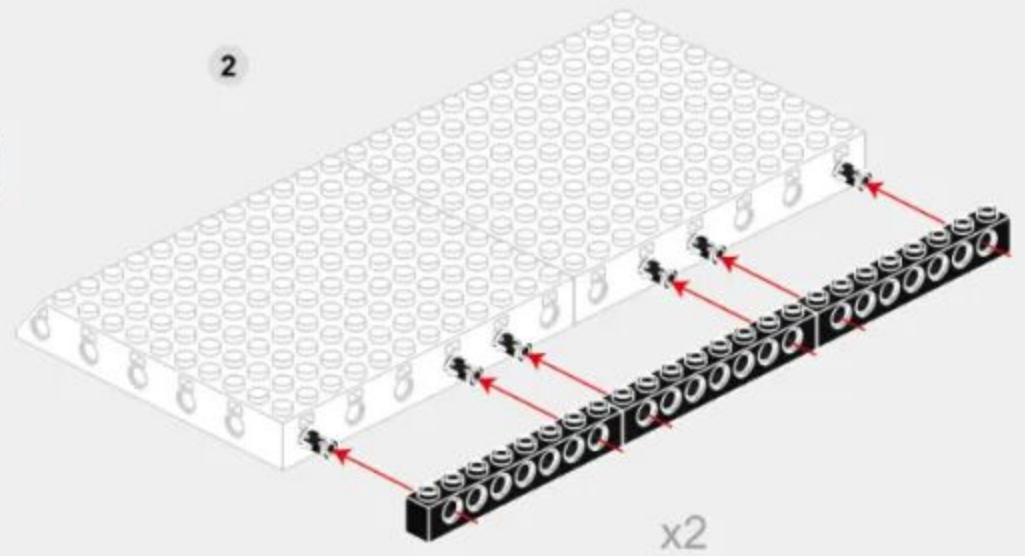
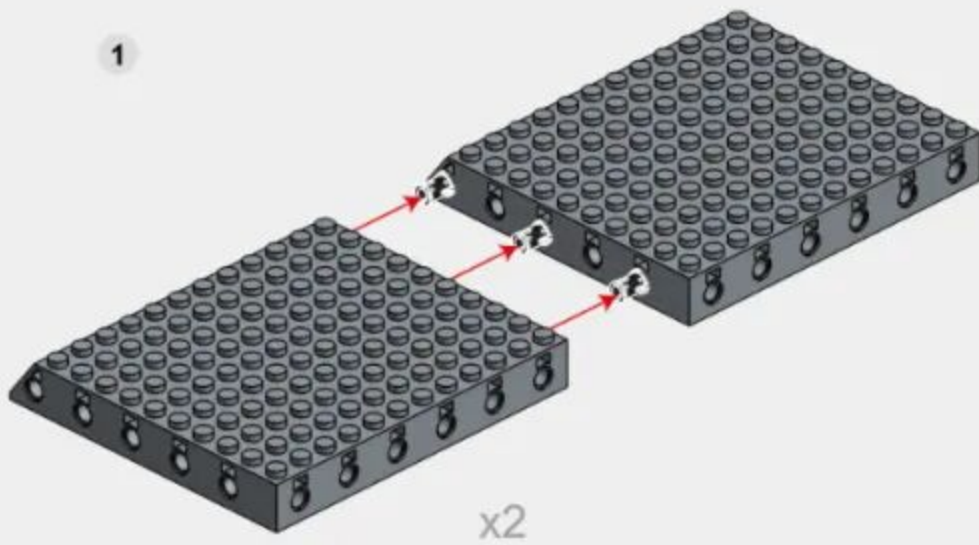
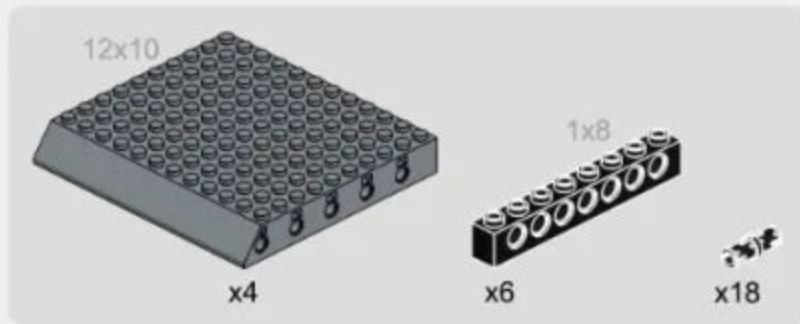

1-3

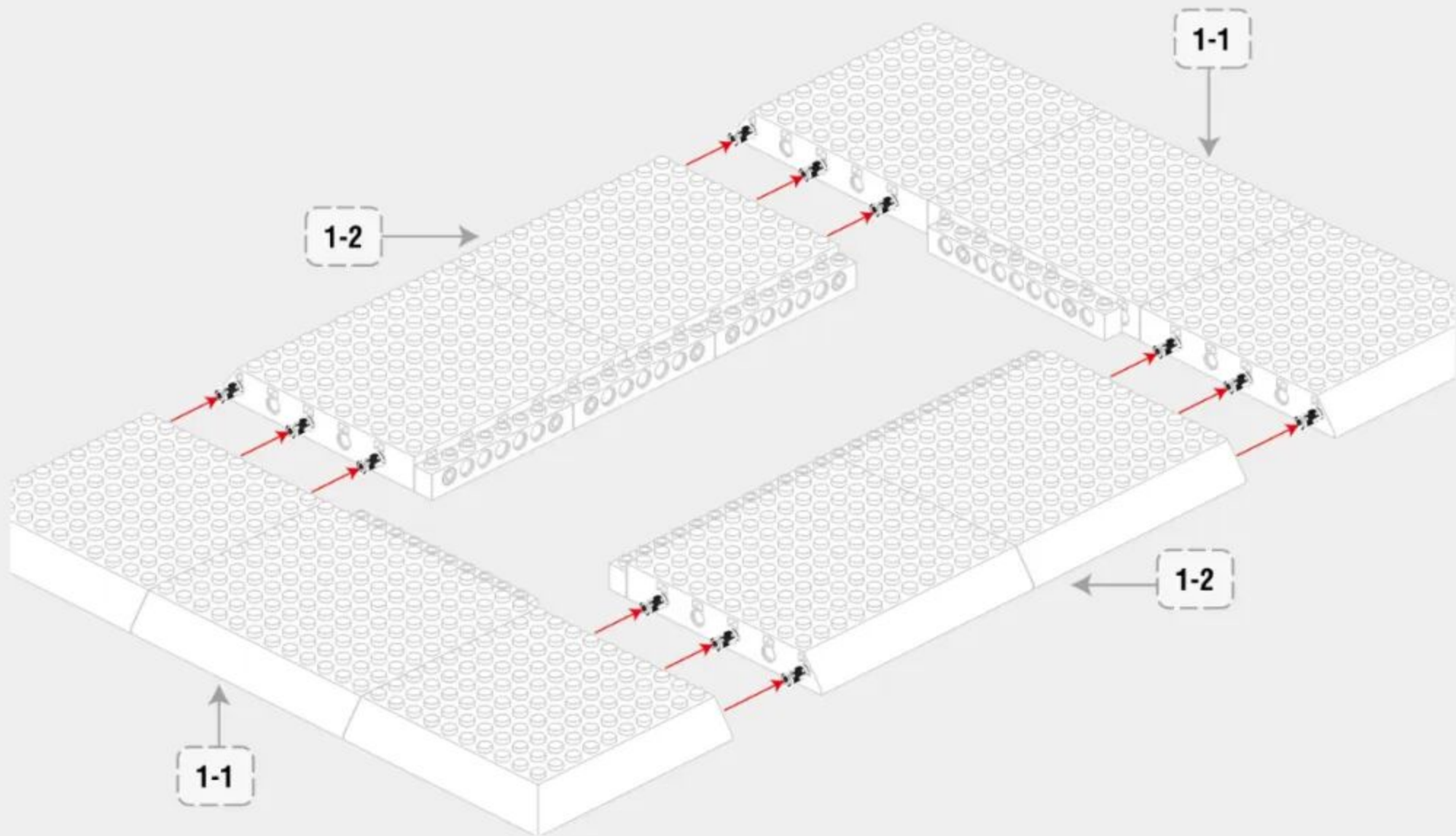

1-4

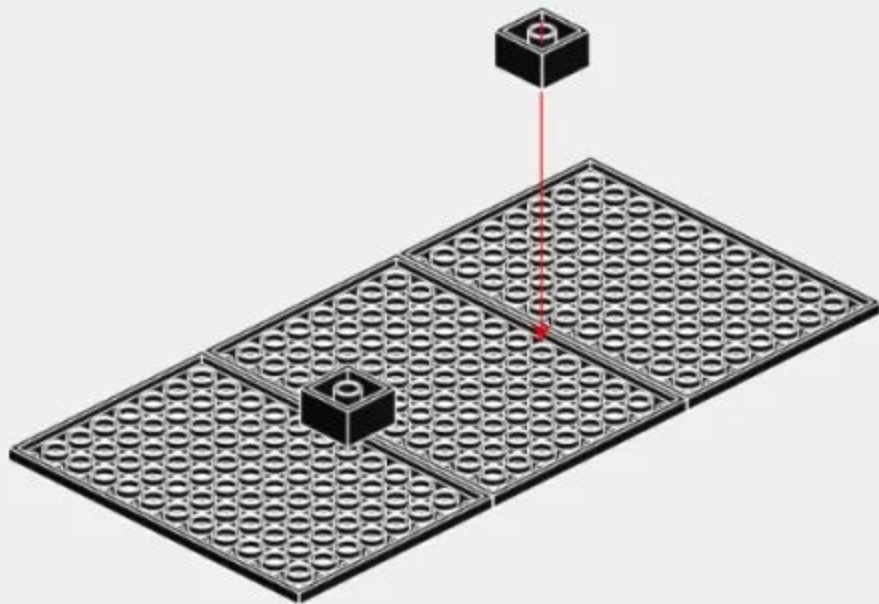
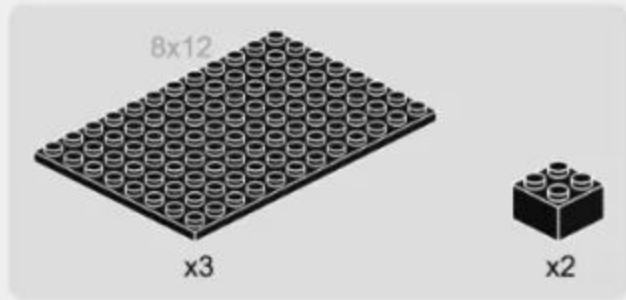

1-5

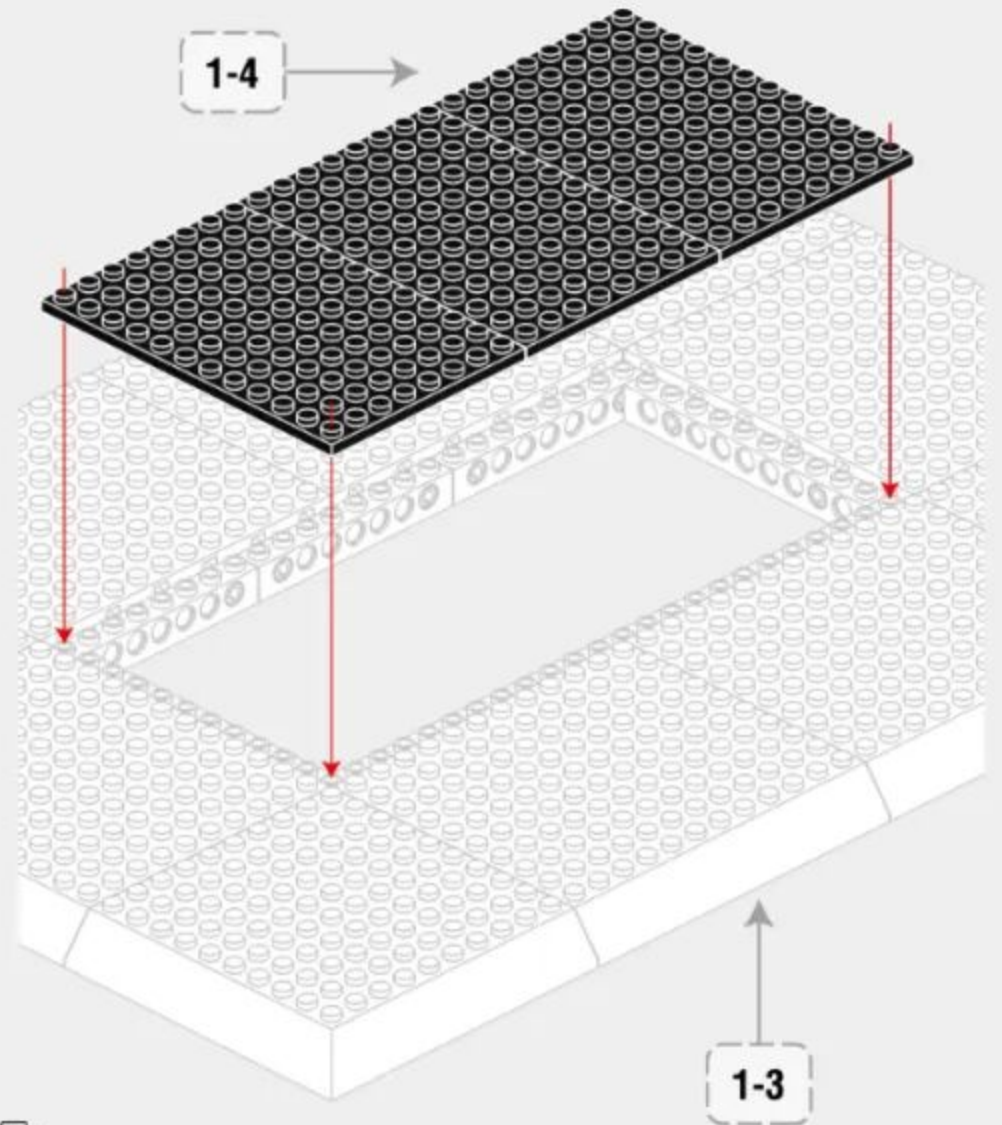

1-6

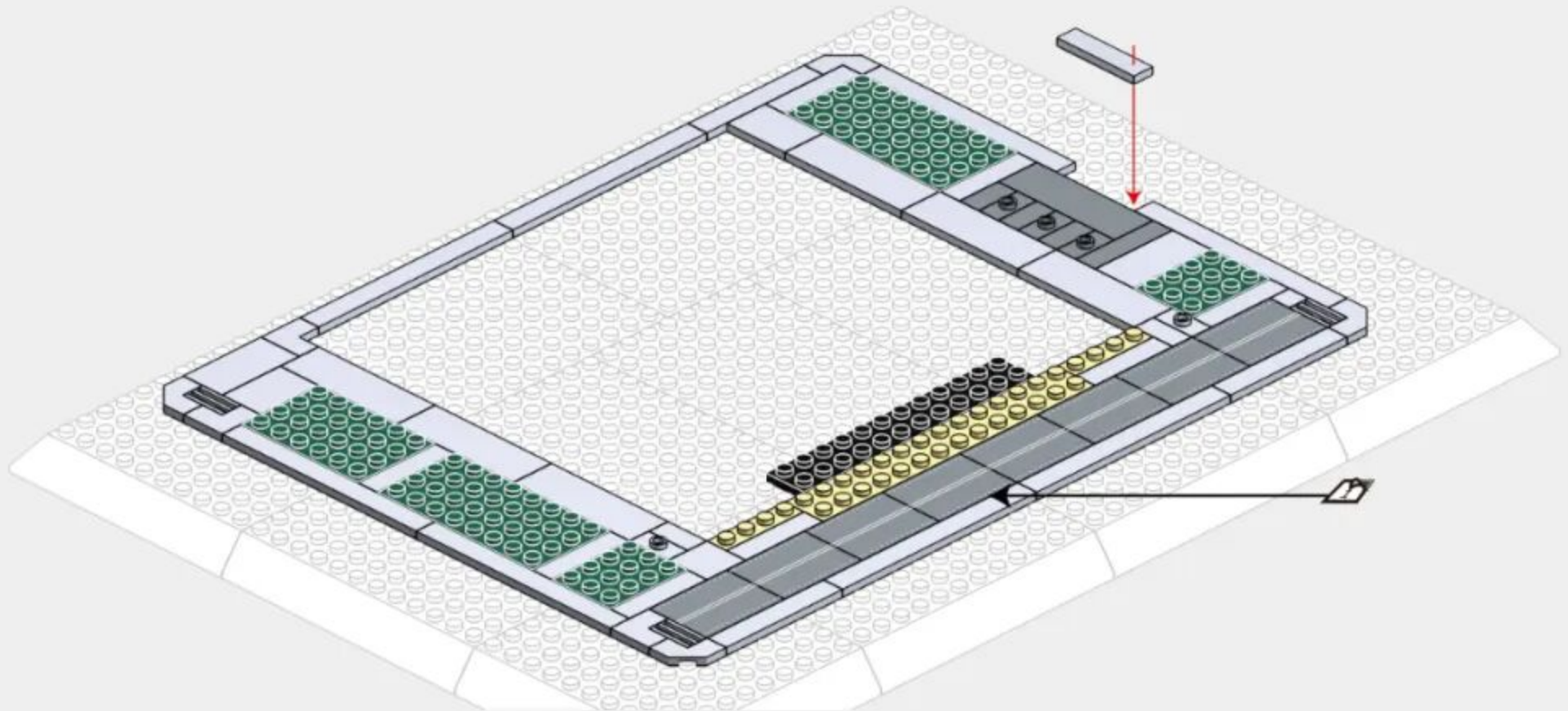
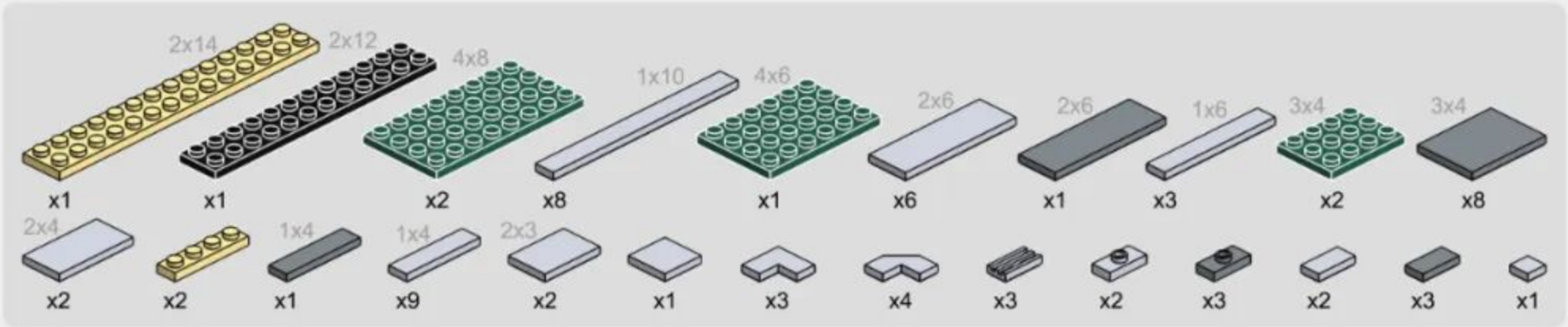

1-7

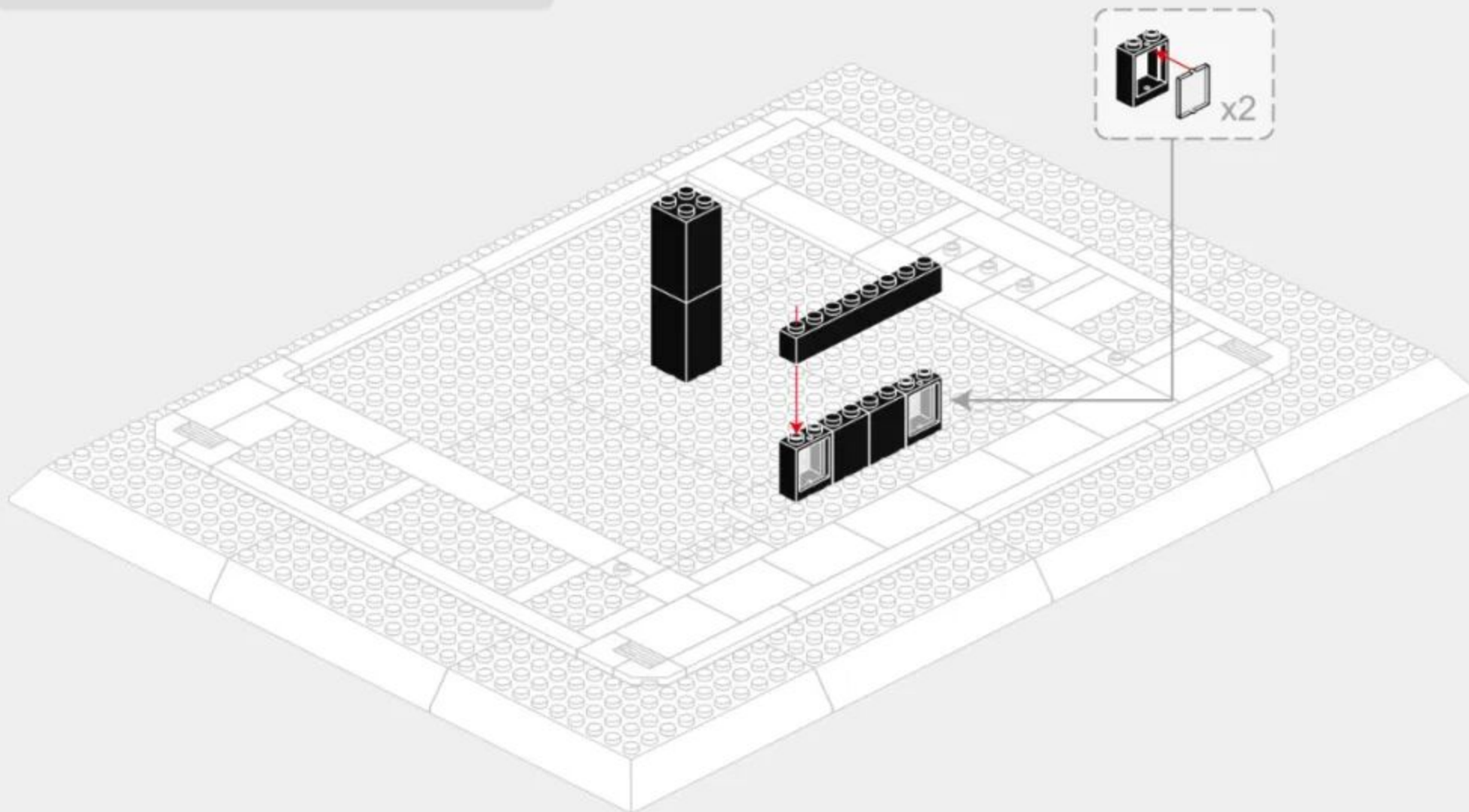
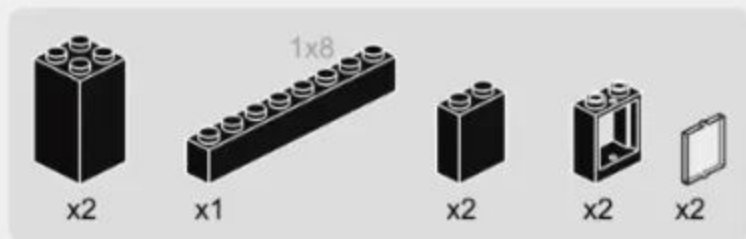

1-8

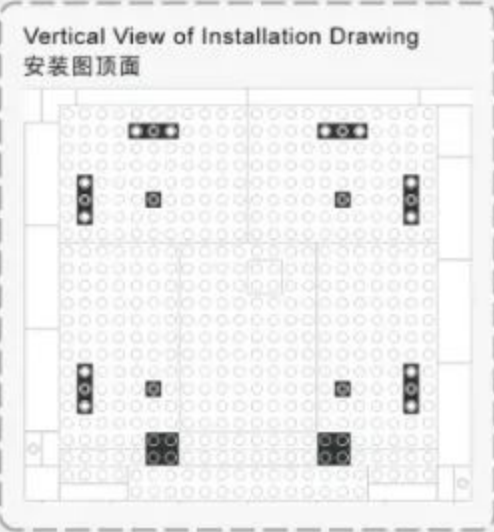
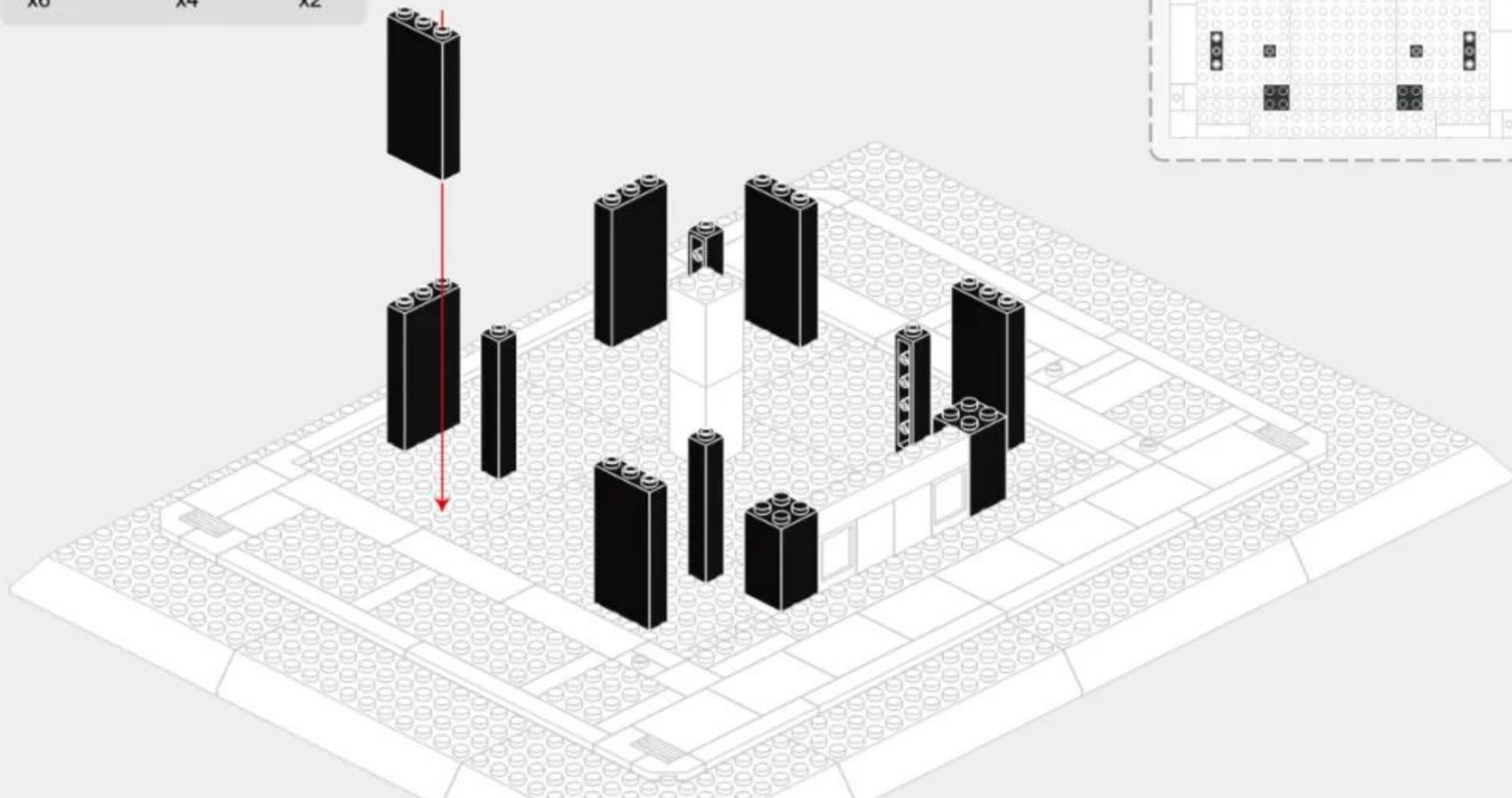
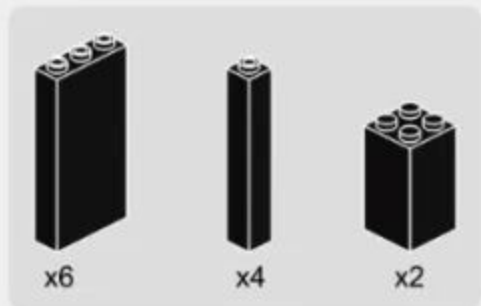

1-9

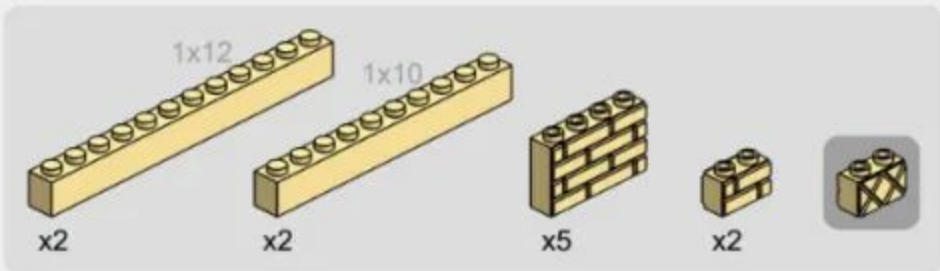

1-10

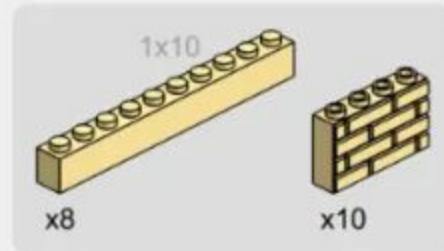

1

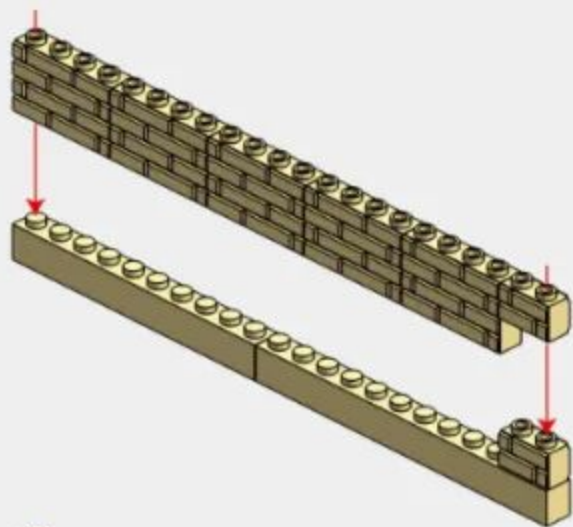

2

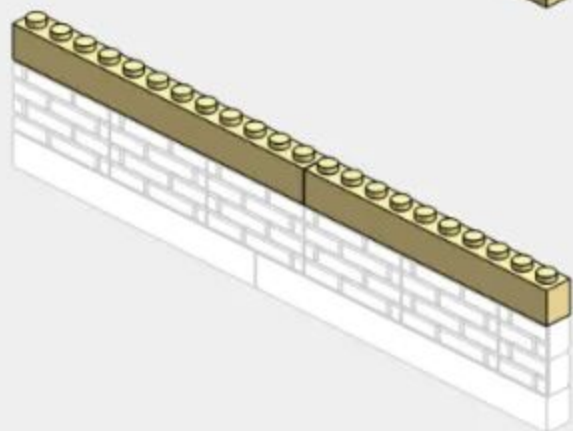

1

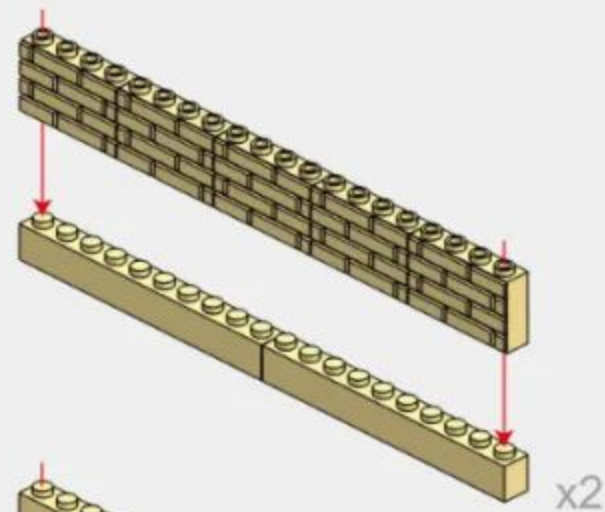

2

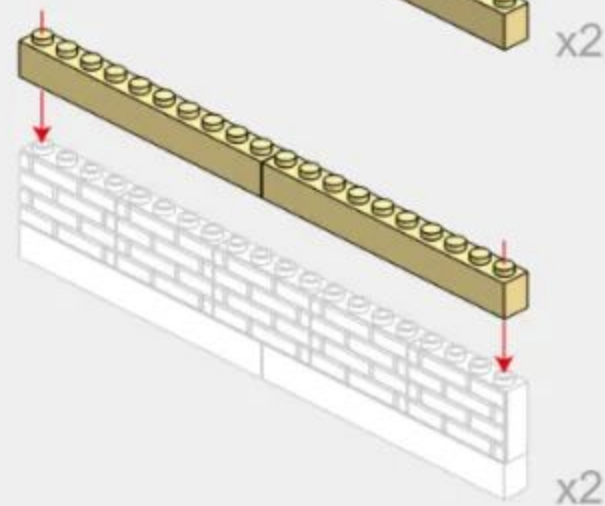

1-11

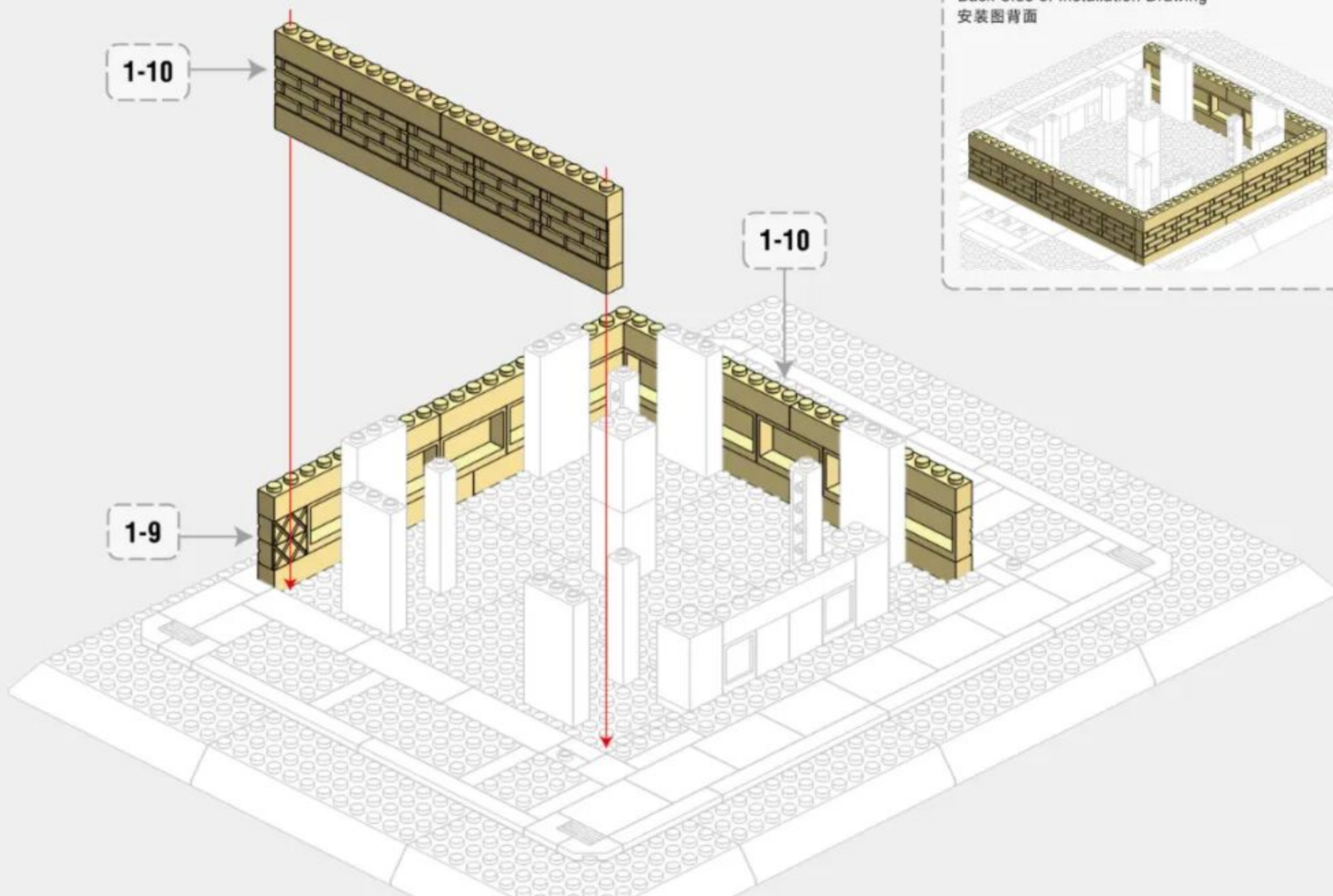

1-12

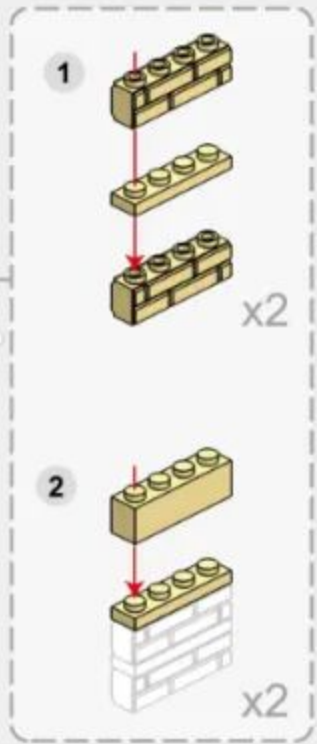
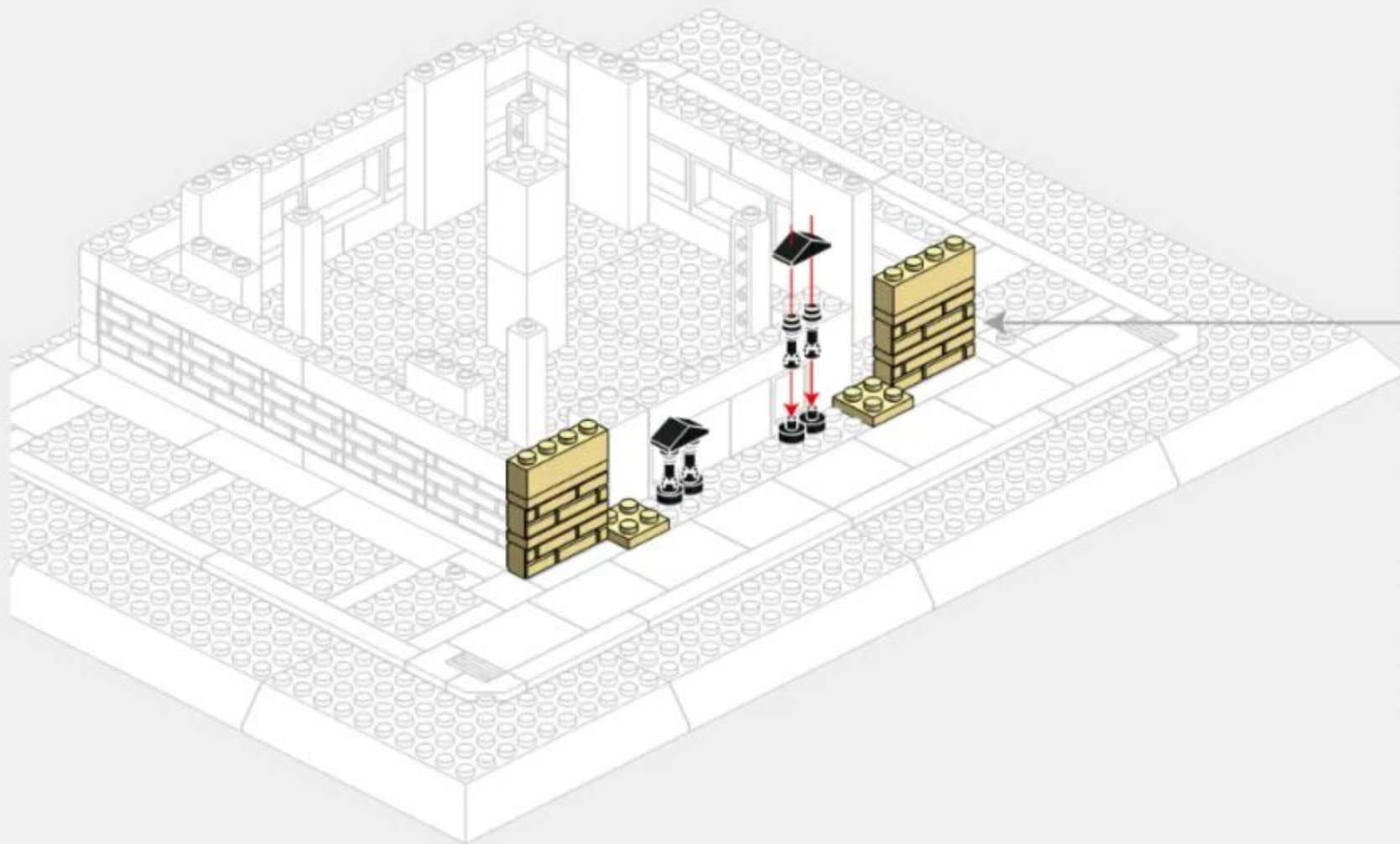
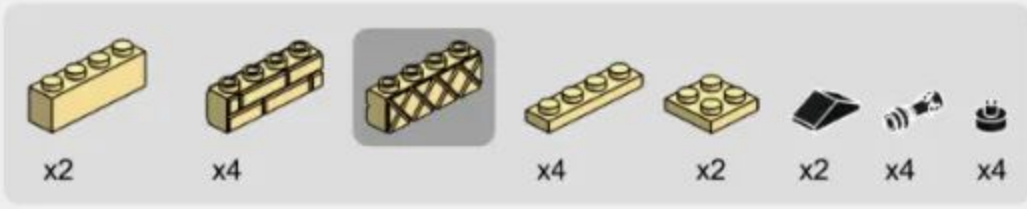

# 1-13

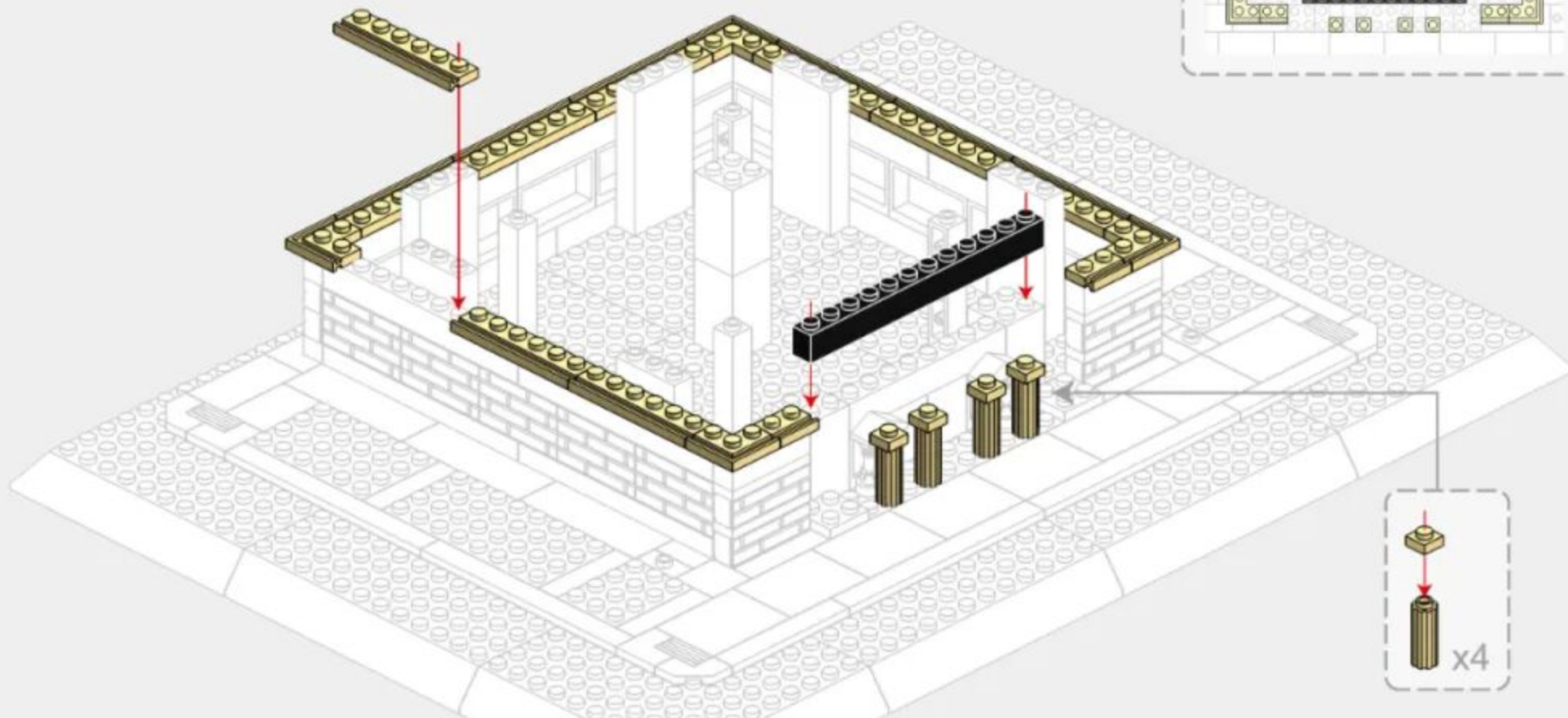
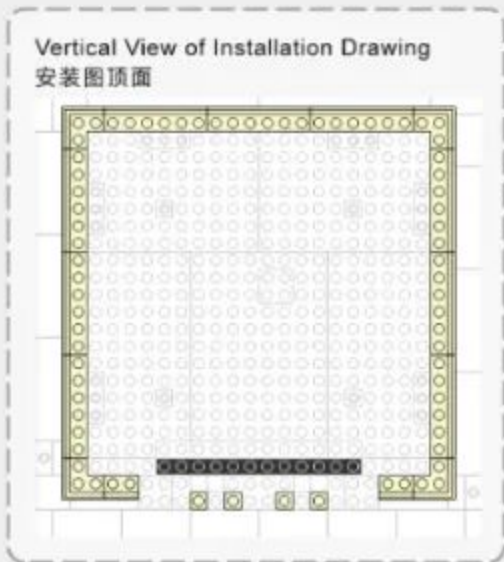

# 1-14

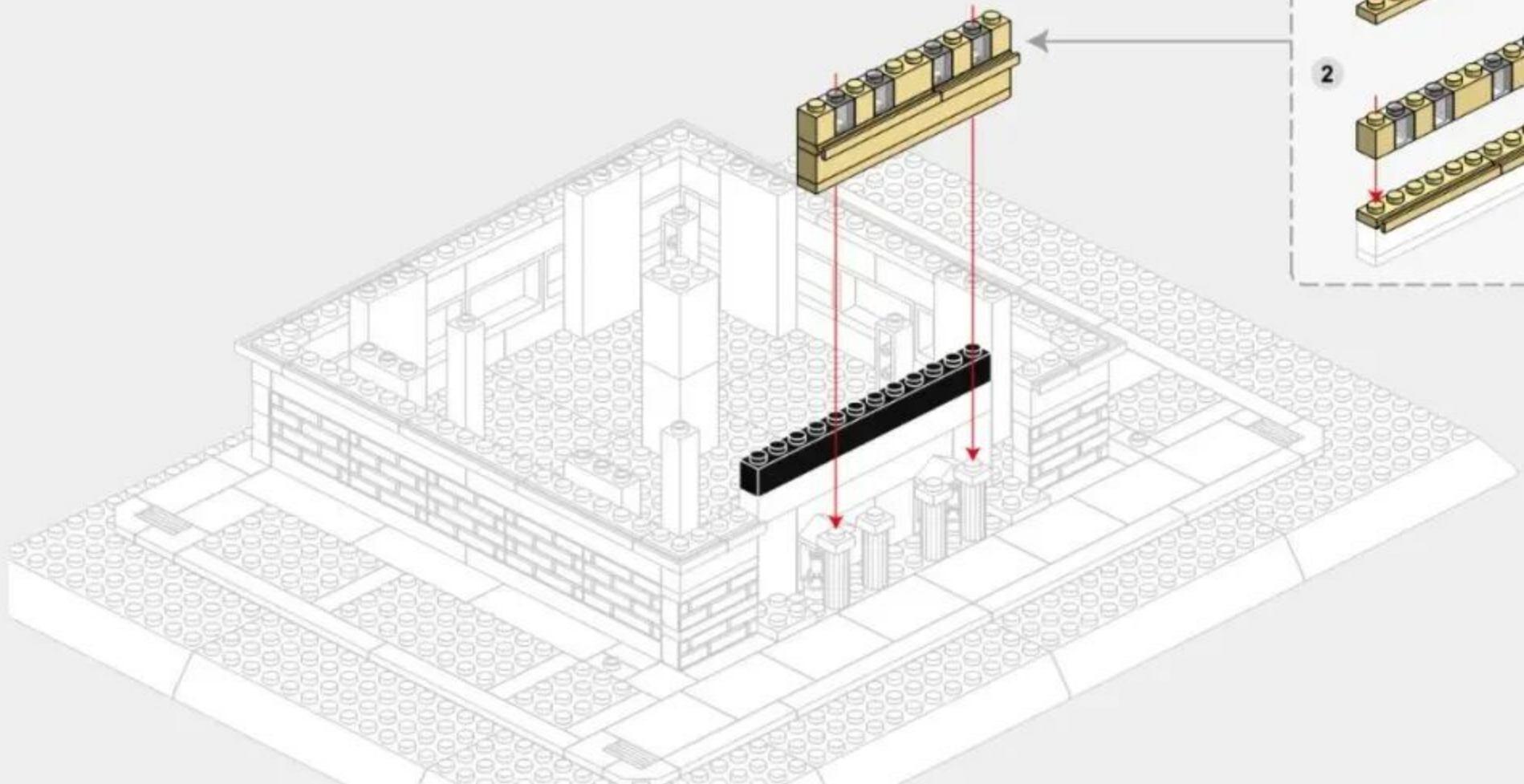
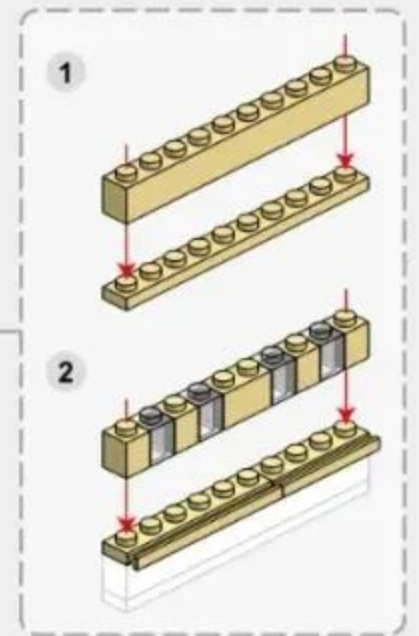
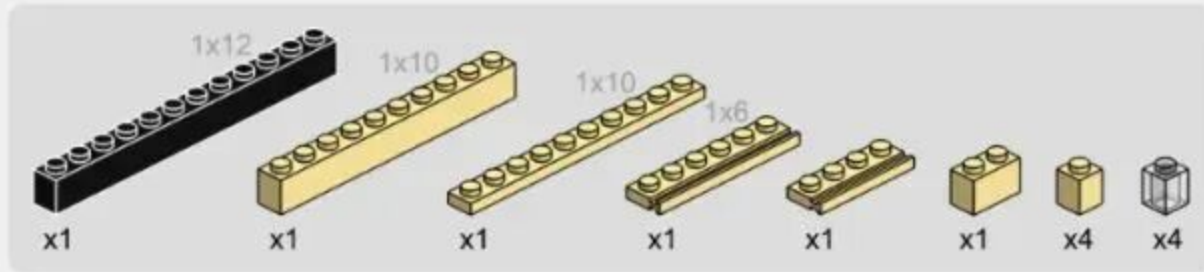

1-15

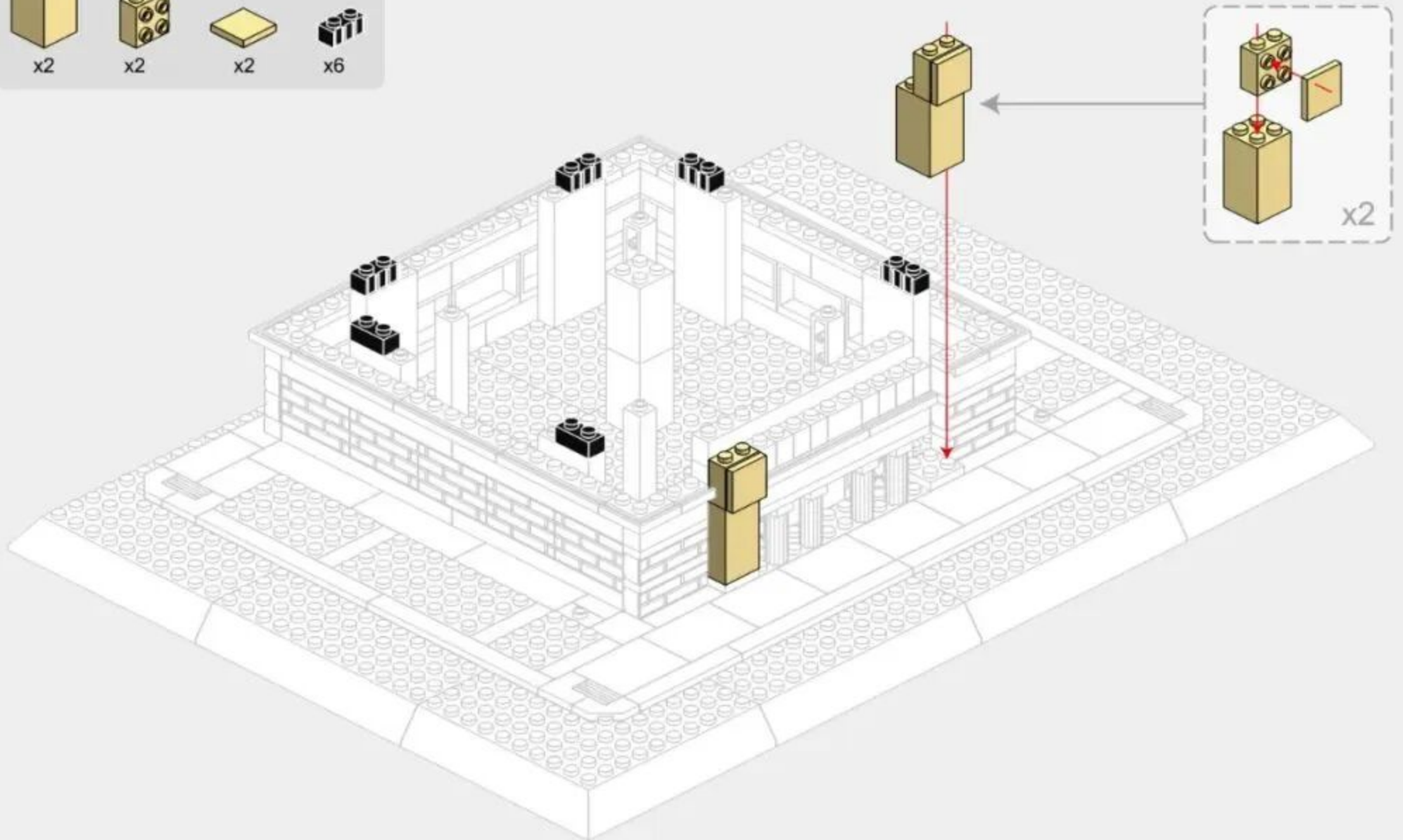



282PCS



32

2-1



x4



x12



x17

Back Side of Installation Drawing  
安装图背面

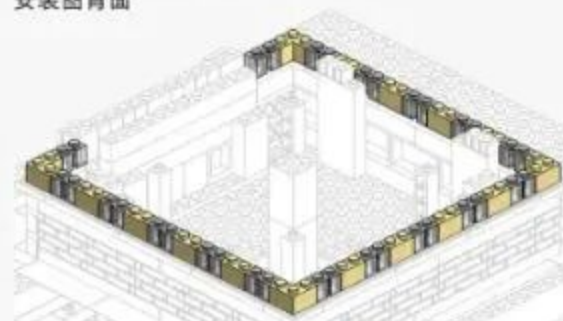

2-2

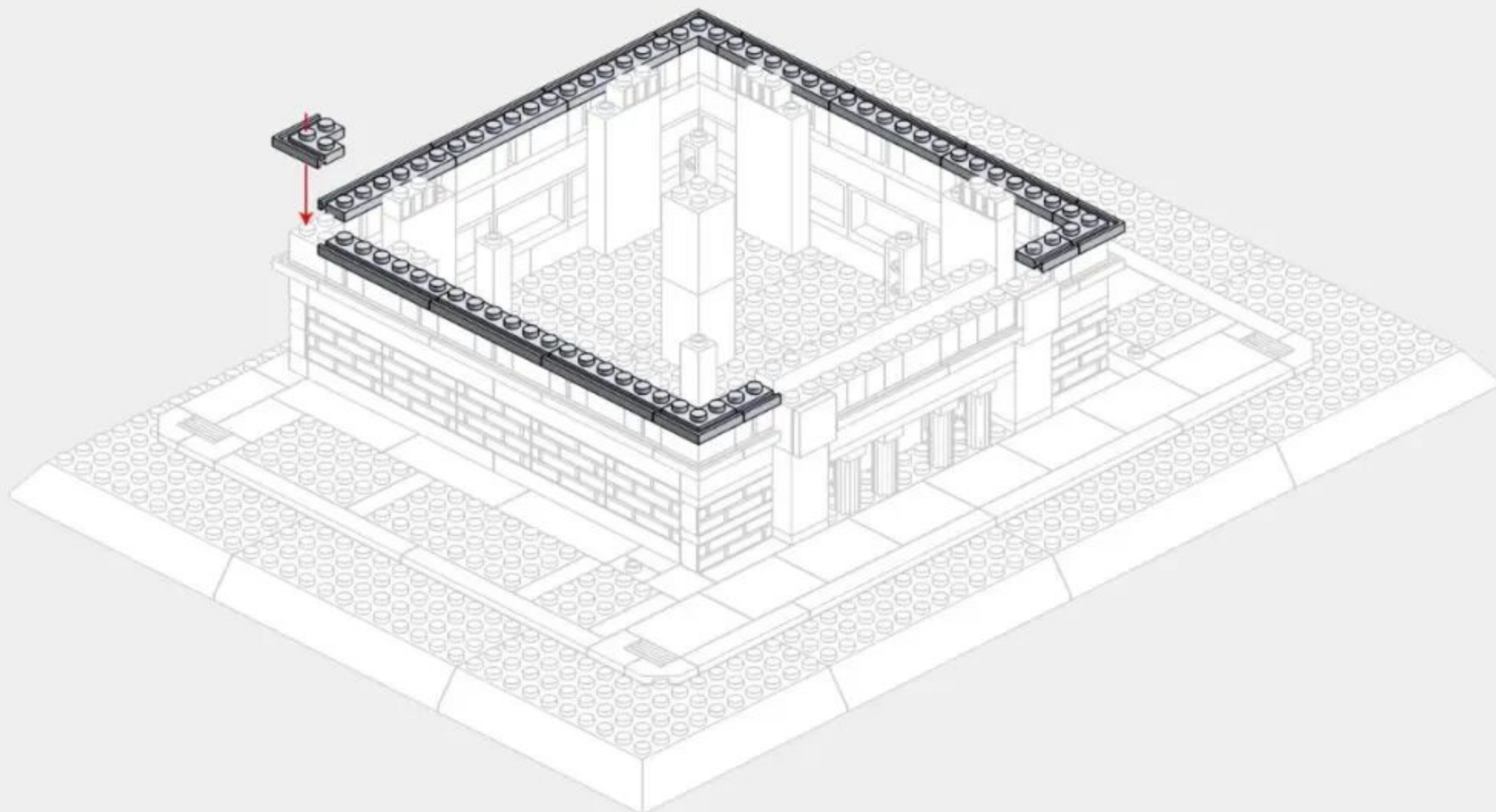
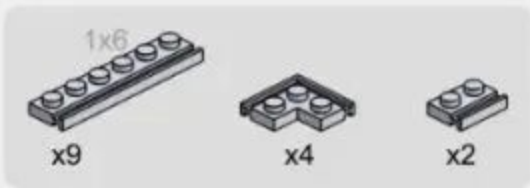

2-3

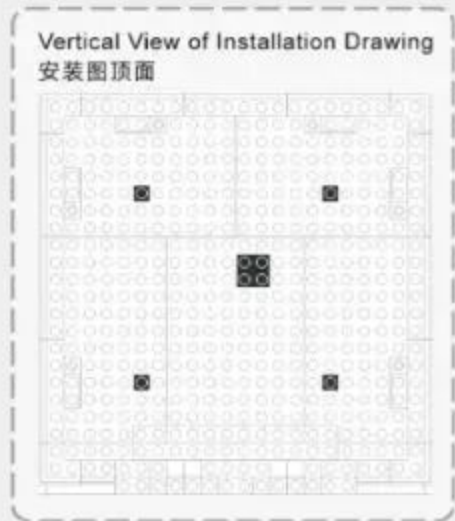
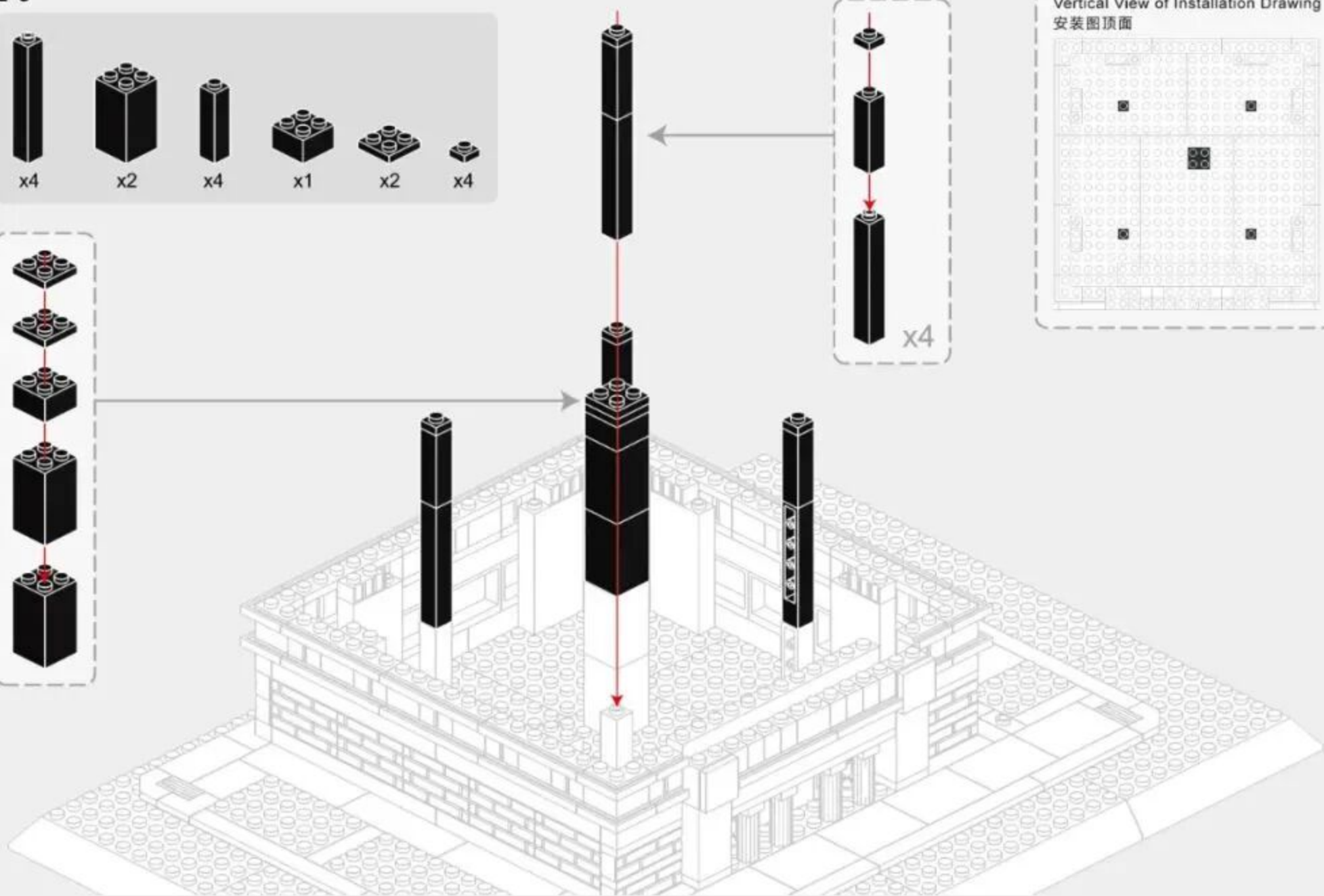
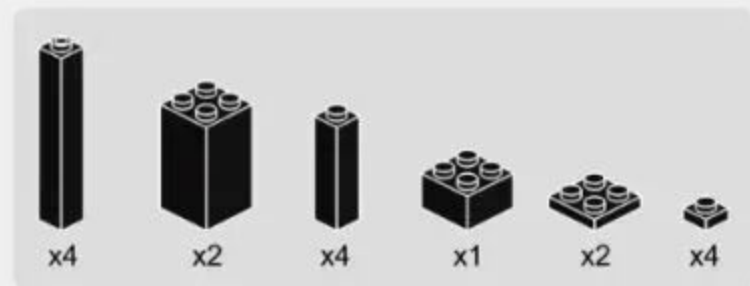

2-5

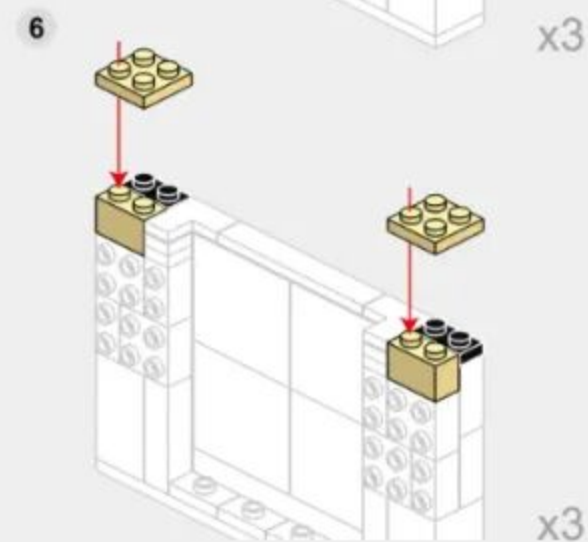
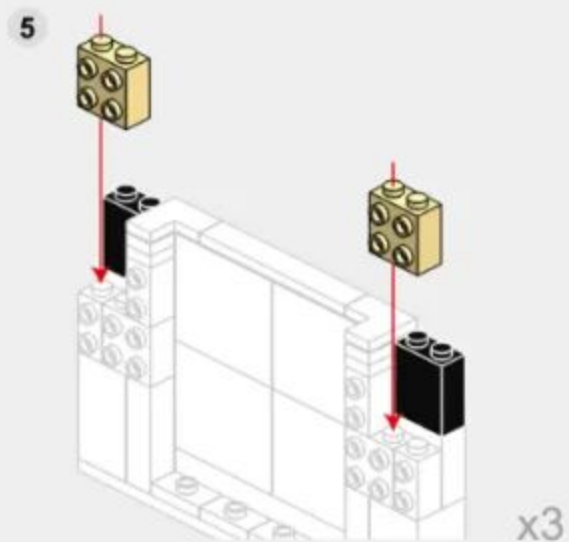
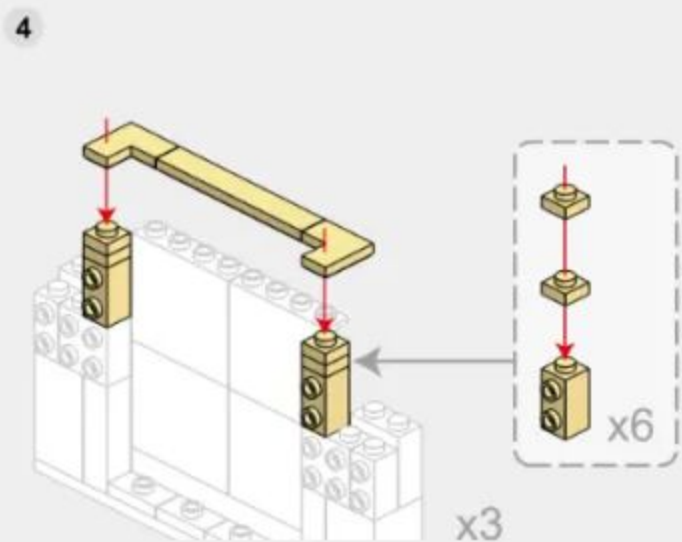
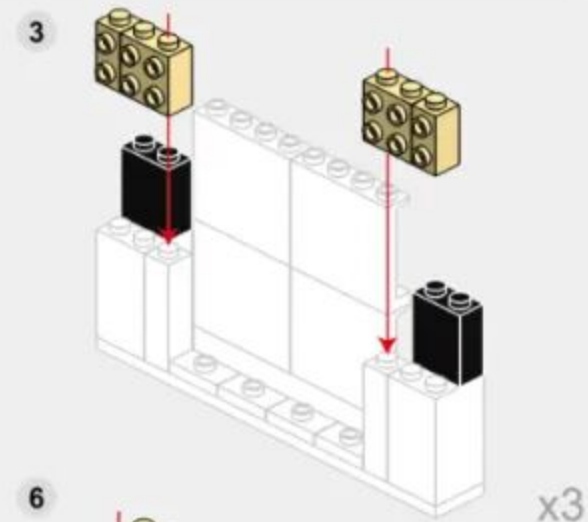
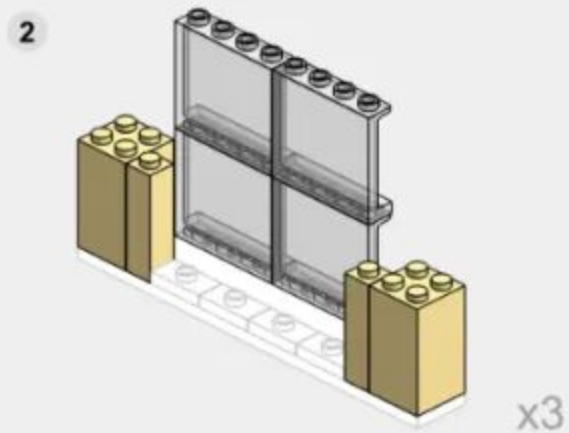
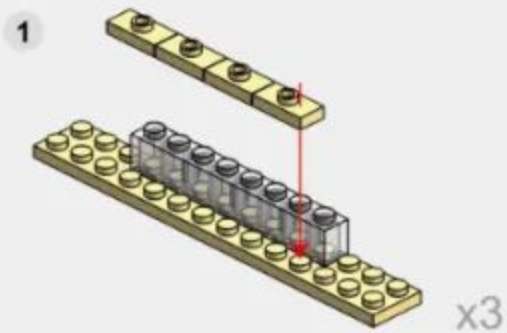
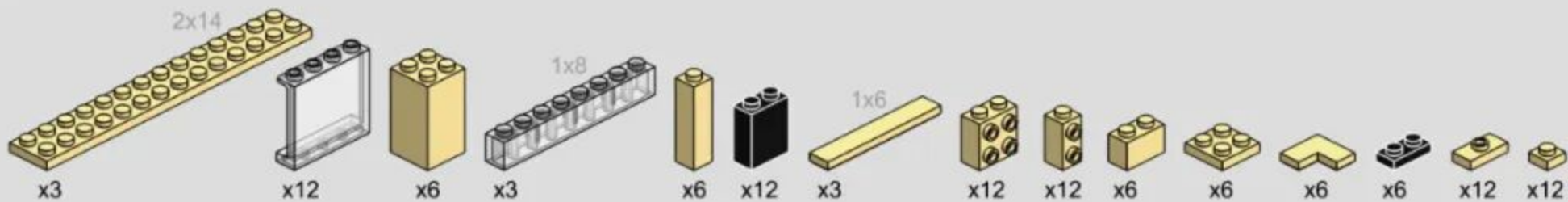

2-6

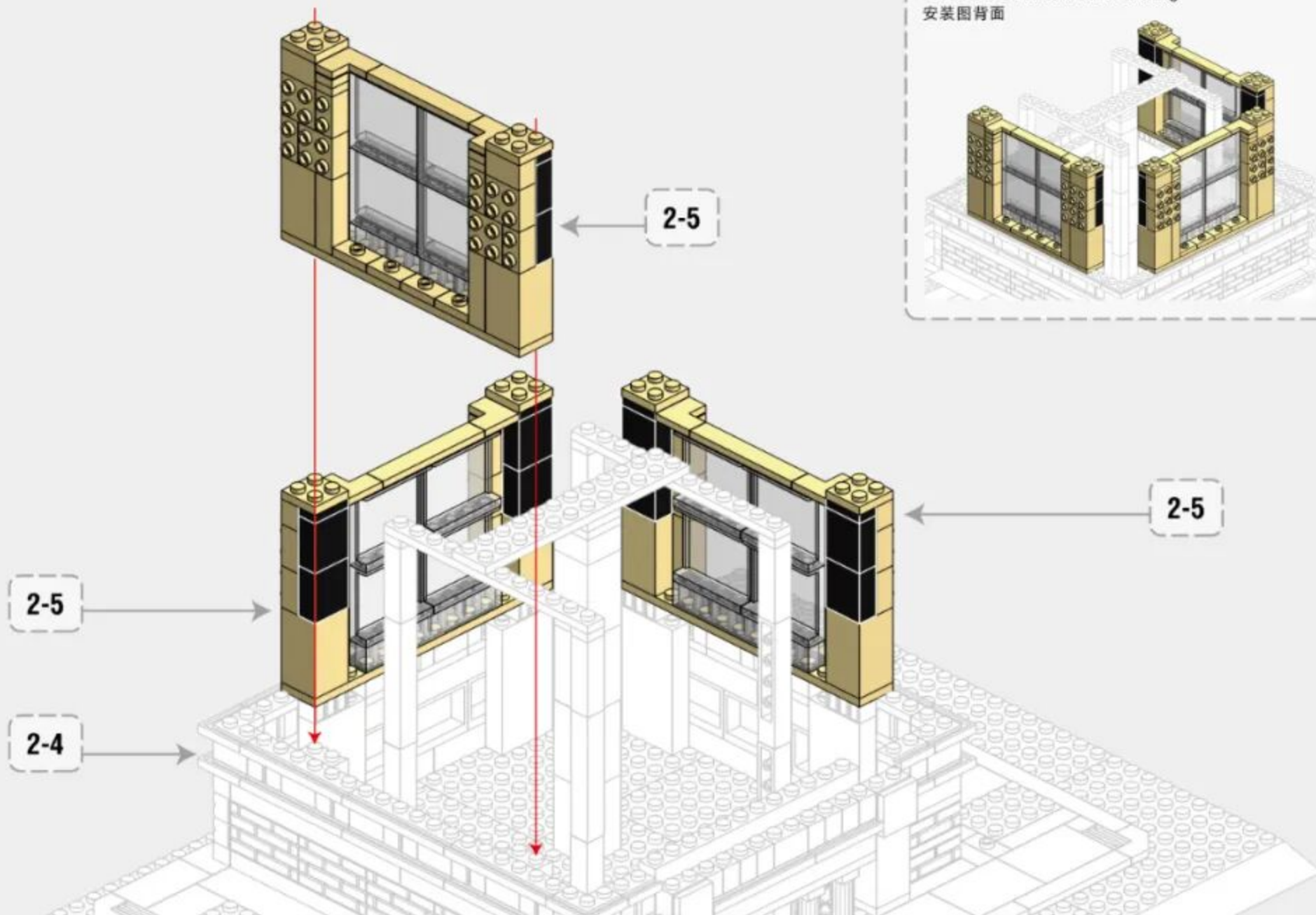

2-7

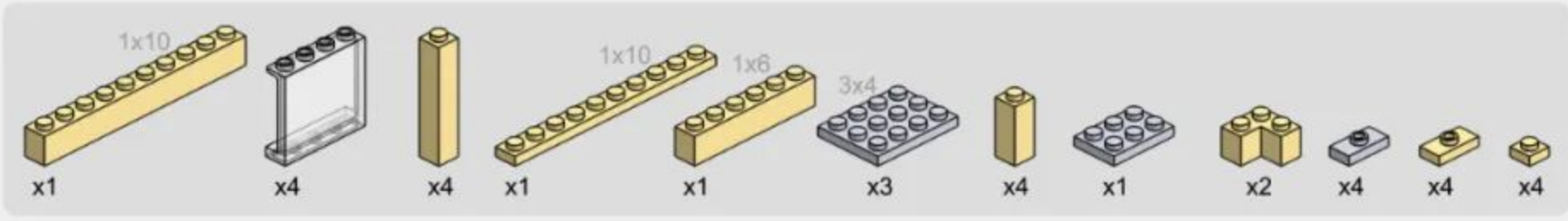

1

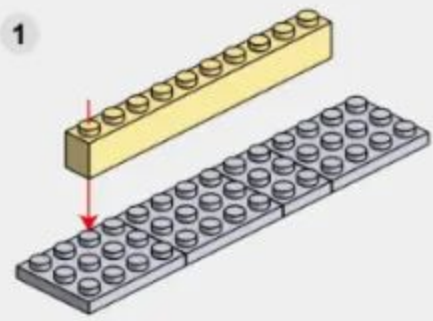

2

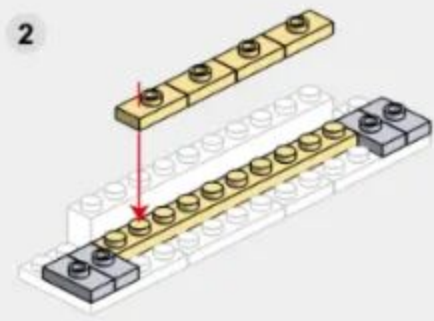

3

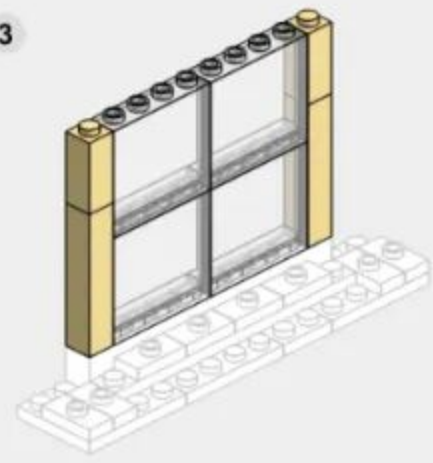

4

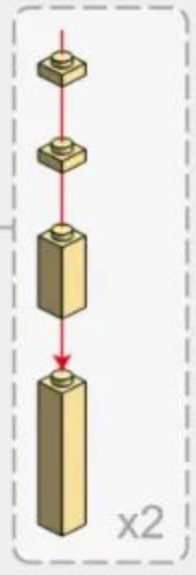
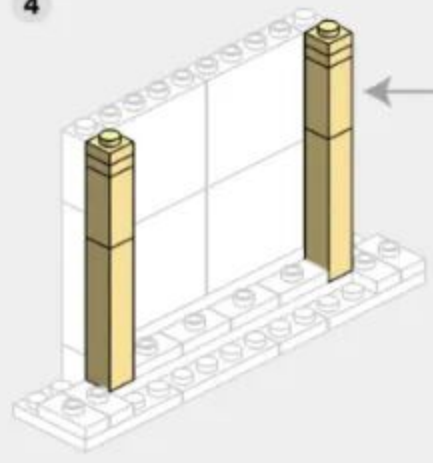

5

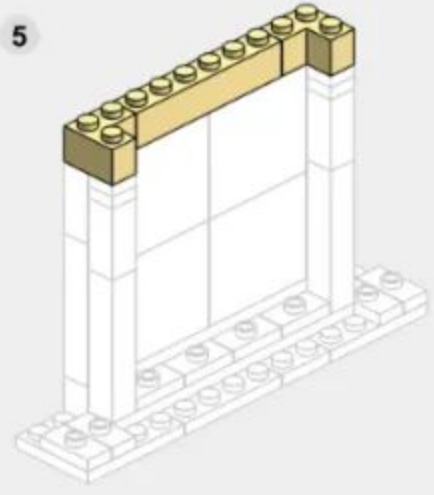

2-8

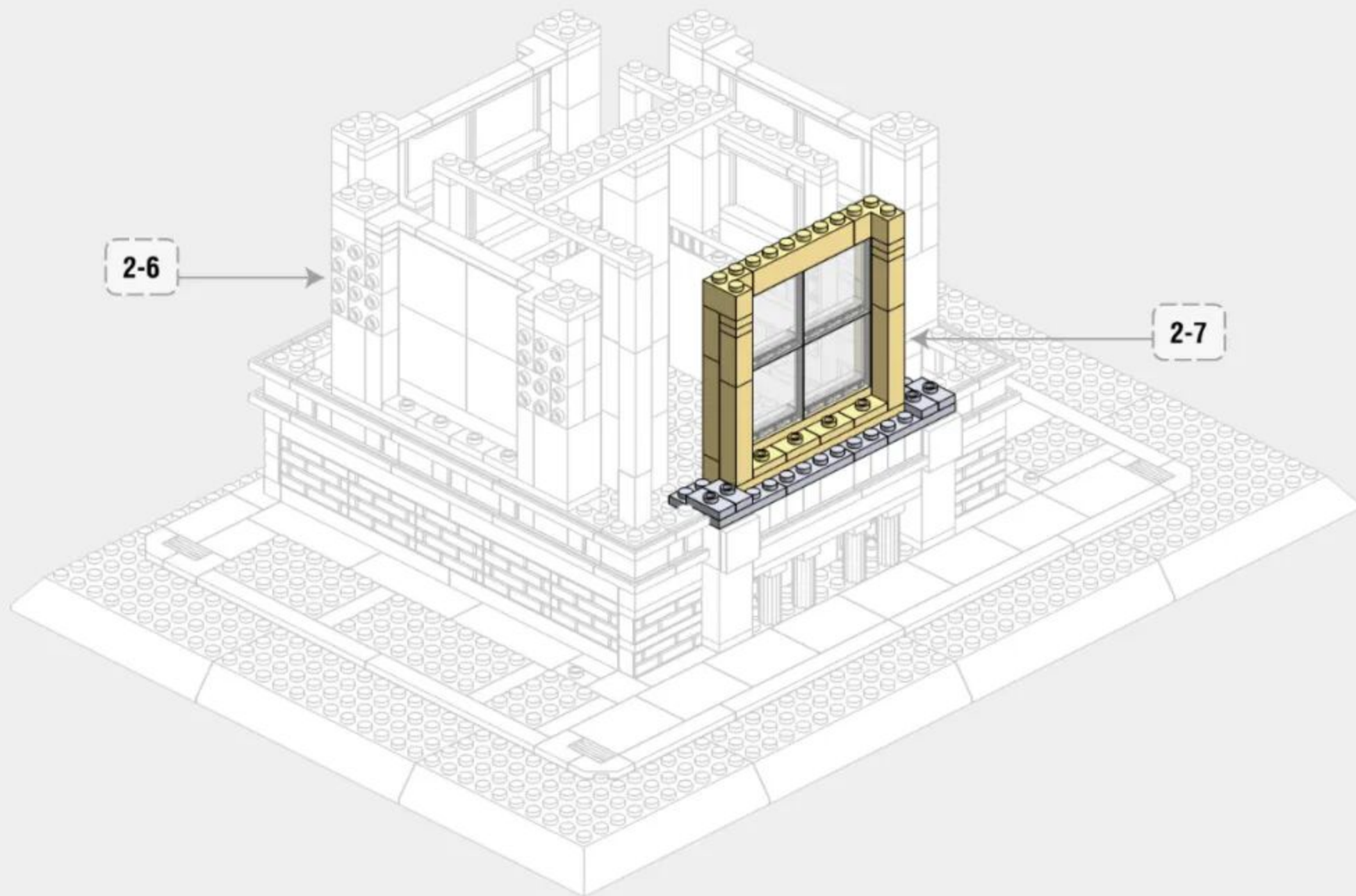

2-9



x4



x24



x2



x2



x4

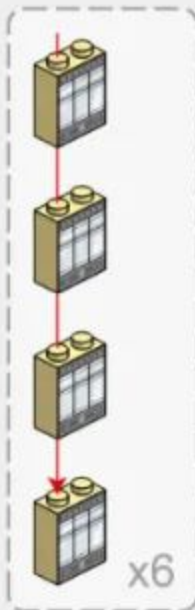

x6

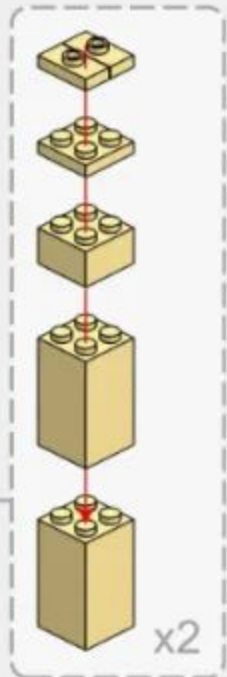
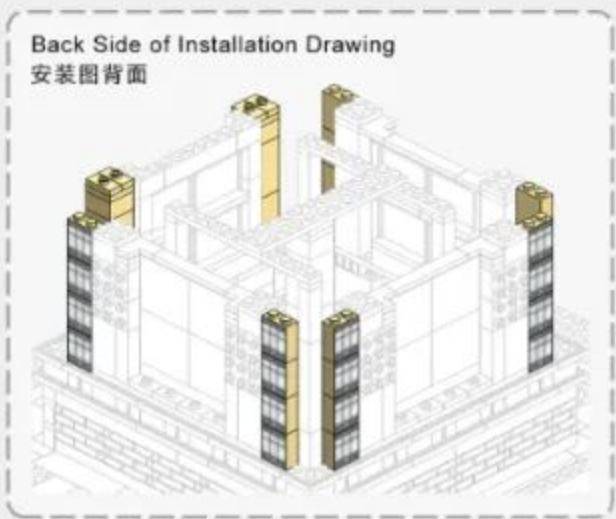

x2

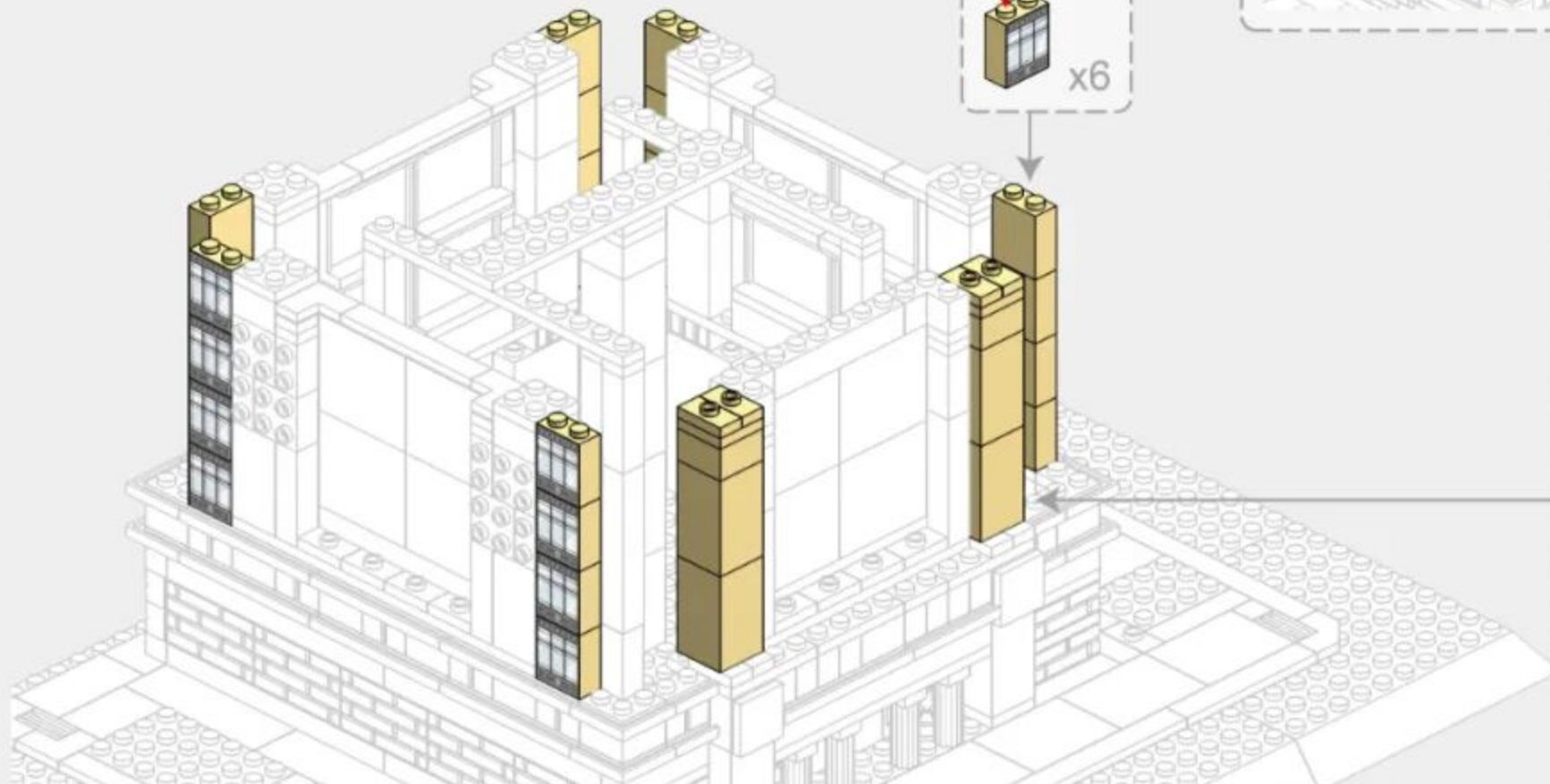

# 2-10

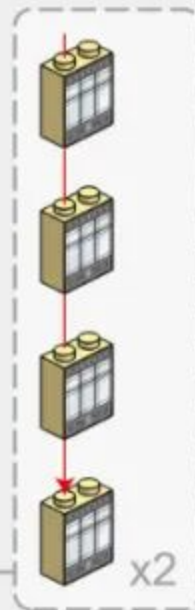
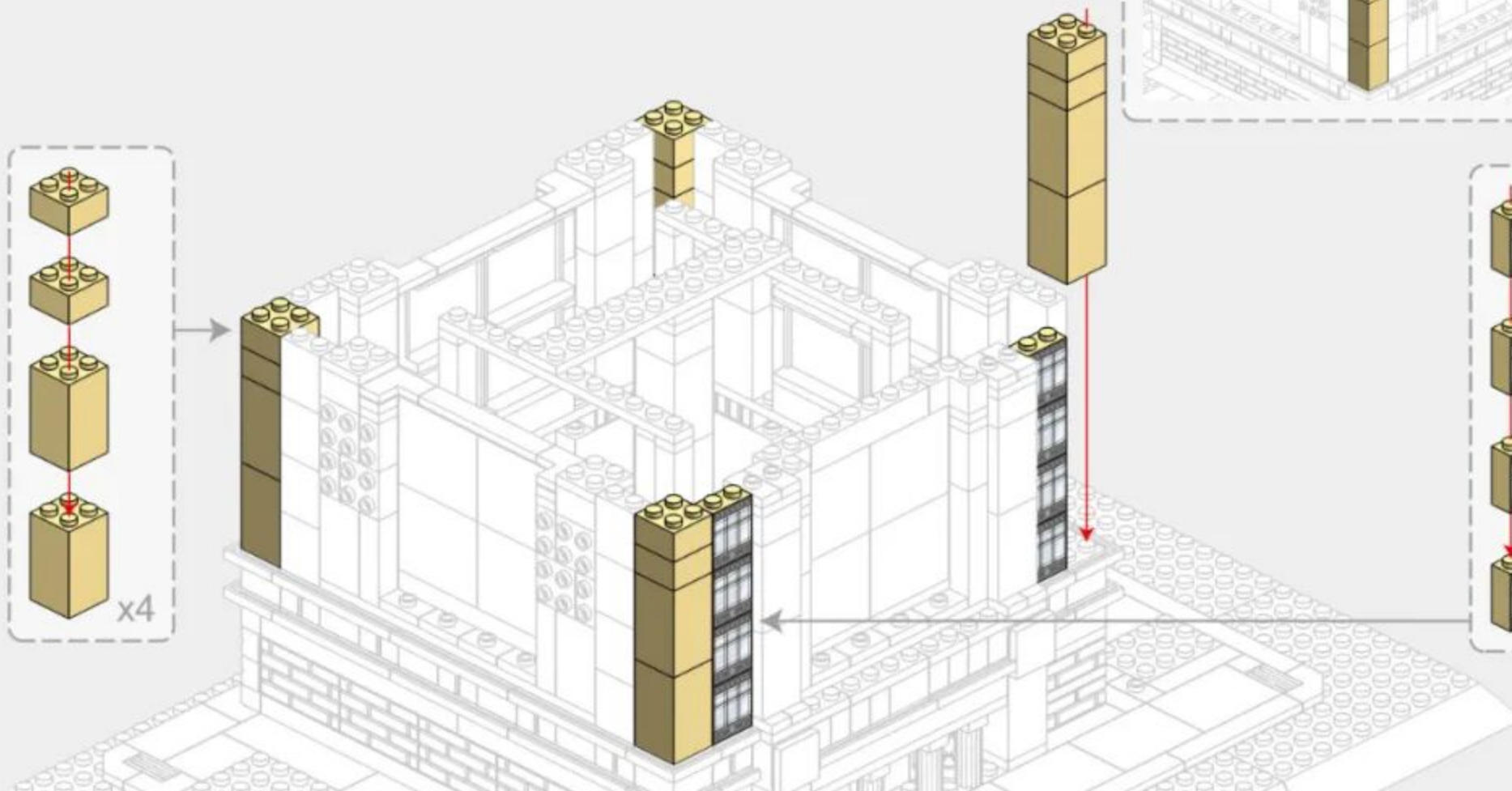
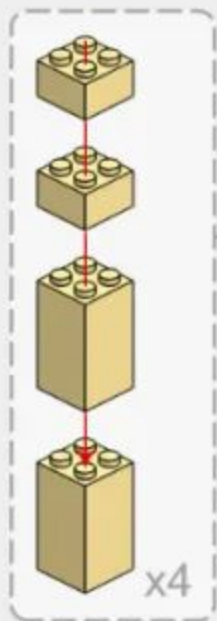
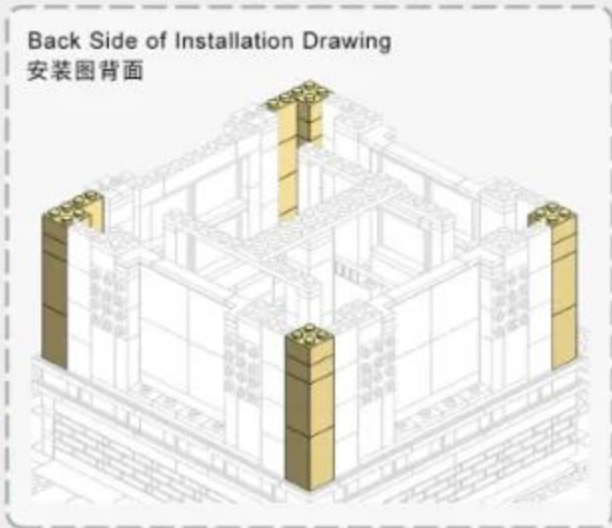

2-11

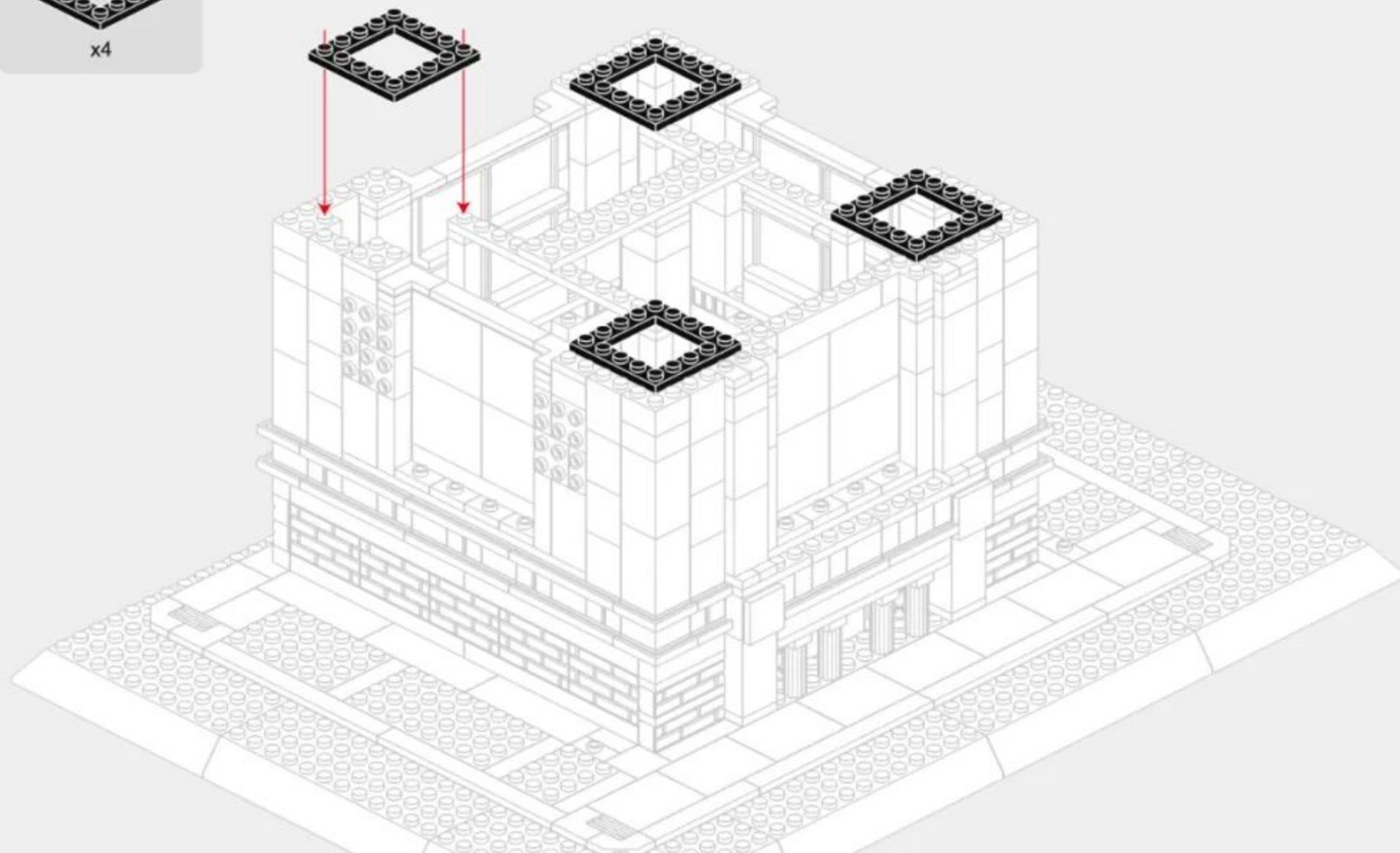
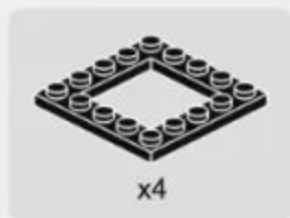



282PCS



# 3-1

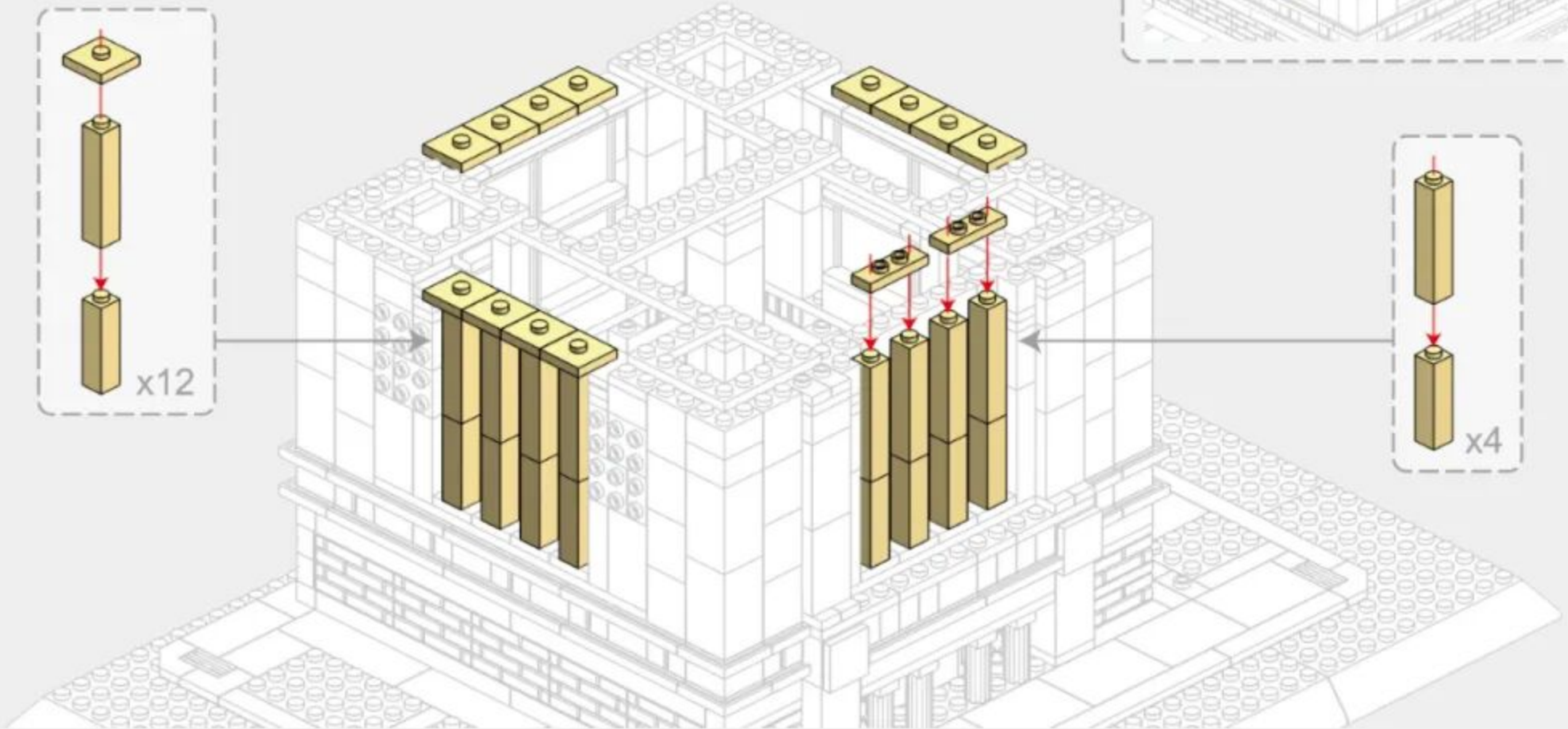
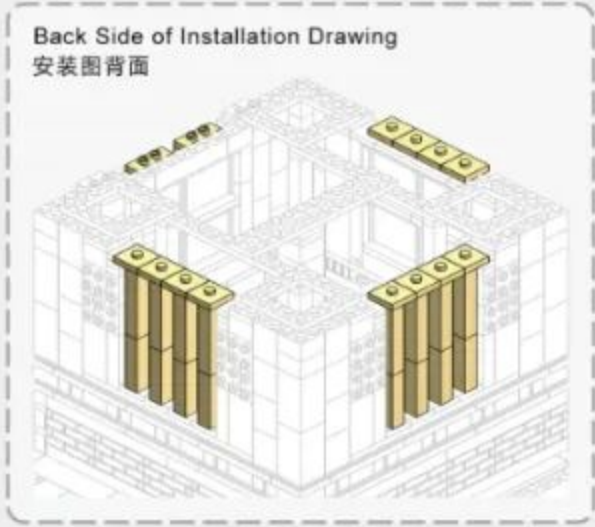

3-2

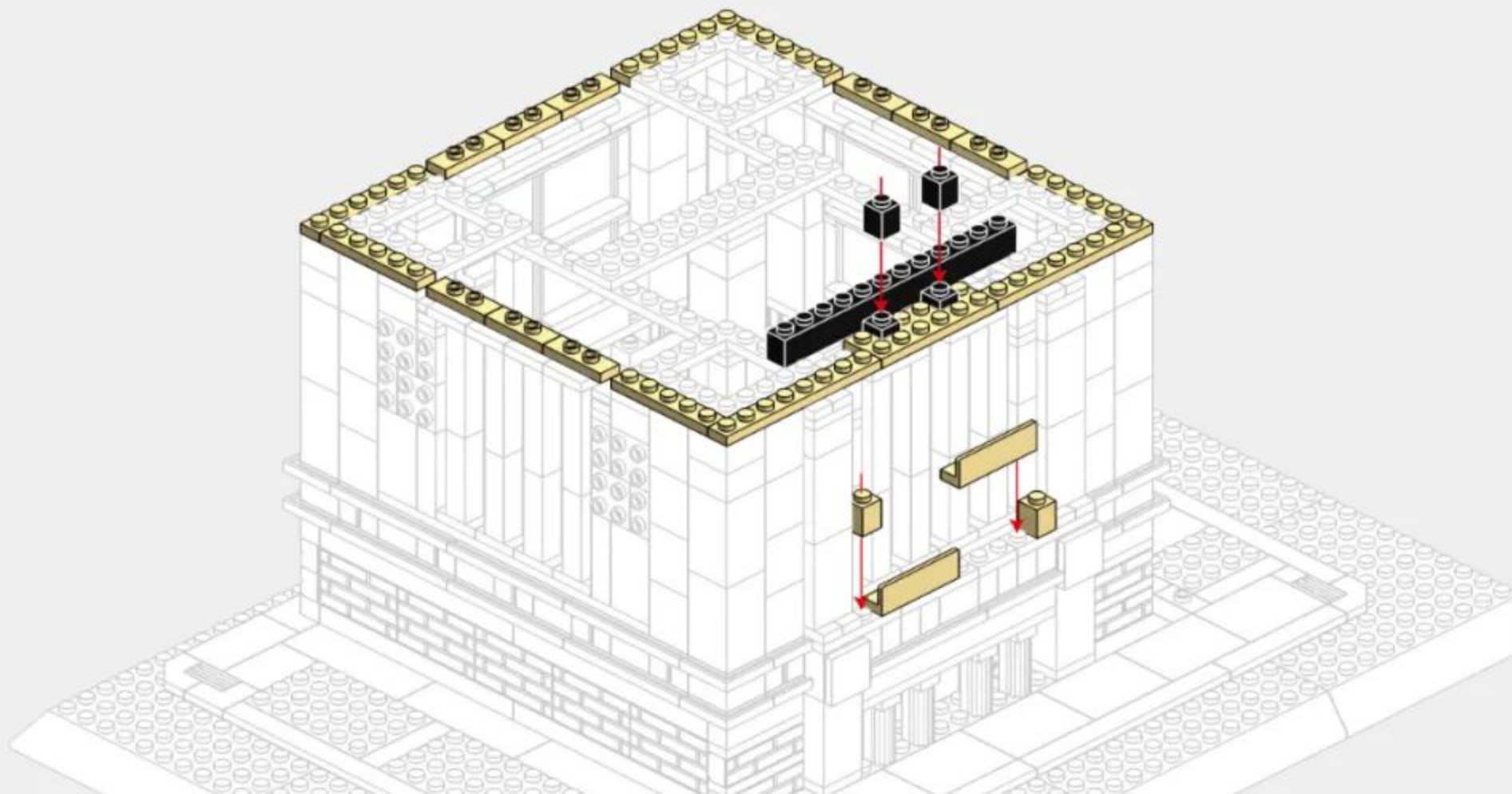
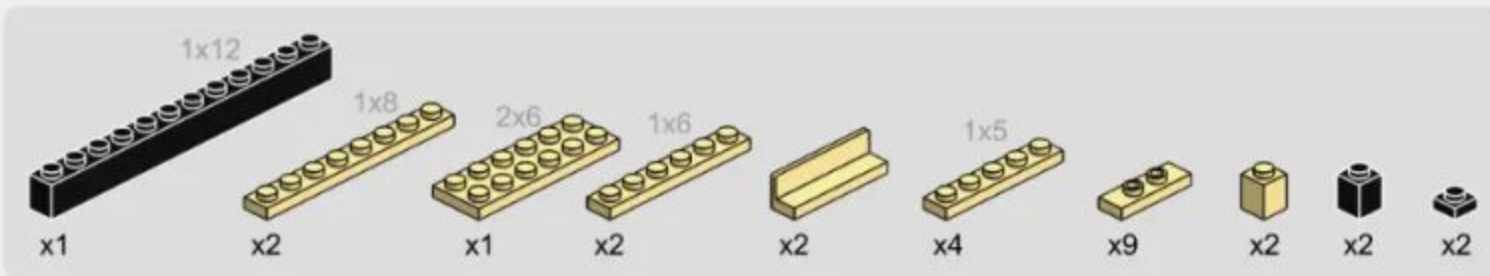

# 3-3

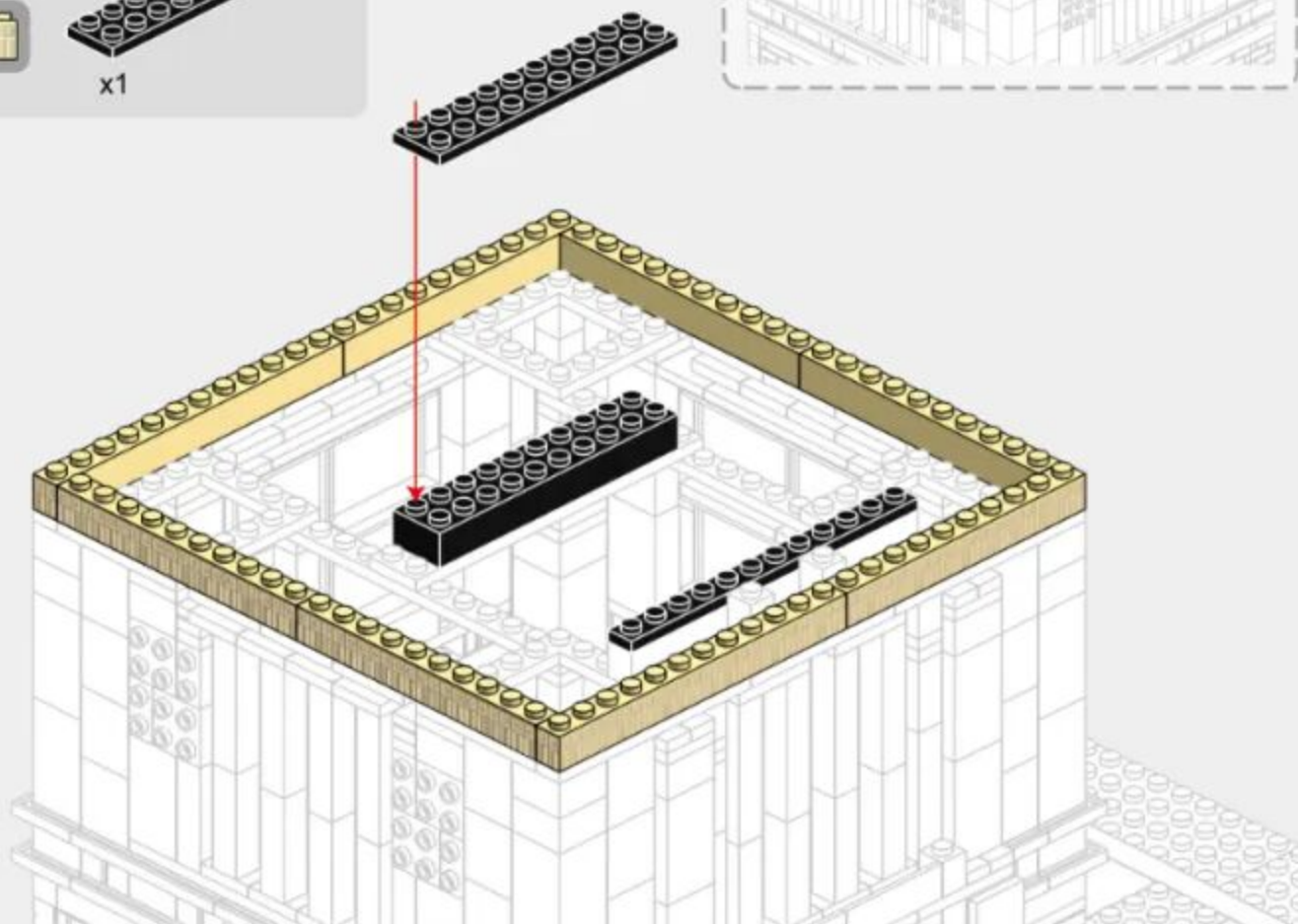
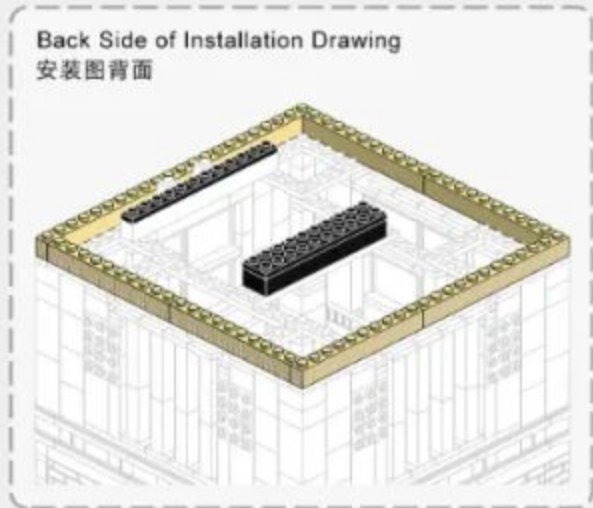
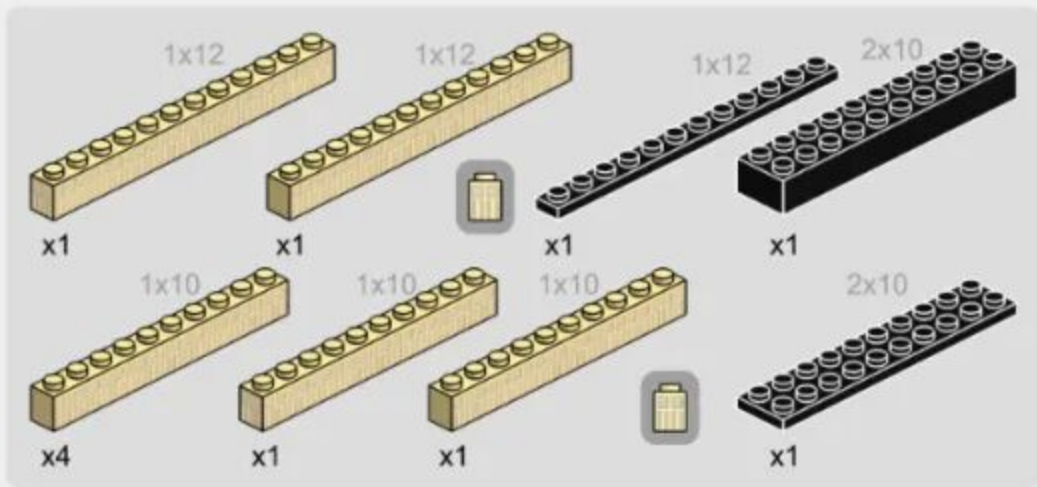

3-4

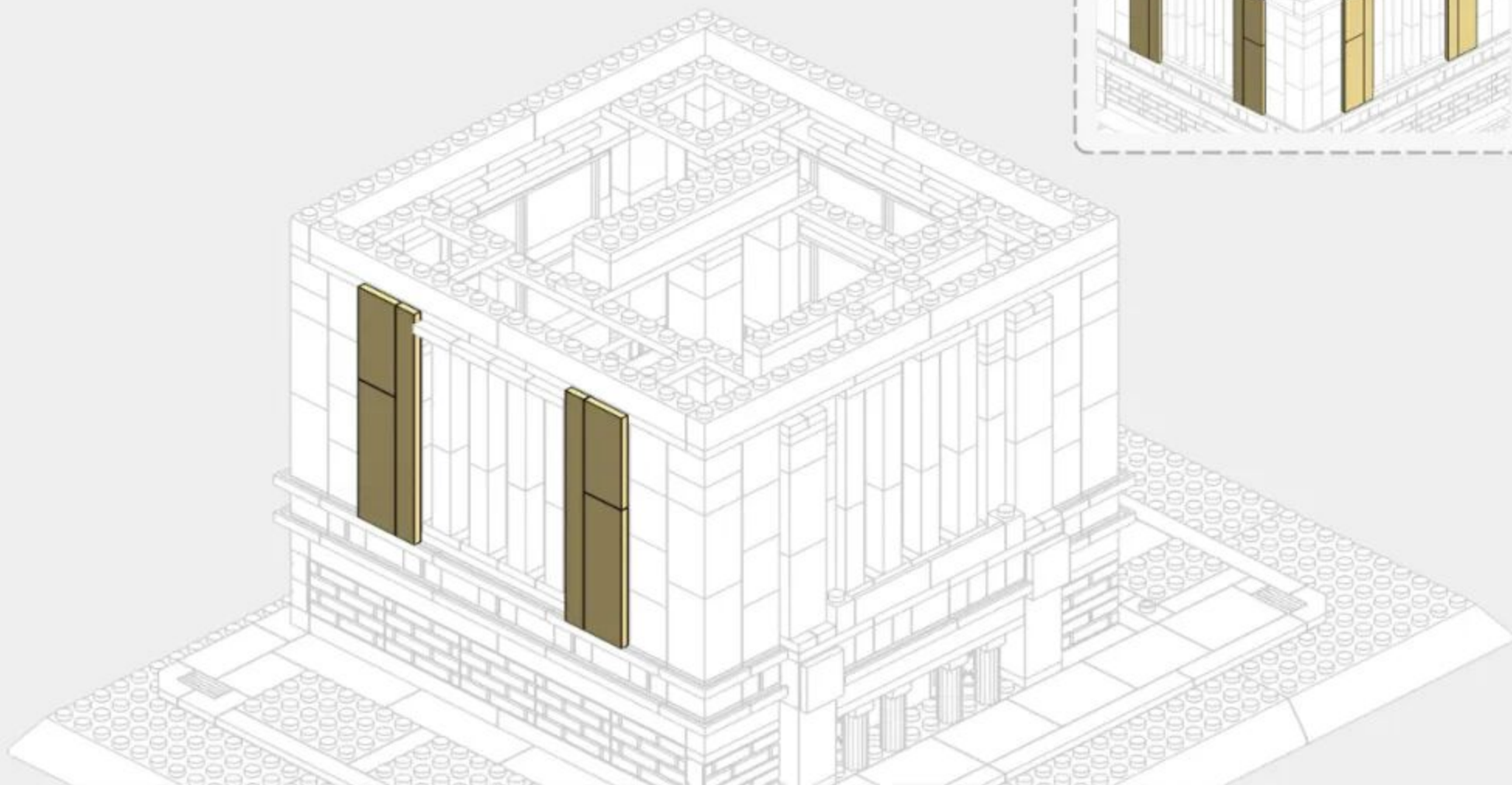
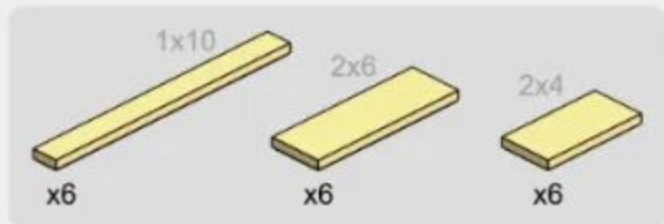

3-5

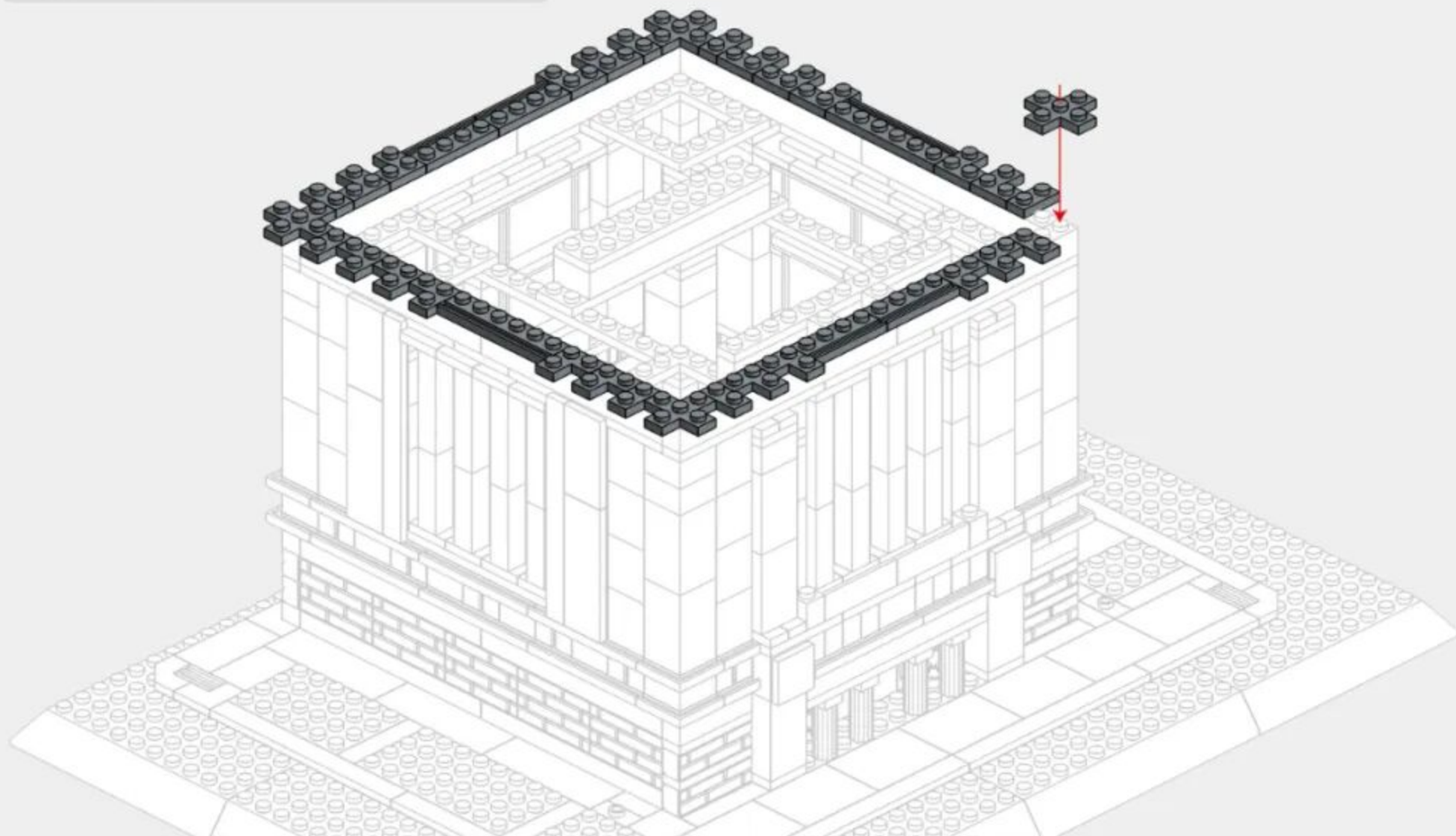

3-6

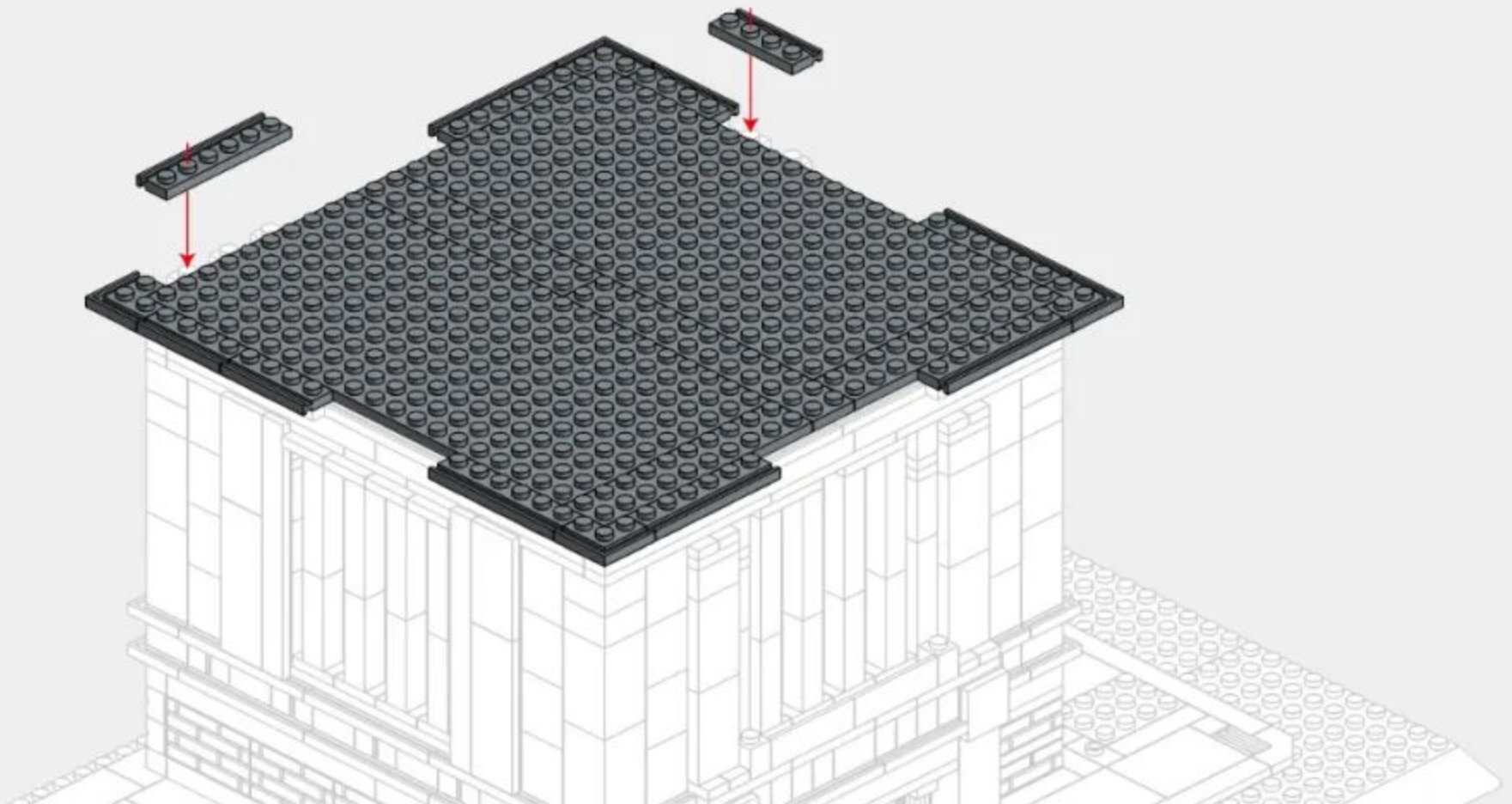
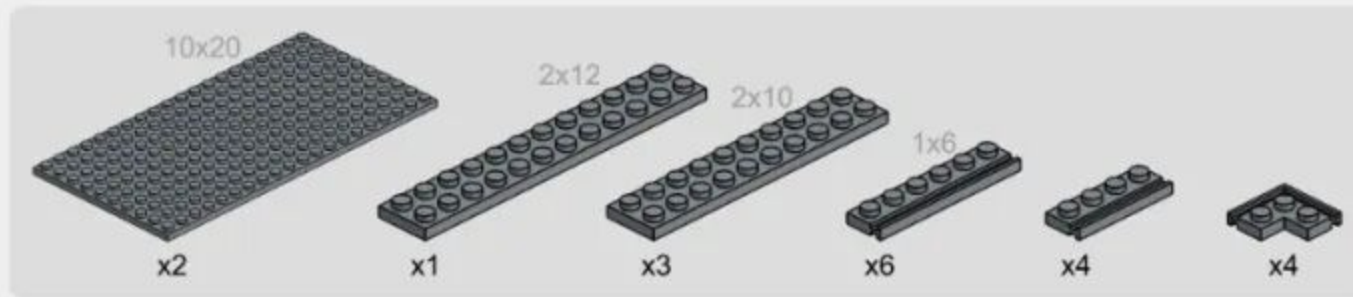

3-7

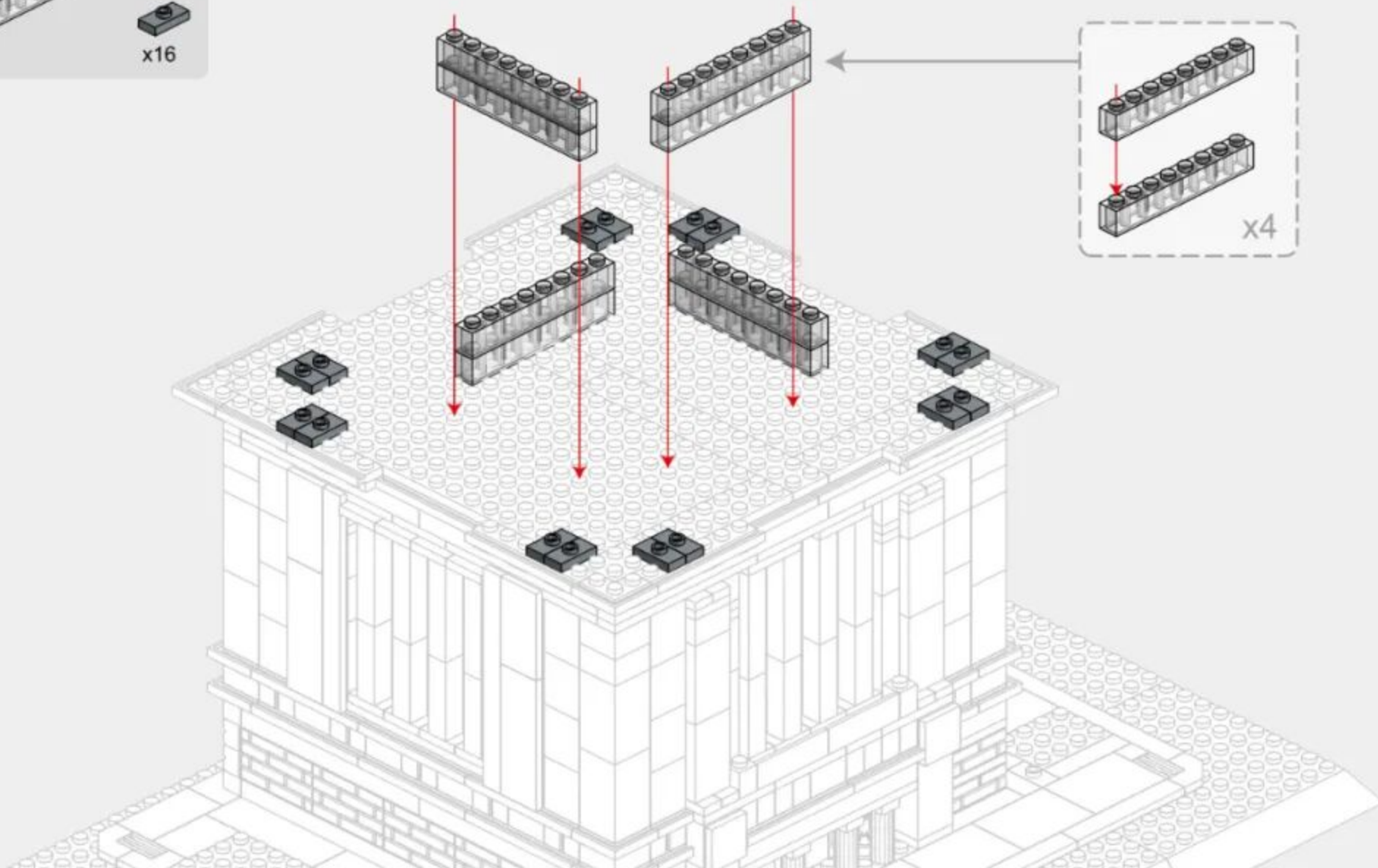
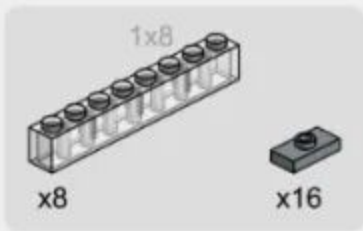

3-8

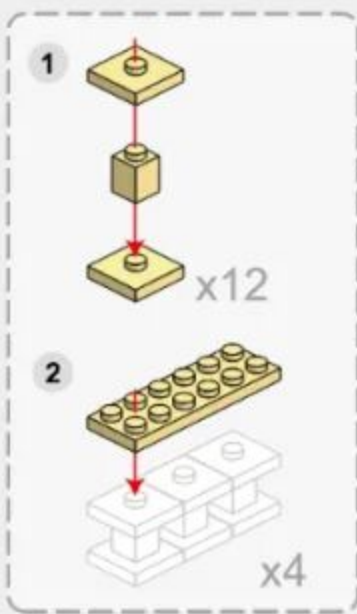
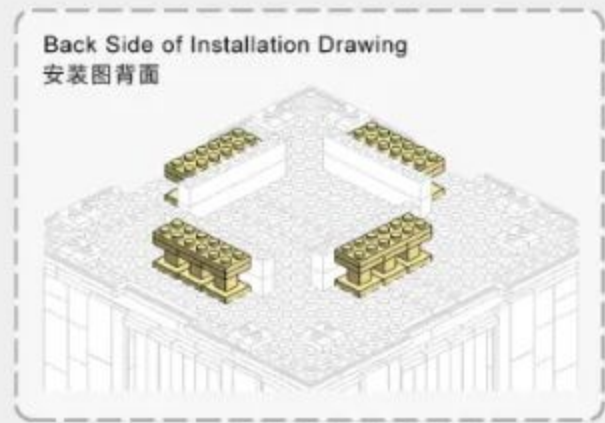
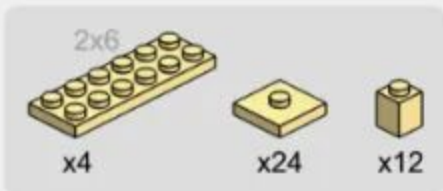

3-9



x8



x2



x6



x4

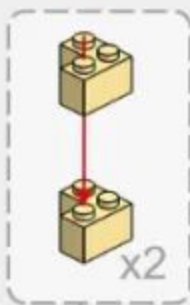

x2

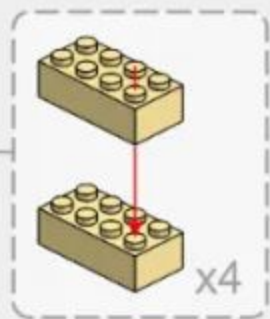
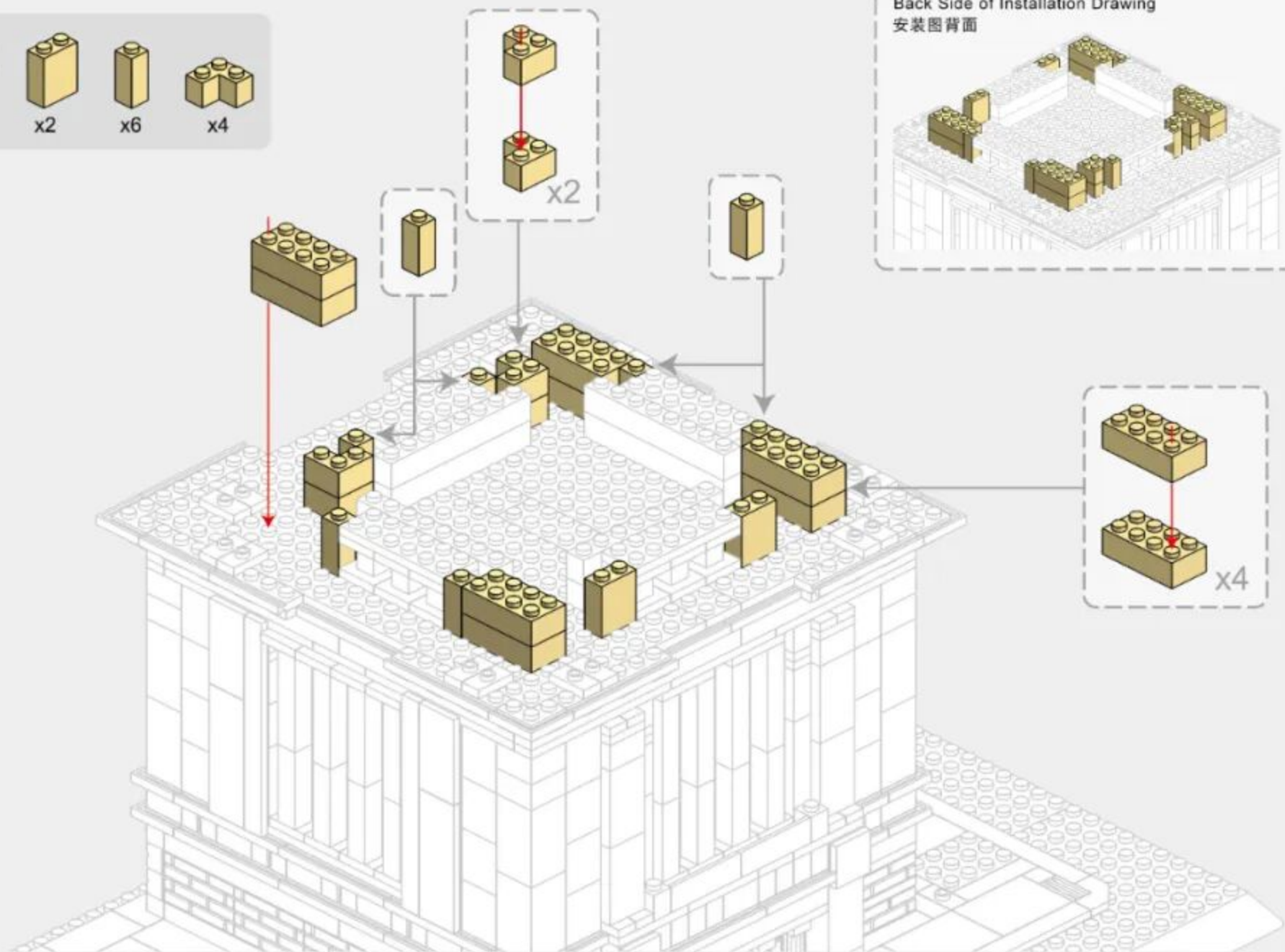

3-10



x7



x2



x4

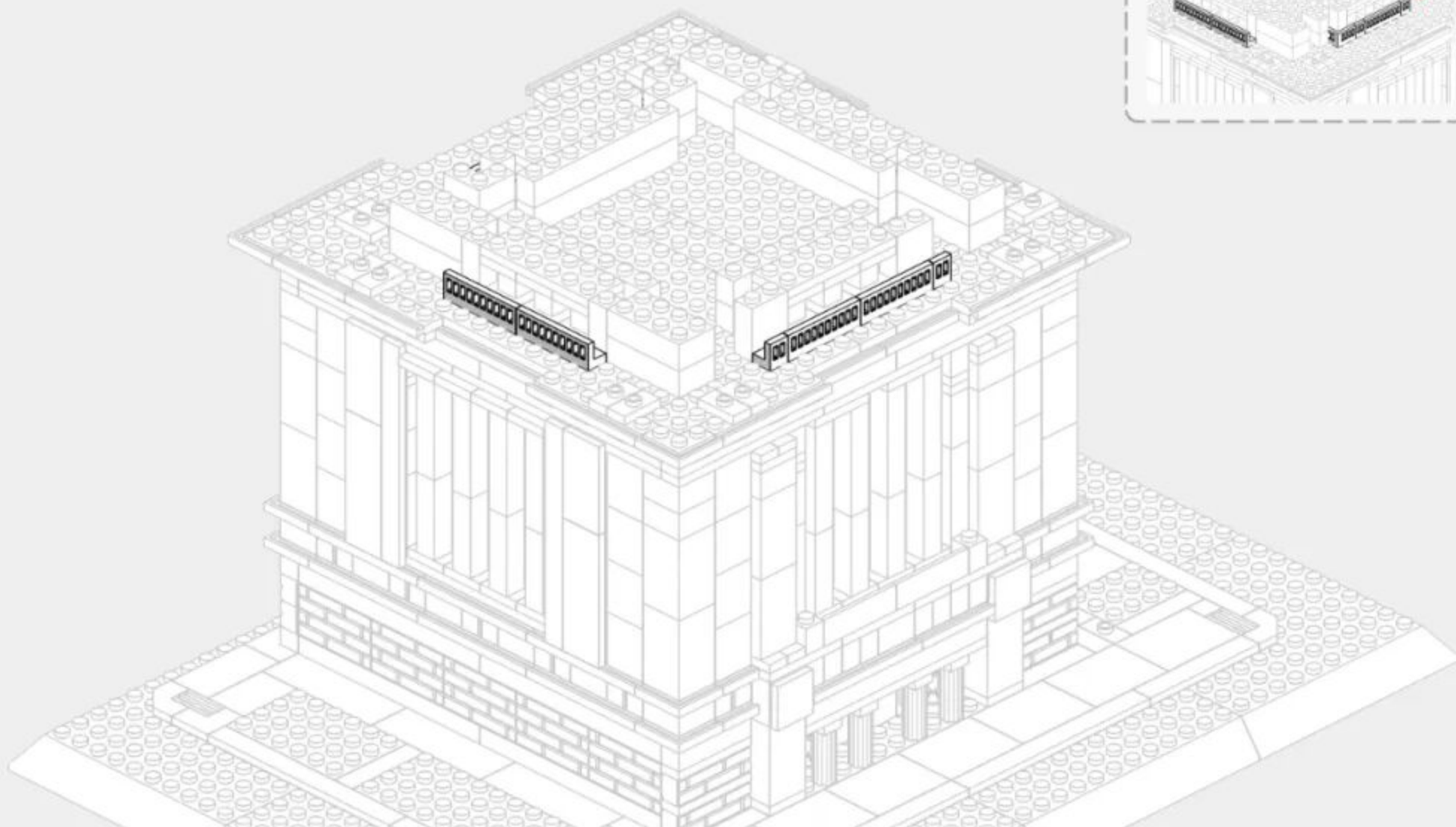

Back Side of Installation Drawing  
安装图背面

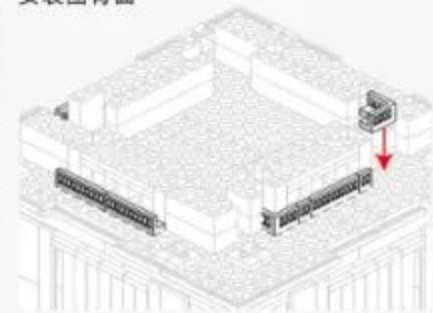

3-11

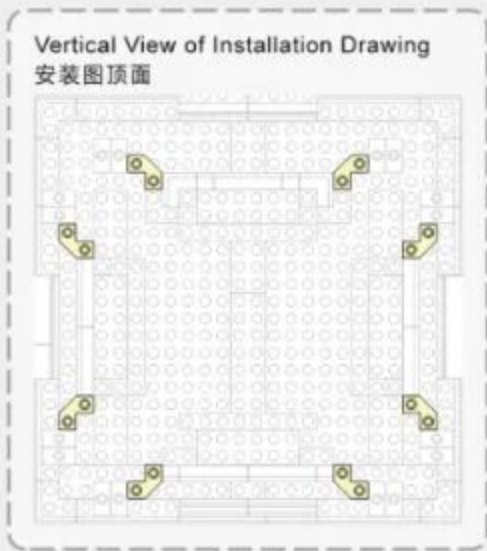
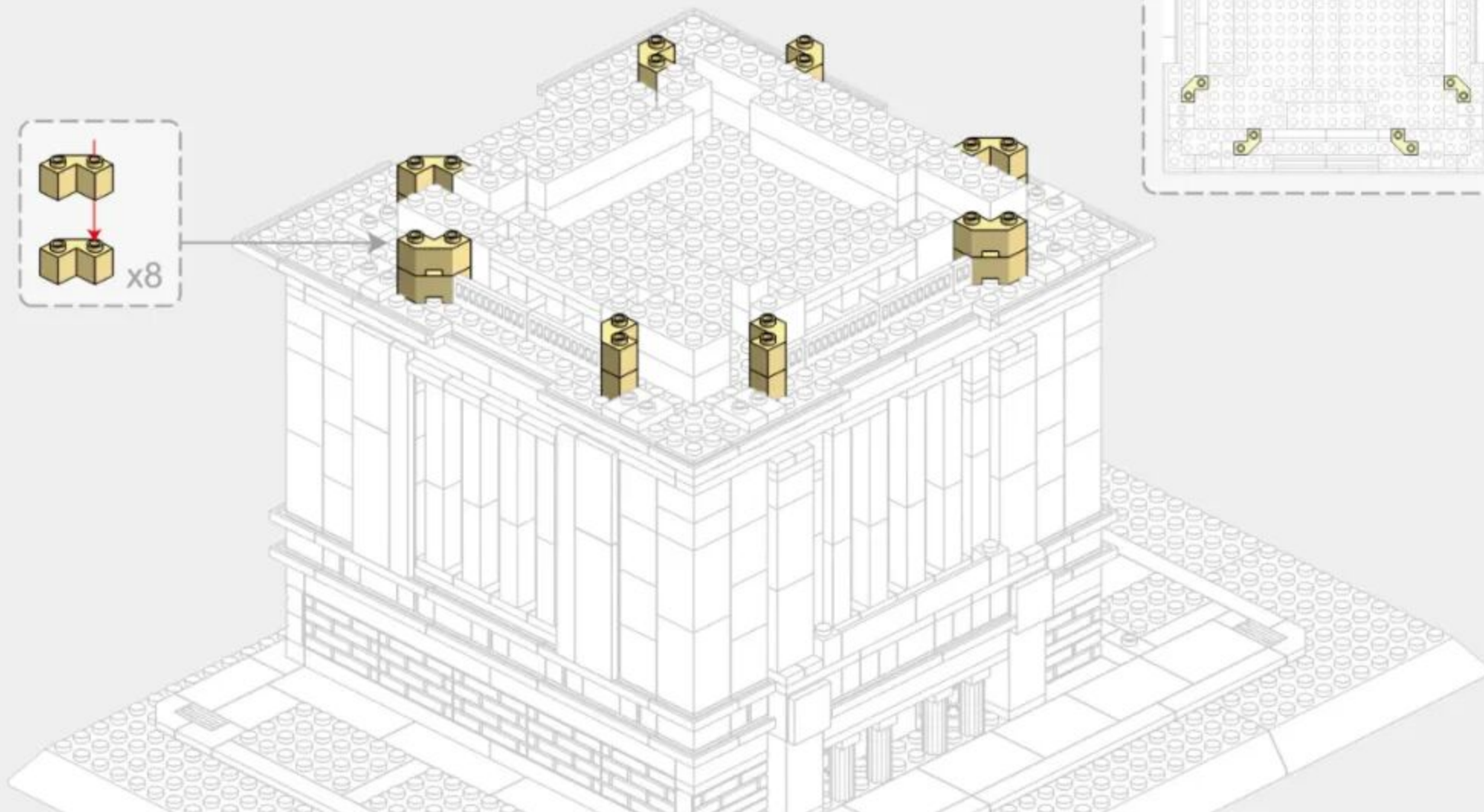
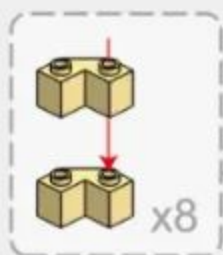

# 3-12

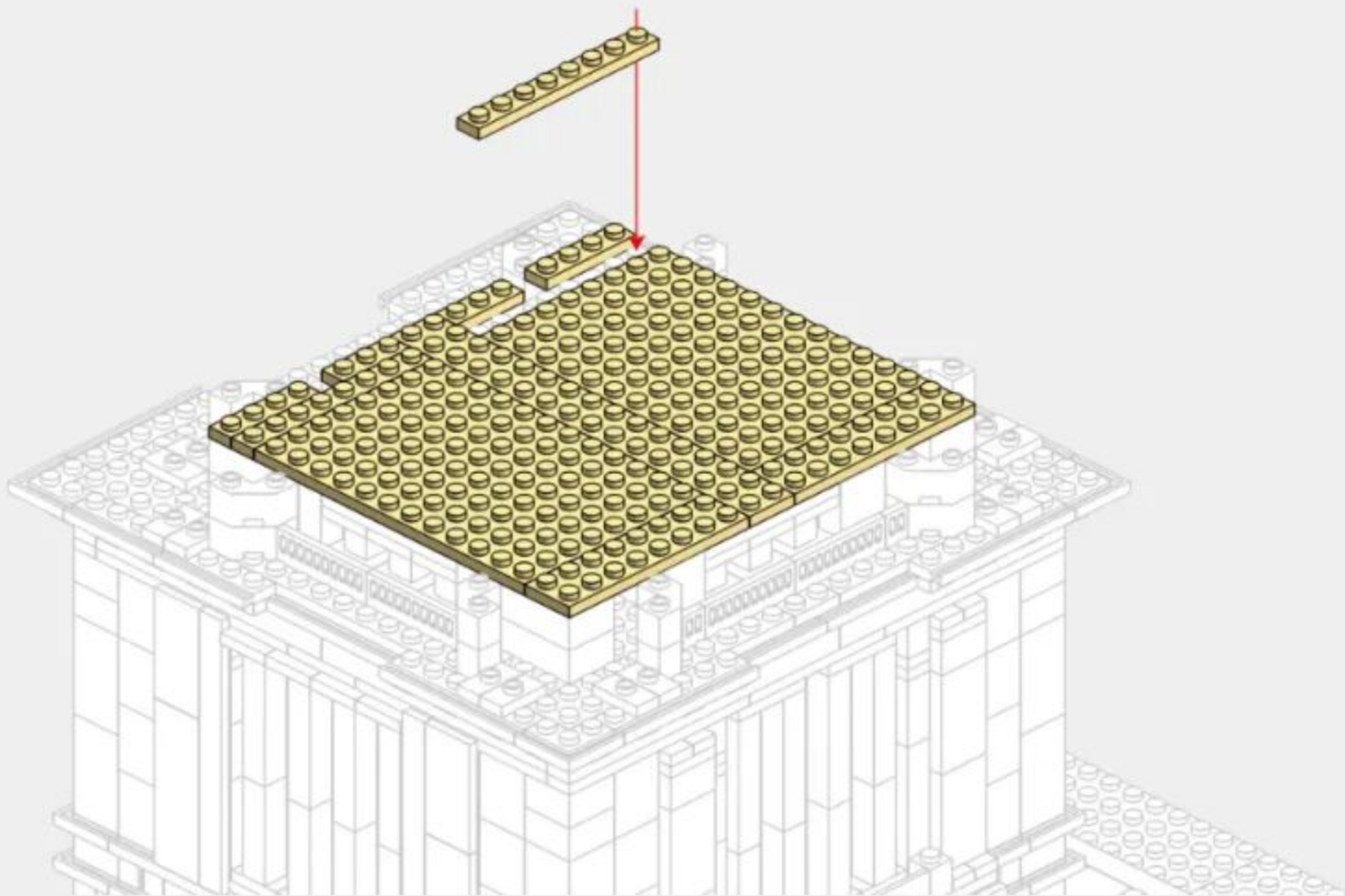
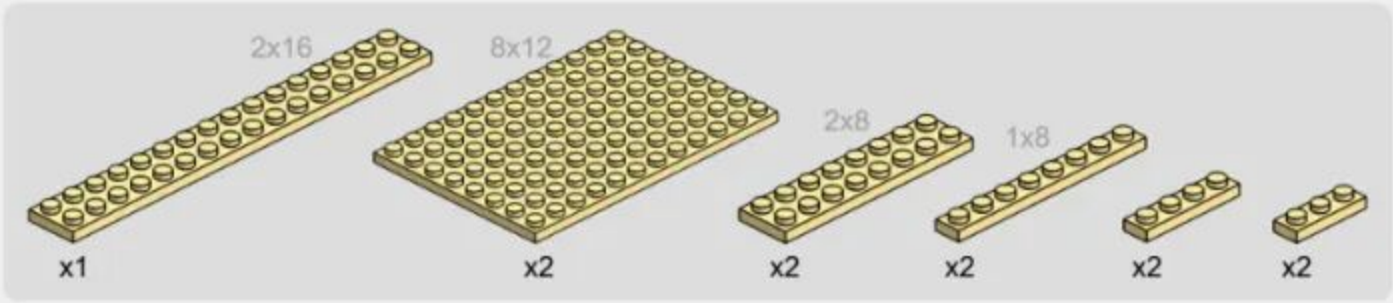



283PCS

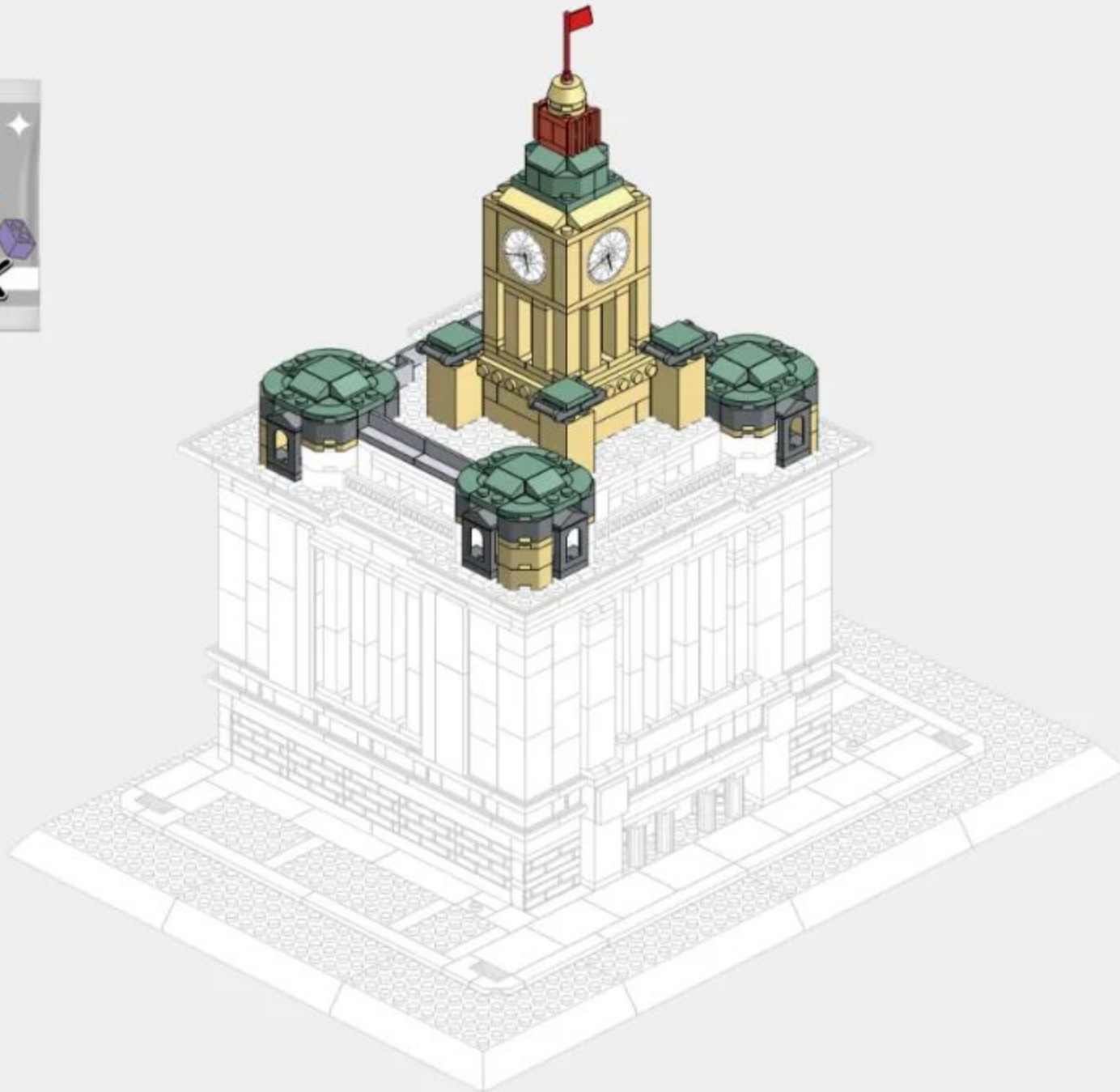

57

# 4-1

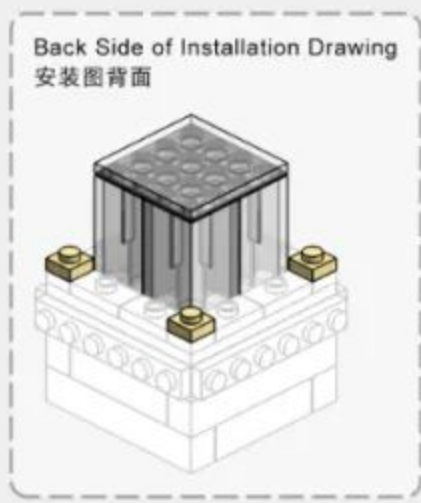
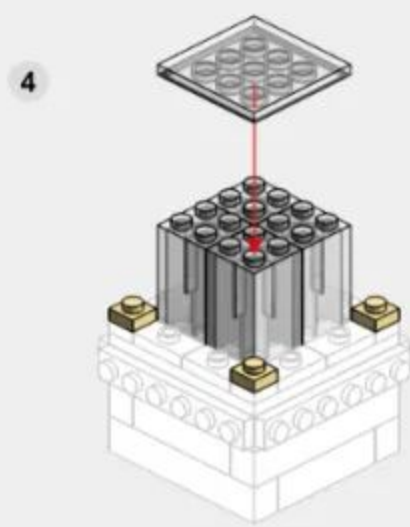
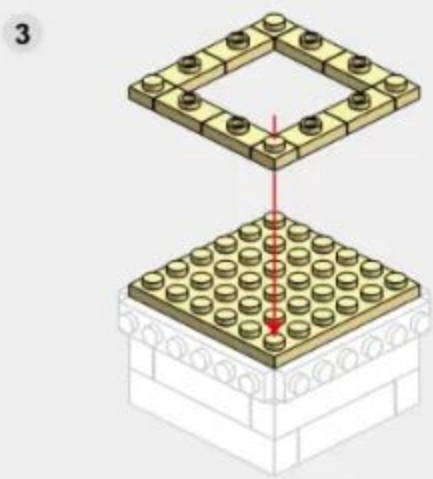
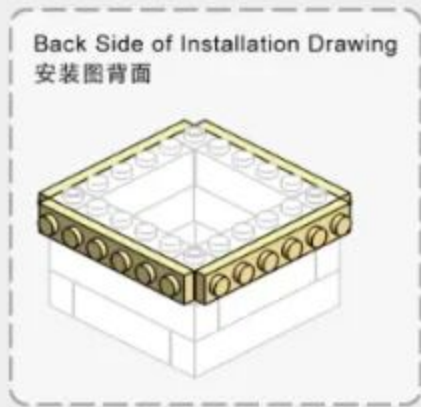
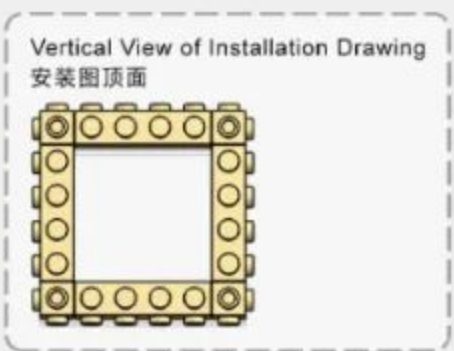
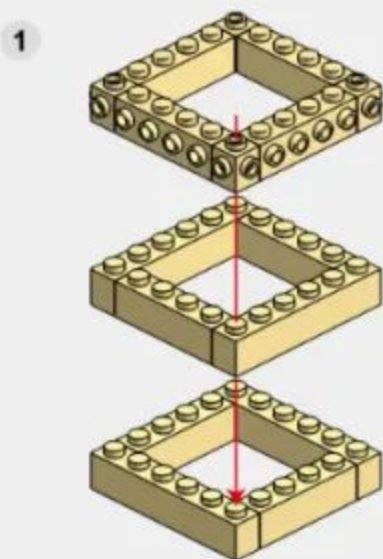

# 4-2

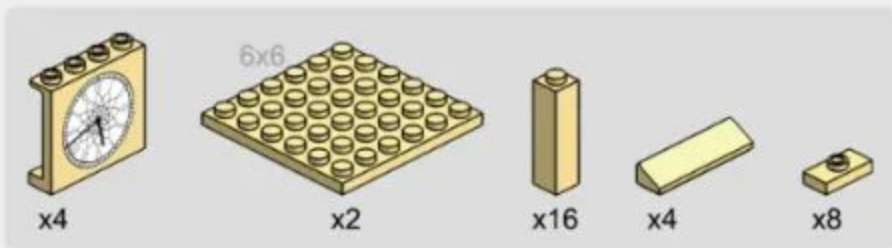

5

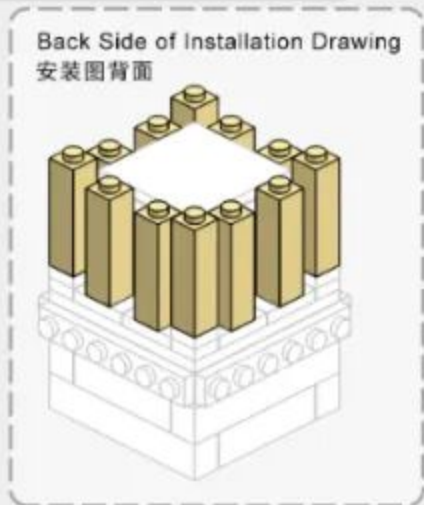
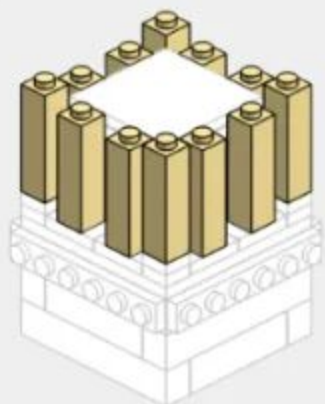

6

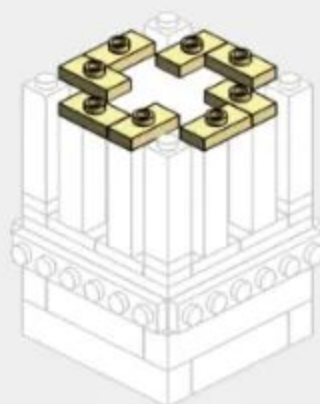

7

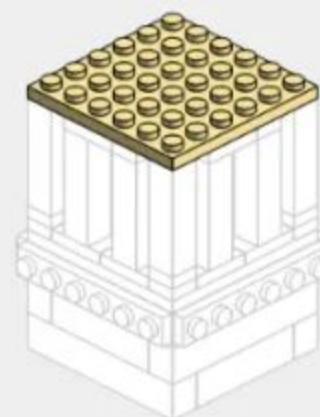

8

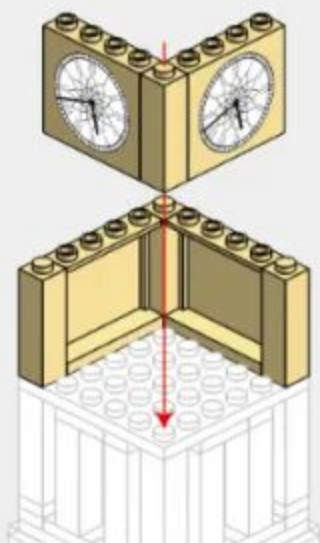

9

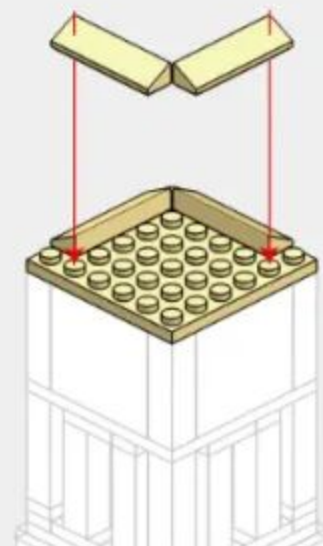

# 4-3



10

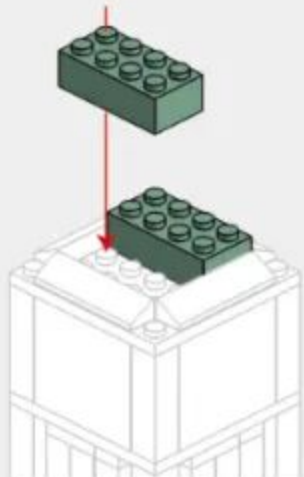

11

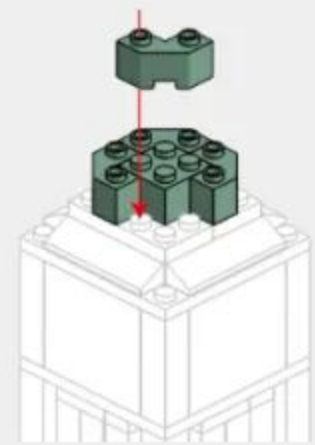

12

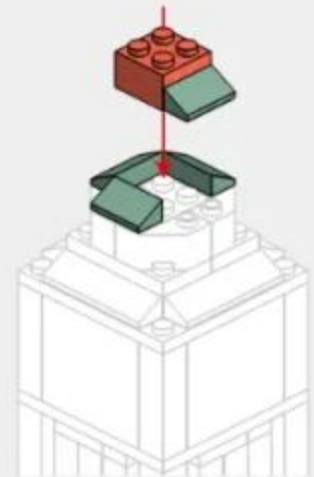

13



14

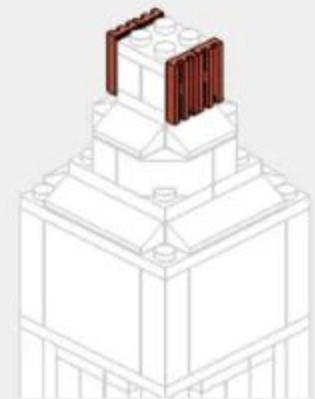

15

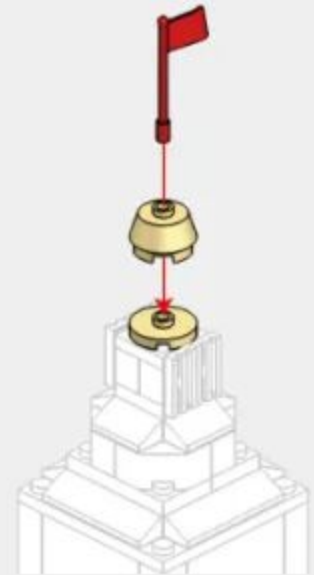

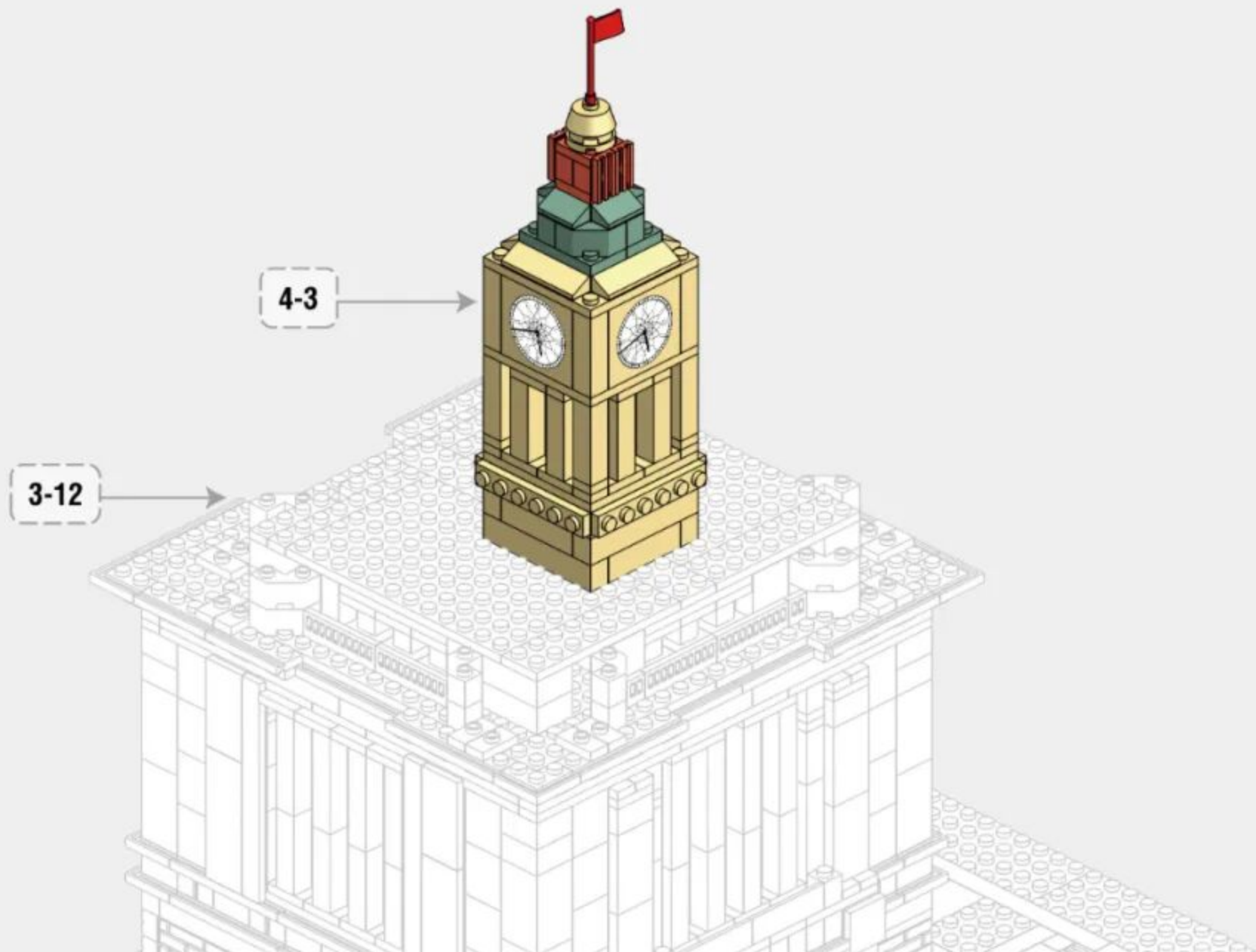

4-5

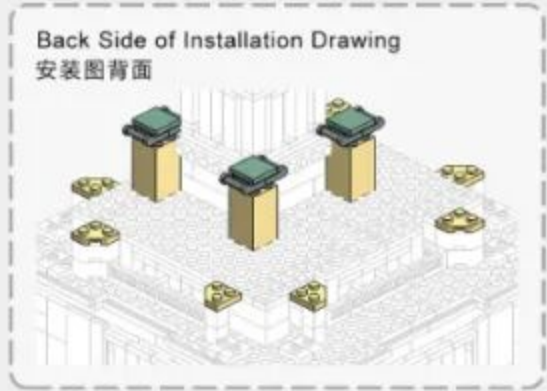
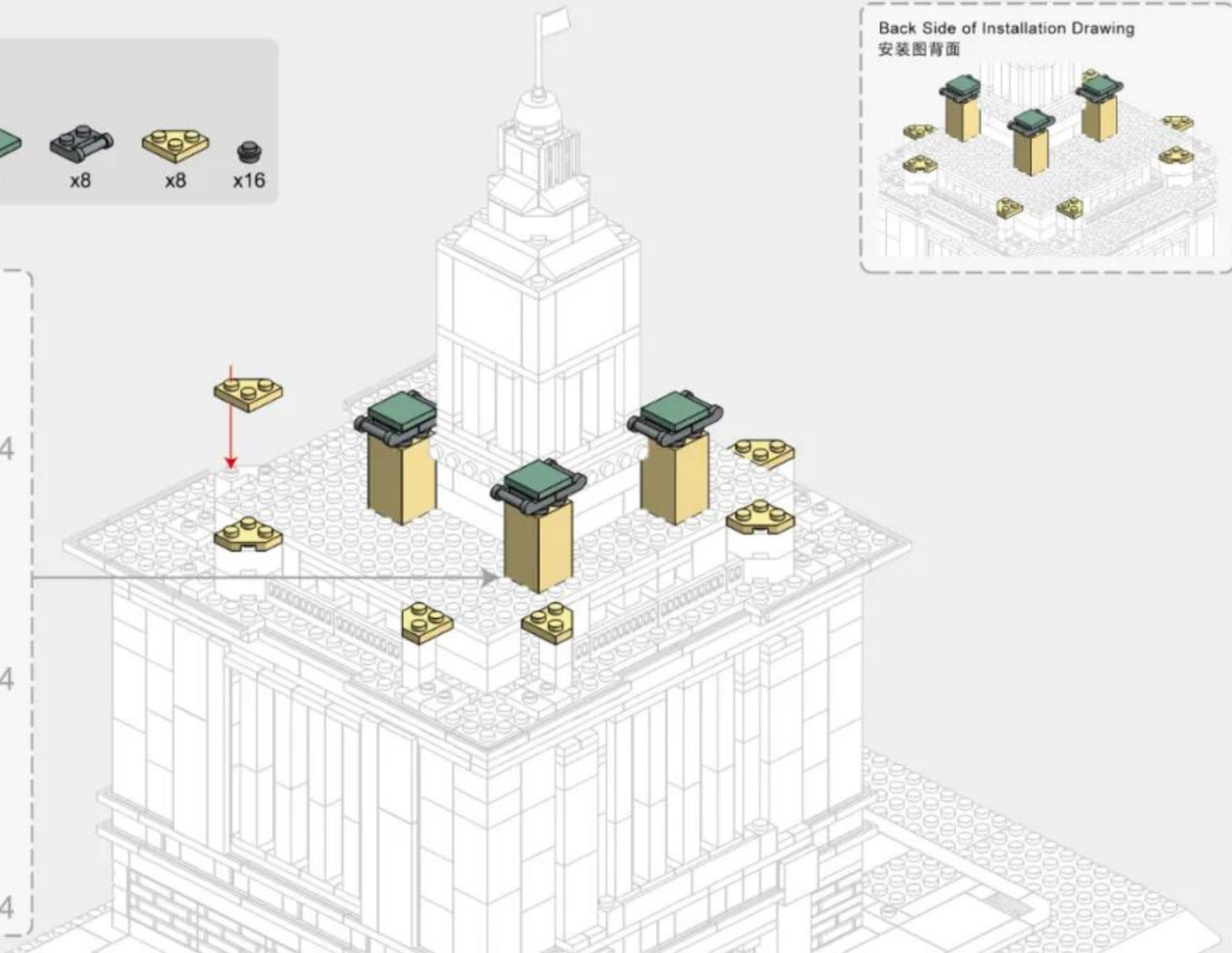
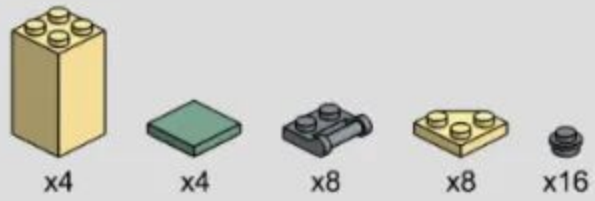

4-6

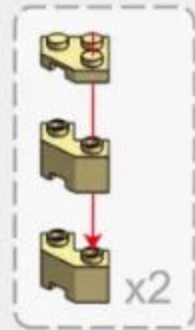
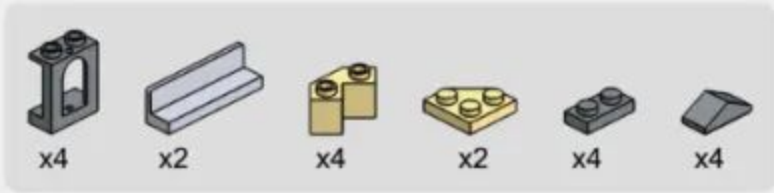

4-7



x4



x4



x4

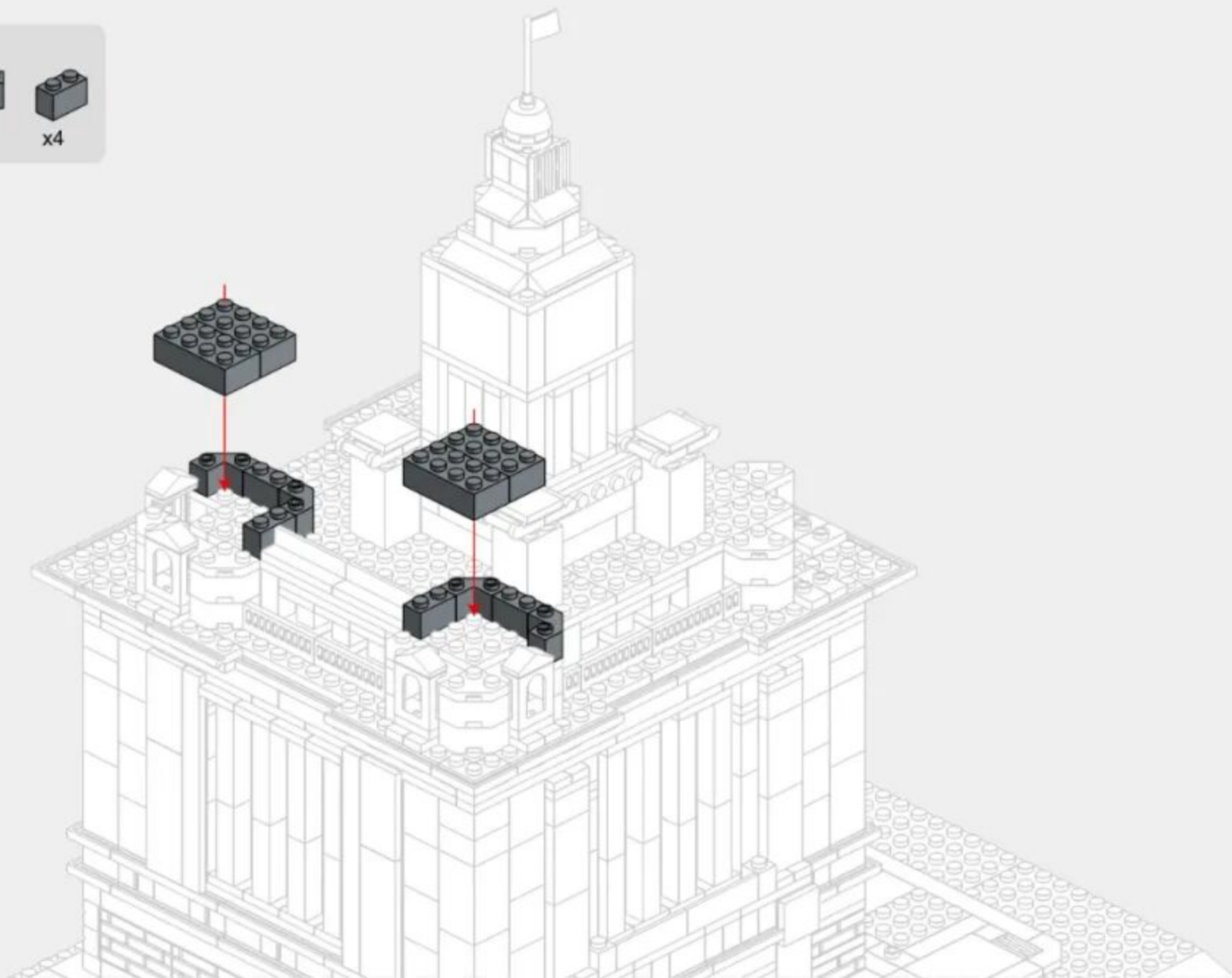

4-8

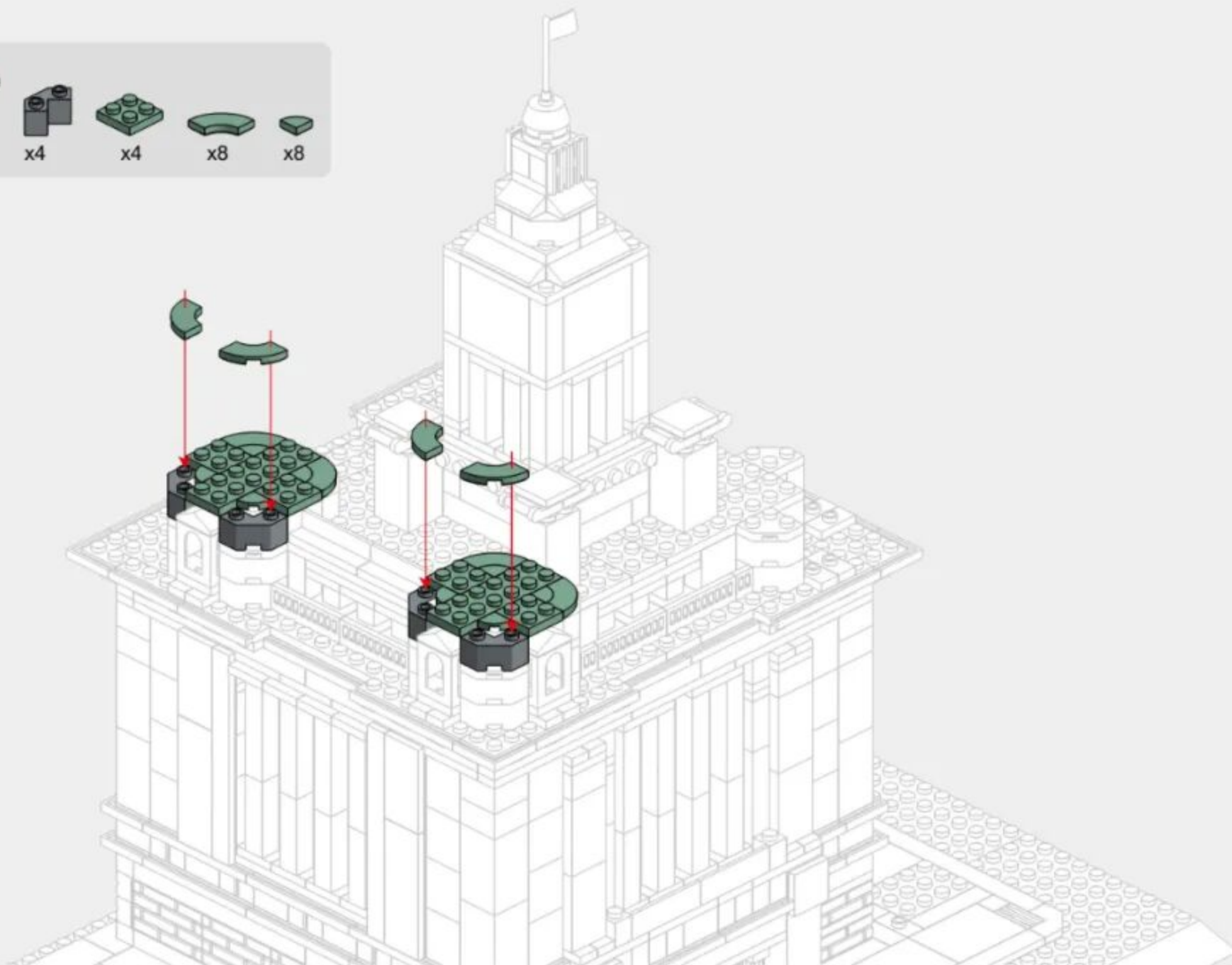

4-9

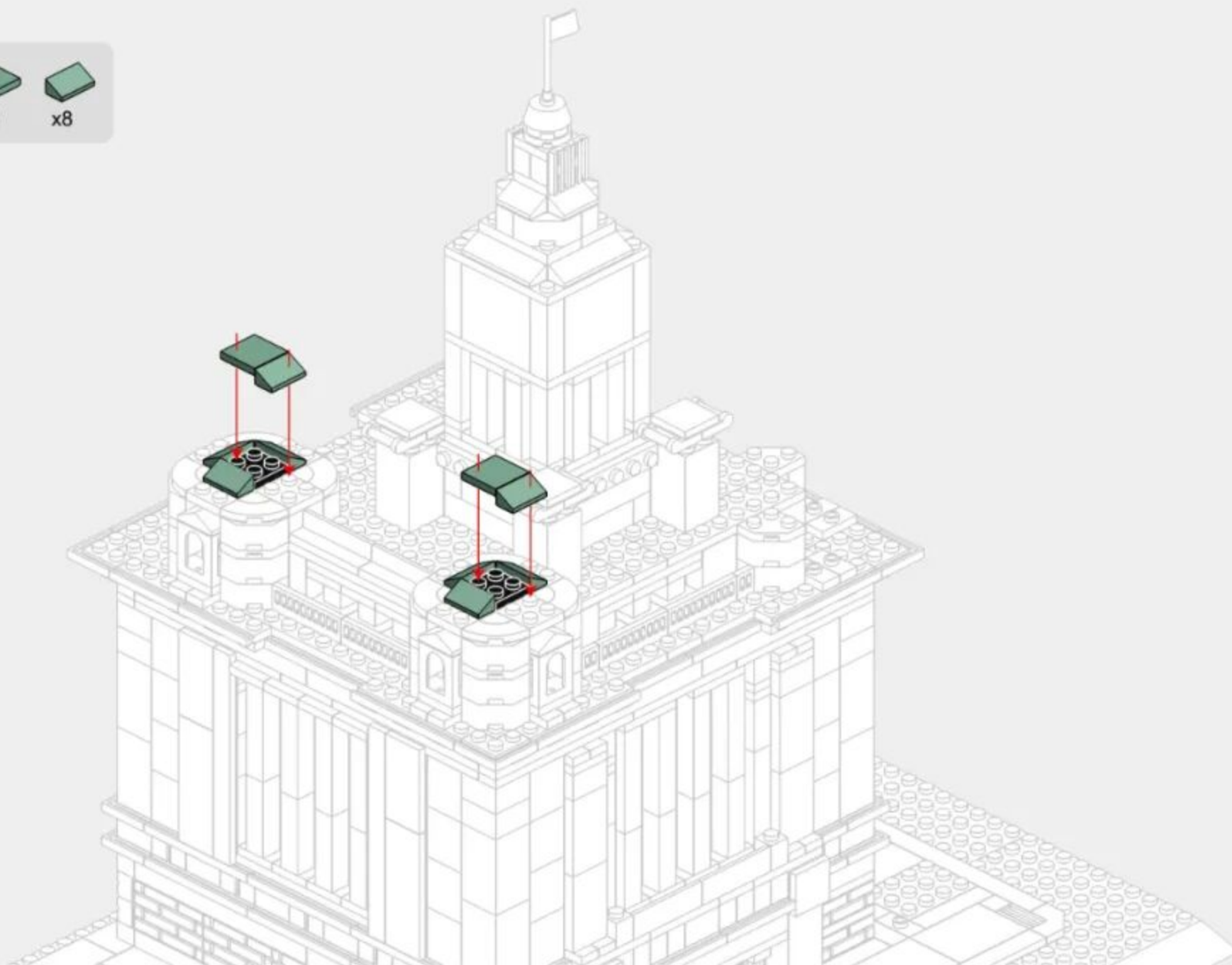

4-10

- 1x6
- x1
- x4
- x2
- x2
- x4
- x2
- x4
- x4
- x2

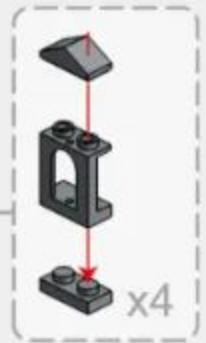
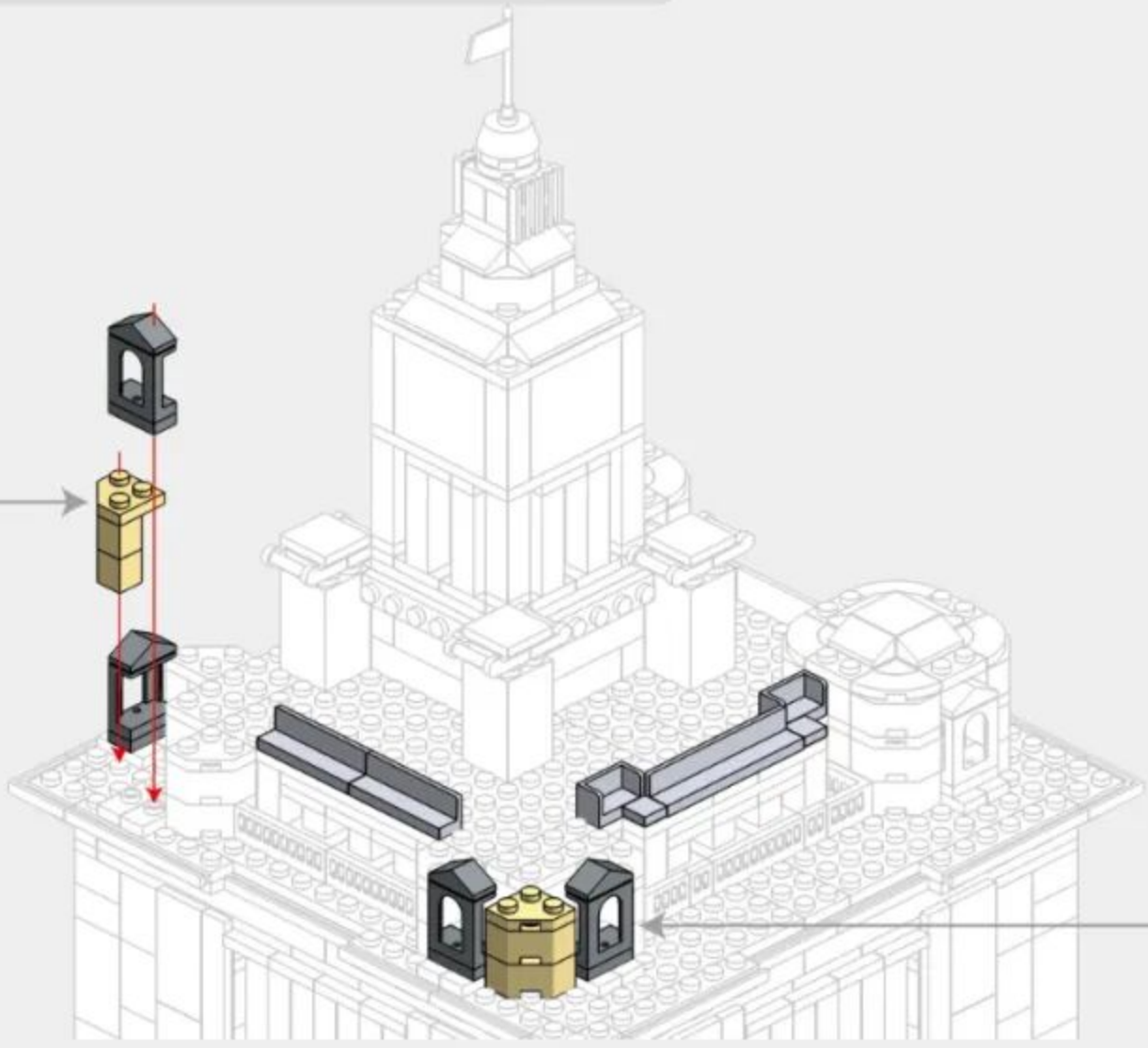
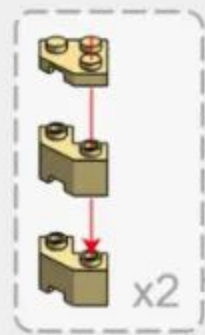

4-11

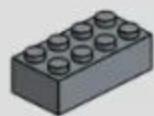

x4



x4



x4

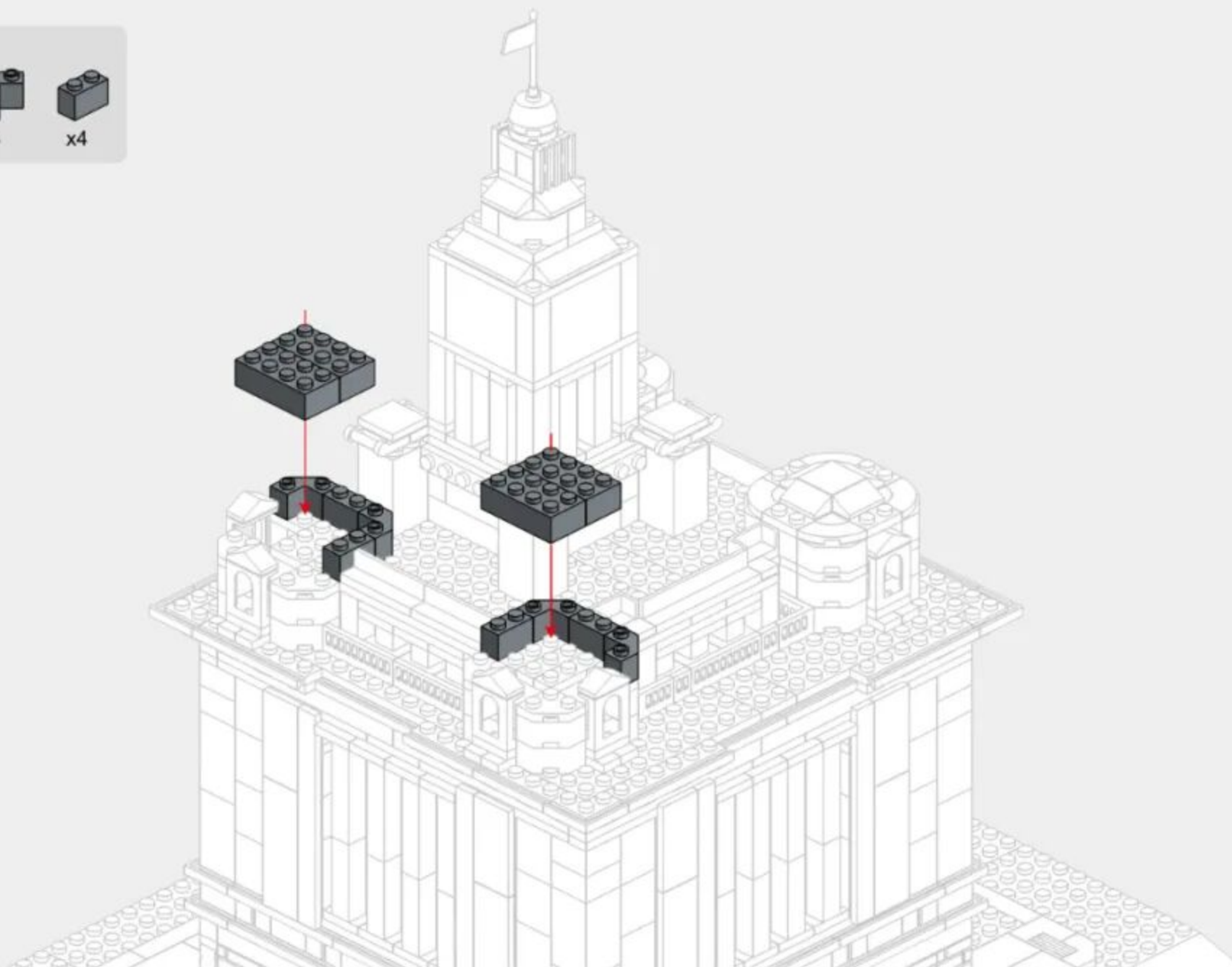

4-12

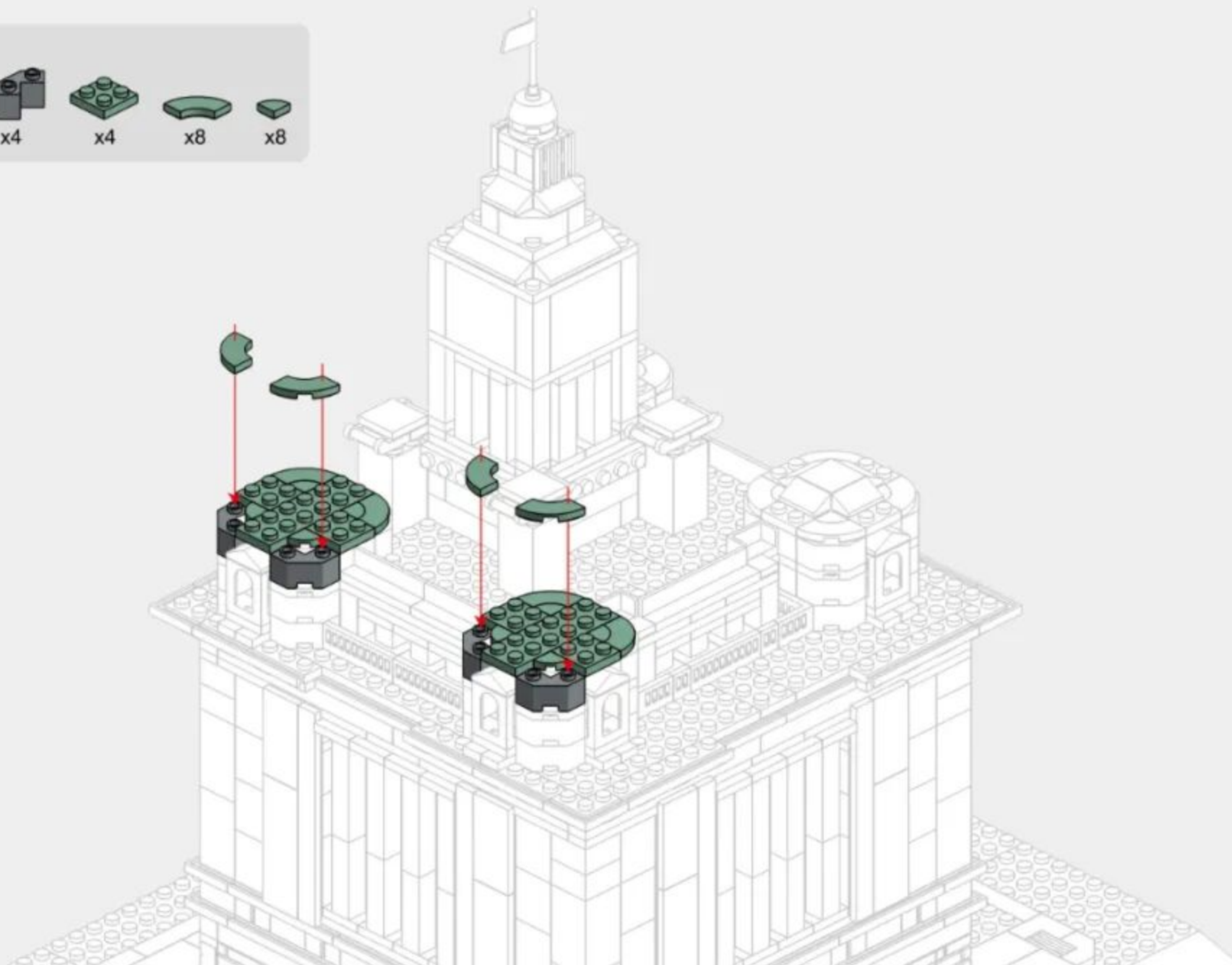

4-13



x2

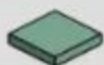

x2



x8

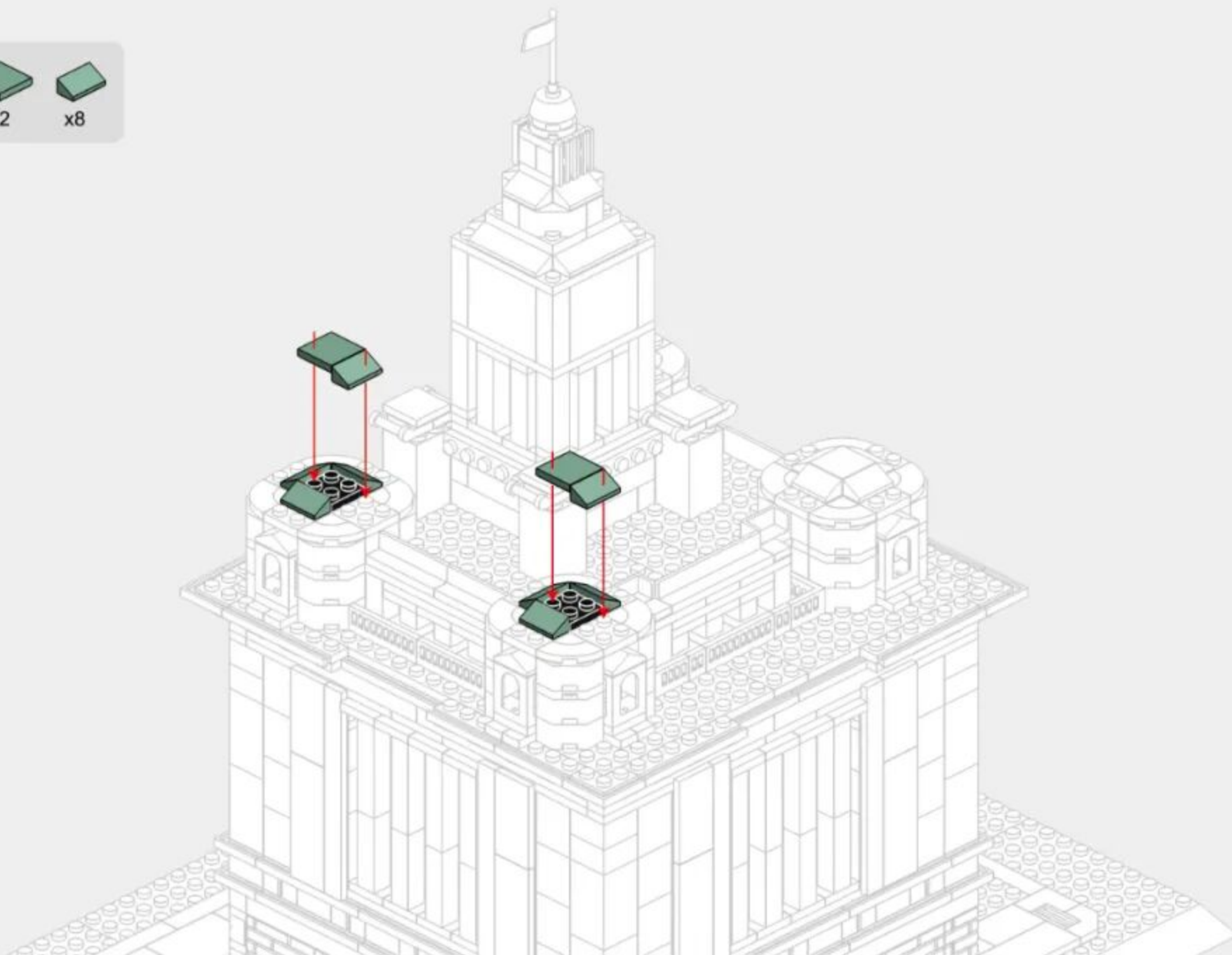



134PCS



71



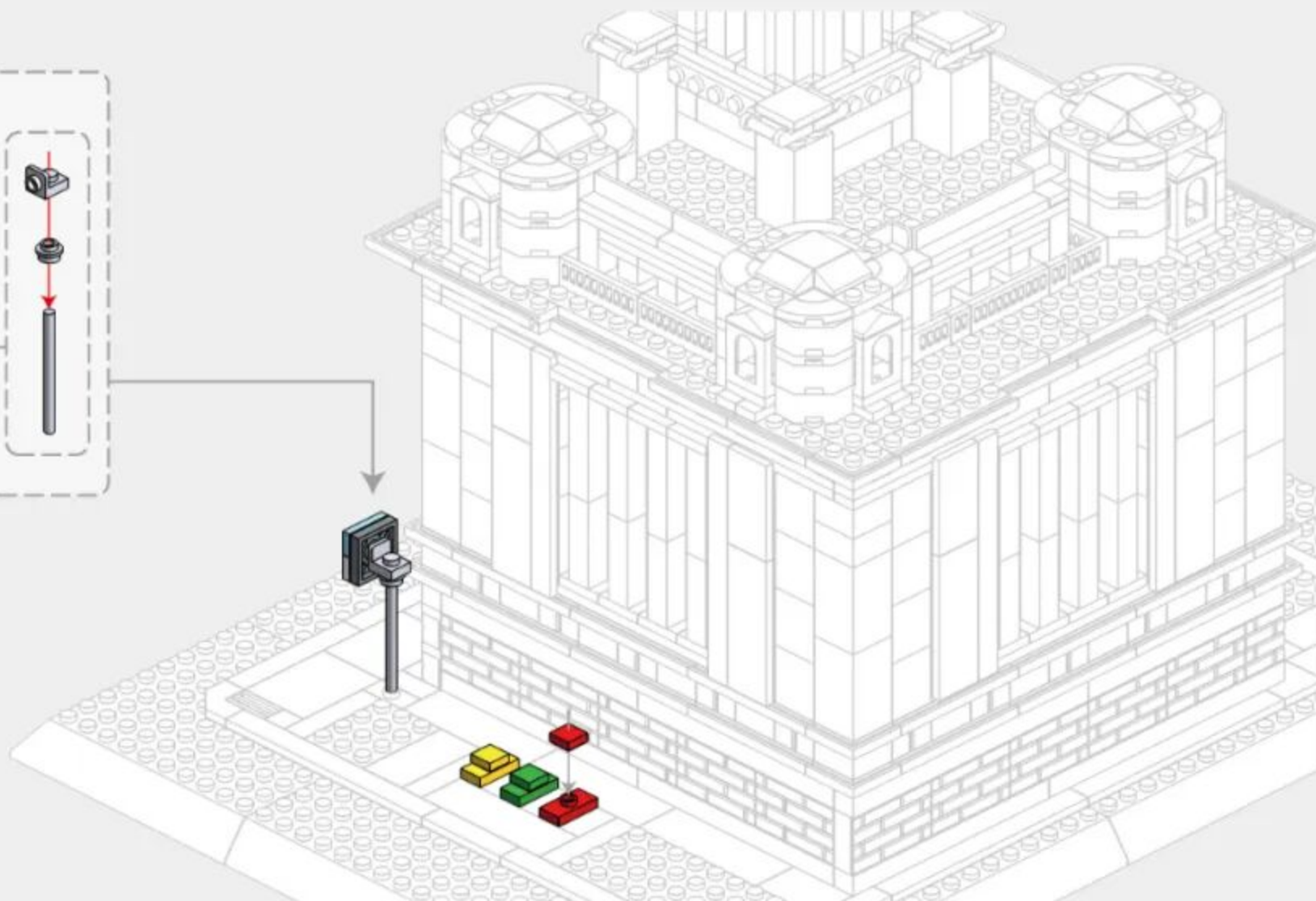
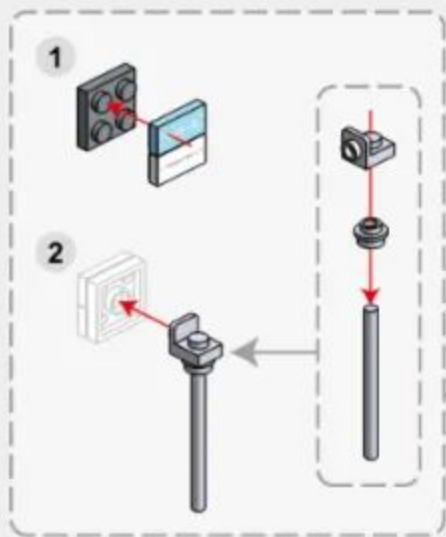

5-1

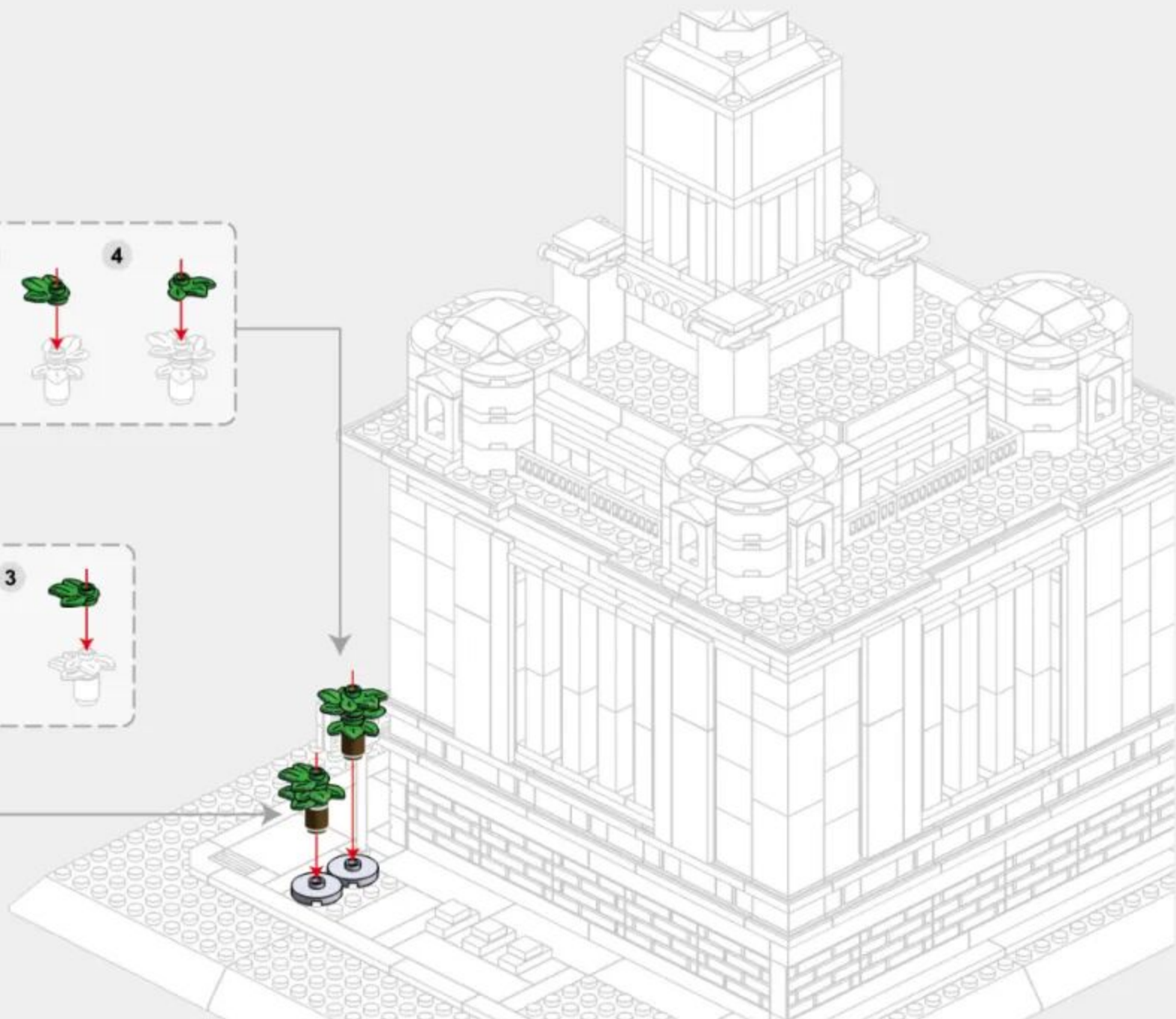
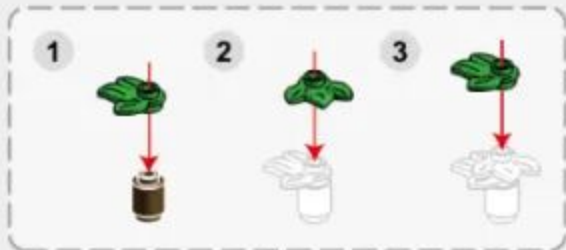
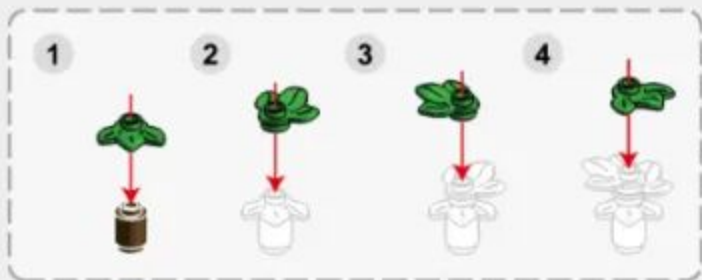

5-2



# 5-3

-  x5
-  x2
-  x20
-  x2
-  x12

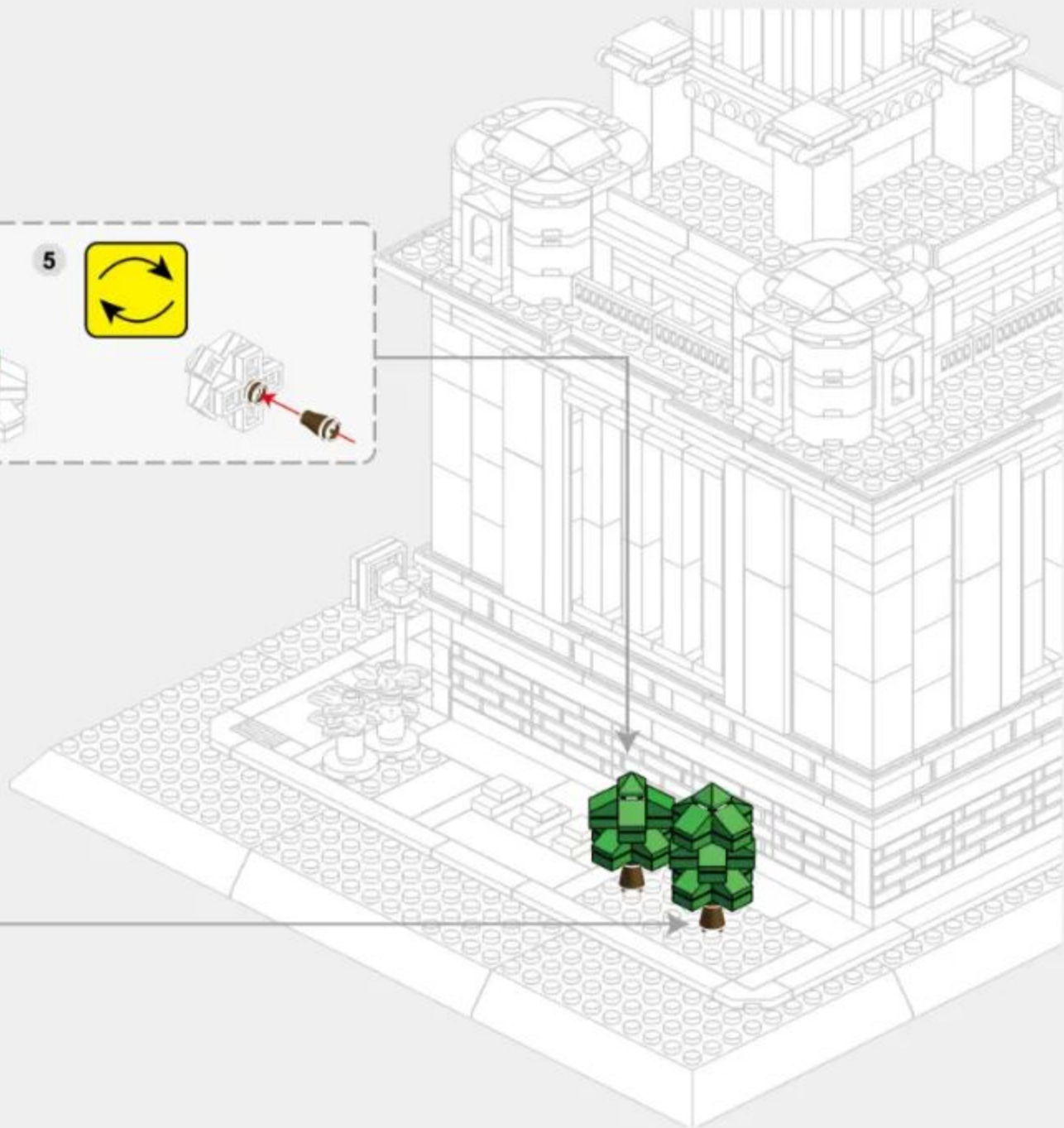
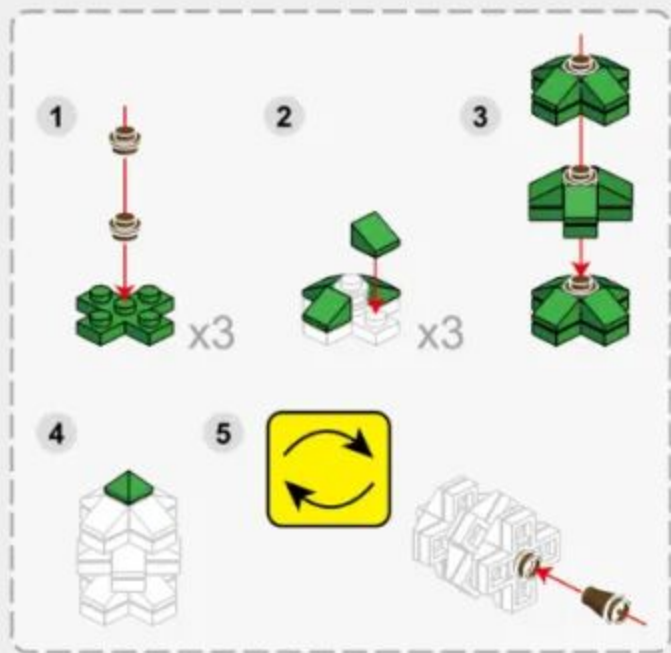
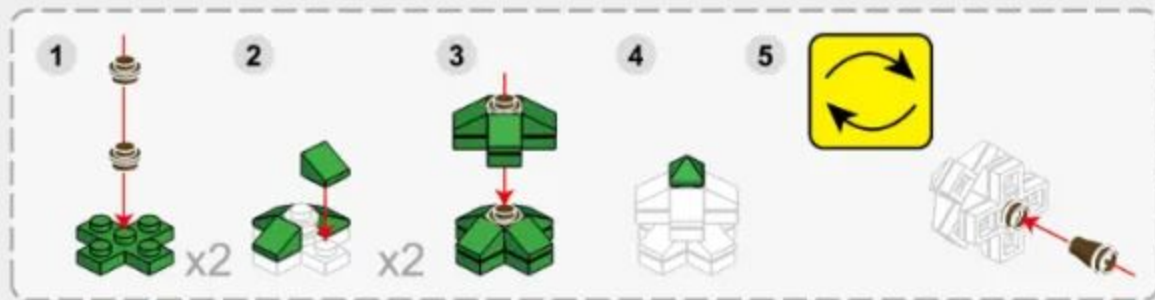

5-4

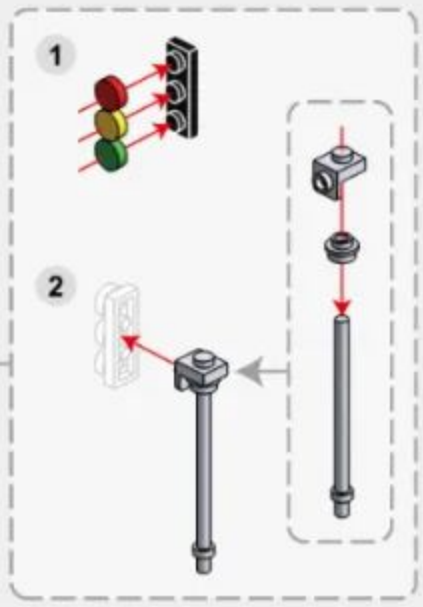
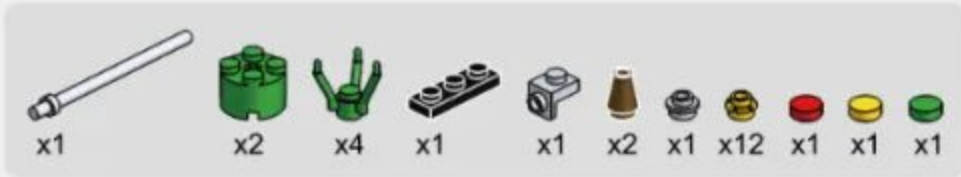

# 5-5

-  x2
-  x1
-  x1
-  x1
-  x1
-  x2
-  x7
-  x1
-  x1
-  x1
-  x1

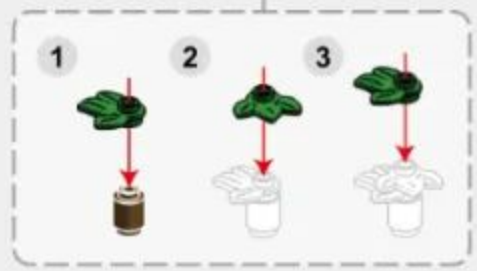
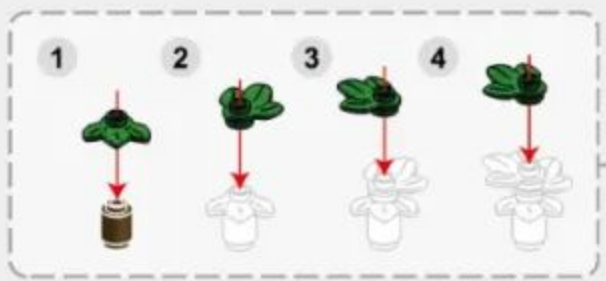

5-6

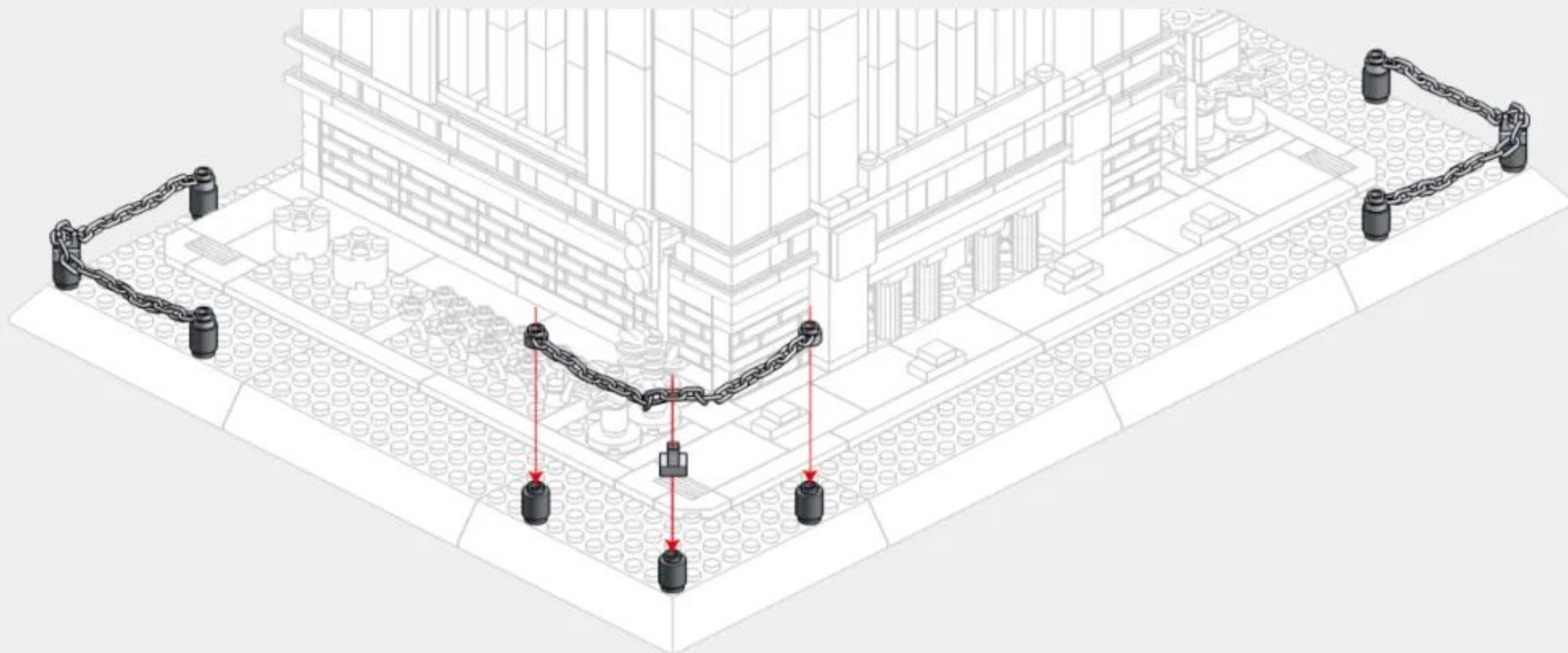

5-7

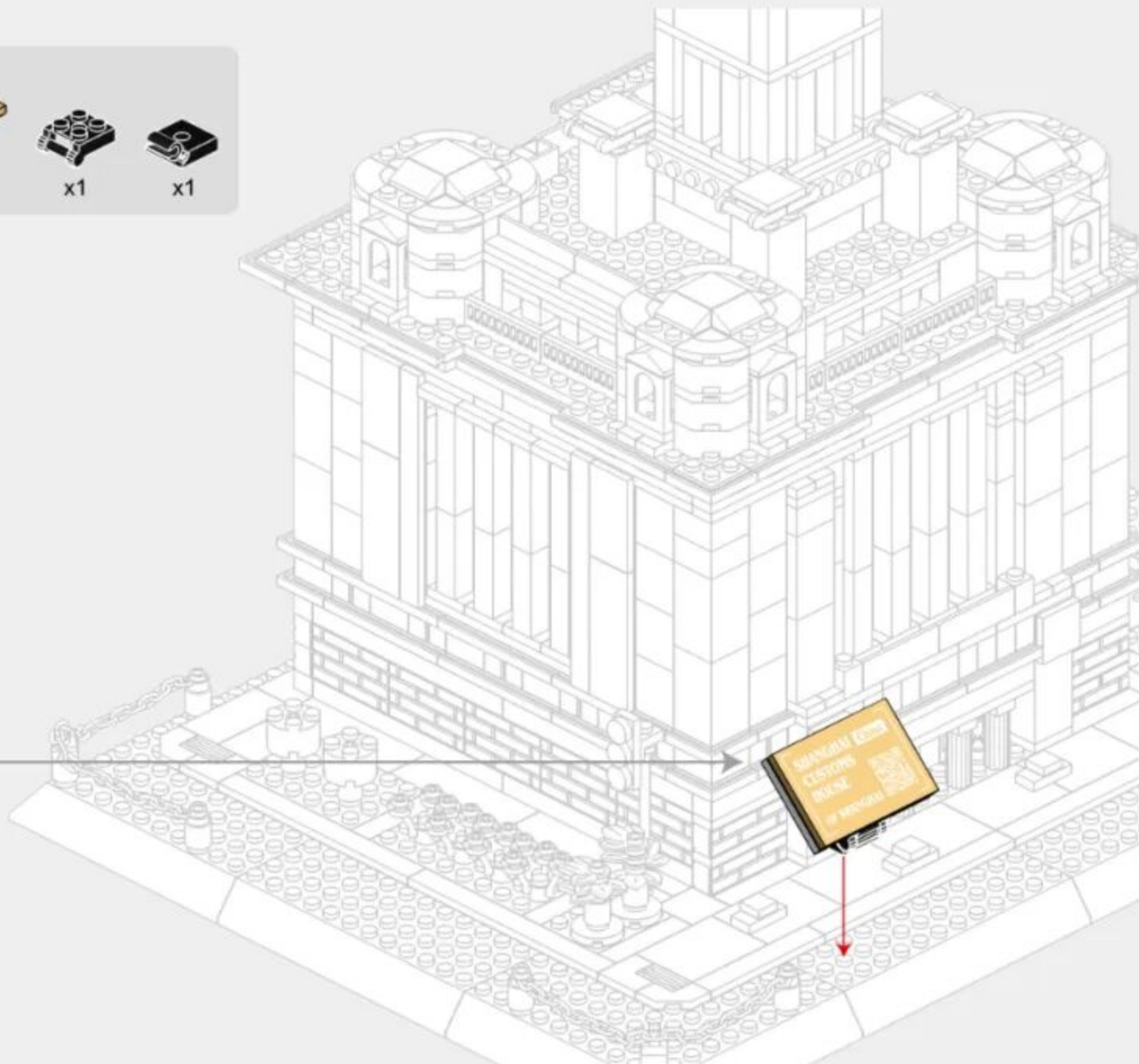
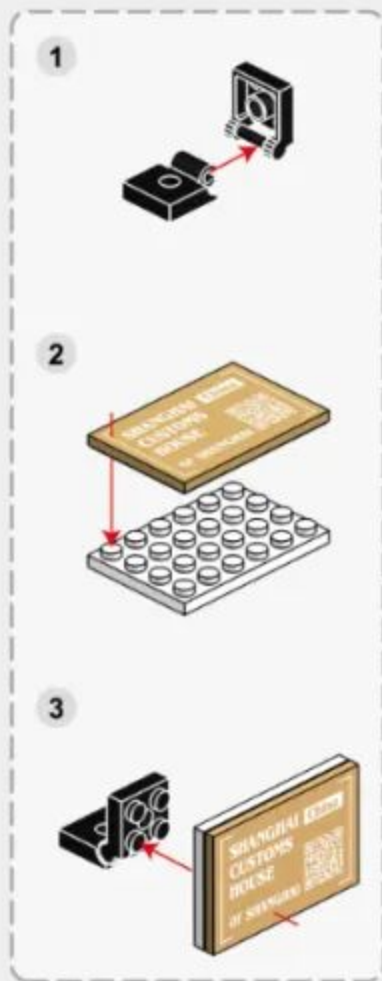
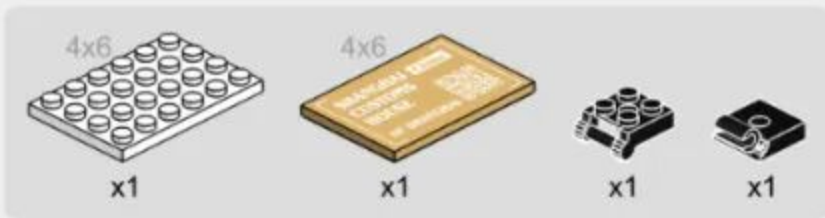



# ARCHITECTURE

The World's great architecture



**6224 英国伦敦白金汉宫**  
BUCKINGHAM PALACE-LONDON,ENGLAND



**5225 意大利罗马斗兽场**  
COLOSSEUM-ROME,ITALY



**5226 日本东京帝国饭店**  
IMPERIAL HOTEL-TOKYO,JAPAN



**5227 美国纽约自由女神像**  
STATUE OF LIBERTY-NEW YORK,AMERICA



**6211 德国柏林勃兰登堡门**  
BRANDENBURG GATE-BERLIN, GERMANY



**6222 中国甘肃长城-嘉峪关**  
JIAYU PASS-GANSU,CHINA



**6212 日本京都清水寺仁王门**  
NIMON GATE OF KIYOMIZU-DERA-KYOTO,JAPAN



**6213 俄罗斯莫斯科瓦西里大教堂**  
SAINT BASIL'S CATHEDRAL-MOSCOW,RUSSIA



**6214 中国武汉黄鹤楼**  
YELLOW CRANE TOWER-WUHAN,CHINA



**6215 英国伦敦眼**  
LONDON EYE-LONDON,ENGLAND



**6221 中国北京故宫-太和殿**  
HALL OF SUPREME HARMONY-BEIJING,CHINA



**6220 沙特阿拉伯麦加大清真寺**  
GREAT MOSQUE OF MECCA,SAUDI ARABIA



**6219 美国纽约联合国大厦**  
UNITED NATIONS HEADQUARTERS-NEW YORK,AMERICA



**4214 美国华盛顿白宫**  
WHITE HOUSE-WASHINGTON D.C.,AMERICA



**4212 意大利罗马许愿池**  
TREVI FOUNTAIN-ROME,ITALY



**4213 法国巴黎卢浮宫**  
MUSÉE DU LOUVRE-PARIS,FRANCE

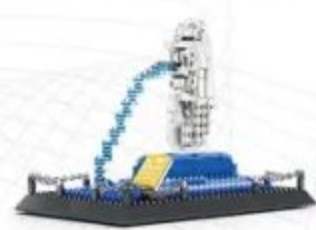

**4218 新加坡-鱼尾狮**  
MERLION,SINGAPORE



**4219 英国伦敦双子塔桥**  
TOWER BRIDGE-LONDON,ENGLAND



**4216 美国华盛顿林肯纪念馆**  
LINCOLN MEMORIAL-WASHINGTON D.C.,AMERICA



**4217 新加坡-金沙酒店**  
MARINA BAY SANDS,SINGAPORE



**4210 埃及开罗吉萨金字塔**  
GREAT PYRAMID OF GIZA-CAIRO,EGYPT



**4221 加拿大渥太华国会山庄**  
PARLIAMENT BUILDINGS-OTTAWA,CANADA



**4211 英国伦敦伊丽莎白塔**  
ELIZABETH TOWER-ENGLAND



**4215 加拿大多伦多电视塔**  
THE CN TOWER-CANADA



**4220 美国纽约熨斗大厦**  
FLATIRON BUILDING-NEW YORK,AMERICA



4222 阿联酋迪拜哈利法塔 THE BURJ KHALIFA TOWER-DUBAI, UAE  
 5224 中国上海东方明珠广播电视塔 ORIENTAL PEARL TOWER-SHANGHAI, CHINA  
 5212 美国纽约帝国大厦 EMPIRE STATE BUILDING-NEW YORK, AMERICA  
 5213 马来西亚吉隆坡石油双塔 PETRONAS TWIN TOWERS-KUALA LUMPUR, MALAYSIA  
 5214 意大利托斯卡纳比萨斜塔 LEANING TOWER OF PISA-TUSCANY, ITALY  
 5216 英国伦敦伊丽莎白白塔 ELIZABETH TOWER-LONDON, ENGLAND



5219 俄罗斯莫斯科克里姆林宫钟楼 SPASSKAYA TOWER-MOSCOW, RUSSIA  
 5220 阿联酋迪拜卓美亚帆船酒店 BURJ AL ARAB HOTEL-DUBAI, UAE  
 5217 法国巴黎埃菲尔铁塔 EIFFEL TOWER-PARIS, FRANCE  
 5221 中国台北101大楼 TAIPEI 101-TAIPEI, CHINA  
 5228 美国芝加哥威利斯大厦 WILLIS TOWER-CHICAGO, AMERICA  
 5231 巴西里约热内卢救世基督像 CRISTO REDENTOR-RIO DE JANEIRO, BRASIL



6223 中国武汉长江大桥 WUHAN YANGTZE RIVER BRIDGE  
 5210 法国巴黎圣母院大教堂 CATHÉDRALE NOTRE DAME DE PARIS-PARIS, FRANCE  
 5211 印度阿格拉泰姬陵 TAJ MAHAL-AGRA, INDIA  
 5223 法国巴黎凯旋门 ARC DE TRIOMPHE-PARIS, FRANCE  
 5215 英国伦敦双子塔桥 TOWER BRIDGE-LONDON, ENGLAND



5222 中国北京天坛祈年殿 HALL OF PRAYER FOR GOOD HARVESTS-BEIJING, CHINA  
 6210 美国旧金山金门大桥 GOLDEN GATE BRIDGE-SAN FRANCISCO, AMERICA  
 6216 中国北京万里长城(八达岭) THE GREAT WALL-BEIJING, CHINA  
 5218 中国北京天安门 TIANANMEN TOWER-BEIJING, CHINA  
 6217 中国西藏布达拉宫 POTALA PALACE-TIBET, CHINA



6218 芬兰罗瓦涅米圣诞老人办公室 SANTA CLAUS OFFICE-ROVANIEMI, FINLAND  
 6225 墨西哥库库尔坎玛雅金字塔 EL CASTILLO-KUKULKAN, MEXICO  
 6226 德国巴伐利亚新天鹅堡 SCHLOSS NEUSCHWANSTEIN-BAYERN, DEUTSCHLAND  
 5229 土耳其伊斯坦布尔少女塔 MAIDEN TOWER-ISTANBUL, TURKEY  
 5230 中国湖南长沙爱晚亭 AIWANTING PAVILION-HUNAN, CHINA



**7210** 中国上海世博会中国馆  
CHINA PAVILION AT EXPO-SHANGHAI, CHINA



**5232** 美国宾夕法尼亚州流水别墅  
FALLINGWATER-PENNSYLVANIA, AMERICA



**5233** 美国芝加哥范斯沃斯住宅  
FARNSWORTH HOUSE-CHICAGO, AMERICA



**5234** 美国华盛顿唐人街  
CHINA TOWN-WASHINGTON, D.C., AMERICA



**3210** 美国纽约自由女神像  
STATUE OF LIBERTY-NEW YORK, AMERICA



**4223** 中国北京清华园  
TSINGHUA CAMPUS-BEIJING, CHINA



**7211** 中国湖南岳阳楼  
YUEYANG TOWER-HUNAN, CHINA



**8210** 澳大利亚悉尼歌剧院  
SYDNEY OPERA HOUSE-BENNELONG POINT, AUSTRALIA



**7212** 中国江西南昌滕王阁  
PAVILION OF PRINCE TENG-JIANGXI, CHINA



**6227** 中国河南郑州嵩山少林寺  
SHAOLIN TEMPLE-HENAN, CHINA



**7213** 中国重庆洪崖洞  
HONGYADONG-CHONGQING, CHINA



**5235** 美国华盛顿国会大厦  
UNITED STATES CAPITOL-WASHINGTON D.C., AMERICA



**5236** 中国安徽滁州醉翁亭  
ZUTONG PAVILION-ANHUI, CHINA



**6228** 中国陕西西安钟楼  
XIAN BELL TOWER-SHAANXI, CHINA



**5238** 美国西雅图太空针塔  
SPACE NEEDLE-SEATTLE, AMERICA



**5237** 法国巴黎萨伏伊别墅  
VILLA SAVOYE-PARIS, FRANCE



**6229** 中国山西运城鹳雀楼  
STORK TOWER-SHANXI, CHINA



**6230** 希腊爱情海圣托里尼岛  
SANTORINI-FIRA, GREECE



**6231** 中国上海海关大楼  
SHANGHAI CUSTOMS HOUSE-SHANGHAI, CHINA

# SHANGHAI CUSTOMS HOUSE

COUNTRY: China  
CITY: Shanghai

