



# THE LAOJUN MOUNTAIN

中国河南洛阳栾川老君山

Henan, China

The world's great architecture



6+ / 6234 / 1692 PCS  
Suitable Age Product Number Parts Total

# THE LAOJUN MOUNTAIN

COUNTRY: China  
CITY: Luoyang





# Architecture

It will be a city...

这将构成一座城市...

# ABOUT THE PRODUCT

关于产品

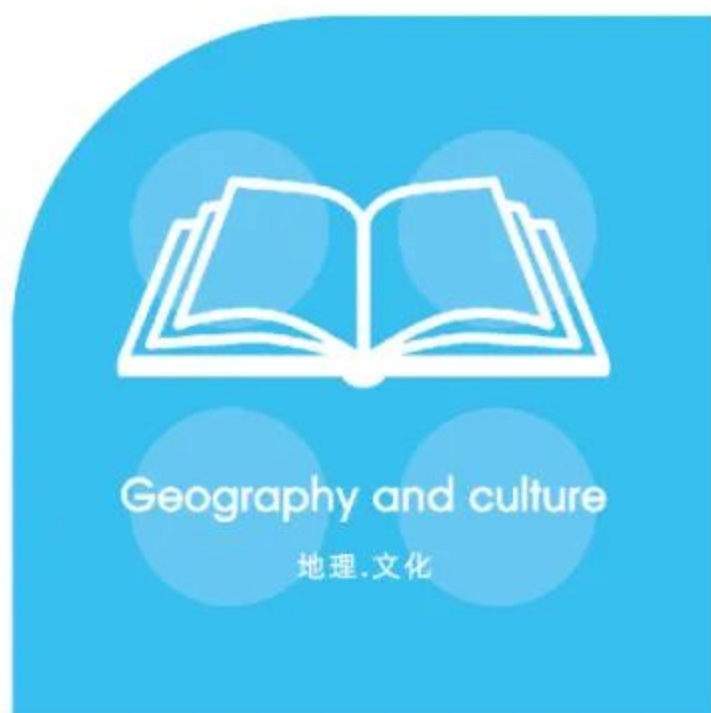

## ARCHITECTURE

WANGE The world's great architect since 1991

Guangdong Baoge Educational Material Sci-Tech Co., Ltd.  
©2014 Wange / Dubie. All Rights Reserved

# The Laojun Mountain



Laojun Mountain, is "the unparalleled holy place in the world, the world's first fairy mountain". Formerly known as Jingshi Mountain, it is located three kilometers southeast of Luanchuan County in Luoyang, the ancient capital of the thirteen dynasties.

# The Laojun Mountain



## Geography and culture

地理·文化



Laojun Mountain was formed in the continental orogenic movement 1.9 billion years ago. In the 31st year of Wanli (1603), Emperor Shenzong of the Ming Dynasty ordered Laojun Mountain to be a "Famous Mountain in the World", becoming the only Chinese country in history to be named a "Famous Mountain in the World" mountains.



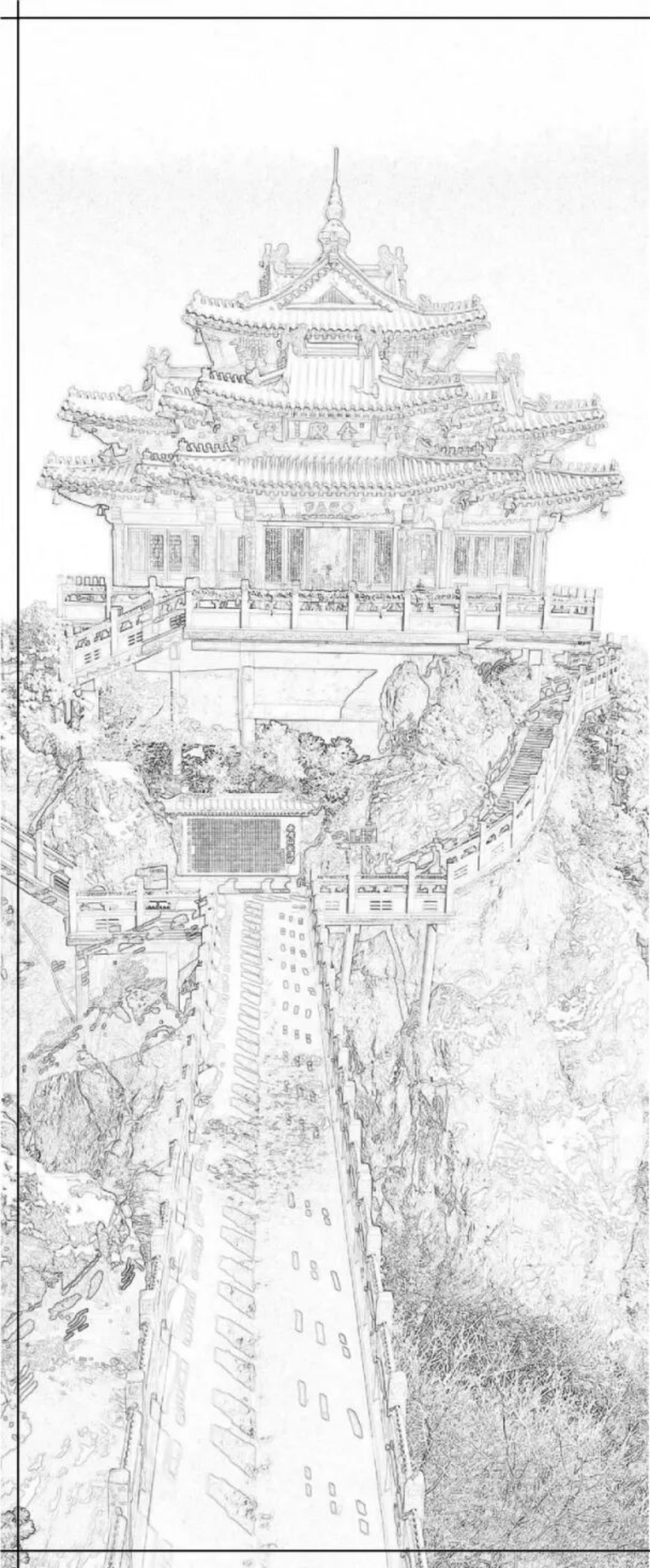

中国河南洛阳栾川老君山

# The Laojun ■ Mountain

China

The contents of this chapter refer to the Wikipedia website.

本章内容参考维基百科网站，  
更多资讯可自行查阅。

The world's great architecture

# Buildings and layout

■ 建筑物和布局



**老君山**是历史上唯一被皇封为“天下名山”的中国山脉。老君山金顶道教建筑群依托山顶建筑，主要包括老君庙、道德府、五母金殿、亮宝台、玉皇顶、钟鼓楼、南天门、朝阳洞、大道院、神道天桥、回廊等，全部采用明清皇家宫殿式建筑形式，特别是金殿、亮宝台、玉皇顶的三座金顶，成为老君山道观群的亮点。金殿又称五母金殿，海拔2173米；与亮宝台、玉皇顶呈三角之势，巧妙构成了二龙戏珠的壮观图案。五母金殿不仅是观赏山景的绝佳之处，而且以其独特的造型成为金顶道观群的画龙点睛之笔。

Laojun Mountain is the only Chinese mountain range in history to have been named by the emperor as one of the 'most famous mountains in the world'. The Golden Dome of Laojun Mountain Taoist Complex is built on the top of the mountain and mainly includes Laojun Temple, Daodeifu, the Golden Hall of the Five Mothers, Liangbaodai, Yuhuangding, the Bell and Drum Tower, the South Heavenly Gate, the Chaoyang Cave, the Daodao Courtyard, the Shinto Sky Bridge and the Cloister, all of which are built in the form of Ming and Qing Dynasty royal palaces. The Golden Hall, also known as the Golden Hall of the Five Mothers, is 2,173 meters above sea level; it is in a triangular position with the Bright Treasure Terrace and the Jade Emperor's Peak, cleverly forming a spectacular pattern of two dragons playing with a pearl. The Golden Hall of Five Mothers is not only an excellent place to enjoy the mountain scenery but is also the finishing touch to the Golden Dome Taoist Temple Group with its unique shape.



## Symbolism

老君山现为世界地质公园、国家AAAAA级旅游景区、国家地质公园、国家级自然保护区、省级重点文物保护单位、省级风景名胜区，中国北方道教信众拜谒圣地，中原山水文化杰出代表。老君山景观区6处、有景点179个，太清宫、十方院、灵官殿、淋醋殿、牧羊圈、救苦殿、传经楼、观音殿、三清殿、老君庙等庙宇16处。马鬃岭南侧有三千余亩石林景观对游人开放，被地质学者称为“北国石林”。

Laojun Mountain is now a world geopark, a national AAAA tourist attraction, a national geological park, a national nature reserve, a provincial key cultural relic protection unit, a provincial scenic spot, a sacred place of worship for Taoist believers in northern China, and an outstanding representative of Zhongyuan landscape culture. There are 6 landscape areas in Laojun Mountain, 179 attractions, and 16 temples. On the south side of Mahailing, there are more than 3,000 acres of rocky landscape open to visitors, known by geologists as the "Stone Forest of the North".



## Design and construction

金殿为明清皇宫建筑风格，建筑面积360m<sup>2</sup>，整体建筑采用重檐十字脊建筑，分3层24檐角，每个檐角下均系一铜铃。匾额写着母仪天下，大殿供奉人母女娲，地母，天皇母，西王母，无极母，整个建筑看起来富丽堂皇，华贵端庄。楼体四面各建一突出的抱厦，四个抱厦两两对称，形成八个角，有两仪生四象、四象生八卦之态，为这座建筑增添了更多的神秘感。金殿世纪宝鼎放置在金殿上方，高3.65米，直径1.5米，呈葫芦型。葫芦谐音“福禄”，其枝茎为蔓带，谐音为“万代”，寓意“福禄万代”，是吉祥的象征，蔓与叶为子孙万代，葫芦多种籽，寓意多子多孙，属于吉祥物。据说，宝葫芦下还有藏宝箱，珍藏着数十件非常珍贵的文物。春秋时期，被公认为道教始祖的老子李耳到此归隐修炼，使之成为“道源”和“祖庭”。北魏始于其上建老君庙以纪念。贞观十一年（637年），唐太宗重修景室山铁顶老君庙，赐名“老君山”，成为道教主流全真派圣地。万历三十一年（1603年），明神宗诏谕老君山为“天下名山”，并发帑金建殿，成为历史上唯一被皇封为“天下名山”的中国山脉。

The Golden Hall is built in the Ming and Qing dynasty palace style, with a floor area of 360 square metres. The whole building is built with heavy eaves and cross ridges and is divided into three levels with 24 gables, each with a brass bell tied underneath. The building has a protruding hut on each of its four sides, and the four huts are symmetrical, forming eight corners, adding to the mystique of the building. The century-old treasure censer is placed above the Golden Hall, 3.65 metres high and 1.5 metres in diameter, in the shape of a gourd.

# Force Balance

受力平衡

Physical operations

物理运算

$$F = G \frac{m_1 m_2}{d^2}$$

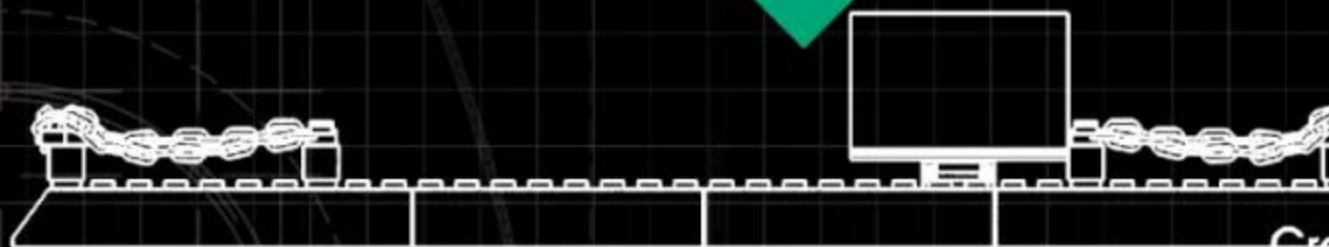
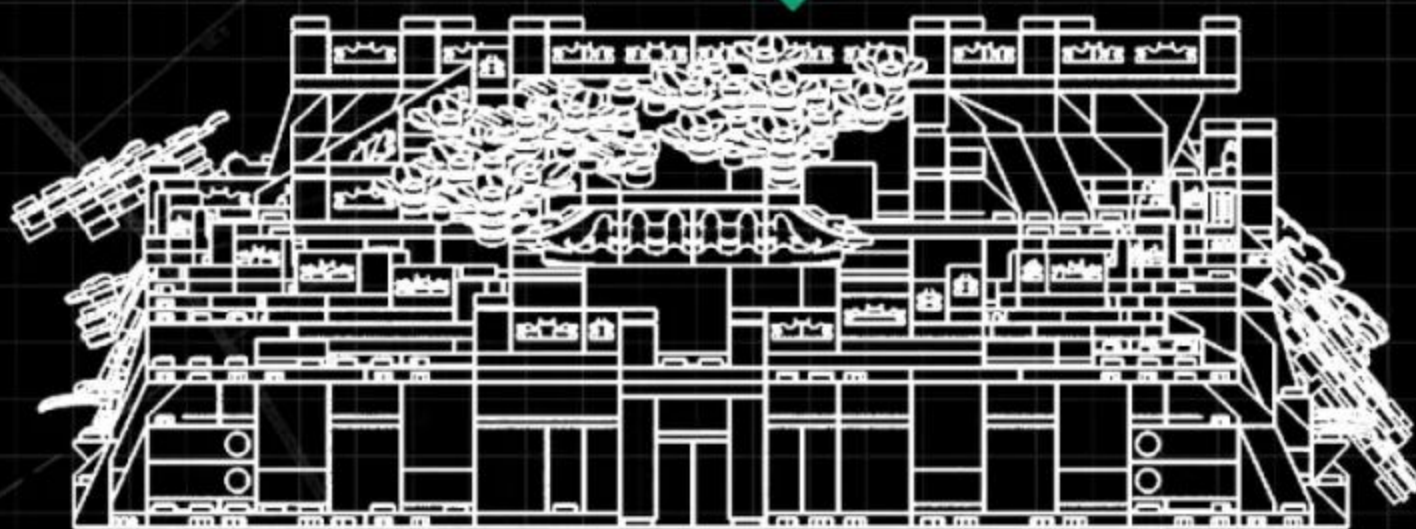
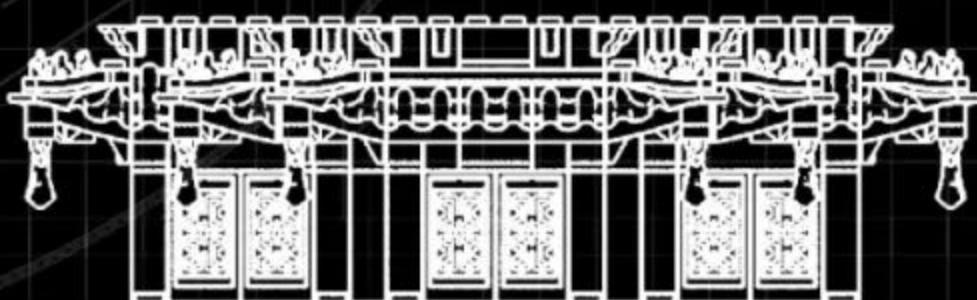

Creation and thinking

创作·思考

$$S=4\pi \cdot r^2$$

# Special parts

特殊零件的开发利用

$$a^2+b^2=c^2$$

**WG1275**

2孔栏杆



**WG1545**

带孔平角瓦片



**WG1284**

2孔龙头砖



**WG1026**

竹子



**WG1276**

斜角栏杆



**WG1544**

2孔小瓦片



**WG1403**

中式回纹窗页



**WG1546**

脊兽短条



**WG1267**

四倍窗

$$\sin^2 a + \cos^2 a = 1$$



features and function

特点.功能

# Main Color Matching

配色方案



Pantone 478C



Pantone 7550C



Pantone 7509C



Pantone 143C



Pantone 285C



Pantone 3435C



Pantone 2422C



Pantone 2300C



Pantone Black 6C



Pantone 431C



Pantone Cool Gray 6C

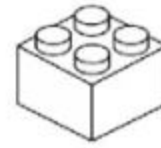

White



## Color matching

Adopting 3 main colors, Gold, dark grey and blackish green as the main color, the more reasonable and Green color matching on the original building, making the product more atmospheric and the whole design is more reasonable.

# The Laojun Mountain

中国河南洛阳栾川老君山



Front

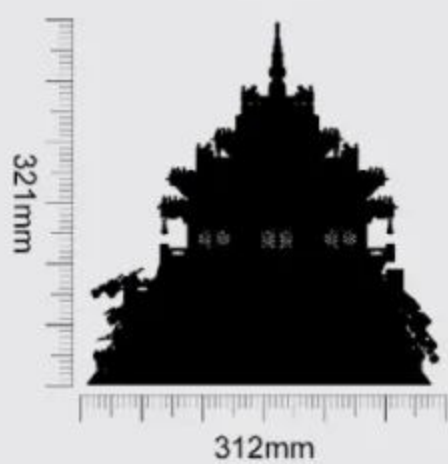

Left

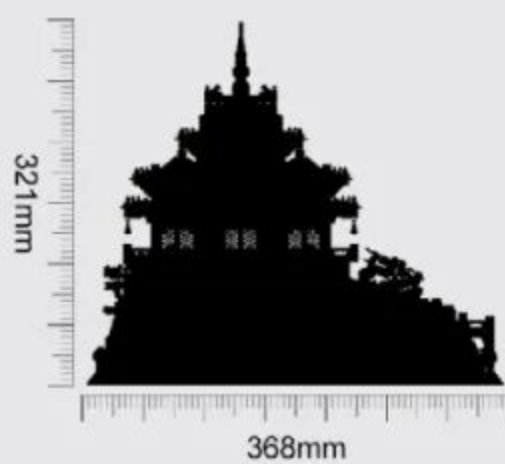

Back

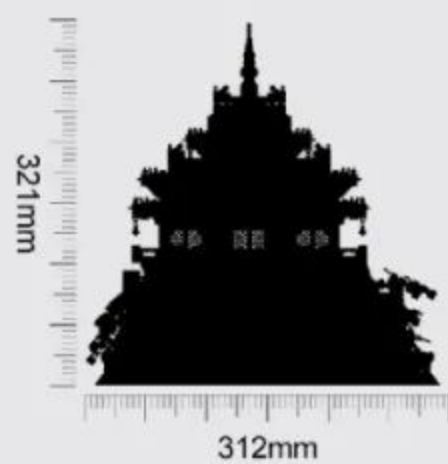

Product Size:312X368X321mm



# Instructions For Use

积木起件器使用说明  
Brickseparator

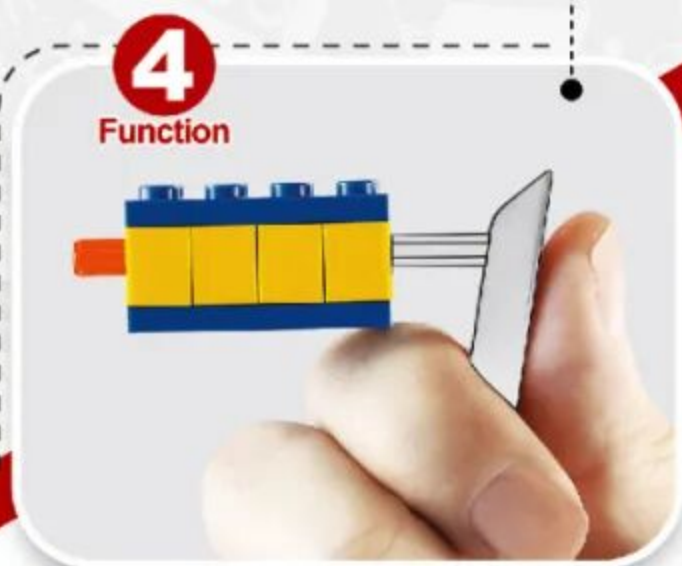
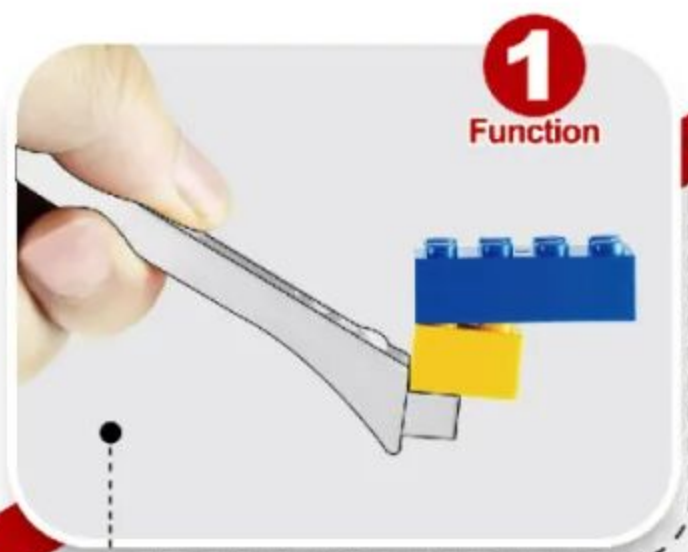

4 ways to make installation easier  
让安装更简单



■ First open the product packaging according to the instructions.

按指导用正确方式拆解产品外包装。



■ Summarize all parts to count the number of familiar accessories.

对照说明书清单确认积木包数量与积木数量。



■ Arranging all accessories by color helps to quickly install the product.

把确认好的积木以类型、颜色进行分类排好以便安装。



■ Carefully install the product and learn about building.

按说明书步骤拼装并完成你的积木模型。



# 1:1 Physical Reference Table

十字棒配件1:1尺寸参照表



Instructions For Use

让安装更简单

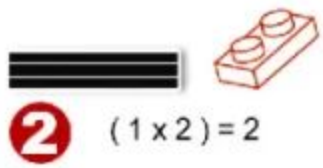

**2** (1x2)=2

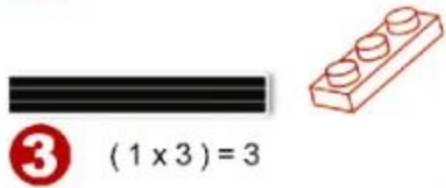

**3** (1x3)=3

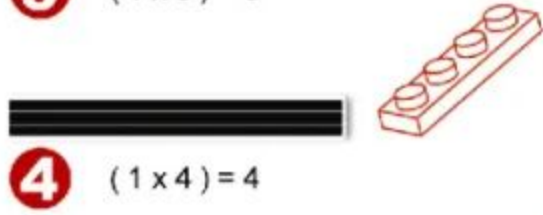

**4** (1x4)=4



**5** (1x5)=5



**6** (1x6)=6

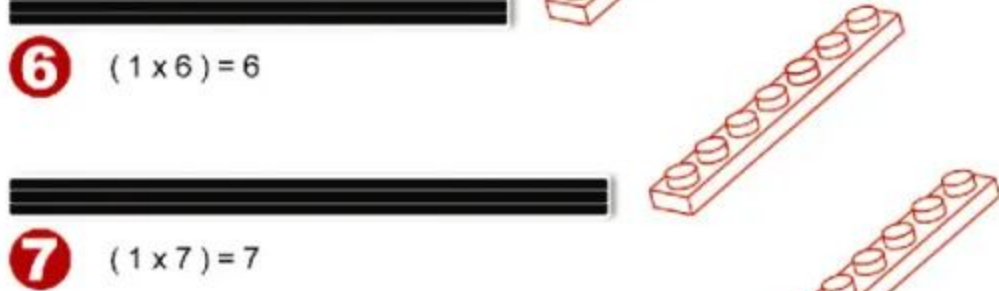

**7** (1x7)=7



**8** (1x8)=8



**9** (1x9)=9



**10** (1x10)=10



**12** (1x12)=12



**16** (1x16)=16







# PARTS LIST

配件清单

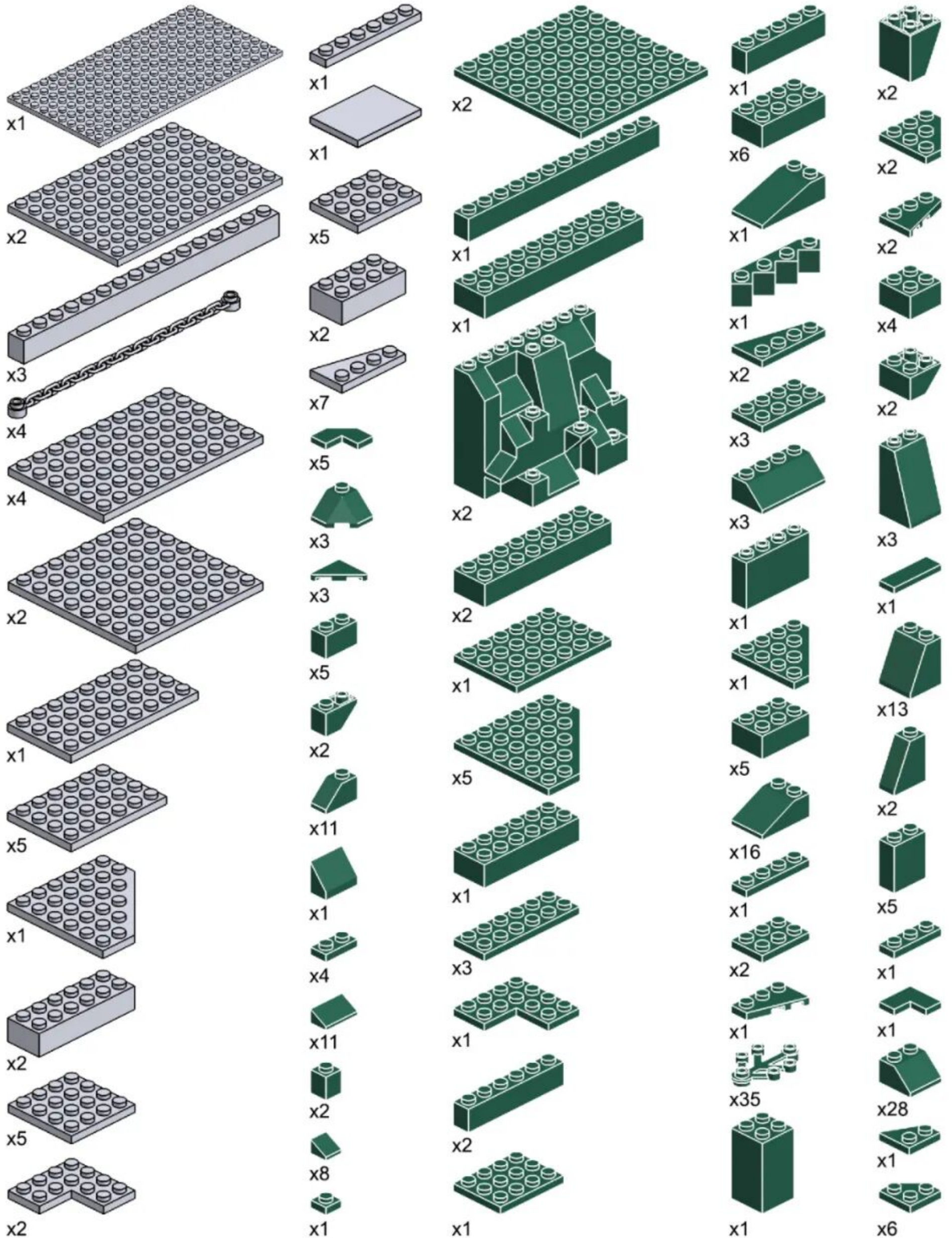

产品有增补件请以实物为准  
If product has additional parts, please in kind prevail.

# PARTS LIST

配件清单

x2	x9	x4	x2	x6	x1
x2	x2	x4	x2	x1	x1
x5	x2	x4	x8	x1	x1
x2	x28	x4	x2	x1	x1
x2	x28	x4	x1	x1	x1
x8	x4	x4	x1	x1	x1
x4	x4	x4	x1	x1	x1
x8	x24	x24	x4	x1	x1
x8	x20	x4	x18	x1	x1
x8	x4	x16		x1	x1
x4	x4	x1	x12	x1	x1
x2	x24	x1	x2	x56	
					x24
x1	x4	x10	x32	x1	x6
x12	x4	x5	x4	x16	x37
x2	x2	x6	x56	x16	x22
x2	x1	x6	x56	x16	
x2	x1	x6	x56	x16	



219PCS

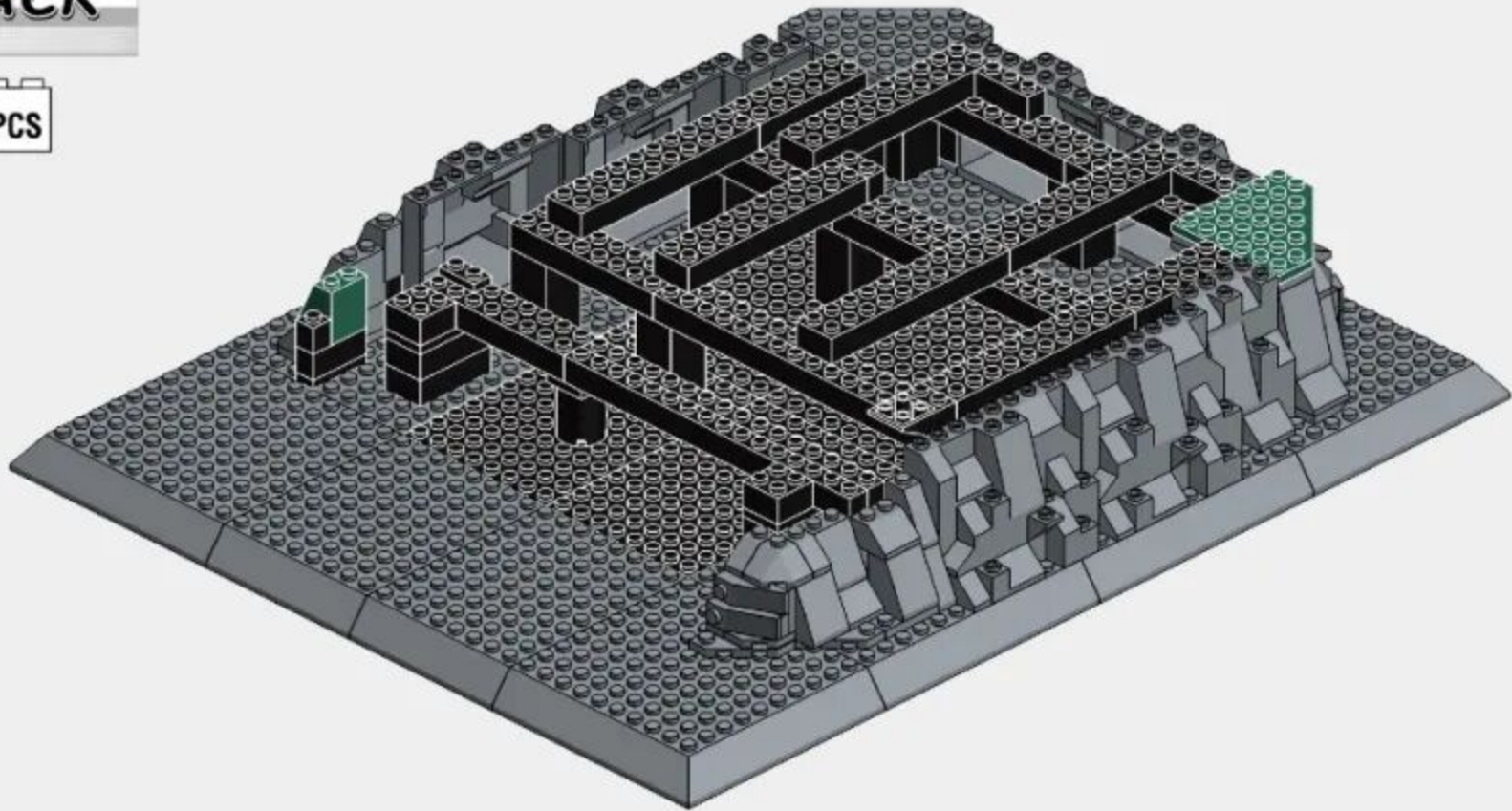

1-1



微信扫一扫  
补件更简单

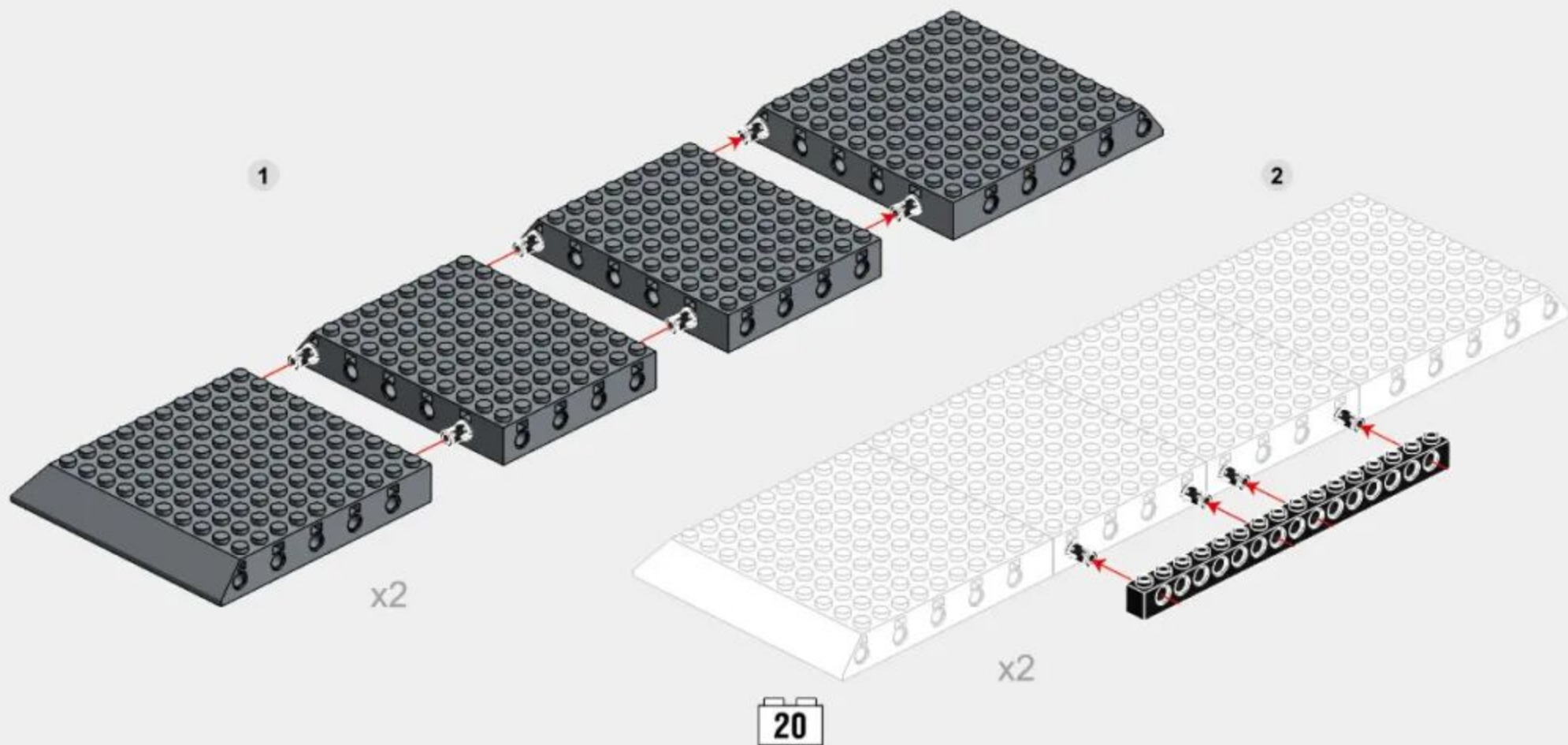
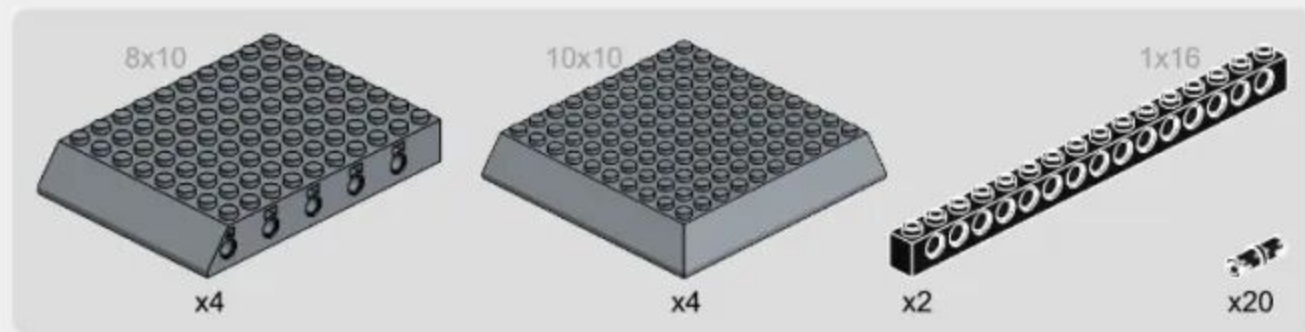

1-2

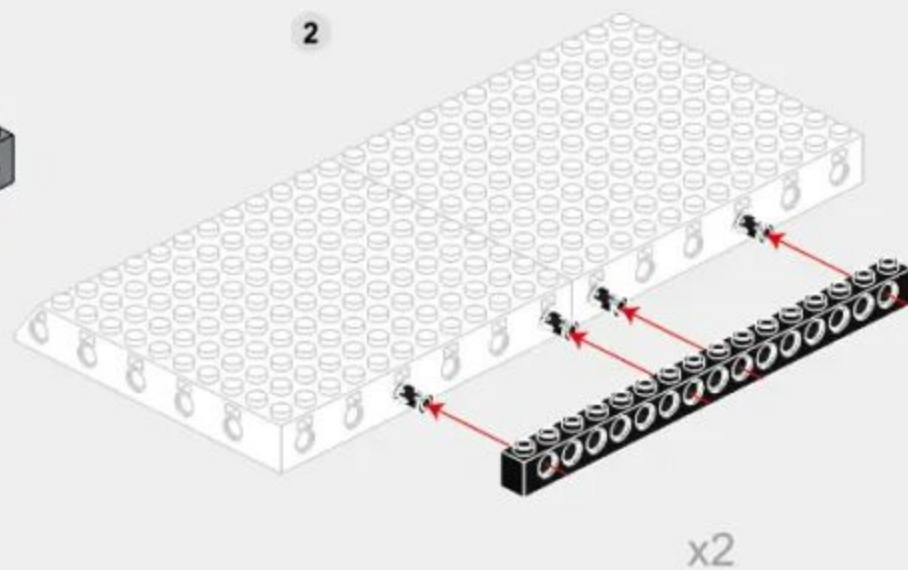
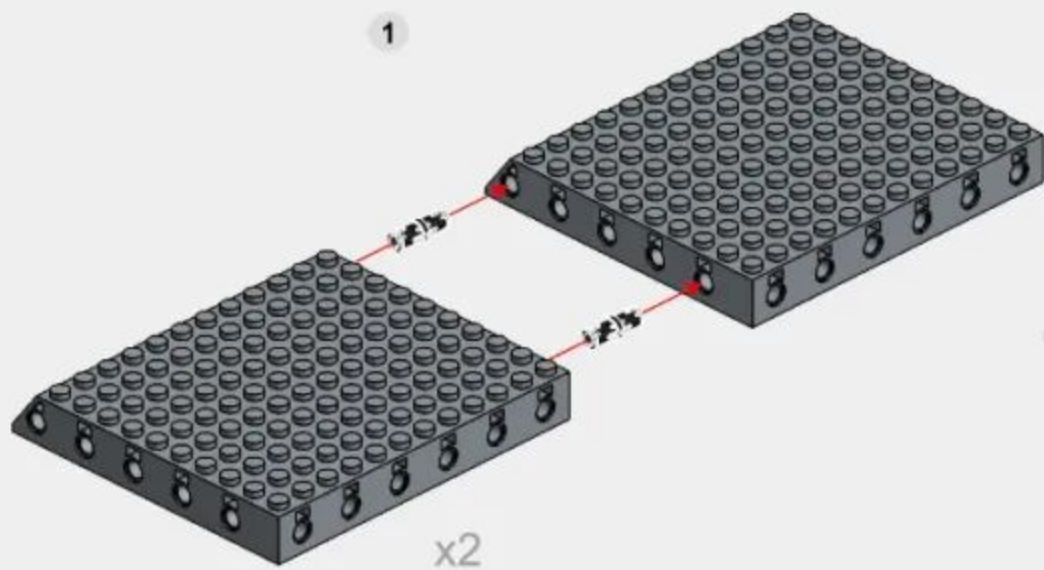
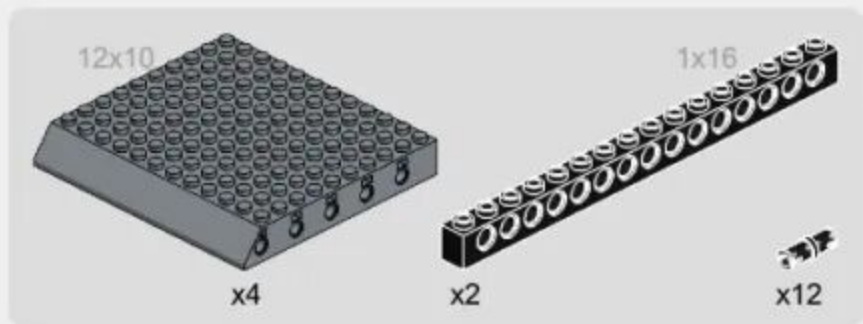

1-3

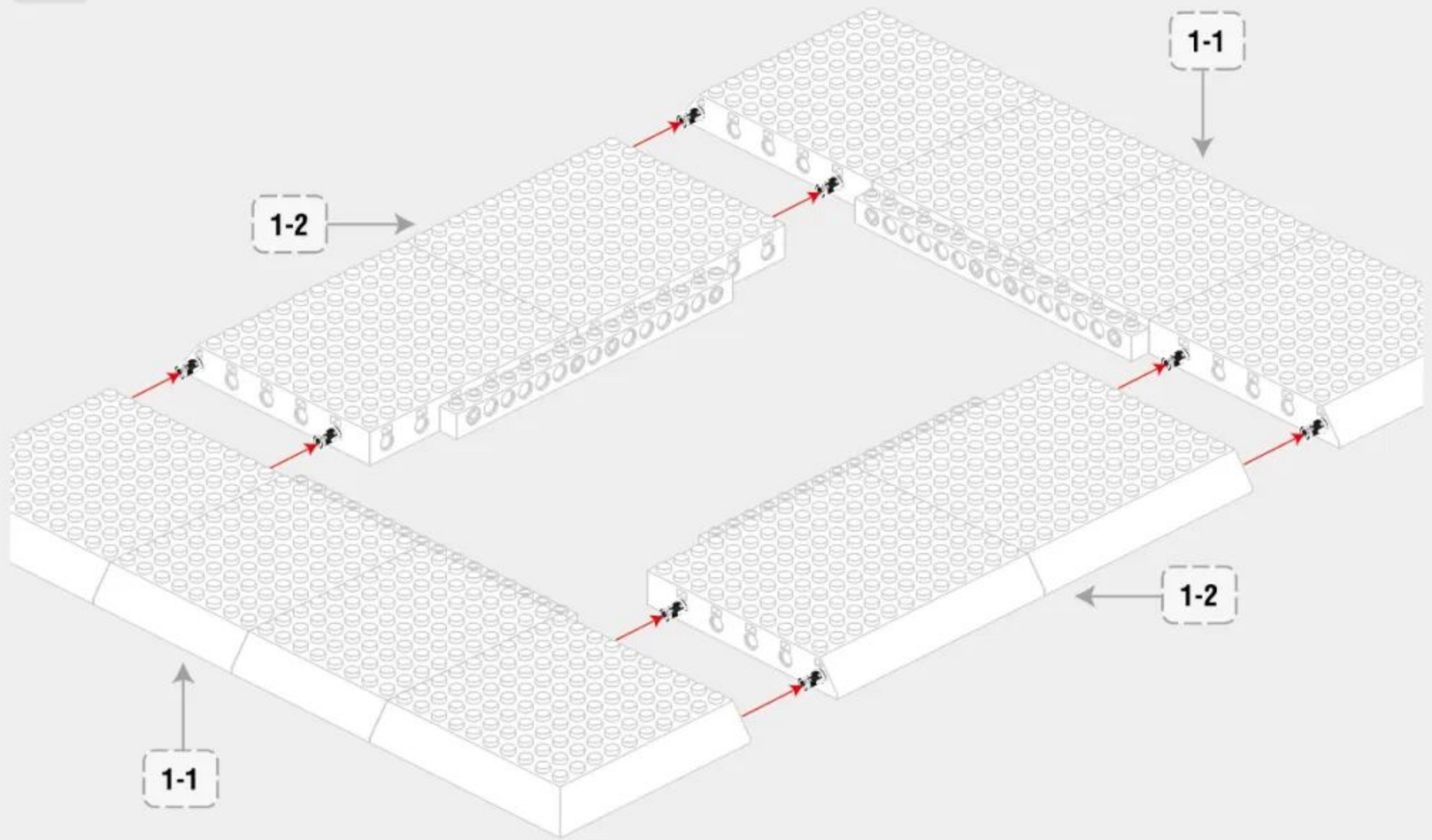

1-4

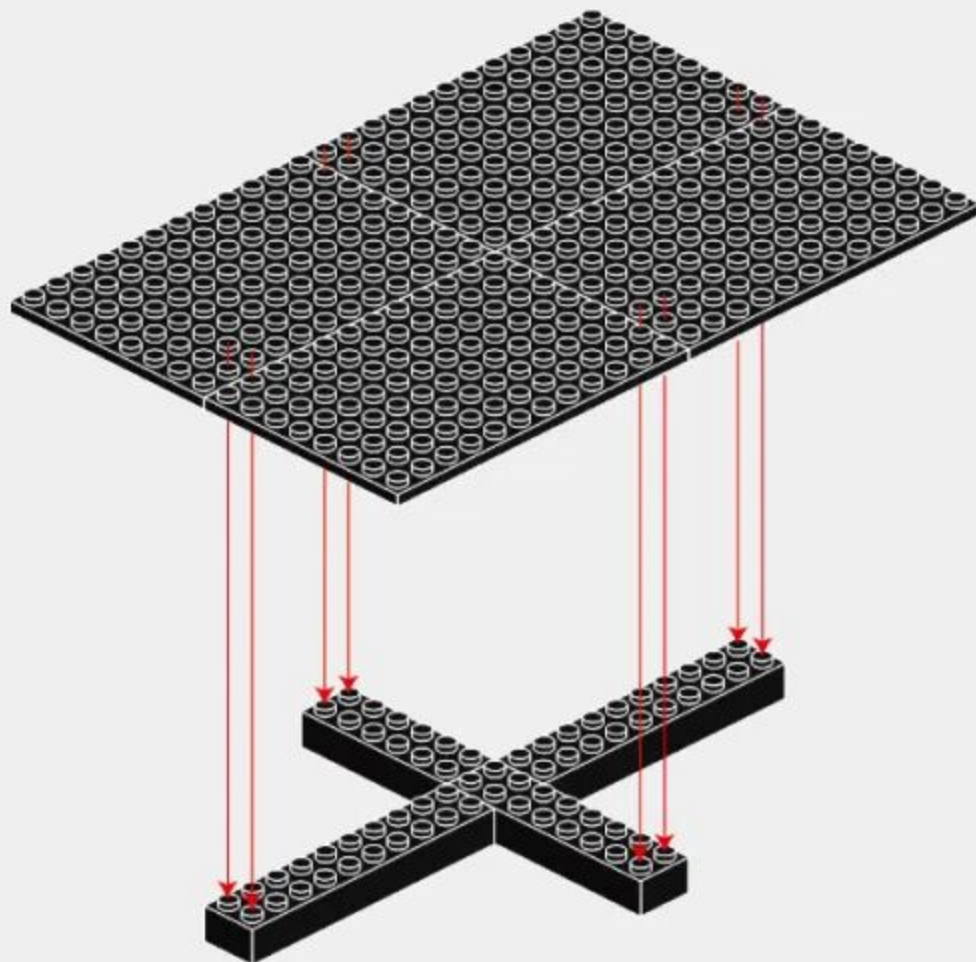
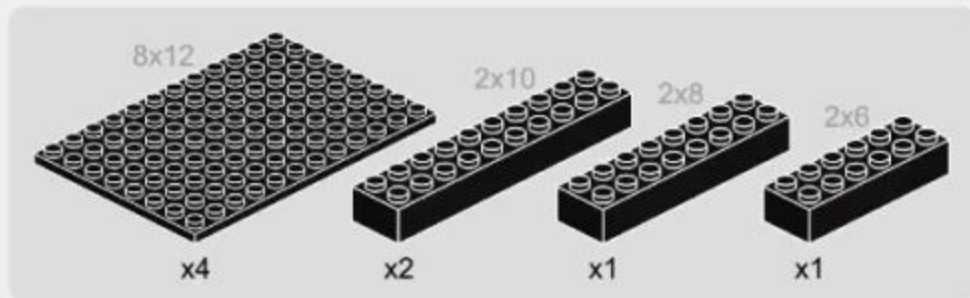

1-5

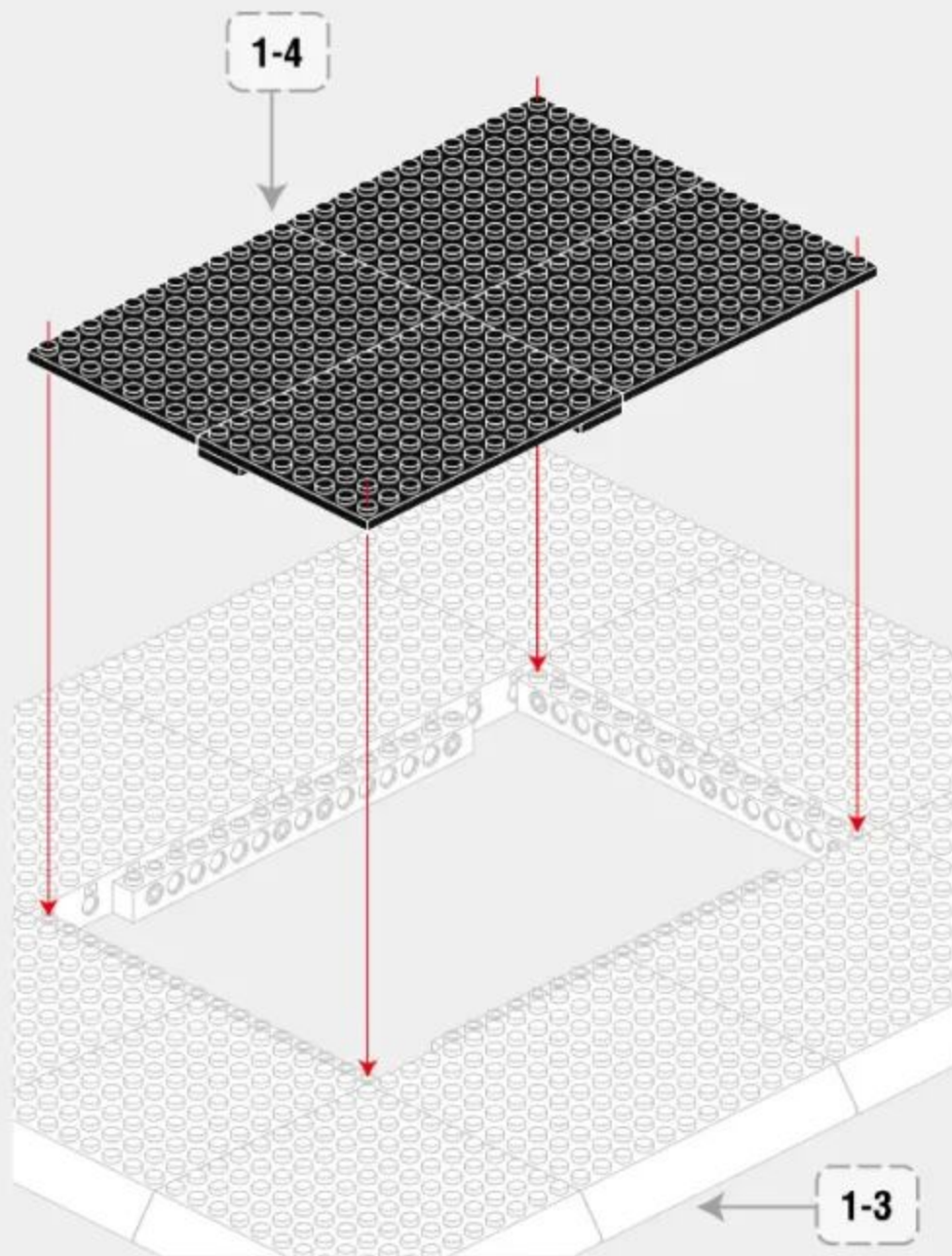



1-7

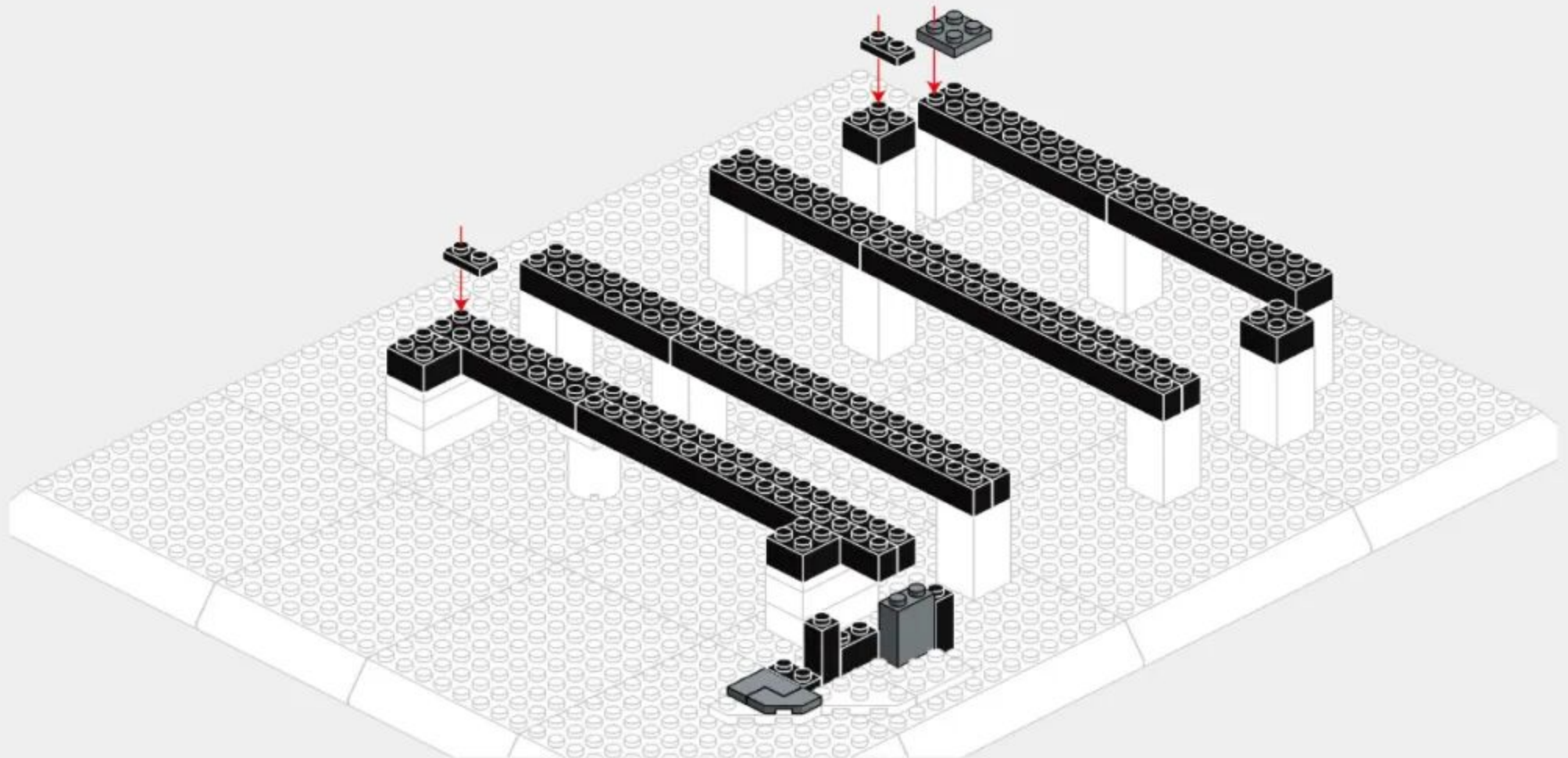
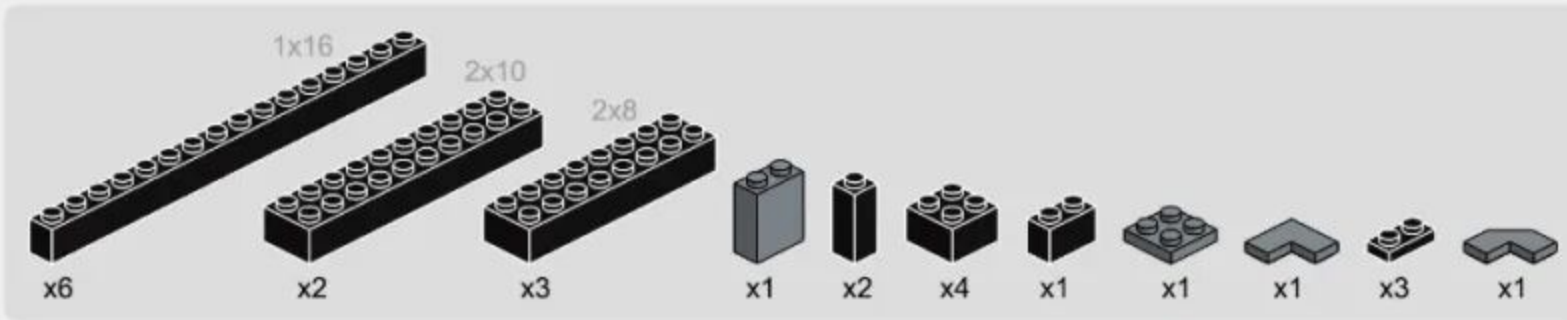

1-8

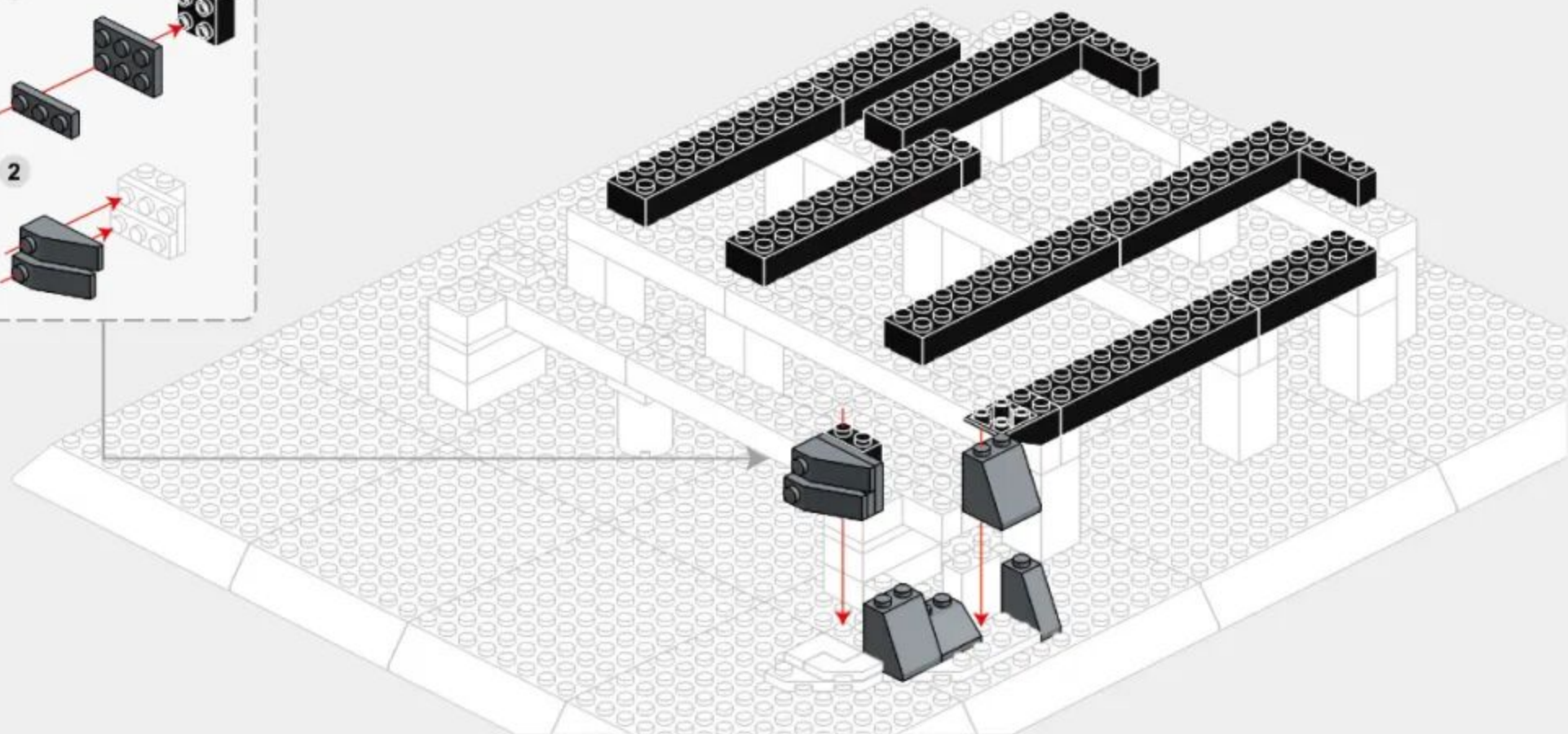
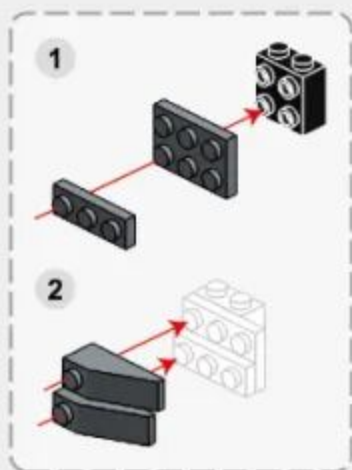
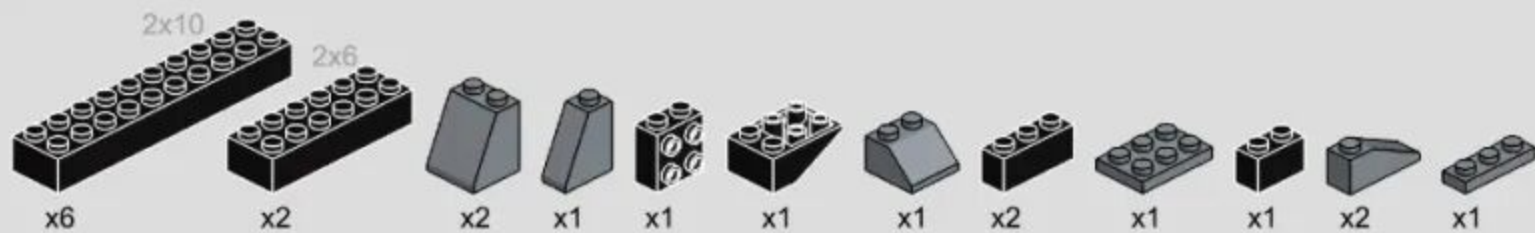

1-9

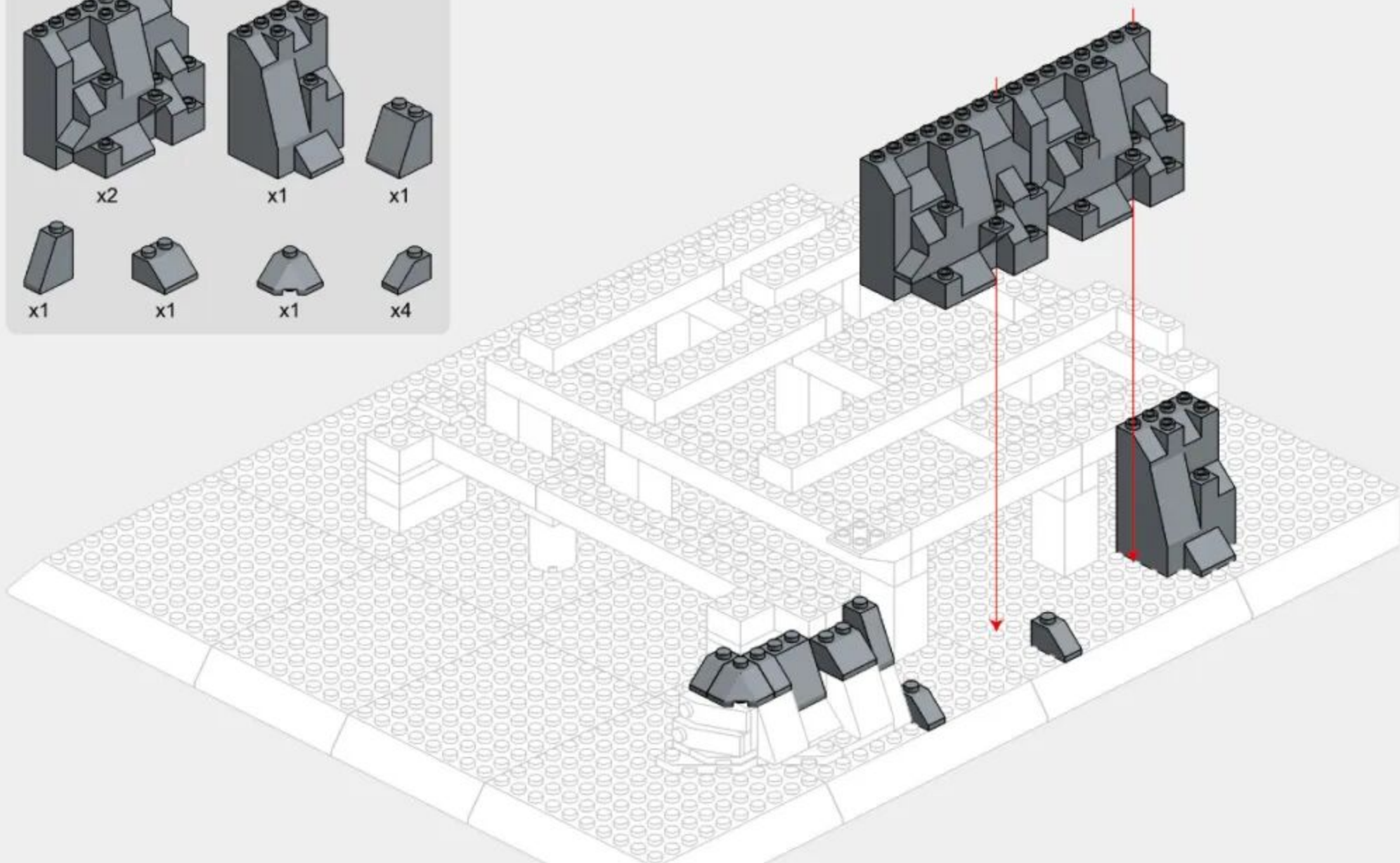
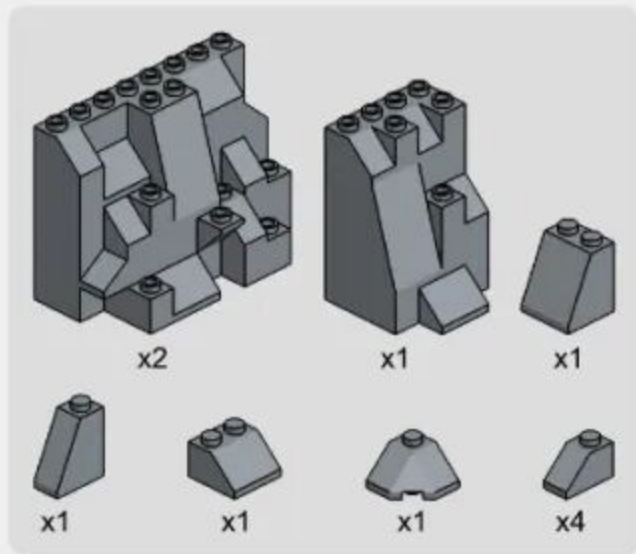

1-10

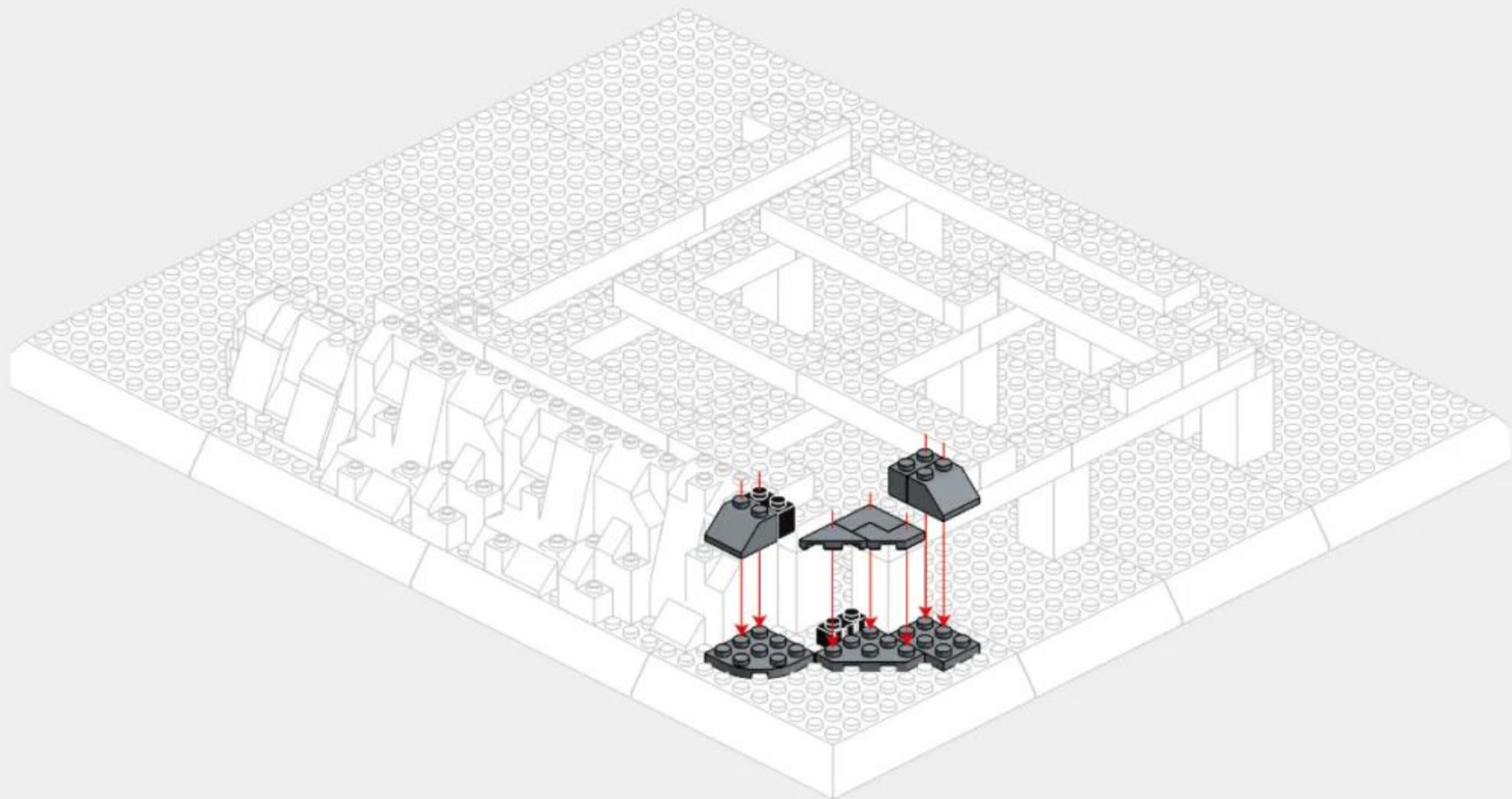
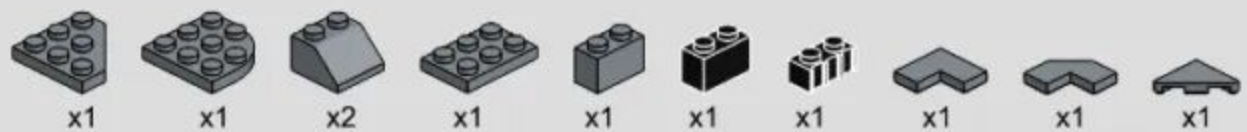

# 1-11

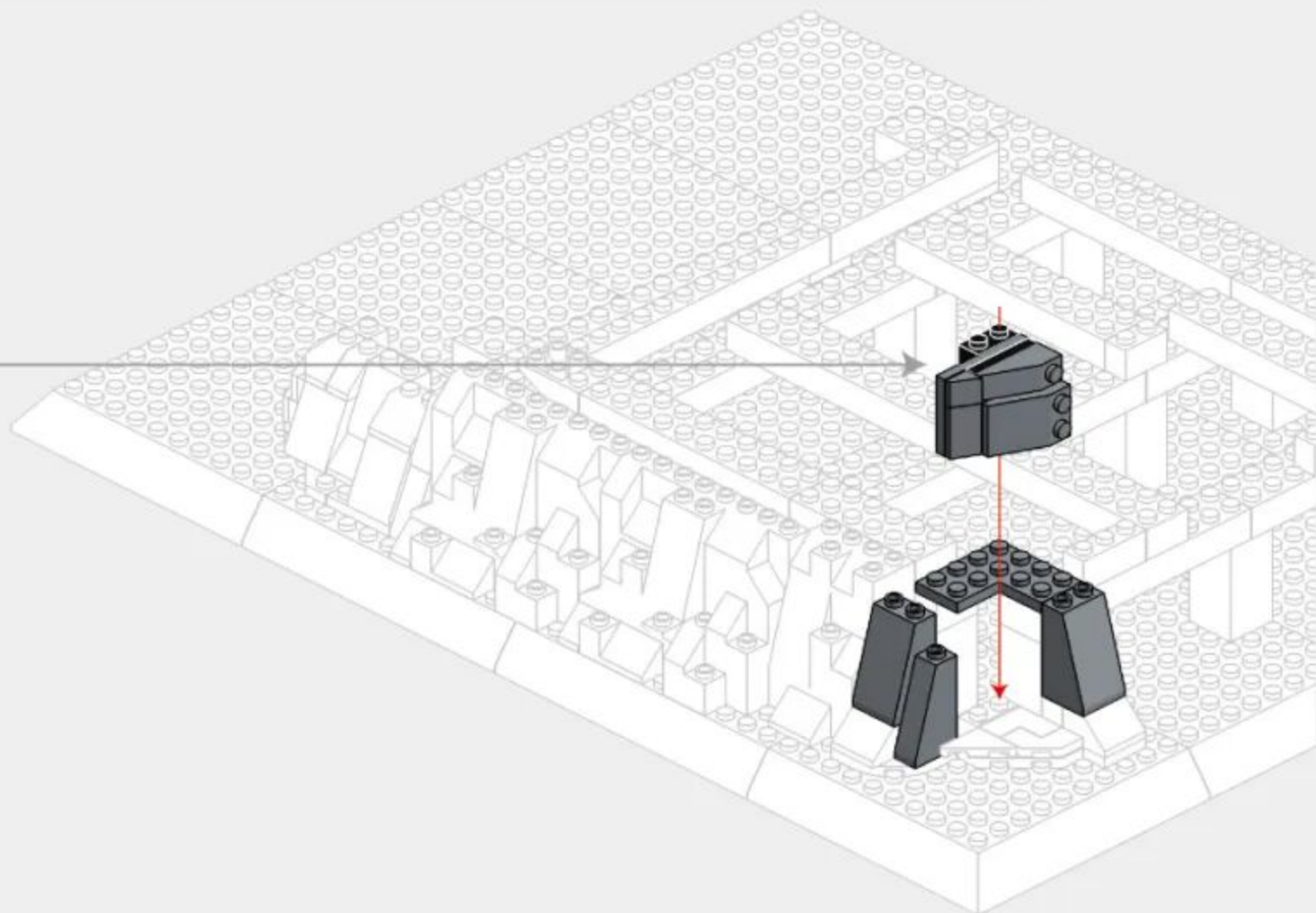
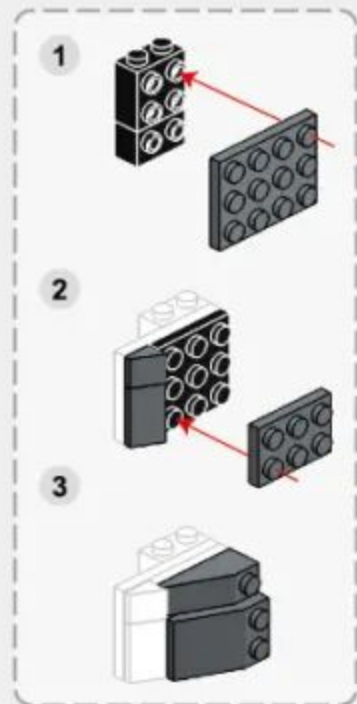
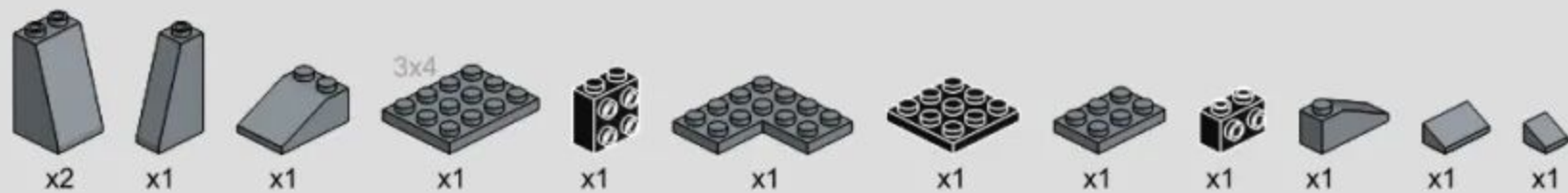

1-12

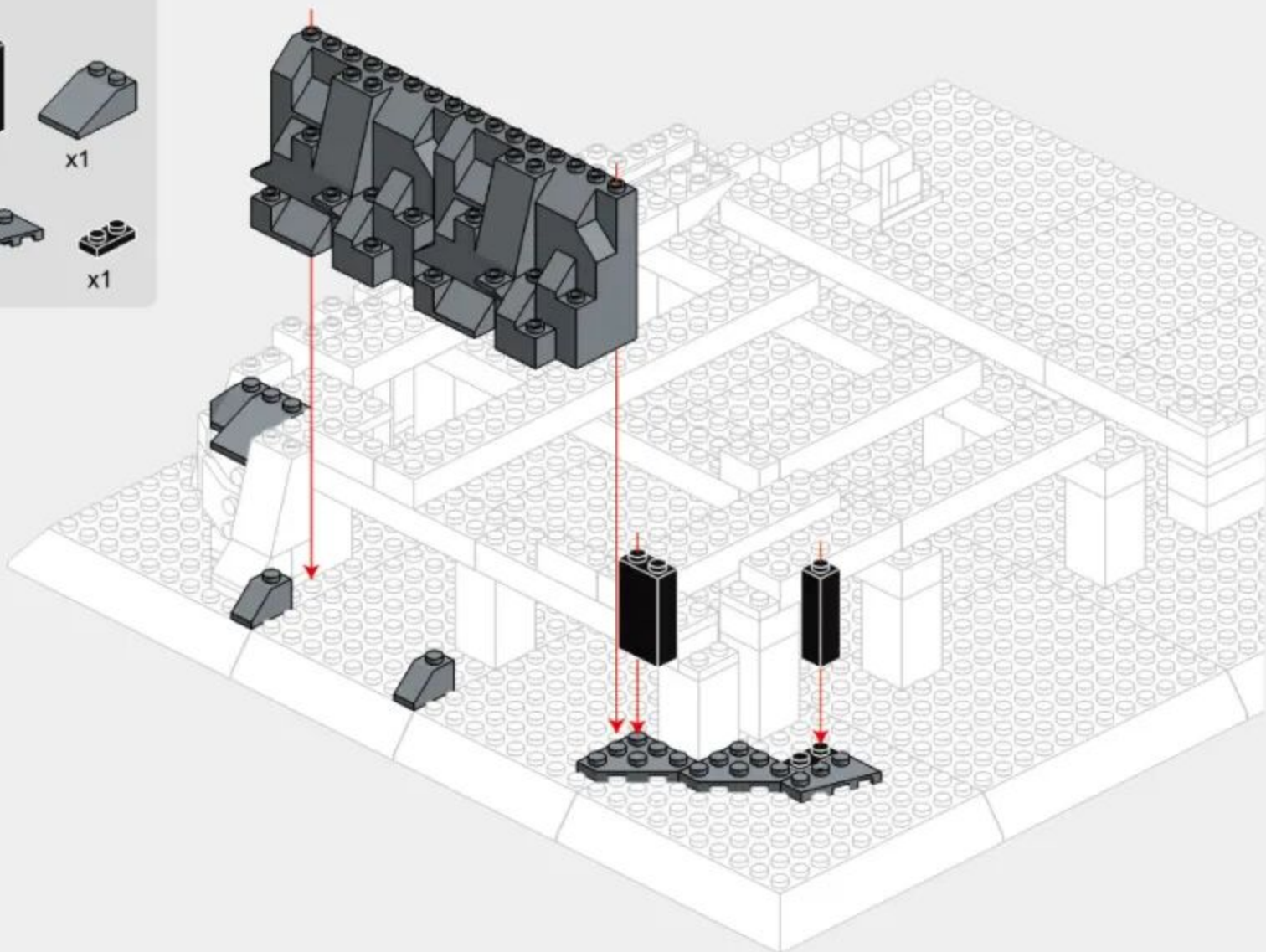
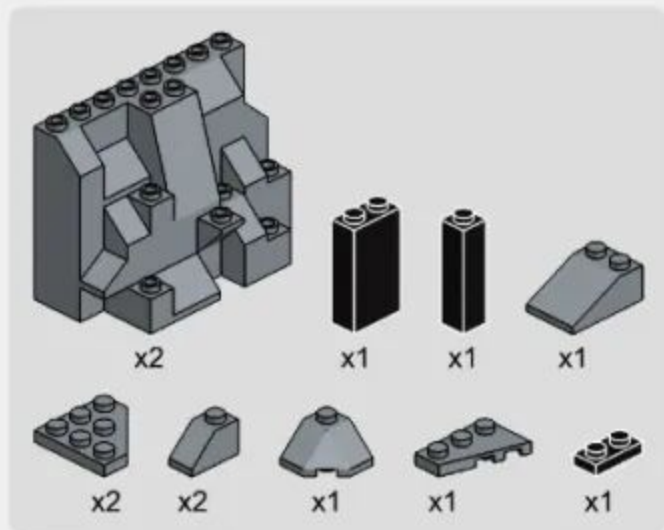

1-13

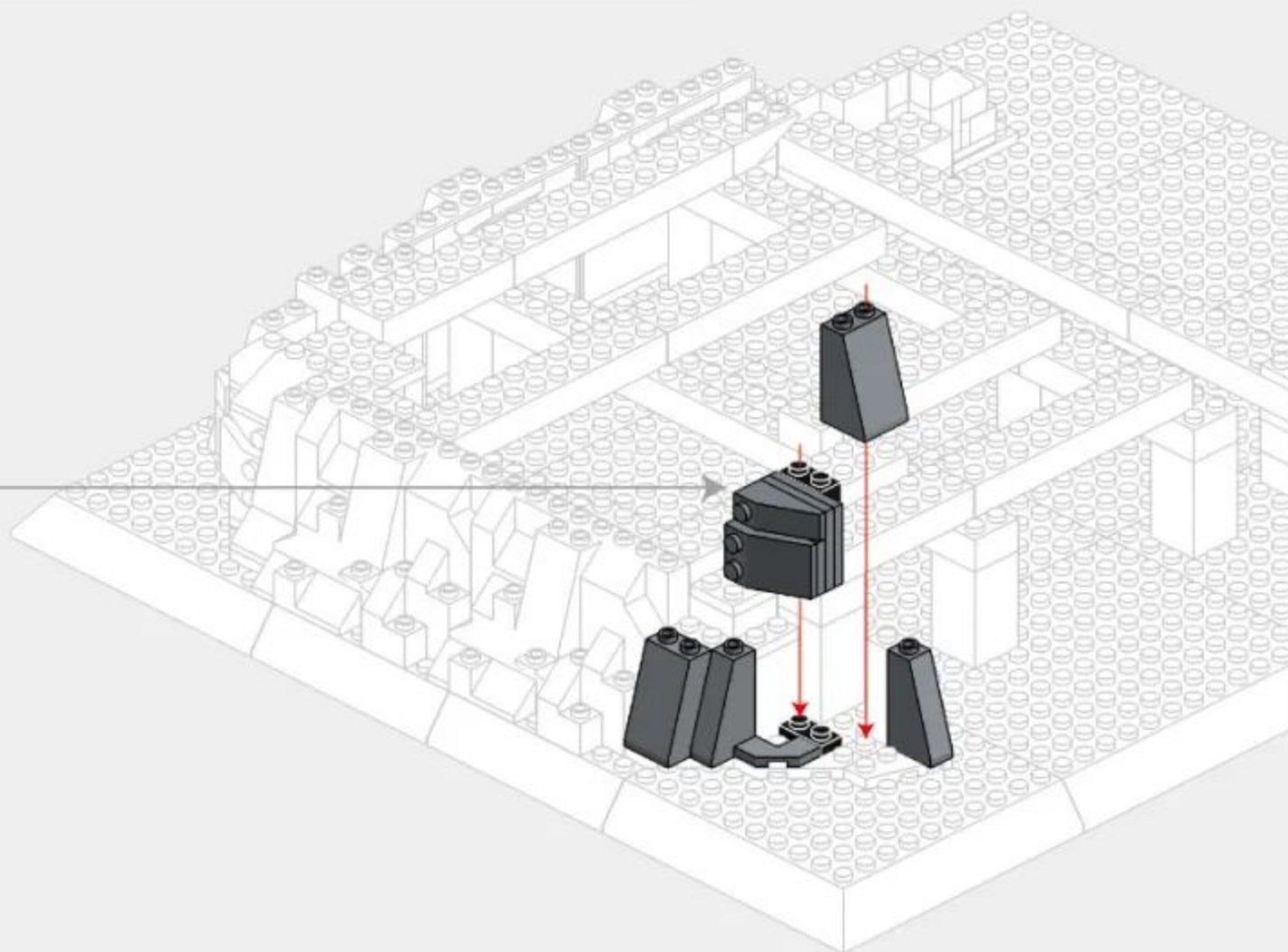
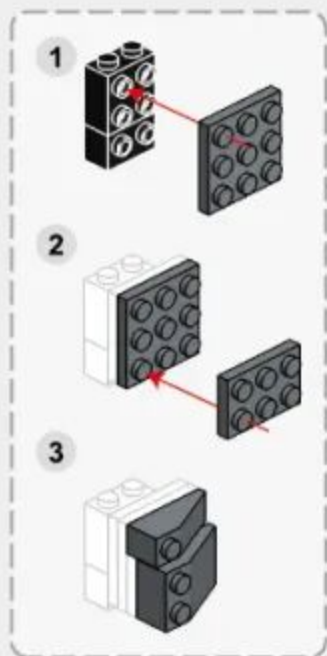
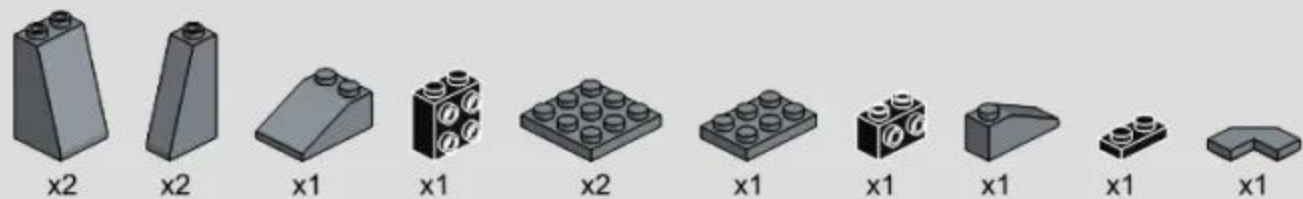

1-14

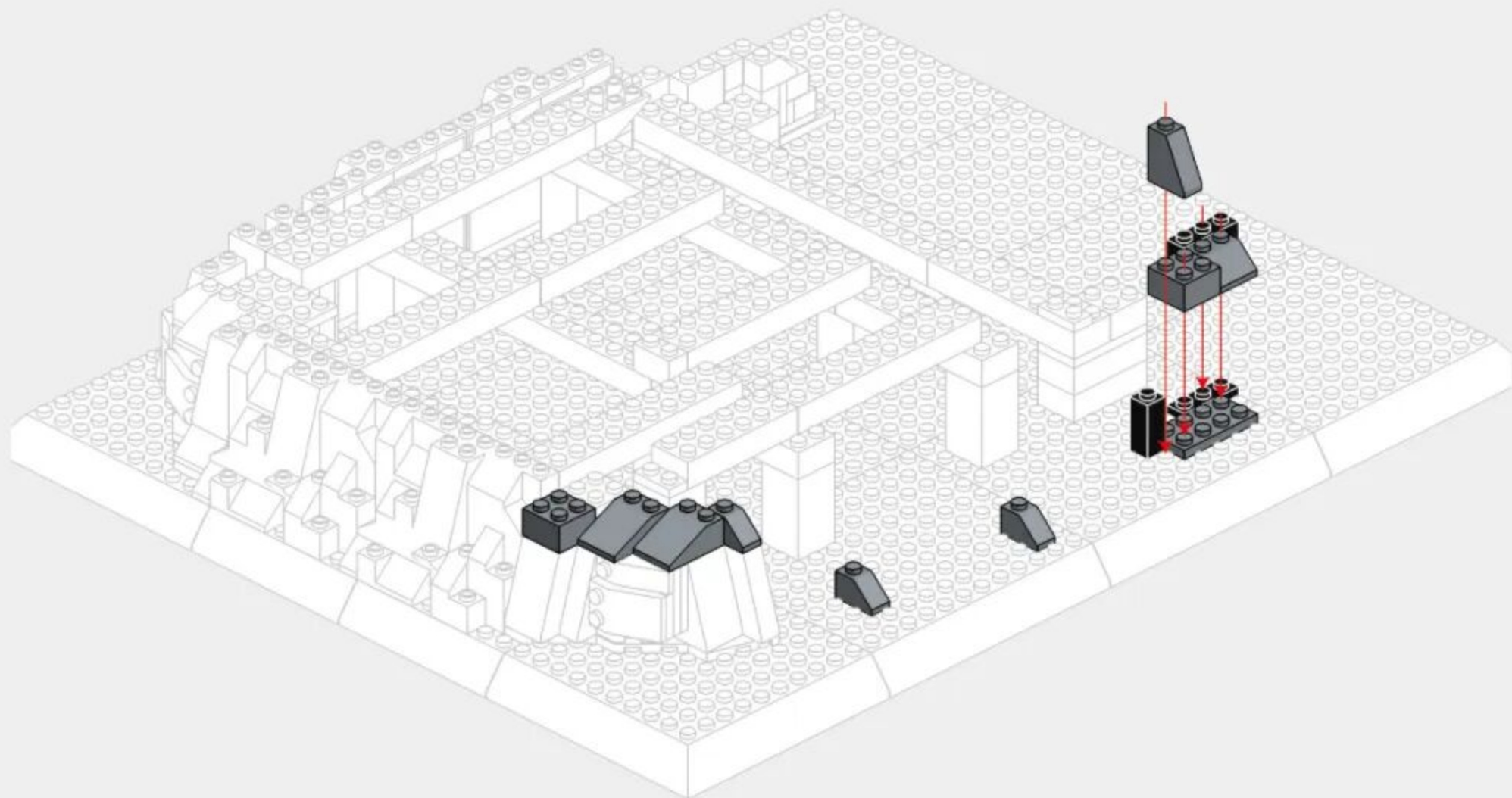
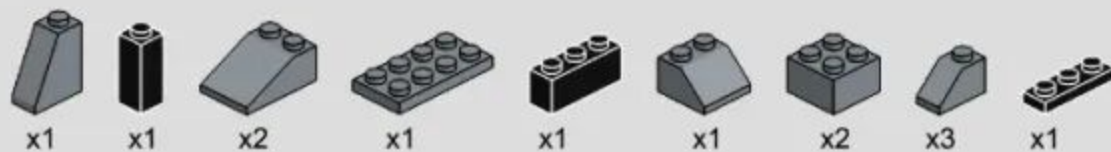

1-15

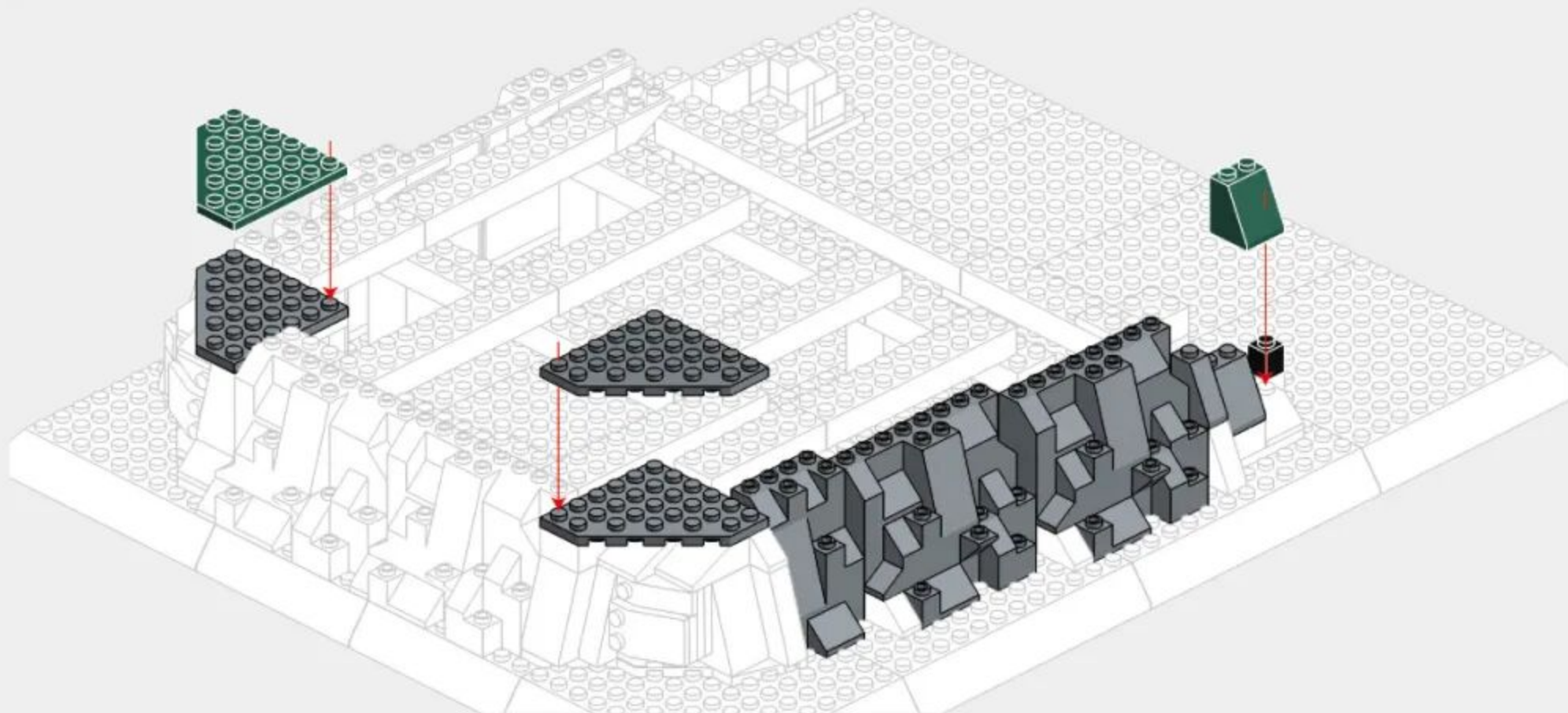
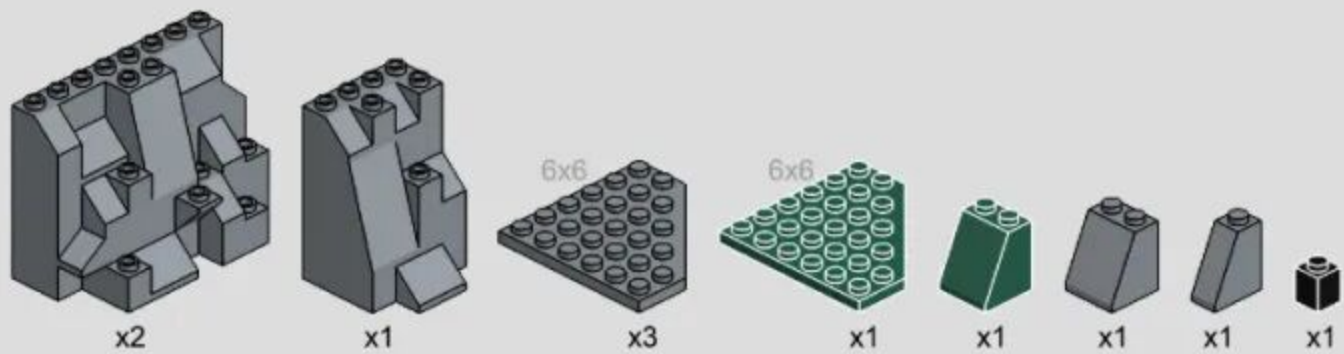



258PCS

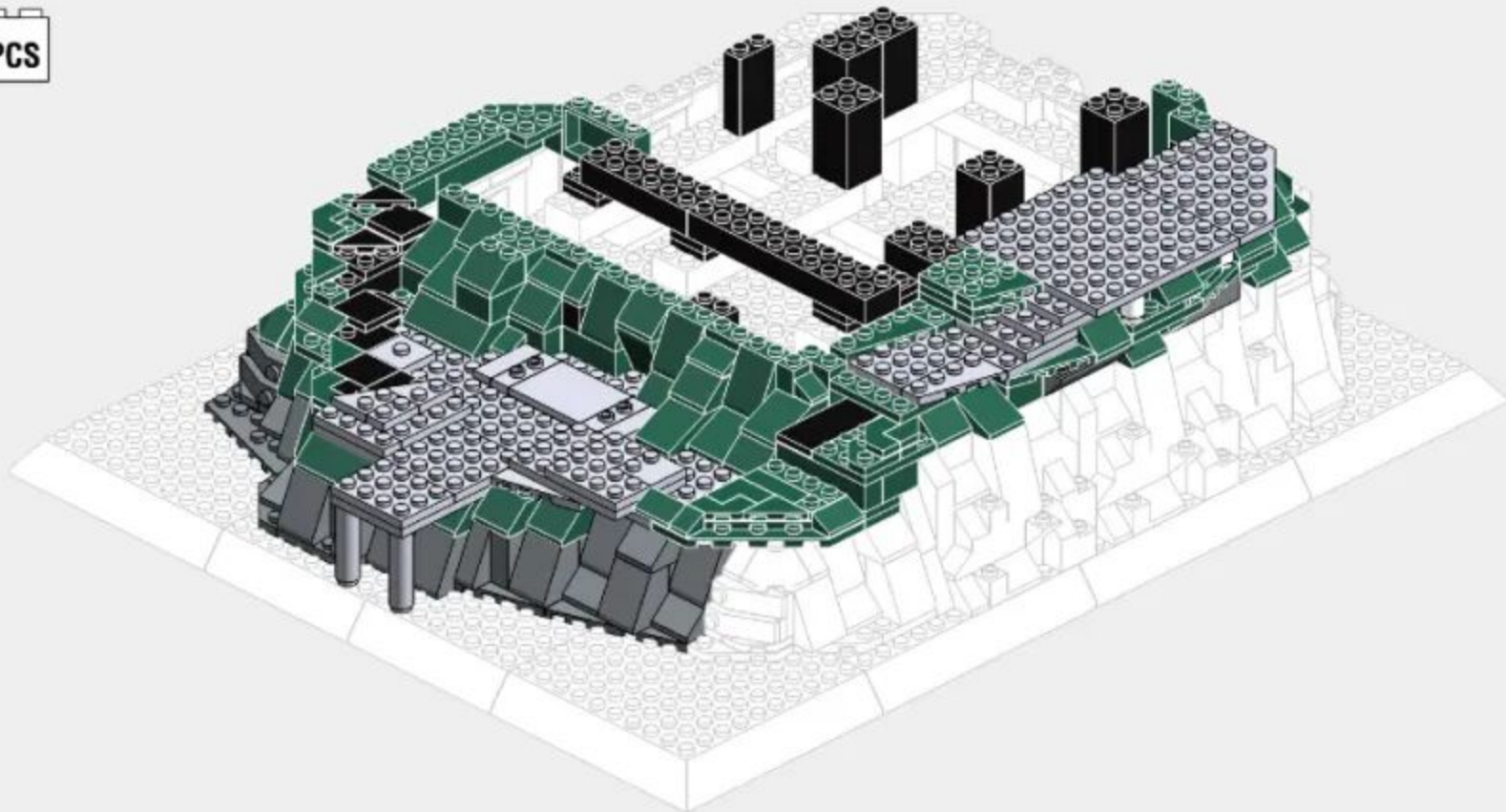

2-1

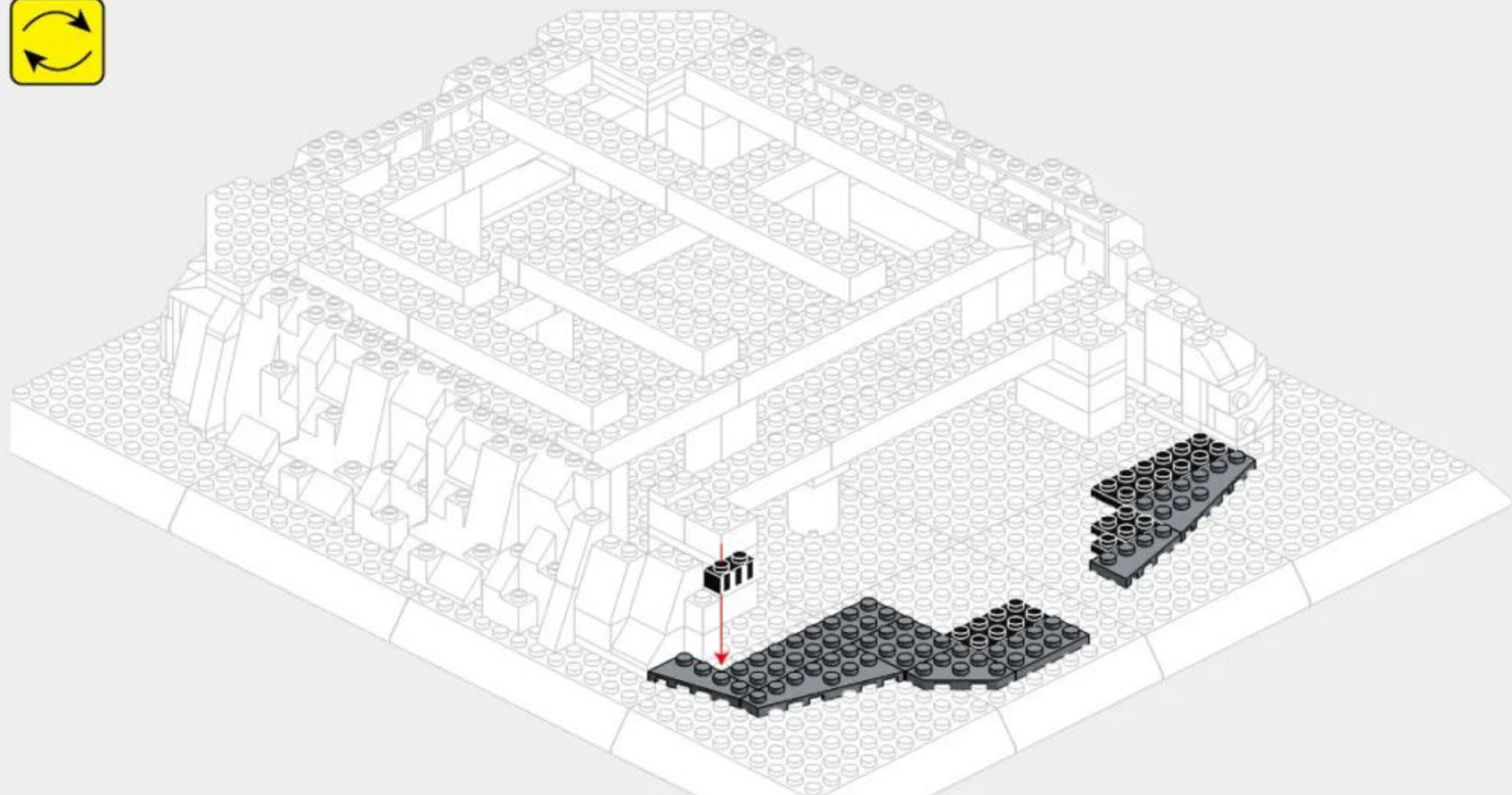
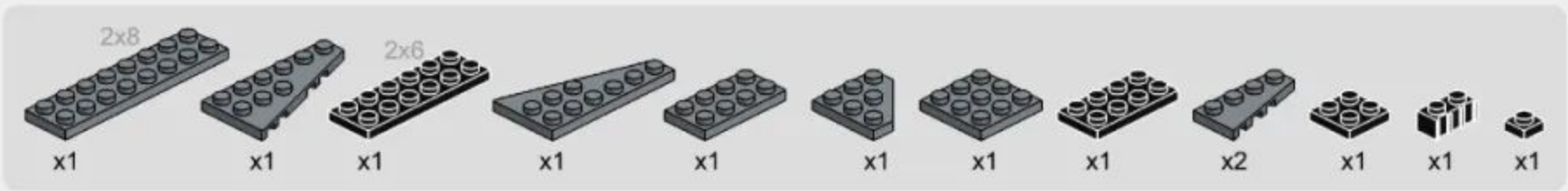

2-2



x2



x3



x1



x3



x1



x1

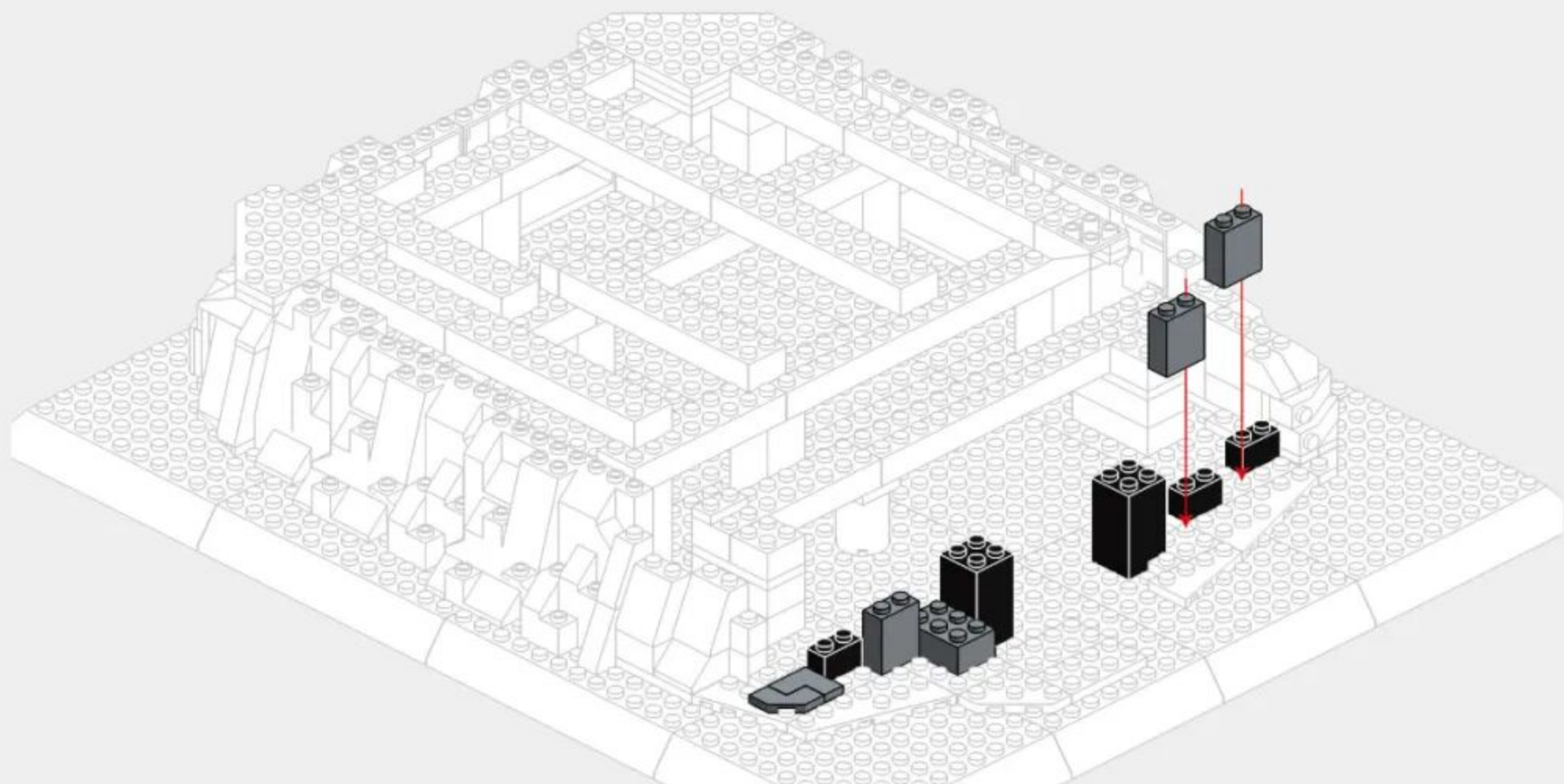

2-3

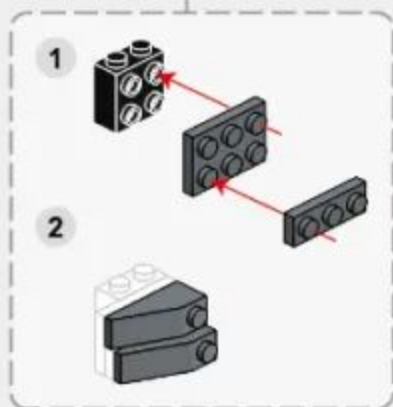
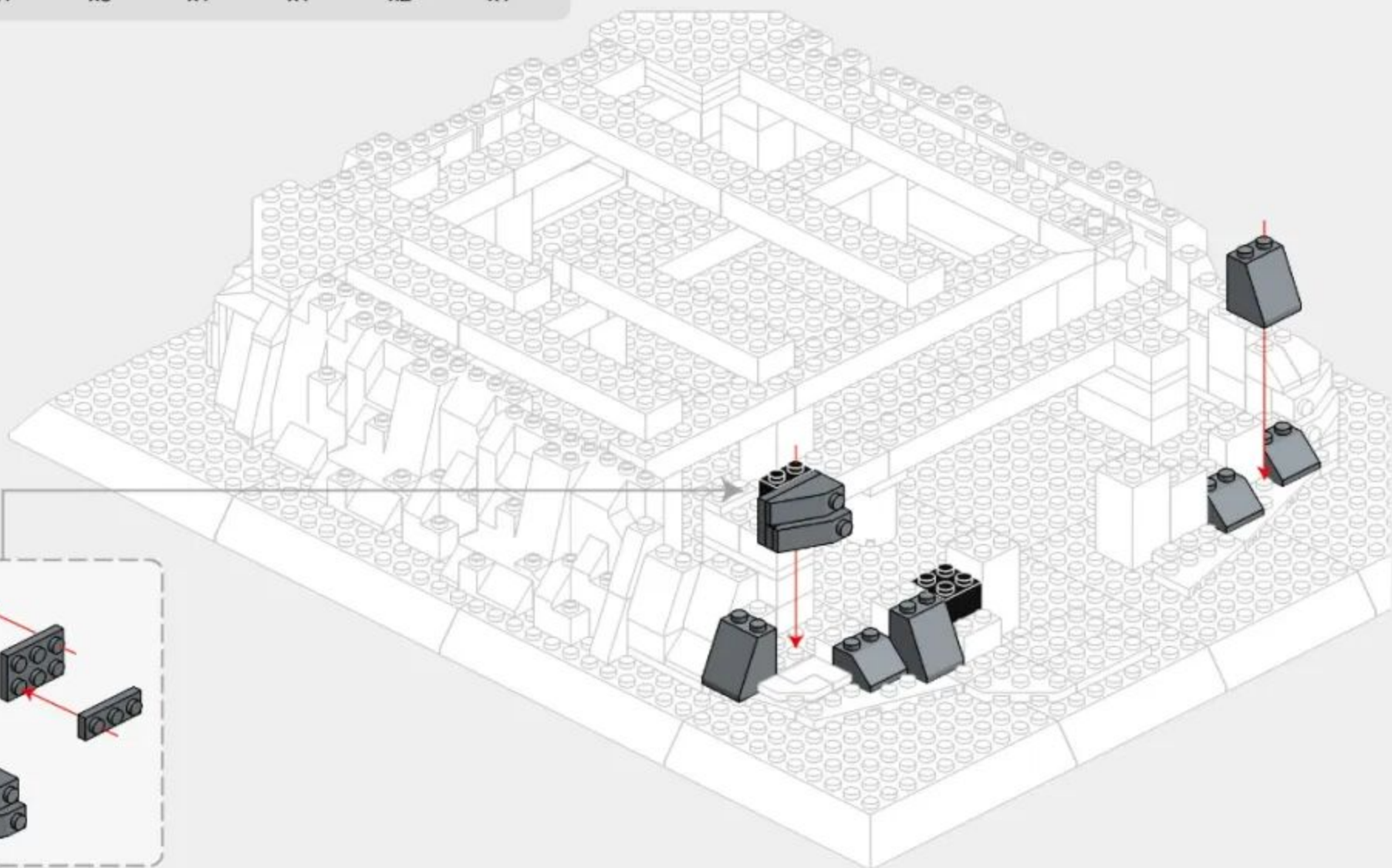
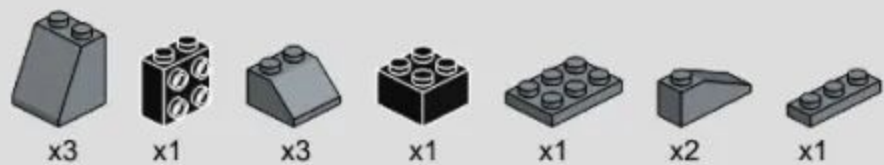

2-4



x1



x3



x1



x1

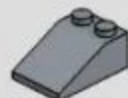

x1



x1



x1

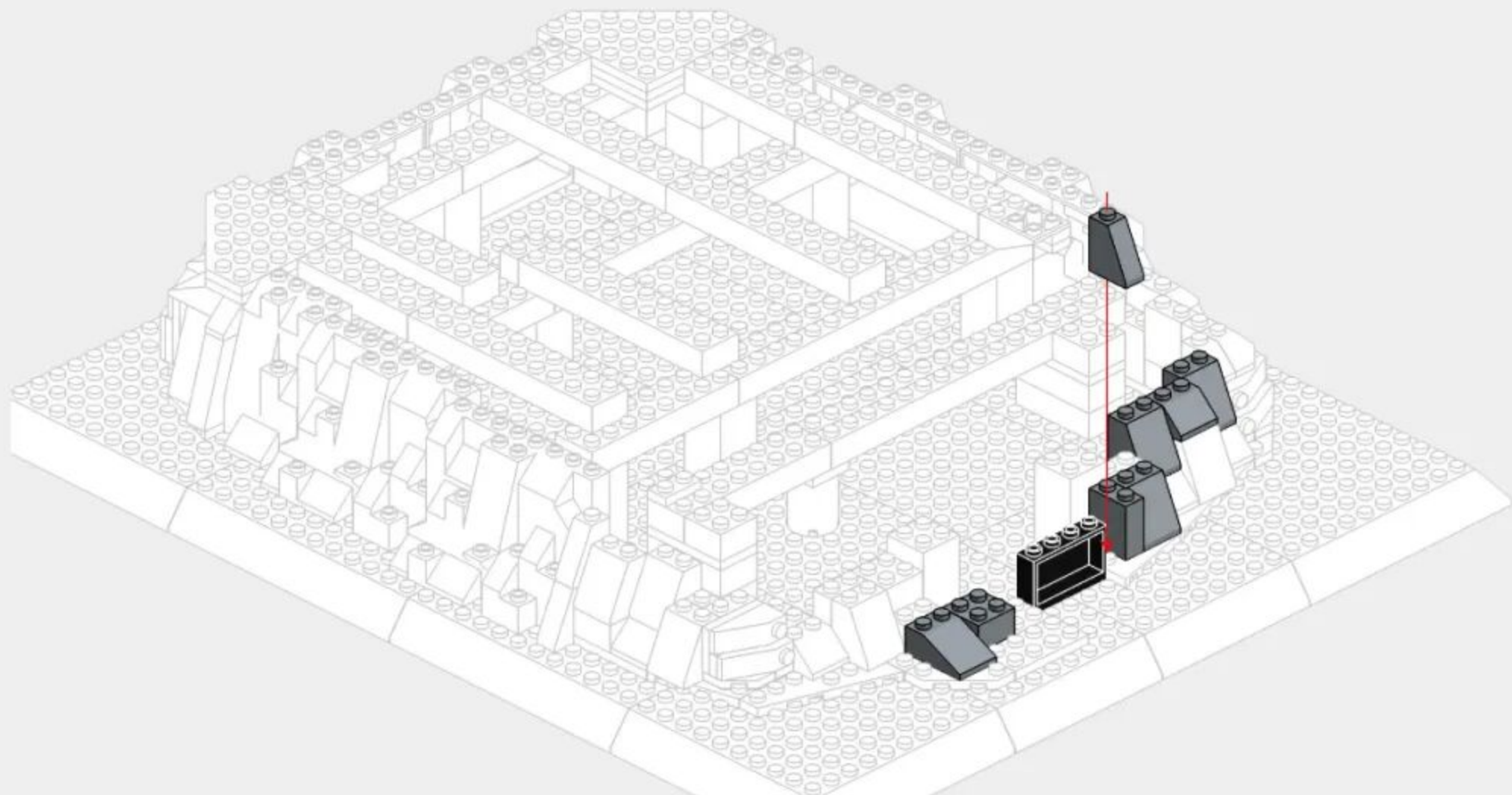

2-5

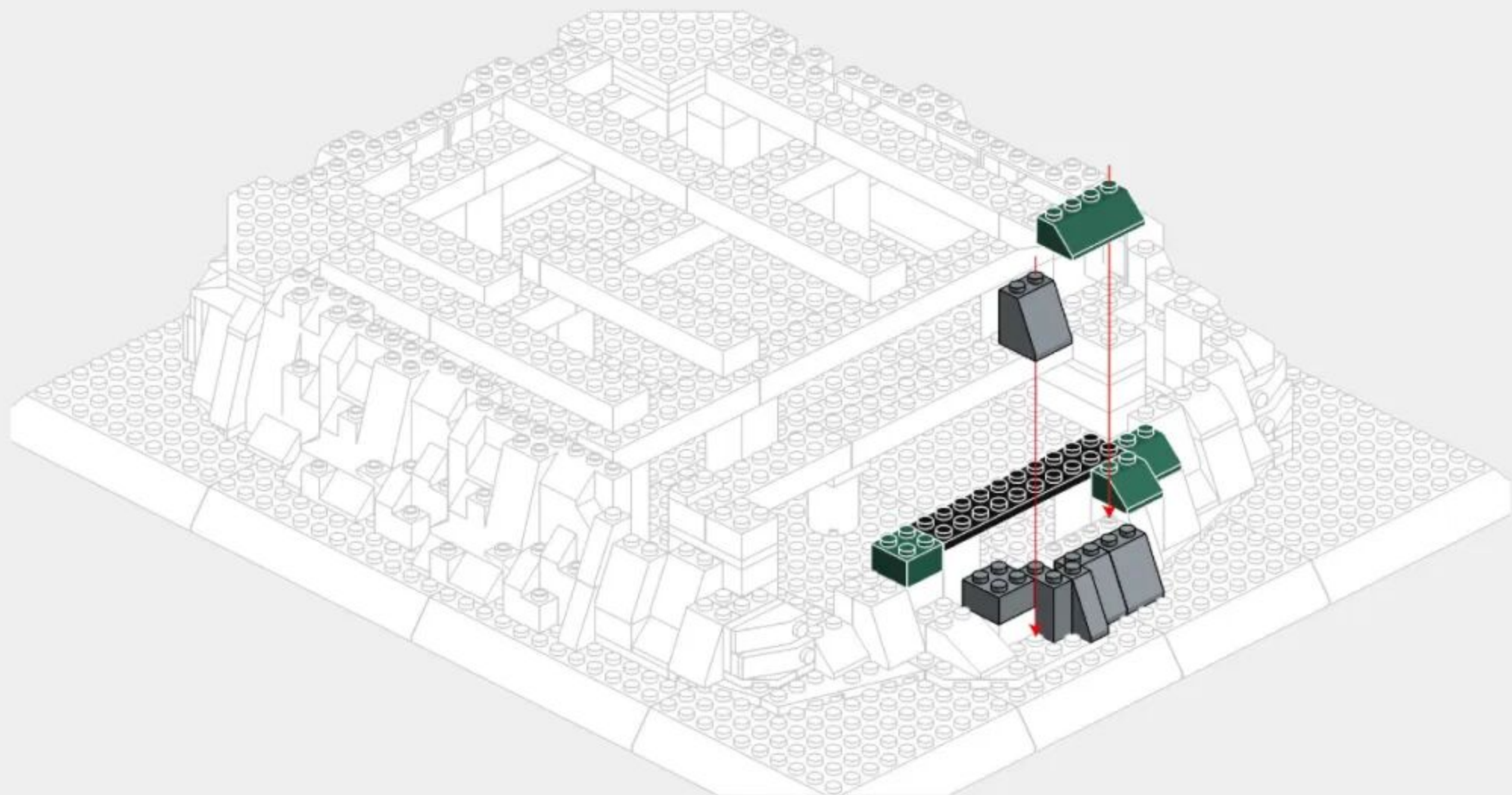
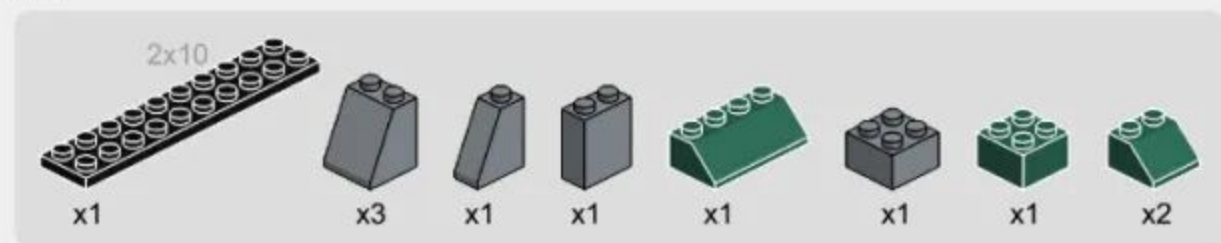

2-6

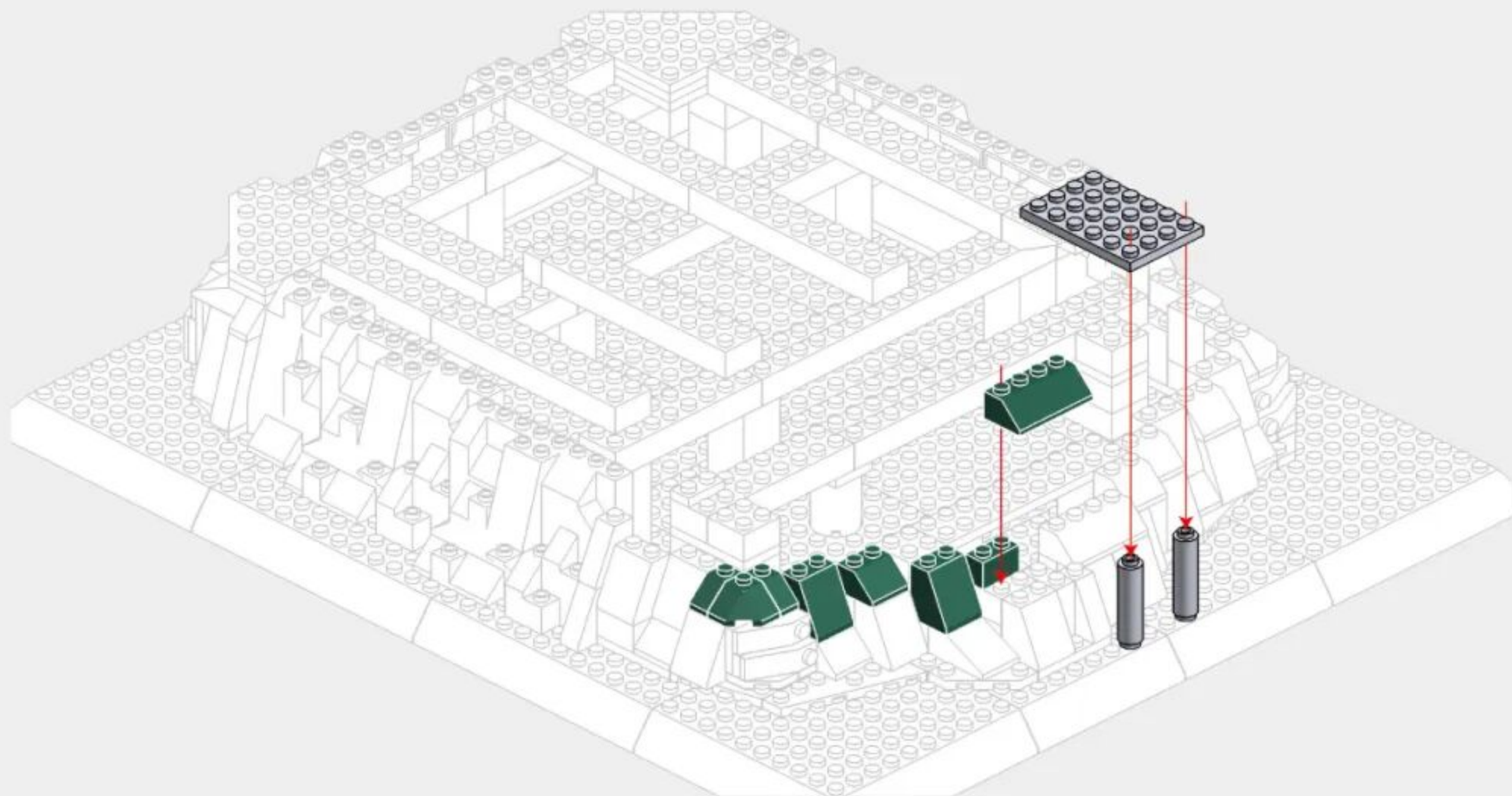

2-7

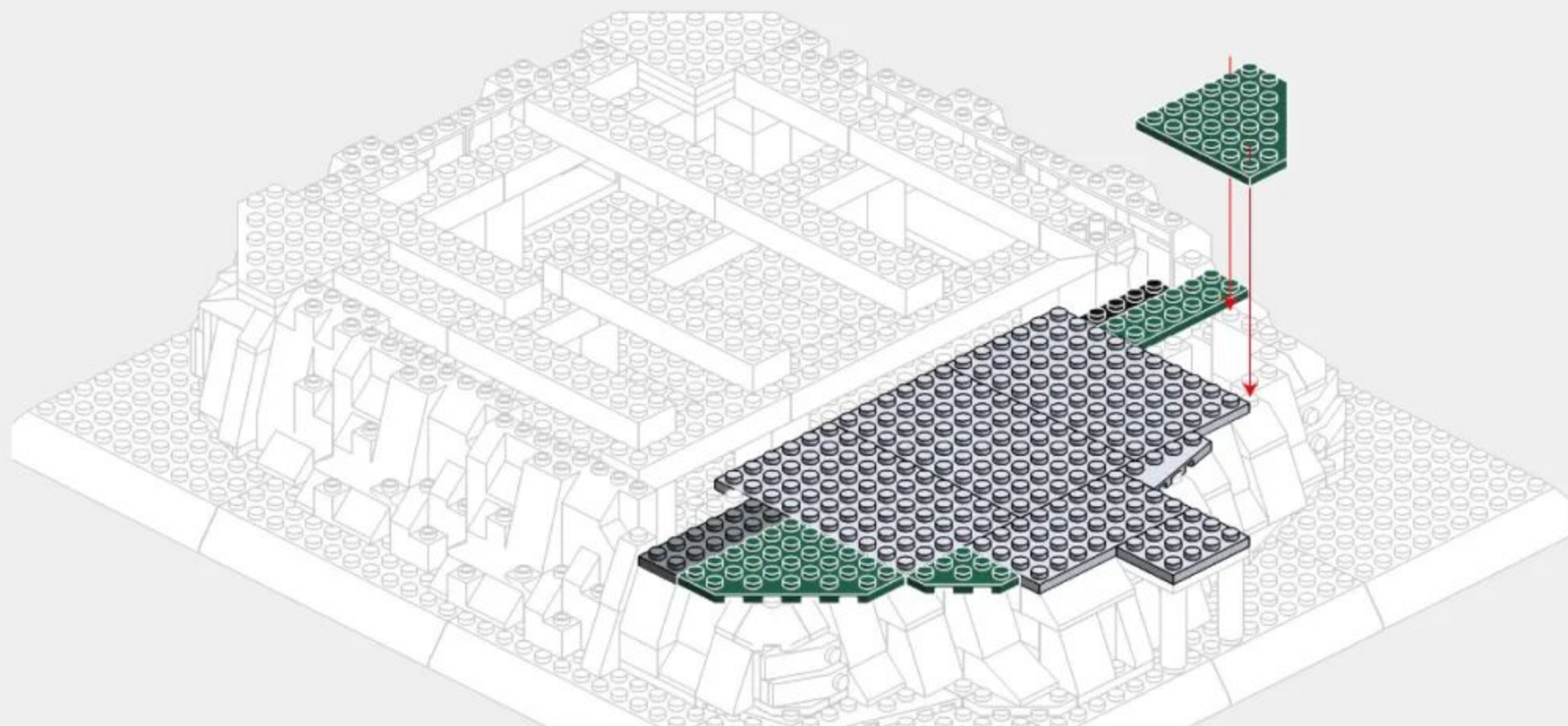
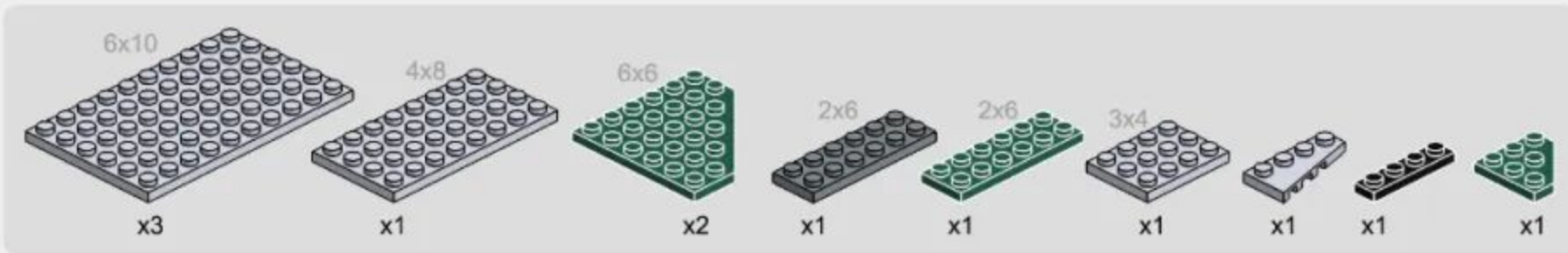

2-8

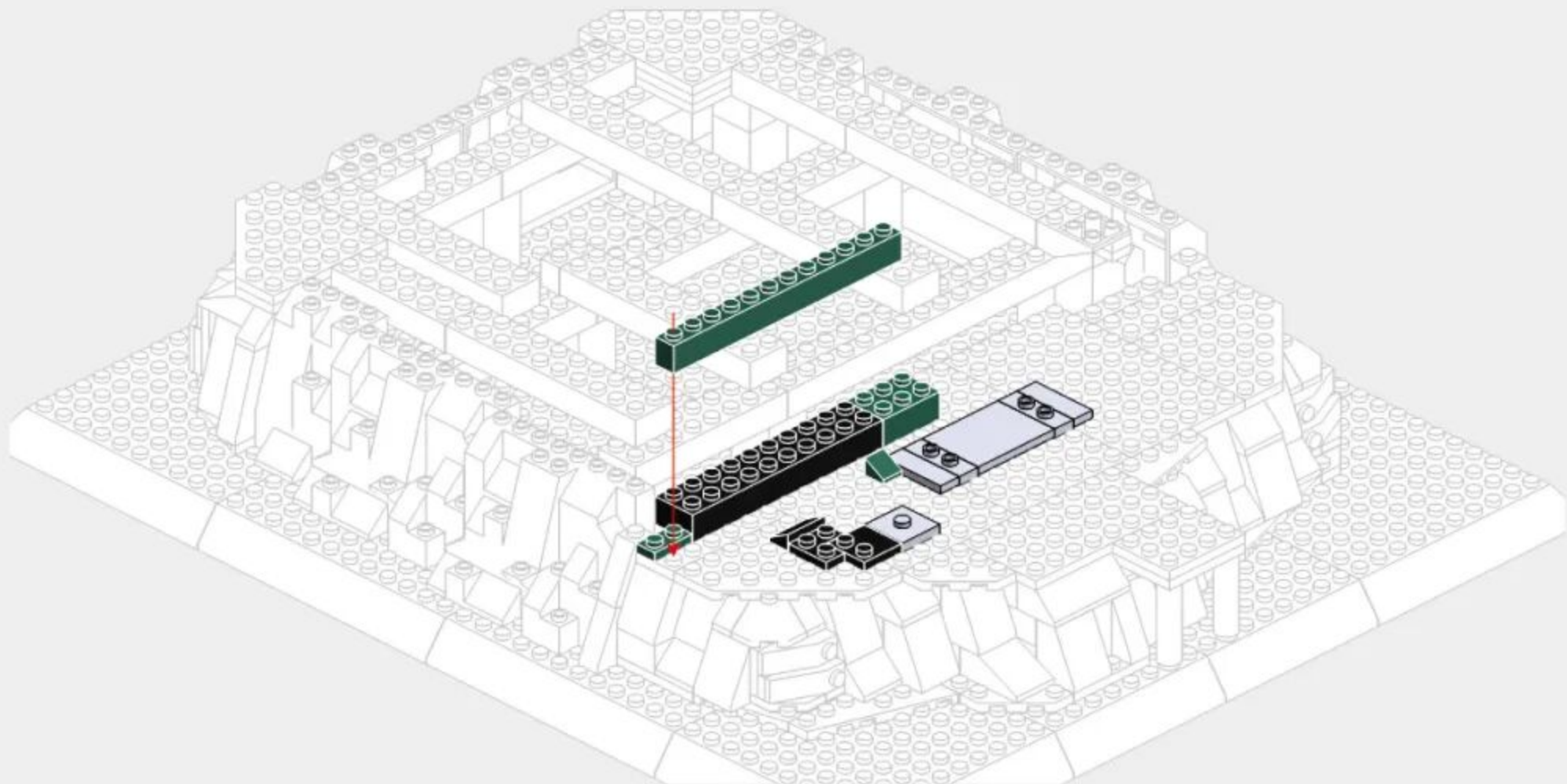
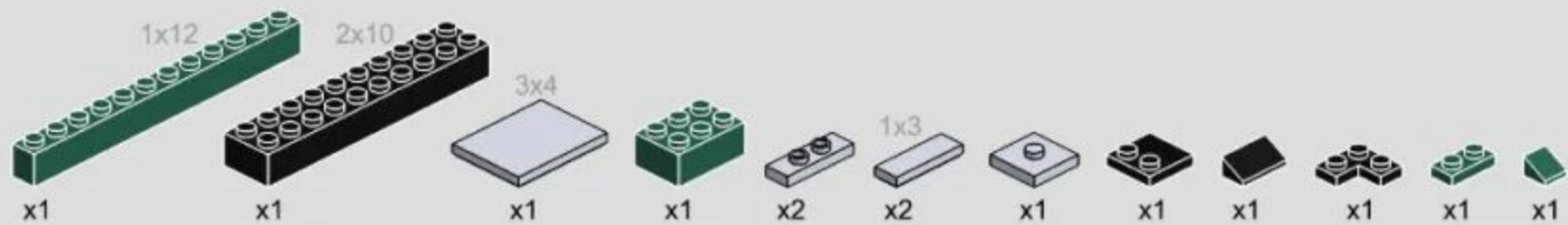

2-9

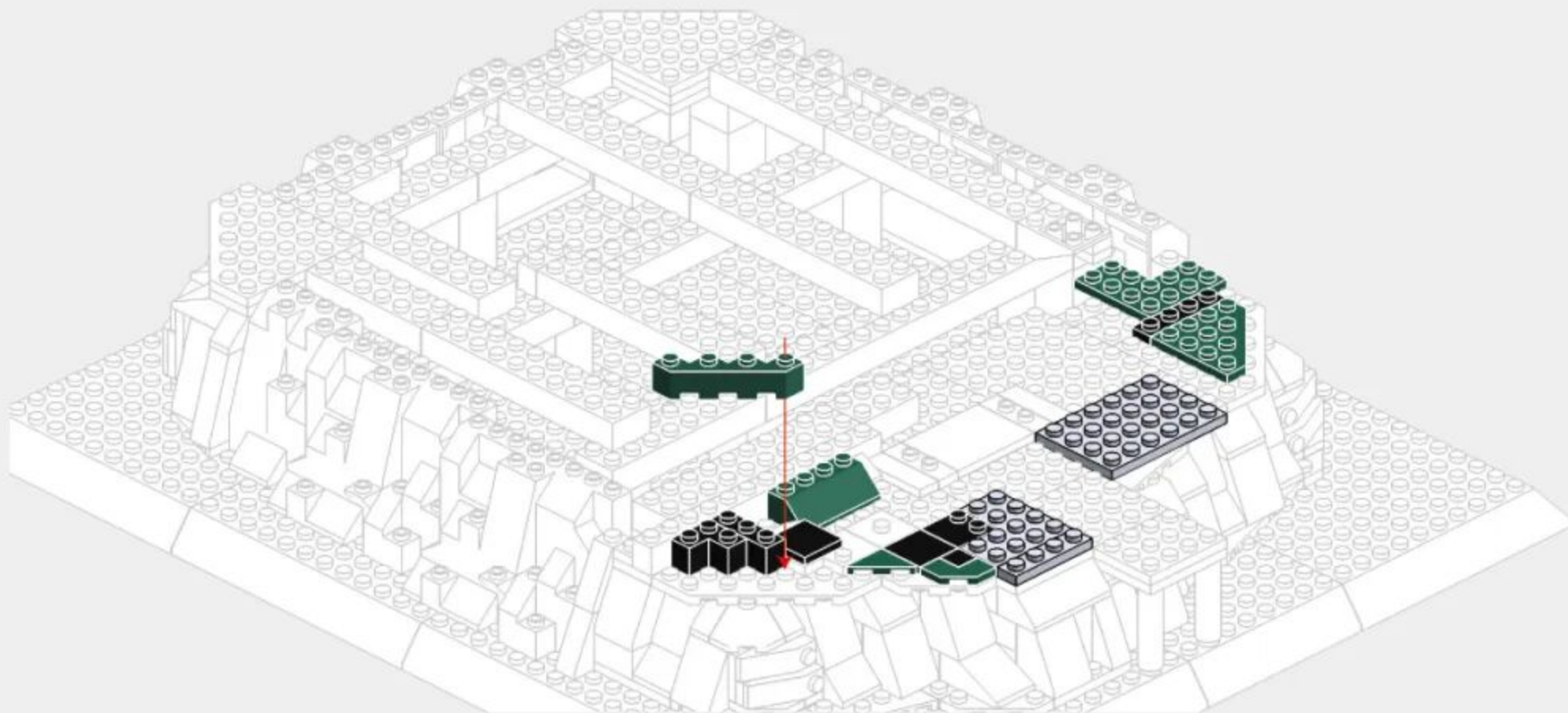
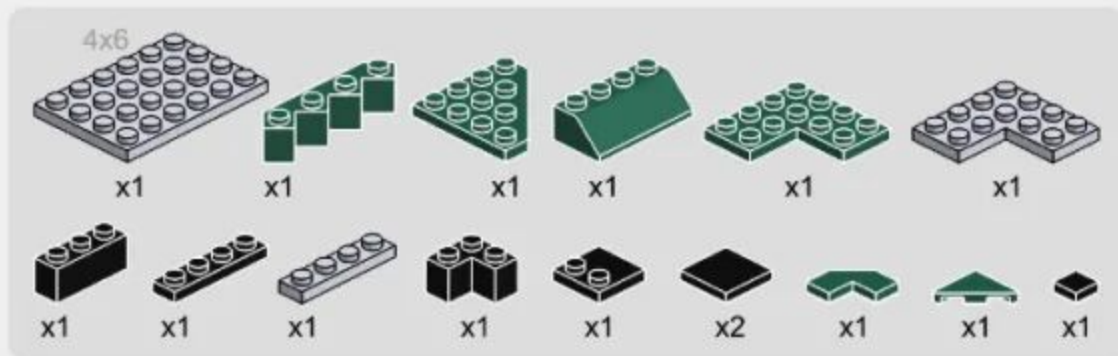

# 2-10

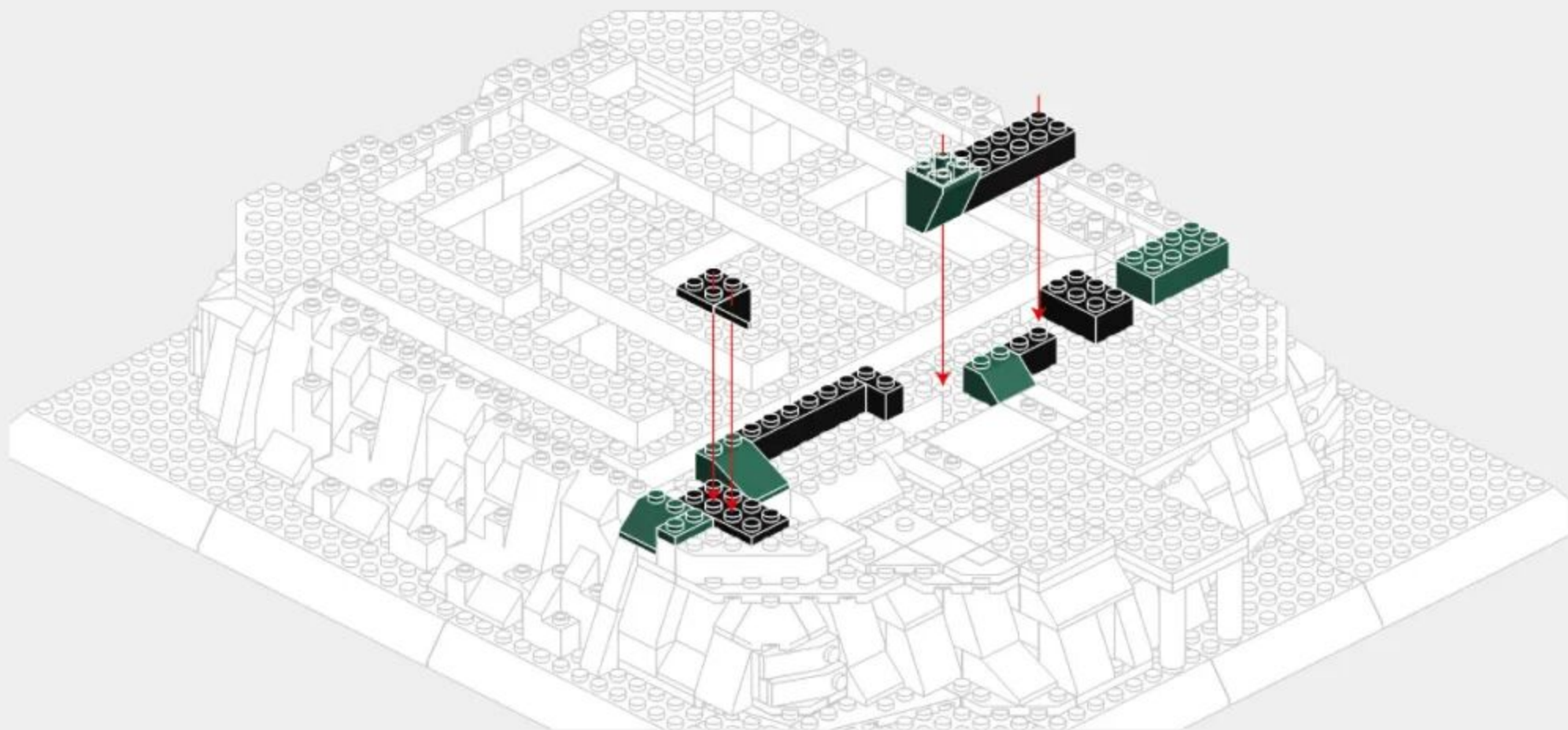
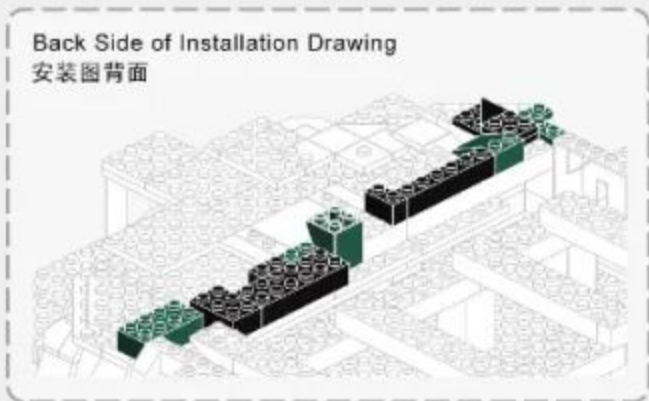
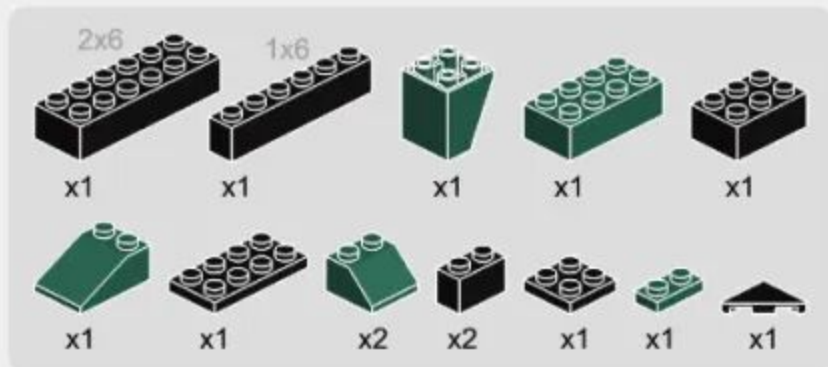





2-13

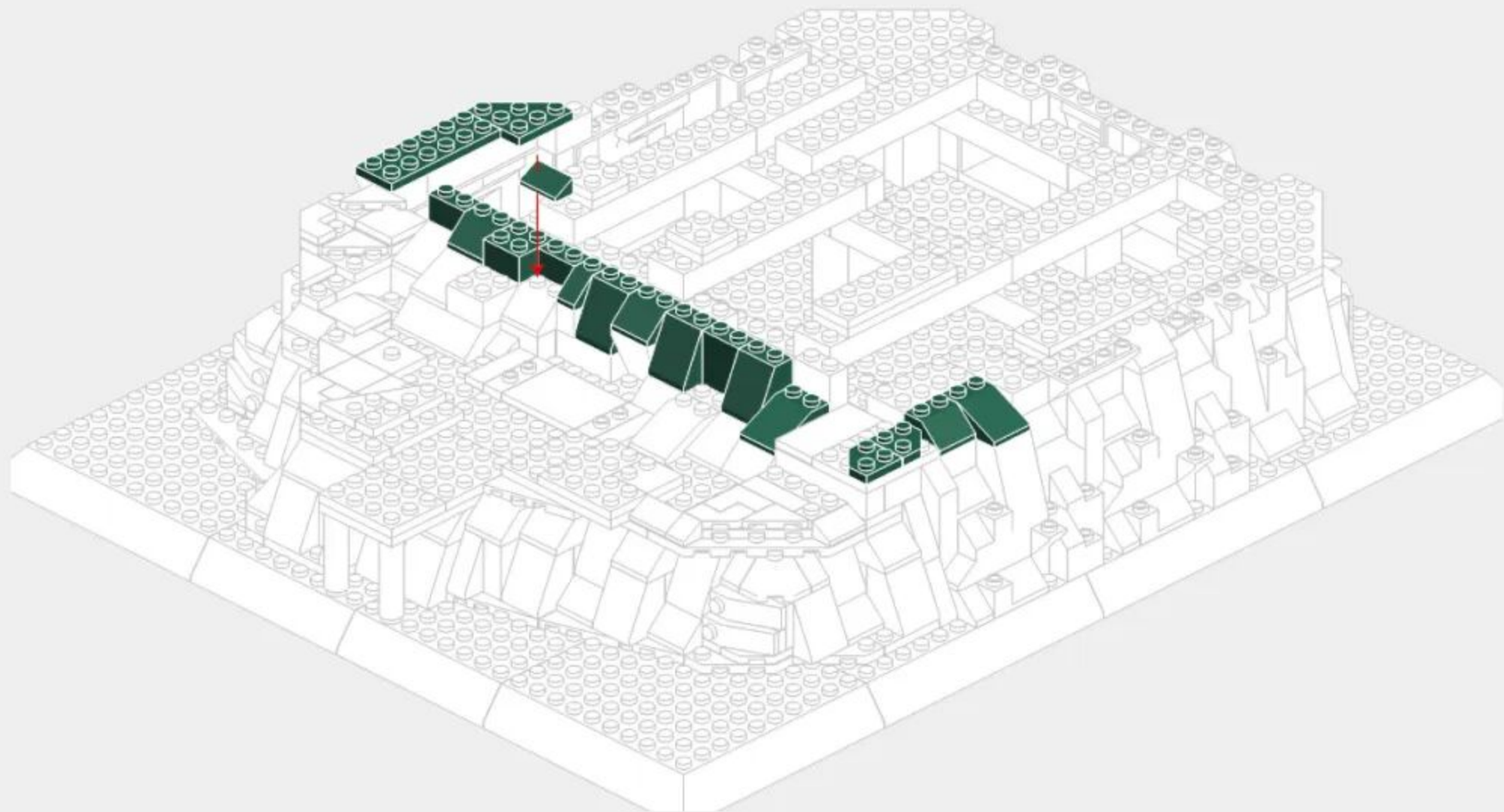

# 2-14

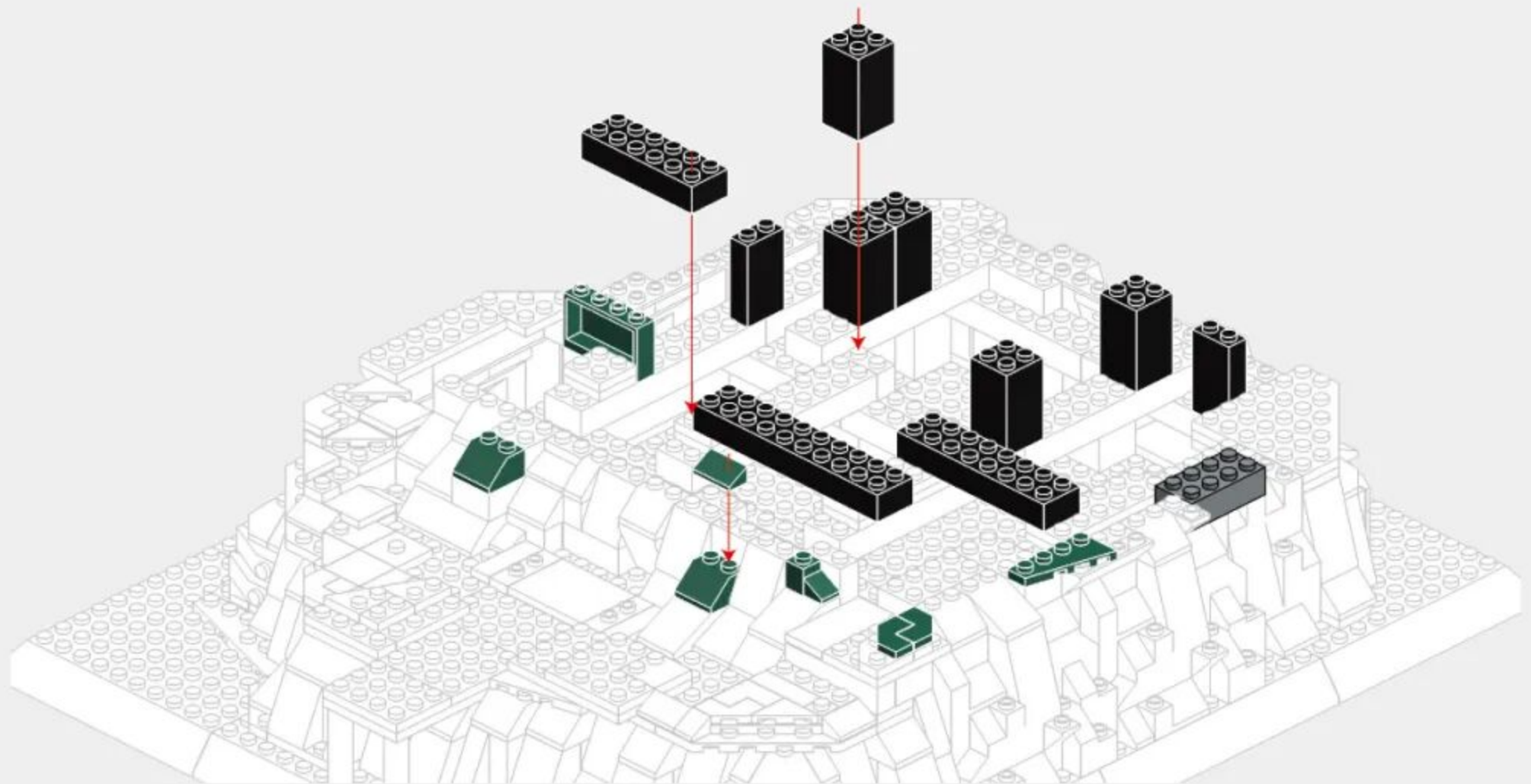
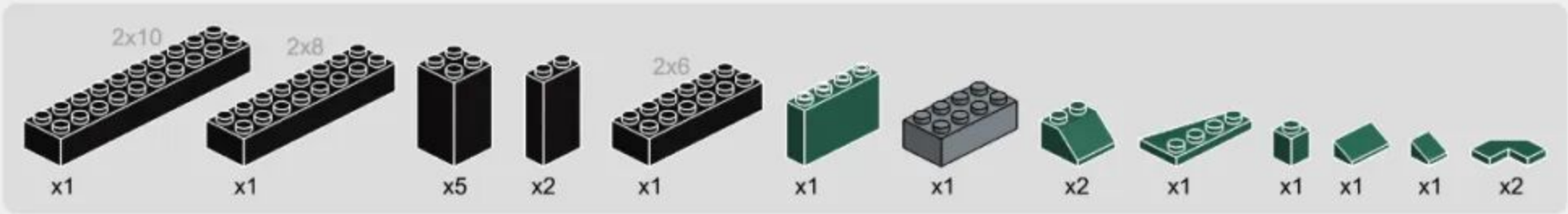

2-15



x1

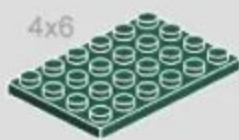

x1



x1



x1



x3



x1



x1



x1

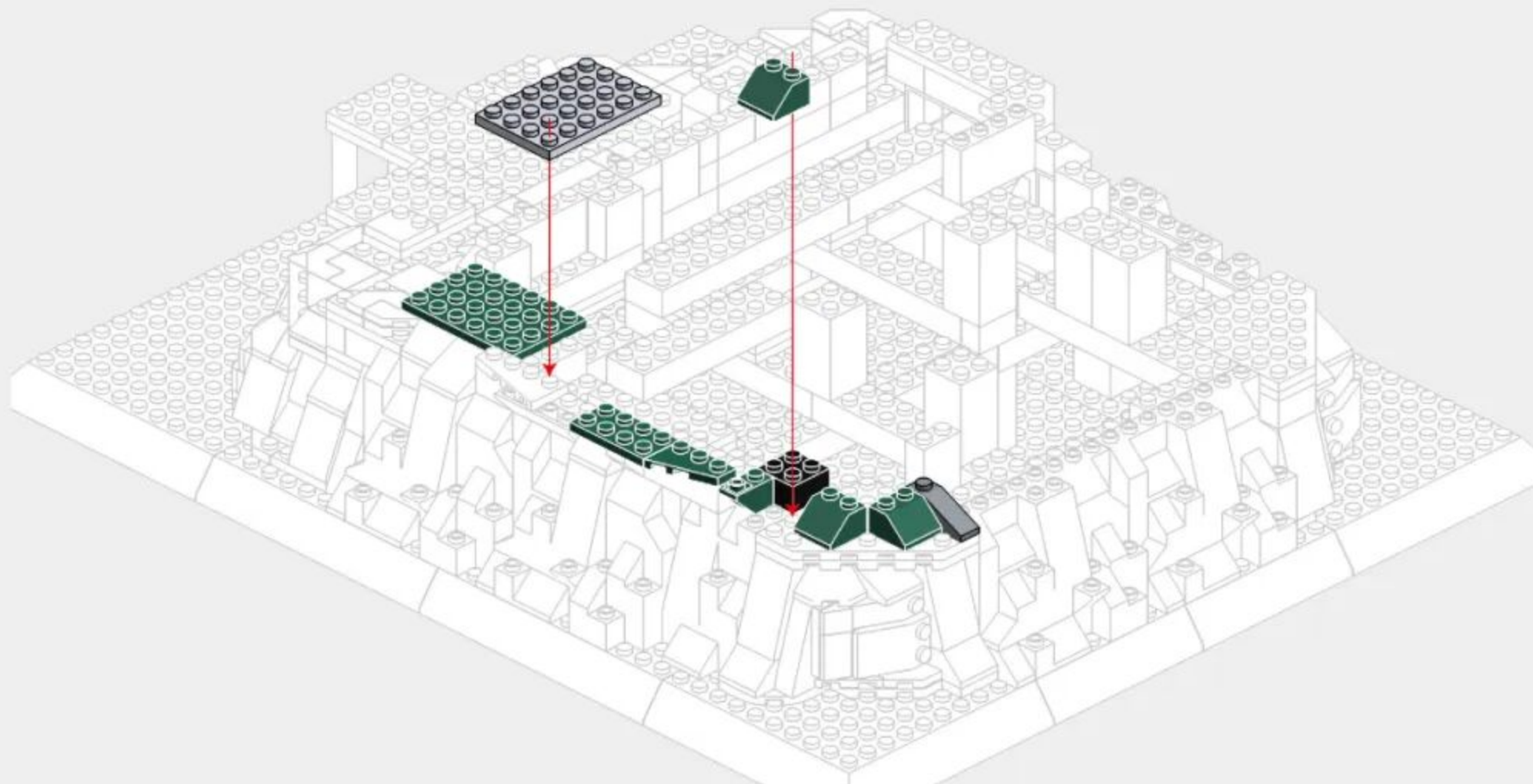

2-16

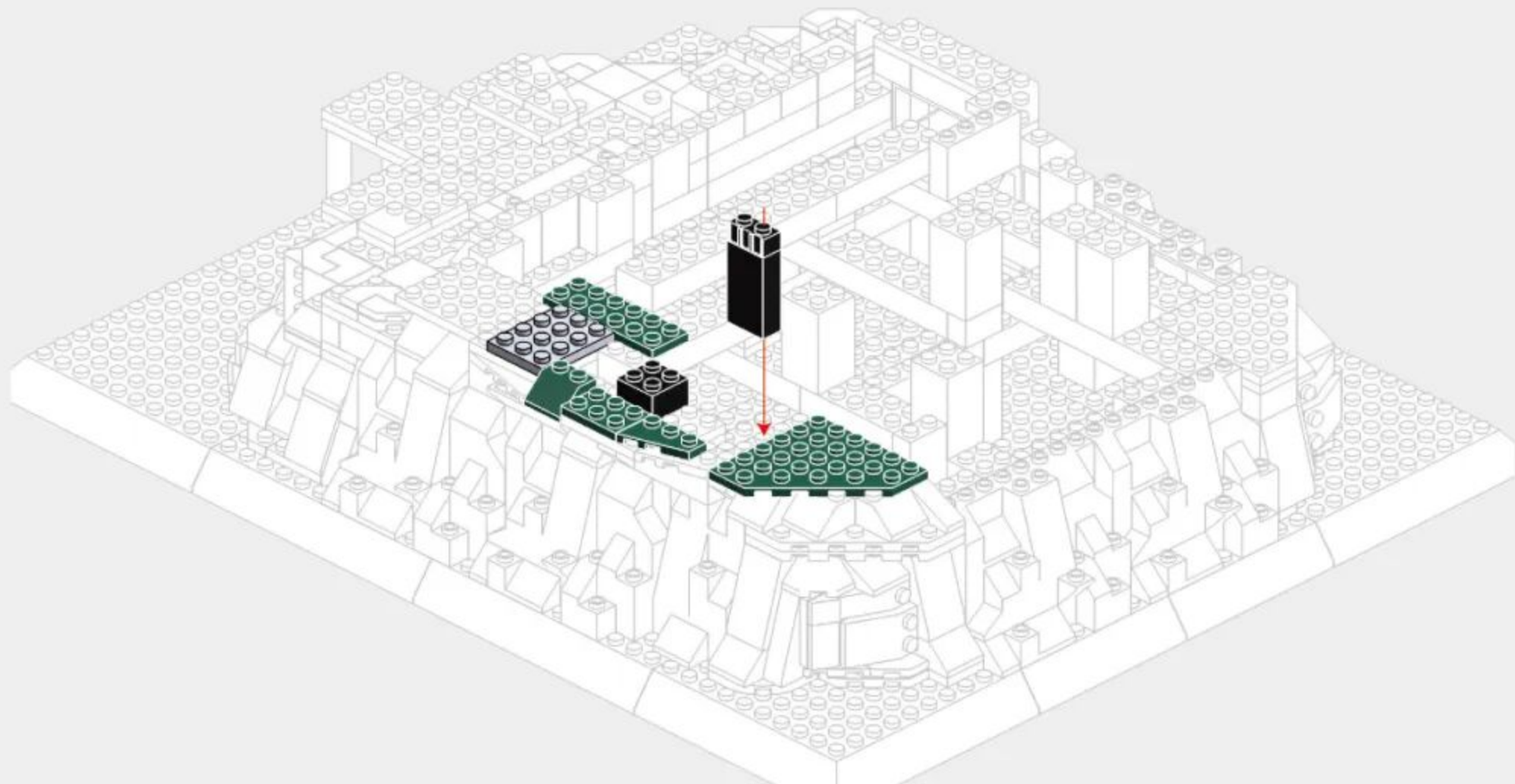
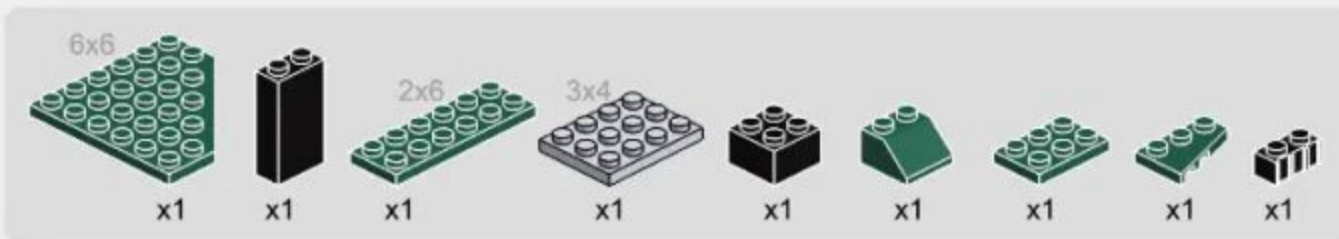

2-17

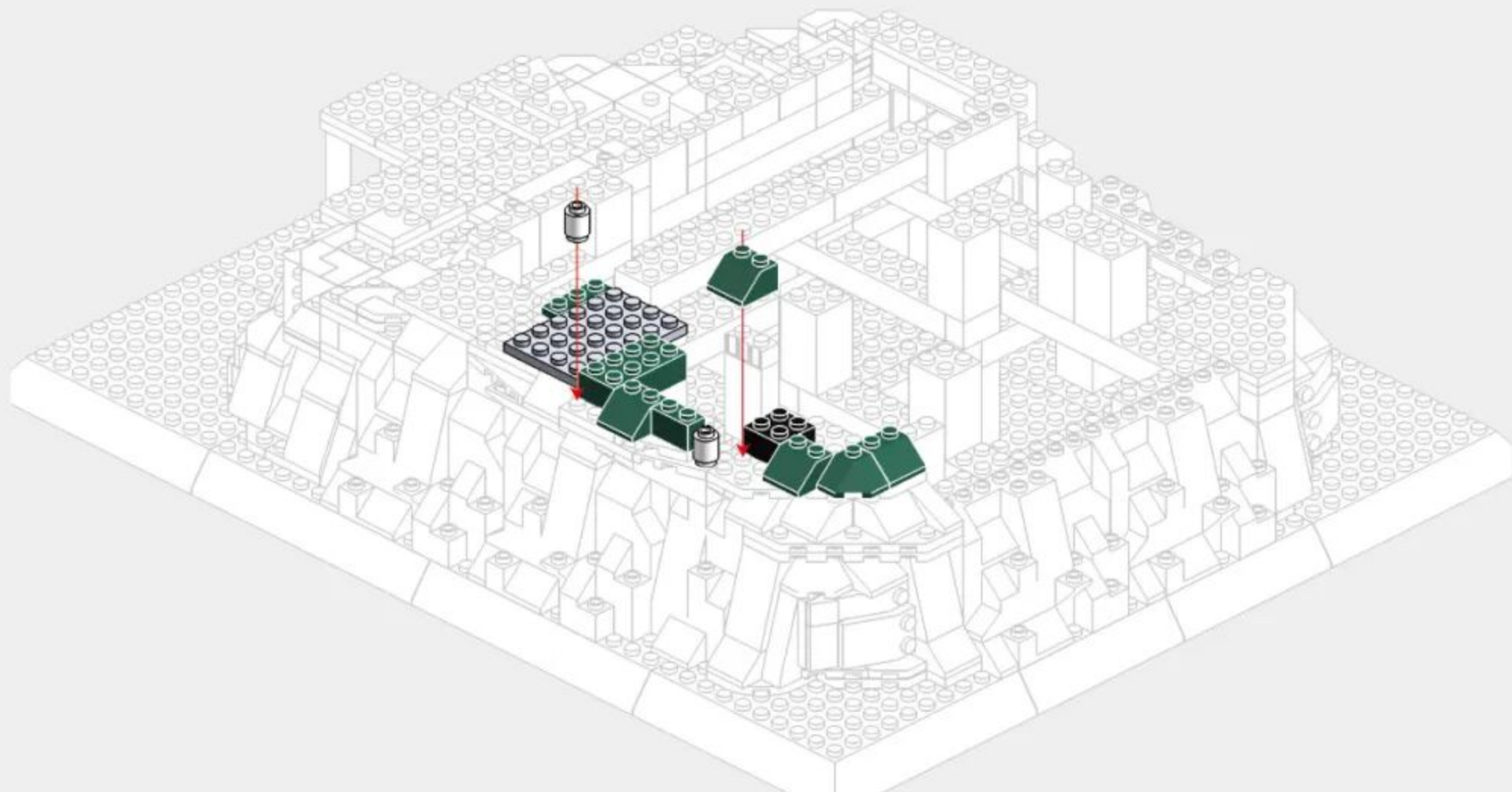





282 PCS

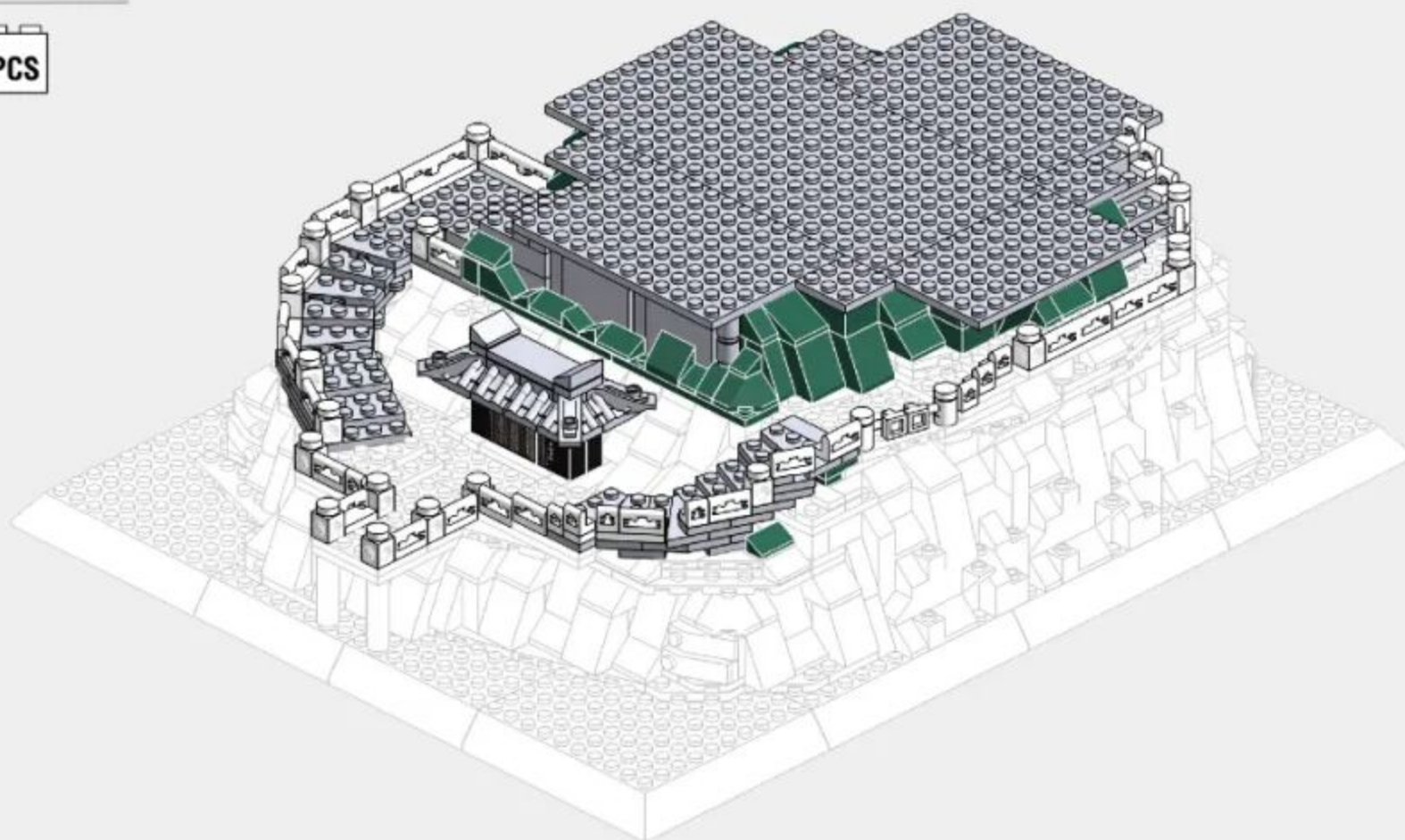

3-1

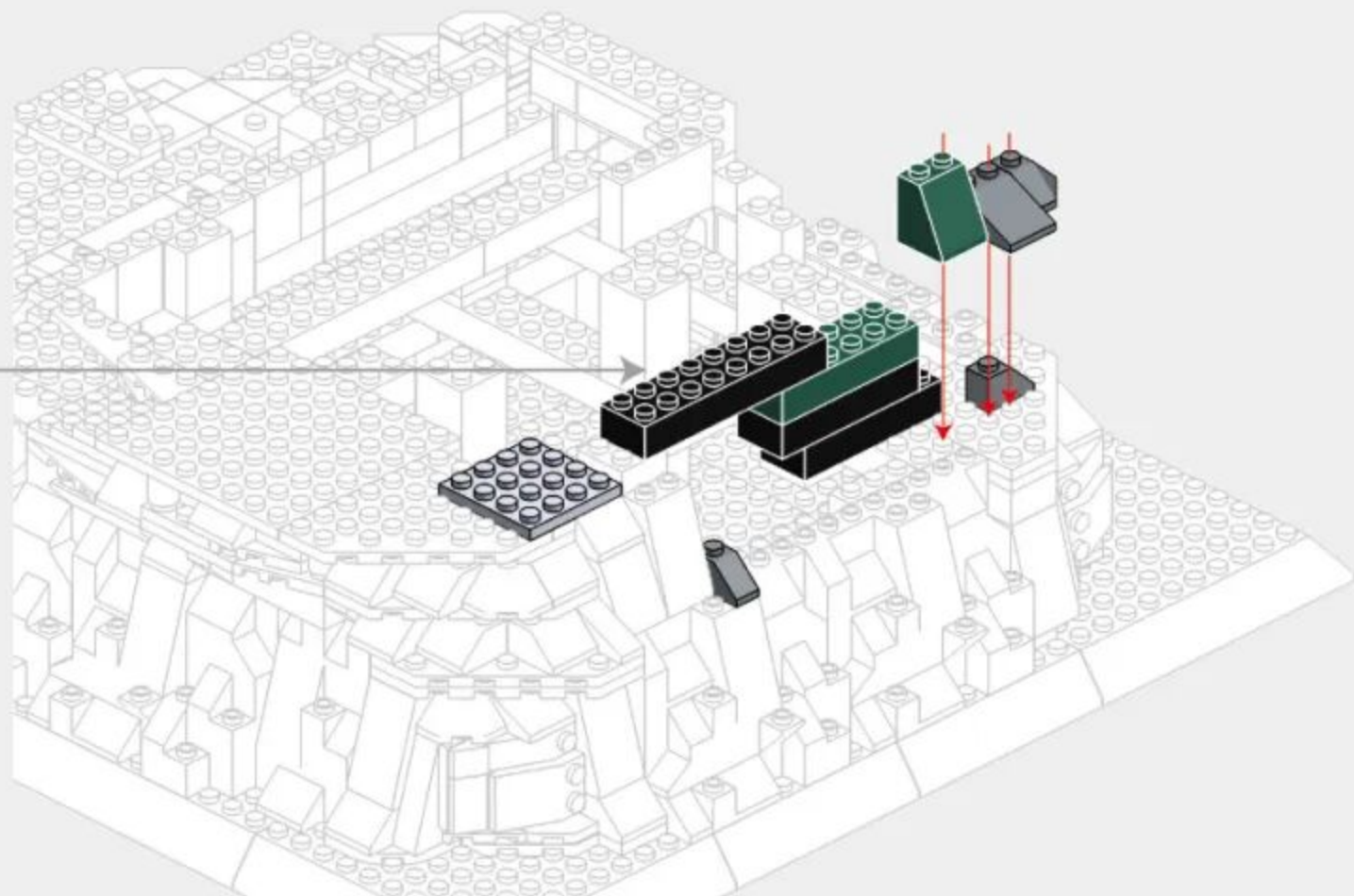
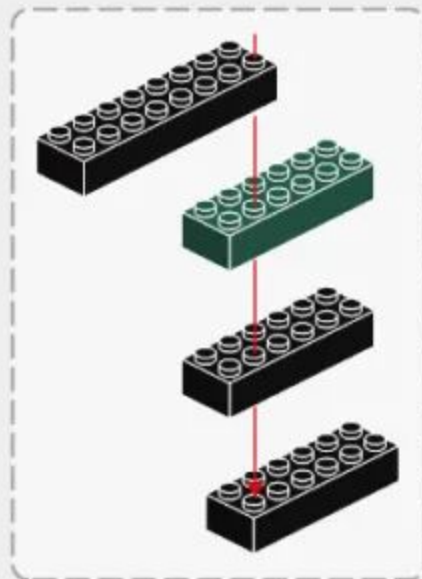

3-2

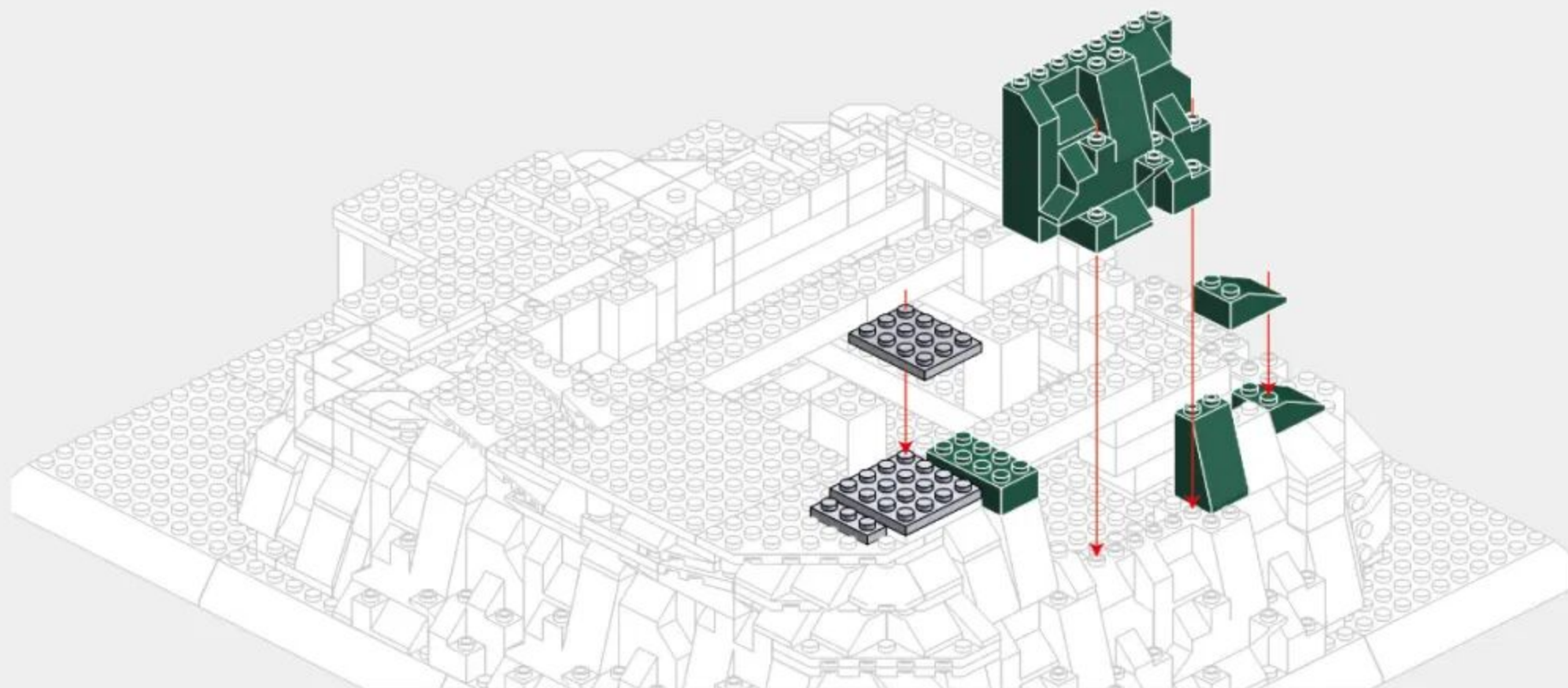
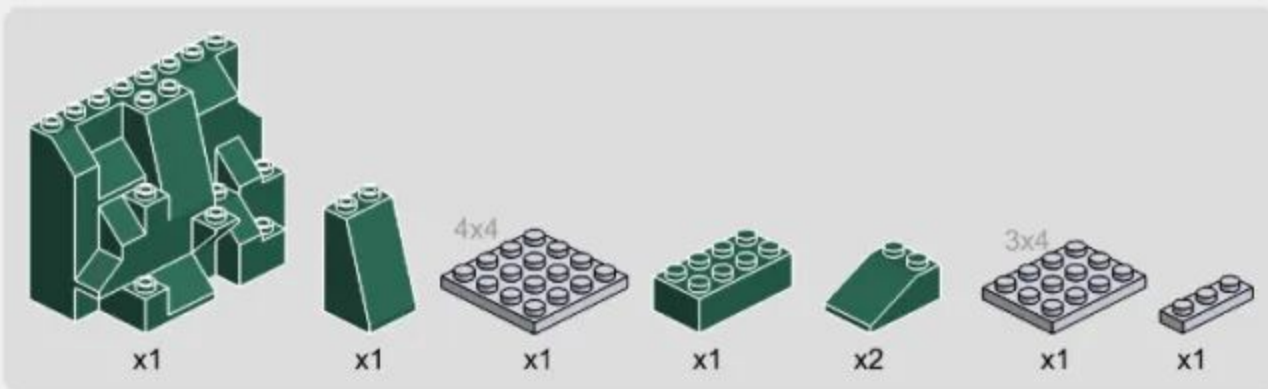

### 3-3

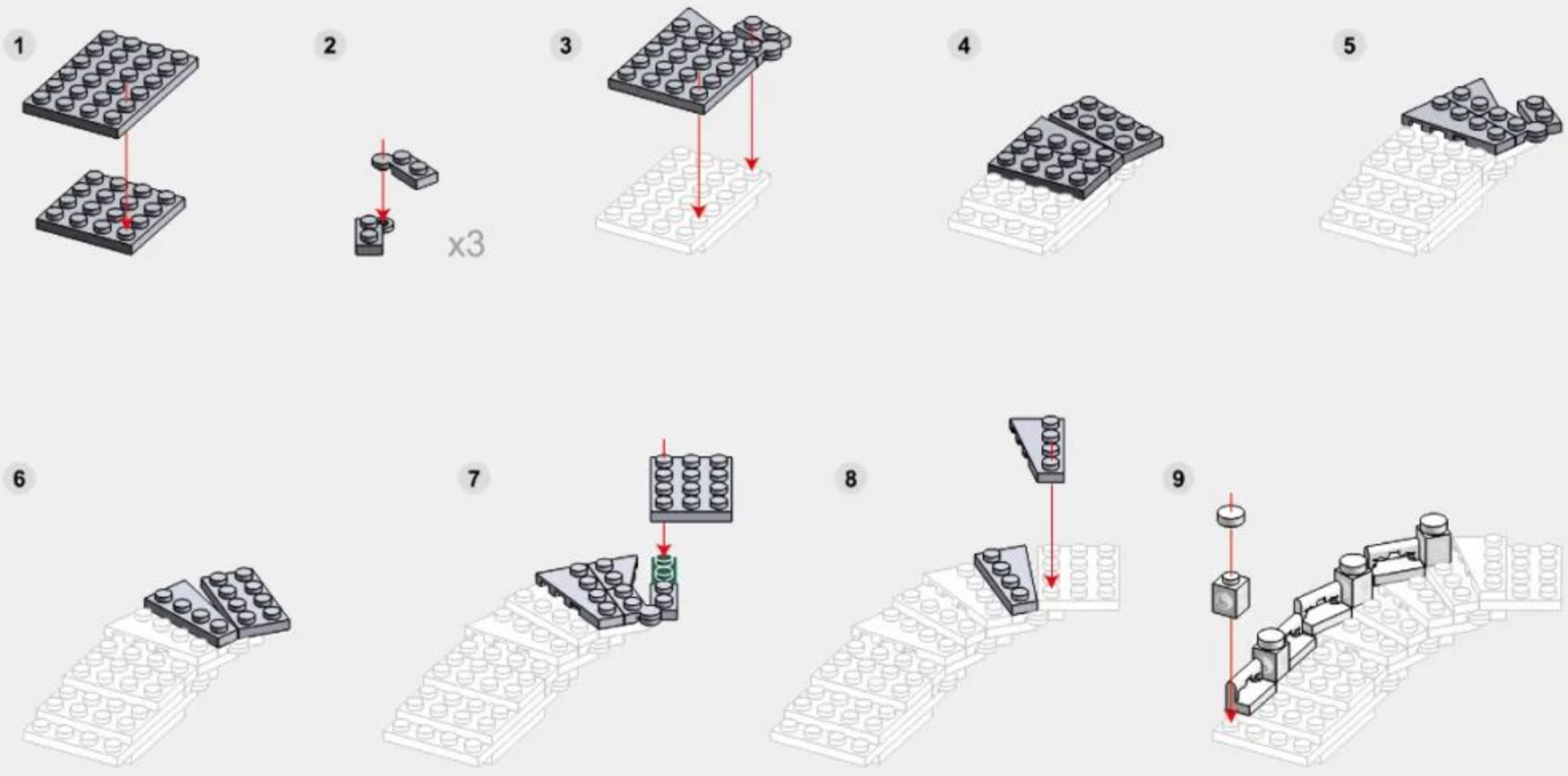
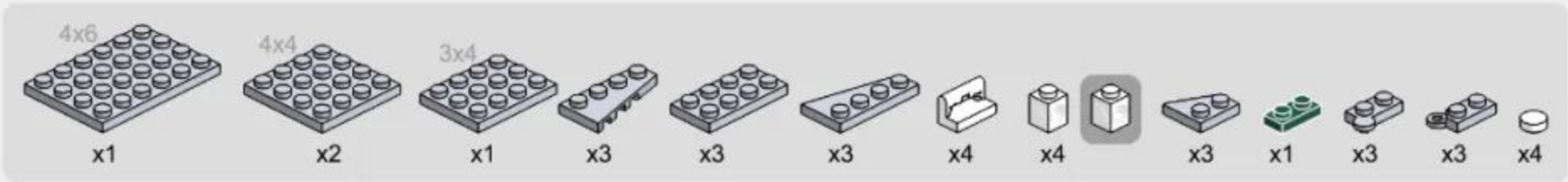

3-4

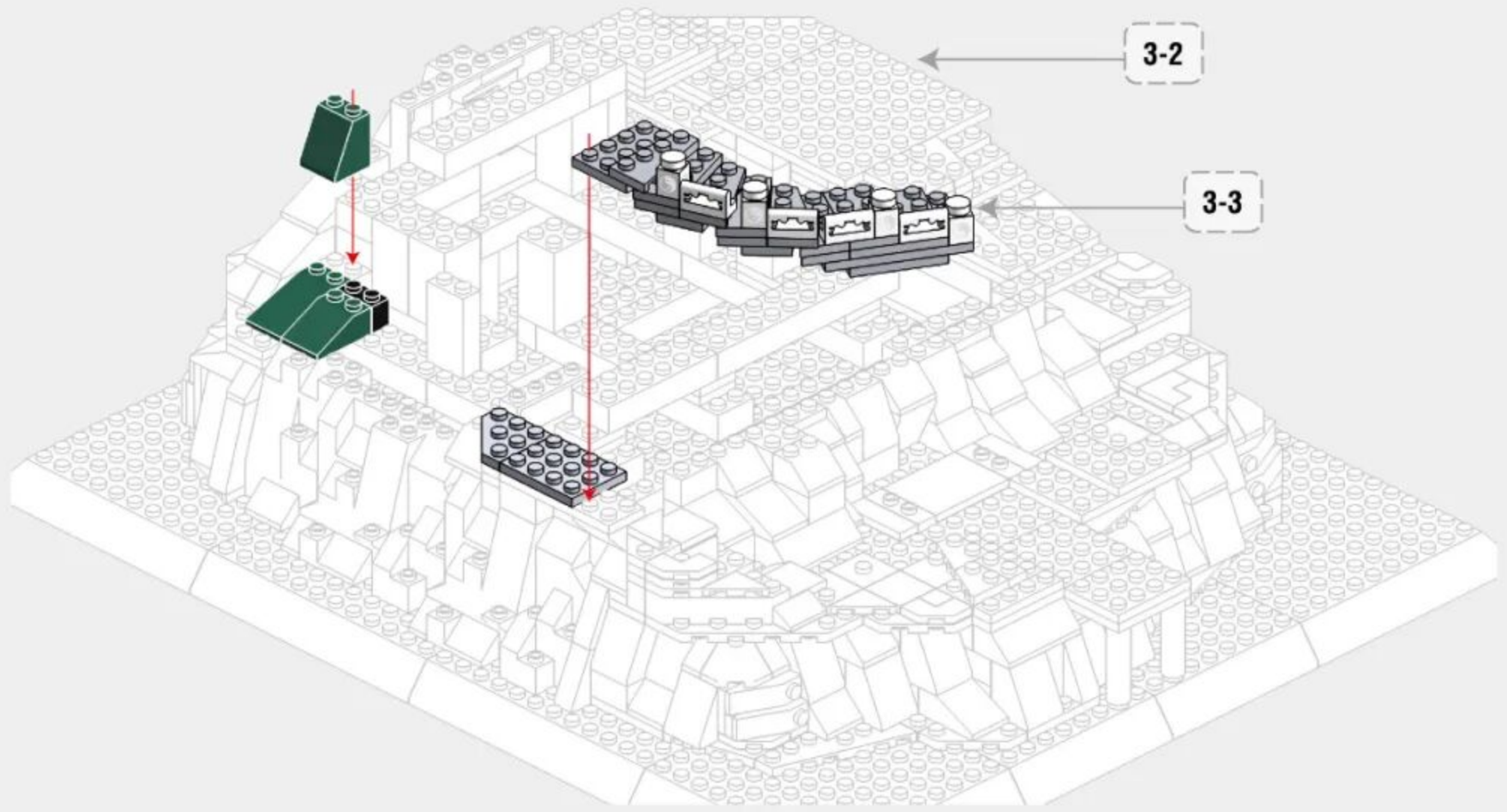
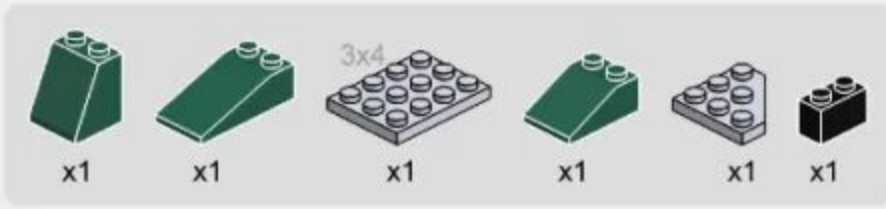

3-5

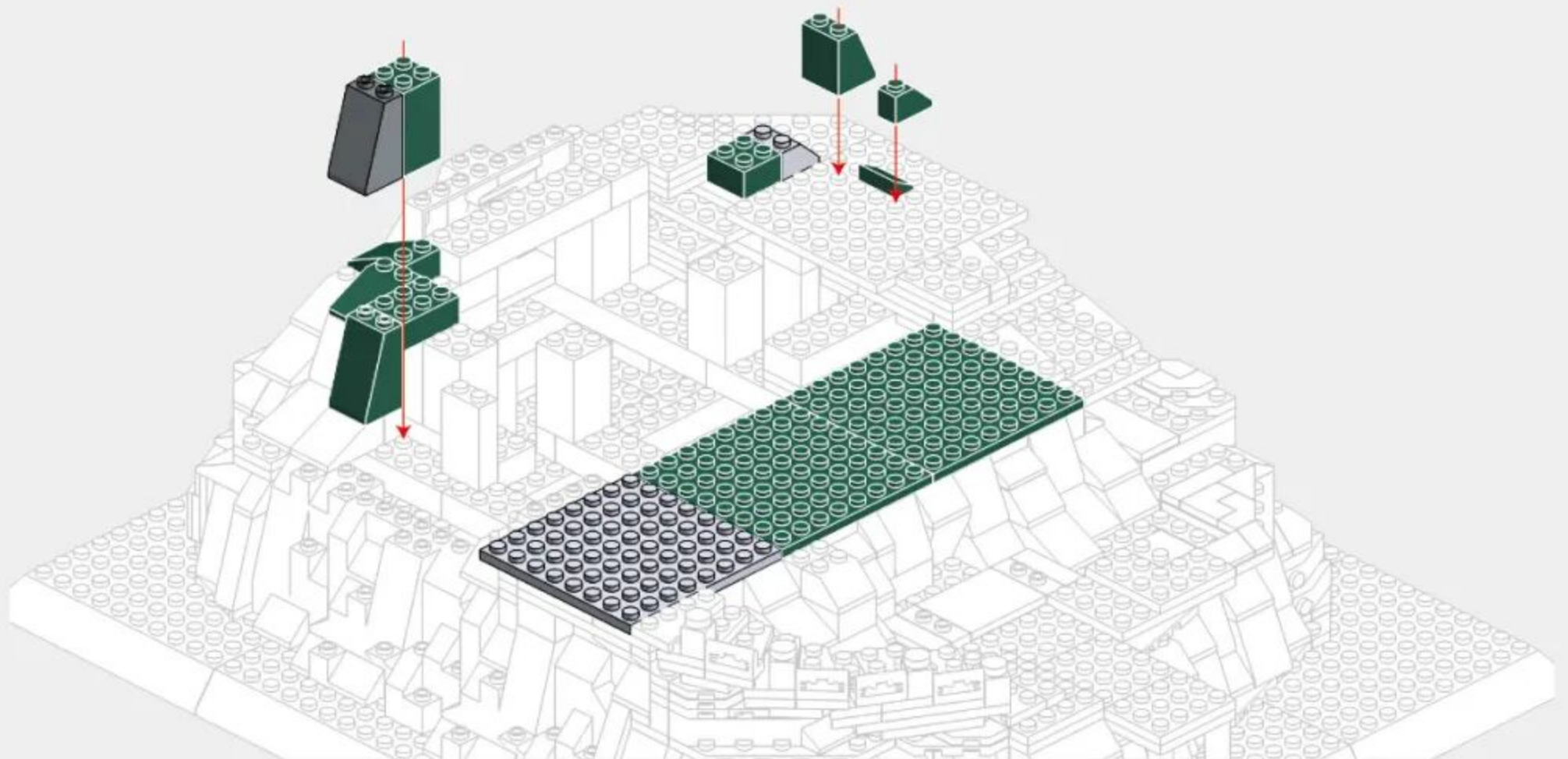
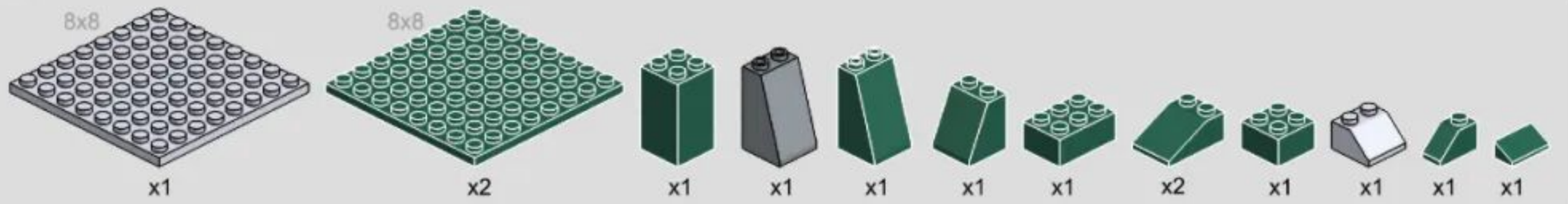

# 3-6

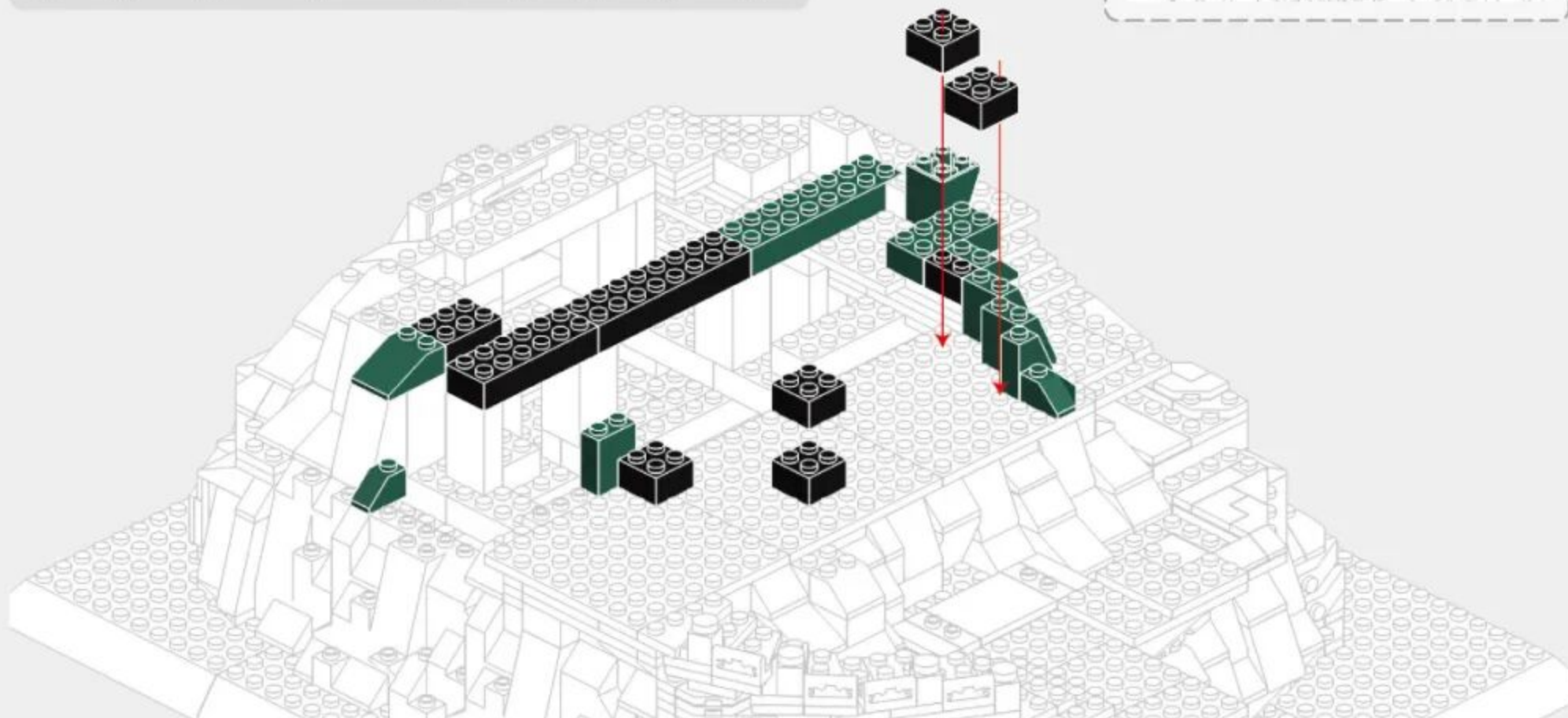
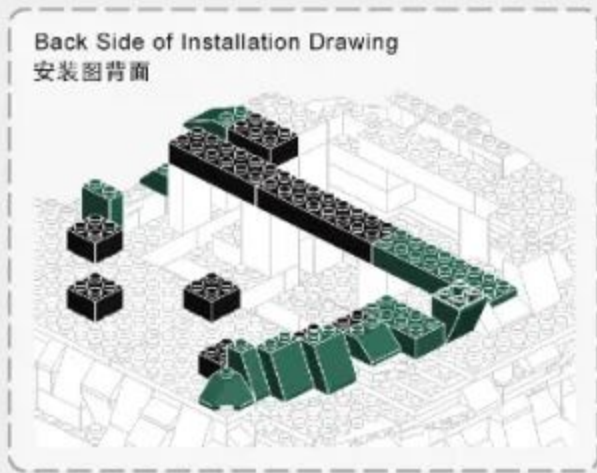
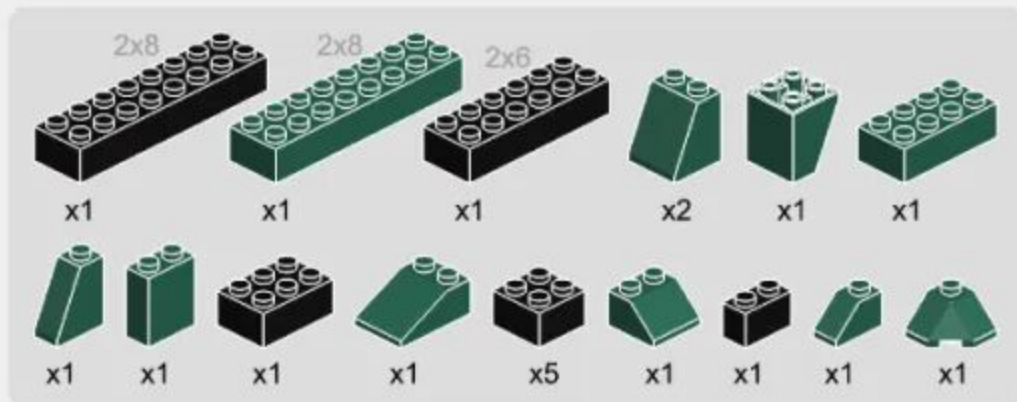

3-7

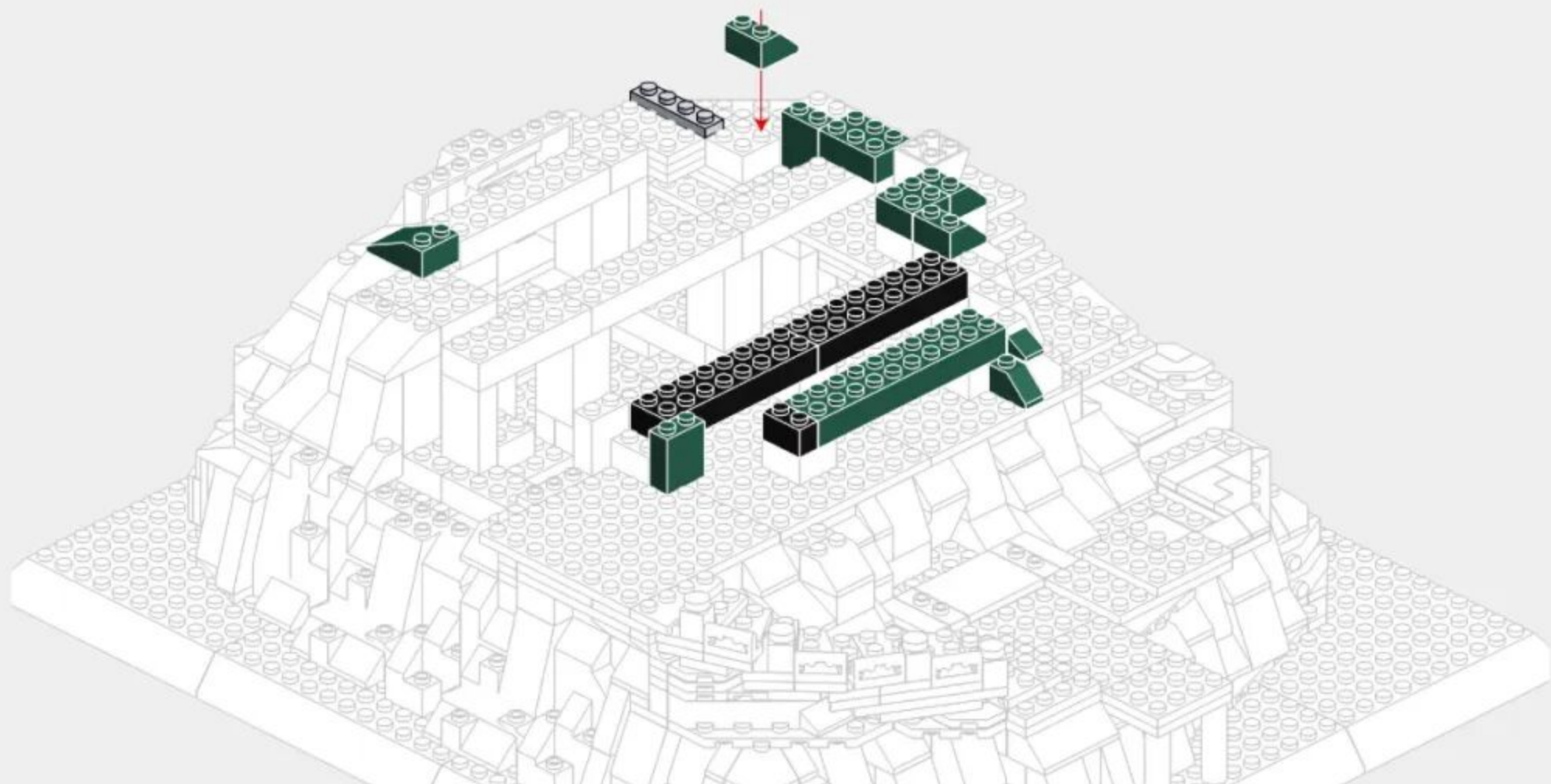
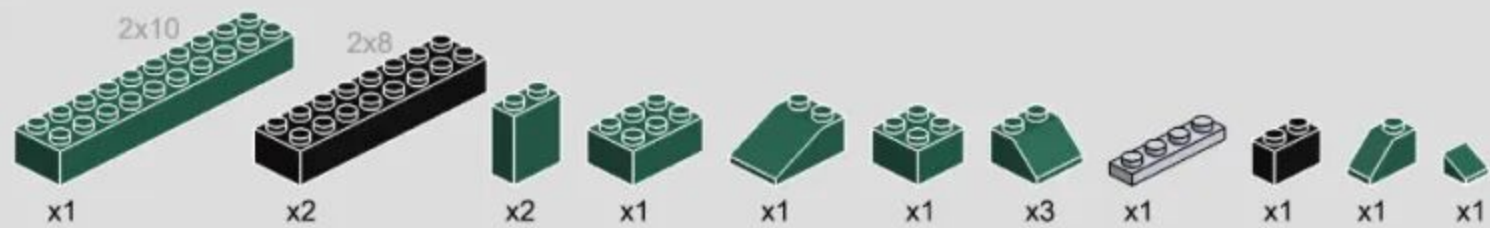

3-8

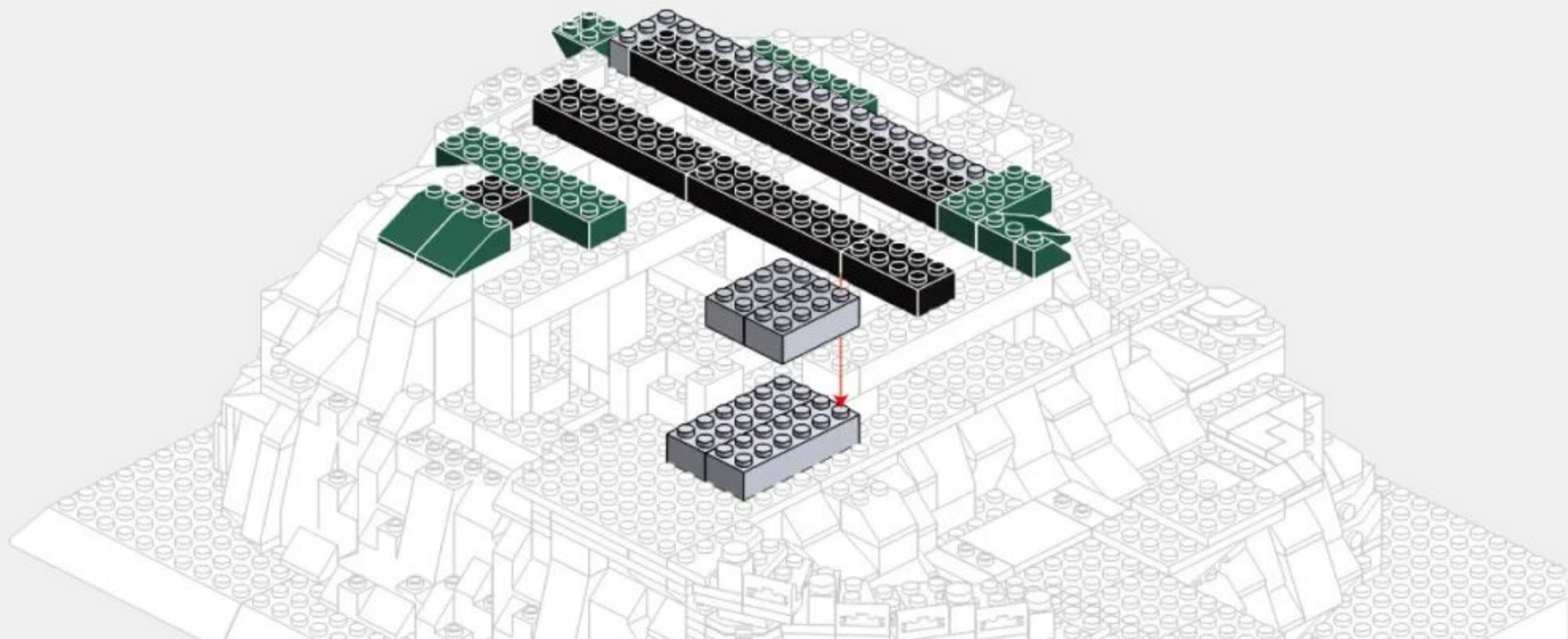
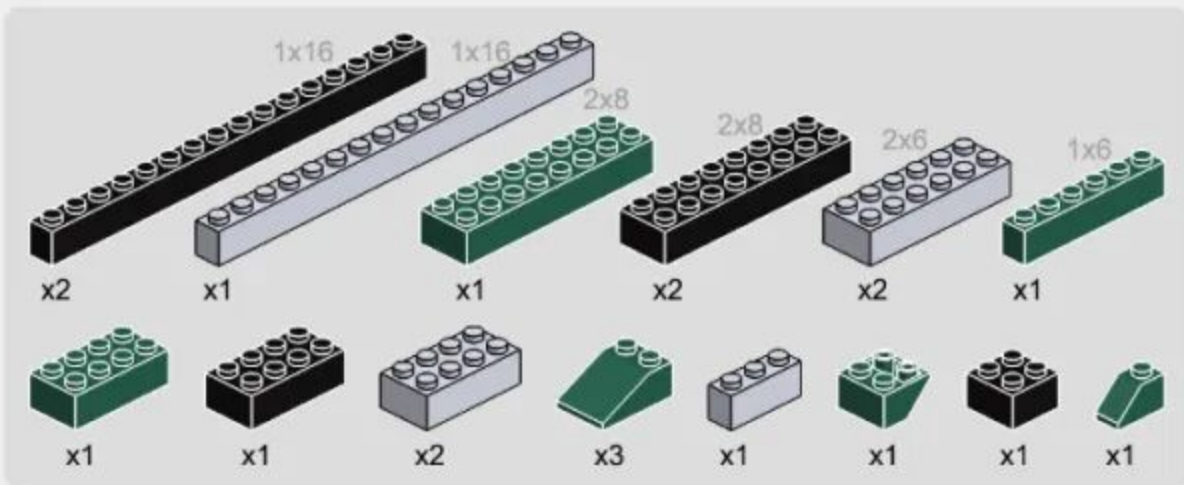

3-9

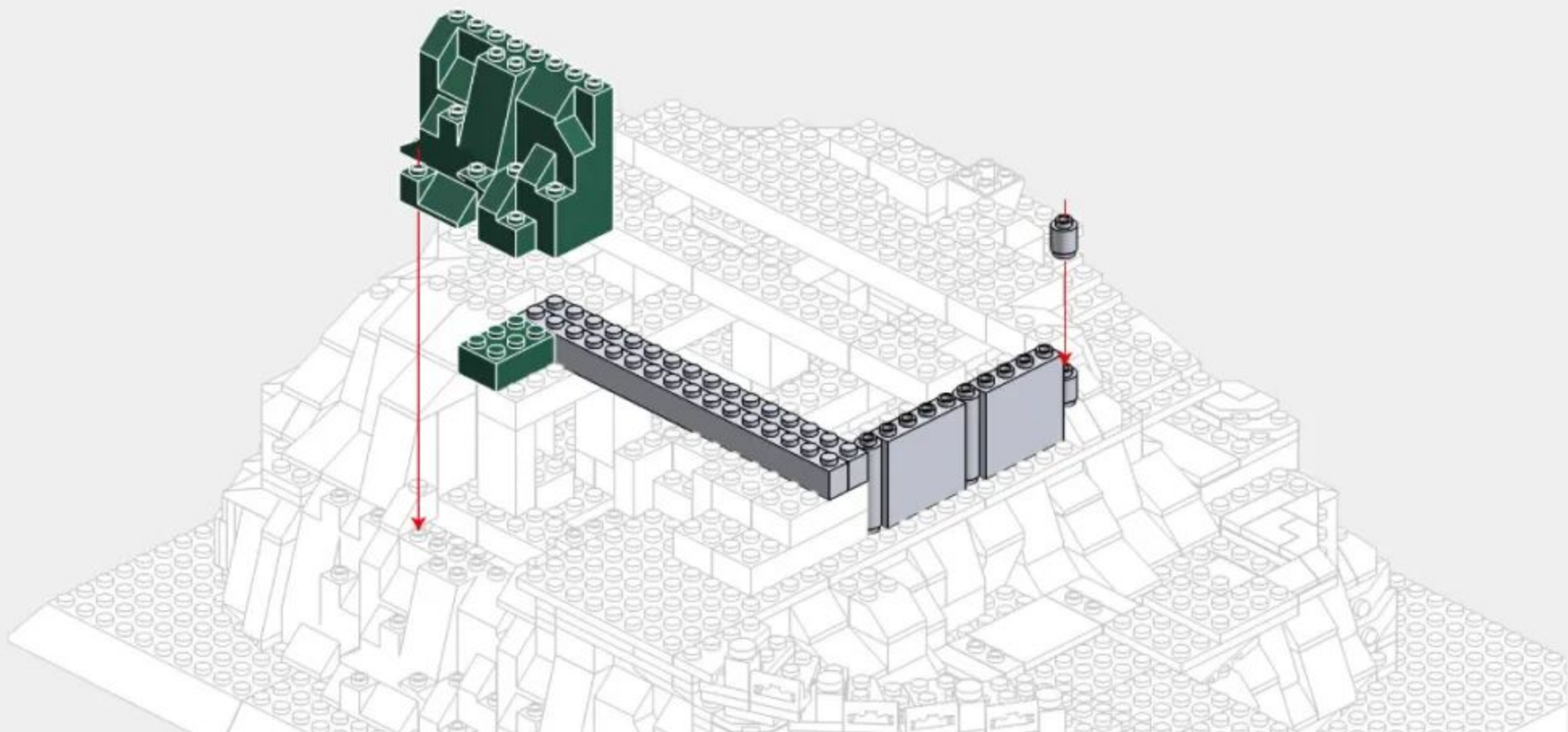
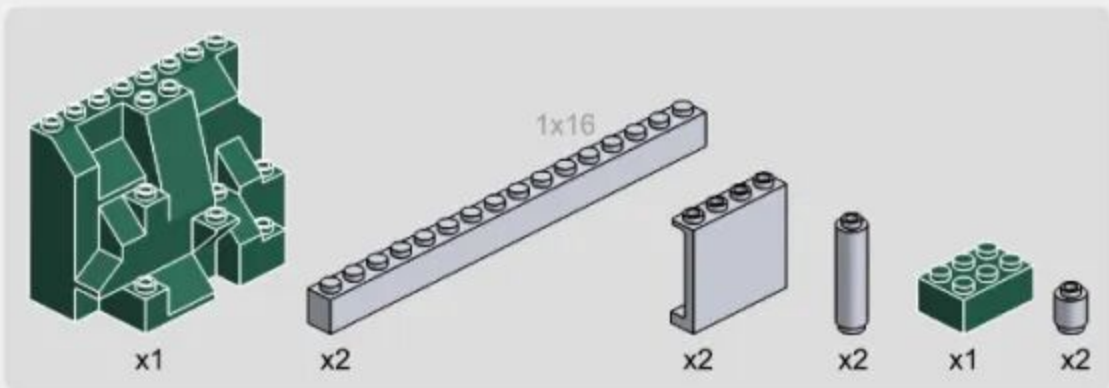

3-10

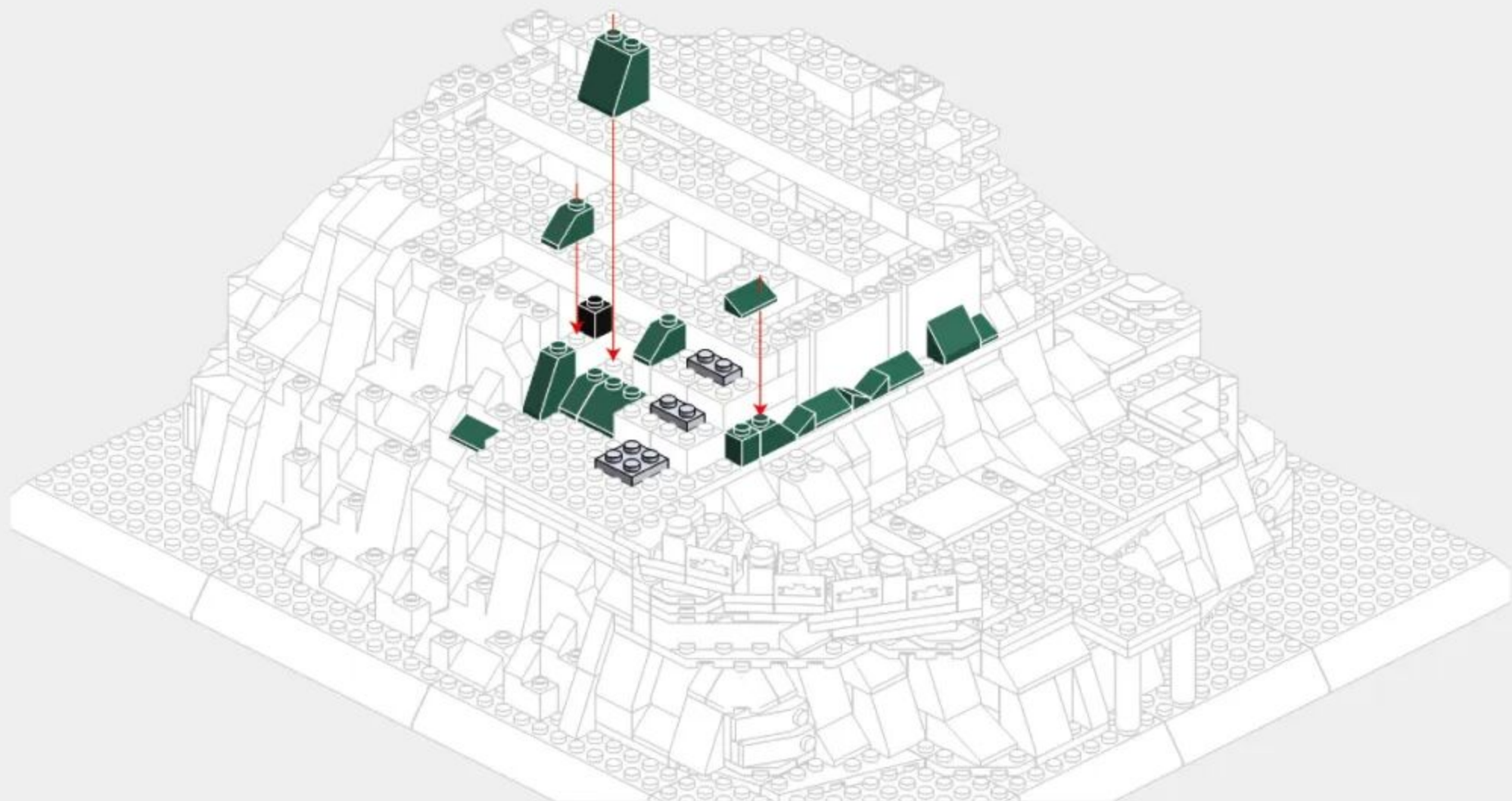



3-12



3-10

3-11



### 3-13

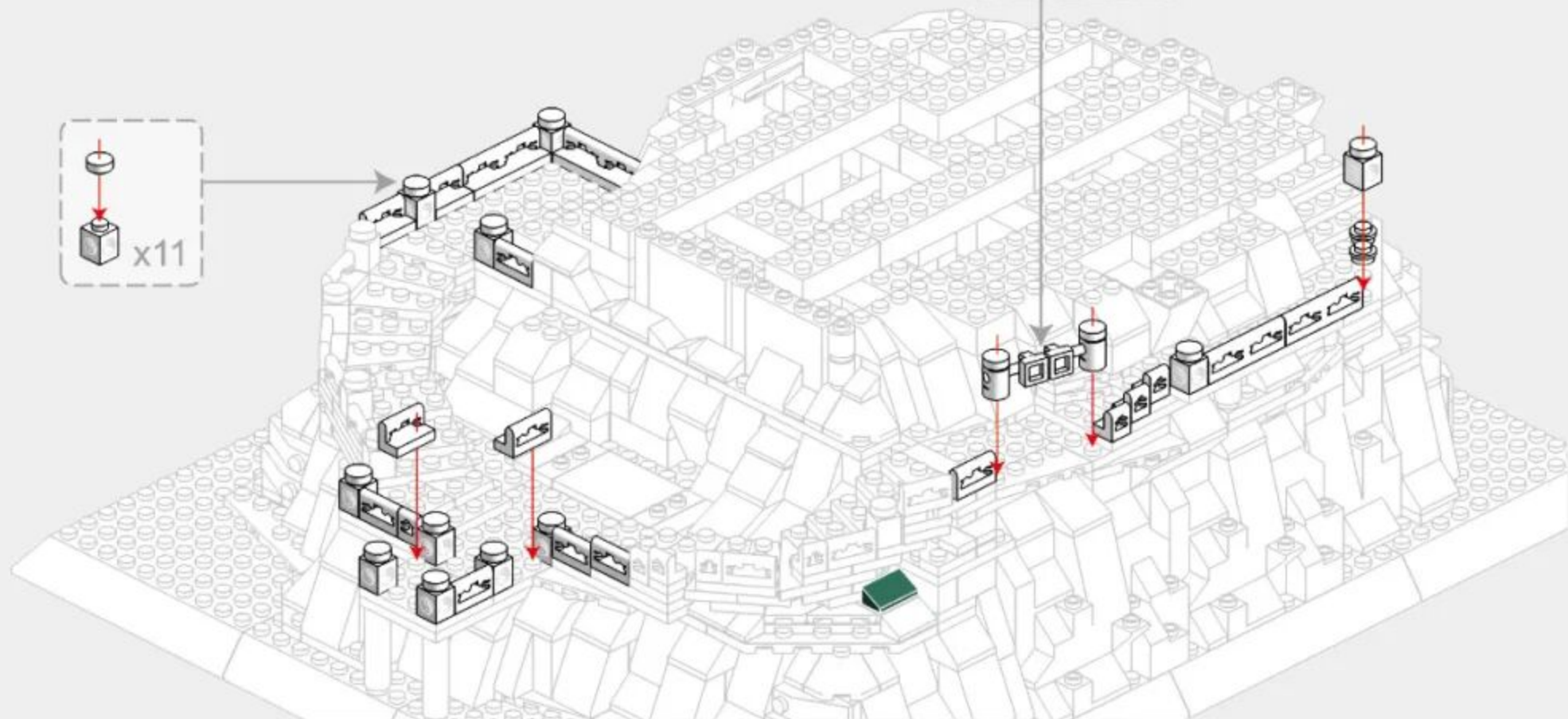
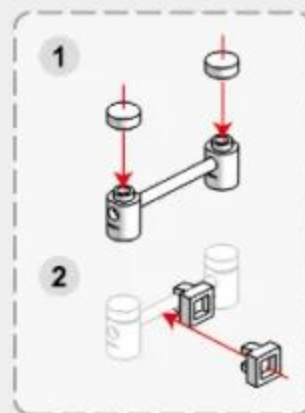

### 3-14

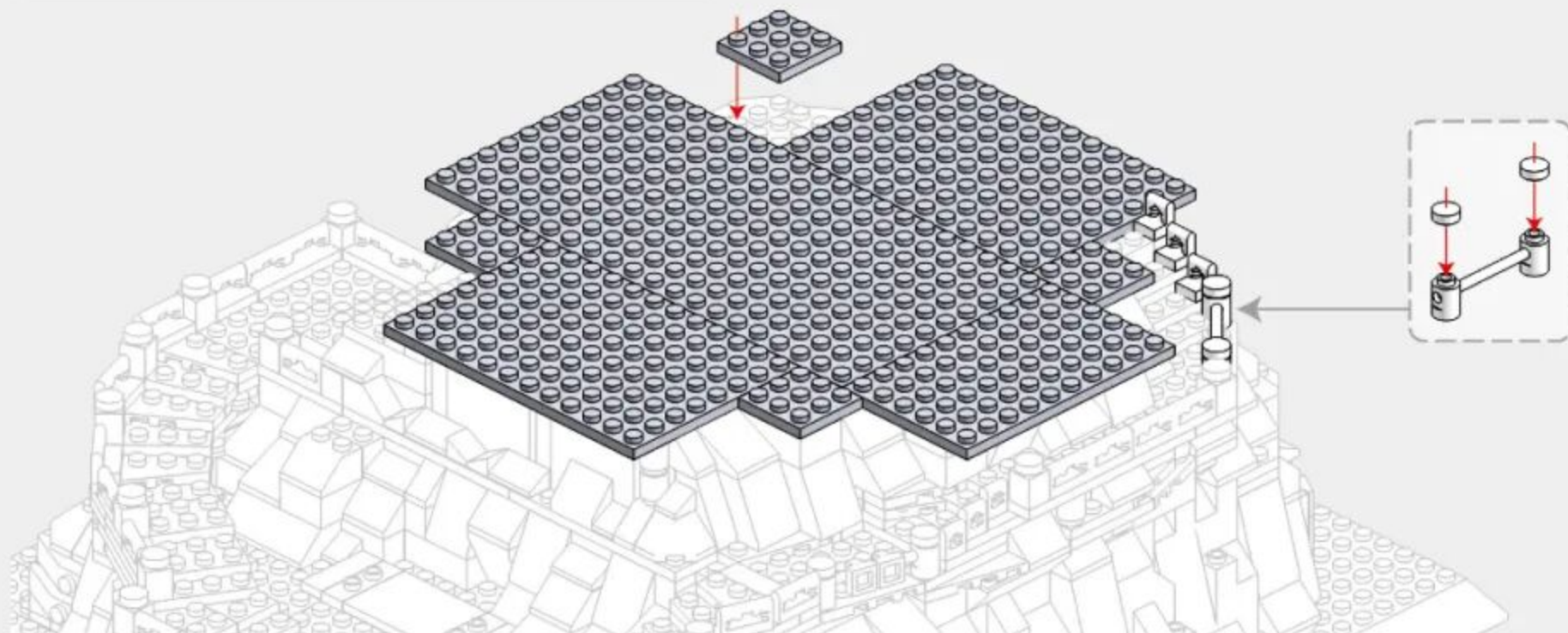
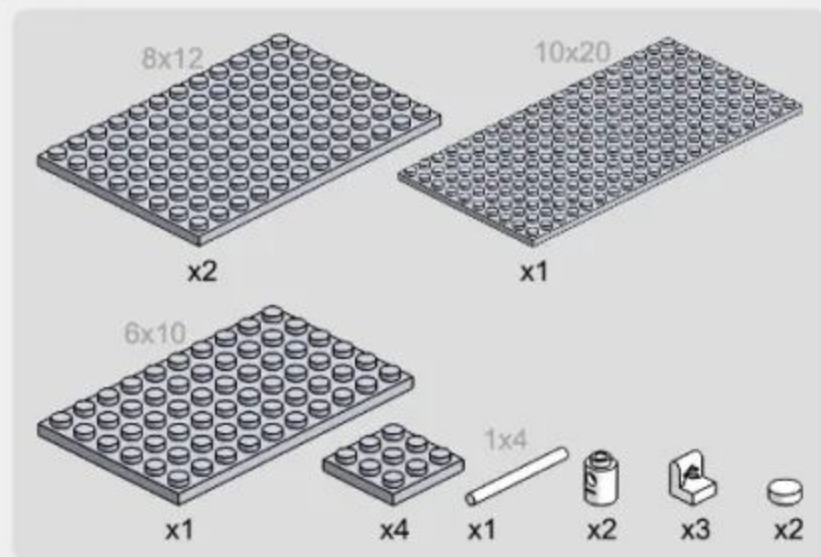





218PCS

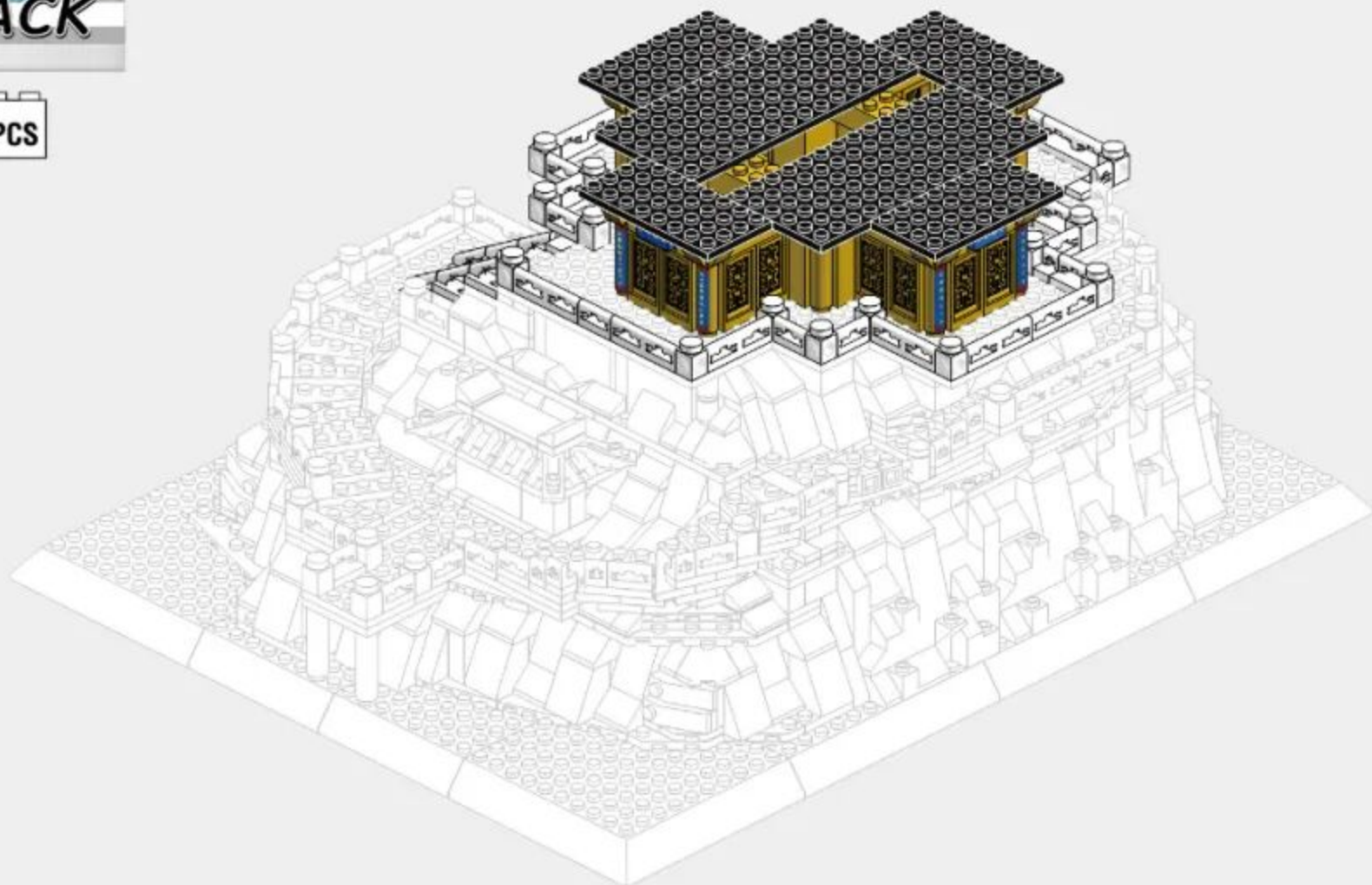

69

# 4-1

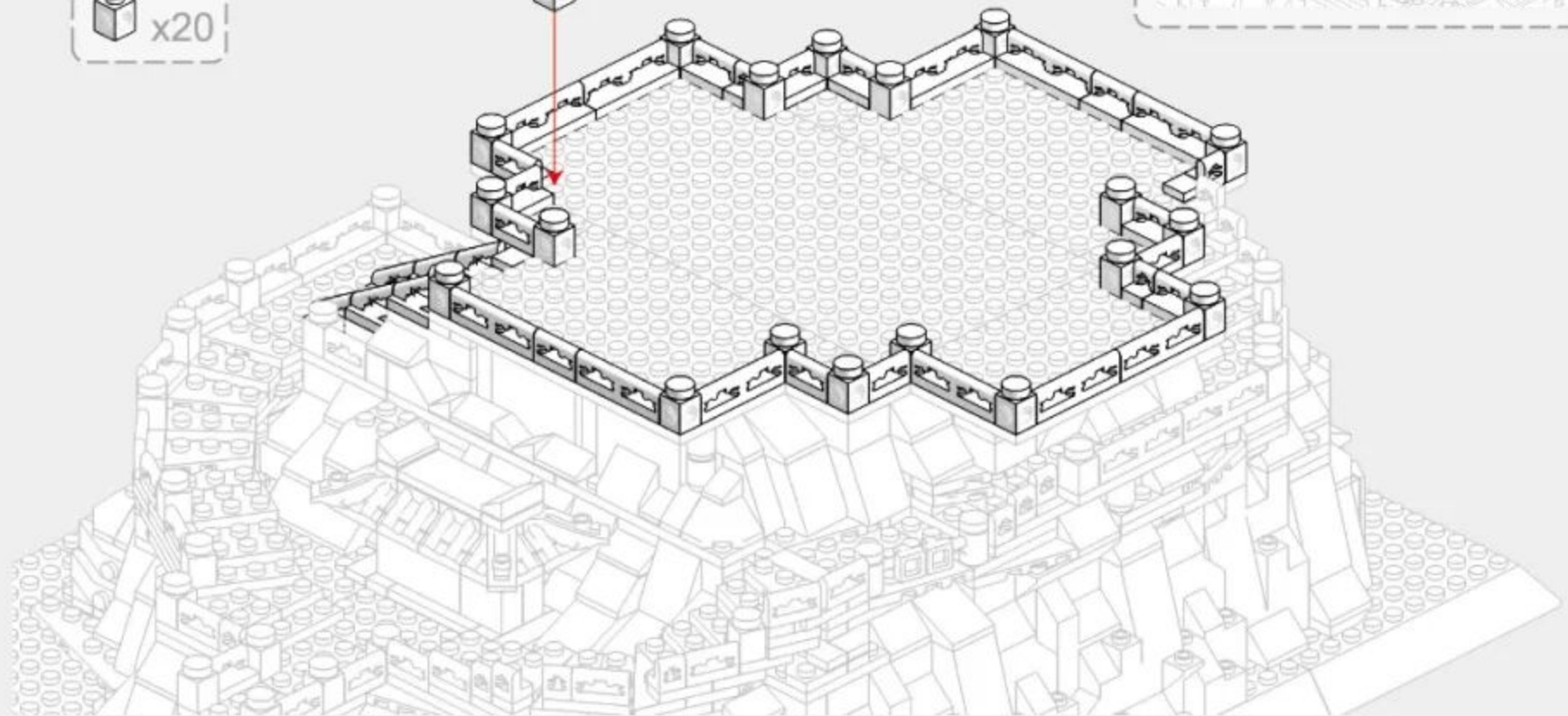
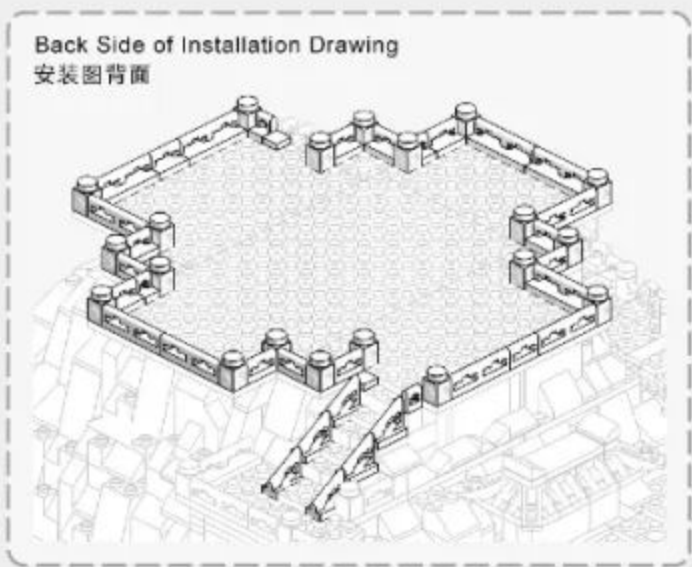

4-2

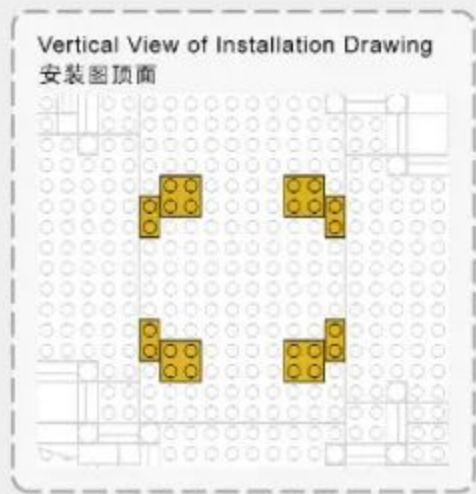
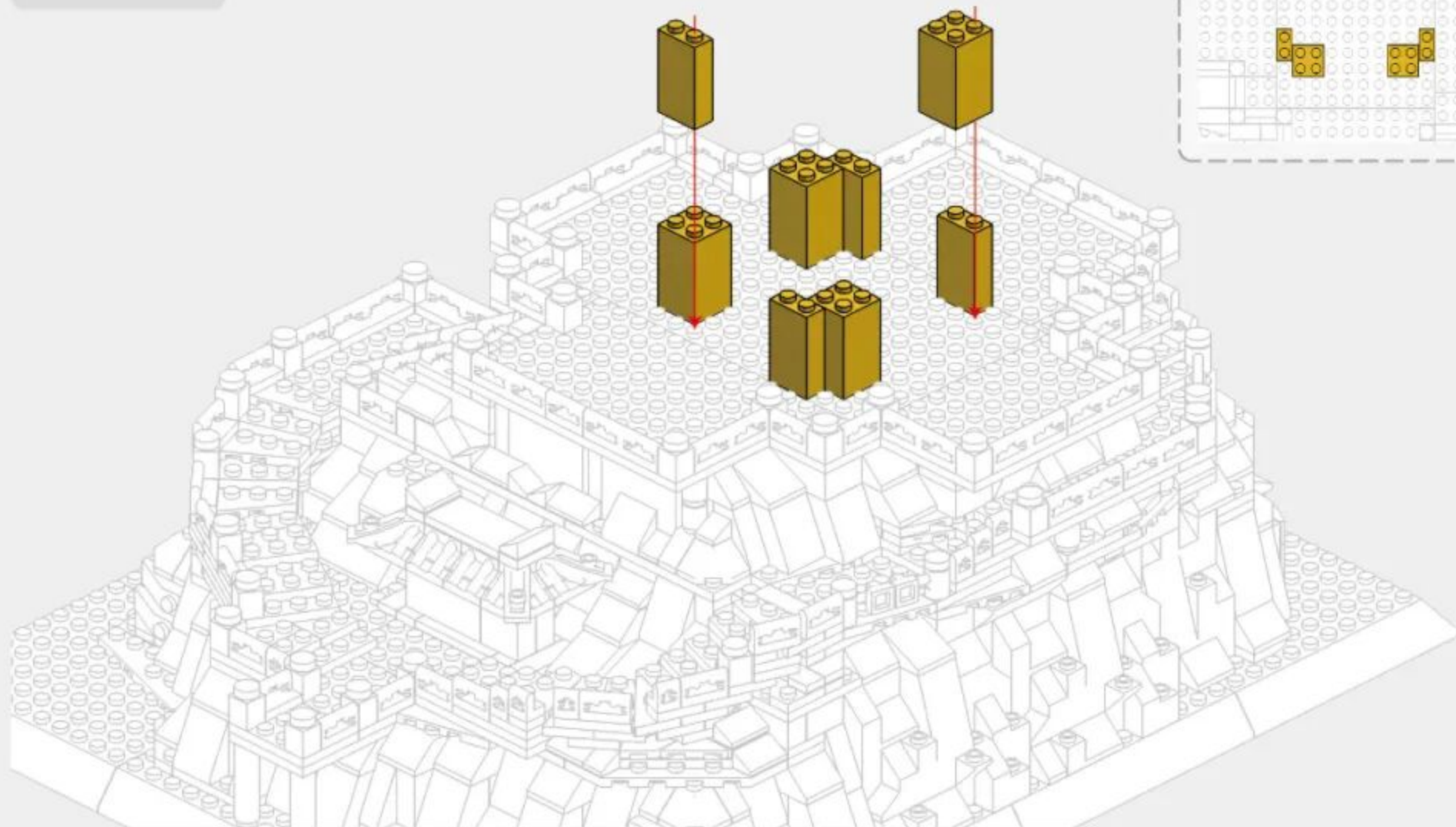

4-3



五母参天棠川扬懿德

三花聚顶宝地隐玄机

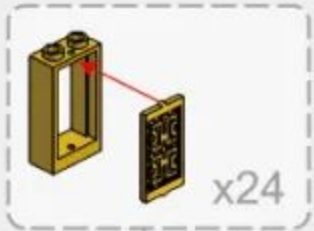

Back Side of Installation Drawing  
安装图背面

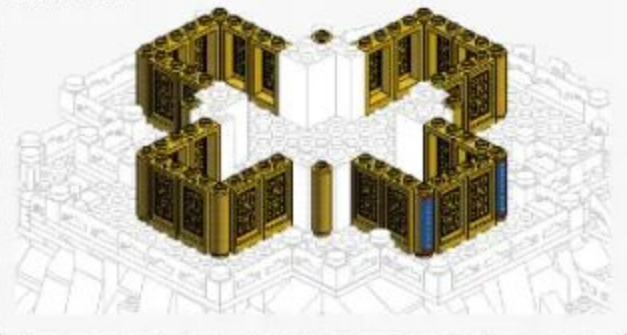

三清凝道气日月同光

五母绕慈云天人共仰

云雾凌空九万里

苍松拔地三千年

4-4



Back Side of Installation Drawing  
安装图背面

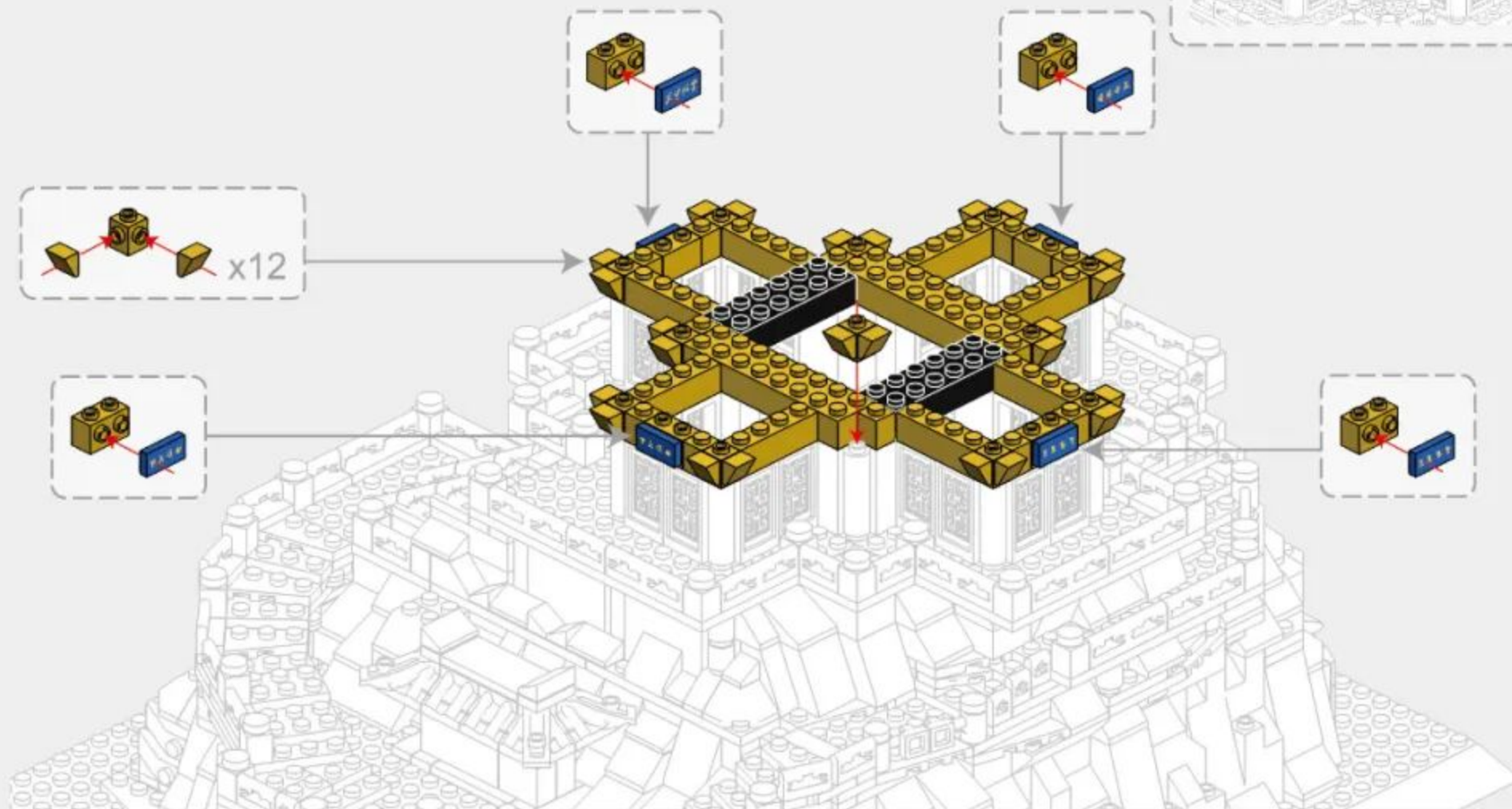

4-5

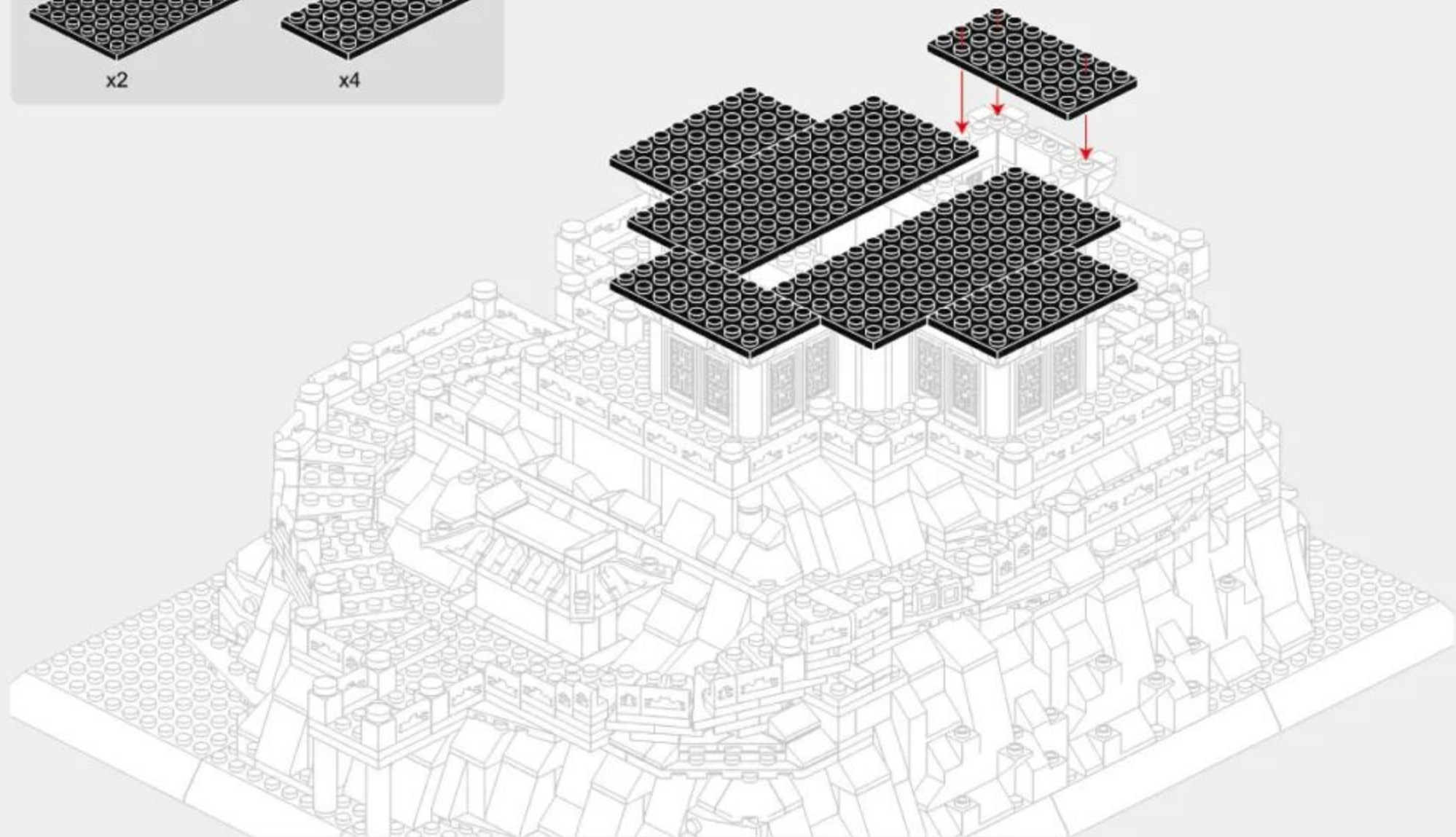
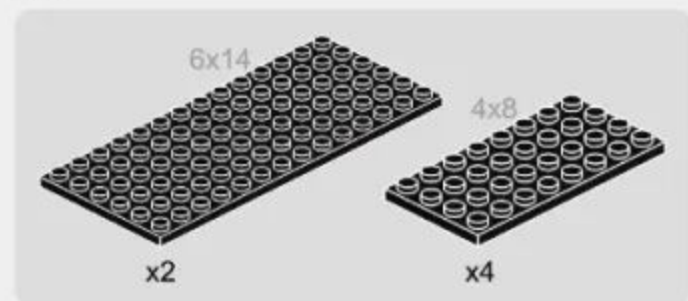



204PCS

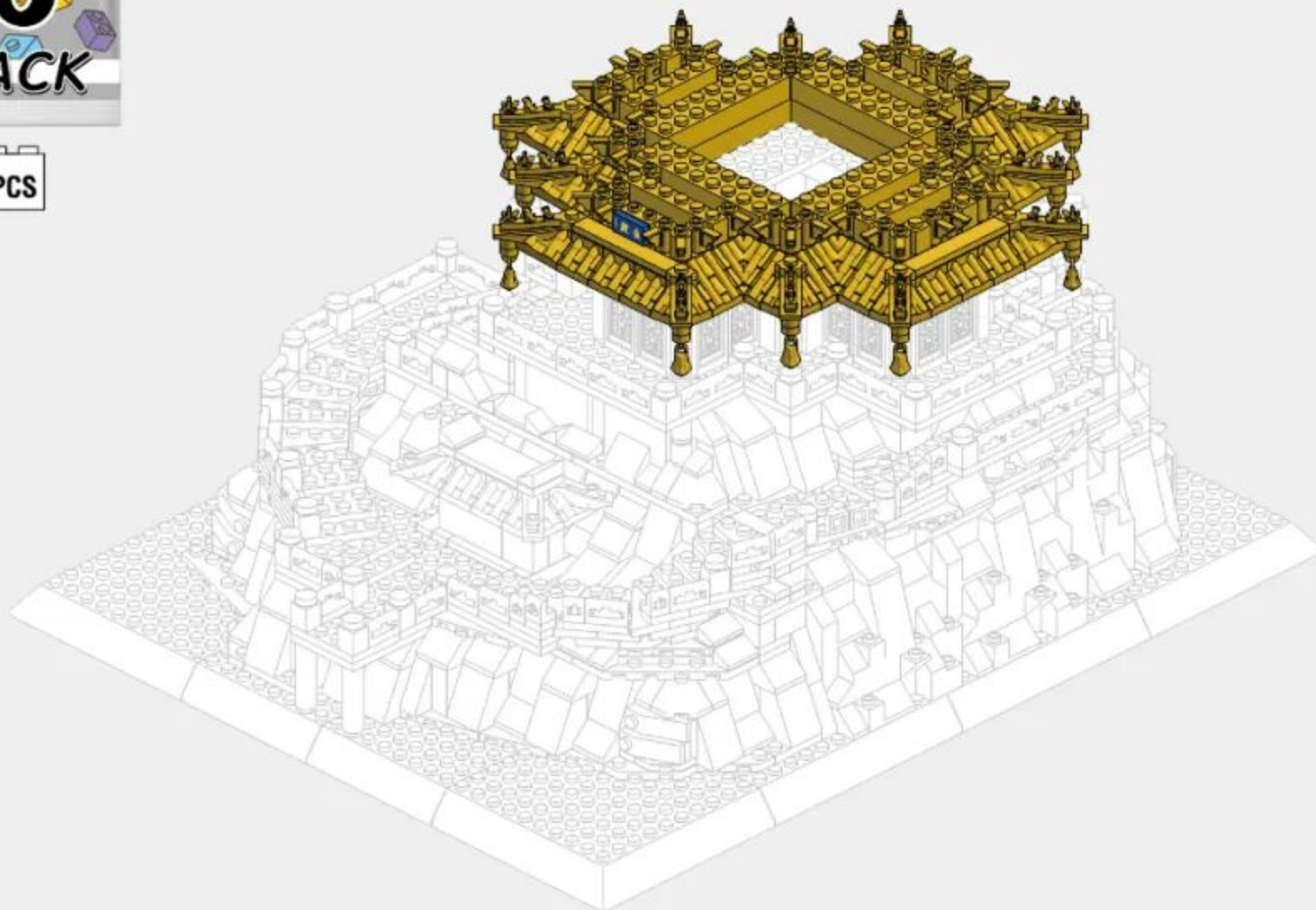

75



5-2

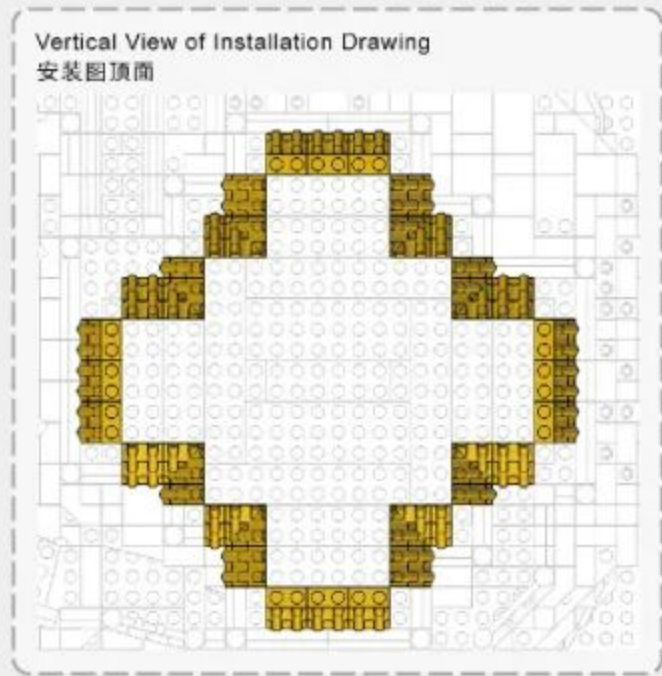
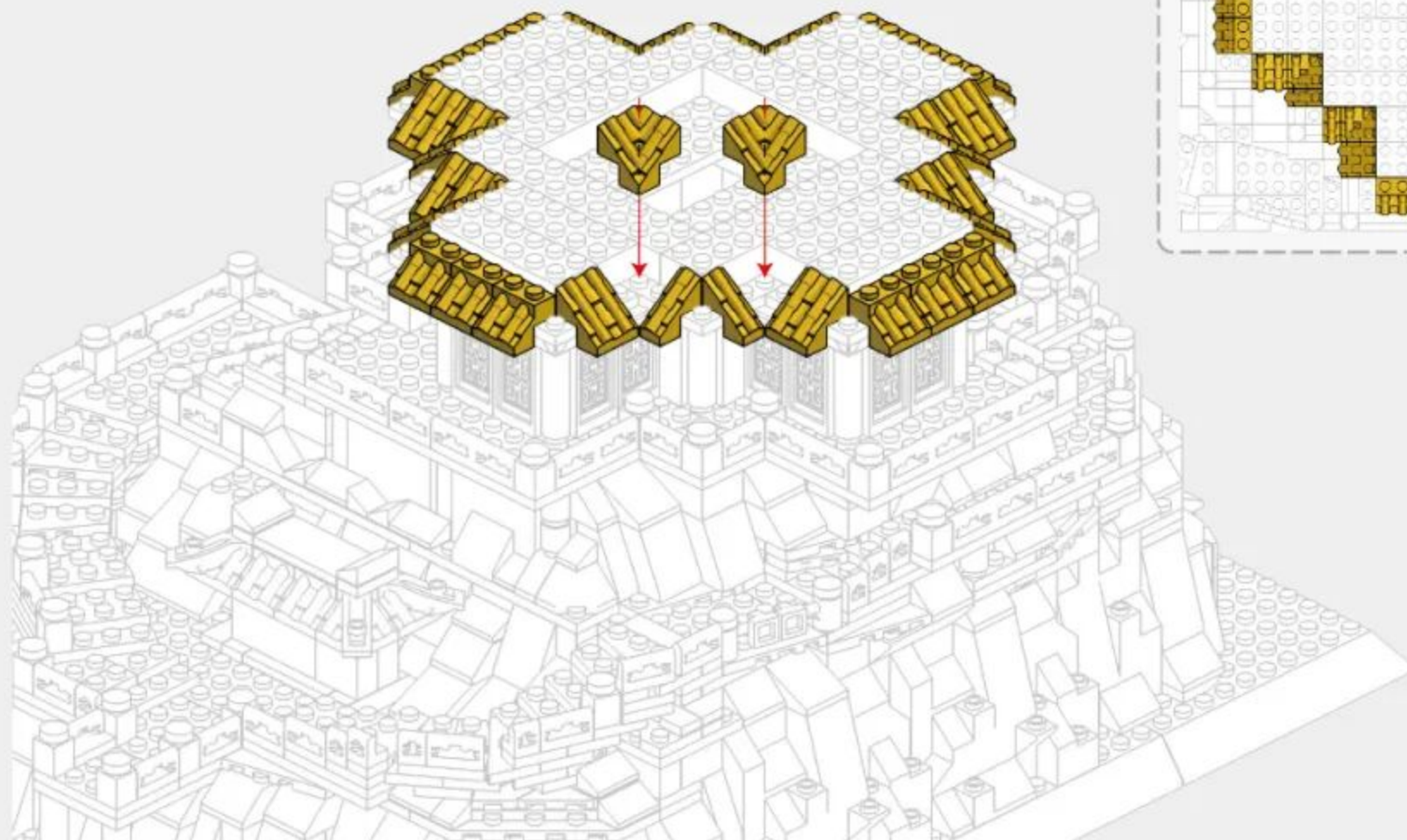

# 5-3

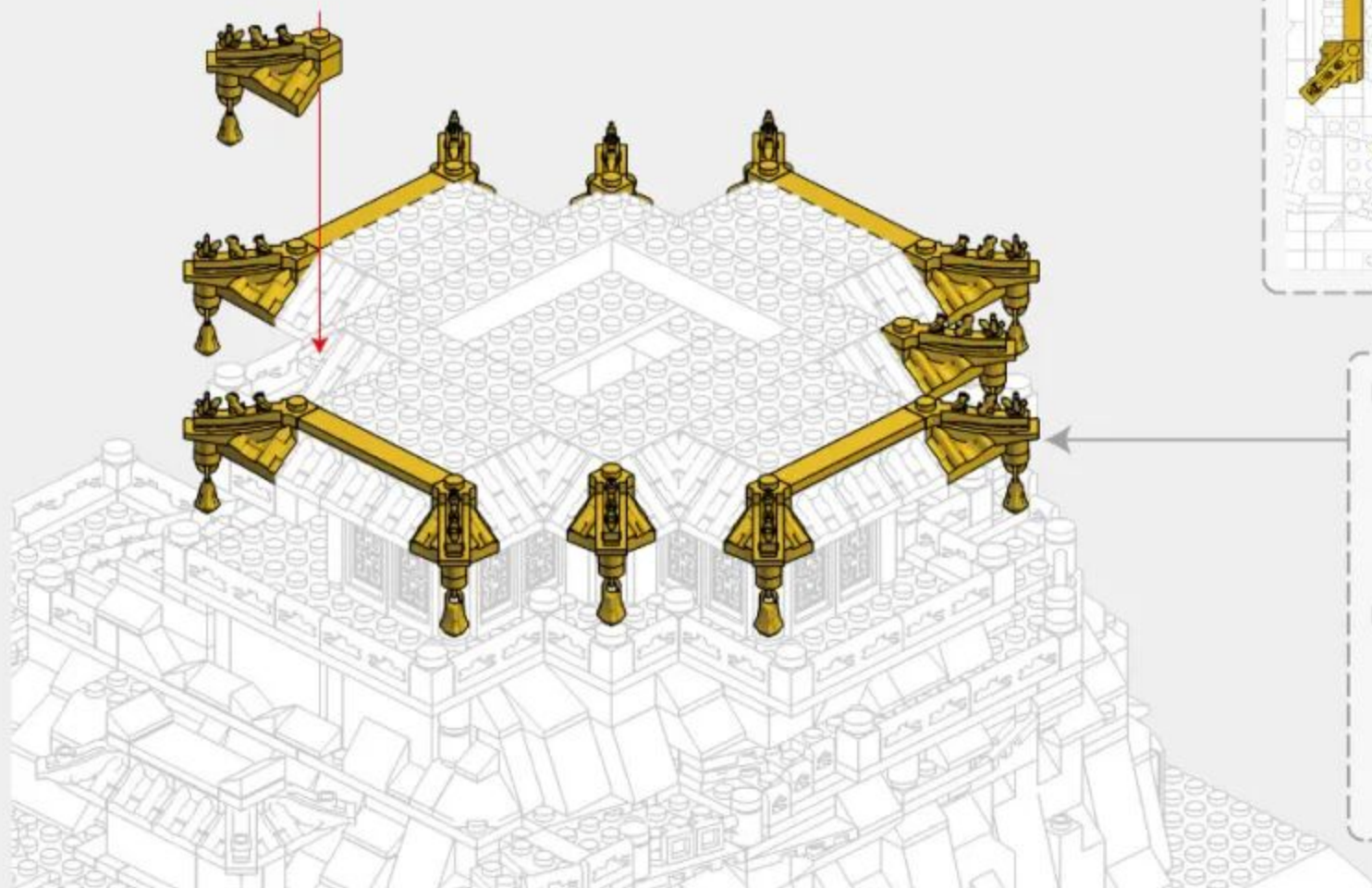

5-4

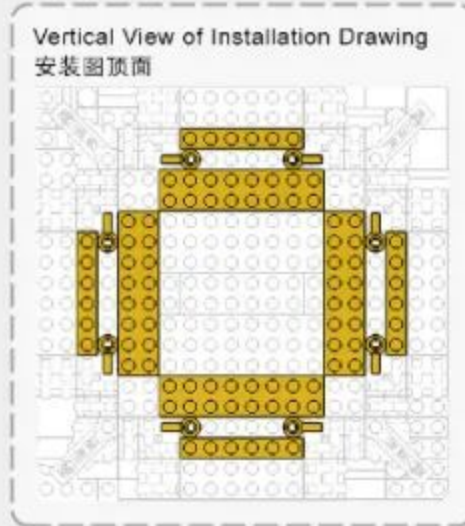
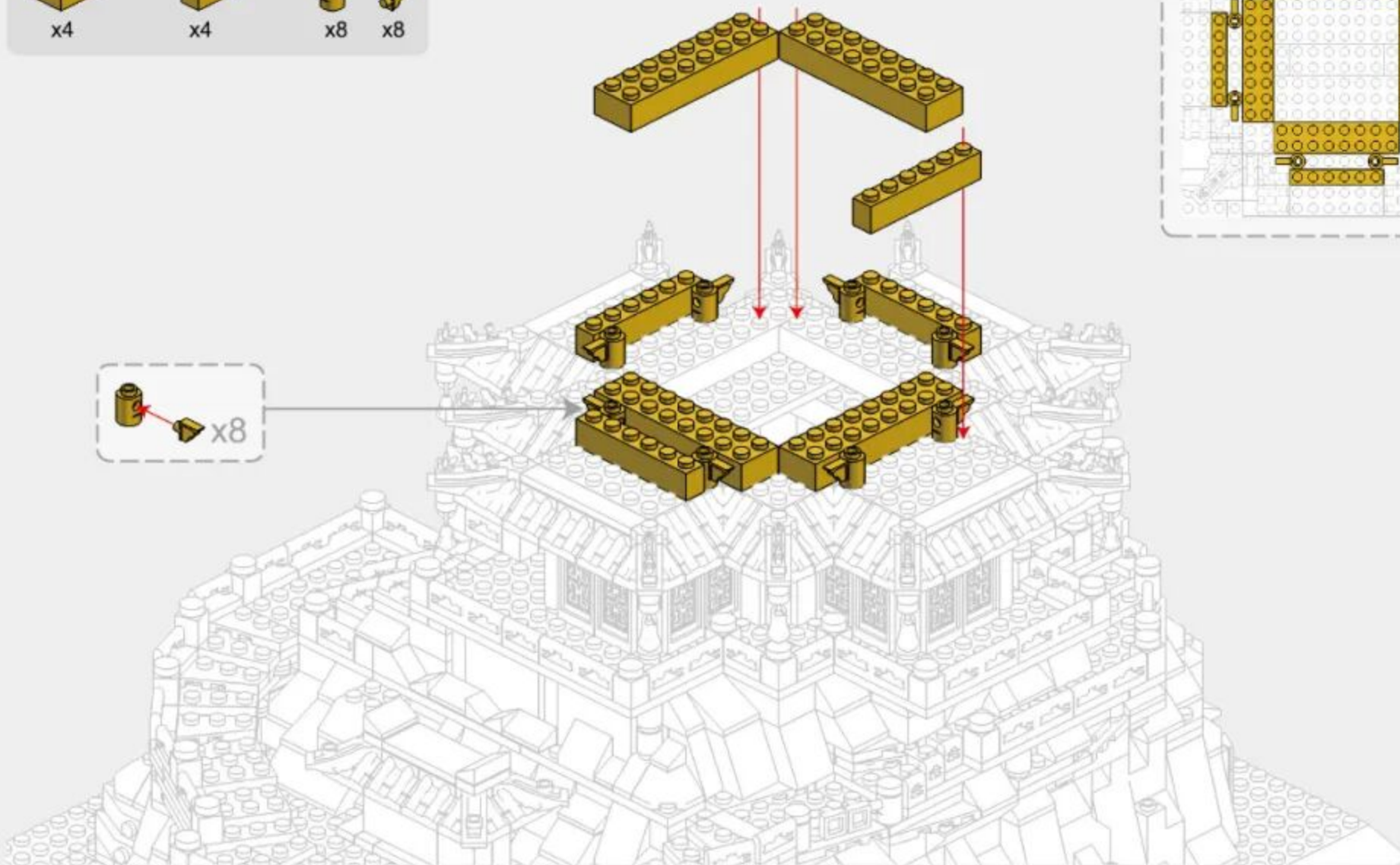
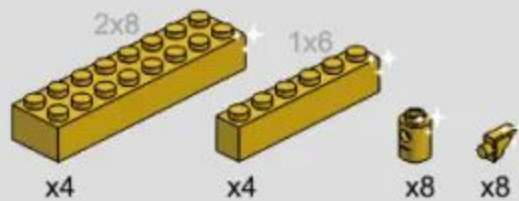

# 5-5

-  x1
-  x6
-  x36
-  x1
-  x36

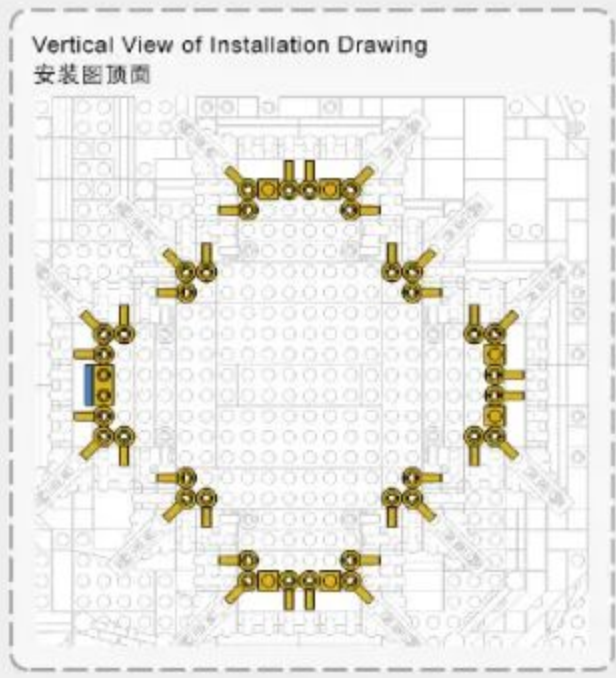
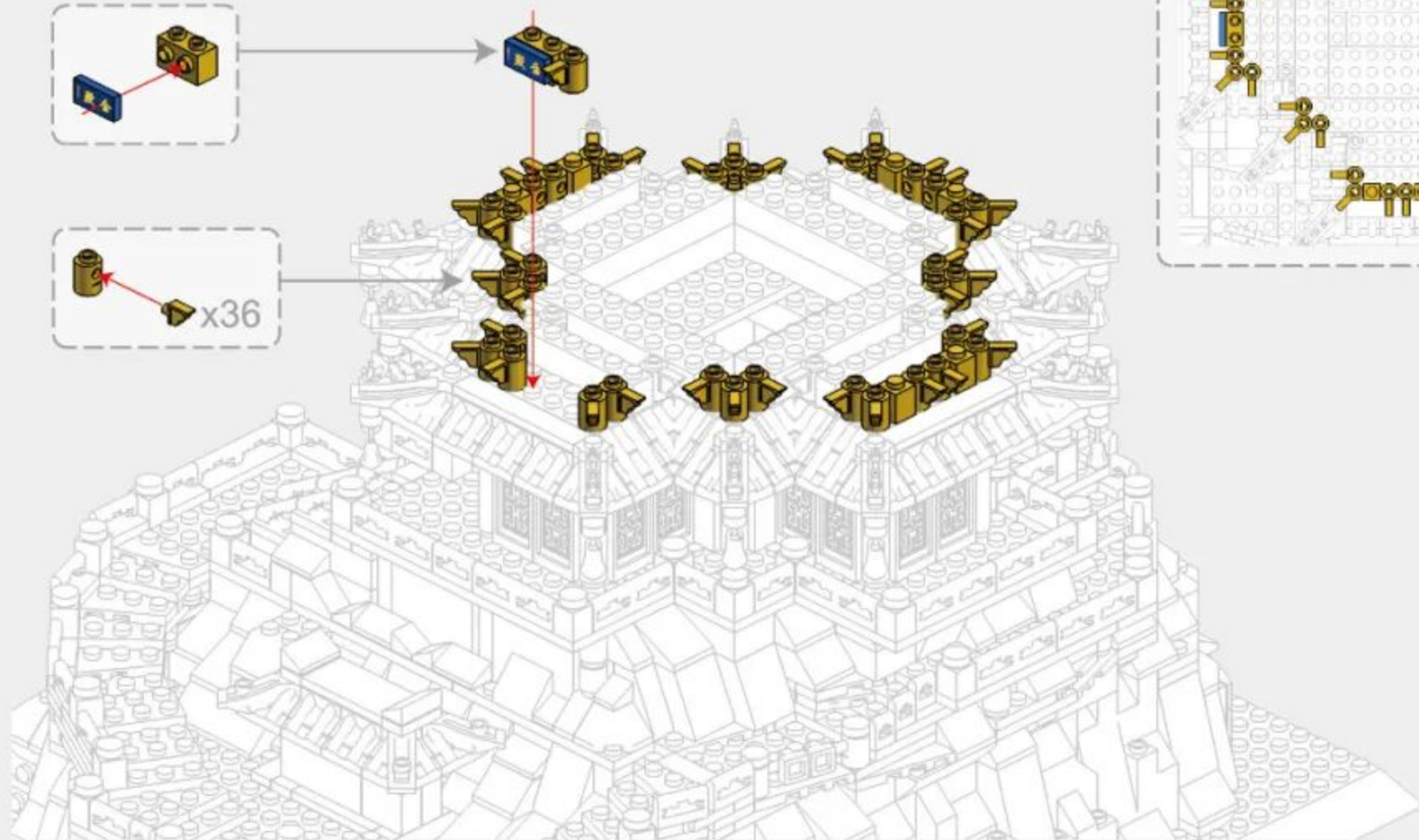
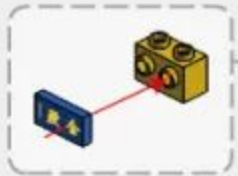



276PCS

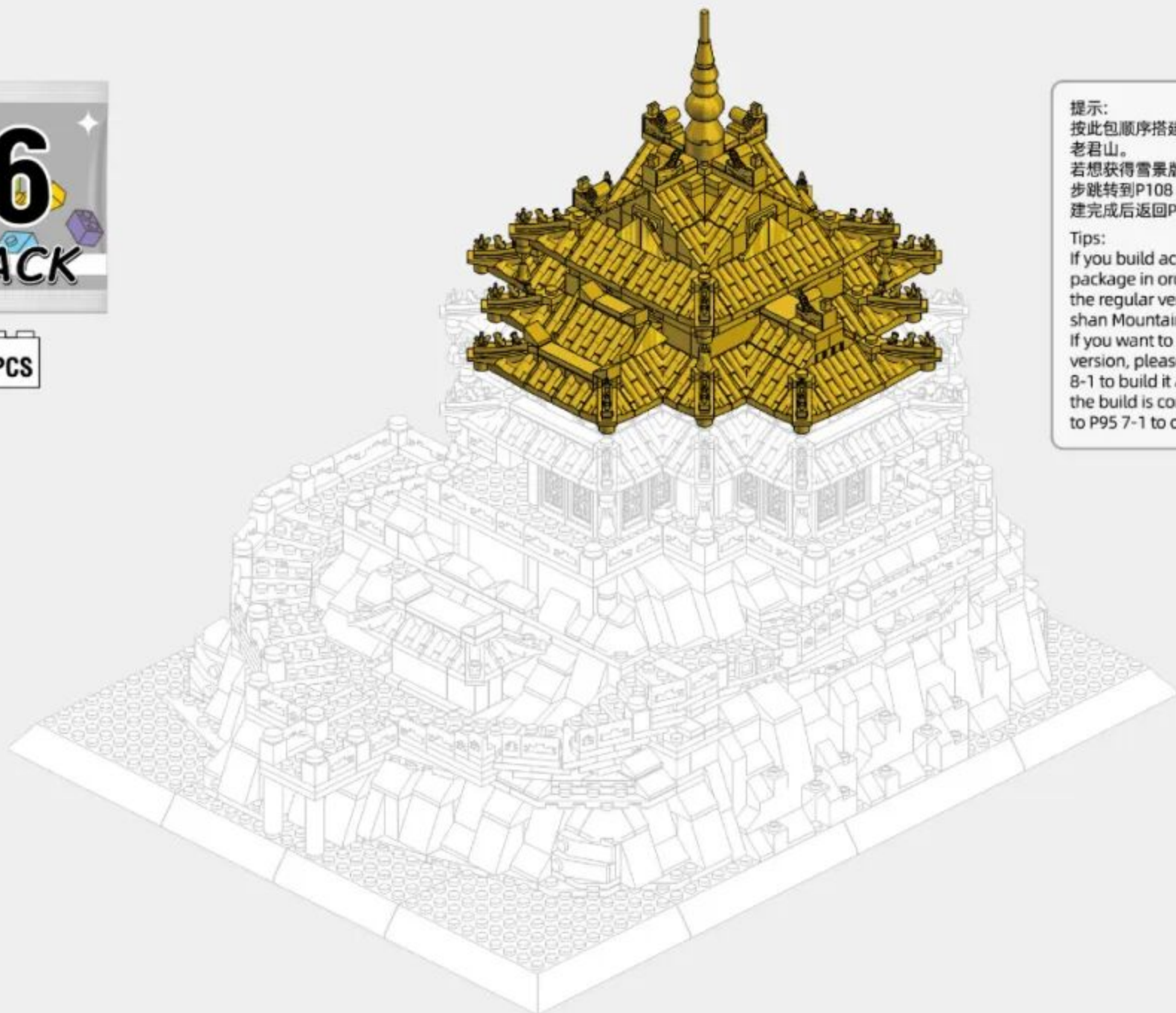

提示：  
按此包顺序搭建，将获得常规版老君山。  
若想获得雪景版老君山，请在此步跳转到P108 8-1进行搭建，搭建完成后返回P95 7-1 继续搭建！

Tips:  
If you build according to this package in order, you will get the regular version of Laojunshan Mountain.  
If you want to get the snow version, please jump to P108 8-1 to build it at this step. After the build is completed, return to P95 7-1 to continue building.

81



6-2

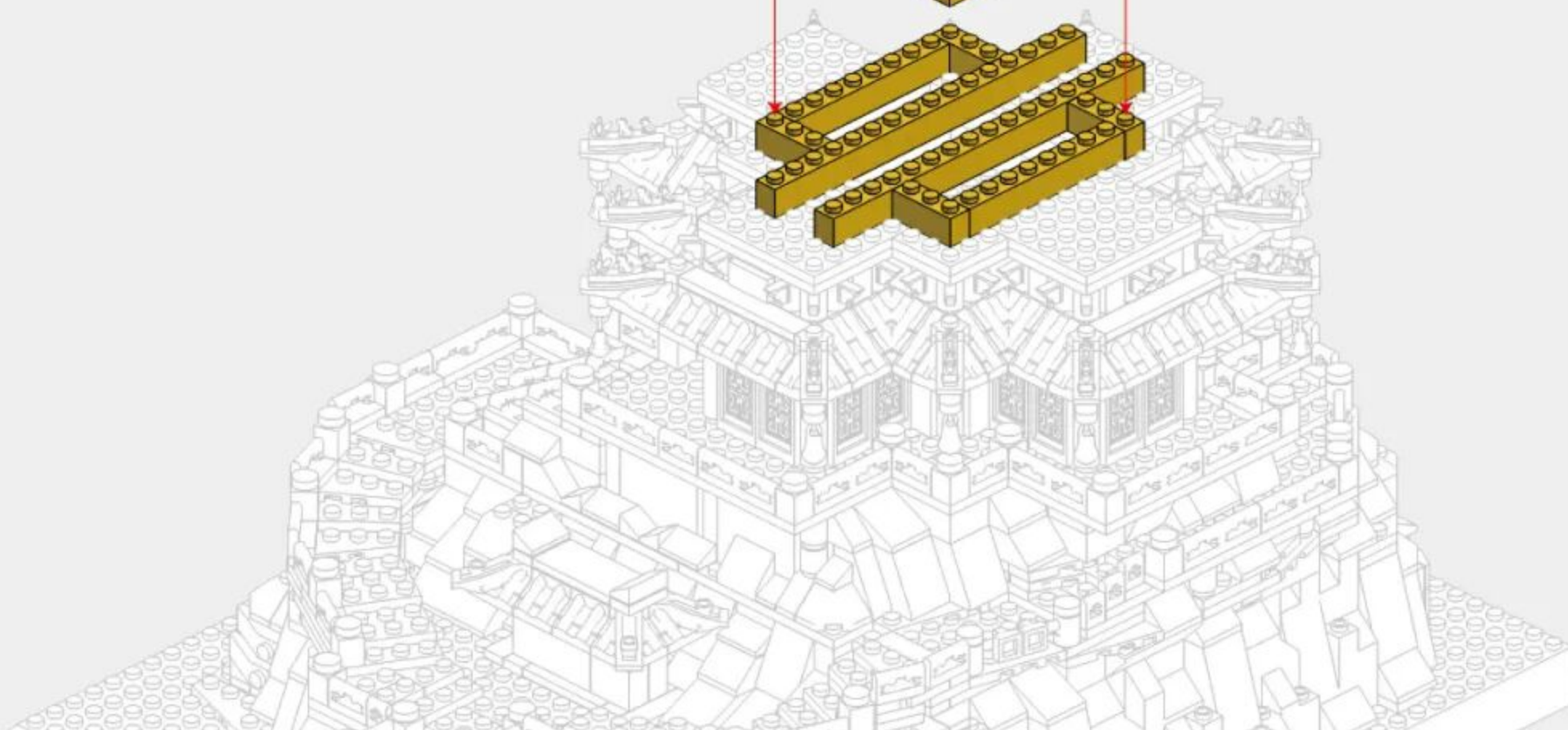
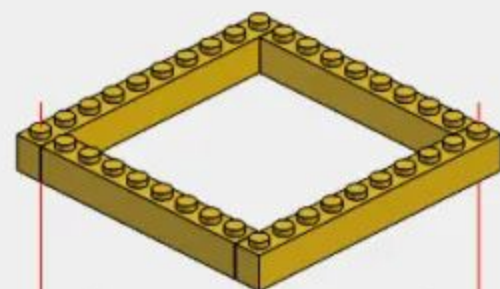
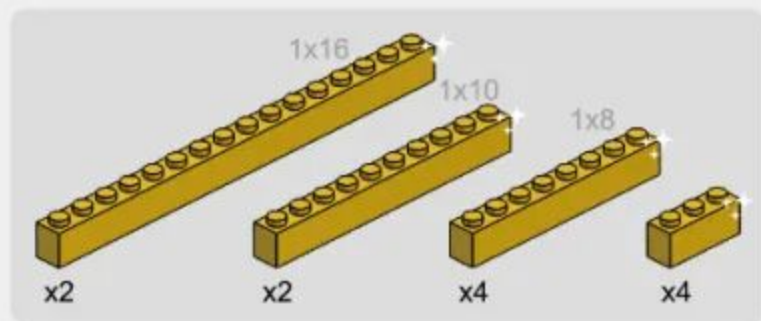

# 6-3

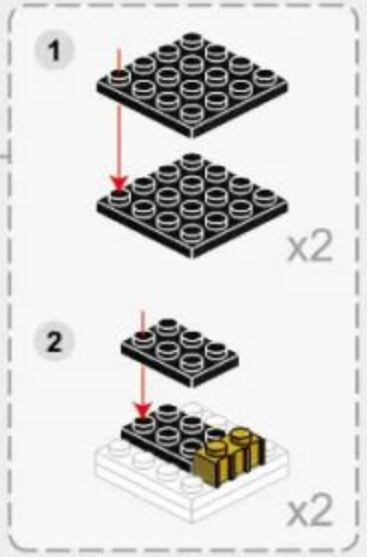
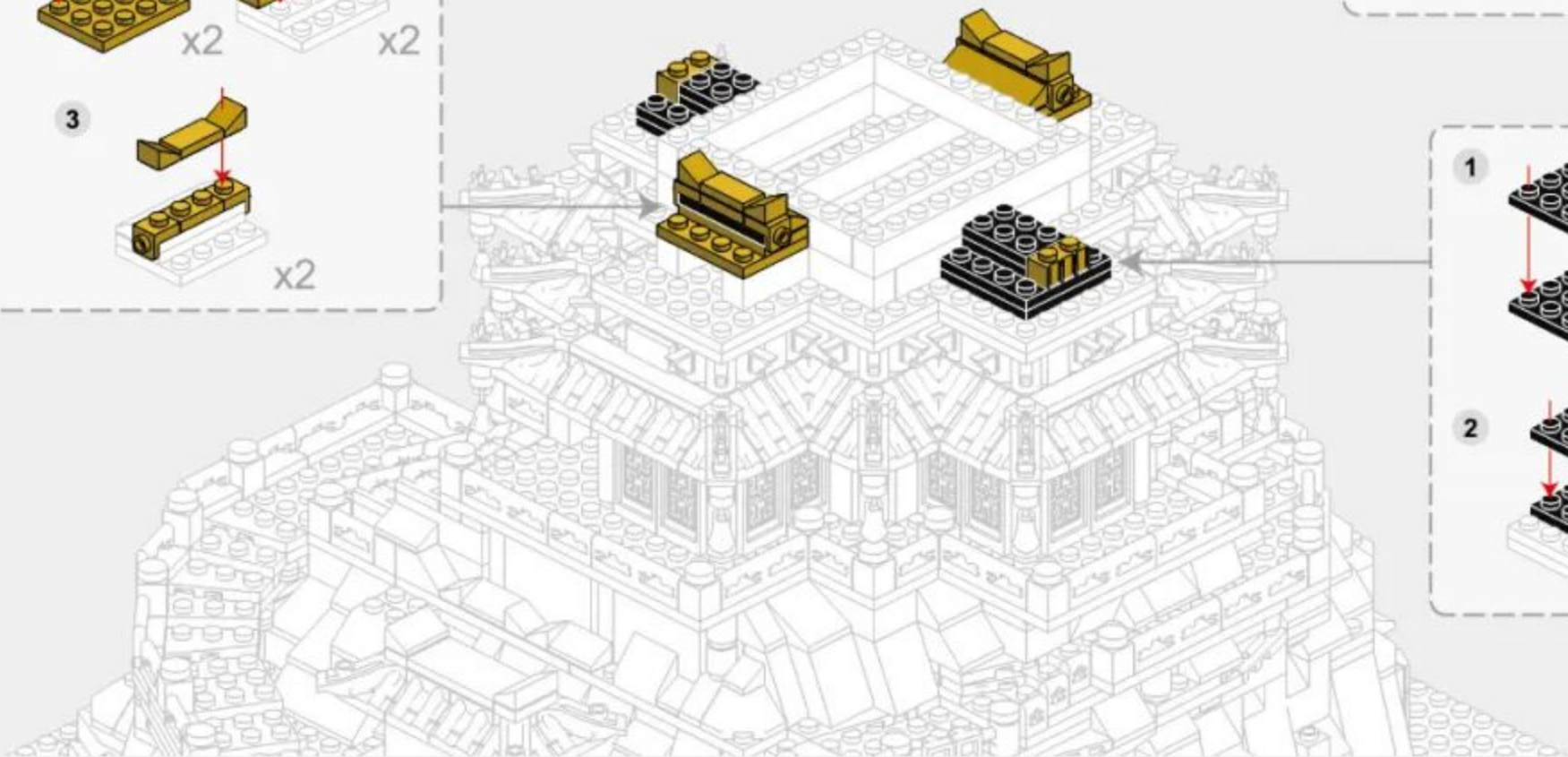
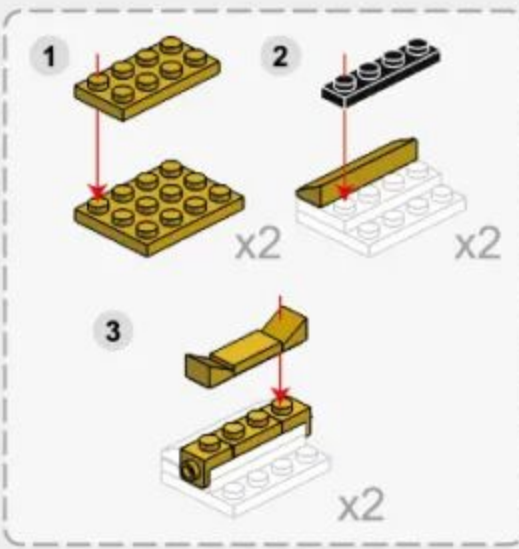
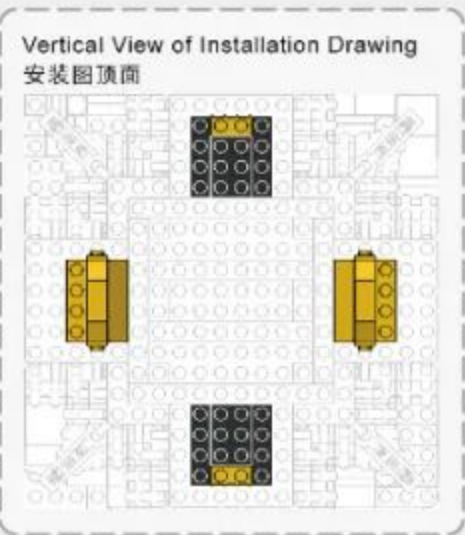
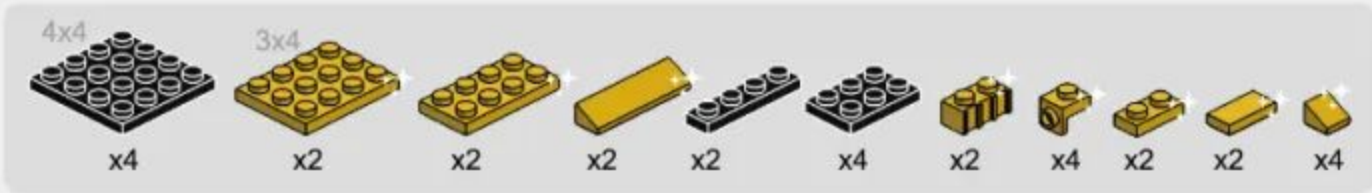

6-4

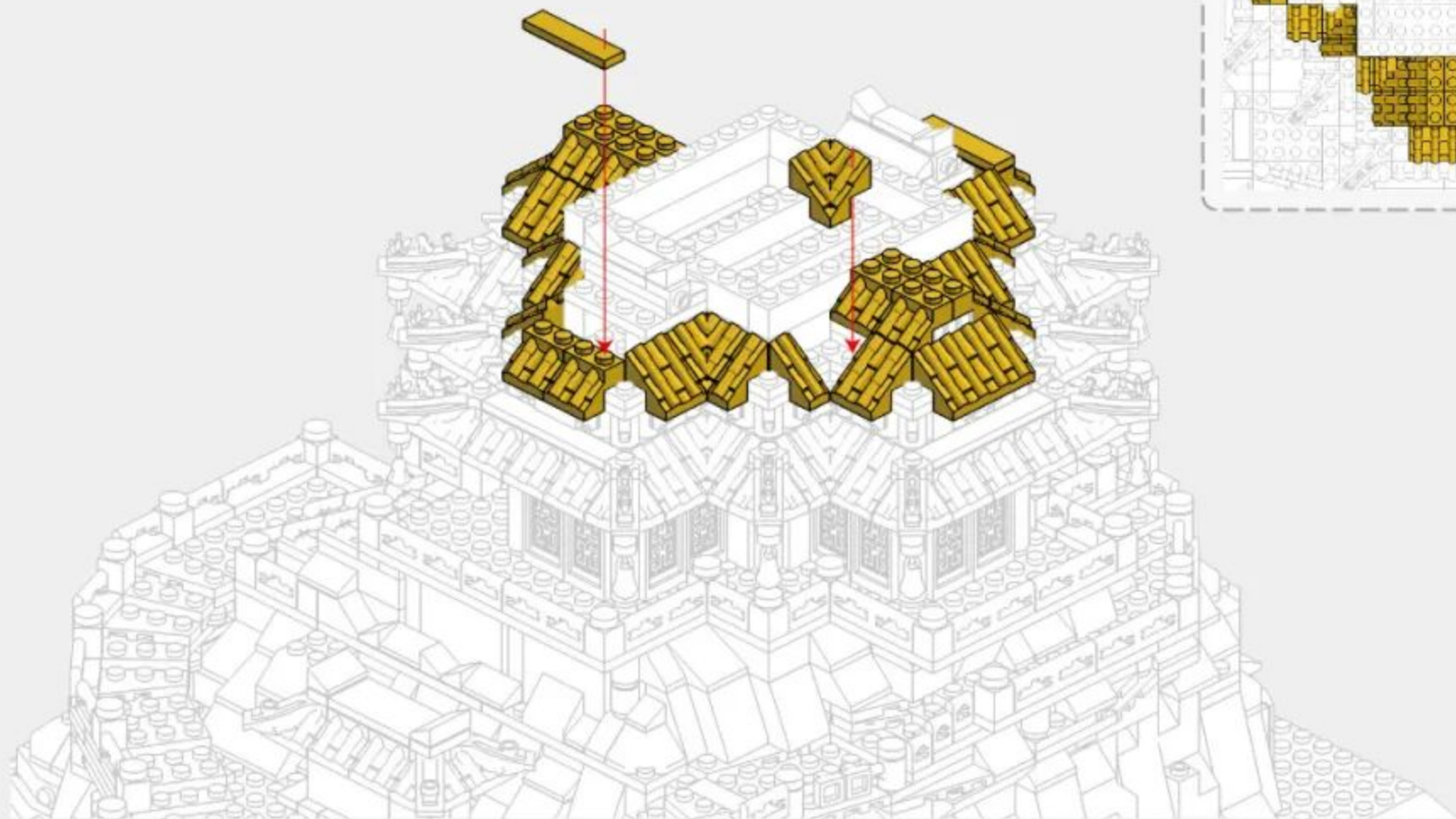

Vertical View of Installation Drawing  
安装图顶面

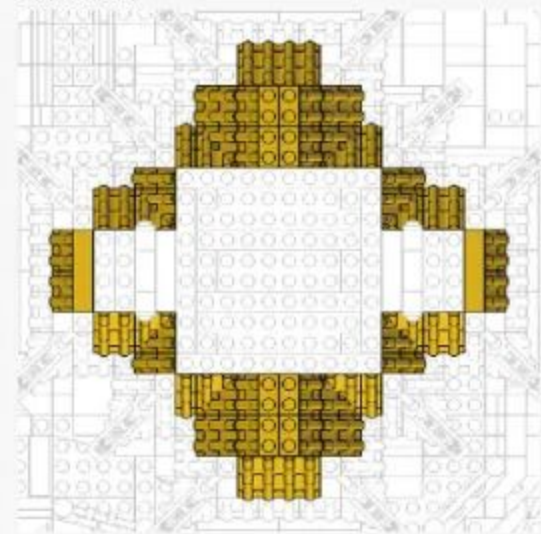

6-5

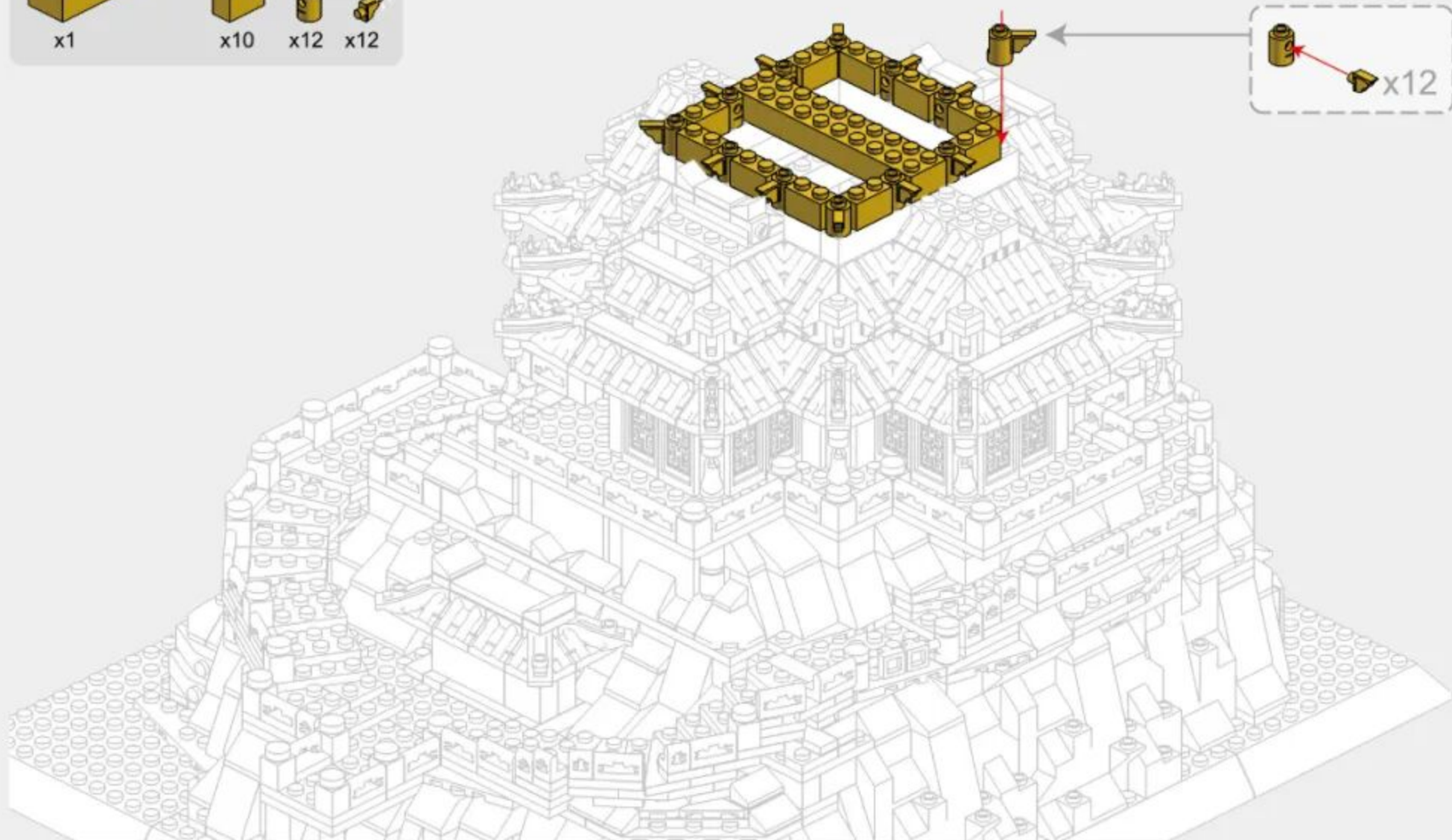
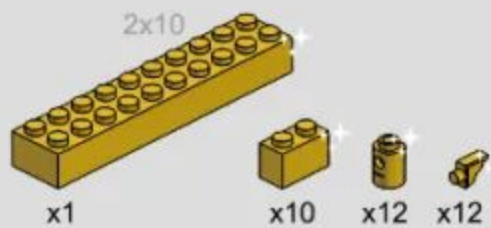

# 6-6

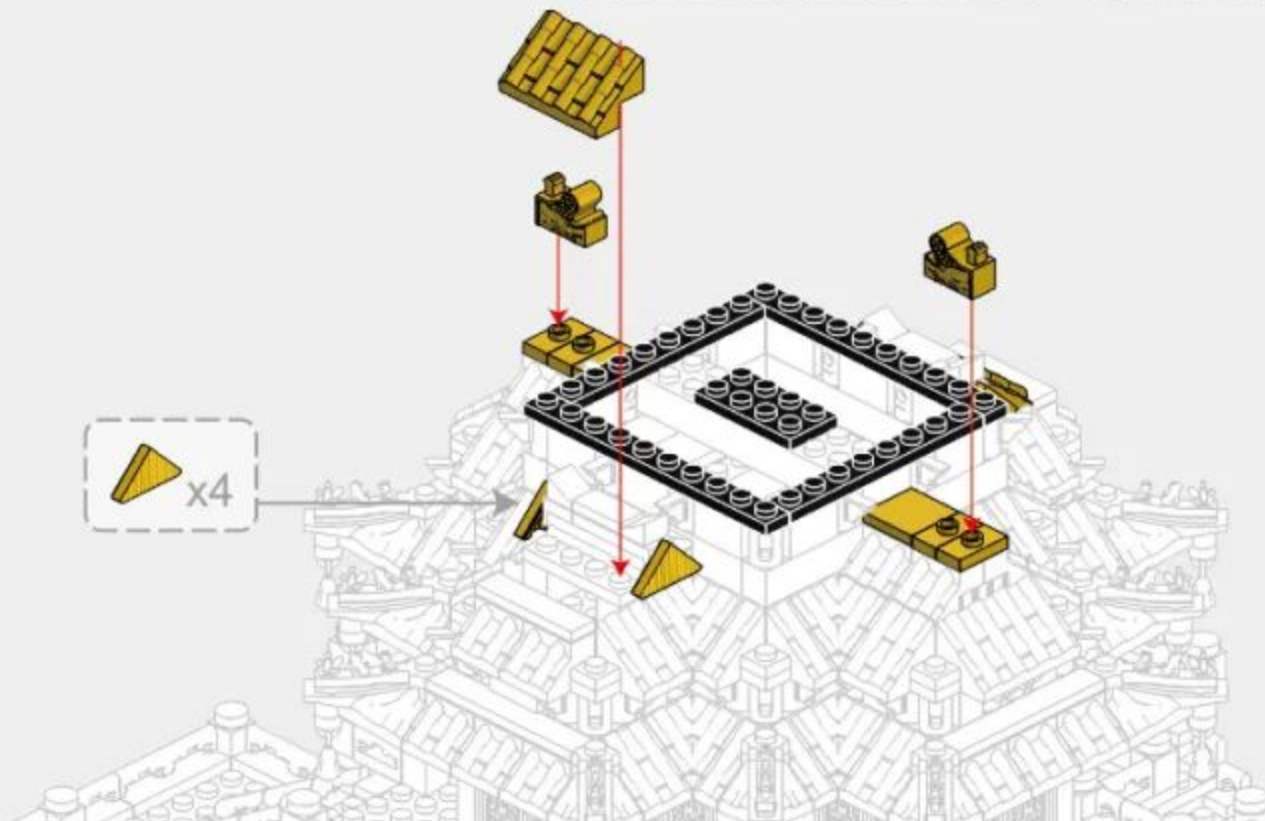
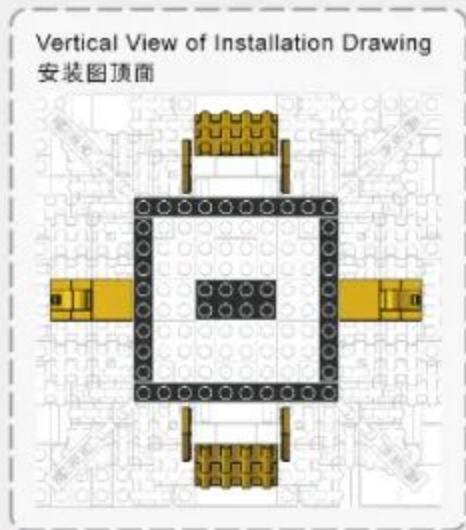

6-7

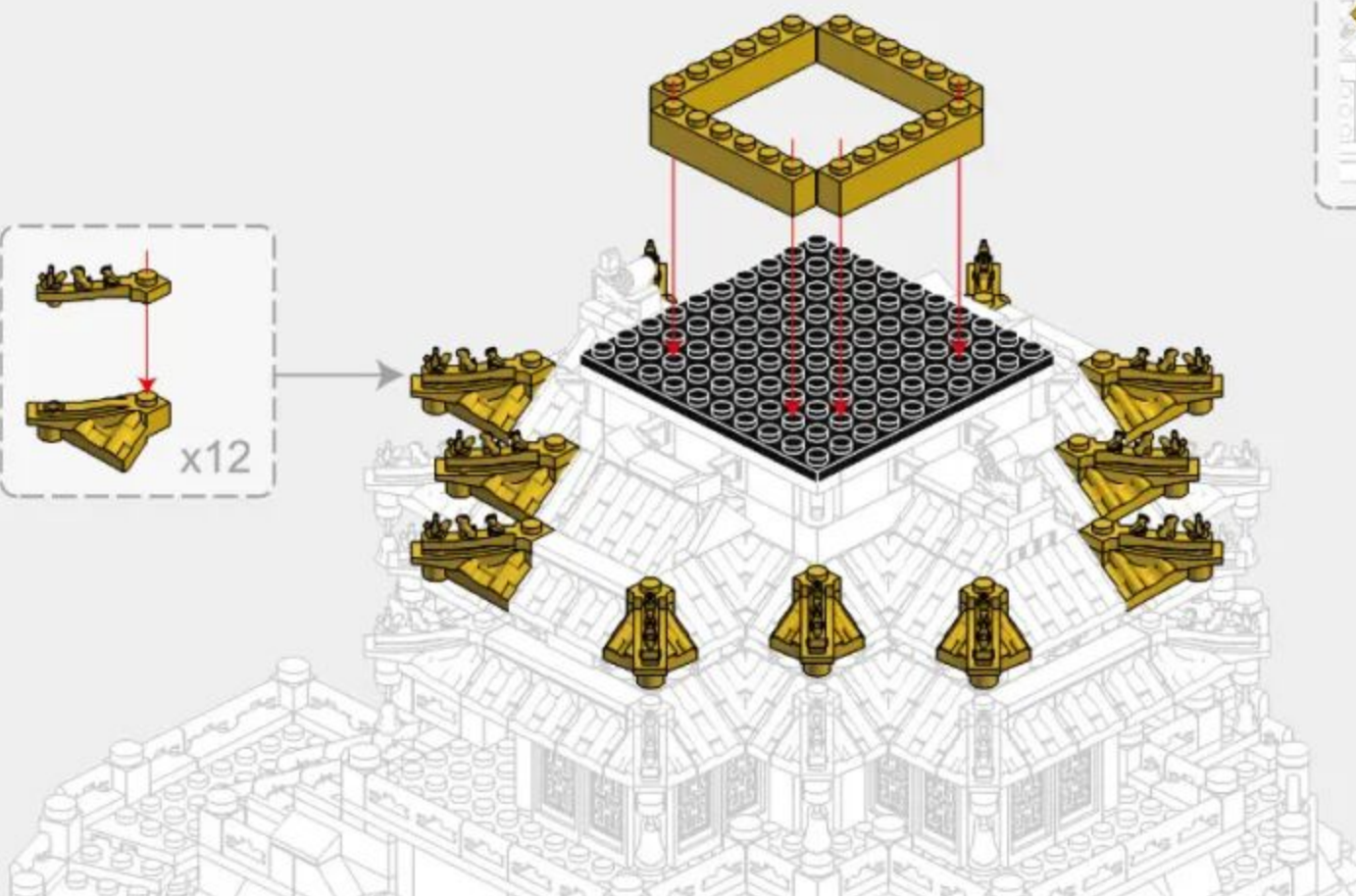
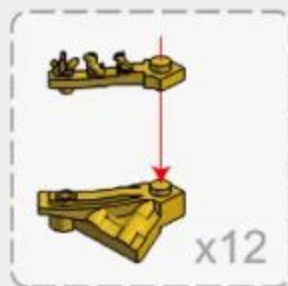
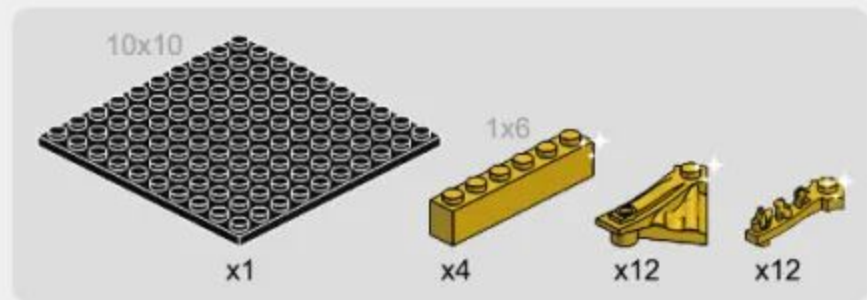

6-8

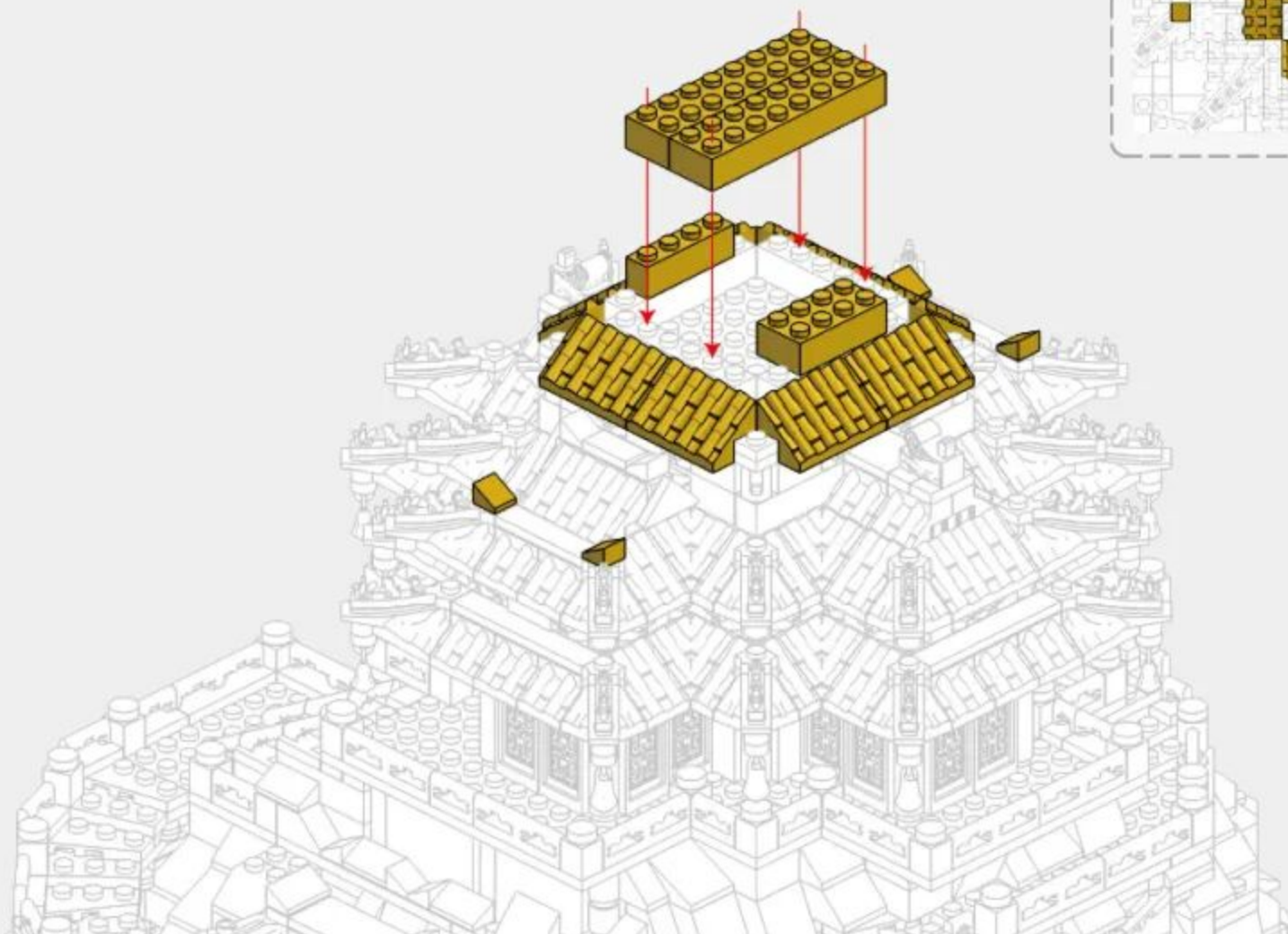

# 6-9

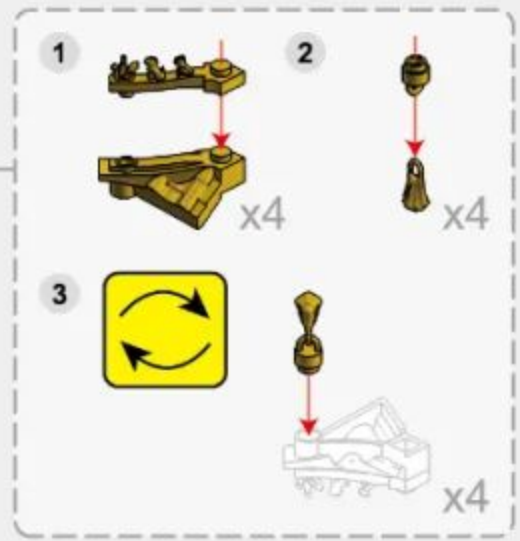
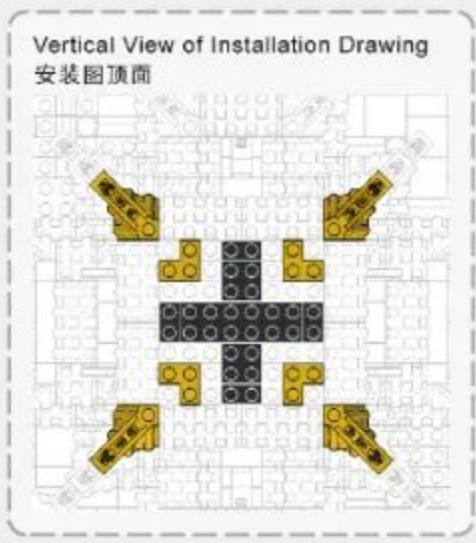

6-10

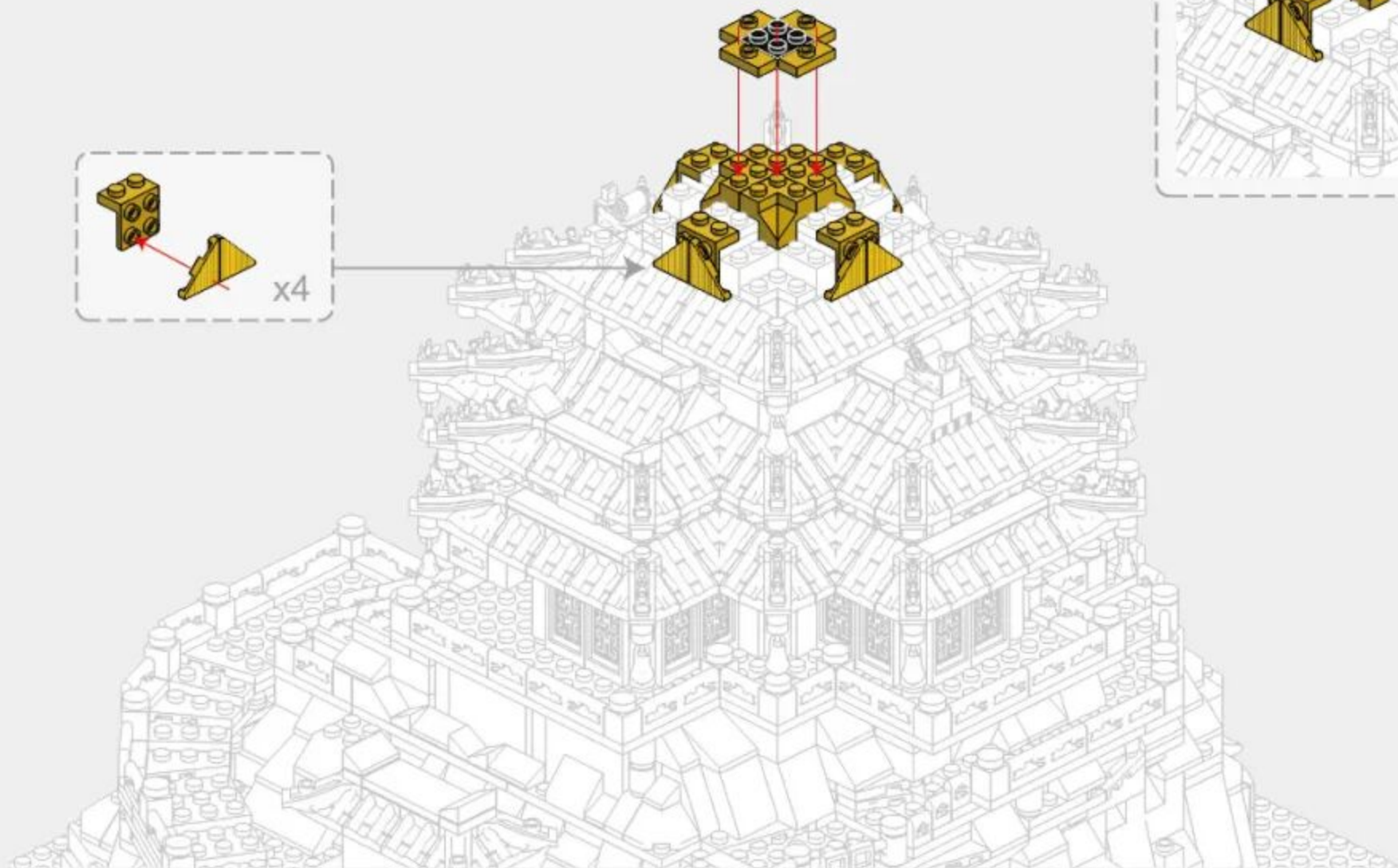
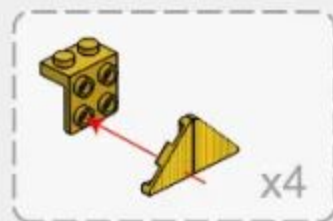

Back Side of Installation Drawing  
安装图背面



6-11



x4



x8



x1

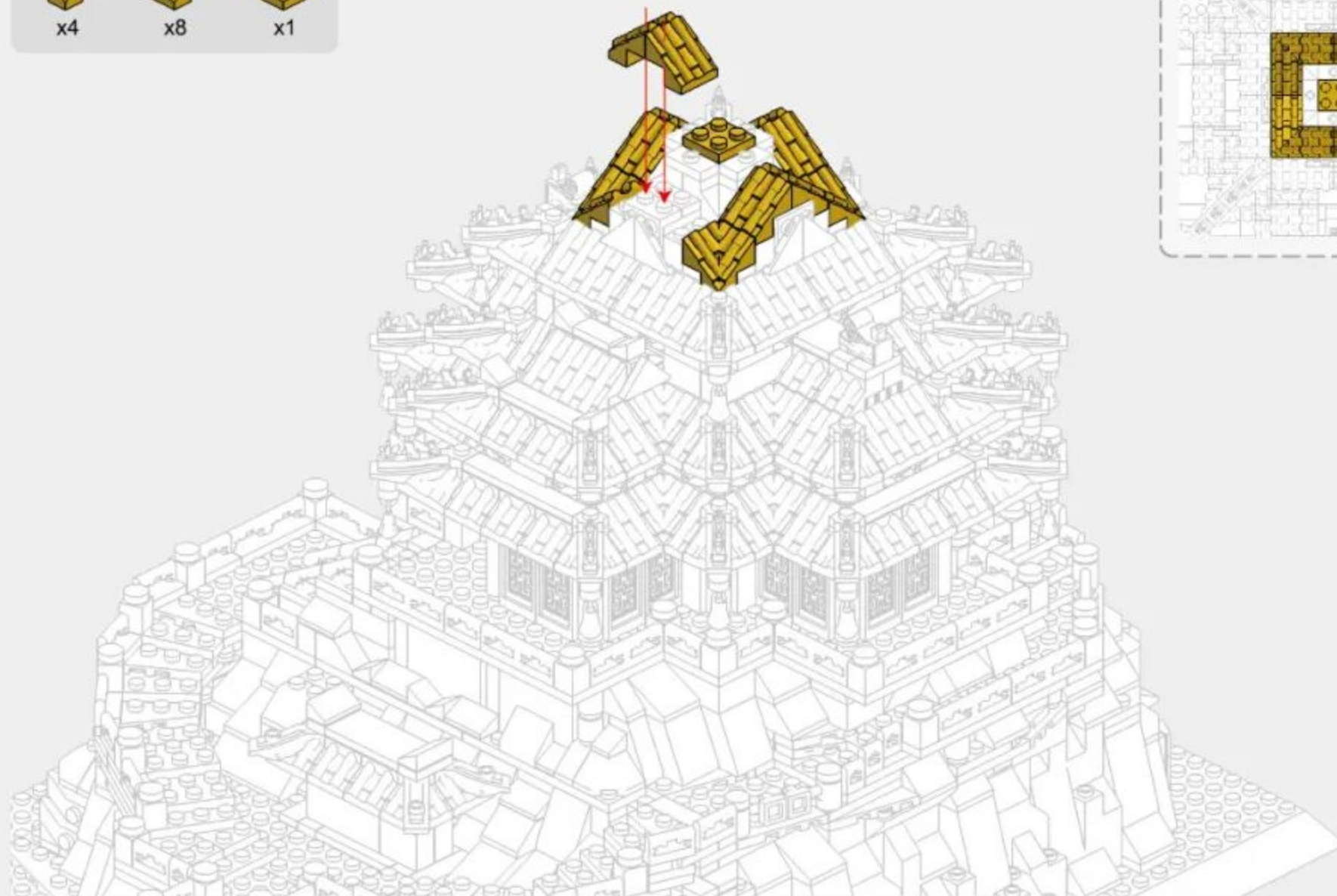

Vertical View of Installation Drawing  
安装图顶面

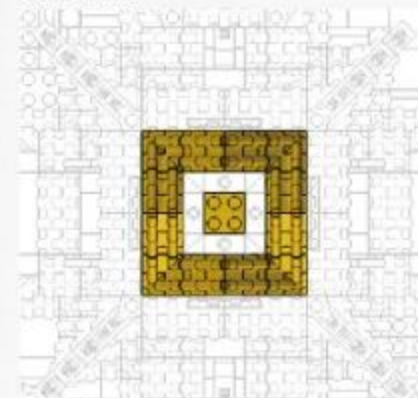

6-12

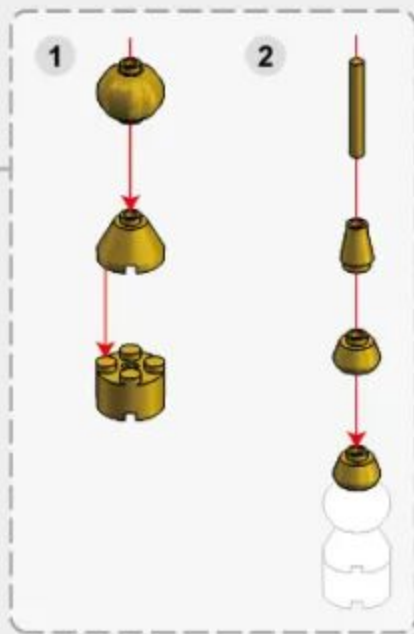
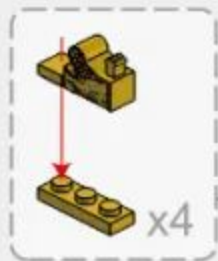



144PCS



94

7-1



7-2



1



2



3

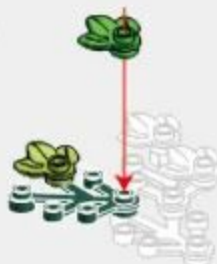

4



5

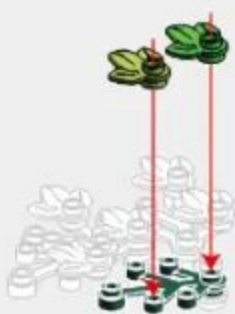

6

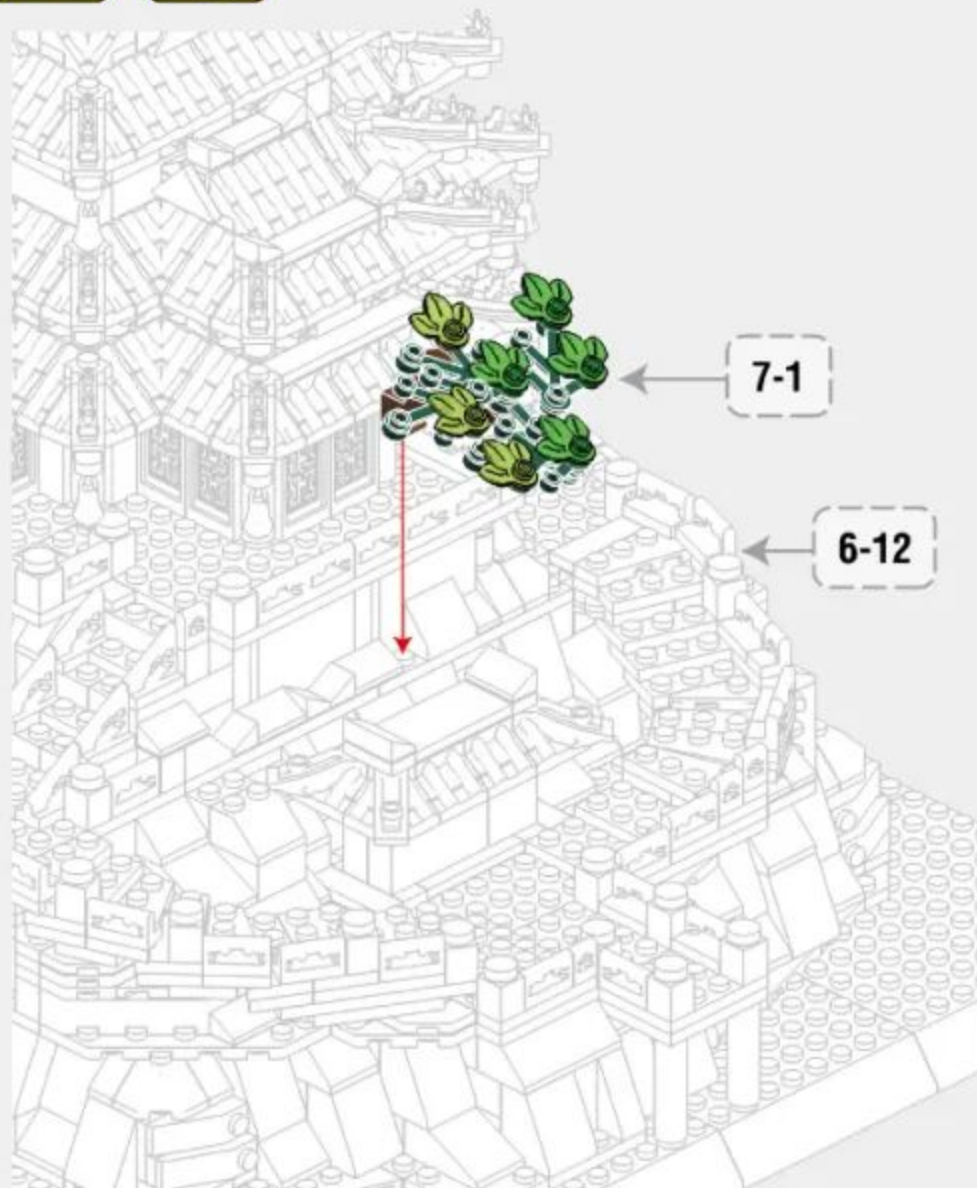

# 7-3

x1 x5 x1 x1 x5 x4 x1



1



2

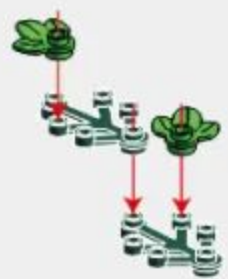

3



4



5

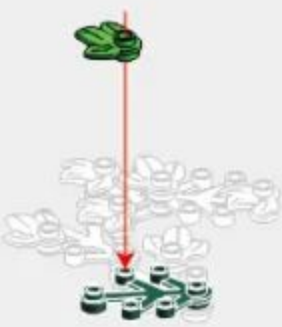

6

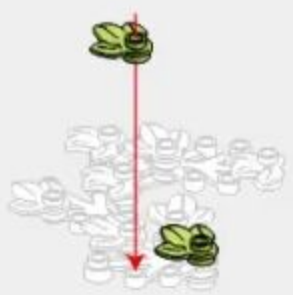



7



7-4



# 7-5

-  x4
-  x1
-  x3
-  x5
-  x1



# 7-6

-  x4

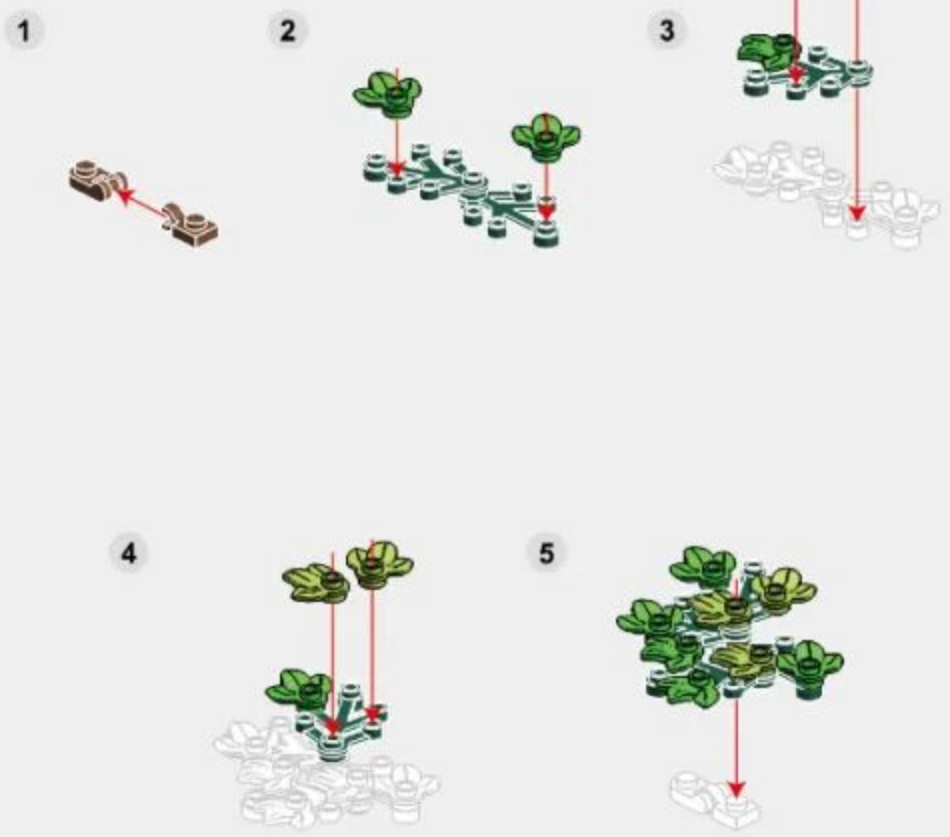

7-7



7-8



1



2



3



4

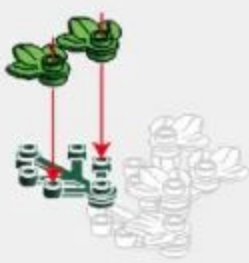

5

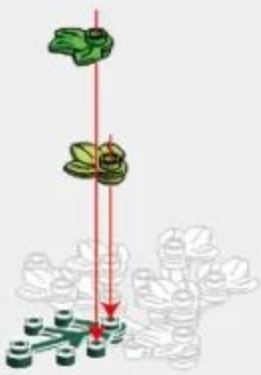

6

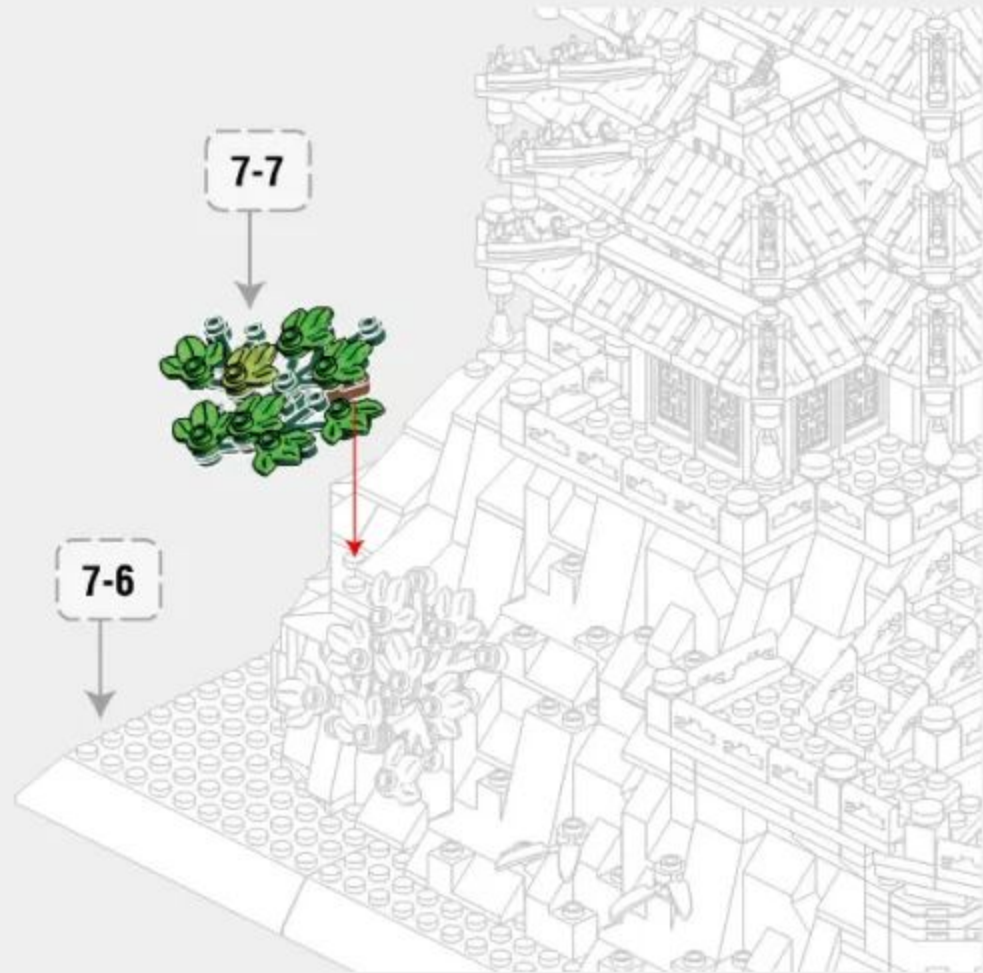

7-9



x4



x1



x3



x5



x1



7-10



1



2



3

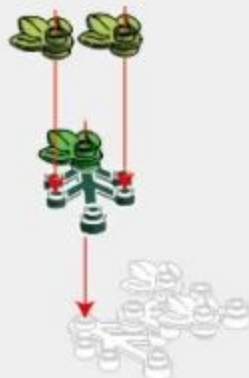

4

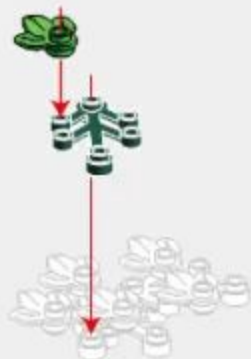

5

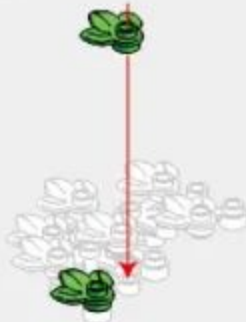

6



7-11



7-12



1



2

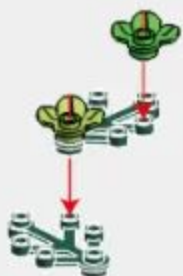

3

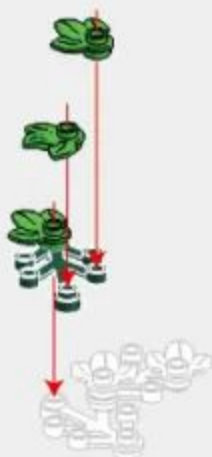

4

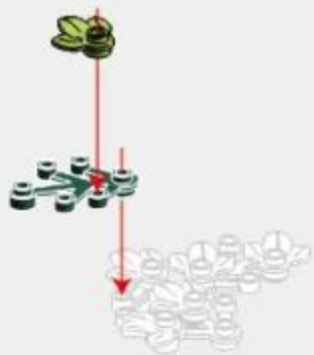

5



7-11

7-10

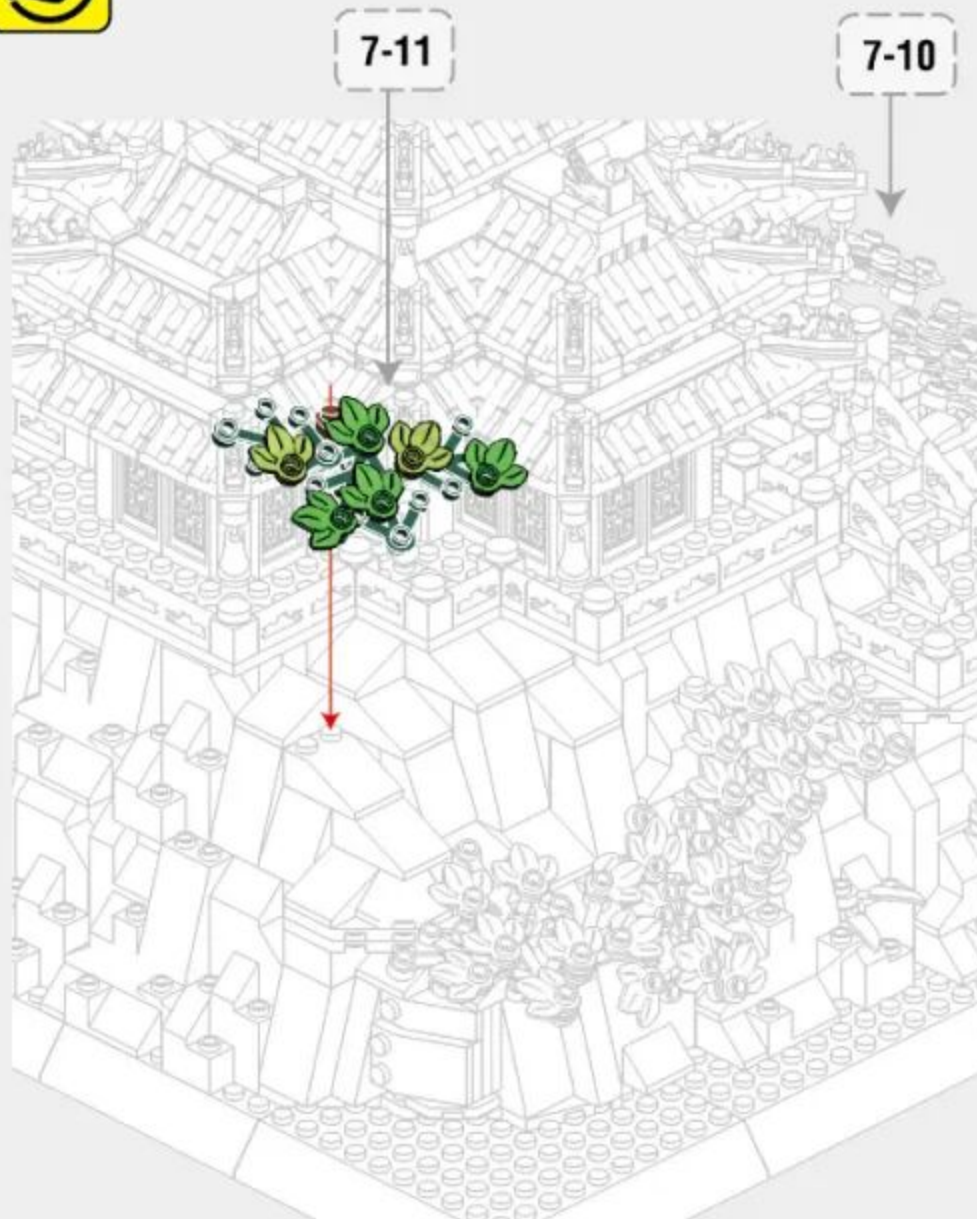

# 7-13





 x5  
 x1  
 x2  
 x4  
 x1  

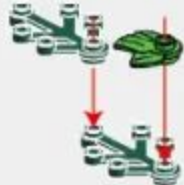

# 7-14

 x2  

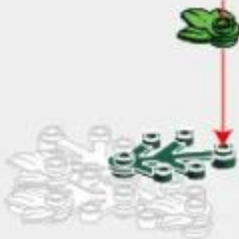
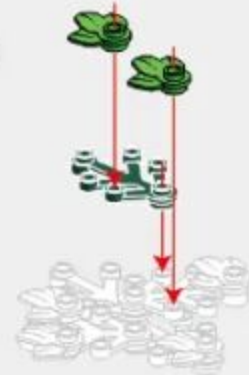

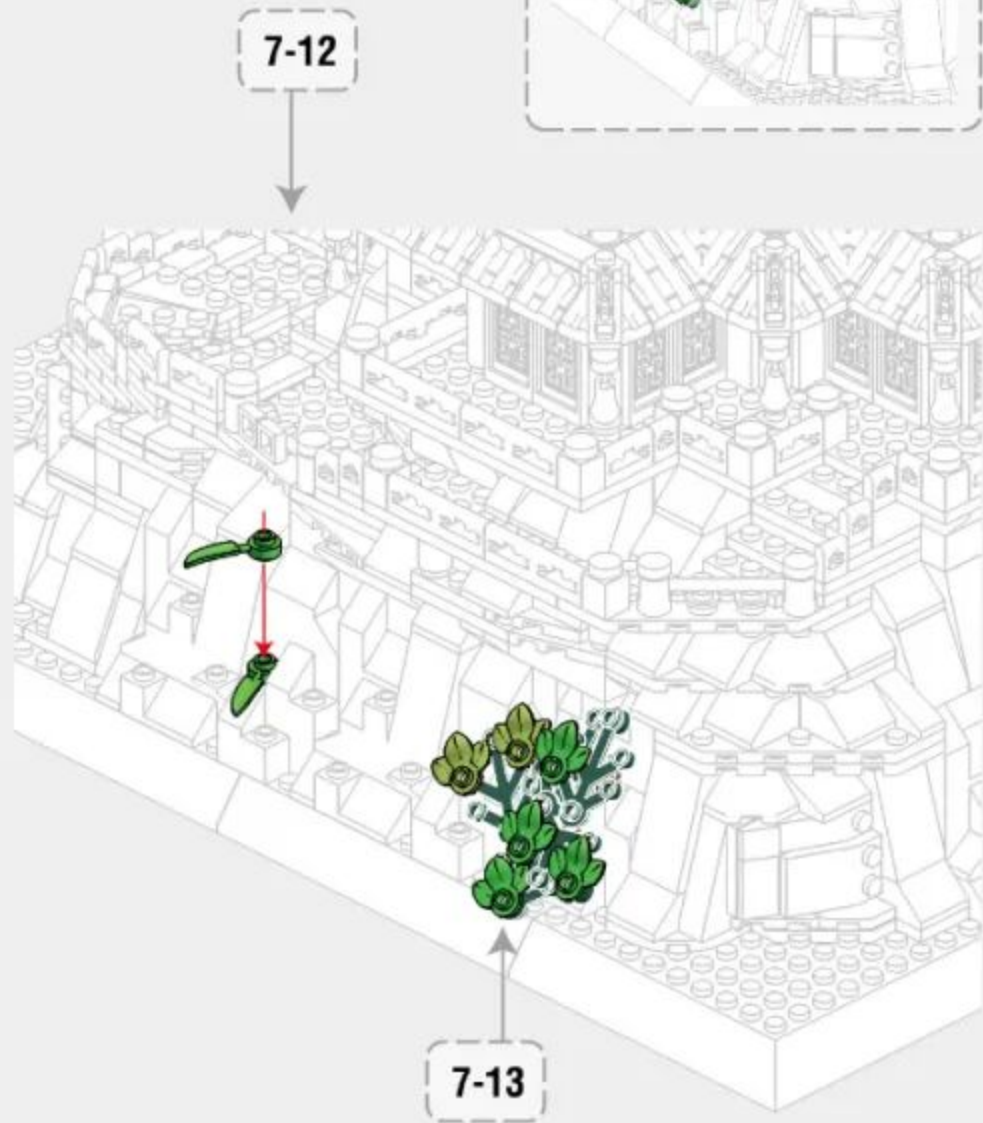

- 1 
- 2 
- 3 
- 4 
- 5 
- 6 



7-15



x4



x1



x3



x4



x1



7-16



1



2

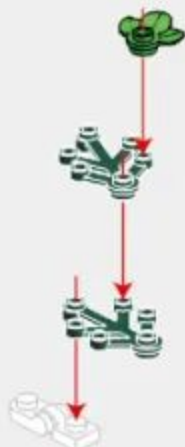

3



4



5

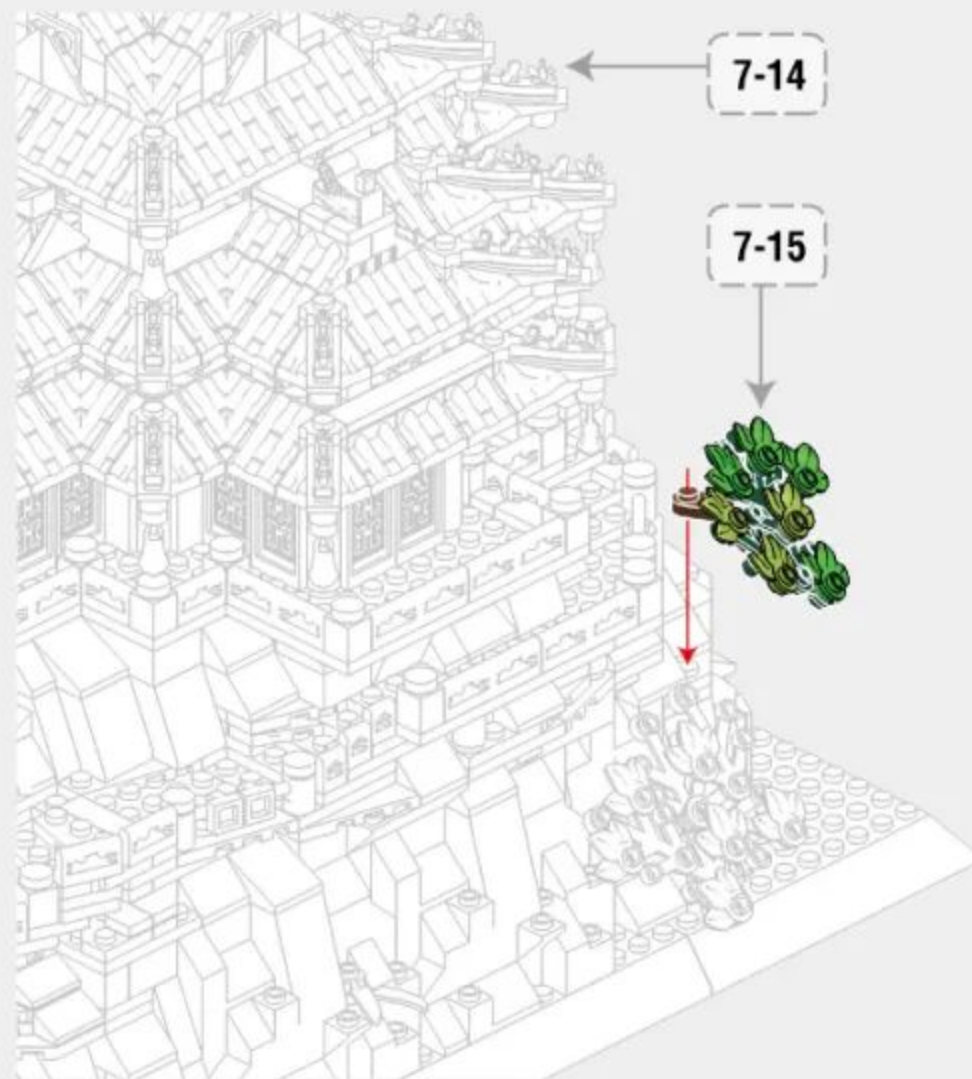
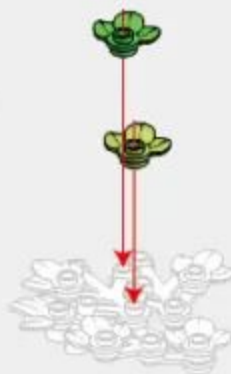

7-17

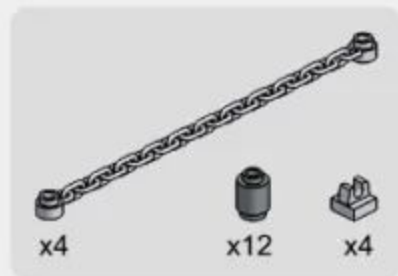

Vertical View of Installation Drawing  
安装图顶面

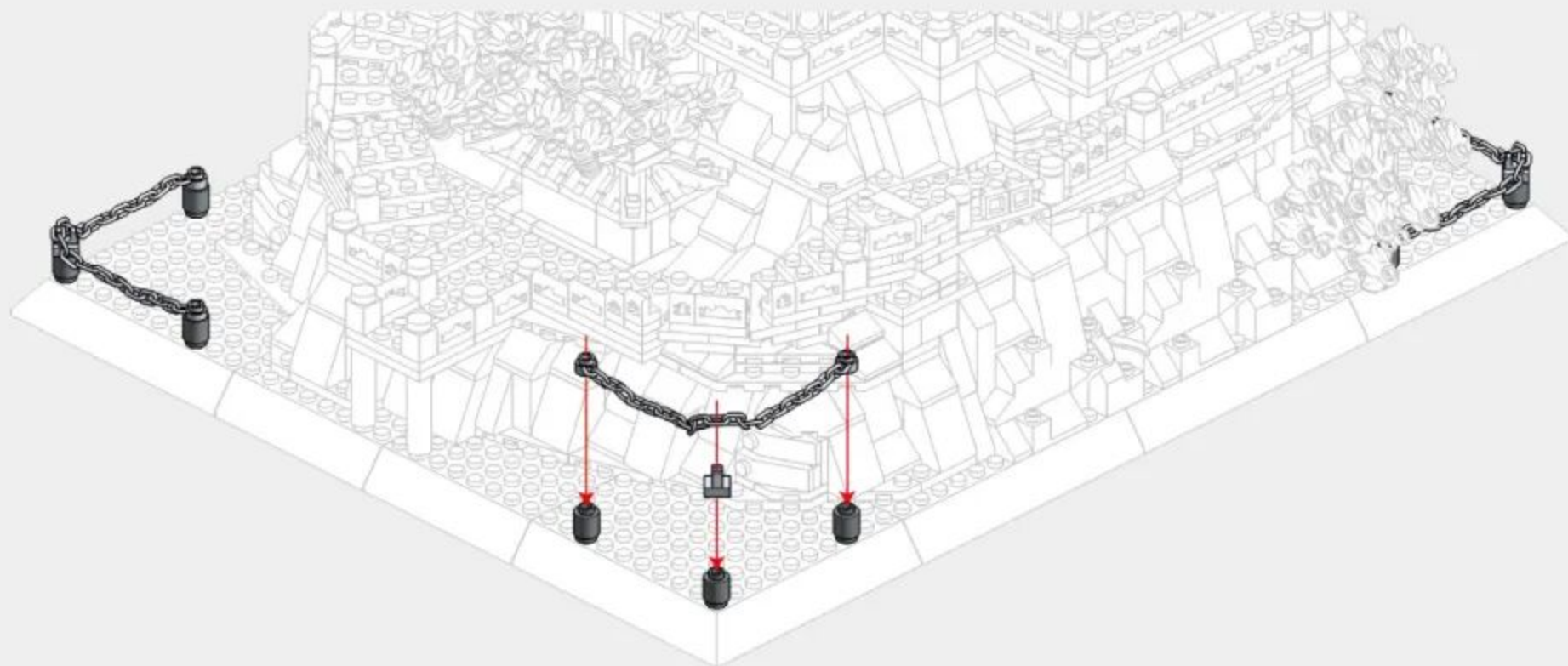
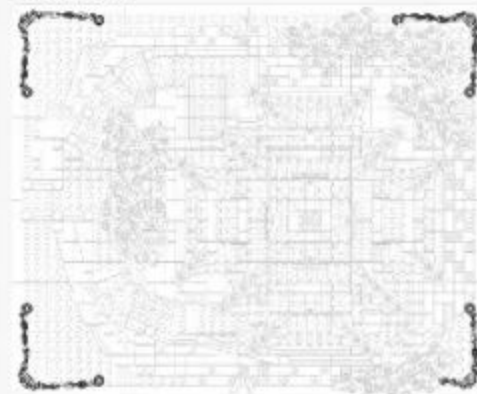

# 7-18

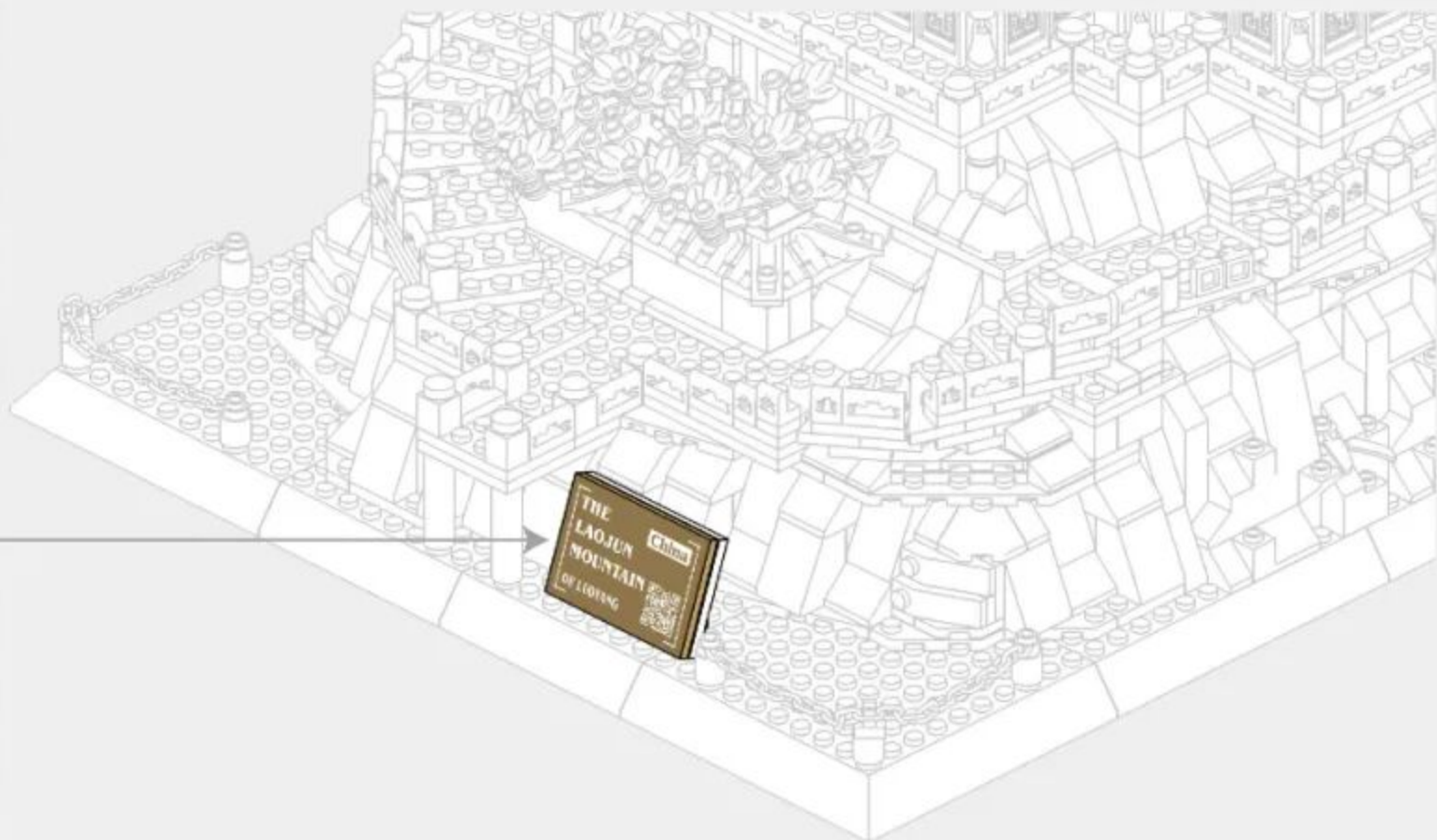
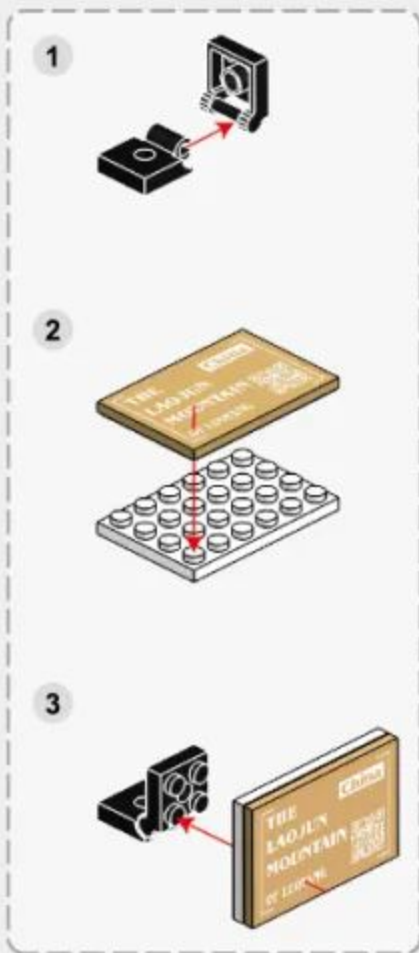
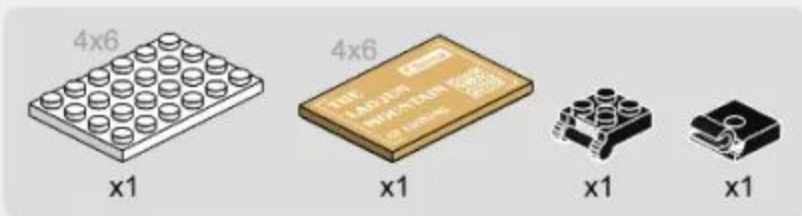





276PCS

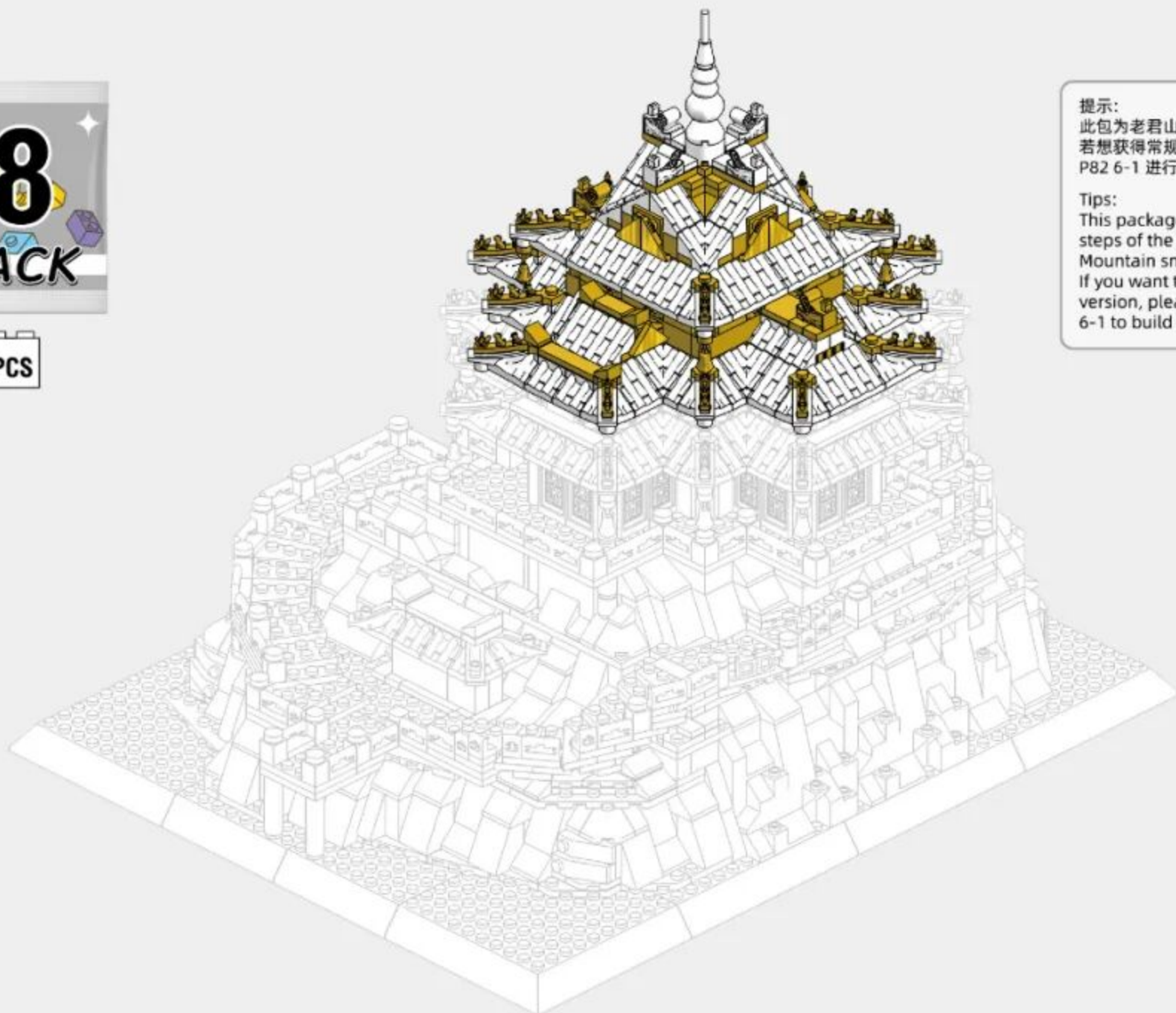

提示：  
此包为老君山雪景版搭建步骤。  
若想获得常规版老君山，请返回  
P82 6-1 进行搭建！

Tips:  
This package is the assembly  
steps of the Laojunshan  
Mountain snow version.  
If you want to get the regular  
version, please return to P82  
6-1 to build it.

107

8-1

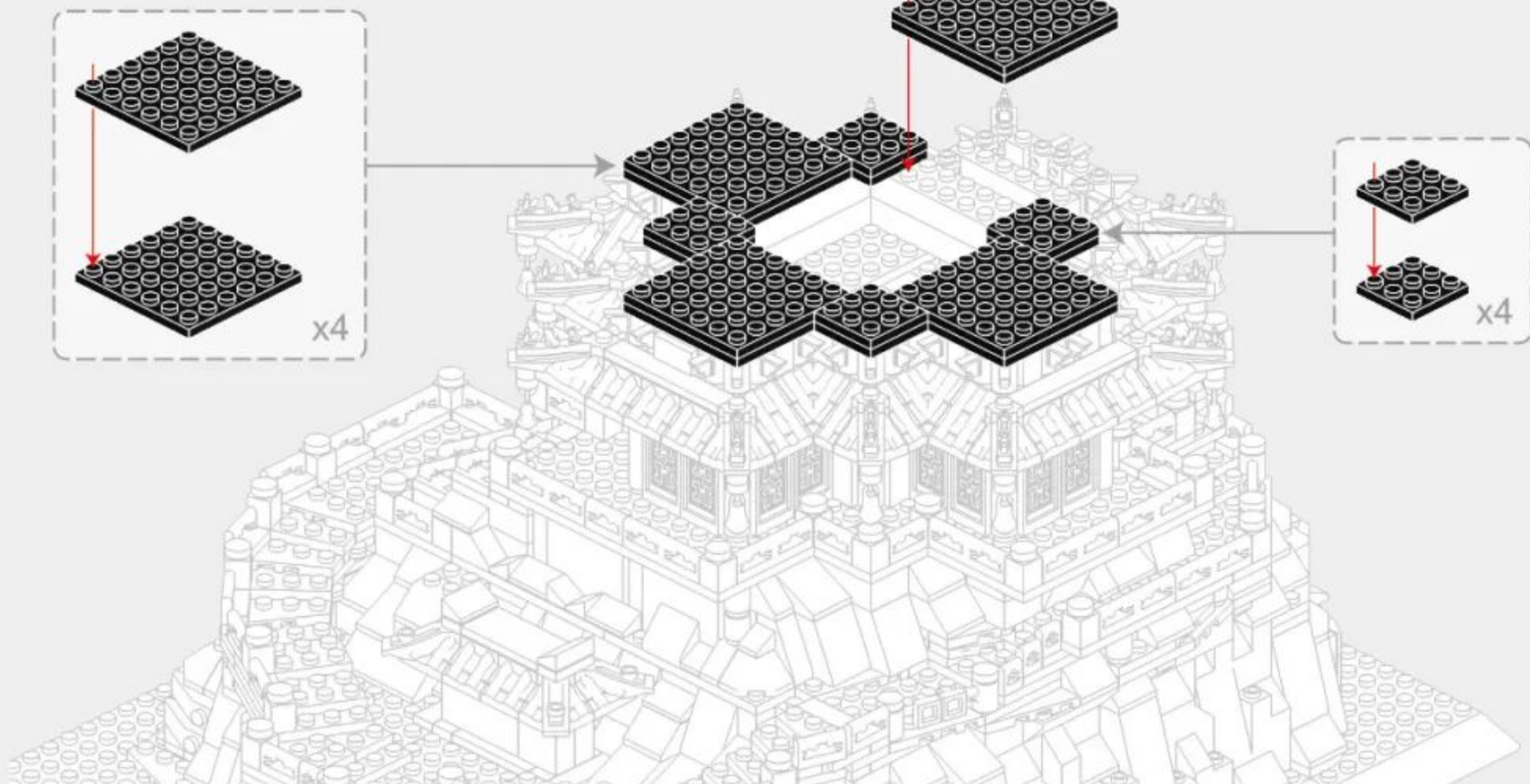
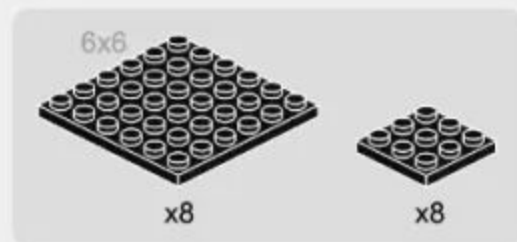

8-2

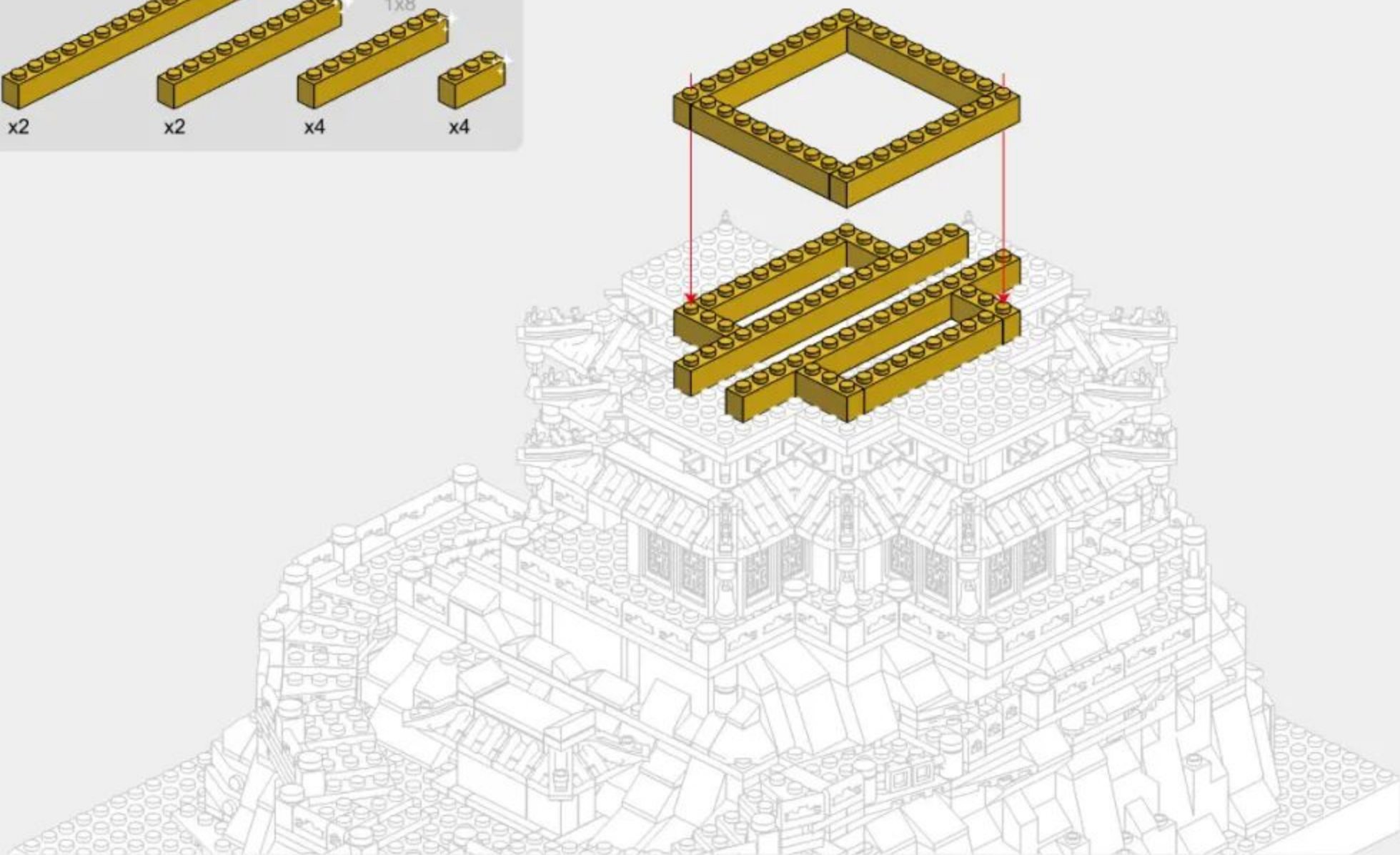
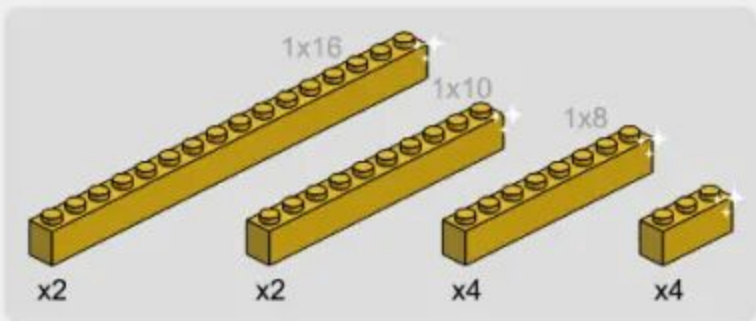

# 8-3

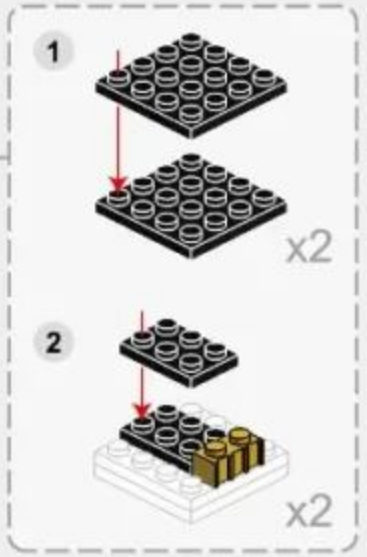
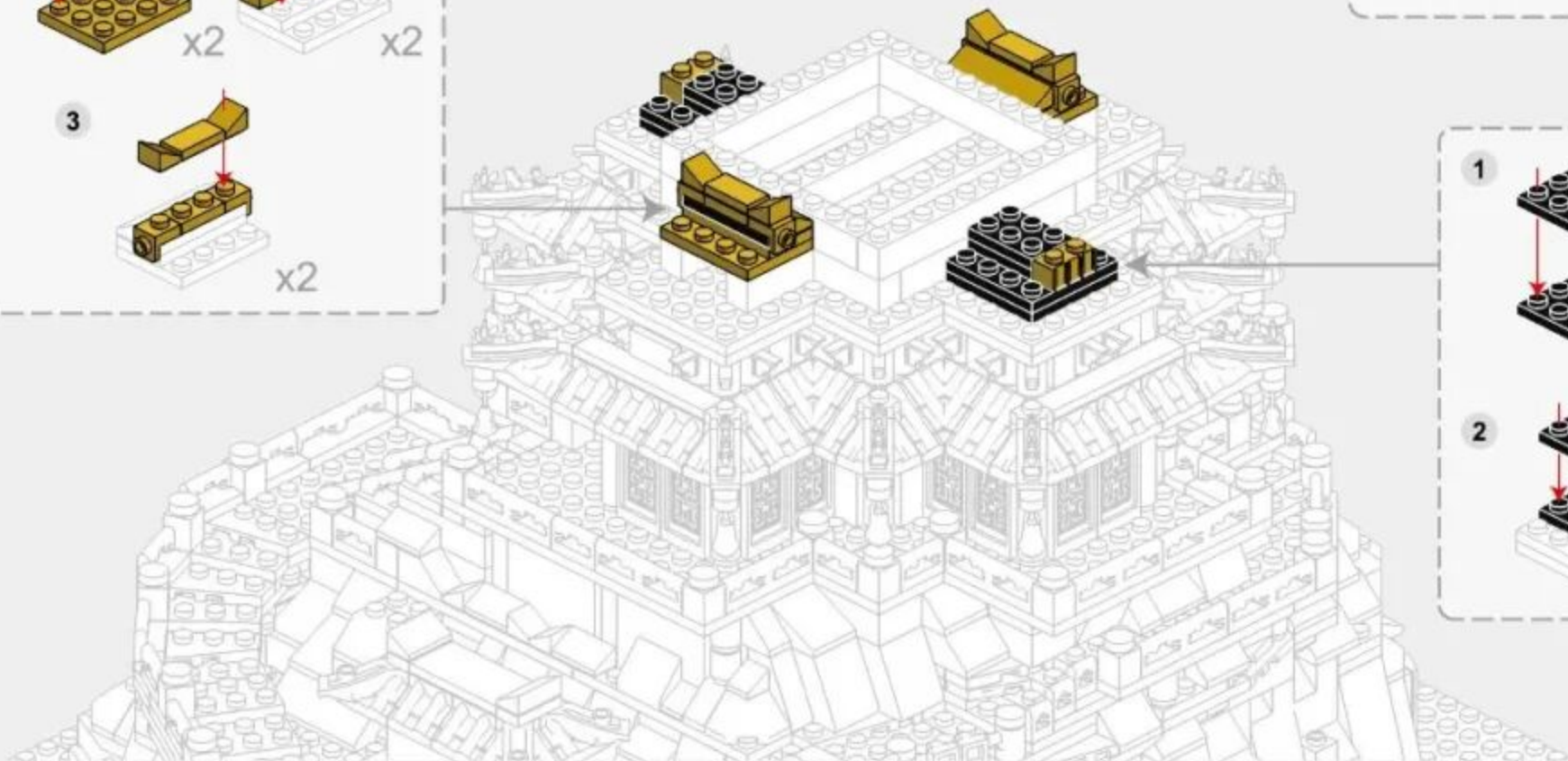
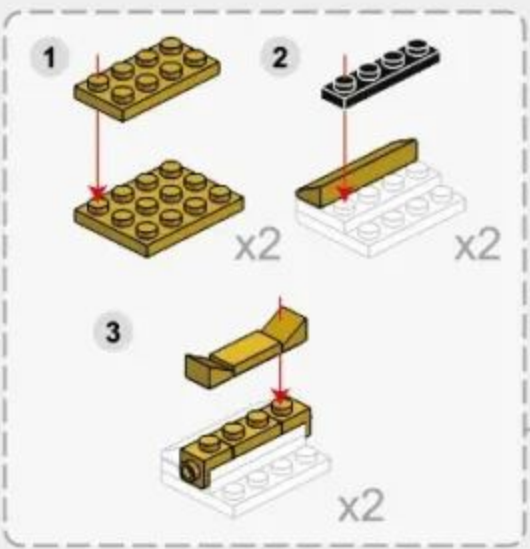
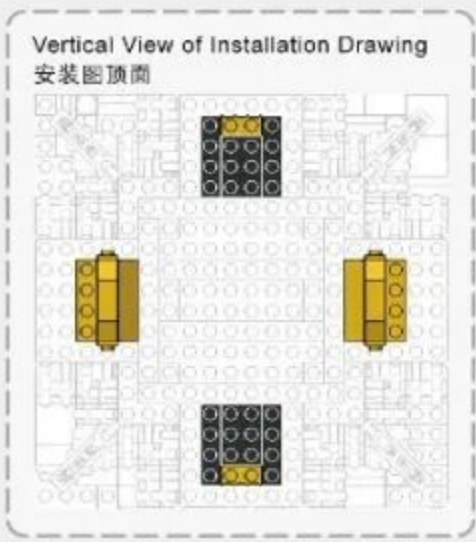

8-4

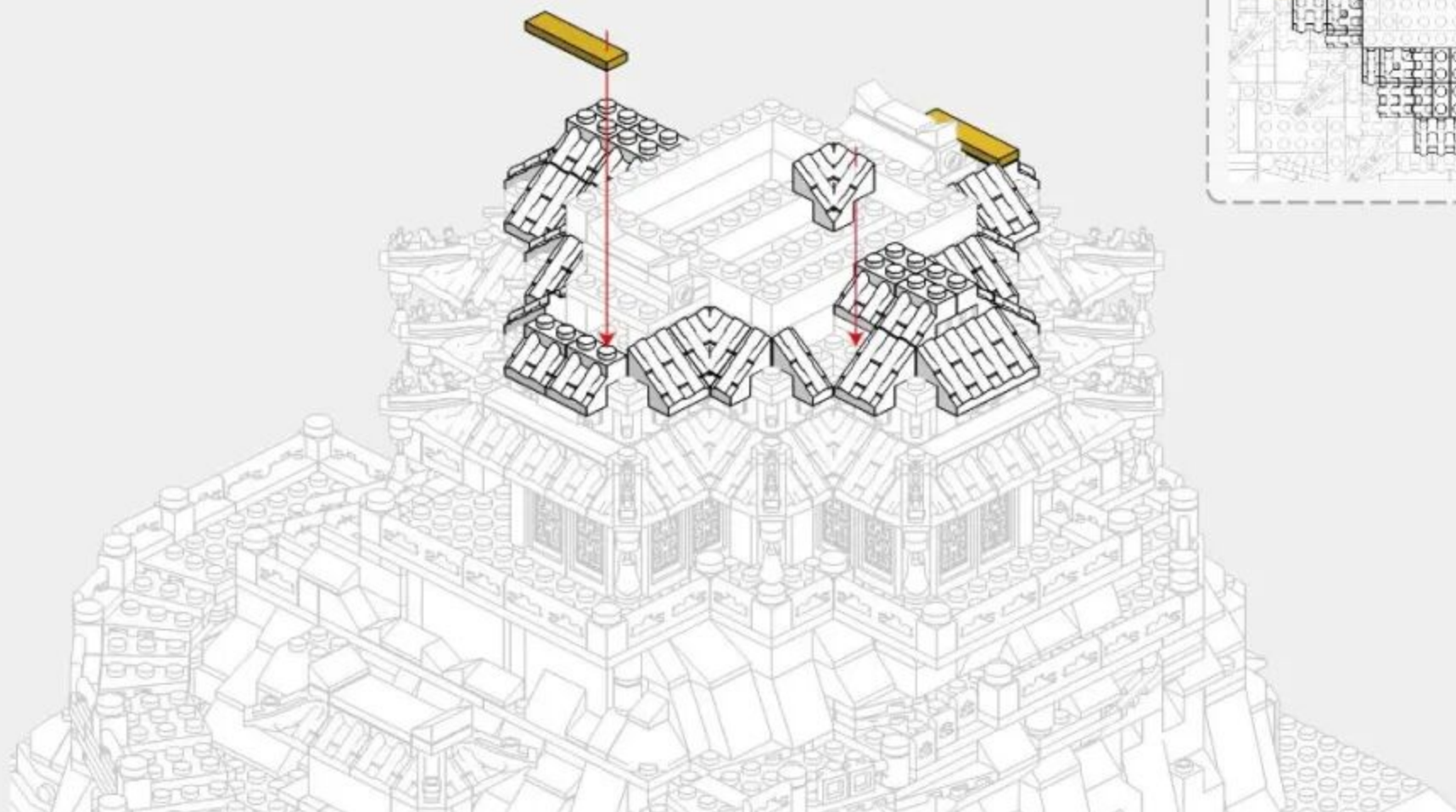
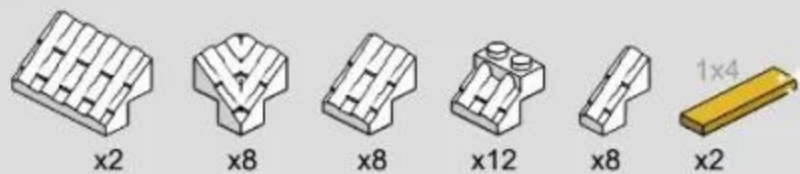

Vertical View of Installation Drawing  
安装图顶面

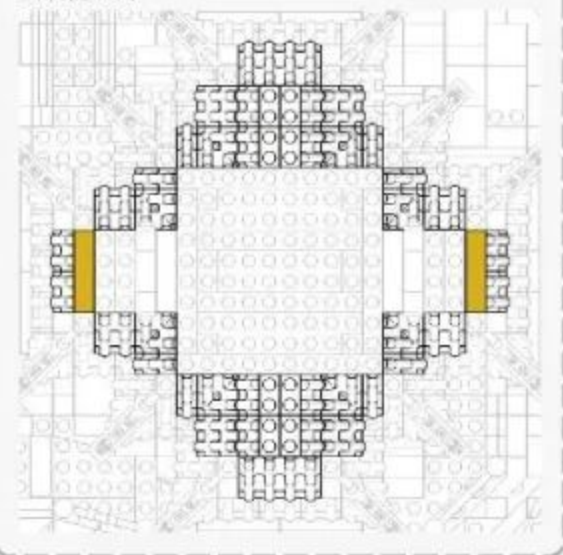

8-5

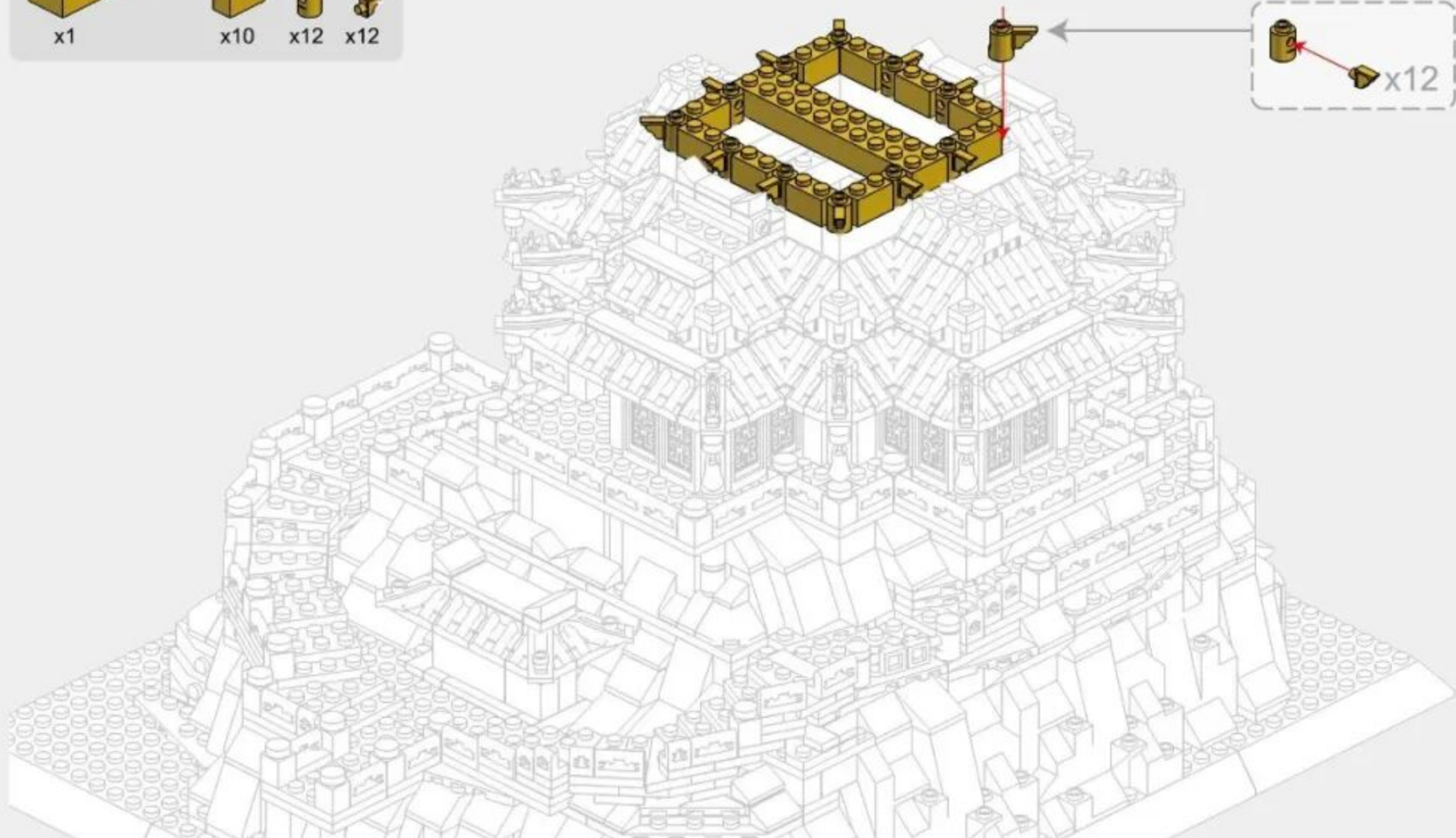
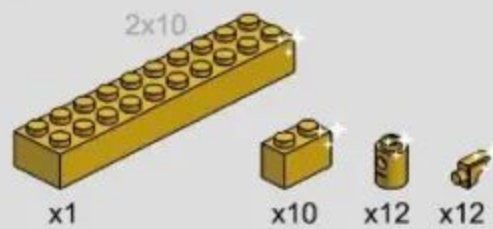

# 8-6

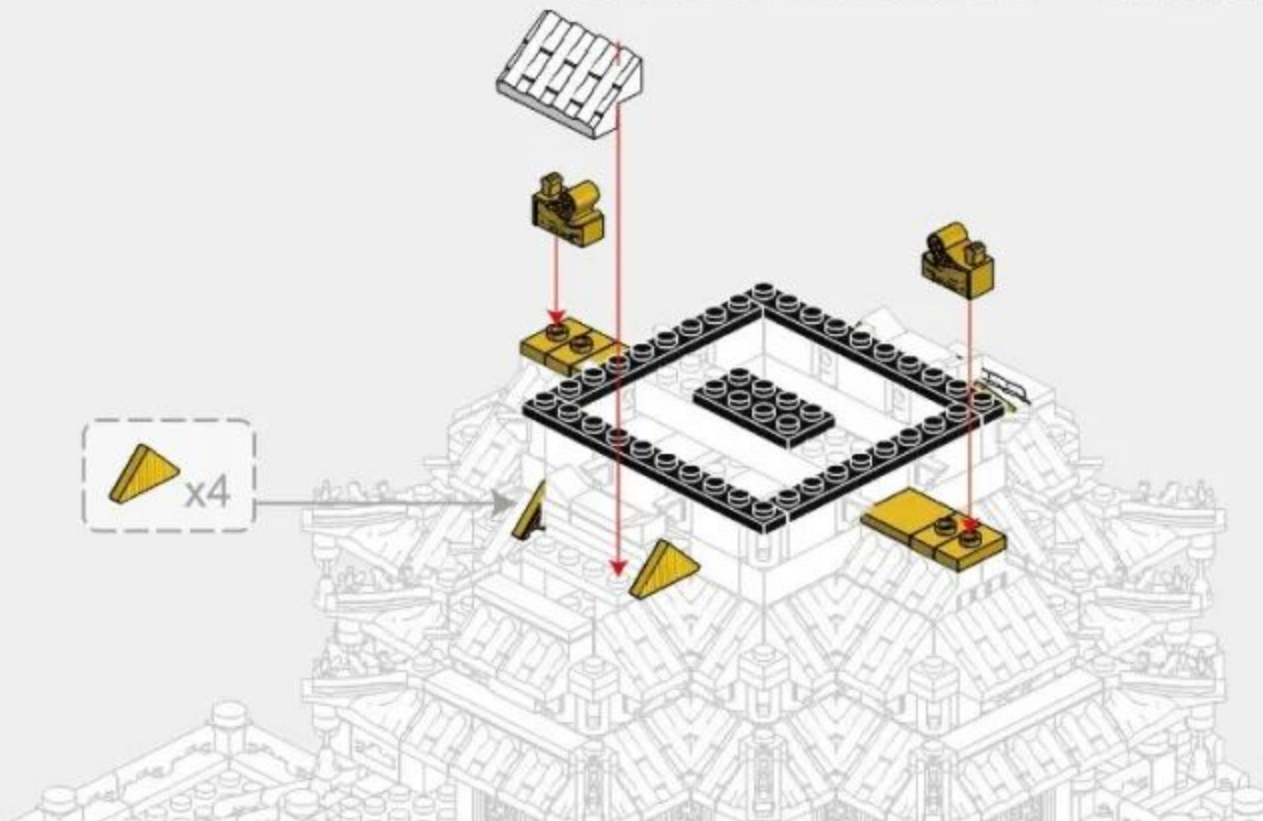
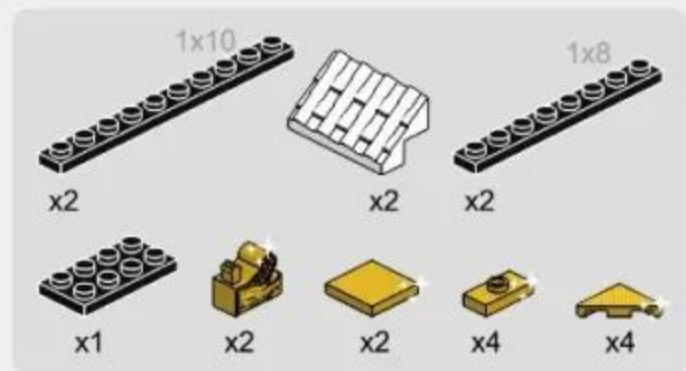

8-7

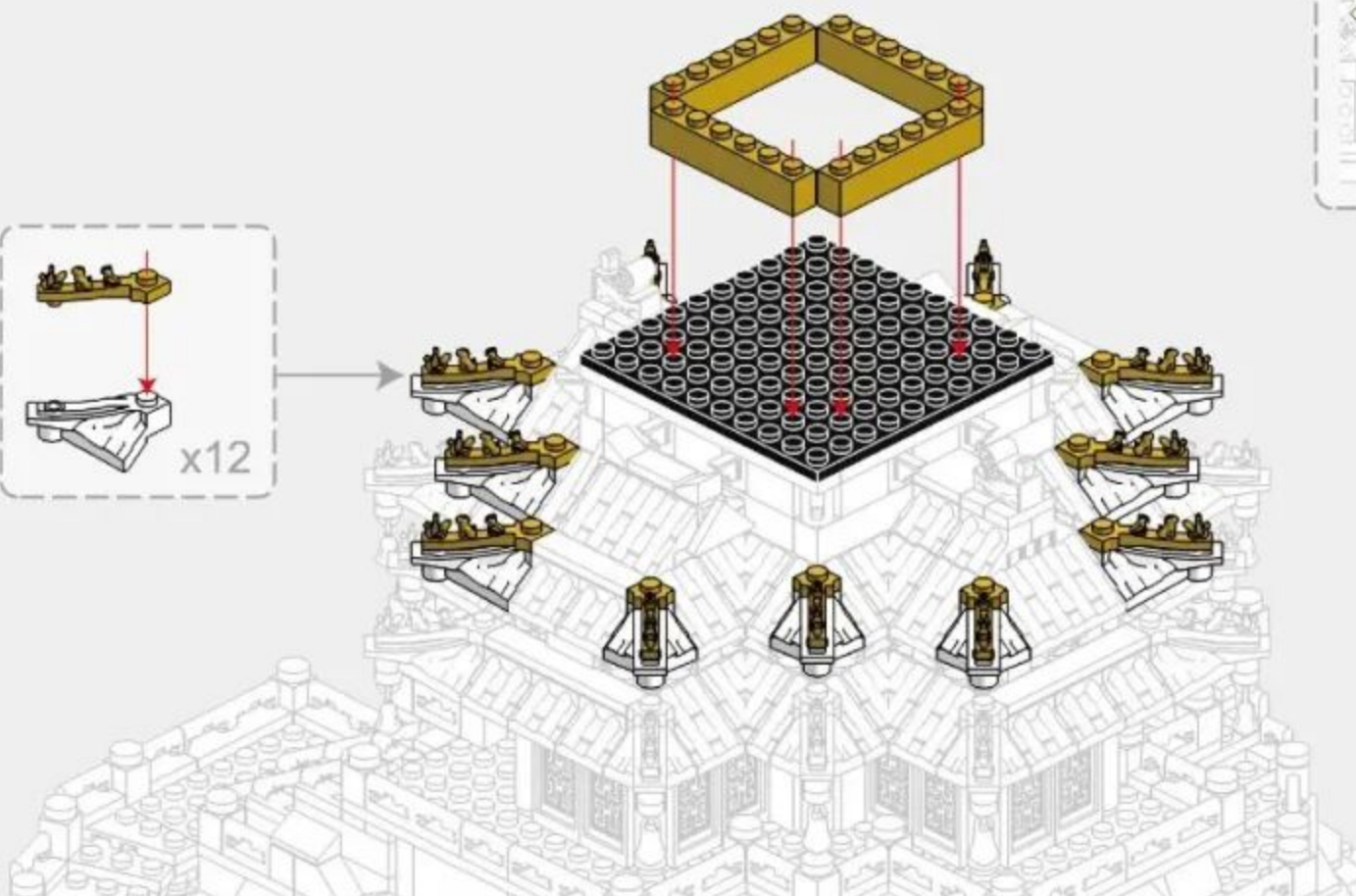
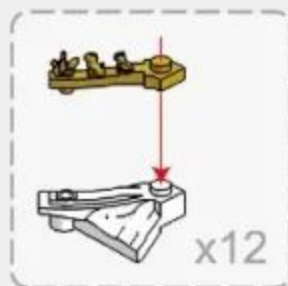
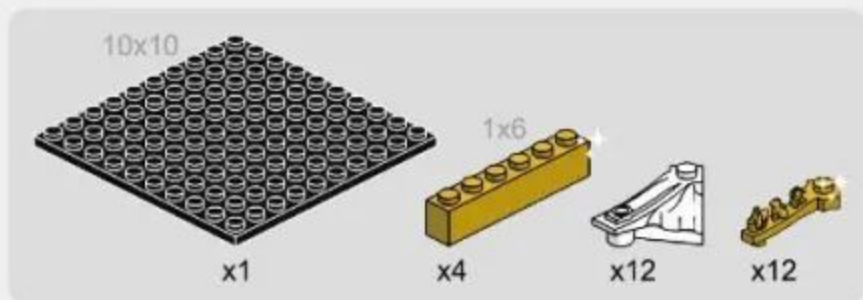

8-8

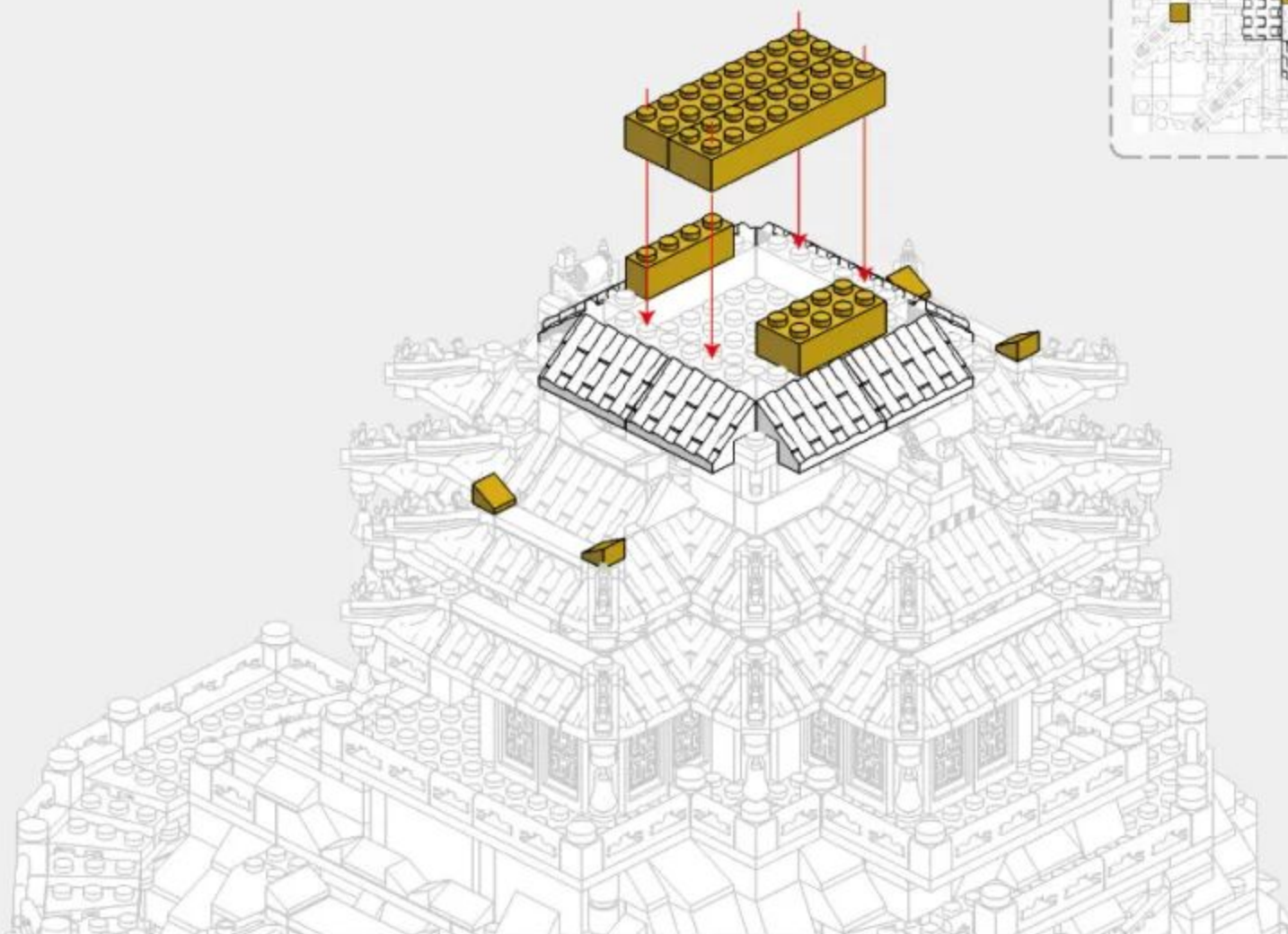
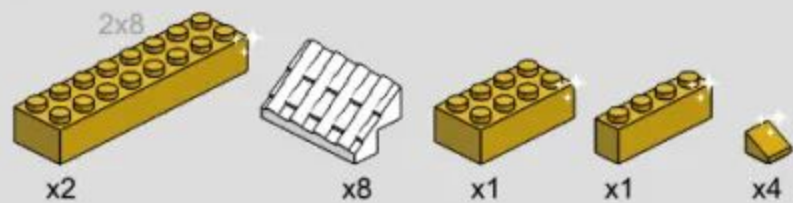

Vertical View of Installation Drawing  
安装图顶面

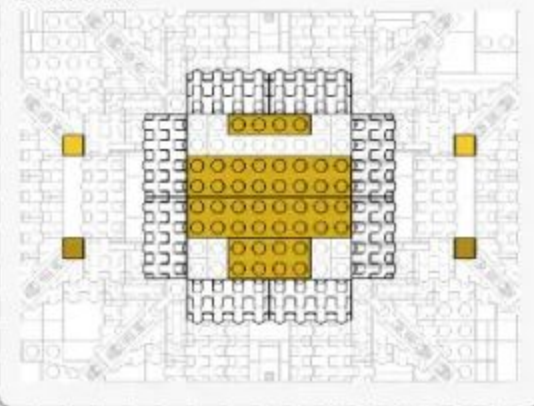

8-9

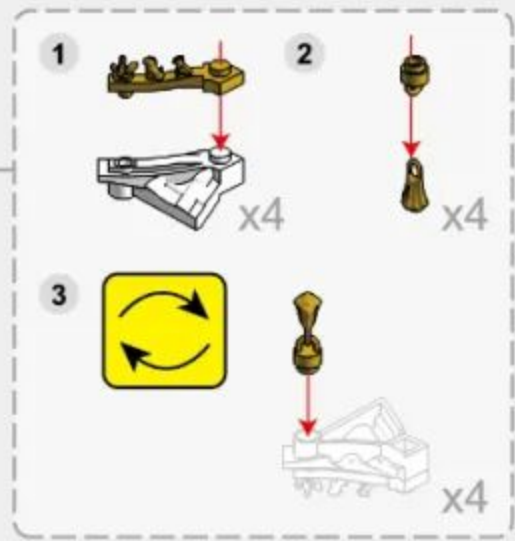

8-10



Back Side of Installation Drawing  
安装图背面

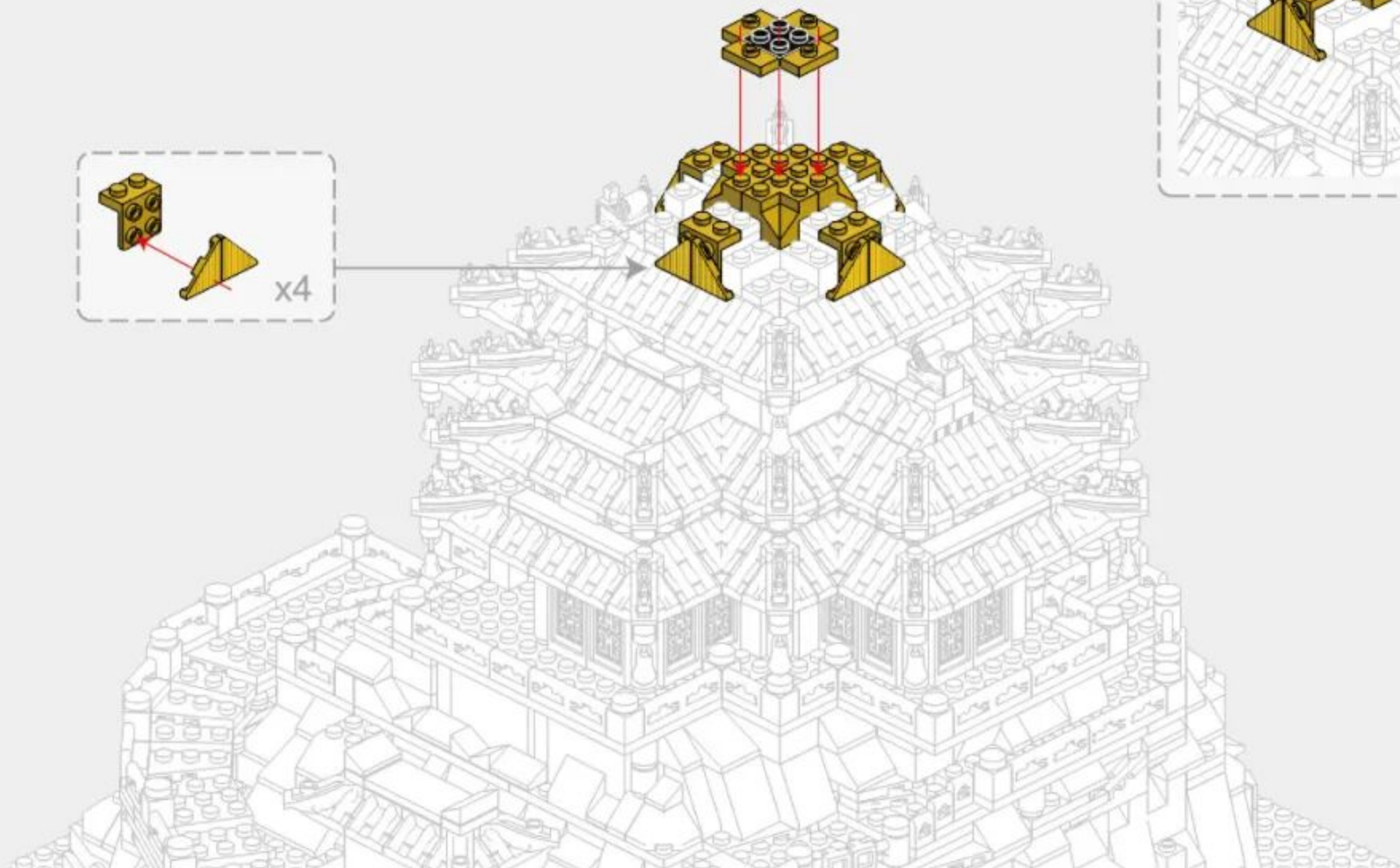
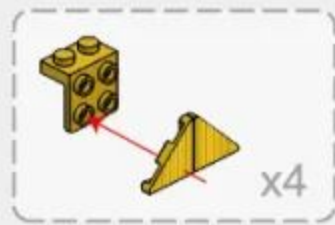

8-11



x4



x8



x1

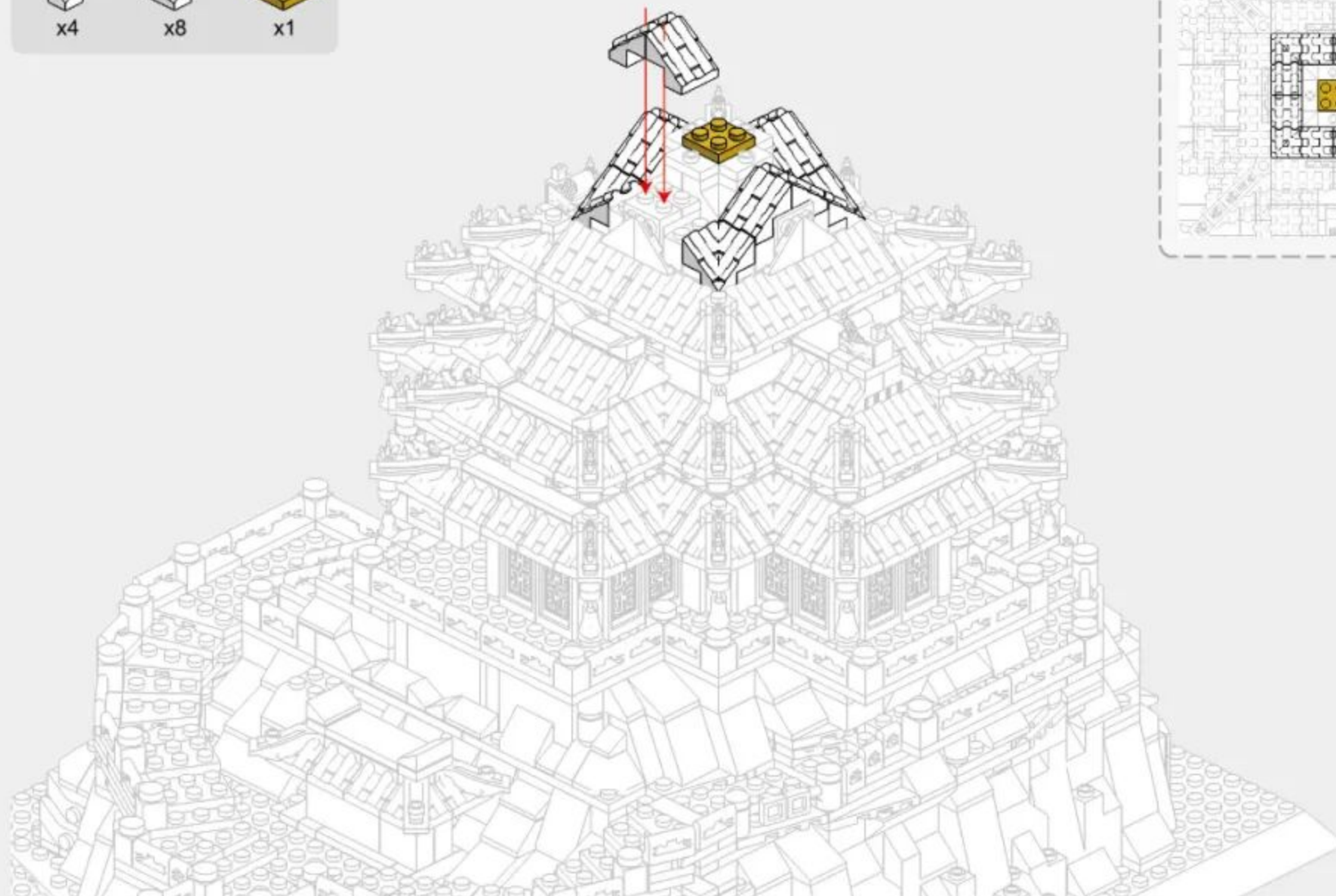

Vertical View of Installation Drawing  
安装图顶面

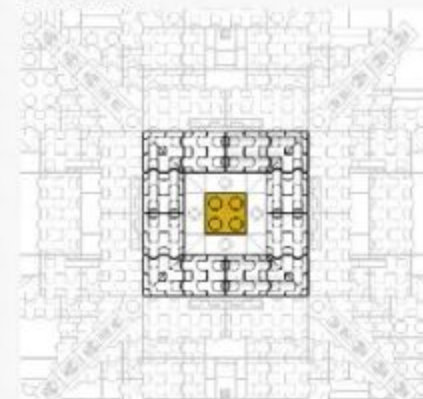





# ARCHITECTURE

The World's great architecture



**6224 英国伦敦白金汉宫**  
BUCKINGHAM PALACE-LONDON,ENGLAND



**5225 意大利罗马斗兽场**  
COLOSSEUM-ROME,ITALY



**5226 日本东京帝国饭店**  
IMPERIAL HOTEL-TOKYO,JAPAN



**6211 德国柏林勃兰登堡门**  
BRANDENBURG GATE-BERLIN, GERMANY



**6222 中国甘肃长城-嘉峪关**  
JIAYU PASS-GANSU,CHINA



**6212 日本京都清水寺仁王门**  
NIOMON GATE OF KIYOMIZU-DERA-KYOTO,JAPAN



**6214 中国武汉黄鹤楼**  
YELLOW CRANE TOWER-WUHAN,CHINA



**6215 英国伦敦眼**  
LONDON EYE-LONDON,ENGLAND



**6221 中国北京故宫-太和殿**  
HALL OF SUPREME HARMONY-BEIJING,CHINA



**6213 俄罗斯莫斯科瓦西里大教堂**  
SAINT BASIL'S CATHEDRAL-MOSCOW,RUSSIA



**6220 沙特阿拉伯麦加大清真寺**  
GREAT MOSQUE OF MECCA,SAUDI ARABIA



**6219 美国纽约联合国大厦**  
UNITED NATIONS HEADQUARTERS-NEW YORK,AMERICA



**4214 美国华盛顿白宫**  
WHITE HOUSE-WASHINGTON D.C.,AMERICA



**4212 意大利罗马许愿池**  
TREVI FOUNTAIN-ROME,ITALY



**4213 法国巴黎卢浮宫**  
MUSÉE DU LOUVRE-PARIS,FRANCE



**4218 新加坡-鱼尾狮**  
MERLION.SINGAPORE



**4210 埃及开罗吉萨金字塔**  
GREAT PYRAMID OF GIZA-CAIRO,EGYPT



**4219 英国伦敦双子塔桥**  
TOWER BRIDGE-LONDON,ENGLAND



**4216 美国华盛顿林肯纪念堂**  
LINCOLN MEMORIAL-WASHINGTON D.C.,AMERICA



**4217 新加坡-金沙酒店**  
MARINA BAY SANDS,SINGAPORE



**7210** 中国上海世博会中国馆  
CHINA PAVILION AT EXPO-SHANGHAI, CHINA



**4221** 加拿大渥太华国会山庄  
PARLIAMENT BUILDINGS-OTTAWA, CANADA



**4211** 英国伦敦伊丽莎白塔  
ELIZABETH TOWER-ENGLAND



**4220** 美国纽约熨斗大厦  
FLATIRON BUILDING-NEW YORK, AMERICA



**5227** 美国纽约自由女神像  
STATUE OF LIBERTY-NEW YORK, AMERICA



**4215** 加拿大多伦多电视塔  
THE CN TOWER-CANADA



**4222** 阿联酋迪拜哈利法塔  
THE BURJ KHALIFA TOWER-DUBAI, UAE



**5224** 中国上海东方明珠广播电视塔  
ORIENTAL PEARL TOWER-SHANGHAI, CHINA



**5212** 美国纽约帝国大厦  
EMPIRE STATE BUILDING-NEW YORK, AMERICA



**5213** 马来西亚吉隆坡石油双塔  
PETRONAS TWIN TOWERS-KUALA LUMPUR, MALAYSIA



**5214** 意大利托斯卡纳比萨斜塔  
LEANING TOWER OF PISA-TUSCANY, ITALY



**5216** 英国伦敦伊丽莎白塔  
ELIZABETH TOWER-ENGLAND



**5219** 俄罗斯莫斯科克里姆林宫钟楼  
SPASSKAYA TOWER-MOSCOW, RUSSIA



**5220** 阿联酋迪拜卓美亚帆船酒店  
BURJ AL ARAB HOTEL-DUBAI, UAE



**5217** 法国巴黎埃菲尔铁塔  
EIFFEL TOWER-PARIS, FRANCE



**5221** 中国台北101大楼  
TAIPEI 101-TAIPEI, CHINA



**6223** 中国武汉长江大桥  
WUHAN YANGTZE RIVER BRIDGE



**5210** 法国巴黎圣母院大教堂  
CATHEDRALE NOTRE DAME DE PARIS-PARIS, FRANCE



**5223** 法国巴黎凯旋门  
ARC DE TRIOMPHE-PARIS, FRANCE



**5211** 印度阿格拉泰姬陵  
TAJ MAHAL-AGRA, INDIA



**5215 英国伦敦双子塔桥**  
TOWER BRIDGE-LONDON,ENGLAND



**5222 中国北京天坛祈年殿**  
HALL OF PRAYER FOR GOOD HARVESTS-BEIJING,CHINA



**6210 美国旧金山金门大桥**  
GOLDEN GATE BRIDGE-SAN FRANCISCO,AMERICA



**6216 中国北京万里长城（八达岭）**  
THE GREAT WALL-BEIJING,CHINA



**5218 中国北京天安门**  
TIAN'ANMEN TOWER-BEIJING,CHINA



**6217 中国西藏布达拉宫**  
POTALA PALACE-TIBET,CHINA



**6218 芬兰罗瓦涅米圣诞老人办公室**  
SANTA CLAUS OFFICE-ROVANIEMI,FINLAND



**6225 墨西哥库库尔坎玛雅金字塔**  
EL CASTILLO-KUKULKAN,MEXICO



**6226 德国巴伐利亚新天鹅堡**  
SCHLOSS NEUSCHWANSTEIN, BAYERN, DEUTSCHLAND



**5228 美国芝加哥威利斯大厦**  
WILLIS TOWER-CHICAGO, AMERICA



**5229 土耳其伊斯坦布尔少女塔**  
MAIDEN TOWER-ISTANBUL, TURKEY



**5230 中国湖南长沙爱晚亭**  
AIWAN TING PAVILION-HUNAN,CHINA



**5231 巴西里约热内卢救世基督像**  
CRISTO REDENTOR-RIO DE JANEIRO, BRASIL



**5232 美国宾夕法尼亚州流水别墅**  
FALLINGWATER-PENNSYLVANIA, AMERICA



**5233 美国芝加哥范斯沃斯住宅**  
FARNSWORTH HOUSE-CHICAGO, AMERICA



**5234 美国华盛顿唐人街**  
CHINA TOWN-WASHINGTON, D.C., AMERICA



**3210 美国纽约自由女神像**  
STATUE OF LIBERTY-NEW YORK,AMERICA



**4223 中国北京清华园**  
TSINGHUA CAMPUS-BEIJING,CHINA



**7211 中国湖南岳阳楼**  
YUEYANG TOWER-HUNAN,CHINA



**8210 澳大利亚悉尼歌剧院**  
SYDNEY OPERA HOUSE-BENNELONG POINT,AUSTRALIA



**7212** 中国江西南昌滕王阁  
PAVILION OF PRINCE TENG-JIANGXI, CHINA



**6227** 中国河南郑州嵩山少林寺  
SHAOLIN TEMPLE-HENAN, CHINA



**7213** 中国重庆洪崖洞  
HONGYADONG-CHONGQING, CHINA



**5235** 美国华盛顿国会大厦  
UNITED STATES CAPITOL-WASHINGTON D.C., AMERICA



**5236** 中国安徽滁州醉翁亭  
ZUIWENG PAVILION-ANHUI, CHINA



**6228** 中国陕西西安钟楼  
XI'AN BELL TOWER-SHAANXI, CHINA



**5238** 美国西雅图太空针塔  
SPACE NEEDLE-SEATTLE, AMERICA



**5237** 法国巴黎普瓦西萨伏伊别墅  
VILLA SAVOYE-POISSY, PARIS, FRANCE



**6229** 中国山西运城鹳雀楼  
STORK TOWER-SHANXI, CHINA



**6230** 希腊爱情海圣托里尼岛  
SANTORINI-FIRA, GREECE



**6231** 中国上海海关大楼  
SHANGHAI CUSTOMS HOUSE-SHANGHAI, CHINA



**5239** 中国北京紫禁城角楼  
TURRET OF PALACE MUSEUM-BEIJING, CHINA



**5240** 韩国首尔崇礼门  
NAMDAEMUN-SEOUL, KOREA



**5241** 中国江苏南京夫子庙  
CONFUCIUS TEMPLE-JIANGSU, CHINA



**5242** 美国纽约古根海姆博物馆  
GUGGENHEIM MUSEUM-NEW YORK, AMERICA



**6232** 中国江苏南京秦淮河画舫  
QINHUAI RIVER PAINTED BOAT-JIANGSU, CHINA



**6233** 法国诺曼底圣米歇尔山  
SAINT MICHAEL'S MOUNT-NORMANDY, FRANCE



**6234** 中国河南洛阳栾川老君山  
THE LAOJUN MOUNTAIN-HENAN, CHINA