

# HANSHAN TEMPLE

COUNTRY: China  
CITY: Suzhou





# HANSHAN TEMPLE

中国江苏省苏州寒山寺 (普明宝塔)

Suzhou, China

The world's great architecture



Creative  
Ability



Family  
Interaction



Observation  
Ability



Thinking  
Ability



Handwritten  
Ability



6+  
Deliveries  
Age

6235  
Product  
Number

1393 PCS  
Parts  
Total



# Architecture

It will be a city...

这将构成一座城市...

# ABOUT THE PRODUCT

关于产品

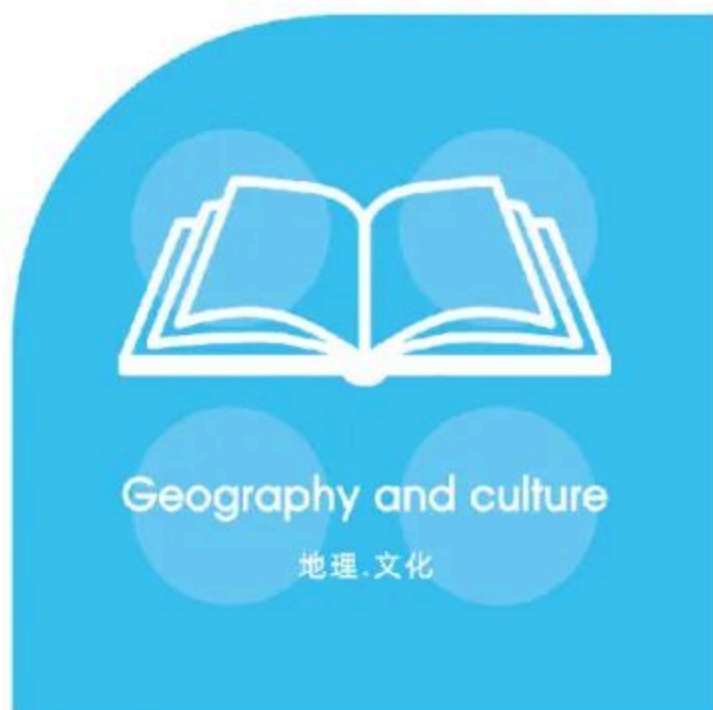

## ARCHITECTURE

WANGE The world's great architect since 1991

# Hanshan Temple

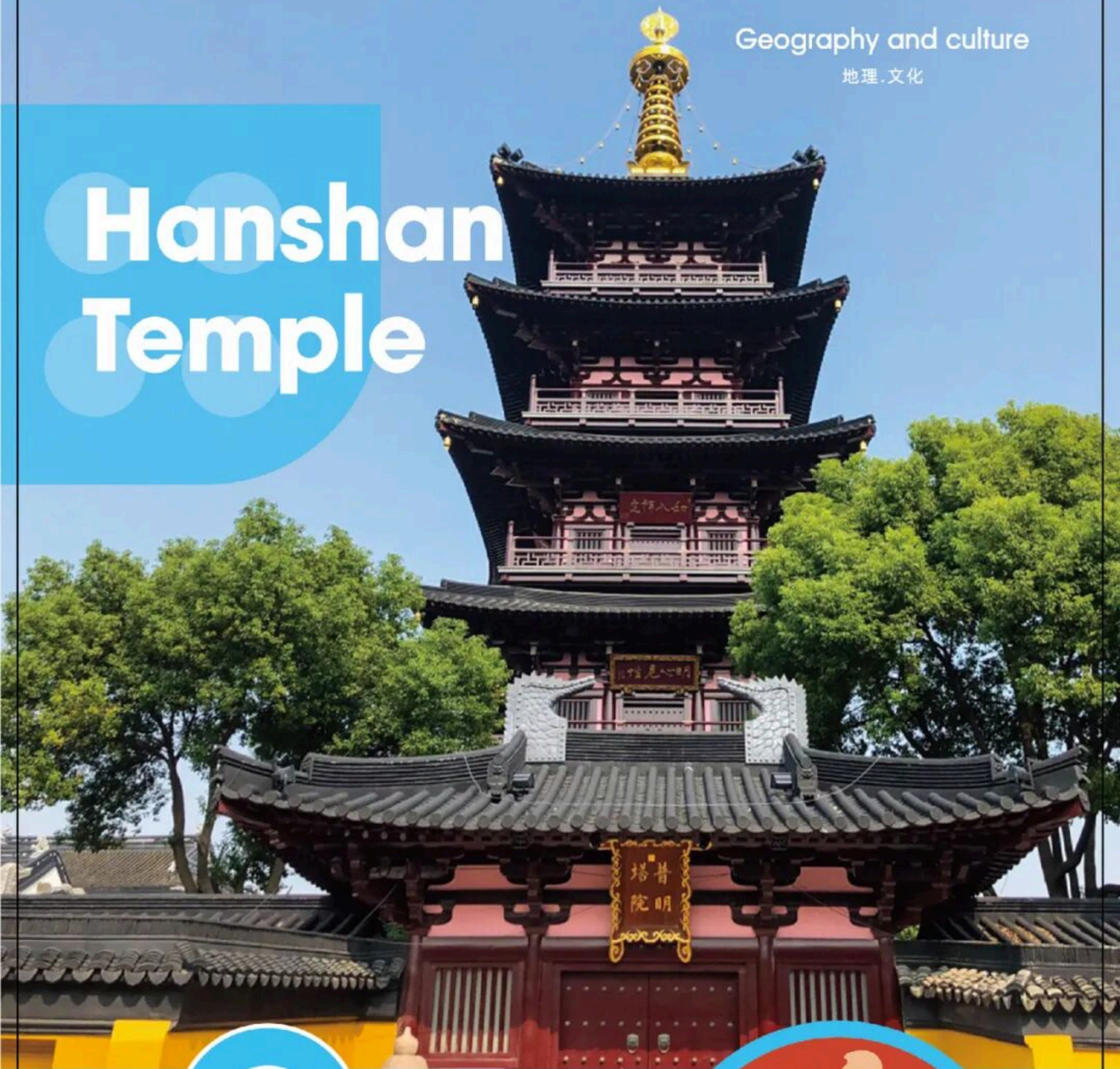

Hanshan Temple, is a Buddhist temple and monastery in Gusu District of Suzhou, Jiangsu, China. It is located at the town of Fengqiao, about 5 kilometers west of Suzhou's old city.

# Hanshan Temple



## Geography and culture

地理·文化



Hanshan Temple, originally known as "Miao Li Pu Ming Pagoda Courtyard", was renamed Hanshan Temple with the title of "Hanshan Temple" during the reign of Zhenguan in the Tang Dynasty.



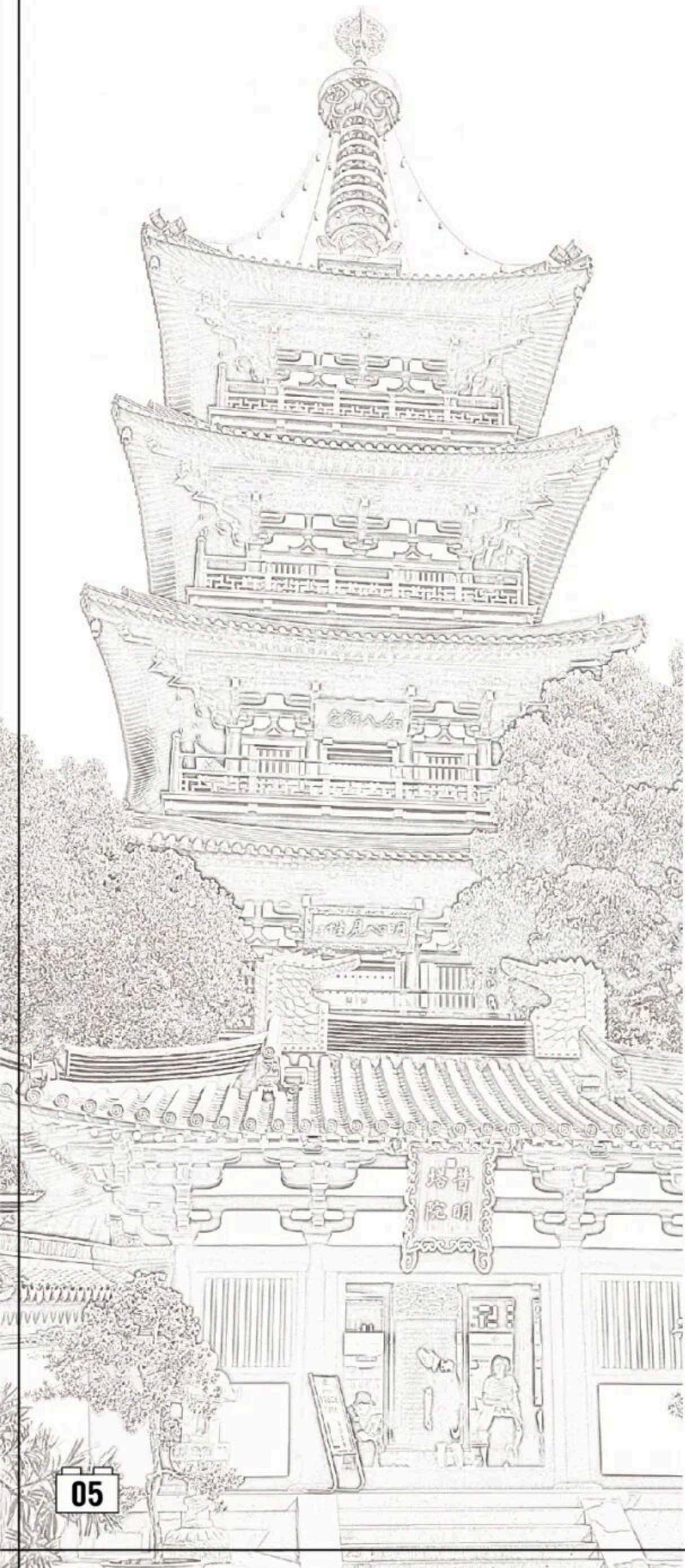

中国江苏苏州寒山寺

# Hanshan ■ Temple

China

The contents of this chapter refer to the Wikipedia website.

本章内容参考维基百科网站，  
更多资讯可自行查阅。

The world's great architecture

# Buildings and layout

■ 建筑物和布局



寒山寺位于苏州城西枫桥镇，现已有1400多年历史。其占地面积约1.3万平方米，建筑面积3400余平方米。曾是我国十大名寺之一，唐代诗人张继的《枫桥夜泊》使之闻名于天下。寺中的主要建有大雄宝殿、庀殿、藏经楼、碑廊、钟楼、枫江第一楼等建筑，以及张继《枫桥夜泊》碑，寒山、拾得的石刻像，文徵明、唐寅所书碑文残片等。

Hanshan Temple, located in Fengqiao Town, west of Suzhou, has a history of more than 1400 years. It covers an area of about 13000 square meters and a building area of more than 3400 square meters. It used to be one of the top ten famous temples in China. The poem "Mooring at Night at Maple Bridge" by the poet Zhang Ji of the Tang Dynasty made it famous all over the world. The main buildings in the temple are the the Shakya ManiHall, the Aisle Hall, the Sutra Collection Building, the Stele Gallery, the Bell Tower, the first floor of the Fengjiang River and other buildings, as well as the monument of Zhang Ji's "Night Mooring on the Maple Bridge", the stone carvings of Han Shan and the collected ones, and the fragments of inscriptions written by Wen Zhengming and Tang Yin.



## Structure

寒山寺塔高 42.2 米，5 层，呈正方形，为仿唐木结构楼阁式塔；塔刹为铜铸镀金，高 9.6 米，重 12 吨；塔外四周挂有 108 个风铃，塔内各层都有木梯可供游人登临远眺，欣赏吴中美景。

The tower of Hanshan Temple is 42.2 meters high and has five floors. It is square, and is a pavilion-style tower with a wooden structure imitating the Tang Dynasty; The tower brake is copper-cast and gold-plated, with a height of 9.6 meters and a weight of 12 tons; There are 108 wind chimes hanging around the outside of the tower, and there are wooden ladders on each floor of the tower for tourists to climb and enjoy the beautiful scenery of Wuzhong.



## History

寒山寺始建时就有“妙利普明塔”，后毁于战火，北宋重建的宝塔元末又毁，后600多年来寒山寺一直无塔，1996年10月30日又建成新塔。寒山寺主要由大雄宝殿、钟楼、碑廊、藏经楼等建筑组成。大雄宝殿内高大的须弥座以汉白玉雕筑，座上安奉释迦牟尼佛金身佛像，两侧靠墙供奉着明代成化年间铸造的十八尊精铁鎏金罗汉像，是由佛教圣地五台山移置于此。

When Hanshan Temple was first built, there was the "Miao Li Pu Ming Pagoda", which was later destroyed in the war. The pagoda rebuilt in the Northern Song Dynasty was destroyed at the end of the Yuan Dynasty. Hanshan Temple has not been built for more than 600 years. A new tower was built on October 30, 1996. Hanshan Temple is mainly composed of the Shakyamuni Hall, Bell Tower, Stele Gallery, Sutra Pavilion and other buildings. The tall Xu Maizuo in the the Shakyamuni Hall is carved with White Marble, on which is enshrined the golden Buddha statue of Sakyamuni Buddha. On both sides of the seat are the eighteen refined iron gilded Arhat statues cast during the Chenghua period of the Ming Dynasty, which were moved here by the Buddhist holy place Mount Wutai.

# Force Balance

受力平衡

Physical operations

物理运算

$$F = G \frac{m_1 m_2}{d^2}$$



Creation and thinking

创作·思考

$$S=4\pi \cdot r^2$$

# Special parts

$$a^2+b^2=c^2$$

特殊零件的开发利用



**WG1513**

小瓦片4孔

$$\sin^2 a + \cos^2 a = 1$$



**WG1519**

带孔弯角瓦片



**WG1256**

3倍柱珠



**WG1505**

弯脊装饰



**WG1289**

雀替柱



features and functions

特点·功能

# Main Color Matching

配色方案



Pantone 7427C



Pantone 109C



Pantone 123C



Pantone 468C



Pantone 509C



Pantone Black 6C



Pantone 477C



Pantone 431C



Pantone Cool Gray 6C



Pantone 7509C



Pantone 3435C



Pantone 2422C



## Color matching

Adopting 3 main colors, Maroon and black color as the main color, the more reasonable and yellow on the original building, making the product more atmospheric and the whole design is more reasonable.

# Hanshan Temple

寒山寺



Front

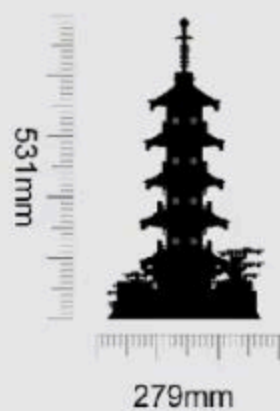

Left

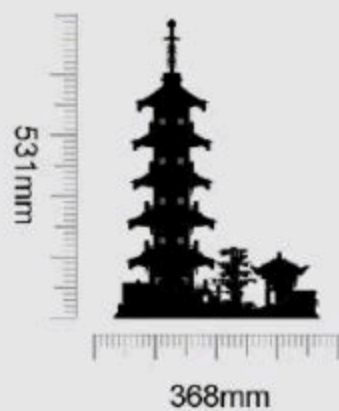

Back

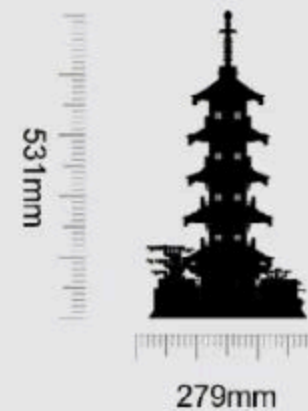

Product Size:279X368X531mm



# Instructions For Use

积木起件器使用说明  
Brickseparator

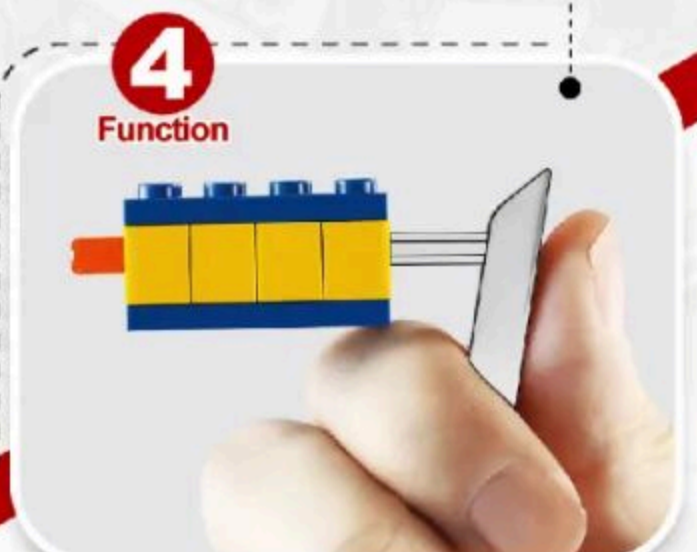
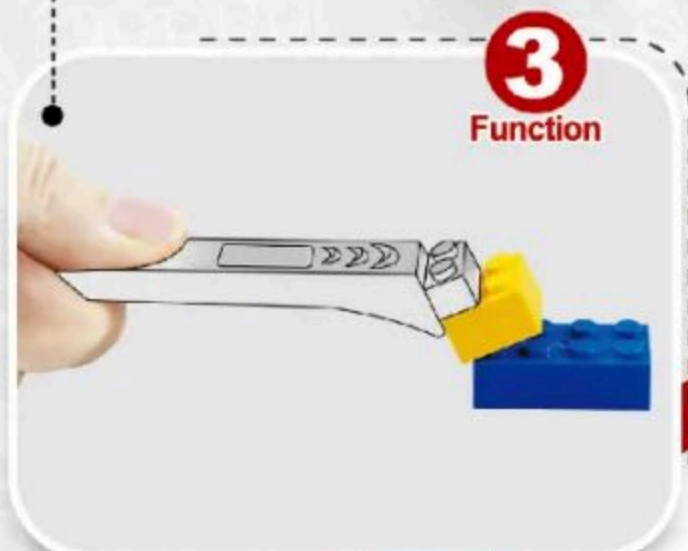
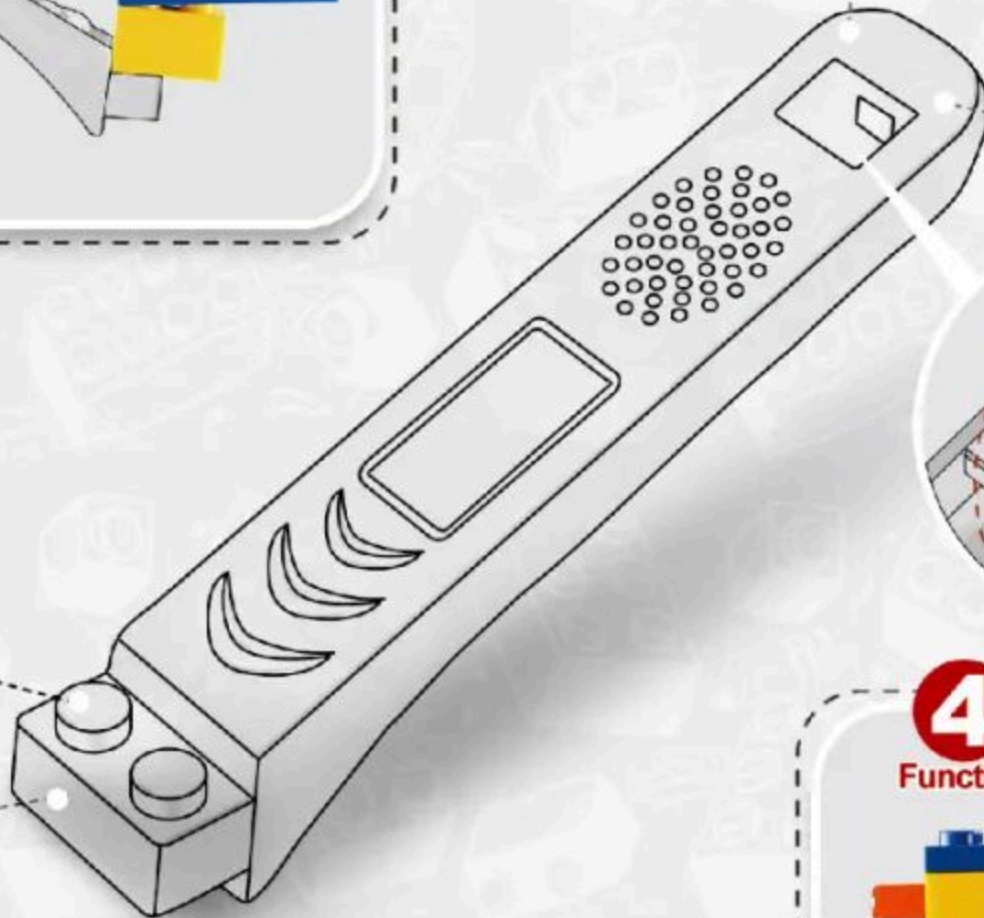
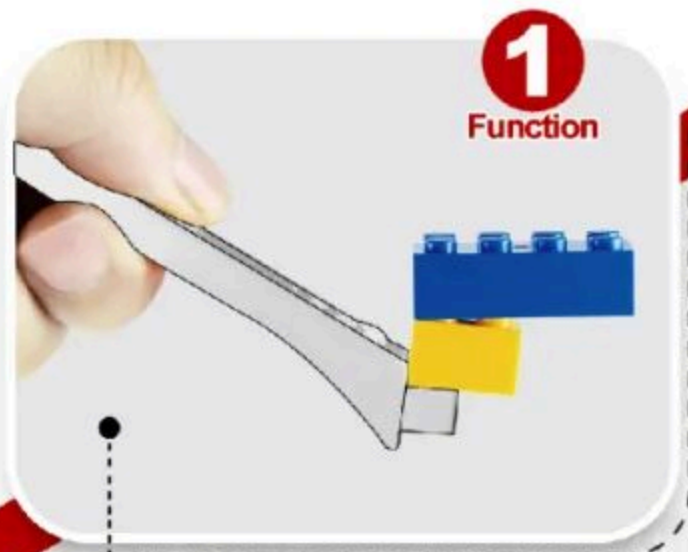

4 ways to make installation easier  
让安装更简单



■ First open the product packaging according to the instructions.

按指导用正确方式拆解产品外包装。



■ Summarize all parts to count the number of familiar accessories.

对照说明书清单确认积木包数量与积木数量。



■ Arranging all accessories by color helps to quickly install the product.

把确认好的积木以类型、颜色进行分类排好以便安装。



■ Carefully install the product and learn about building.

按说明书步骤拼装并完成你的积木模型。



# 1:1 Physical Reference Table

十字棒配件1:1尺寸参照表



Instructions For Use

让安装更简单



**2**  $(1 \times 2) = 2$



**3**  $(1 \times 3) = 3$



**4**  $(1 \times 4) = 4$



**5**  $(1 \times 5) = 5$



**6**  $(1 \times 6) = 6$



**7**  $(1 \times 7) = 7$



**8**  $(1 \times 8) = 8$



**9**  $(1 \times 9) = 9$



**10**  $(1 \times 10) = 10$



**12**  $(1 \times 12) = 12$















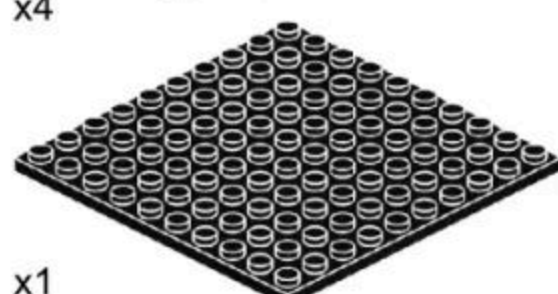
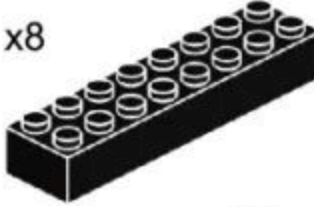



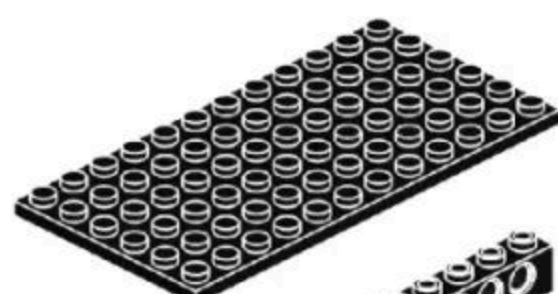











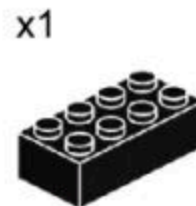







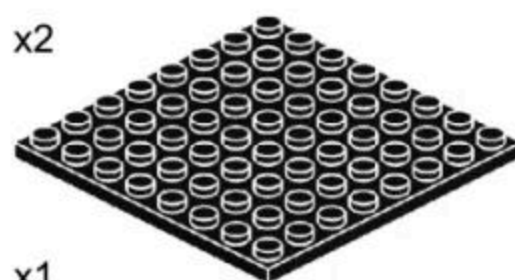
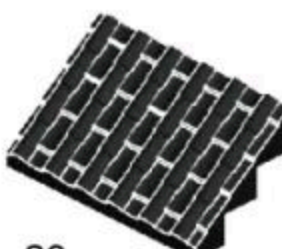







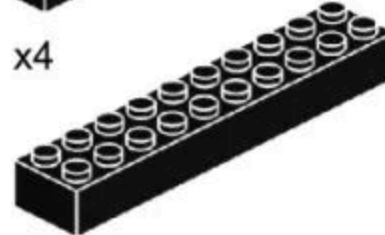









**16**  $(1 \times 16) = 16$



# PARTS LIST

配件清单

				
x4	x8	x20	x6	x1
				
x1	x1	x2	x1	x4
				
x4	x6	x5	x6	x3
				
x4	x2	x1	x4	x2
				
x2	x8	x4	x1	x4
				
x2	x3	x14	x5	x4
				
x1	x20	x3	x10	x1
				
x4	x4	x4	x1	x2
				
x4	x1	x24	x12	x34
				
x15	x2	x2	x1	x4
				
x2	x1	x6	x1	x2
				
				x4

产品有增补件请以实物为准

If product has additional parts, please in kind prevail.

# PARTS LIST

配件清单

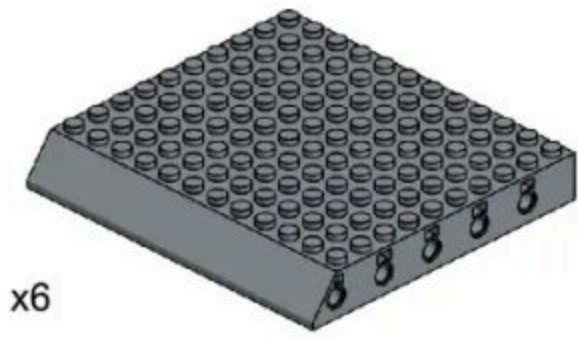

x6

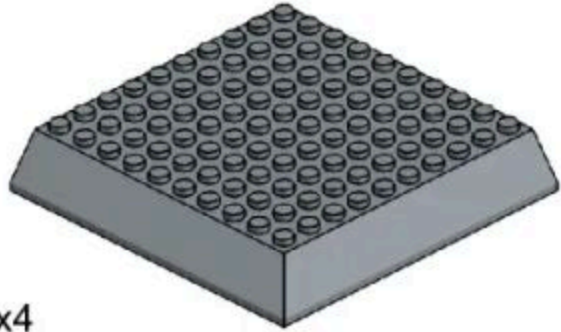

x4



x3

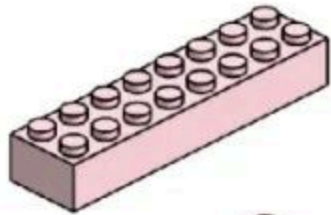

x2

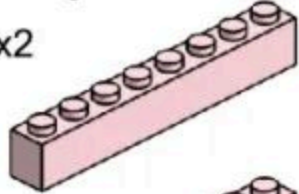

x6

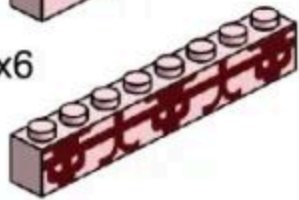

x4

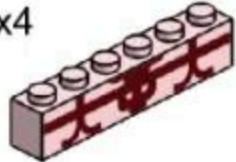

x16

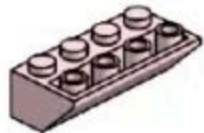

x4

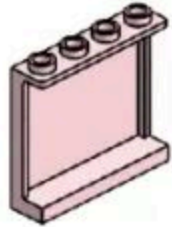

x1

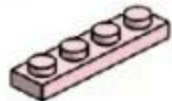

x3



x8



x1



x67



x12

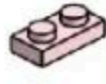

x6



x2



x1



x2



x3



x2



x1



x2



x8



x1



x1



x1



x3



x3



x10



x2



x3



x6



x1



x6



x2



x3



x2



x8



x6

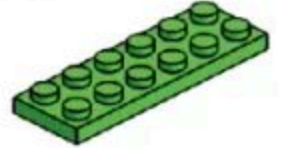

x6



x12

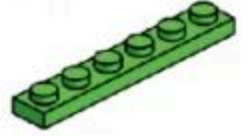

x2



x2



x1



x73



x8



x1

产品有增补件请以实物为准

If product has additional parts, please in kind prevail.

# PARTS LIST

配件清单

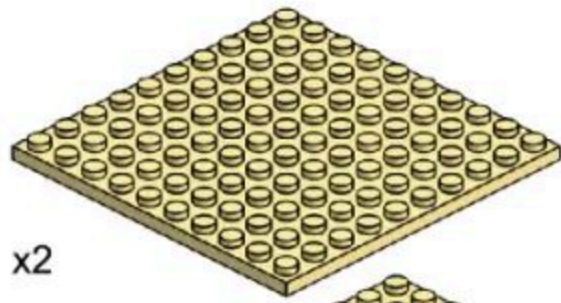

x2

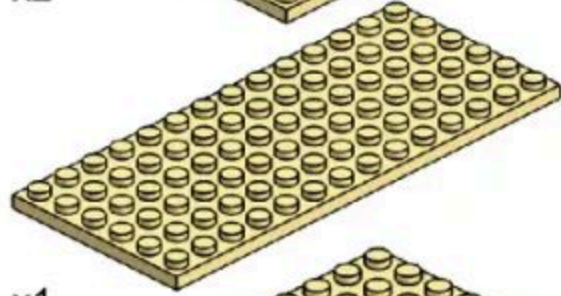

x1

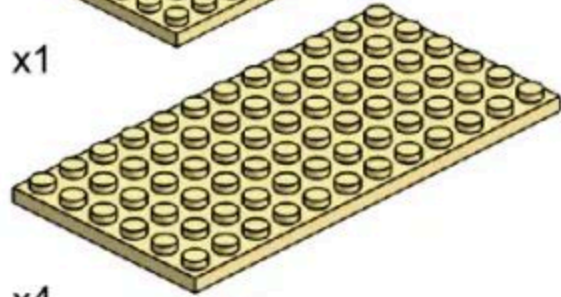

x4



x4

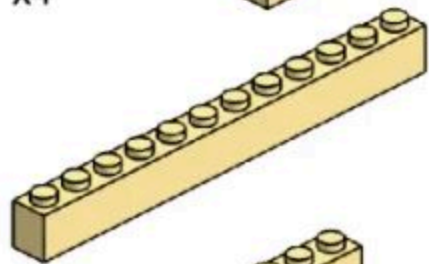

x4

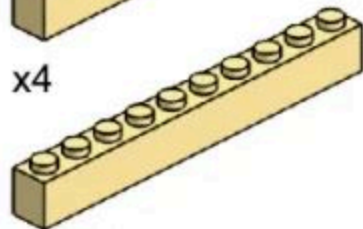

x4

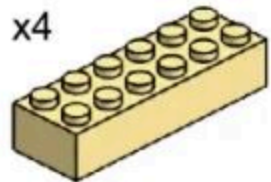

x3

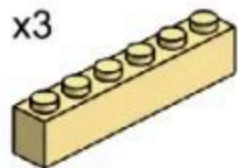

x4

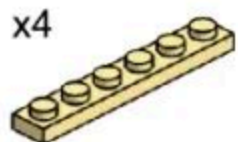

x4

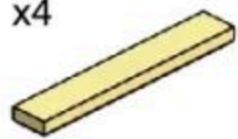

x1

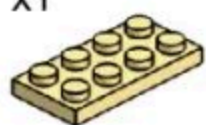

x4

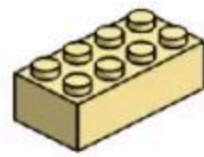

x2



x2

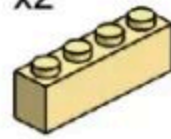

x1

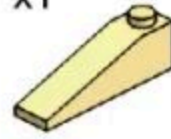

x2



x6



x2

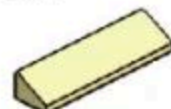

x12



x2

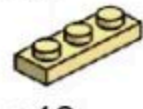

x10



x2



x4



x2



x2



x8



x2



x12



x2

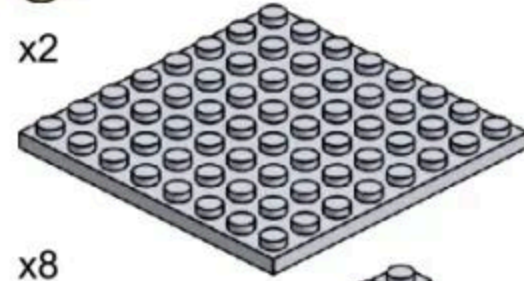

x8

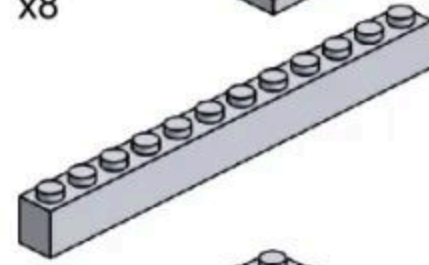

x2

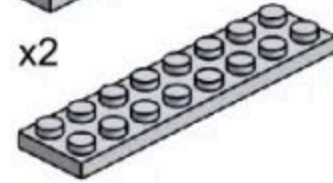

x2

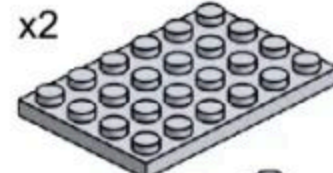

x1

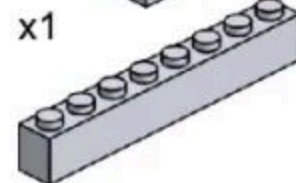

x6

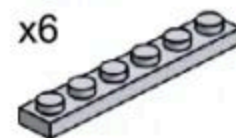

x5

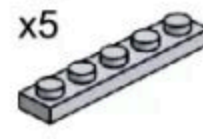

x4

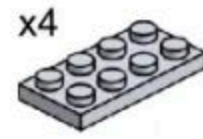

x3

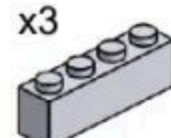

x3

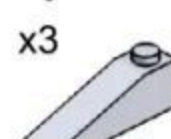

x6

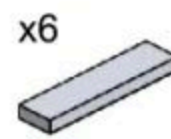

x9

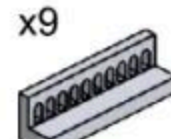

x10



x3



x4



x1



x2



x2



x1



x2



x2

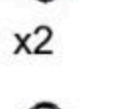

x1



x2



x1



x2



x4



x2



x2













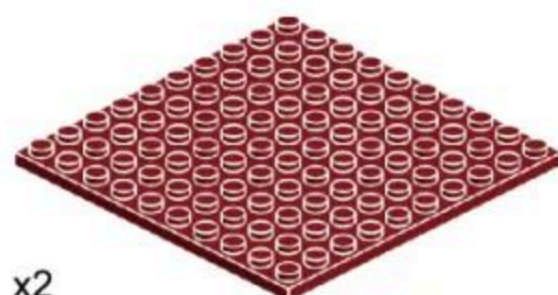



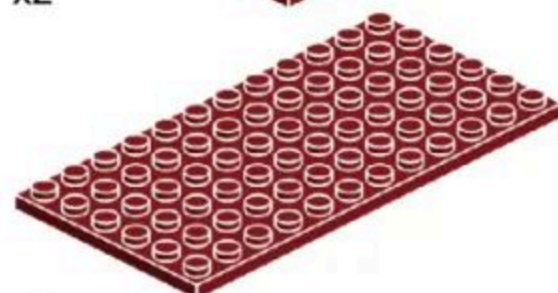



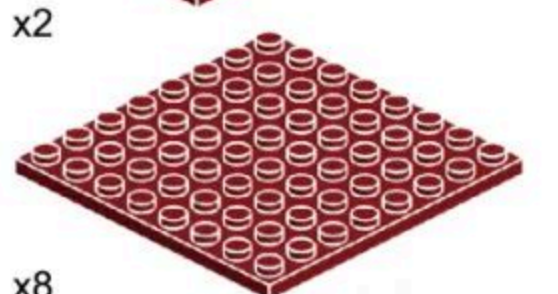



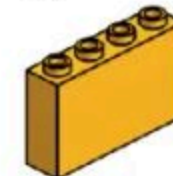
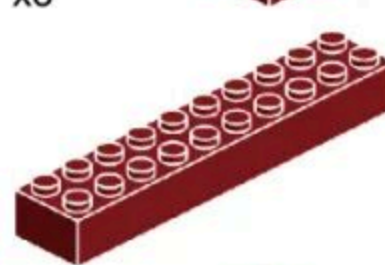



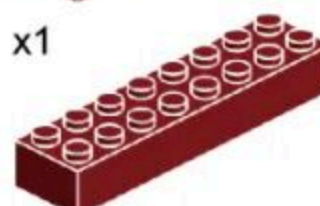

































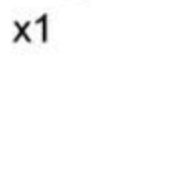



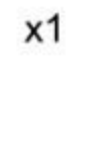

x2

产品有增补件请以实物为准

If product has additional parts, please in kind prevail.

# PARTS LIST

配件清单

				
x2	x1	x42	x20	x23
				
x2	x1	x16	x10	x3
				
x8	x1	x24	x8	x1
				
x1	x1	x1	x1	
				
x1	x1	x12	x1	x2
				
x2	x1	x22	x1	x1
				
x4	x40	x22	x1	x6
				
x1	x9	x8	x4	x2
				
x1	x8	x16	x1	x2
				
x1	x20	x16	x1	x2
				
x1	x1	x4	x6	x2
				
x1	x24	x42	x1	x2
				
x1	x11	x44	x5	x2
				
x1	x22	x28	x4	x1
				
			x7	

产品有增补件请以实物为准

If product has additional parts, please in kind prevail.



274PCS



1-1

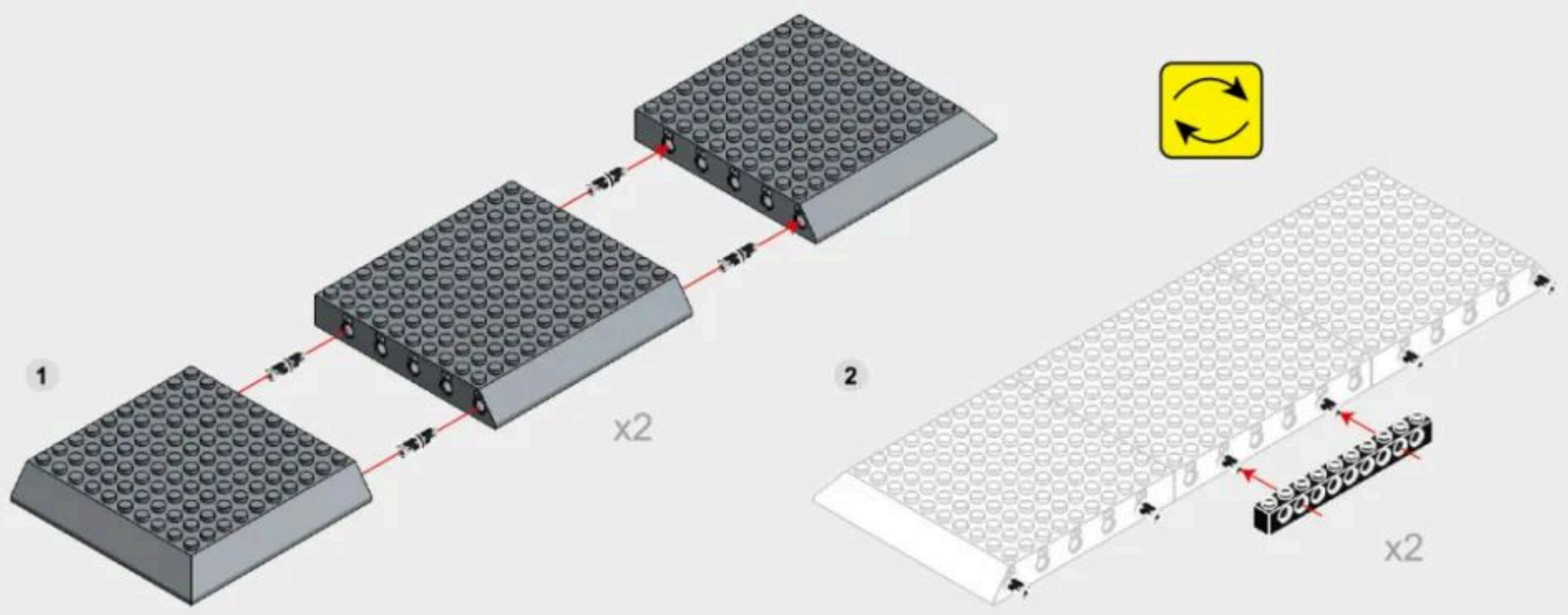
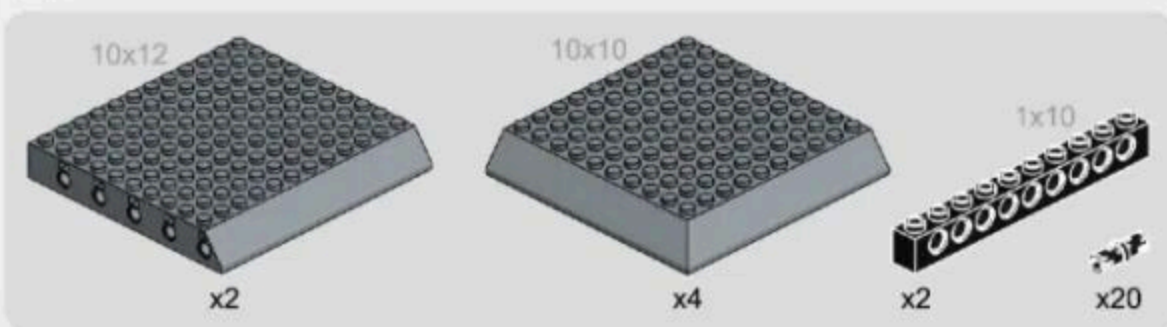

1-2

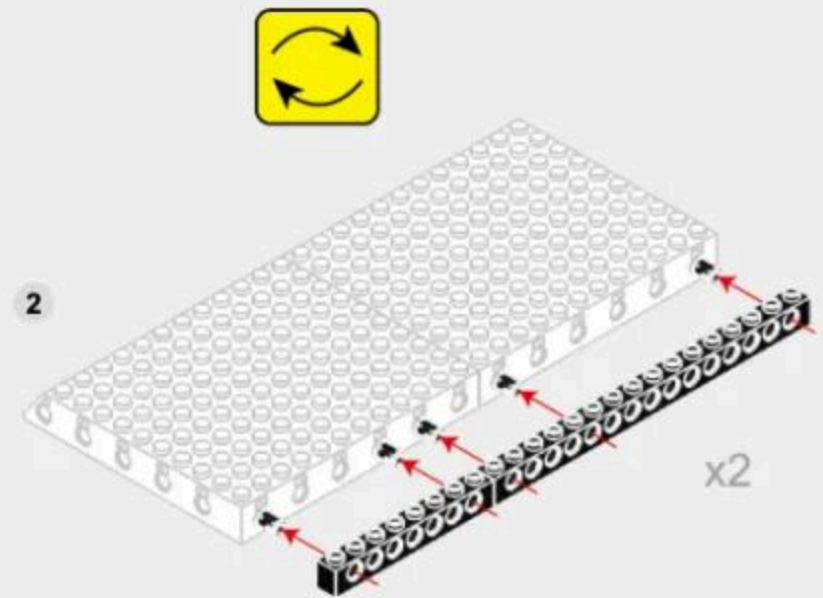
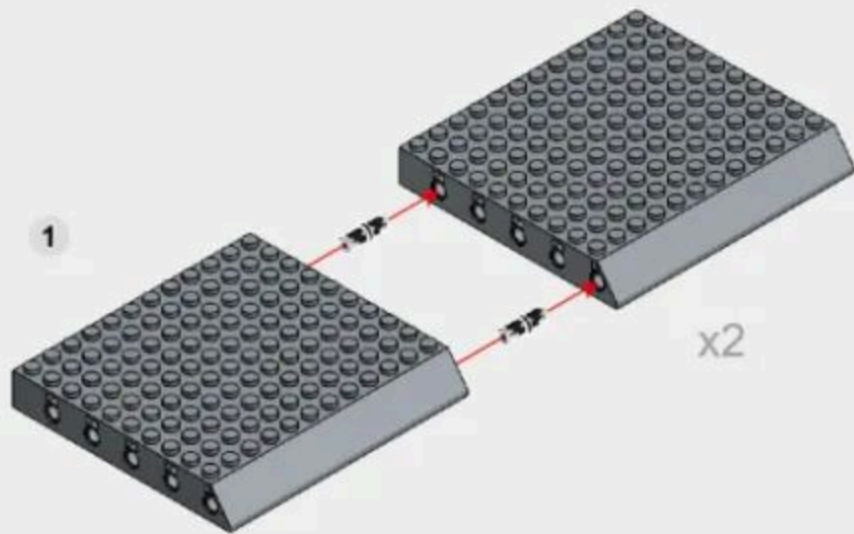
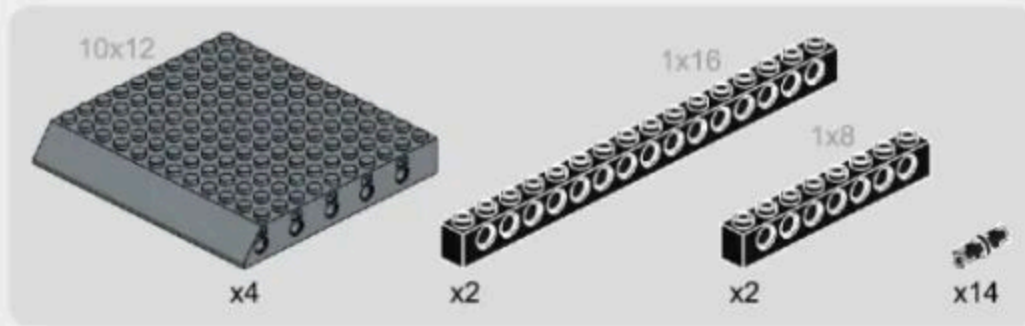

1-3

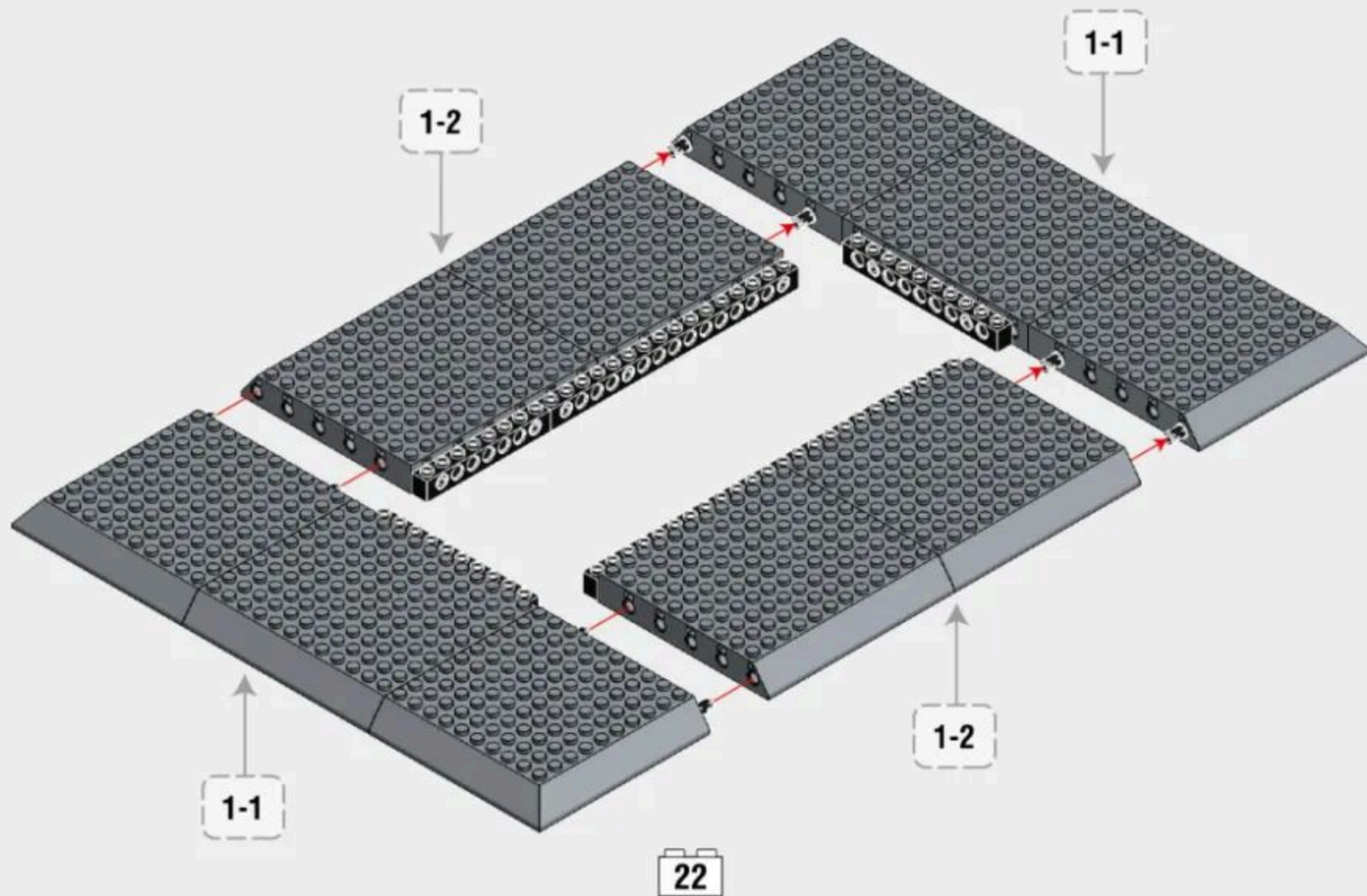

1-4

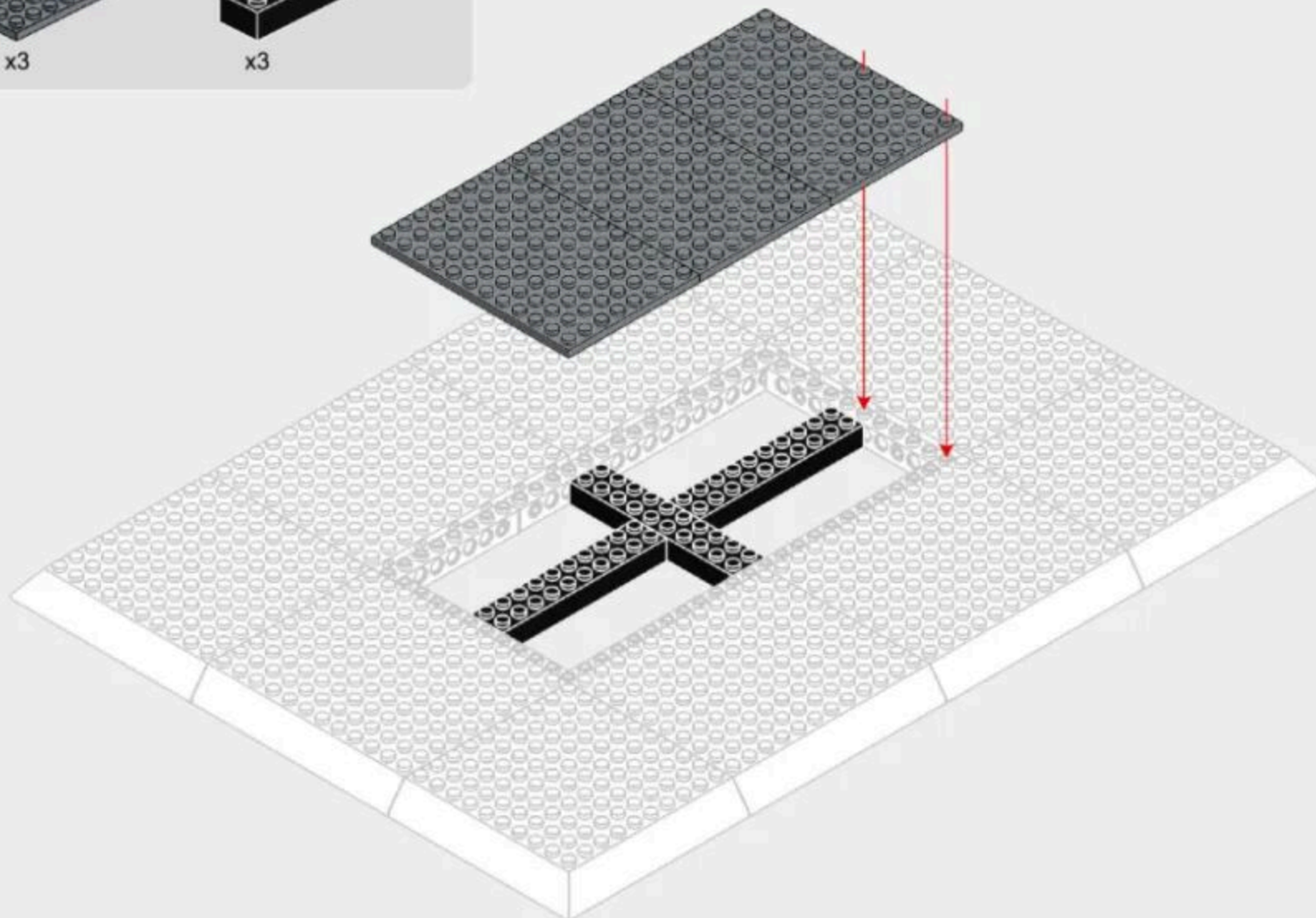
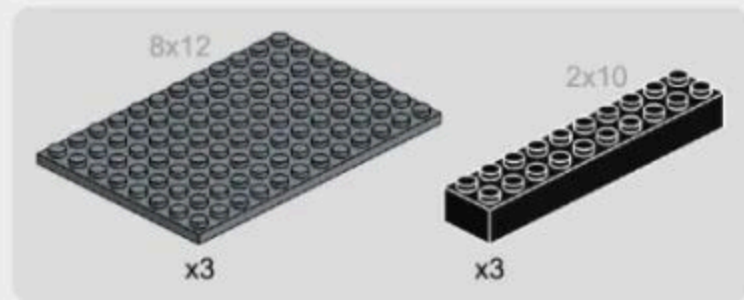

1-5

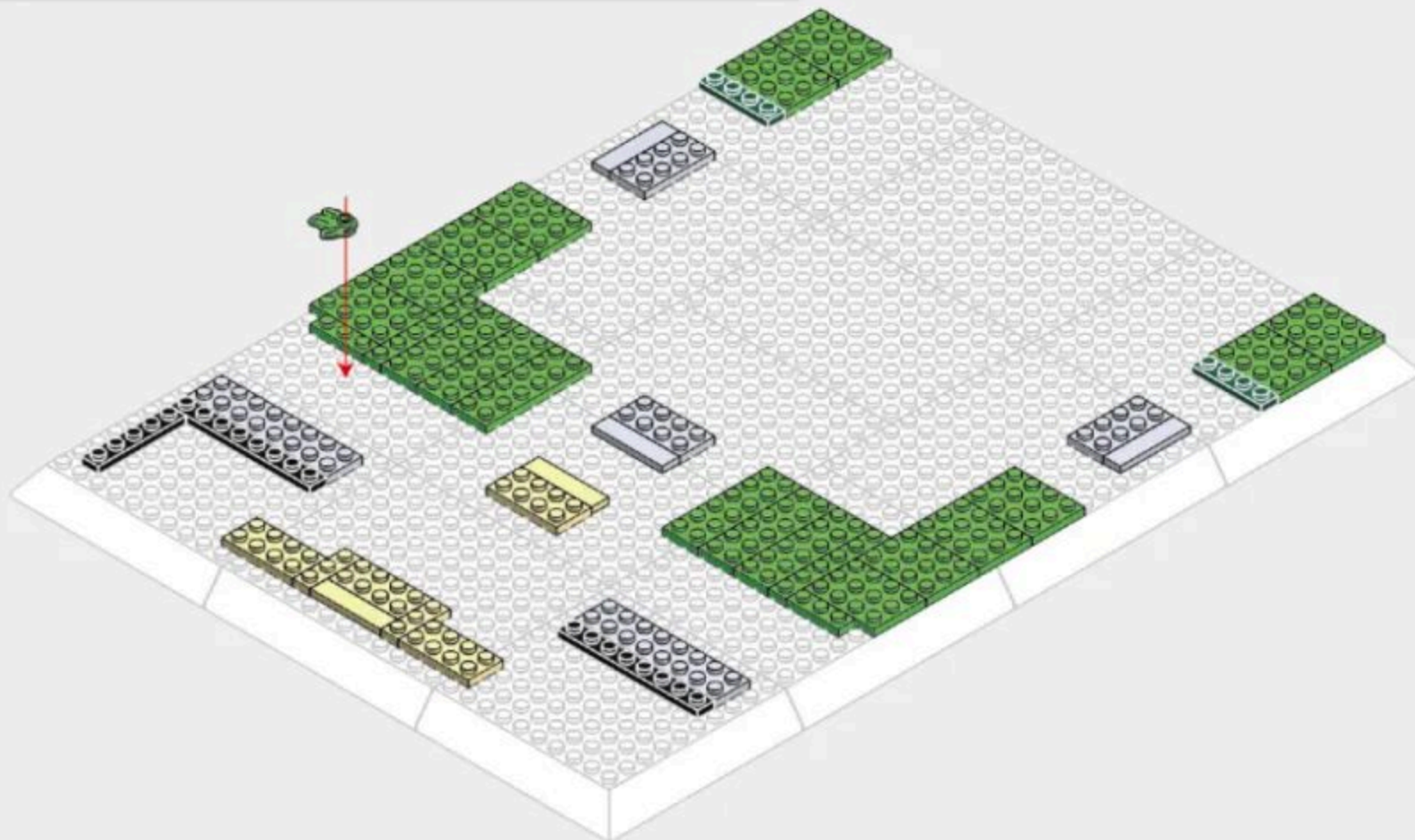
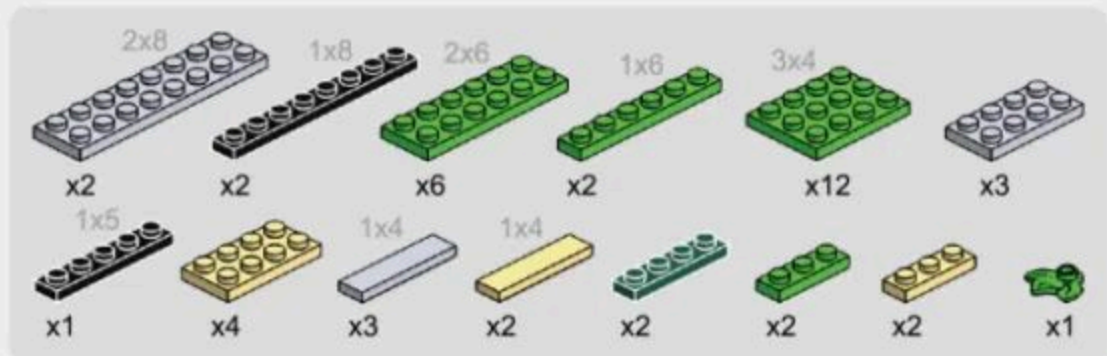

1-6

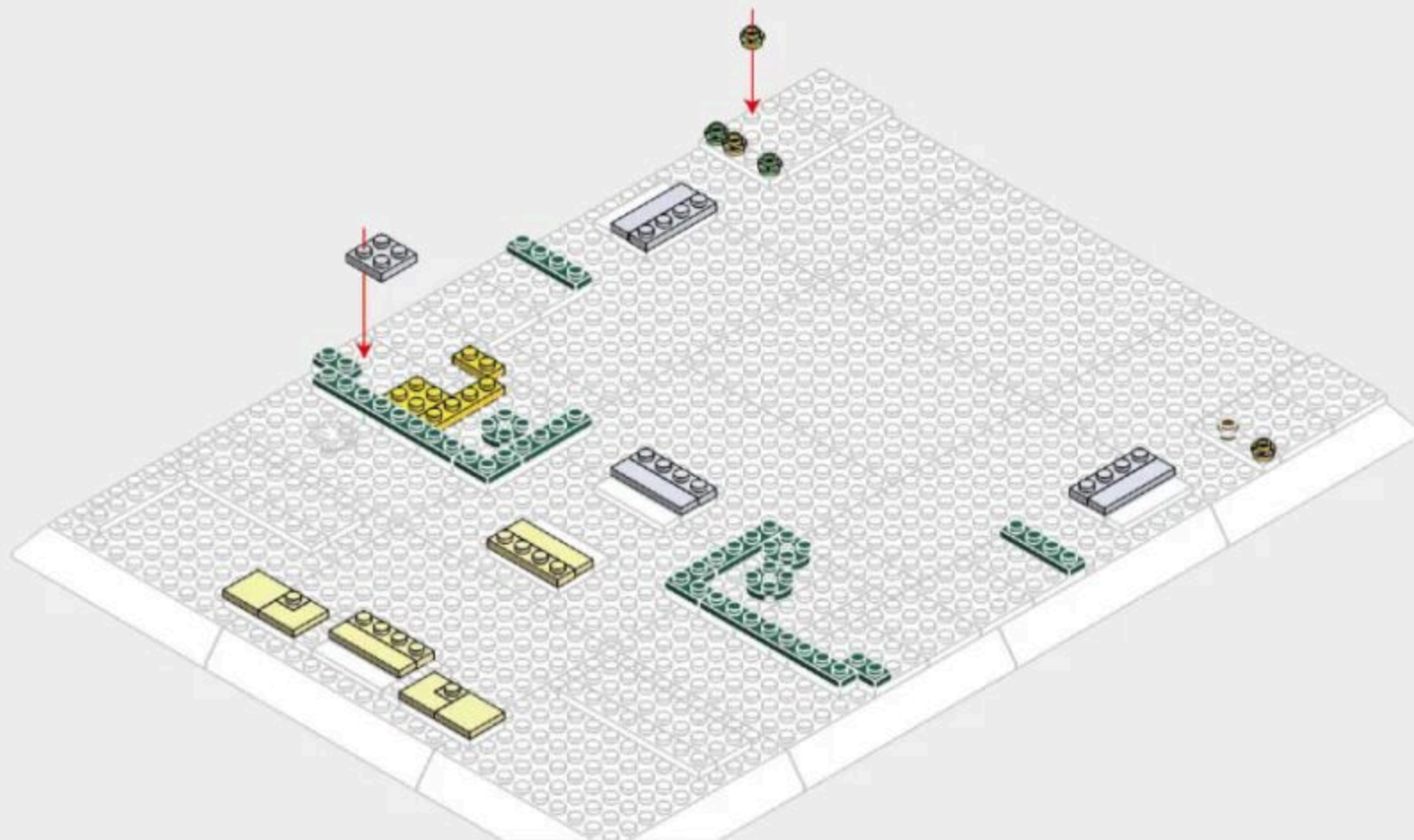

1-7

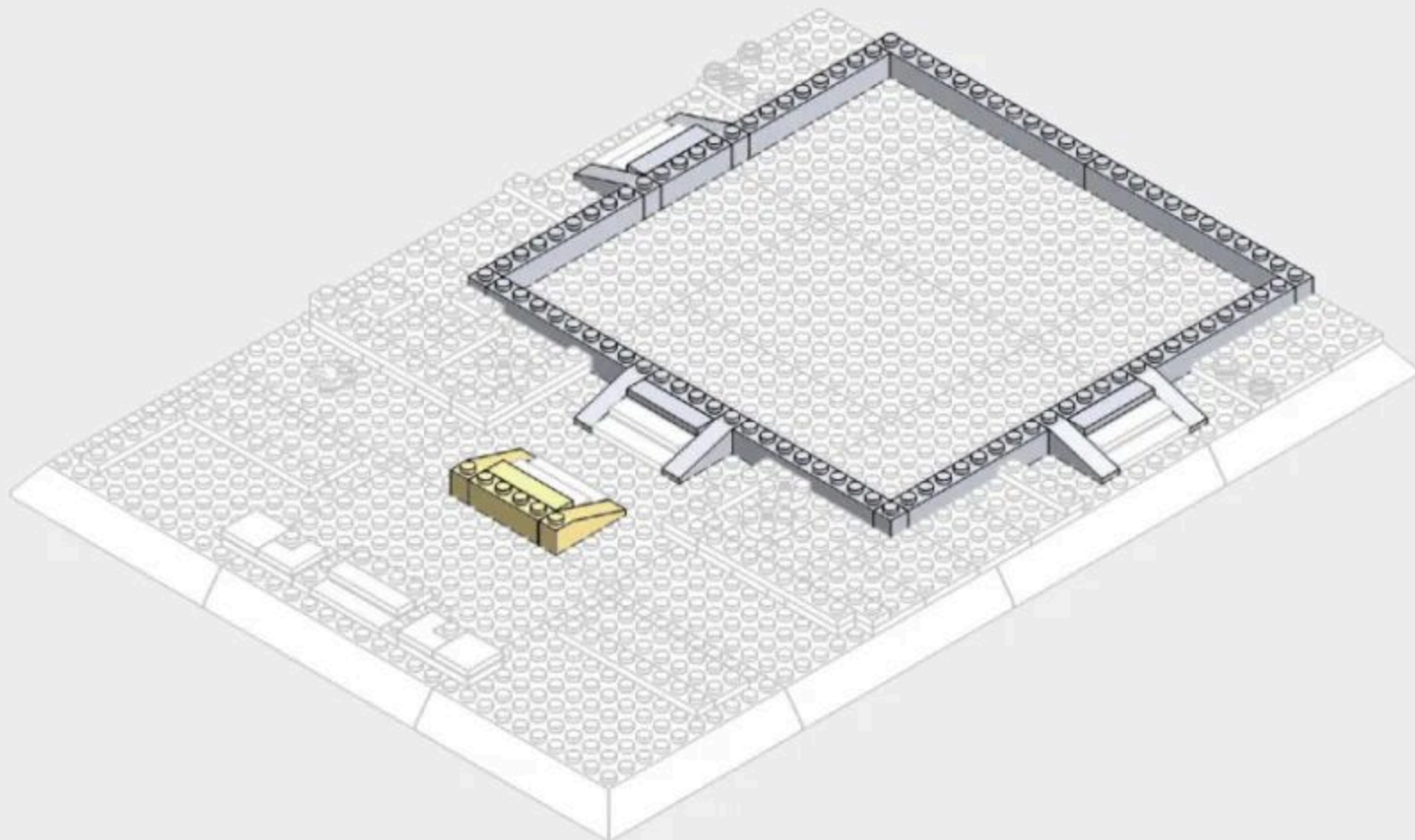
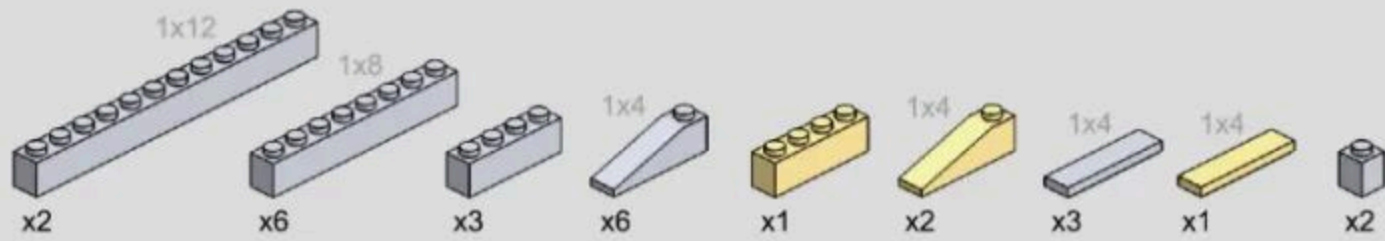

1-8

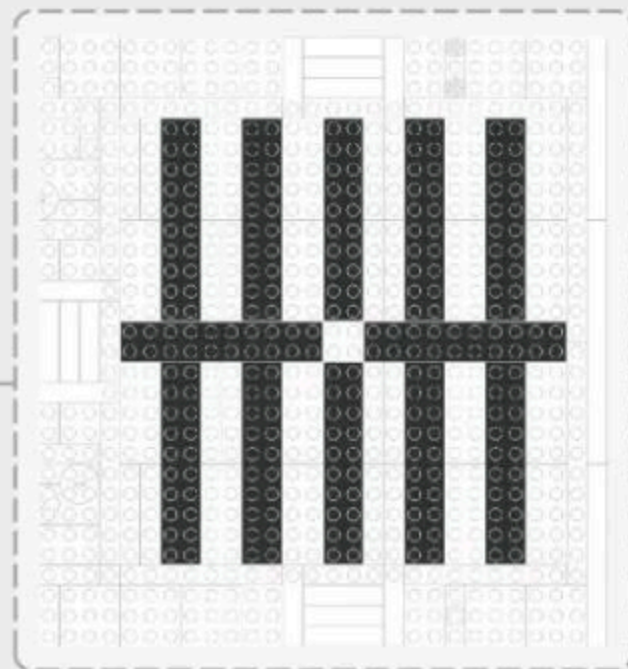
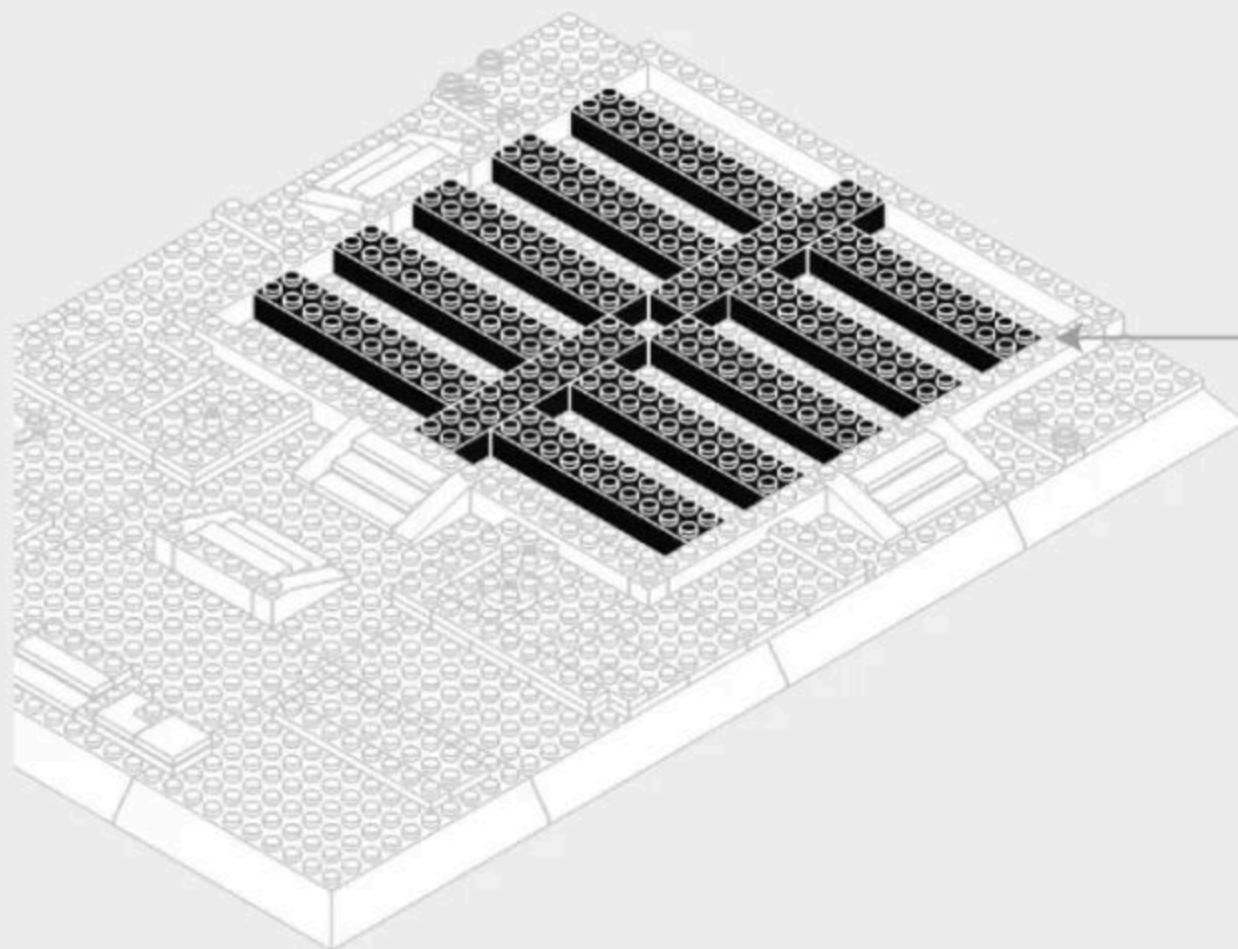
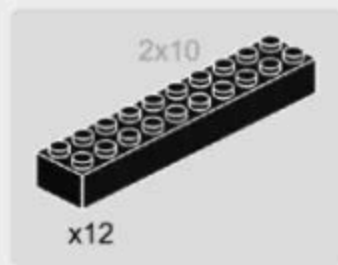

1-9

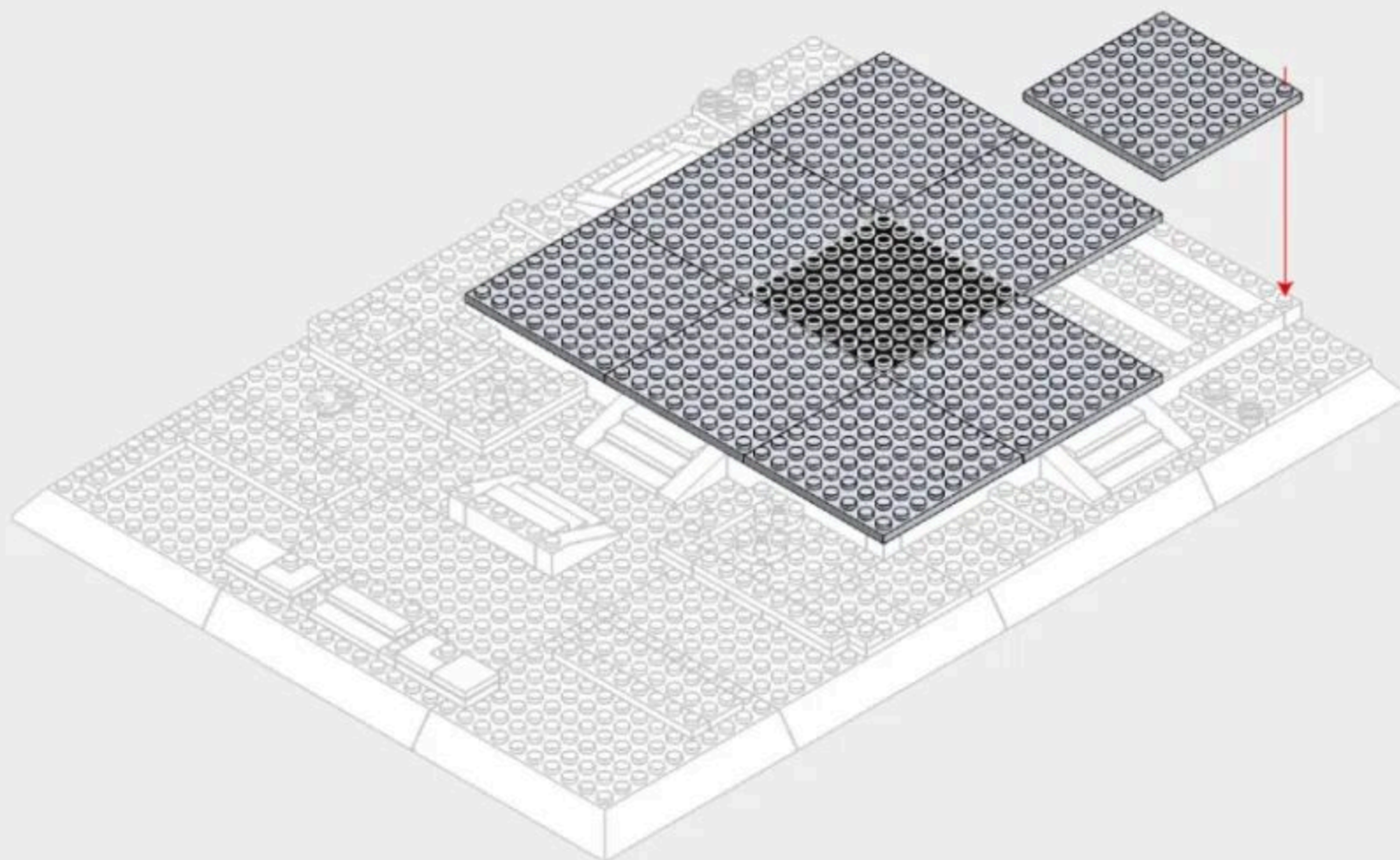
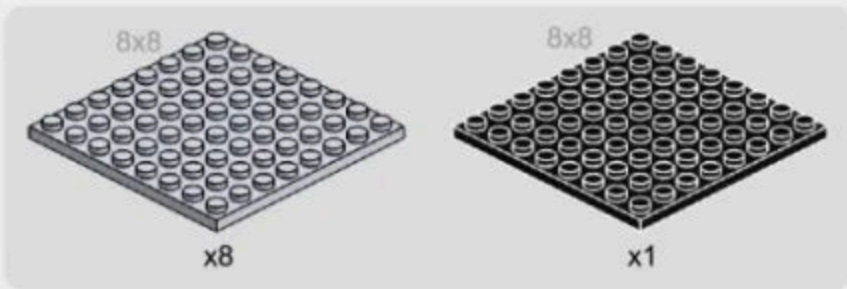

1-10

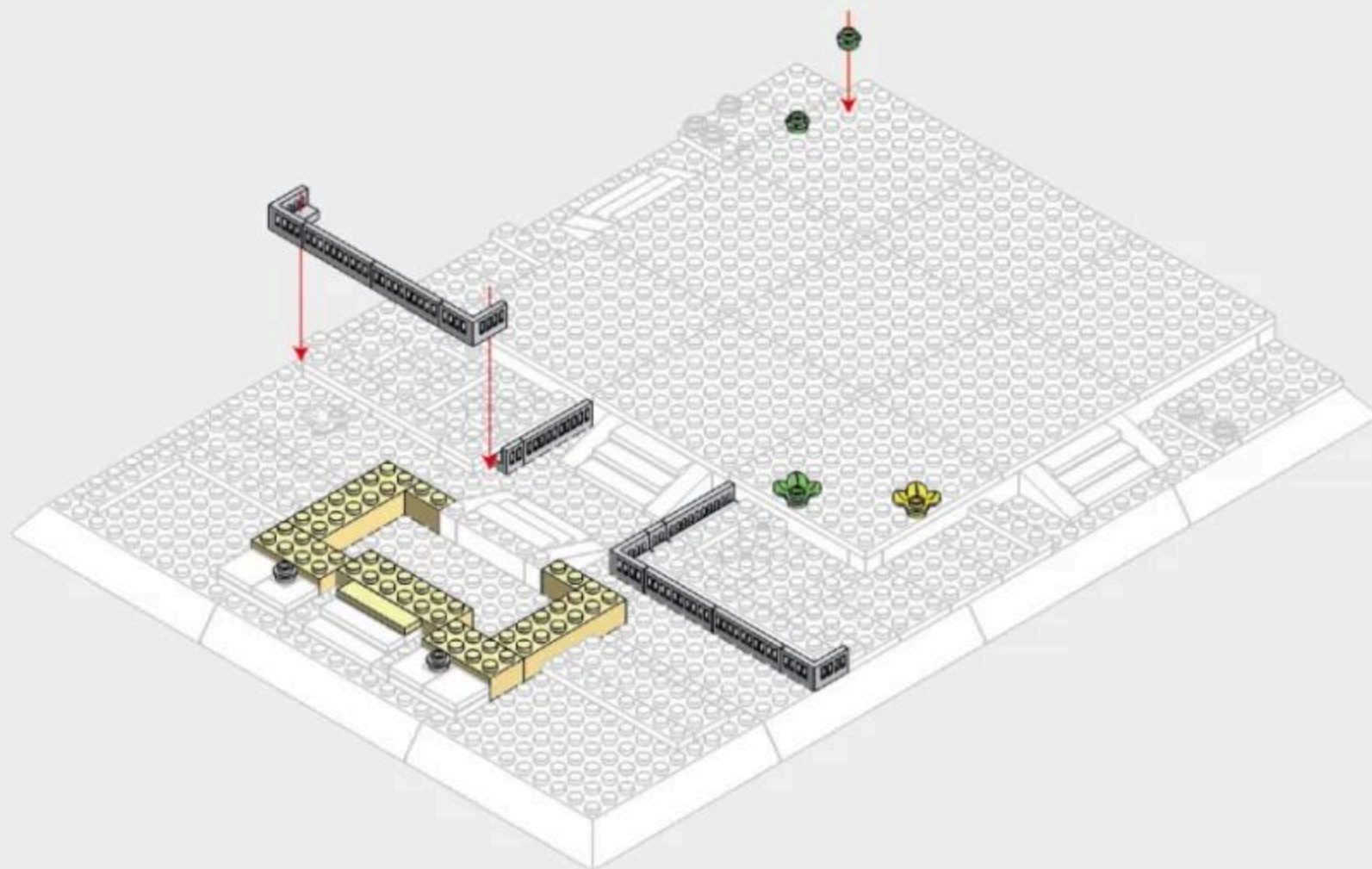
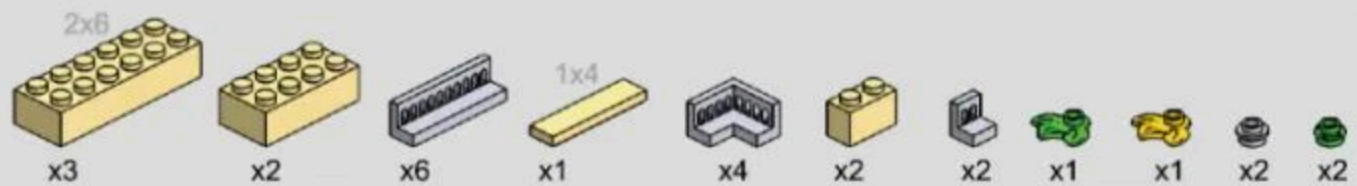

1-11

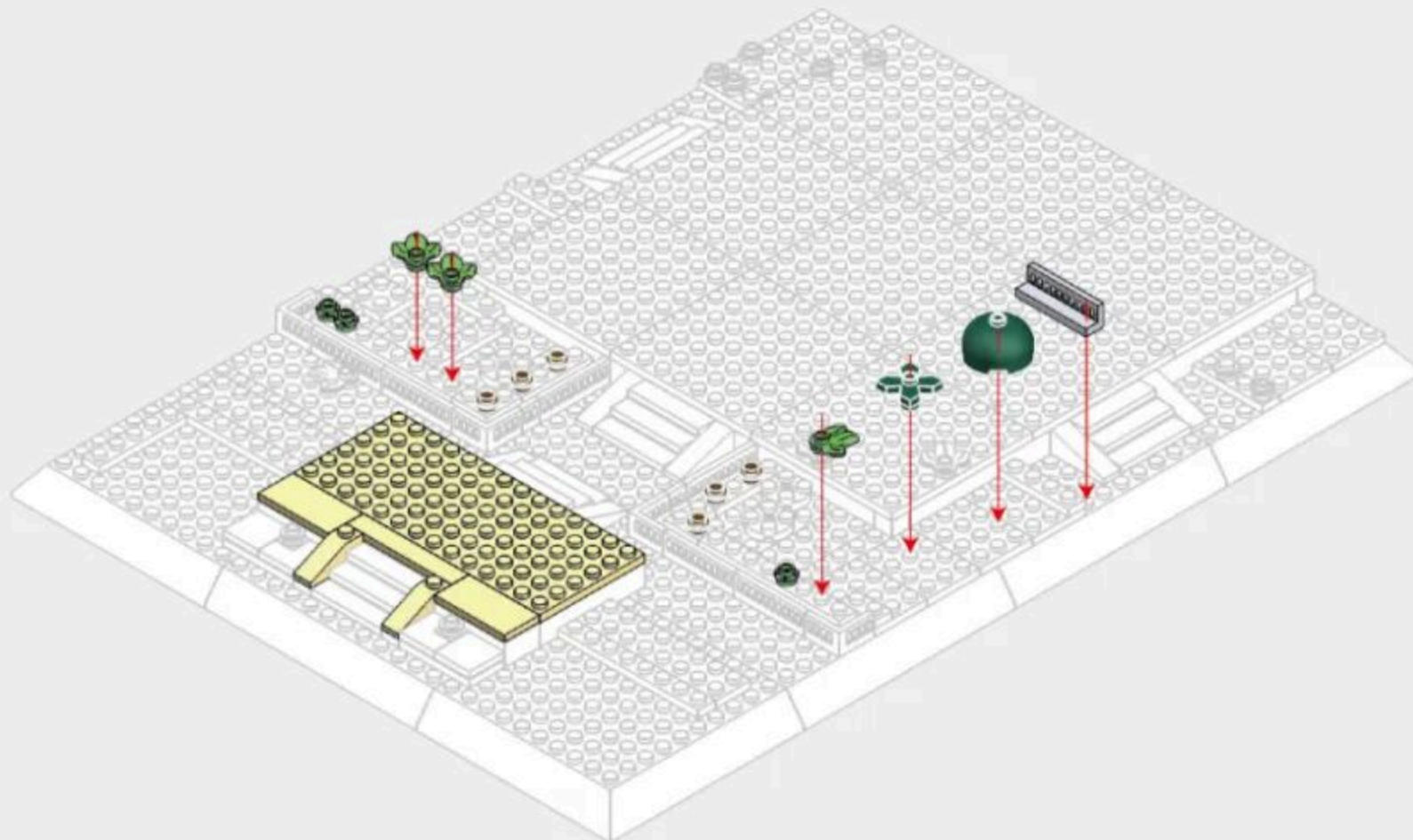
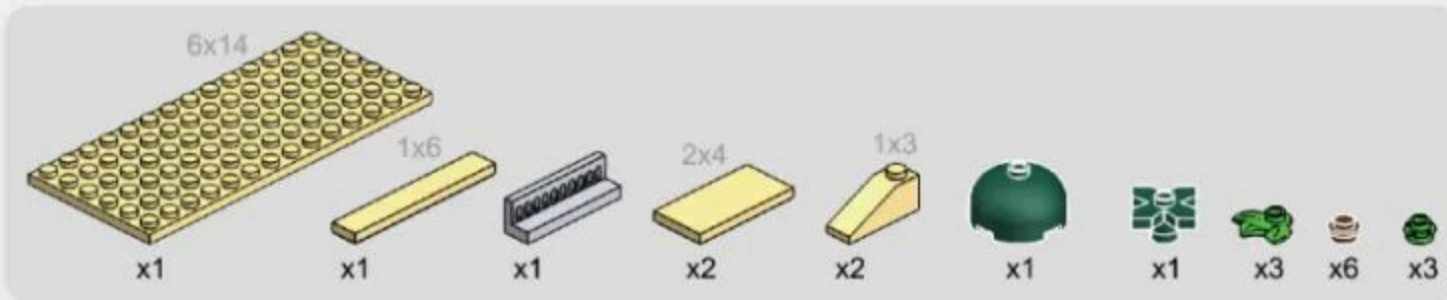

1-12



x1



x3



x1



x11







285PCS



2-1

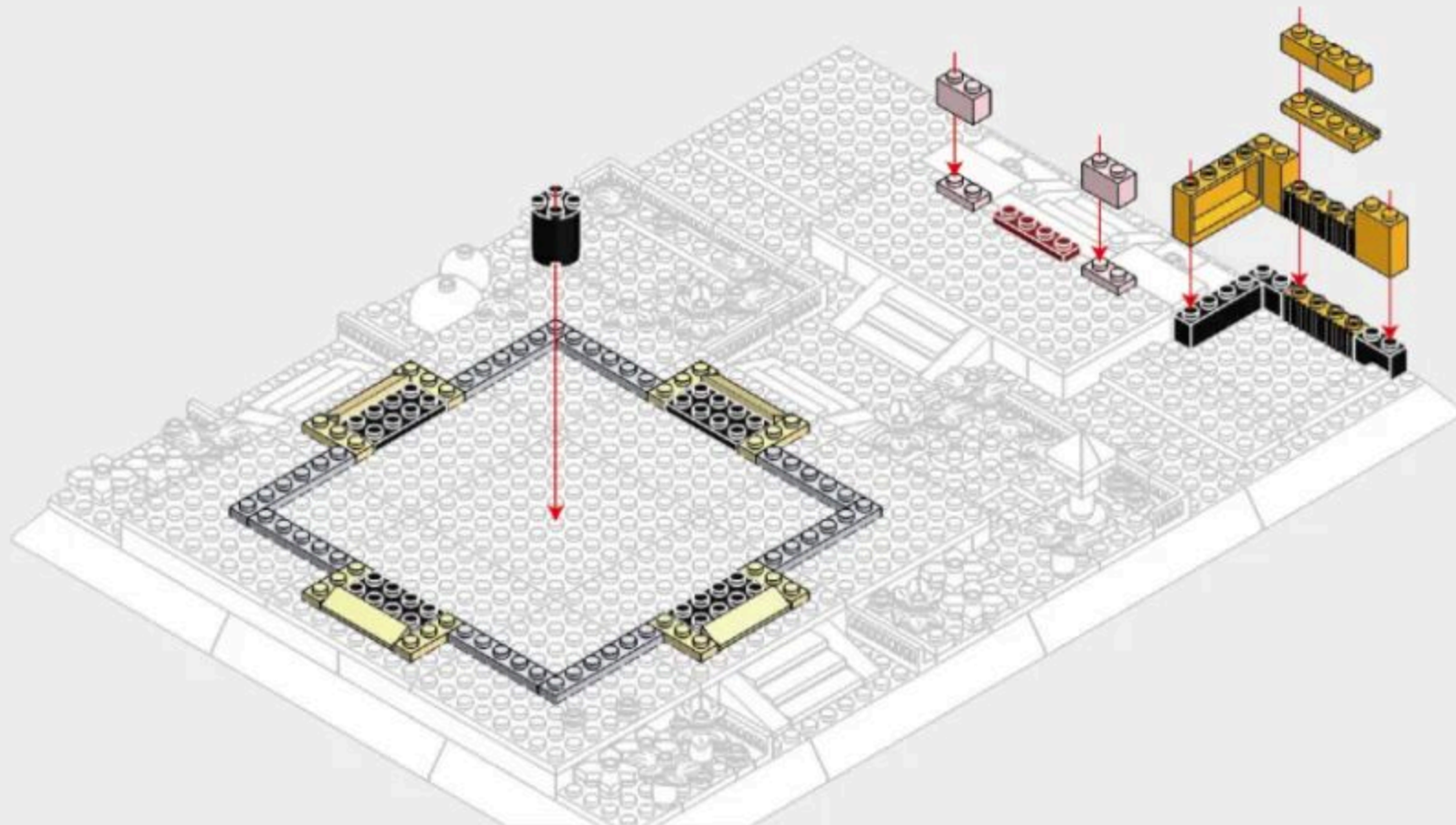
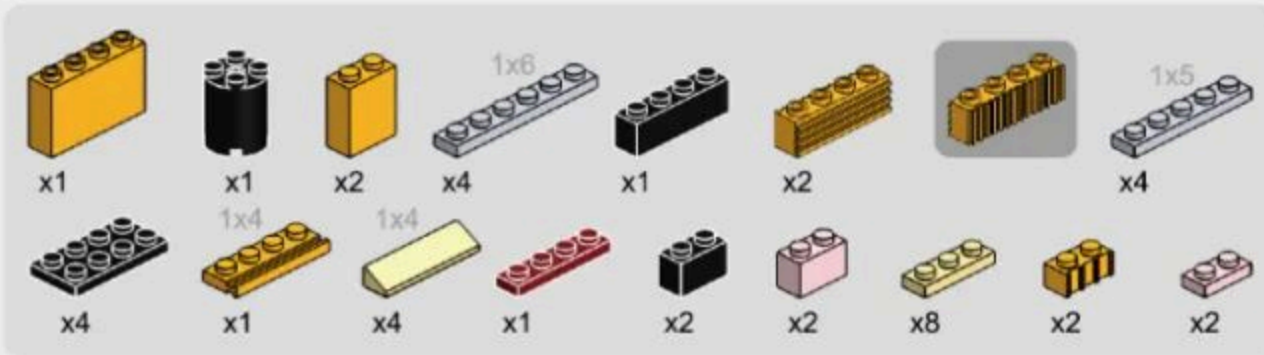



2-3

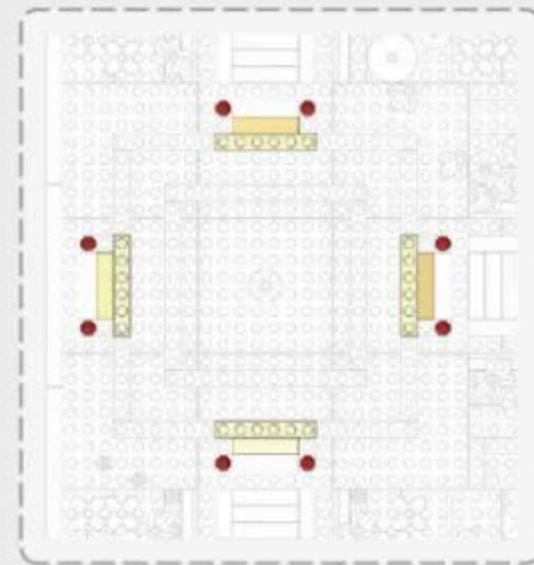
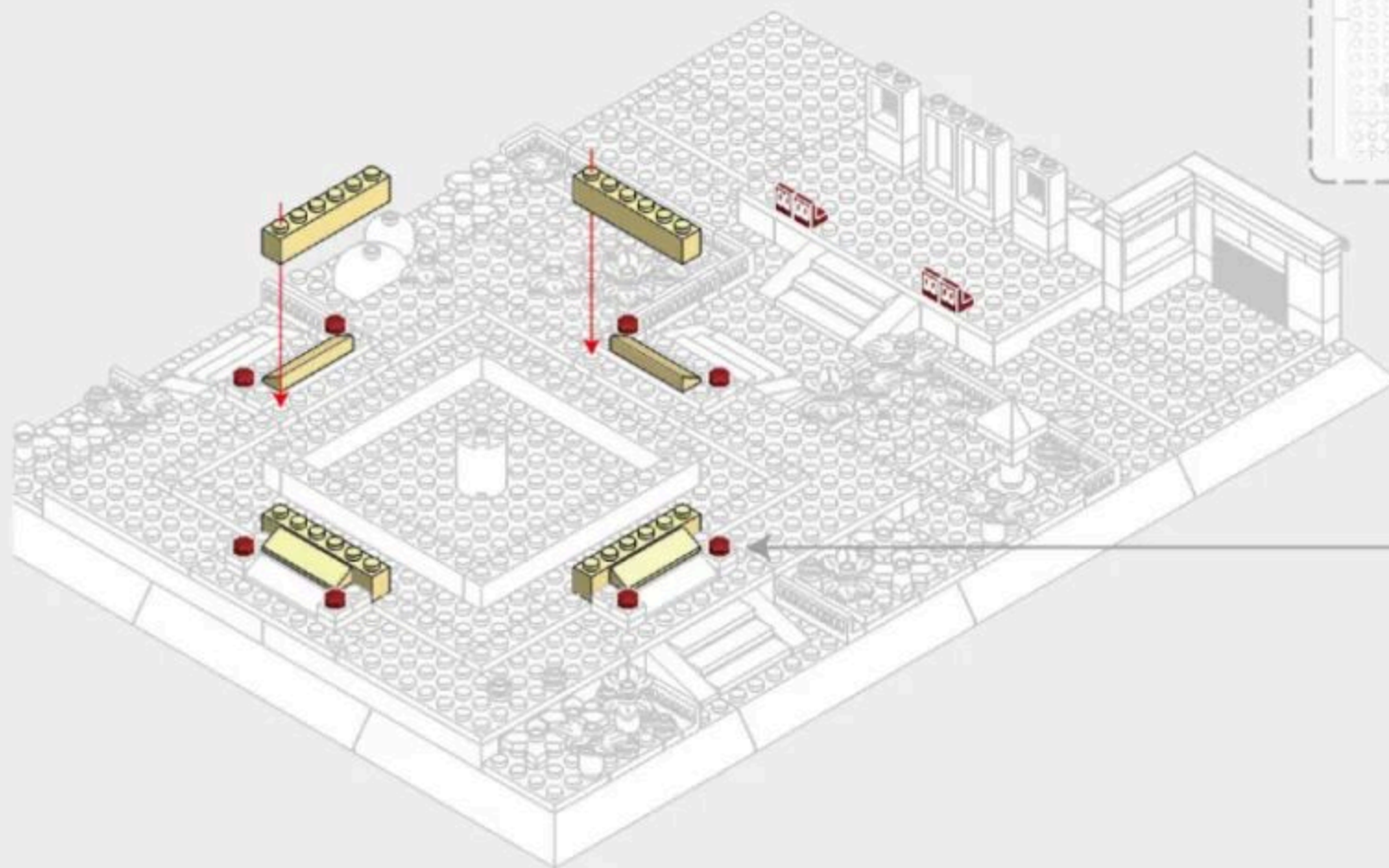
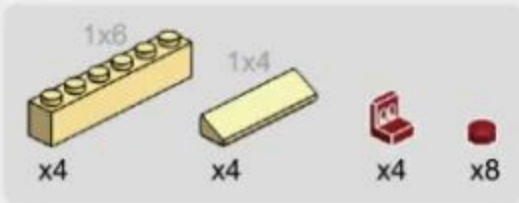

2-4

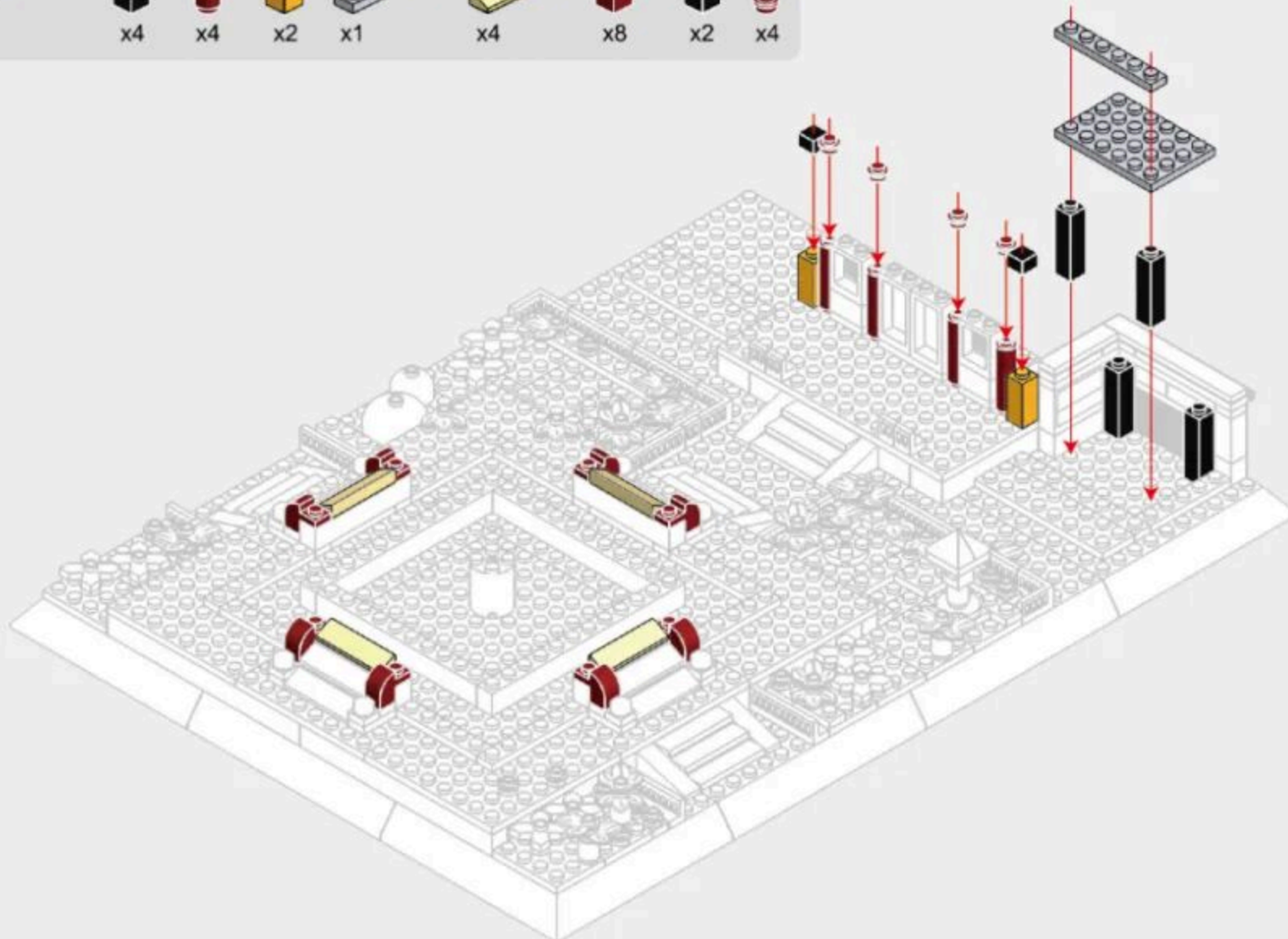

2-5

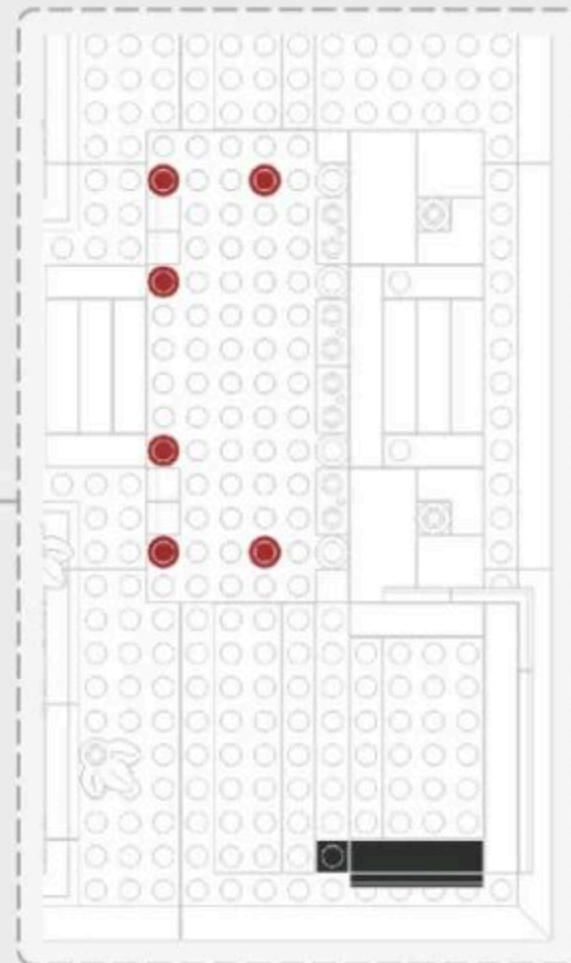
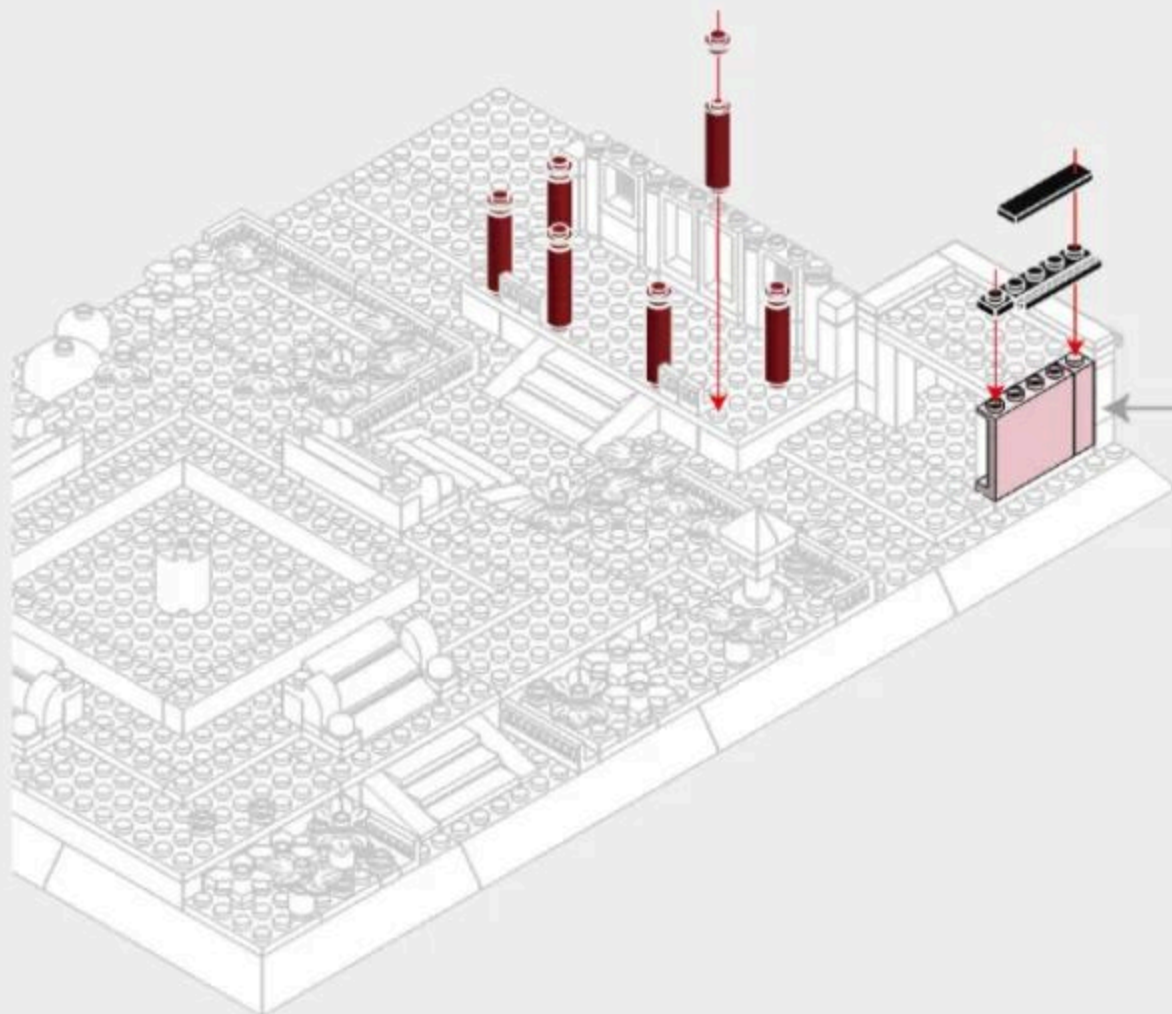

2-6

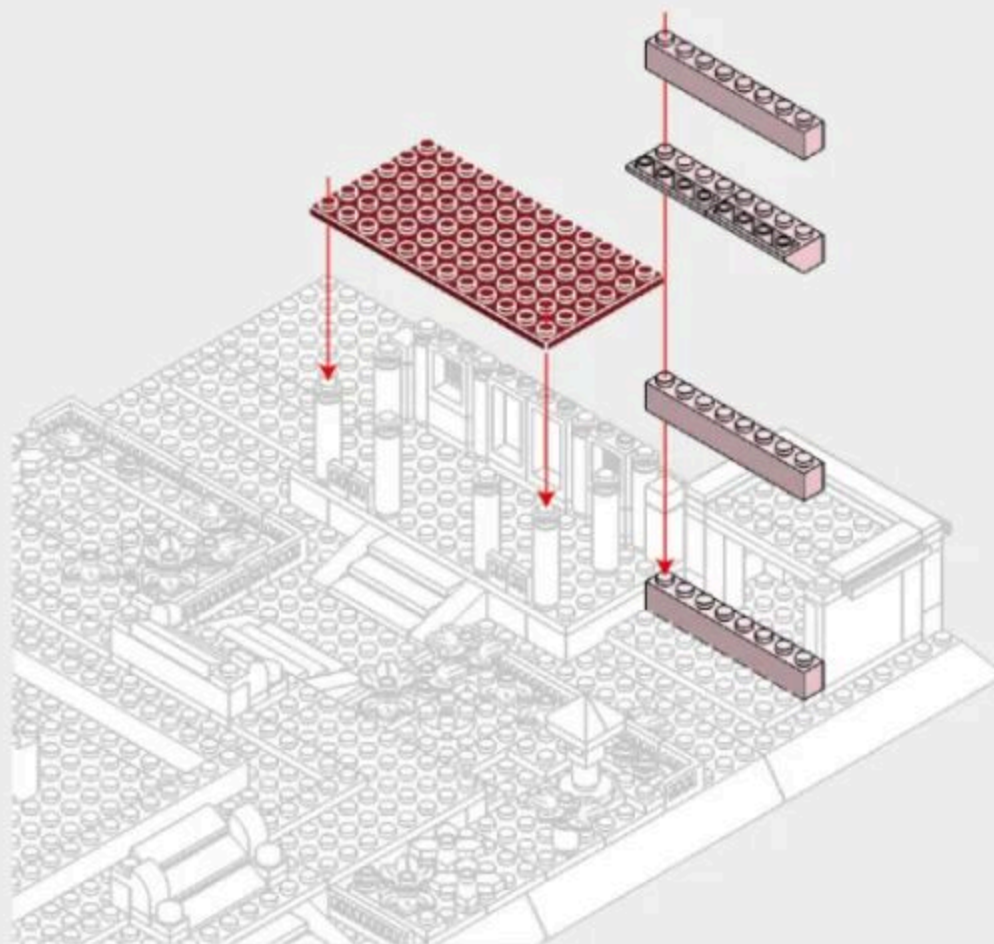
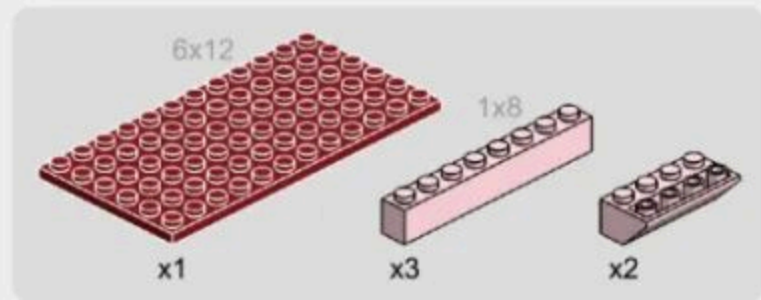

2-7

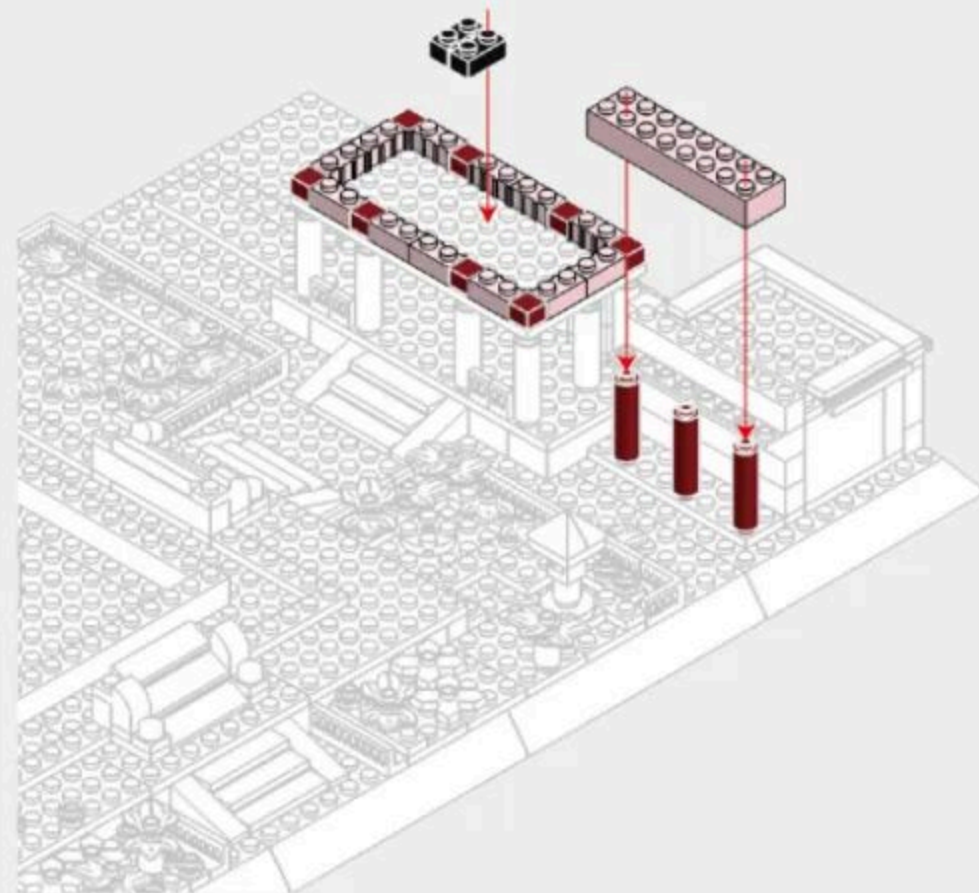

2-8

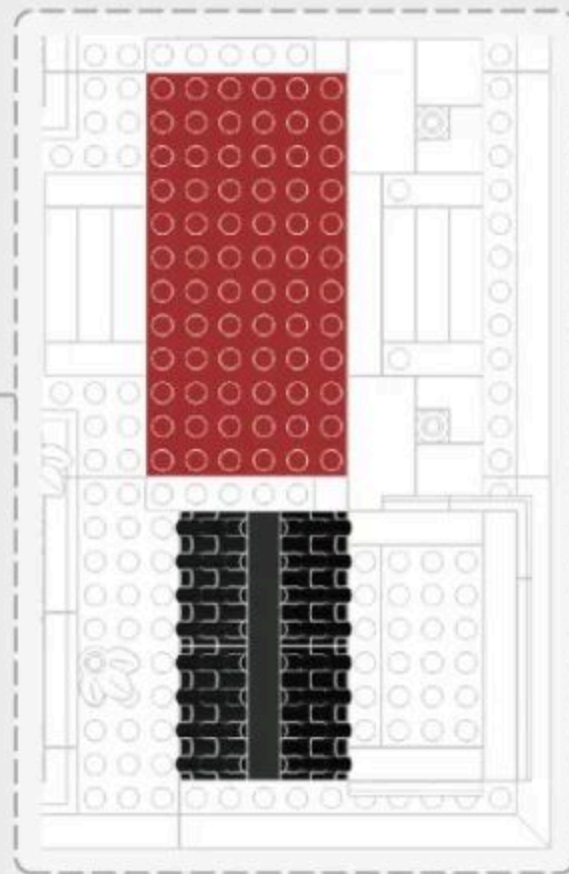
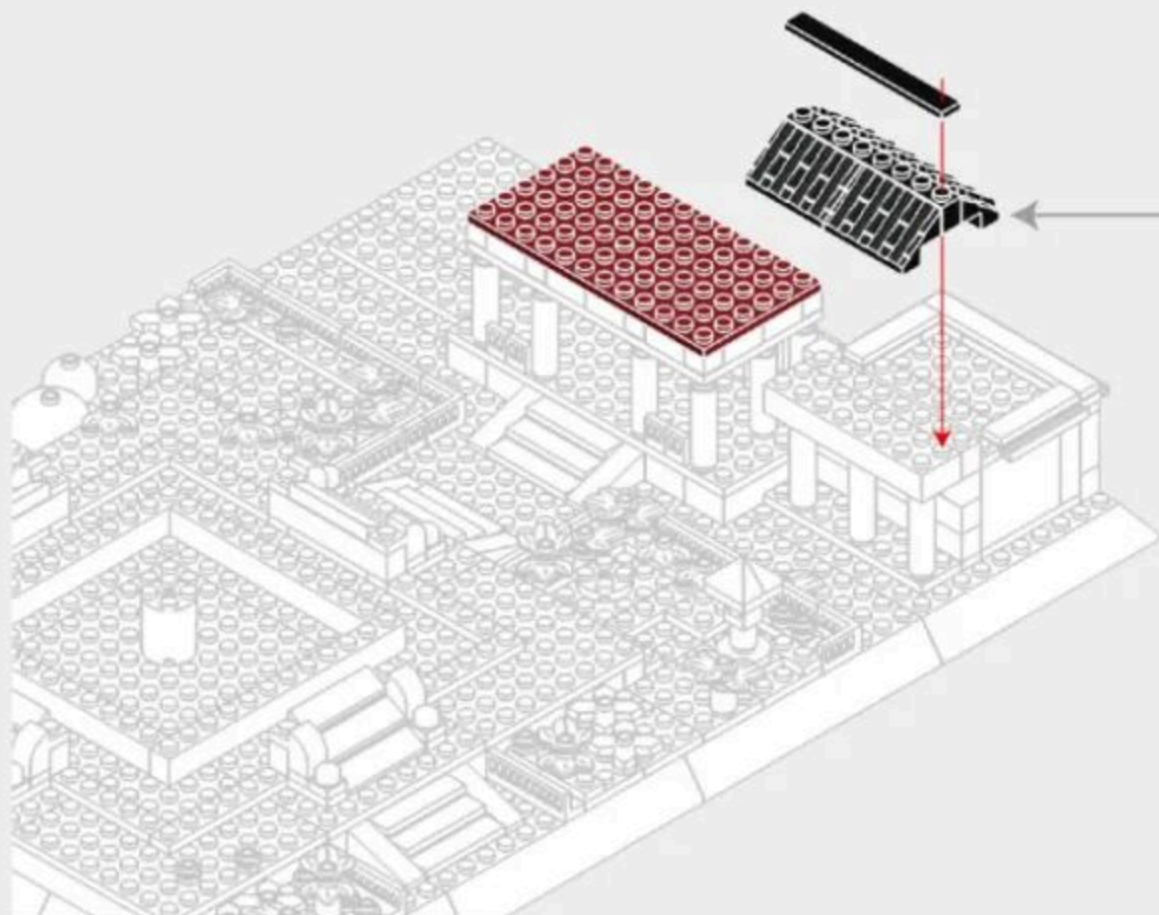
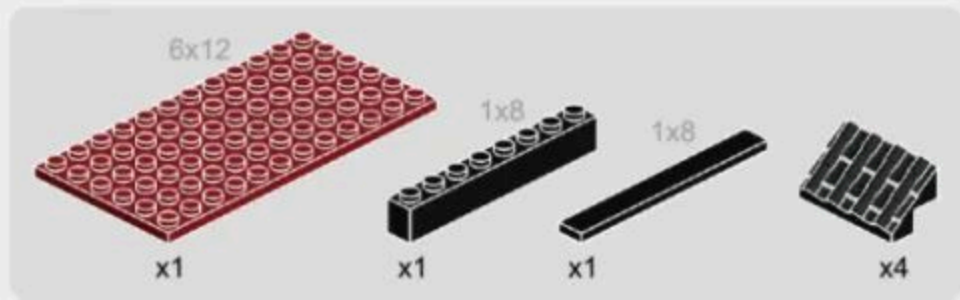

2-9

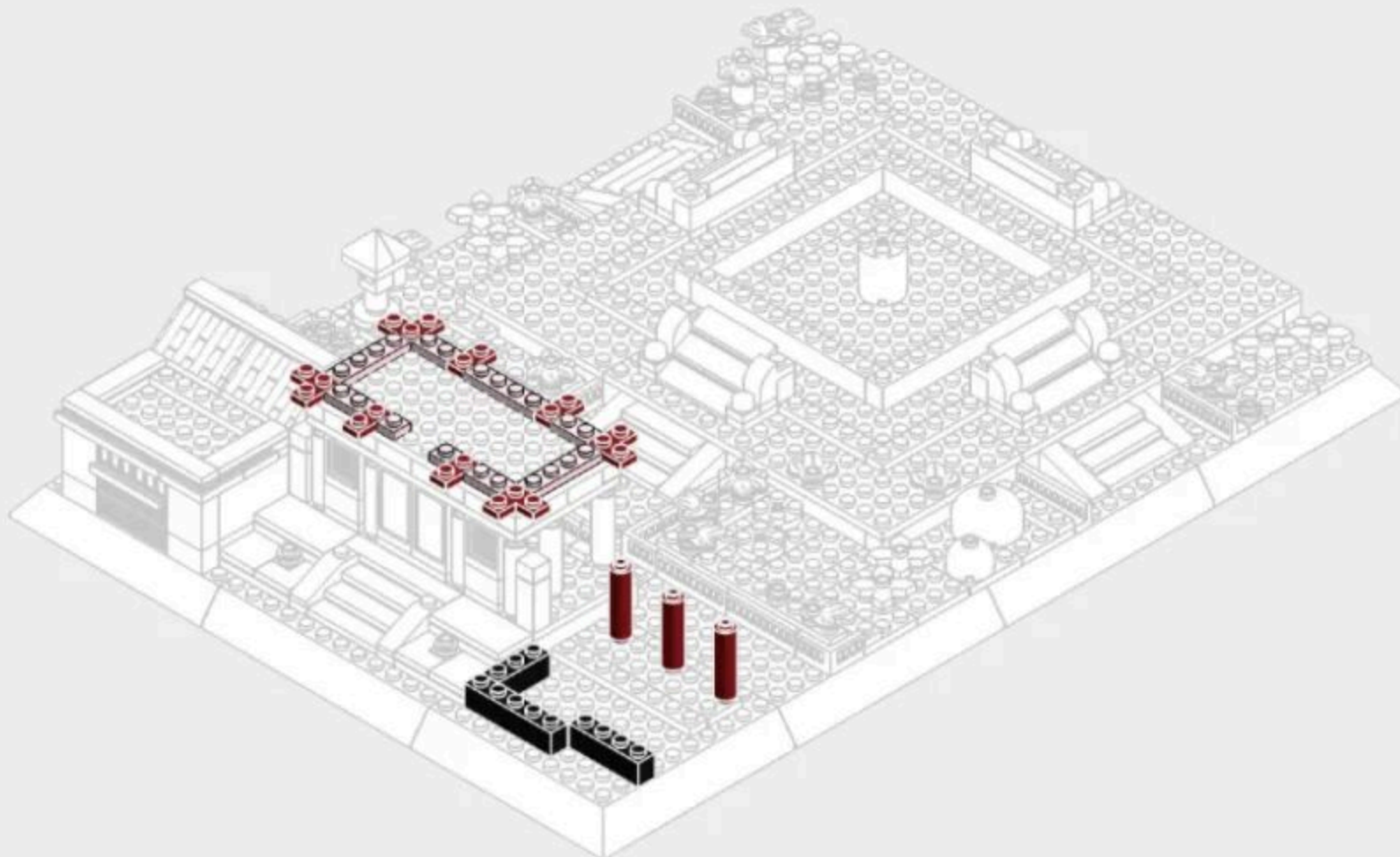
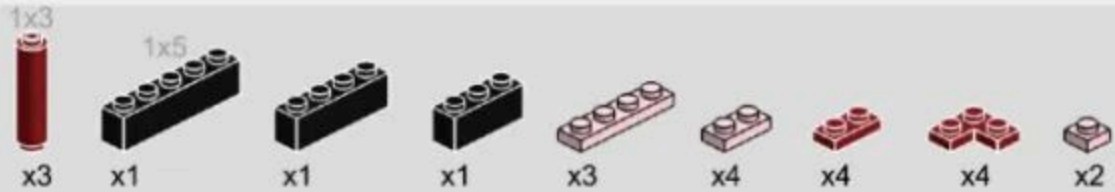

2-10

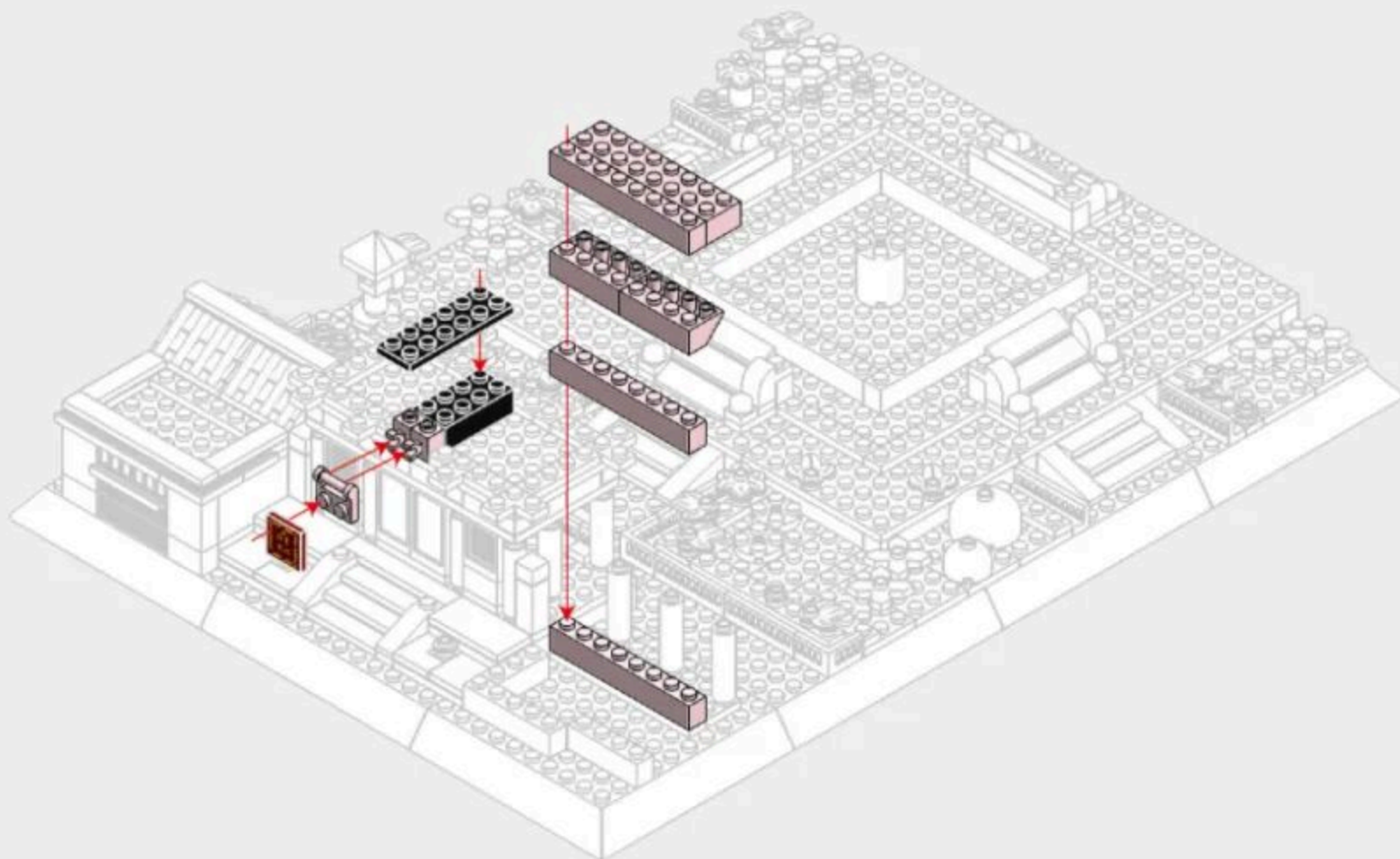
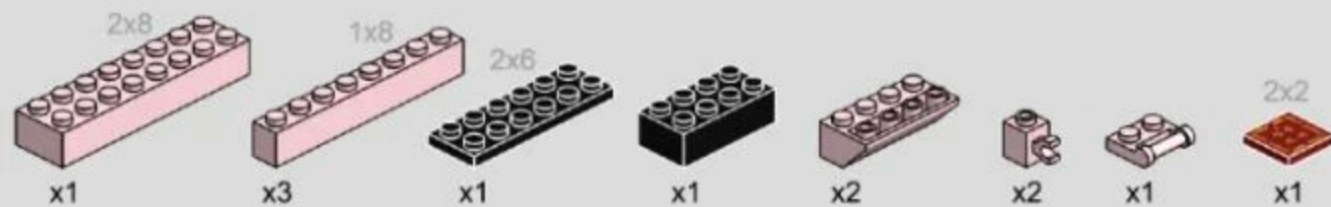

2-11

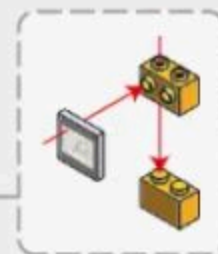
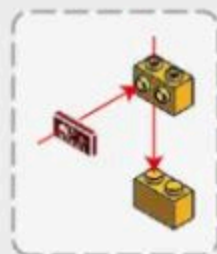
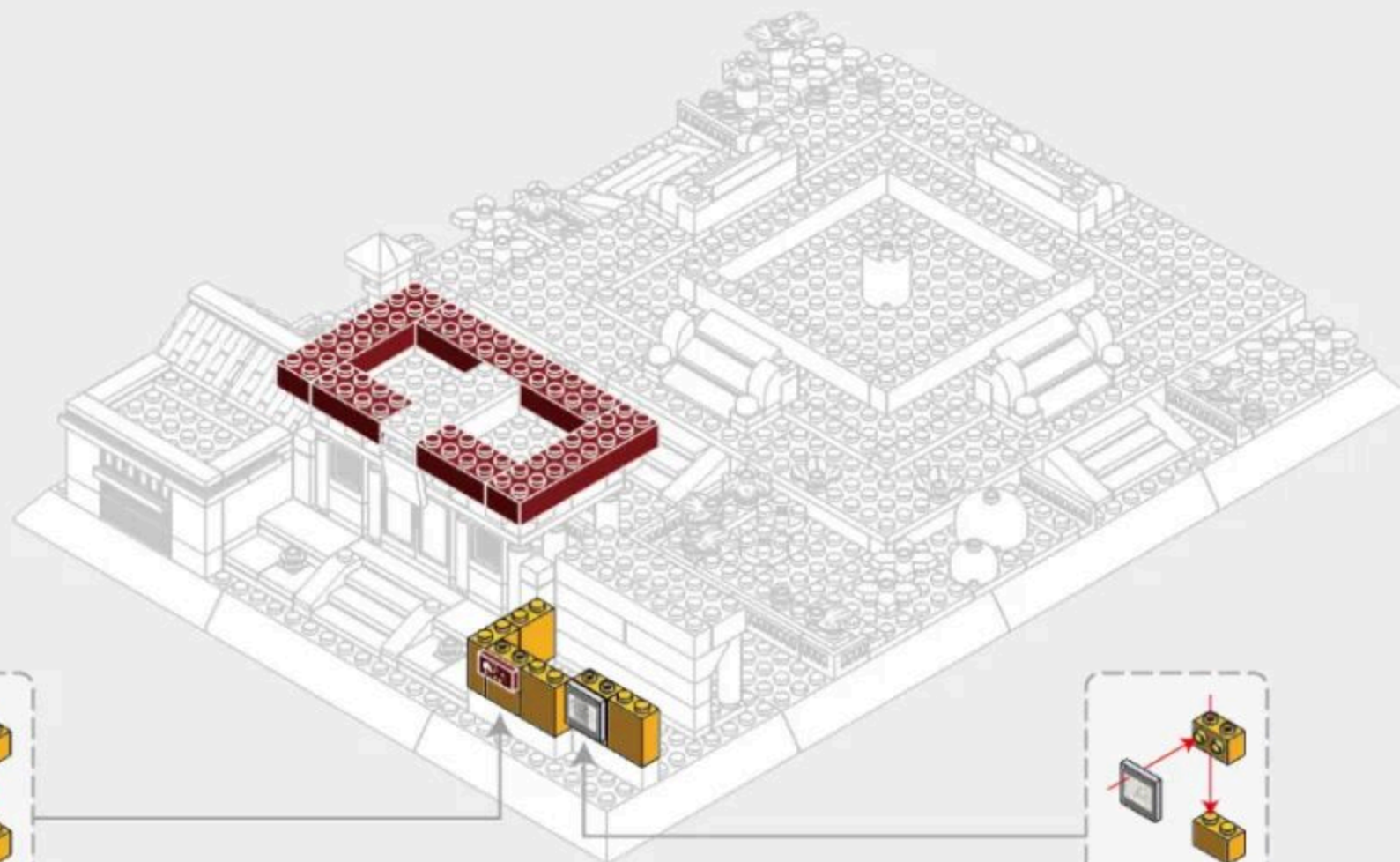
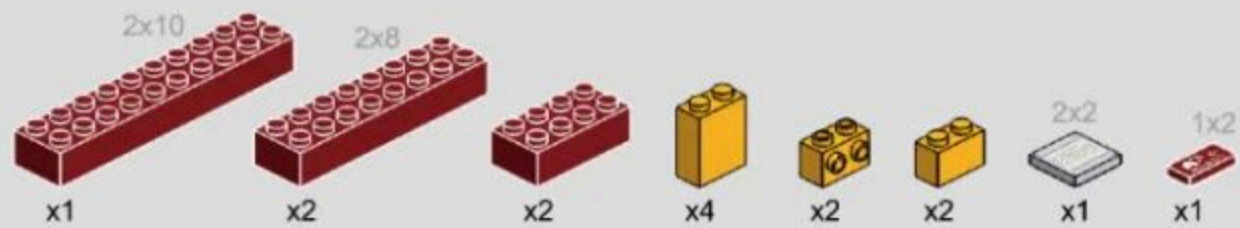

## 2-12

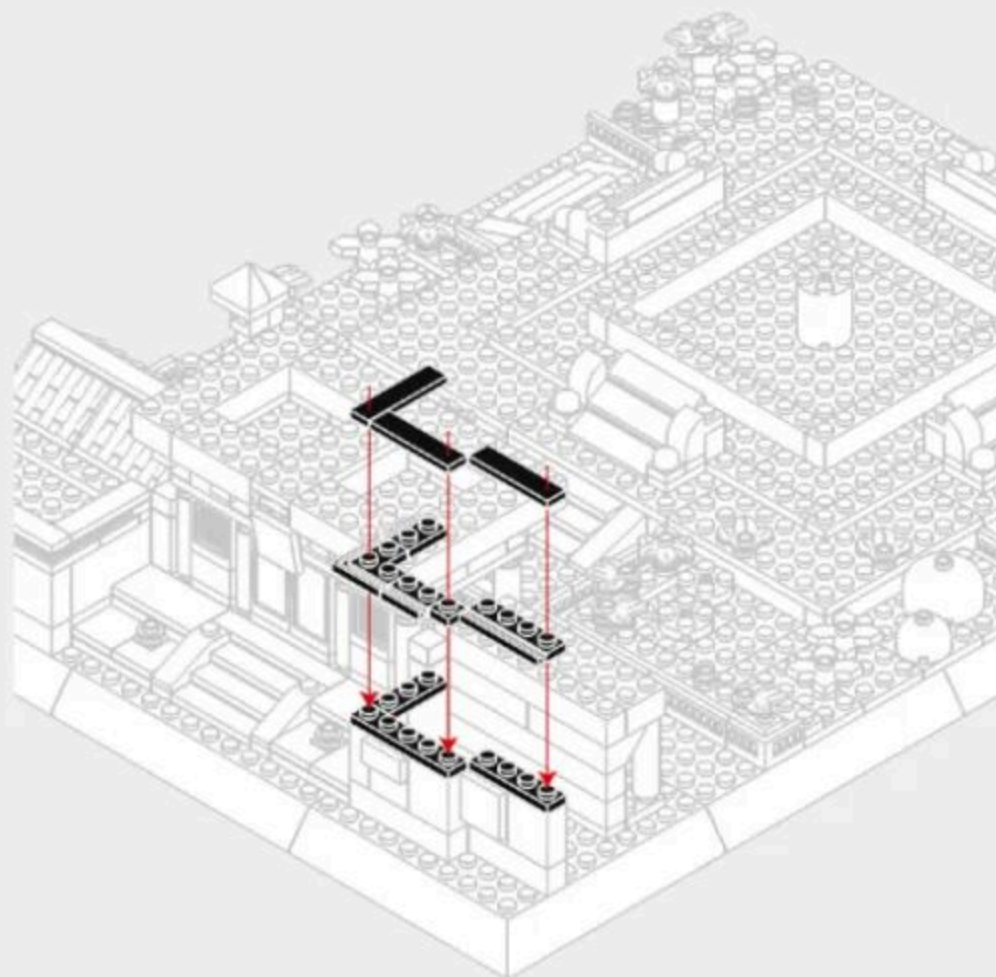
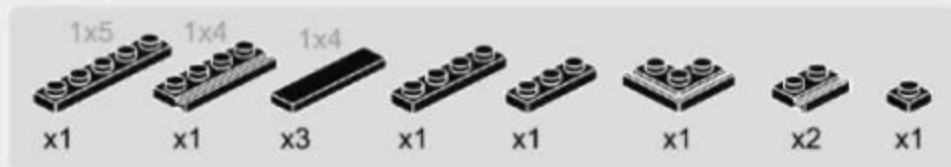

## 2-13

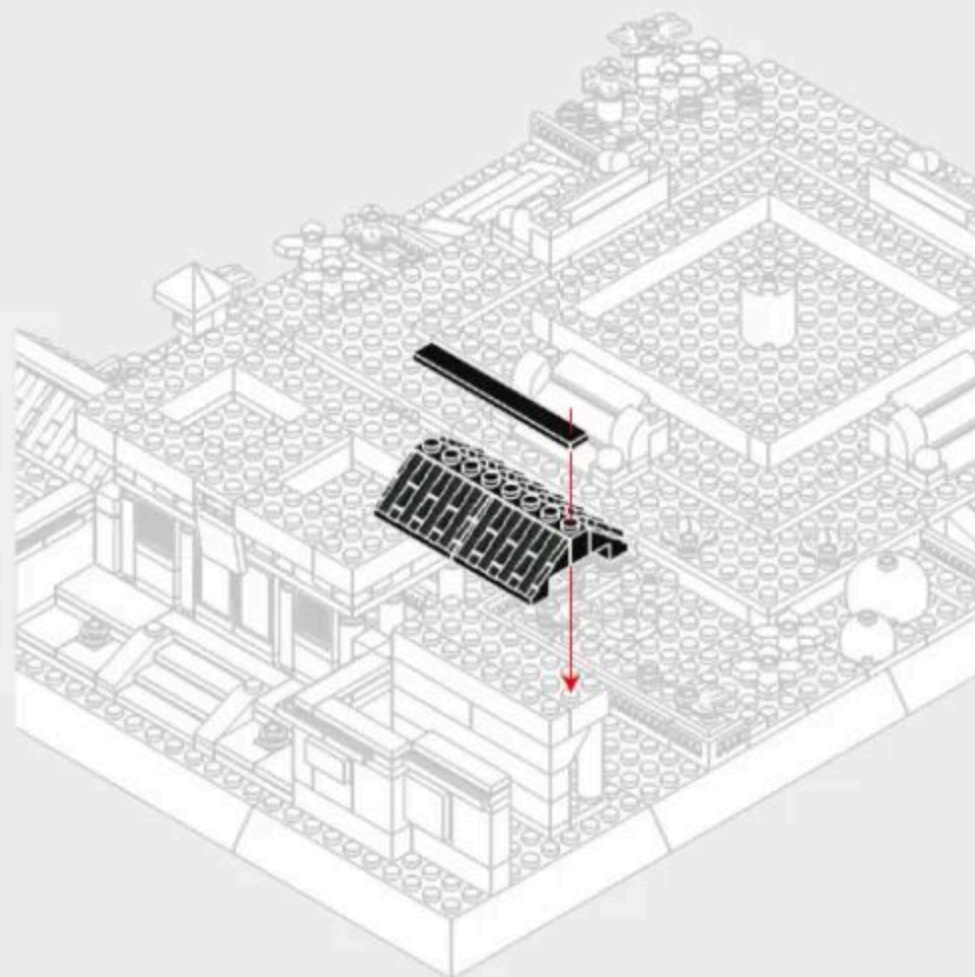

2-14

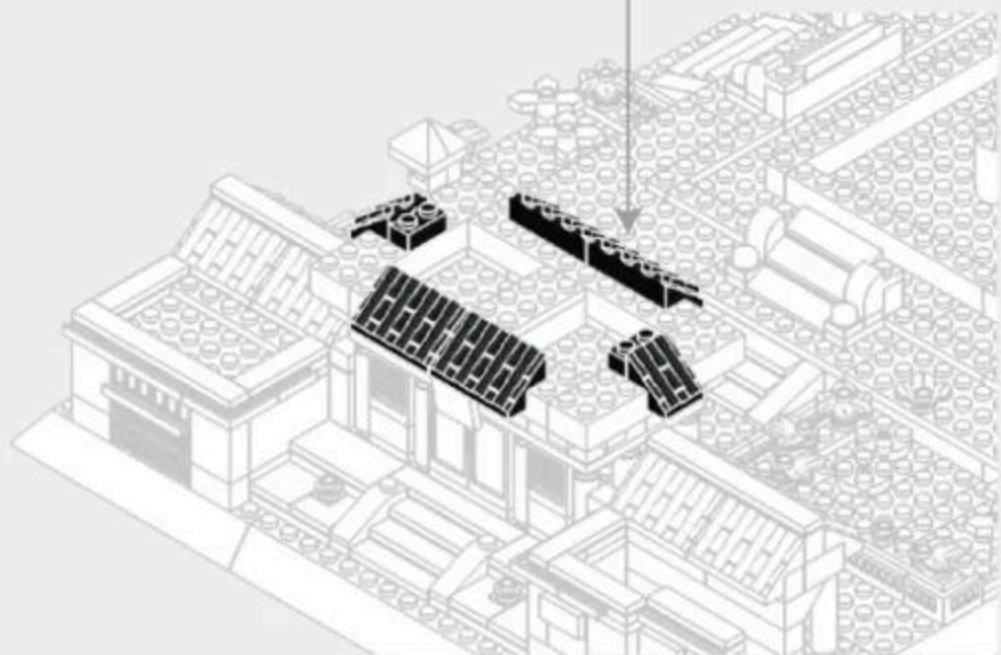
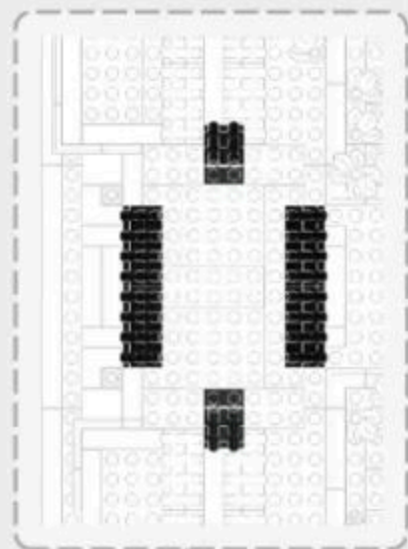
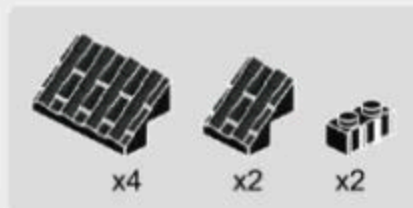

2-15

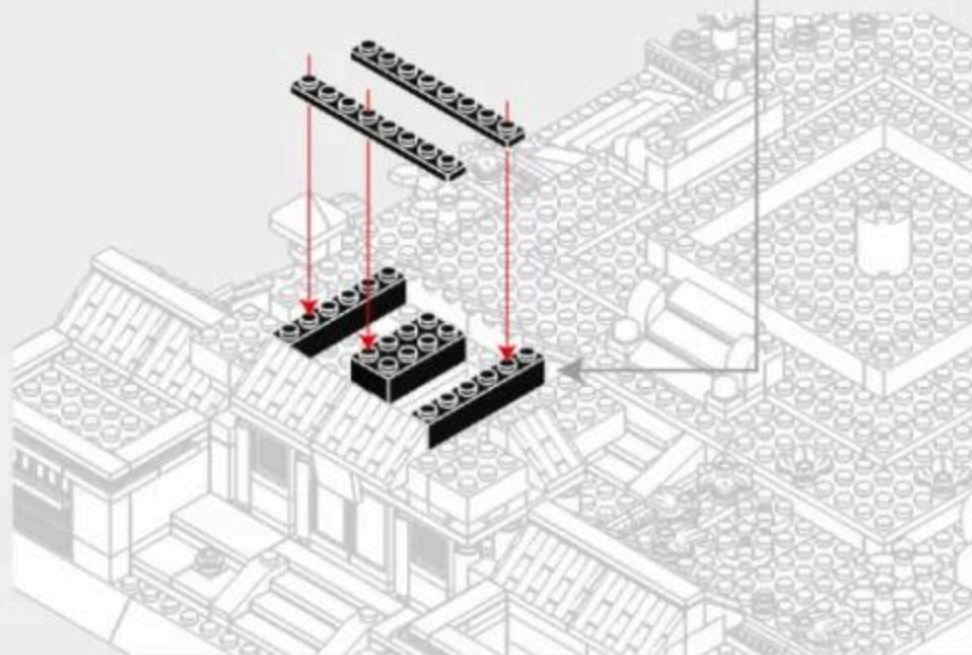
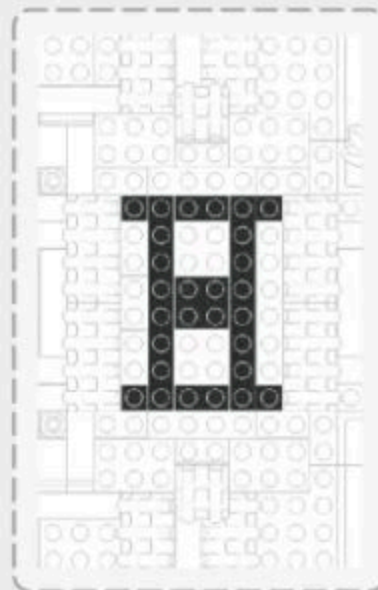
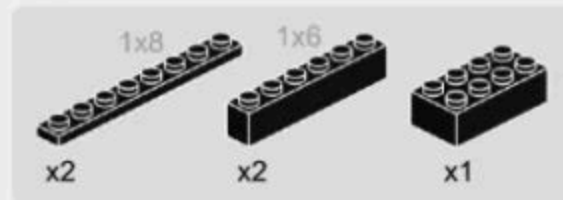

2-16

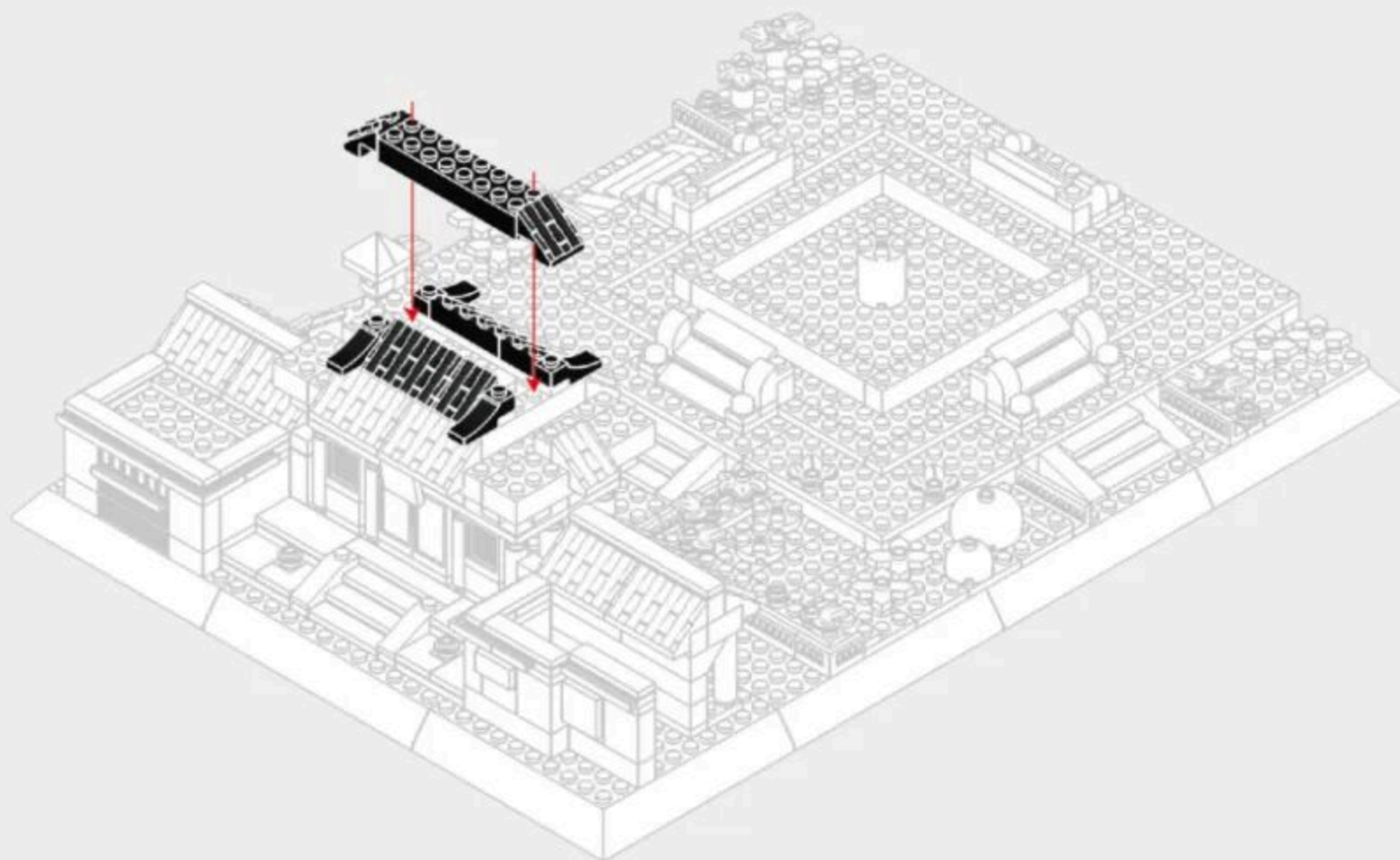
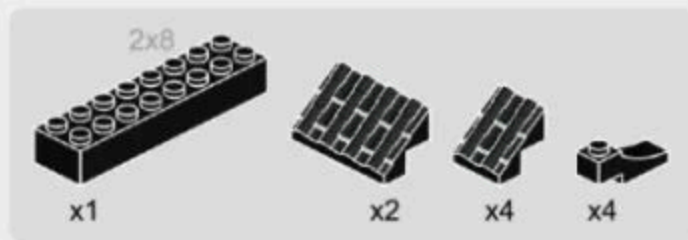

2-17

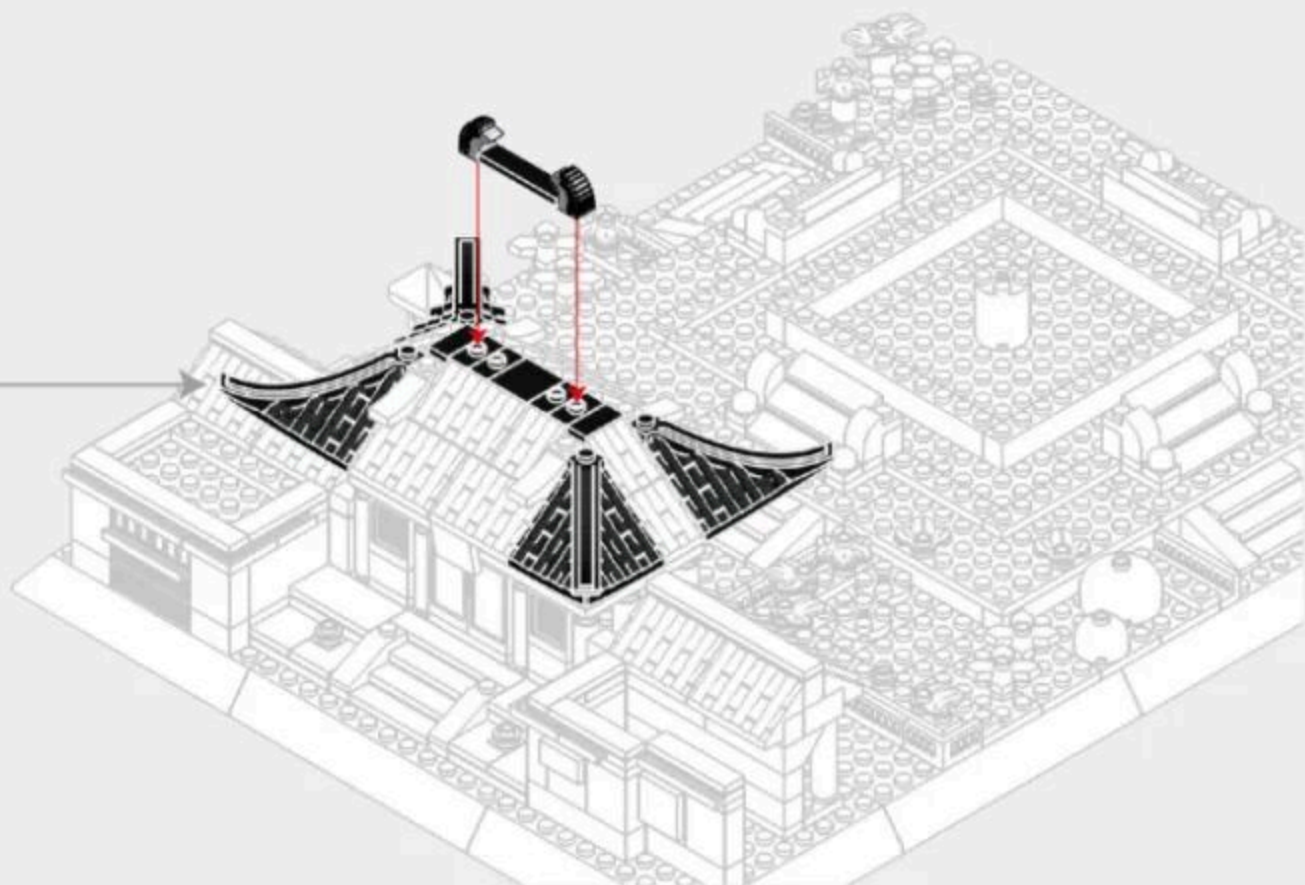
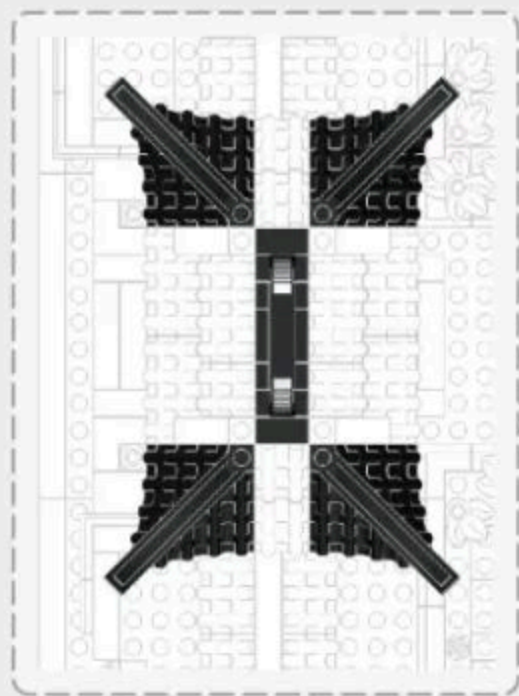
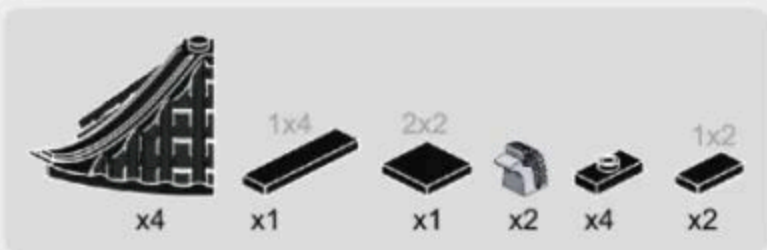



271 PCS

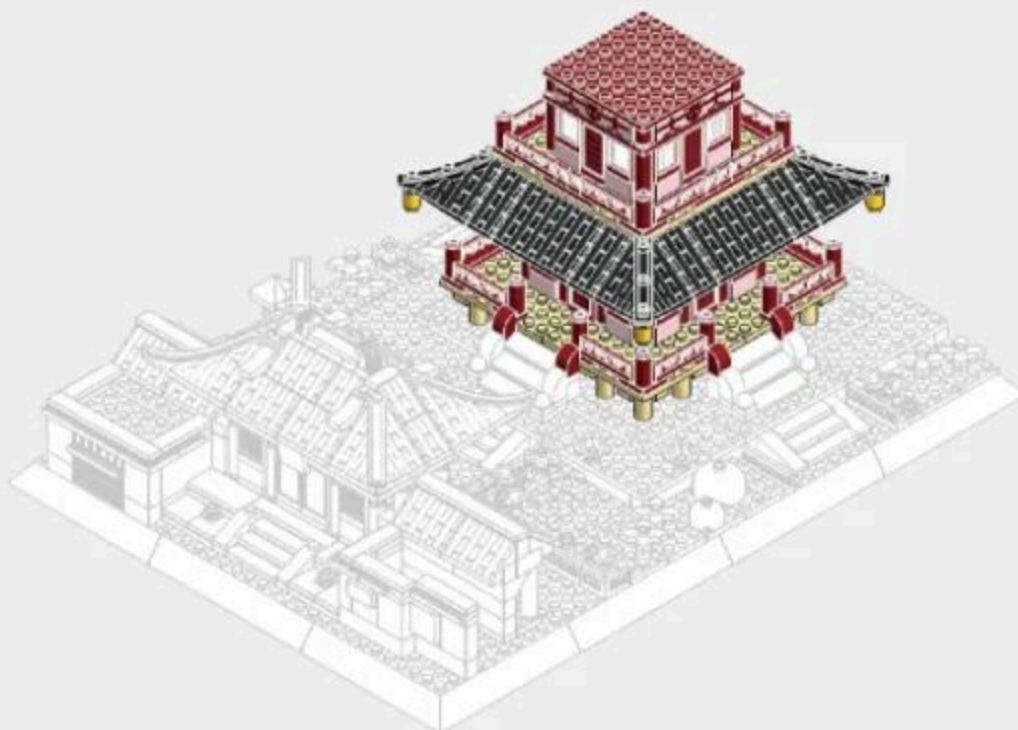

3-1

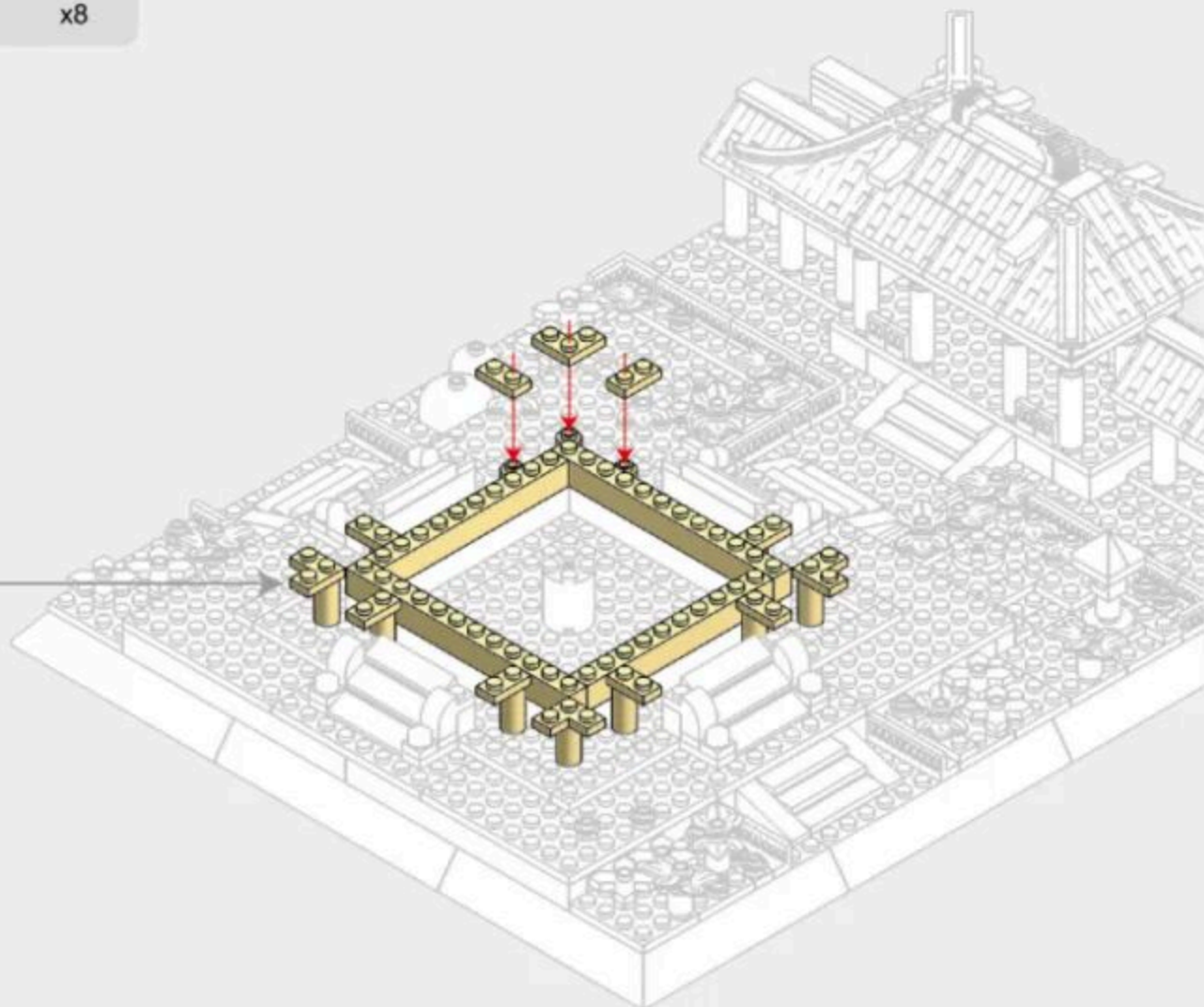
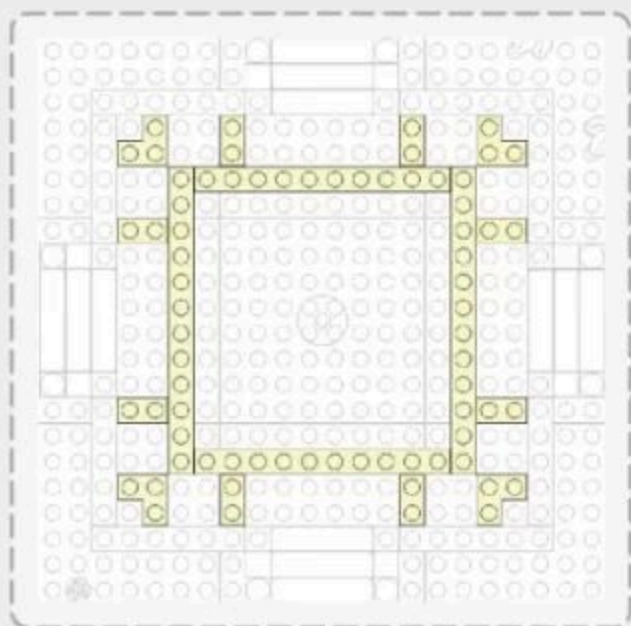
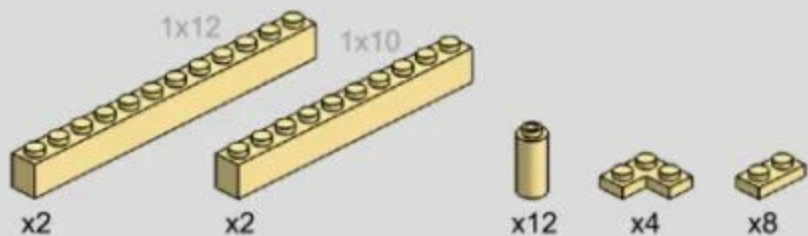

3-2

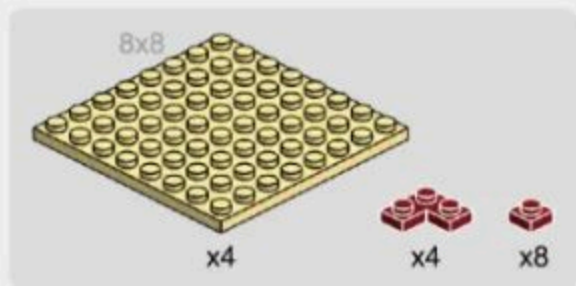

3-3

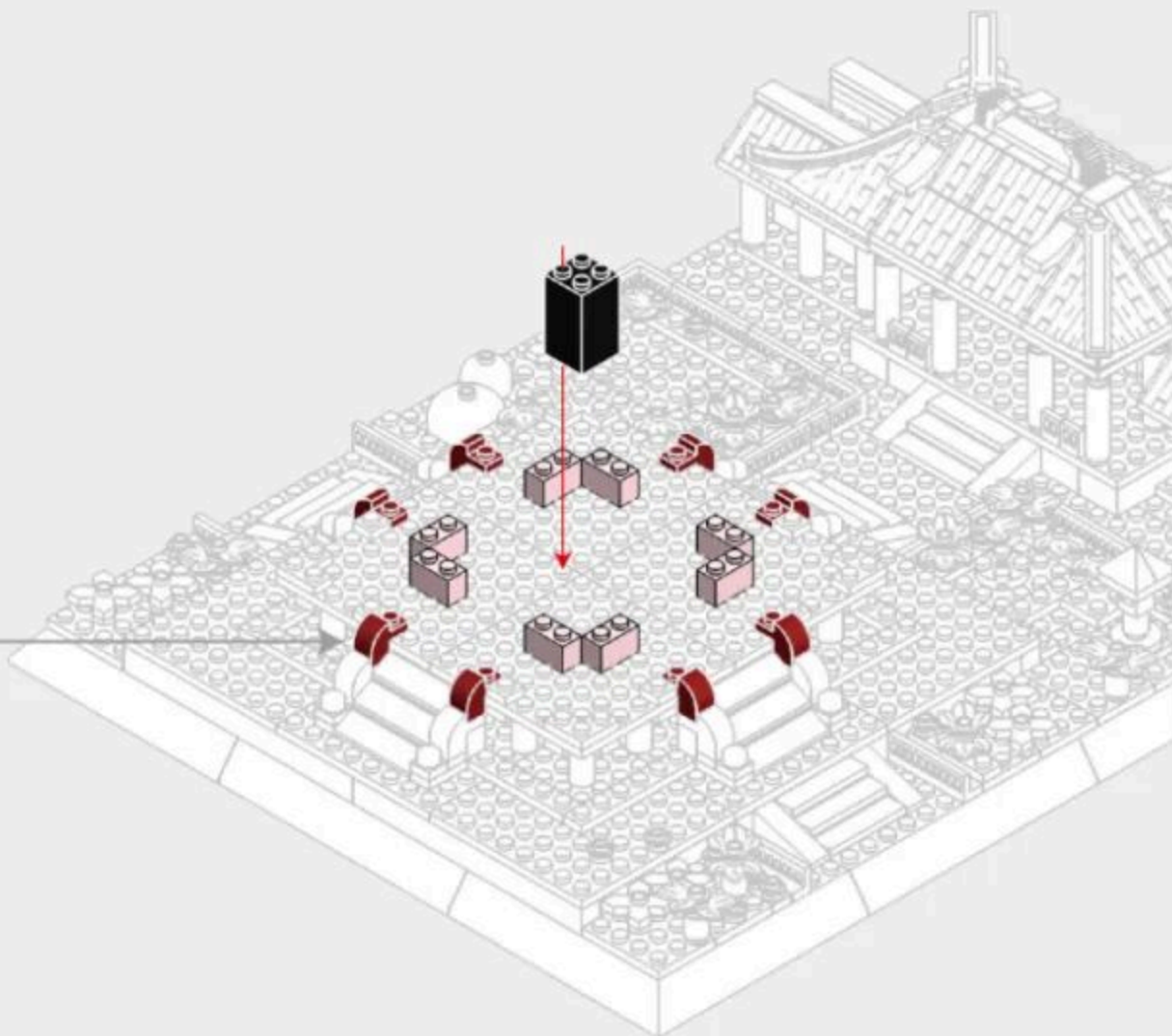
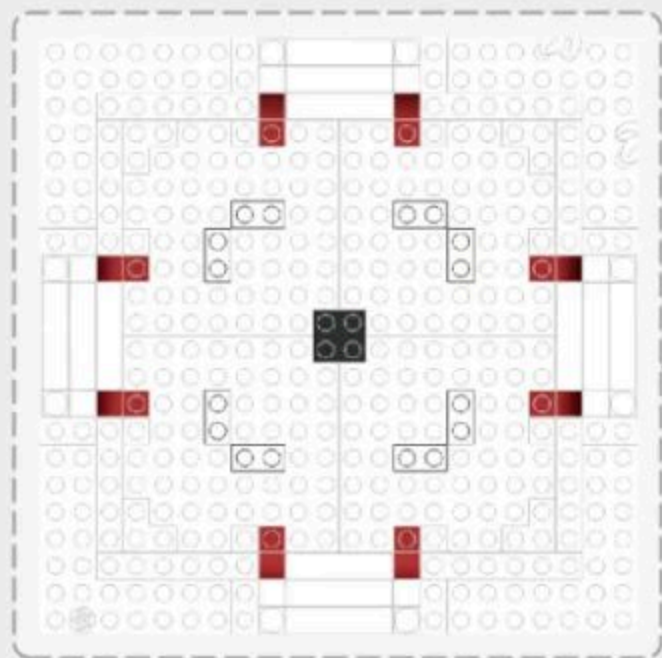

3-4

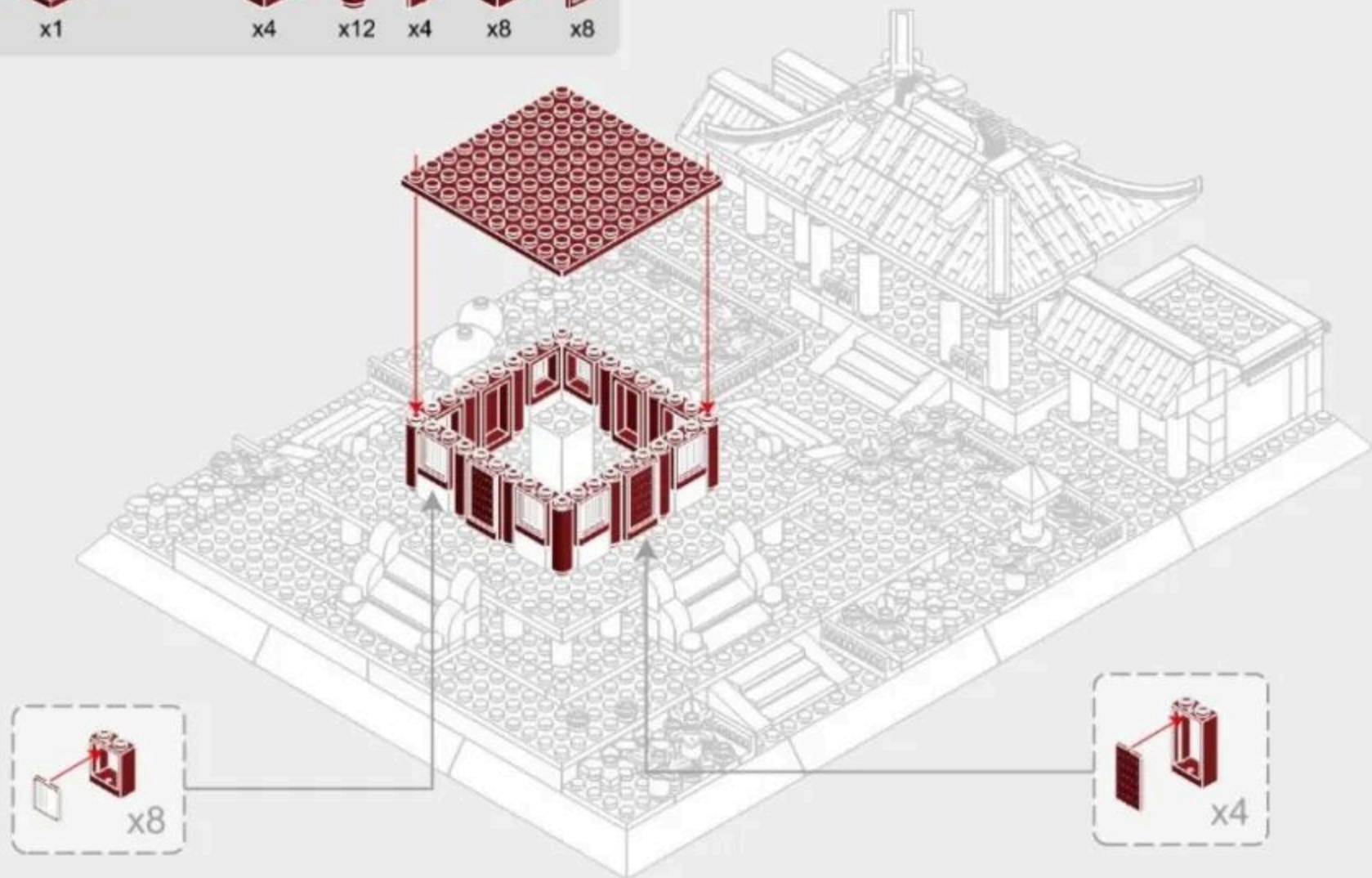
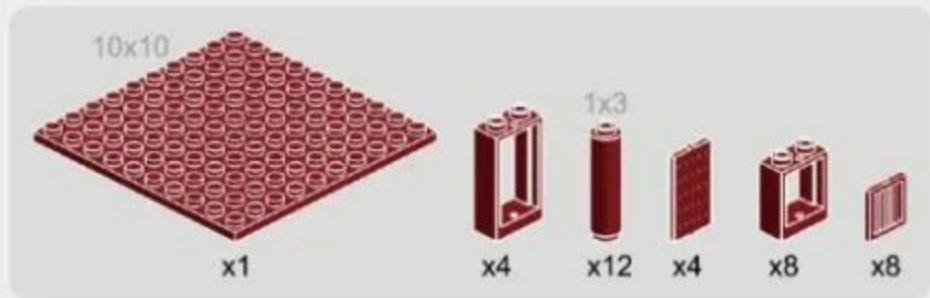

3-5

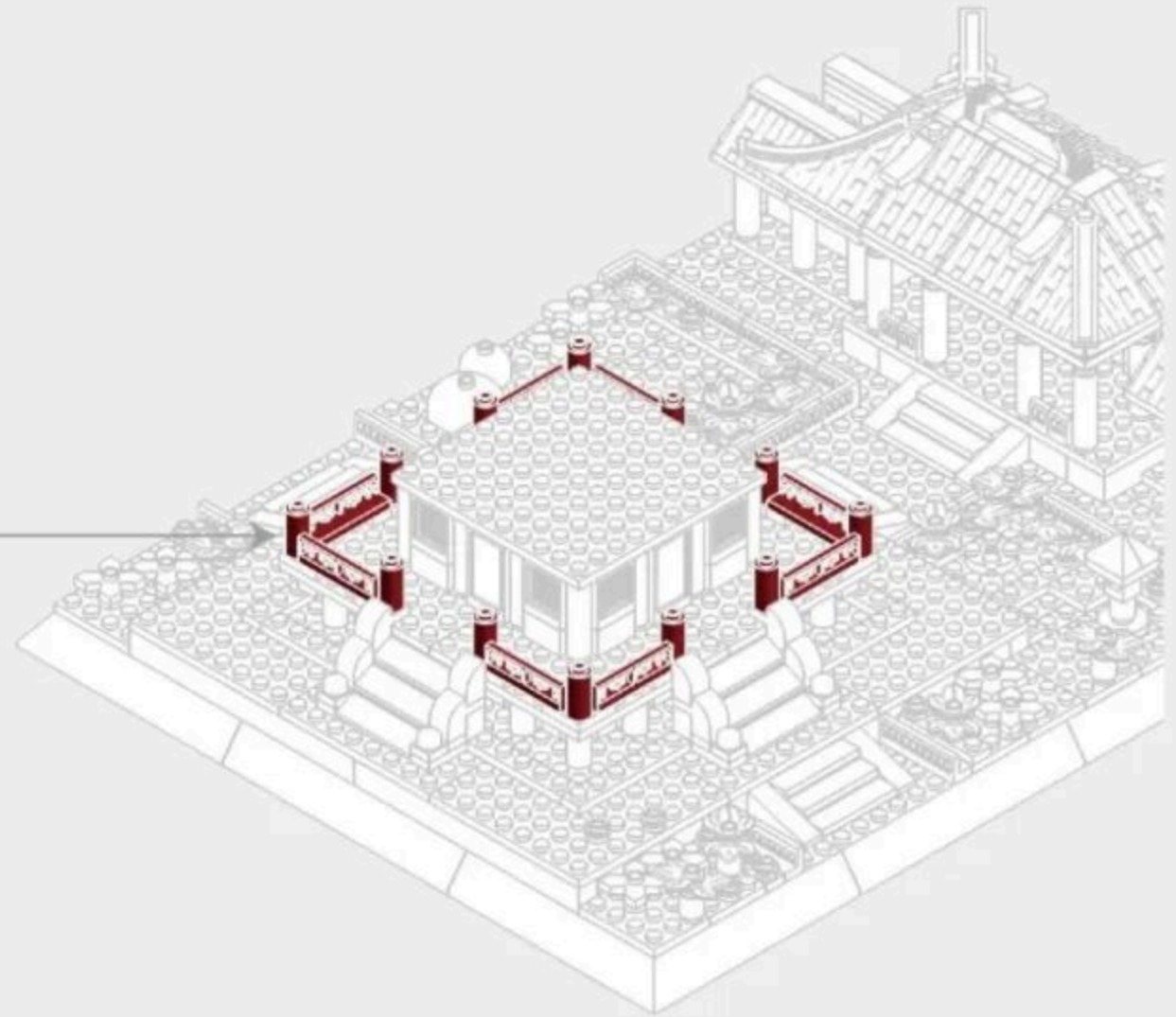
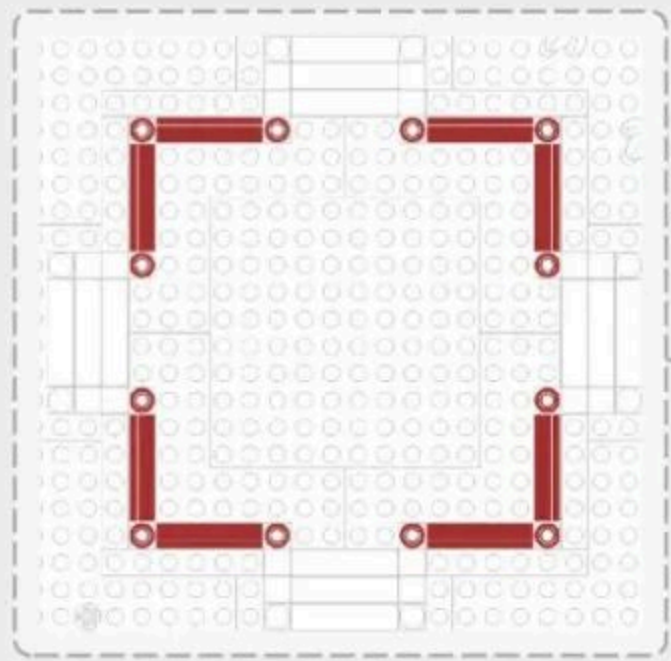

3-6

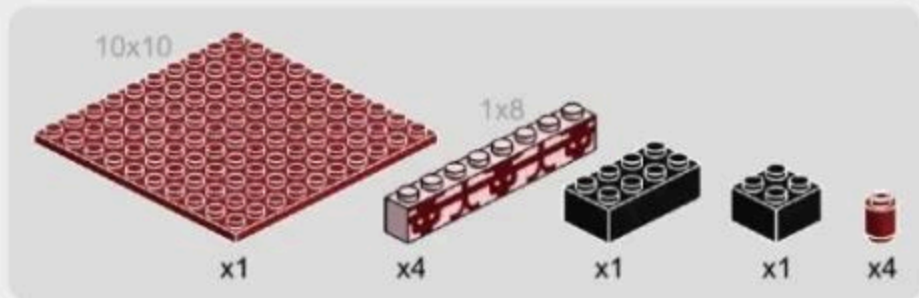

3-7

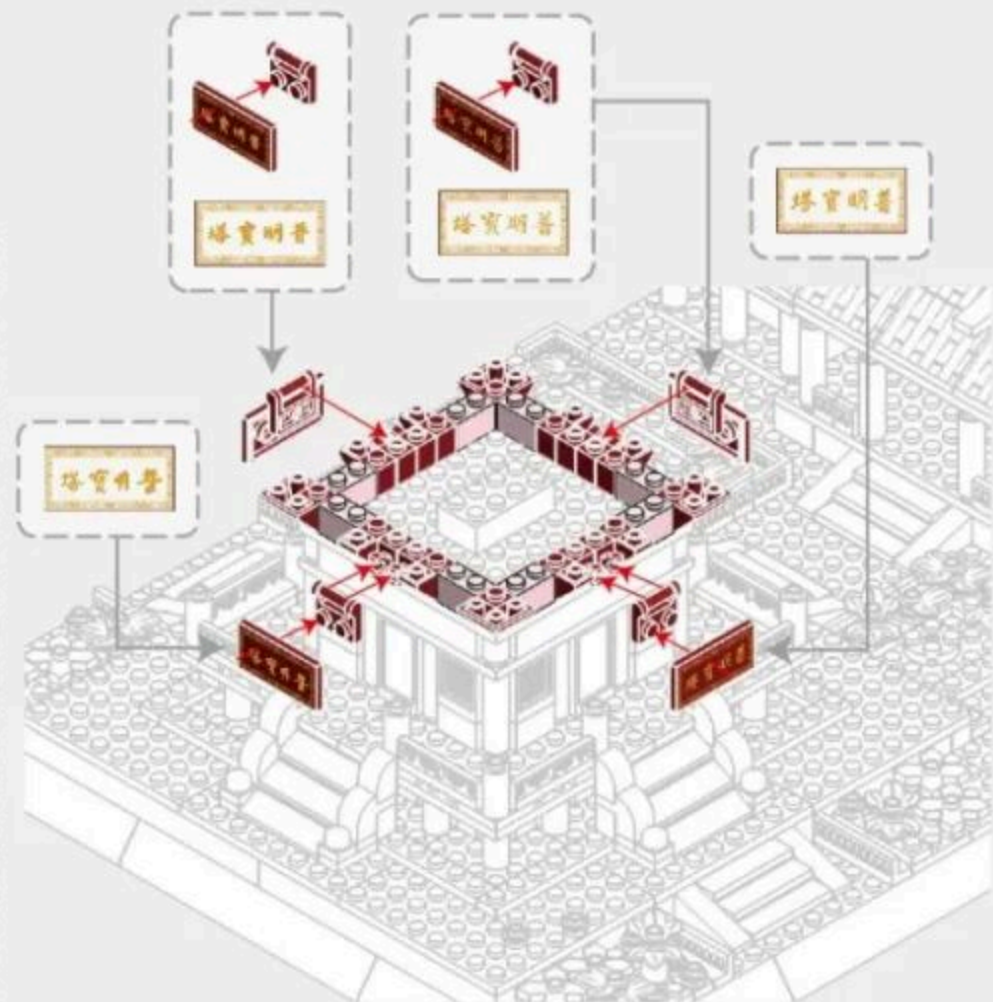
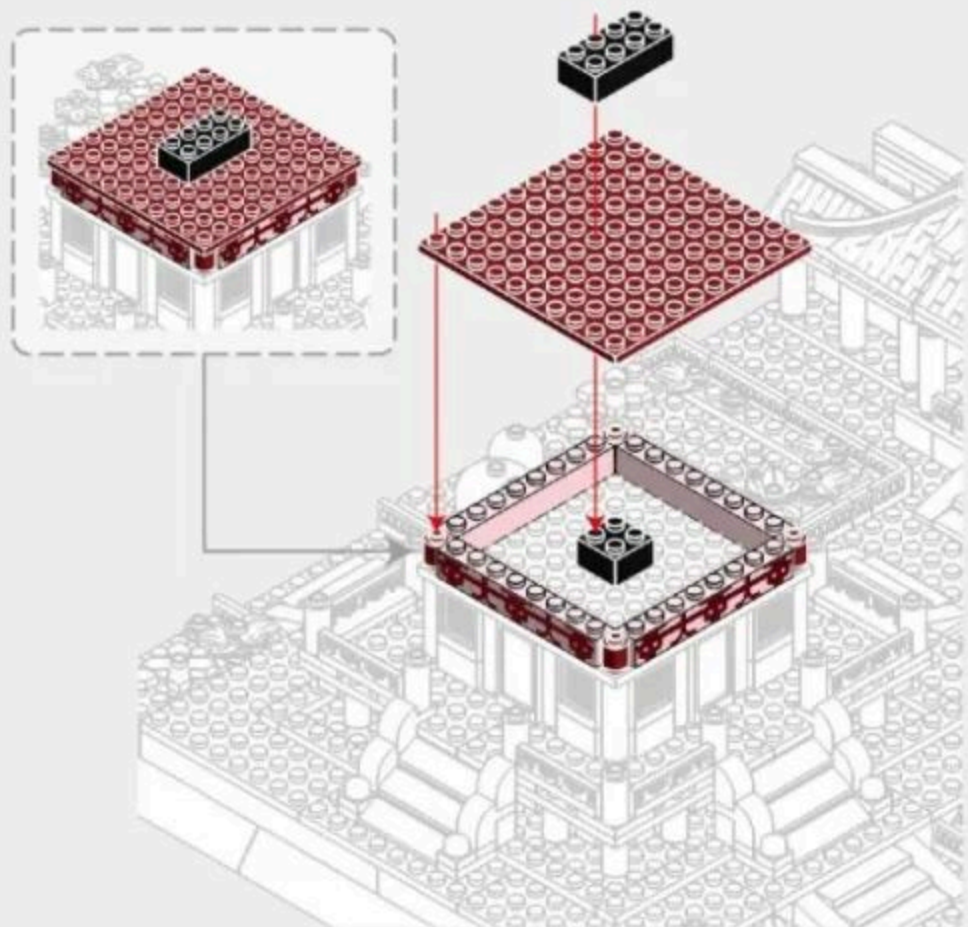

3-8

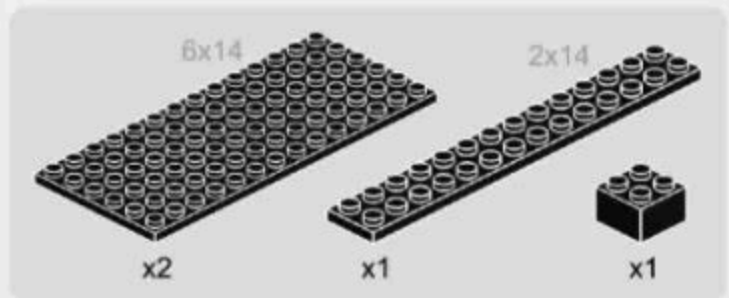

3-9

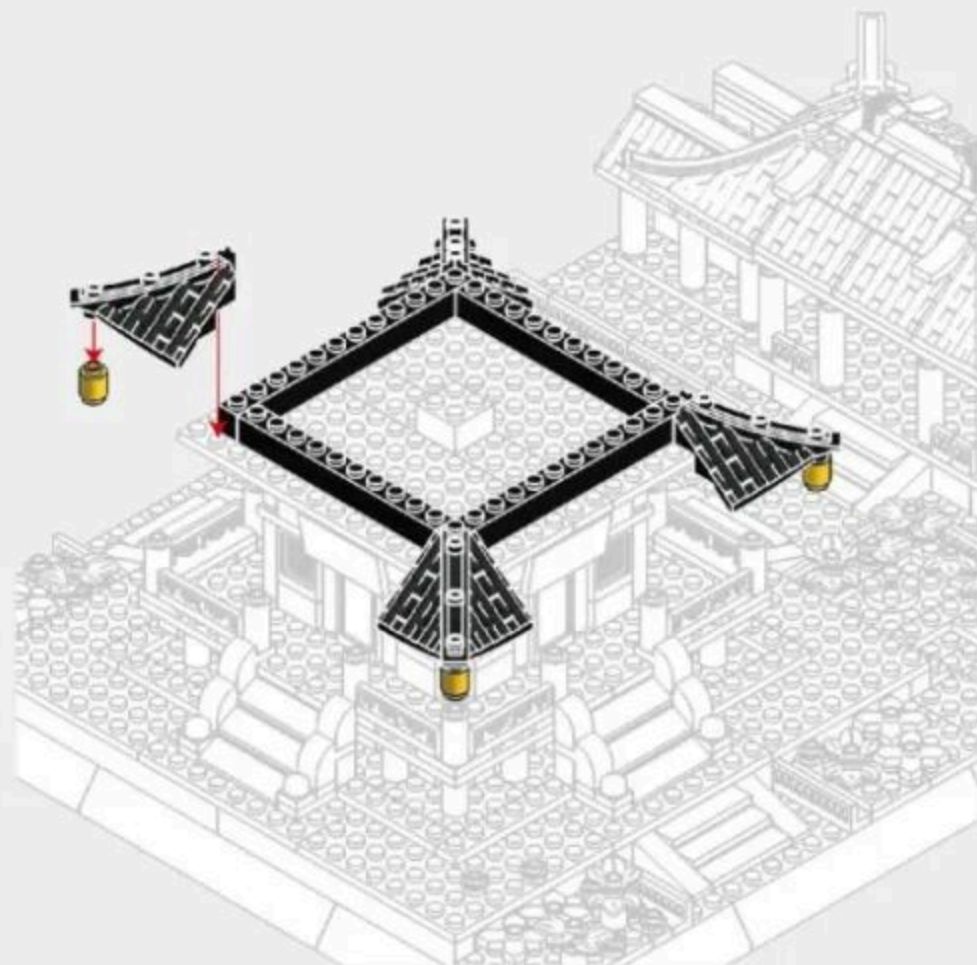
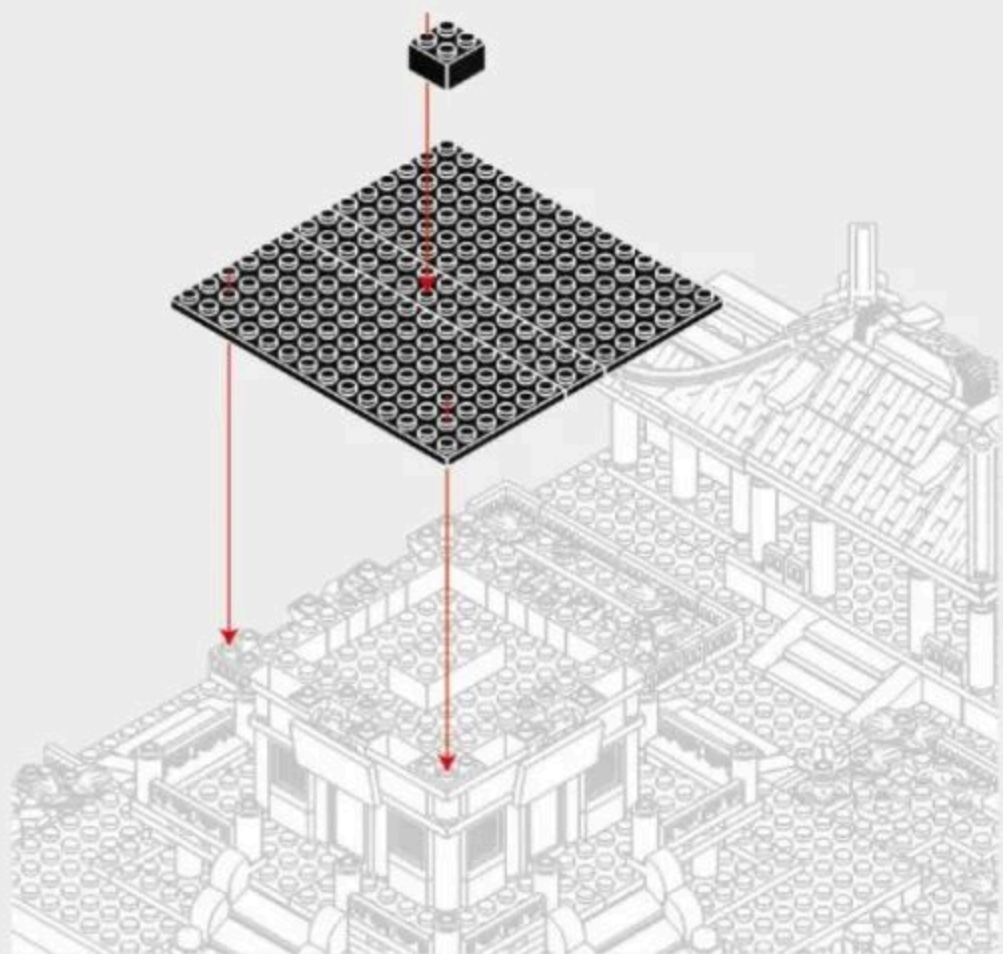
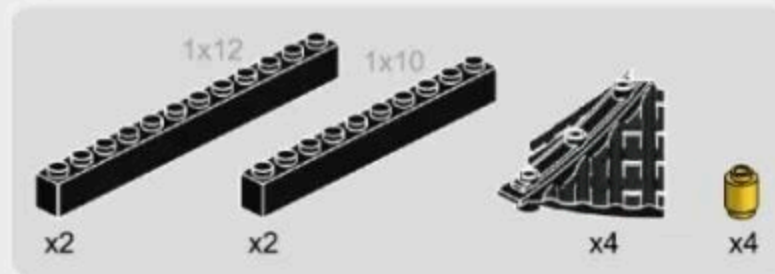

3-10

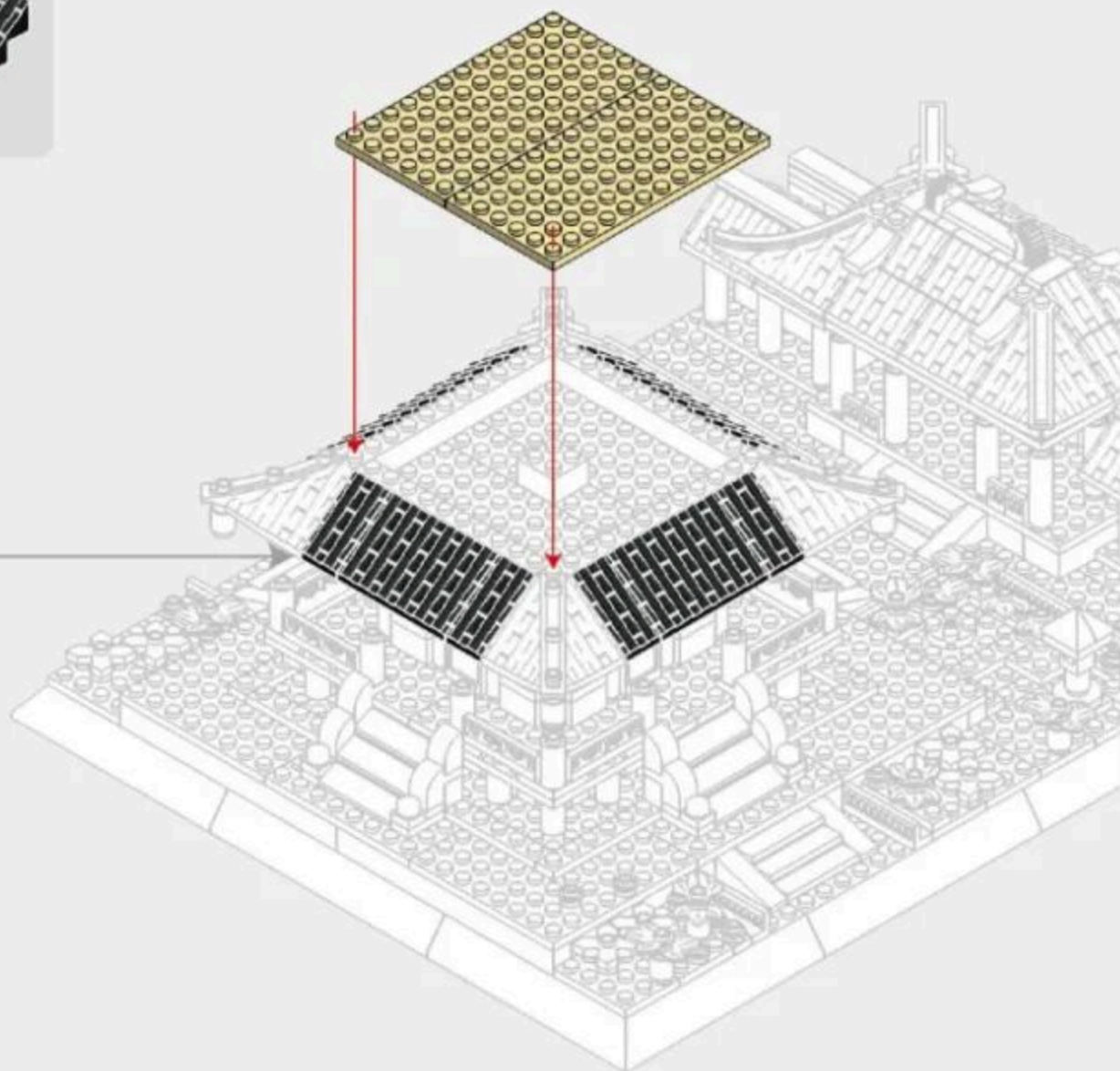
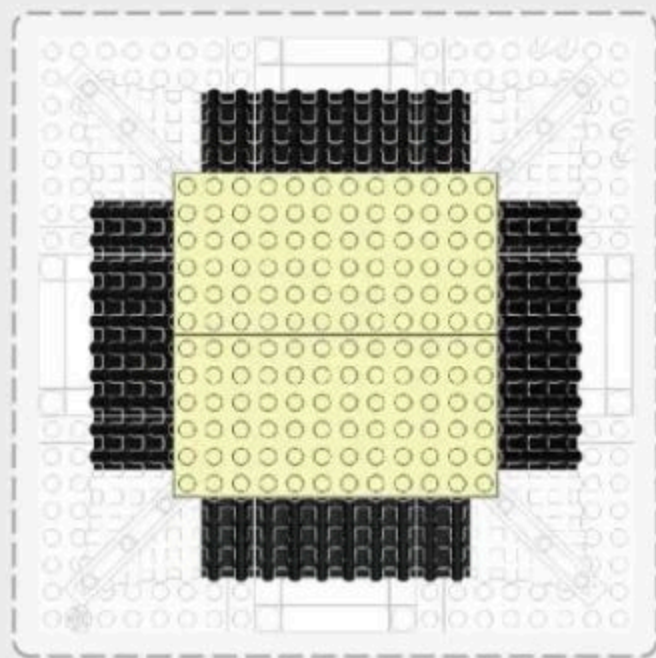
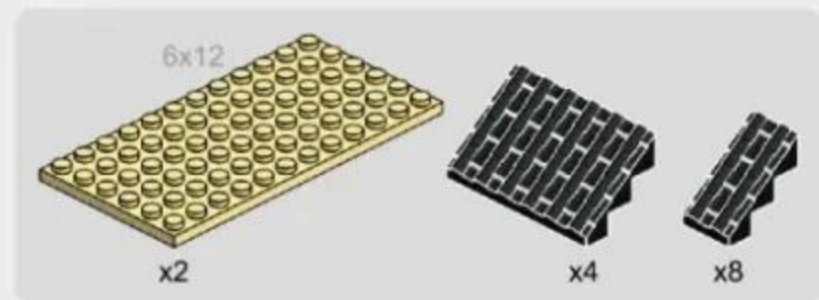

3-11

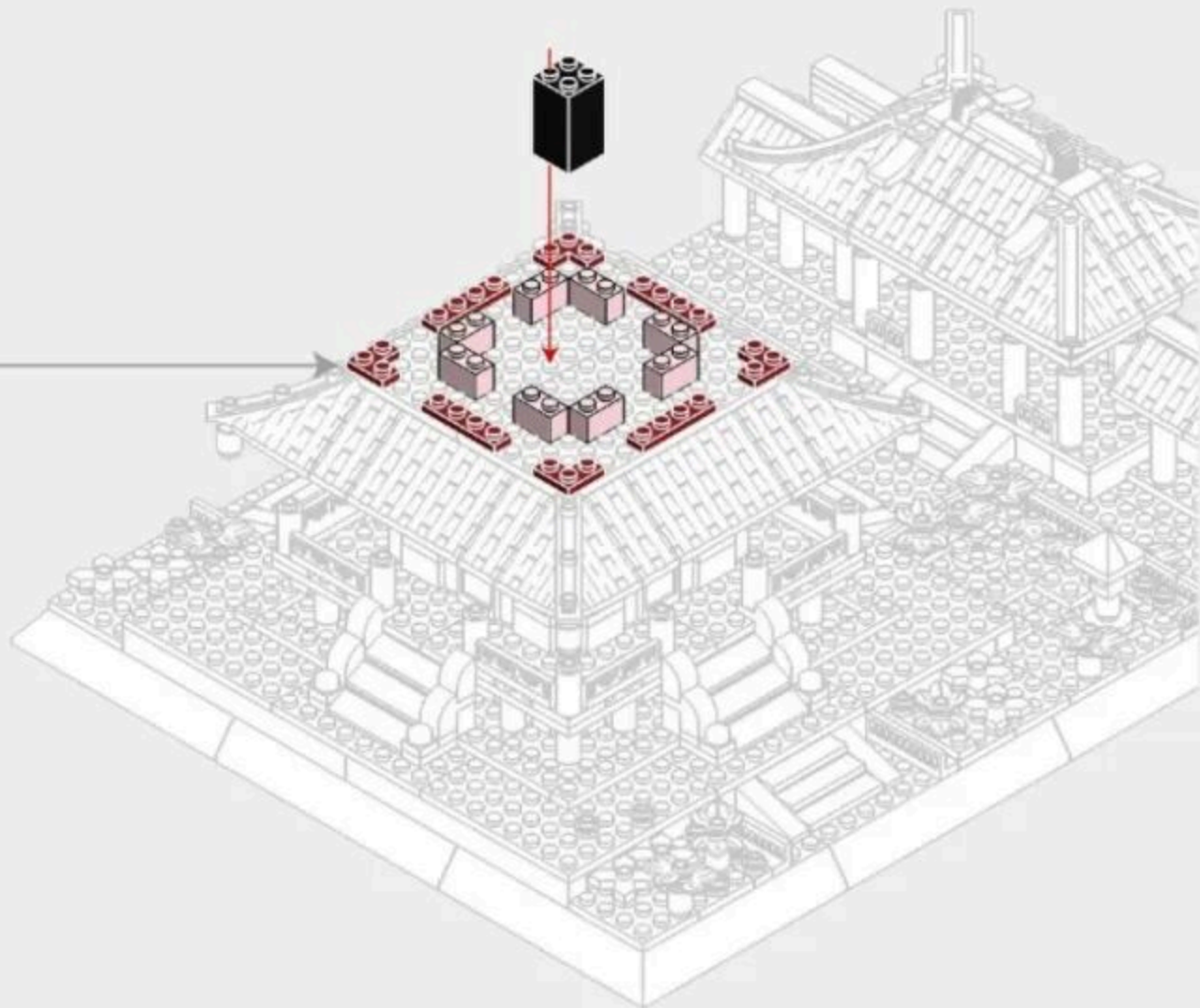
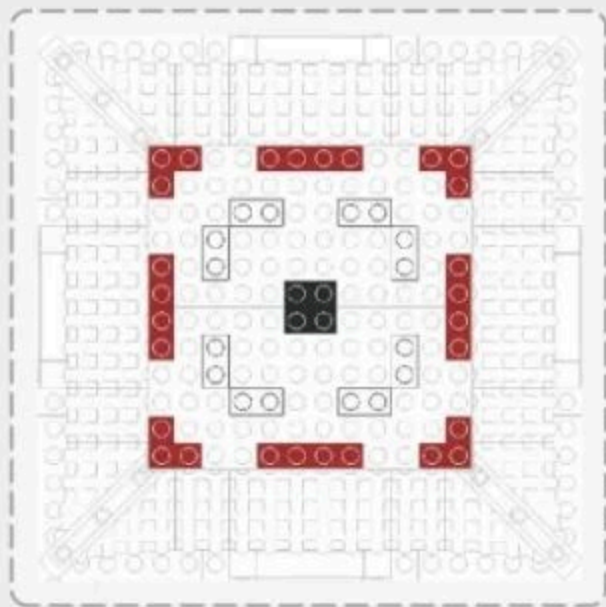
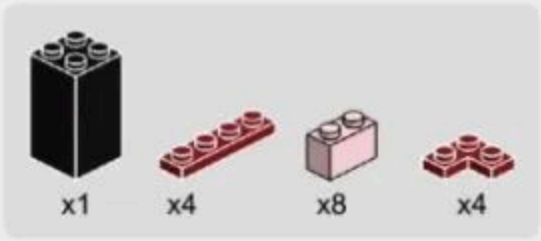

3-12

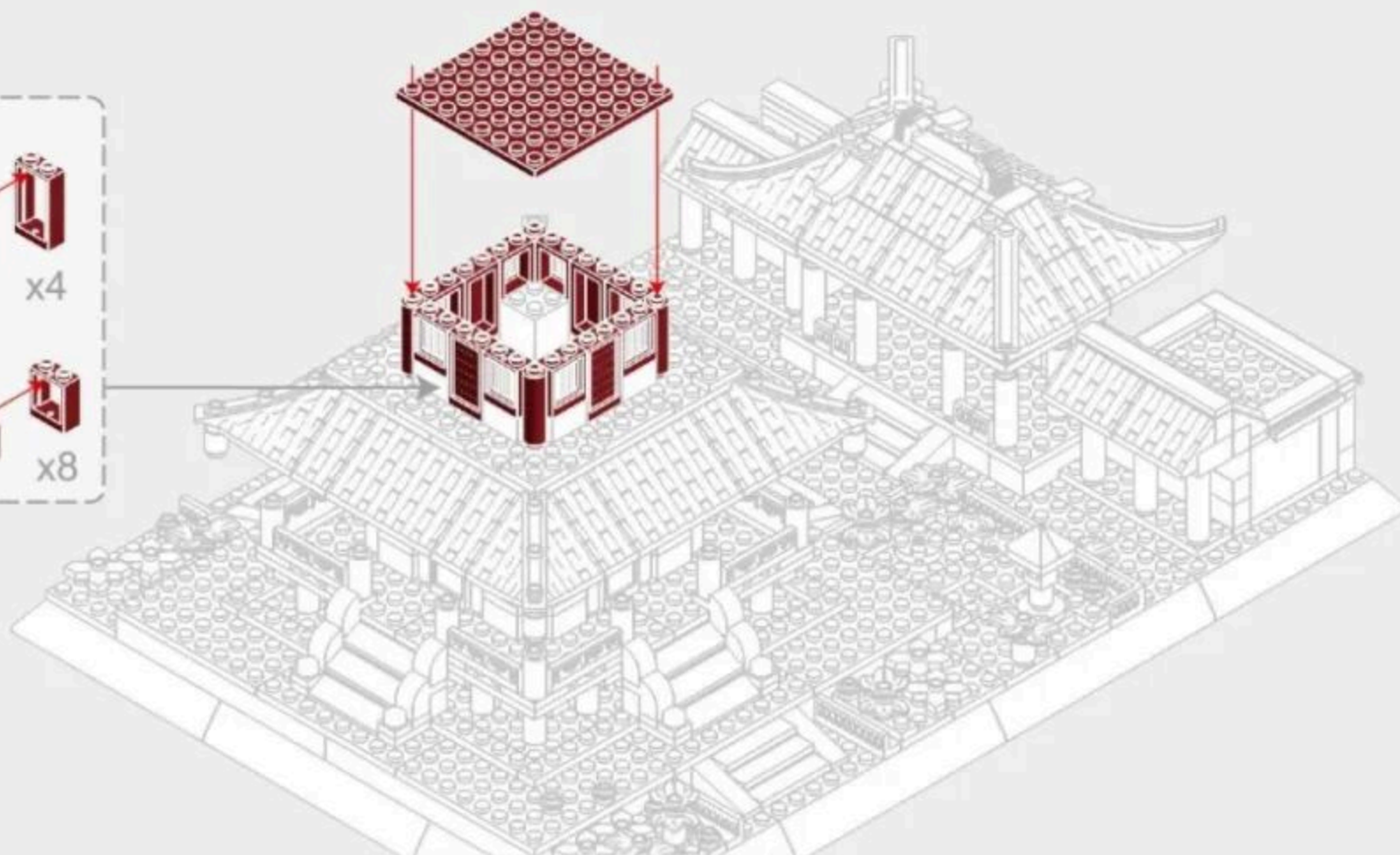
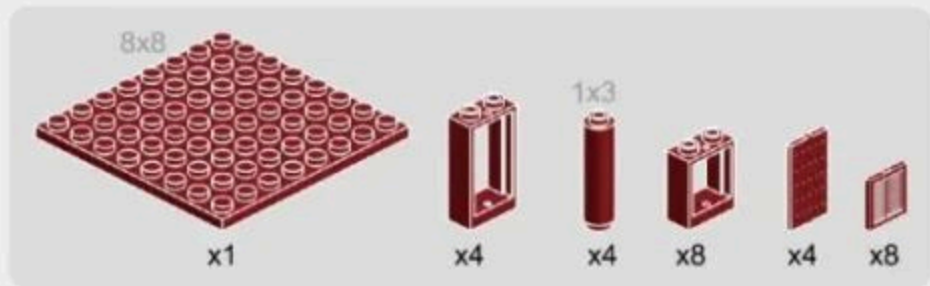

3-13

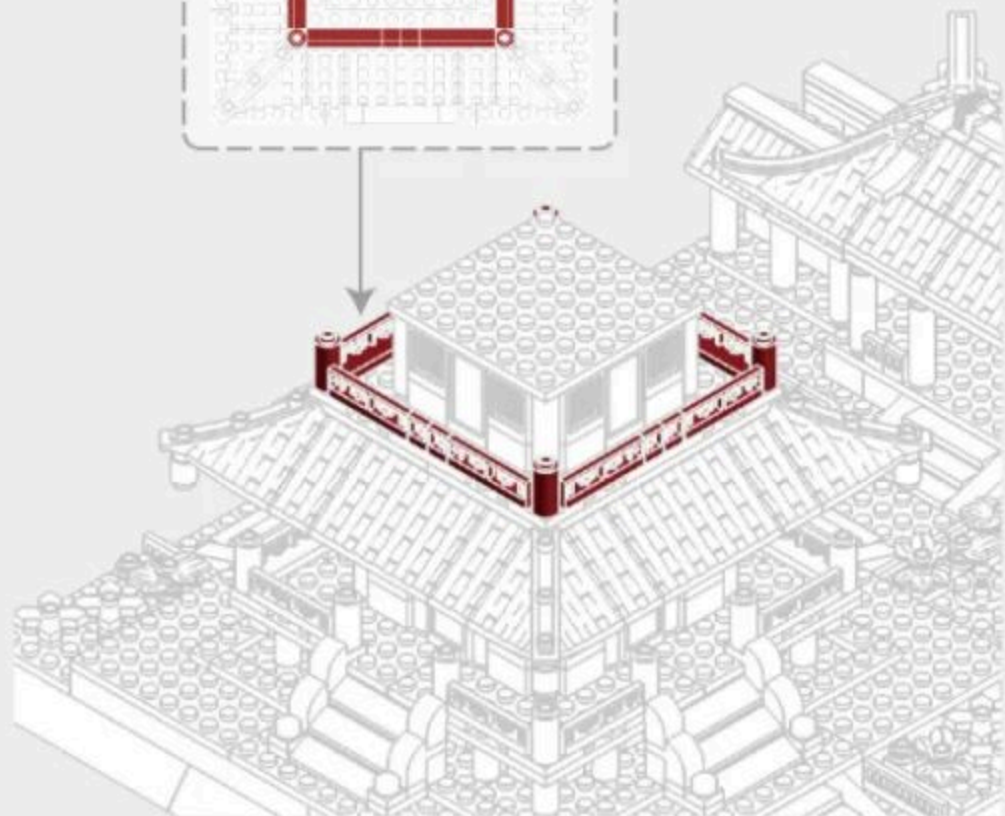
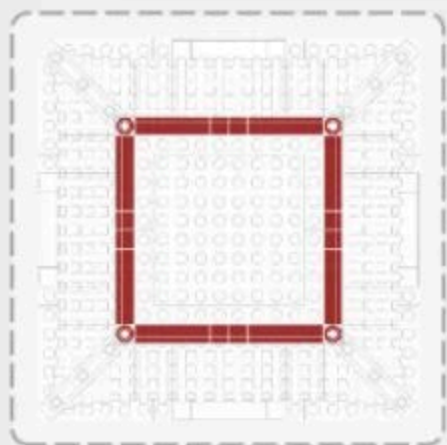

3-14

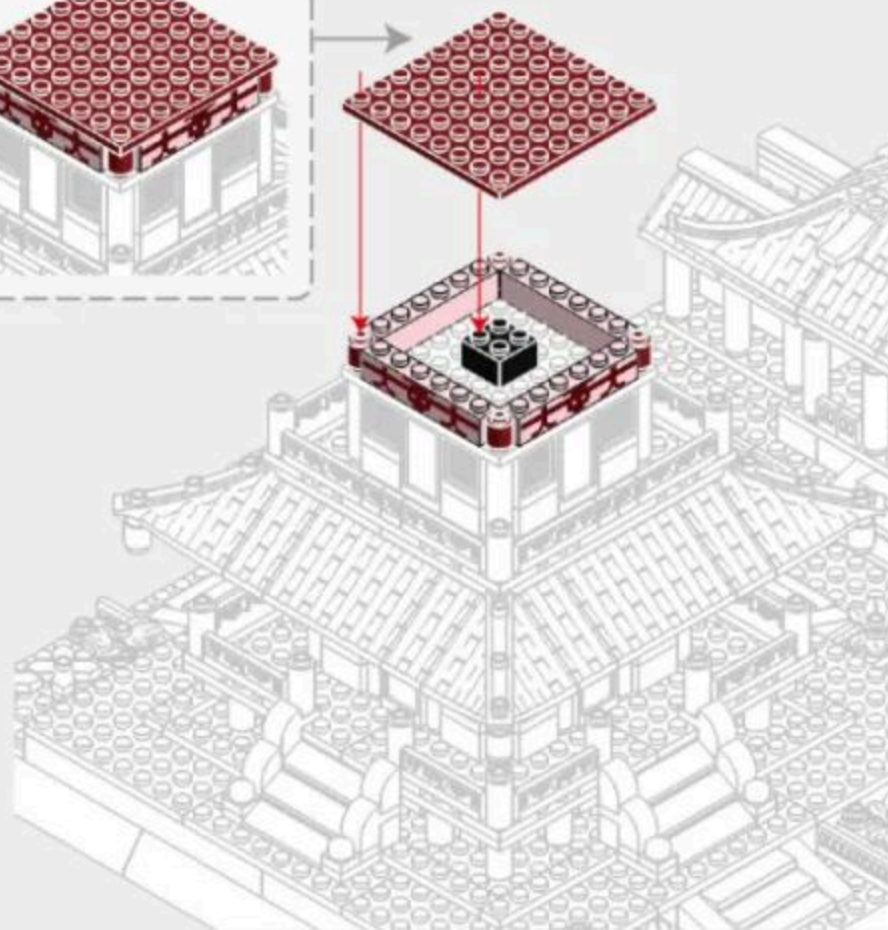
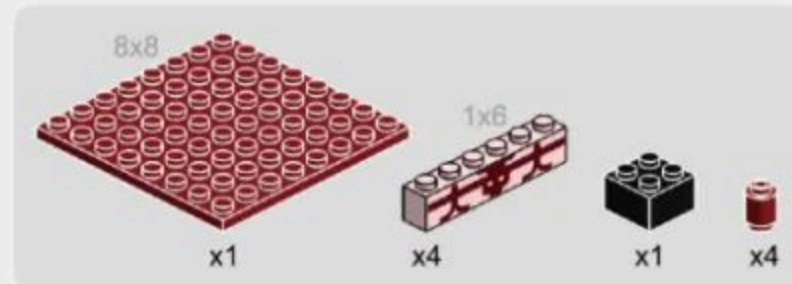



280PCS

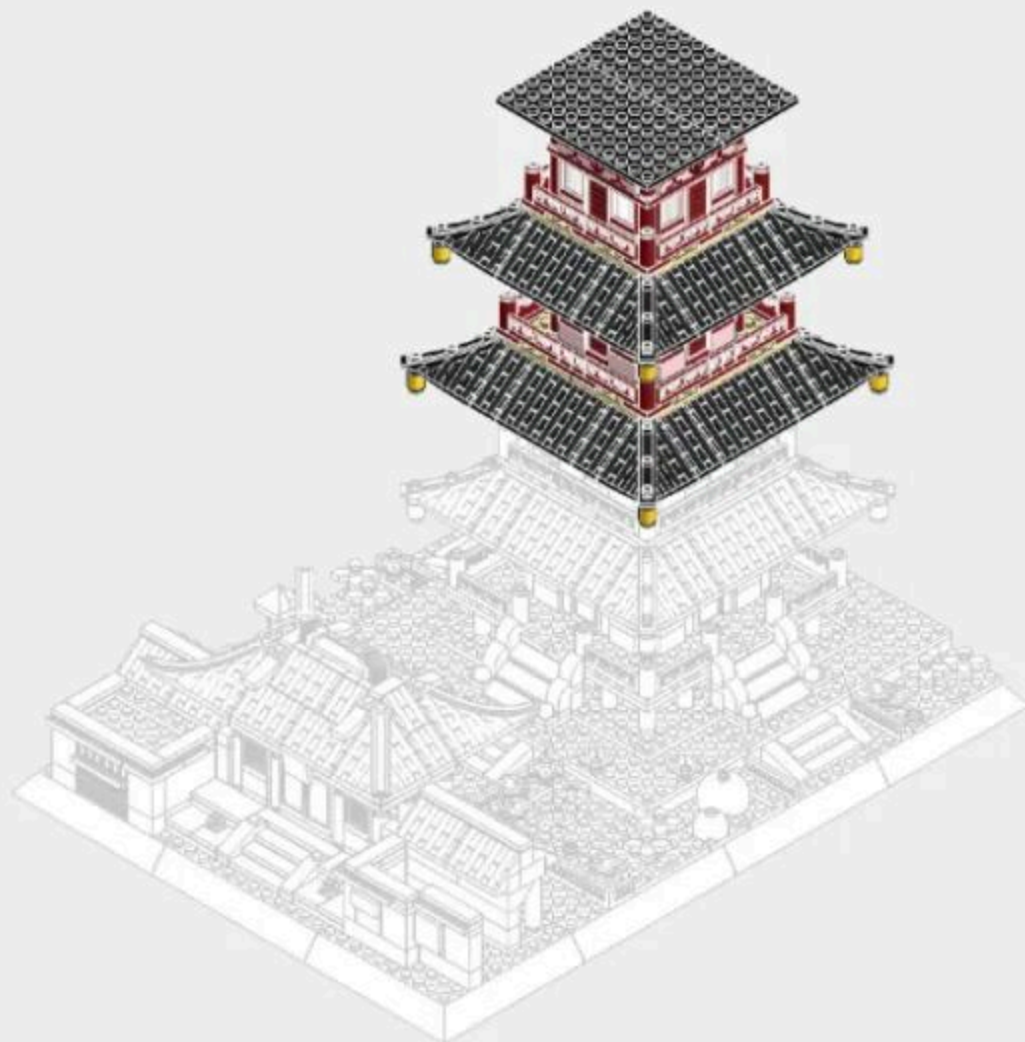

60

4-1

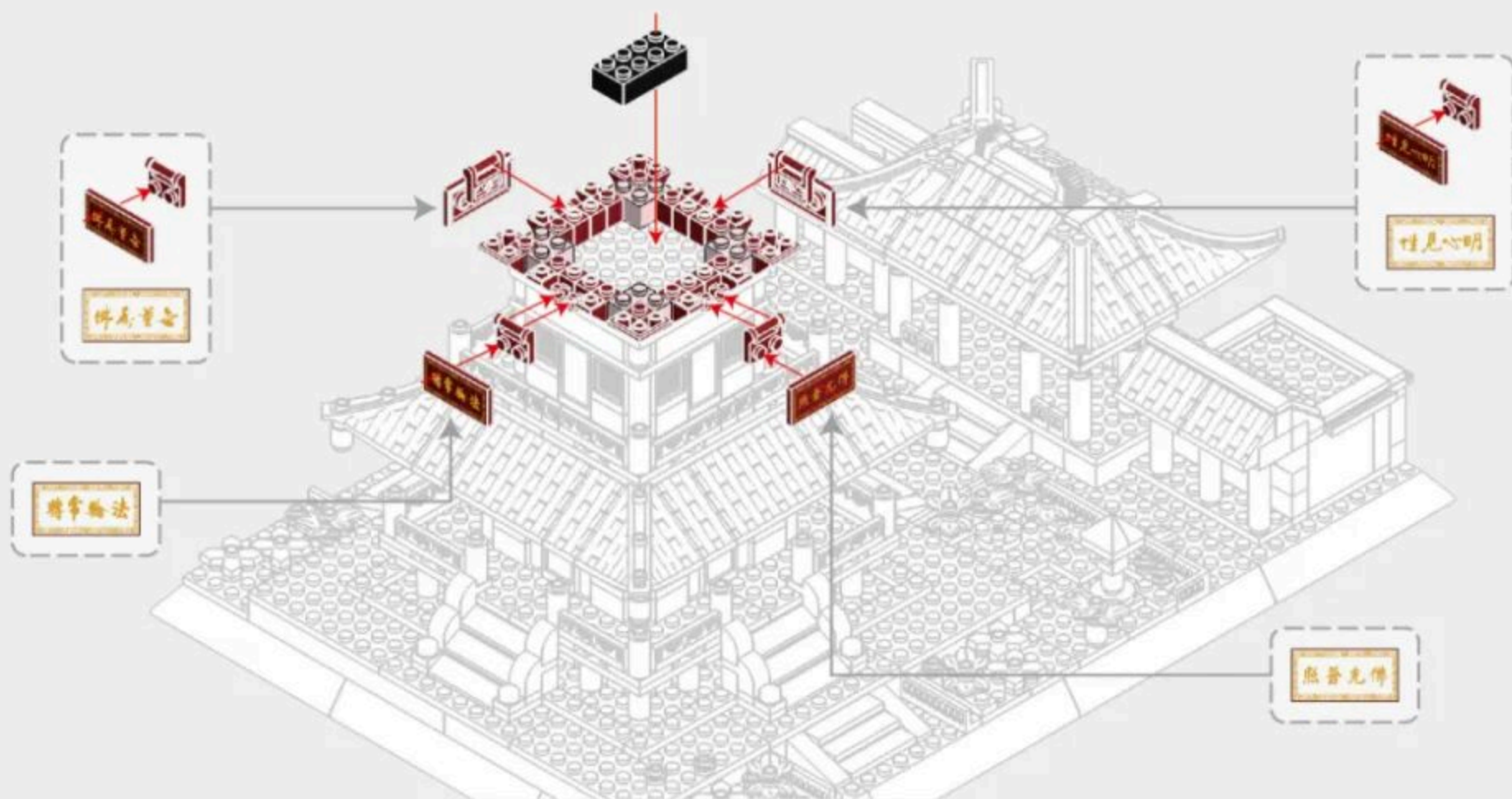
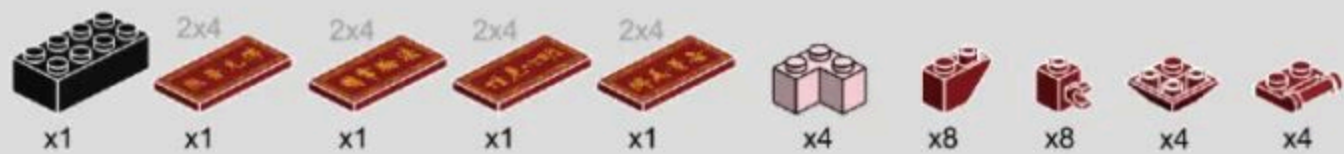

4-2

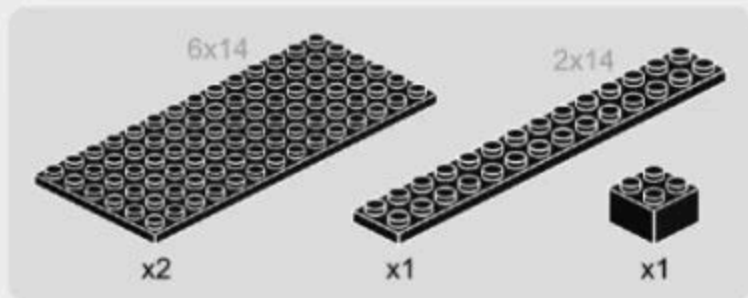

4-3

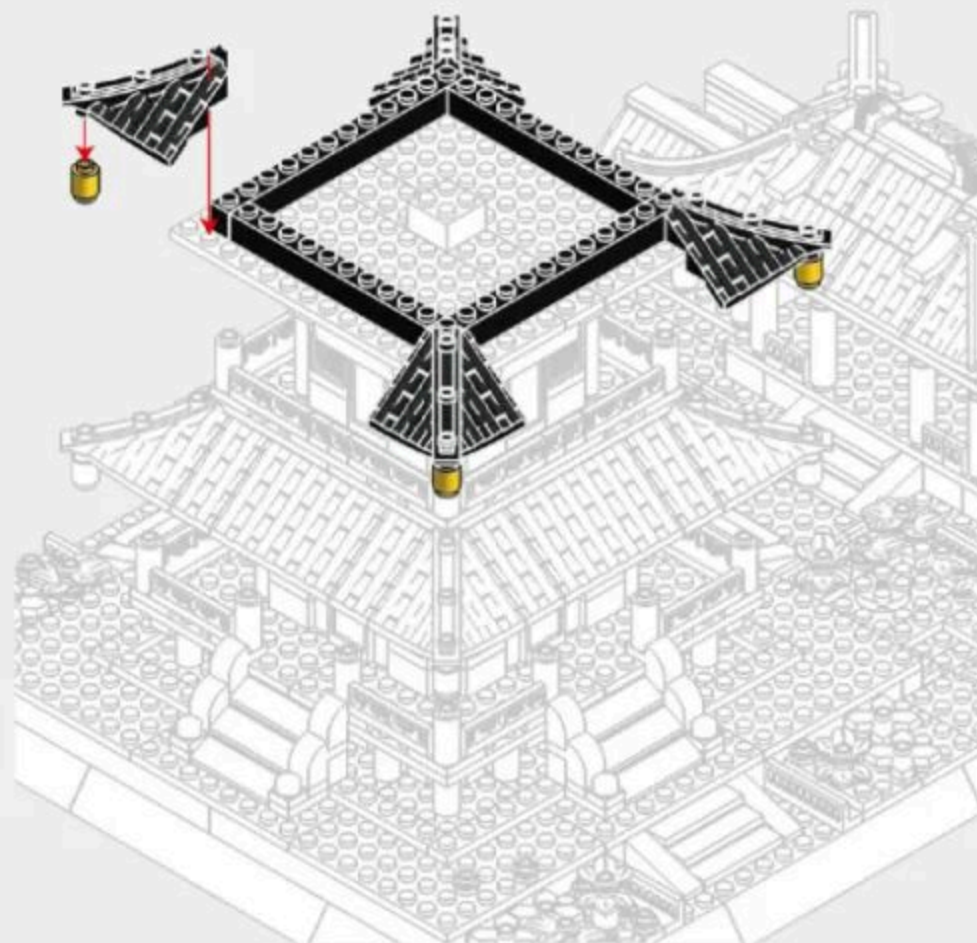
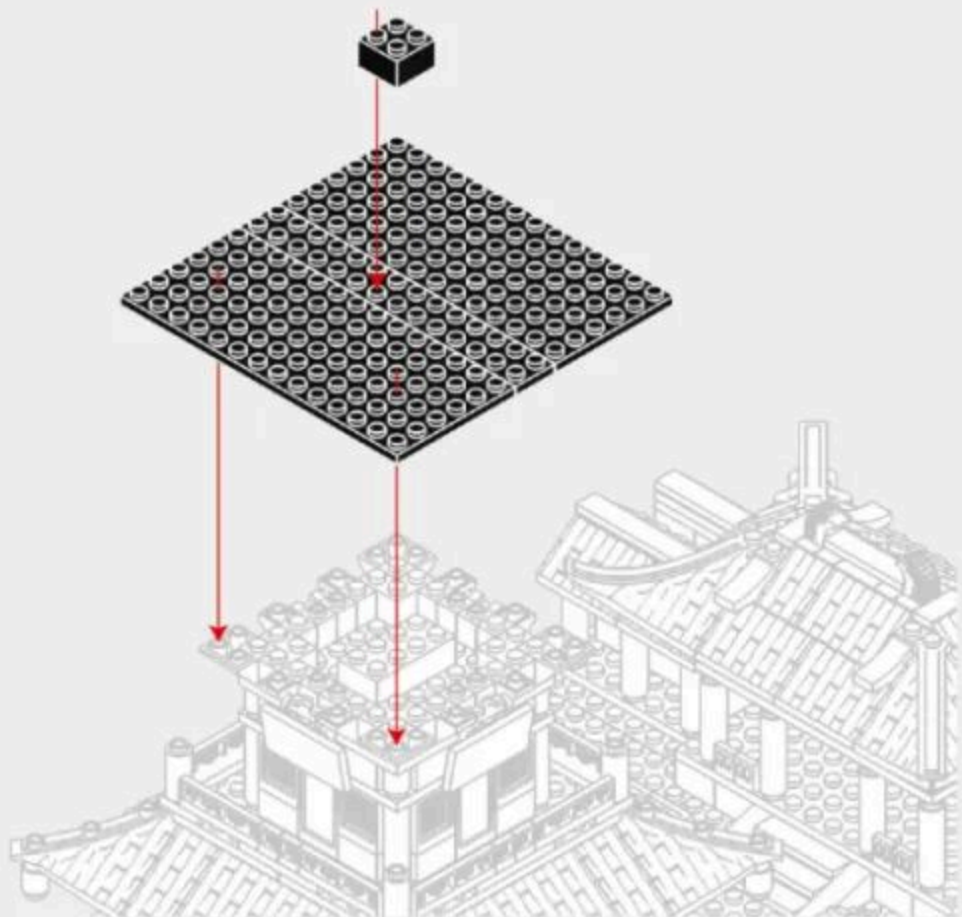
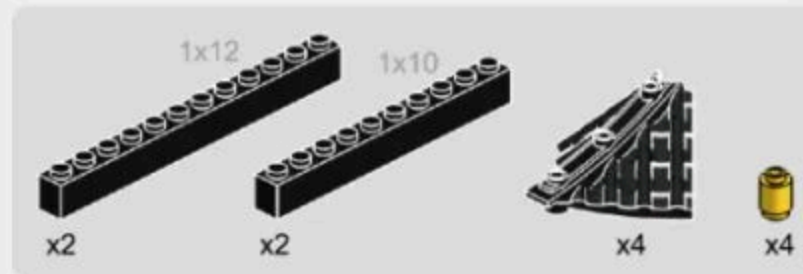

4-4

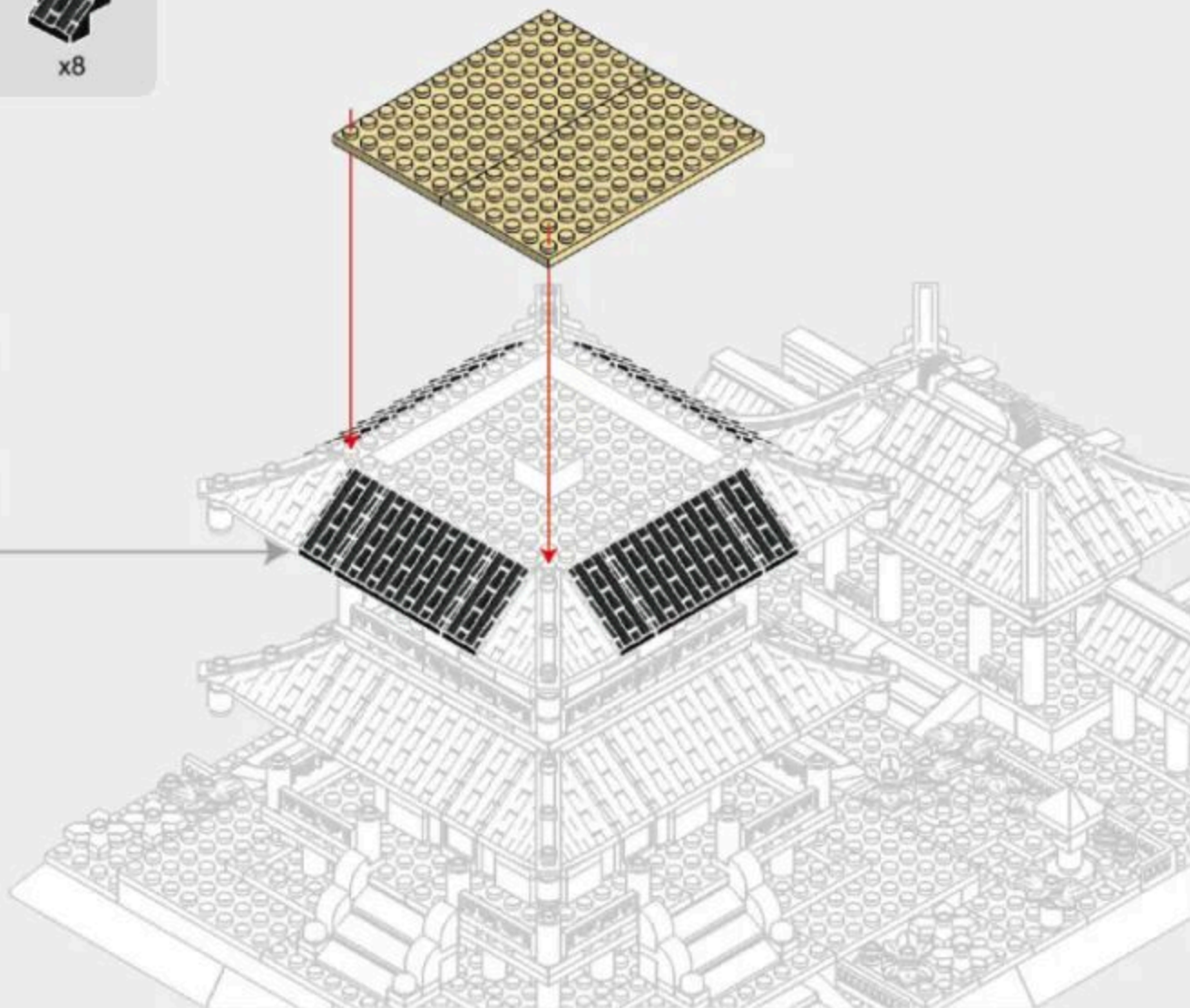
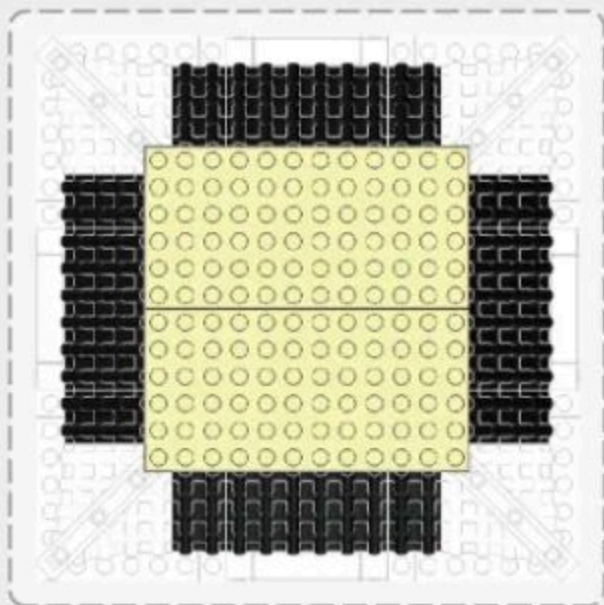
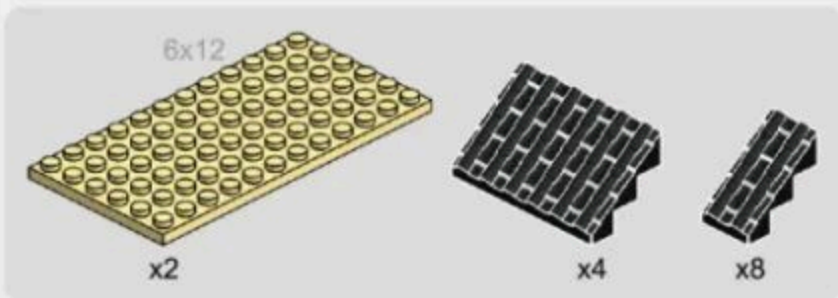

4-5

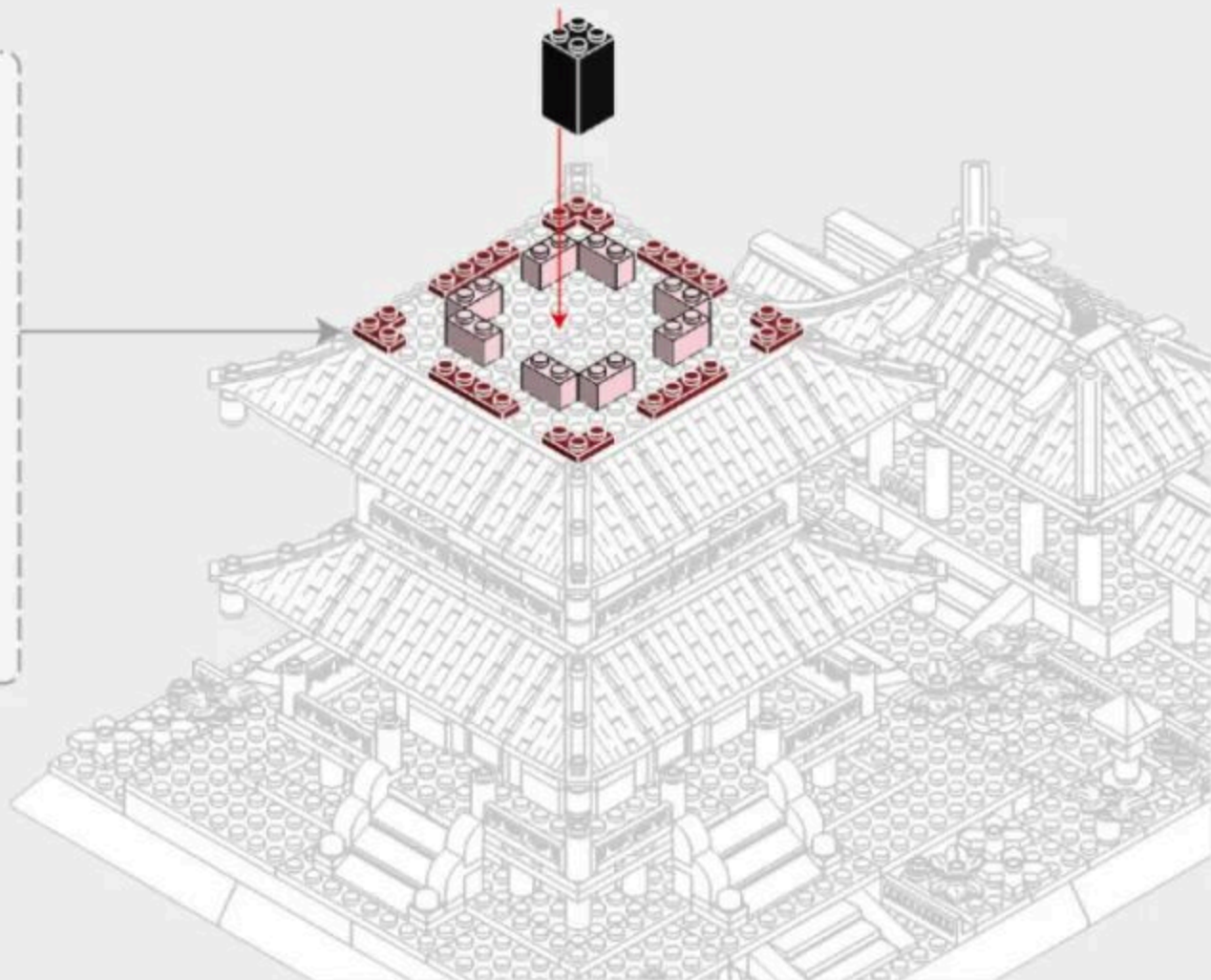
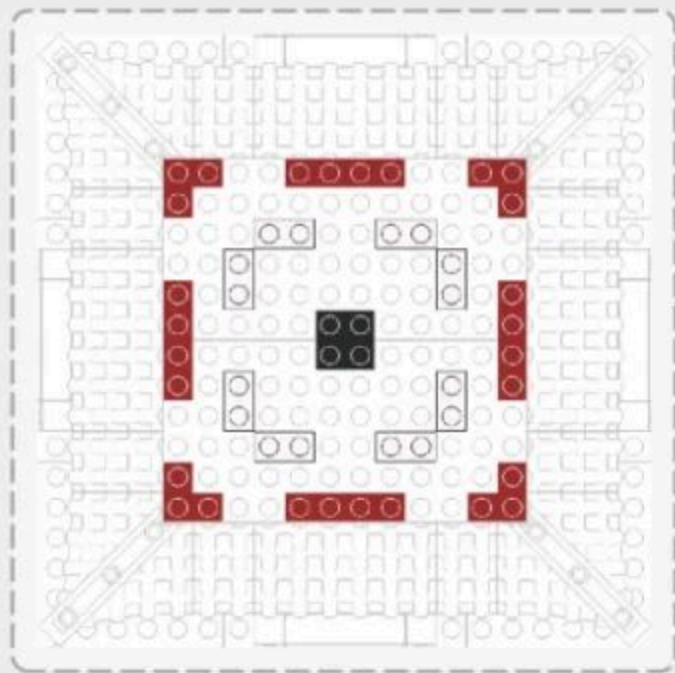
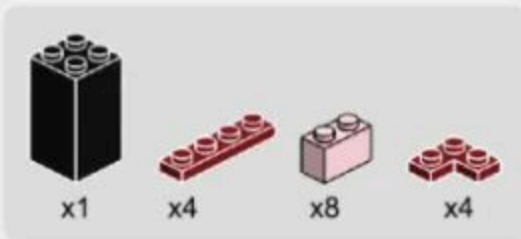

4-6

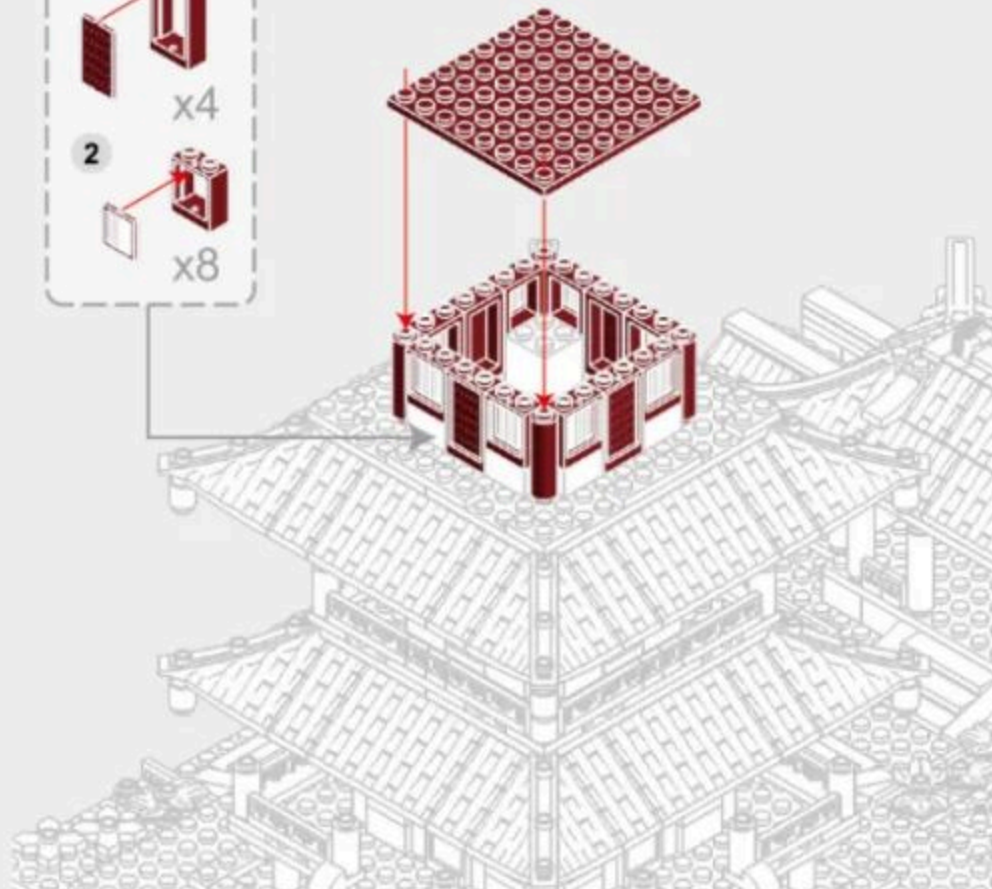
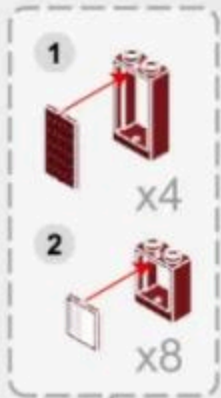
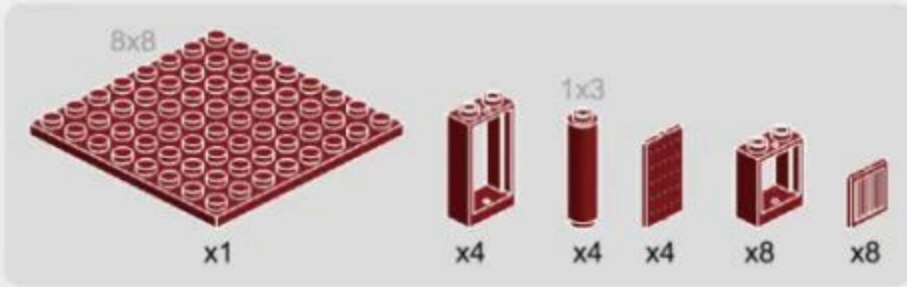

4-7

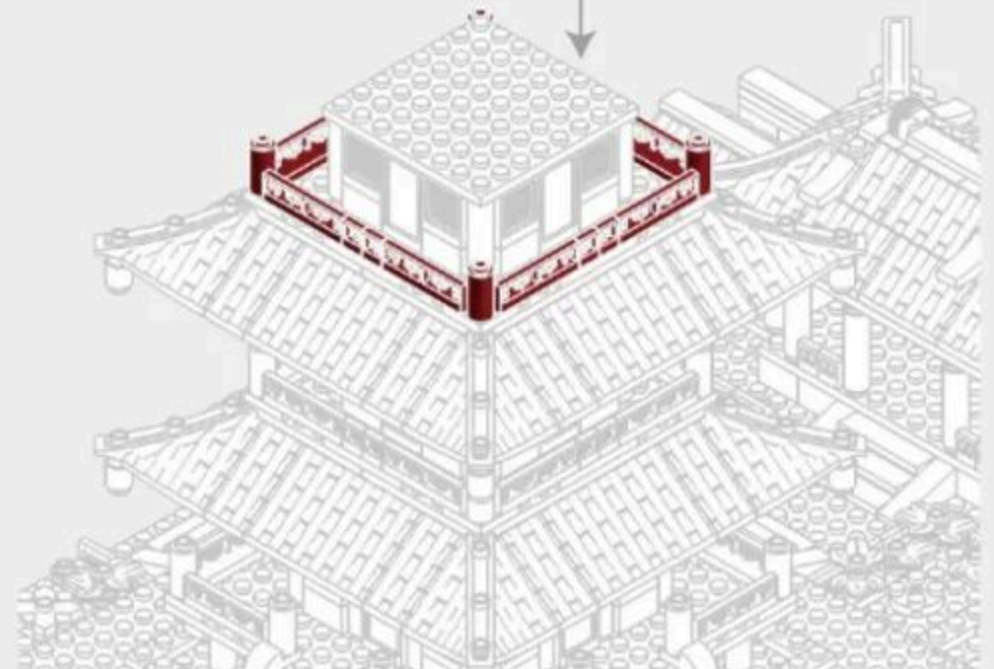
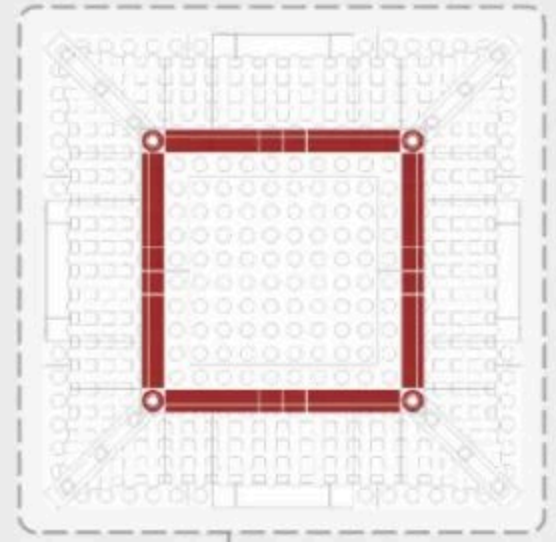



4-10

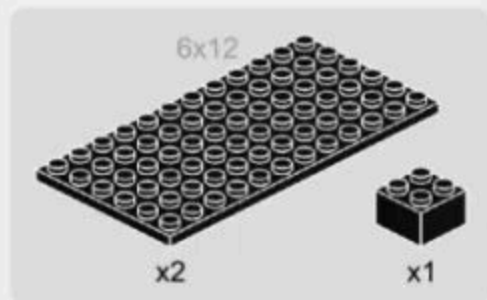

4-11

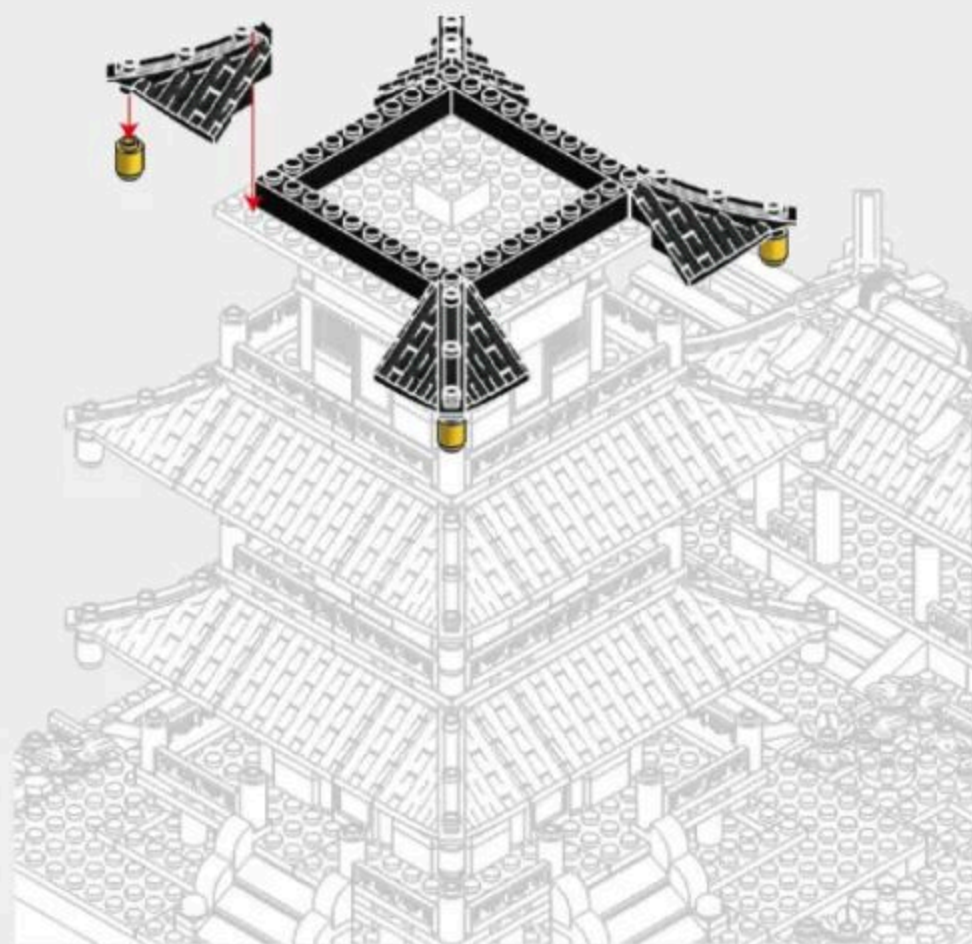
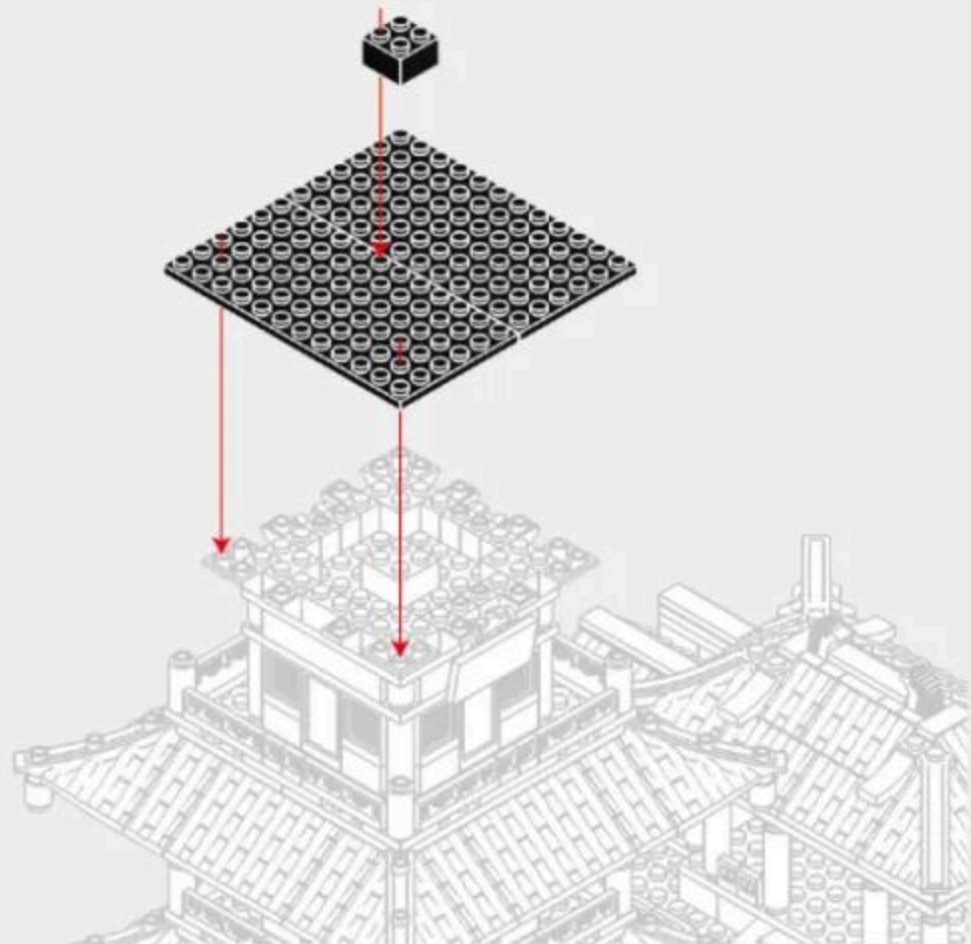
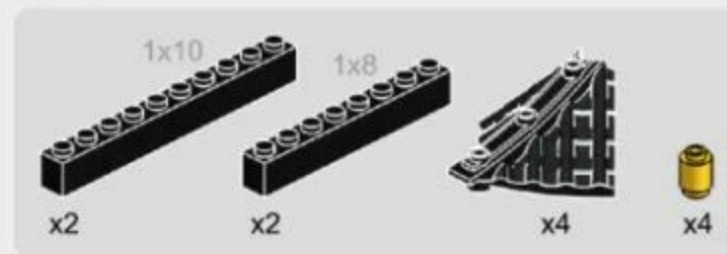

4-12

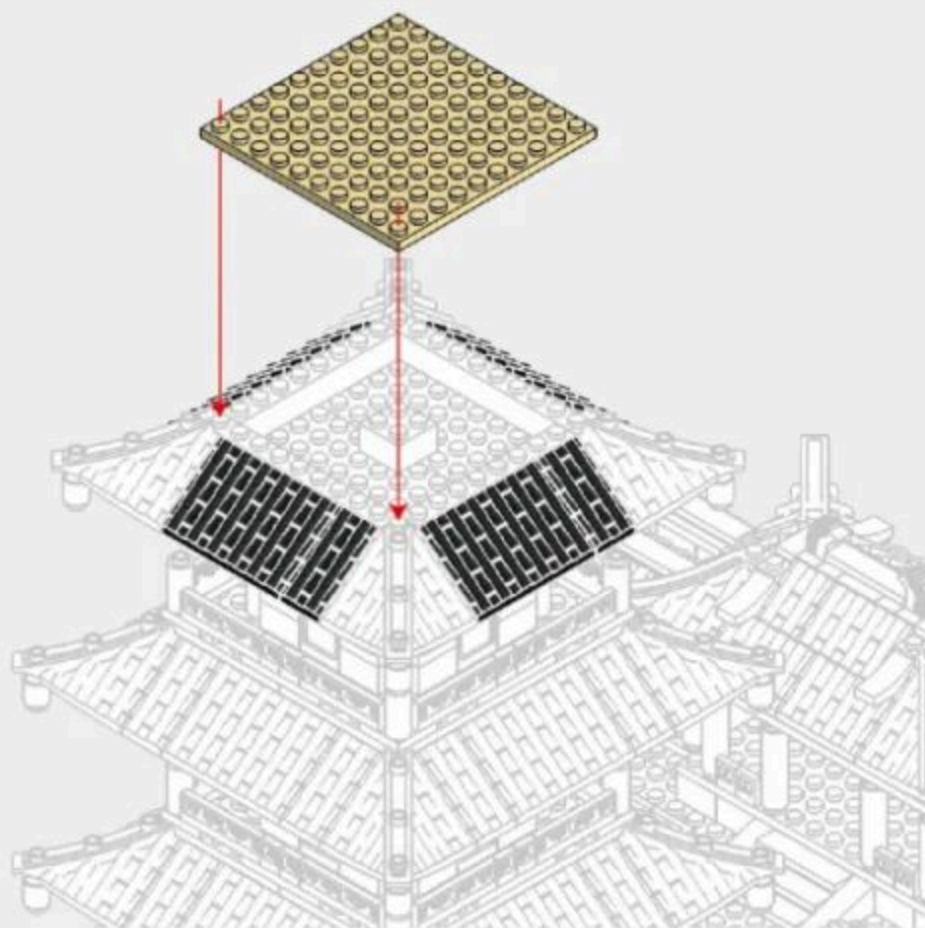
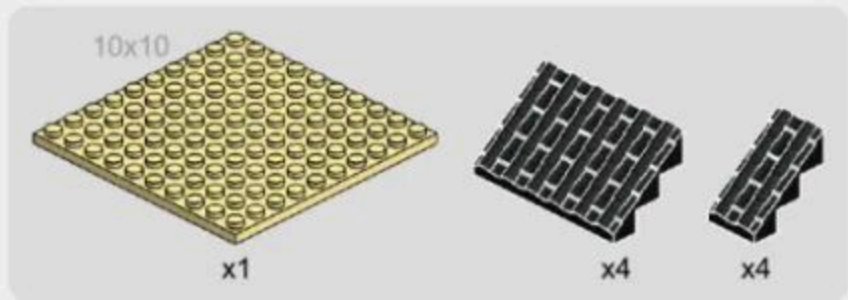

4-13

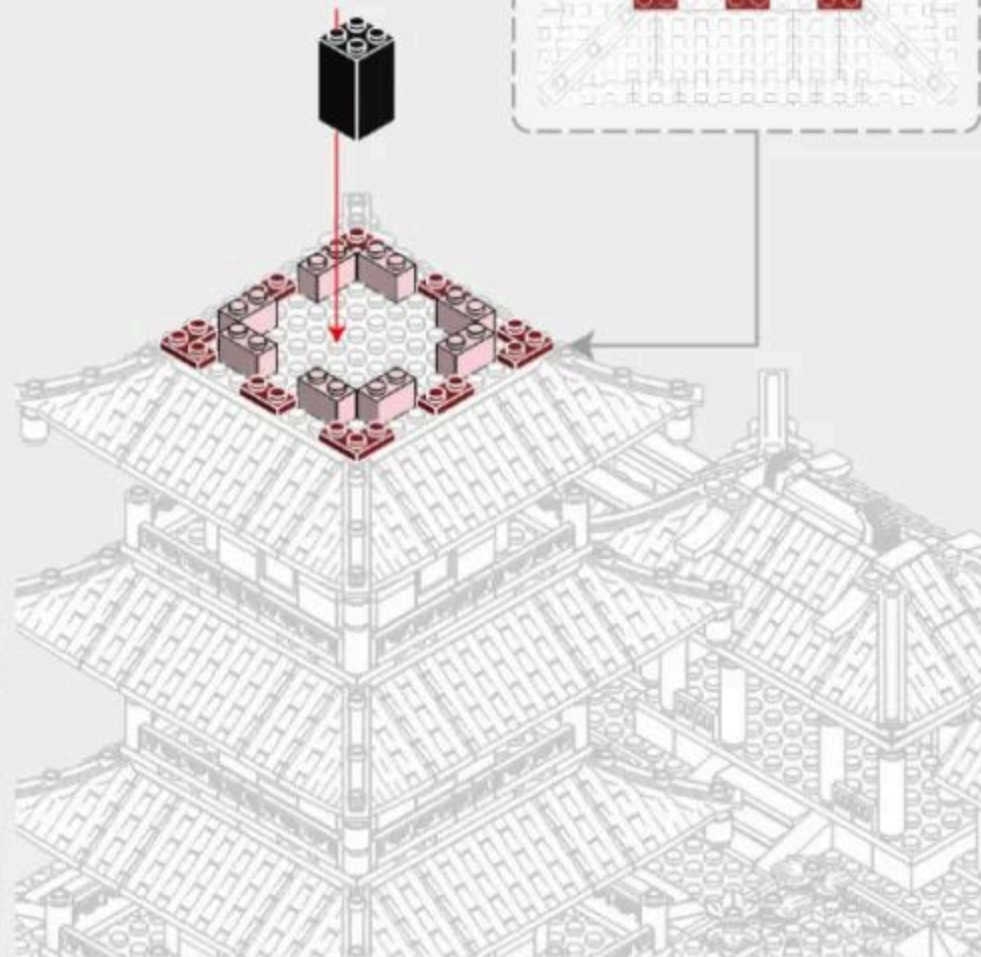
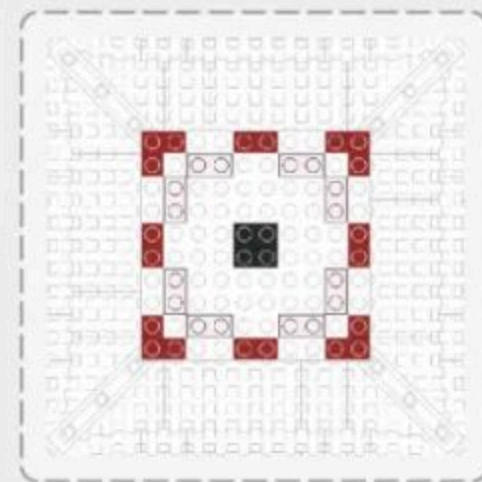

4-14

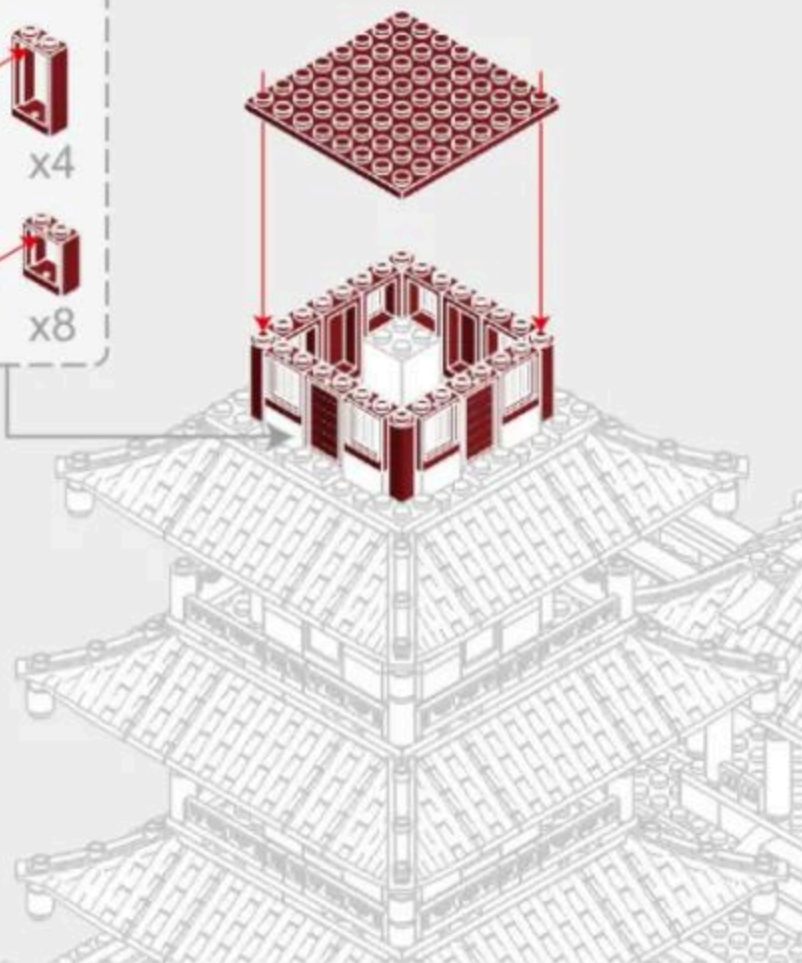
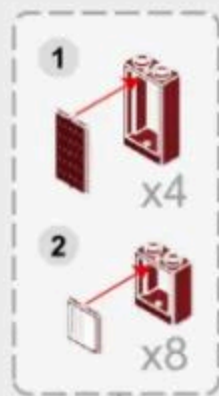

4-15

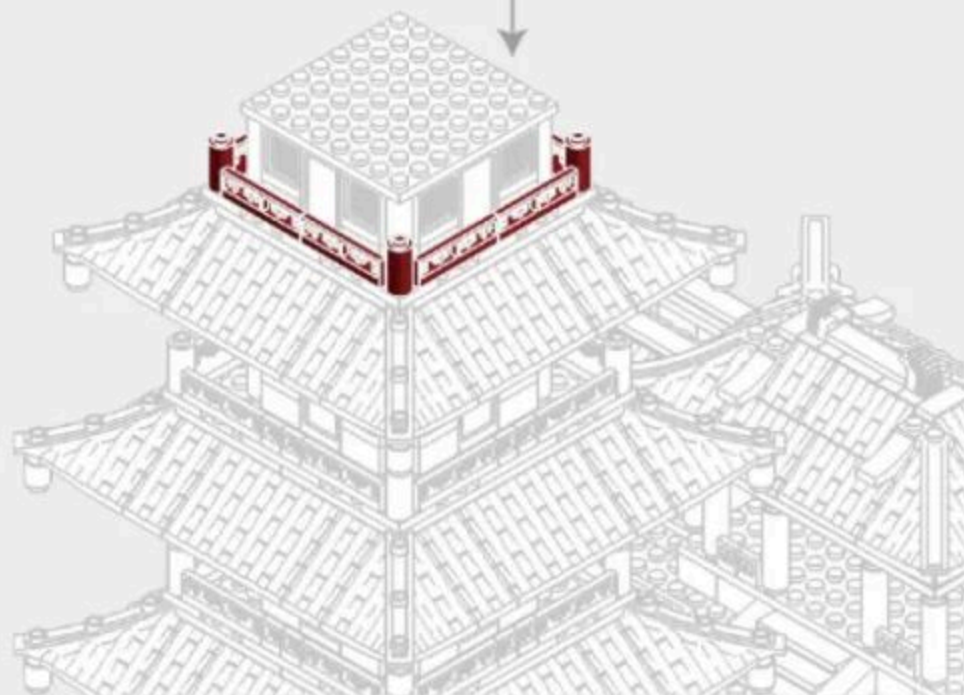
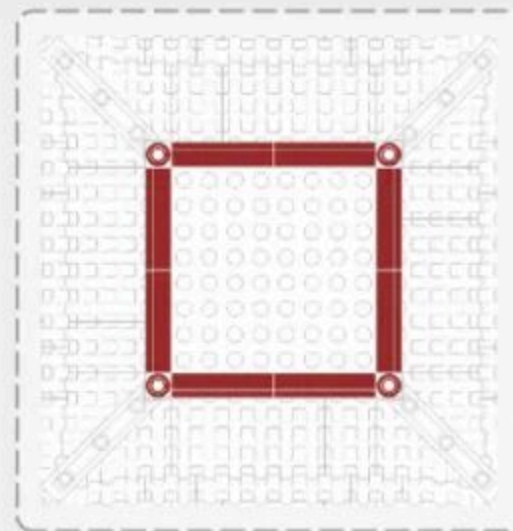

4-16

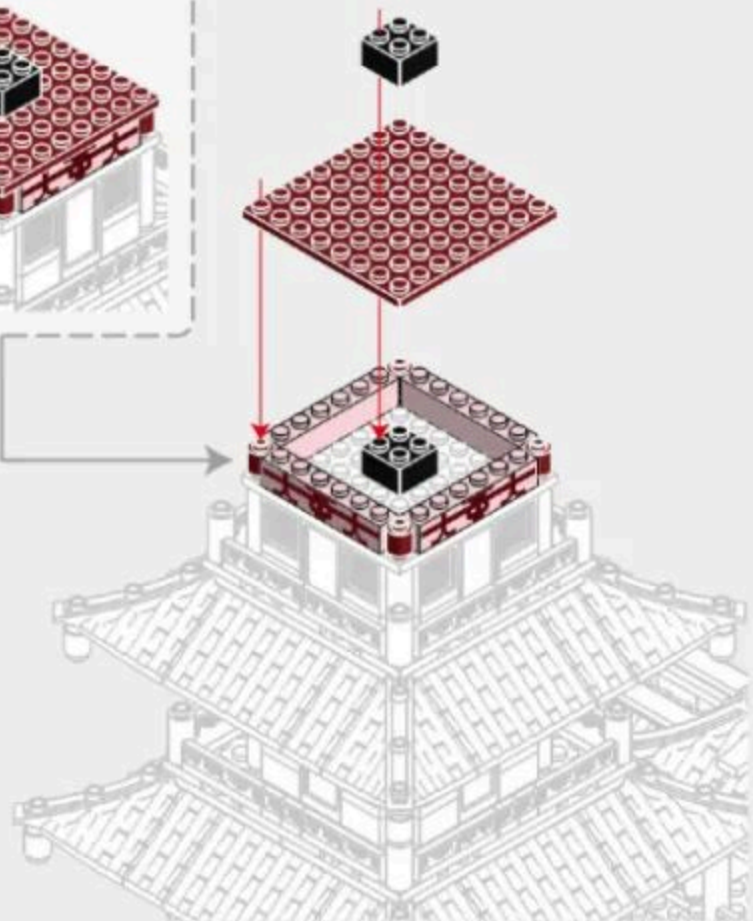
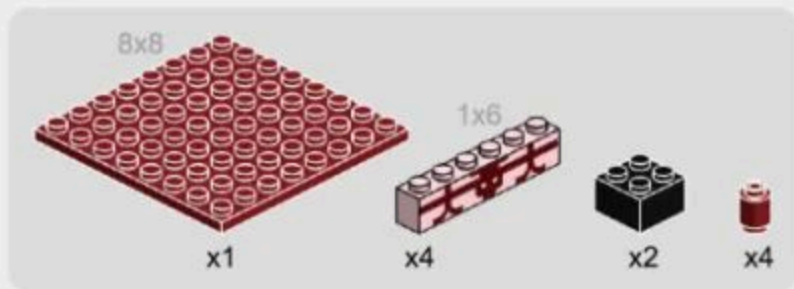

4-17

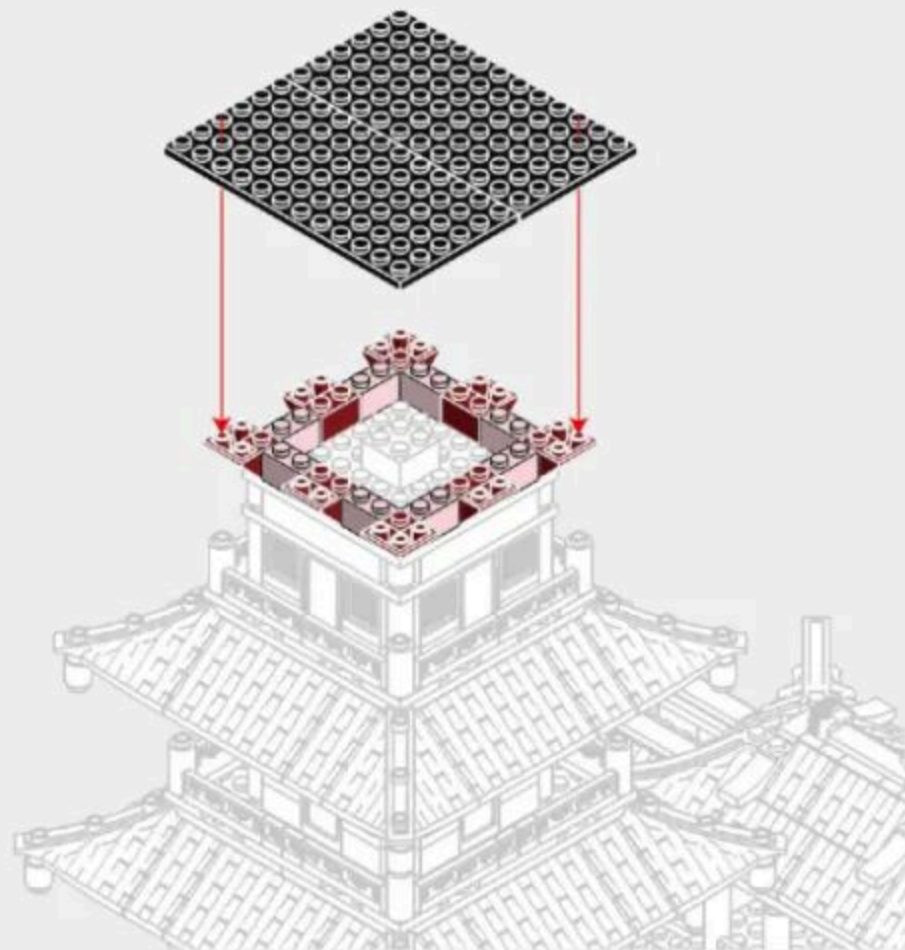
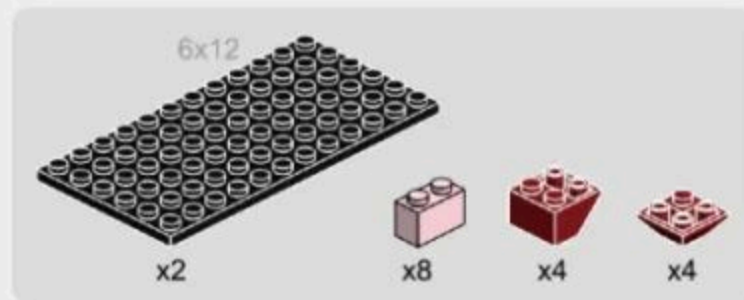



283PCS



71

5-1

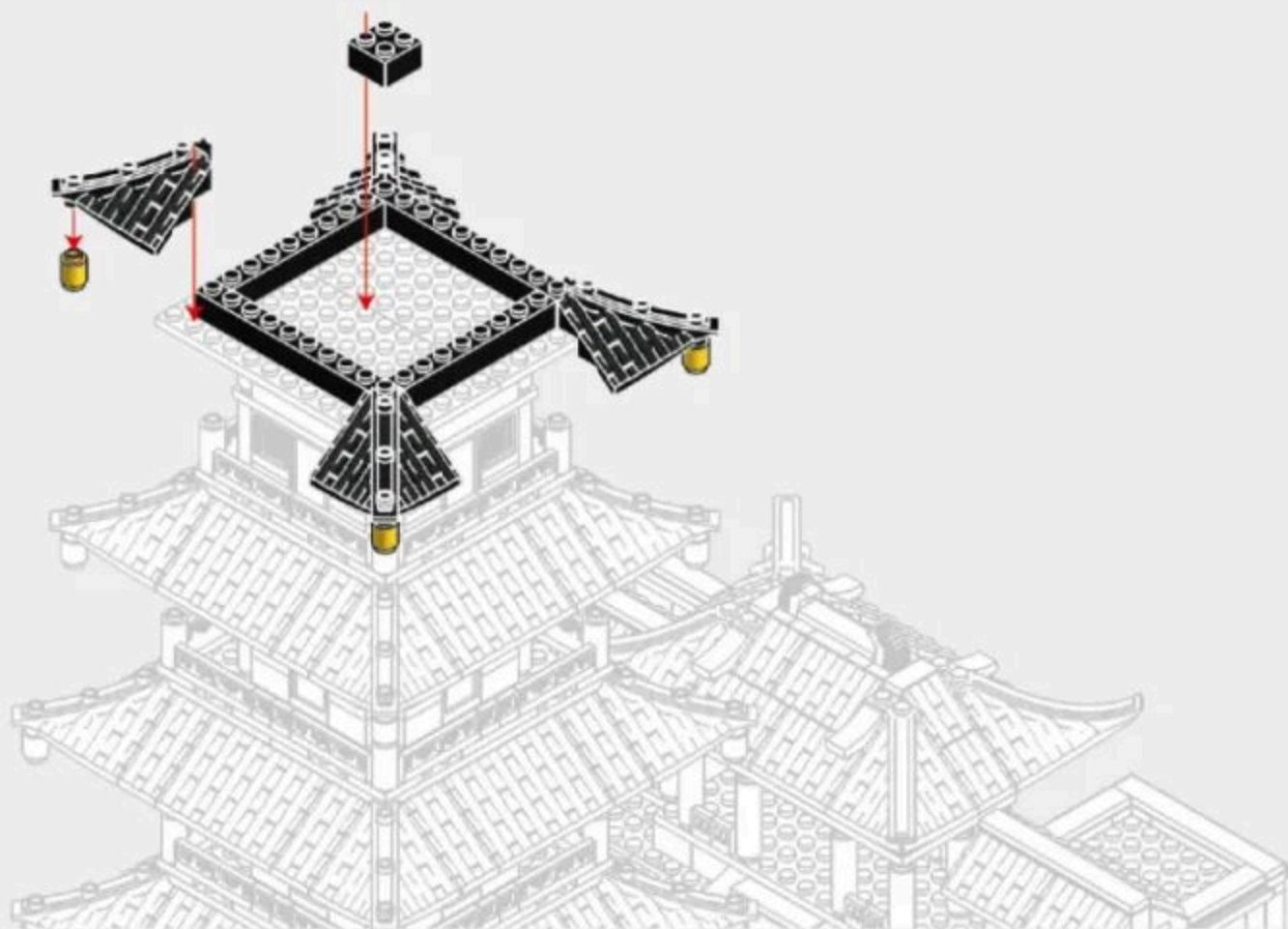
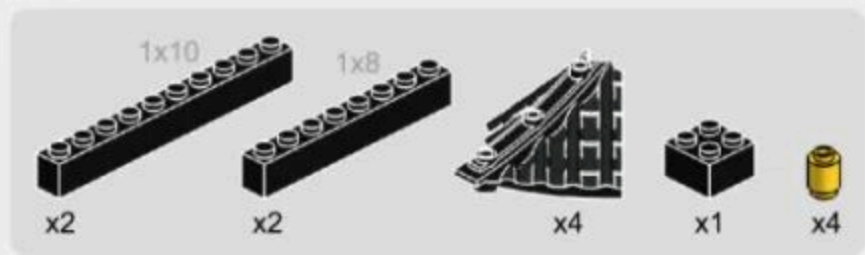

5-2

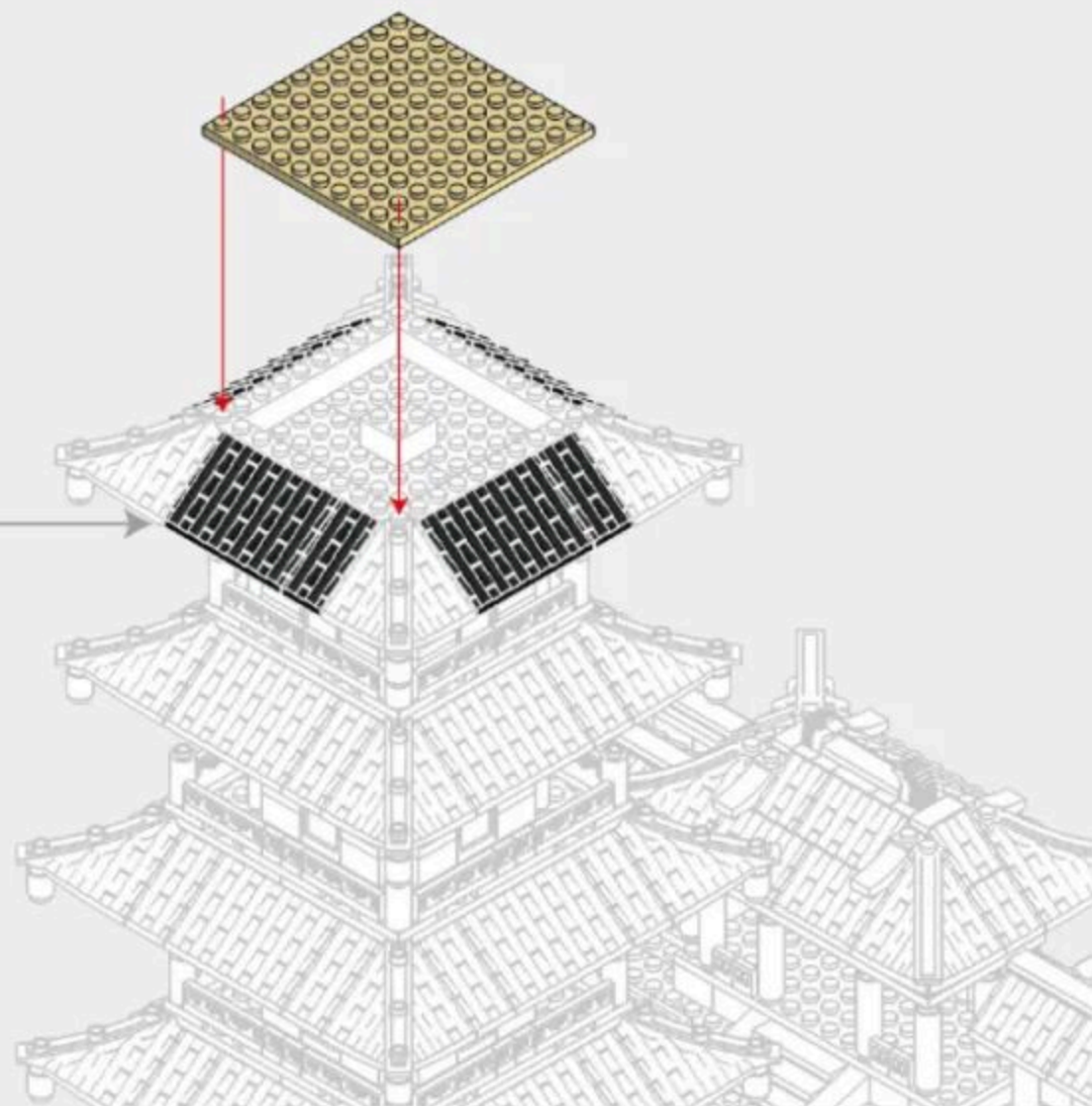
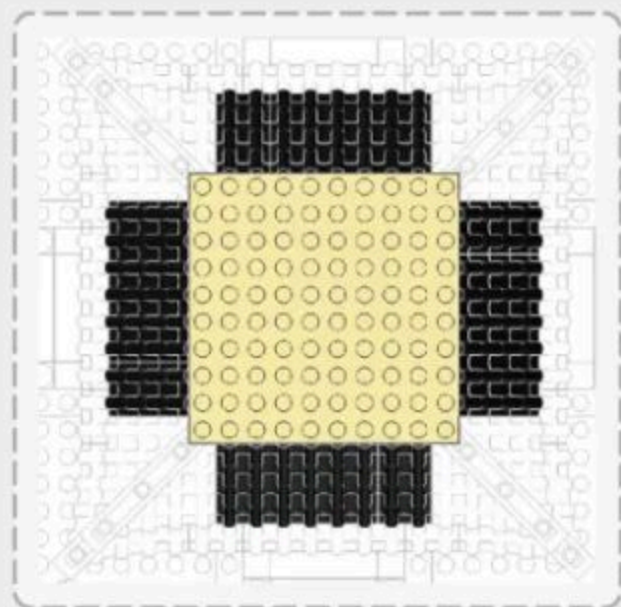
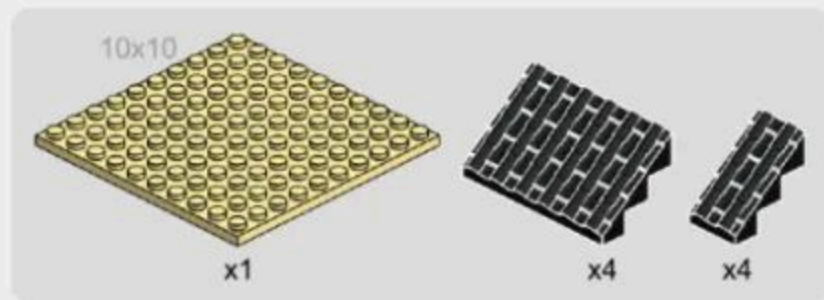

5-3

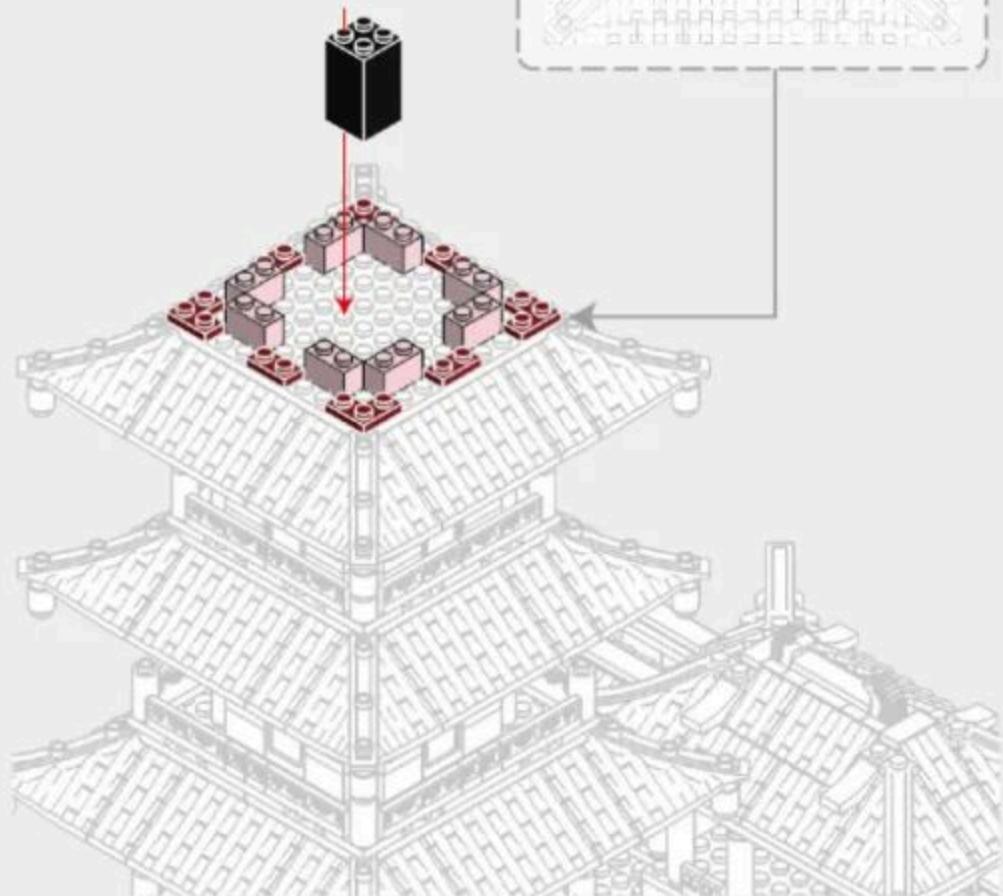
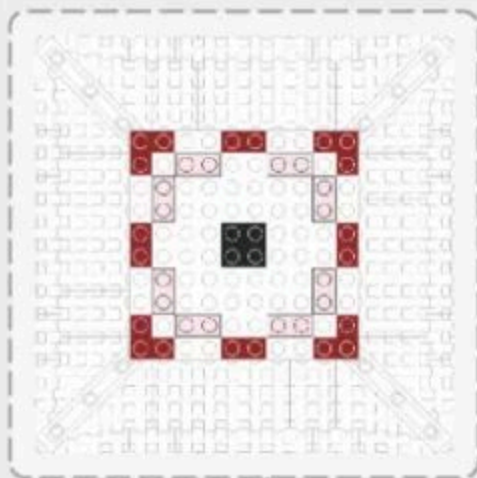
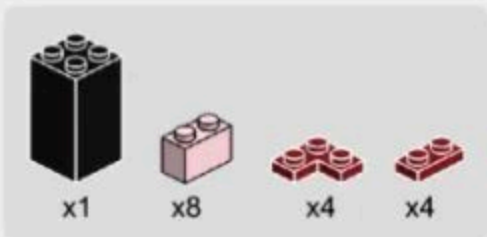

5-4

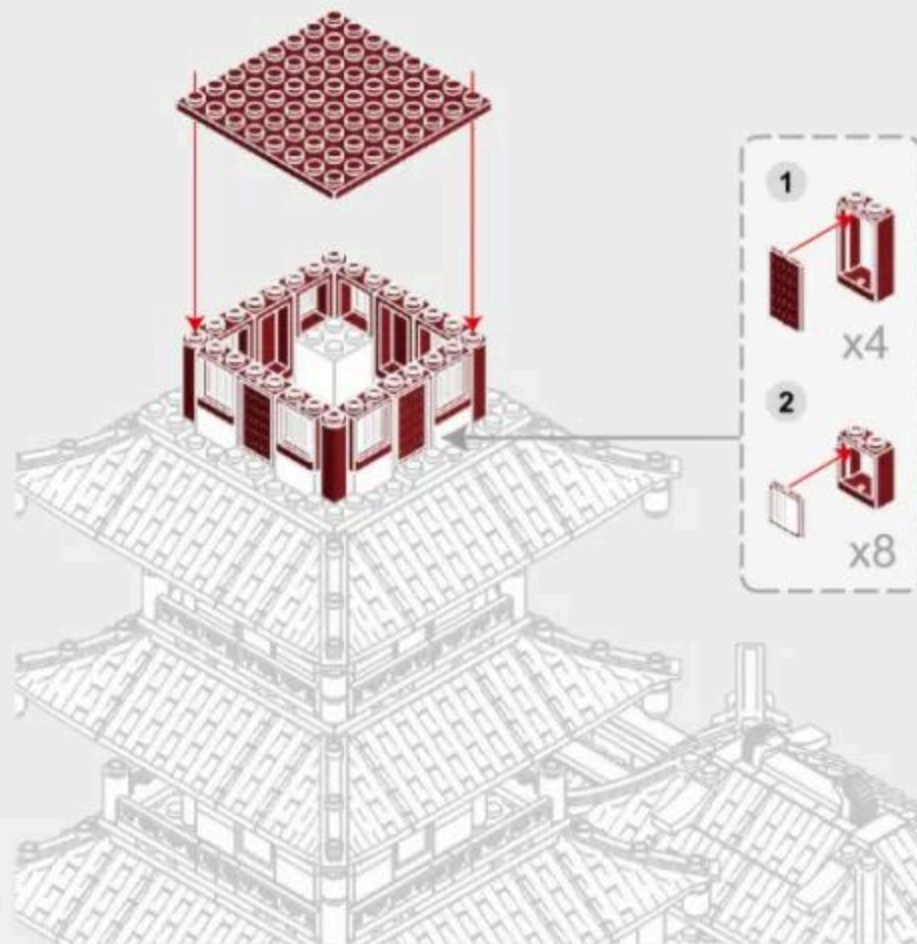
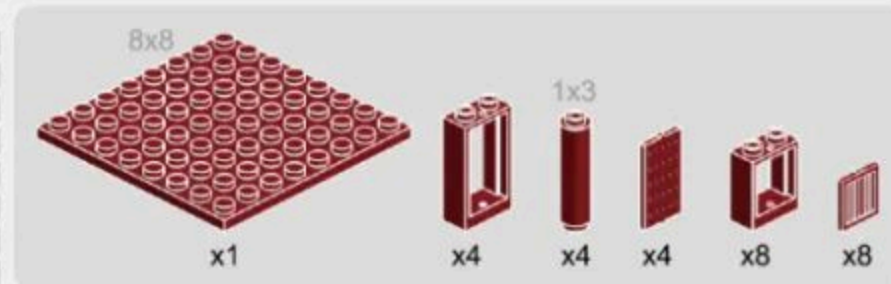

5-5

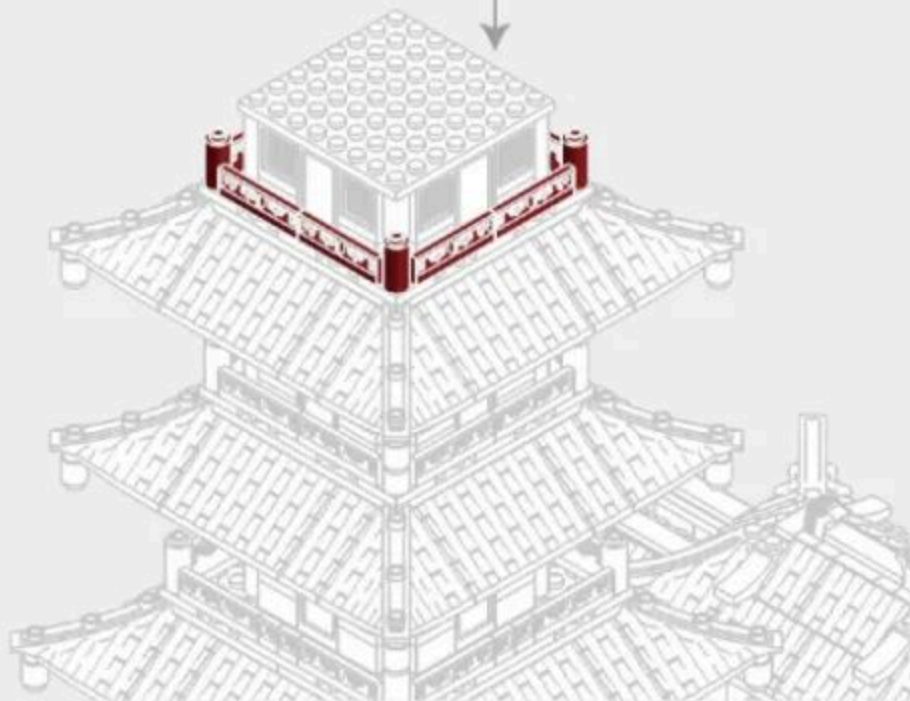
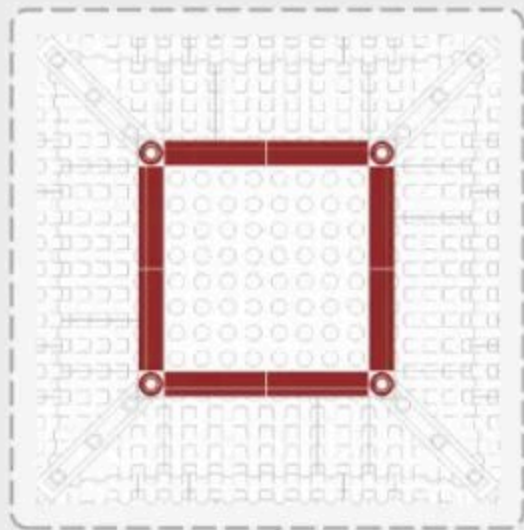

5-6

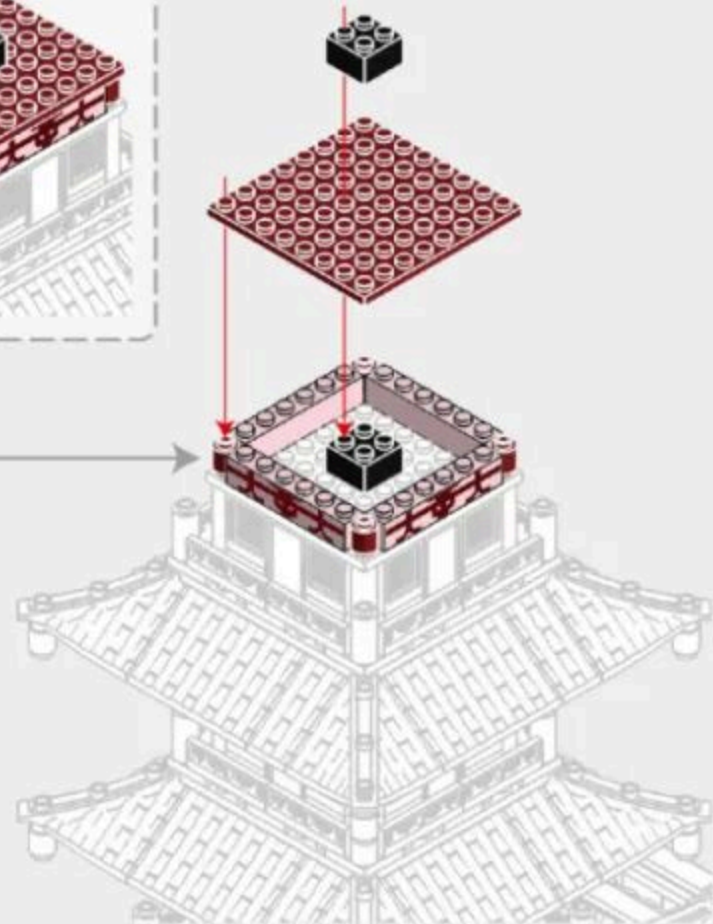
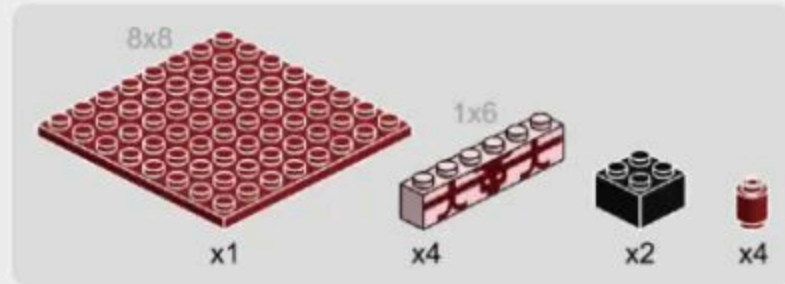

5-7

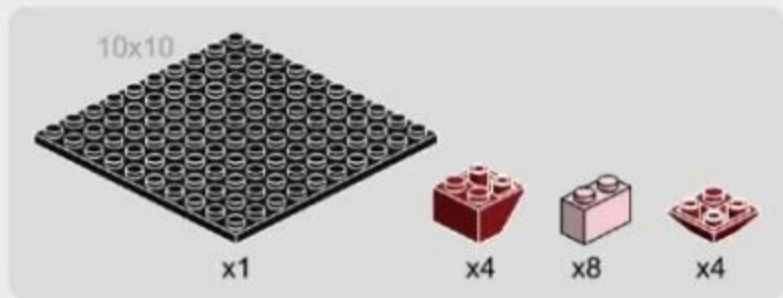

5-8

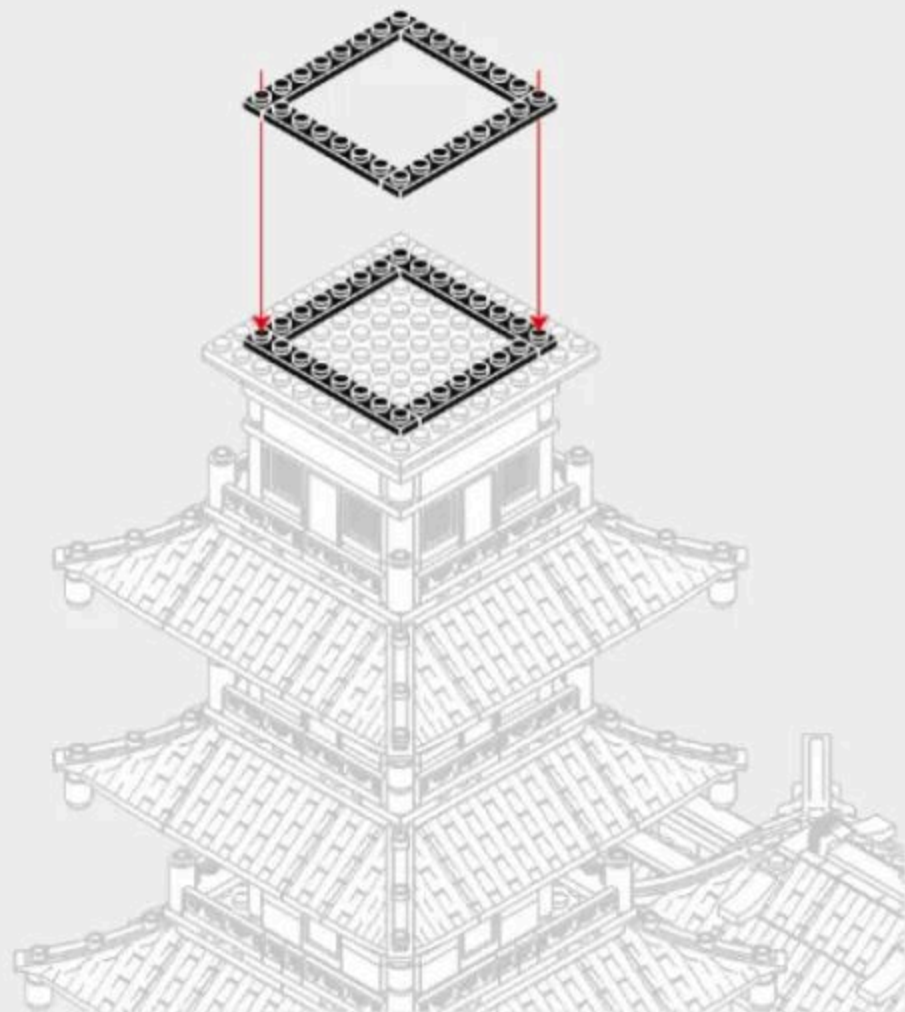
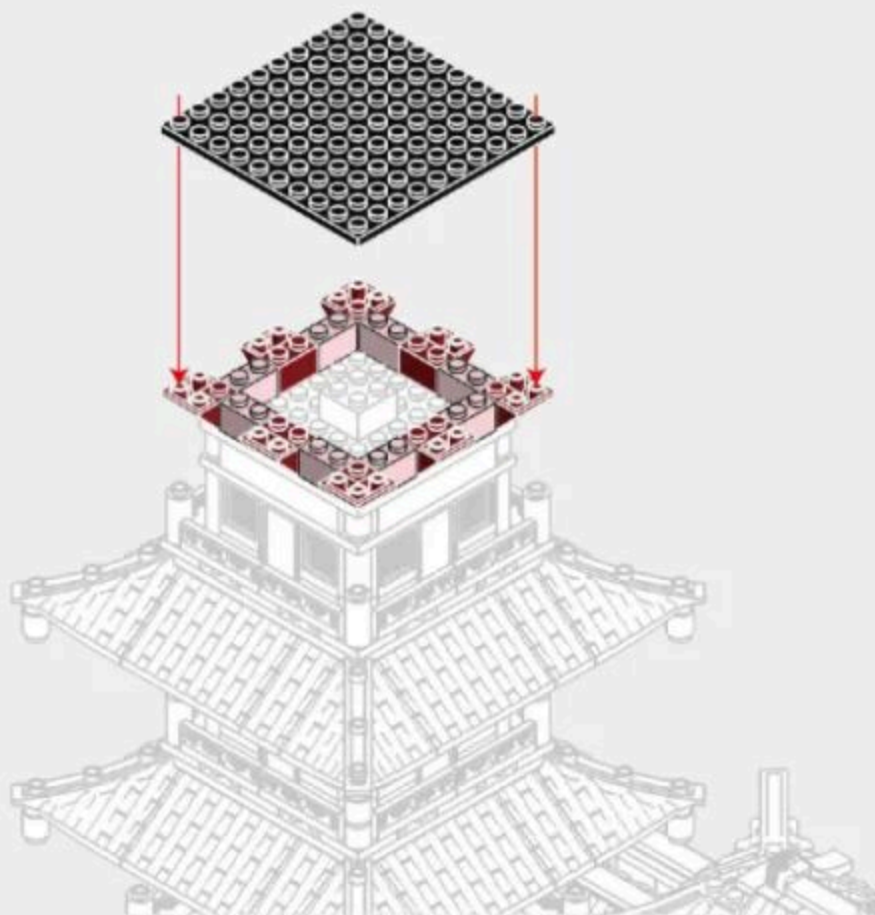
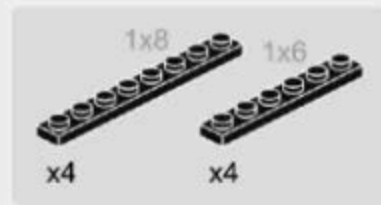

5-9

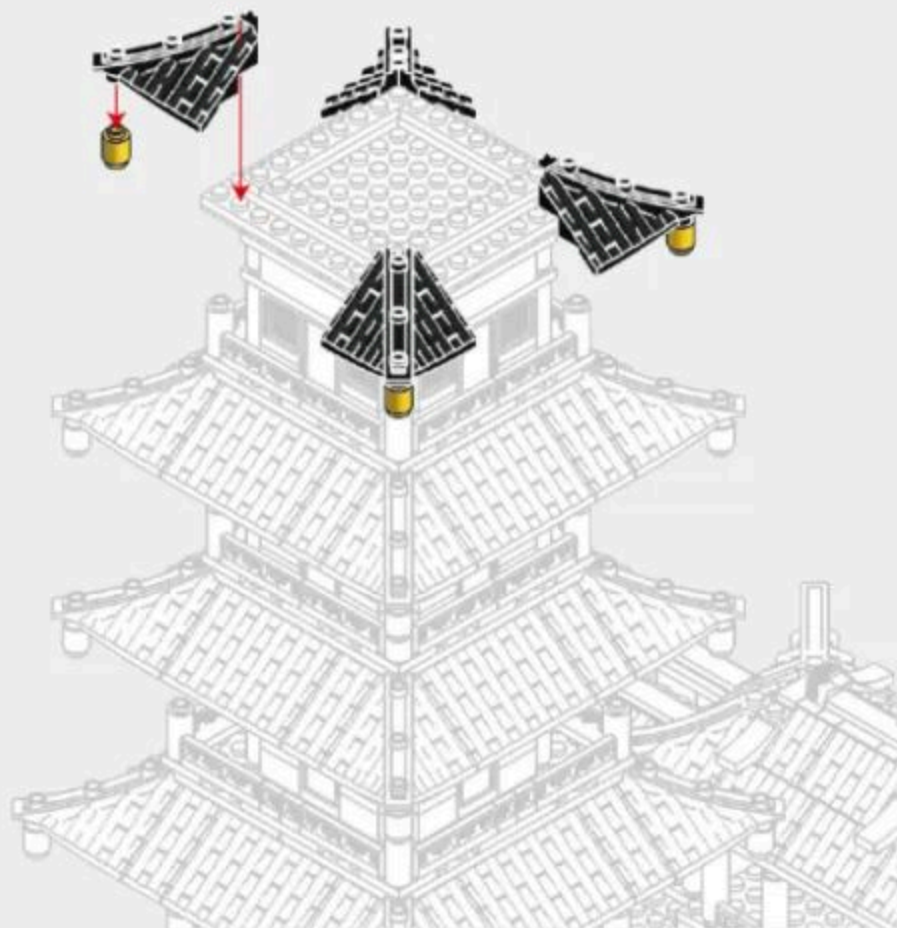

5-10

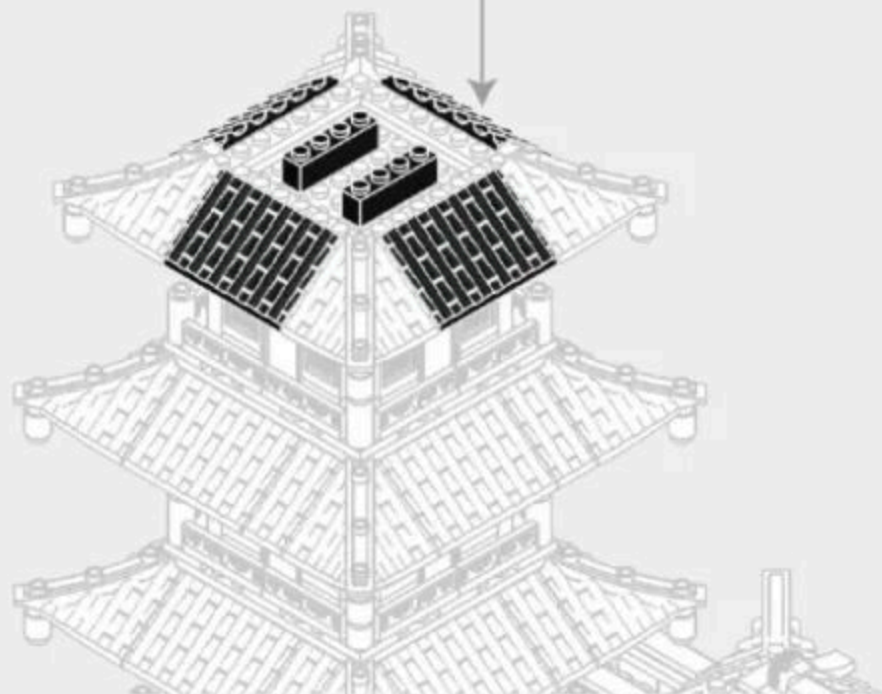
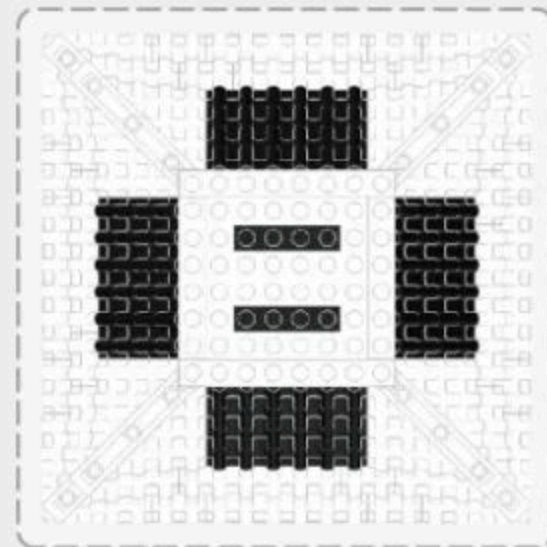
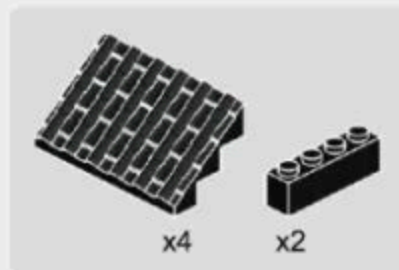

5-11

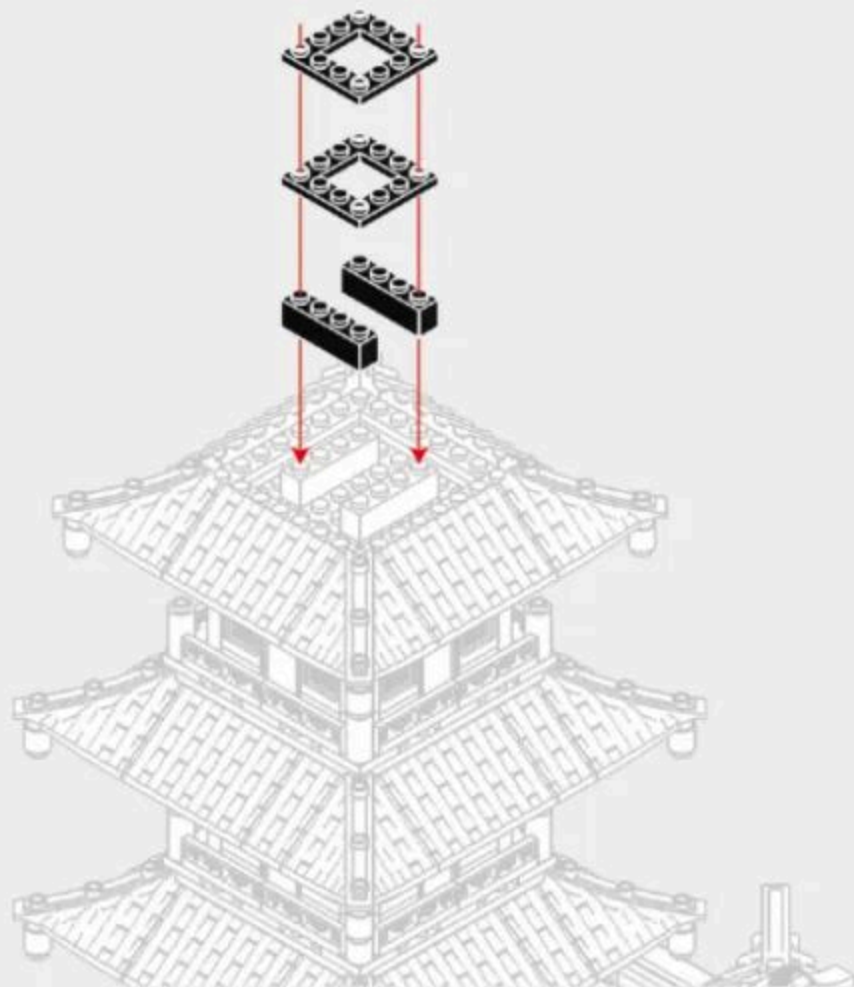

5-12

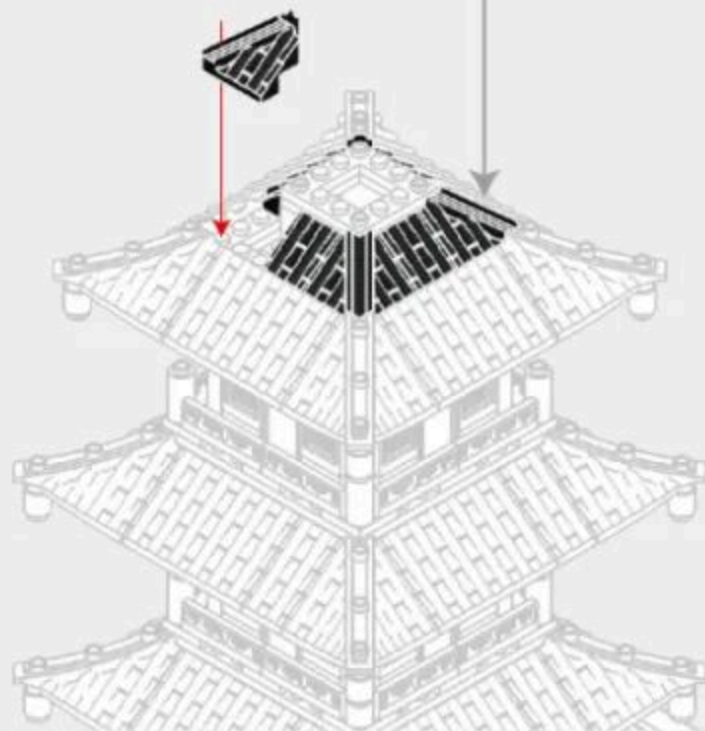
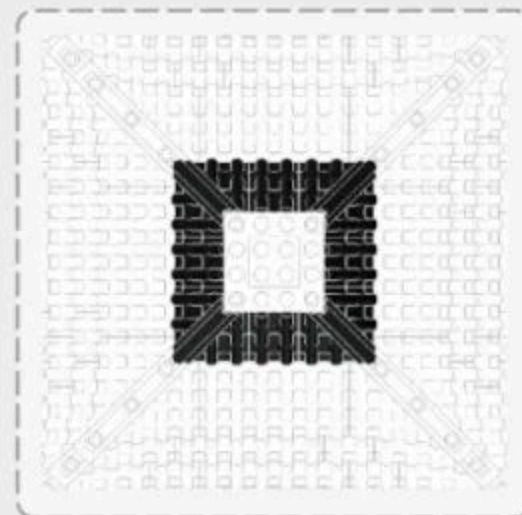
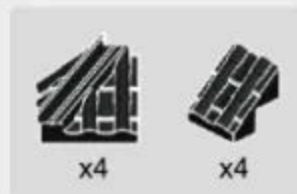

5-13

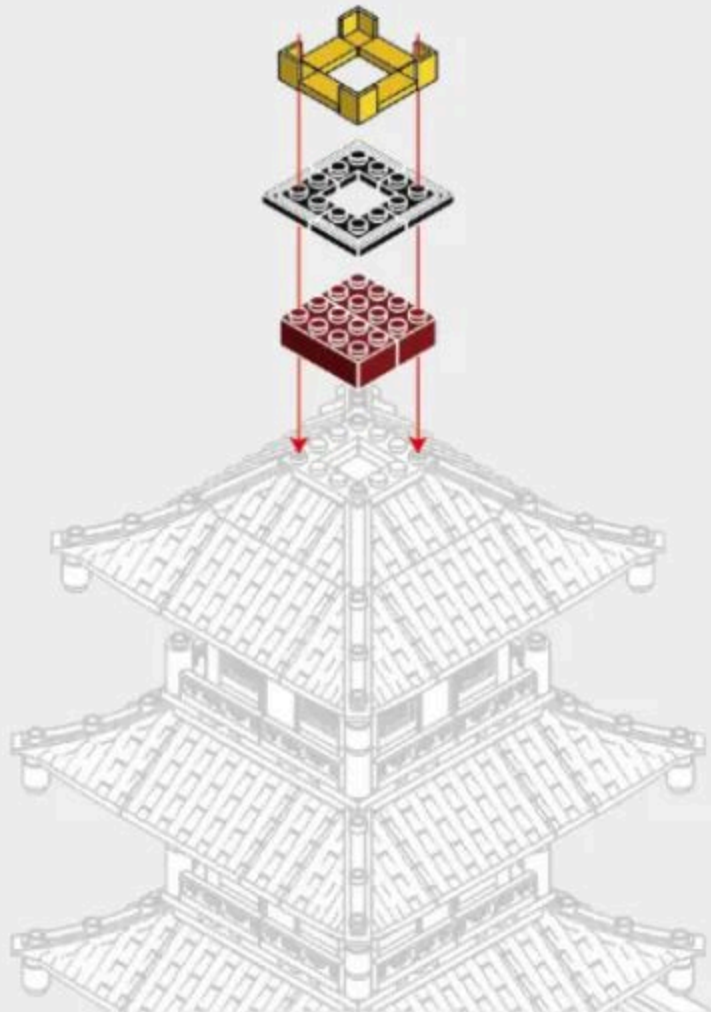

5-14

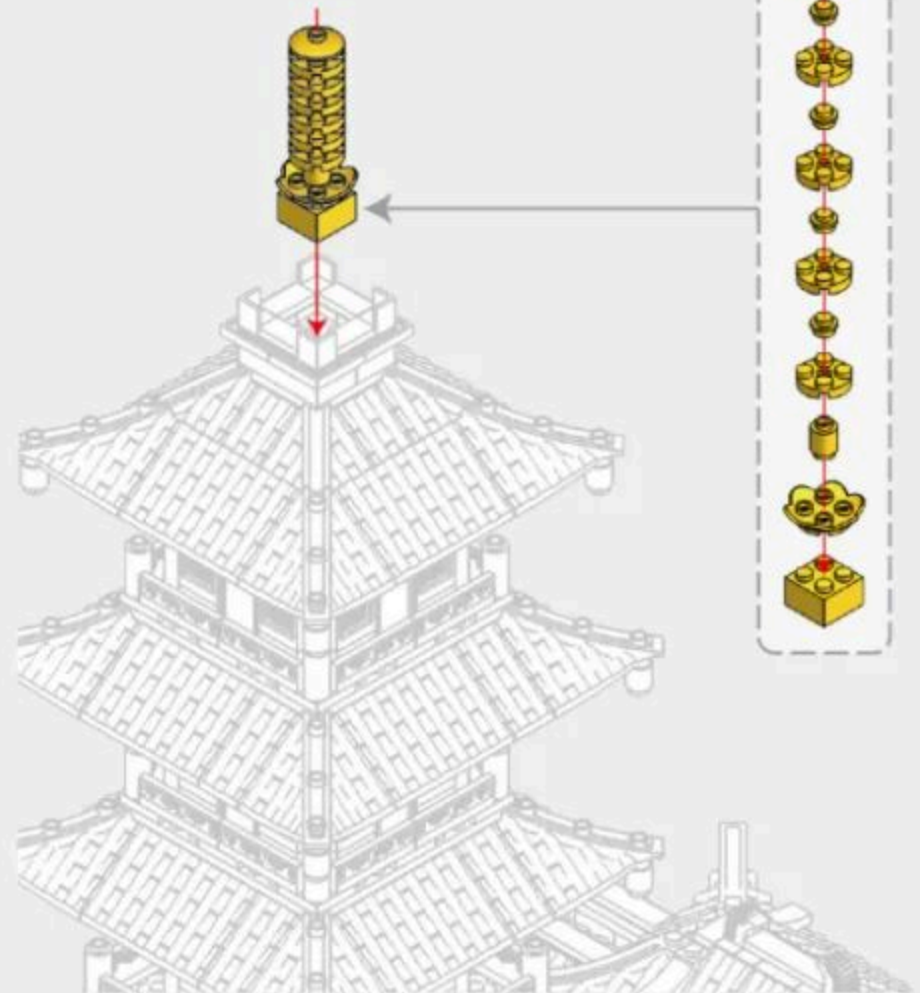

5-15

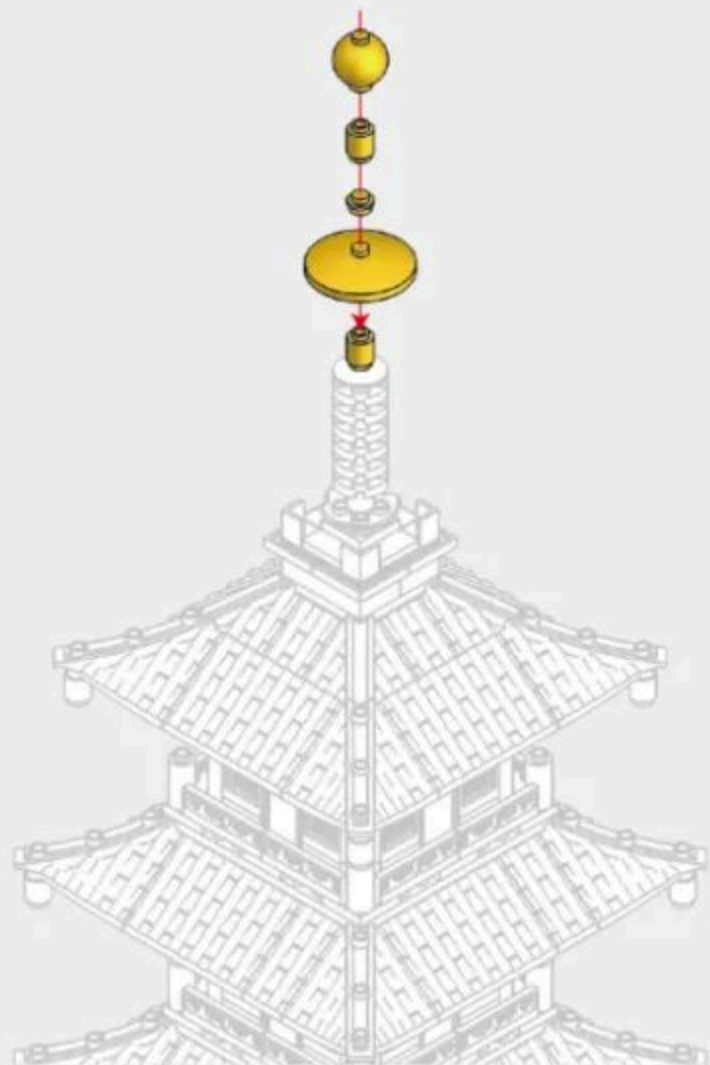

5-16

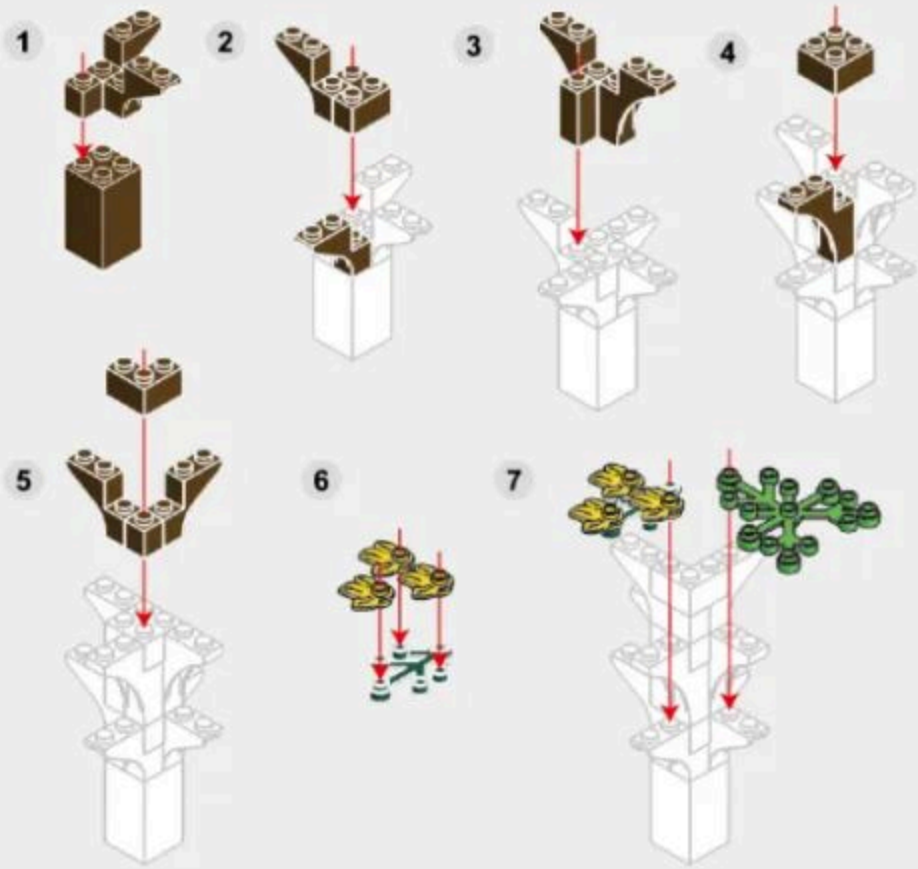
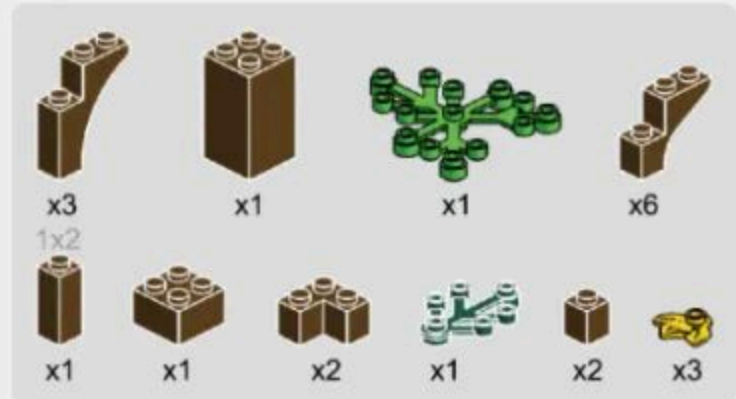

5-17

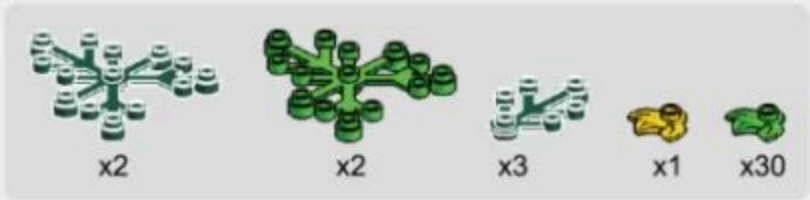

5-16

5-18



x2



x2



x4

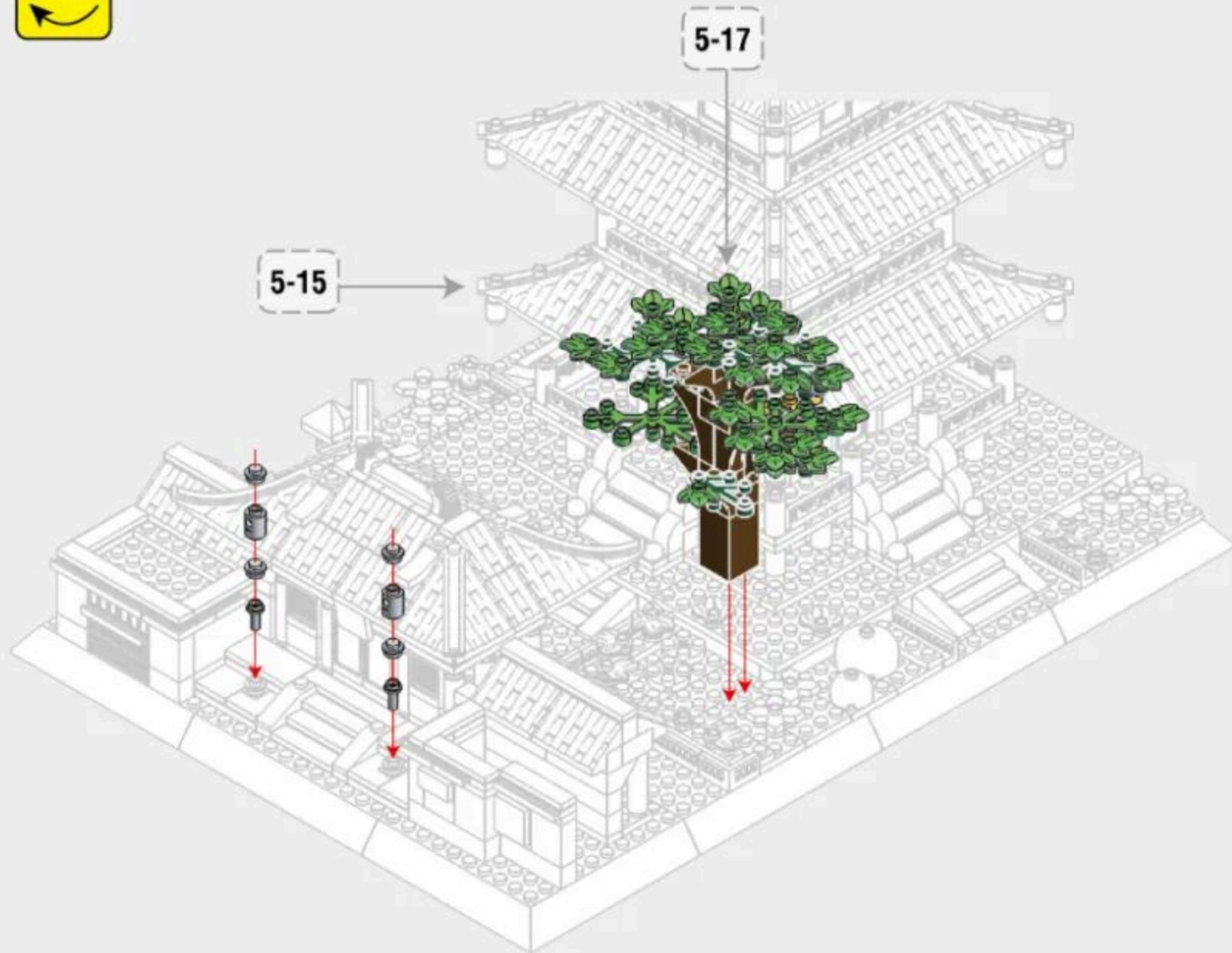

5-19

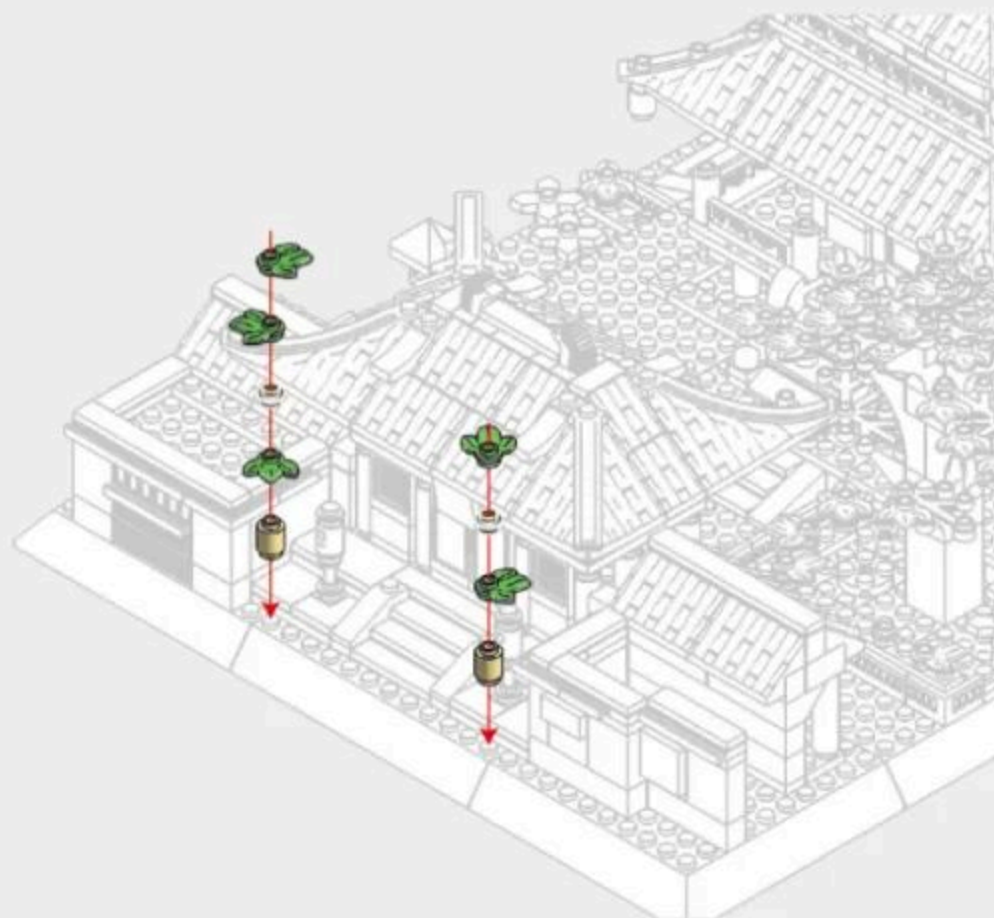

5-20

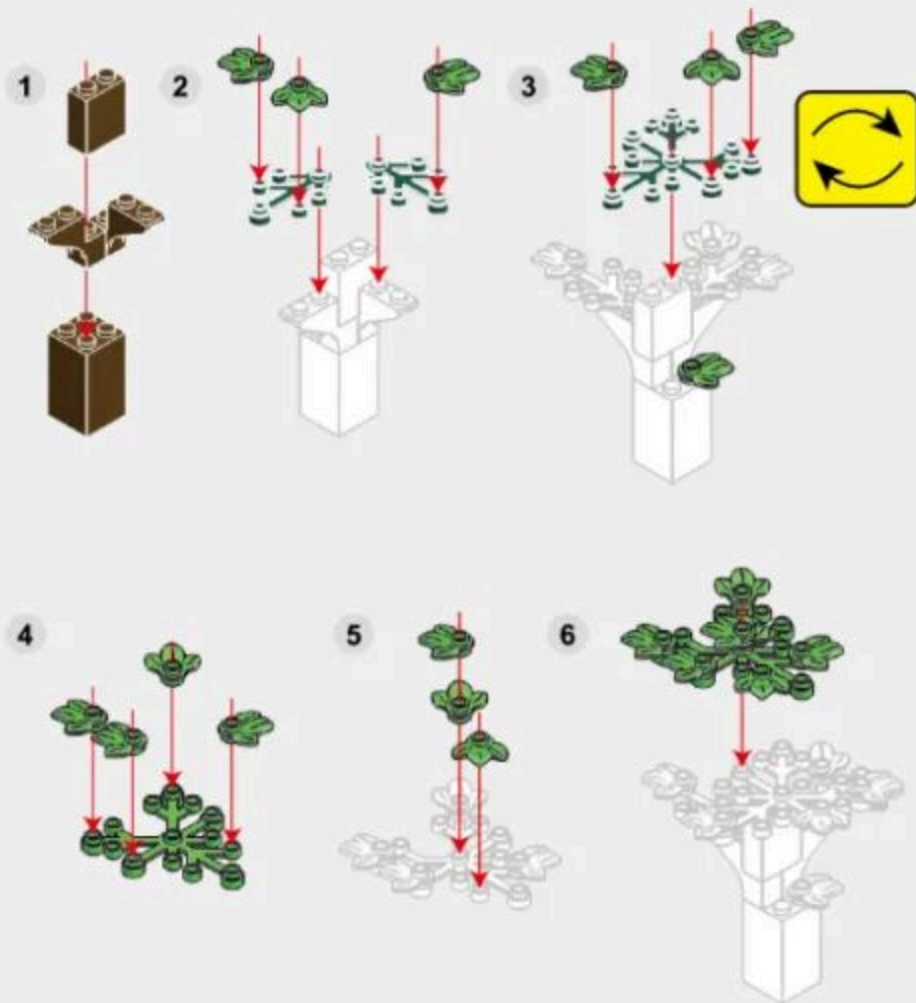
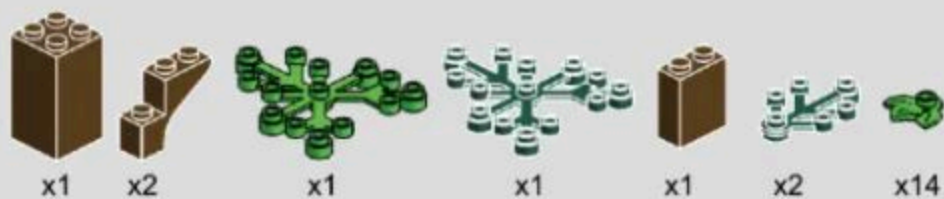

5-21

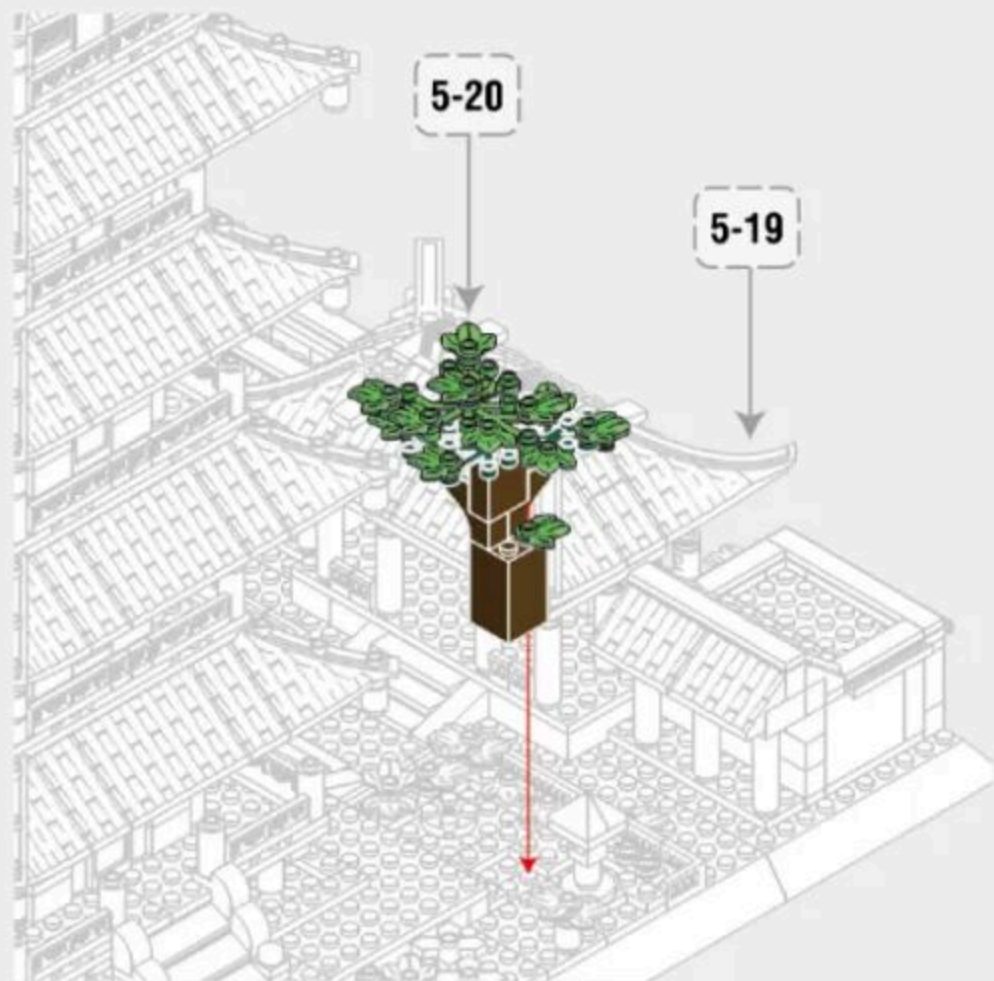

5-22

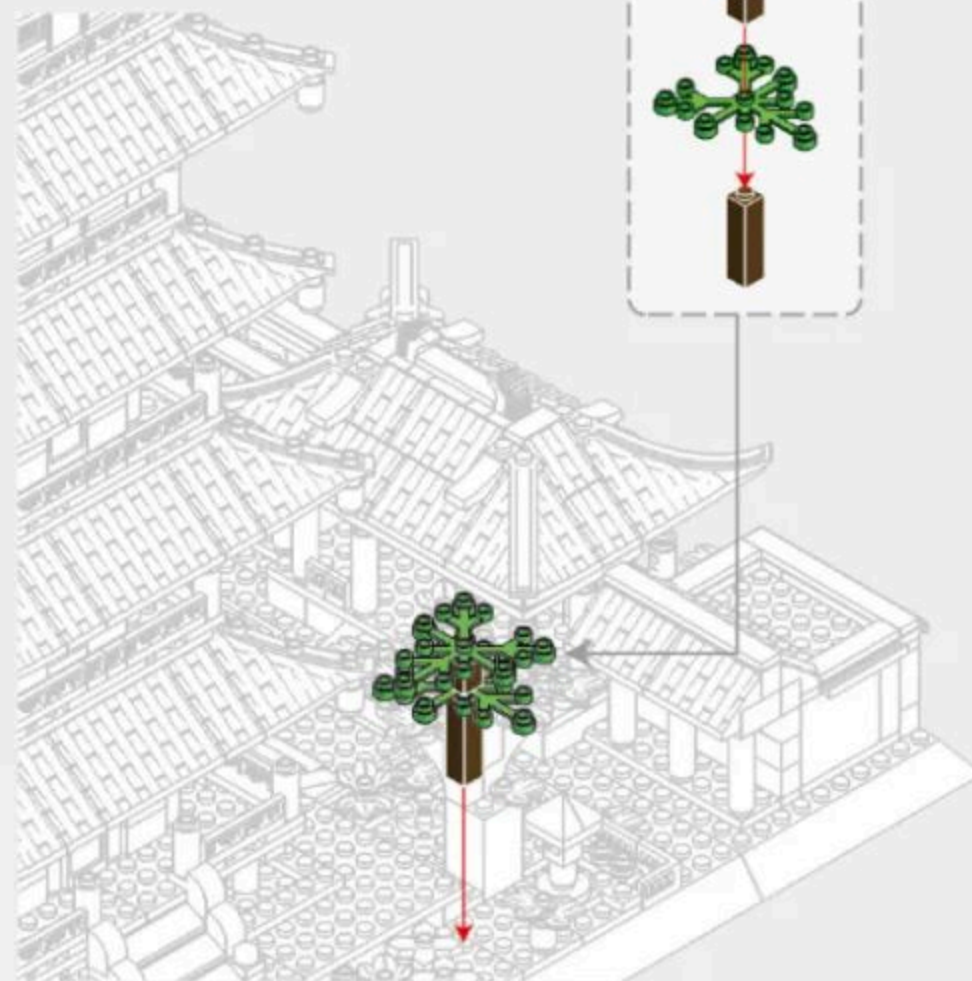

5-23

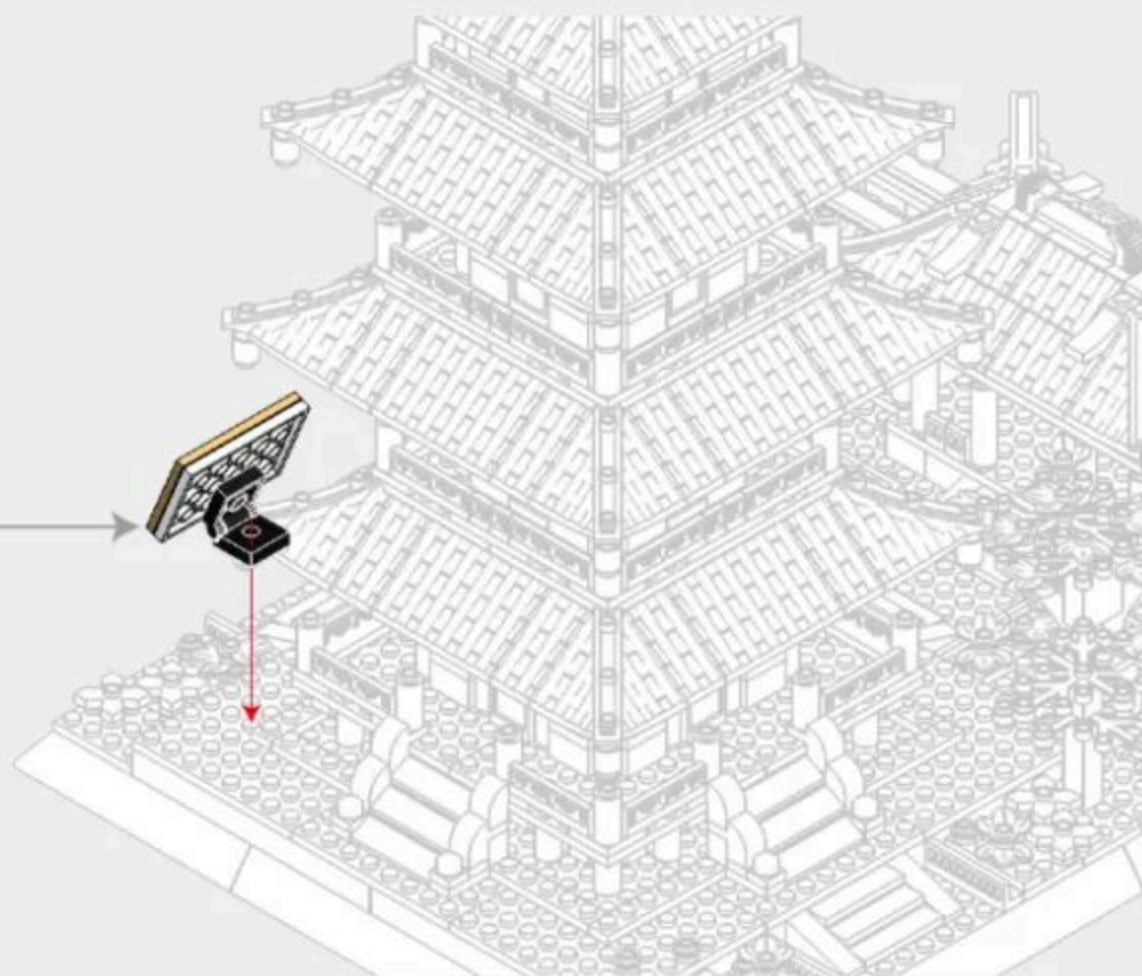
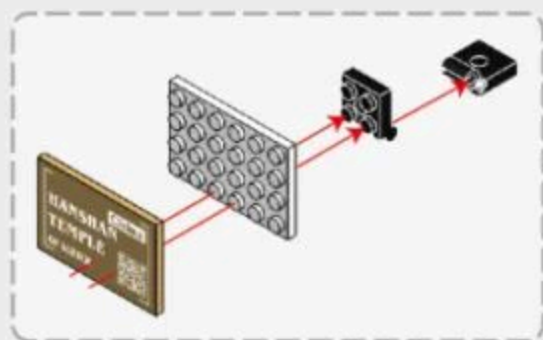
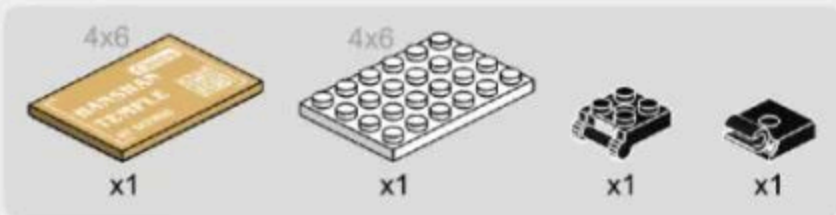



# ARCHITECTURE

The World's great architecture



**6224** 英国伦敦白金汉宫  
BUCKINGHAM PALACE-LONDON,ENGLAND

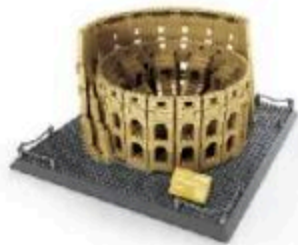

**5225** 意大利罗马斗兽场  
COLOSSEUM-ROME,ITALY



**5226** 日本东京帝国饭店  
IMPERIAL HOTEL-TOKYO,JAPAN



**6211** 德国柏林勃兰登堡门  
BRANDENBURG GATE-BERLIN, GERMANY



**6222** 中国甘肃长城-嘉峪关  
JIAYU PASS-GANSU,CHINA



**6212** 日本京都清水寺仁王门  
NIOMON GATE OF KIYOMIZU-DERA-KYOTO,JAPAN



**6214** 中国武汉黄鹤楼  
YELLOW CRANE TOWER-WUHAN,CHINA



**6215** 英国伦敦眼  
LONDON EYE-LONDON,ENGLAND



**6221** 中国北京故宫-太和殿  
HALL OF SUPREME HARMONY-BEIJING,CHINA



**6213** 俄罗斯莫斯科瓦西里大教堂  
SAINT BASIL'S CATHEDRAL-MOSCOW,RUSSIA



**6220** 沙特阿拉伯麦加大清真寺  
GREAT MOSQUE OF MECCA,SAUDI ARABIA



**6219** 美国纽约联合国大厦  
UNITED NATIONS HEADQUARTERS-NEW YORK,AMERICA



**4214** 美国华盛顿白宫  
WHITE HOUSE-WASHINGTON D.C.,AMERICA



**4212** 意大利罗马许愿池  
TREVI FOUNTAIN-ROME,ITALY



**4213** 法国巴黎卢浮宫  
MUSÉE DU LOUVRE-PARIS,FRANCE



**4218** 新加坡-鱼尾狮  
MERLION,SINGAPORE



**4210** 埃及开罗吉萨金字塔  
GREAT PYRAMID OF GIZA-CAIRO,EGYPT



**4219** 英国伦敦双子塔桥  
TOWER BRIDGE-LONDON,ENGLAND



**4216** 美国华盛顿林肯纪念堂  
LINCOLN MEMORIAL-WASHINGTON D.C.,AMERICA



**4217** 新加坡-金沙酒店  
MARINA BAY SANDS,SINGAPORE



**7210** 中国上海世博会中国馆  
CHINA PAVILION AT EXPO-SHANGHAI, CHINA



**4221** 加拿大渥太华国会山庄  
PARLIAMENT BUILDINGS-OTTAWA, CANADA



**4211** 英国伦敦伊丽莎白塔  
ELIZABETH TOWER-ENGLAND



**4220** 美国纽约熨斗大厦  
FLATIRON BUILDING-NEW YORK, AMERICA



**5227** 美国纽约自由女神像  
STATUE OF LIBERTY-NEW YORK, AMERICA



**4215** 加拿大多伦多电视塔  
THE CN TOWER-CANADA



**4222** 阿联酋迪拜哈利法塔  
THE BURJ KHALIFA TOWER-DUBAI, UAE



**5224** 中国上海东方明珠广播电视塔  
ORIENTAL PEARL TOWER-SHANGHAI, CHINA



**5212** 美国纽约帝国大厦  
EMPIRE STATE BUILDING-NEW YORK, AMERICA



**5213** 马来西亚吉隆坡石油双塔  
PETRONAS TWIN TOWERS-KUALA LUMPUR, MALAYSIA



**5214** 意大利托斯卡纳比萨斜塔  
LEANING TOWER OF PISA-TUSCANY, ITALY



**5216** 英国伦敦伊丽莎白塔  
ELIZABETH TOWER-ENGLAND



**5219** 俄罗斯莫斯科克里姆林宫钟楼  
SPASSKAYA TOWER-MOSCOW, RUSSIA



**5220** 阿联酋迪拜卓美亚帆船酒店  
BURJ AL ARAB HOTEL-DUBAI, UAE



**5217** 法国巴黎埃菲尔铁塔  
EIFFEL TOWER-PARIS, FRANCE



**5221** 中国台北101大楼  
TAIPEI 101-TAIPEI, CHINA



**6223** 中国武汉长江大桥  
WUHAN YANGTZE RIVER BRIDGE



**5210** 法国巴黎圣母院大教堂  
CATHEDRALE NOTRE DAME DE PARIS-PARIS, FRANCE



**5223** 法国巴黎凯旋门  
ARC DE TRIOMPHE-PARIS, FRANCE



**5211** 印度阿格拉泰姬陵  
TAJ MAHAL-AGRA, INDIA



**5215 英国伦敦双子塔桥**  
TOWER BRIDGE-LONDON,ENGLAND



**5222 中国北京天坛祈年殿**  
HALL OF PRAYER FOR GOOD HARVESTS-BEIJING,CHINA



**6210 美国旧金山金门大桥**  
GOLDEN GATE BRIDGE-SAN FRANCISCO,AMERICA



**6216 中国北京万里长城（八达岭）**  
THE GREAT WALL-BEIJING,CHINA



**5218 中国北京天安门**  
TIANANMEN TOWER-BEIJING,CHINA



**6217 中国西藏布达拉宫**  
POTALA PALACE-TIBET,CHINA



**6218 芬兰罗瓦涅米圣诞老人办公室**  
SANTA CLAUS OFFICE-ROVANIEMI,FINLAND



**6225 墨西哥库库尔坎玛雅金字塔**  
EL CASTILLO-KUKULKAN,MEXICO



**6226 德国巴伐利亚新天鹅堡**  
SCHLOSS NEUSCHWANSTEIN, BAYERN, DEUTSCHLAND



**5228 美国芝加哥威利斯大厦**  
WILLIS TOWER-CHICAGO, AMERICA



**5229 土耳其伊斯坦布尔少女塔**  
MAIDEN TOWER-ISTANBUL,TURKEY



**5230 中国湖南长沙爱晚亭**  
AIWAN TING PAVILION-HUNAN,CHINA



**5231 巴西里约热内卢救世基督像**  
CRISTO REDENTOR-RIO DE JANEIRO, BRASIL



**5232 美国宾夕法尼亚州流水别墅**  
FALLINGWATER-PENNSYLVANIA, AMERICA



**5233 美国芝加哥范斯沃斯住宅**  
FARNSWORTH HOUSE-CHICAGO, AMERICA



**5234 美国华盛顿唐人街**  
CHINA TOWN-WASHINGTON, D.C., AMERICA



**3210 美国纽约自由女神像**  
STATUE OF LIBERTY-NEW YORK,AMERICA



**4223 中国北京清华园**  
TSINGHUA CAMPUS-BEIJING,CHINA



**7211 中国湖南岳阳楼**  
YUEYANG TOWER-HUNAN,CHINA



**8210 澳大利亚悉尼歌剧院**  
SYDNEY OPERA HOUSE-BENNELONG POINT,AUSTRALIA



**7212** 中国江西南昌滕王阁  
PAVILION OF PRINCE TENG-JIANGXI, CHINA



**6227** 中国河南郑州嵩山少林寺  
SHAOLIN TEMPLE-HENAN, CHINA



**7213** 中国重庆洪崖洞  
HONGYADONG-CHONGQING, CHINA



**5235** 美国华盛顿国会大厦  
UNITED STATES CAPITOL-WASHINGTON D.C., AMERICA



**5236** 中国安徽滁州醉翁亭  
ZUIWENG PAVILION-ANHUI, CHINA



**6228** 中国陕西西安钟楼  
XIAN BELL TOWER-SHAANXI, CHINA



**5238** 美国西雅图太空针塔  
SPACE NEEDLE-SEATTLE, AMERICA



**5237** 法国巴黎普瓦西萨伏伊别墅  
VILLA SAVOYE-POISSY, PARIS, FRANCE



**6229** 中国山西运城鹳雀楼  
STORK TOWER-SHANXI, CHINA



**6230** 希腊爱情海圣托里尼岛  
SANTORINI-FIRA, GREECE



**6231** 中国上海海关大楼  
SHANGHAI CUSTOMS HOUSE-SHANGHAI, CHINA



**5239** 中国北京紫禁城角楼  
TURRET OF PALACE MUSEUM-BEIJING, CHINA



**5240** 韩国首尔崇礼门  
NAMDAEMUN-SEOUL, KOREA



**5241** 中国江苏南京夫子庙  
CONFUCIUS TEMPLE-JIANGSU, CHINA



**5242** 美国纽约古根海姆博物馆  
GUGGENHEIM MUSEUM-NEW YORK, AMERICA



**6232** 中国江苏南京秦淮河画舫  
QINHUAI RIVER PAINTED BOAT-JIANGSU, CHINA



**6233** 法国诺曼底圣米歇尔山  
SAINT MICHAEL'S MOUNT-NORMANDY, FRANCE



**6234** 中国河南洛阳栾川老君山  
THE LAOJUN MOUNTAIN-HENAN, CHINA



**5243** 耶路撒冷岩石圆顶  
DOME OF THE ROCK-JERUSALEM



**6235** 中国江苏省苏州寒山寺（普明宝塔）  
HANSHAN TEMPLE-JIANGSU, CHINA