

LEIFENG PAGODA

中国浙江杭州雷峰塔
Zhejiang, China

The world's great architecture



Creative Ability

Family Interaction

Observation Ability

Thinking Ability

Practical Ability



6+
Suitable Age

6236
Product Number

1498 PCS
Parts Total



Architecture

It will be a city...

这将构成一座城市...

ABOUT THE PRODUCT

关于产品

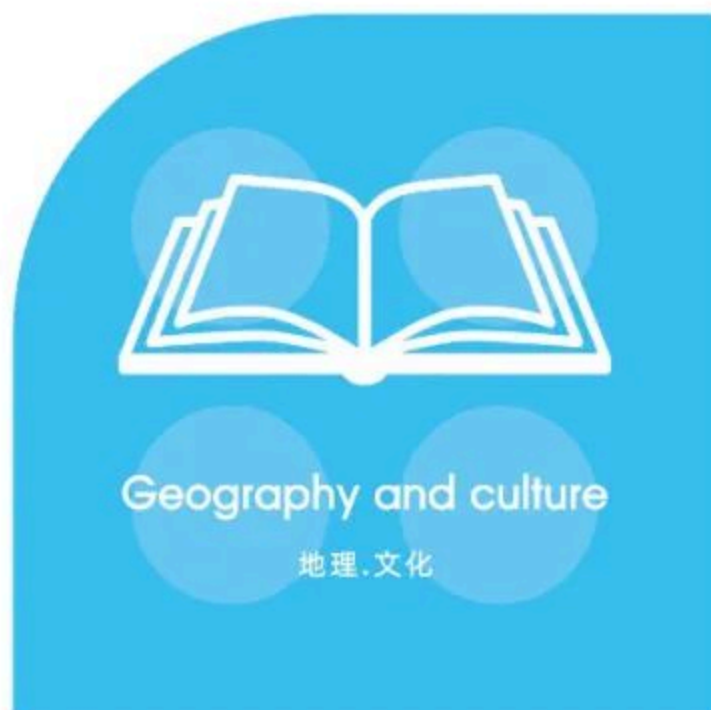

ARCHITECTURE

WANGE The world's great architect since 1991

Hangzhou Leifeng Pagoda



Leifeng Pagoda, originally named Huangfei Pagoda, is located in Xihu District, Hangzhou City, Zhejiang Province, on the Xizhao Mountain on the south bank of the West Lake Scenic area.

Hangzhou Leifeng Pagoda



Geography and culture

地理·文化



Leifeng Pagoda, initially known as Huangfei Pagoda, also known as Xiguan Brick Pagoda, commonly known as 'Huangfei Pagoda', was rebuilt in 2002.



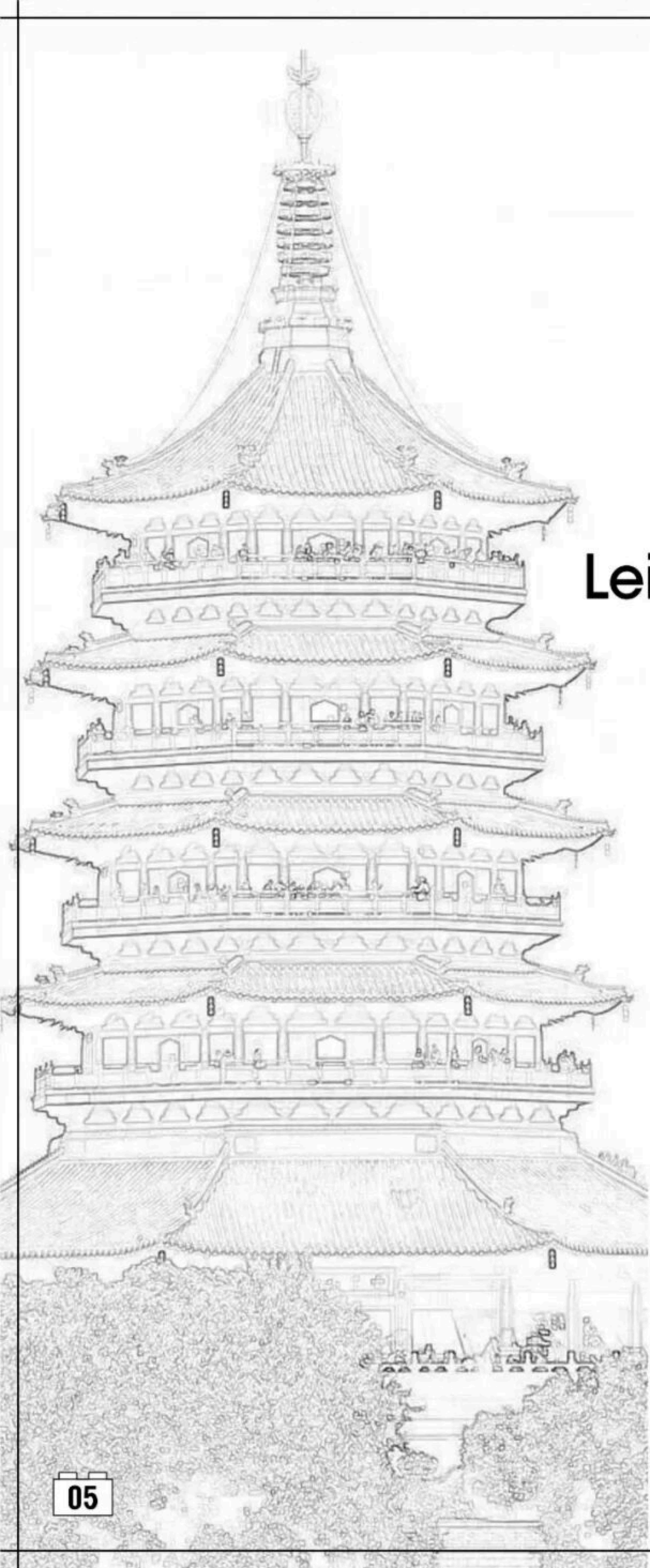

中国浙江杭州雷峰塔

Hangzhou ■ Leifeng Pagoda

China

The contents of this chapter refer to the Wikipedia website.

本章内容参考维基百科网站，
更多资讯可自行查阅。

The world's great architecture

Buildings and layout

■ 建筑物和布局



杭州雷峰塔

雷峰塔原名皇妃塔，文献及民间亦名黄妃塔、王妃塔、黄皮塔，原为五代吴越王钱俶所建供养舍利的佛塔，位于今中国浙江省杭州市西湖区西湖南岸净慈寺前雷峰之上，与北岸宝石山上的保俶塔南北对峙、遥相呼应。原塔于1924年坍塌，仅存遗址，2002年在原址重建新塔。夕阳西下时余晖映照雷峰塔形成著名的雷峰夕照景观，为西湖十景之一。雷峰塔也因在传说《白蛇传》中作为法海镇压白娘子之处而知名于世。

Leifeng Pagoda is a five story tall tower with eight sides, located on Sunset Hill south of the West Lake in Hangzhou, Zhejiang, China. Originally constructed in the year AD 975, it collapsed in 1924 but was rebuilt in 2002. Since then, it has become a popular tourist attraction. As a protected cultural heritage unit, the Ten Views of West Lake - Leifeng Sunset consists of the Sunset Hill, Leifeng Pagoda, the Imperial Monument (rebuilt in recent years) and the courtyard and other buildings.



Structure

重建的雷峰塔新塔位于遗址之上，主要建筑构件如柱、斗拱瓦等用铜制作。新塔由保护罩、塔身和塔刹三部分组成，总高71.679米，其中为保护古塔遗址而建的保护罩高9.7米，分上下两层，采用24根倾斜钢柱与水平钢梁组成钢网架结构，形成大跨度的无柱空间，在覆盖遗址的同时承托上部塔身，塔身高约45米分五层，内设两部液压电梯和钢制楼梯，塔刹高16.1米。

The newly reconstructed Lei Feng Pagoda is located on the original site. The new pagoda consists of three parts: a protective cover, the pagoda body, and the spire. It stands at a height of 71.679 meters, with the protective cover standing 9.7 meters high and consisting of two layers of inclined steel pillars and horizontal steel beams, forming a column-free space with a span of 48 meters that covers the original site and supports the upper pagoda body. The pagoda body is approximately 45 meters high and consists of five stories, with two hydraulic elevators and steel stairs inside. The spire is 16.1 meters high.



History

雷峰塔由五代吴越王钱俶主持修建，约北宋开宝五年（972）兴建，太平兴国二年（977）完工，塔内奉藏释迦牟尼佛“佛螺髻发”舍利，建造时称西关砖塔，建成后名皇妃塔，以纪念孙妃并感恩宋廷的封妃、谥妃之举，文献及民间又称黄妃塔、王妃塔、黄皮塔。雷峰塔原为砖木结构的楼阁式塔，外有木构檐廊，内为砖砌塔身，可登临，塔壁上嵌有《华严经》石刻。根据民国时所拍摄的照片推断，原塔底层高约12米，其它各层高约8米，总高约50米，塔顶尚有圆柱形砖砌塔刹基座。

Leifeng Pagoda was built by Qian Chu, King of Wuyue, to worship the Buddha Luoji hair relics and pray for national prosperity and people's safety. It was built in 977 in the second year of Taiping and Xing Guo of the Northern Song Dynasty and has been continuously repaired. The existing building was designed based on the original Leifeng Pagoda and rebuilt in 2002. It is one of the "ten views of the West Lake", one of the nine famous towers in China, and the first colorful bronze carved pagoda in China. "Lei Feng Sunset" is one of the ten sights of the West Lake. Among them, Chen Qingbo painted Leifeng Pagoda landscape painting, titled "Leifeng sunset", and passed "Leifeng sunset". Whenever the setting sun shines in the west, the tower shadow is in the sky, and the pavilion is golden, this landscape is in line with the title, and it has become one of the ten scenic spots of the West Lake known for thousands of years "Leifeng Sunset".

Force Balance

受力平衡

Physical operations

物理运算

$$F = G \frac{m_1 m_2}{d^2}$$

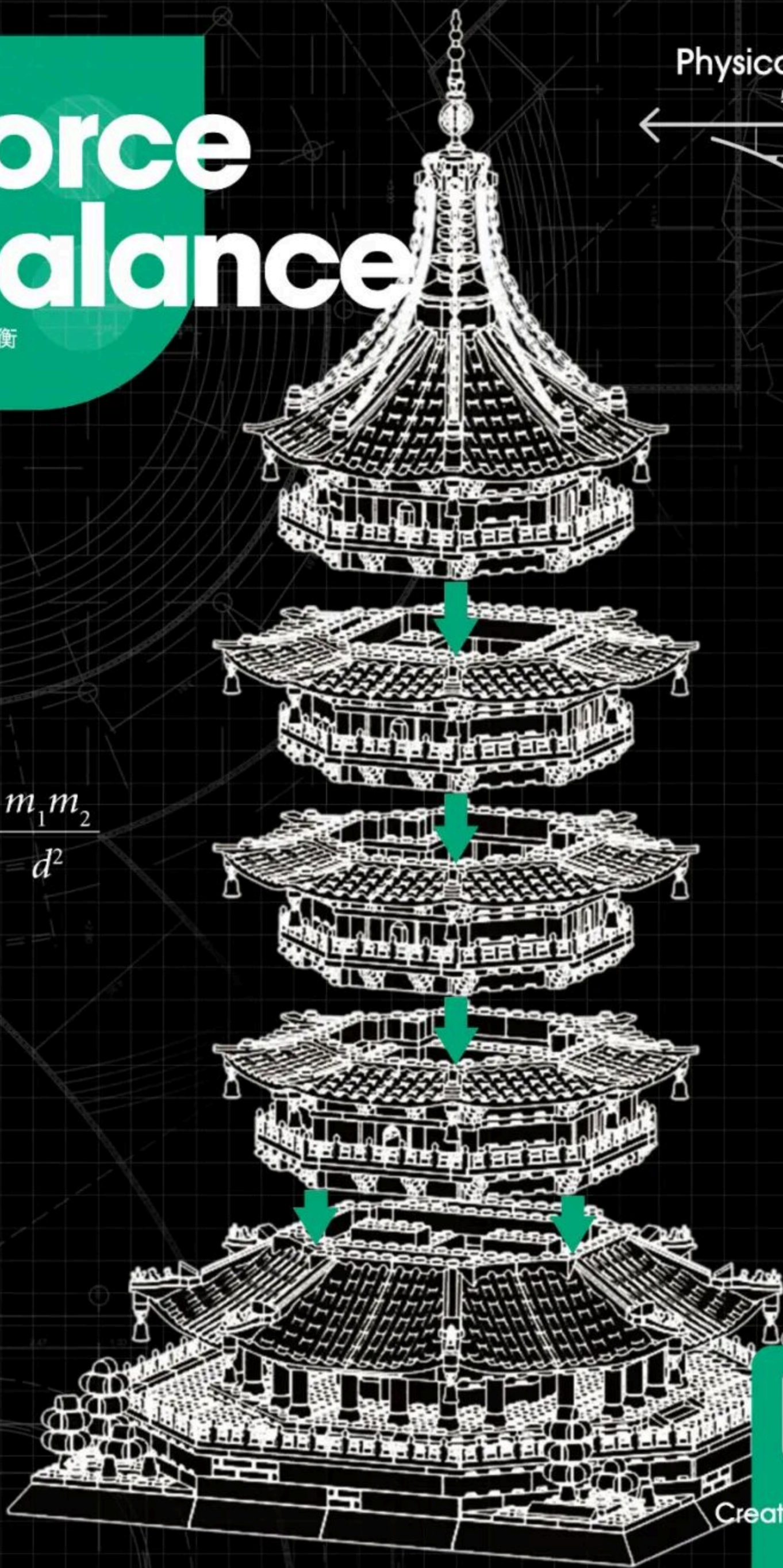

Creation and thinking

创作·思考

08

Special parts

特殊零件的开发利用

WG1700

1孔望柱右栏杆



$$S=4\pi \cdot r^2$$

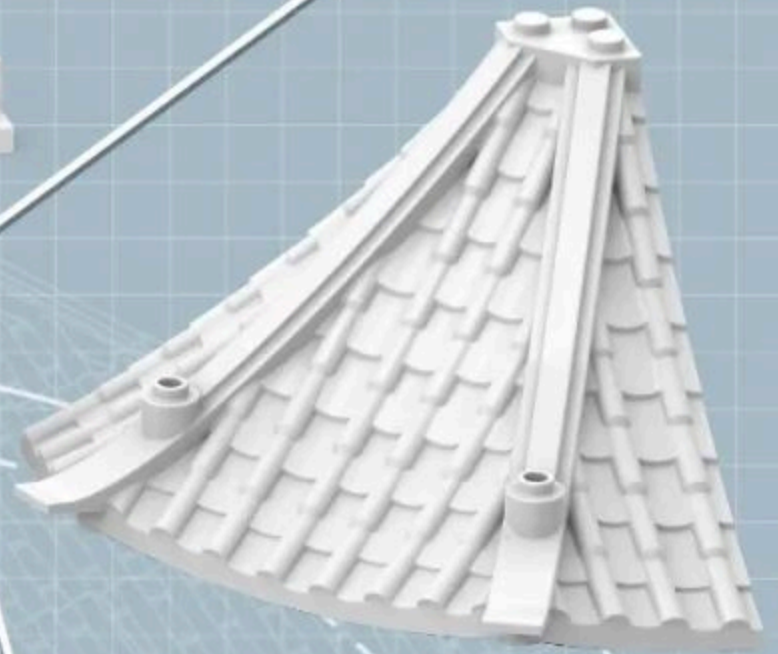

WG1698B

仰月圆光塔饰B



WG1698A

仰月圆光塔饰A



$$a^2+b^2=c^2$$

WG1709

八角尖顶瓦片

WG1706

2孔望柱栏杆



WG1704

4孔望柱栏杆



WG1705

斜4孔望柱栏杆

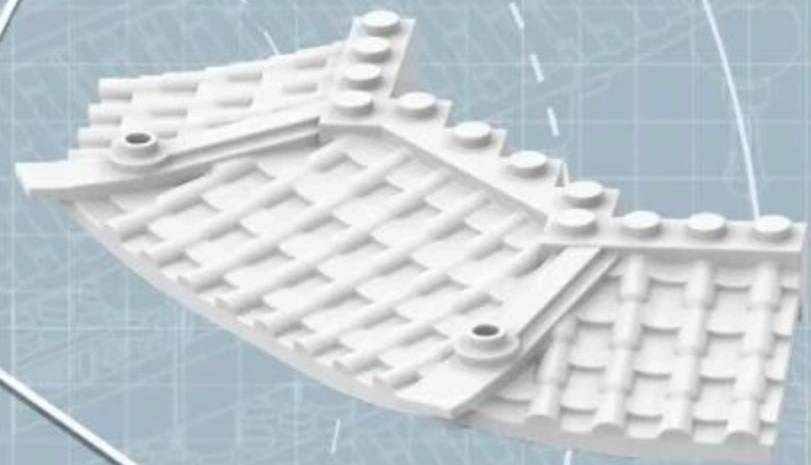

WG1708

八角中瓦片

WG1695

高斜角1孔



WG1696

矮五边斜角21孔

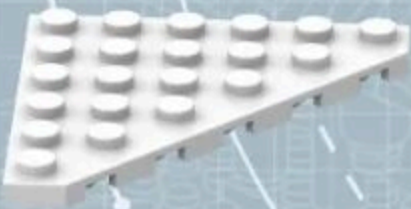

WG1697

带孔铃铛



WG1707B

八角大瓦片B

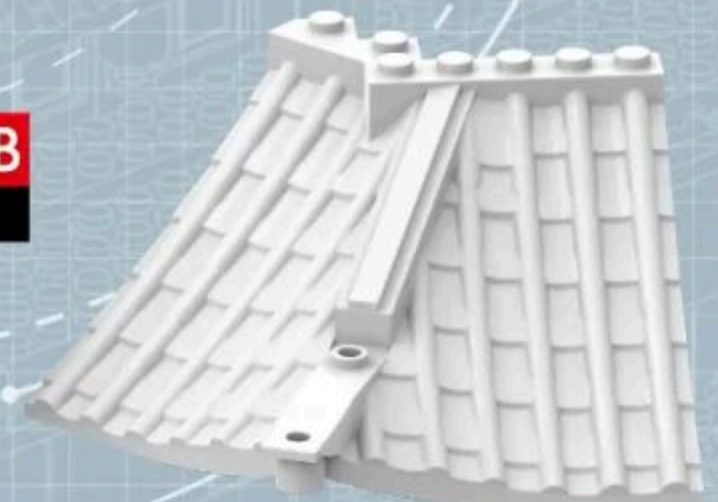

WG1699

1孔望柱左栏杆



WG1707A

八角大瓦片A

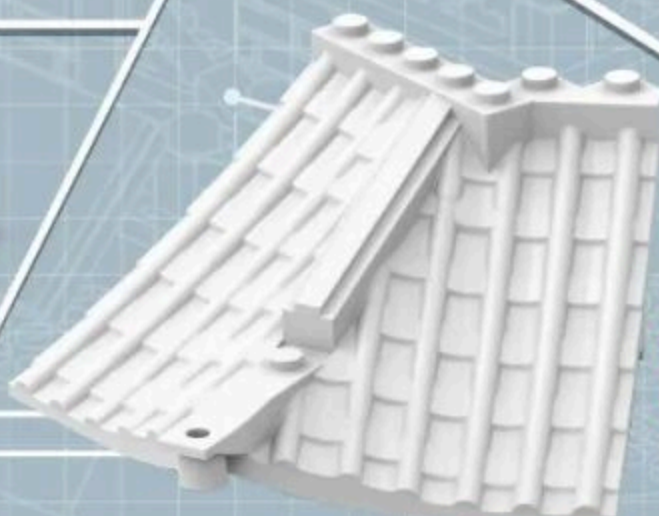

features and functions

特点.功能

Main Color Matching

配色方案



Pantone Black 6C



Pantone 478C



Pantone 7550C



Pantone 2310C



Pantone 7427C



Pantone 3435C



Pantone 2422C



Pantone 573C



Pantone 123C



Pantone 7500C



Pantone 509C



Pantone Cool Gray 6C



Color matching

Adopting 3 main colors, Adopting three main colors of black, gray and red, it is more reasonable on the original building. Together with the yellow color matching, it makes the product more fashionable. The color matching is atmospheric and the overall design is more reasonable.

Hangzhou Leifeng Pagoda

中国浙江杭州雷峰塔



Front

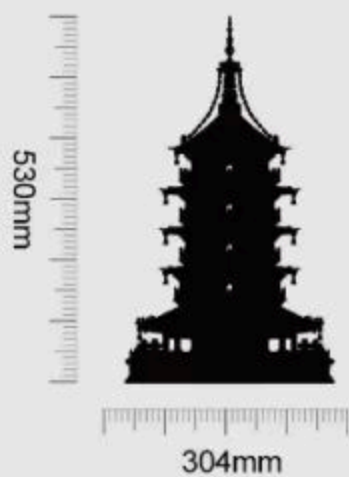

Left



Back



Product Size:304X304X530mm





■ First open the product packaging according to the instructions.

按指导用正确方式拆解产品外包装。



■ Summarize all parts to count the number of familiar accessories.

对照说明书清单确认积木包数量与积木数量。



■ Arranging all accessories by color helps to quickly install the product.

把确认好的积木以类型、颜色进行分类排好以便安装。



■ Carefully install the product and learn about building.

按说明书步骤拼装并完成你的积木模型。



1:1 Physical Reference Table

十字棒配件1:1尺寸参照表



Instructions For Use

让安装更简单

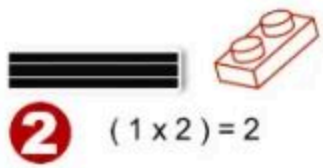

2 (1x2)=2

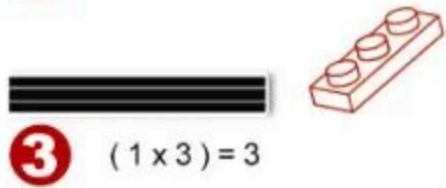

3 (1x3)=3

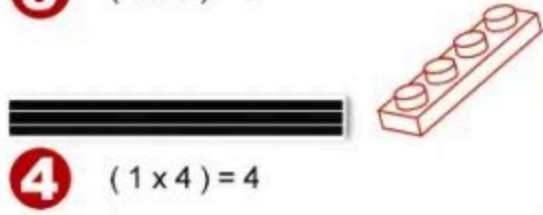

4 (1x4)=4



5 (1x5)=5



6 (1x6)=6

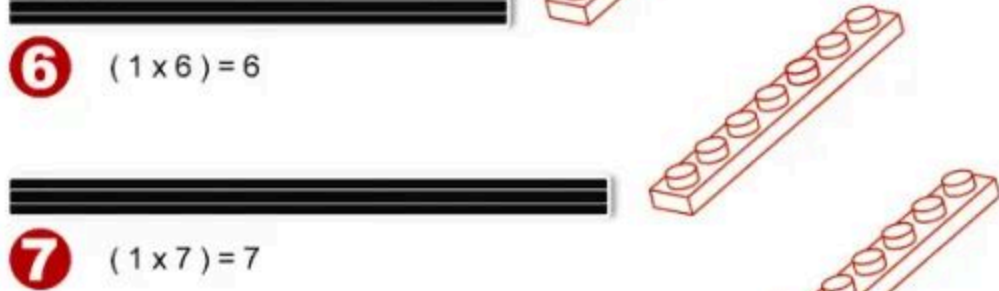

7 (1x7)=7



8 (1x8)=8



9 (1x9)=9



10 (1x10)=10



12 (1x12)=12



16 (1x16)=16



PARTS LIST

配件清单



x8

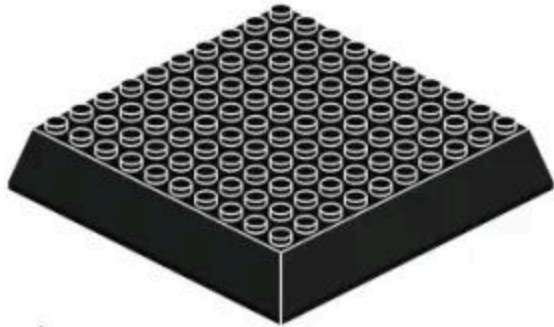

x4

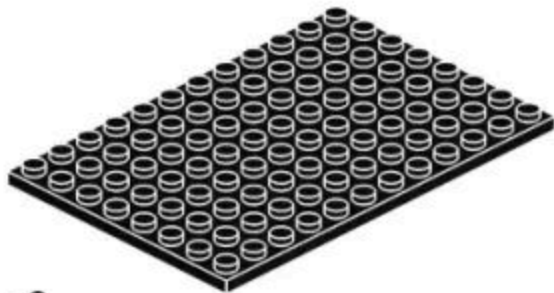

x2

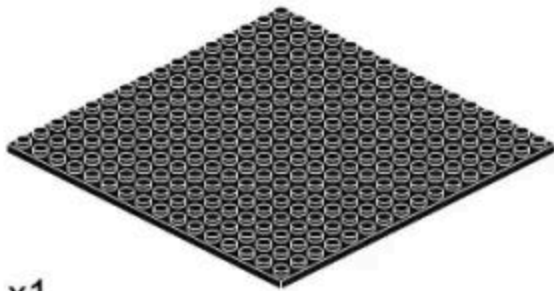

x1

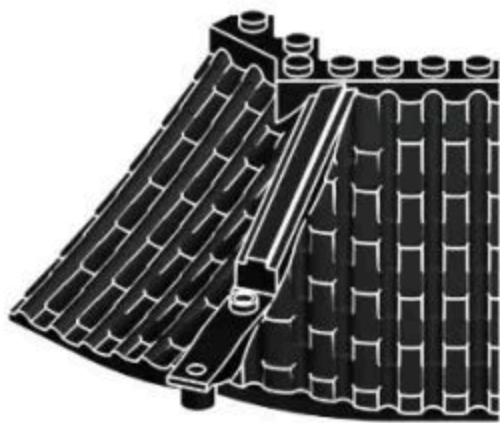

x4

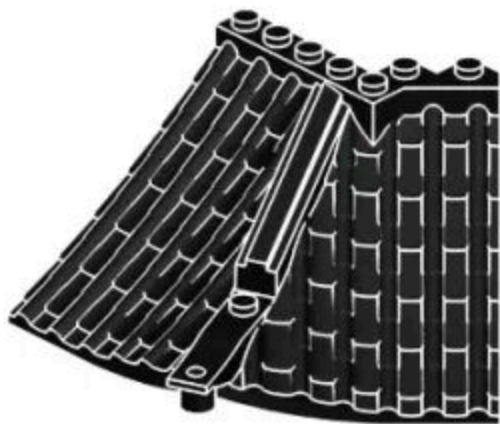

x4



x12

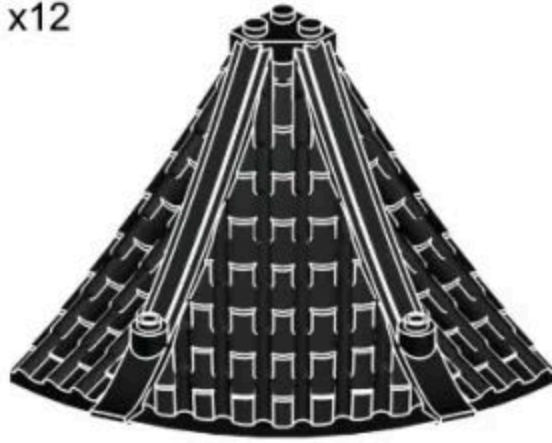

x4



x4



x2



x10



x6



x2

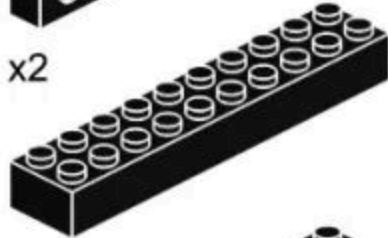

x6

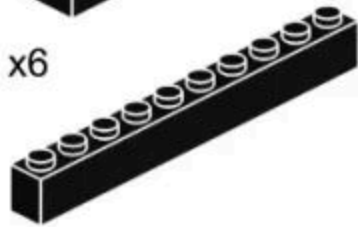

x4



x8



x4

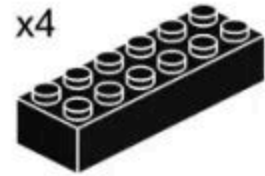

x1

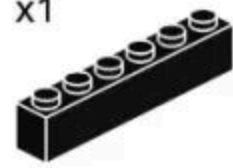

x12



x4



x1



x2



x1



x12



x8



x1



x4



x8



x3



x4



x40



x16



x8



x8



x4



x8



x13



x62



x8

产品有增补件请以实物为准

If product has additional parts, please in kind prevail.

PARTS LIST

配件清单



x8



x1



x1



x1



x1



x7



x1



x8



x4



x2



x4



x9



x40



x40



x1



x1



x4



x4



x4



x4



x4



x20



x12



x52



x11

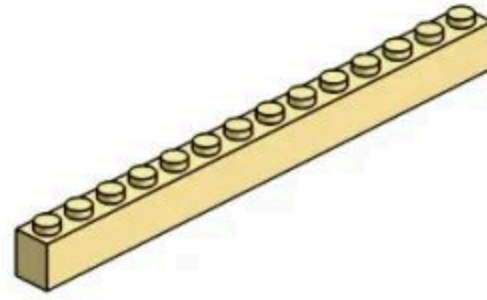

x1

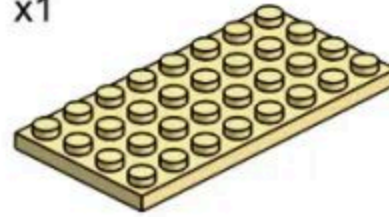

x4

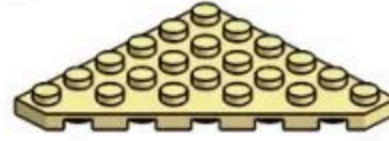

x16

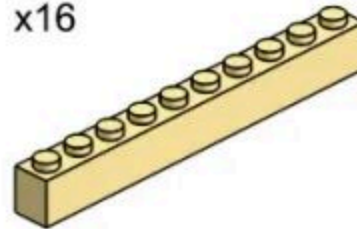

x4

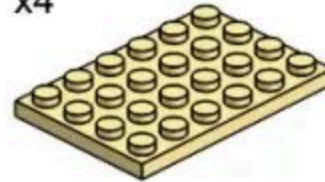

x4

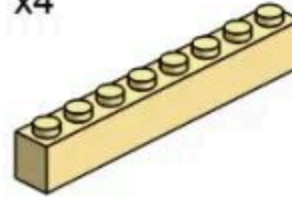

x3

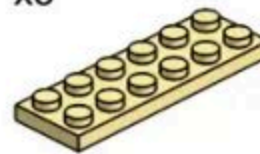

x8

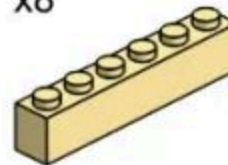

x3



x4

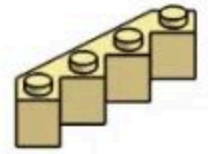

x16



x16



x4

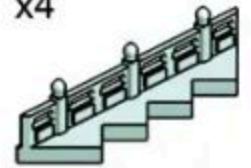

x24

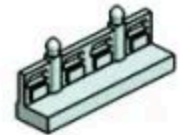

x36



x12



x16



x16



x1



x1



x10



x4

产品有增补件请以实物为准

If product has additional parts, please in kind prevail.

PARTS LIST

配件清单



x1

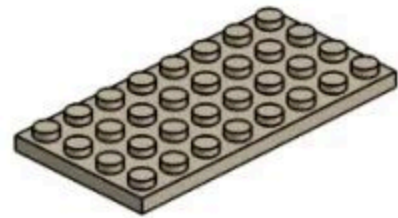

x4

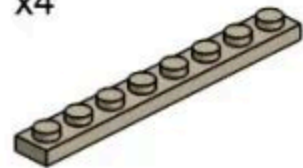

x12



x8



x12



x4



x4



x8

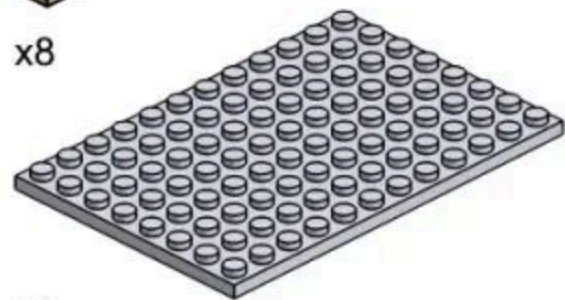

x4

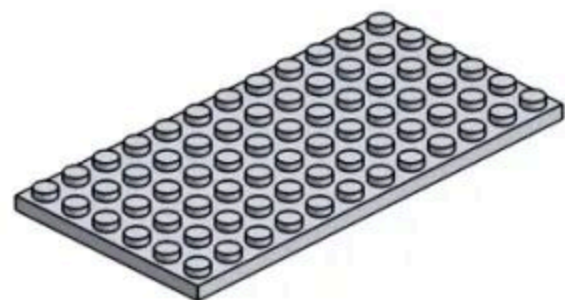

x4

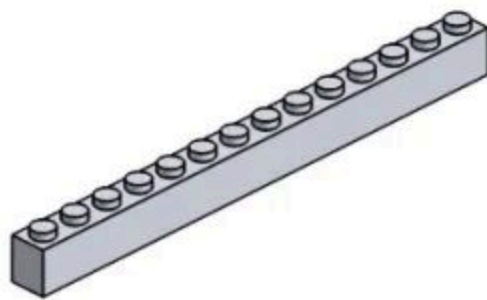

x2

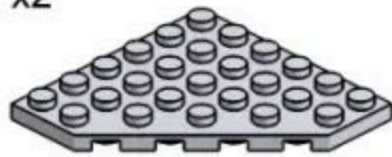

x8

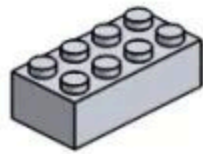

x4

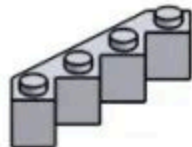

x64

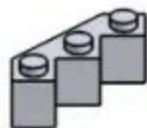

x12



x8



x12



x4



x16



x32



x24



x44



x24



x4



x4



x16

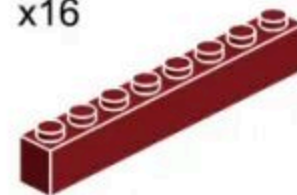

x12



x4



x28



x4



x8



x4



x8



x4



x8



x152



x4



x3



x88



x64



x4



x4

产品有增补件请以实物为准

If product has additional parts, please in kind prevail.



284PCS

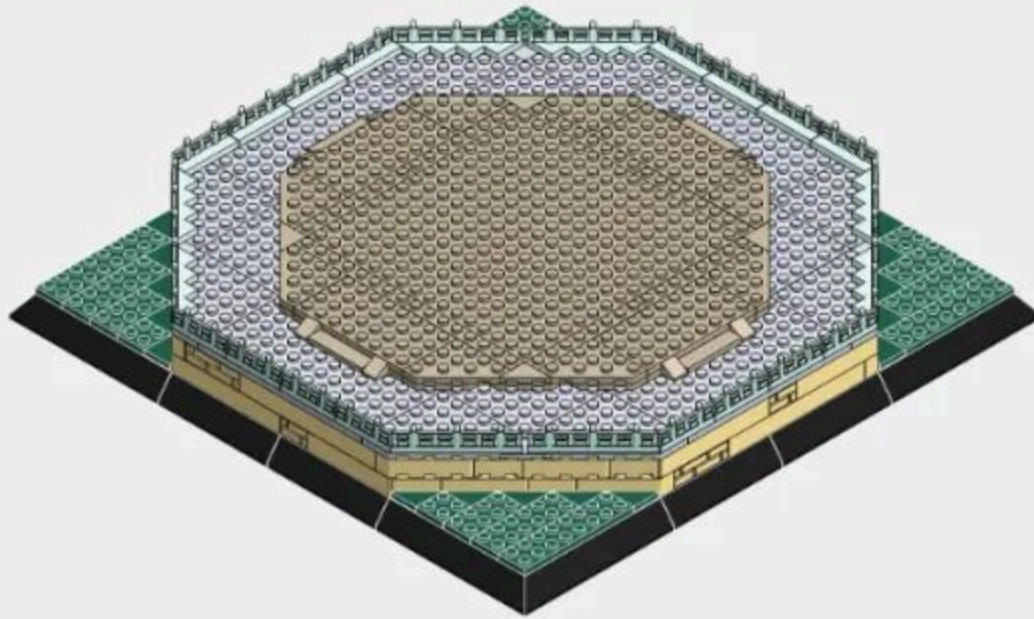

1-1



微信扫一扫
补件更简单

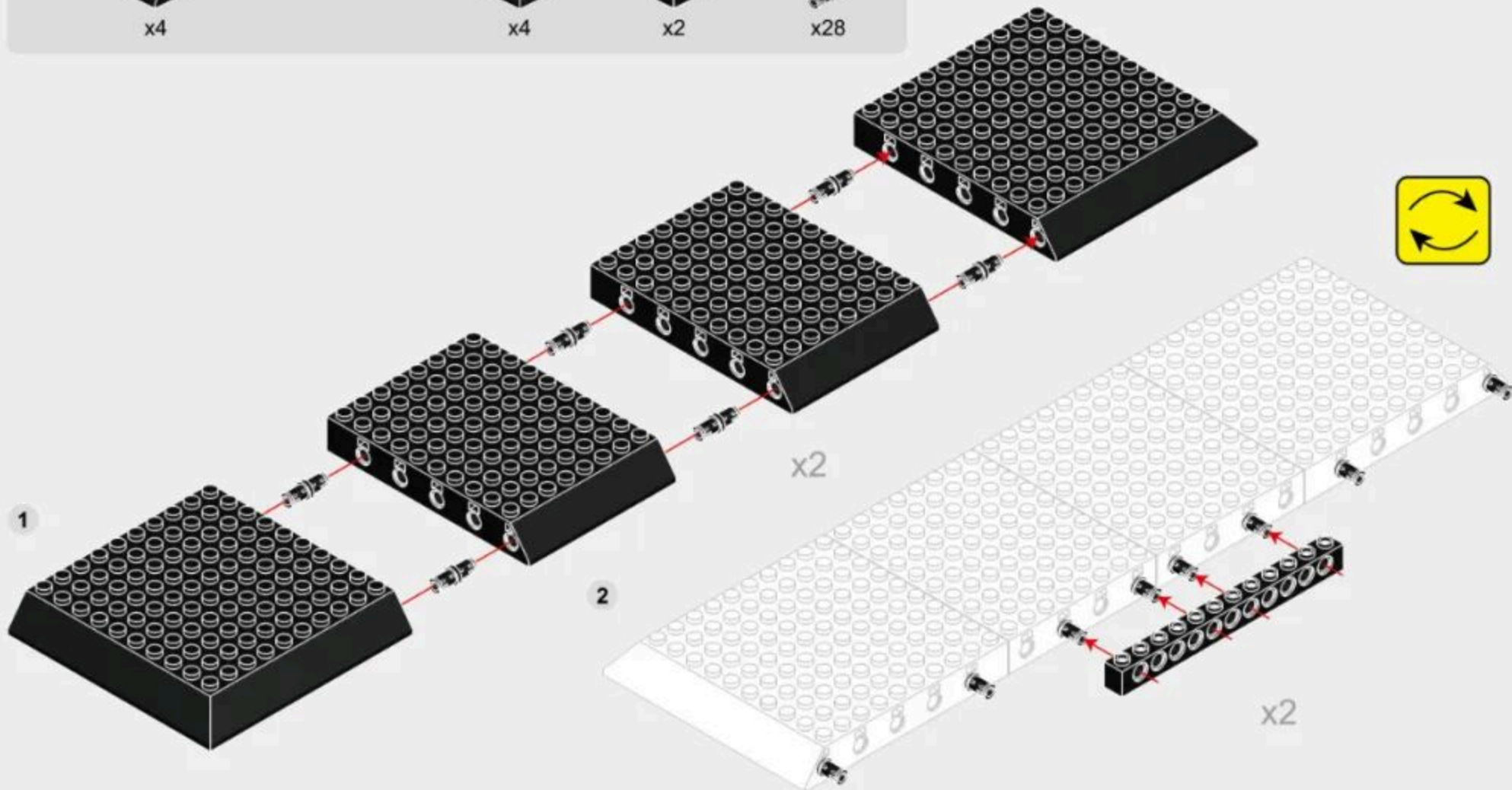
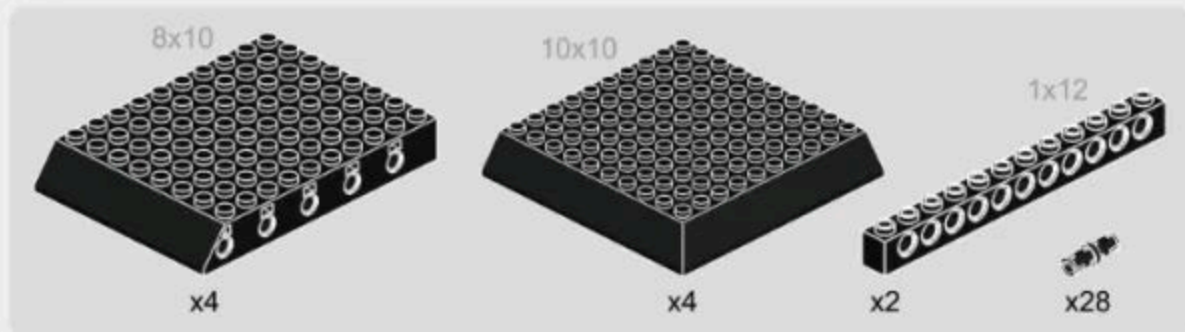

1-2

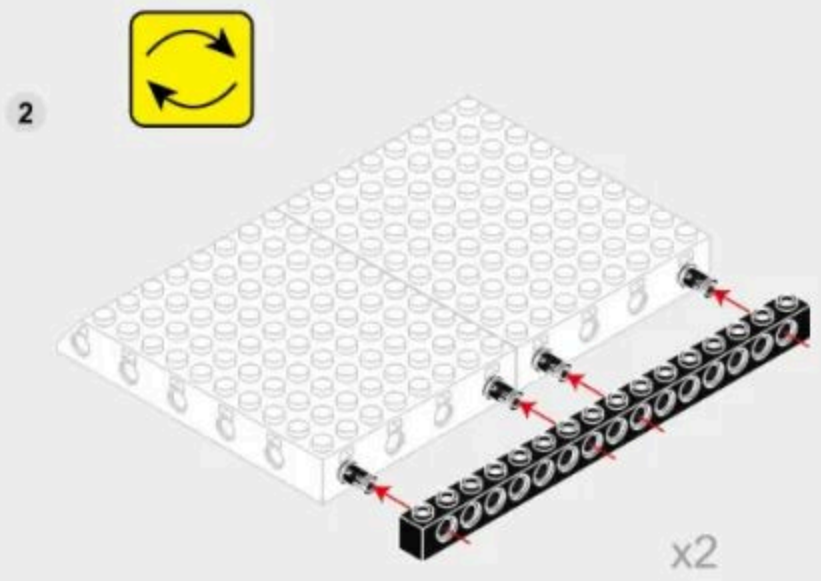
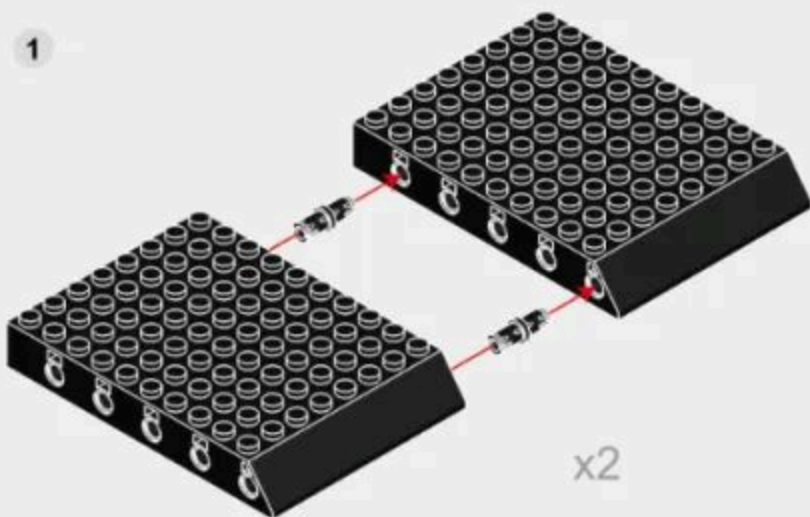
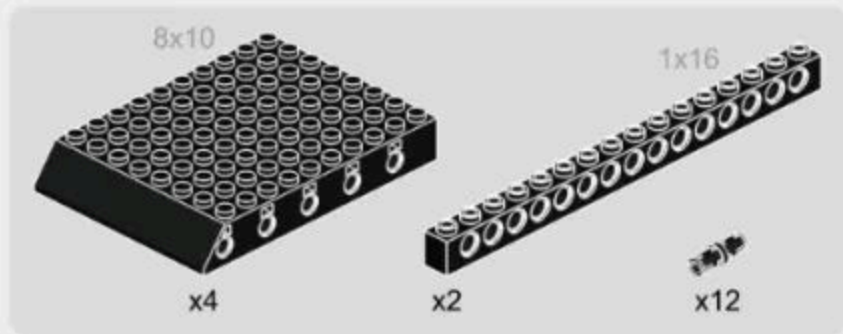

1-3

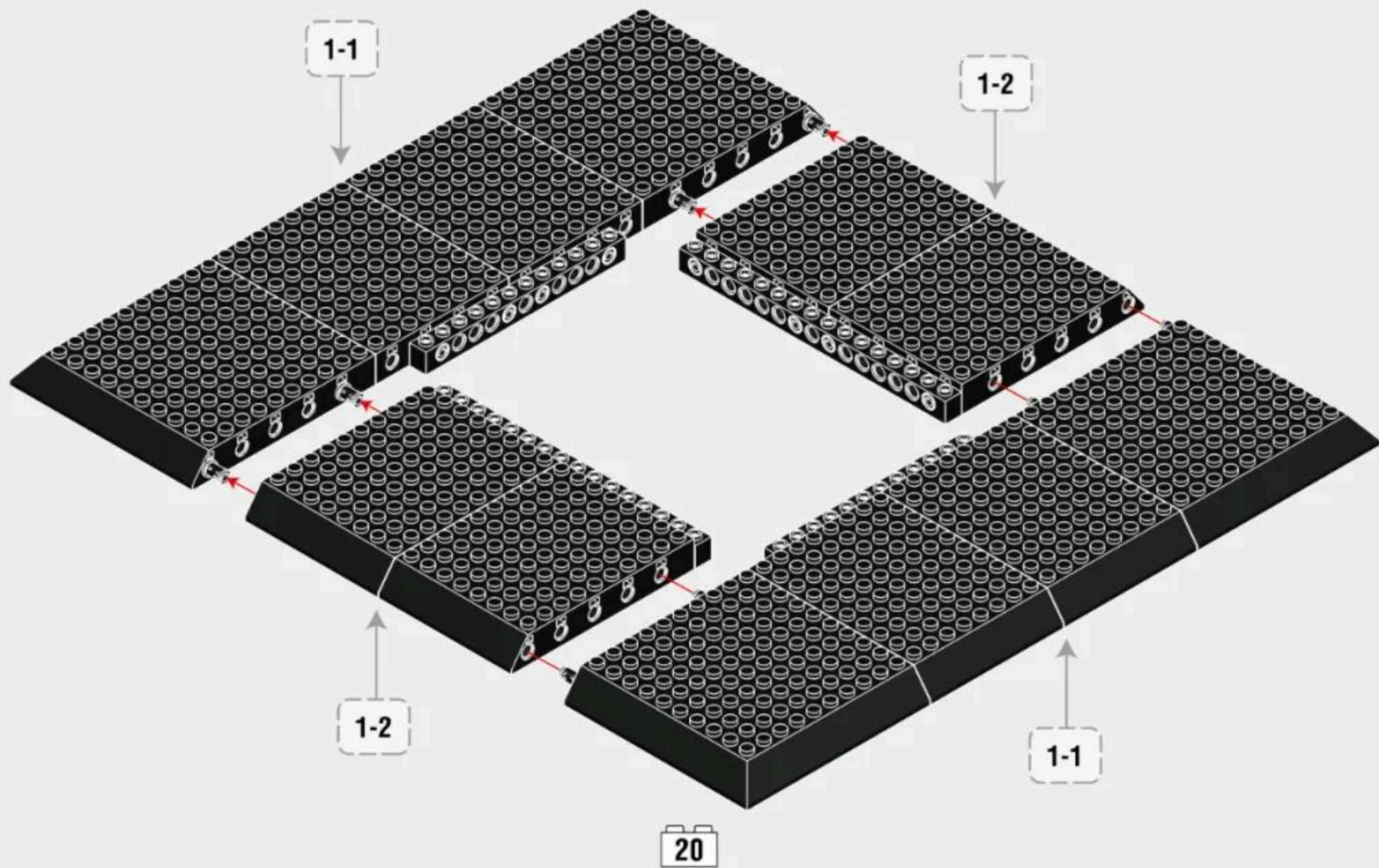

1-4

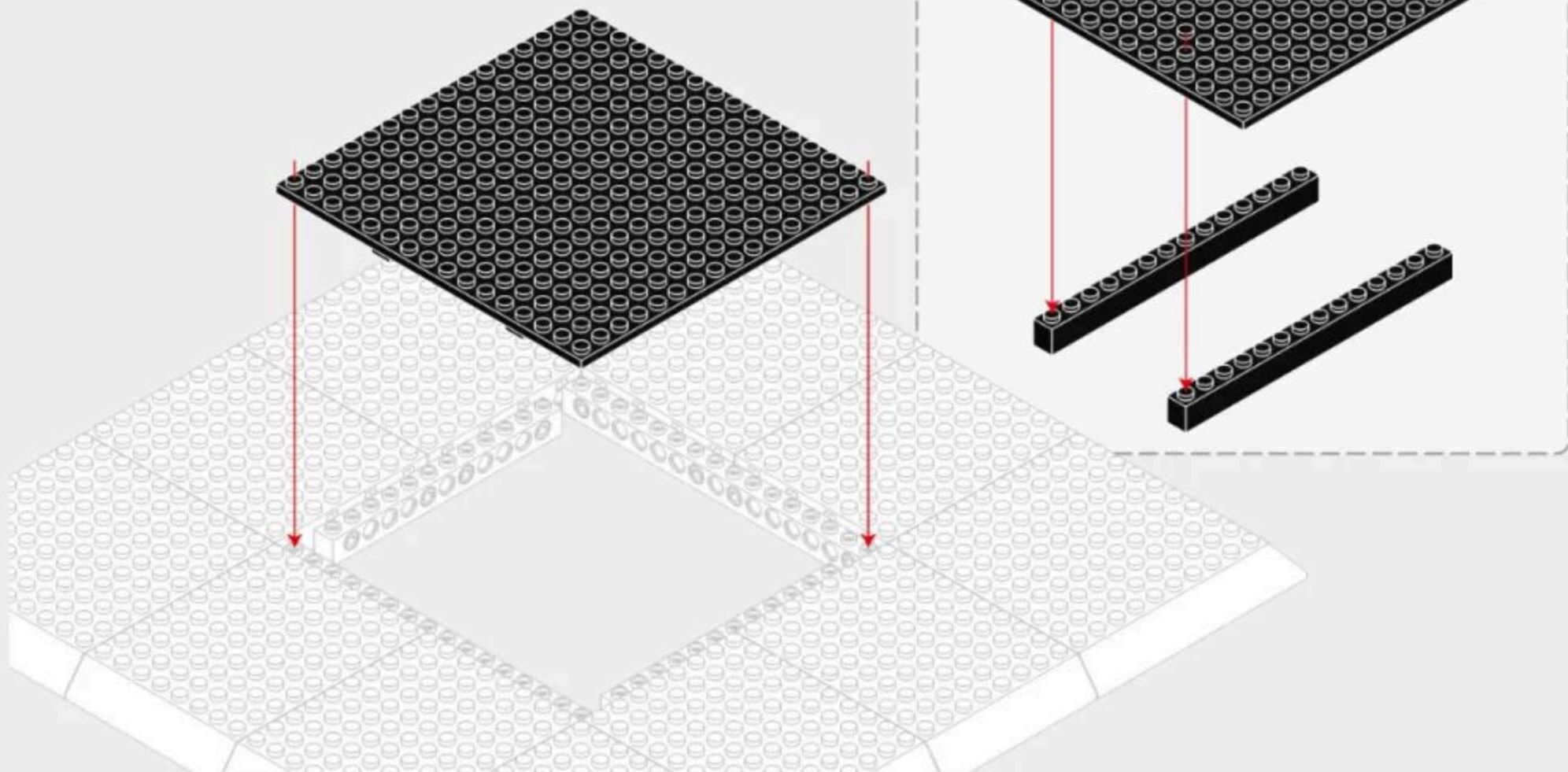
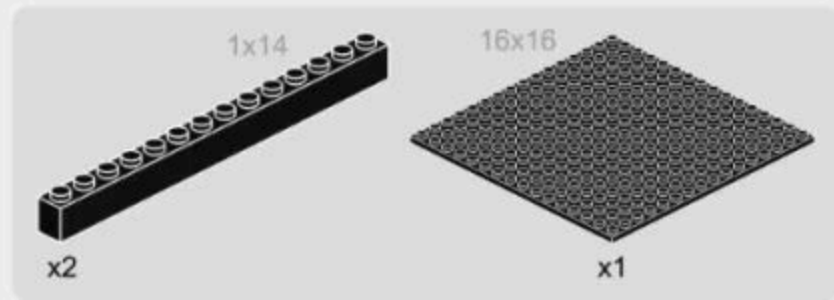

1-5

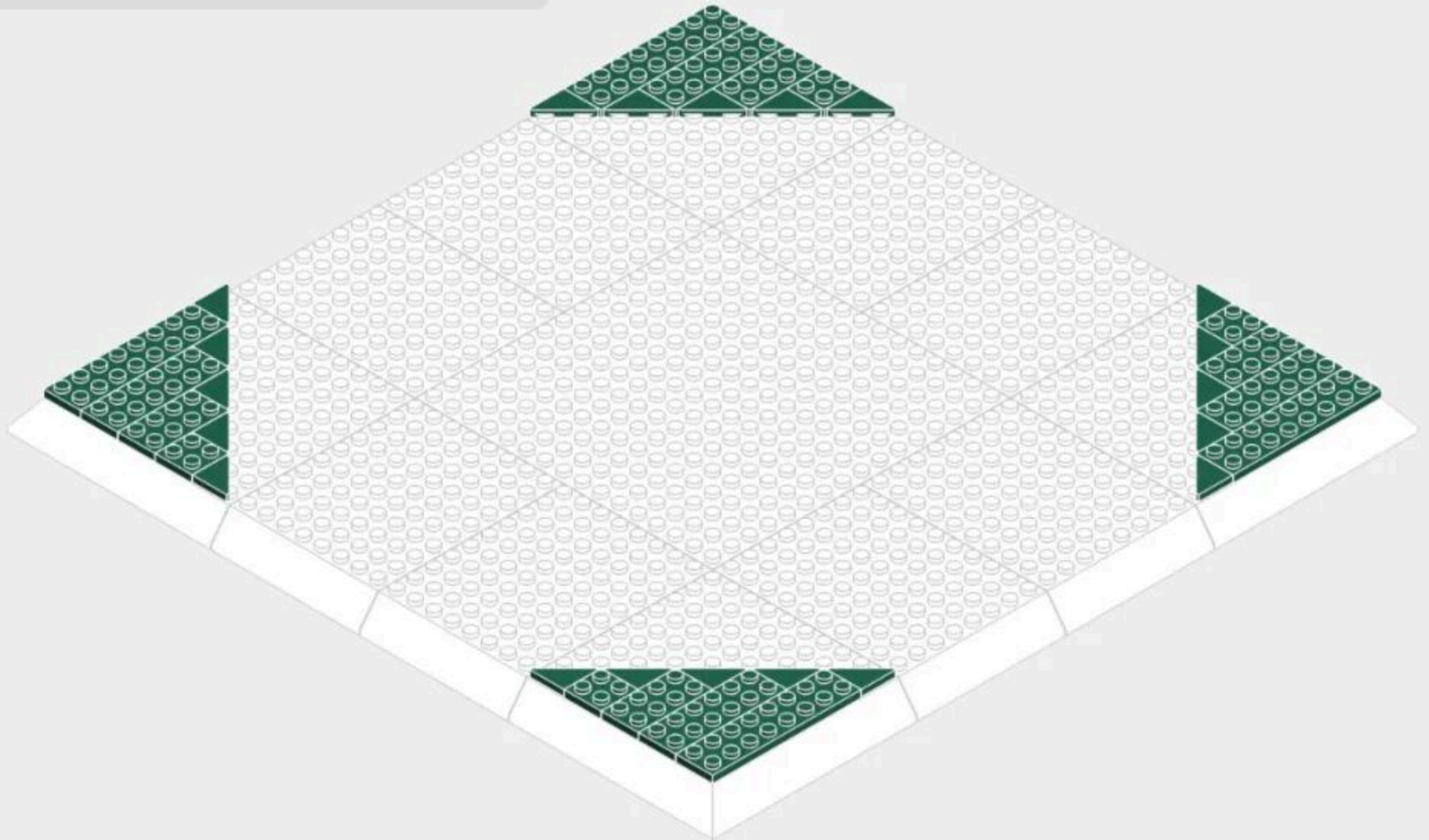
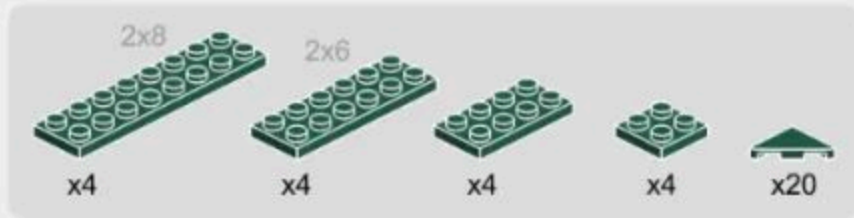

1-6

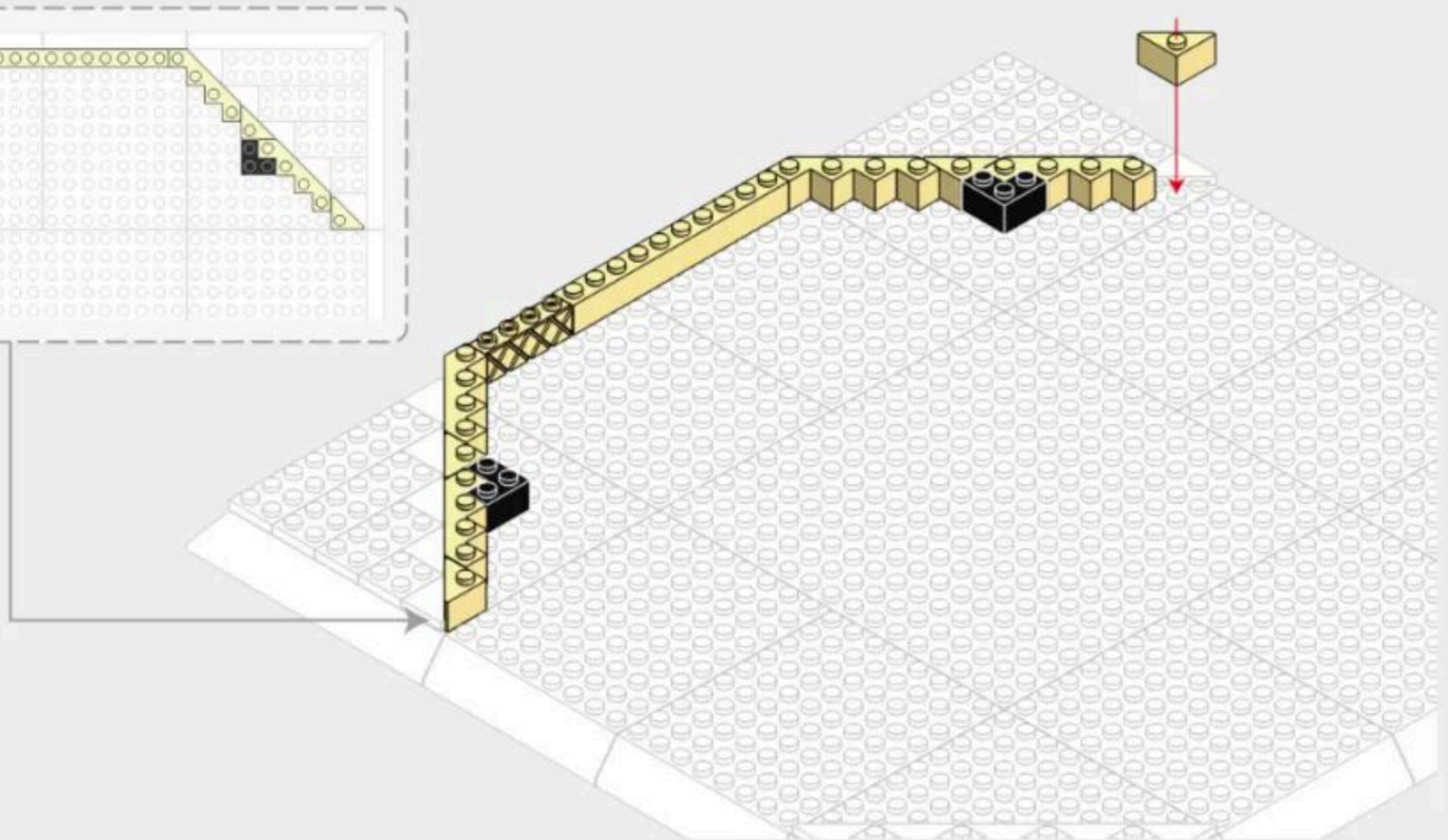
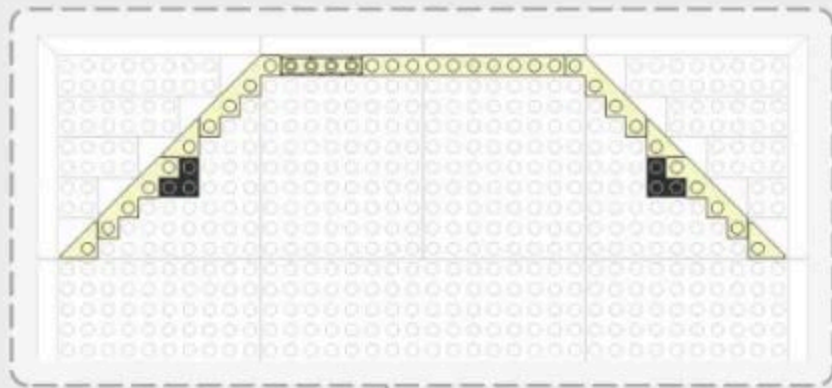
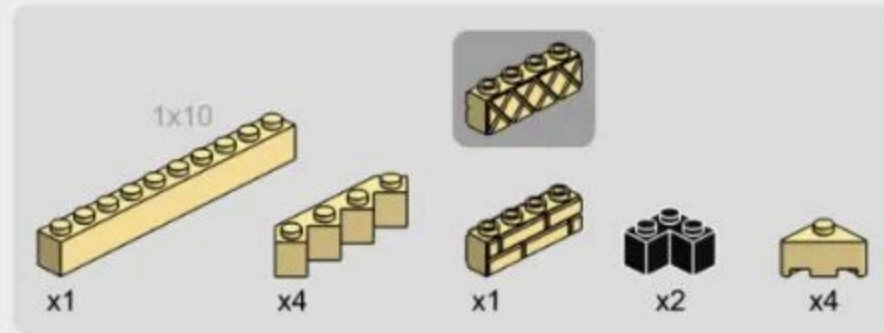

1-7

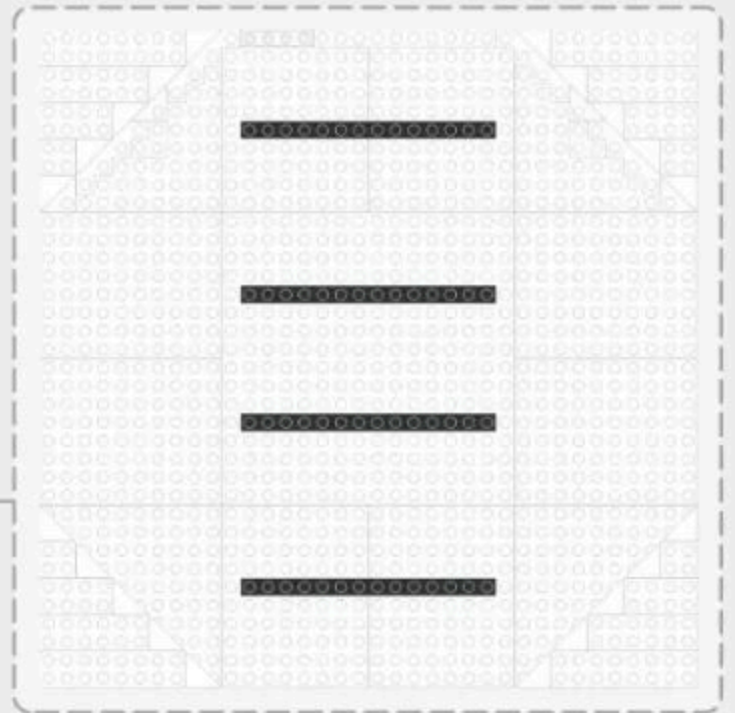
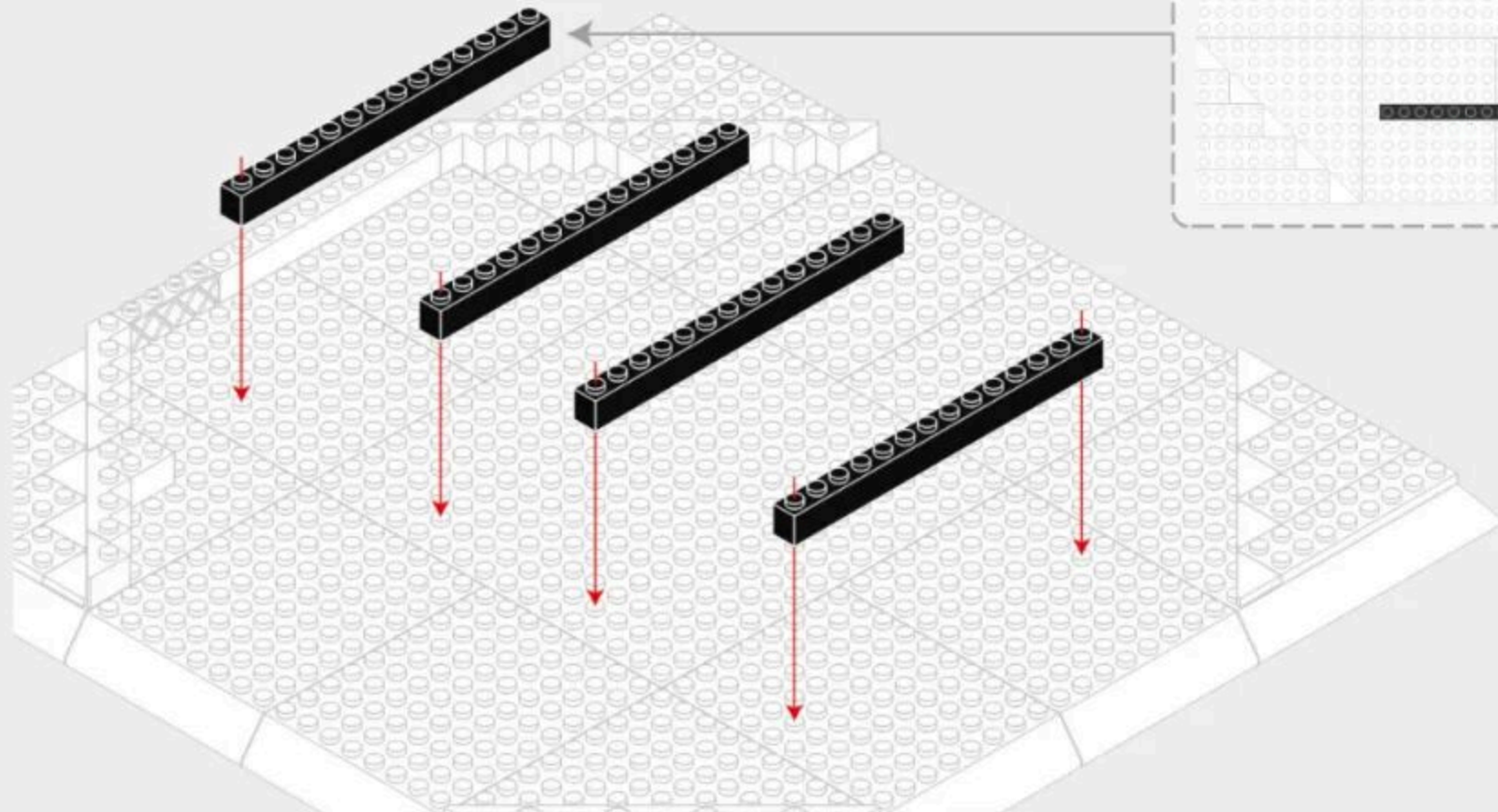
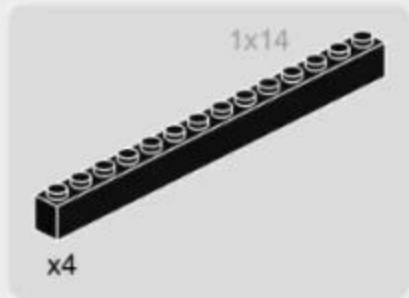

1-8

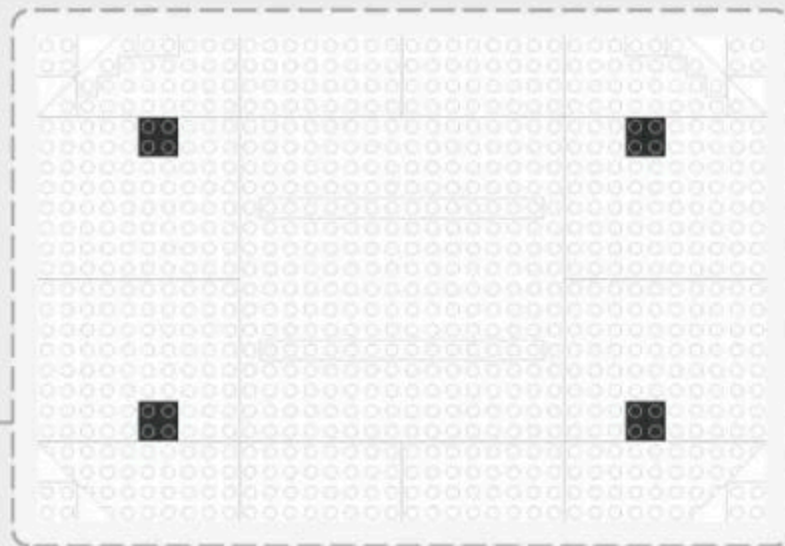
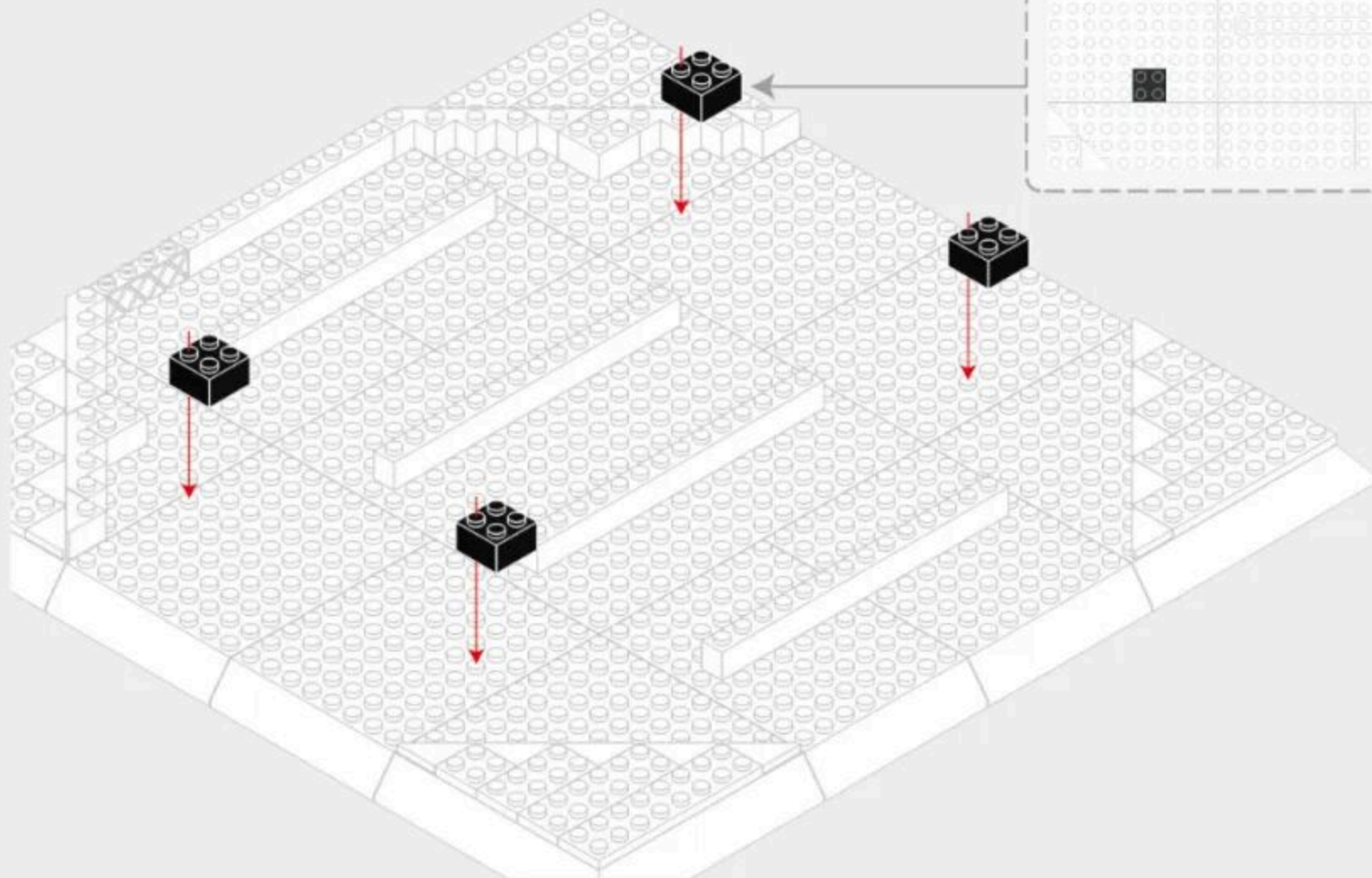

1-9

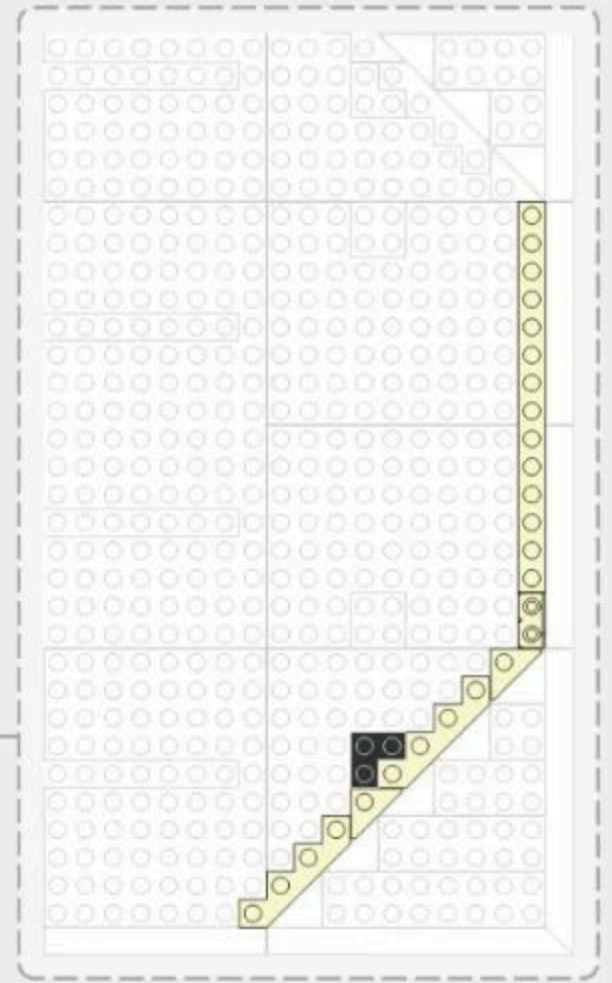
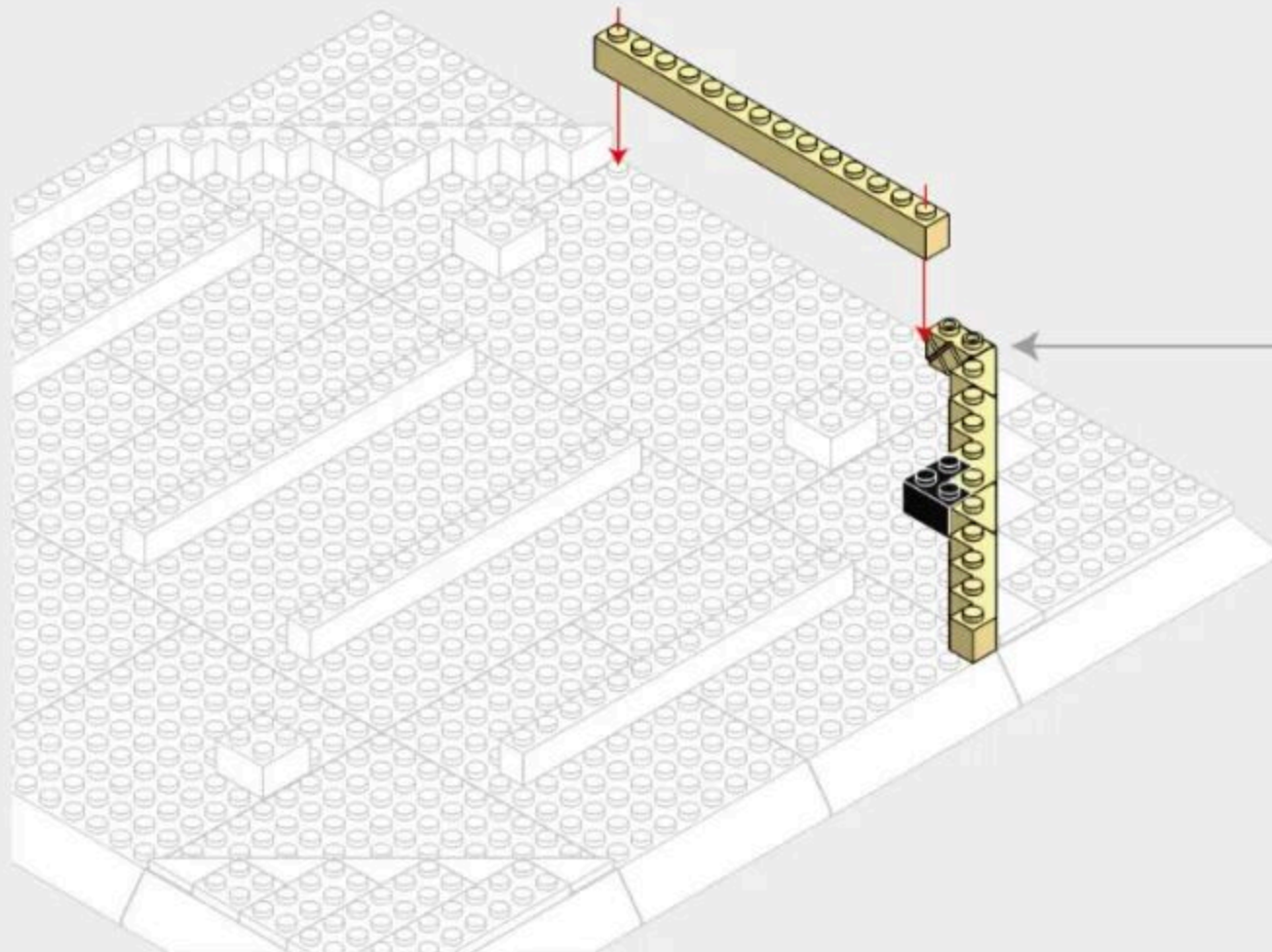
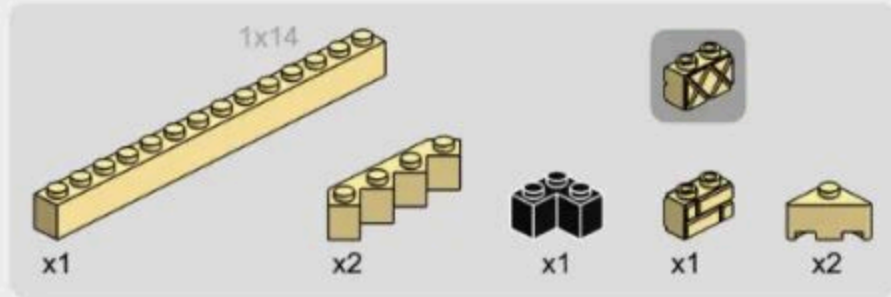

1-10

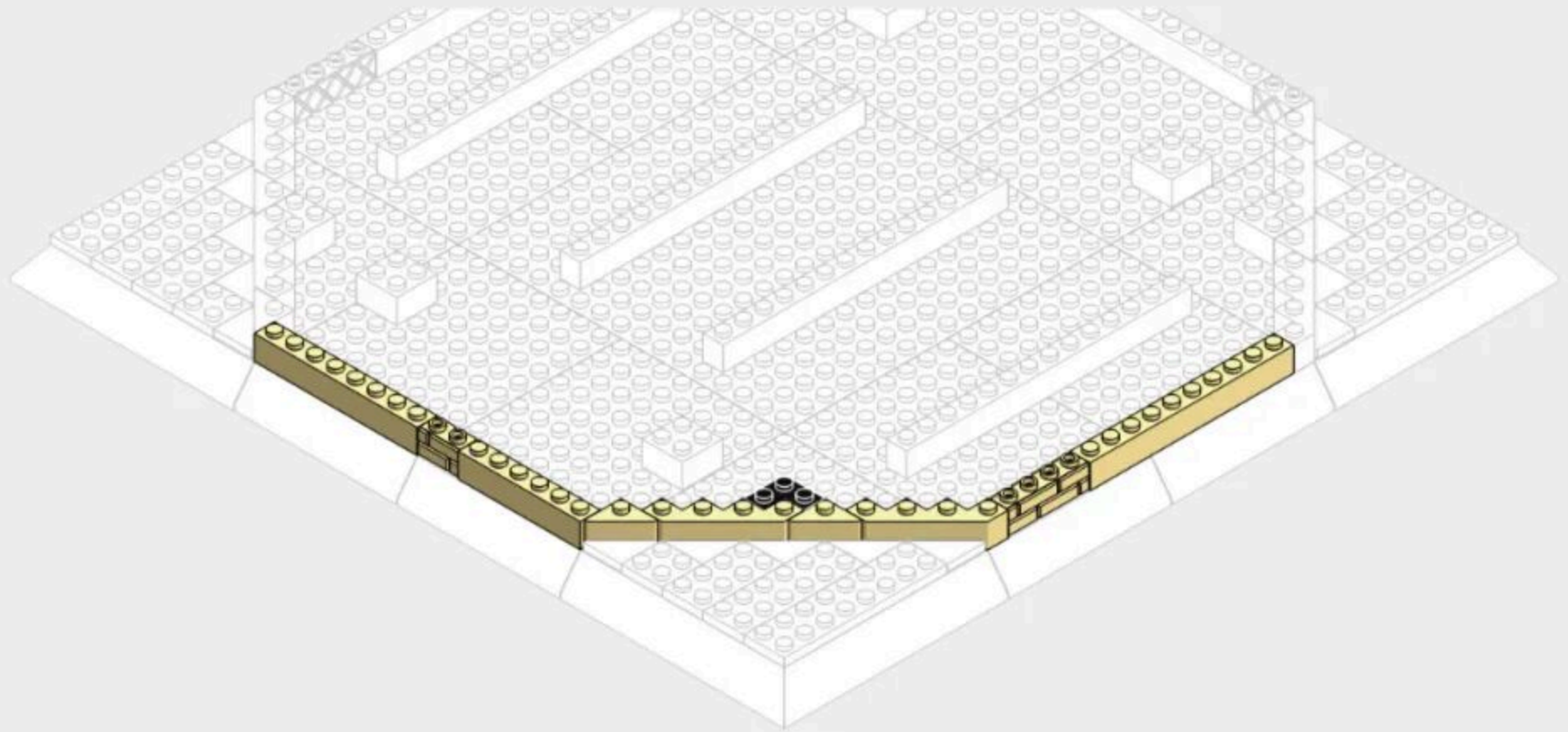
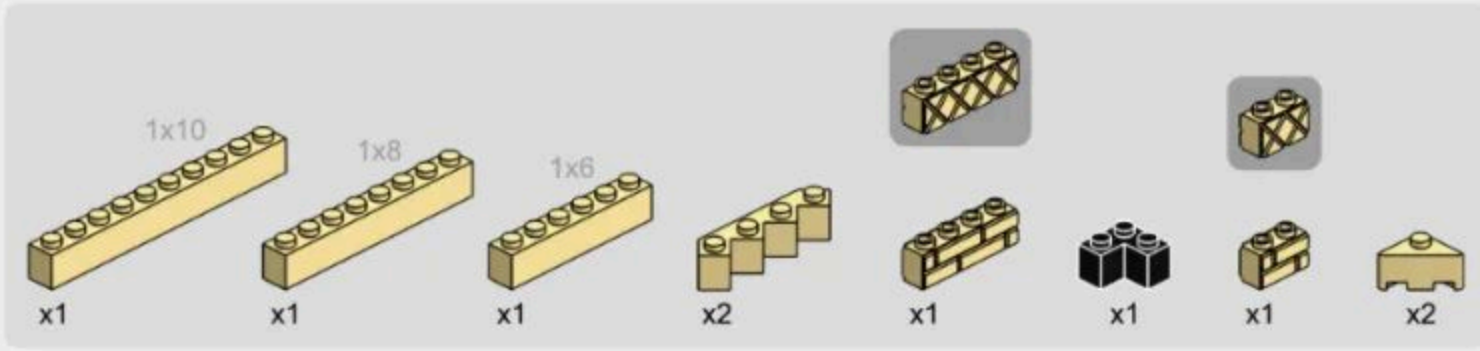

1-11

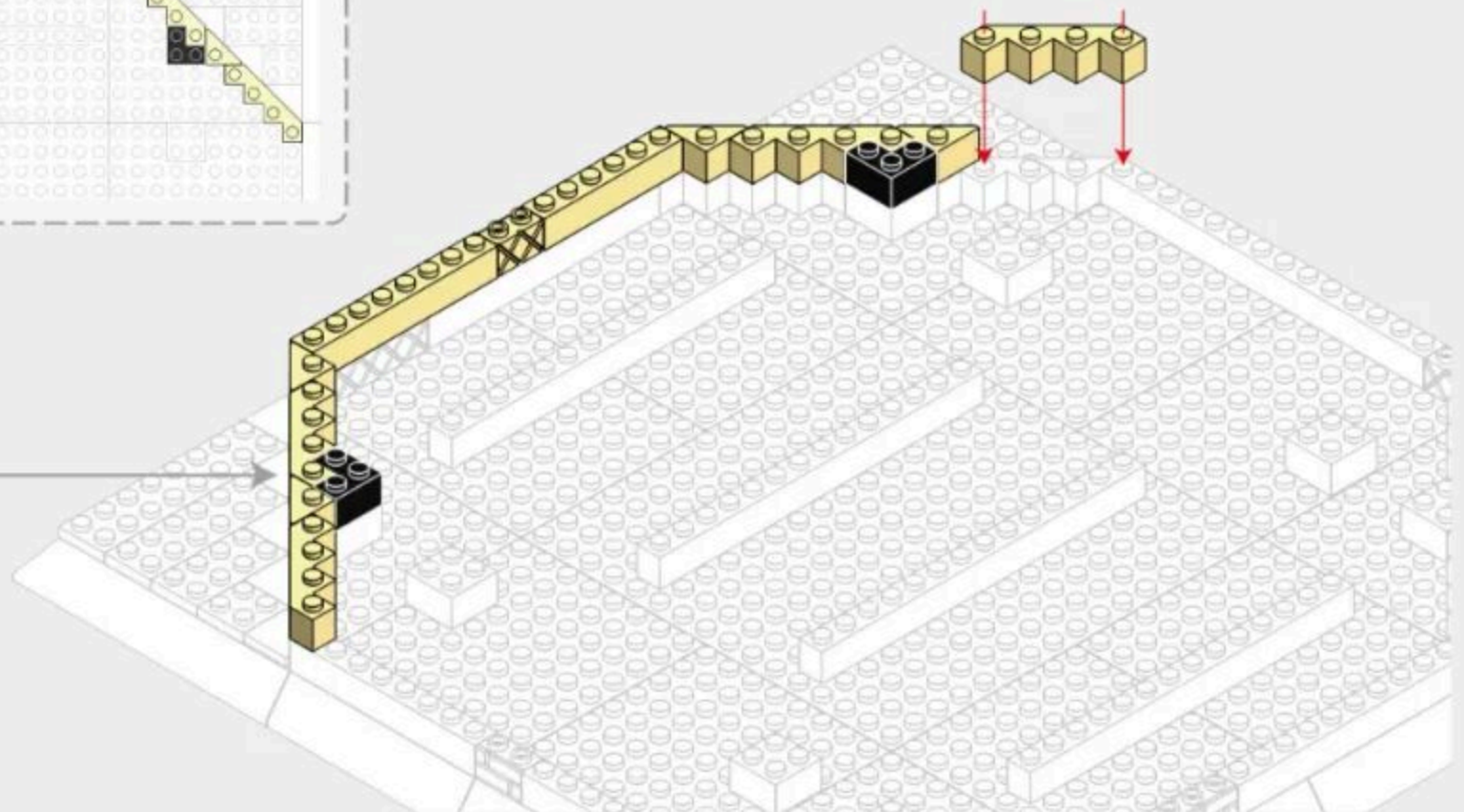
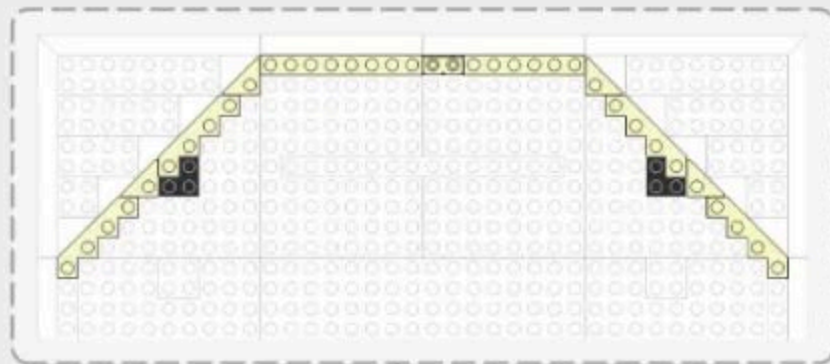
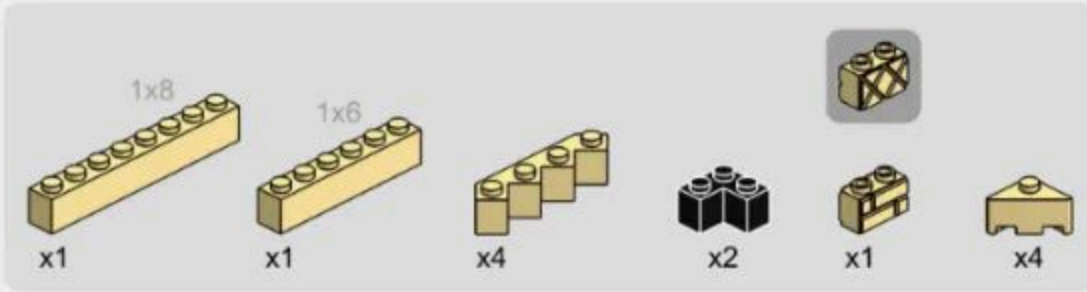

1-12

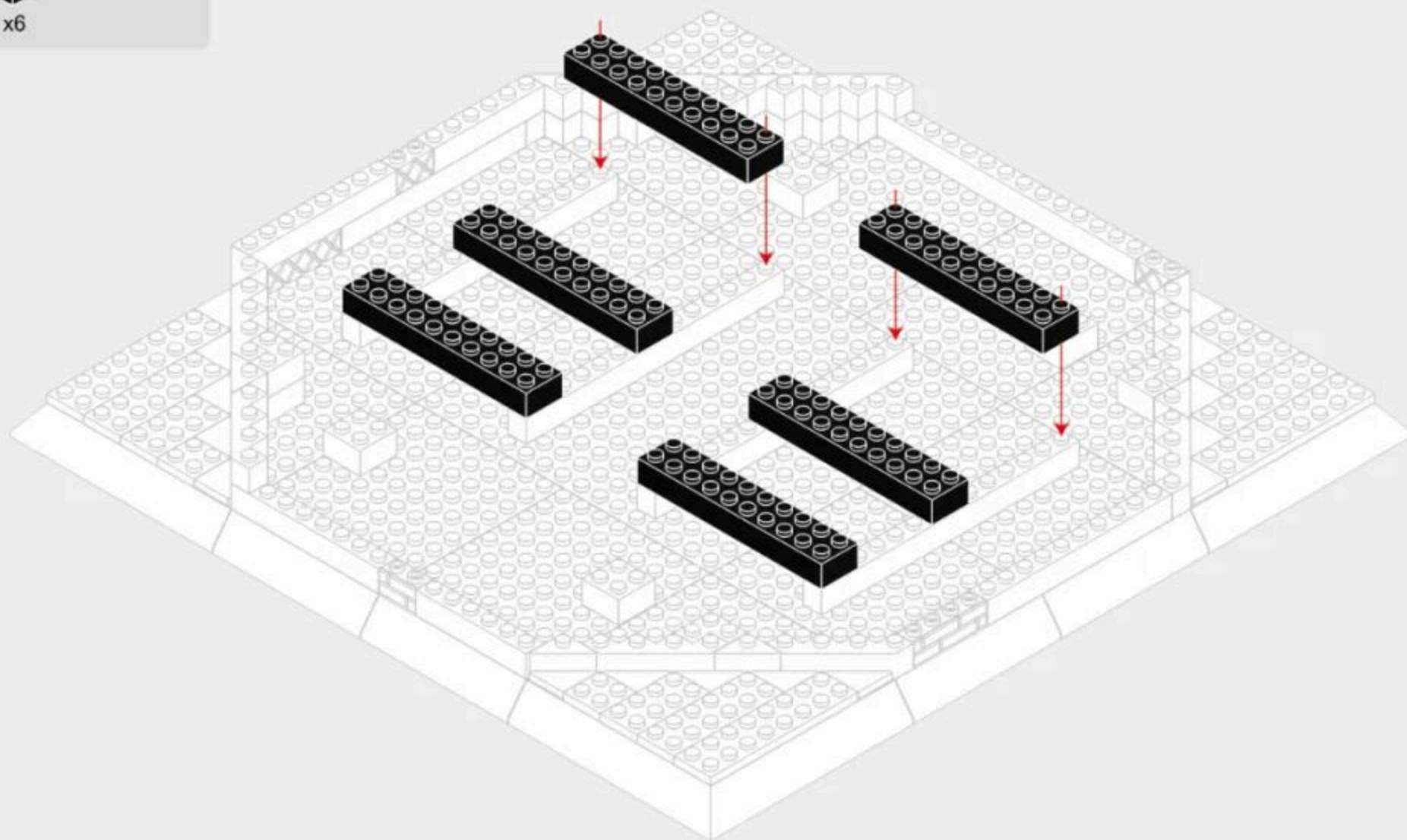
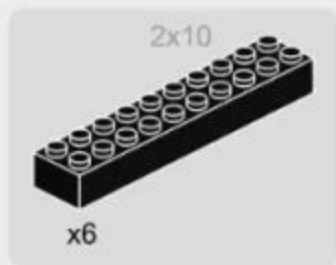

1-13

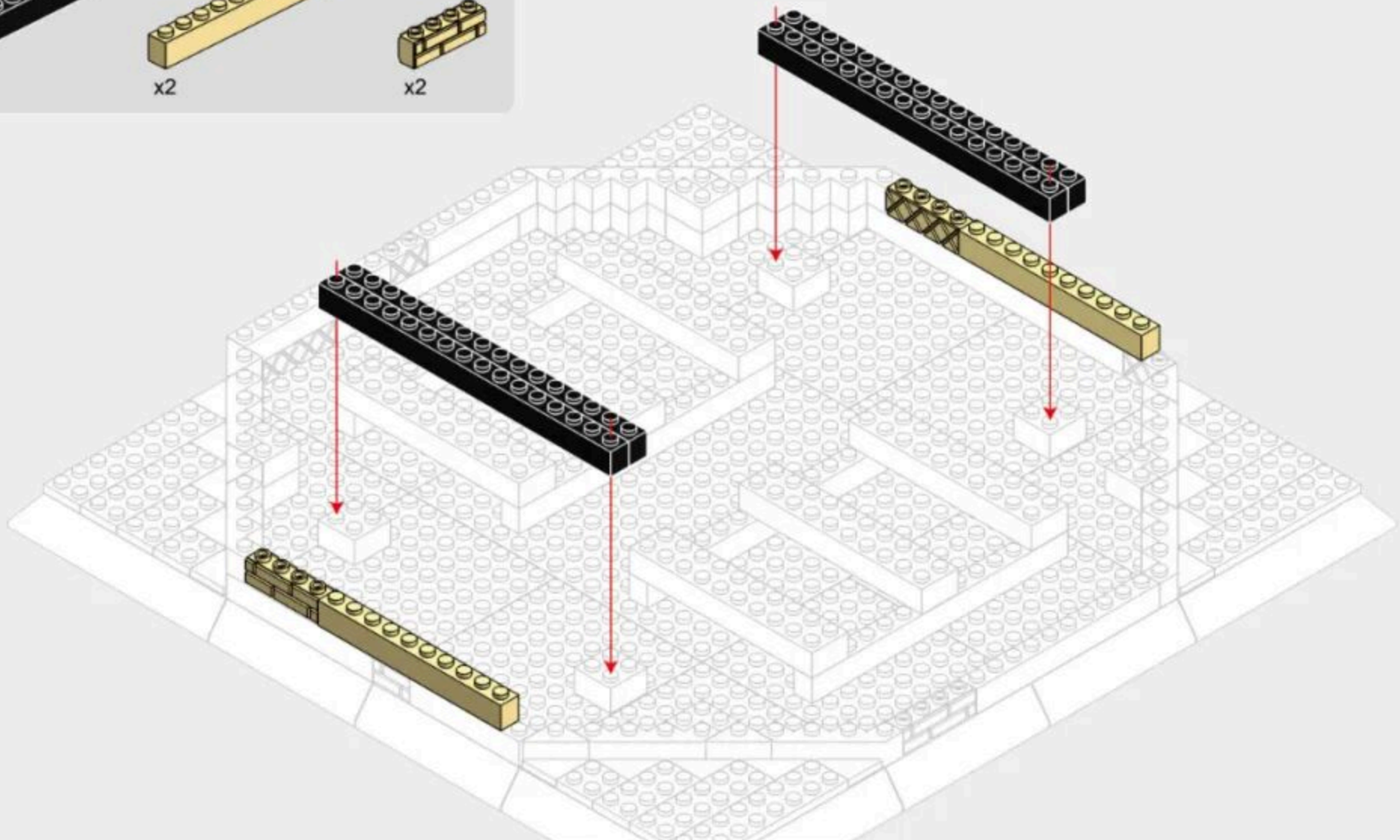
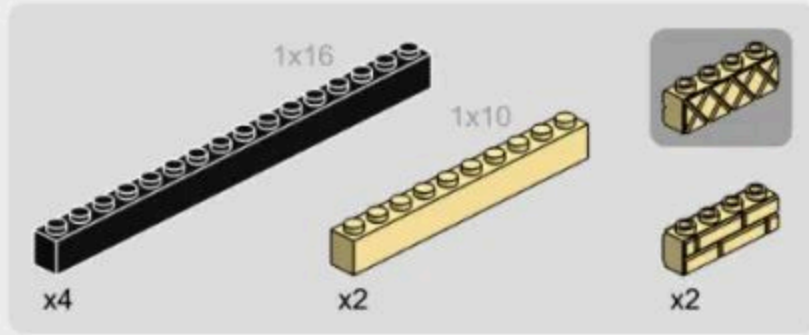

1-14

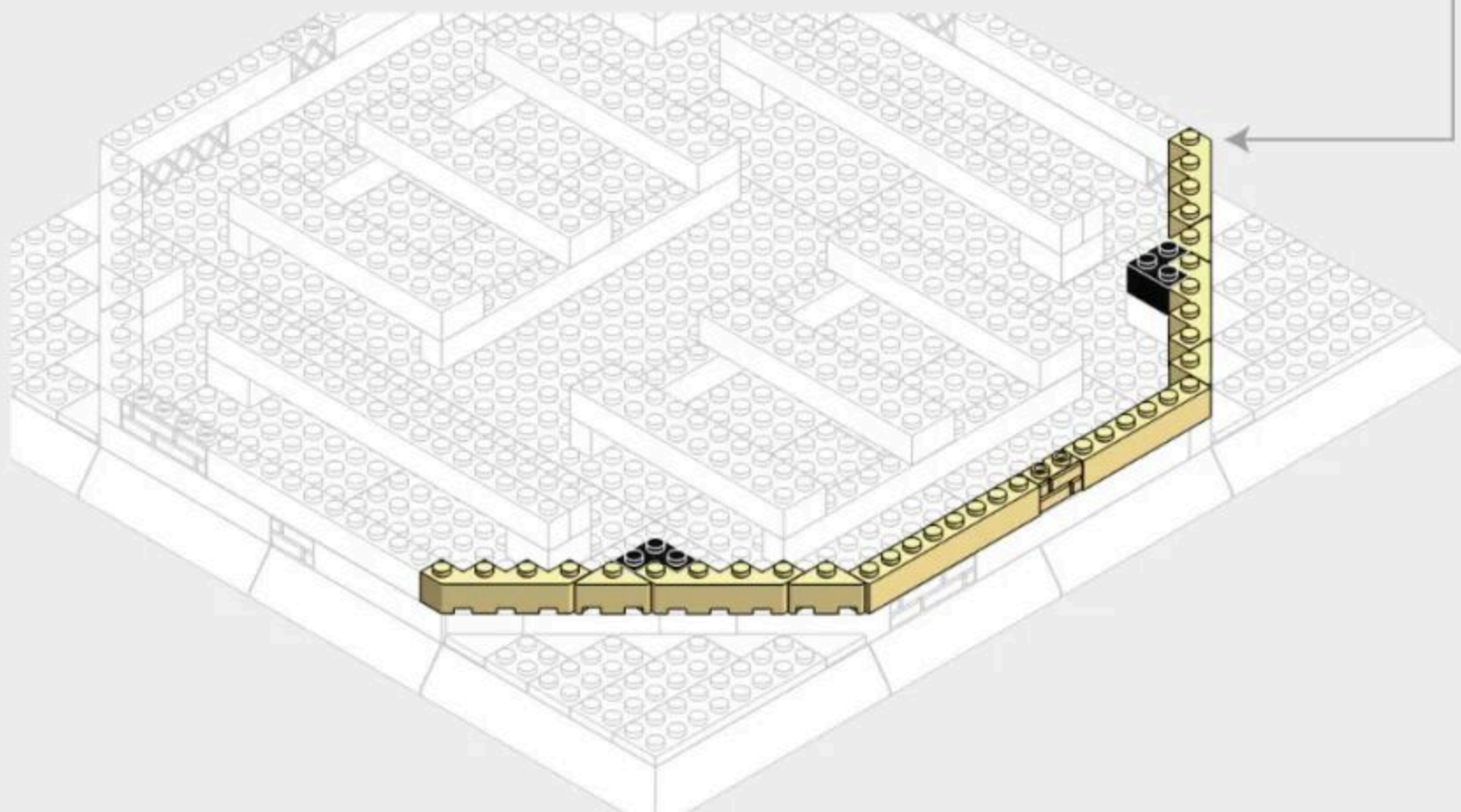
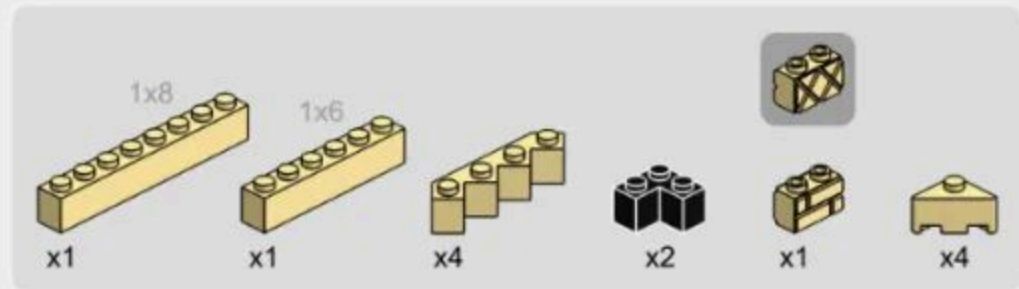

1-15

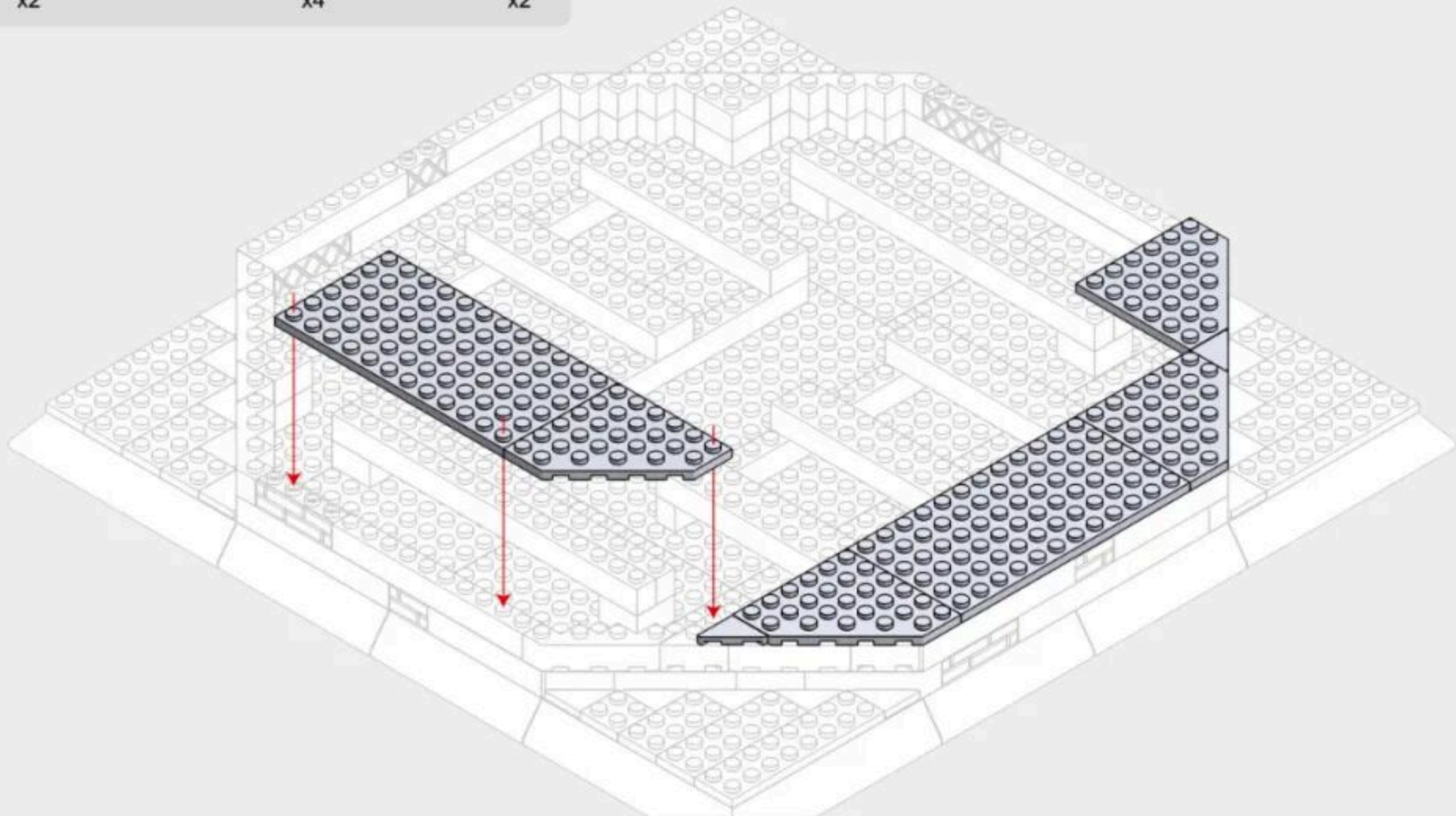
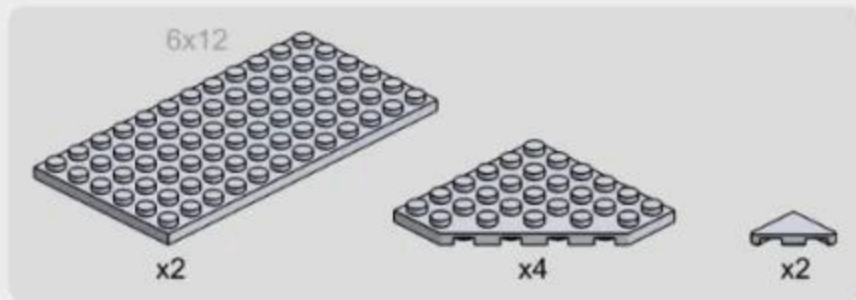

1-16

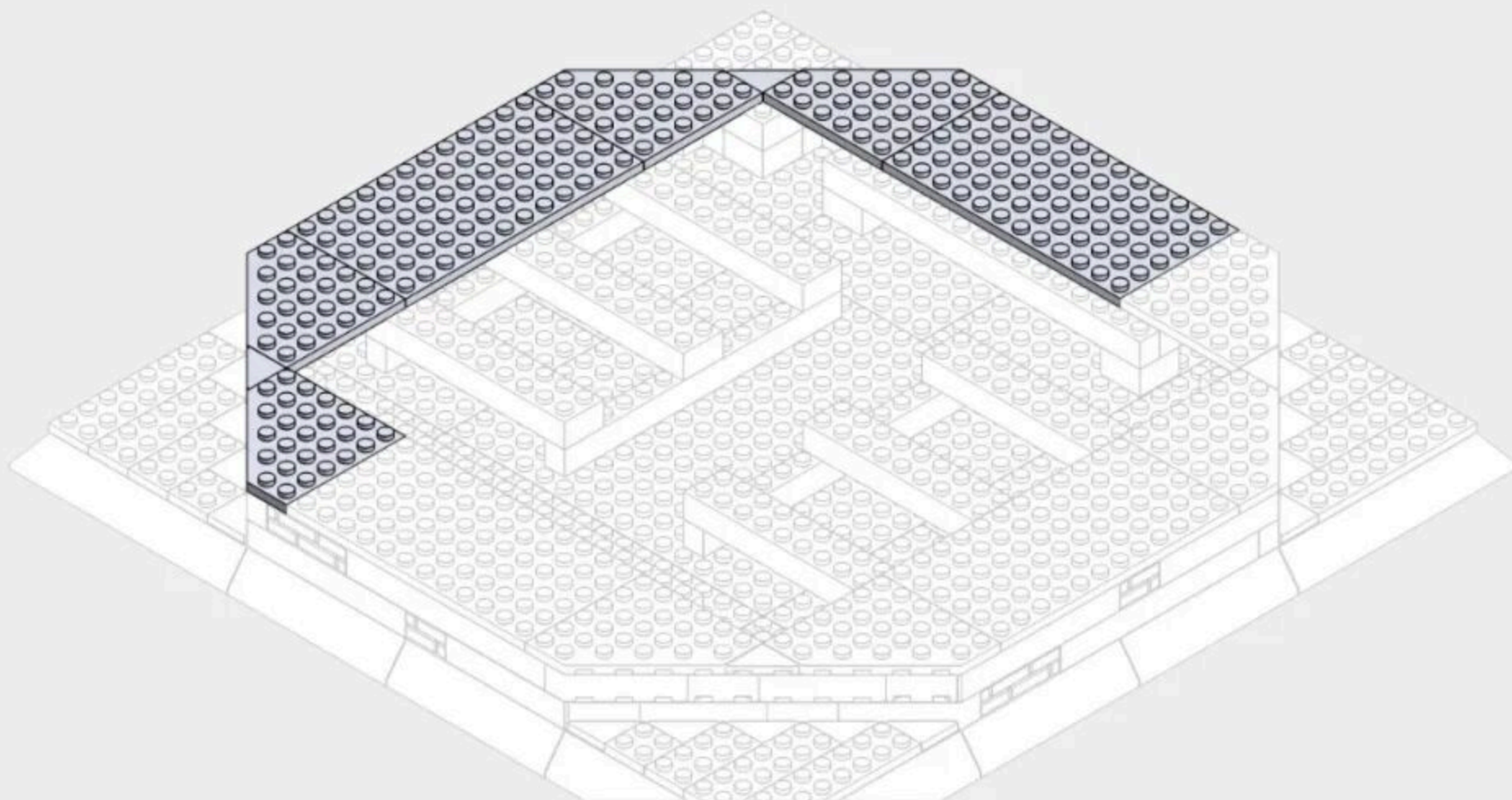
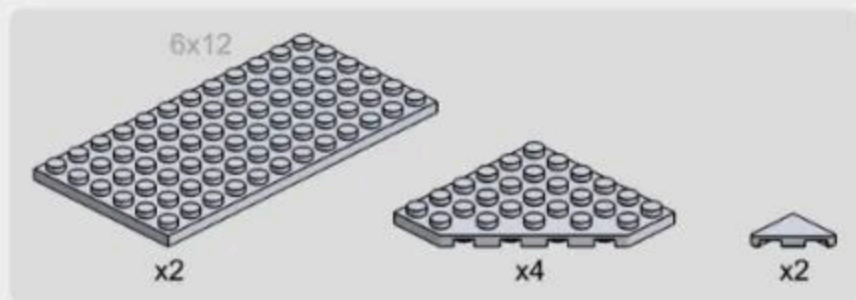

1-17

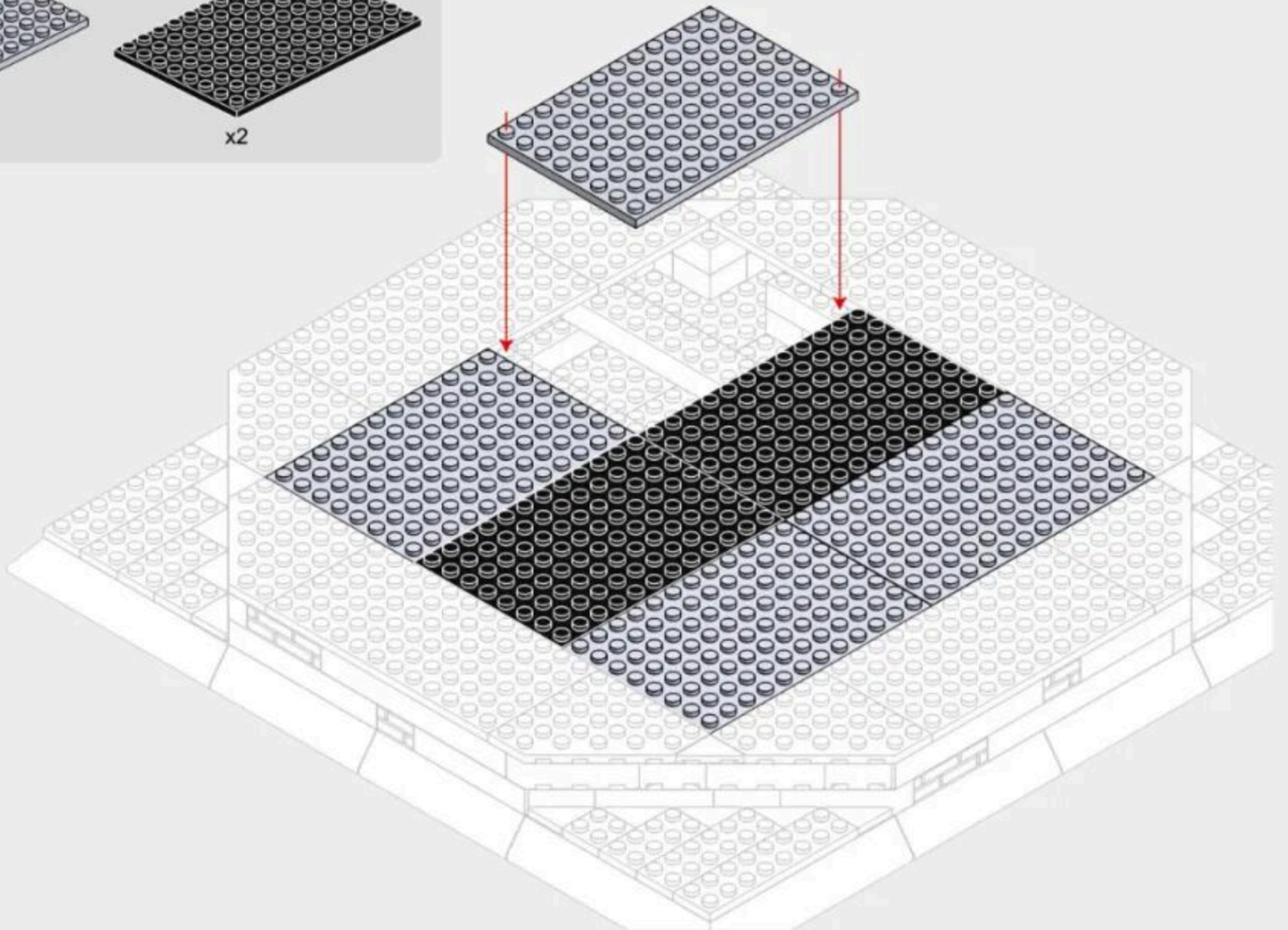
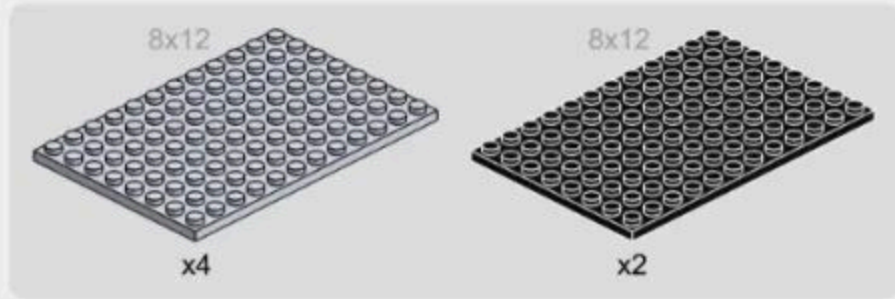

1-18

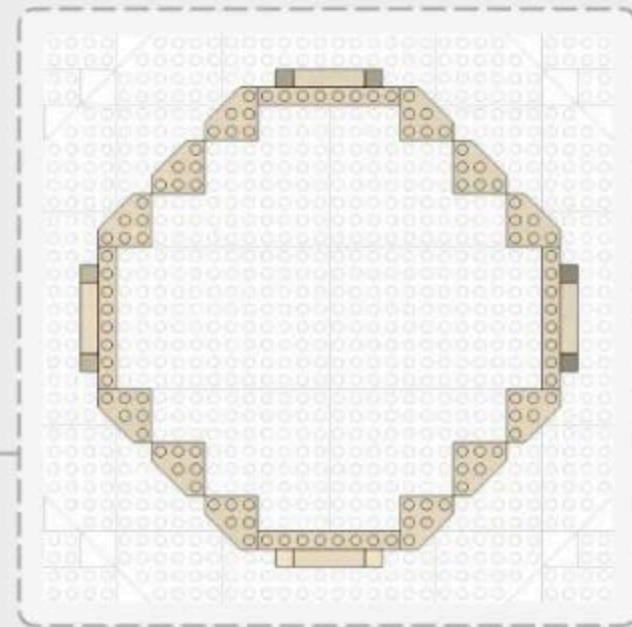
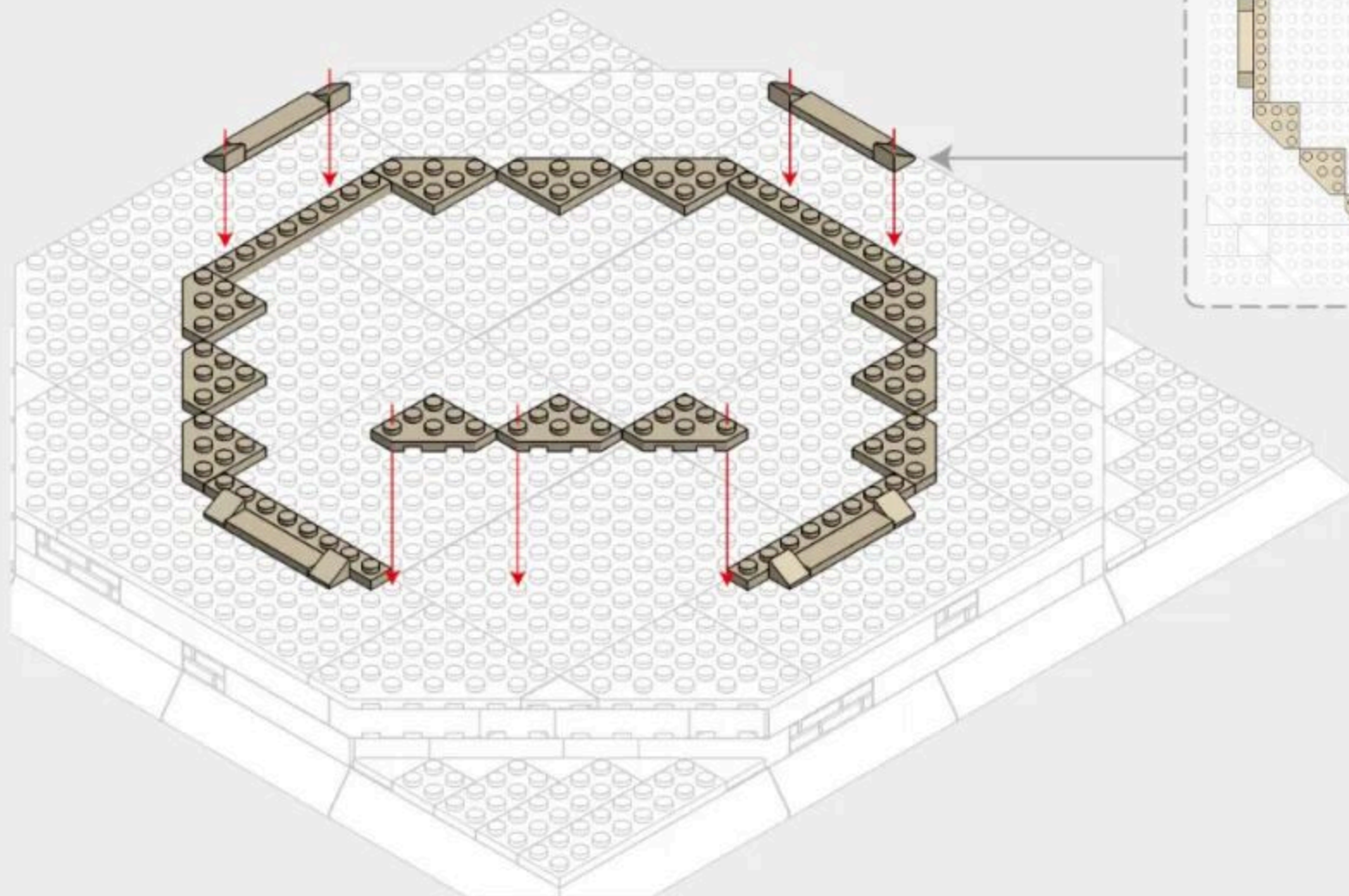
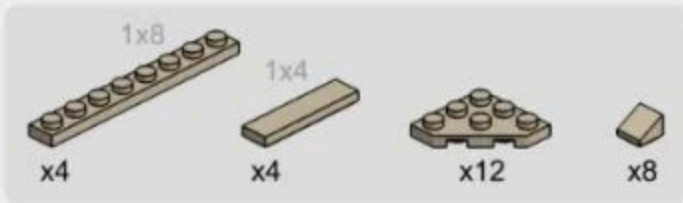

1-19

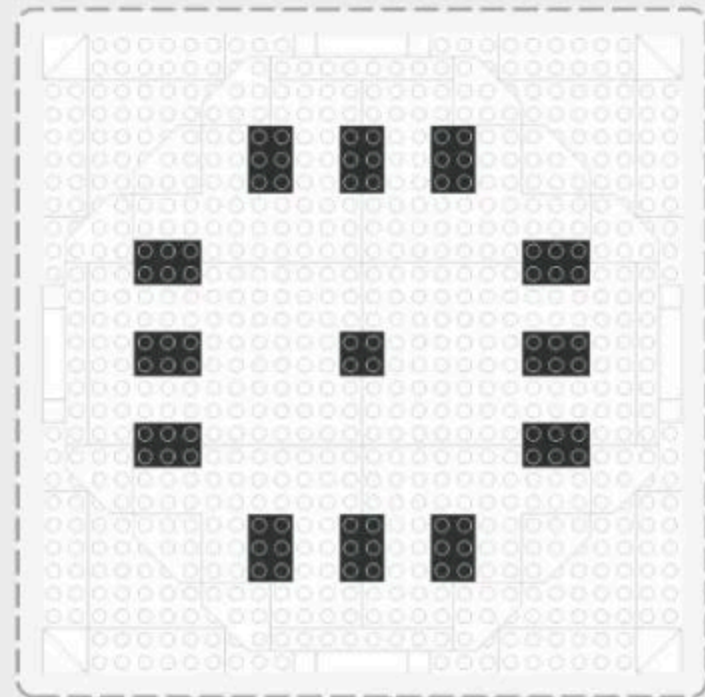
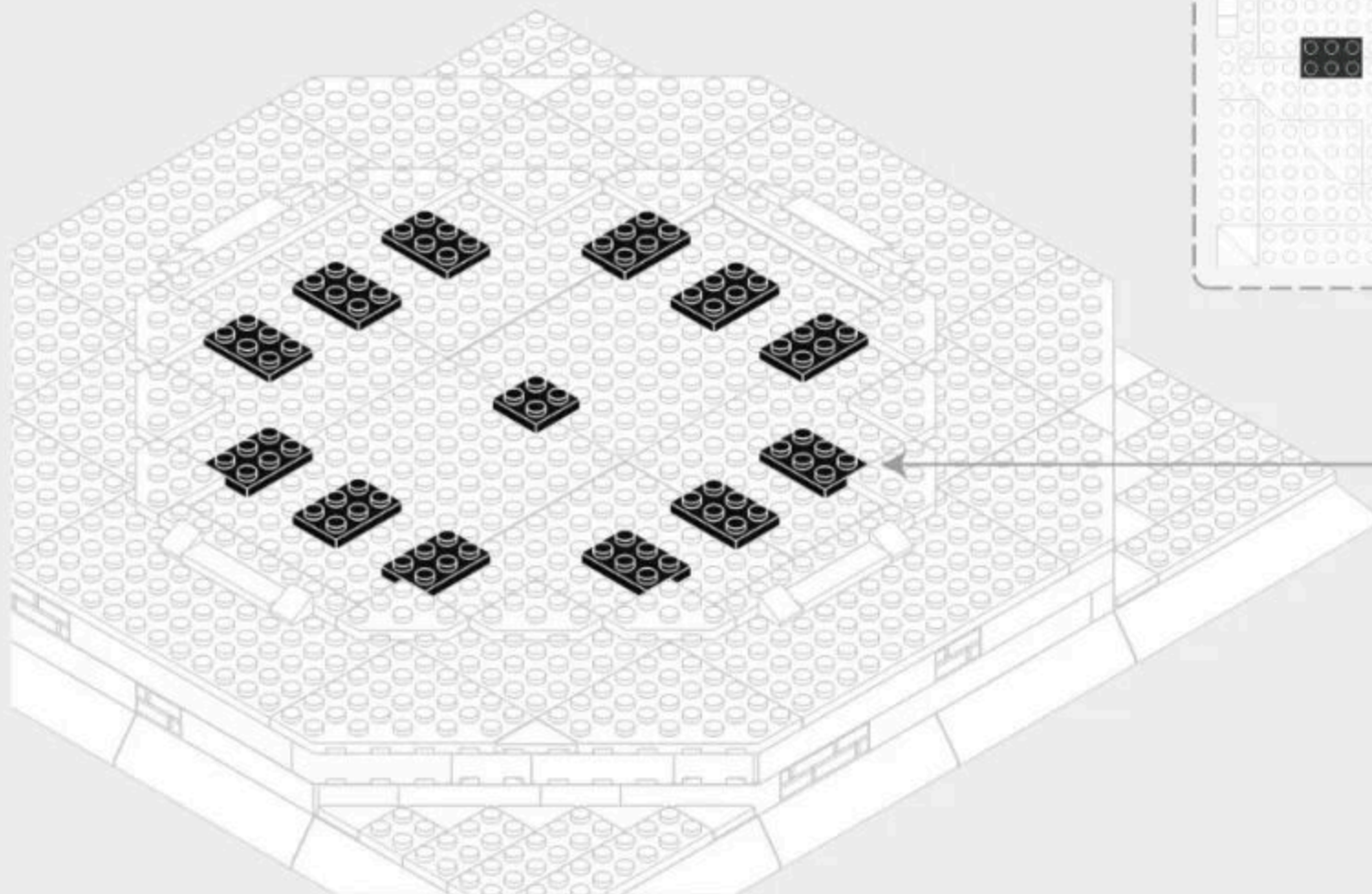

1-20

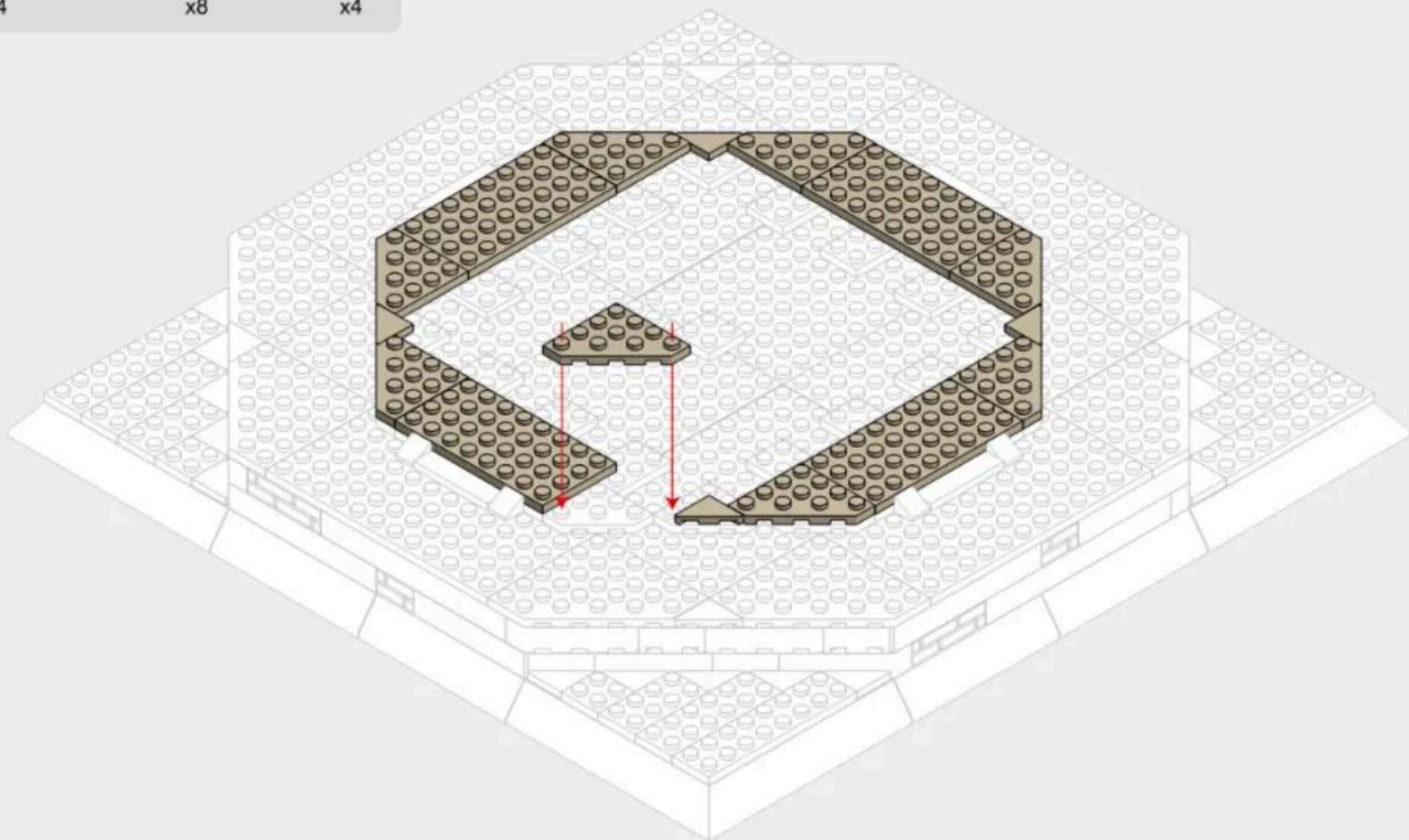
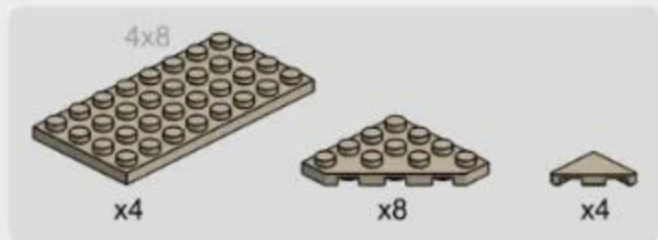

1-21

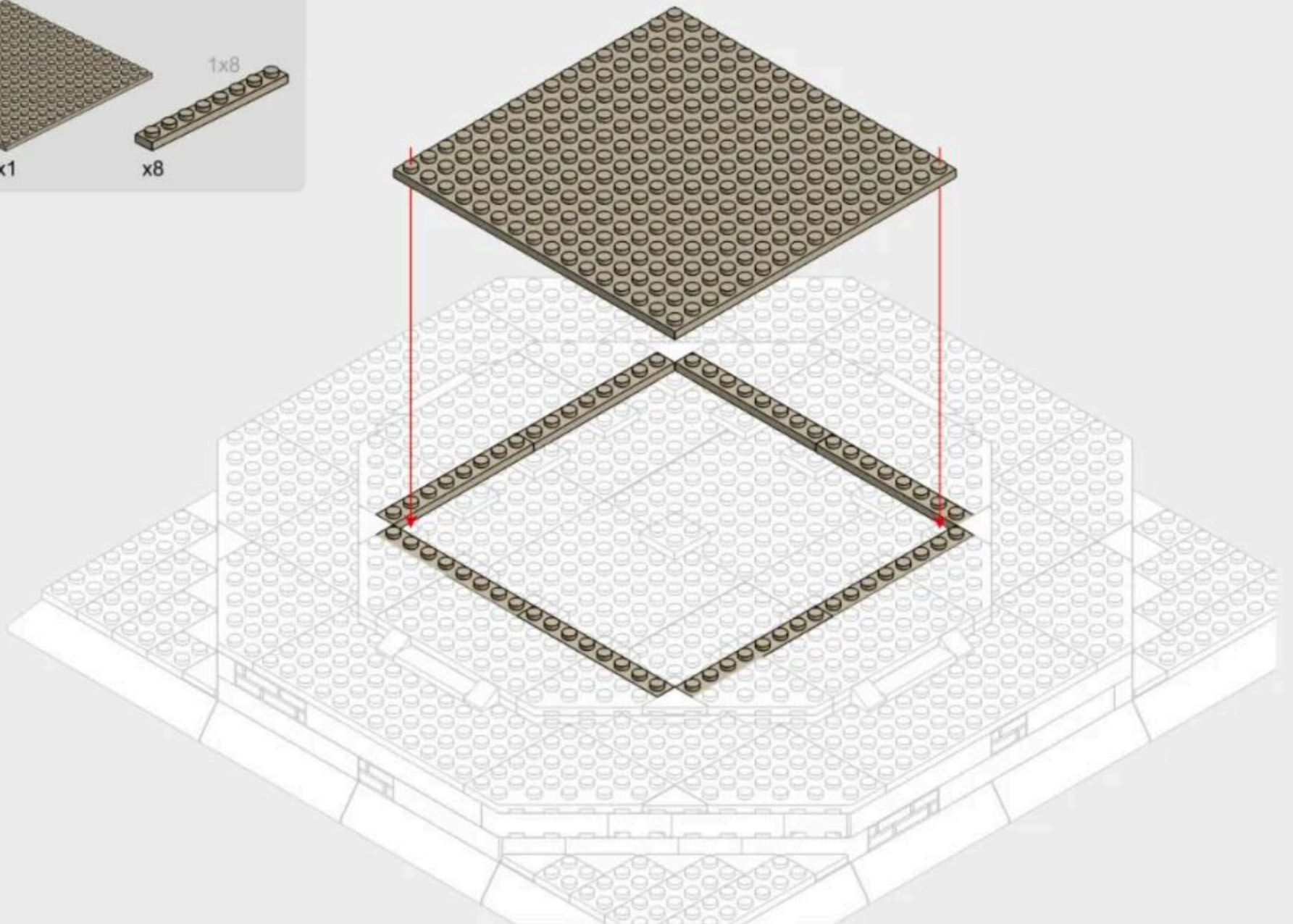
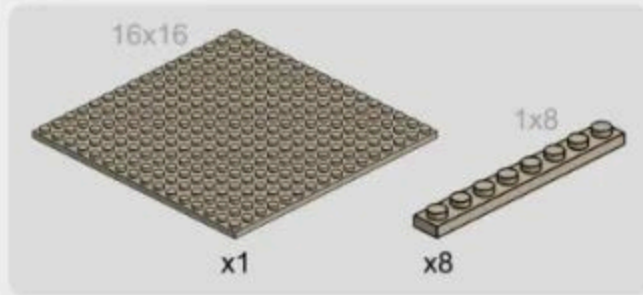

1-22

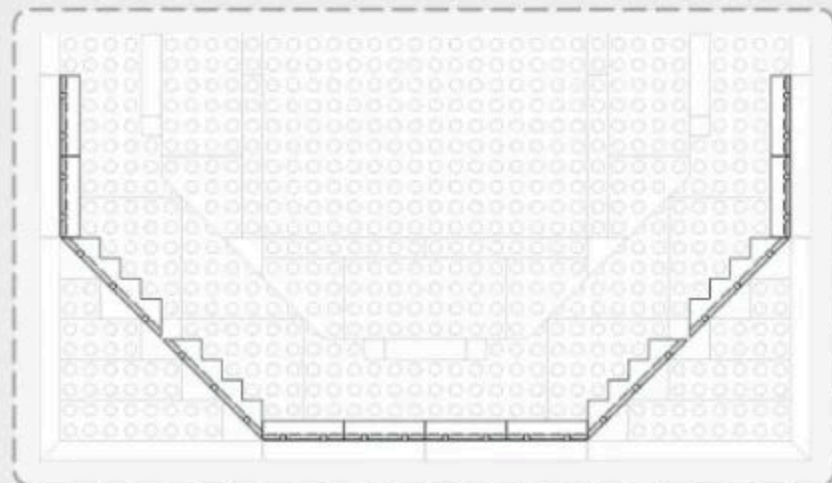
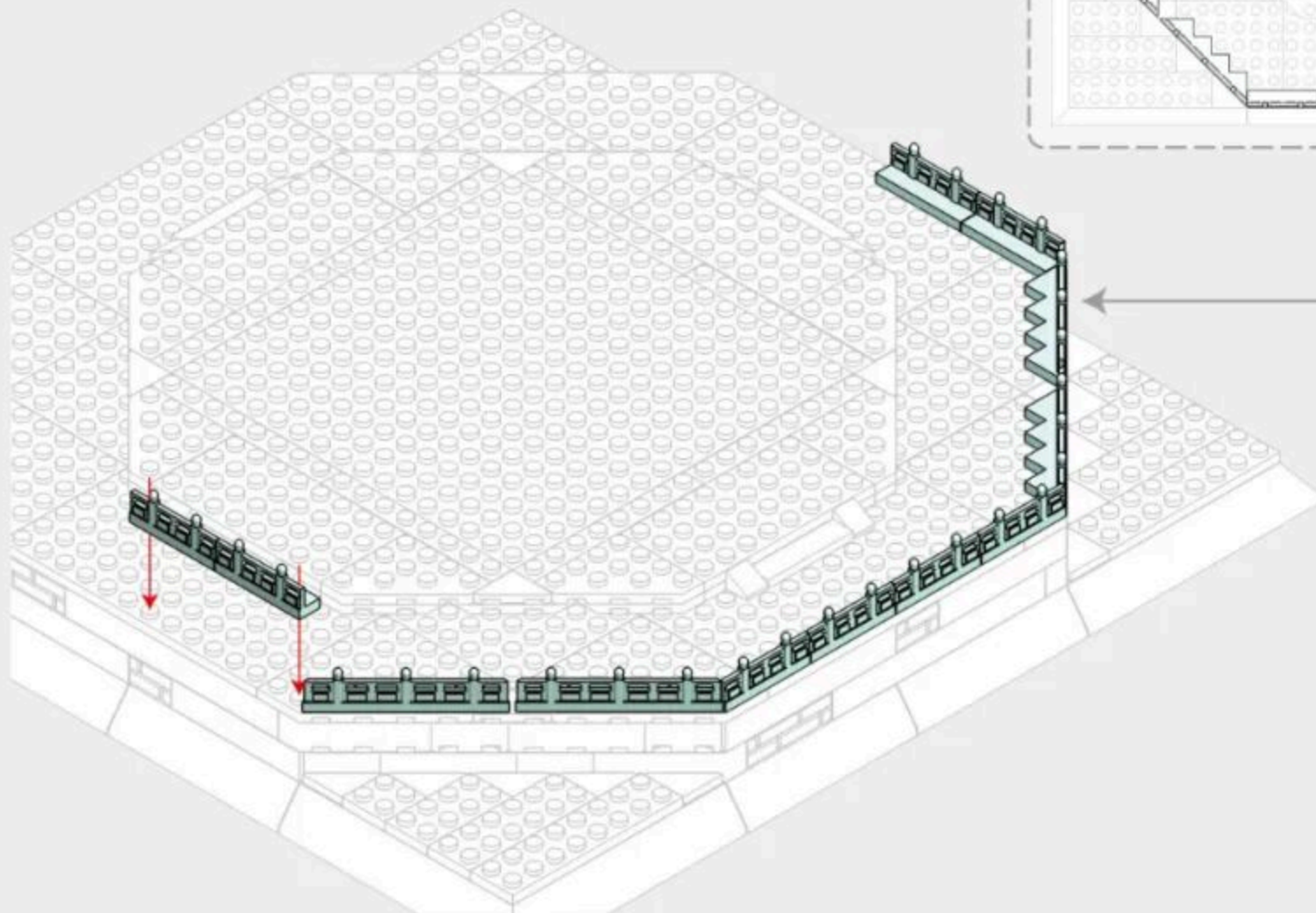
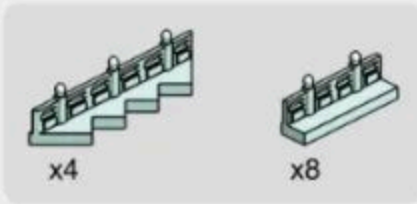

1-23

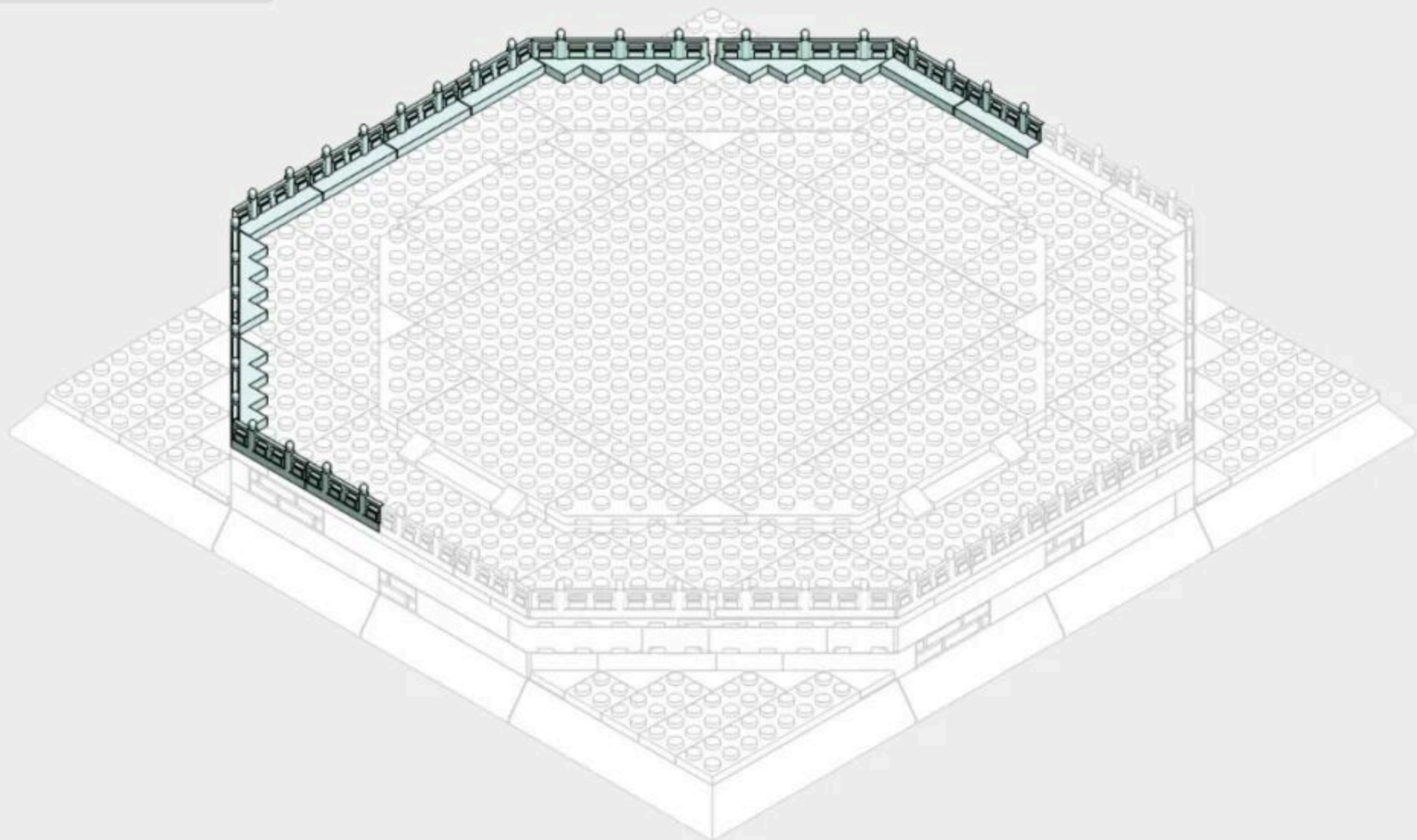



276PCS

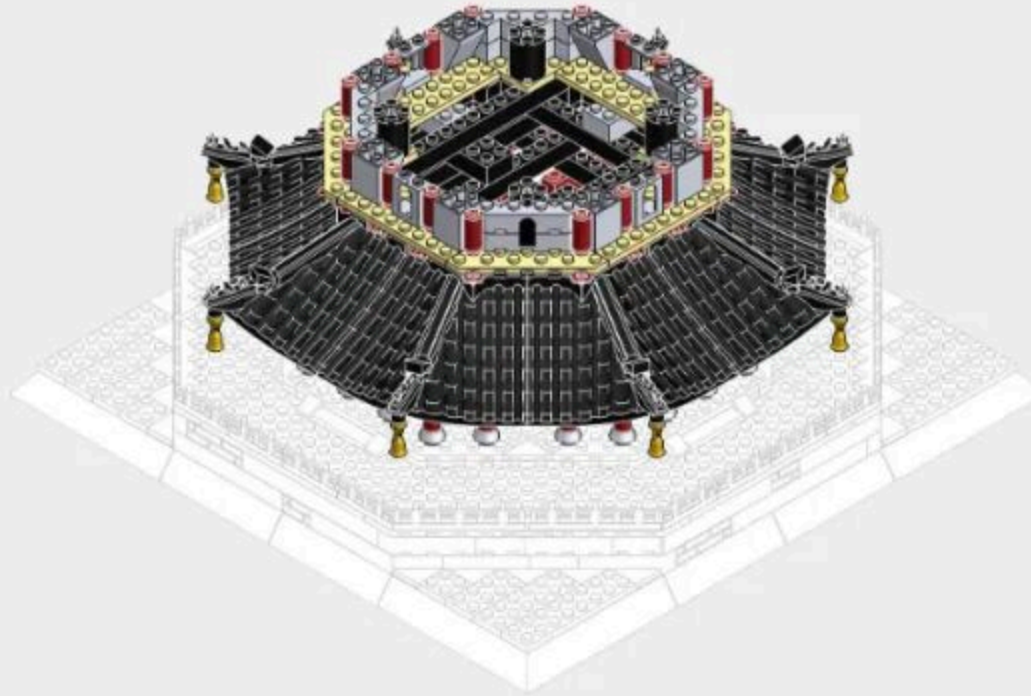

2-1

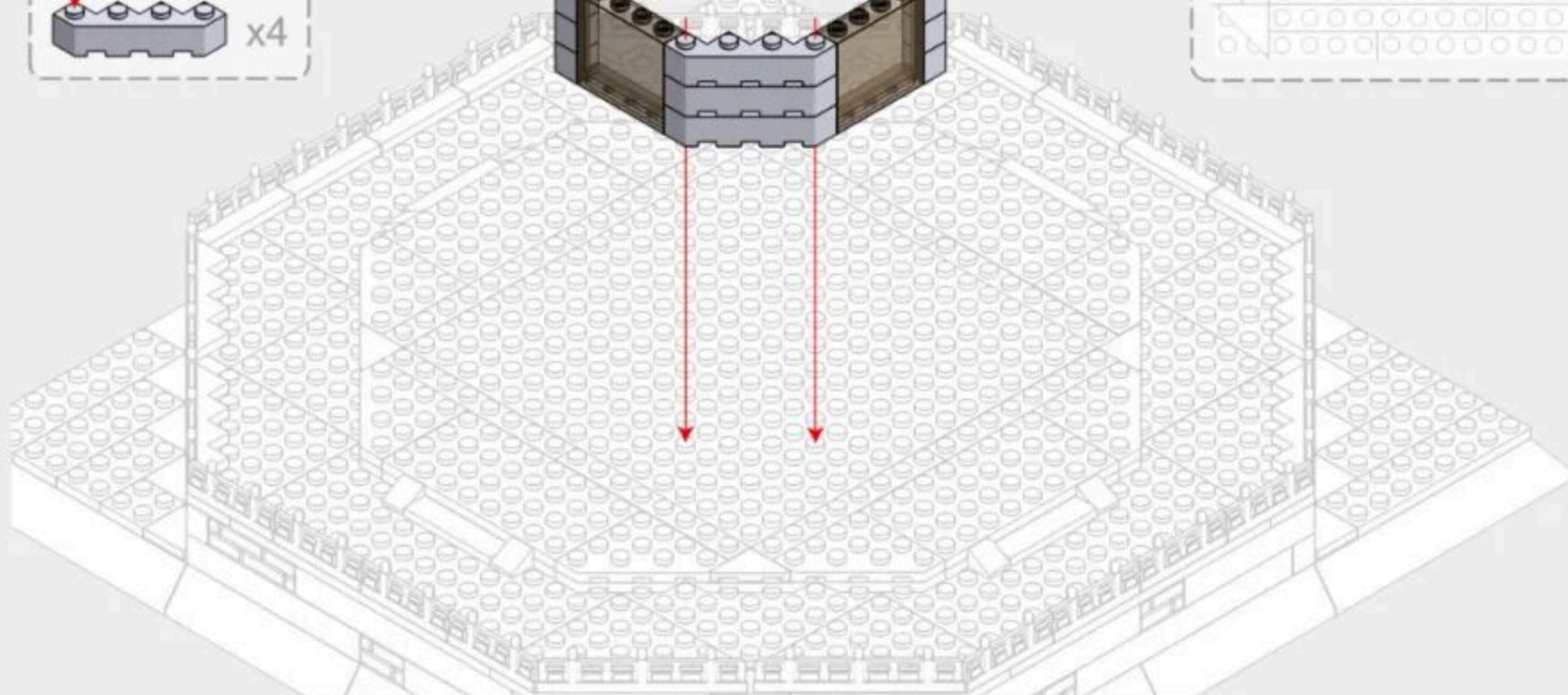
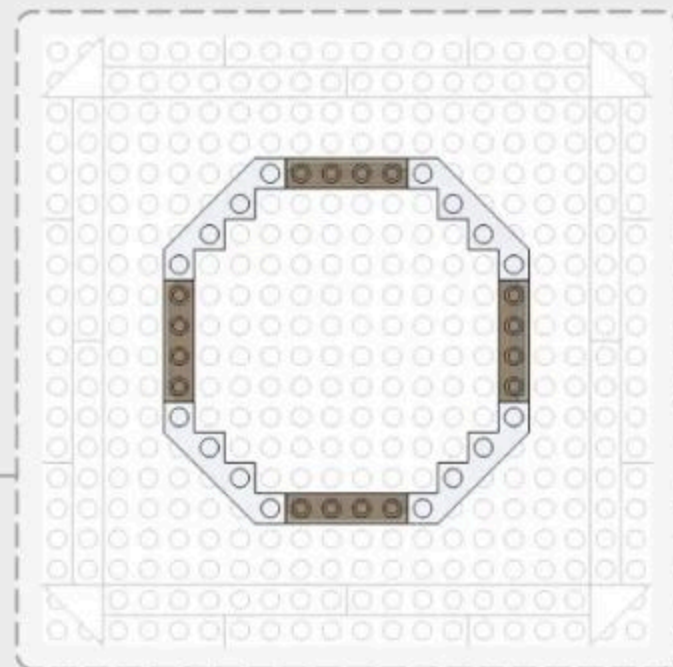
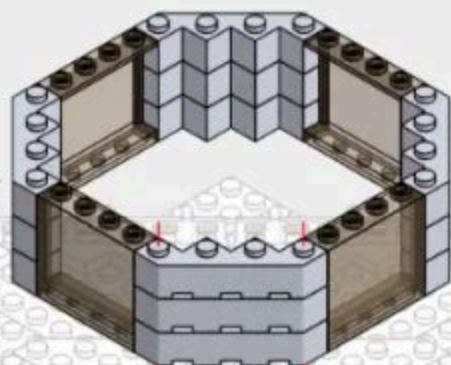
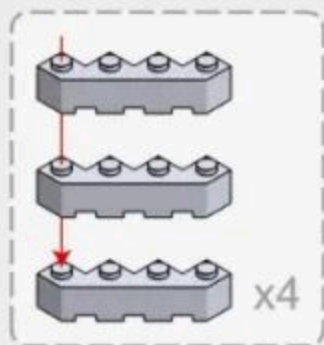
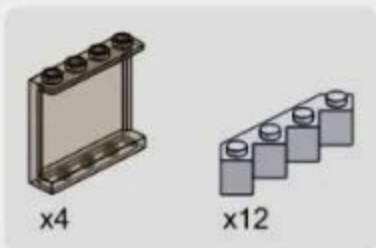

2-2

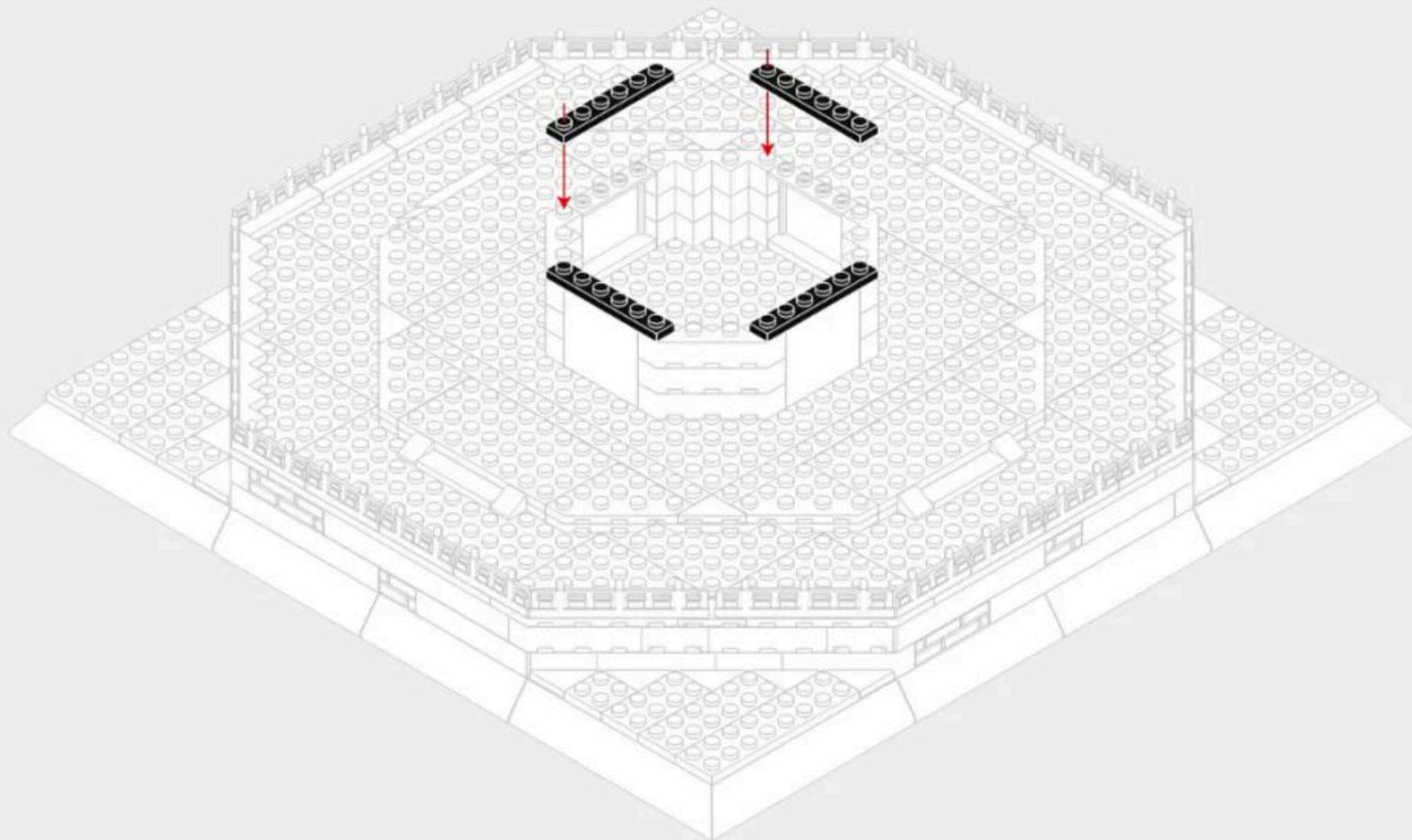

2-4

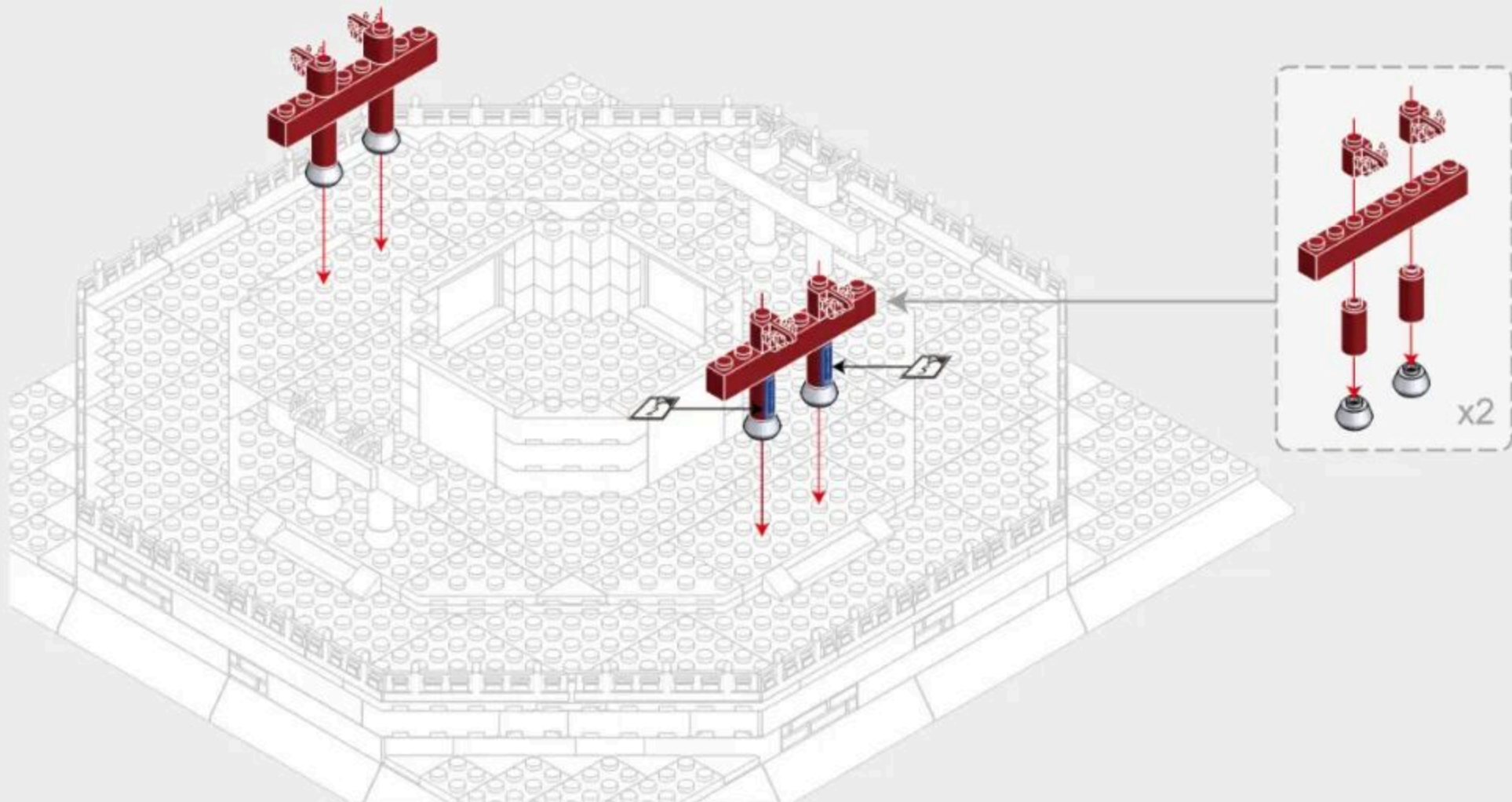
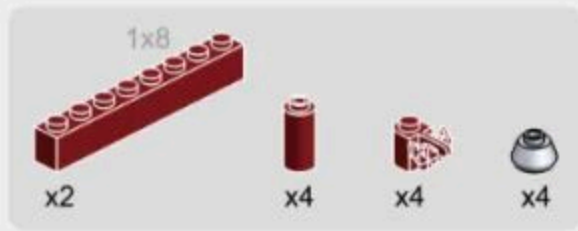

2-5

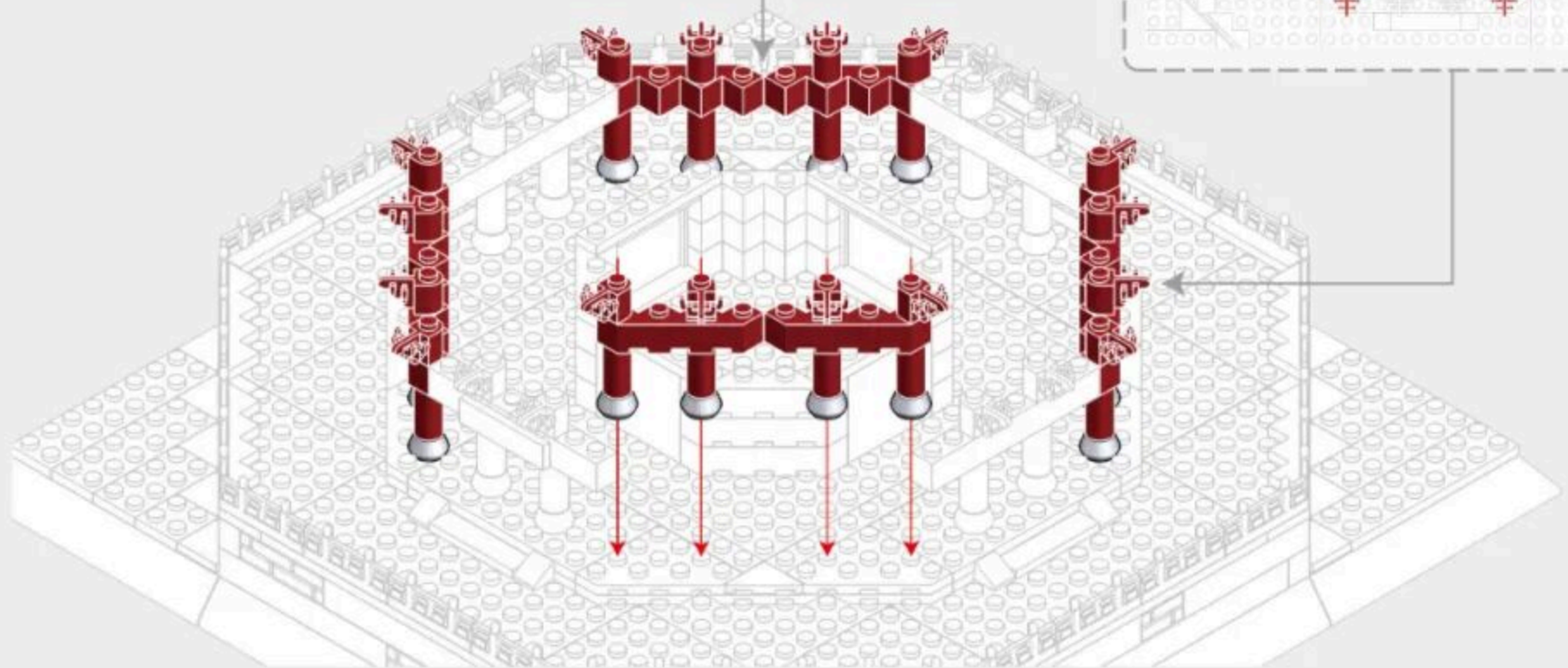
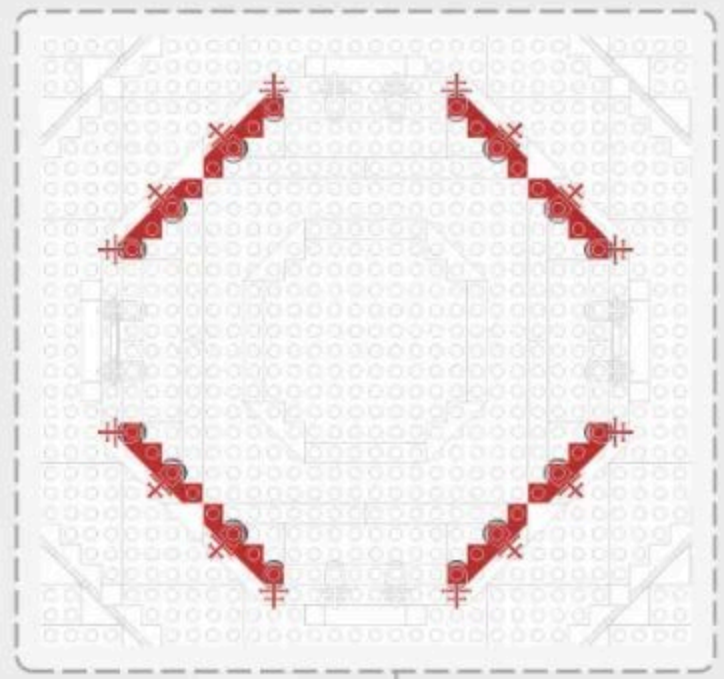
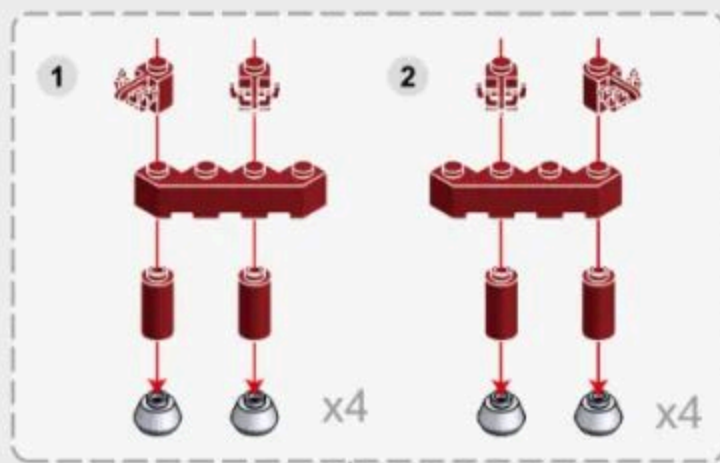

2-6

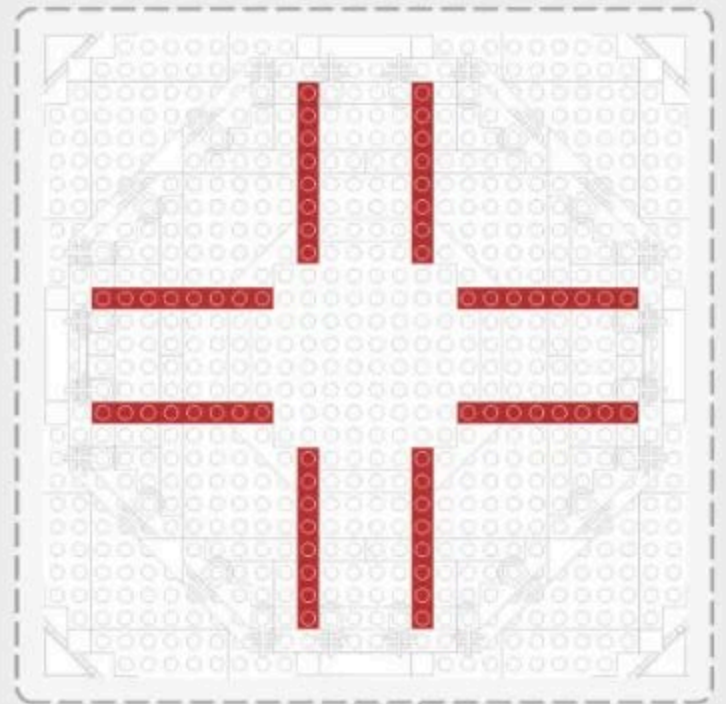
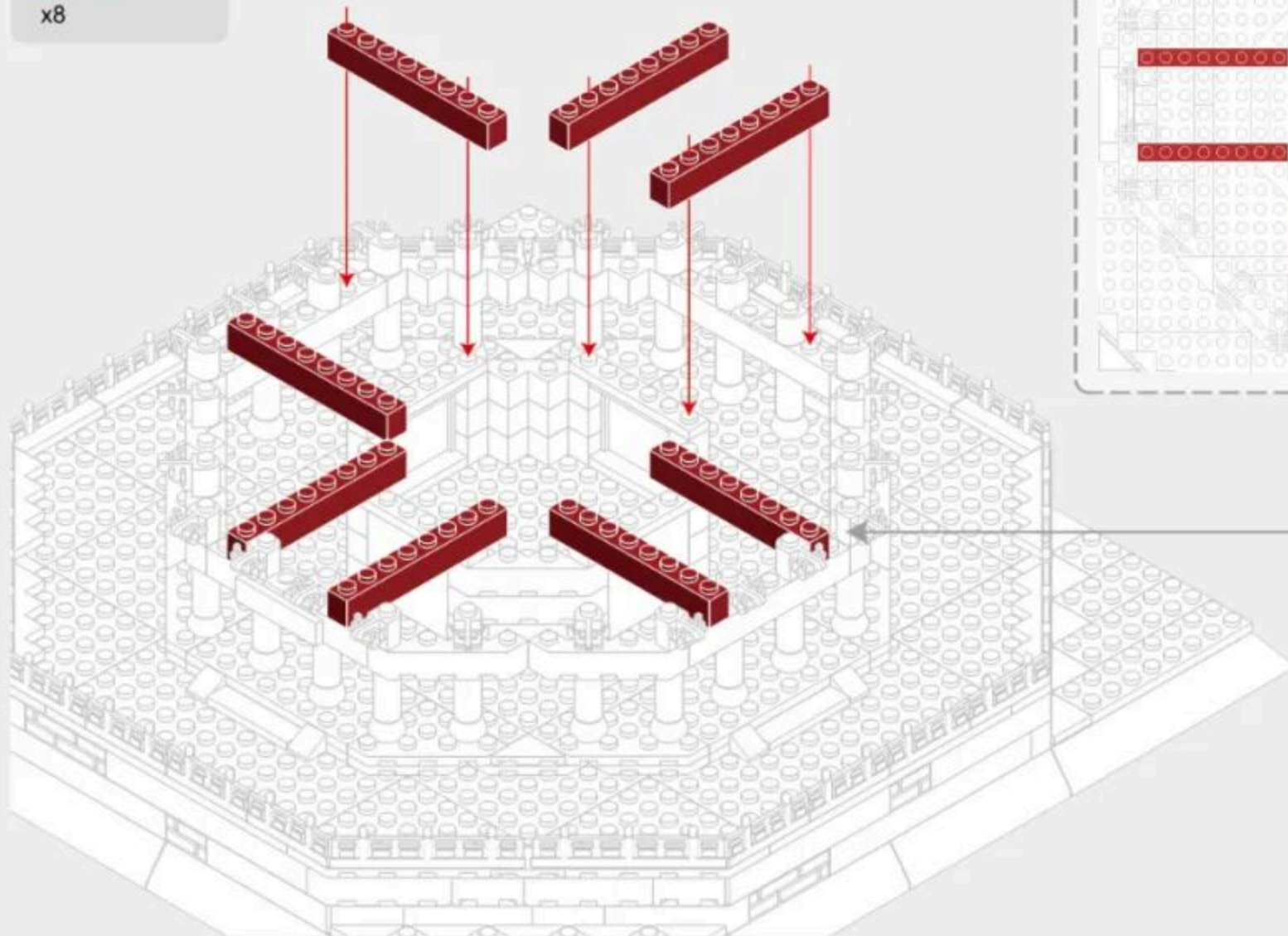
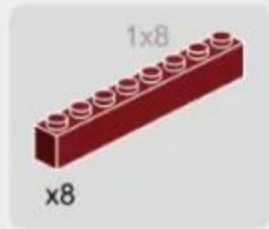

2-7

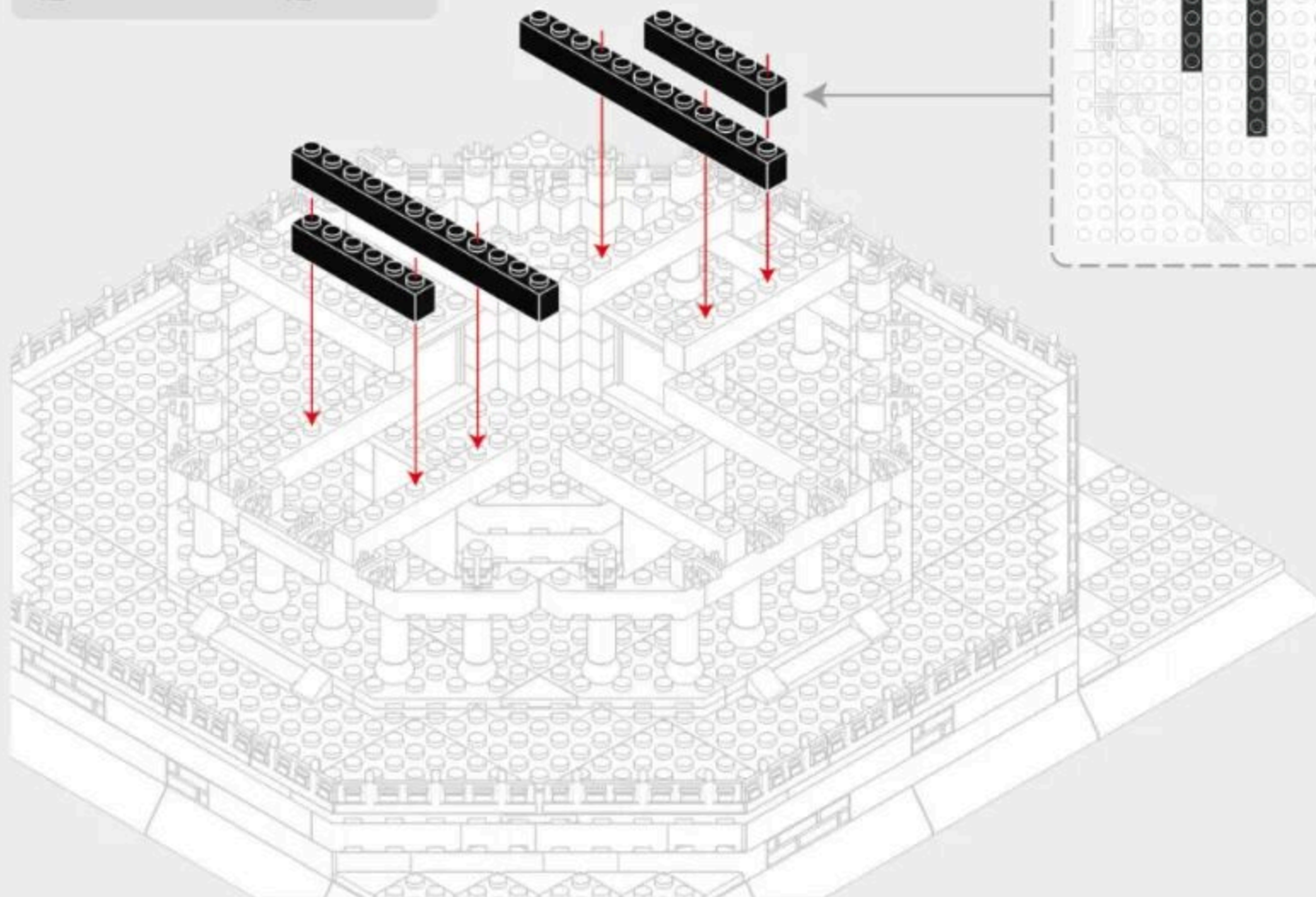
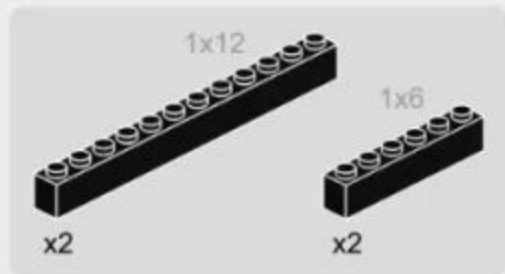

2-8

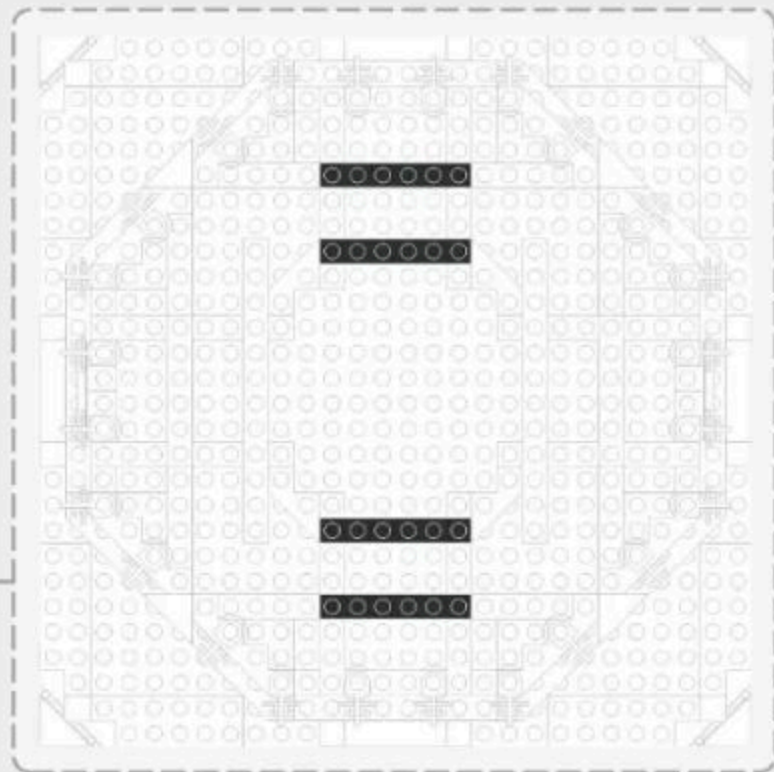
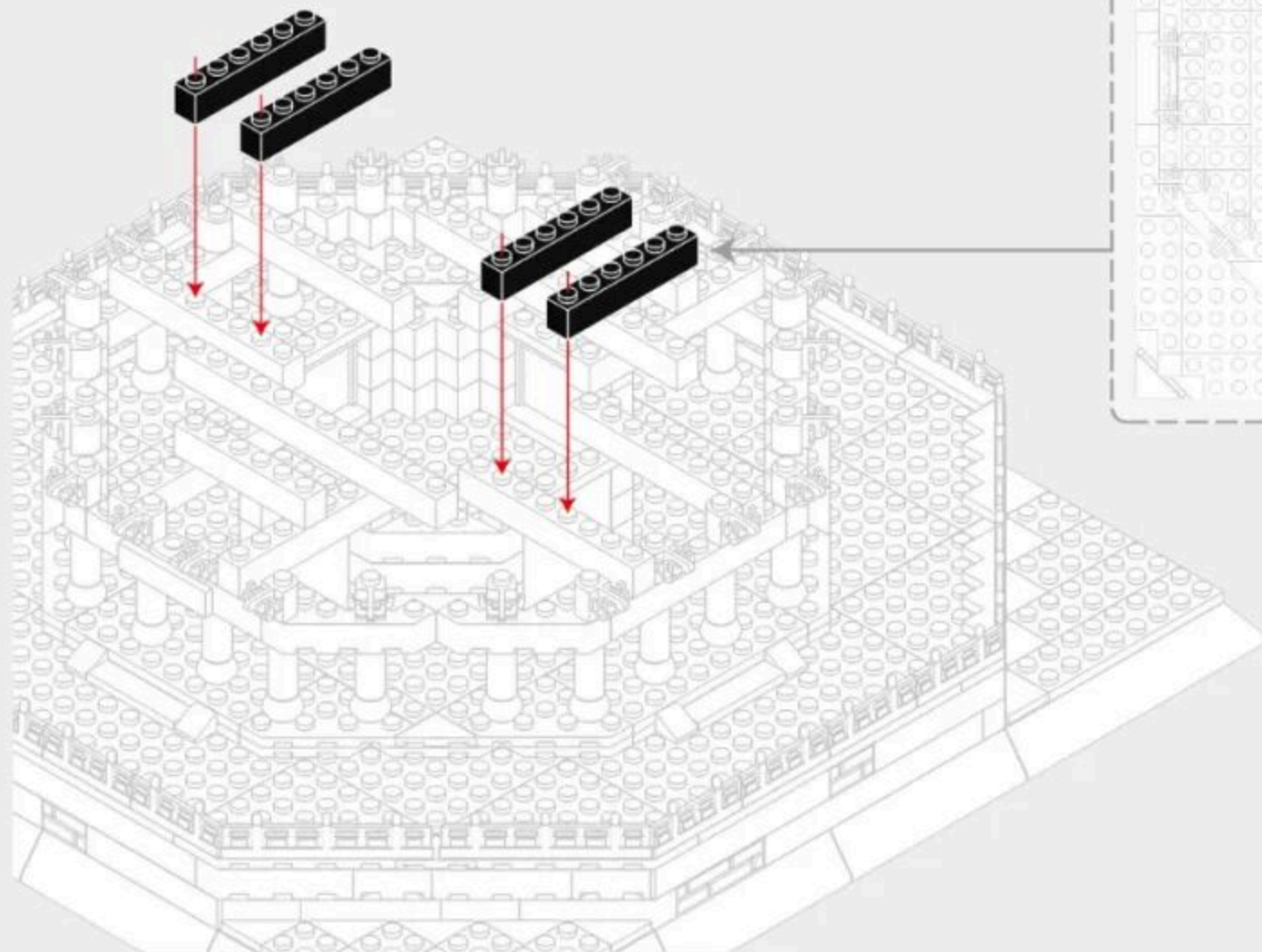

2-9

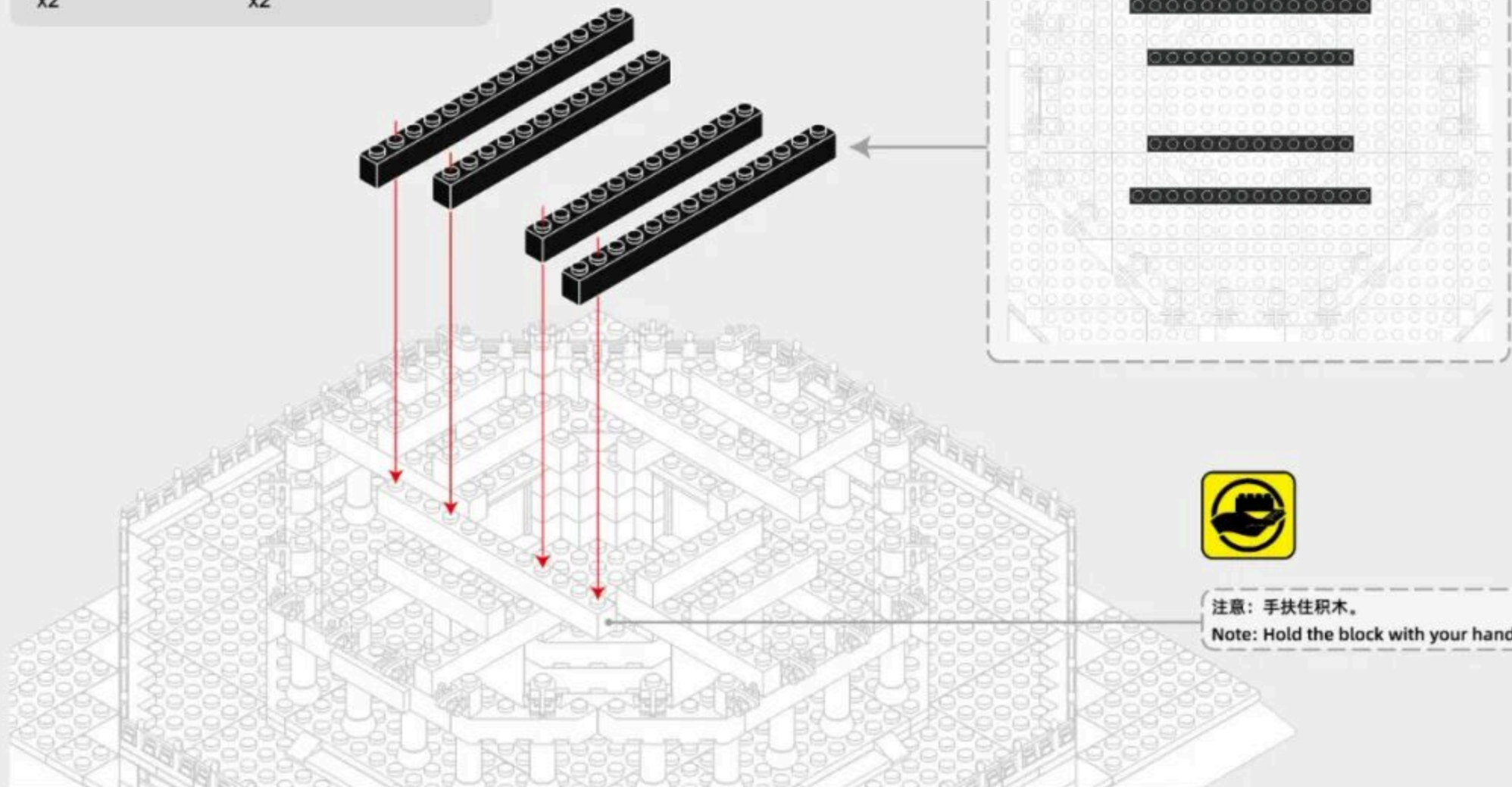
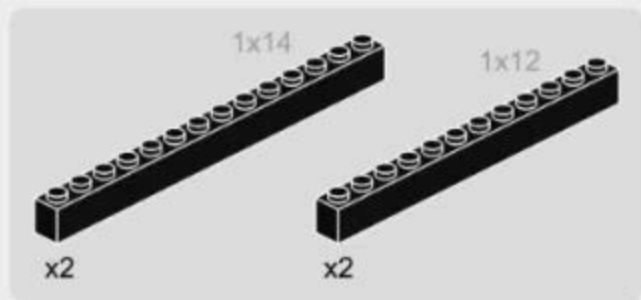

注意：手扶住积木。
Note: Hold the block with your hand.

2-10

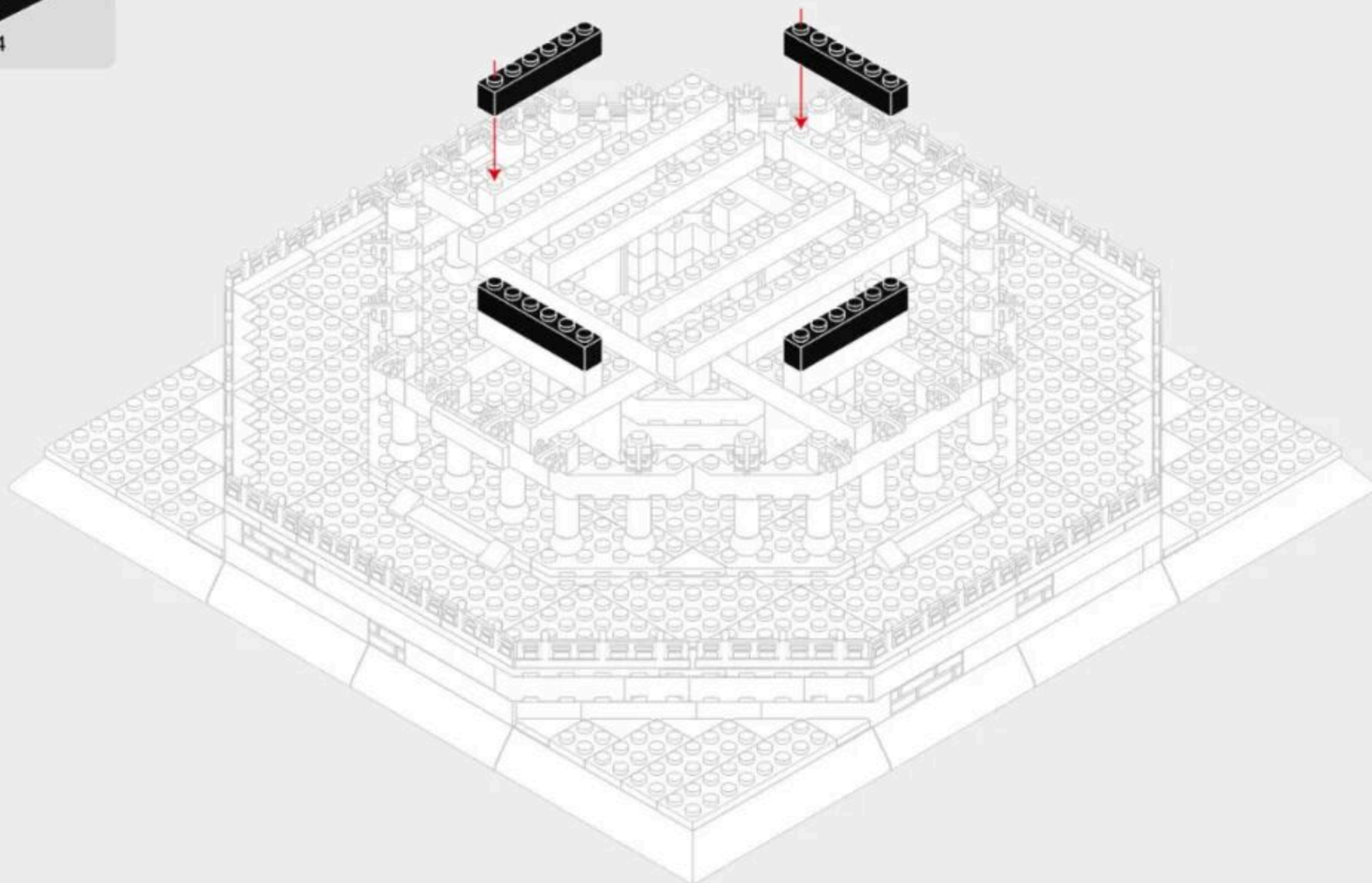

2-11

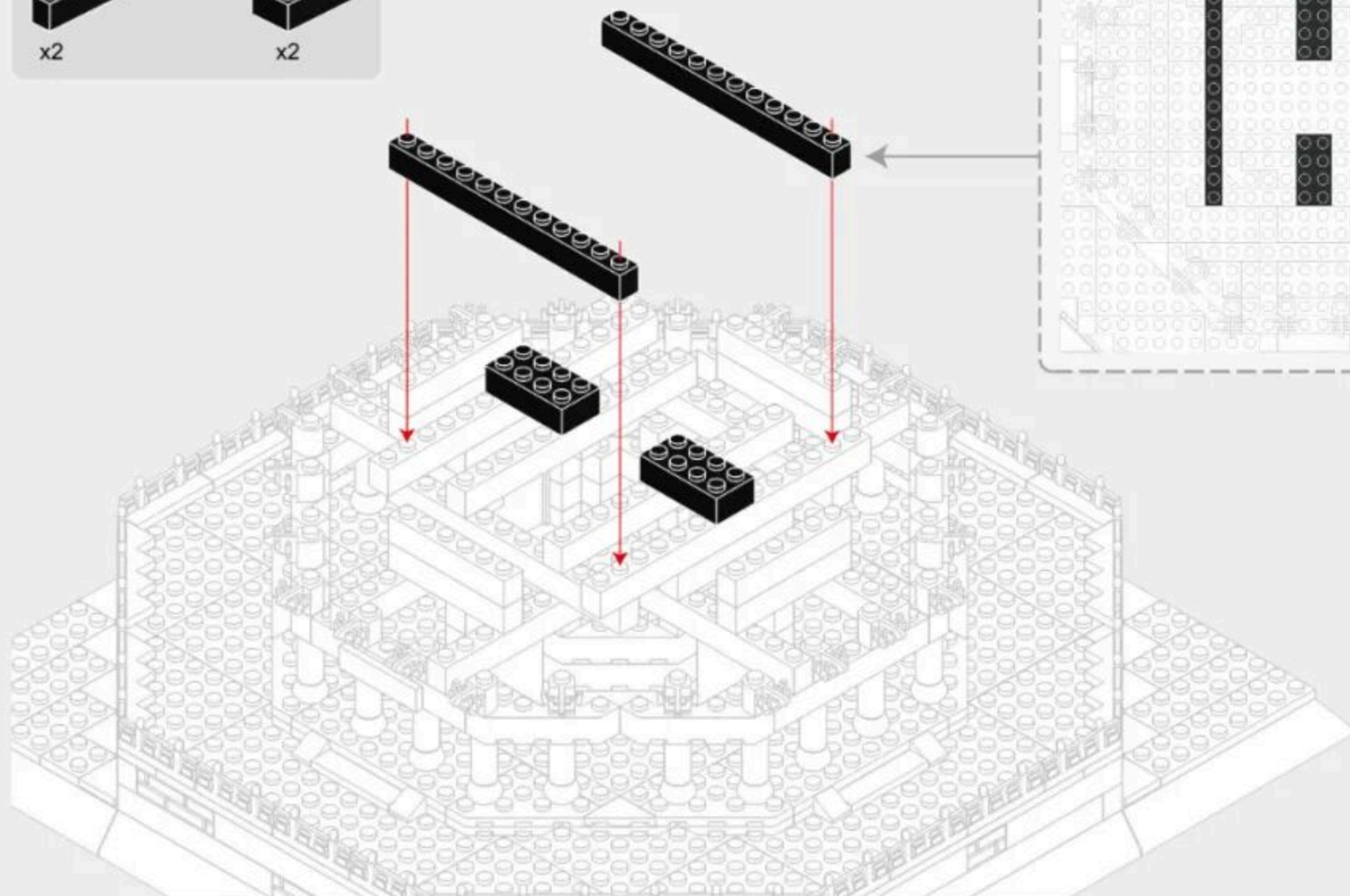
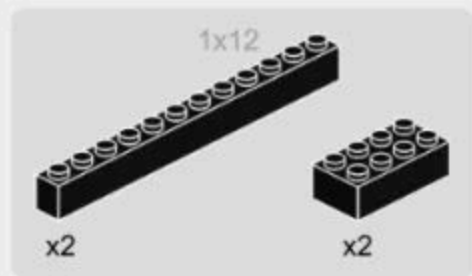

2-12

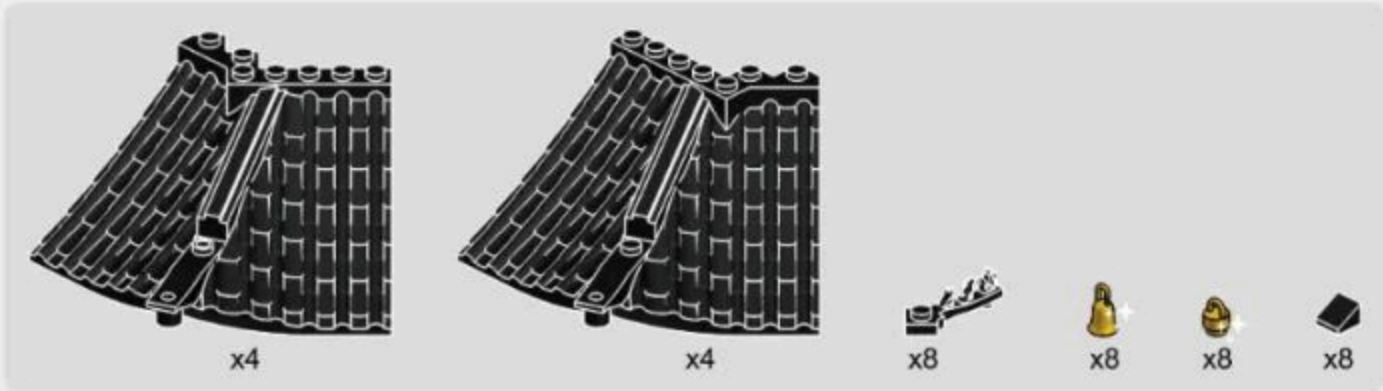

1



2

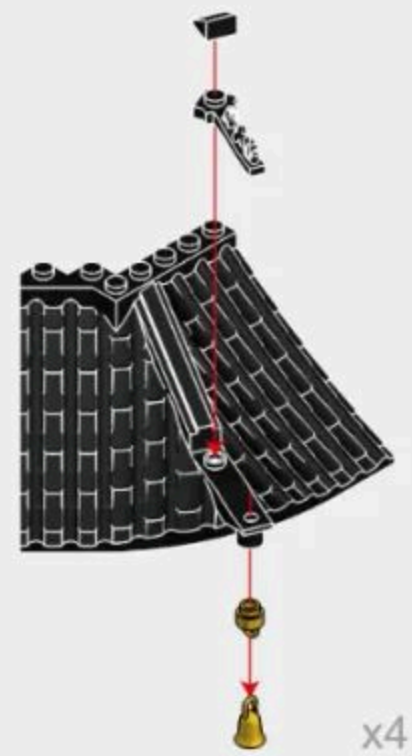

2-13

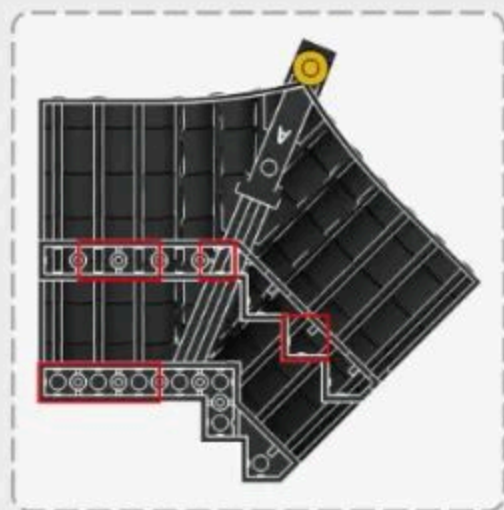

注意：红色框为下方积木孔拼接标示。
Note: The red box indicates the connection point for the bottom block hole.

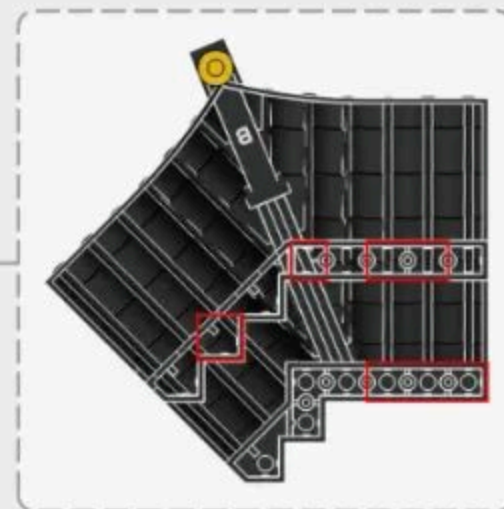

注意：红色框为下方积木孔拼接标示。
Note: The red box indicates the connection point for the bottom block hole.

2-11

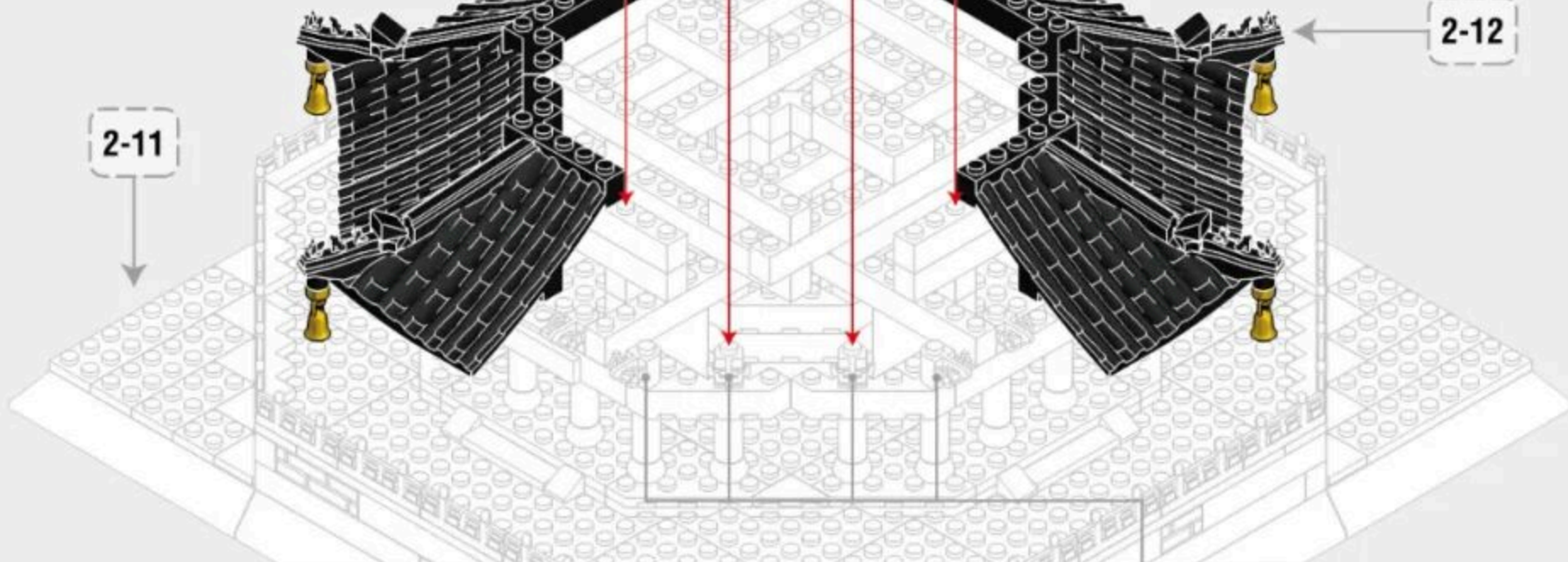

2-12

54

注意：屋檐搭建需扣紧所有的孔位，避免搭建错位。
Note: Ensure all holes are tightly connected when assembling the eaves to avoid misalignment.

2-14

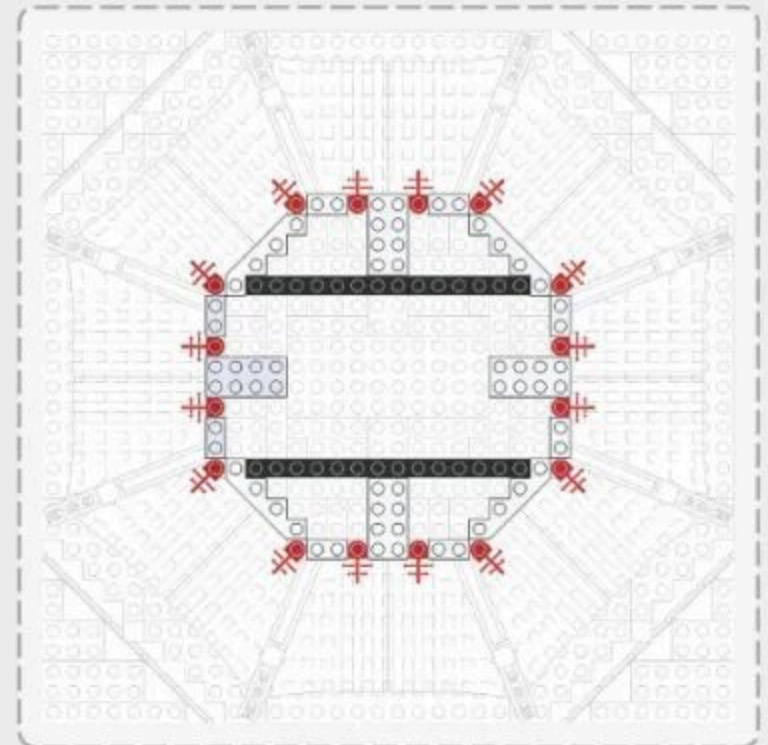
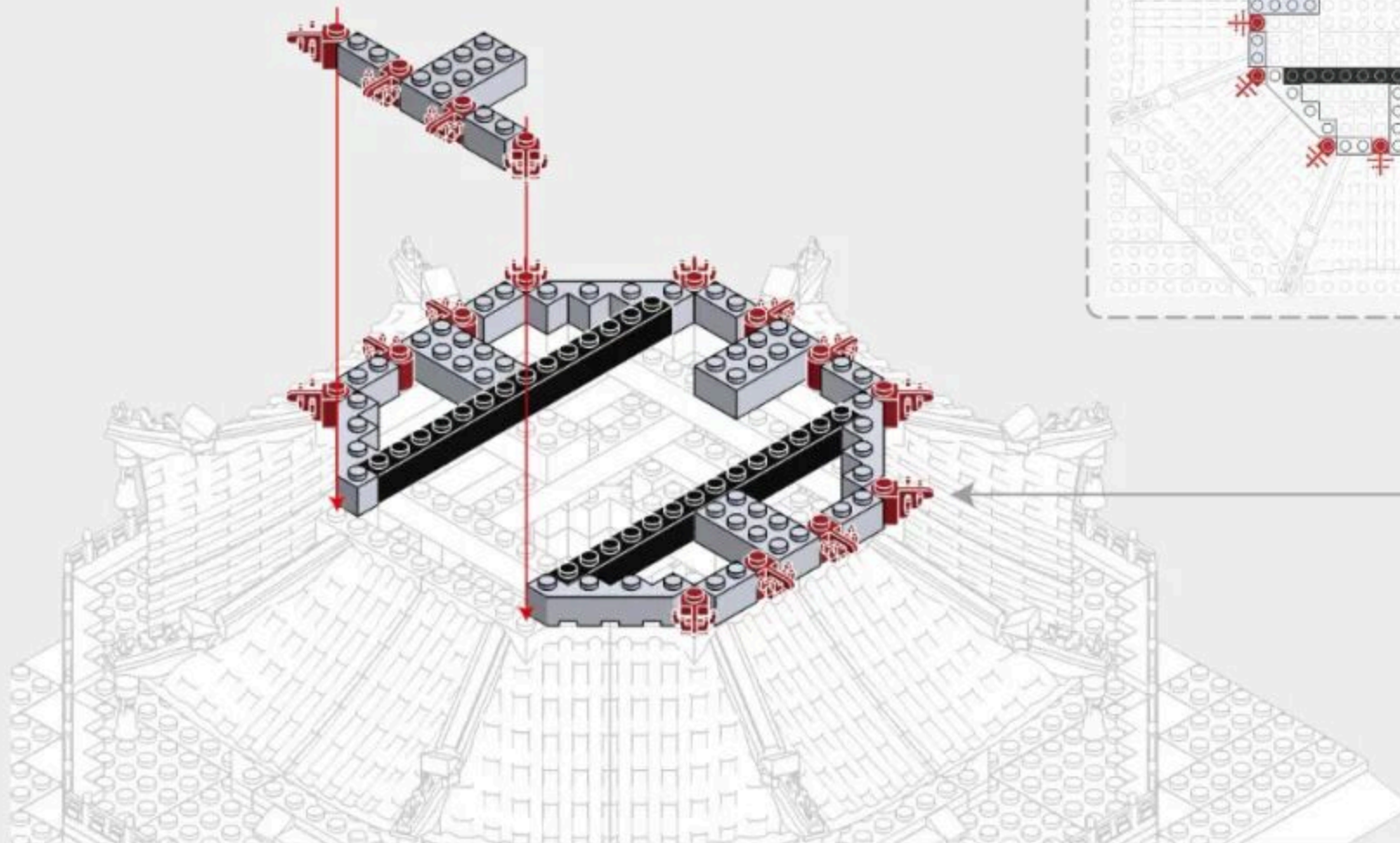
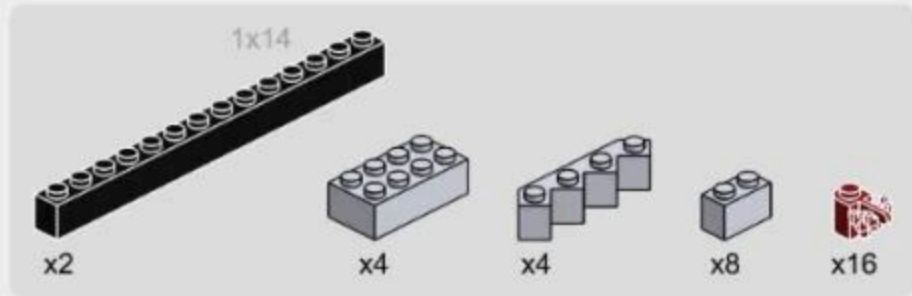

2-15

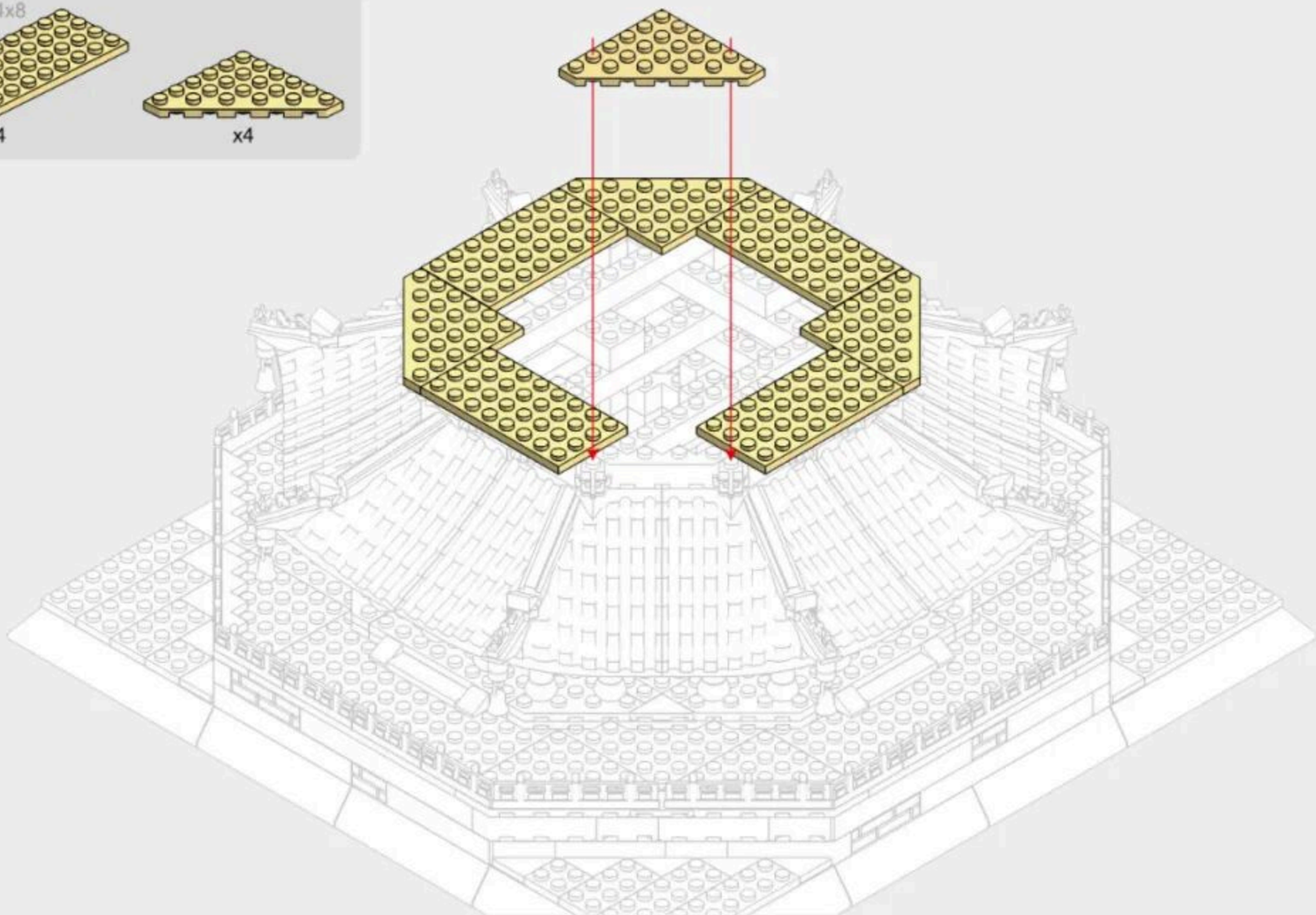
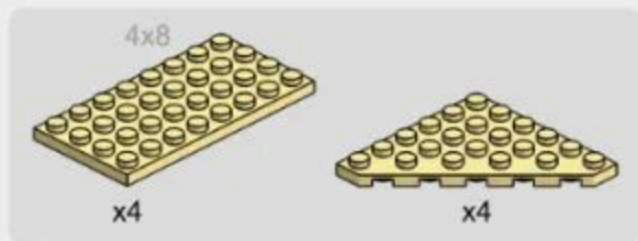

2-16

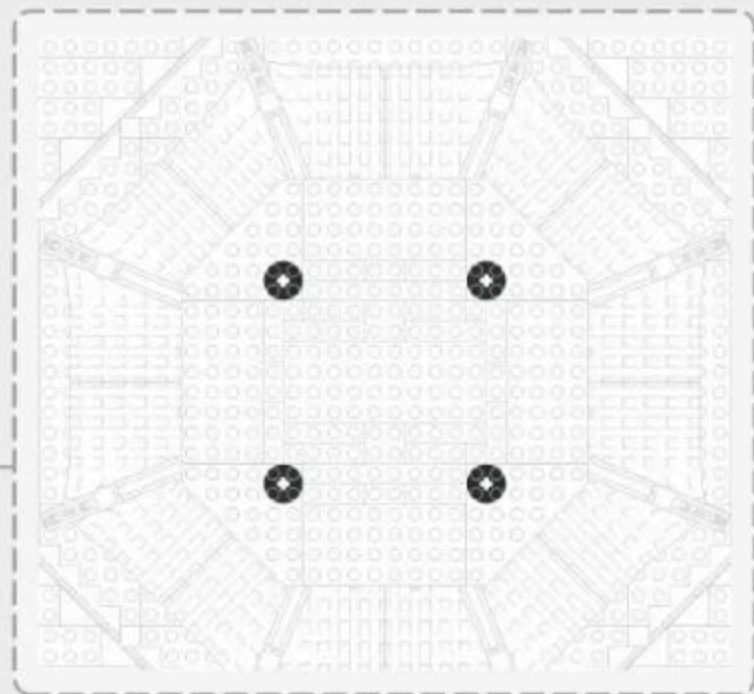
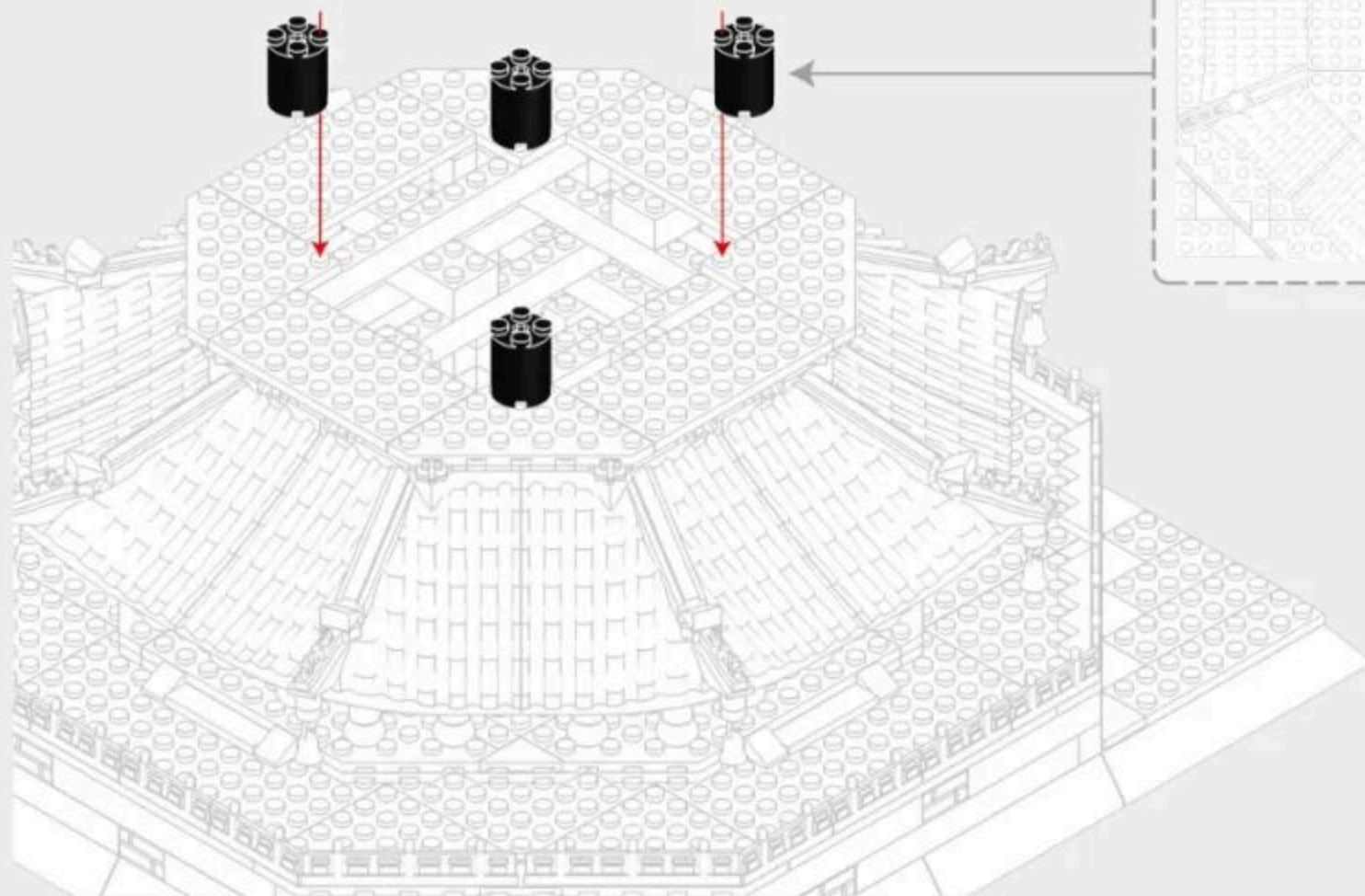

2-17

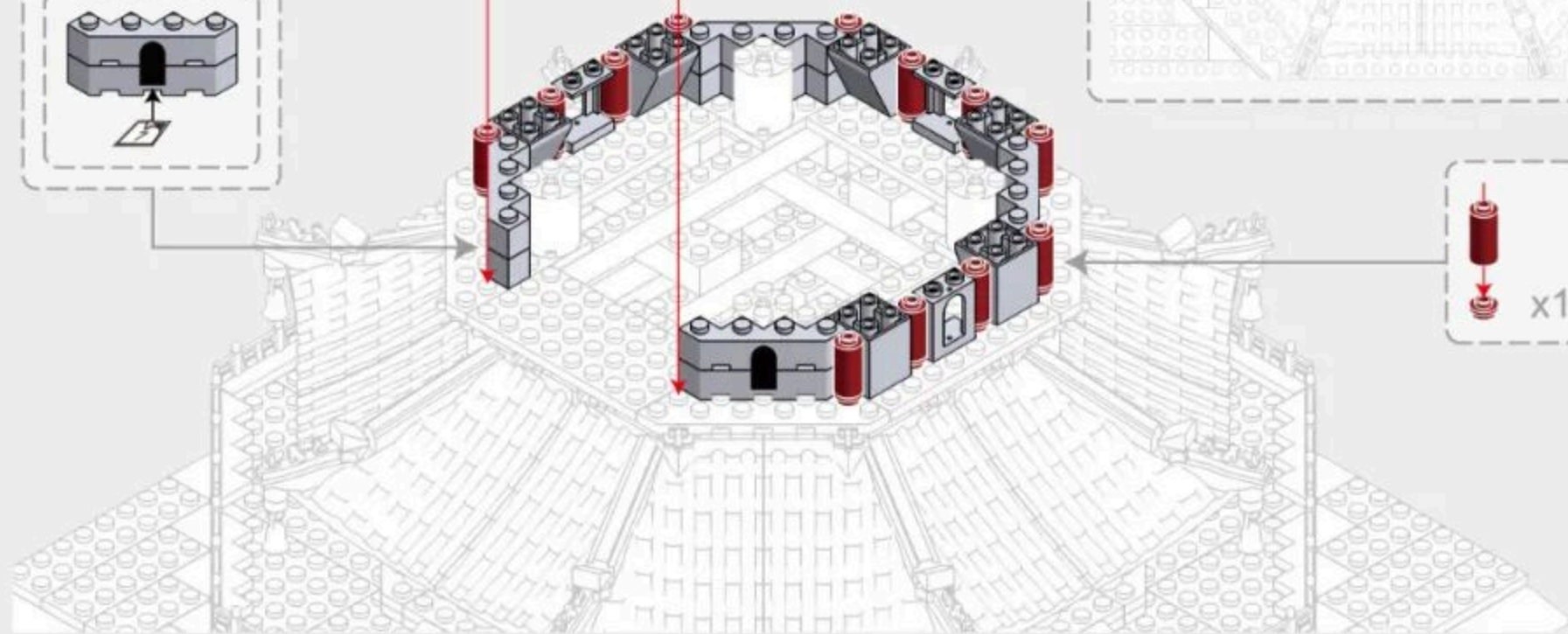
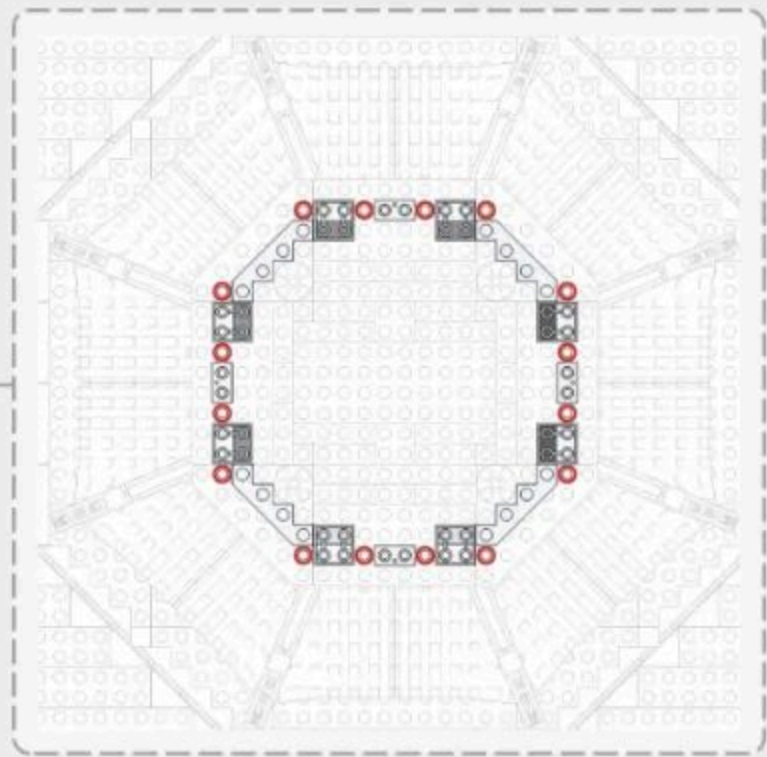
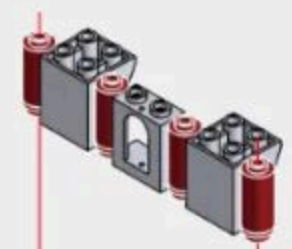
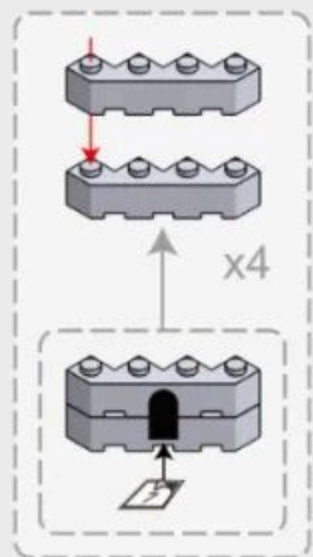
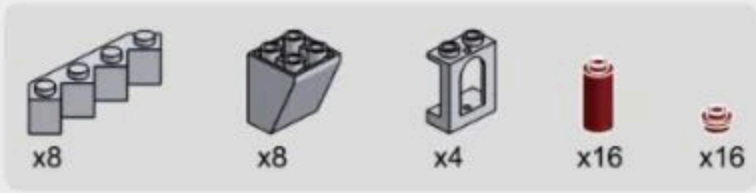



276PCS



3-1

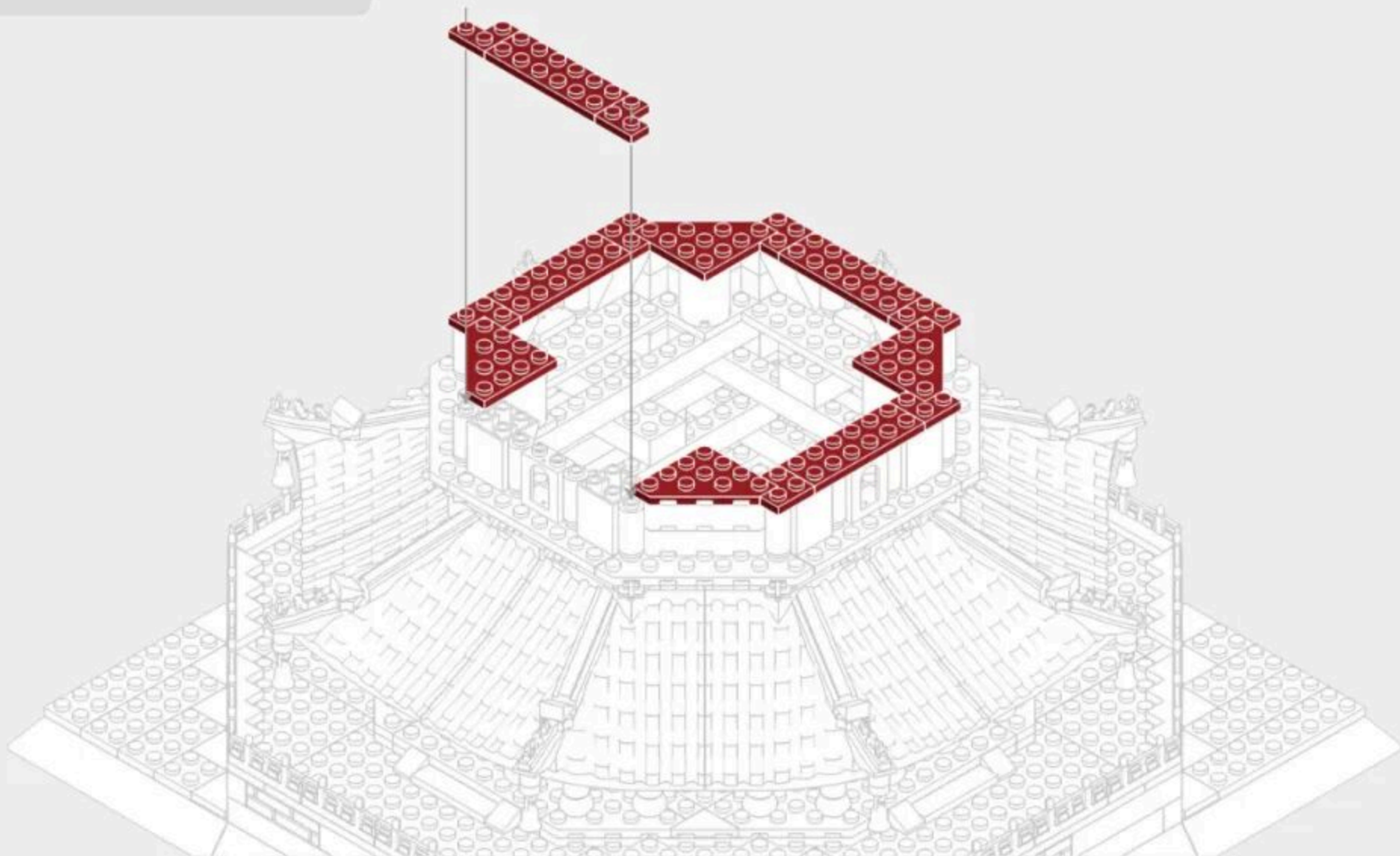

3-2

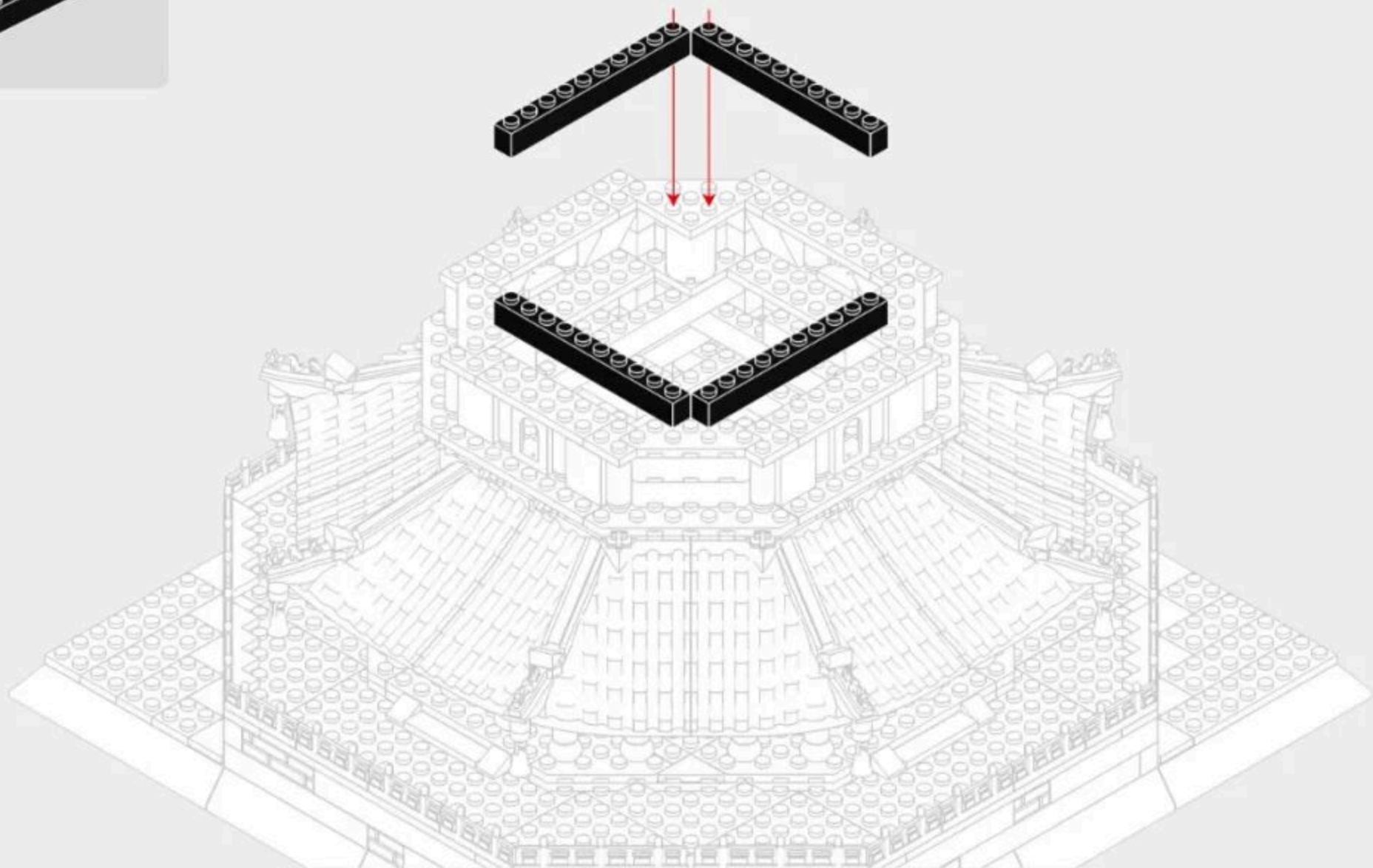
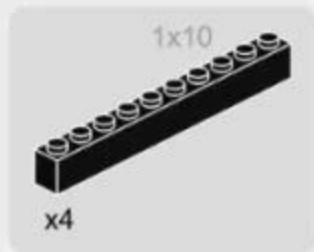

3-3

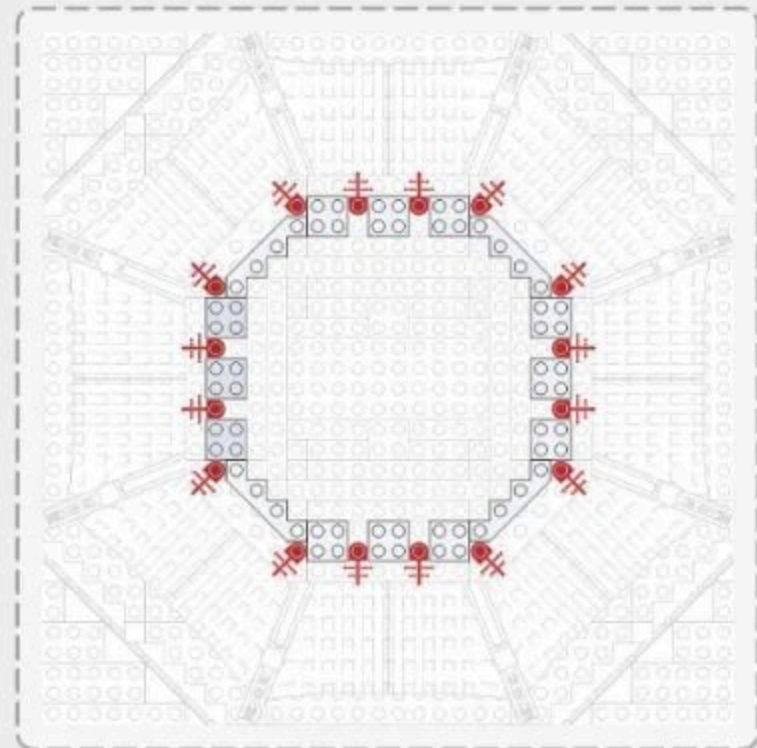
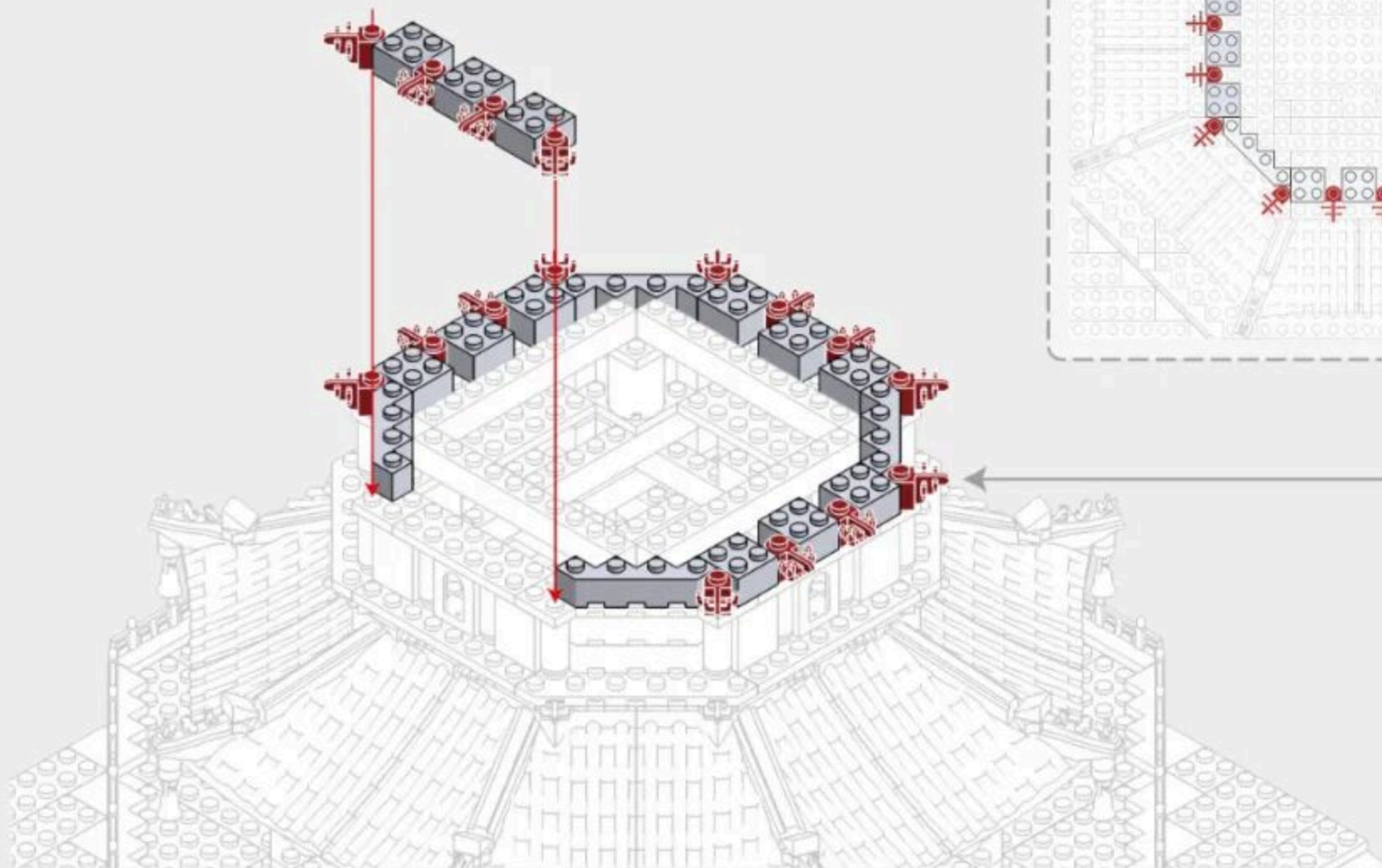
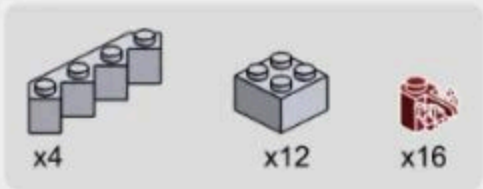

3-4

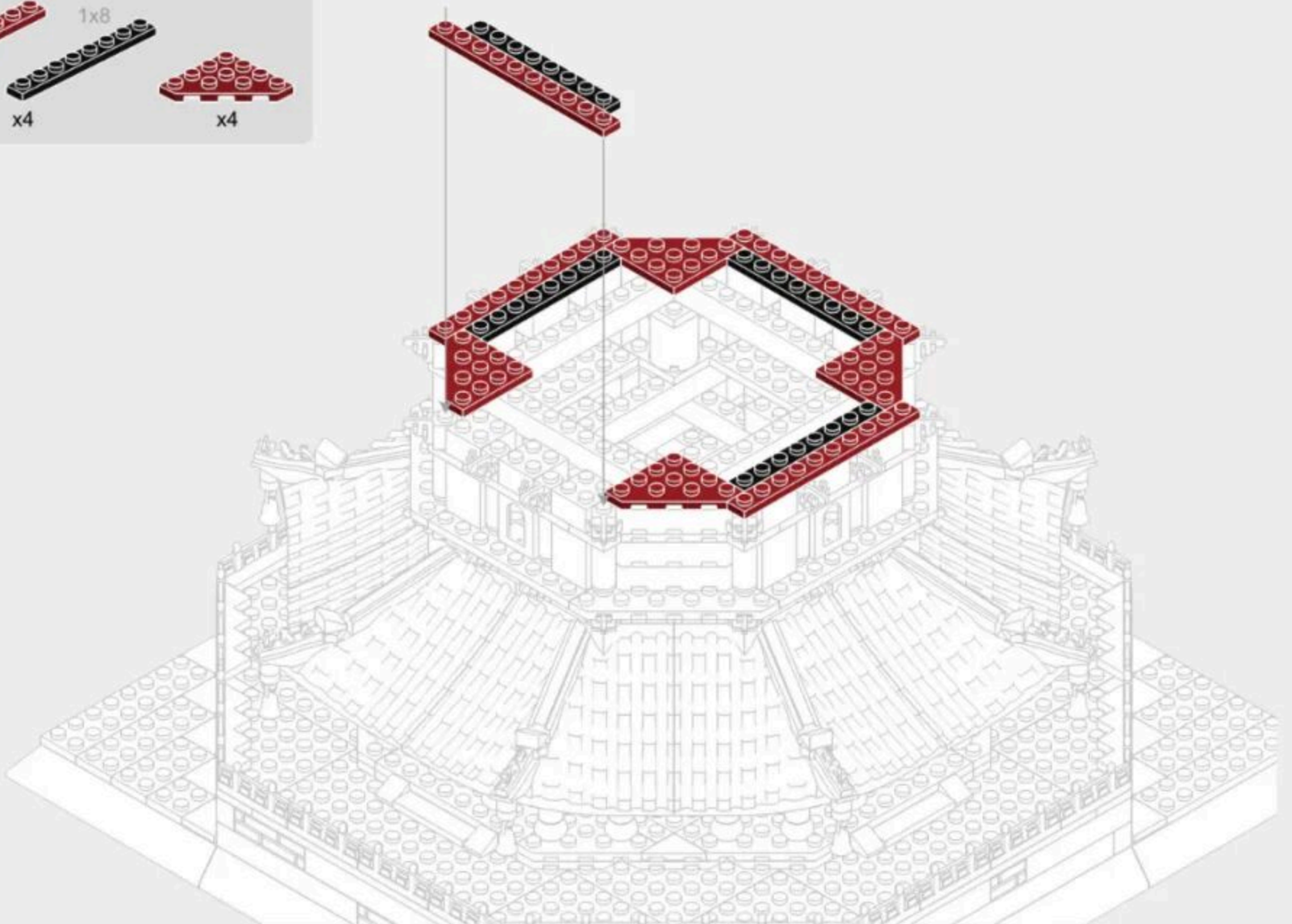
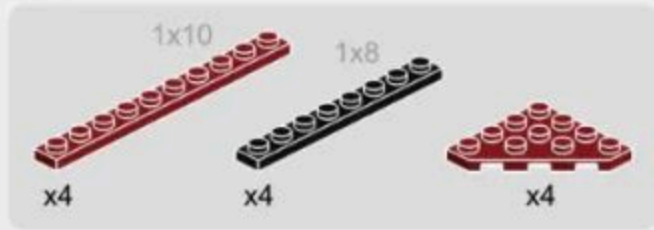

3-5

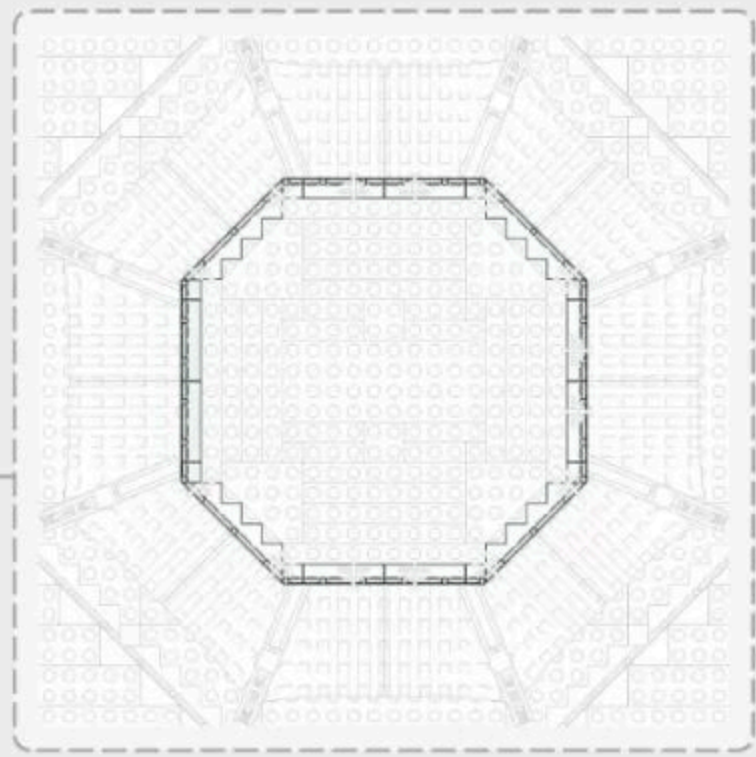
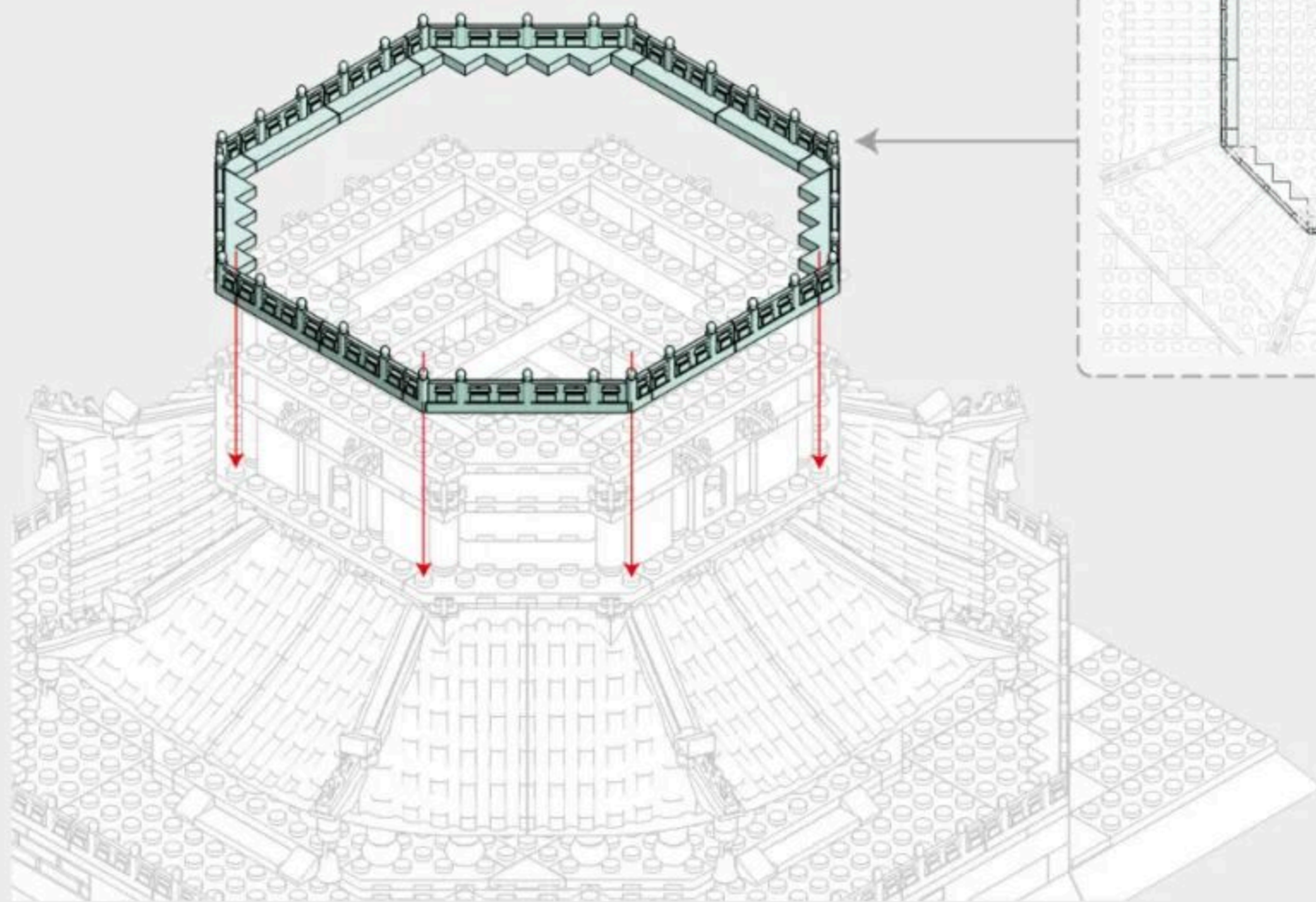

3-6

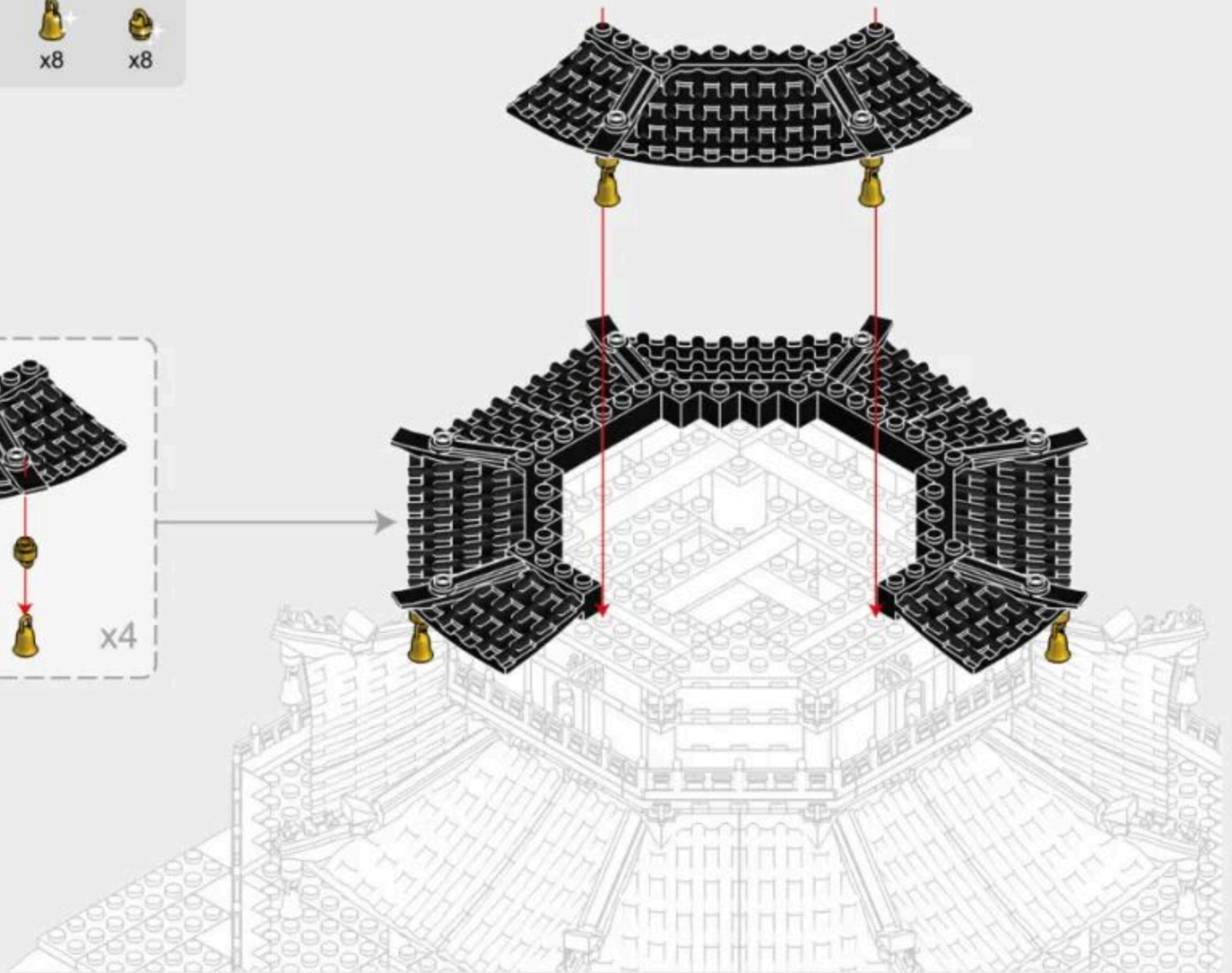
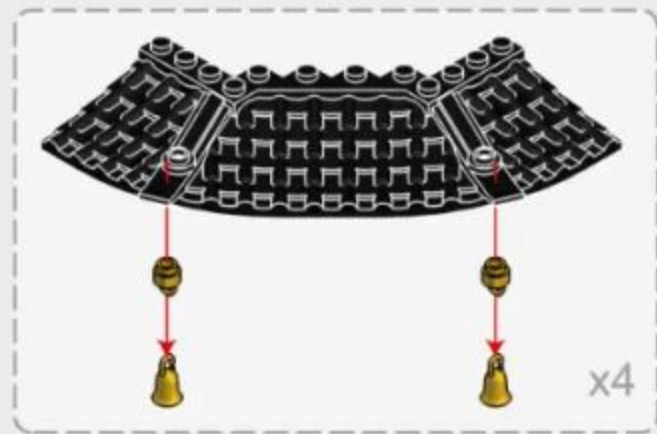

3-8

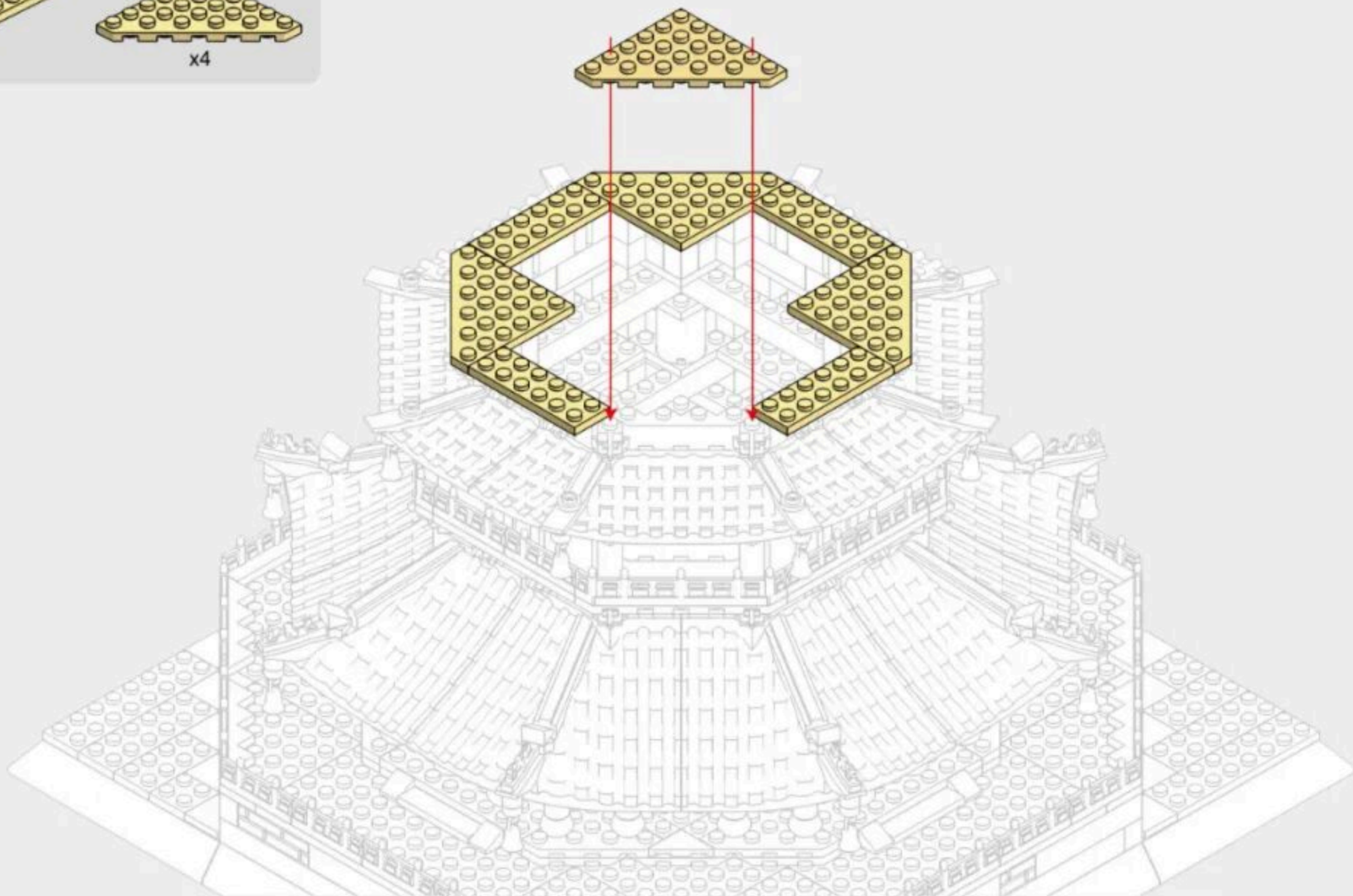
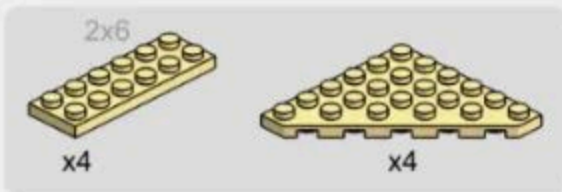

3-9

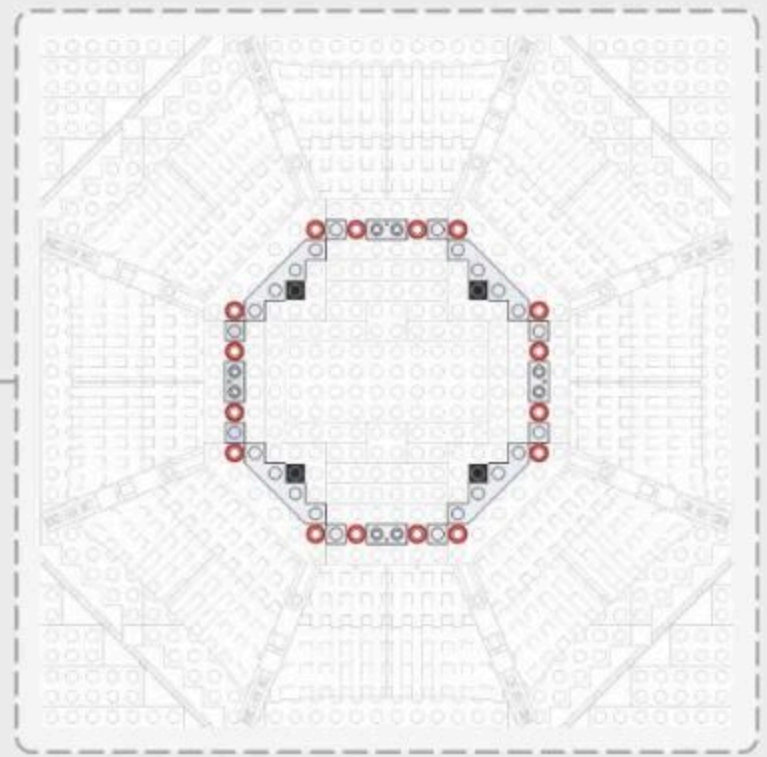
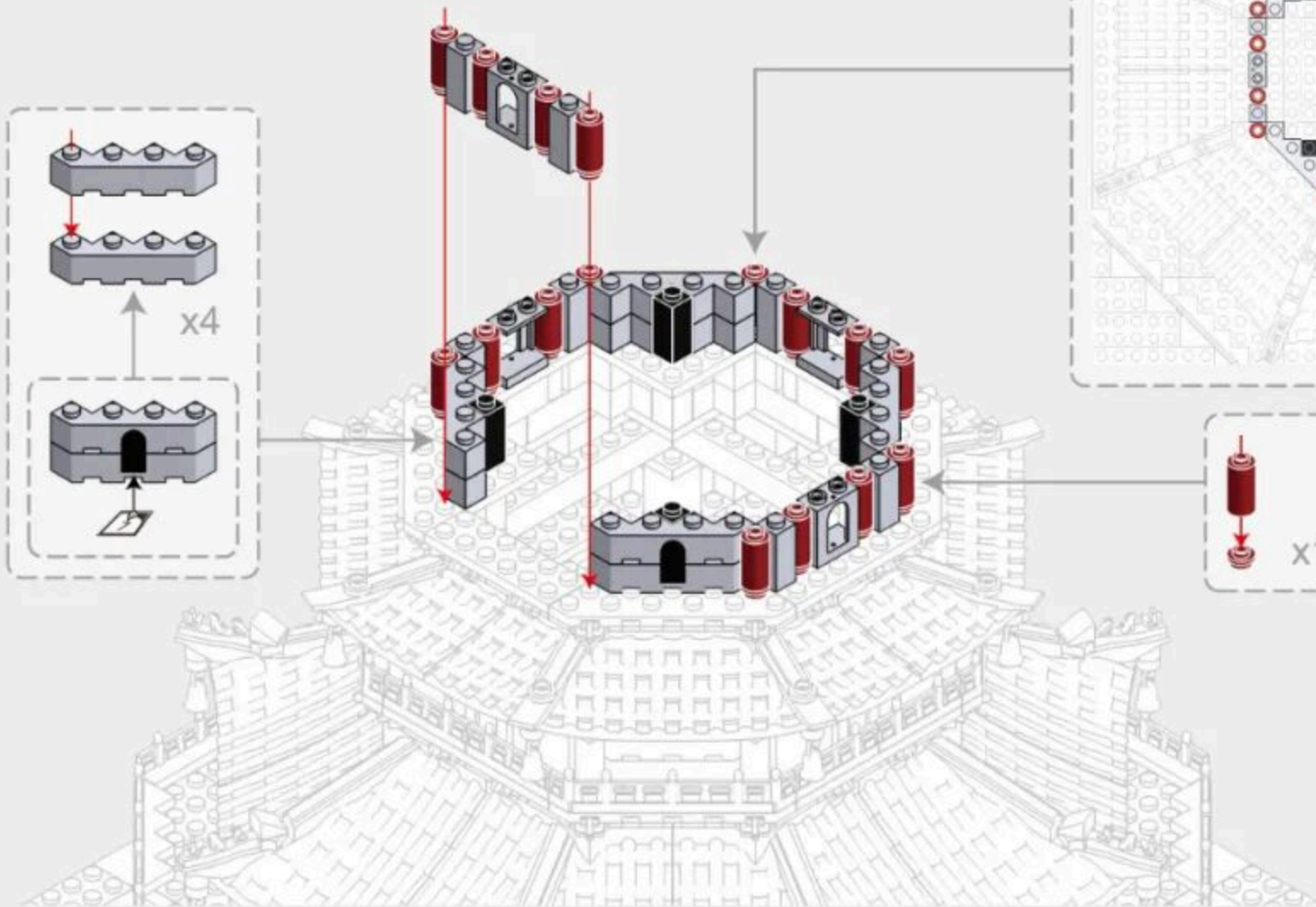
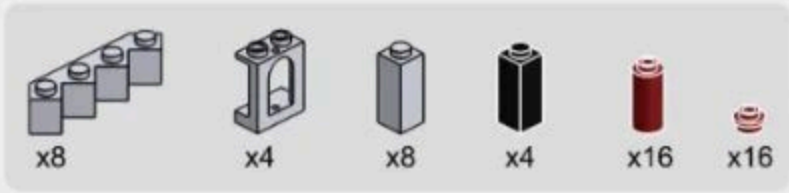

3-10

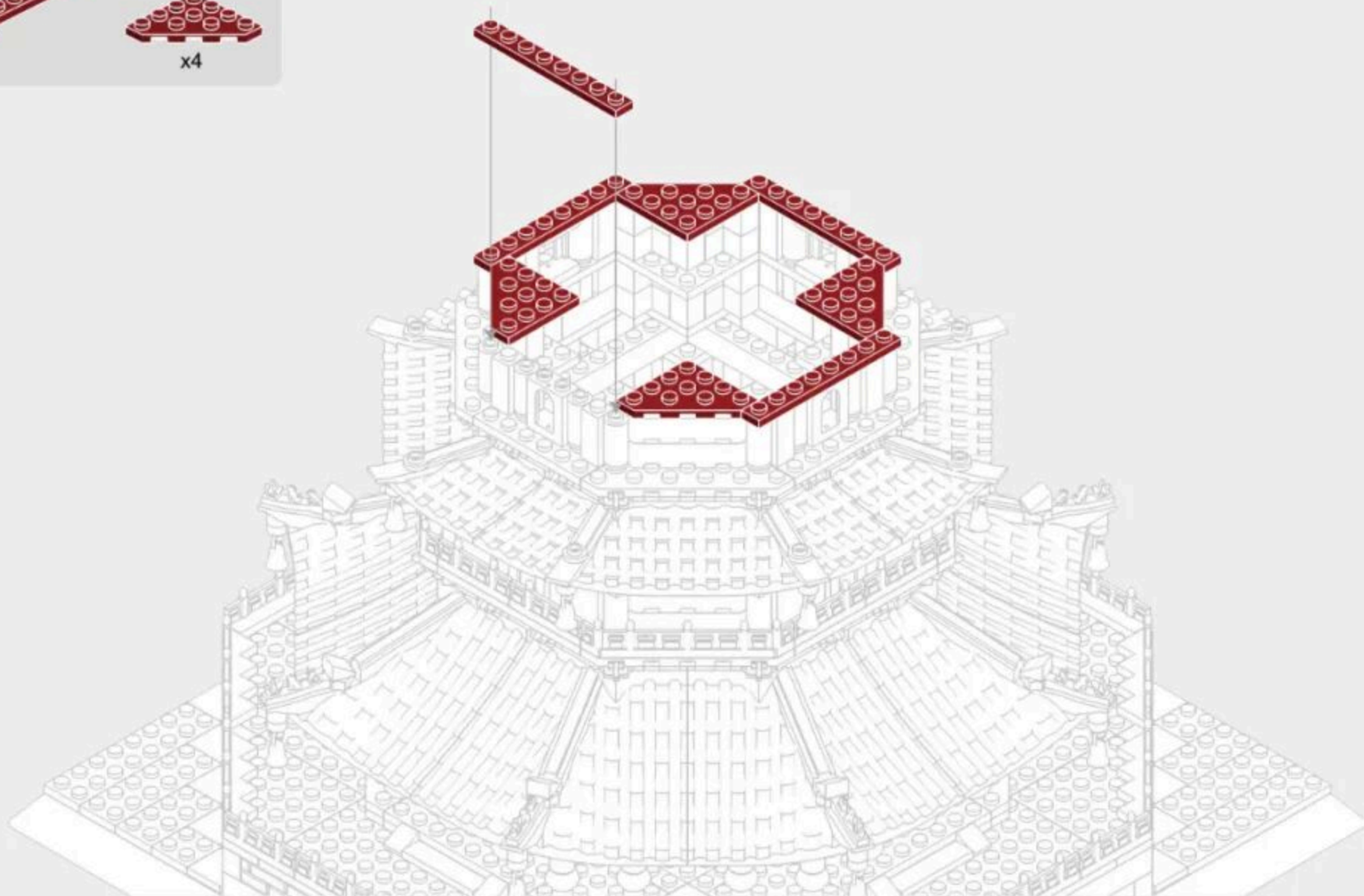

3-11

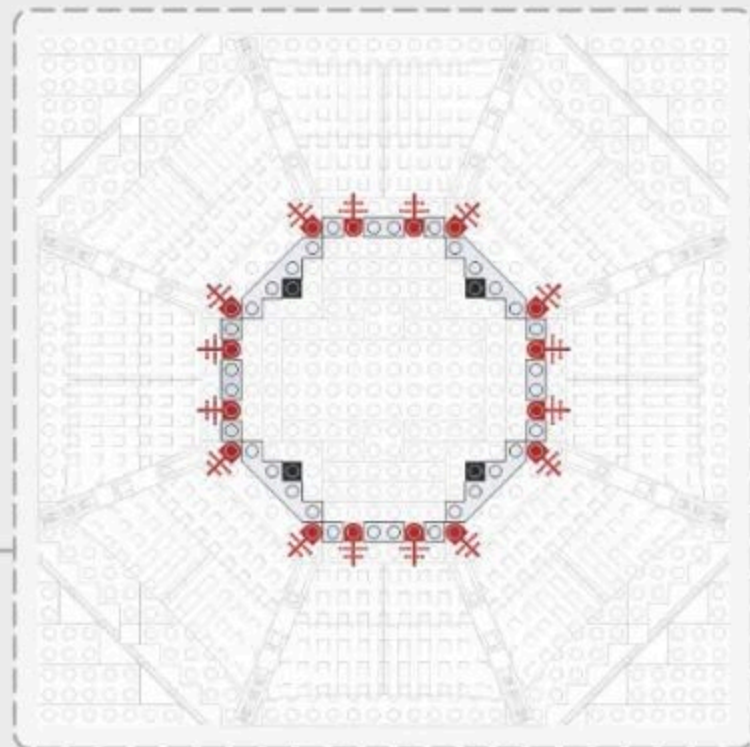
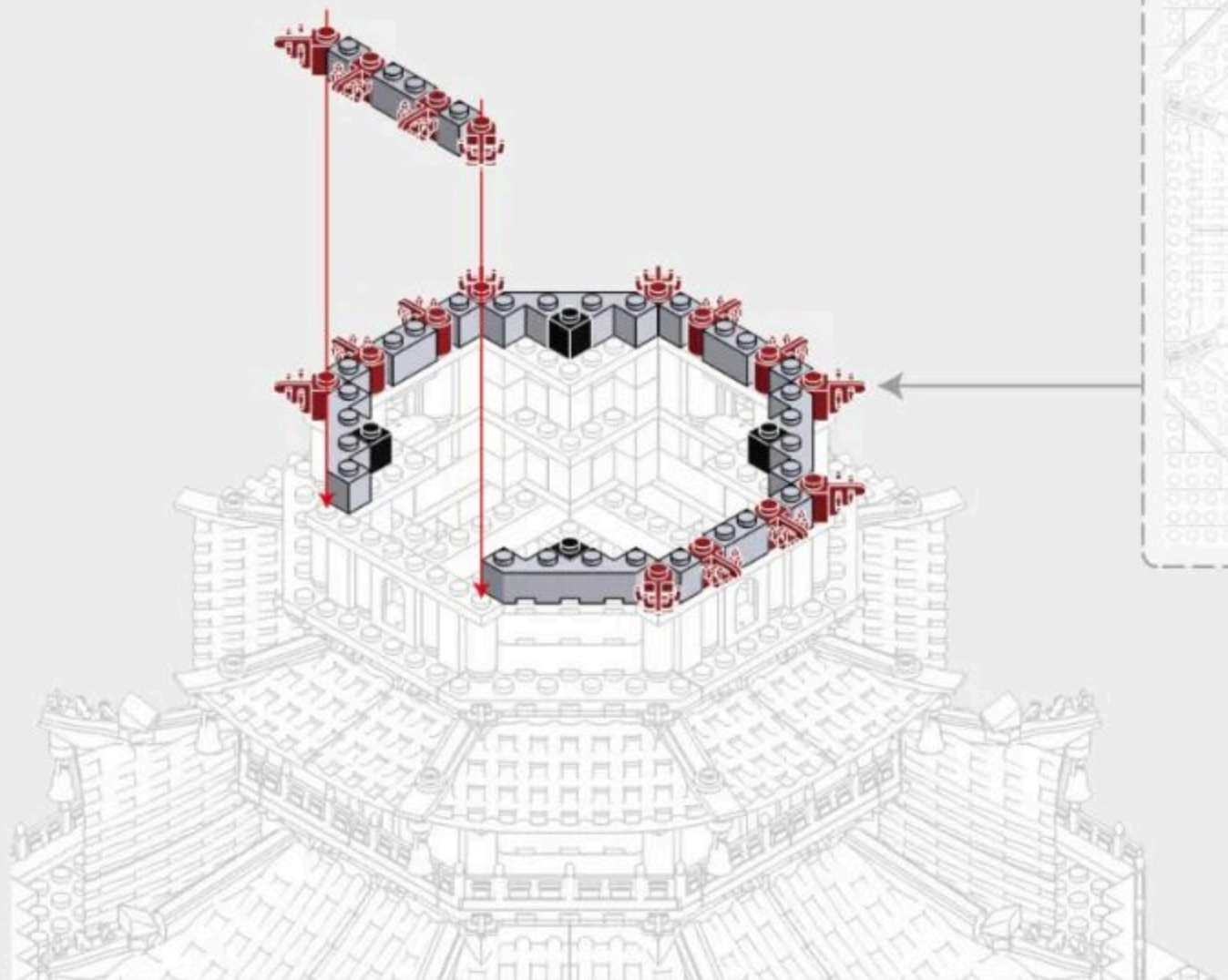
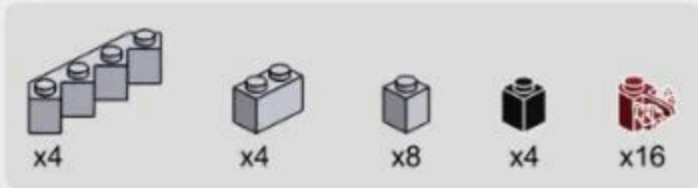

3-12

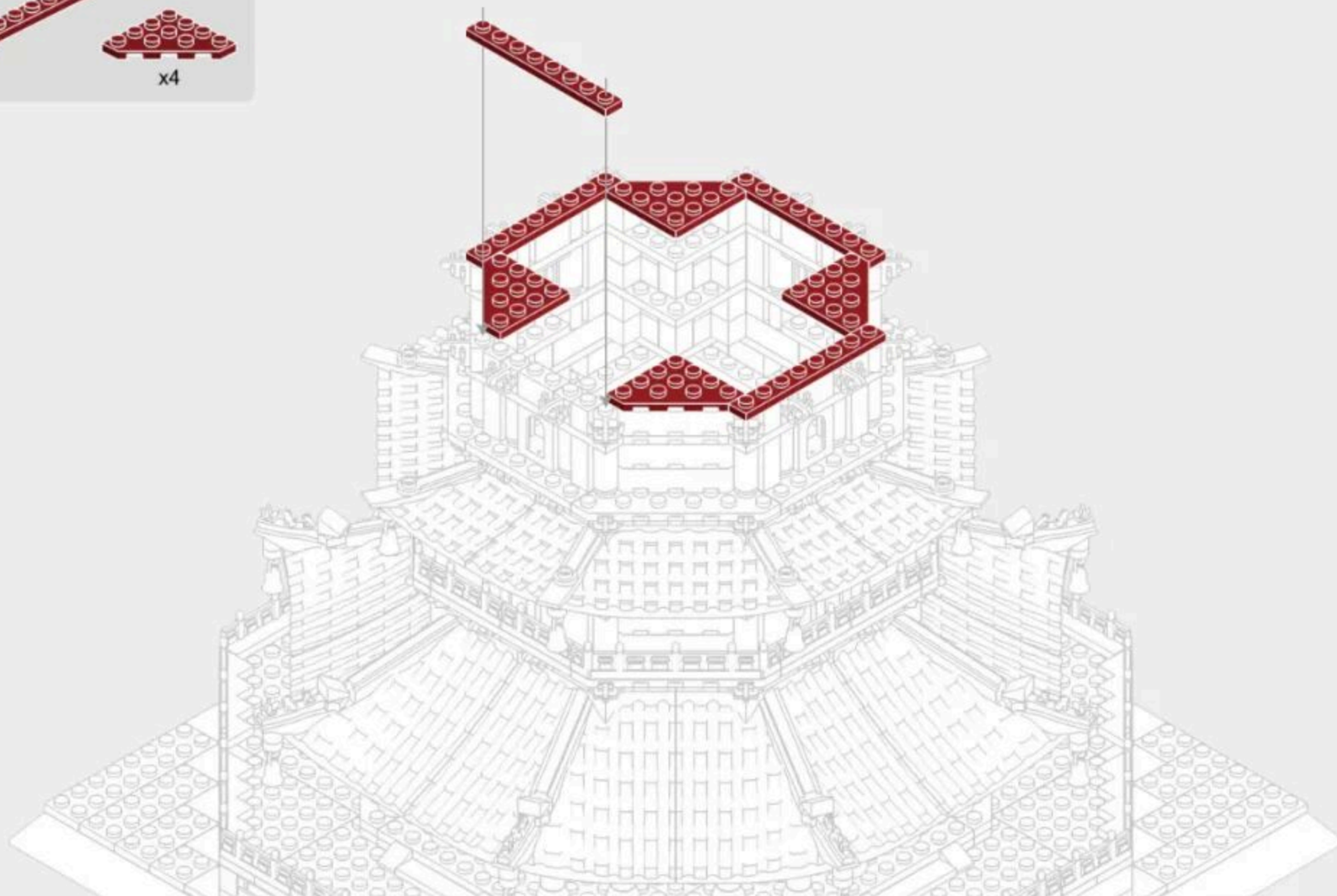
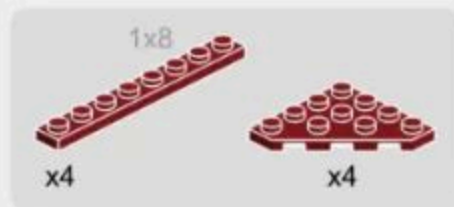

3-13



x4



x4



x4



x4



x4

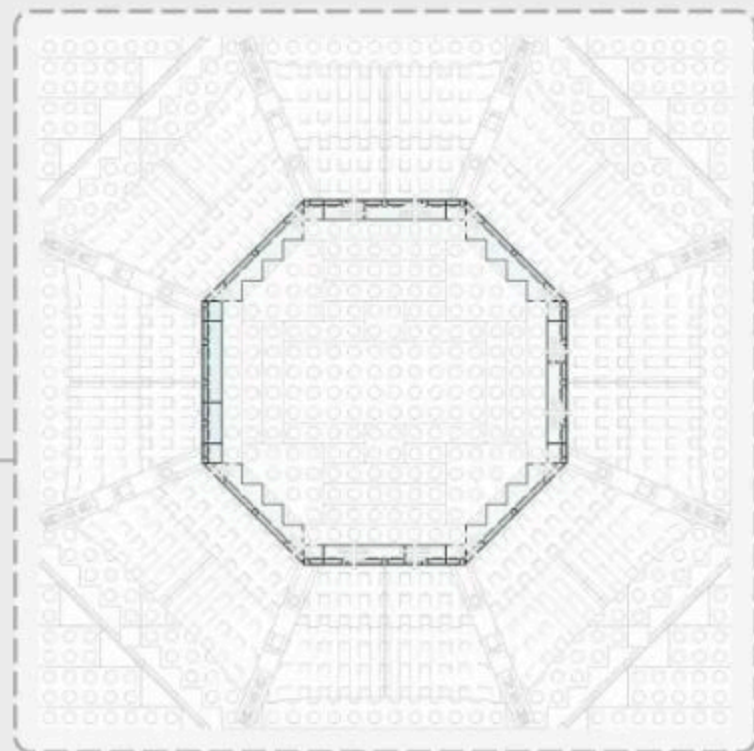
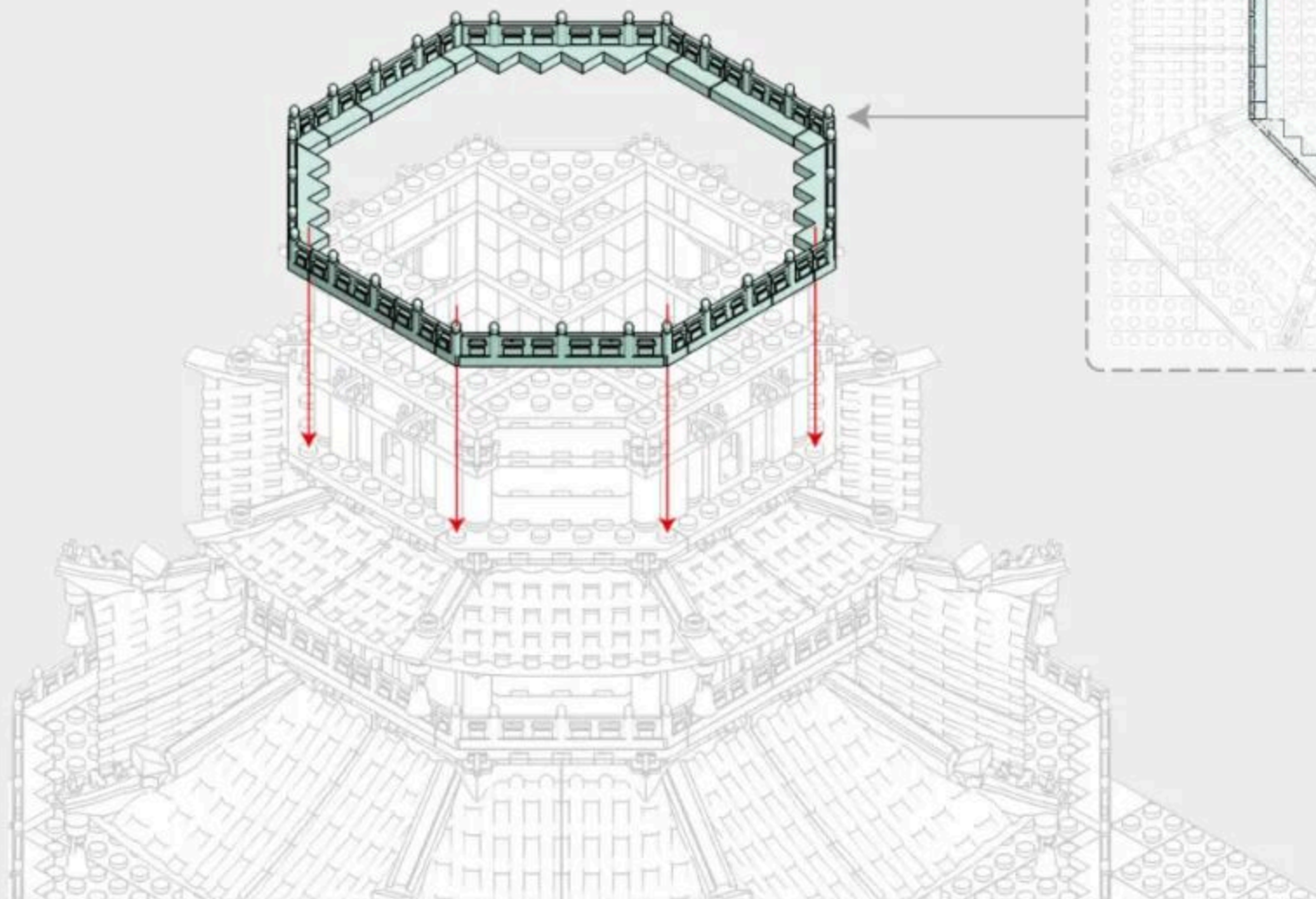



260PCS

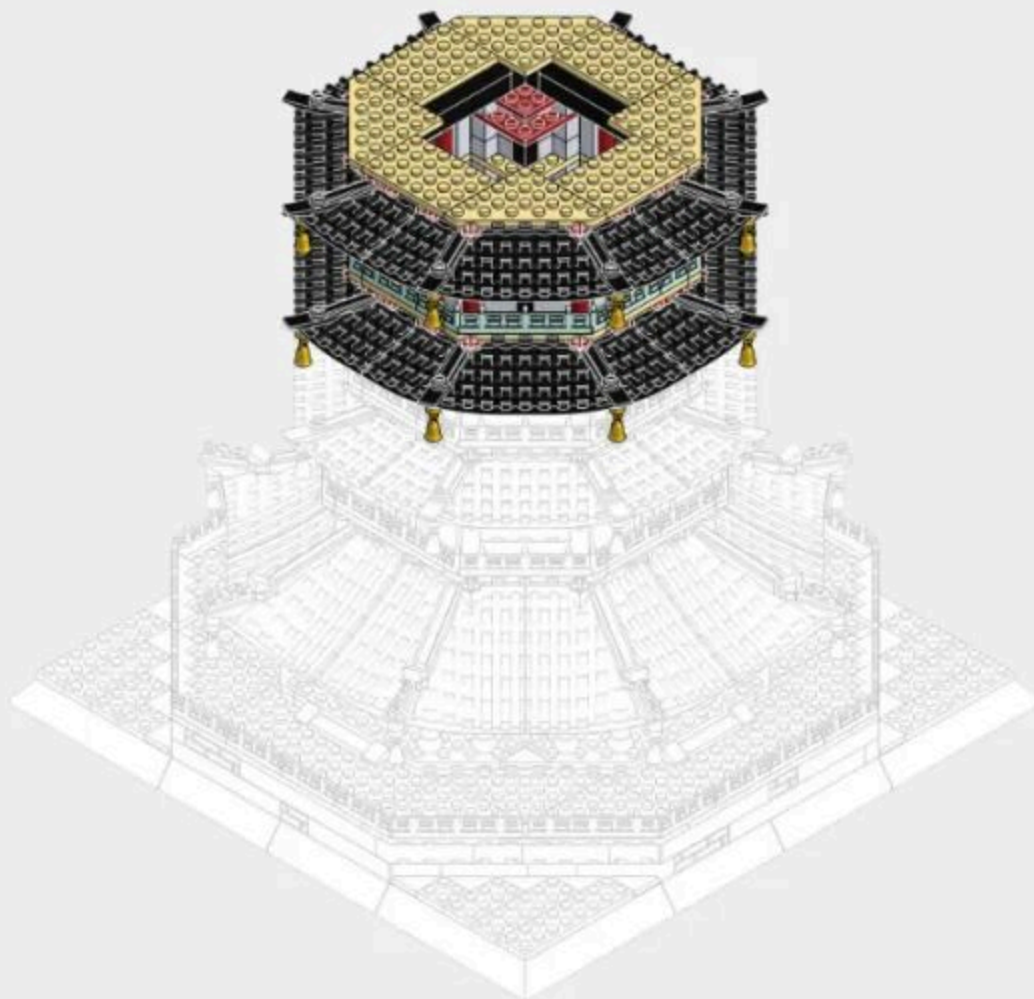

73

4-1

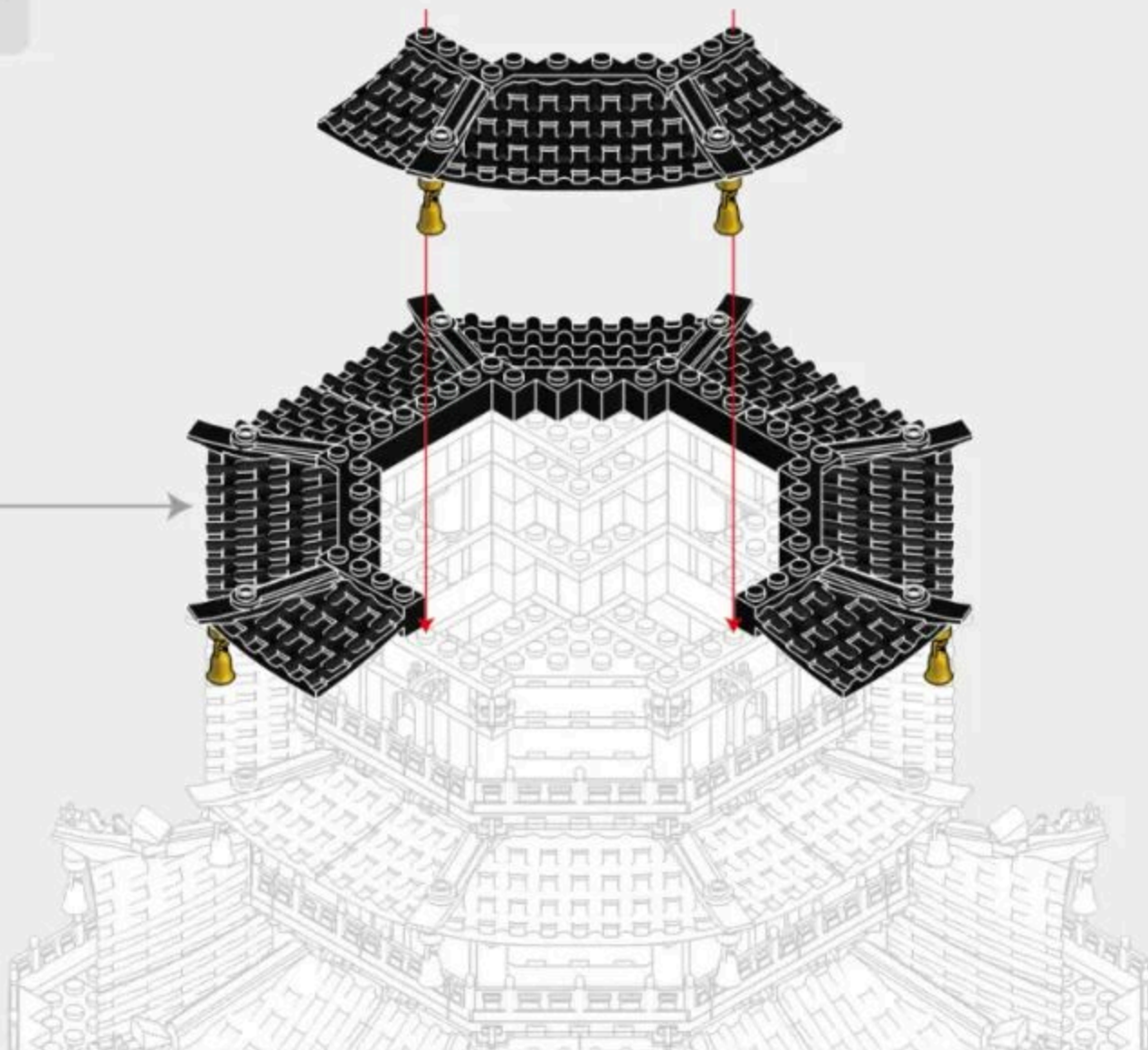
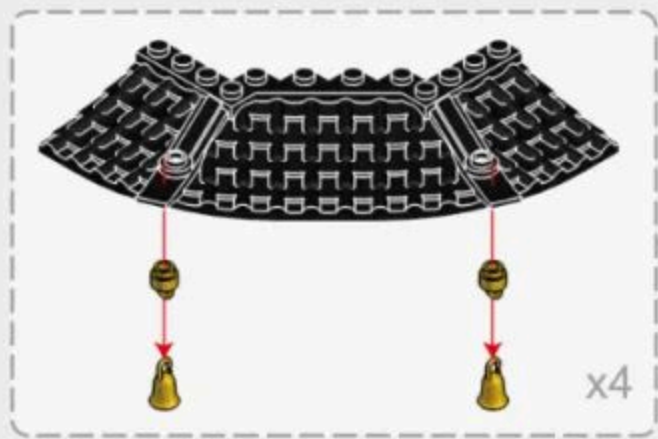

4-2



x4



x4



x4



x16



x8

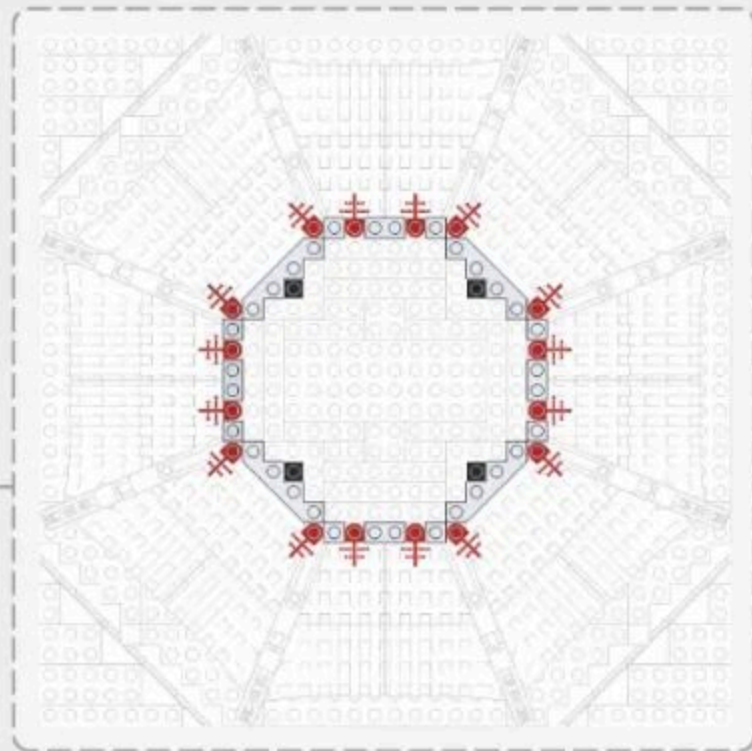
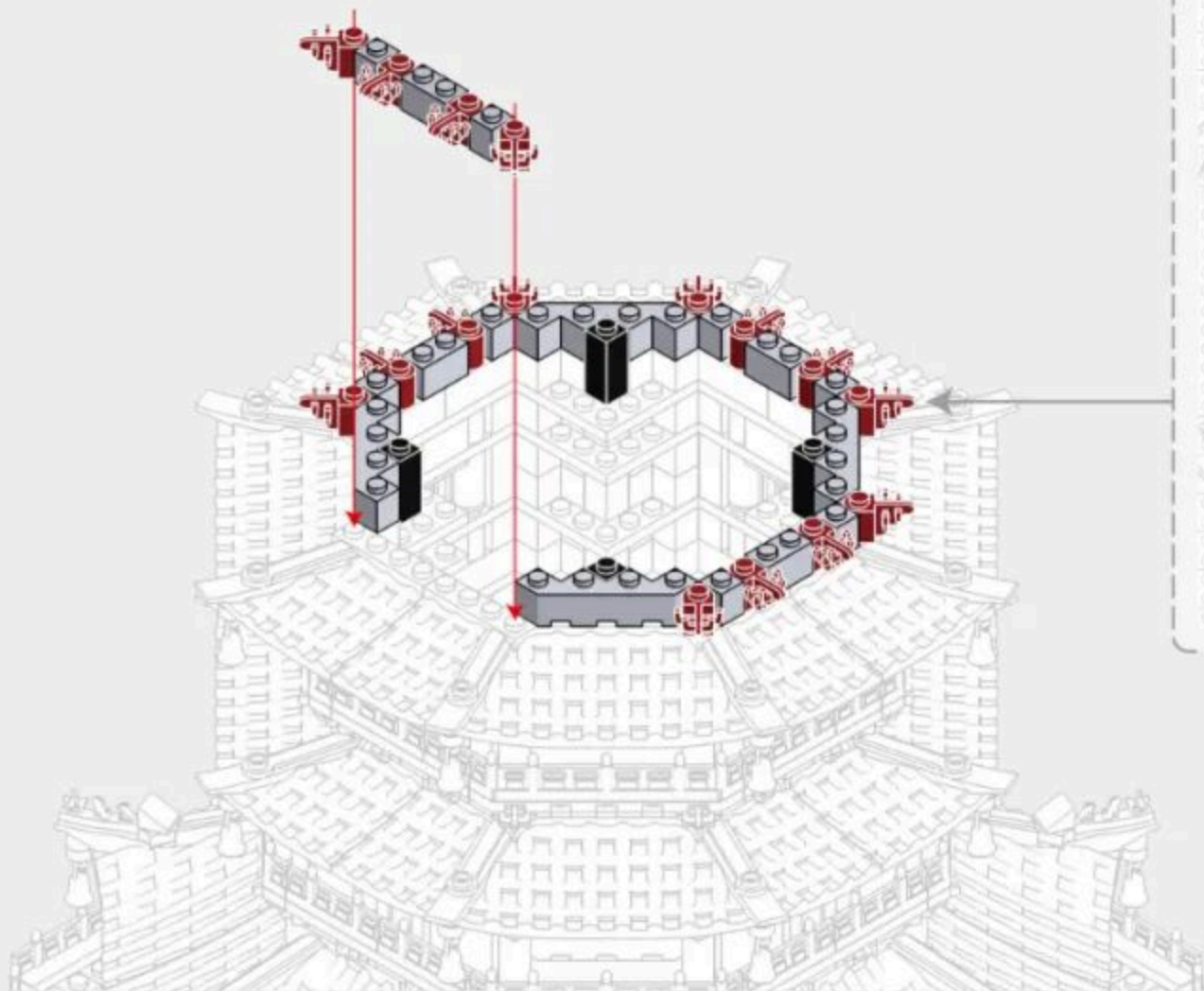

4-3

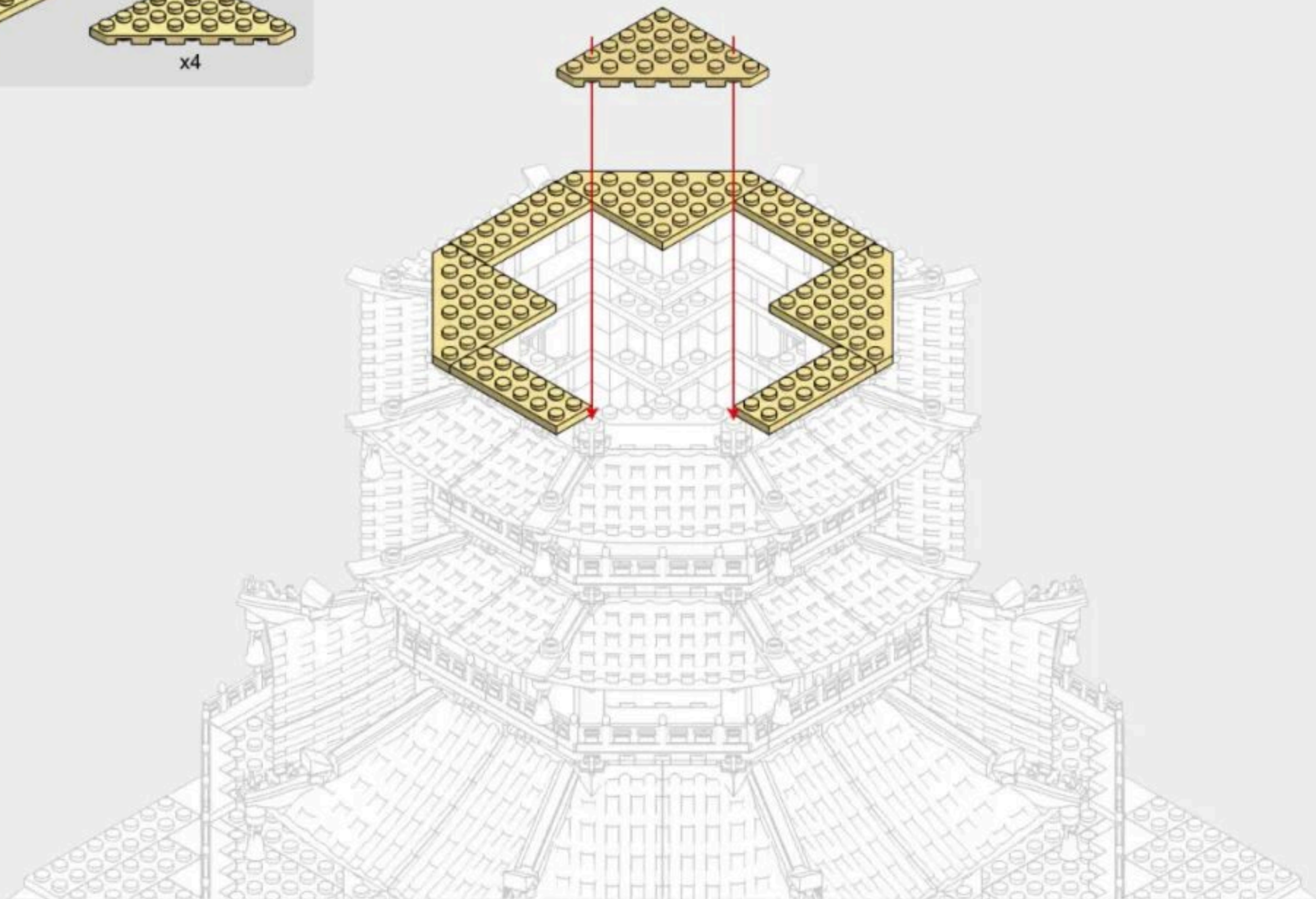

4-4

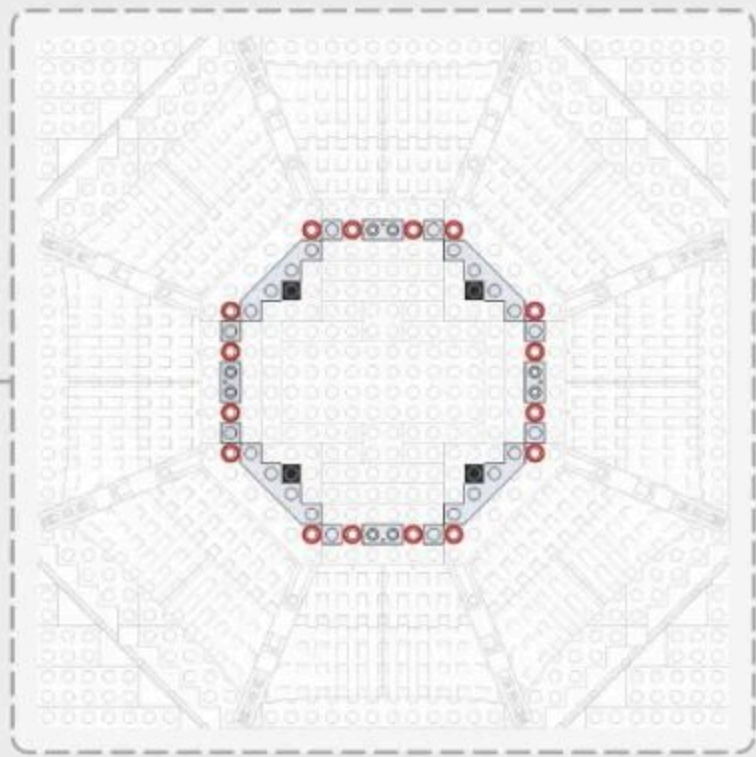
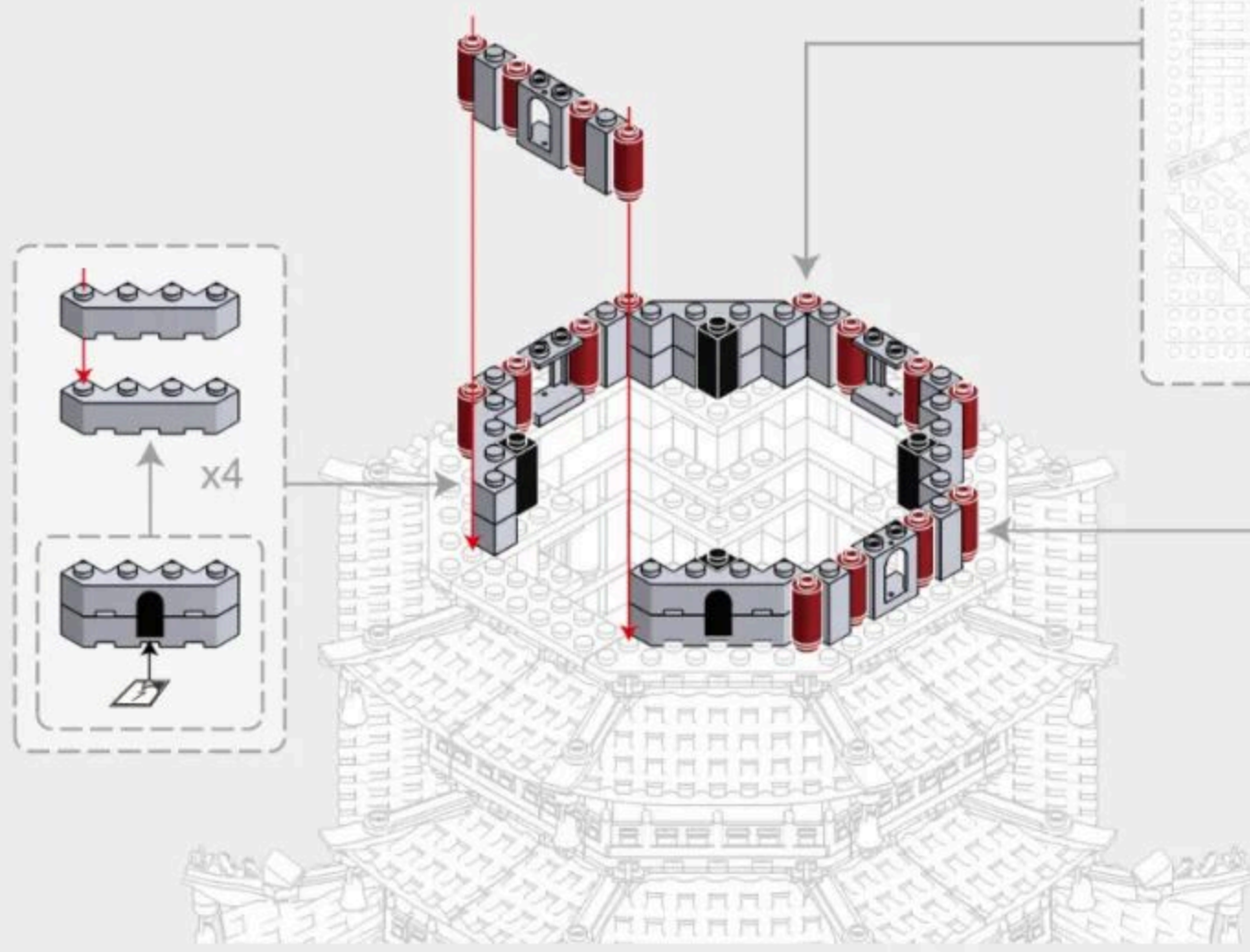
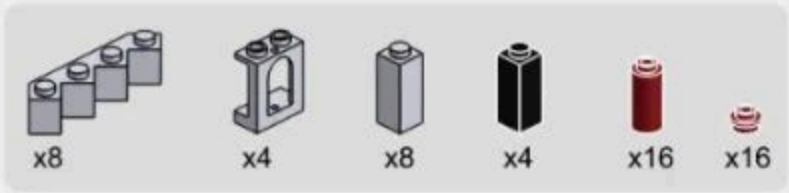

4-5

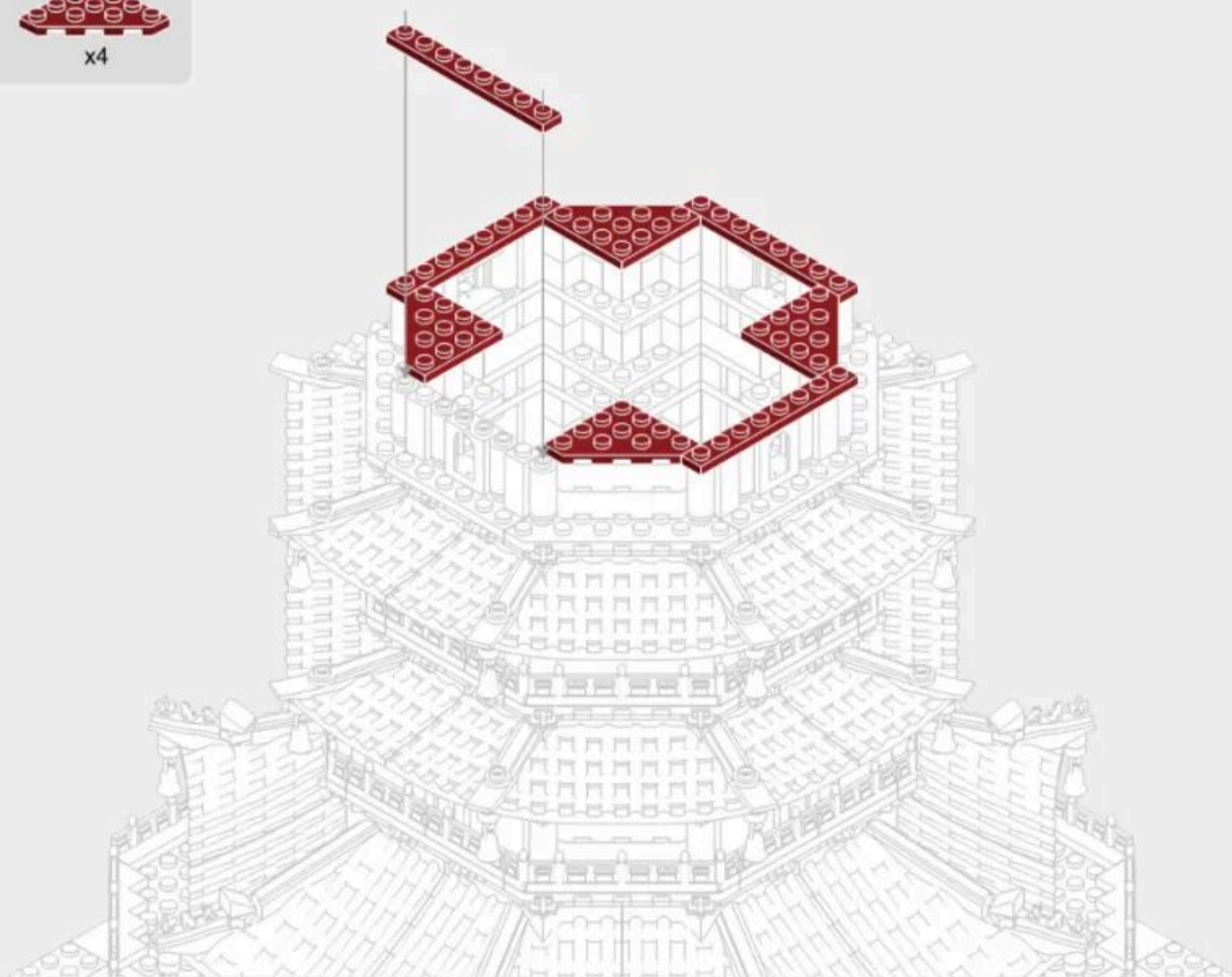

4-6



x4



x4



x8



x4



x16

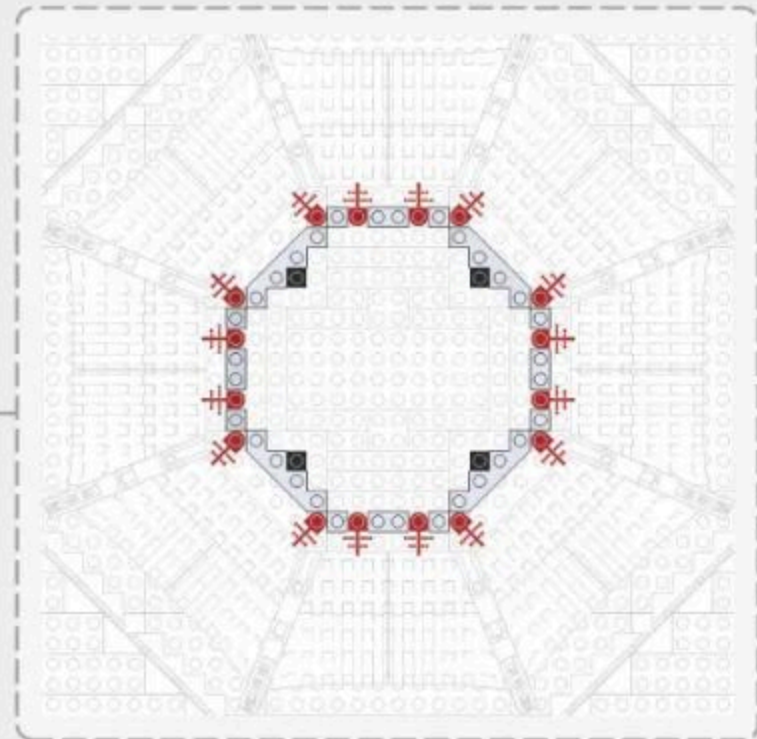
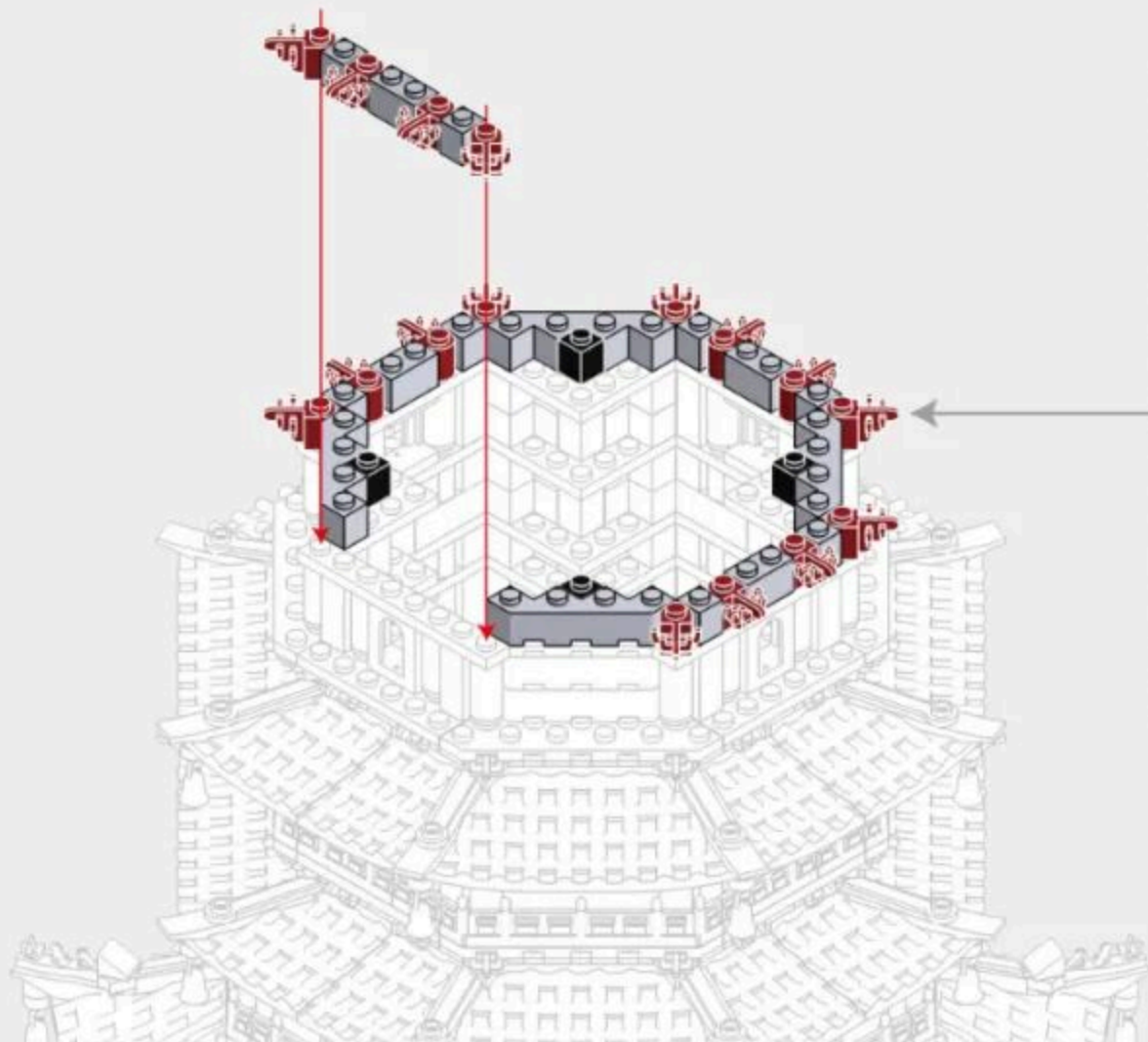

4-7

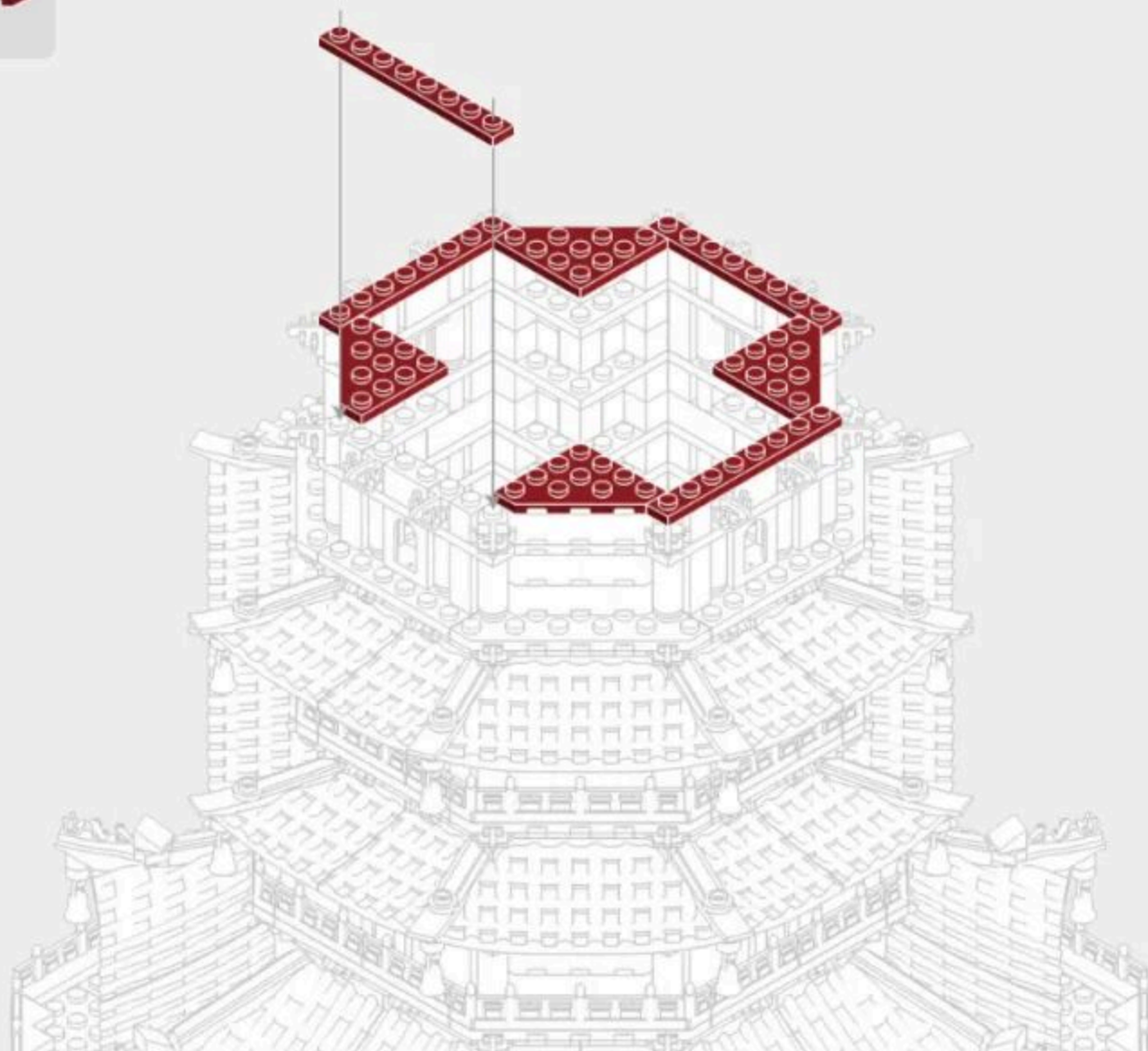

4-8



x4



x4



x4



x4



x4

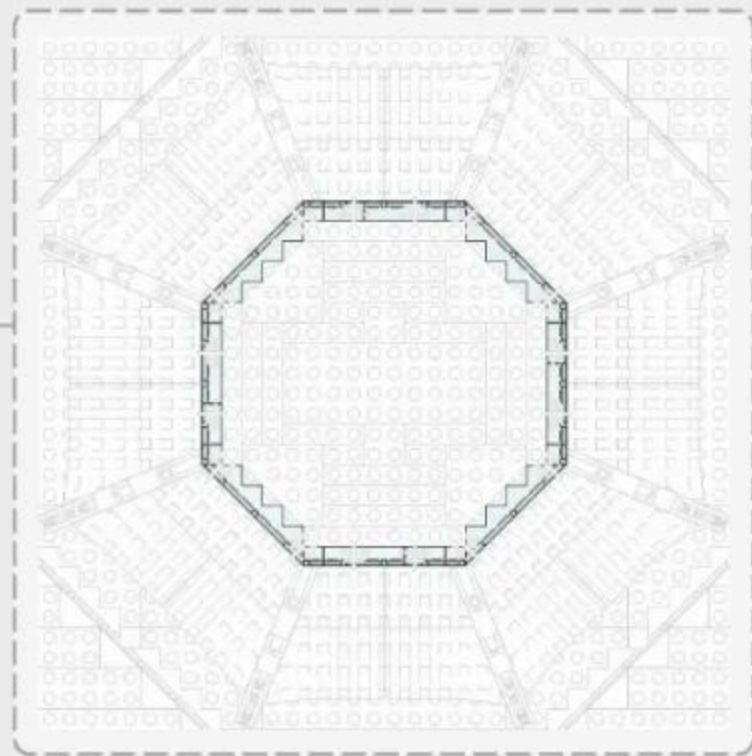
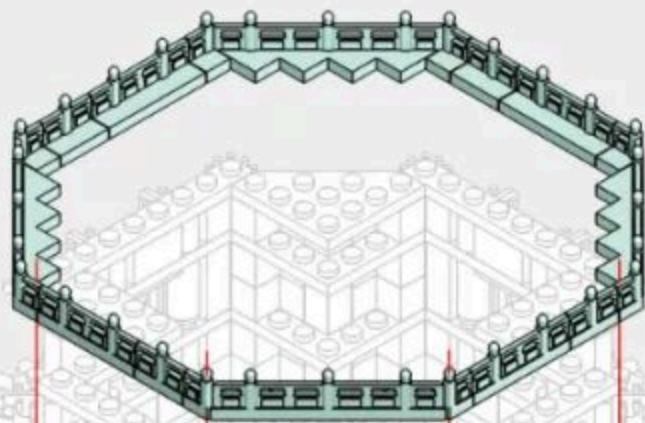

4-9

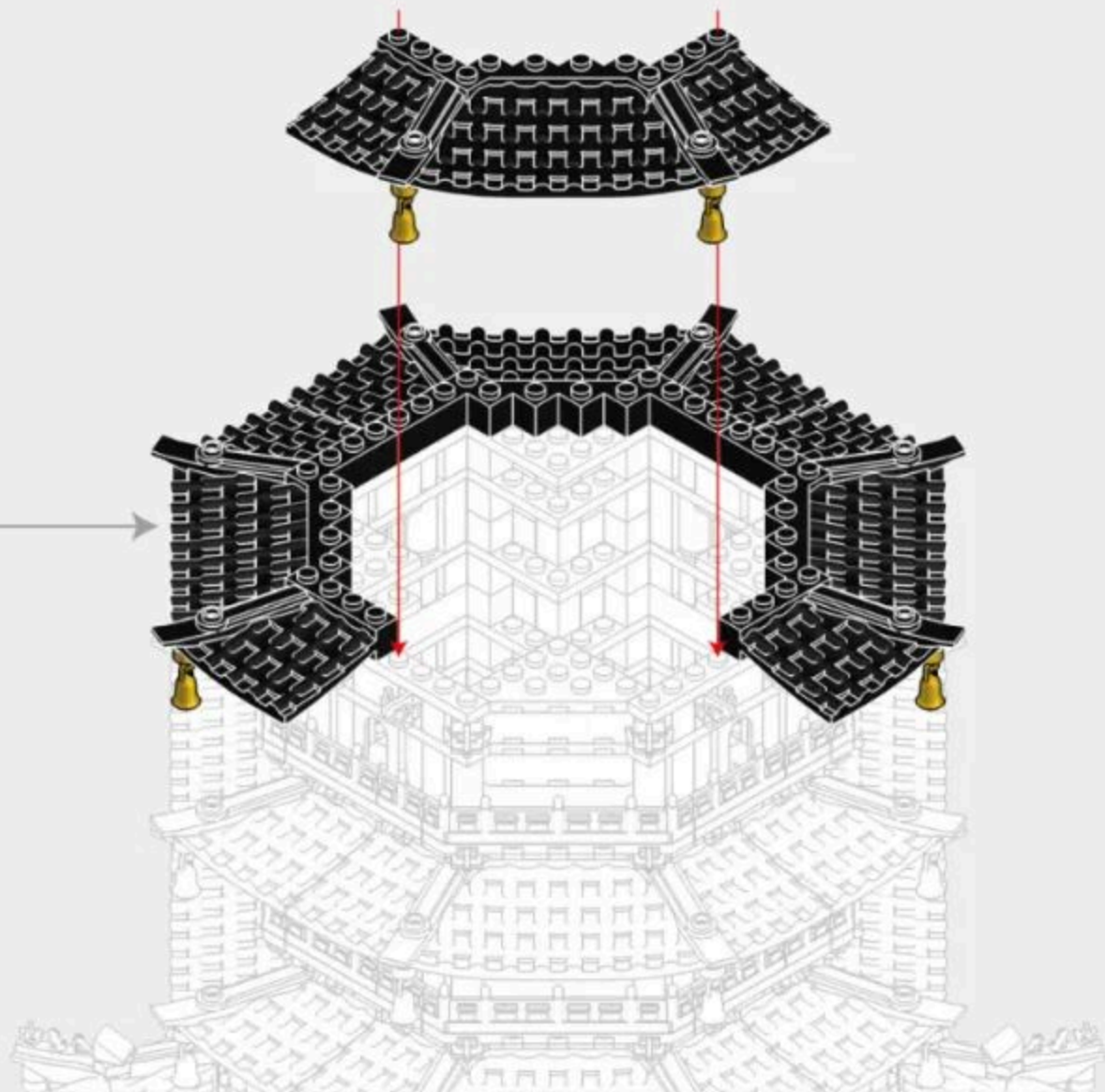
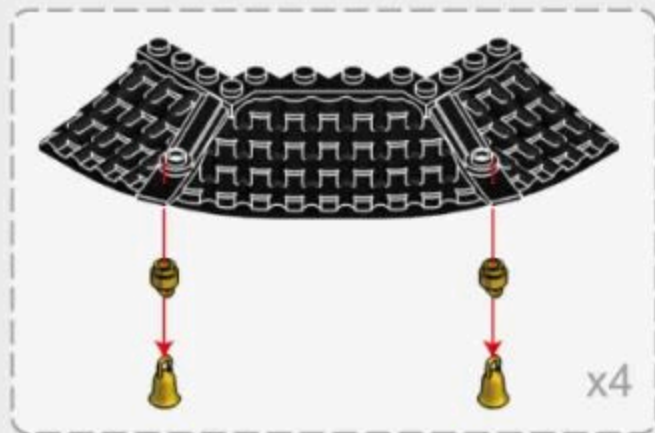

4-10

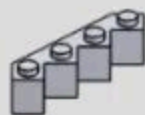

x4



x4



x8



x16

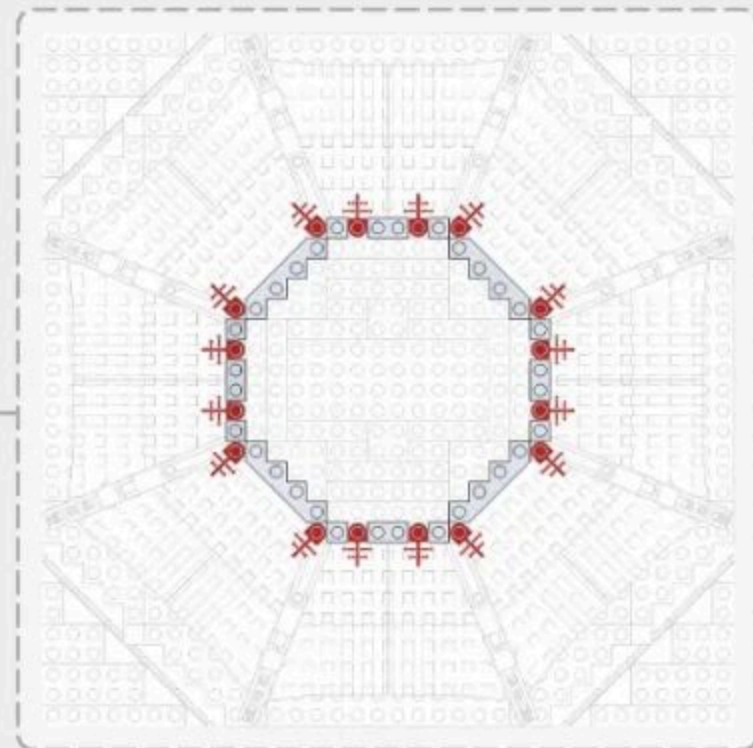
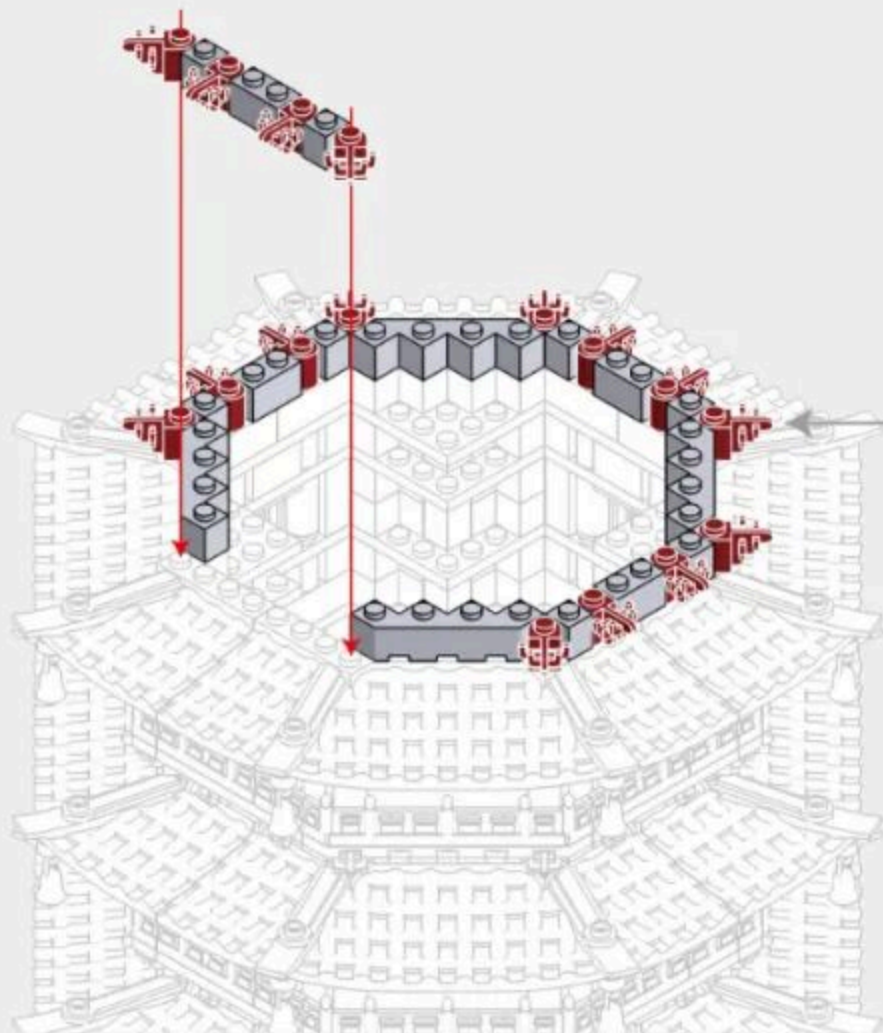

4-11

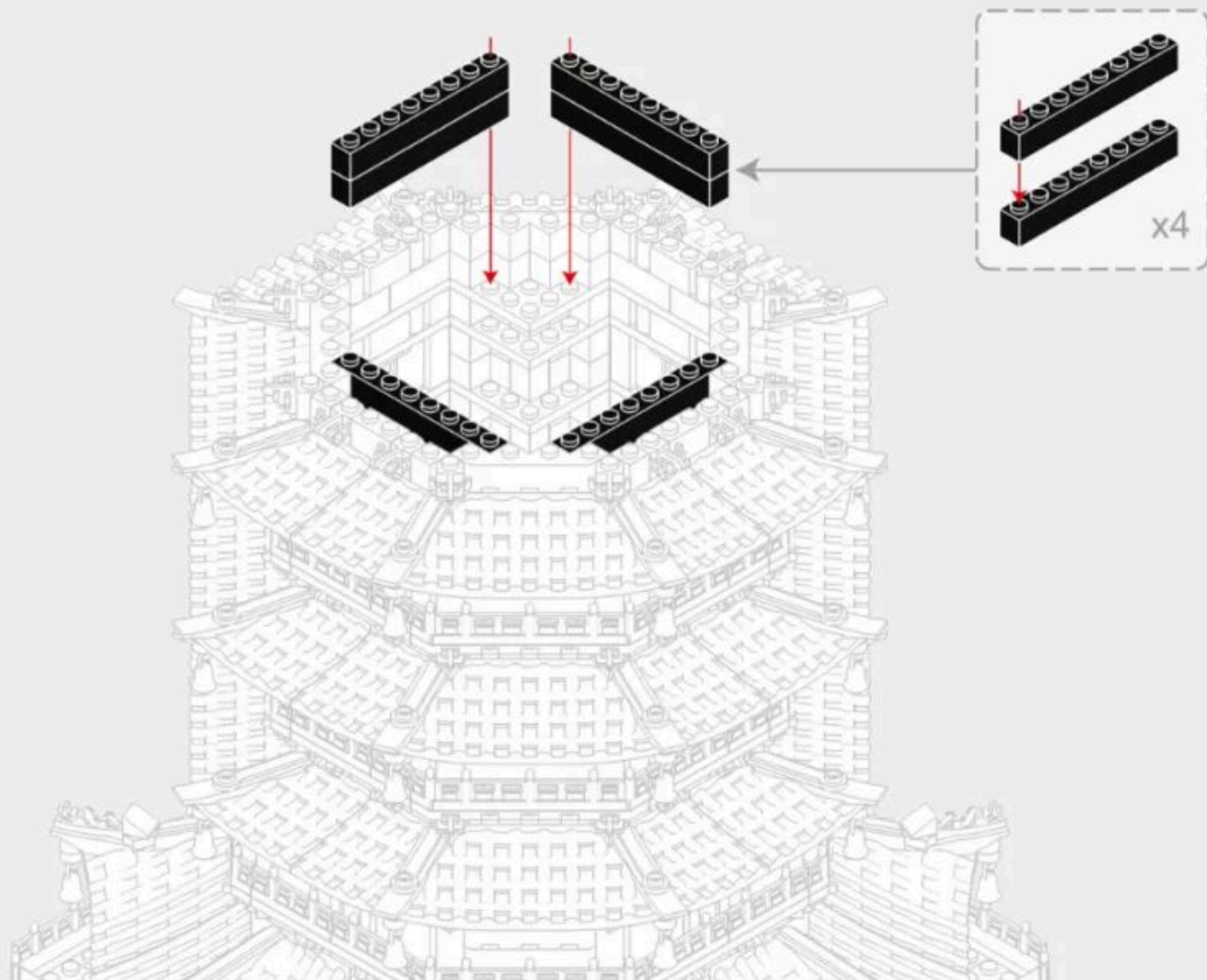
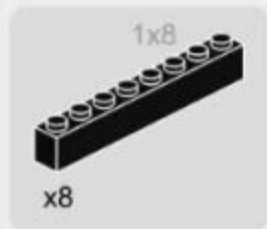

4-12

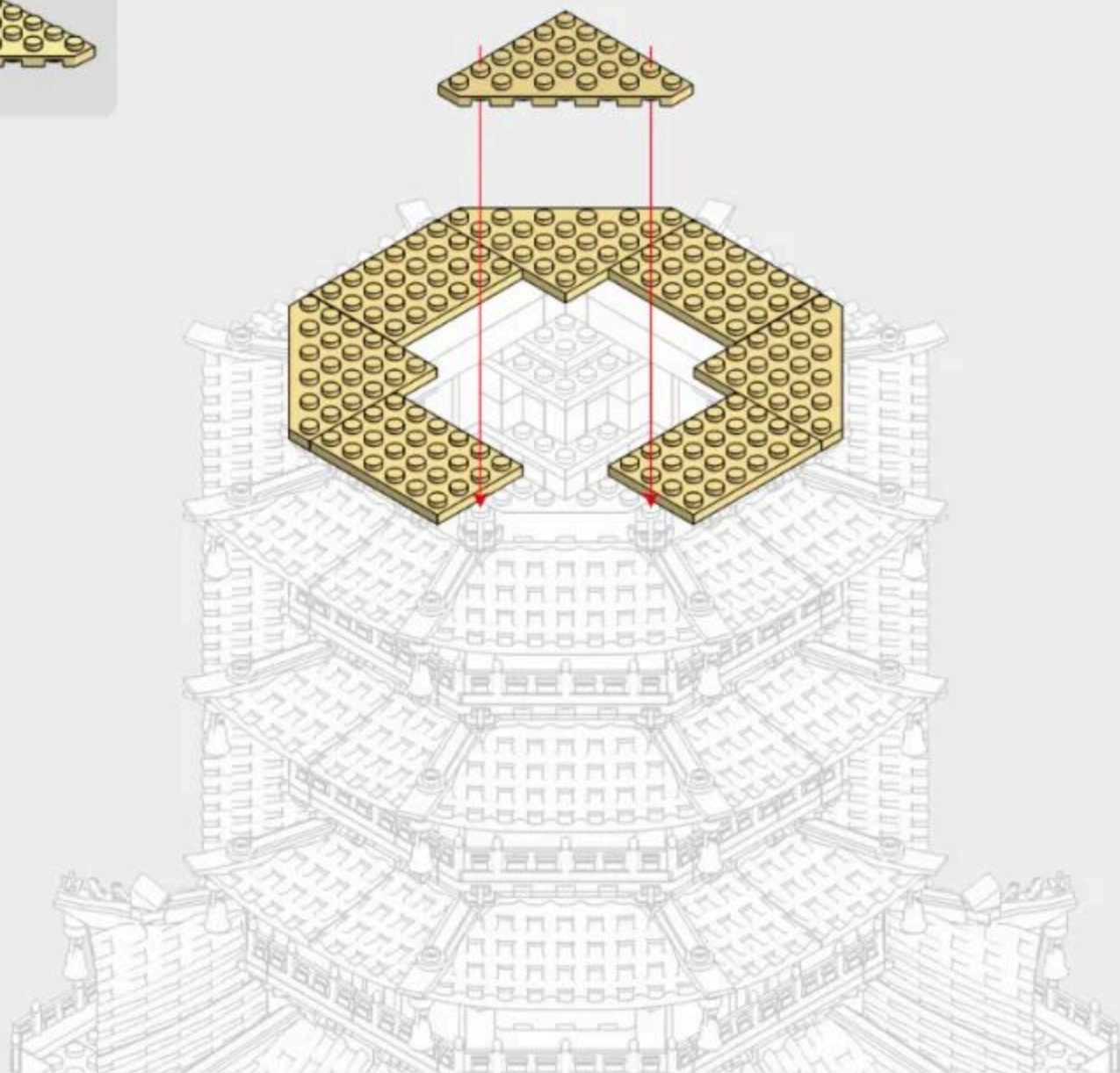
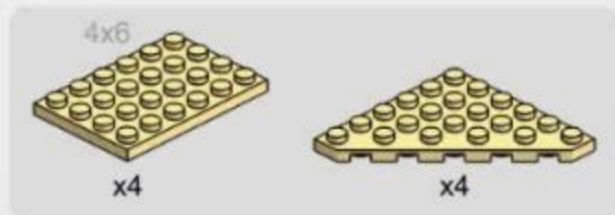



214PCS



86

5-1



x4

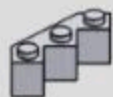

x8



x8



x16



x16

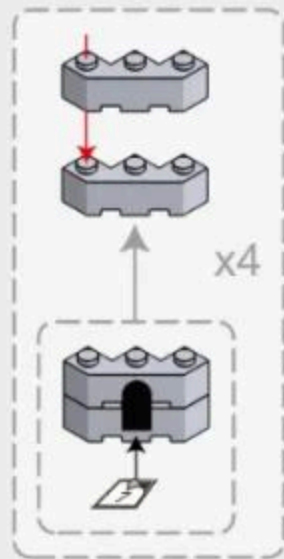

x4

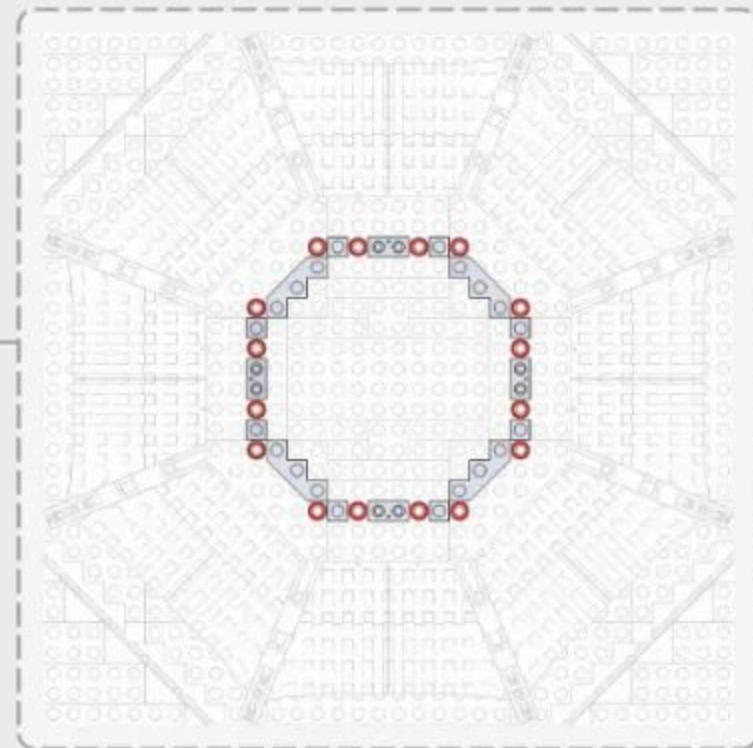
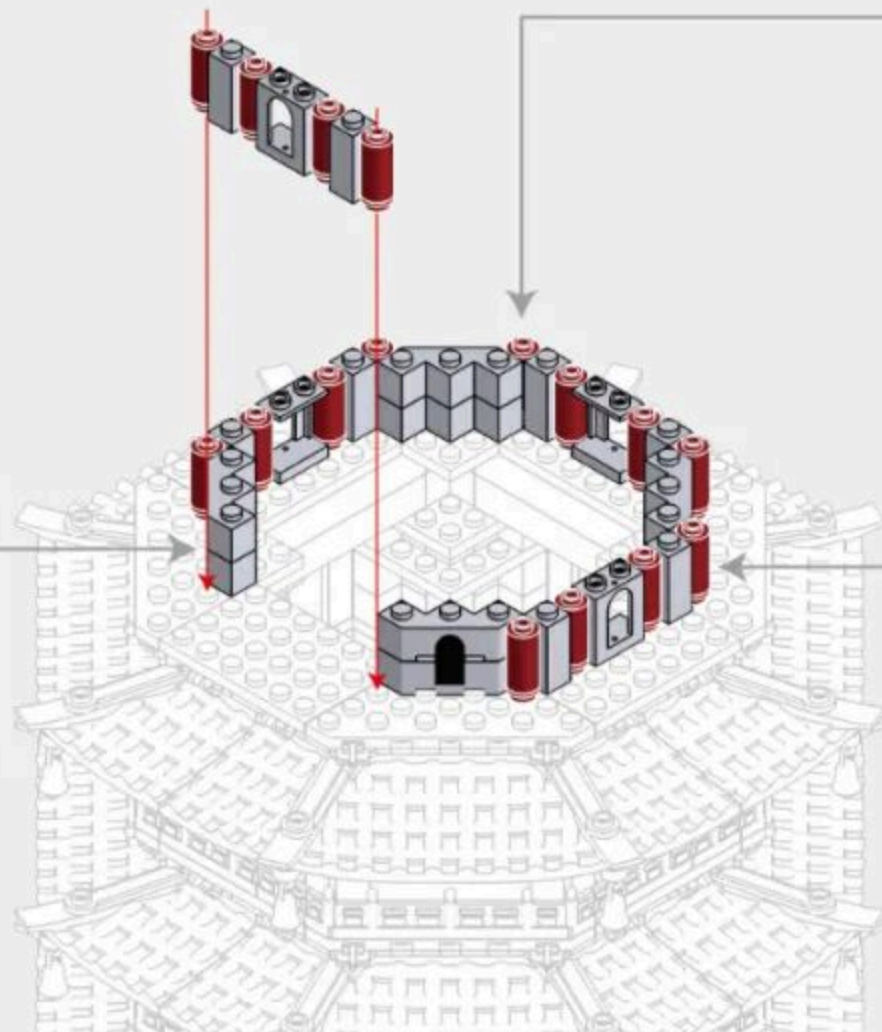

x16

5-2

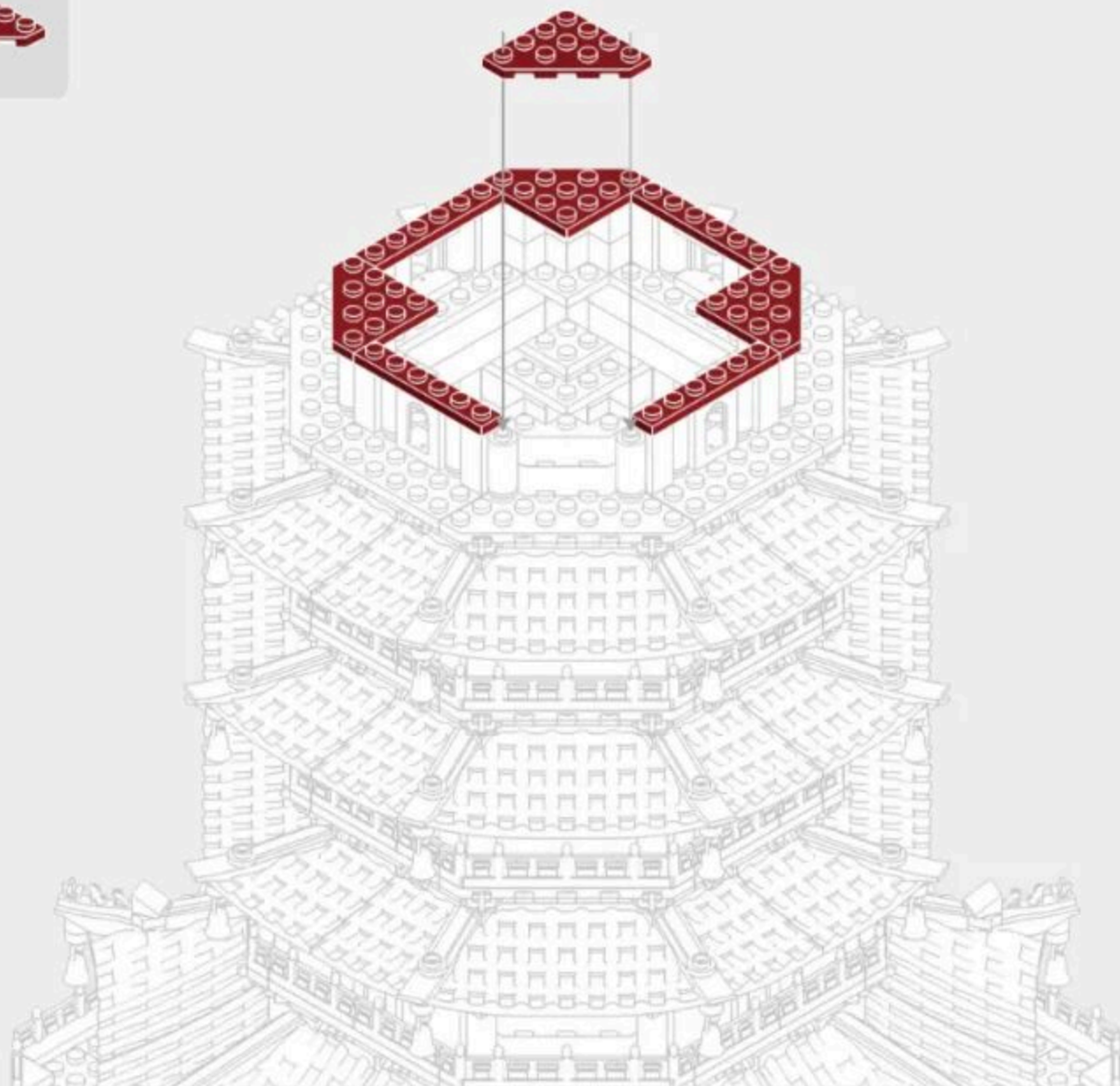

5-3

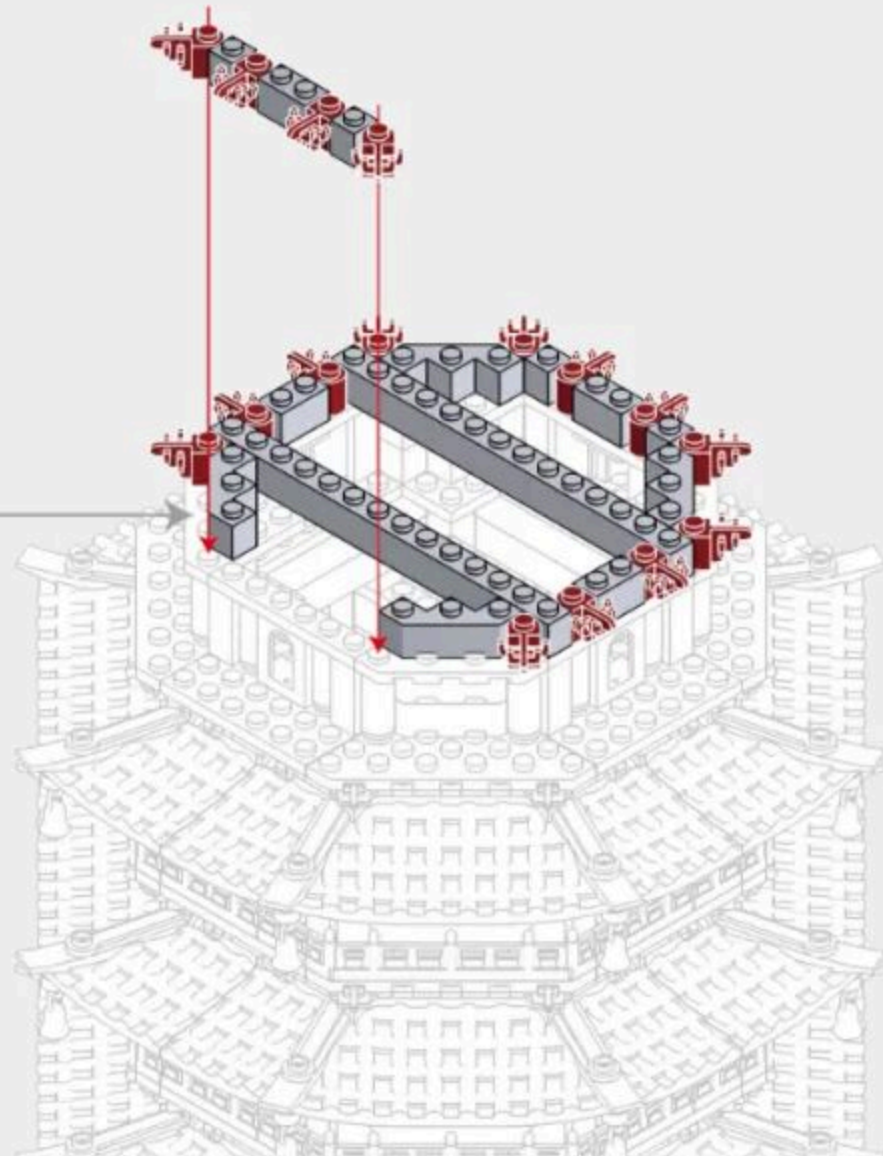
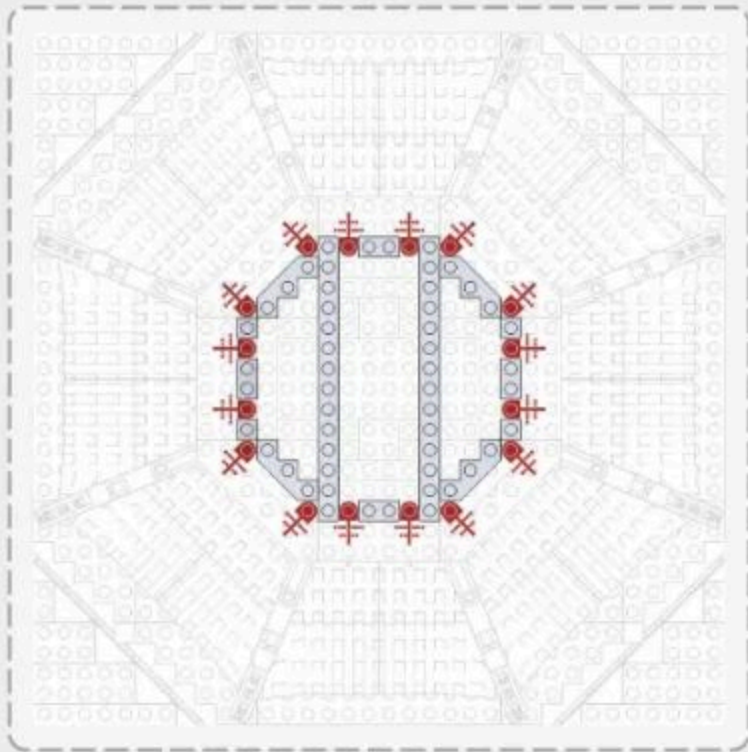
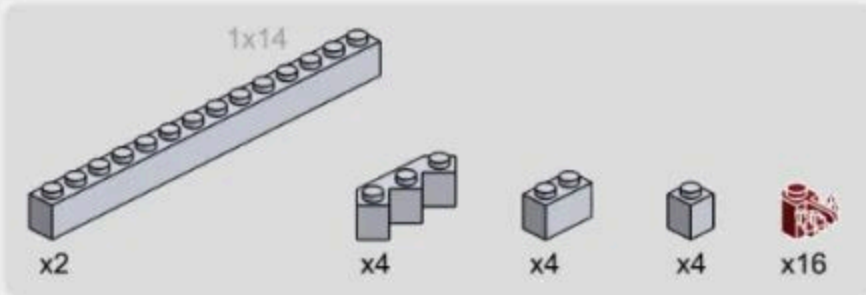

5-4

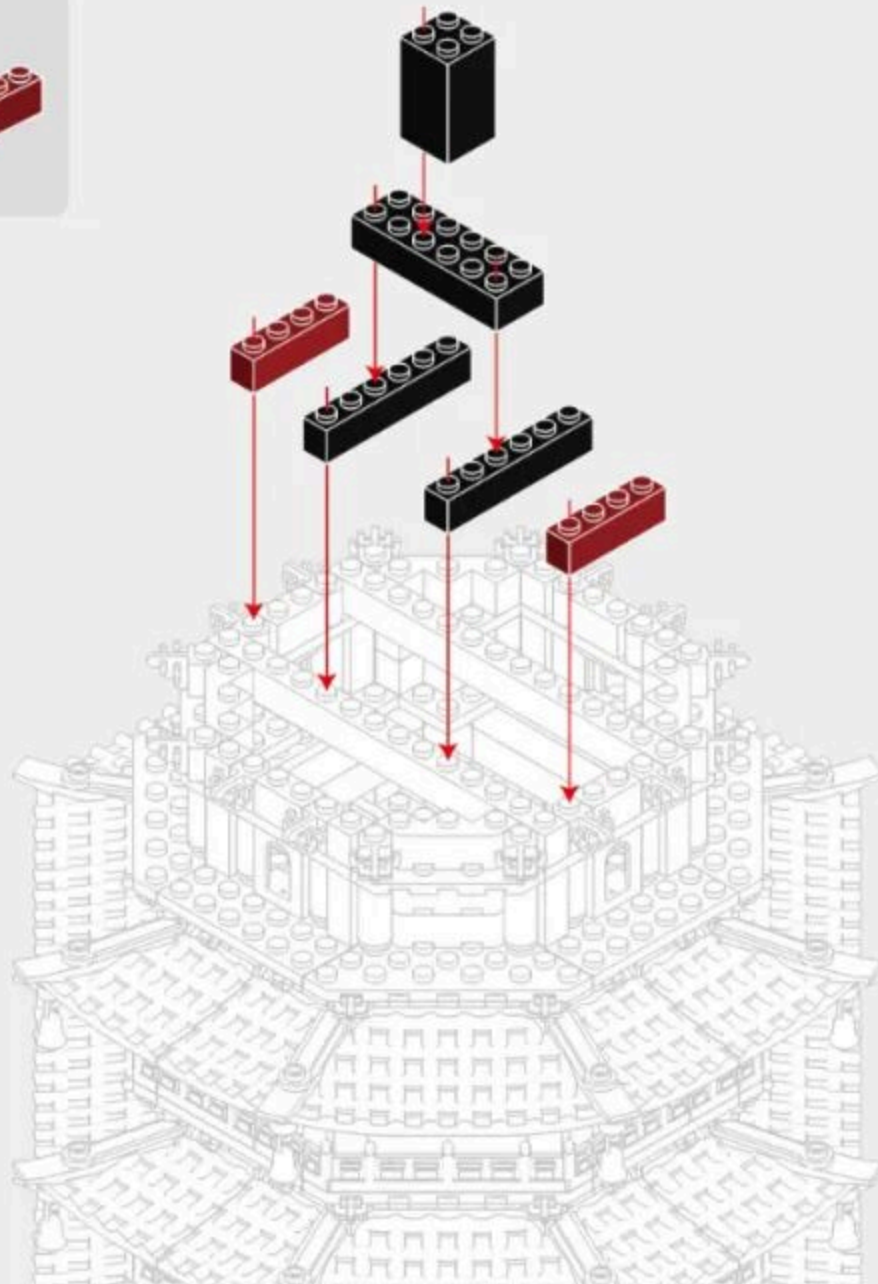
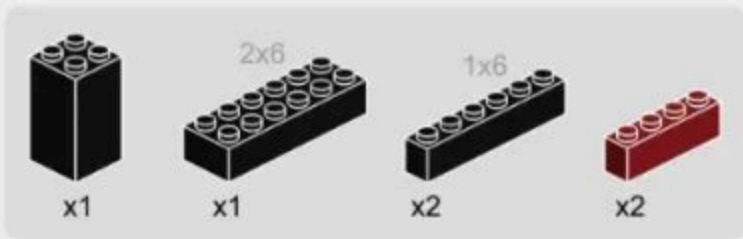

5-5

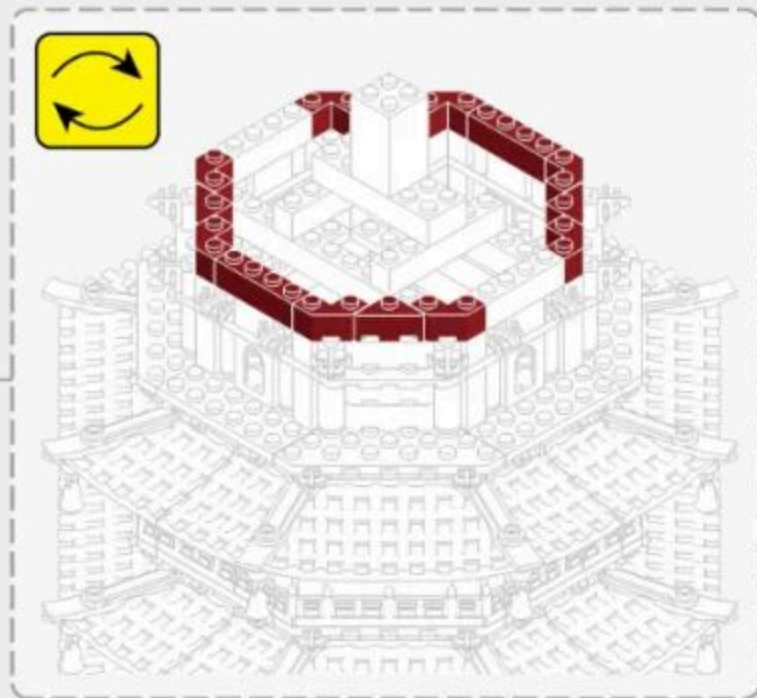
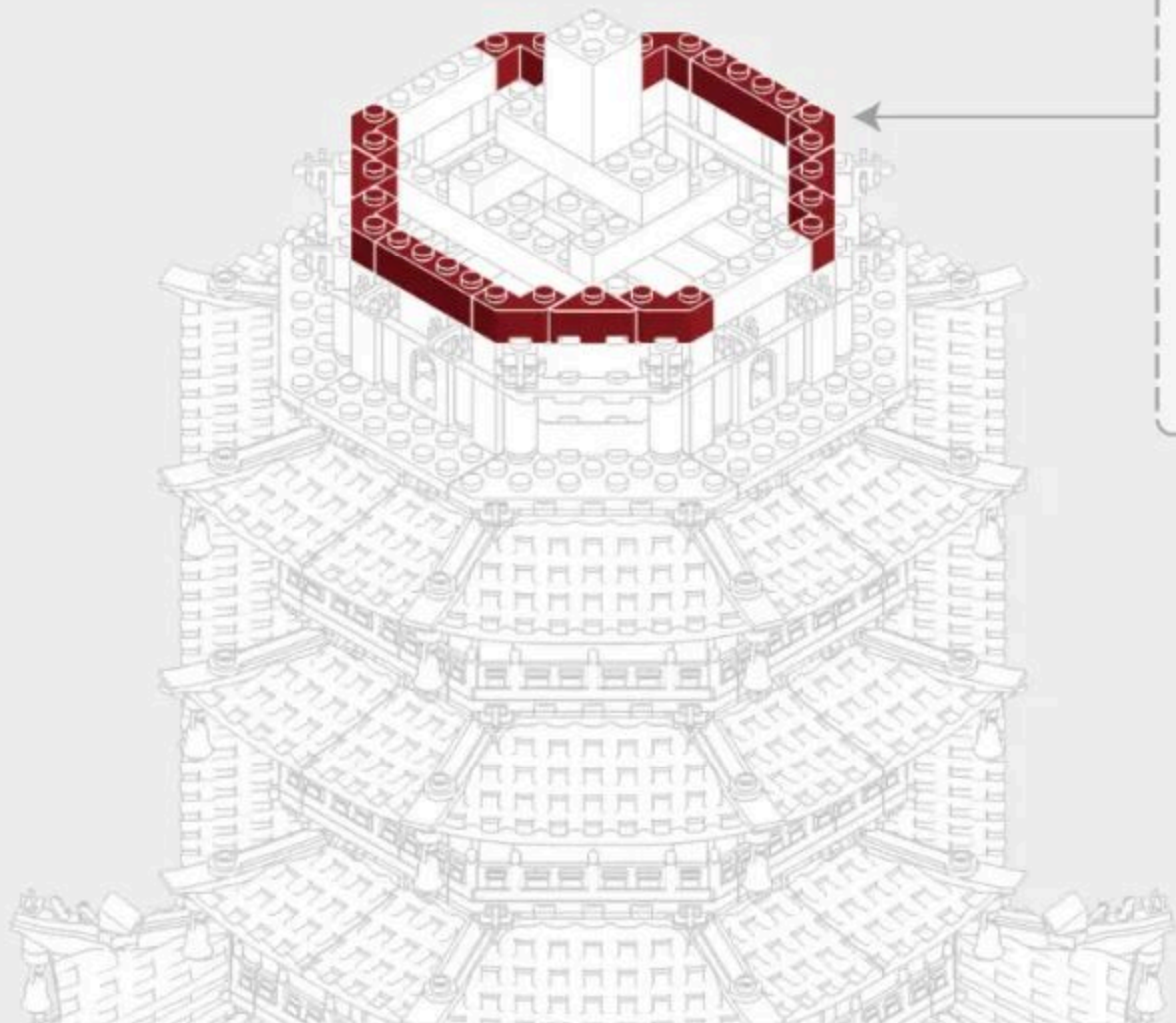

5-6

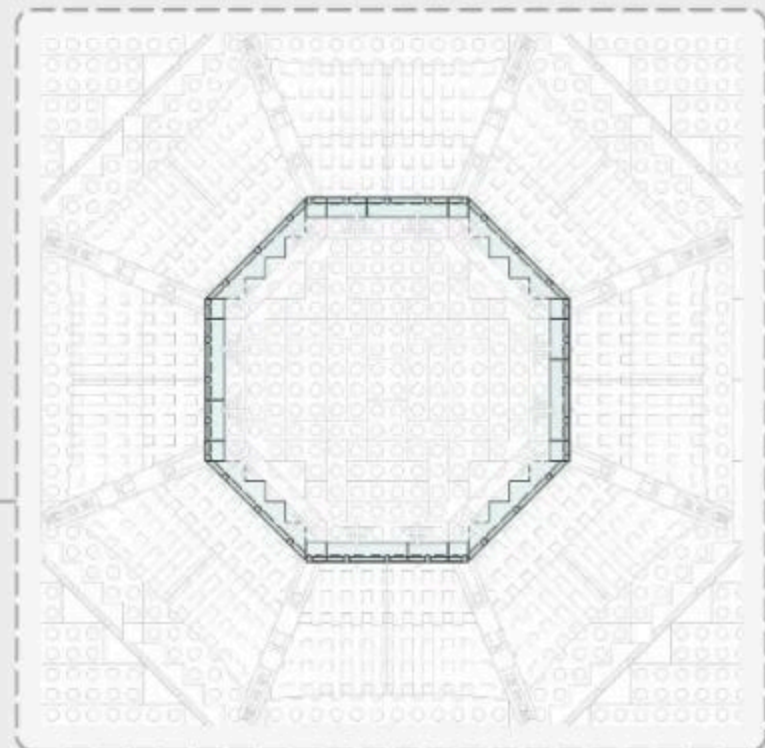
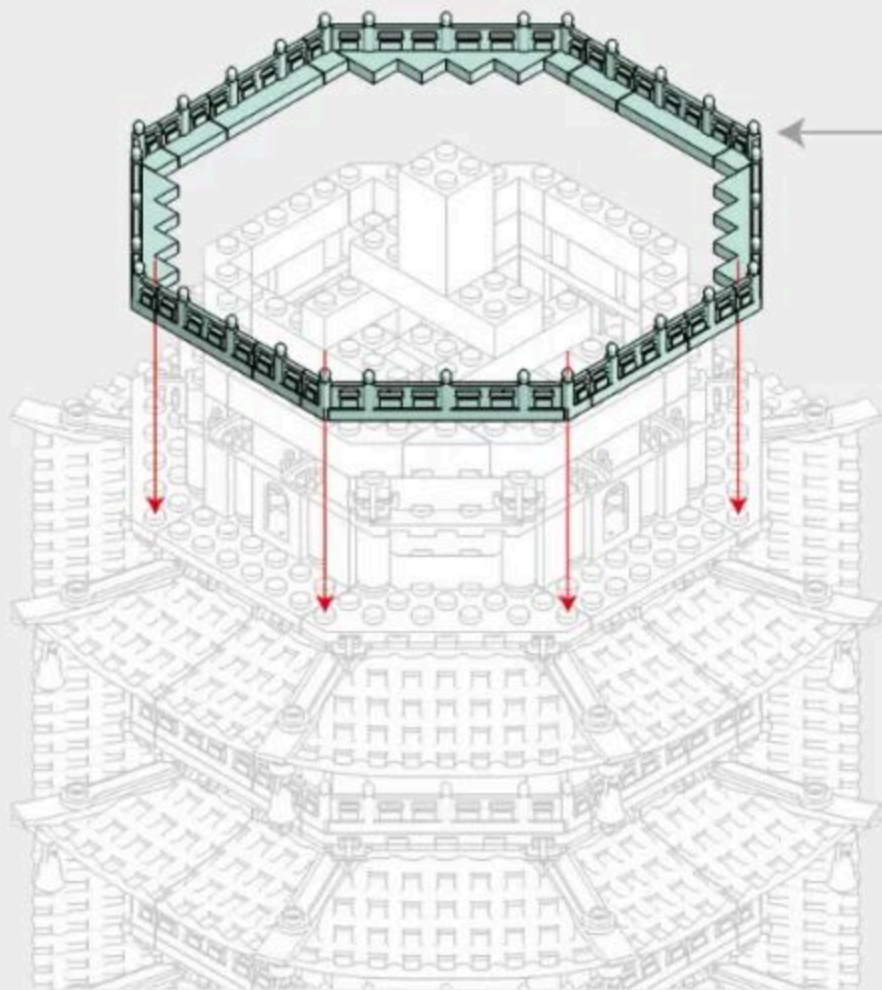
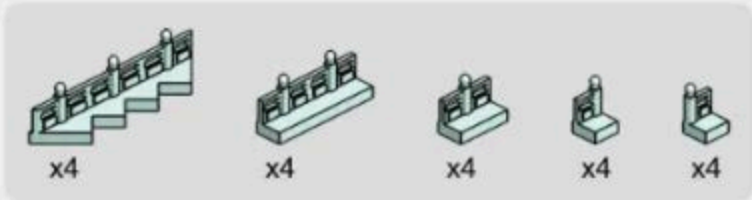

5-7

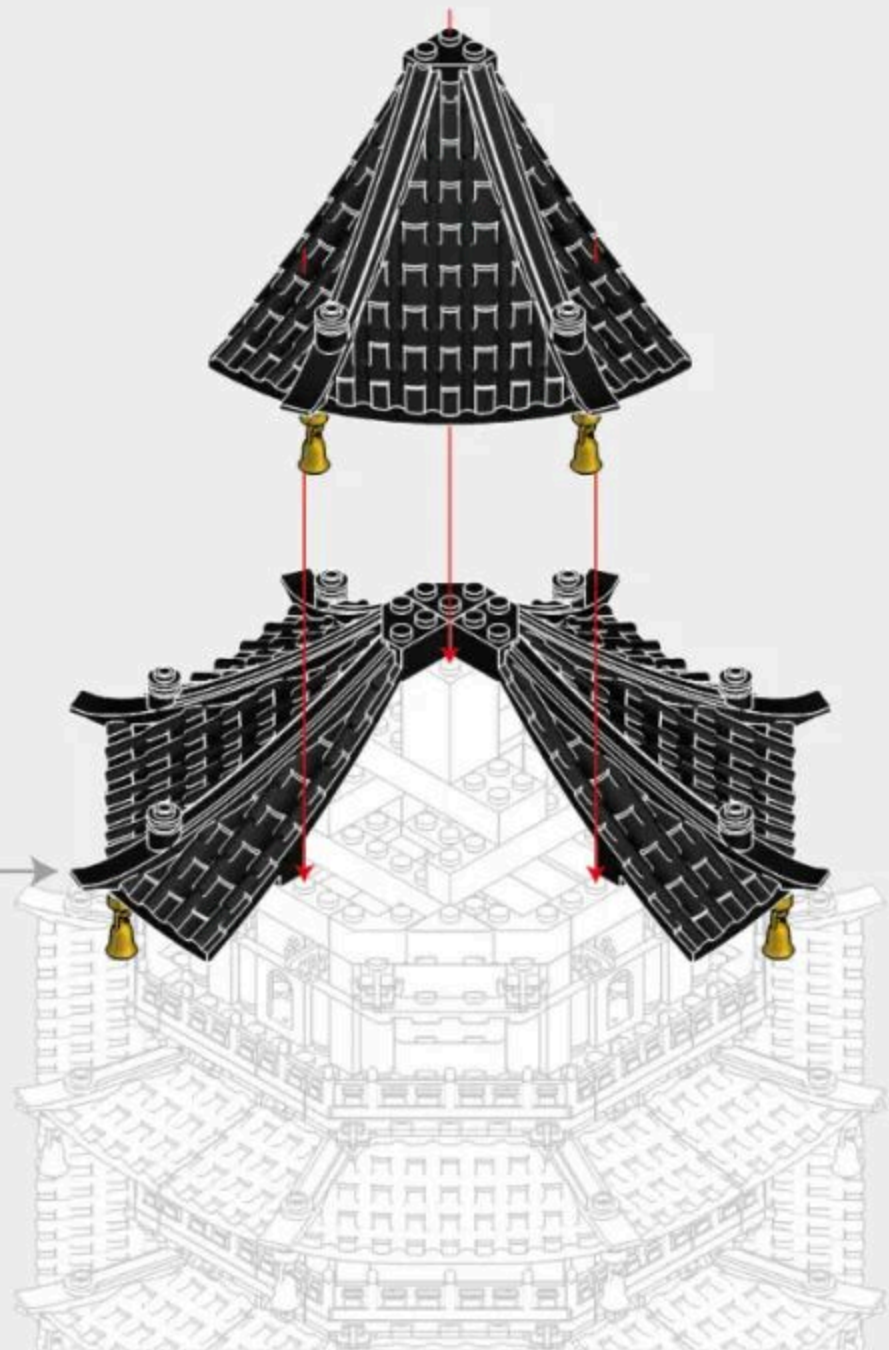
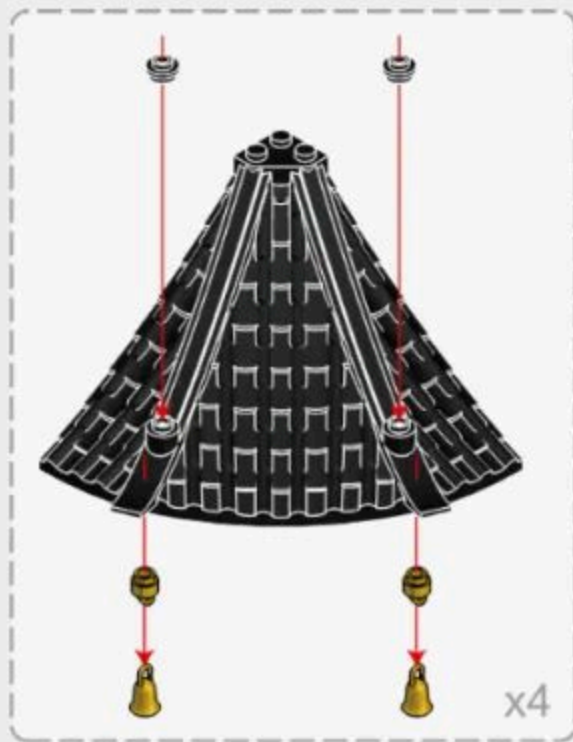
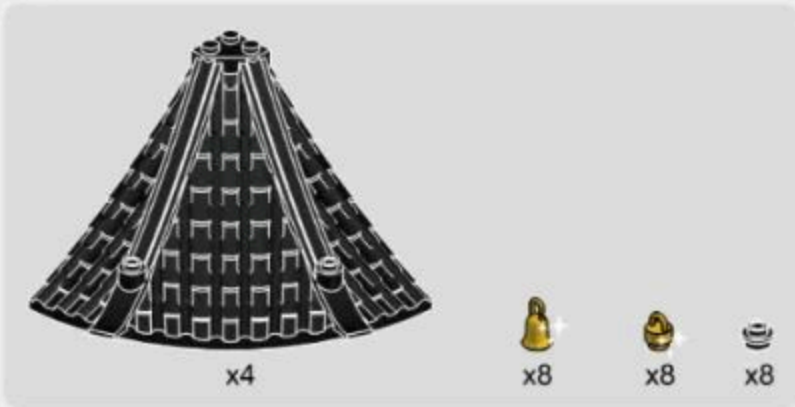

5-8



x4



x1



x2



x4



x4

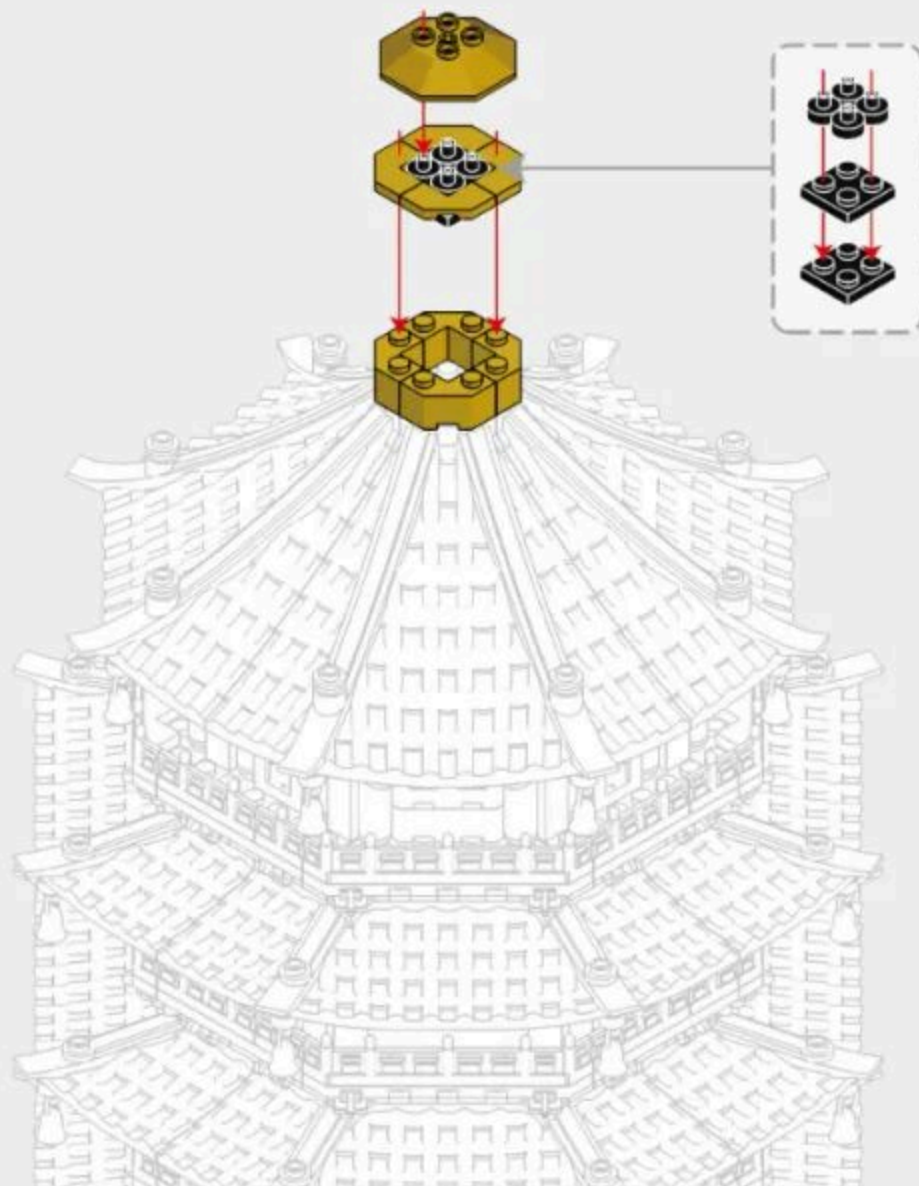

5-9

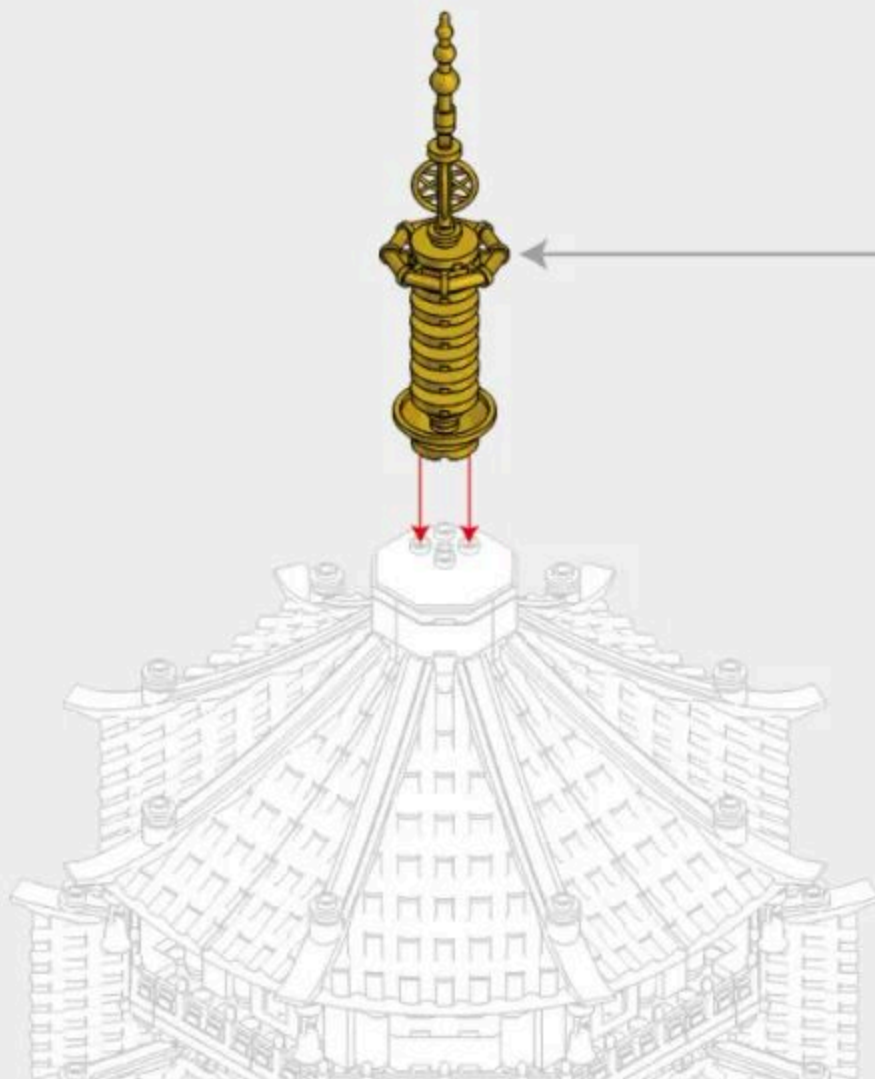

5-10

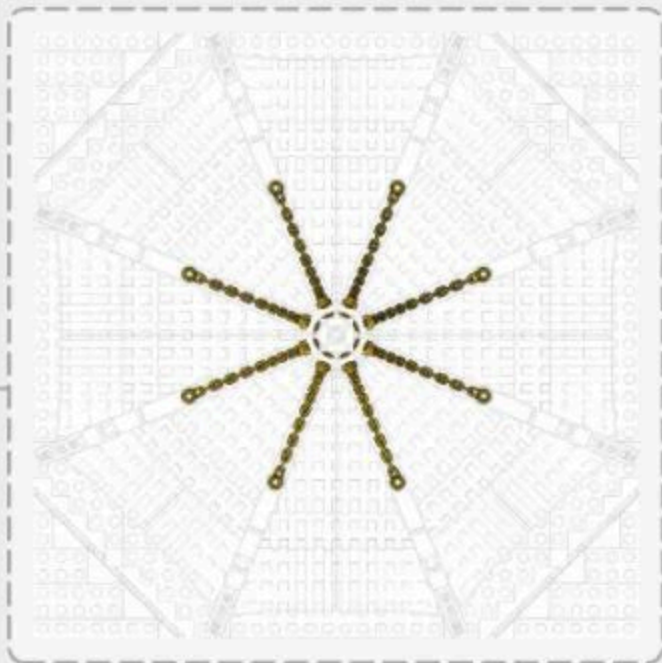
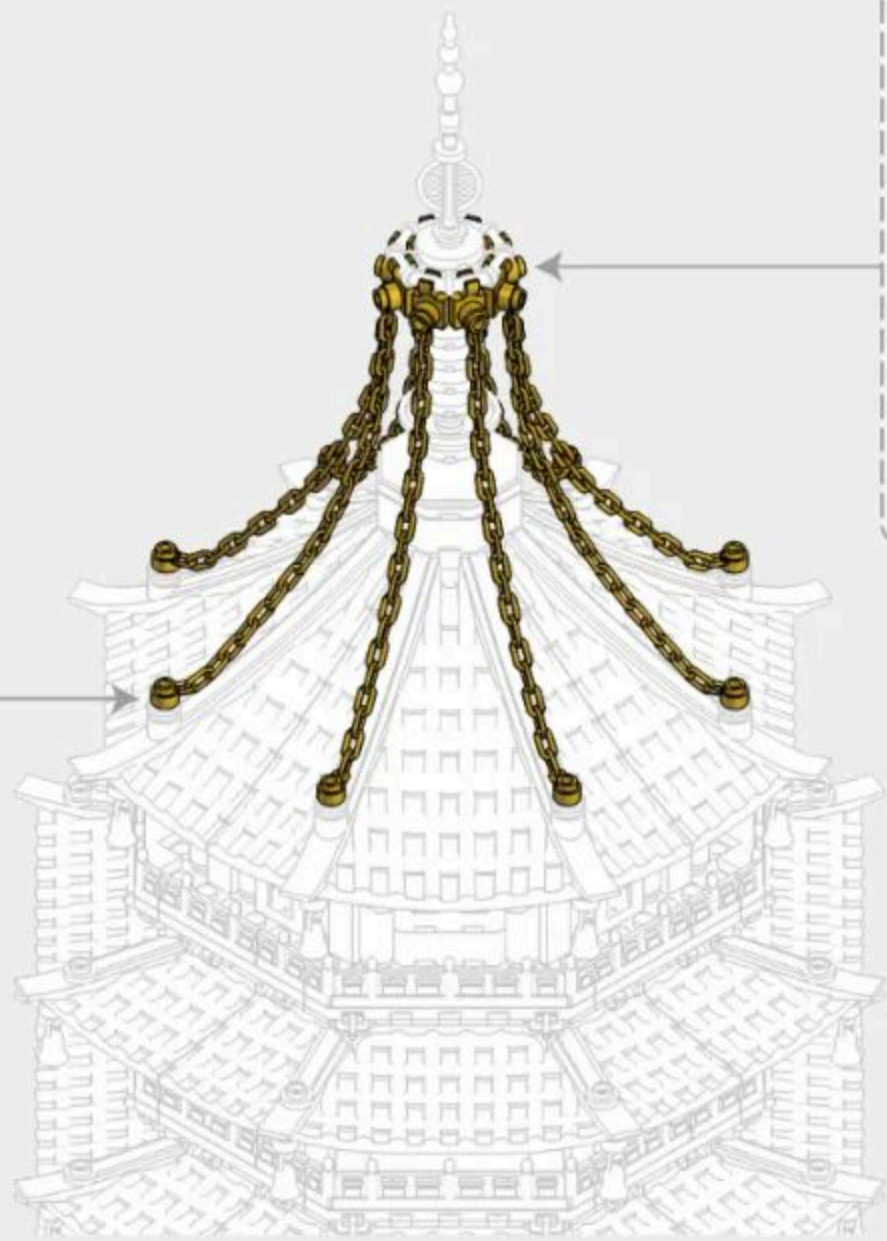



188PCS



97

6-1

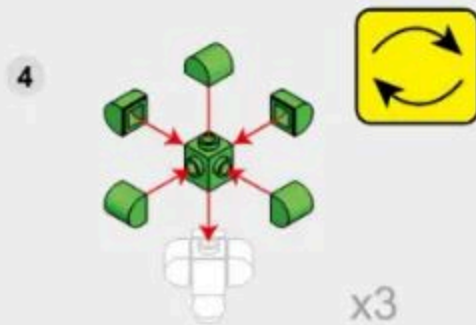
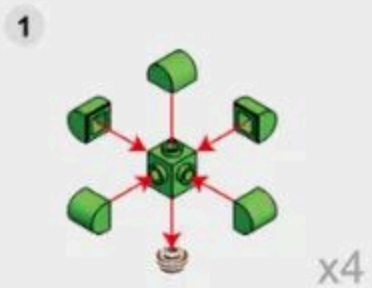

6-2

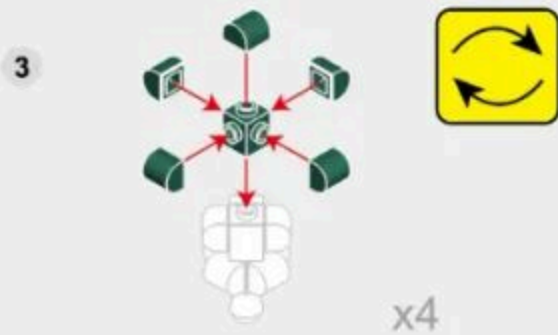

6-3

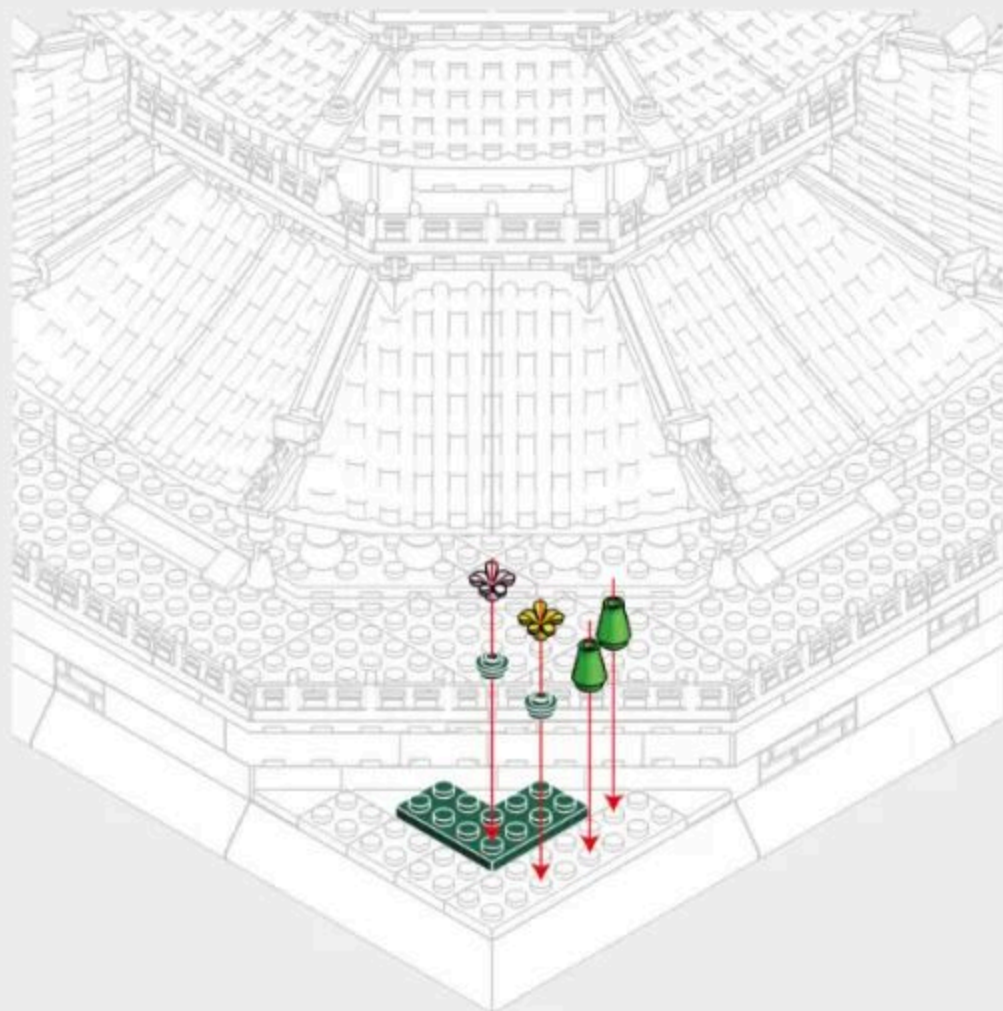

6-4

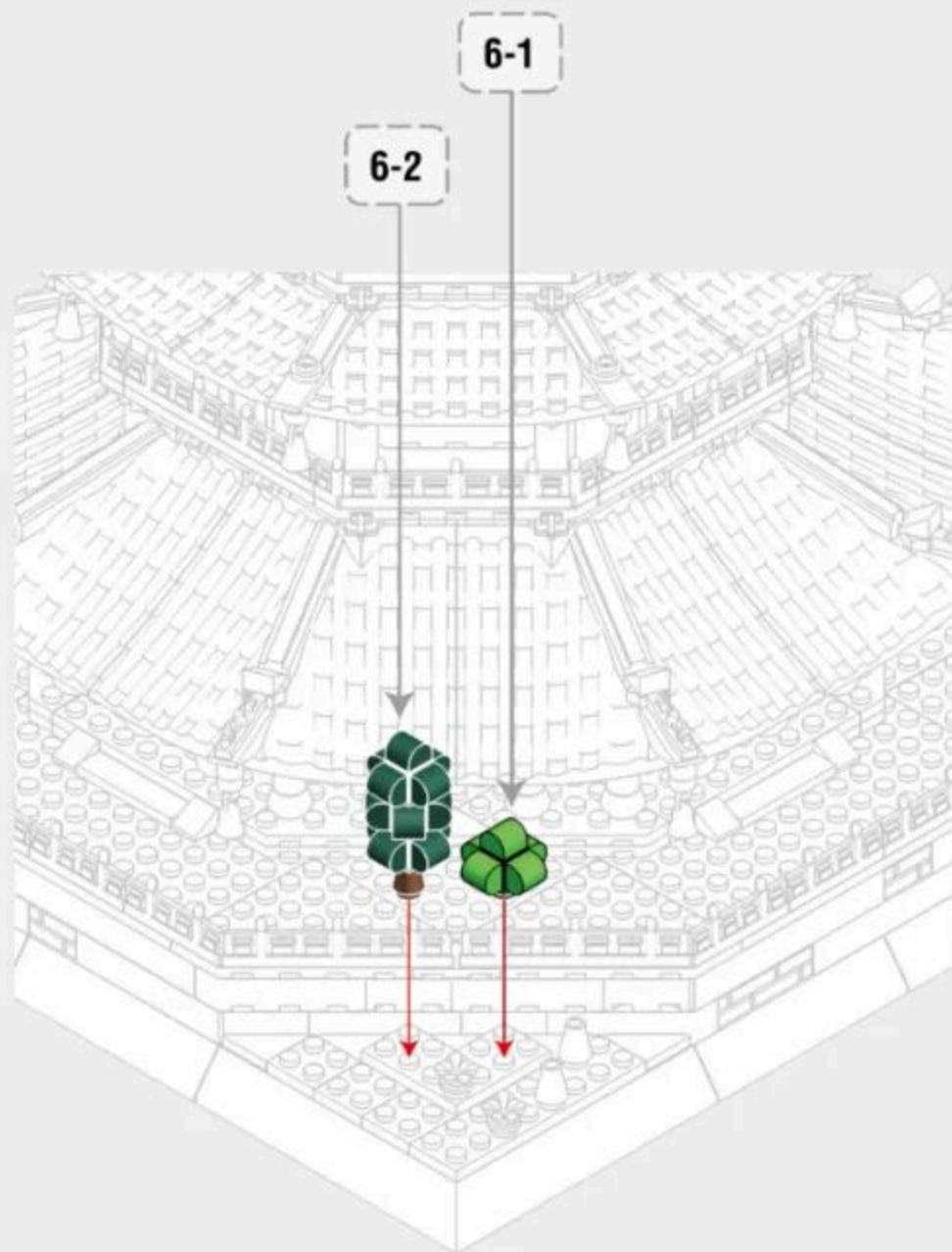

6-5

x1  x2  x1  x1  x1  x3 

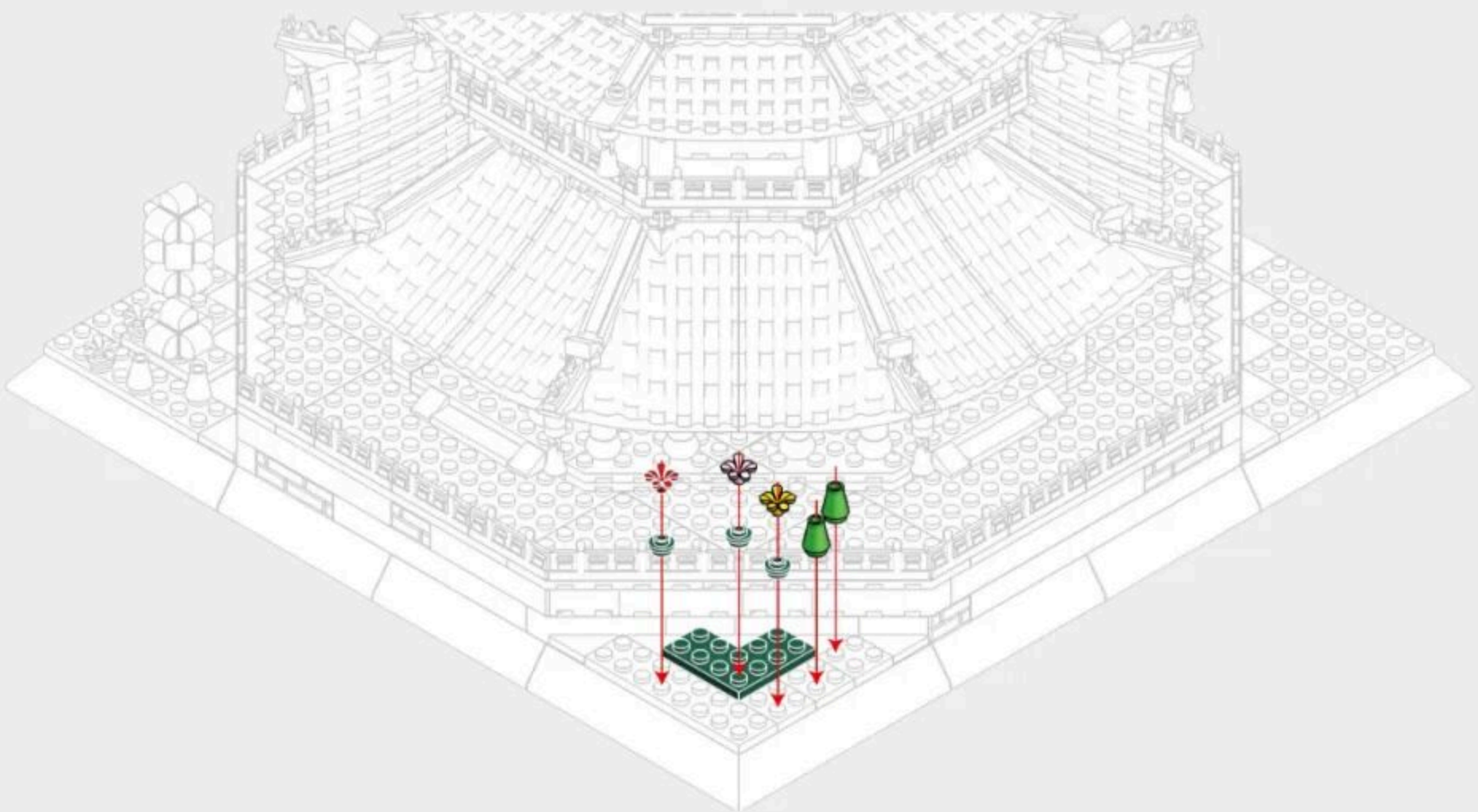

6-6

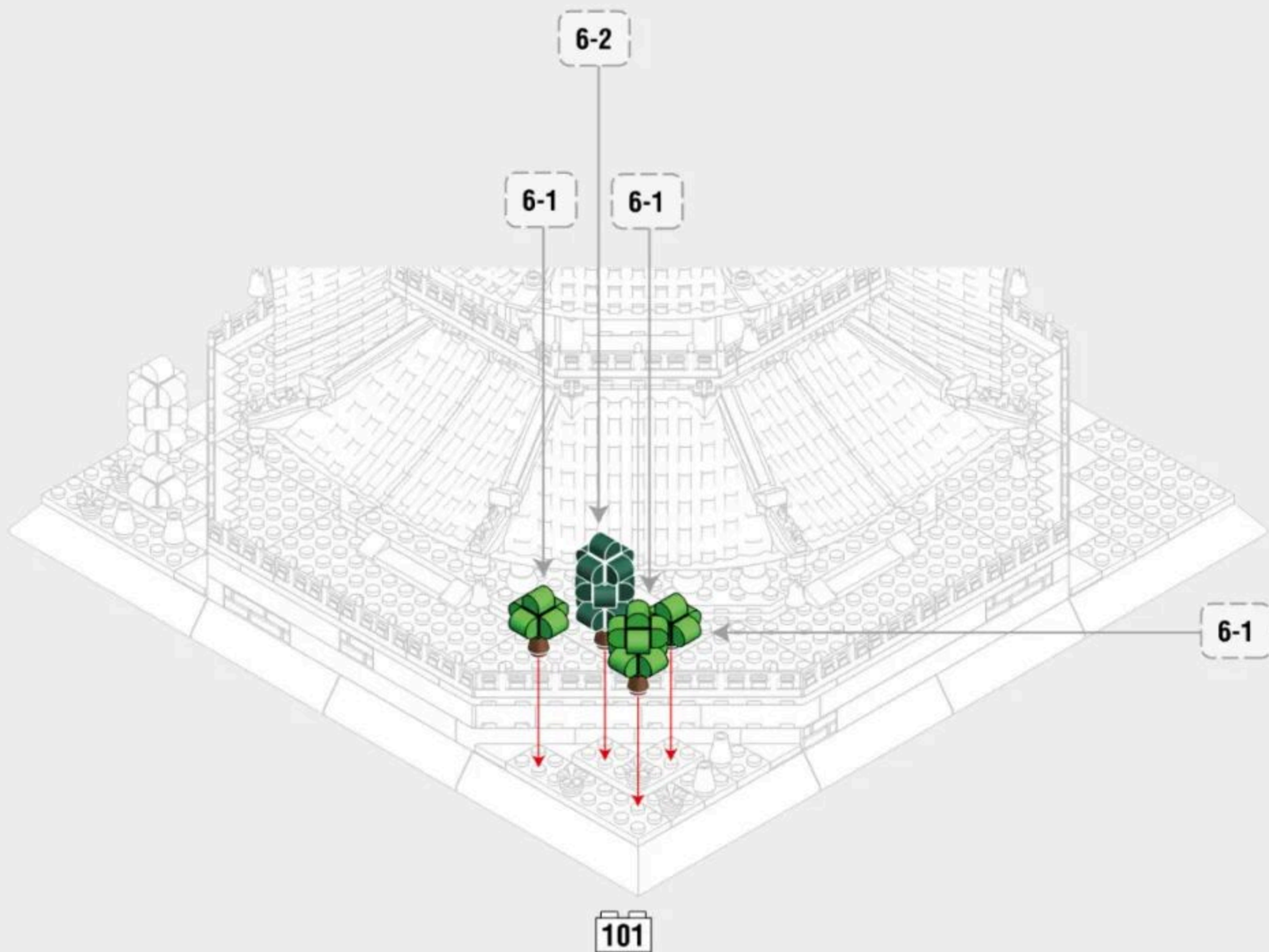

6-7

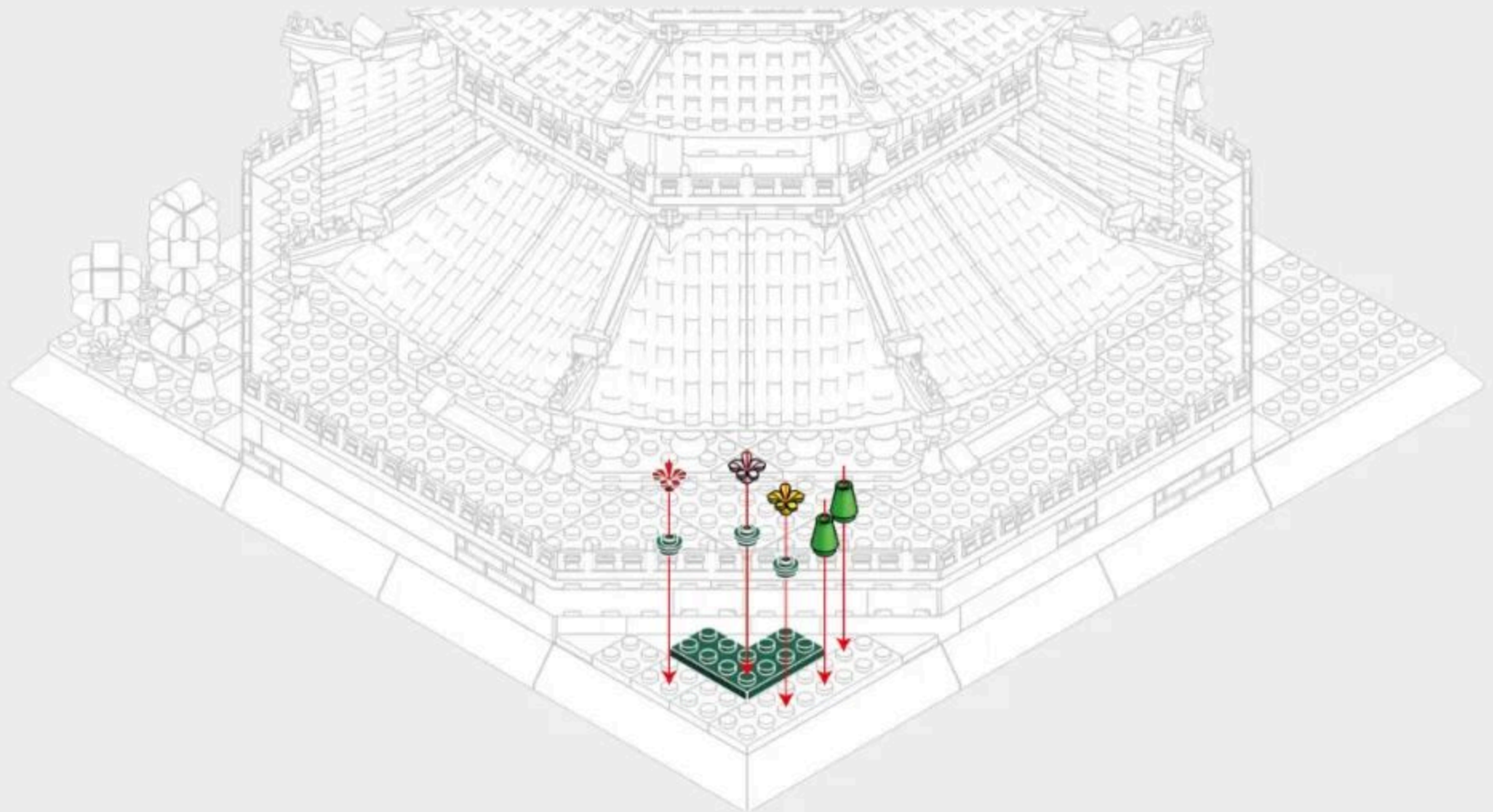
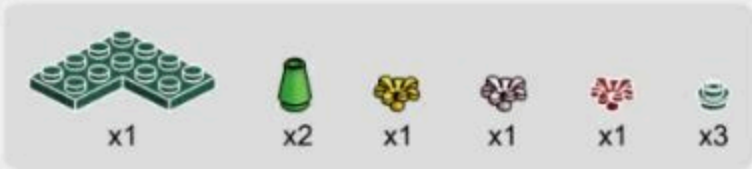

6-8

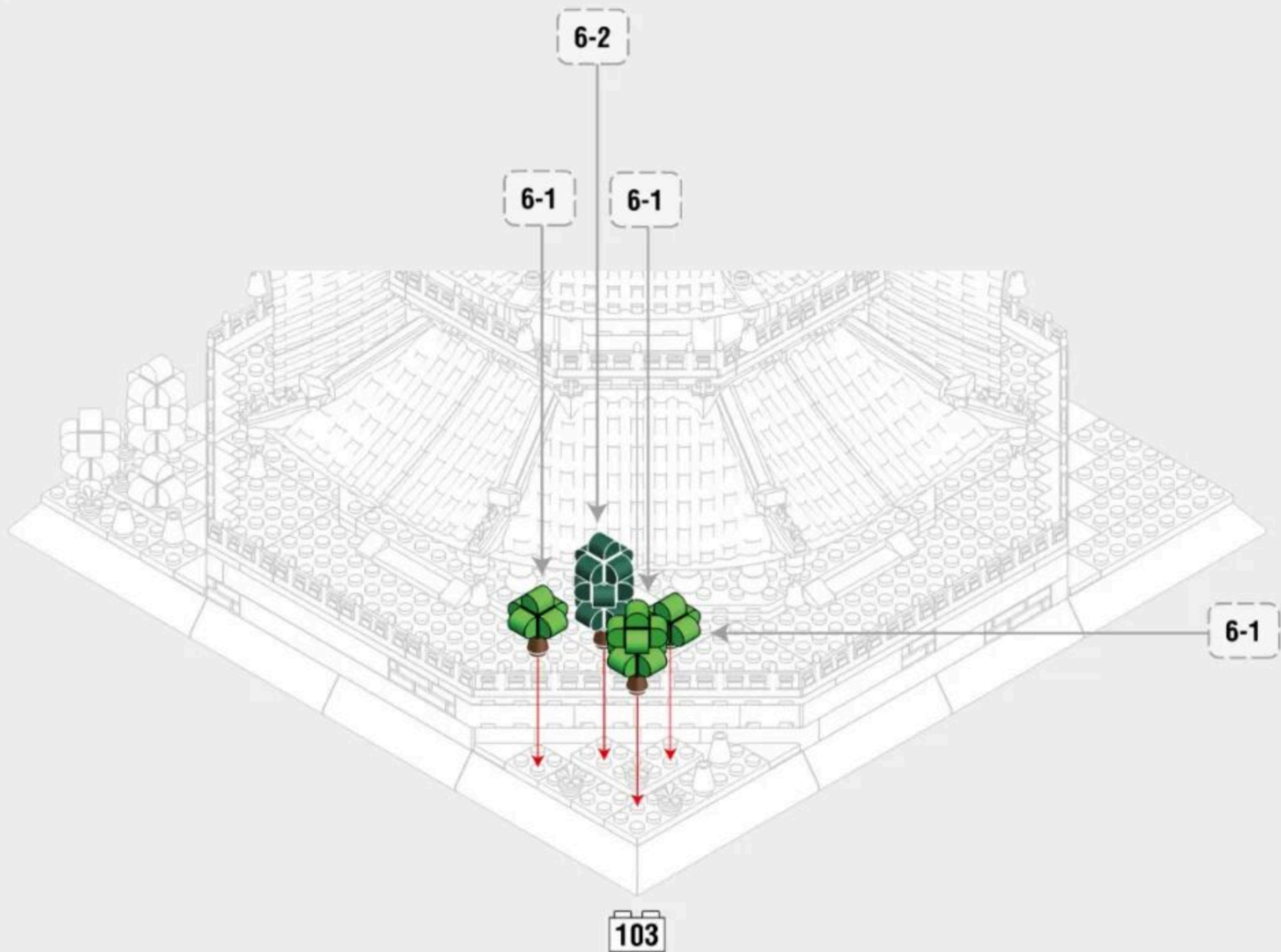

6-9

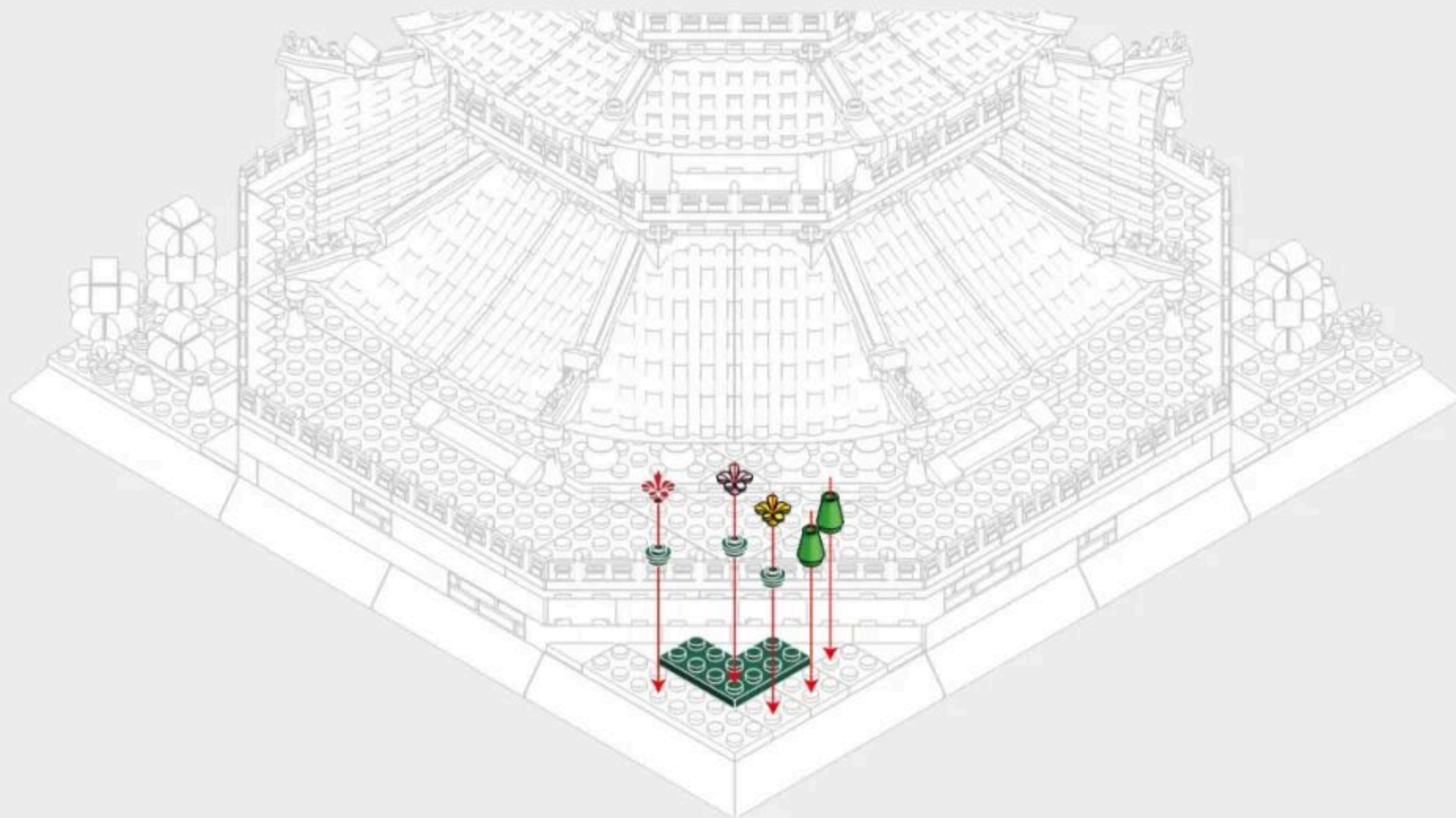

6-10

6-11

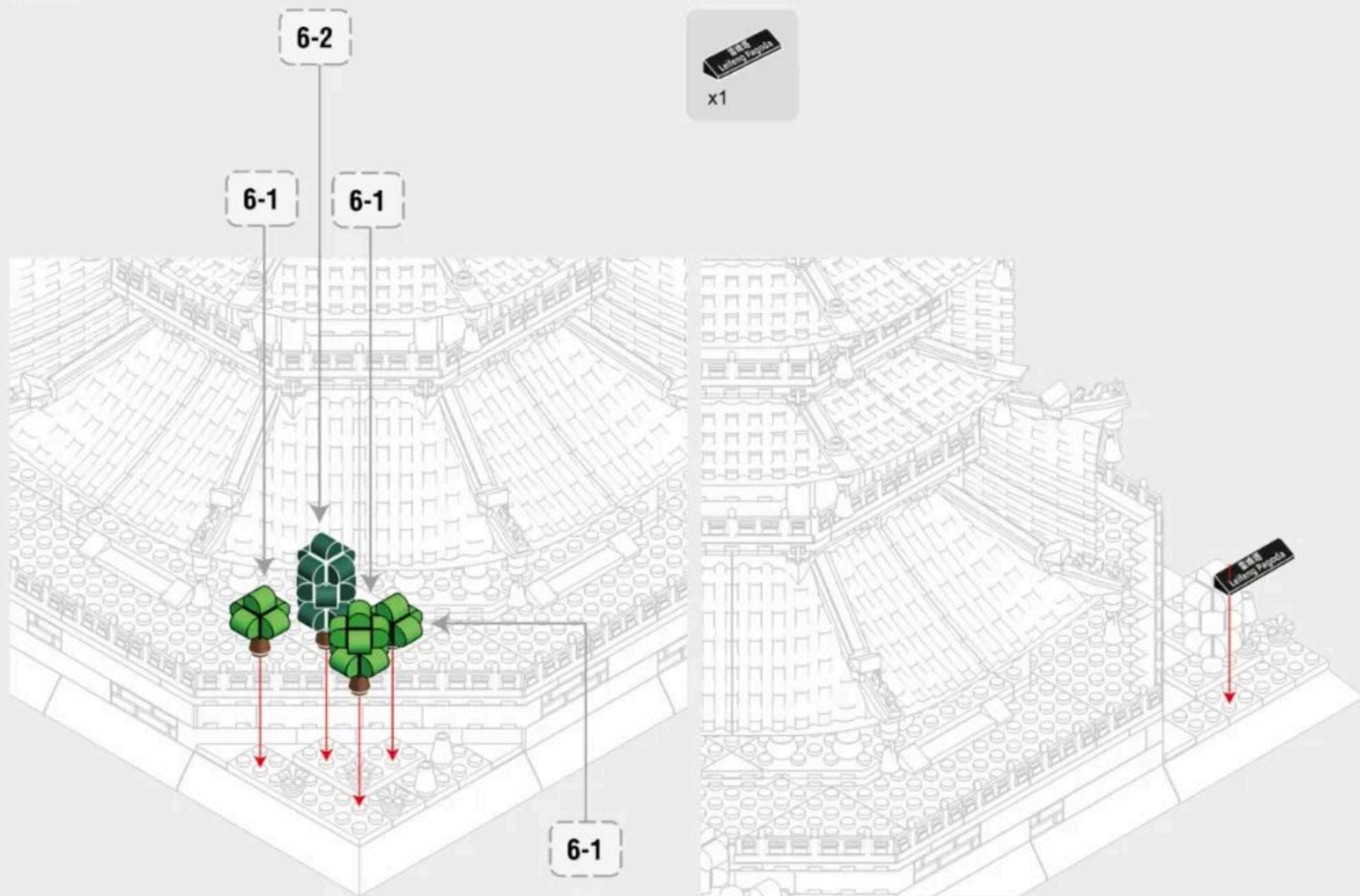

6-12



扫一扫
了解产品更多信息

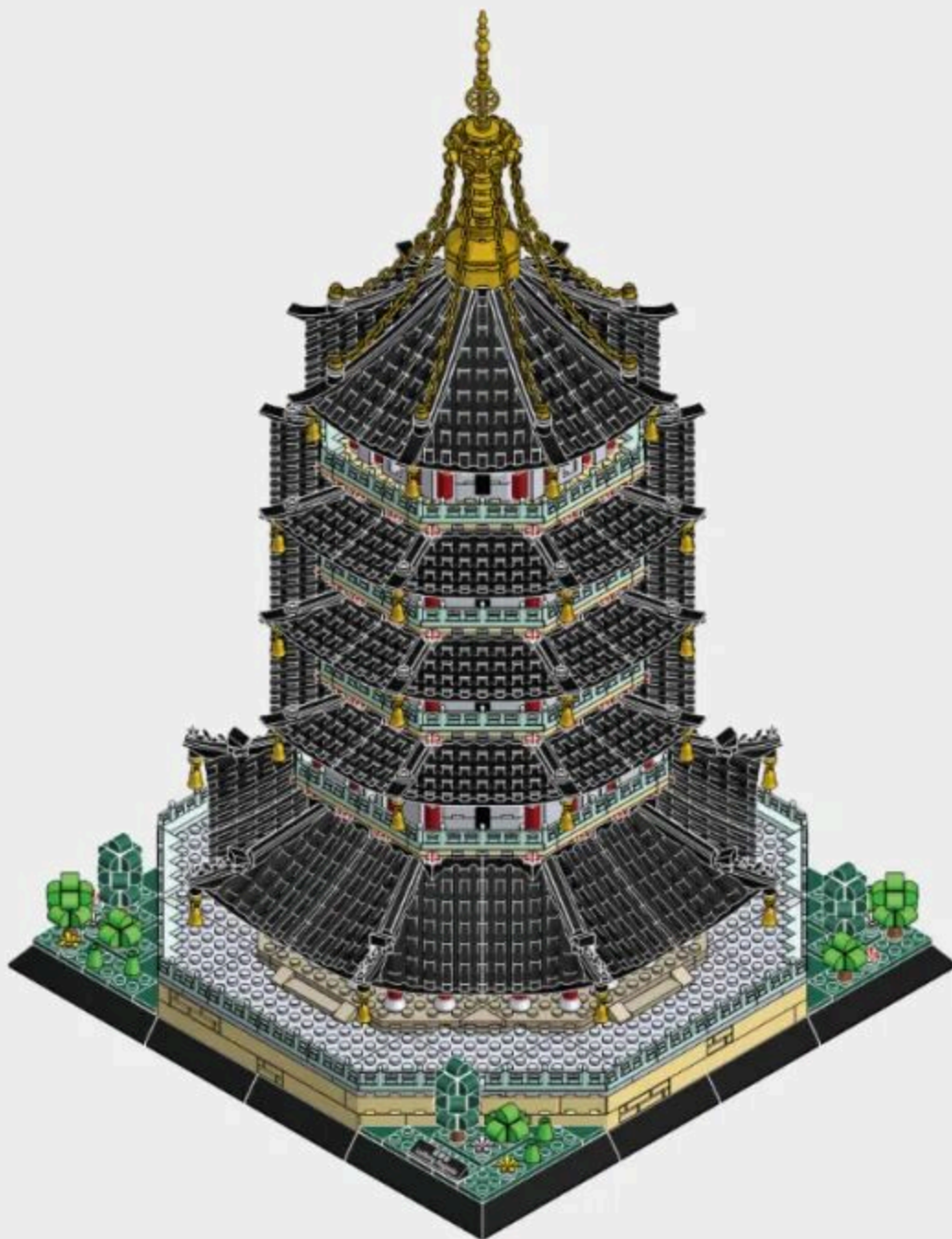

106

ARCHITECTURE

The World's great architecture



Shaping Skills



Imagination
& Curiosity



Mathematical



Self-Discovery
& Perception



Parent-Child
Interaction



Problem Solving



Creativity



6224 英国伦敦白金汉宫
BLIKINGHAM PALACE,LONDON,ENGLAND

5225 意大利罗马斗兽场
COLOSSEUM-ROME,ITALY

5226 日本东京帝国饭店
IMPERIAL HOTEL-TOKYO,JAPAN

5227 美国纽约自由女神像
STATE OF LIBERTY,NEW YORK,AMERICA

6211 德国柏林勃兰登堡门
BRANDENBURG GATE-BERLIN,GERMANY

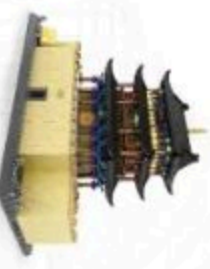

6222 中国甘肃长城-嘉峪关
JIAYU PASS-CANSU,CHINA

6212 日本京都清水寺仁王门
NEMON GATE OF KYOMIZU-dera,KYOTO,JAPAN

6213 俄罗斯莫斯科瓦西里大教堂
SAINT BASIL'S CATHEDRAL,MOSCOW,RUSSIA

6214 中国武汉黄鹤楼
YELLOW CRANE TOWER,WUHAN,CHINA

6215 英国伦敦眼
LONDON EYE,LONDON,ENGLAND



6221 中国北京故宫-太和殿
HALL OF SUPREME HARMONY,BEIJING,CHINA

6220 沙特阿拉伯麦加大清真寺
GREAT MOSQUE OF MECCA,SAUDI ARABIA

6219 美国纽约联合国大厦
UNITED NATIONS HEADQUARTERS-NEW YORK,AMERICA

4214 美国华盛顿白宫
WHITE HOUSE,WASHINGTON D.C.,AMERICA

4212 意大利罗马许愿池
TREVI FOUNTAIN-ROME,ITALY



4213 法国巴黎卢浮宫
MUSEE DU LOUVRE-PARIS,FRANCE

4218 新加坡-鱼尾狮
MERLION,SINGAPORE

4219 英国伦敦双子塔桥
TOWER BRIDGE,LONDON,ENGLAND

4216 美国华盛顿林肯纪念馆
LINCOLN MEMORIAL,ASHINGTON D.C.,AMERICA

4217 新加坡-金沙酒店
MARINA BAY SANDS,SINGAPORE



4210 埃及开罗吉萨金字塔
GREAT PYRAMID OF GIZA-CAIRO,EGYPT

4221 加拿大渥太华国会山庄
PARLIAMENT BUILDINGS,OTTAWA,CANADA

4211 英国伦敦伊丽莎白塔
ELIZABETH TOWER,ENGLAND

4215 加拿大多伦多电视塔
THE CN TOWER-CANADA

4220 美国纽约熨斗大厦
FLATIRON BUILDING-NEW YORK,AMERICA



4222 阿联酋迪拜哈利法塔 THE BURJ-KHALIFA TOWER-DUBAI, U.A.E. ORIENTAL PEARL TOWER-SHANGHAI, CHINA



5212 美国纽约帝国大厦 EMPIRE STATE BUILDING-NEW YORK, AMERICA

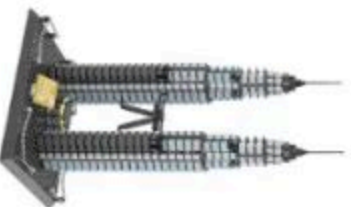

5213 马来西亚吉隆坡石油双塔 PETRONAS TWIN TOWERS-KUALA LUMPUR, MALAYSIA



5214 意大利比萨斜塔 LEANING TOWER OF PISA-ITALY



5216 英国伦敦伊丽莎白塔 BIG BEN-LONDON, ENGLAND

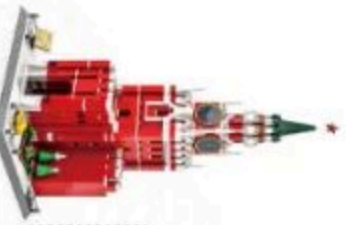

5219 巴西里约热内卢基督救世像 CRISTO REDENTOR-DE RIO DE JANEIRO, BRAZIL



5220 阿联酋迪拜阿拉伯塔酒店 BURJ AL ARAB-KUWAIT, U.A.E.

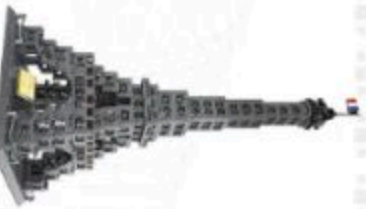

5217 法国巴黎埃菲尔铁塔 EIFFEL TOWER-PARIS, FRANCE



5221 中国台北101大楼 TAIPEI 101-TAIPEI, CHINA



5228 美国芝加哥威利斯大厦 WILLIS TOWER-CHICAGO, AMERICA



5231 巴西里约热内卢基督救世像 CRISTO REDENTOR-DE RIO DE JANEIRO, BRAZIL



6223 中国武汉长江大桥 WUHAN YANGTZE RIVER BRIDGE



5210 法国巴黎圣母院大教堂 CATHEDRALE NOTRE-DAME DE PARIS-PARIS, FRANCE



5211 印度阿格拉泰姬陵 TAJ MAHAL-AGRA, INDIA



5223 法国巴黎凯旋门 ARC DE TRIOMPHE-PARIS, FRANCE



5215 英国伦敦双子塔桥 TOWER BRIDGE-LONDON, ENGLAND



5222 中国北京天坛祈年殿 HALL OF PRAYER FOR GOOD HARVESTS-BEIJING, CHINA



6210 美国旧金山金门大桥 GOLDEN GATE BRIDGE-SAN FRANCISCO, AMERICA



6216 中国北京万里长城 (八达岭) THE GREAT WALL-BEIJING, CHINA



5218 中国北京天安门 TIAN ANMEN TOWER-BEIJING, CHINA



6217 中国西藏布达拉宫 POTALA PALACE-TIBET, CHINA



6218 芬兰罗瓦涅米圣诞老人办公室 SANTA CLAUS OFFICE-FINLAND



6225 墨西哥库库尔坎玛雅金字塔 EL CASTILLO-KUUKULKAN, MEXICO



6226 德国巴伐利亚新天鹅堡 SCHLOSS WELSHOLSTEIN-SLEISSEN, DENMARK



5229 土耳其伊斯坦布尔少女塔 MADENTOMB-ISTANBUL, TURKEY



5230 中国湖南长沙爱晚亭 POTALA PALACE-TIBET, CHINA



7210 中国上海世博会中国馆
CHINA PAVILION AT EXPO-SHANGHAI, CHINA



5232 美国宾夕法尼亚州流水别墅
FALLINGWATER PENNSYLVANIA, AMERICA



5233 美国芝加哥范斯沃斯住宅
FANNINGORTH HOUSE-CHICAGO, AMERICA



5234 美国华盛顿唐人街
CHINA TOWN-WASHINGTON, D.C., AMERICA



3210 美国纽约自由女神像
STATE OF LIBERTY-NEW YORK, AMERICA



4223 中国北京清华园
TUNGSHA CAMPUS-BEIJING, CHINA



7211 中国湖南岳阳楼
YUEYANG TOWER-HUNAN, CHINA



8210 澳大利亚悉尼歌剧院
SYDNEY OPERA HOUSE-BENBOW POINT-AUSTRALIA



7212 中国江西南昌滕王阁
PAVILION OF PRINCE TENG-JIANGXI, CHINA



6227 中国河南郑州嵩山少林寺
SHAOLIN TEMPLE-HENAN, CHINA



7213 中国重庆洪崖洞
HONGYADONG-CHONGQING, CHINA



5235 美国华盛顿国会大厦
UNITED STATES CAPITOL-WASHINGTON, D.C., AMERICA



5236 中国安徽滁州醉翁亭
ZHUWENG PAULOU-ANHUI, CHINA



6228 中国陕西西安钟楼
YAN BELL TOWER-SHAANXI, CHINA



5238 美国西雅图太空针塔
SPACE NEEDLE-SEATTLE, AMERICA



5237 法国巴黎萨伏伊别墅
VILLA SAVOYE-PARIS, FRANCE



6229 中国山西运城鹳雀楼
STORK TOWER-SHANYI, CHINA



6230 希腊爱琴海圣托里尼岛
SANTORINI-PHIA, GREECE



6231 中国上海海关大楼
SHANGHAI CUSTOMS HOUSE-SHANGHAI, CHINA



5239 中国北京紫禁城角楼
TOWER OF PALACE MUSEUM-BEIJING, CHINA



5240 韩国首尔崇礼门
NAEOMDONG-SEOUL, KOREA



5241 中国江苏南京夫子庙
CONFUCIUS TEMPLE-HUAIJIANG, CHINA



5242 美国纽约古根海姆博物馆
GUGENHEIM MUSEUM-NEW YORK, AMERICA



6232 中国江苏南京秦淮河画舫
QINHUAI RIVER PAINTED BOAT-HUAIJIANG, CHINA



6233 法国诺曼底圣米歇尔山
SAINT MICHAEL'S MOUNT-NORMANDY, FRANCE



6234 中国河南省栾川老君山
THE LAOJUN MOUNTAIN, HENAN, CHINA



5243 耶路撒冷岩石圆顶
DOME OF THE ROCK, JERUSALEM



6235 中国江苏苏州寒山寺 (普明宝塔)
HANSHAN TEMPLE, JIANGSU, CHINA



4224 英国威尔特郡巨石阵
STONEHENGE, WILTSHIRE, ENGLAND



4225 中国内蒙古自治区蒙古包
MONGOLIAN YURT, INNER MONGOLIA, CHINA



8211 中国福建土楼(承启楼)
CHENGQI EARTH BUILDING, FUJIAN, CHINA



4226 沙特阿拉伯麦加大清真寺(克尔白)
KERBAL GREAT MOSQUE OF MECCA, SAUDI ARABIA



5244 俄罗斯圣彼得堡冬宫
WINTER PALACE, ST. PETERSBURG, RUSSIA



7214 中国陕西西安鼓楼
XIAN DRUM TOWER, SHAANXI, CHINA



5245 中国重庆李子坝站
LIZIBA STATION, CHONGQING, CHINA



4227 俄罗斯莫斯科国立大学
MOSCOW STATE UNIVERSITY, MOSCOW, RUSSIA



4228 沙特阿拉伯麦地那先知清真寺
PROPHET'S MOSQUE, MEDINA, SAUDI ARABIA



6236 中国浙江杭州雷峰塔
LEIFENG PAGODA, HANGZHOU, ZHEJIANG, CHINA

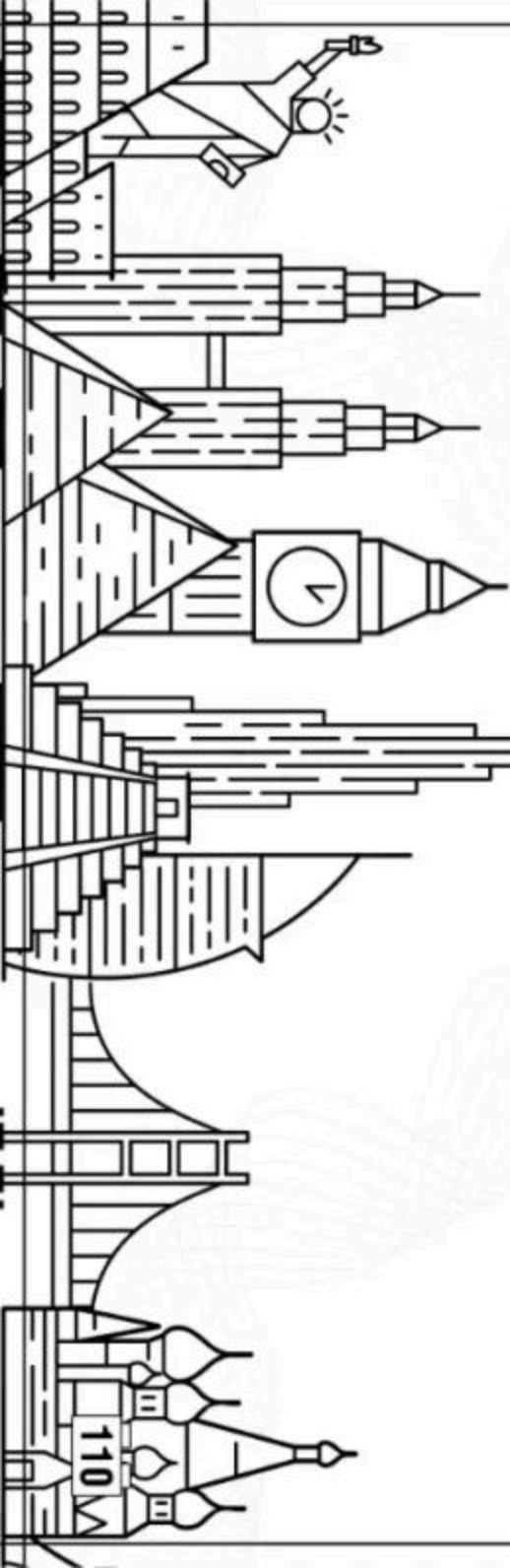



LEIFENG PAGODA

COUNTRY: China
CITY: Hangzhou

