



# ARCHITECTURE

## GARDEN COFFEE HOUSE

France  
World - style architecture

Ages  
**6+**



Creative  
Ability



Family  
Interaction



Observation  
Ability



Problem  
Solving



Imagination  
Ability



NO.6310  
**2313 PCS**

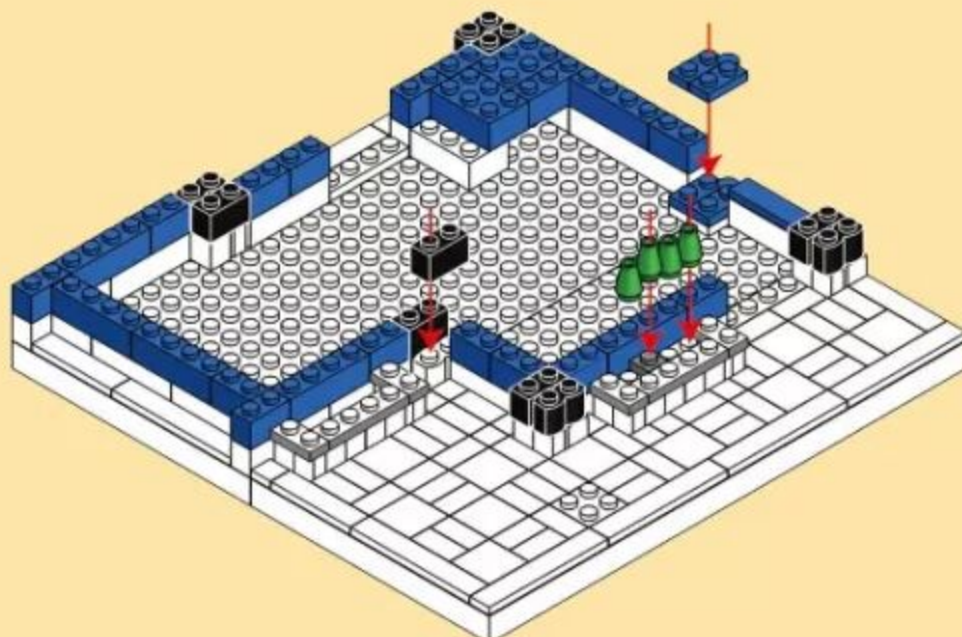
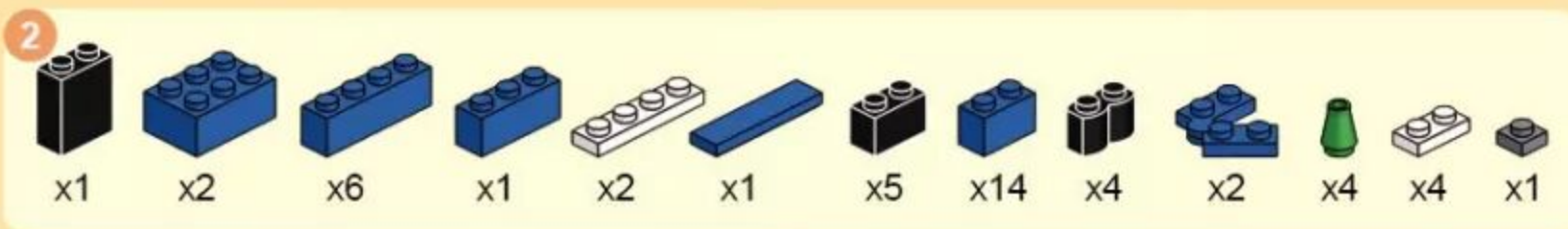
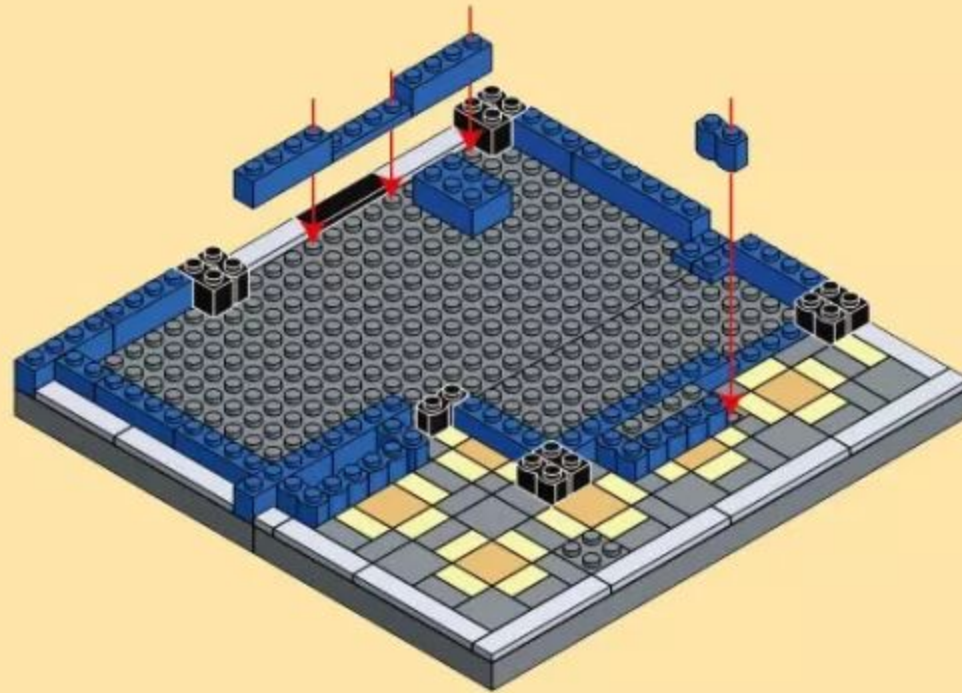
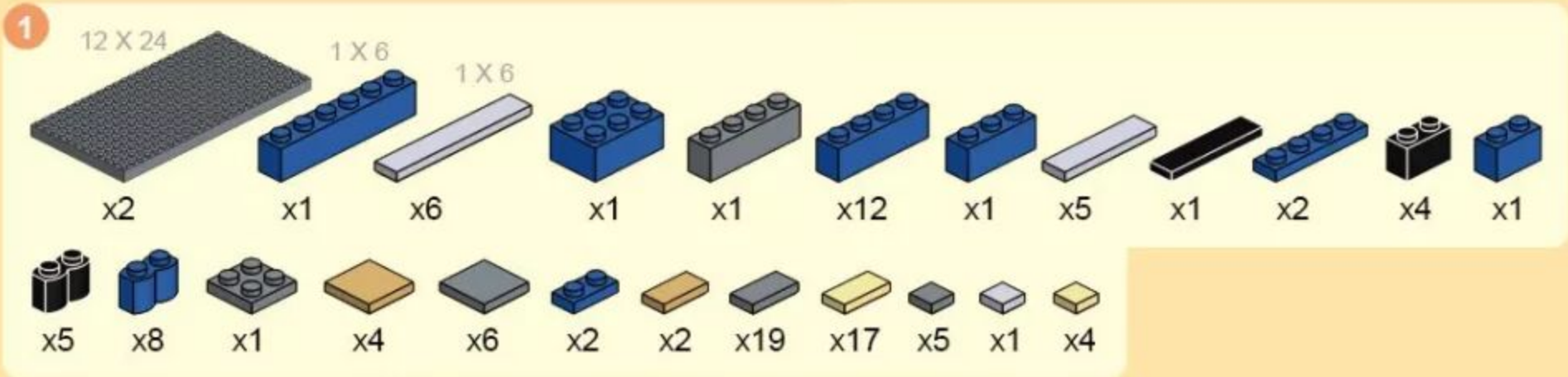

3 1 X 6

x1 x1 x1 x1 x2 x4 x3 x16 x5 x3 x4 x4 x1 x2

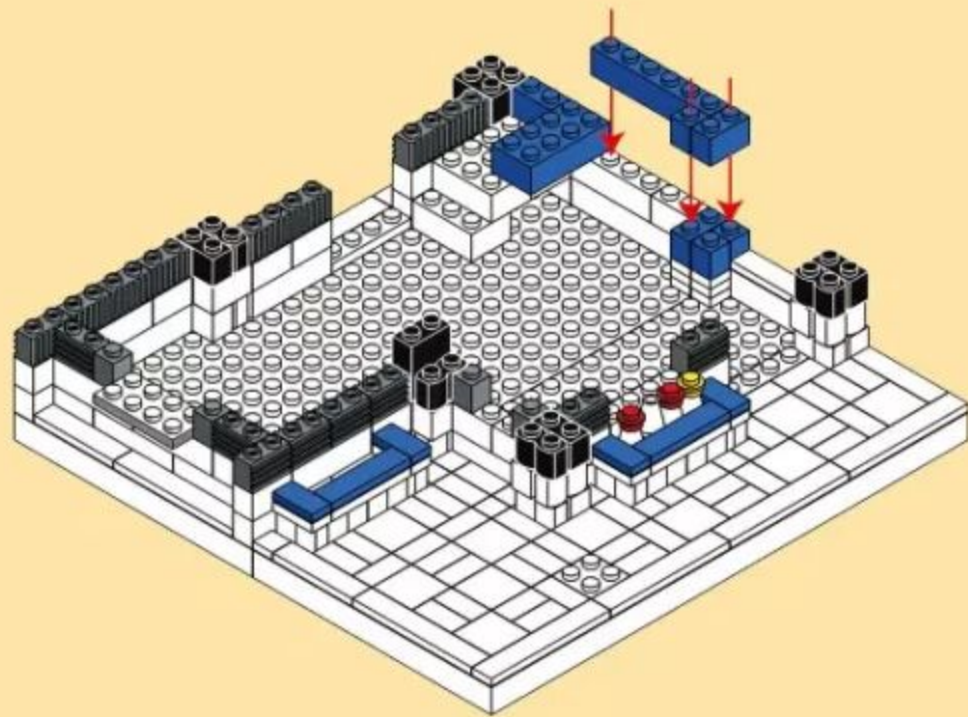

4

x3 x3 x1 x7 x2 x3 x1 x5 x3 x4 x6 x3 x2 x1

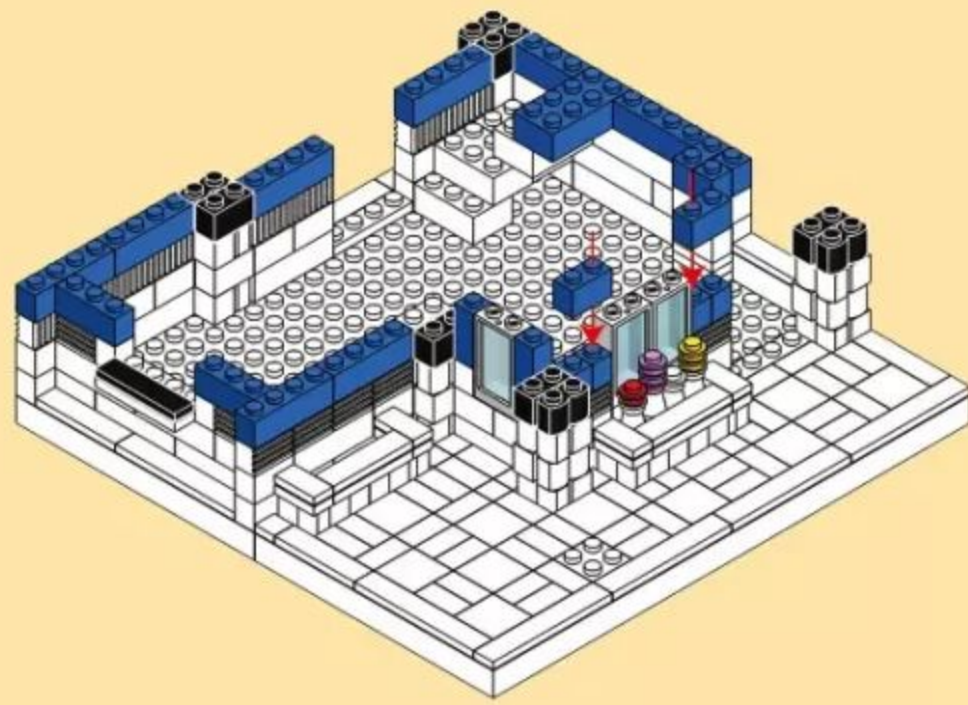

5

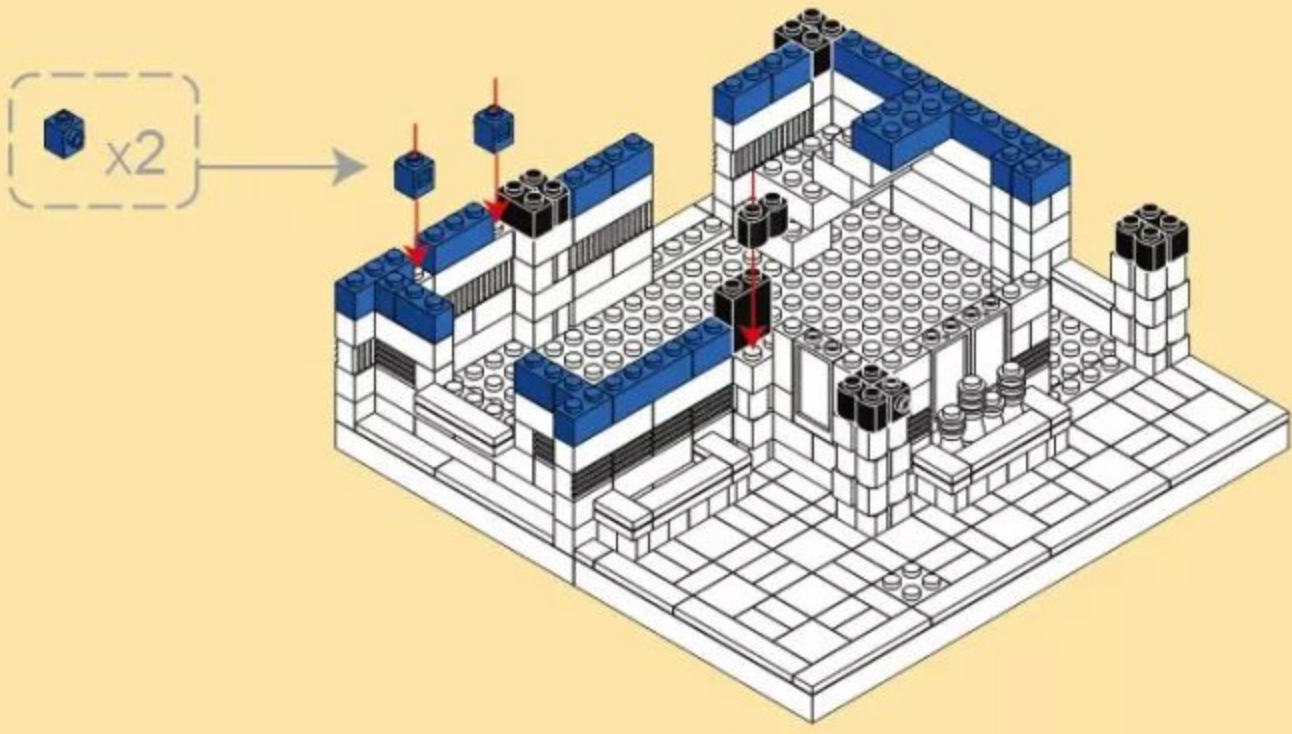
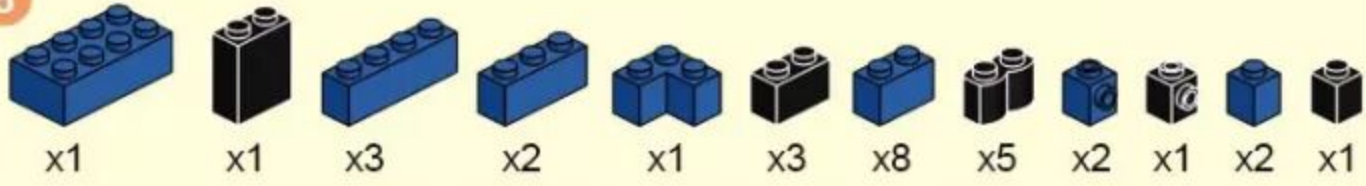

6

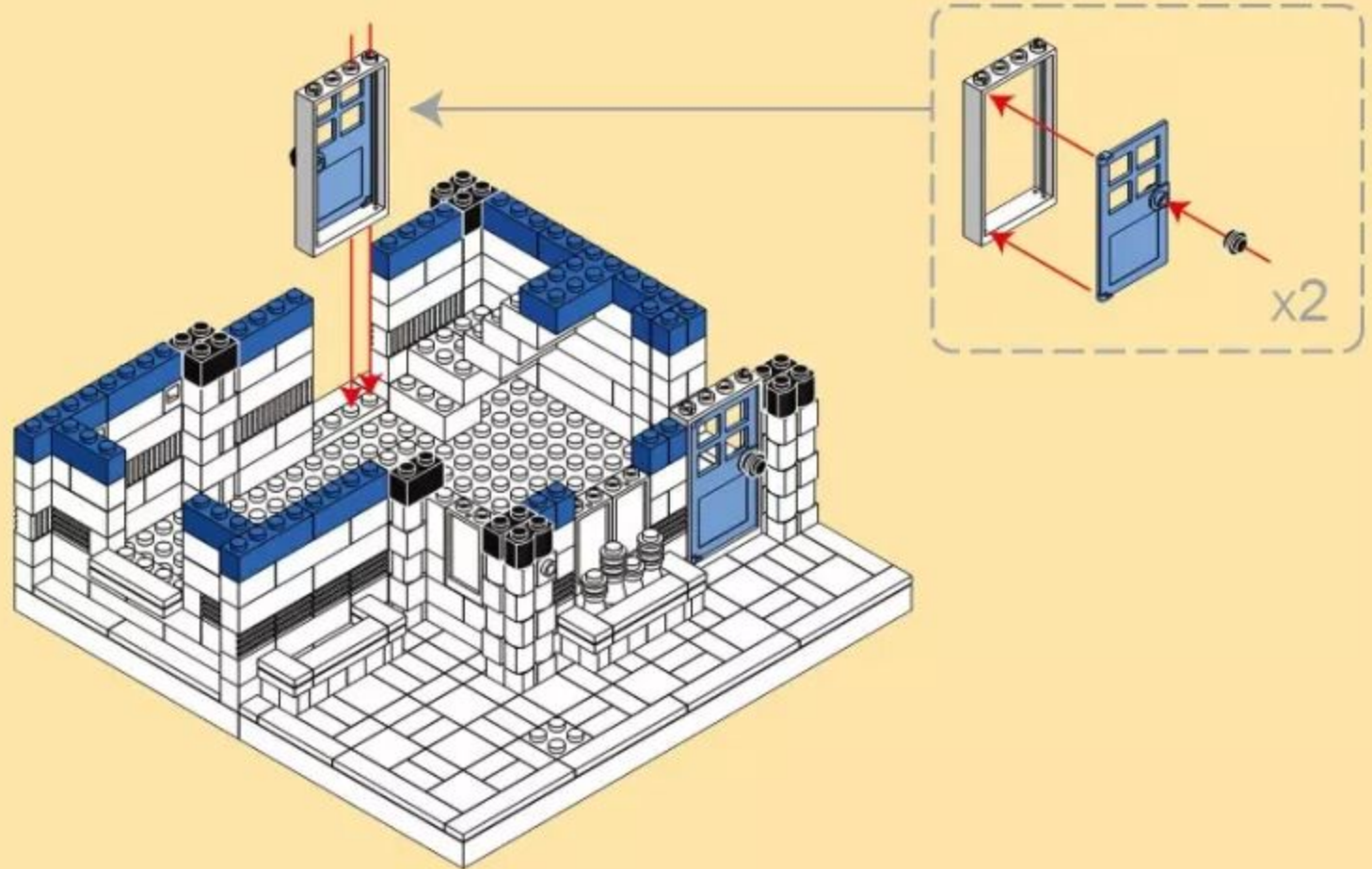
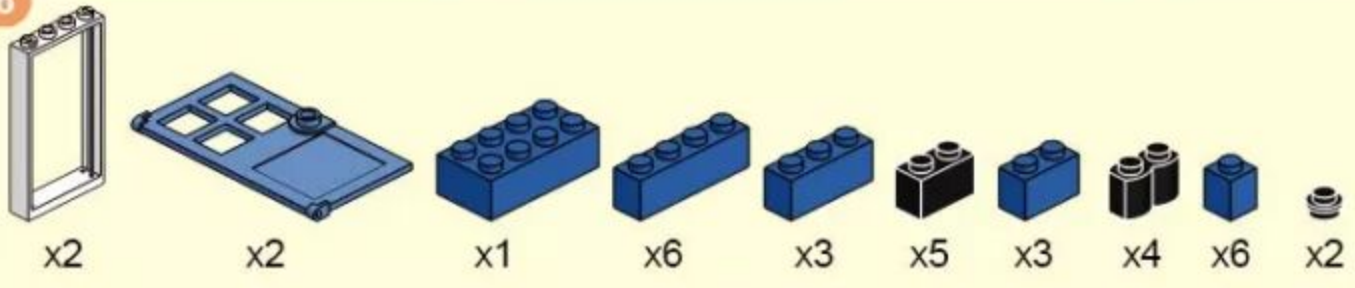

**7** 1 X 6

x1    x1    x1    x3    x2    x2    x3    x12    x5    x3    x3    x1

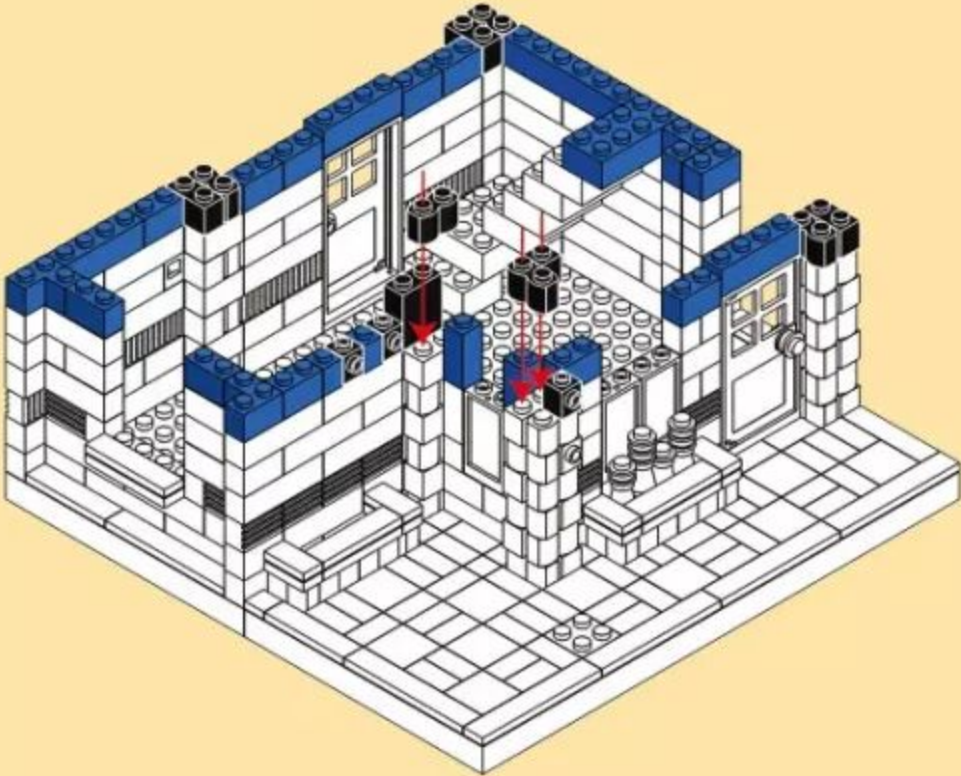

**8**

x3    x3    x1    x1    x7    x2    x1    x4    x1    x1    x2    x3    x1    x1    x5

x1    x5    x4    x3    x4    x1    x2

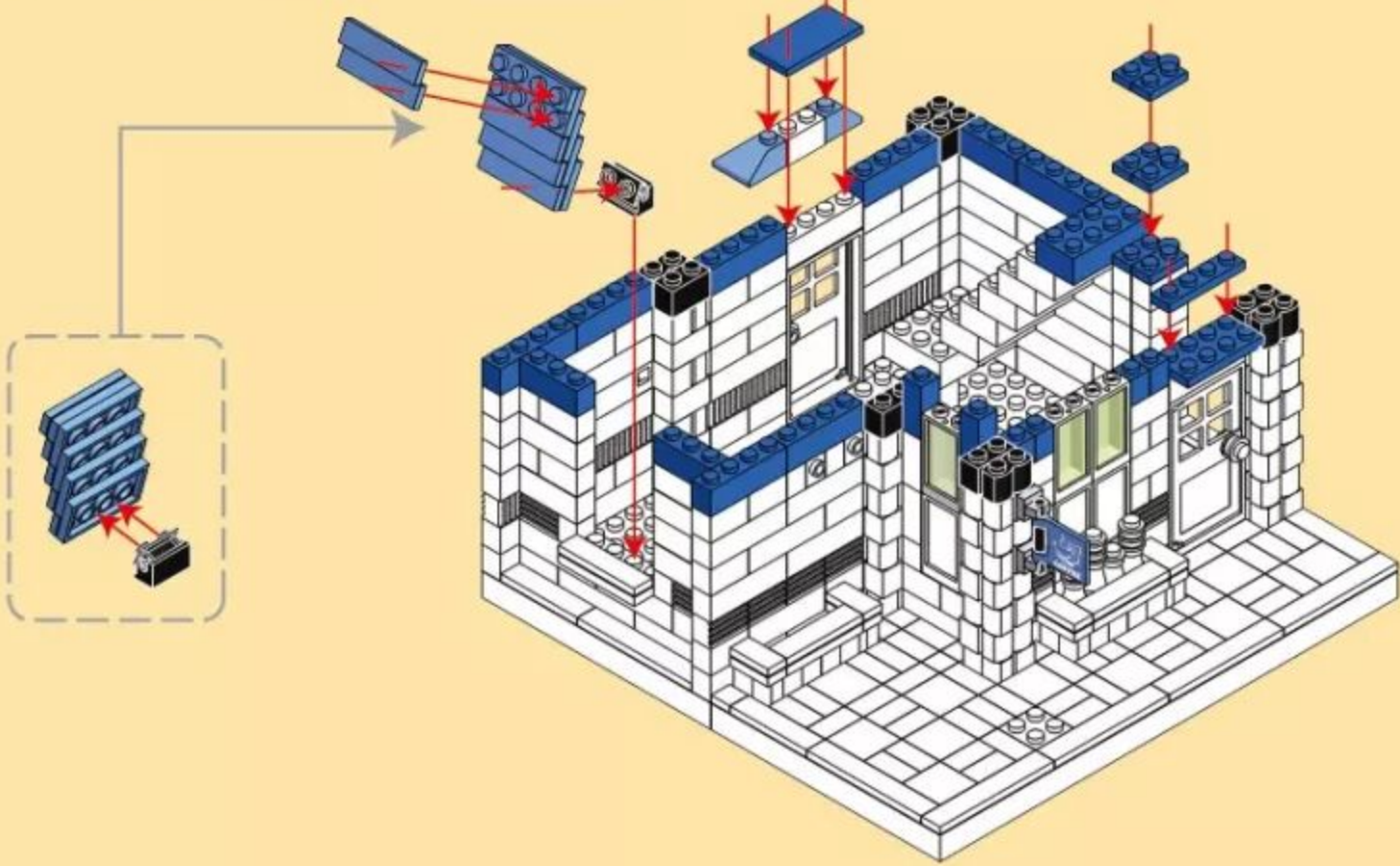

- 9**
- 1 X 8 (blue) x3
  - 1 X 6 (blue) x1
  - 1 X 6 (blue, curved) x1
  - 1 X 6 (blue) x1
  - White curved (1/2) x2
  - Blue curved (1/2) x2
  - Blue 1 X 3 x2
  - Blue 1 X 4 x2
  - Blue 1 X 3 x3
  - White 1 X 3 x3
  - Blue 2 X 2 x2
  - Black 2 X 2 x4
  - Blue 2 X 2 x5
  - Black 1 X 1 x1
  - Black 1 X 1 x5
  - Blue 2 X 2 x1
  - Blue 1 X 1 x1
  - Black 1 X 1 x1
  - Blue 1 X 1 x2
  - Blue 1 X 1 x2
  - White 1 X 3 x1

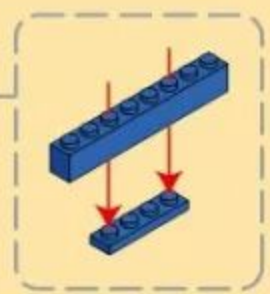
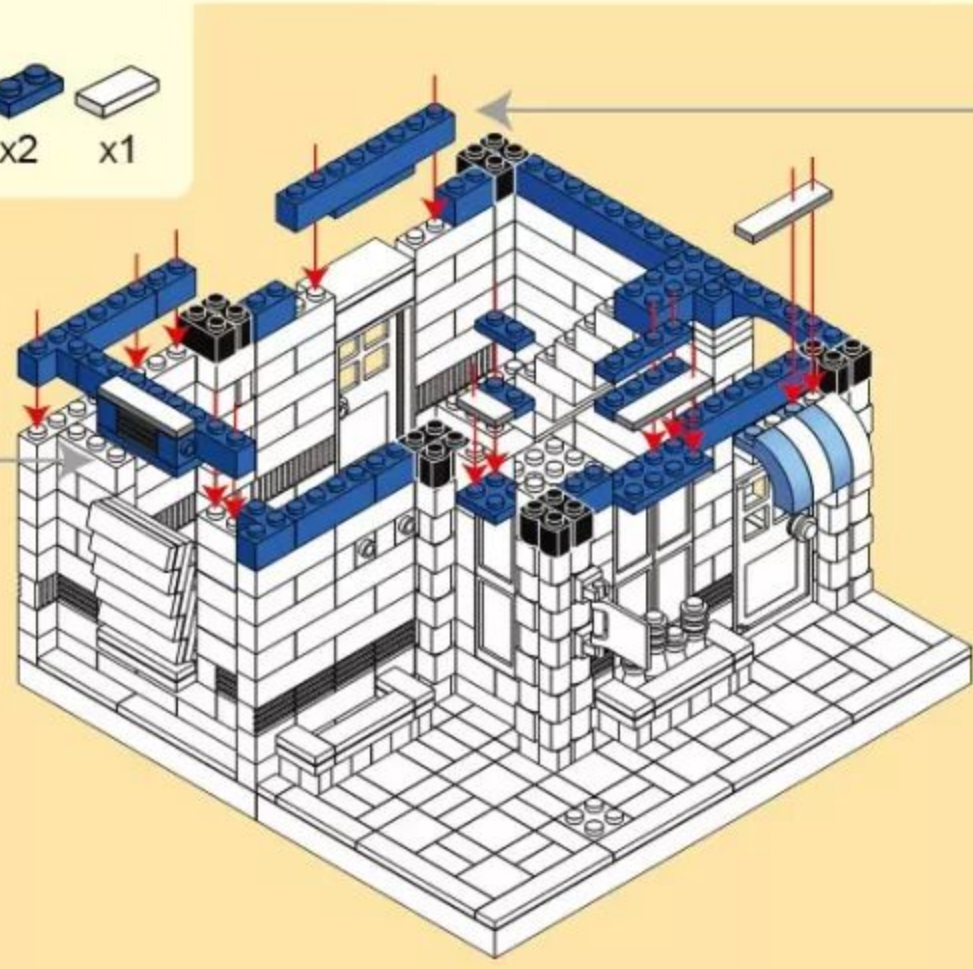
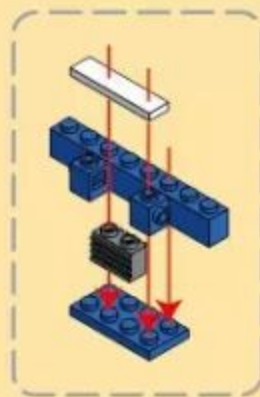

- 10**
- 1 X 16 (black) x2
  - 1 X 8 (black) x1
  - 1 X 8 (white) x2
  - Blue 1 X 3 x6
  - Black 1 X 3 x1
  - Blue 1 X 3 x3
  - Blue 2 X 2 x1
  - White 1 X 3 x4
  - Black 2 X 2 x1
  - Black 2 X 2 x3
  - Blue 2 X 2 x2
  - Black 2 X 2 x4
  - Blue 1 X 1 x10
  - Blue 1 X 1 x5

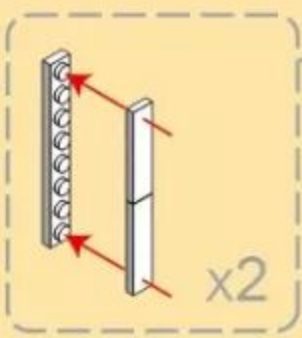
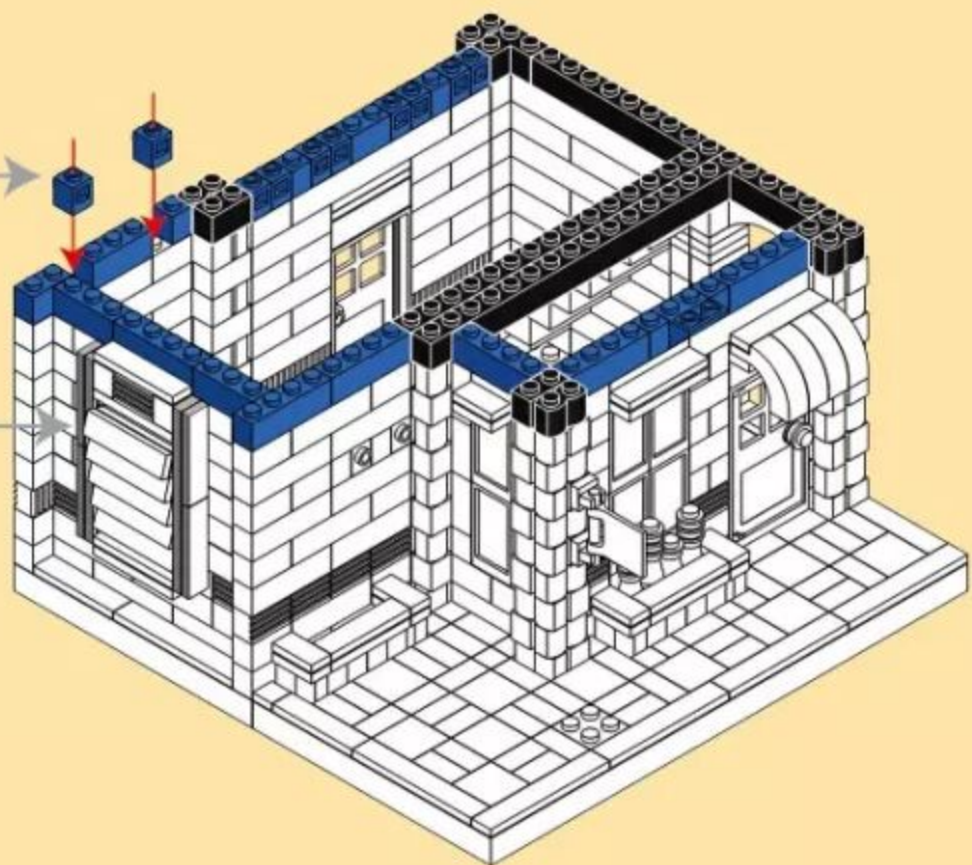

11

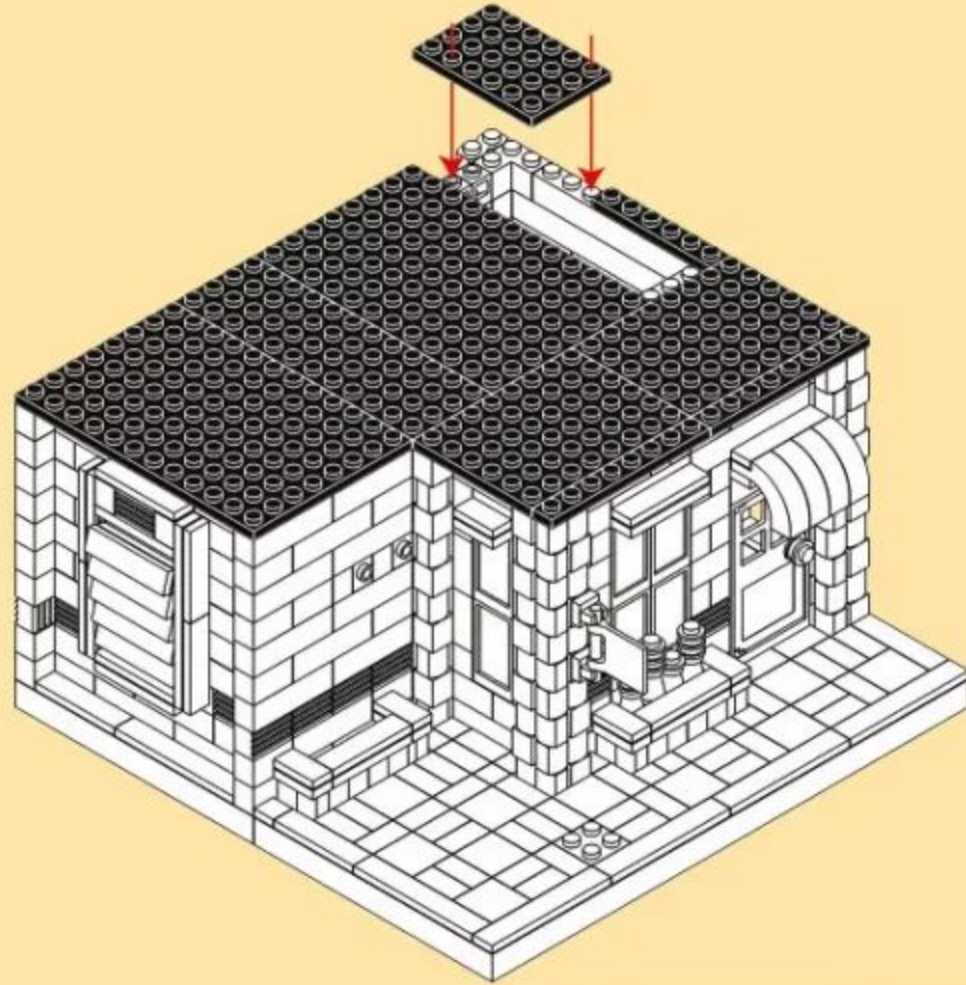
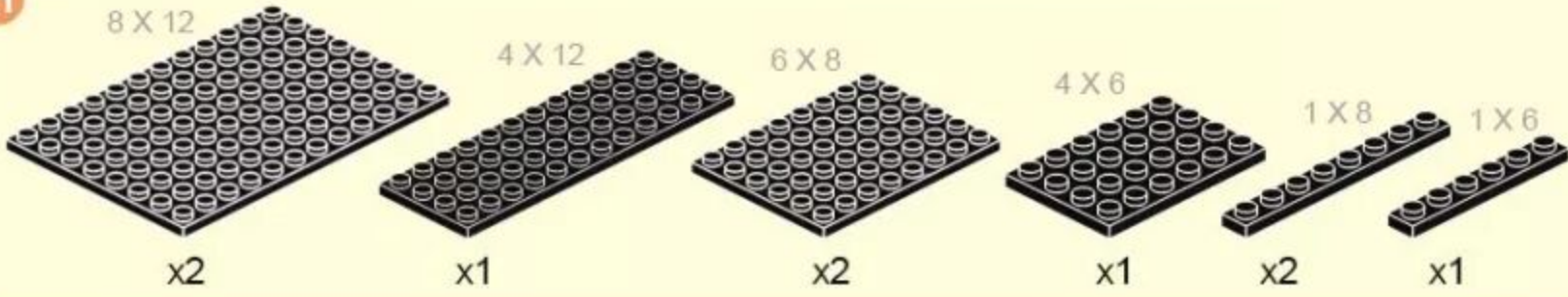

12

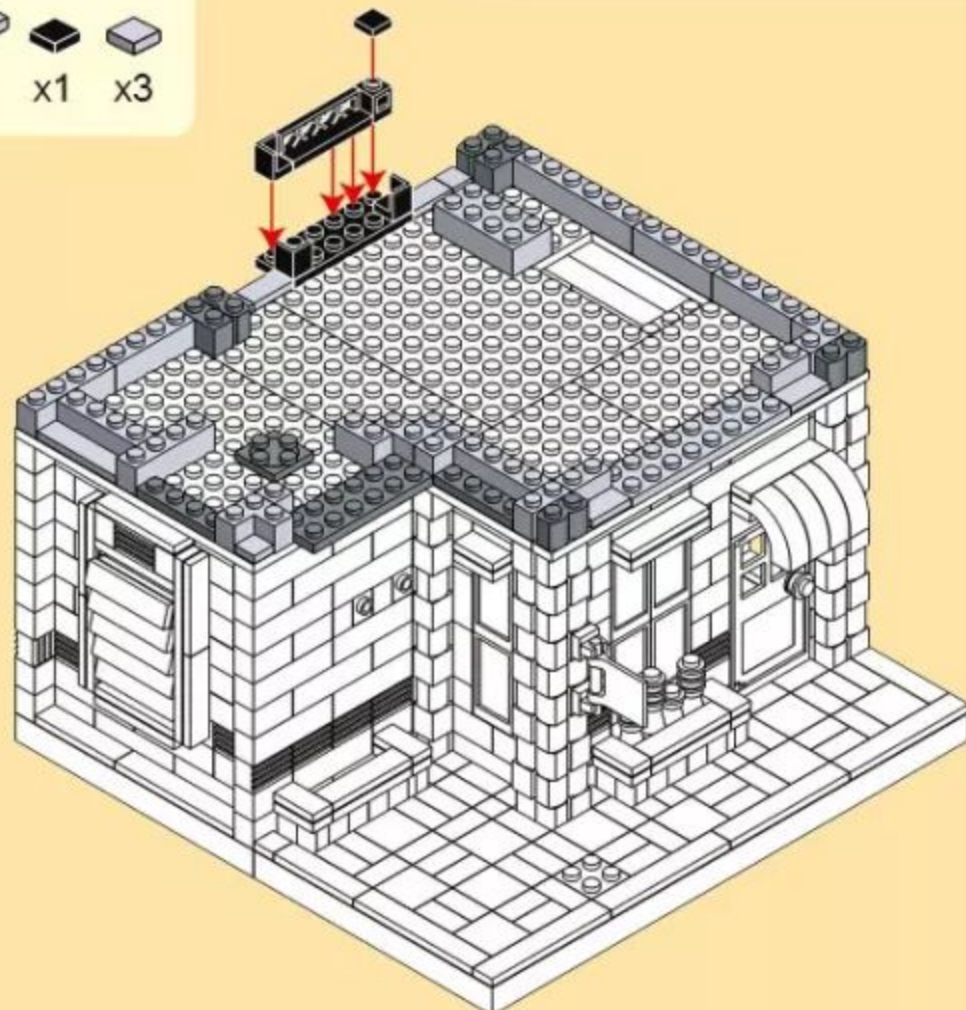
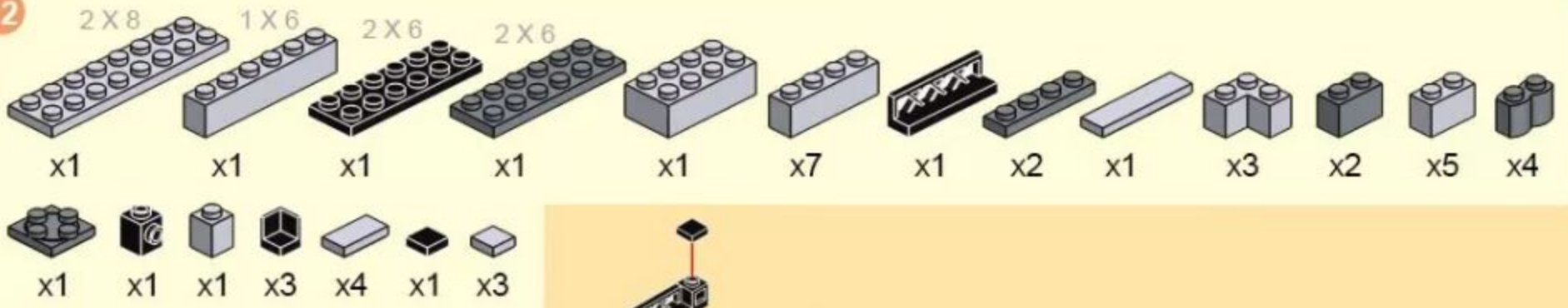

- 13**
- 1x6 (light grey) x1
  - 1x6 (dark grey) x2
  - 1x6 (yellow) x2
  - 1x6 (brown) x1
  - 1x6 (blue) x5
  - 1x6 (light grey) x1
  - 1x6 (grey) x1
  - 1x6 (yellow) x3
  - 1x6 (brown) x1
  - 1x6 (grey) x1
  - 1x2 (grey) x3
  - 1x2 (blue) x2
  - 1x2 (grey) x2
  - 1x2 (light grey) x6
  - 1x2 (dark grey) x6
  - 1x2 (yellow) x2
  - 1x2 (grey) x6
  - 1x2 (grey) x10
  - 1x2 (light grey) x1
  - 1x2 (yellow) x2
  - 1x2 (grey) x2
  - 1x2 (brown) x4

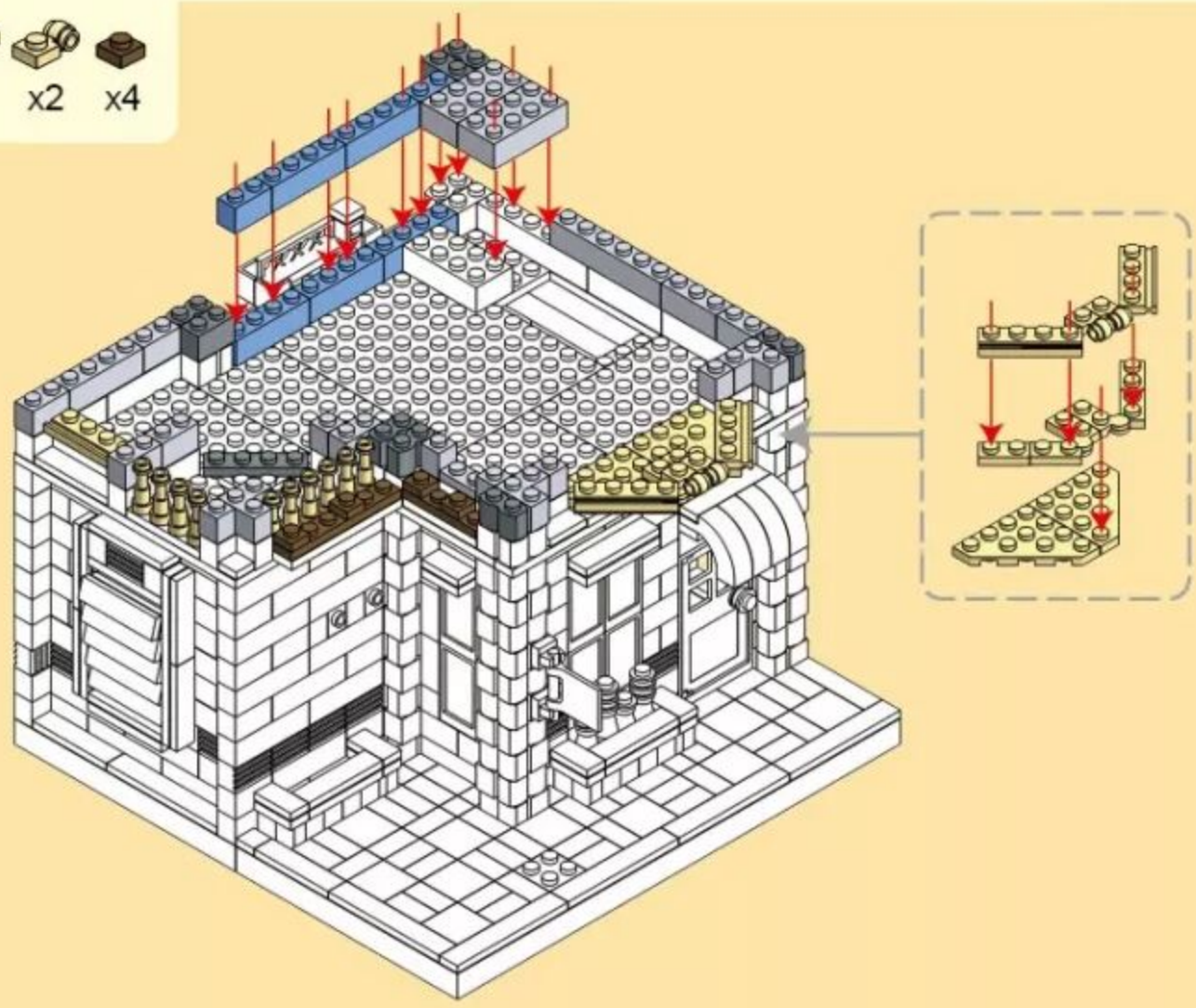

- 14**
- 1x6 (light grey) x1
  - 1x6 (dark grey) x1
  - 1x6 (blue) x3
  - 1x6 (light grey) x2
  - 1x6 (grey) x2
  - 1x6 (dark grey) x1
  - 1x2 (grey) x5
  - 1x2 (dark grey) x2
  - 1x2 (light grey) x5
  - 1x2 (dark grey) x4
  - 1x2 (yellow) x3
  - 1x2 (grey) x1
  - 1x2 (light grey) x2

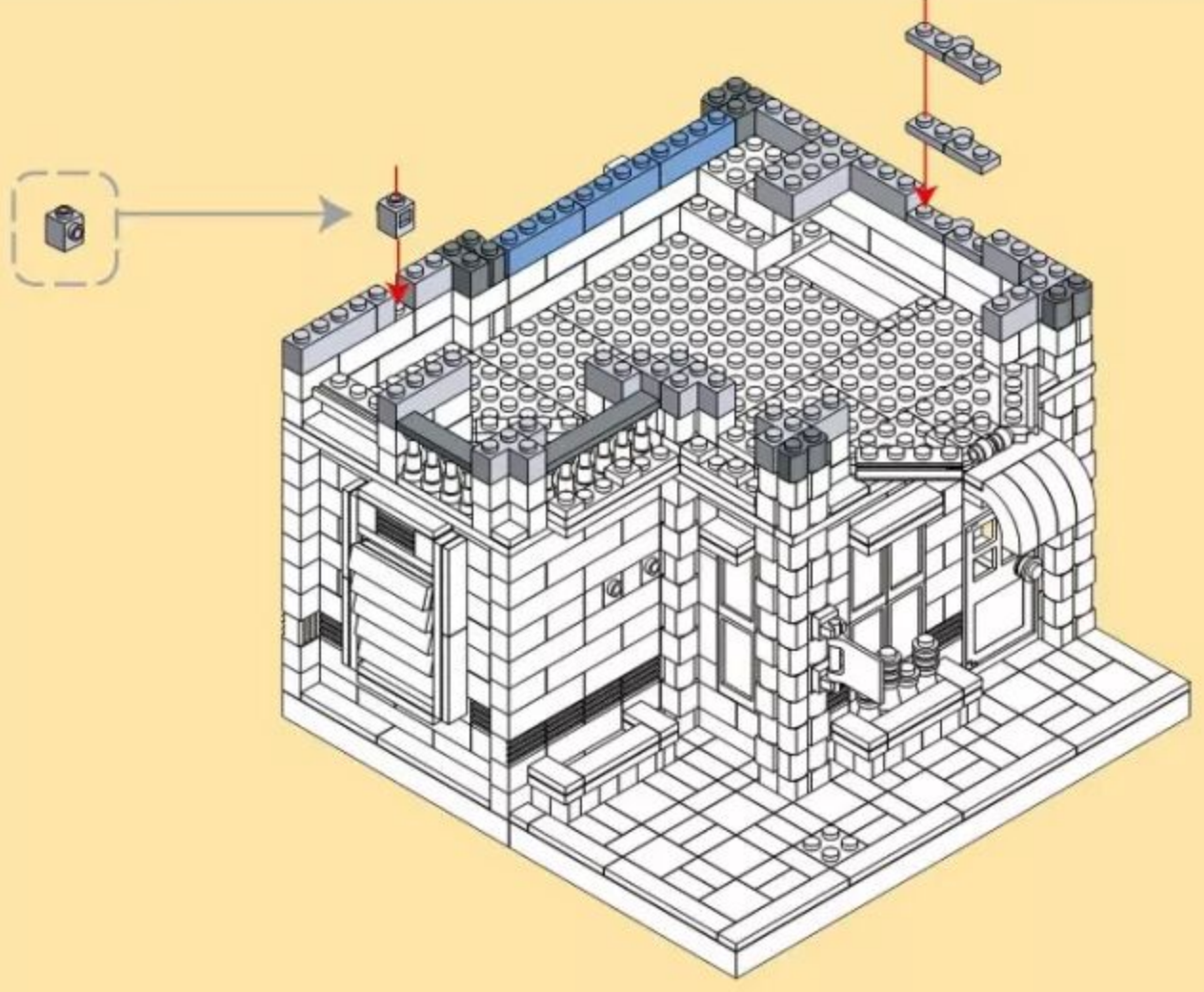

15

- x1
- x1
- x2
- x1
- x1
- x3
- x1
- x1
- x3
- x2
- x6
- x4
- x6
- x6



16



x1



x2

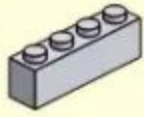

x4



x2



x5



x2



x4



x4



x1

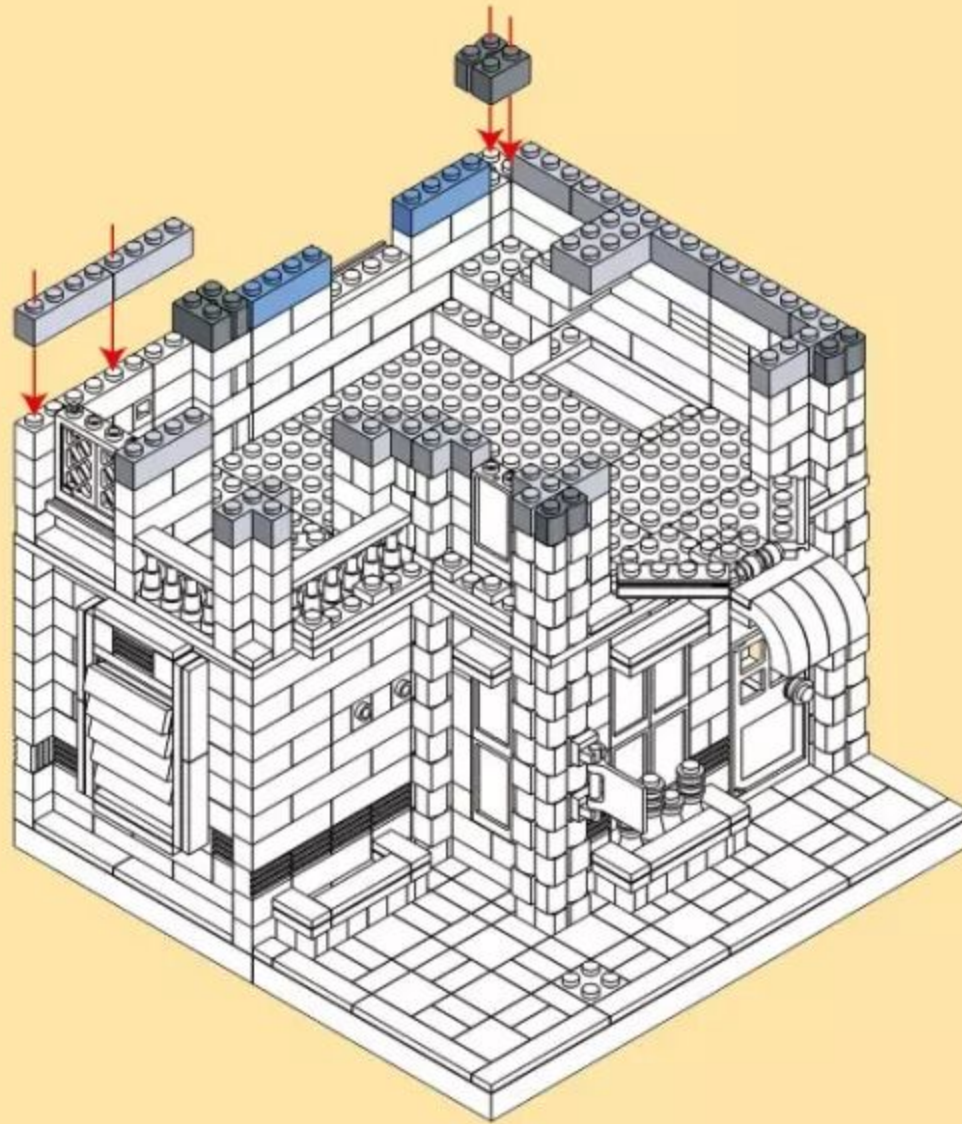

17



x1



x1



x1

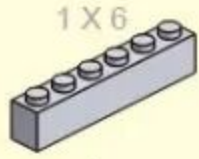

x1



x2

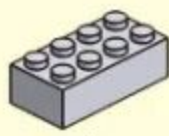

x1

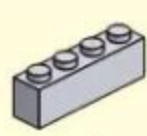

x1



x1



x3



x2



x7



x2



x6



x2



x6



x2



x1

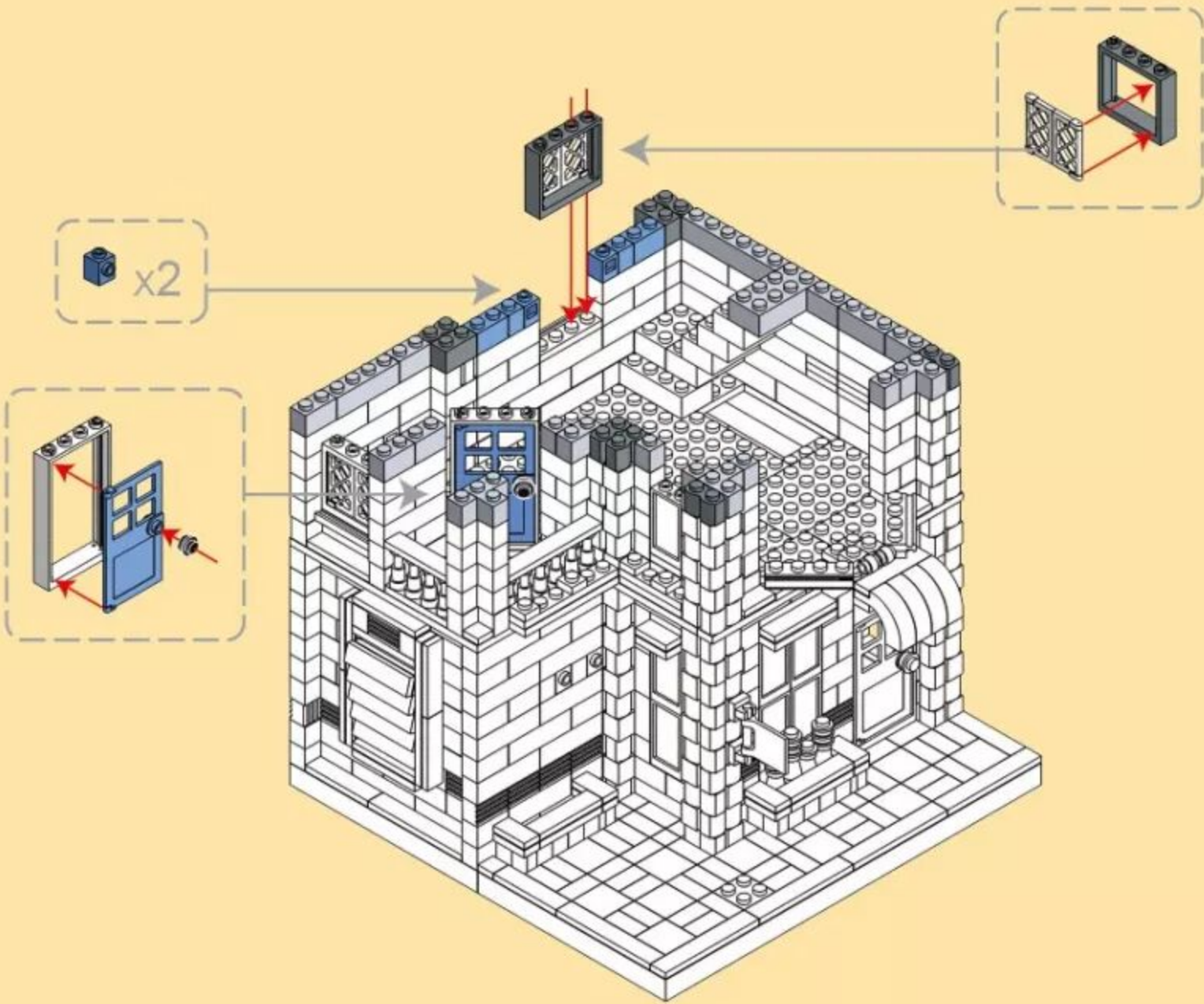

18

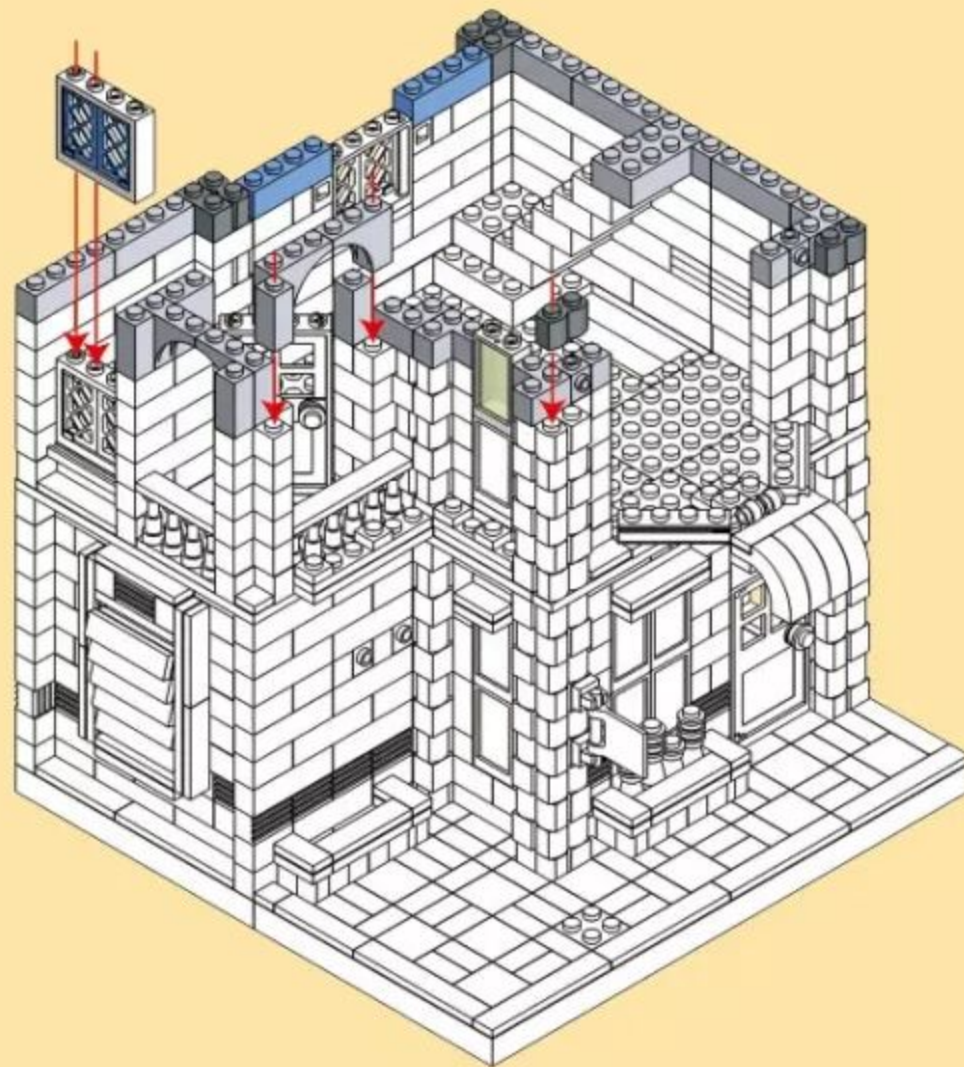
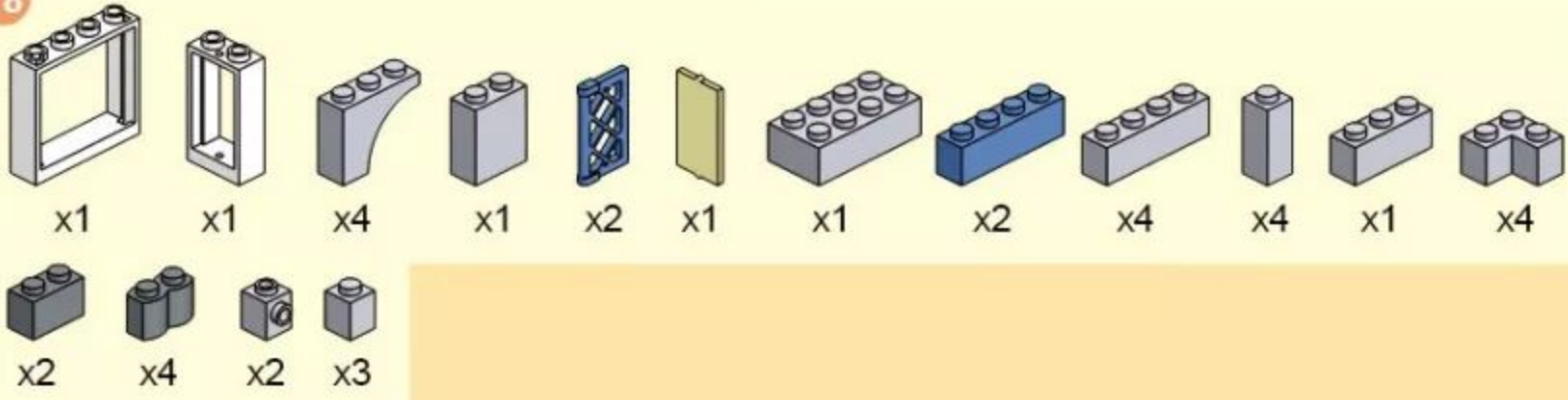

19

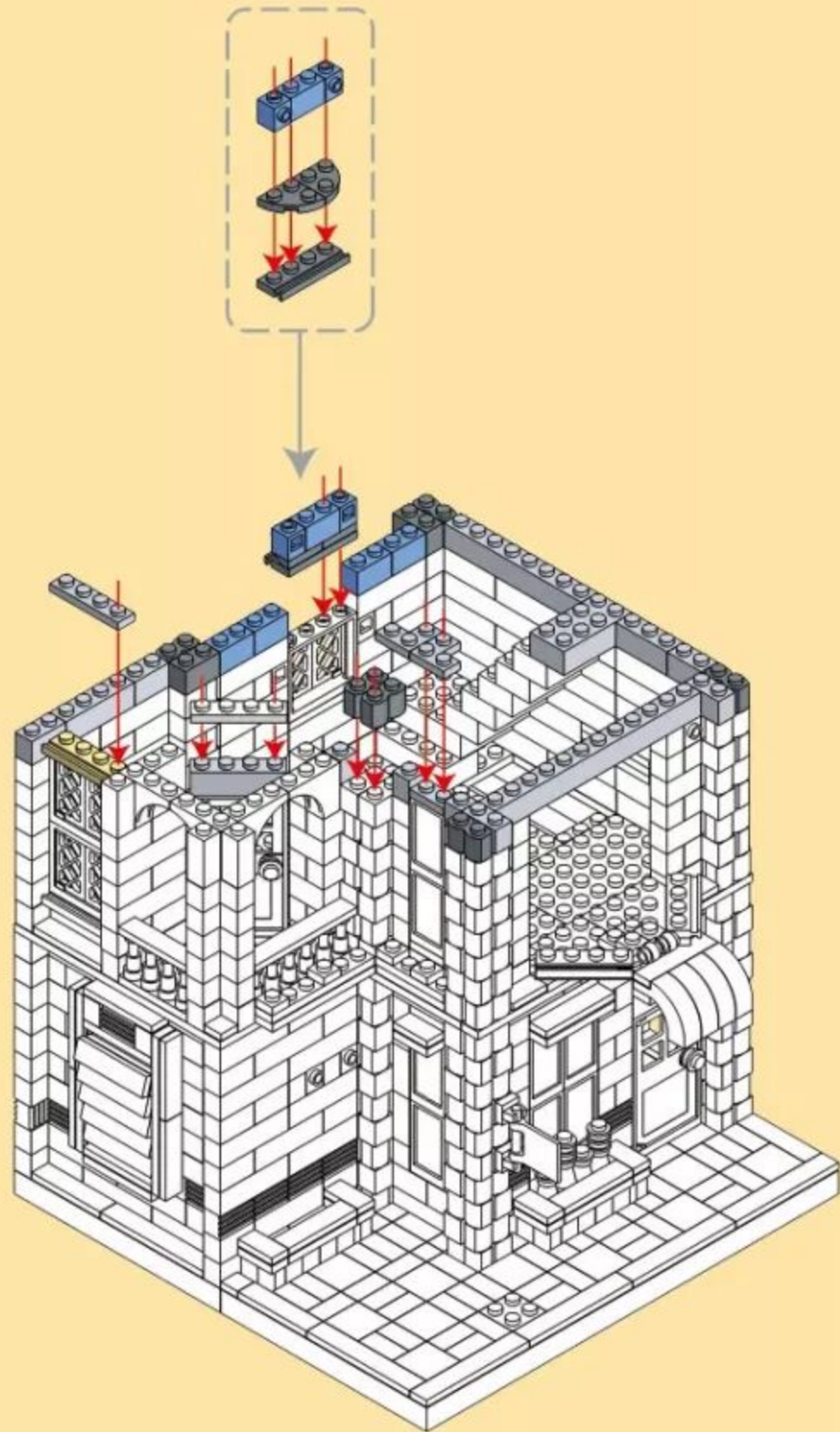
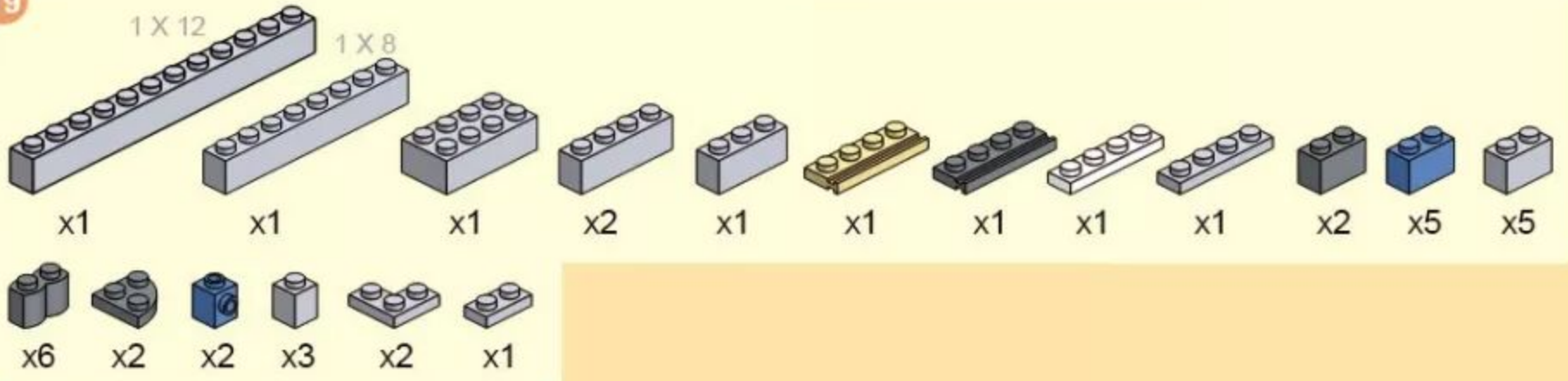

- 20
- 1 X 8 (white) x2
  - Blue curved (1/2) x2
  - White curved (1/2) x2
  - 1 X 6 (white) x4
  - Grey 1 X 3 x1
  - Black 2 X 2 x1
  - Grey 1 X 3 x3
  - White 1 X 3 x1
  - Black 2 X 2 x1
  - Grey 1 X 3 x2
  - Grey 2 X 2 x3
  - Black pin x2
  - White cone x2
  - Grey 1 X 3 x5
  - Black 2 X 2 x1
  - Grey 1 X 3 x4
  - Black pin x2

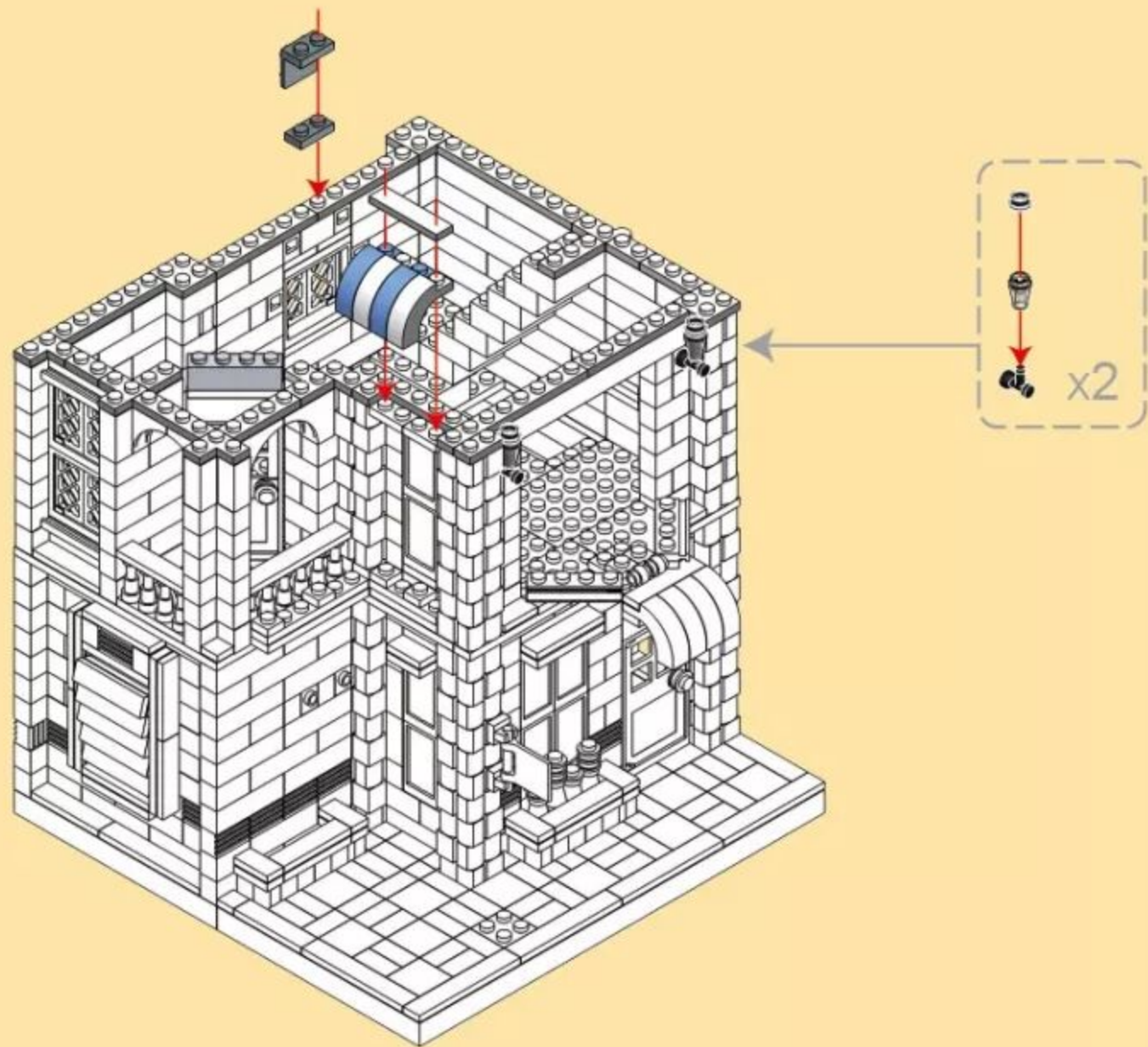

21

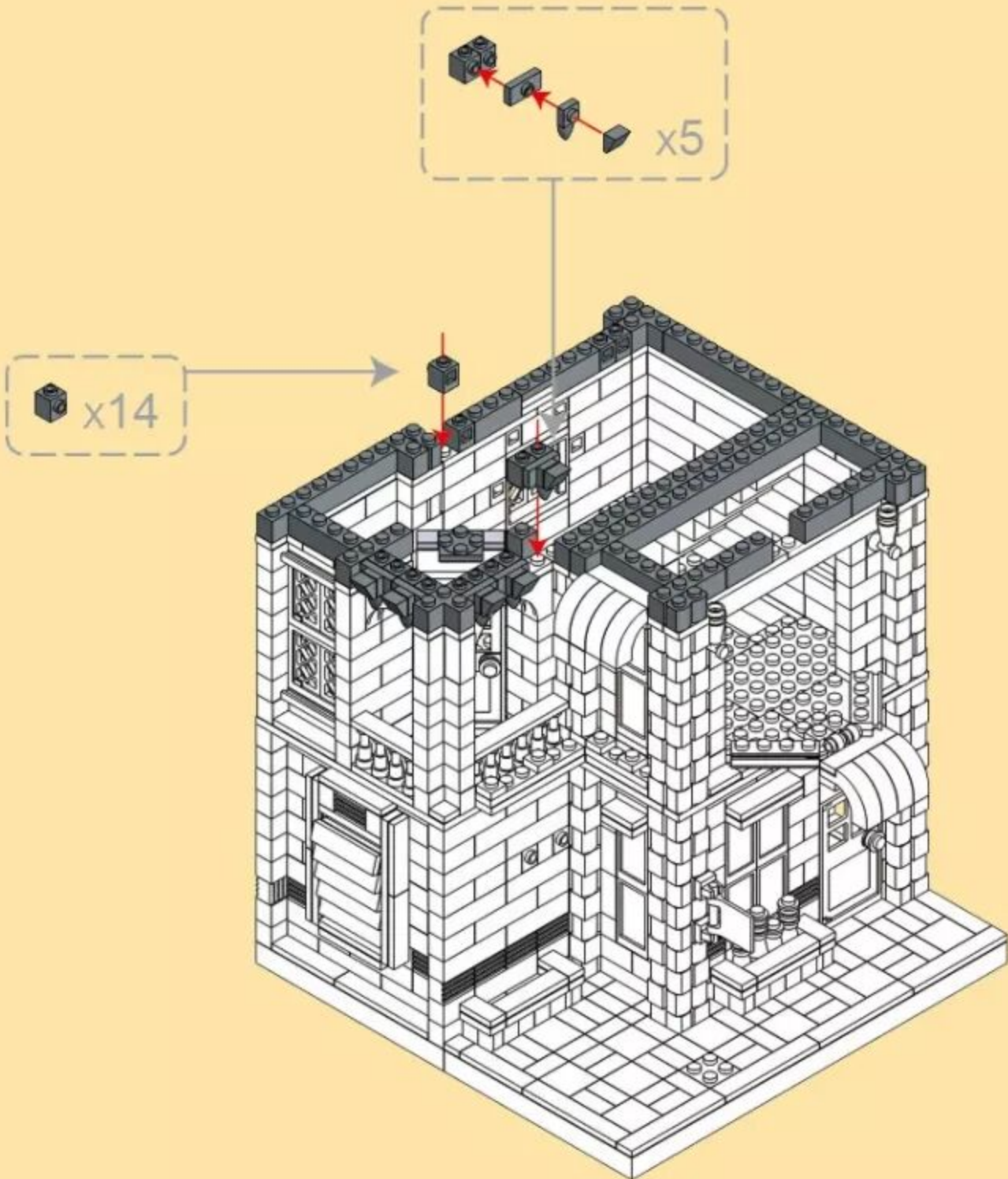
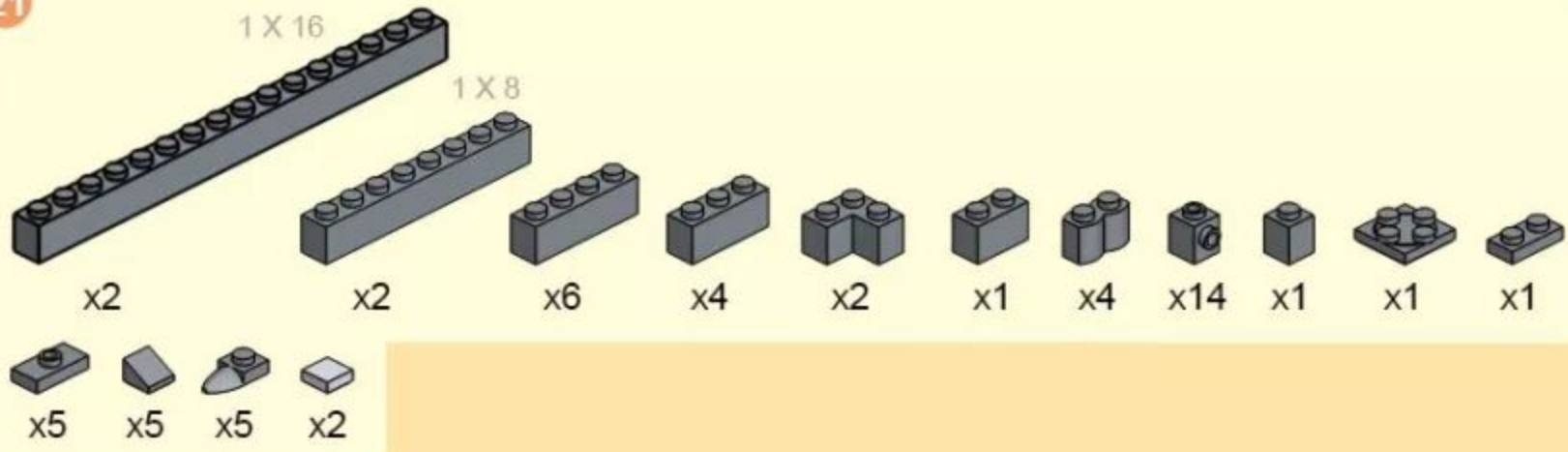

22



x10



x2



x10



x1



x2



x2



x4



x2



x1



x4



x2



x4

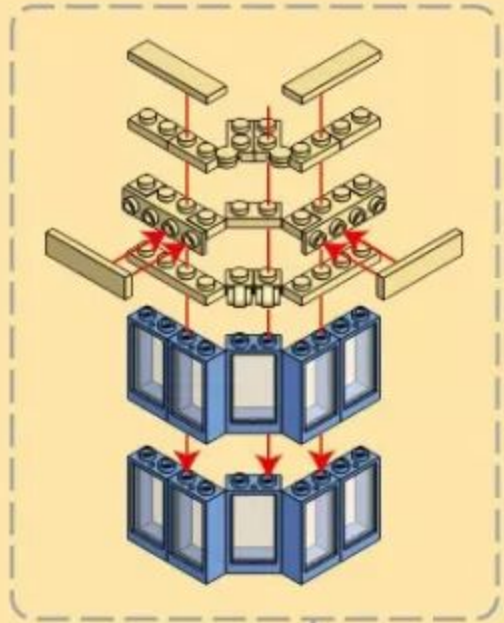
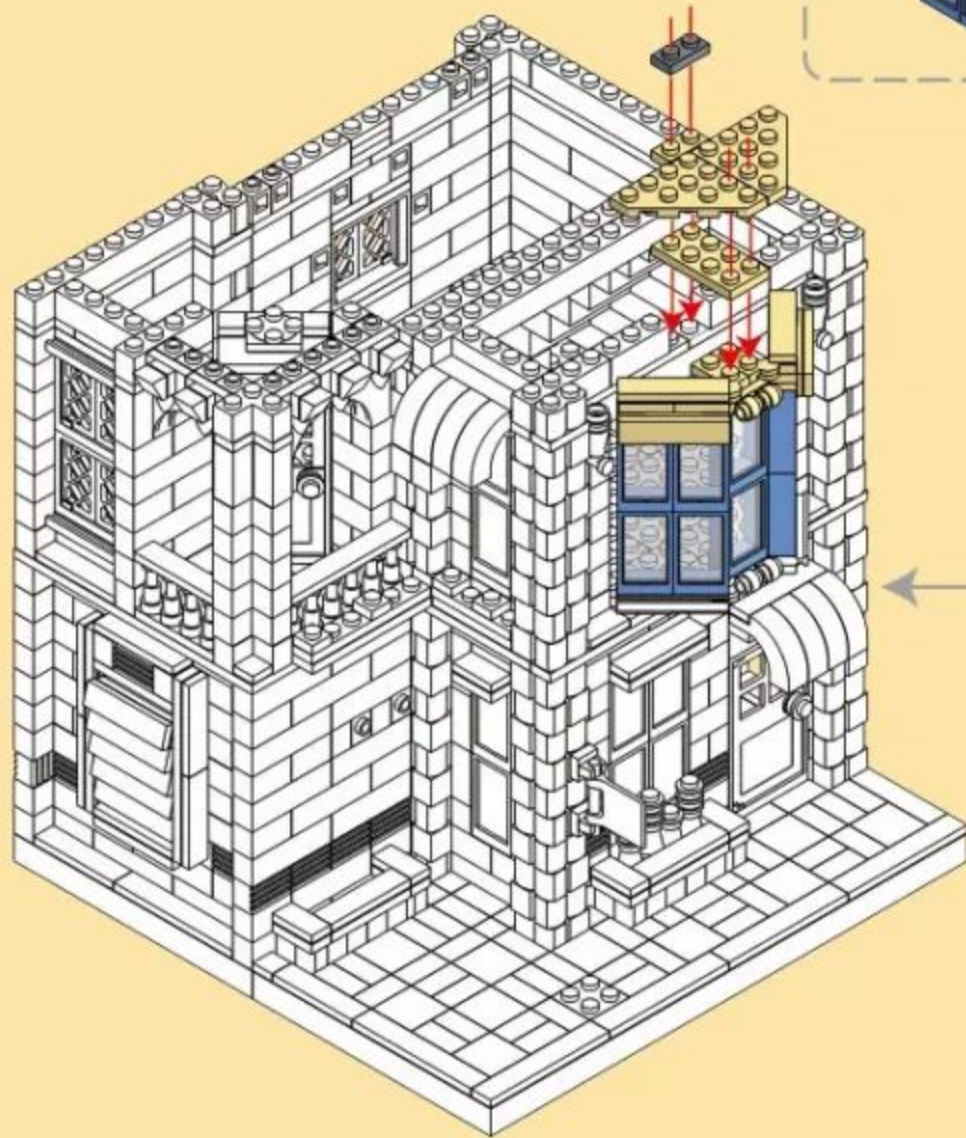

23

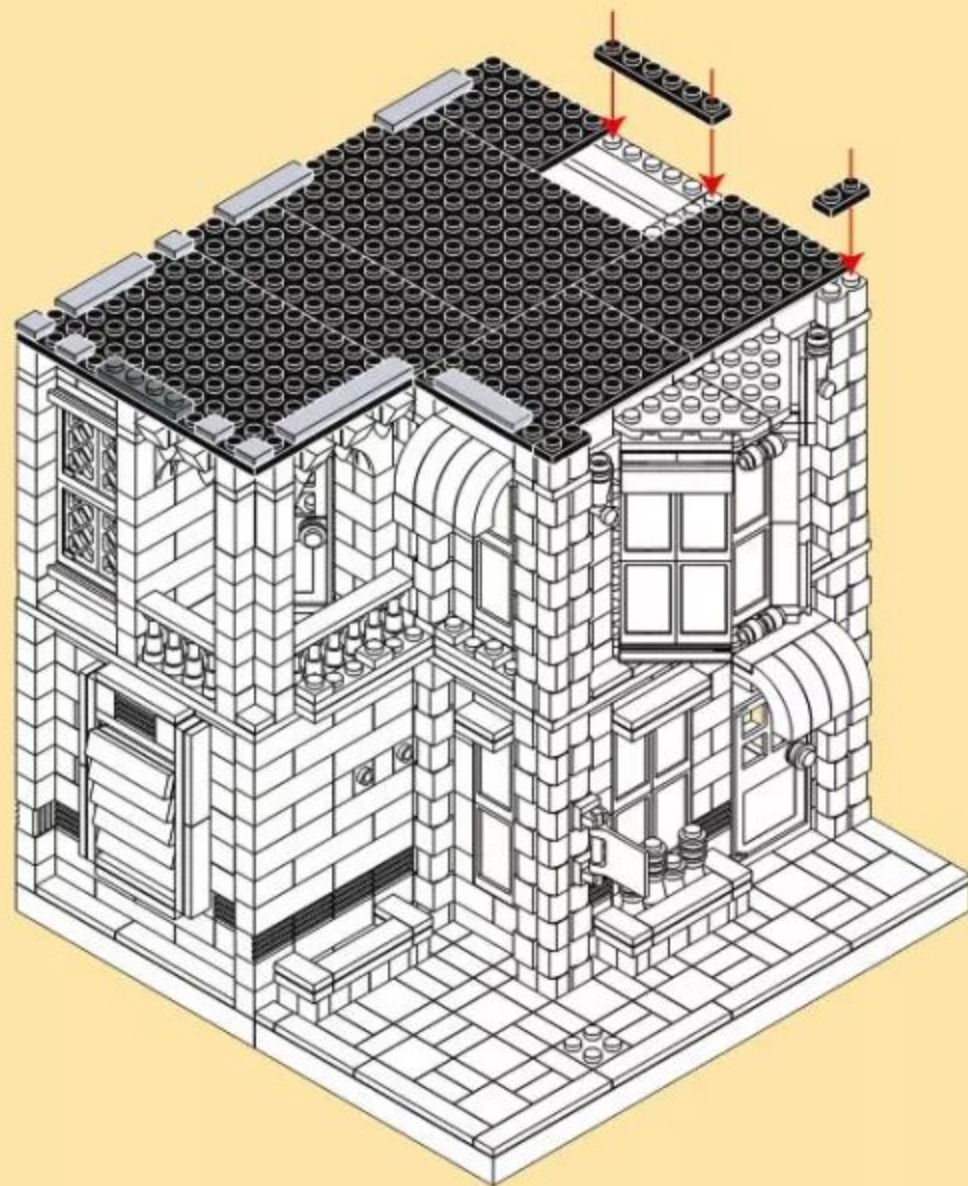
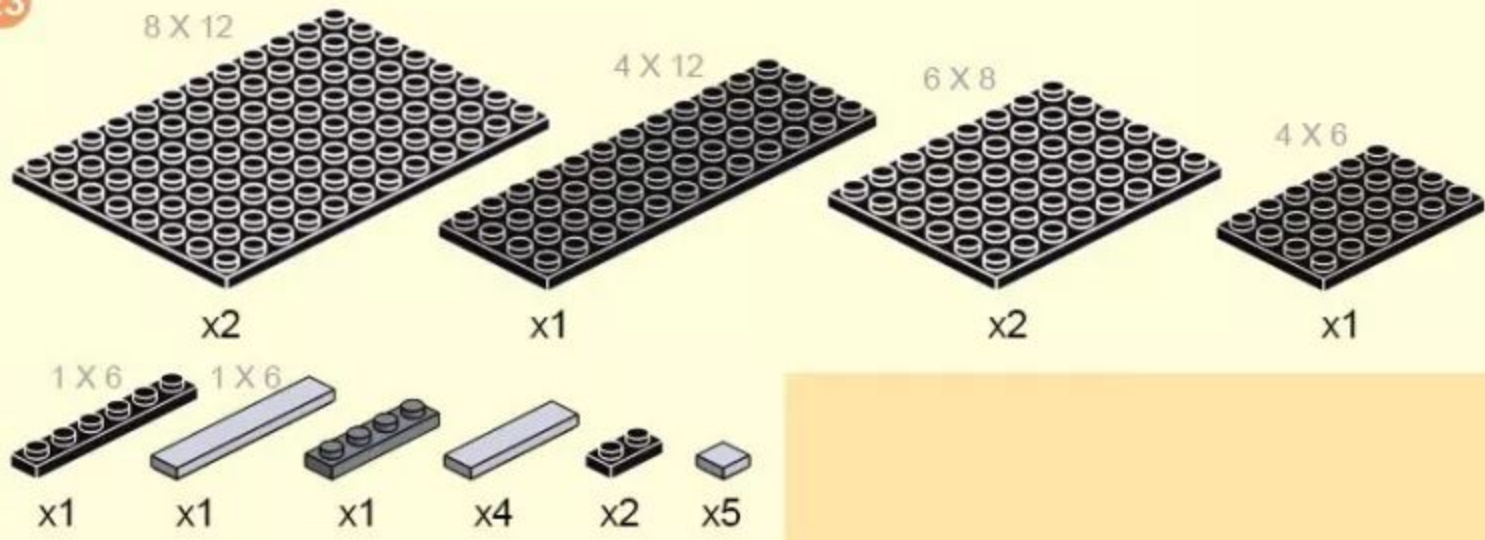

24

1 X 6

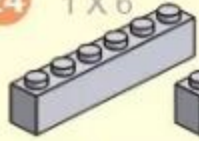

x3



x3

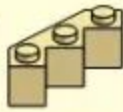

x2



x2



x1



x1



x1

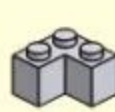

x6



x1



x2



x4



x2



x1



x2



x2

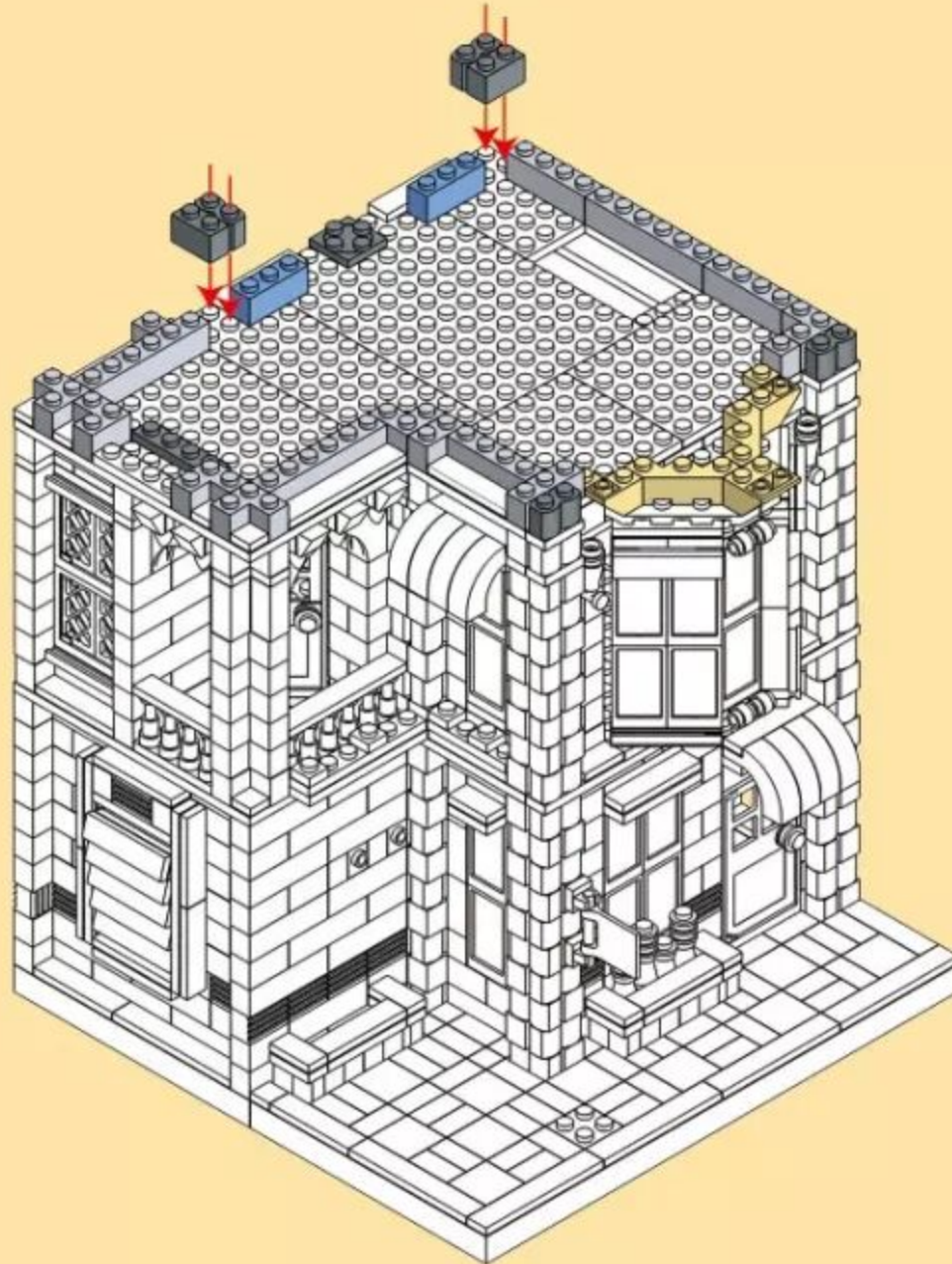



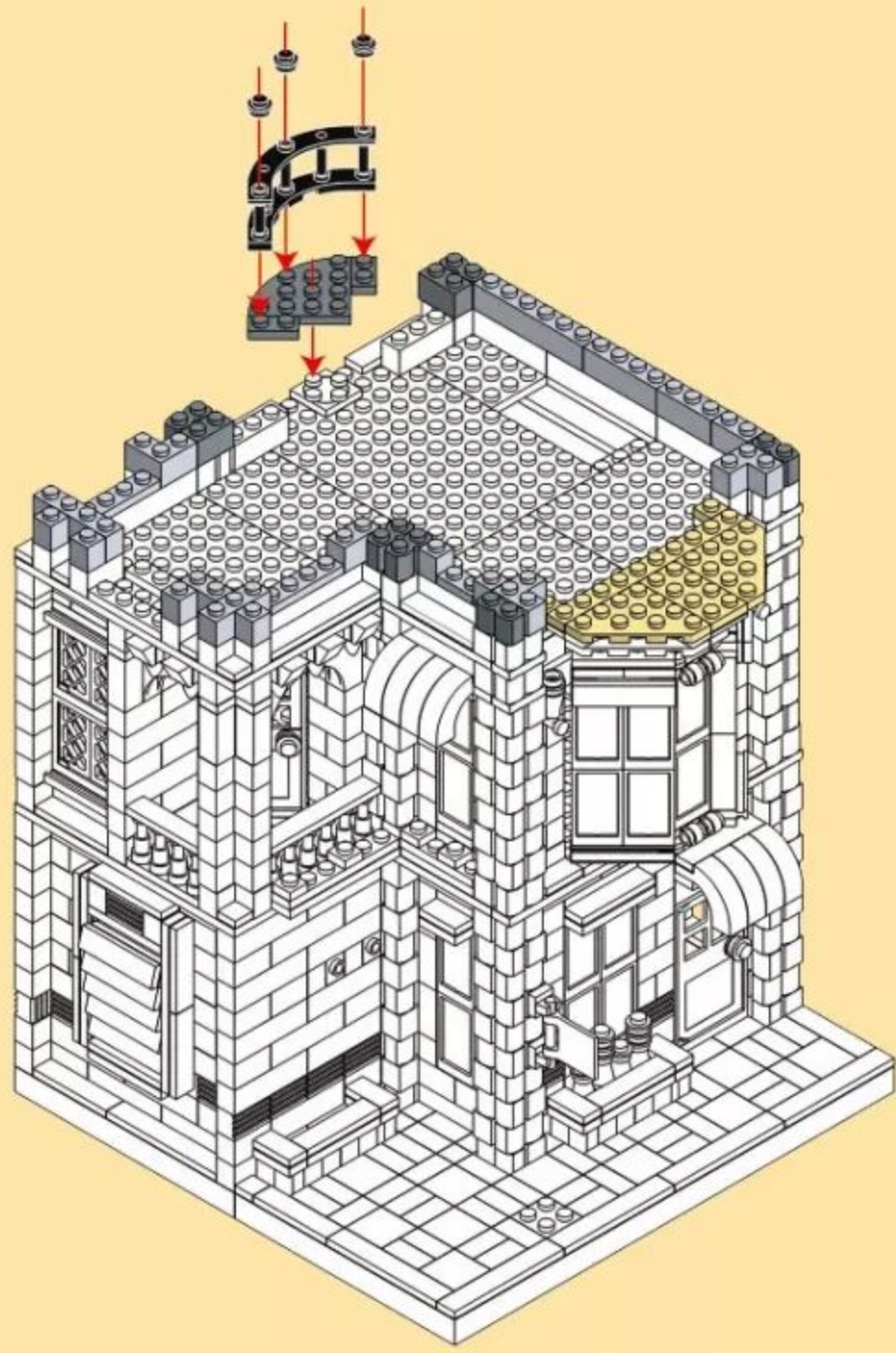
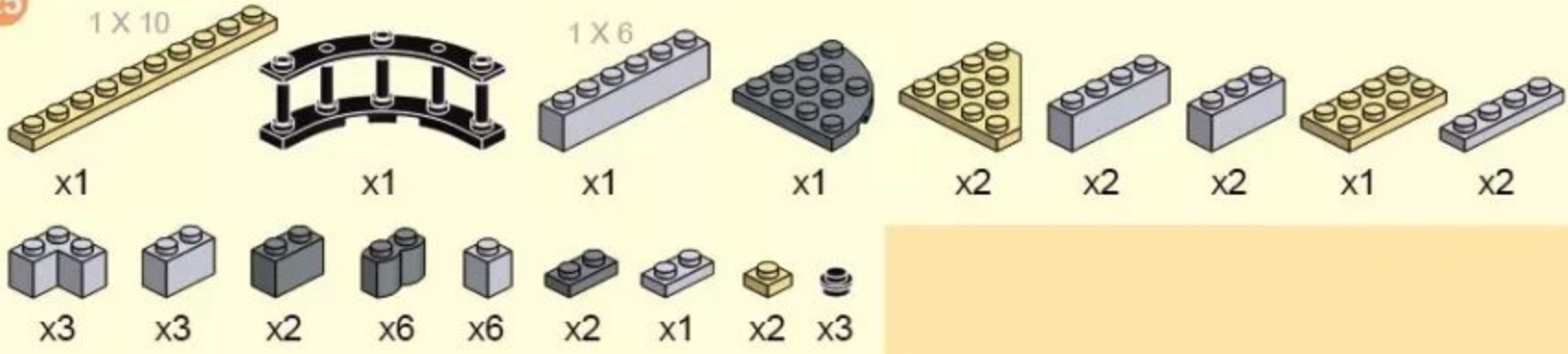



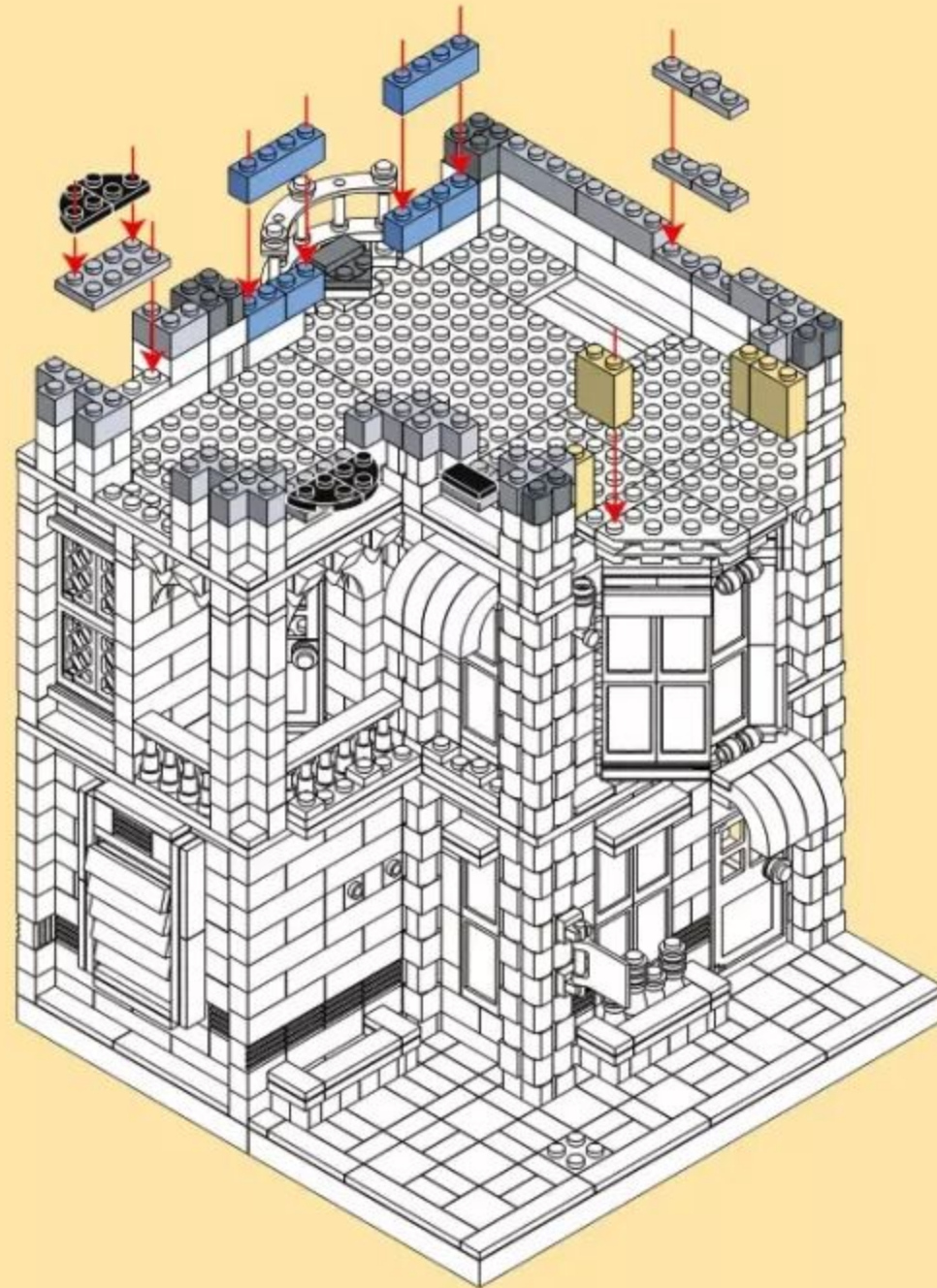
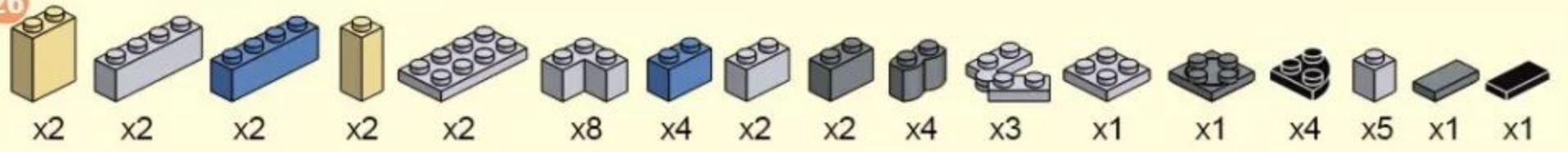

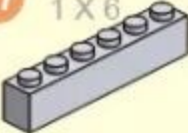

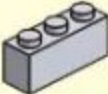

25



26



- 27 1 X 6
-   
x1
  -   
x2
  -   
x2
  -   
x2
  -   
x2
  -   
x2
  -   
x3
  -   
x4
  -   
x2
  -   
x3
  -   
x6
  -   
x6
  -   
x3



28

1 X 6

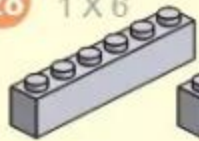

x1



x2



x2



x8



x2



x1



x4



x2



x5

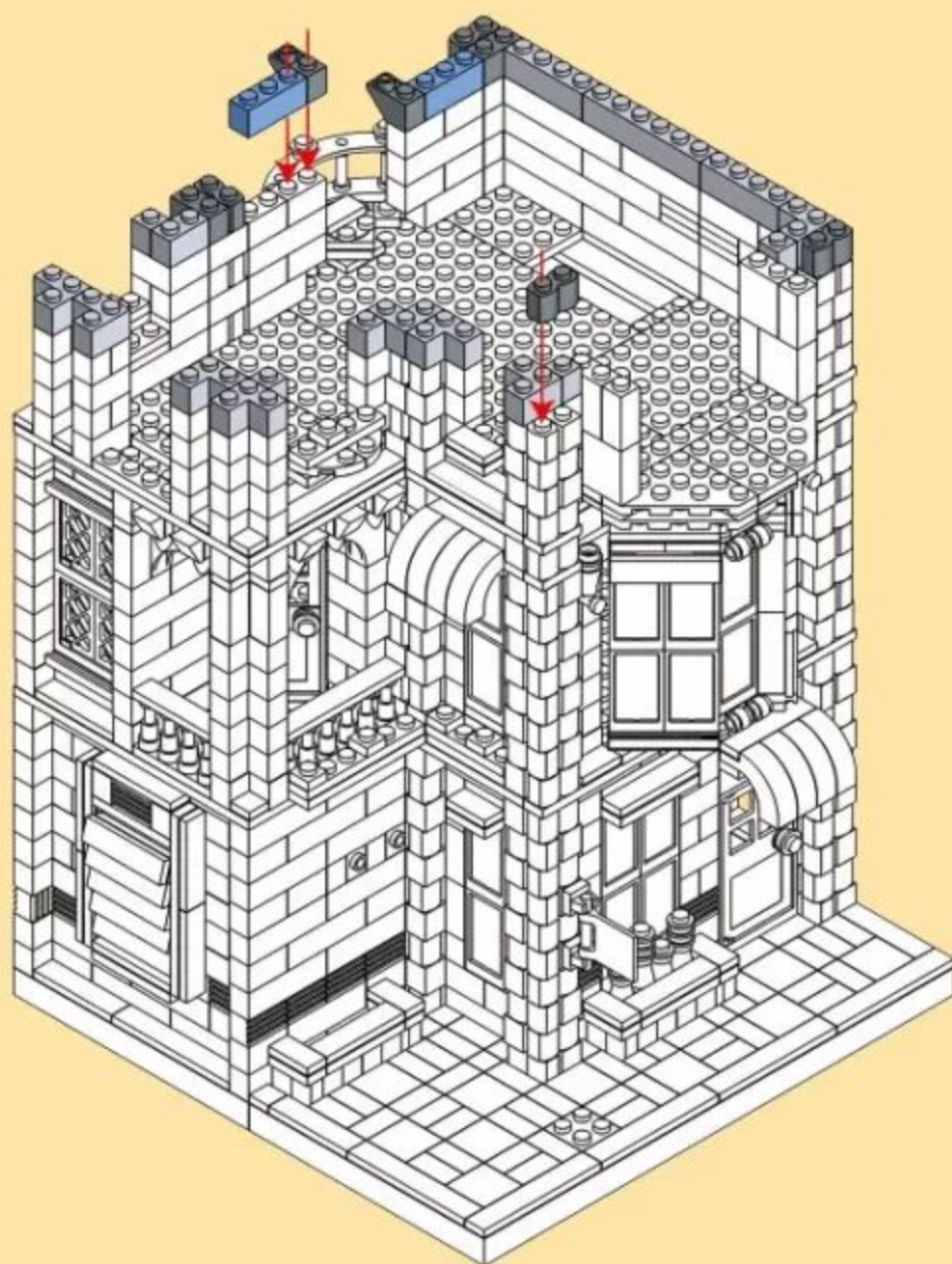

29

1 X 6

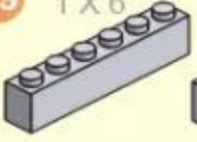

x1

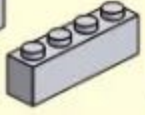

x2



x2



x3



x4



x2



x3



x6



x6



x2



30

1 X 6

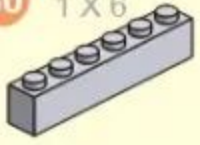

x1



x2

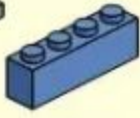

x2

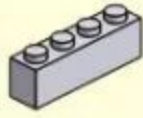

x2



x8



x2



x1



x4



x5



31



x13



x1



x6



x7



x2



x1

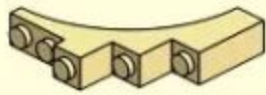

x2



x1



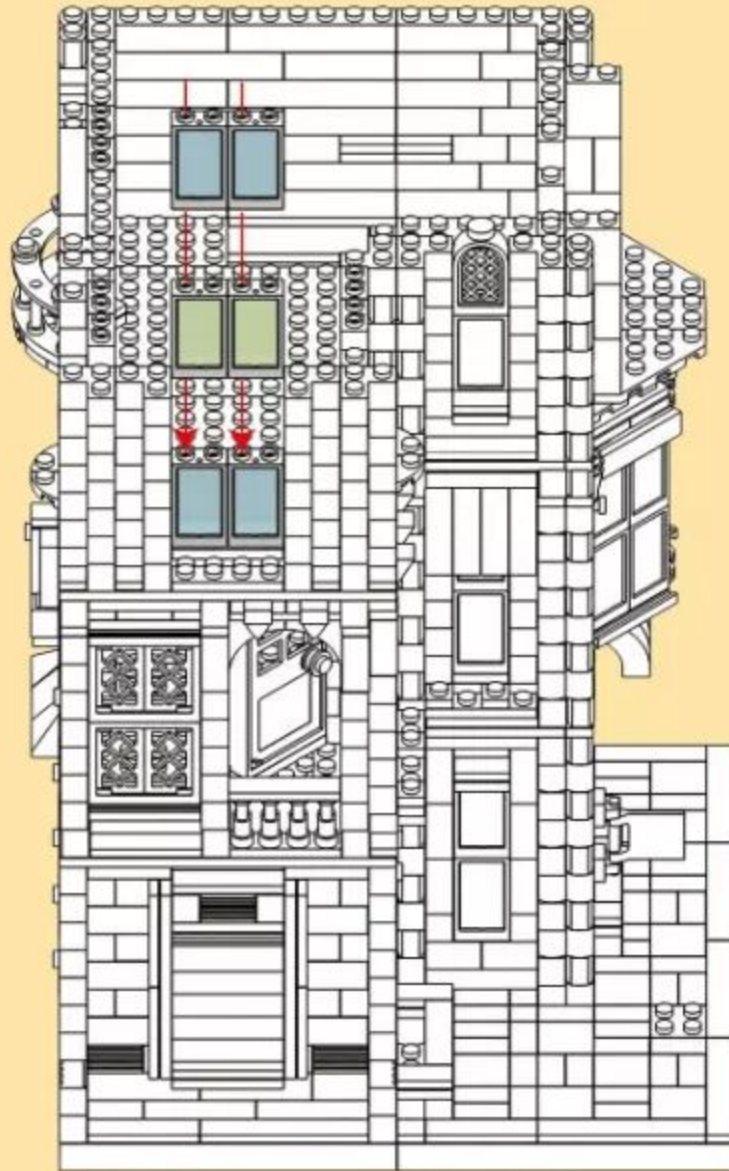
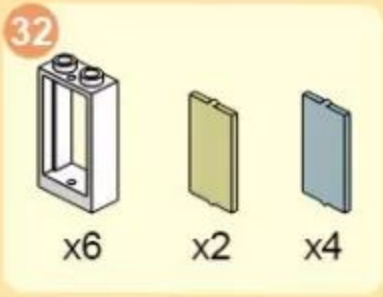

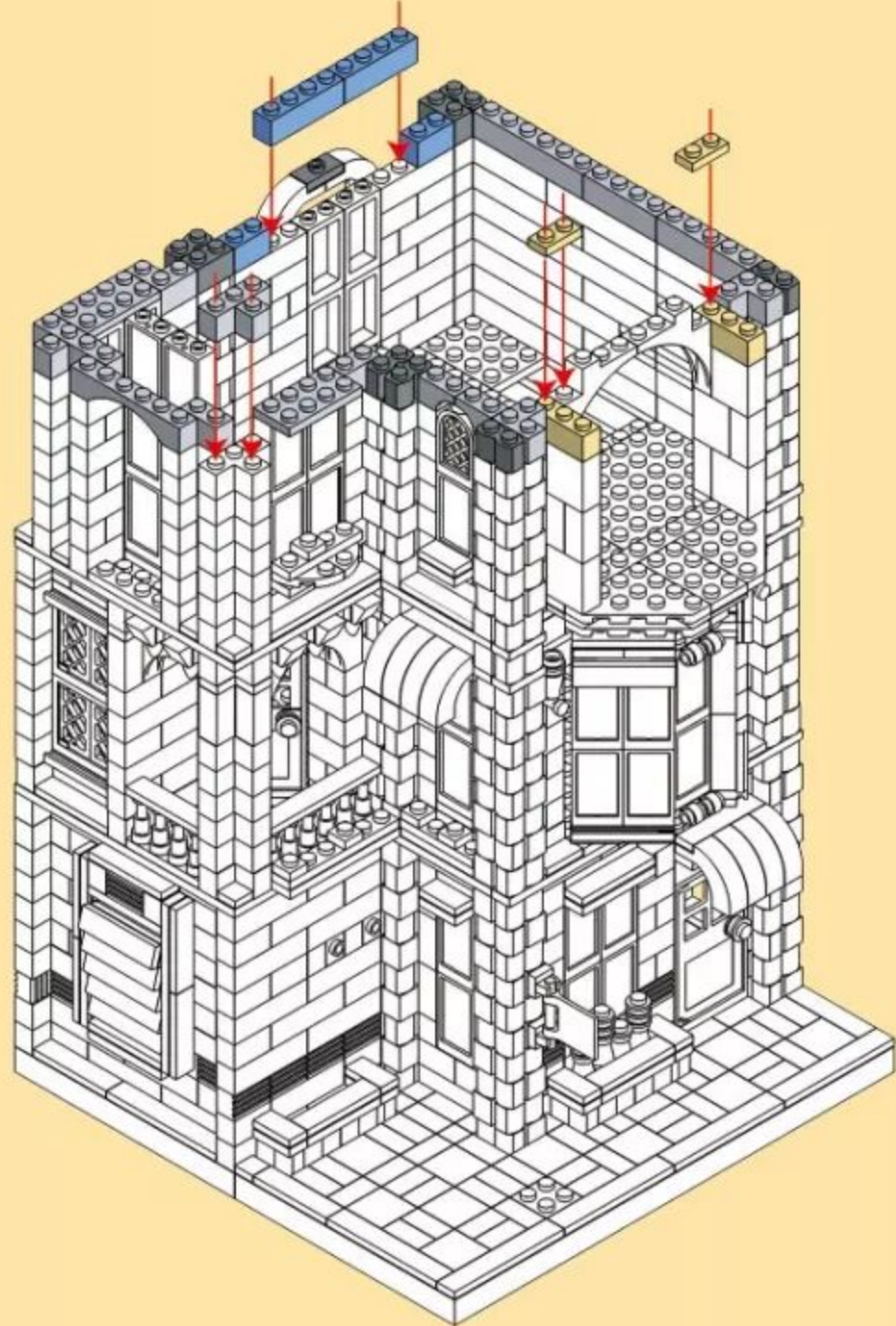
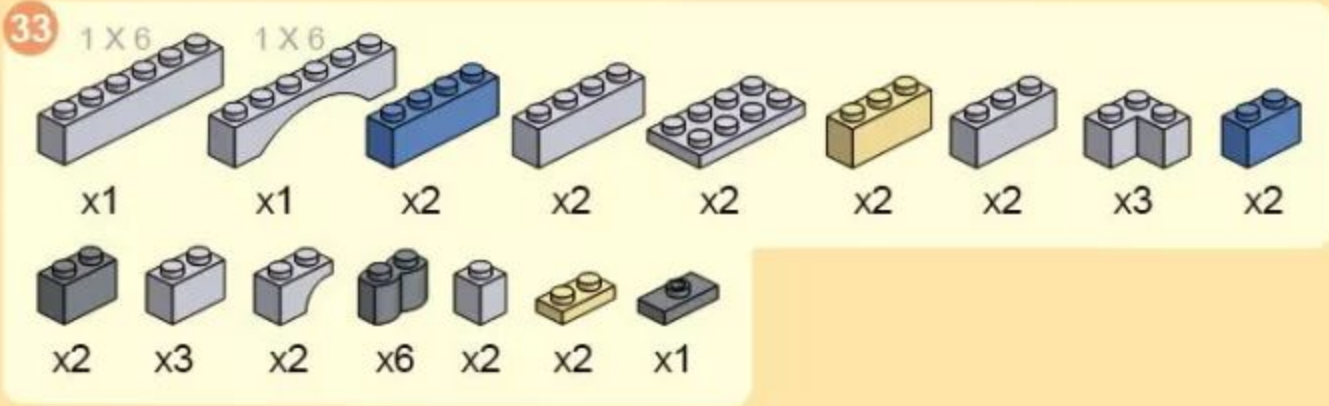

34

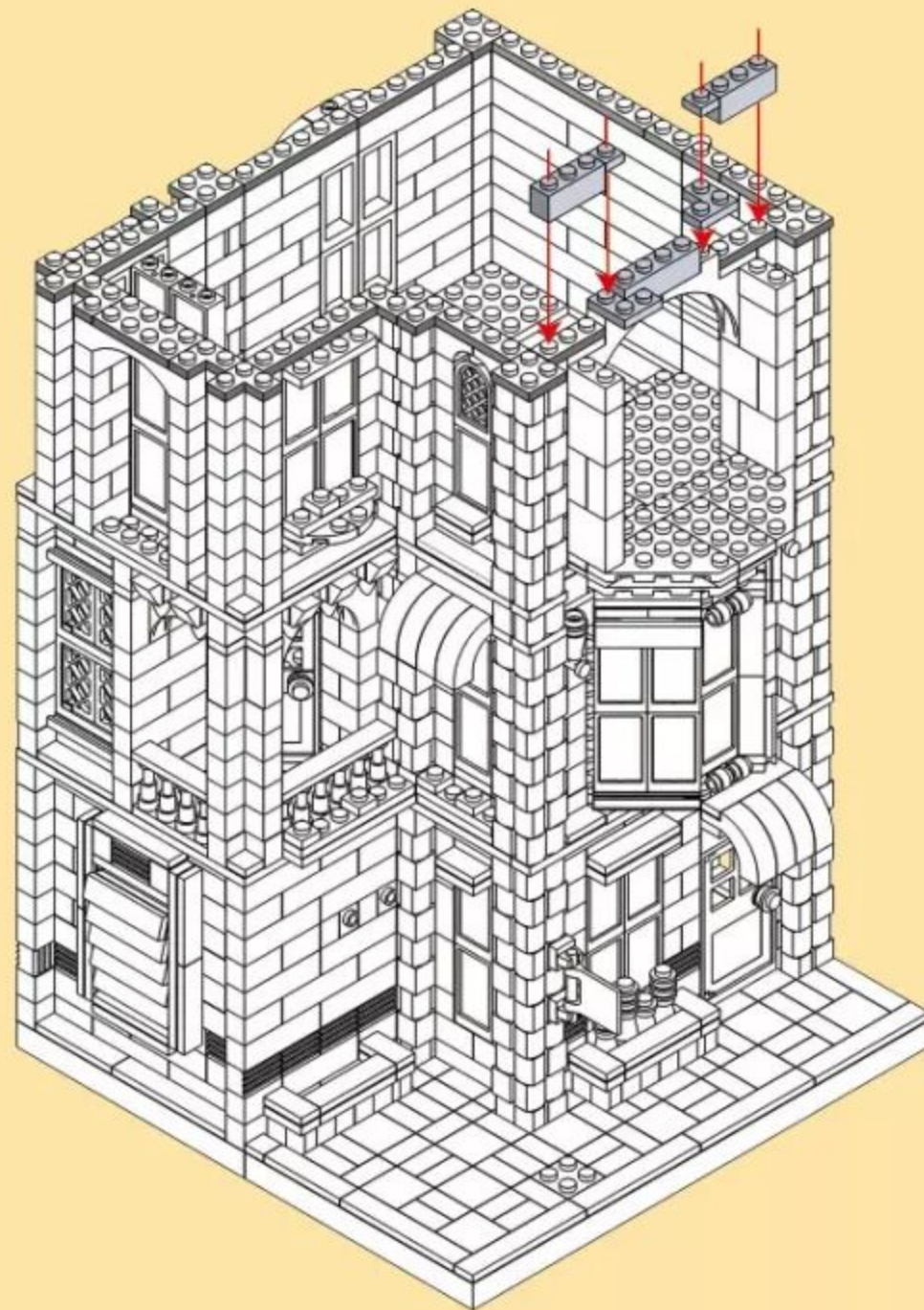
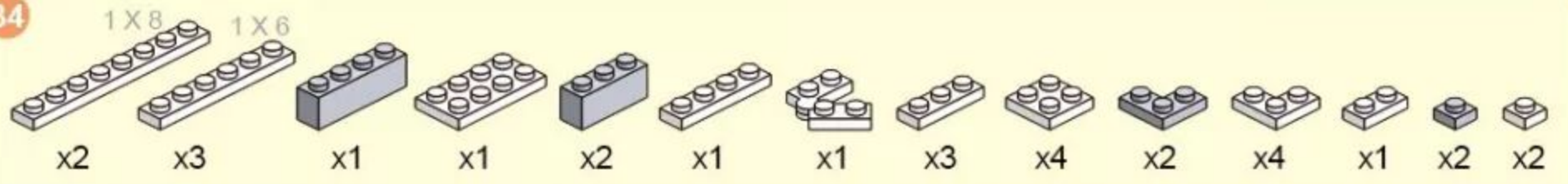

35

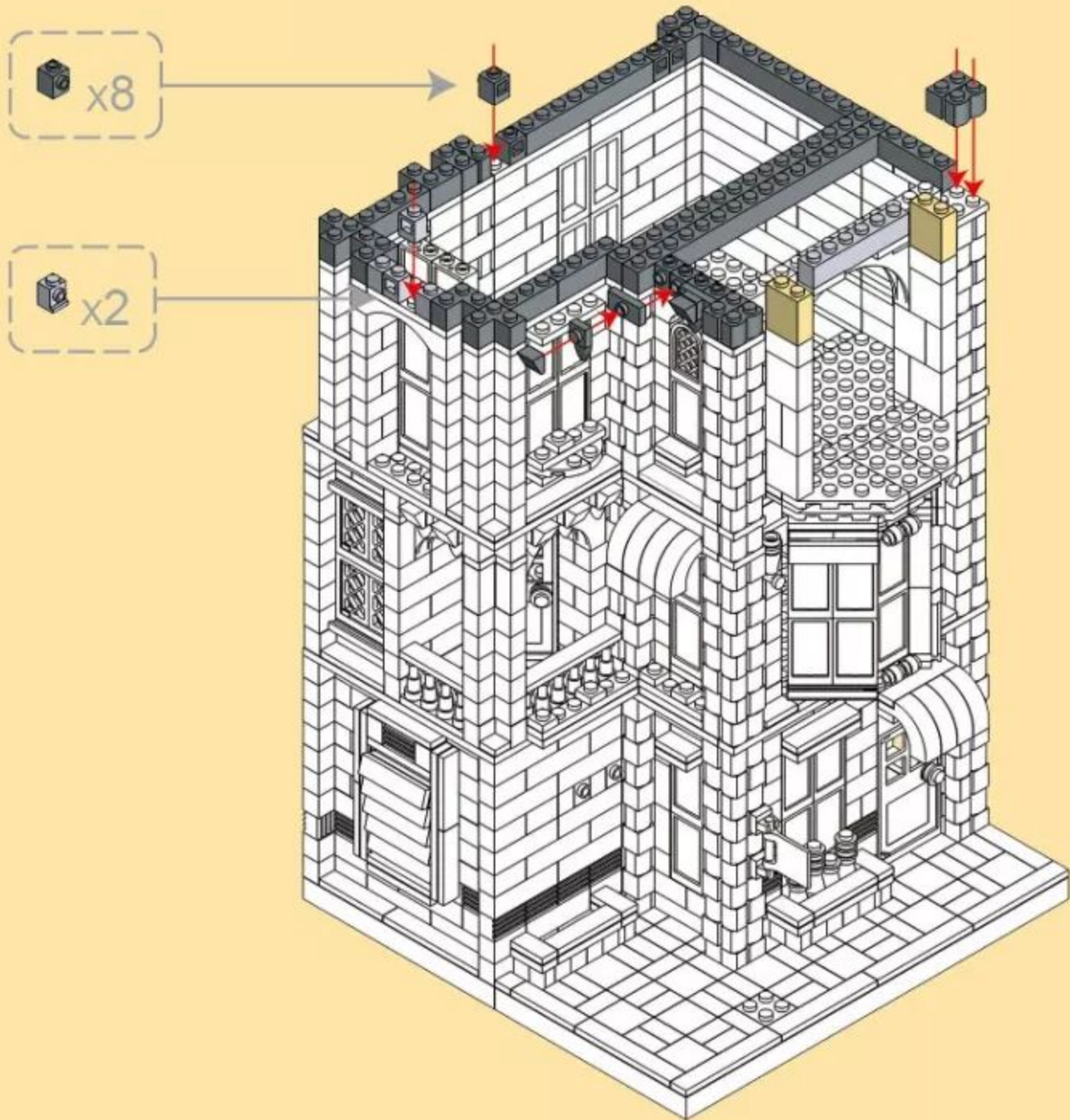
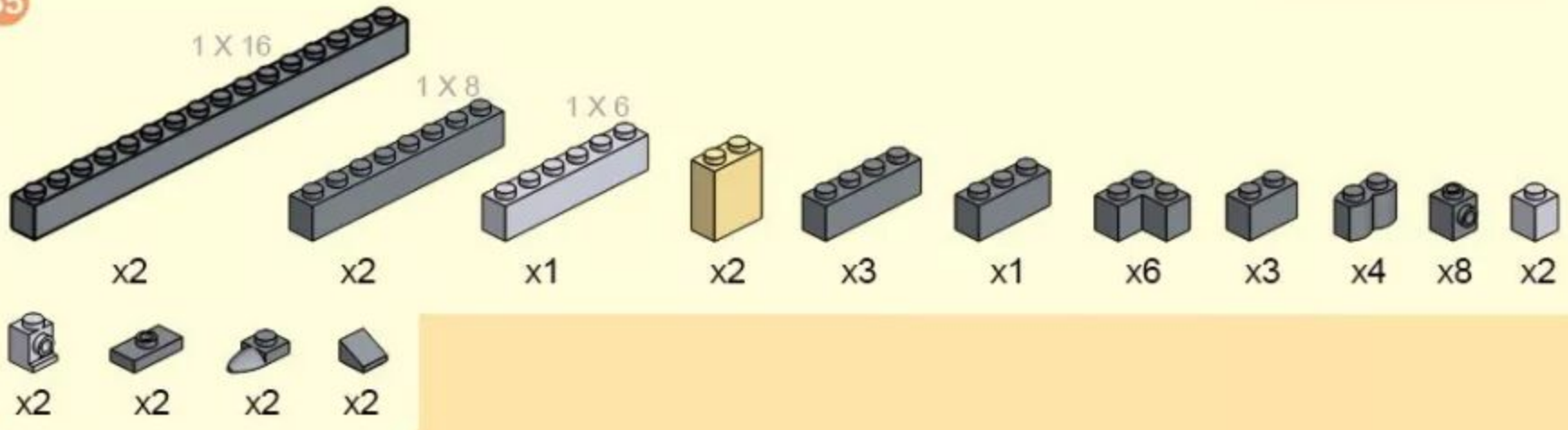



37

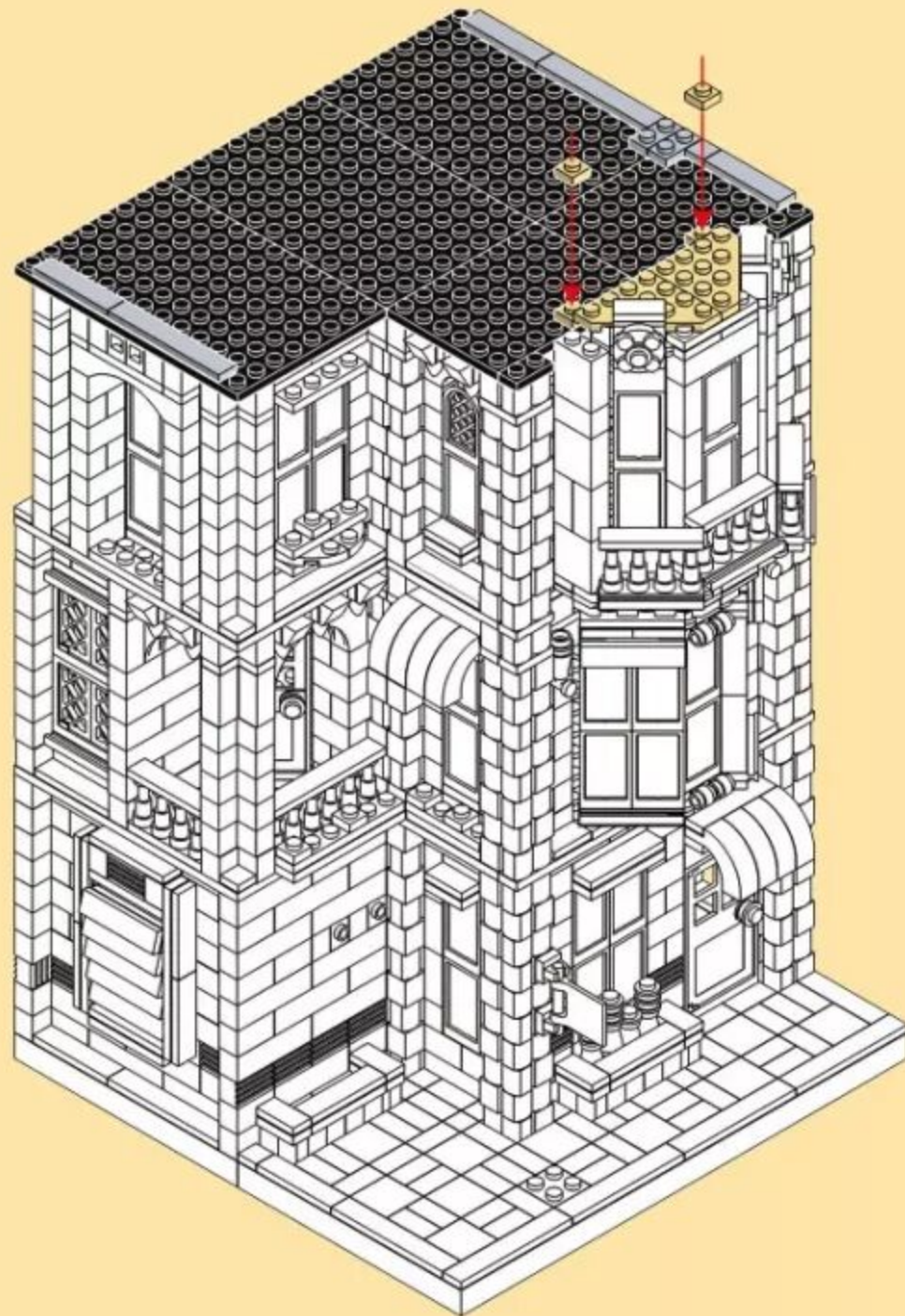
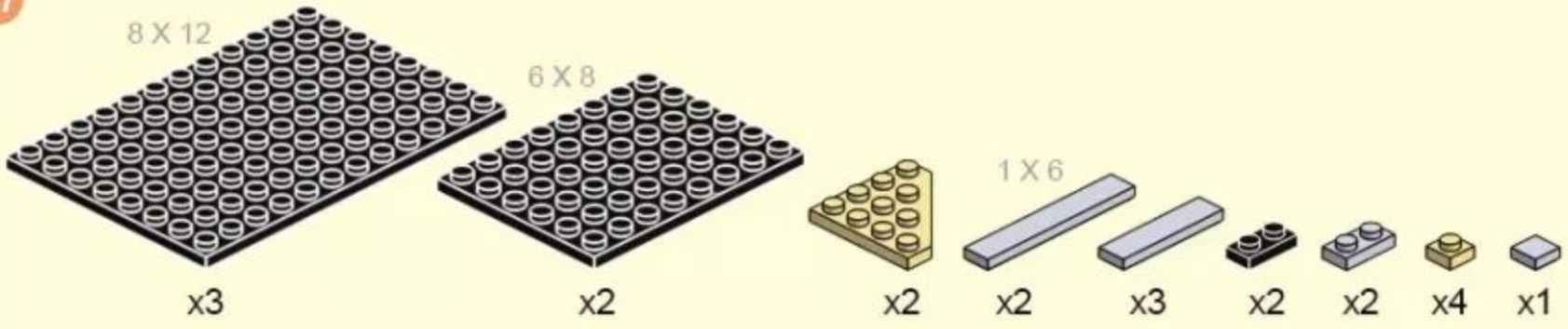

38

- 1 X 8
- x1
- x8
- x3
- x1
- x6
- x2
- x4
- x2
- x1
- x4
- x1
- x2
- x2
- x3
- x2
- x2
- x4
- x1
- x4
- x2
- x1

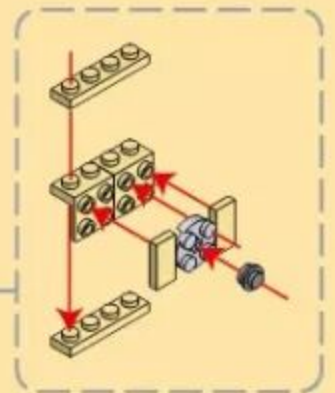
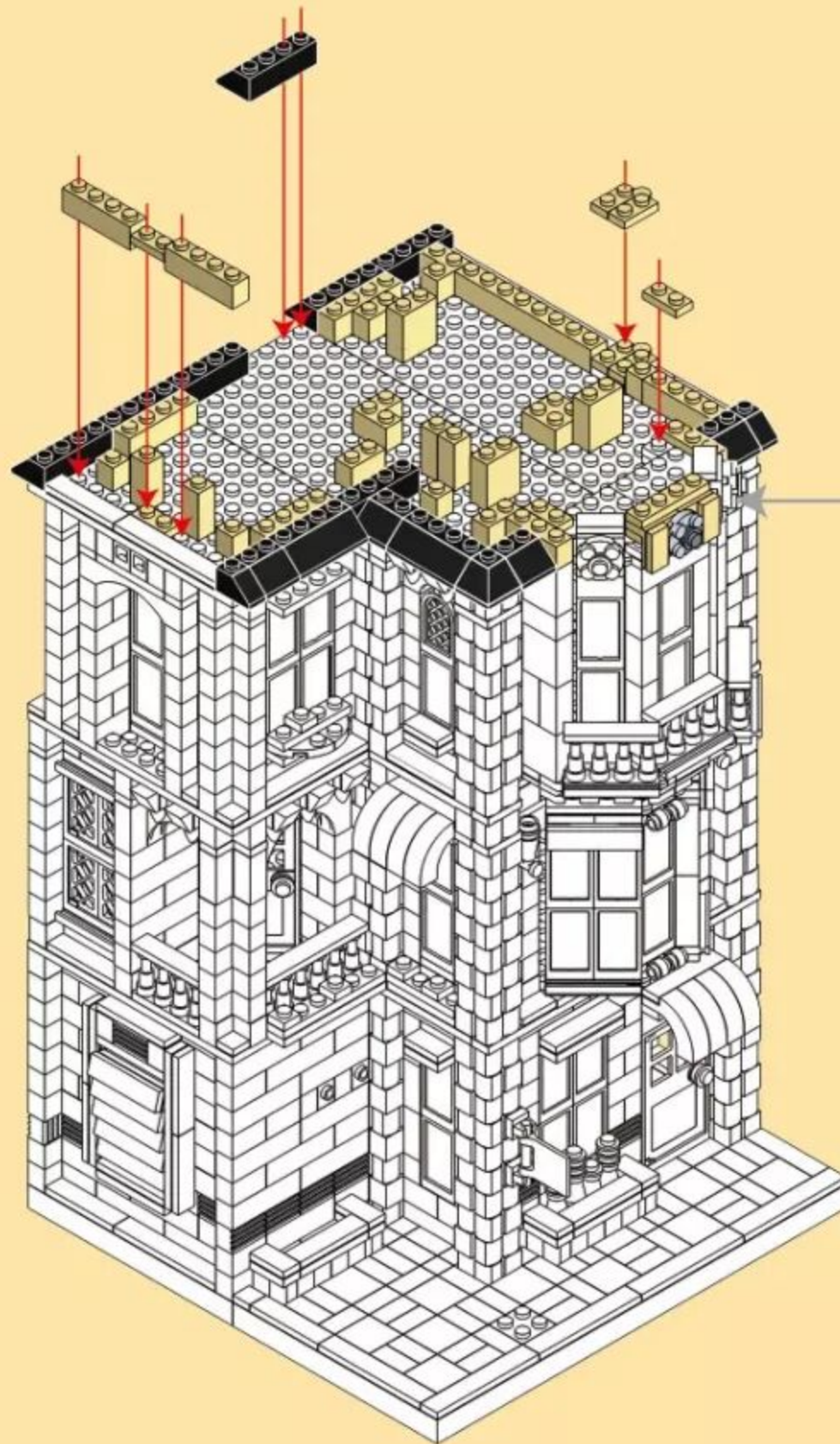

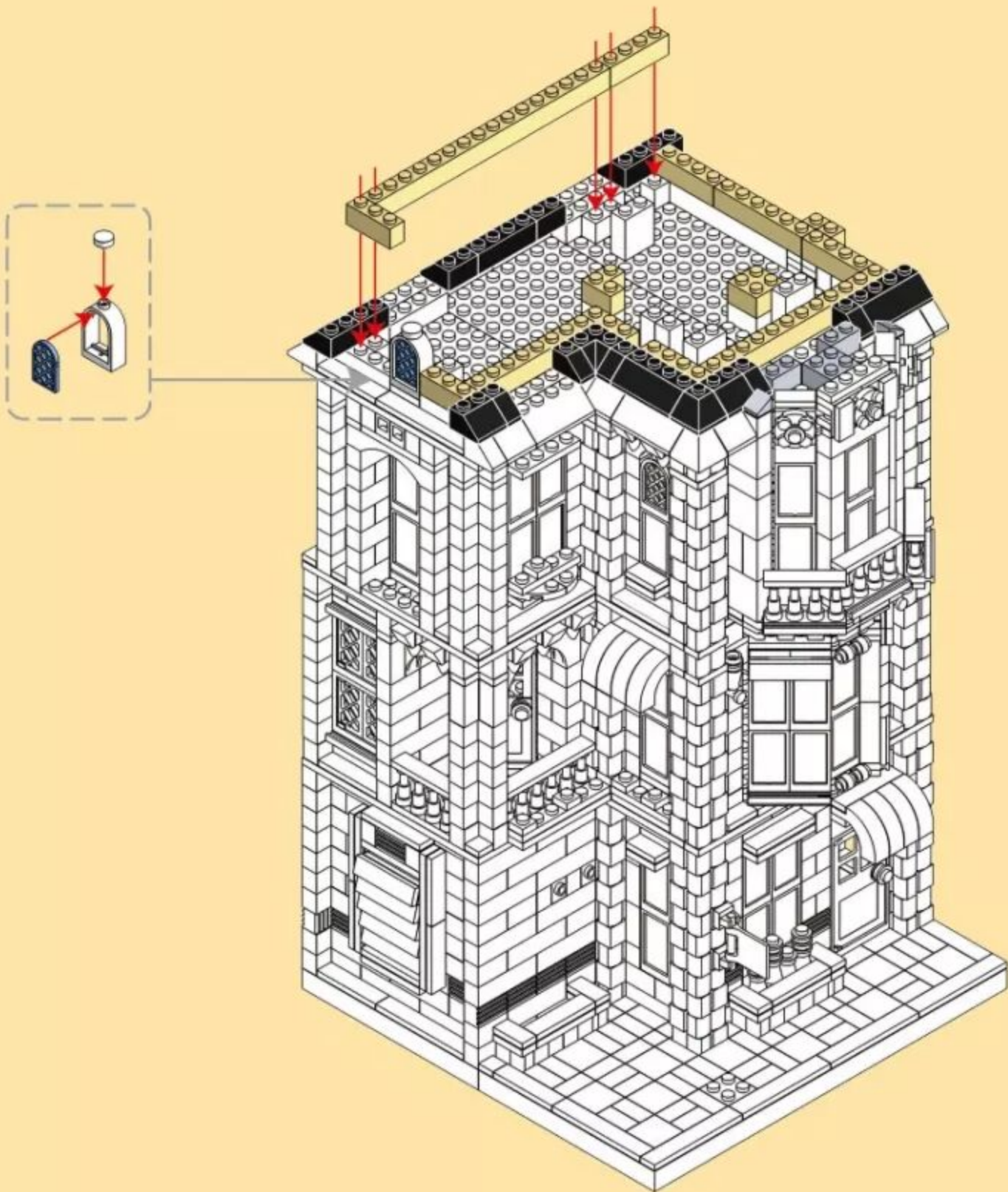
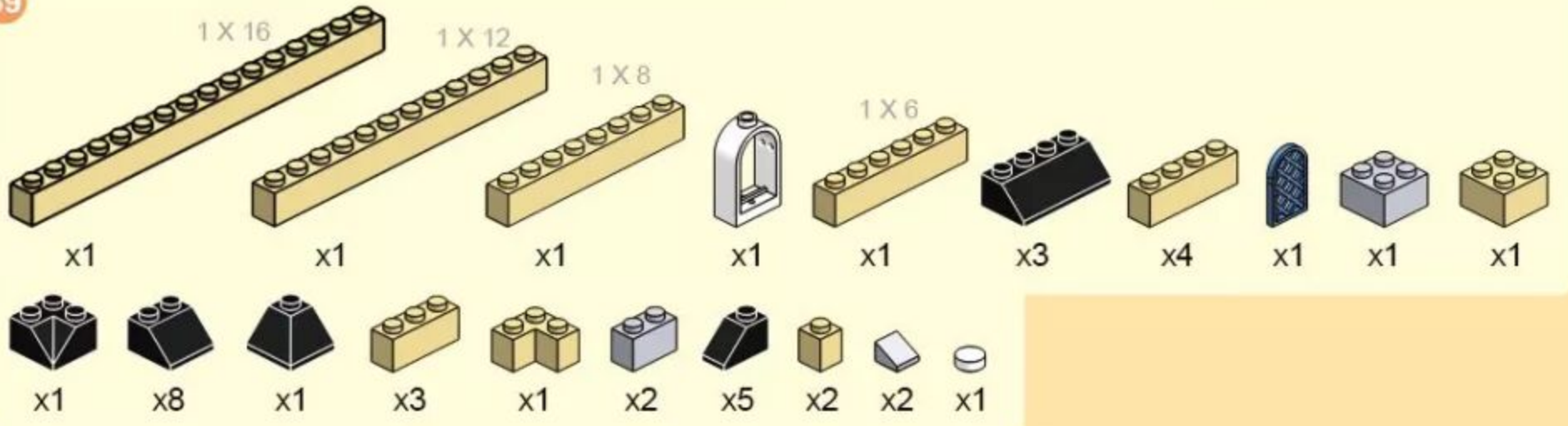



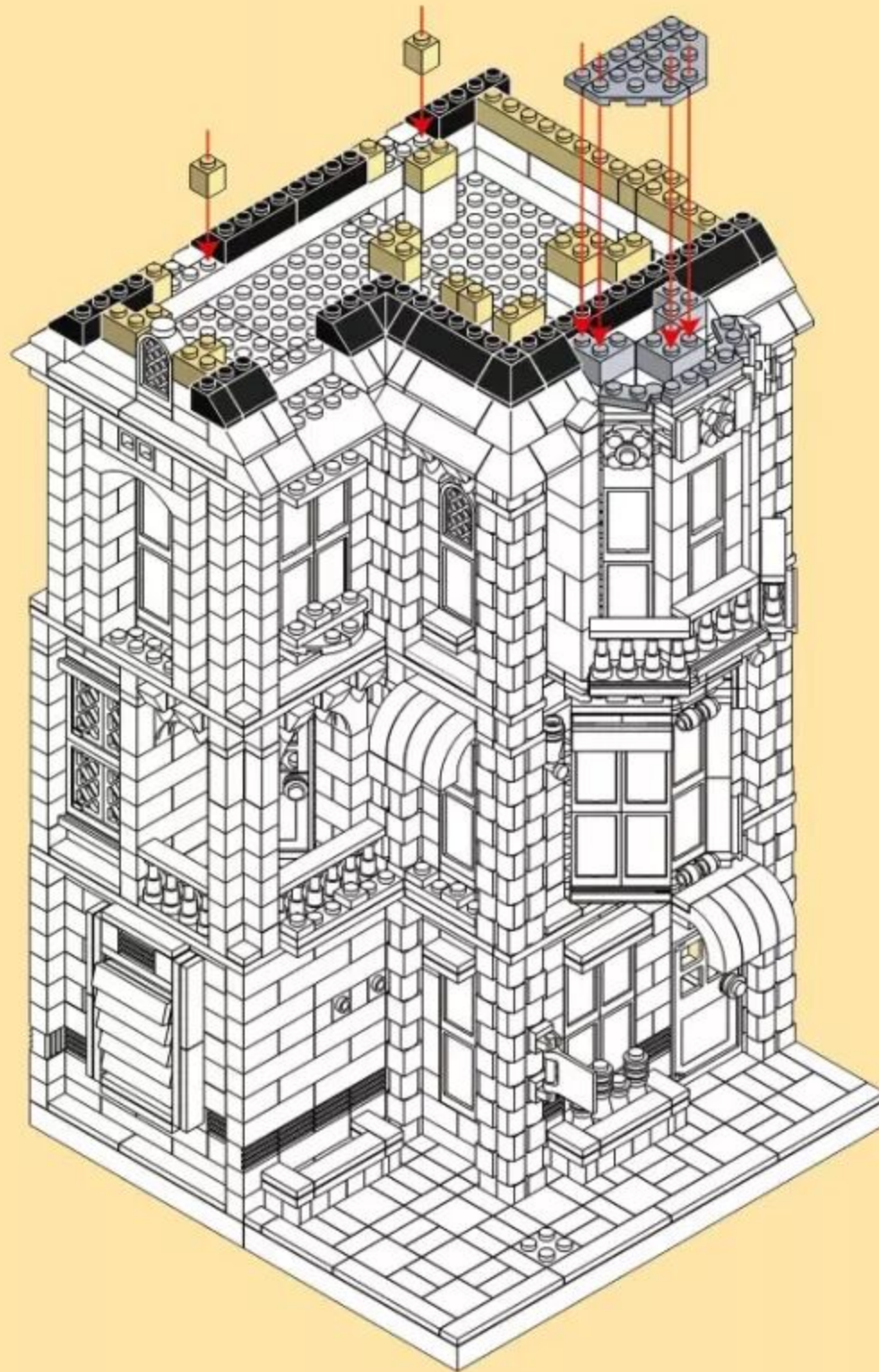
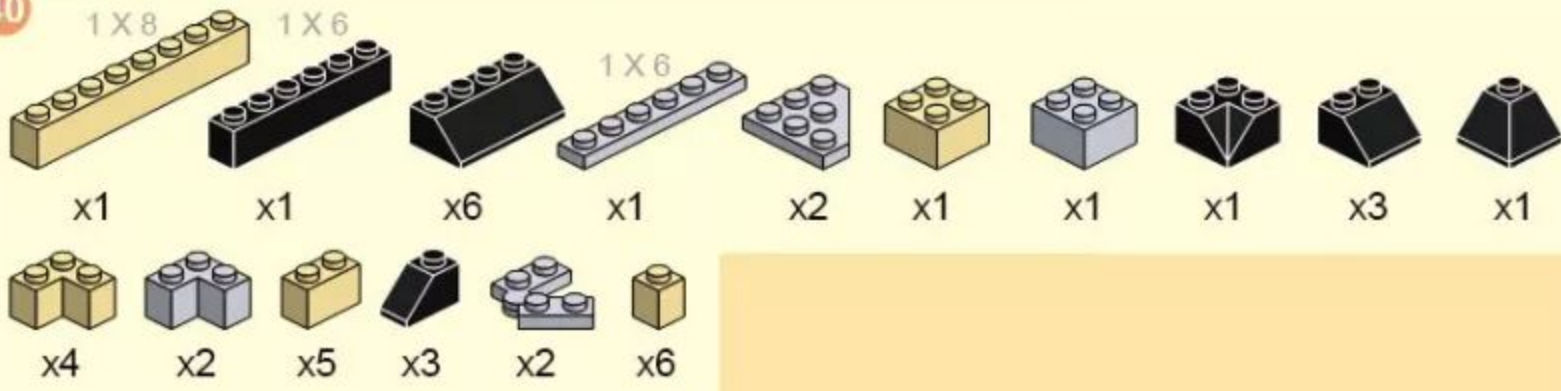



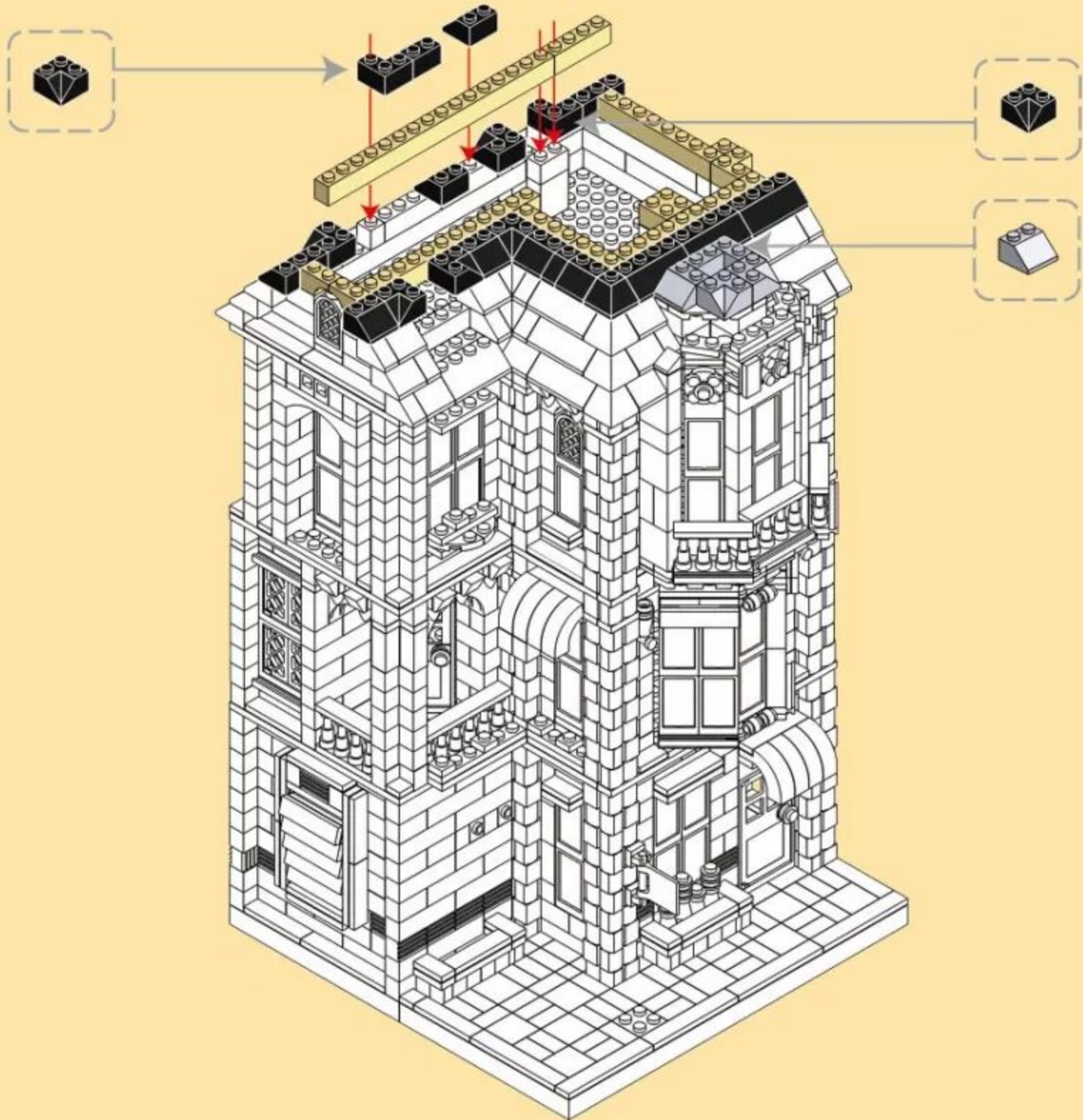
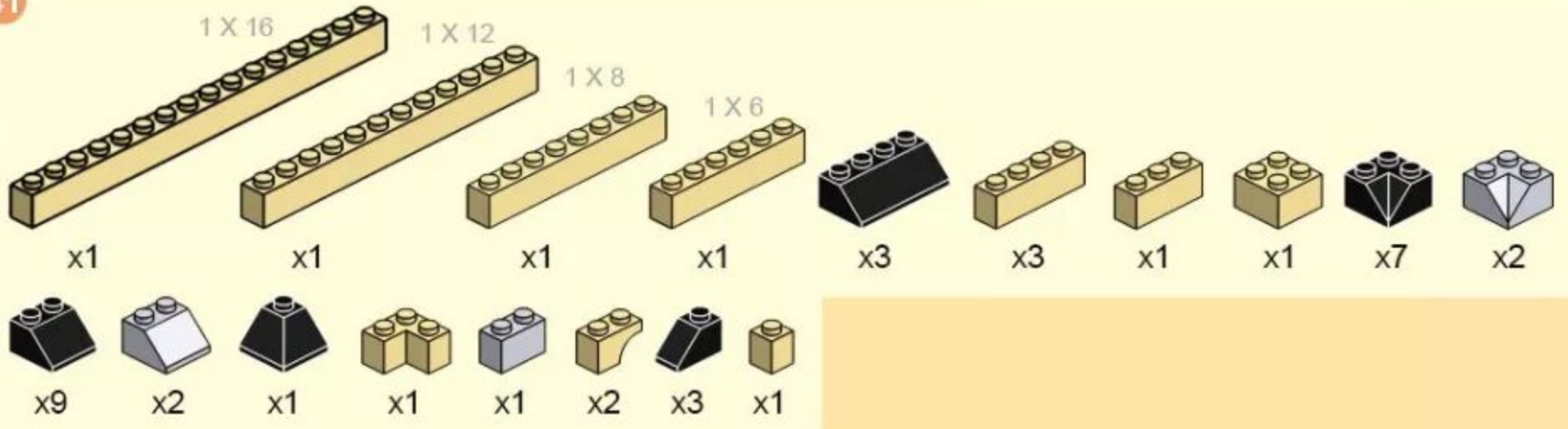

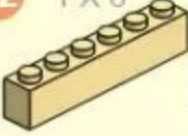



40



41



- 42 1 X 6
-  x1
  -  x7
  -  x1
  -  x7
  -  x1
  -  x4
  -  x2
  -  x1
  -  x1
  -  x9
  -  x3
  -  x2
  -  x2

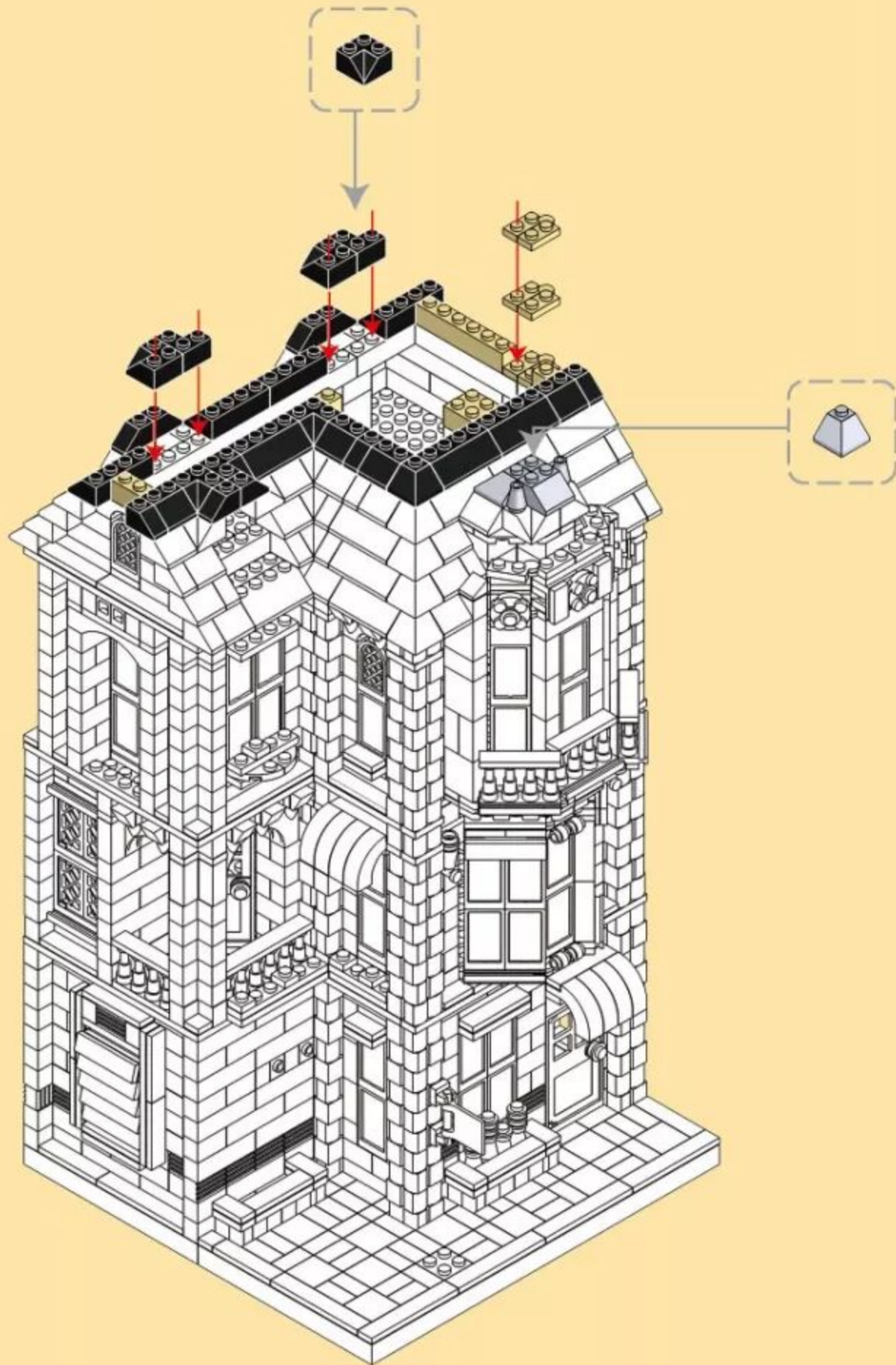

43

4 X 12

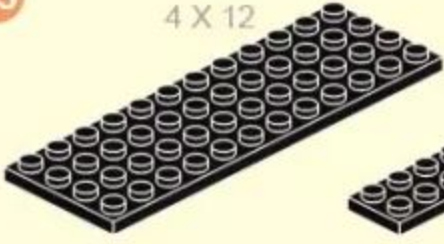

x3

2 X 6



x2

1 X 6



x2



x3



x2

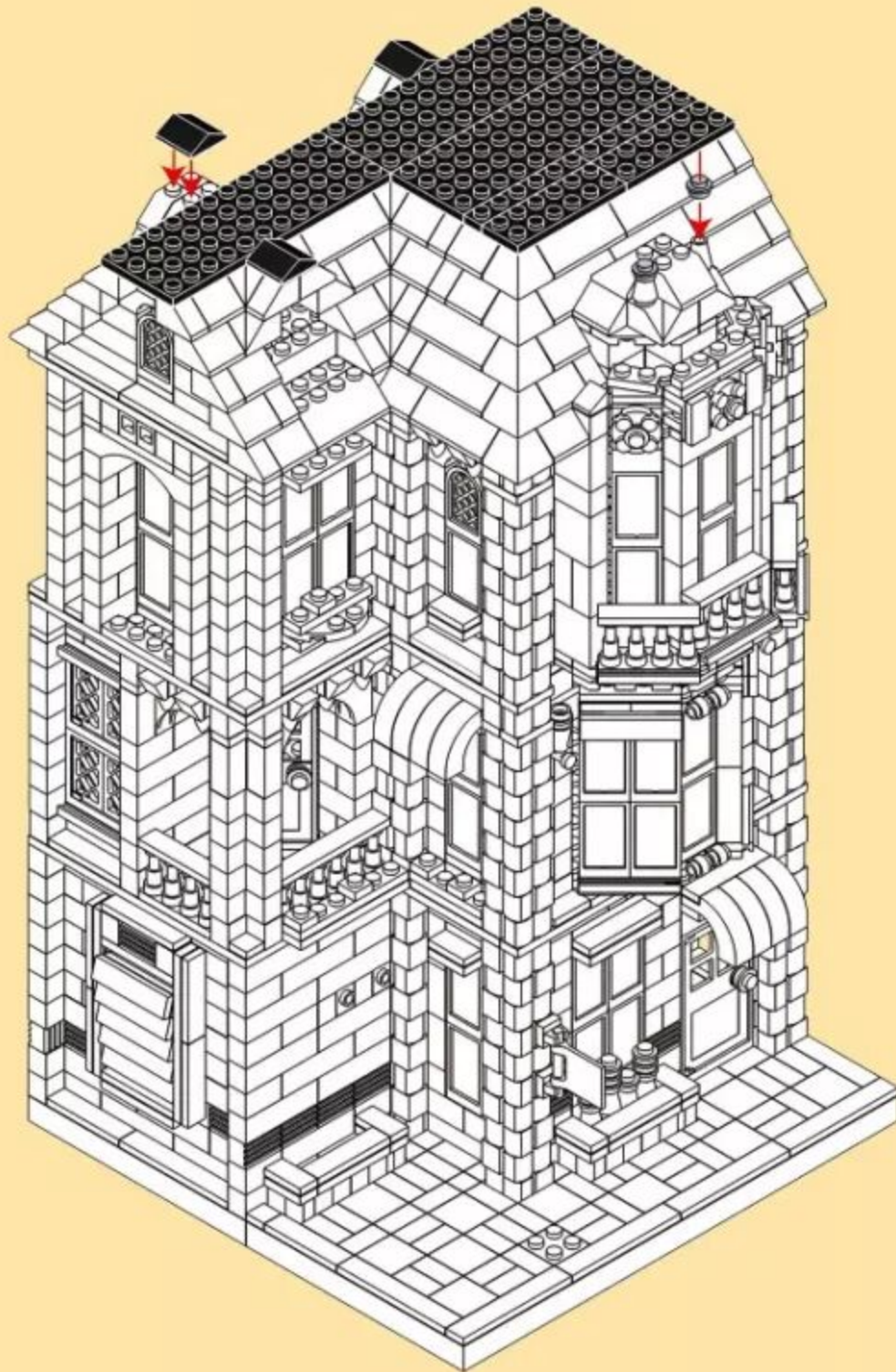

44

- 1x8 x2
- Blue decorative piece x1
- White cone x1
- 1x6 x2
- 1x6 x9
- Grey 1x3 plate x3
- Grey 1x6 plate x9
- Grey 1x4 plate with 2 holes x1
- Grey 1x3 plate with 2 holes x3
- Grey 1x4 plate with 2 holes x4
- Grey 1x3 plate with 2 holes x3
- Grey 1x4 plate with 2 holes x5
- Black cone x1
- Grey 1x2 plate with 2 holes x1
- Grey 1x2 plate with 2 holes x1
- Grey 1x2 plate with 2 holes x1
- Grey 1x6 plate x6
- Grey 1x2 plate with 2 holes x2
- Grey 1x2 plate with 2 holes x1
- Grey 1x2 plate with 2 holes x2
- Grey 1x2 plate with 2 holes x1

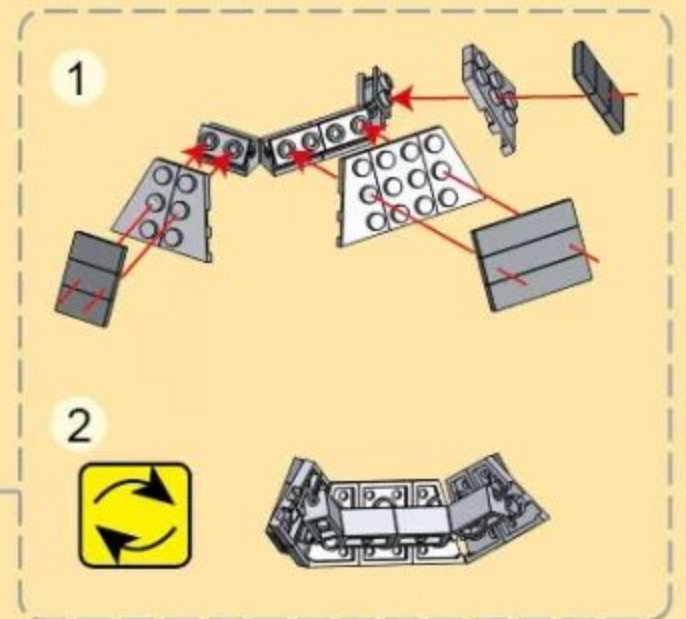
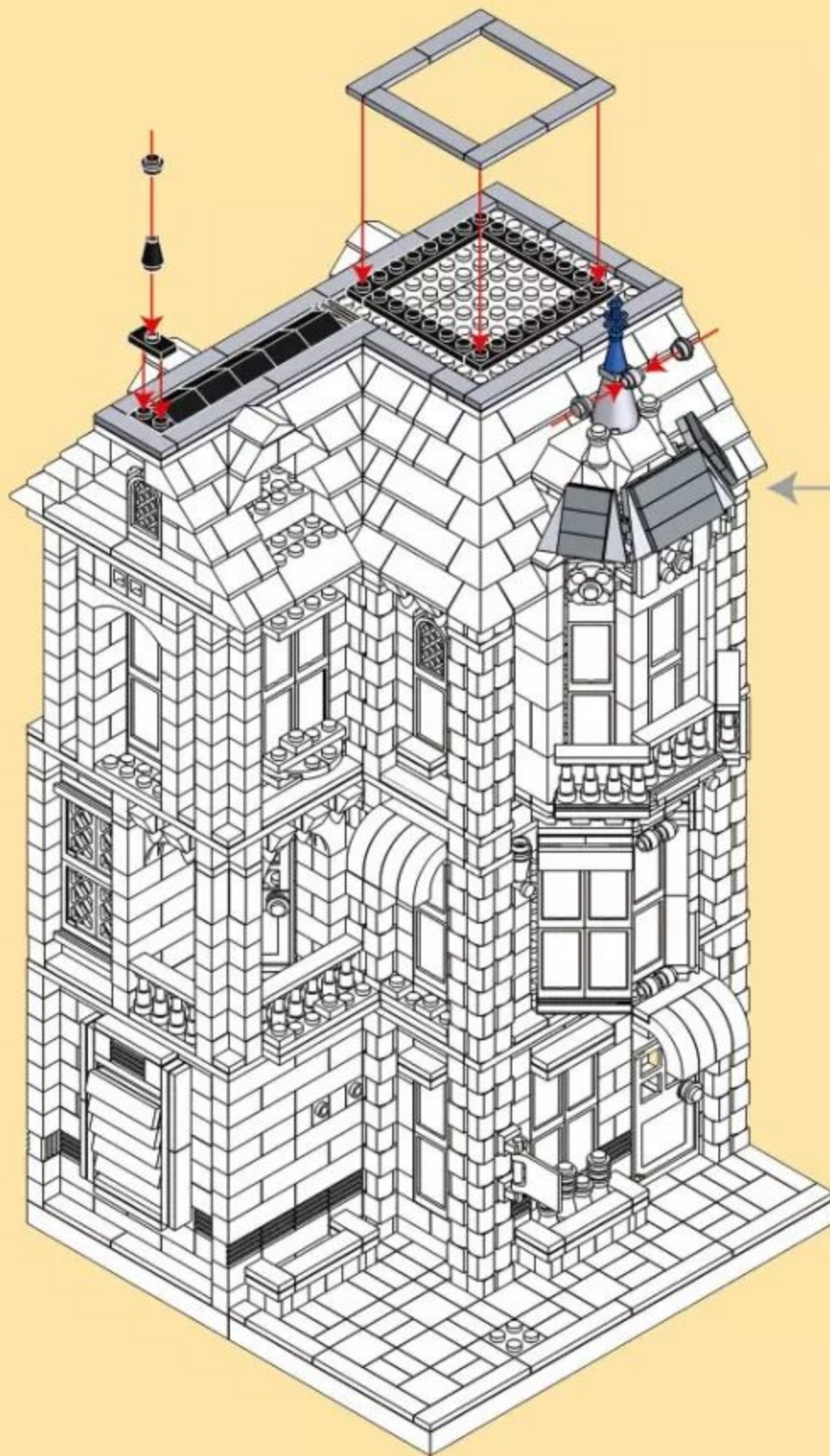

45

1 X 6



x2



x2



x4



x4



x4



x4



x4



x8



x16



x4



x4



x8

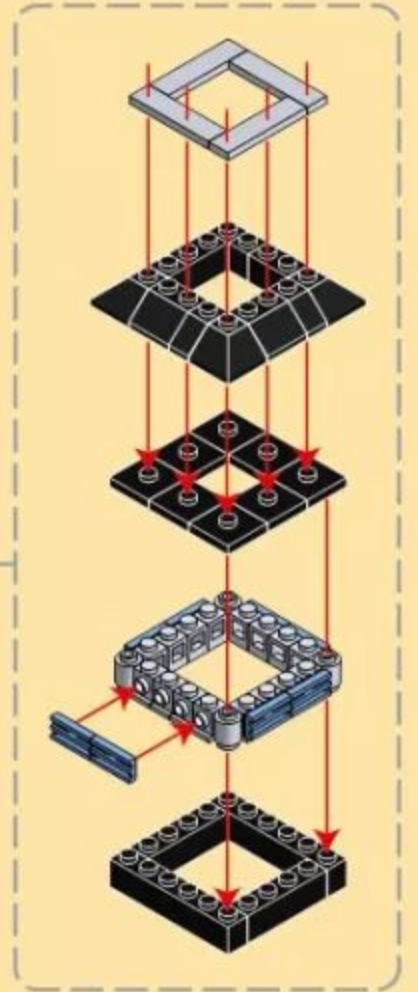
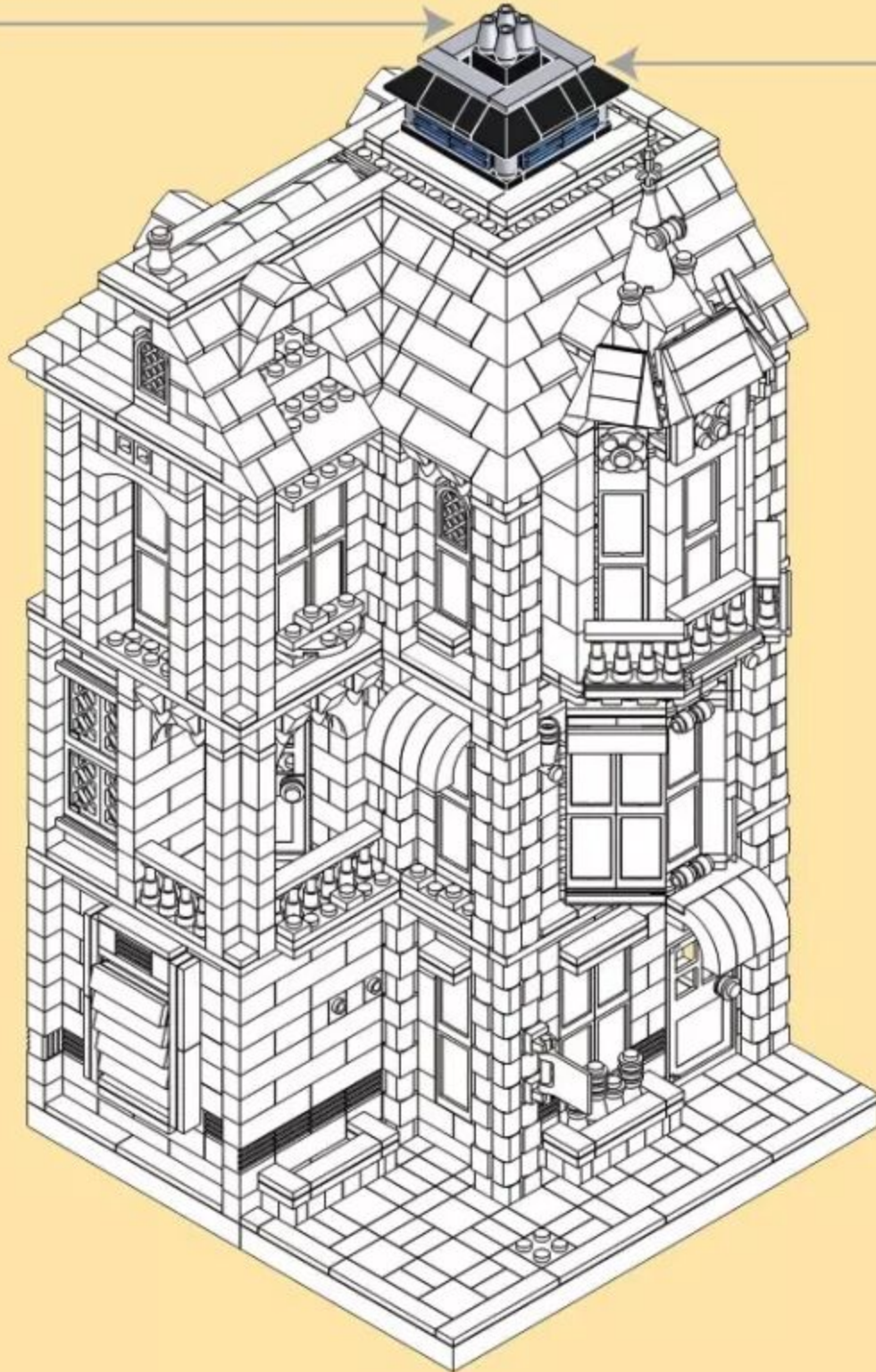

46



x3



x6



x9



x9



x3



x5



- 47
-  x2
  -  x2
  -  x1
  -  x1
  -  x1
  -  x1
  -  x2
  -  x1
  -  x4
  -  x2
  -  x1
  -  x1
  -  x1
  -  x1
  -  x1
  -  x5
  -  x1
  -  x2
  -  x3
  -  x2

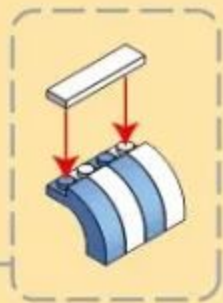
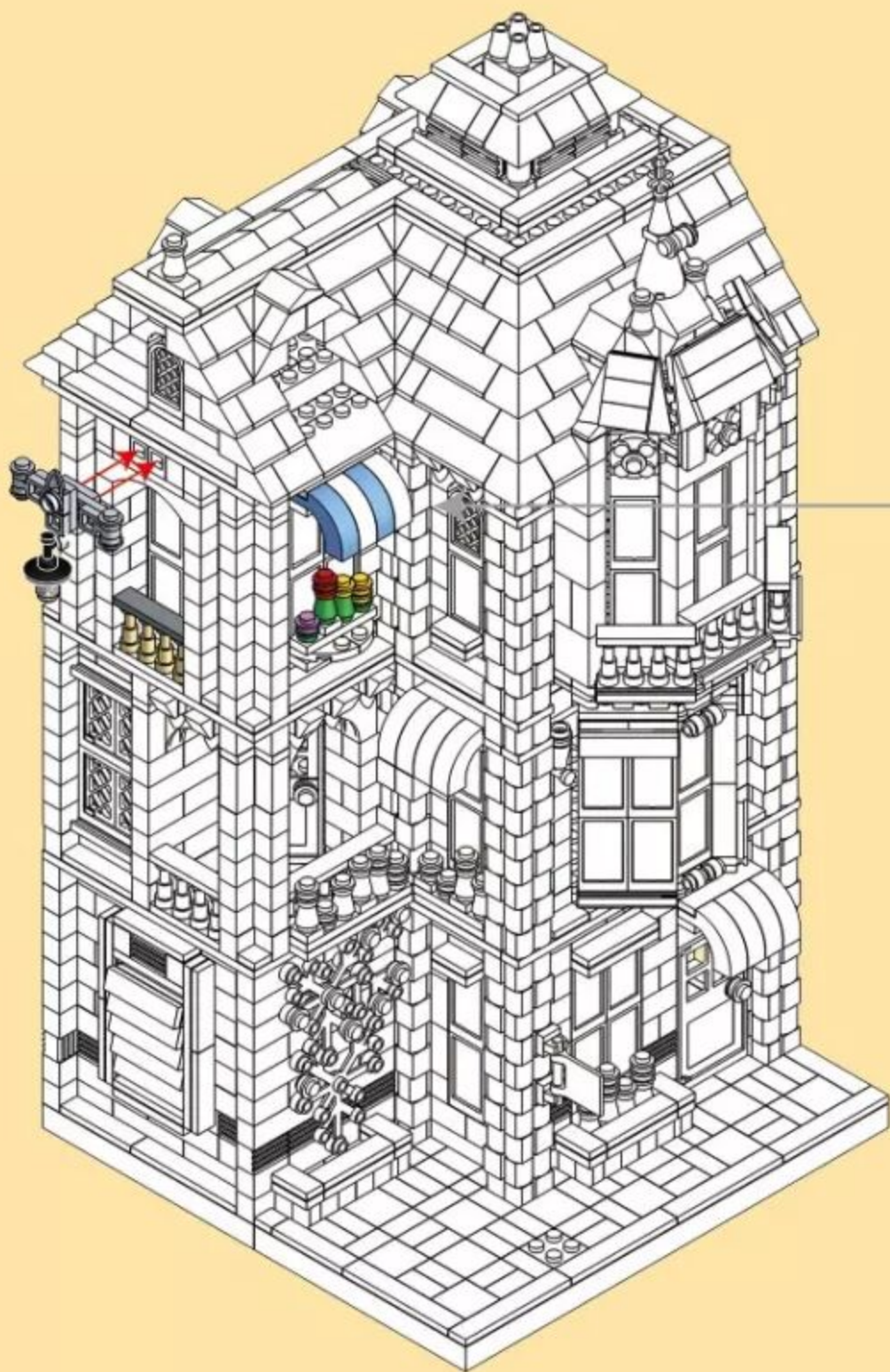
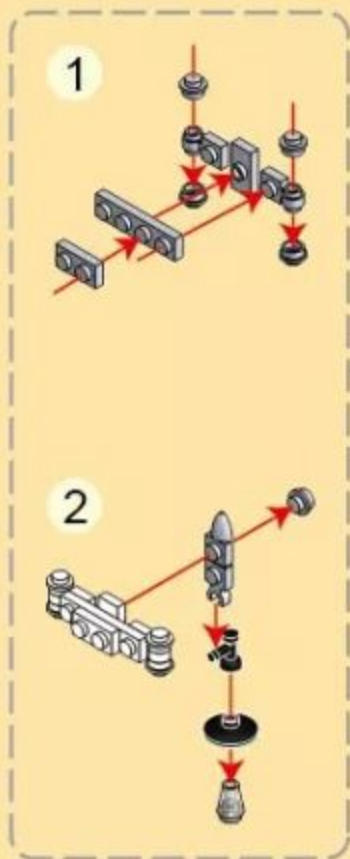

48

- x2
- x2
- x2
- x1
- x2
- x1
- x1
- x3
- x1
- x8
- x4
- x8
- x8
- x2
- x1
- x2
- x3
- x5
- x4
- x2
- x1

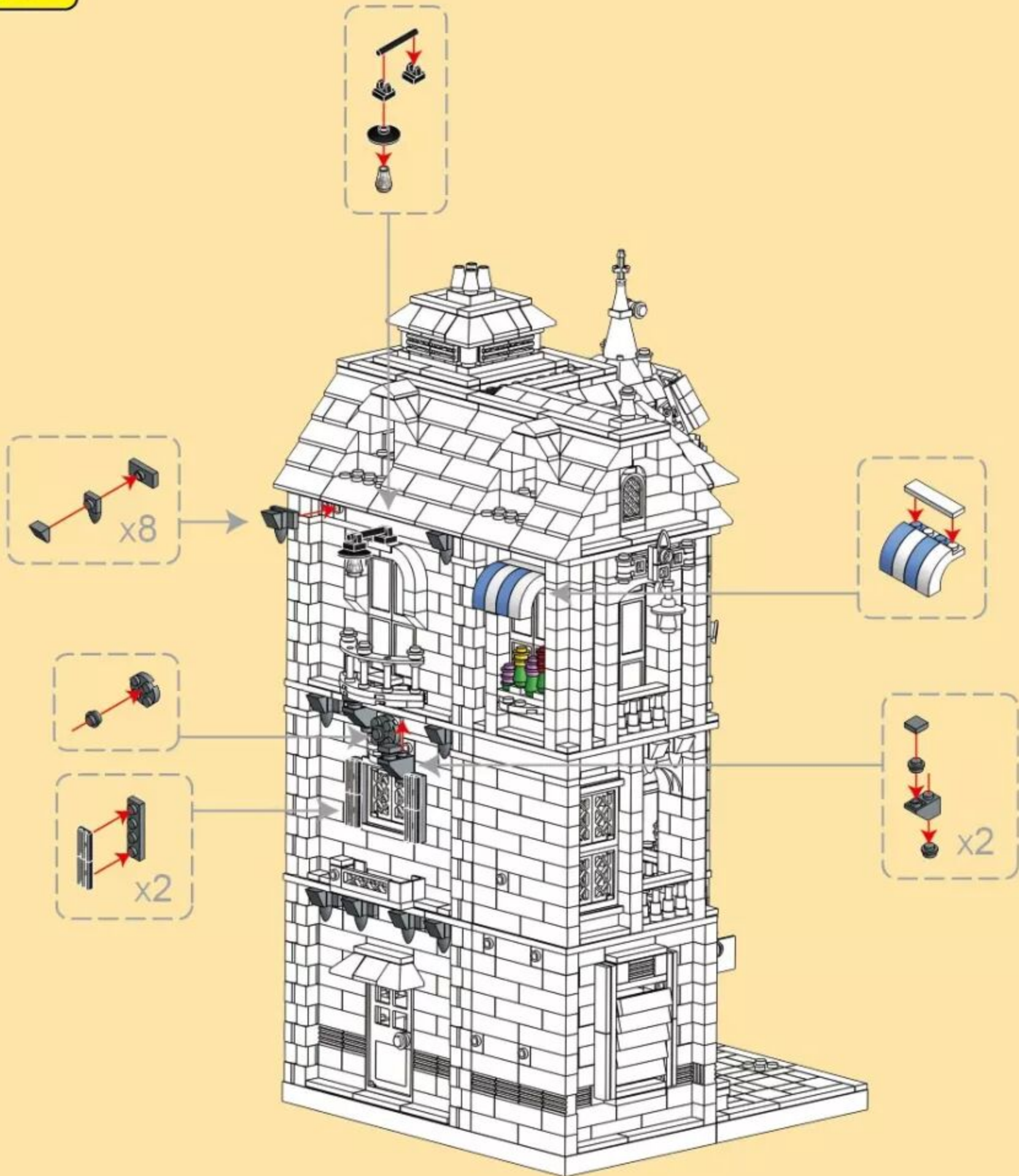

49



x3



x6



x6



x3



x2



x6

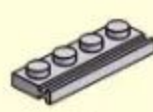

x3



x2



x12



x6



x6



x3



x3



x2



x6



x11



x9



x3



x3



x2



x2



x2

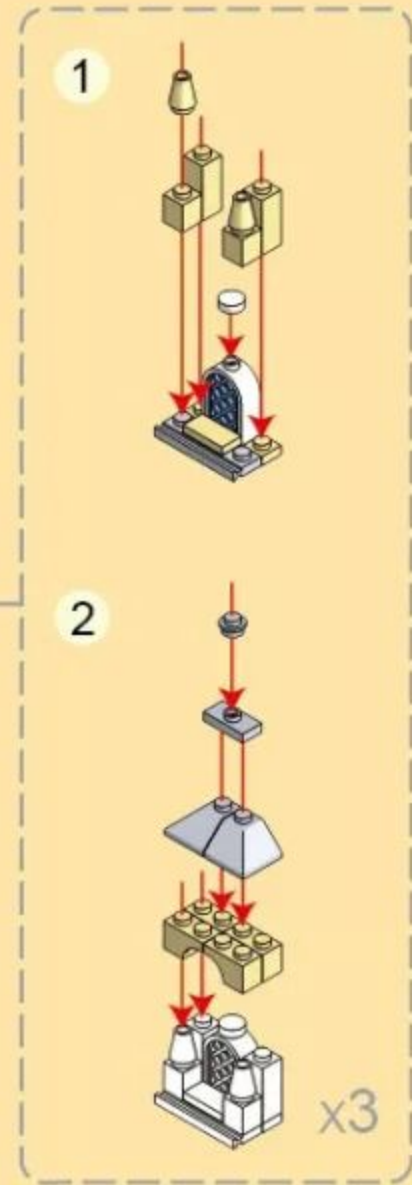

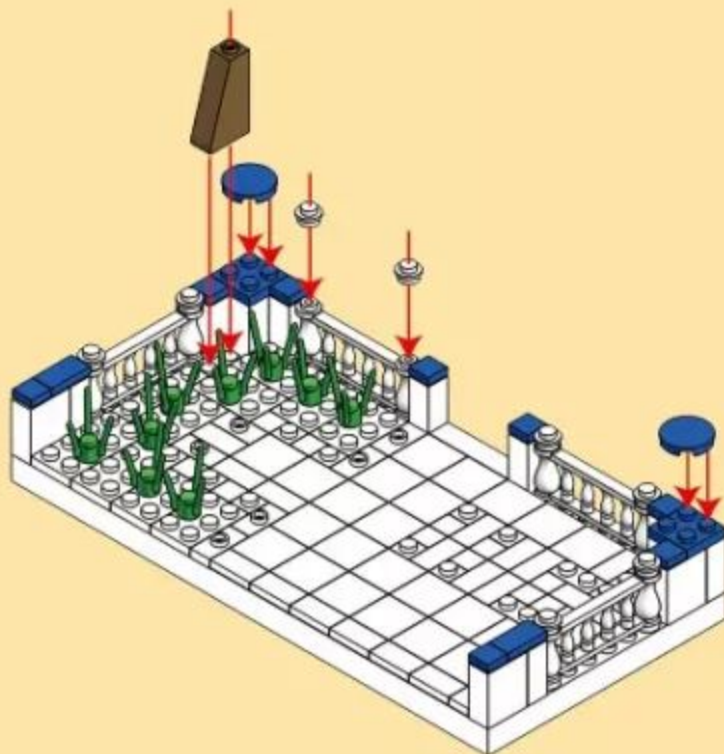
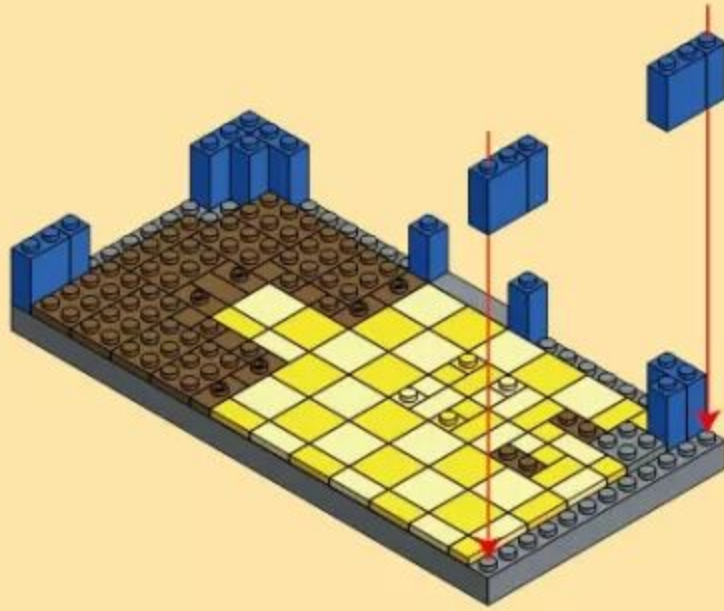
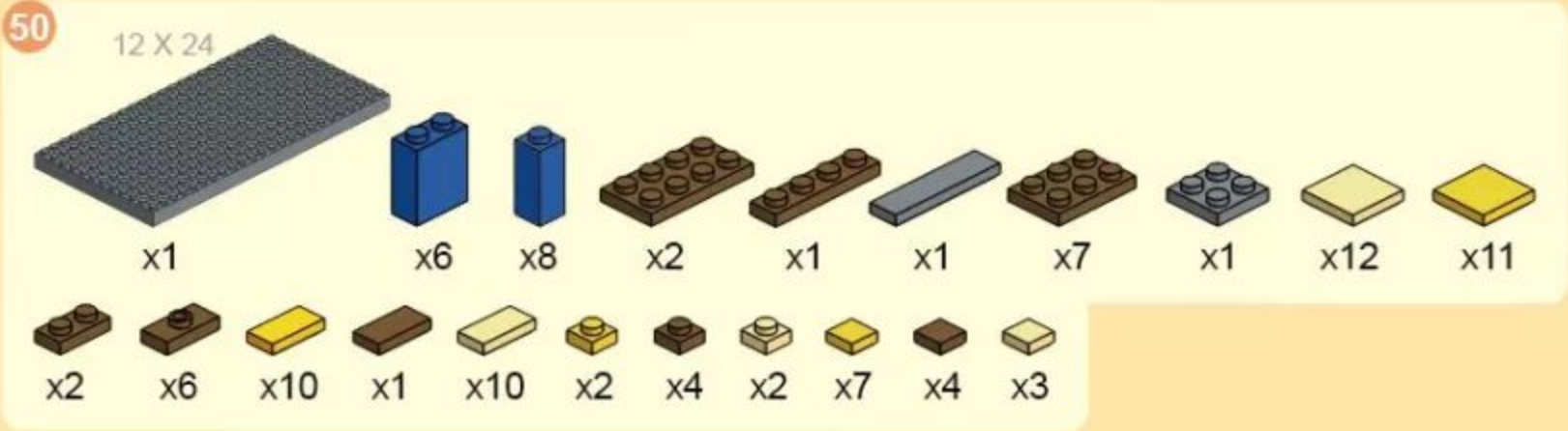



53



x5



x9



x1



x2



x4



x1



x4



x2



x2



x2



x1



x5

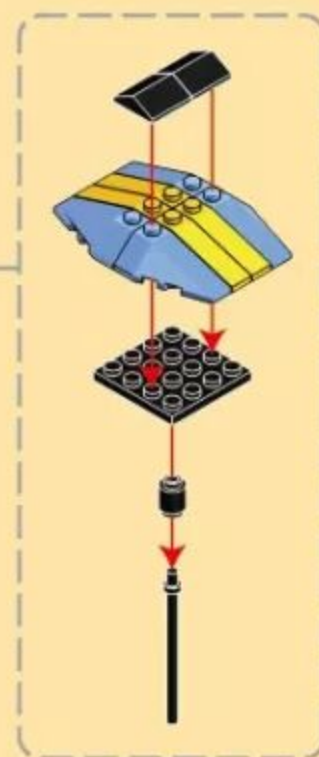
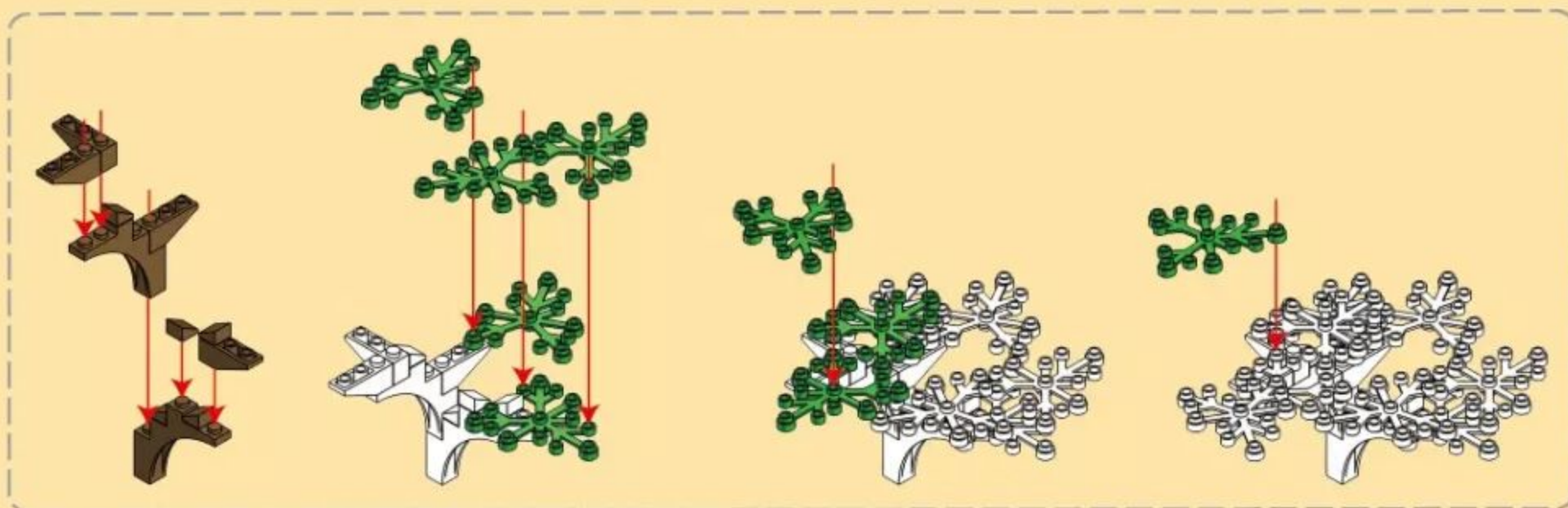

54

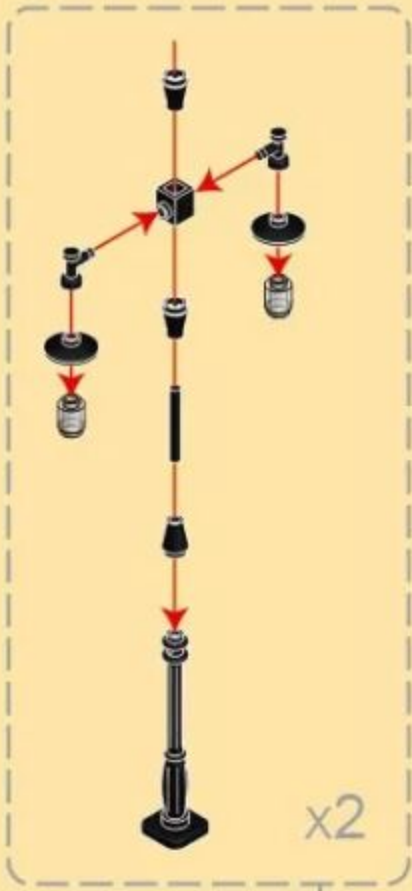

x2

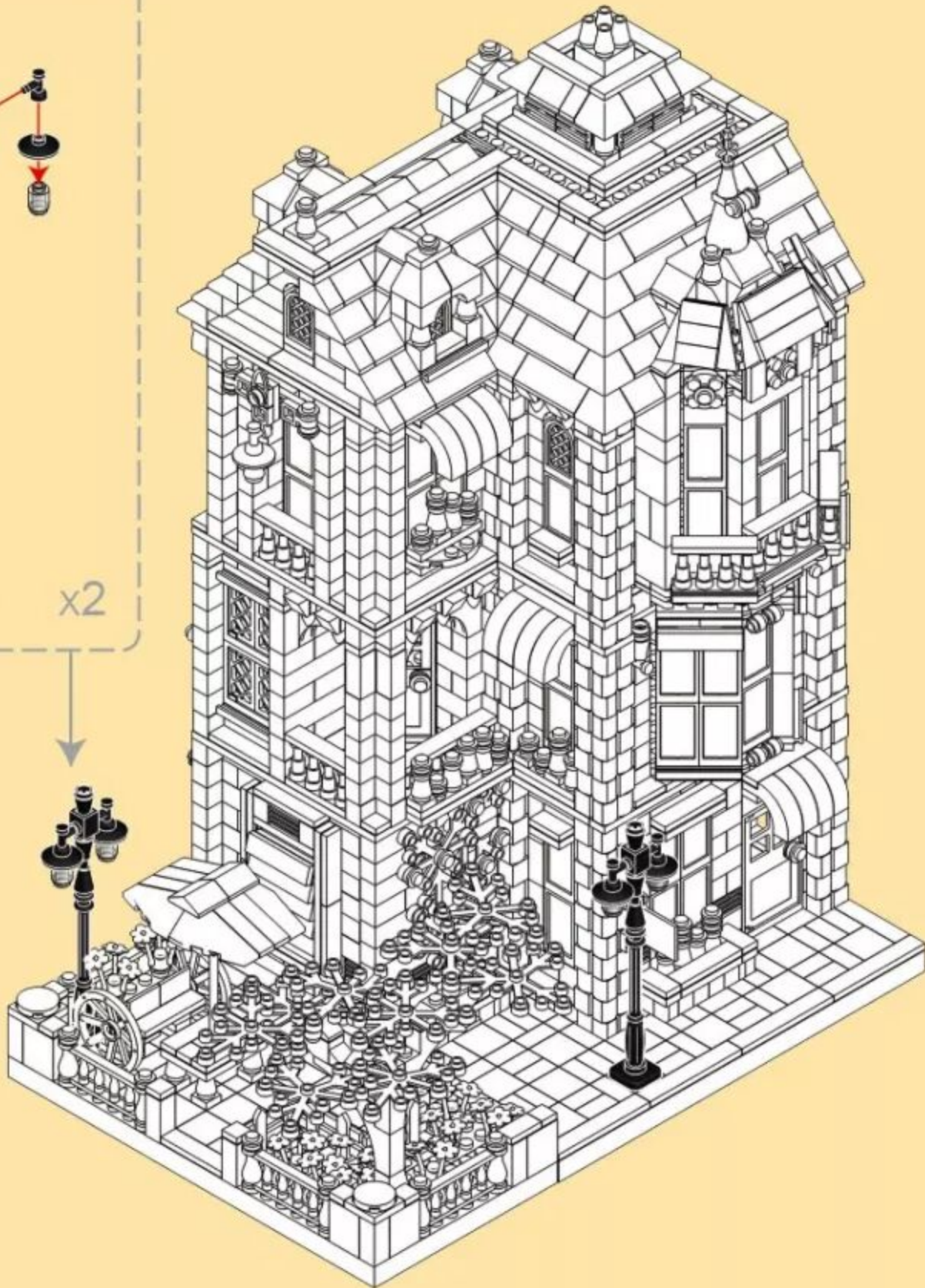



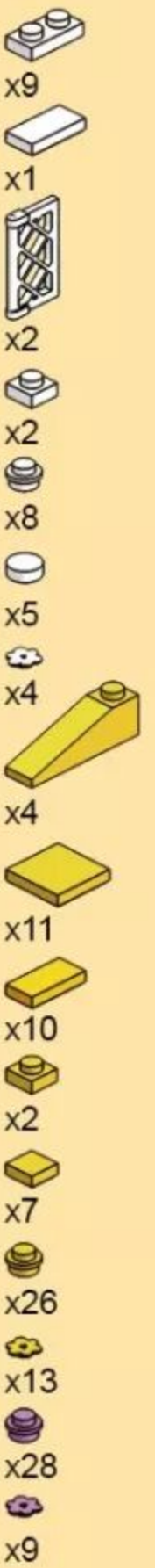
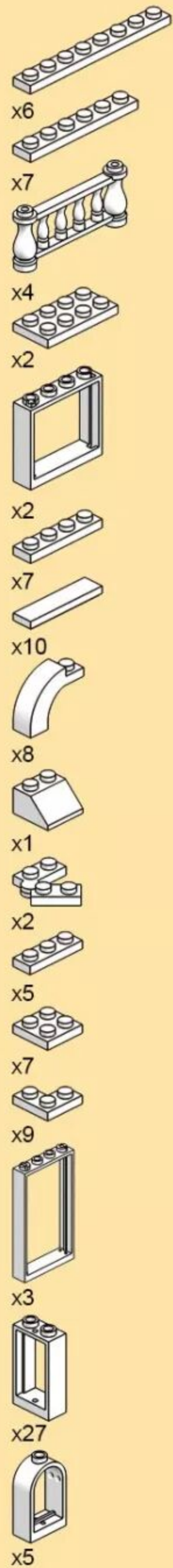
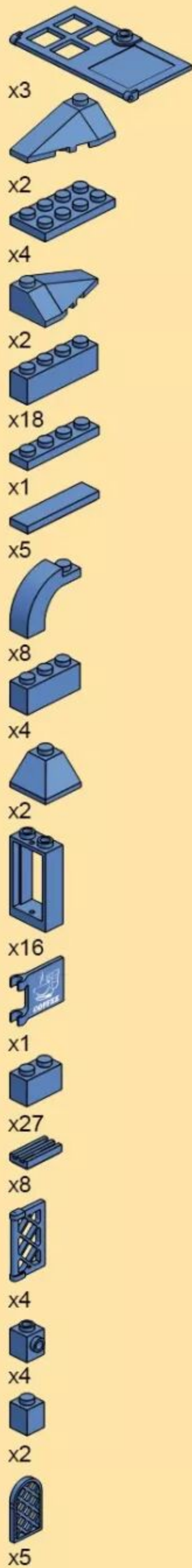
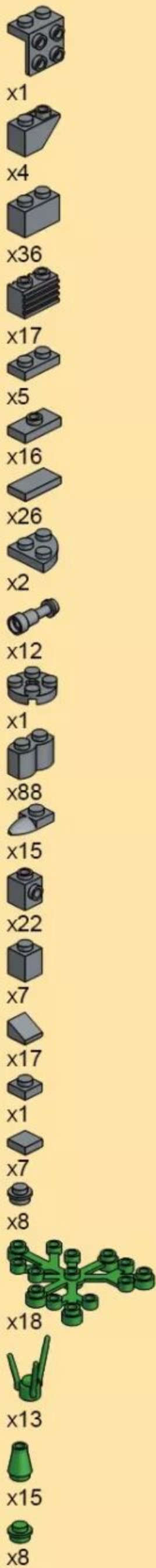
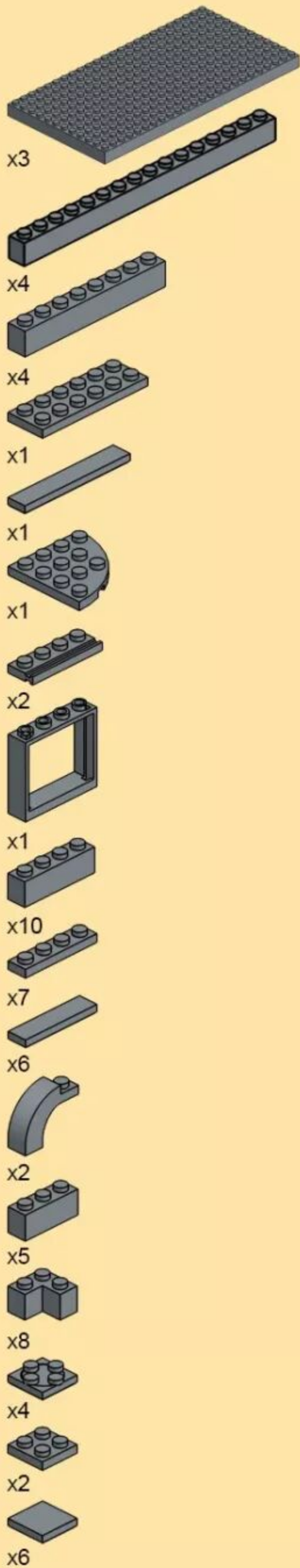

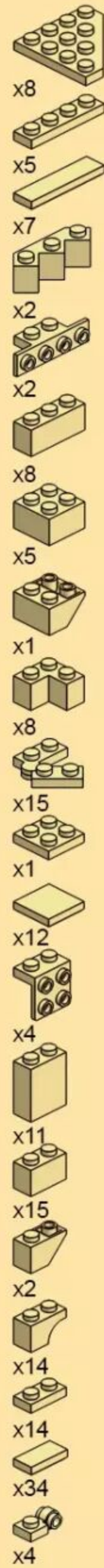
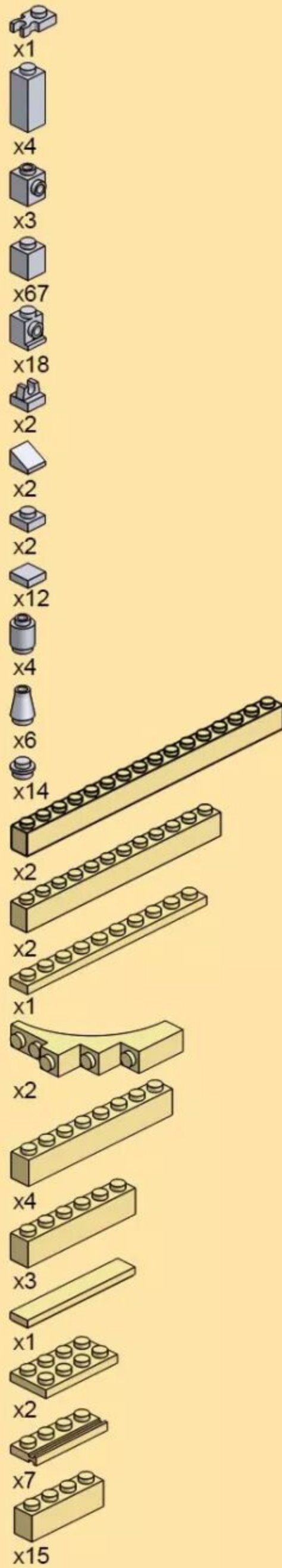
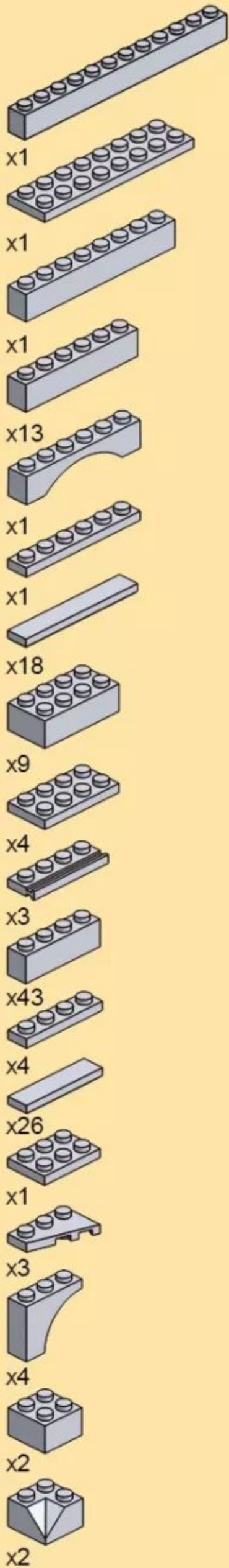

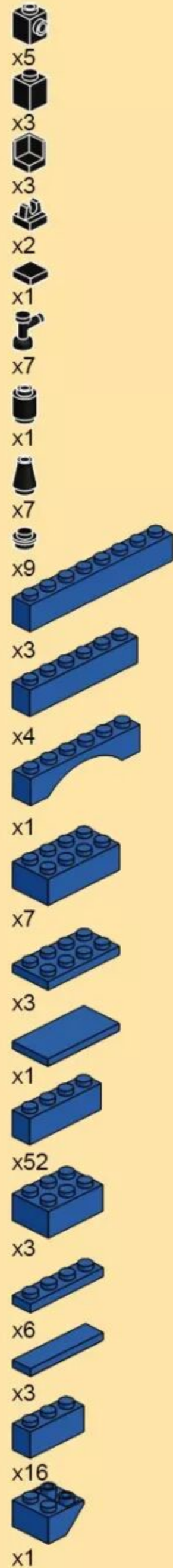
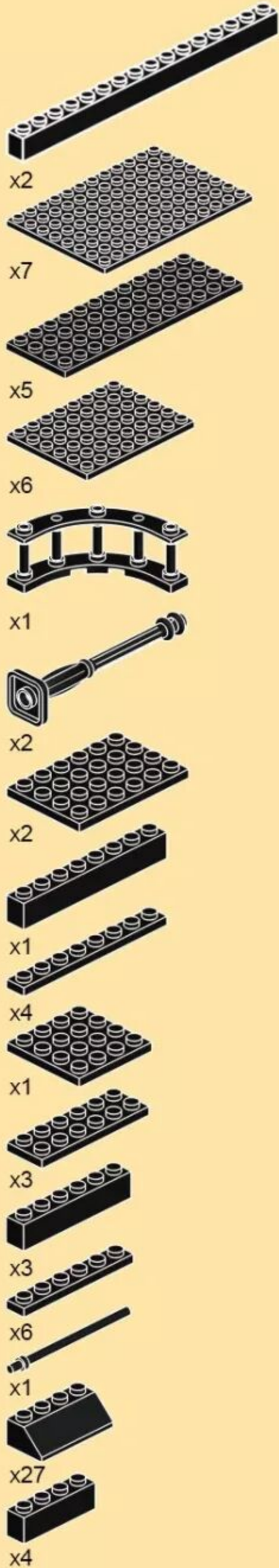
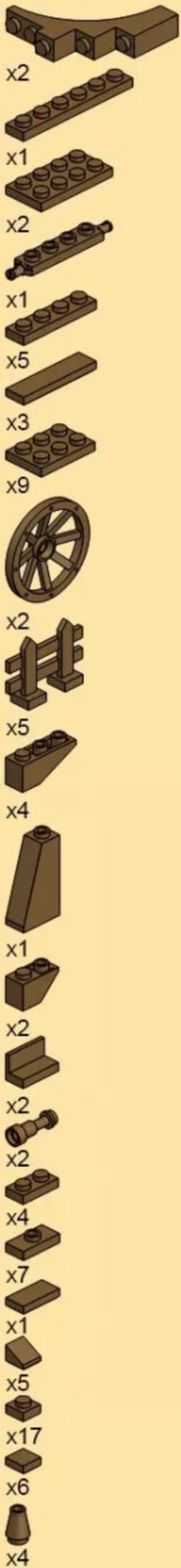

# ARCHITECTURE

## GARDEN COFFEE HOUSE

On our planet, we have more than 200 countries on 5 continents with different cultural characteristics. These characteristics have been showing in many aspects of our lives. Among them, architecture is one of the most representative features that it shows us the evolution of people in different regions in history. Wangestyle architecture is a wholly new building blocks set that specially designed for you, which allows us to travel the world to look for stories of time and history of architecture by these different styles of architecture around the world.

