

CHINA PAVILION AT EXPO

中国上海世博会中国馆

Shanghai, China

The world's great architecture



6+ / 7210 / 3049 PCS
Suitable Age / Product Number / Parts Total

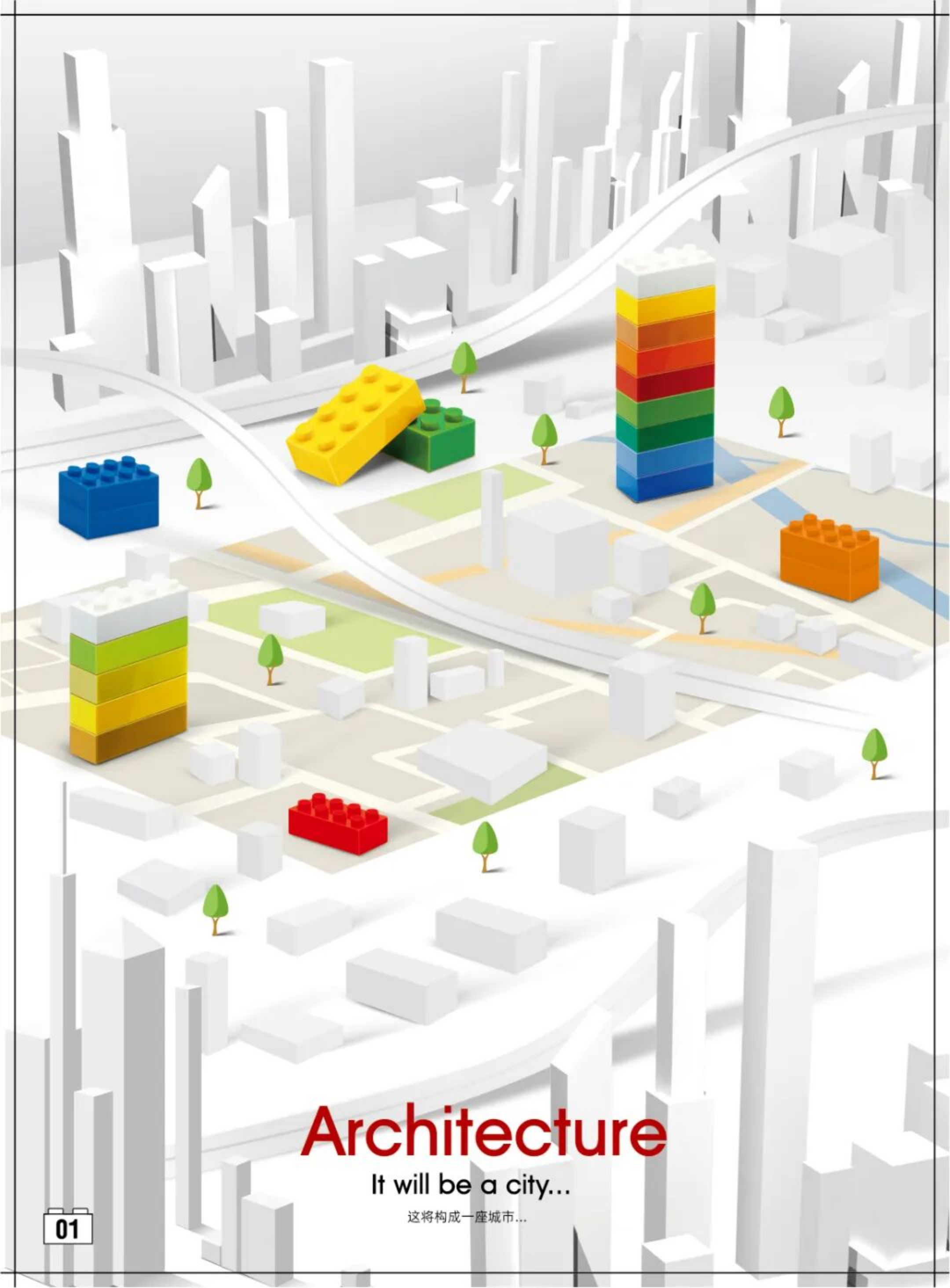

Architecture

It will be a city...

这将构成一座城市...

ABOUT THE PRODUCT

关于产品

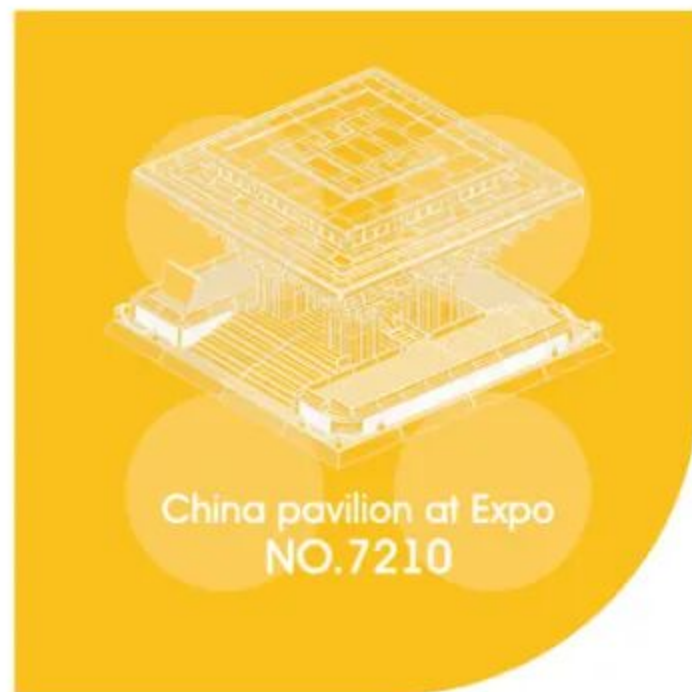
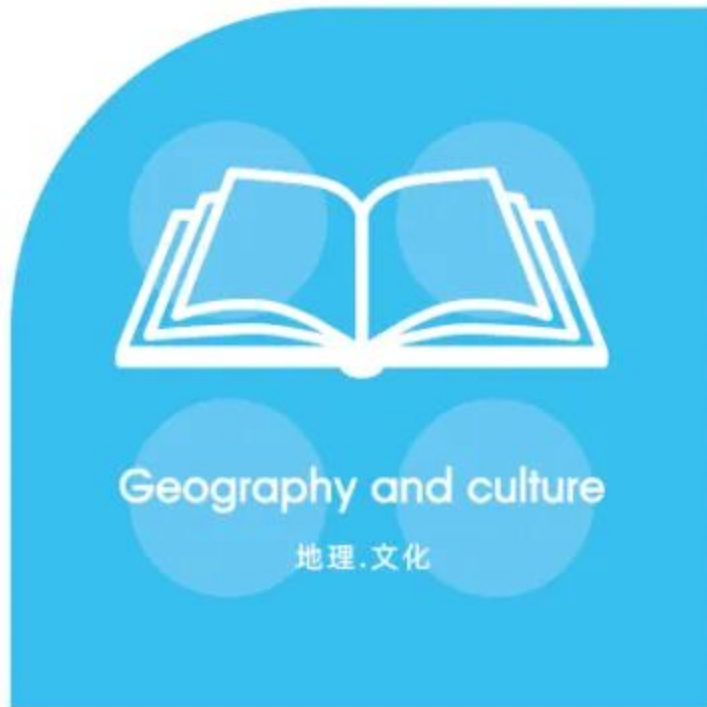

ARCHITECTURE

WANGE The world's great architect since 1991

China pavilion at Expo



The China pavilion at Expo 2010 in Pudong, Shanghai.

China pavilion at Expo



Geography and culture

地理·文化



The China pavilion at Expo 2010 in Pudong, Shanghai, colloquially known as the Oriental Crown.



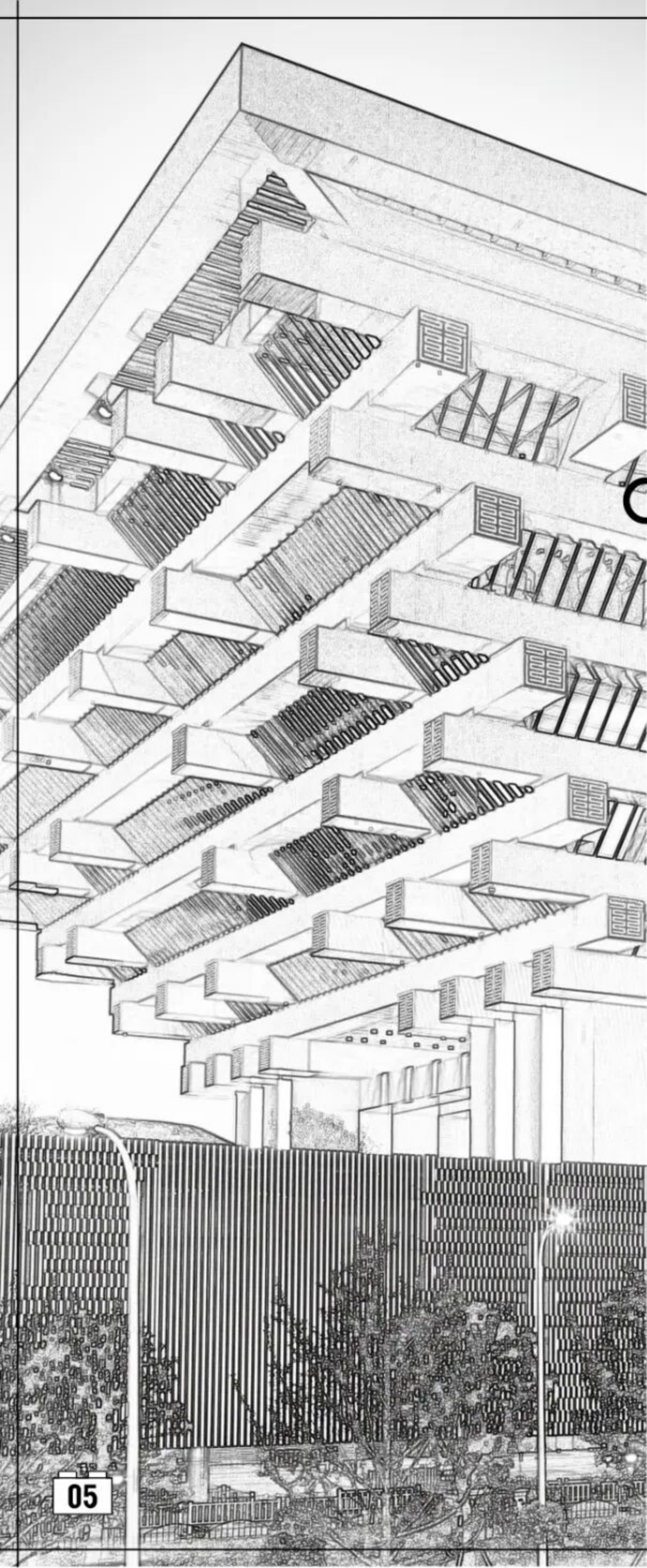

中国上海世博会中国馆

China pavilion ■ at Expo China

The contents of this chapter refer to the Wikipedia website.

本章内容参考维基百科网站，
更多资讯可自行查阅。

The world's great architecture

Buildings and layout

■ 建筑物和布局

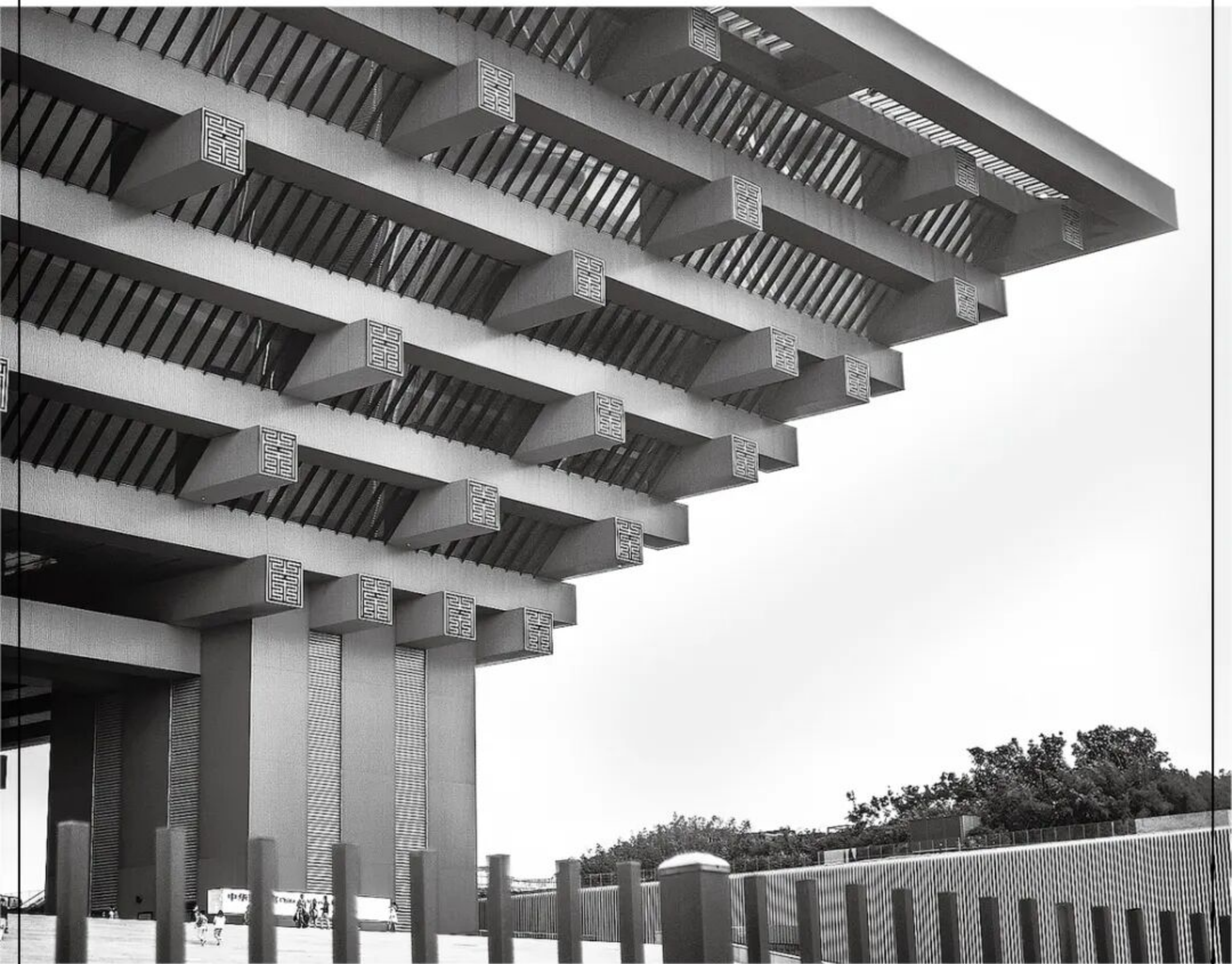

上海世博会中国国家馆是，以城市发展中的中华智慧为主题，表现出了“东方之冠，鼎盛中华，天下粮仓，富庶百姓”的中国文化精神与气质。展馆的展示以“寻觅”为主线，带领参观者行走在“东方足迹”、“寻觅之旅”、“低碳行动”三个展区，在“寻觅”中发现并感悟城市发展中的中华智慧。世博会结束后，更名为中华艺术宫（位于上海地铁8号线中华艺术宫站）。中国馆，共分为国家馆和地区馆两部分，国家馆主体造型雄浑有力，犹如华冠高耸，天下粮仓；地区馆平台基座汇聚人流，寓意社泽神州，富庶四方。国家馆和地区馆的整体布局，隐喻天地交泰、万物咸亨。中国馆以大红色为主要元素，充分体现了中国自古以来以红色为主题的理念，更能体现出喜庆的气氛，让游客叹为观止。设计理念东方之冠、鼎盛中华、天下粮仓、富庶百姓。表达了中国文化的精神与气质。

The China pavilion at Expo 2010 in Pudong, Shanghai, colloquially known as the Oriental Crown, was the largest national pavilion at the Shanghai Expo and the largest display in the history of the World Expo. It was also the most expensive pavilion at the Shanghai Expo, having cost an estimated US\$220 million. The pavilion showcased China's civilization and modern achievements by combining traditional and contemporary elements in its architecture, landscaping and exhibits. After the end of the Expo 2010, the building was converted to a museum. On October 1, 2012, it was reopened as the China Art Museum, the largest art museum in Asia.



Symbolism

大红外观、斗拱造型——上海世博会中国国家馆，是五千年中华文明奉献给159年世博会历史的“中国红”，是坚持改革开放的中国呈现给世界的“中国红”。每次遇到外宾，中国馆馆长徐沪滨都会自豪地说，“这是从中国古建筑营造法则中，特别是故宫的红色中，采集而来的。”

The architectonic feature of the building was inspired by the Chinese roof bracket known as the dougong as well as the Chinese ding vessel. The dougong is a traditional wooden bracket used to support large overhanging eaves which dates back nearly 2,000 years. It represents the union between heaven and earth. The China pavilion's four giant columns resemble the legs of a ding vessel while the inverted pyramid body resembles the bowl of a vessel. The rooftop of the building is in the shape of a grid-like pattern reminiscent of Jiugongge when view from the air. The characters for north, south, east and west are engraved on the red China pavilion, while 24 Chinese solar terms are carved into the silver facade of the provincial pavilion.



Design and construction

中国馆“东方之冠”具有明显的中国特色，它融合了多种中国元素，并用现代手法加以整合、提炼和构成，国家馆的造型还借鉴了夏商周时期鼎器文化的概念。鼎有四足，起支撑作用。作为国家盛典中的标志性建筑，光有斗拱的造型还不够，还要传达出力量感和权威感，这就需要四组巨柱，像巨型的四脚鼎将中国馆架空升起，呈现出挺拔奔放的气势，同时又使这个庞大建筑摆脱了压抑感。这四组巨柱都是18.6米×18.6米，将上部展厅托起，形成21米净高的巨构空间，给人一种“振奋”的视觉效果，而挑出前倾的斗拱又能传达出一种“力量”的感觉。巍峨壮观的中国馆绝对高度63米，相当于西安大雁塔（64米），具有极大的震撼力和视觉冲击力。它的外形既像宝鼎，又像一盏巨大的酒杯，高高举起，盛情欢迎五洲四海的朋友；同时它又像一只展翅欲飞的大鹏，冲天而起，预示着中国将翱翔万里，称雄世界。

The chosen design was selected from a range of 344 design proposals put forward by architects from all over the world. The chief architect of the pavilion was 72-year-old He Jingtang, the director of the Architectural Academy of the South China University of Technology. The construction of the China pavilion began on 18 December 2007 and was completed in November 2009. On 8 February 2010, the completion of construction was commemorated by almost 1,000 people including the pavilion's designers and construction workers. The structure was built with a strong emphasis on sustainable and energy-saving practices with the exterior offering thermal insulation and natural ventilation. The inverted pyramid design and the lower courtyard offers a large overhang for self-shading.

Creation and thinking

创作·思考

Drawing Design

手绘设计



Design Points

结构难点

$$a^2 + b^2 = c^2$$

$$S = 4\pi \cdot r^2$$

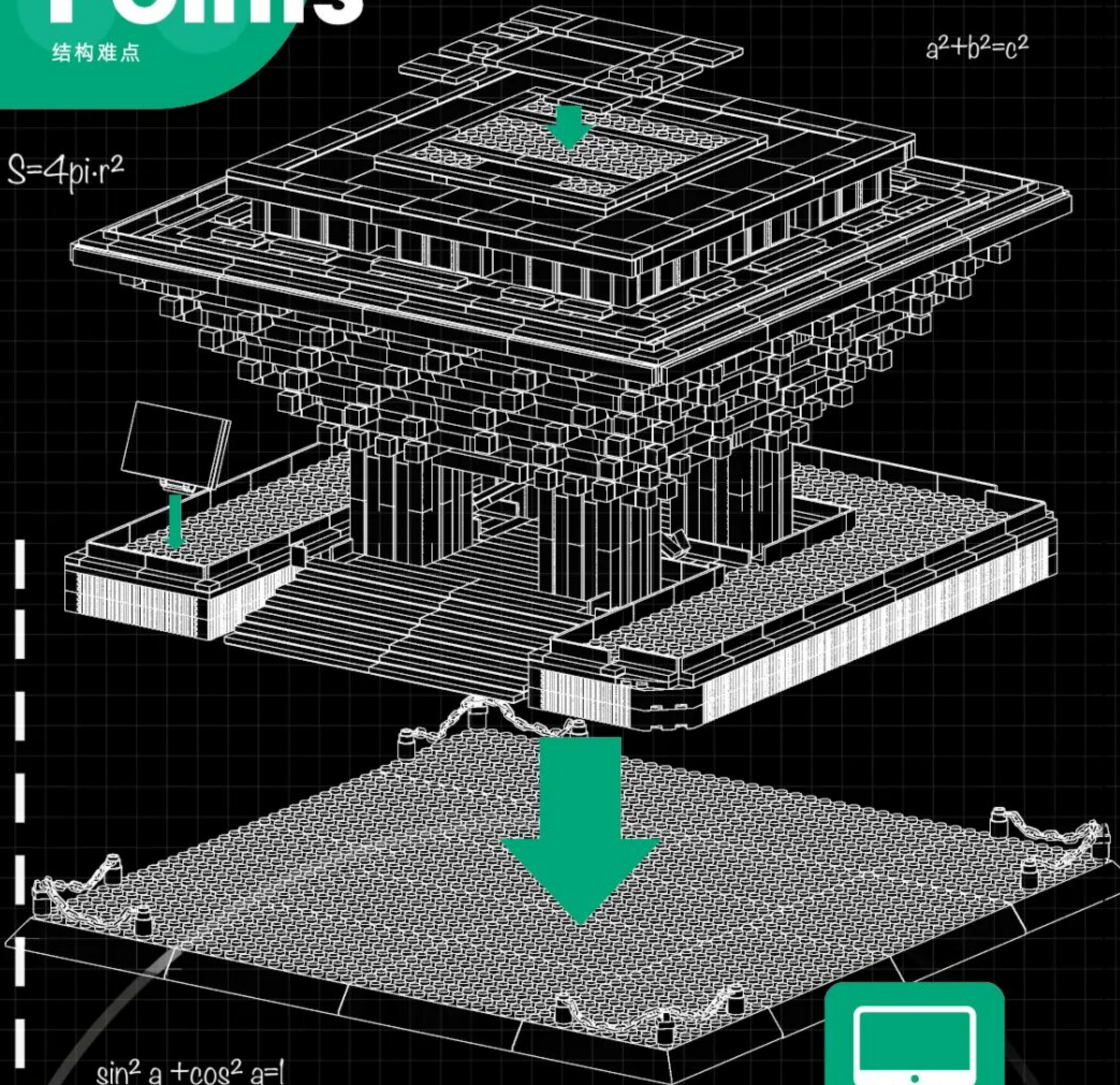

$$\sin^2 a + \cos^2 a = 1$$



Creation and thinking

创作·思考

$$S=4\pi \cdot r^2$$

Special parts

特殊零件的开发利用



WG1356

矮方形盖一孔



WG1344

方形通孔

$$a^2+b^2=c^2$$



WG1281

两面孔4*4



WG1273

4倍半斜



WG1360

波纹4孔



WG1300

高长5孔

WG1355

双面矮一孔



WG1267

四倍窗

$$\sin^2 a + \cos^2 a = 1$$

features and function

特点.功能



Main Color Matching

配色方案



Color matching Adopting 3 main colors, white, red and cool Gray as the main color, the more reasonable and dark green color matching on the original building, making the product more atmospheric and the whole design is more reasonable.

CHINA PAVILION AT EXPO

中国上海世博会中国馆



Front

Left

Back

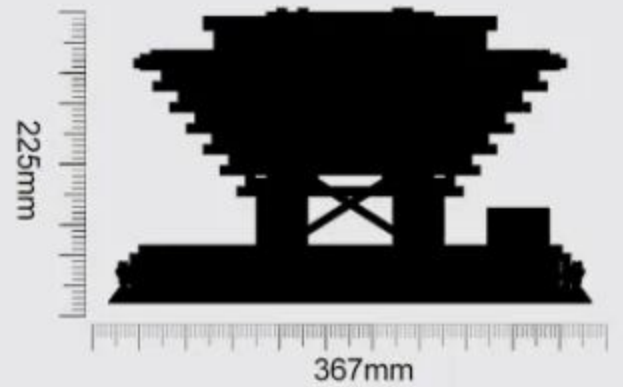
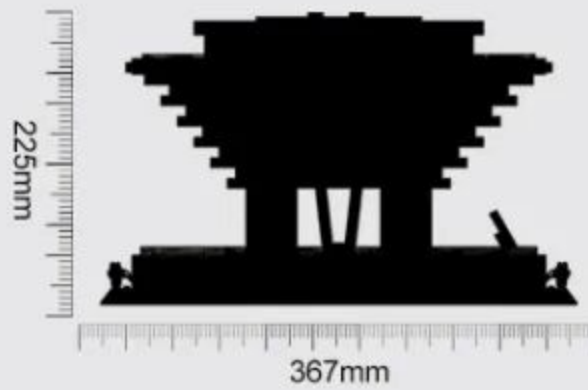
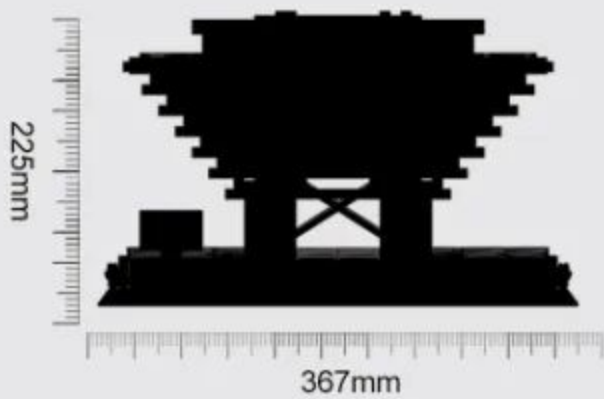

Product Size:367X367x225mm

Creative Ability

Family Interaction

Observation Ability

Thinking Ability

Practical Ability



Instructions For Use

积木起件器使用说明
Brickseparator

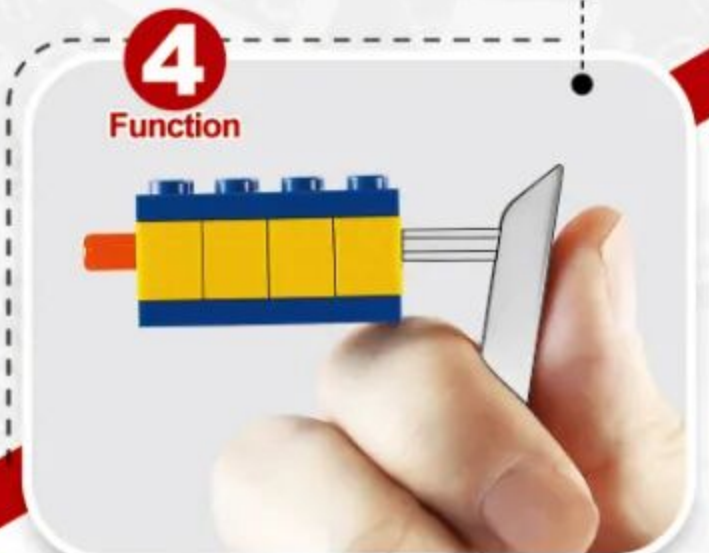
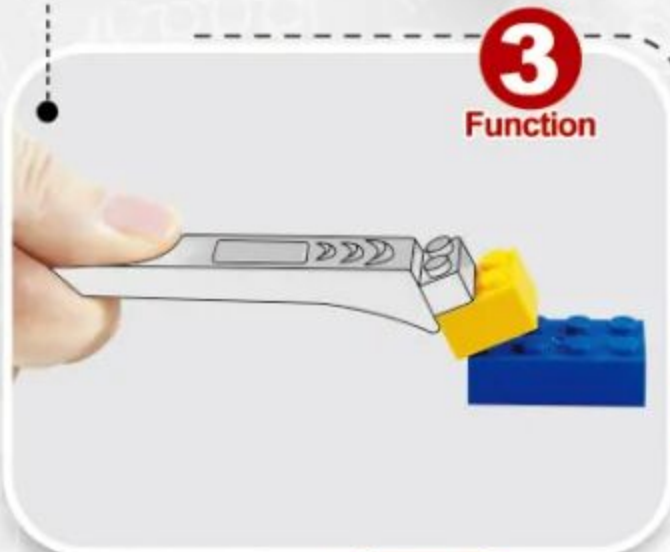
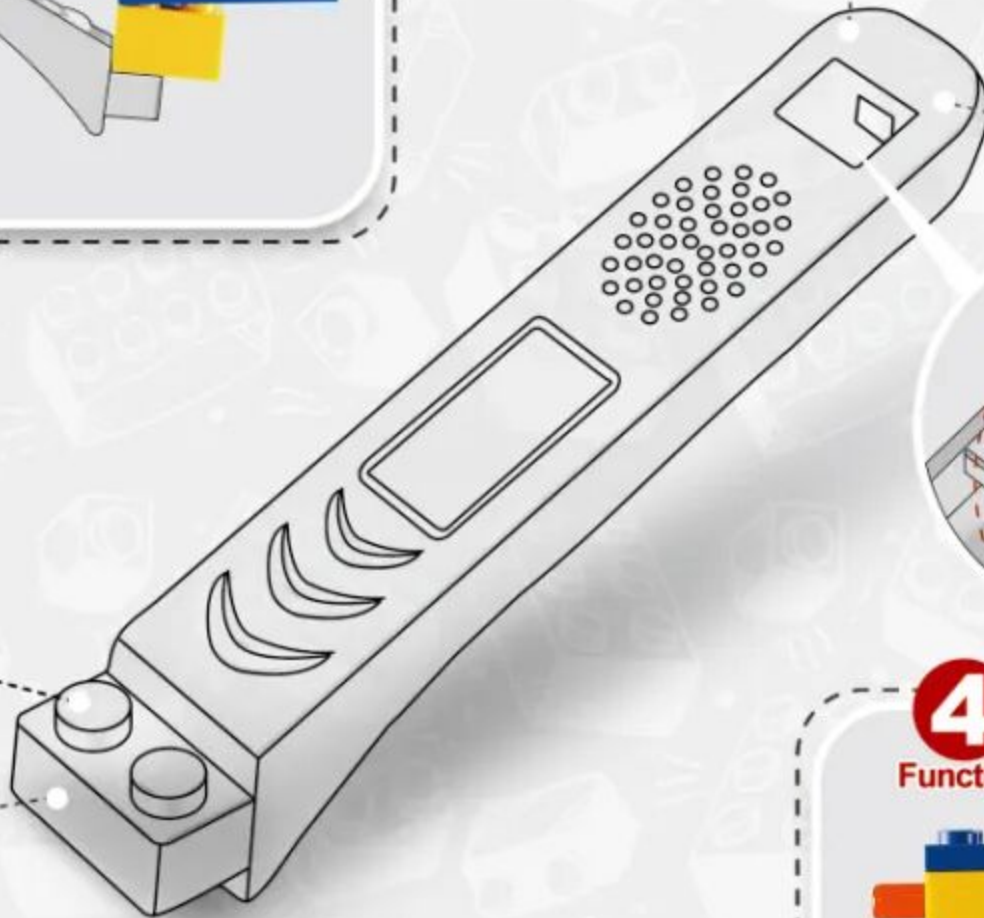
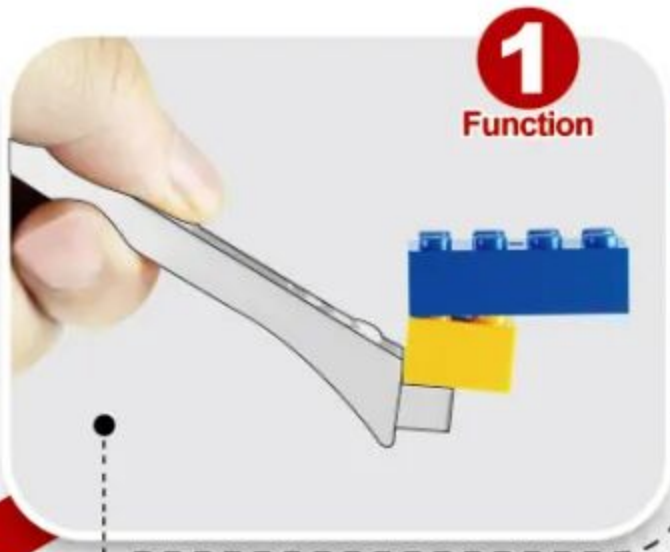

4 ways to make installation easier
让安装更简单



■ First open the product packaging according to the instructions.

按指导用正确方式拆解产品外包装。



■ Summarize all parts to count the number of familiar accessories.

对照说明书清单确认积木包数量与积木数量。



■ Arranging all accessories by color helps to quickly install the product.

把确认好的积木以类型、颜色进行分类排好以便安装。



■ Carefully install the product and learn about building.

按说明书步骤拼装并完成你的积木模型。



1:1 Physical Reference Table

十字棒配件1:1尺寸参照表



Instructions For Use

让安装更简单



2 $(1 \times 2) = 2$



3 $(1 \times 3) = 3$



4 $(1 \times 4) = 4$



5 $(1 \times 5) = 5$



6 $(1 \times 6) = 6$



7 $(1 \times 7) = 7$



8 $(1 \times 8) = 8$



9 $(1 \times 9) = 9$



10 $(1 \times 10) = 10$



12 $(1 \times 12) = 12$



16 $(1 \times 16) = 16$



PARTS LIST

配件清单

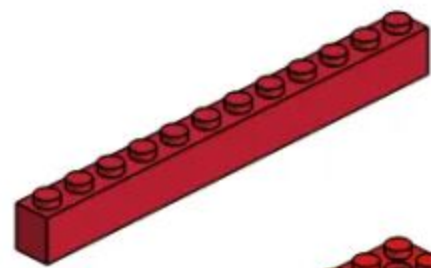

x14

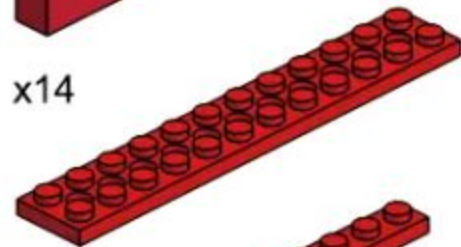

x6



x28



x22



x6



x2



x20



x6

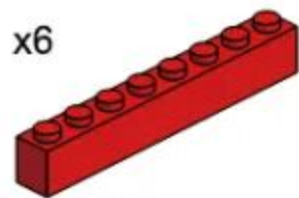

x8



x10

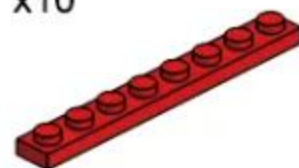

x6



x24



x2



x2

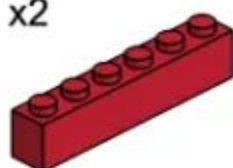

x12



x12

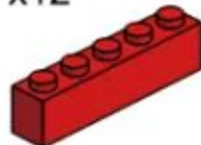

x8



x26



x20



x36



x8



x2



x28



x10

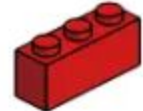

x4



x4



x4



x8



x128



x8



x2



x30



x18



x38



x40



x18



x8



x48



x48



x104



x148



x6



x210



x36



x1



x12



x1



x4



x17



x5

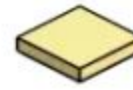

x13



x4



x45



x24



x2

产品有增补件请以实物为准

If product has additional parts, please in kind prevail.

PARTS LIST

配件清单

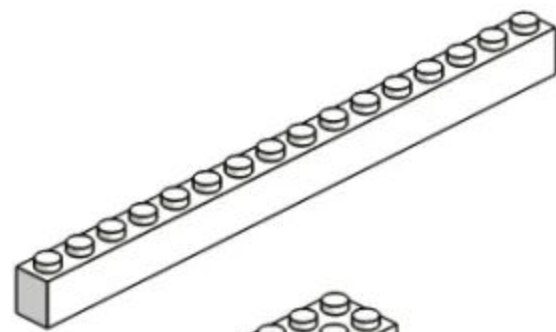

x4

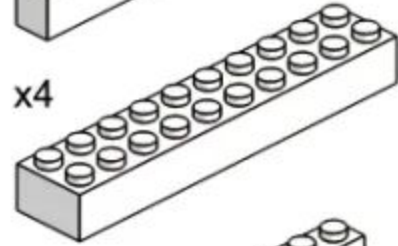

x5

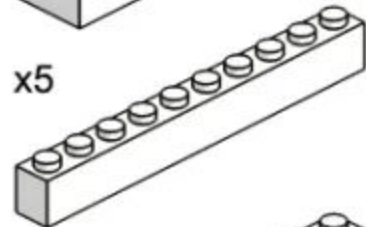

x8

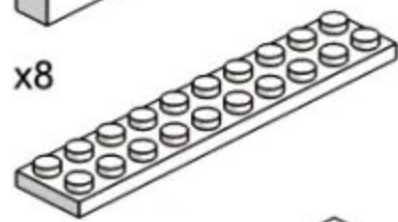

x4



x18

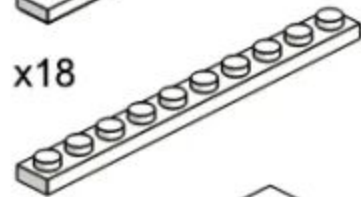

x6



x55

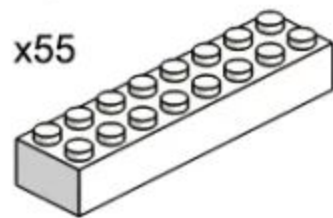

x1

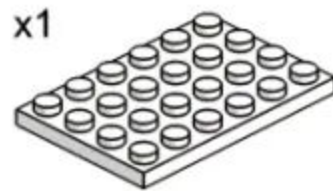

x1

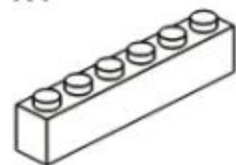

x2

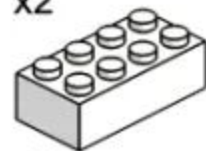

x2



x8

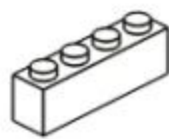

x2



x2

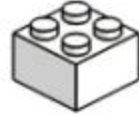

x2



x4

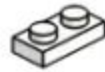

x2



x12



x28



x4



x4

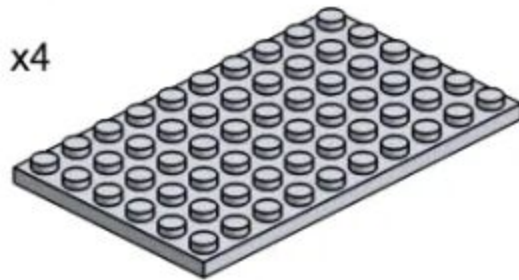

x2

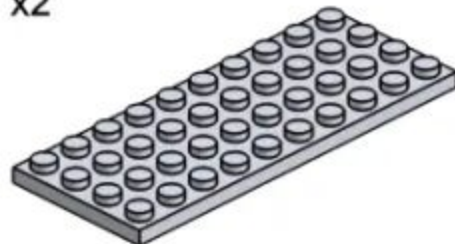

x1

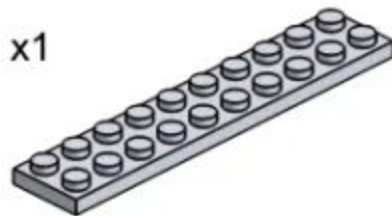

x1

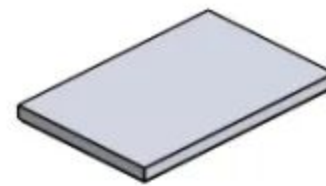

x12



x2

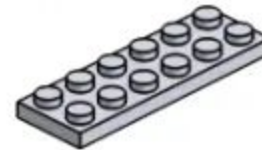

x2

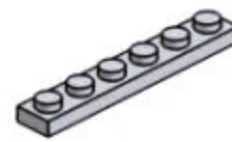

x16



x2

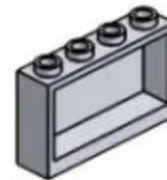

x16



x8



x68

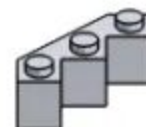

x4



x36

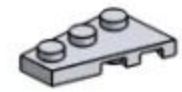

x1



x1



x8



x12



x24



x24

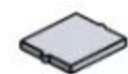

x36



x10



x14

产品有增补件请以实物为准

If product has additional parts, please in kind prevail.

PARTS LIST

配件清单



x8

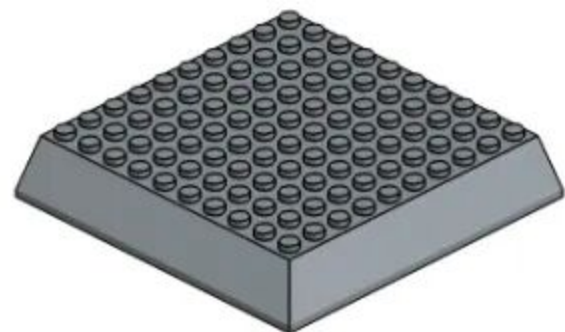

x4



x6



x1



x1



x3



x4



x1



x12

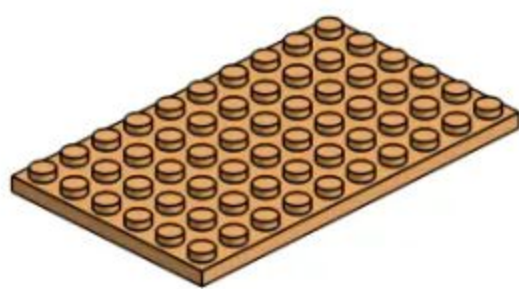

x3

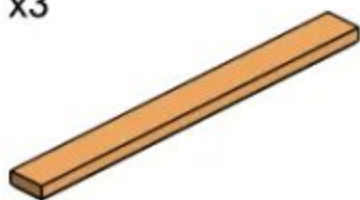

x12

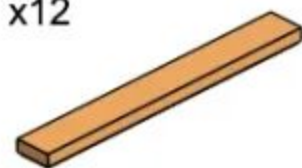

x8



x1



x1

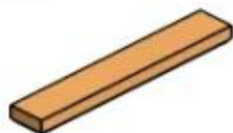

x6



x2



x2



x4



x4

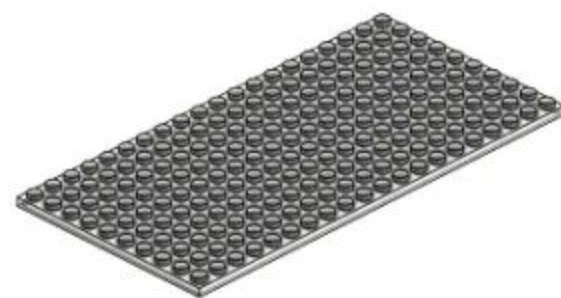

x8



x20



x86



x4



x9



x12



x2



x6

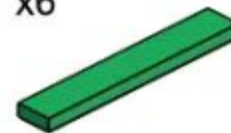

x3



x3



x14



x1

产品有增补件请以实物为准

If product has additional parts, please in kind prevail.



280PCS

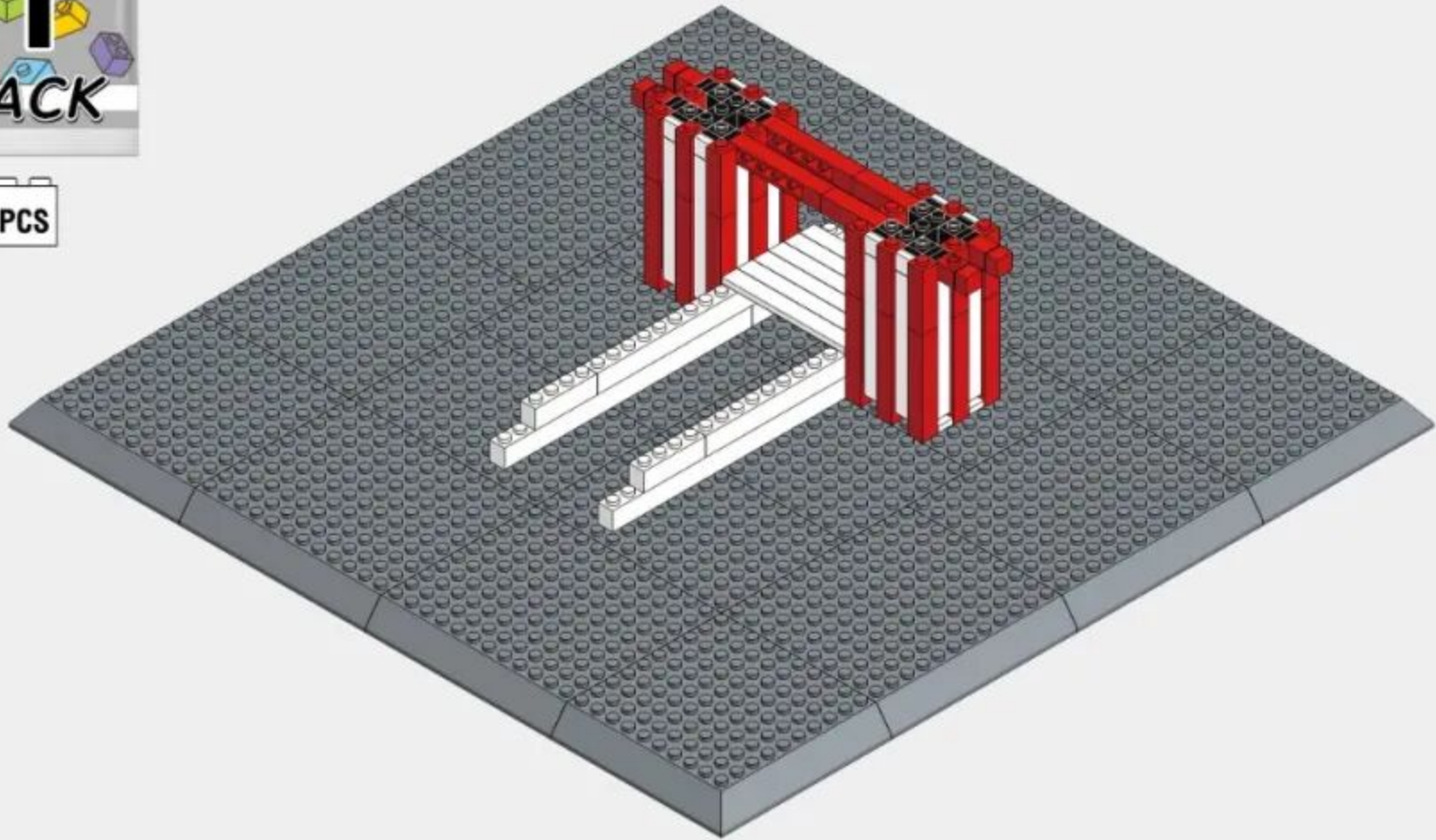

1-1

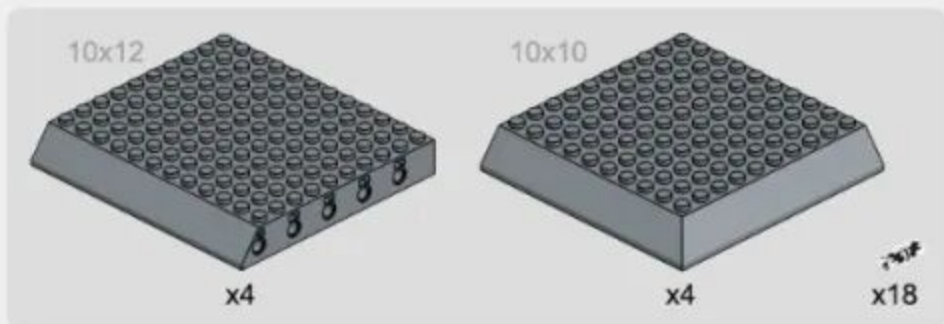

微信扫一扫
补件更简单

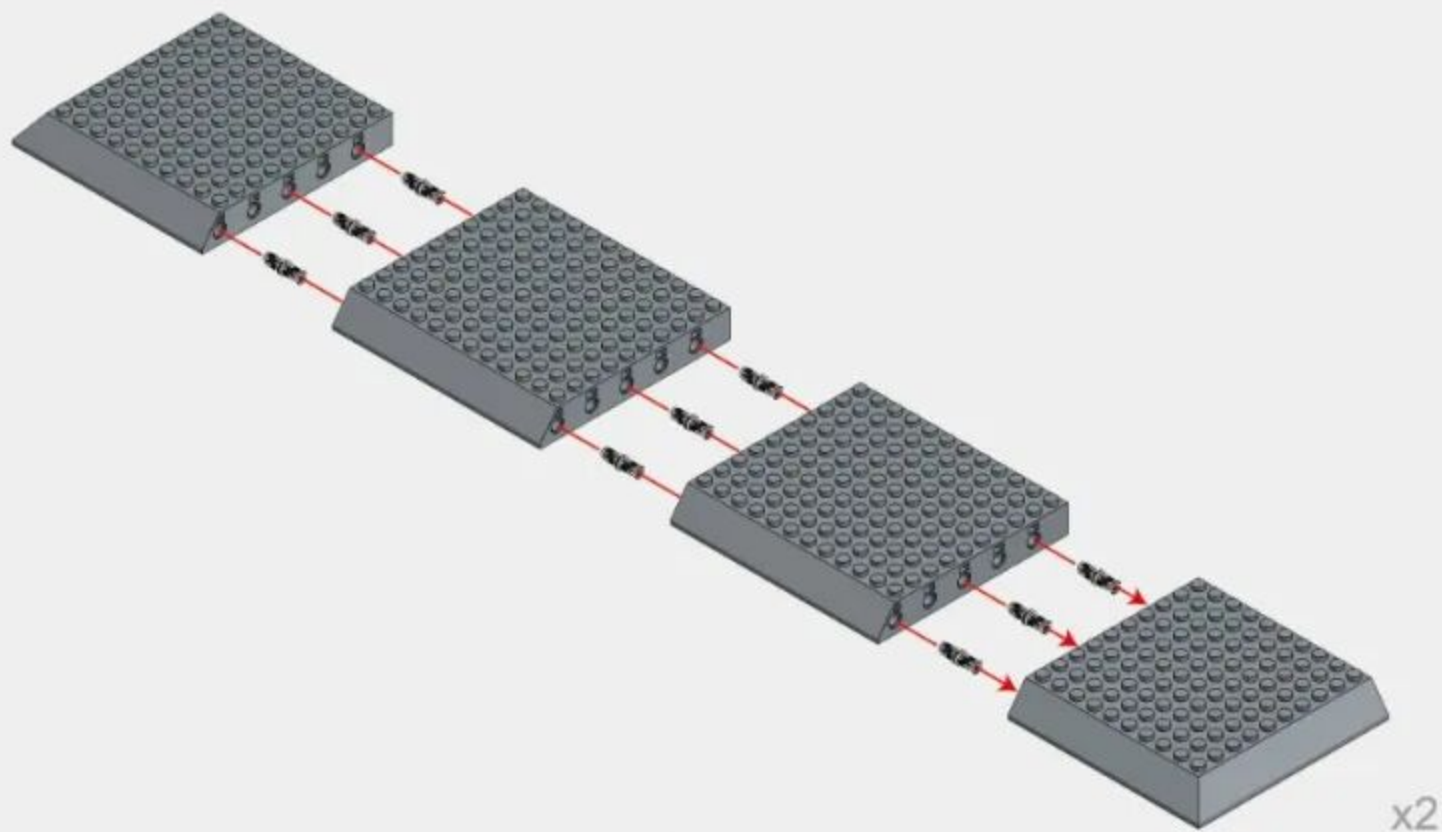

1-2

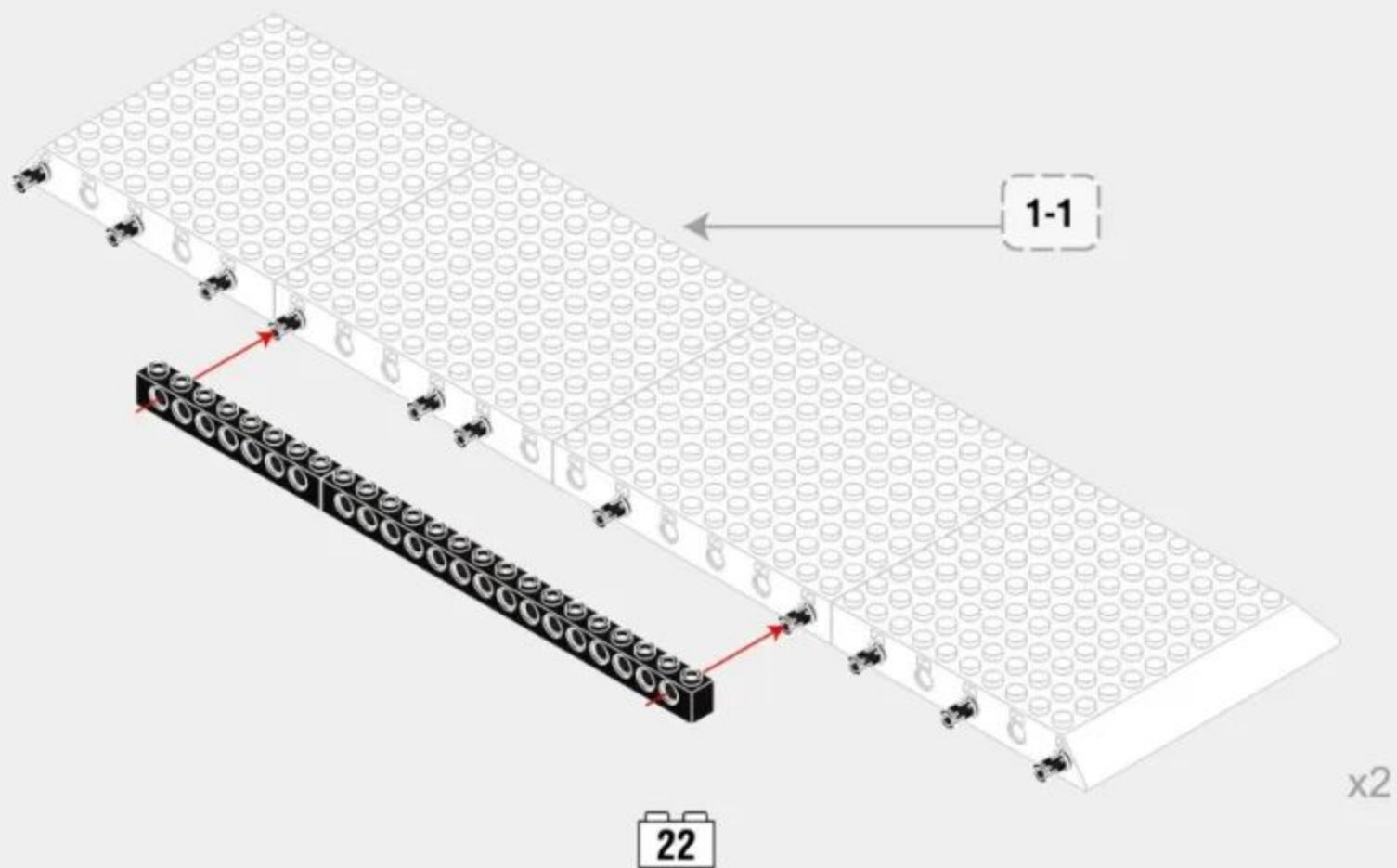
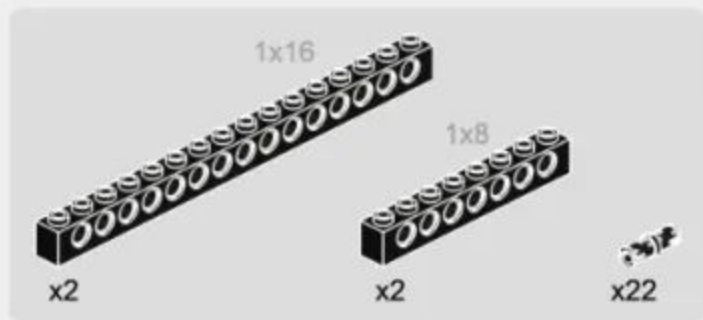

1-3

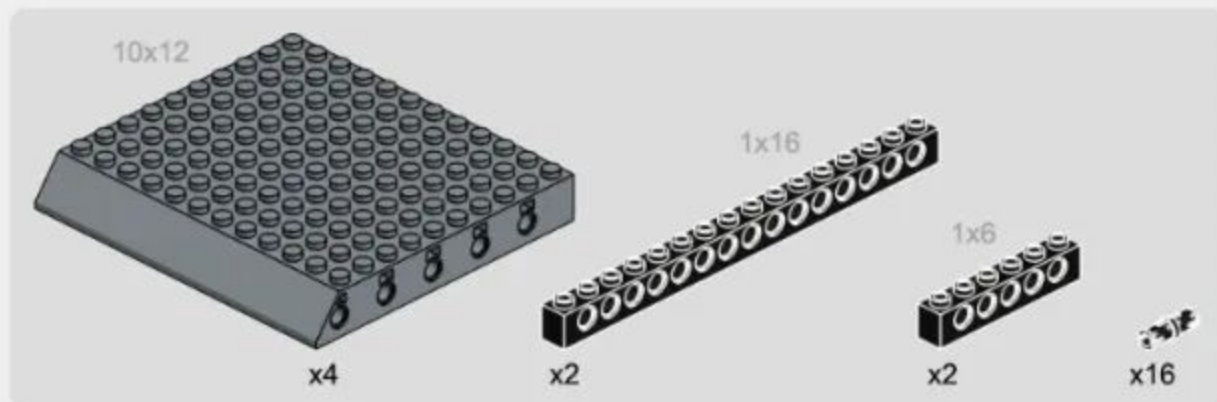

1

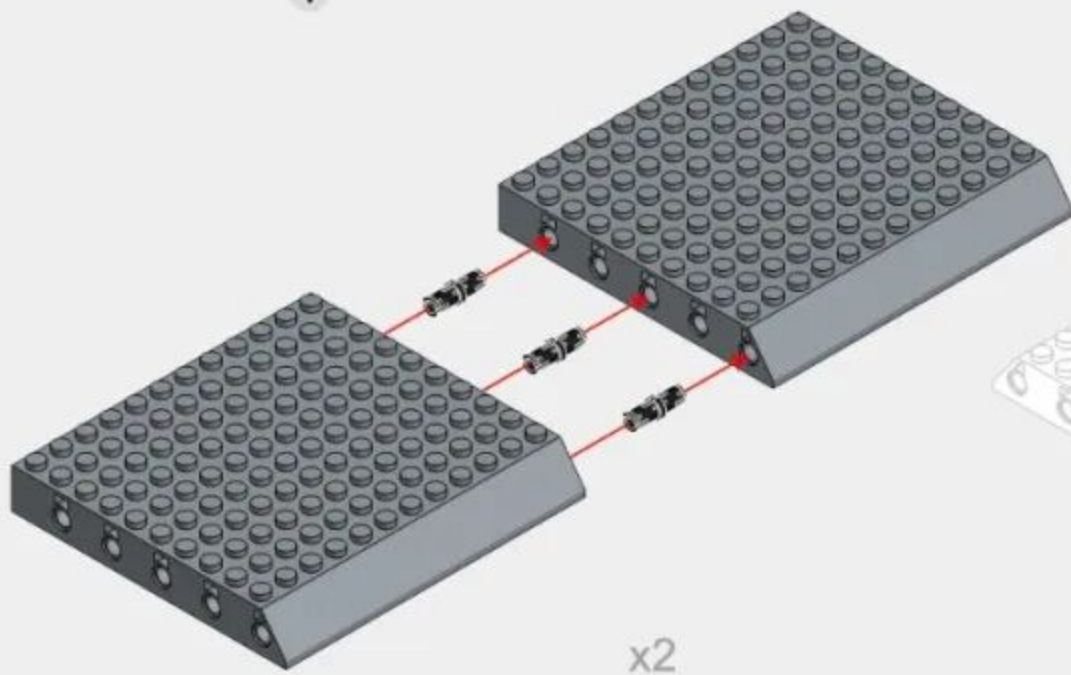

2

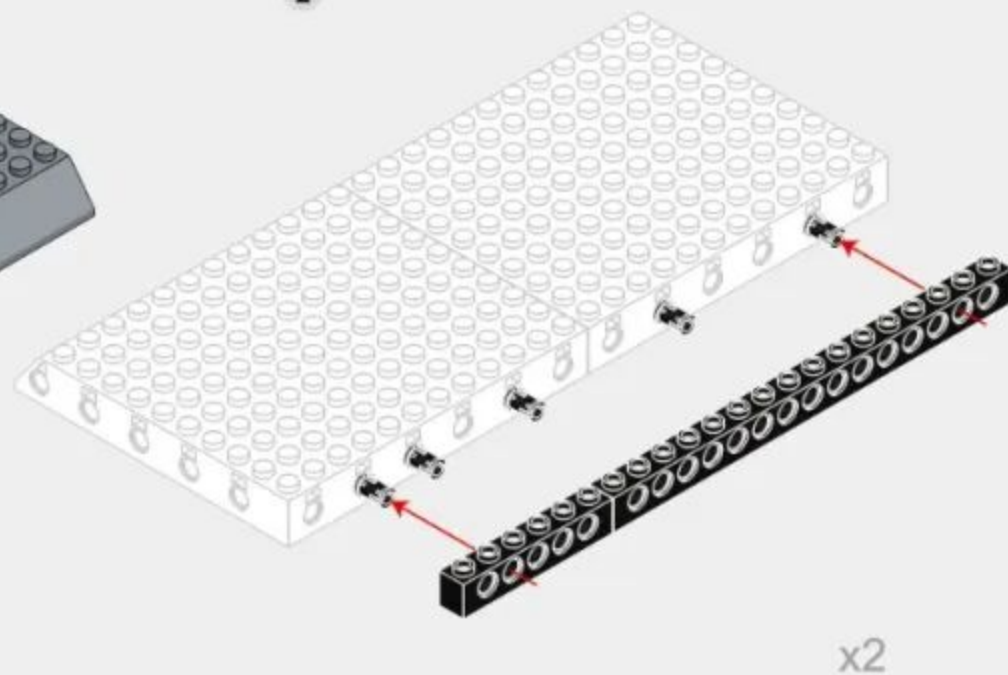

1-4

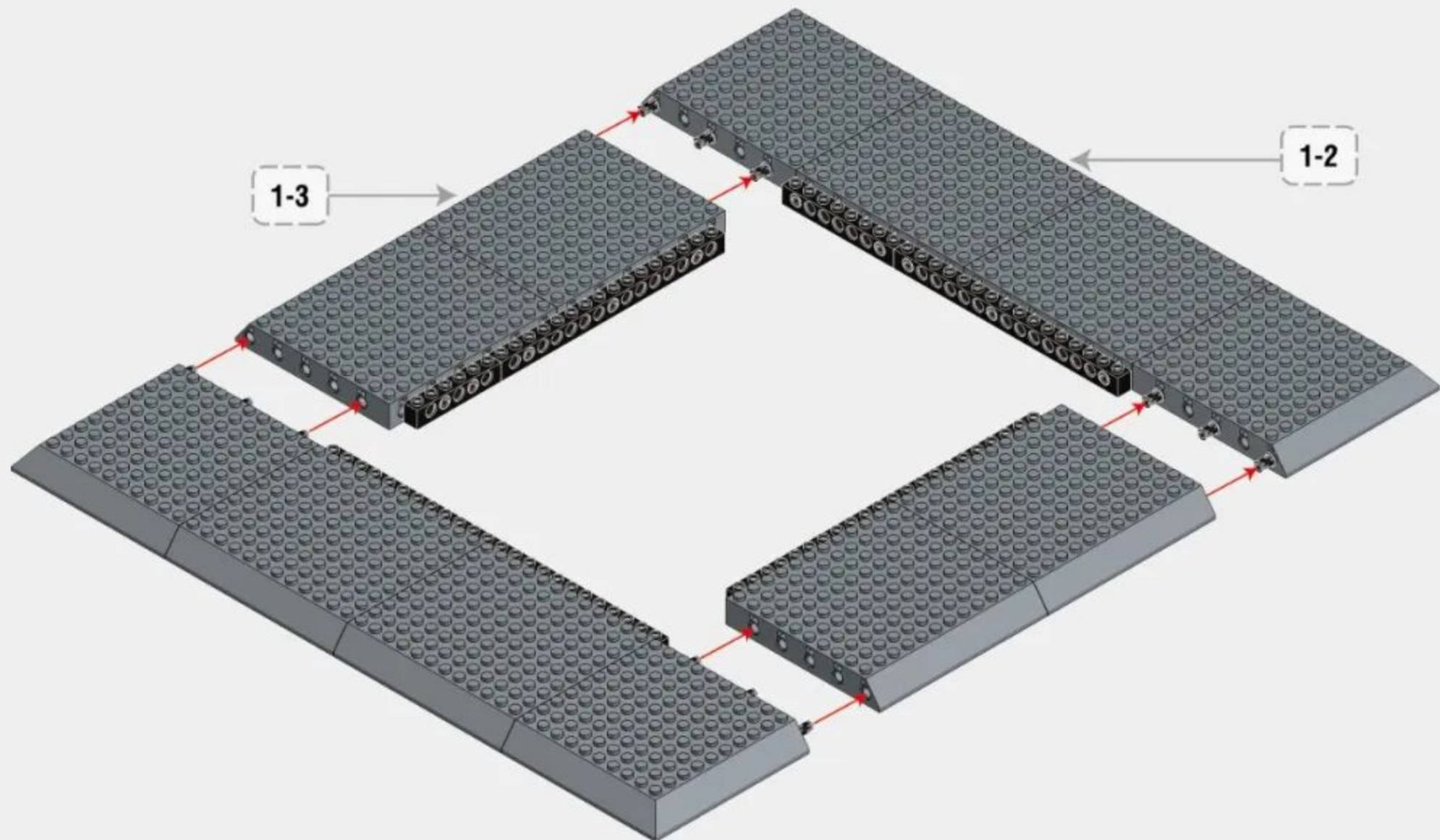

1-5

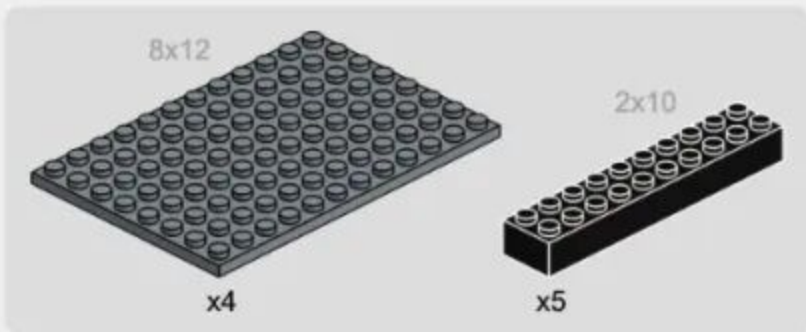

1

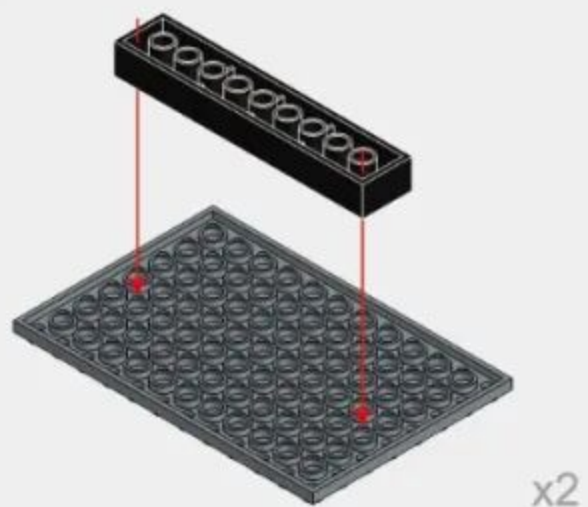

2

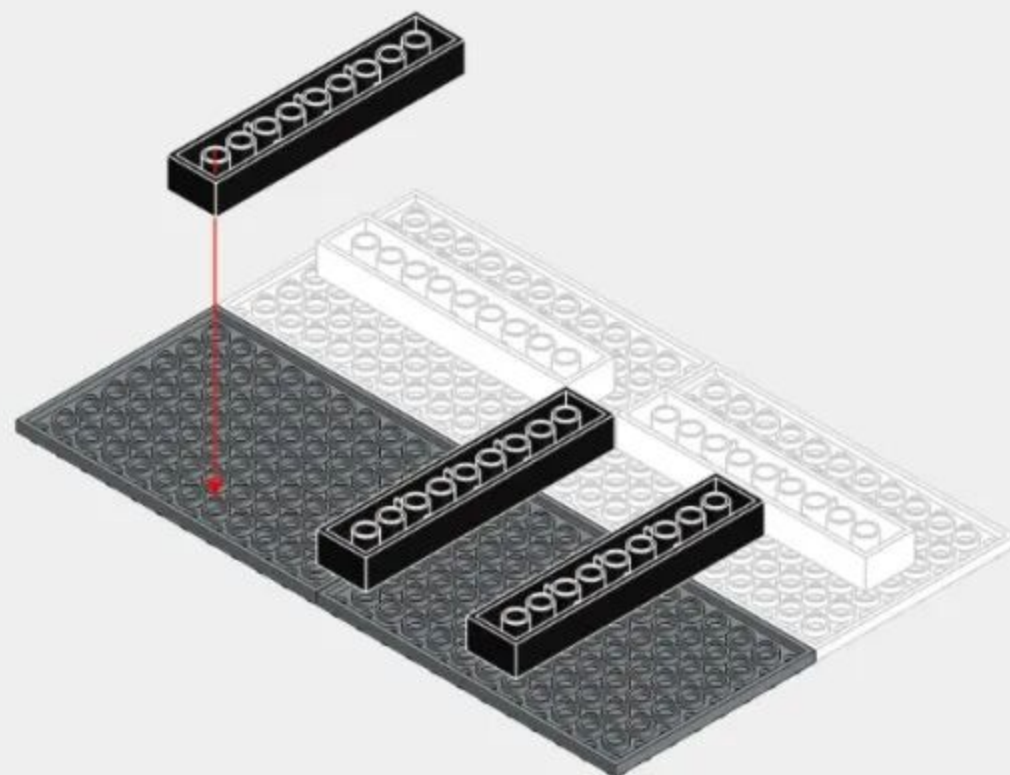

1-6

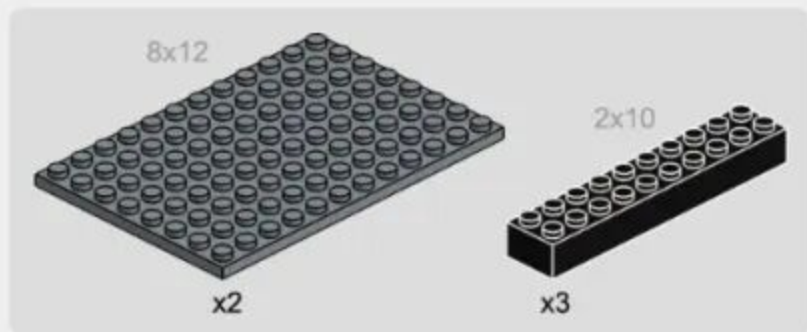

1-5

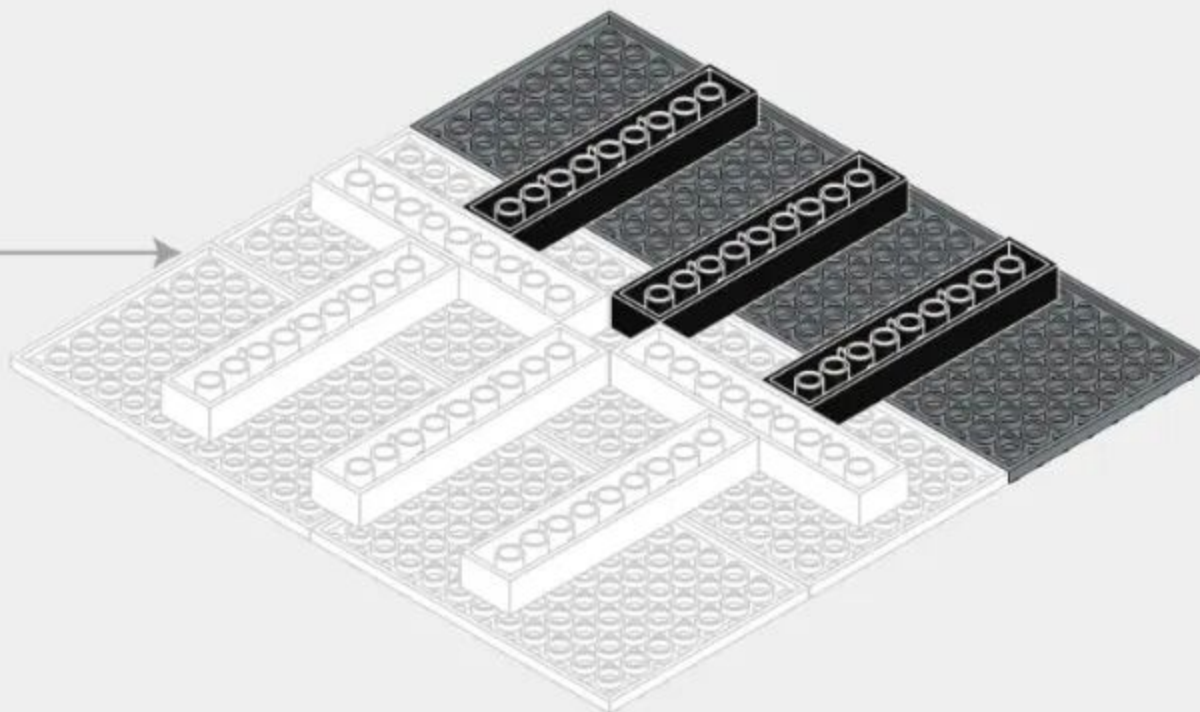

1-7

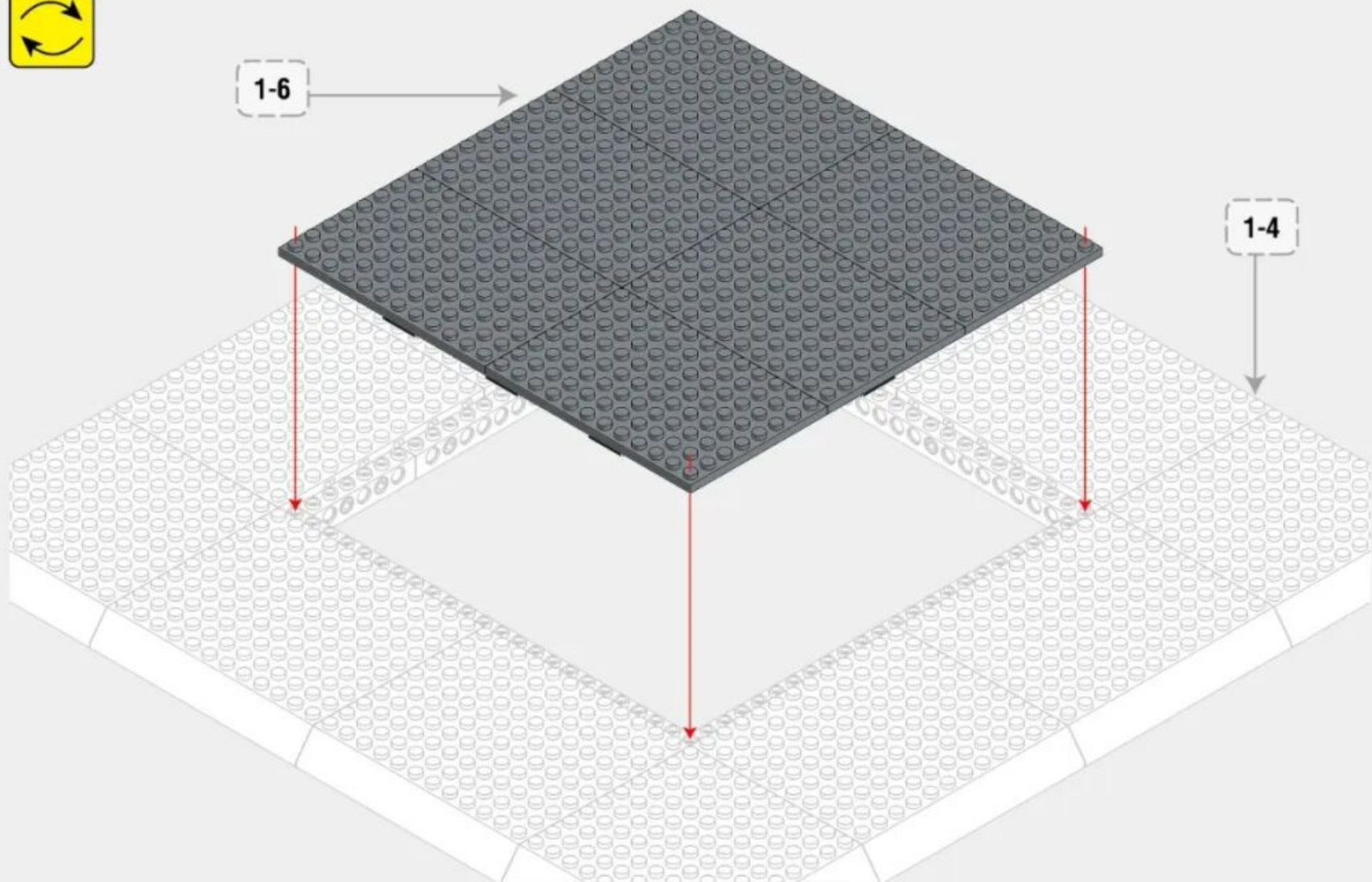

27

1-8

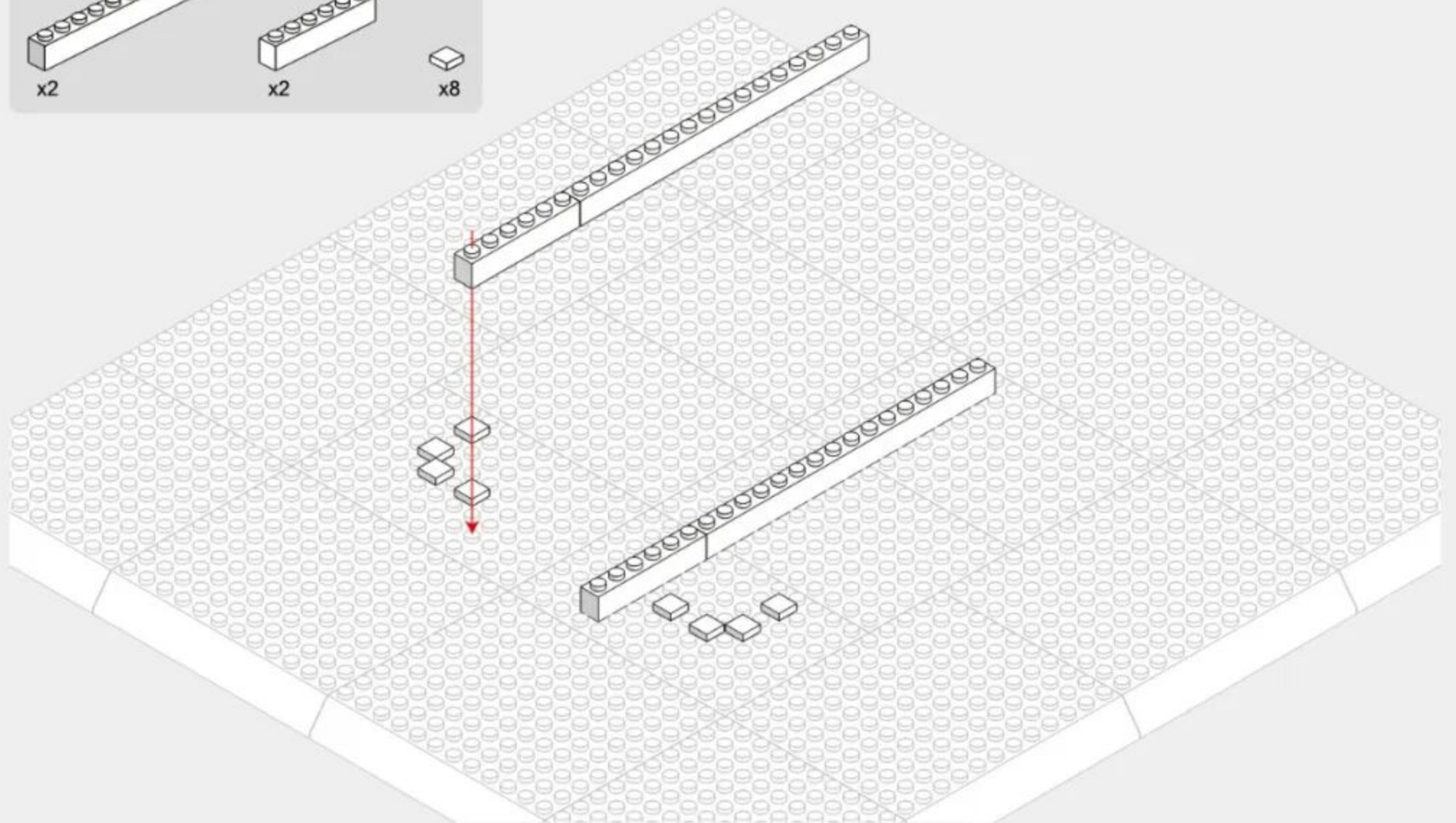
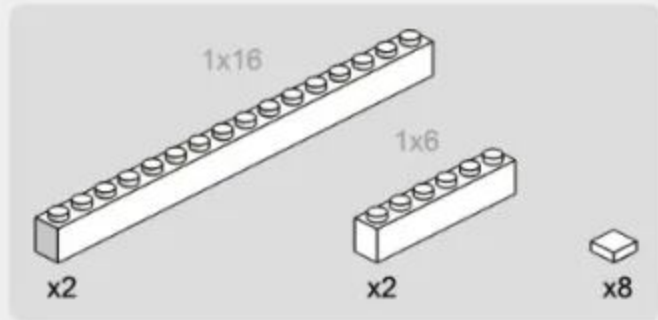

1-9

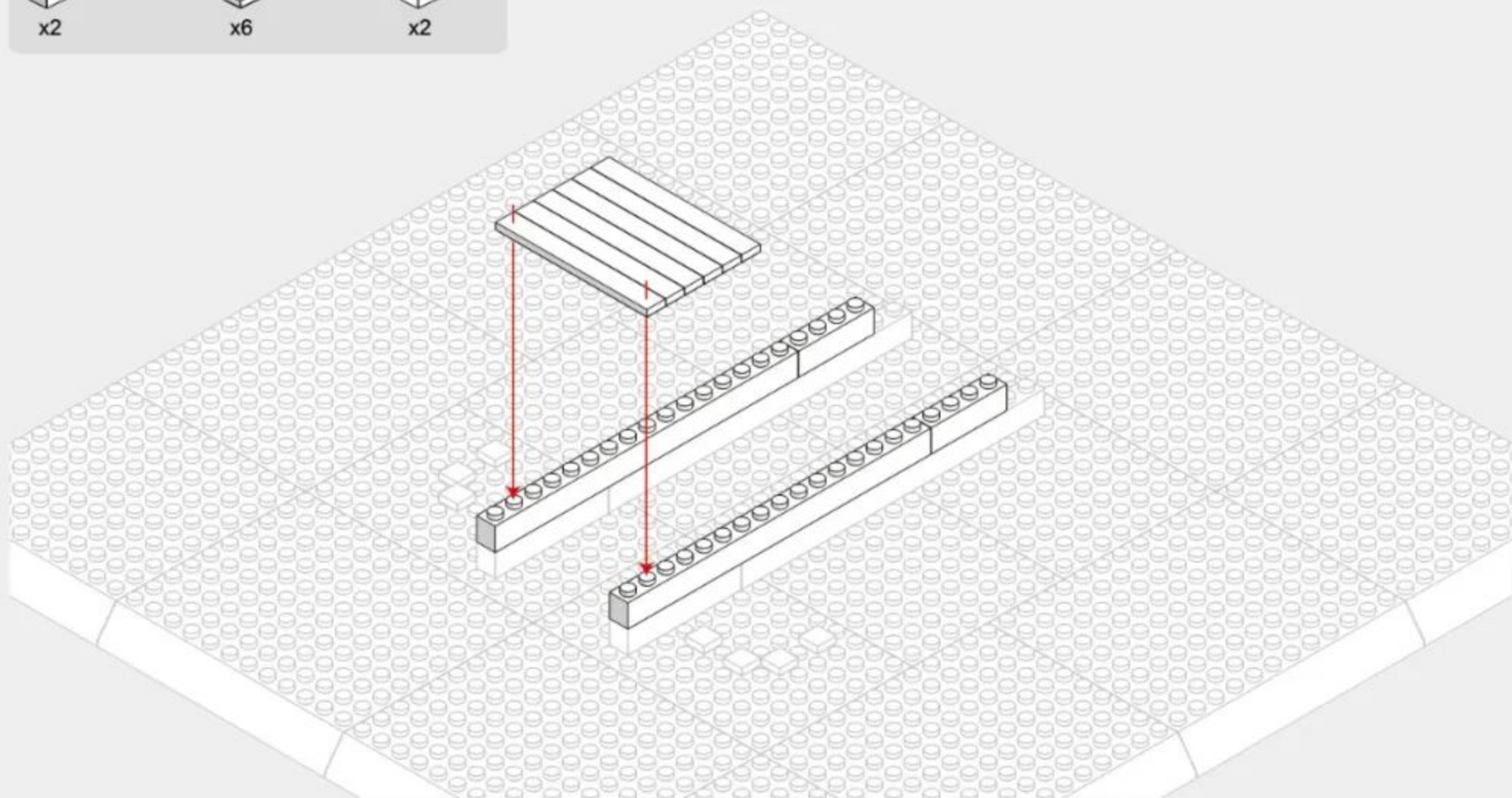
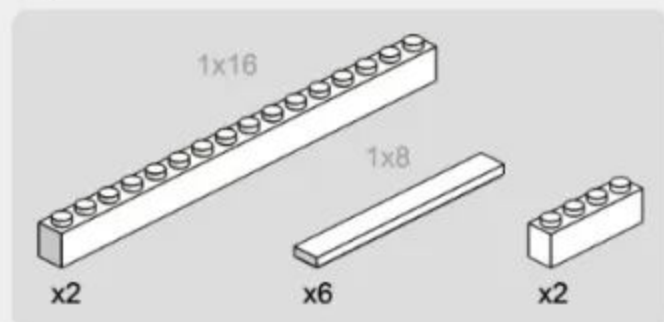

1-10

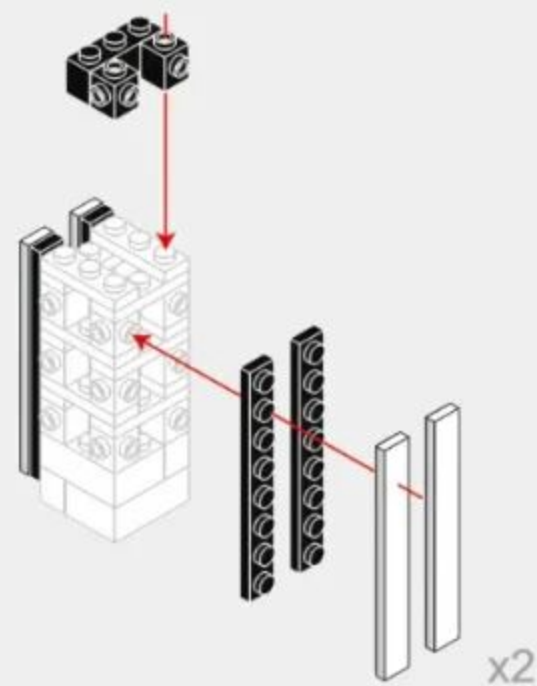
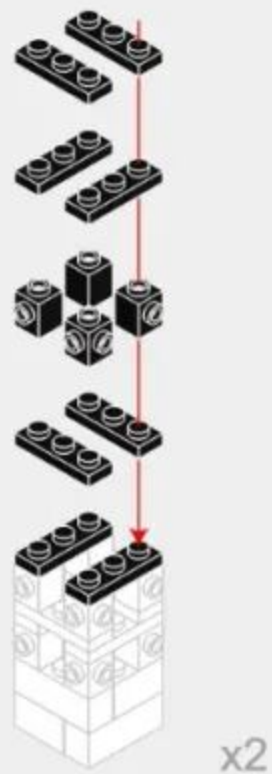
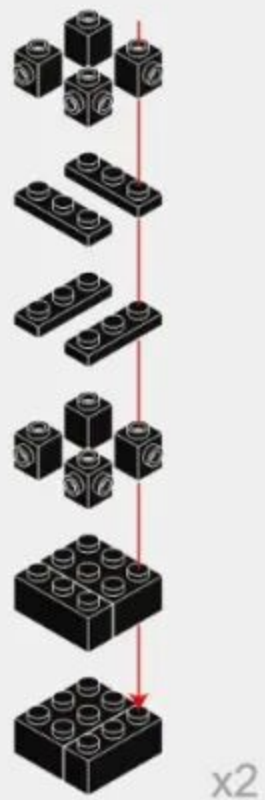
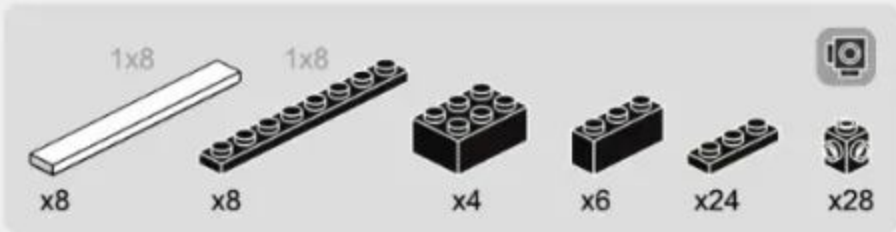

1-11

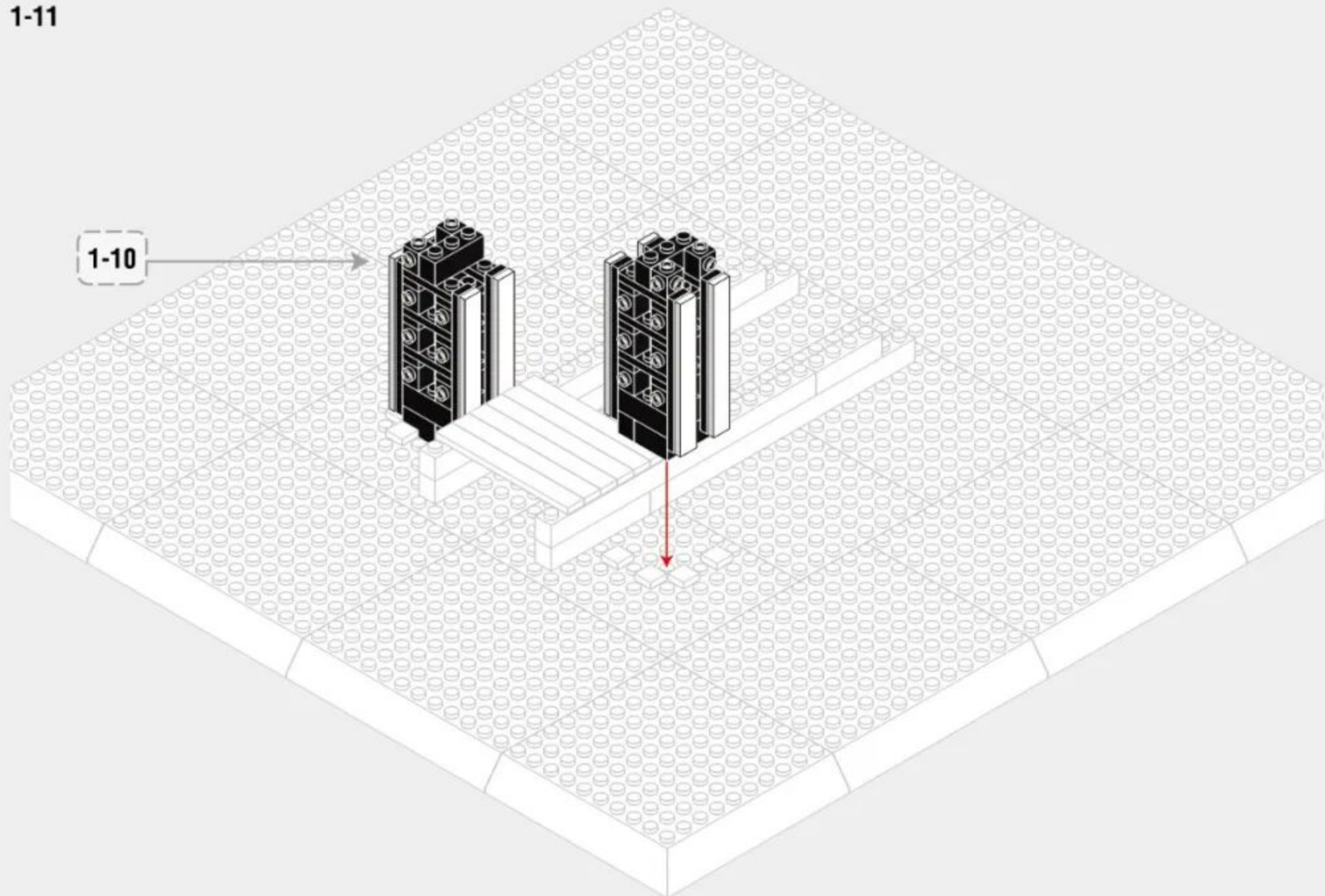

31

1-12

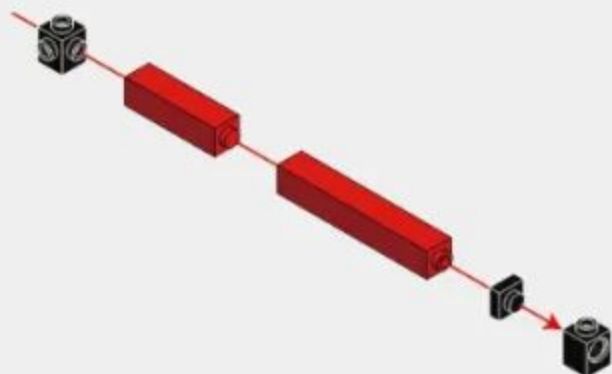

1-13

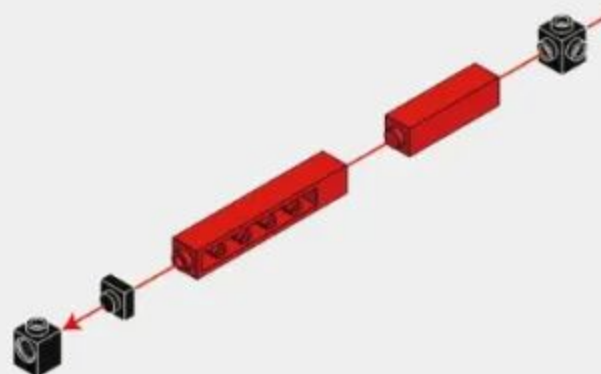

1-14

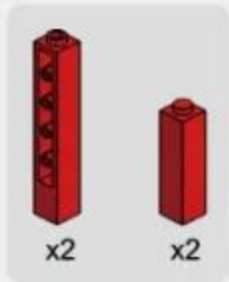

1-12

1-13

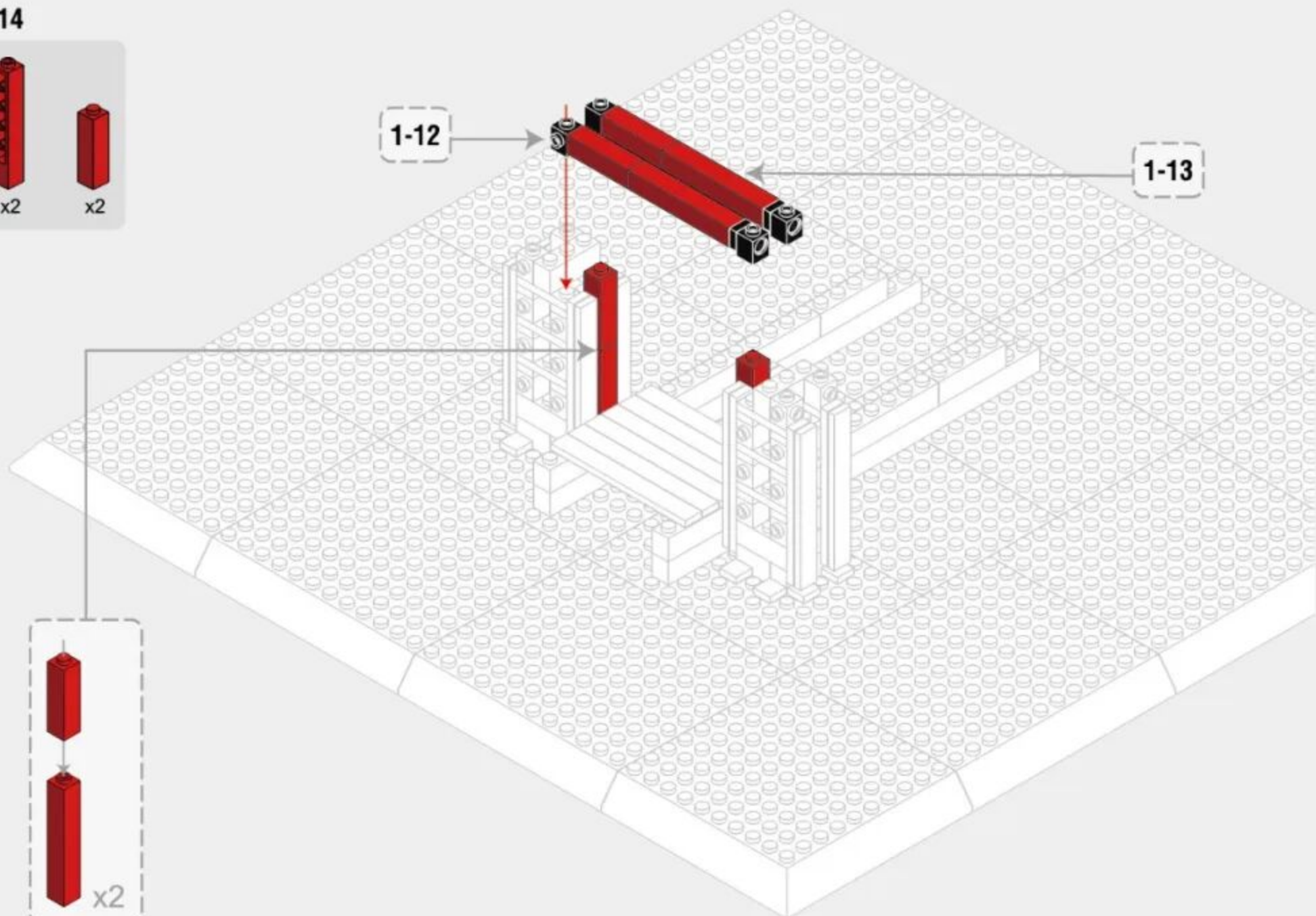

1-15

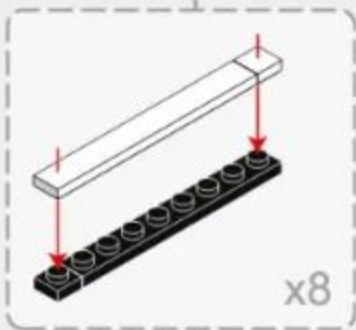
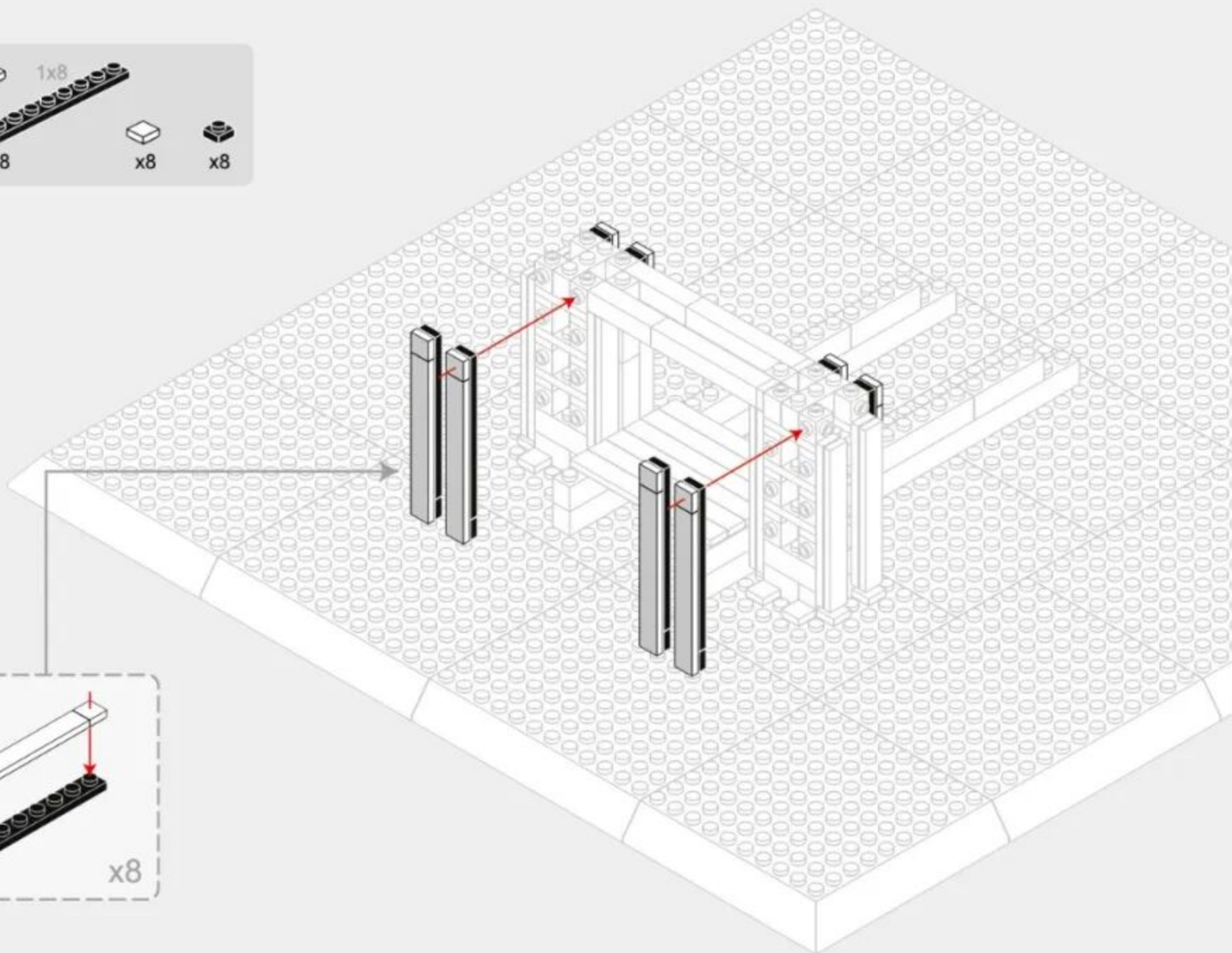
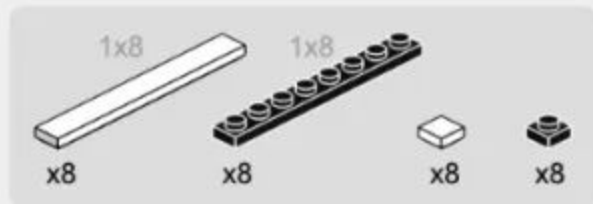

1-16

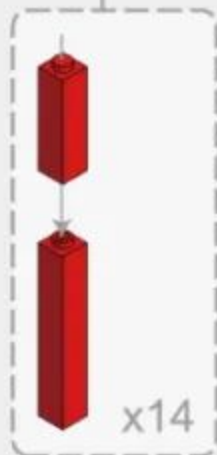
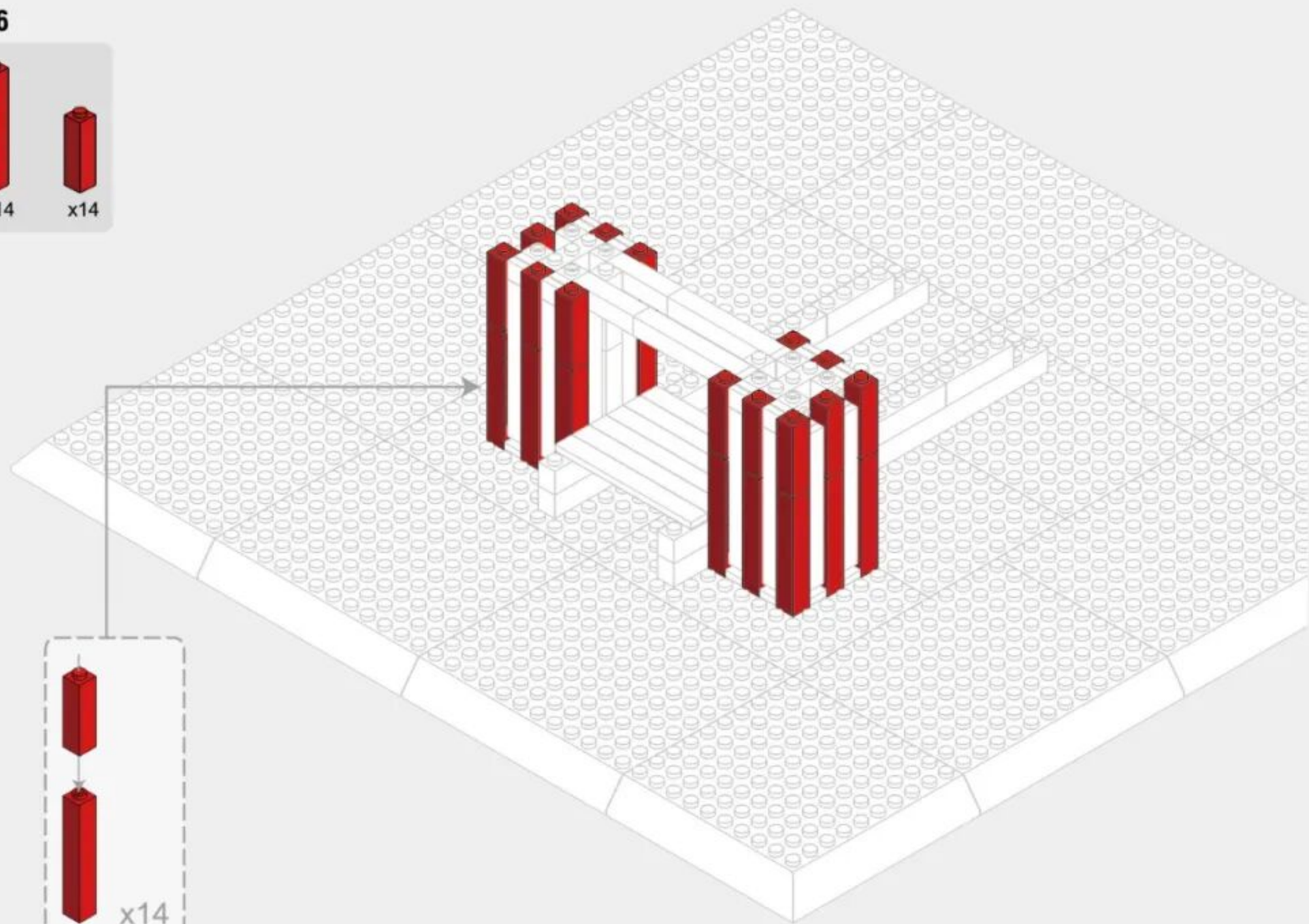
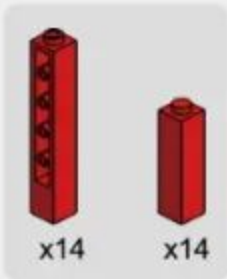

1-17



x2



x2



x4



x8

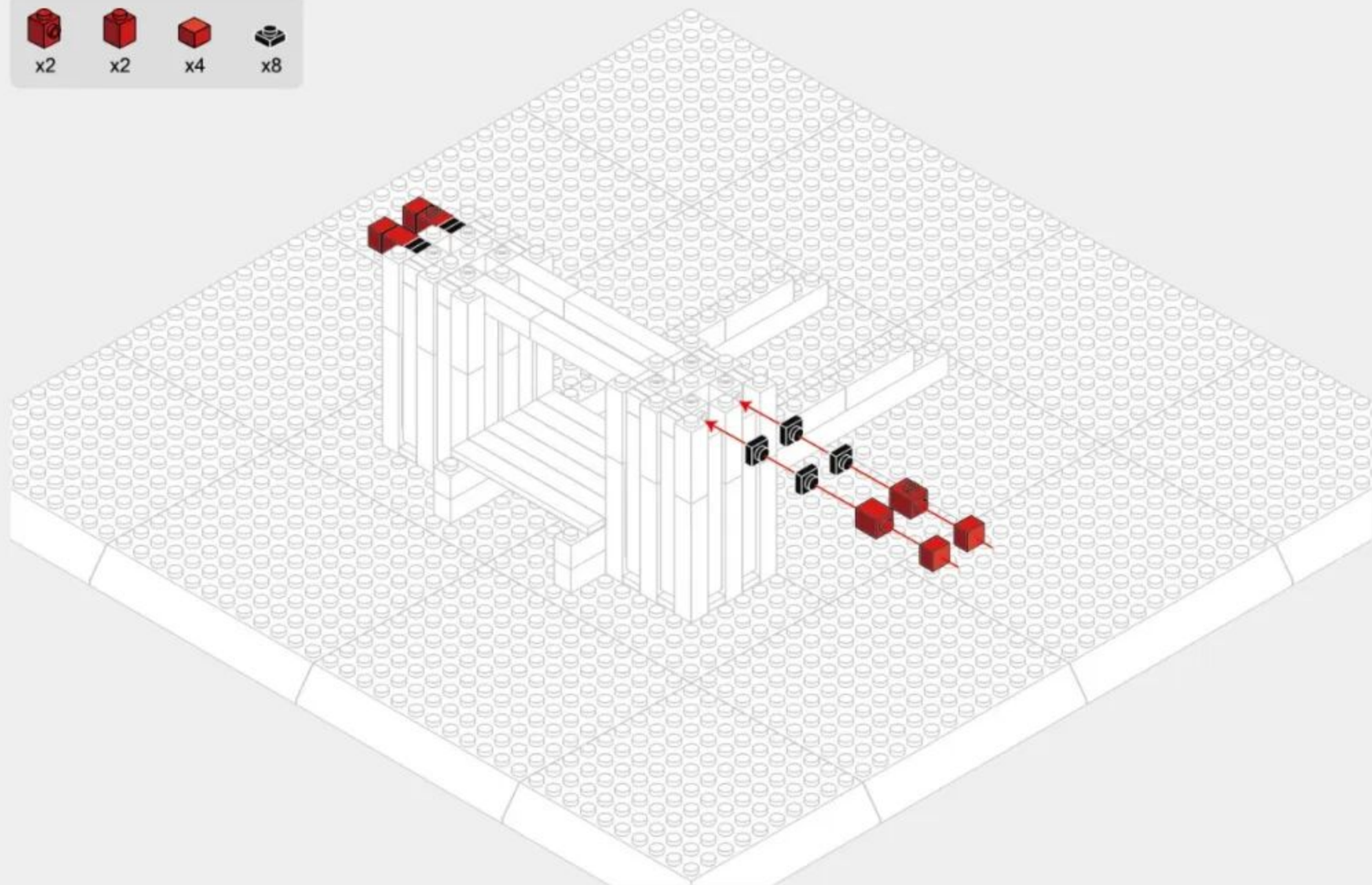



282PCS

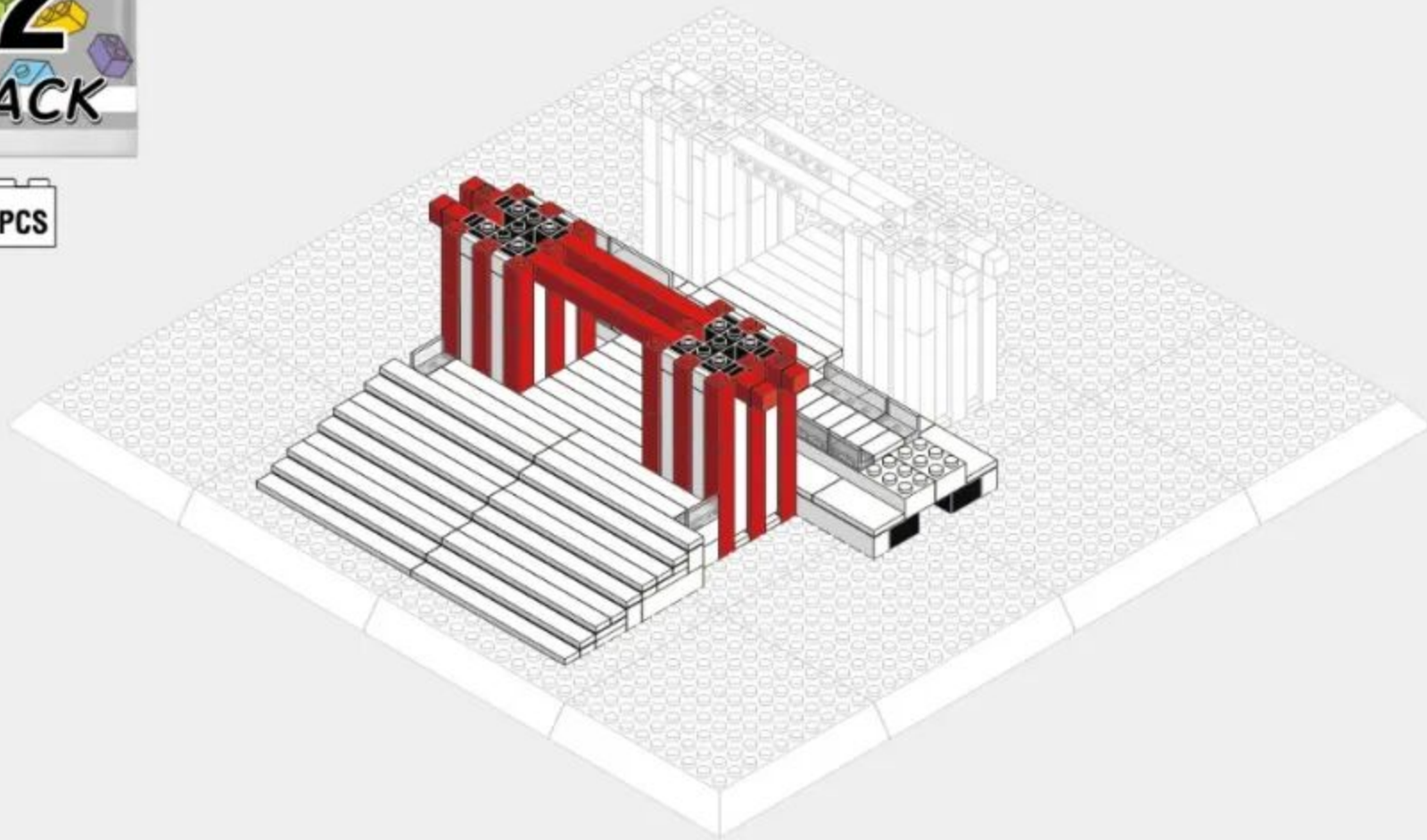

2-1

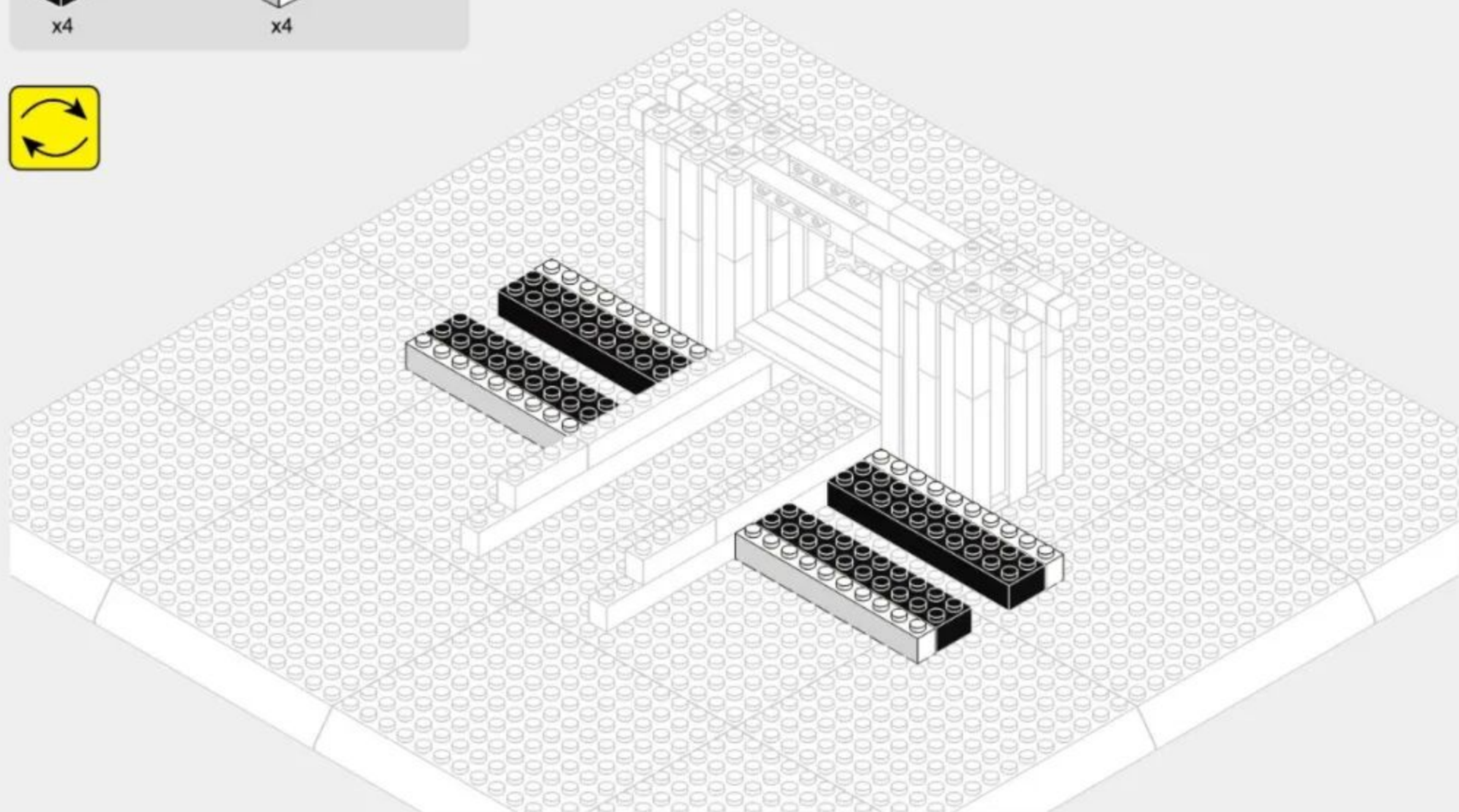
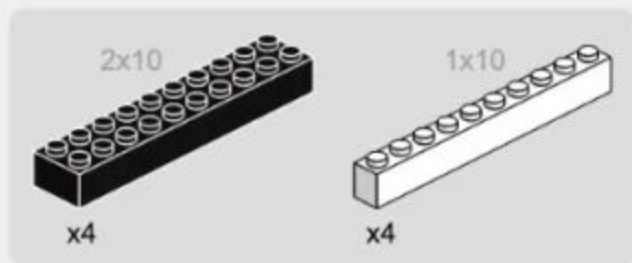

2-2

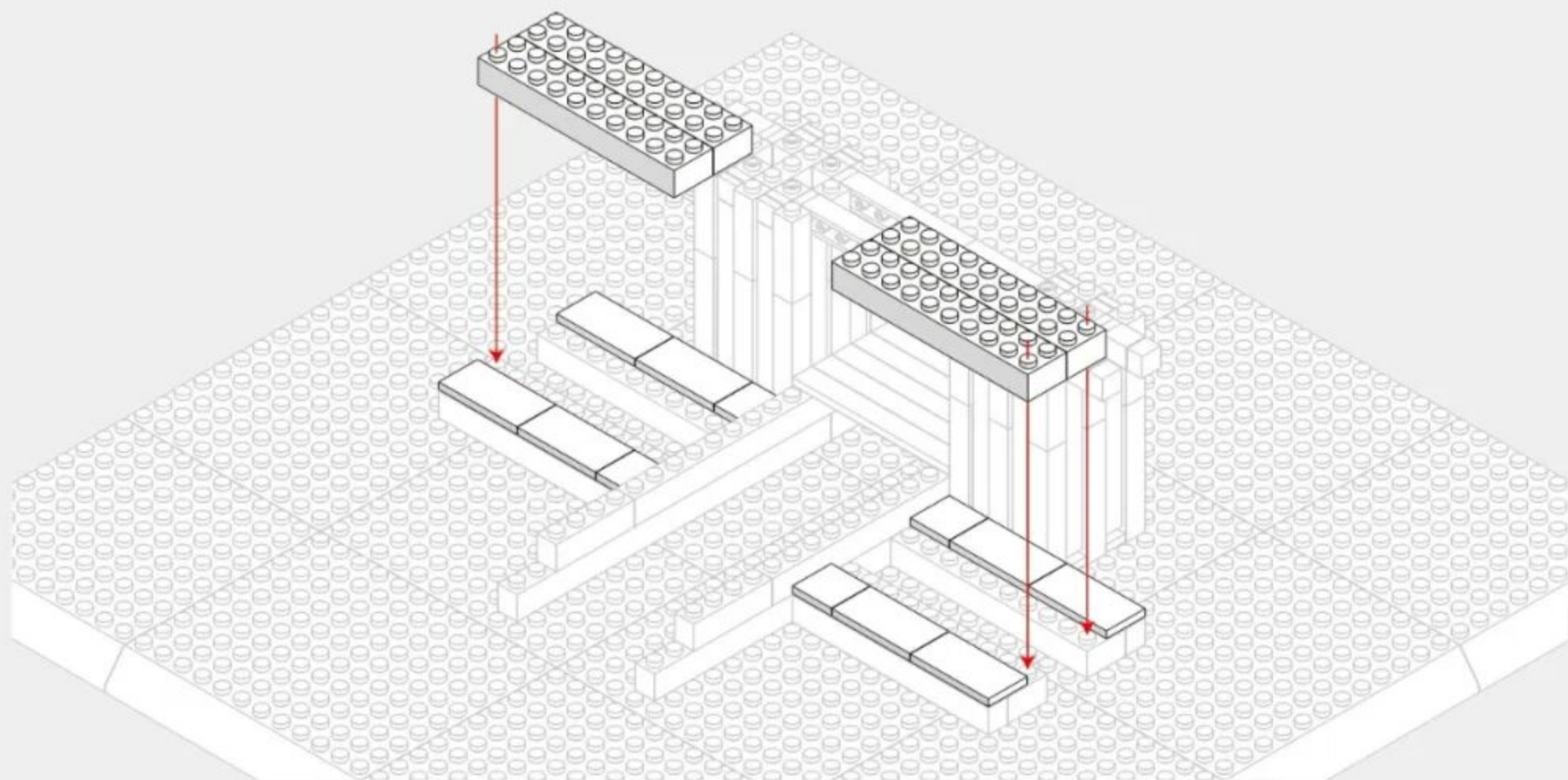
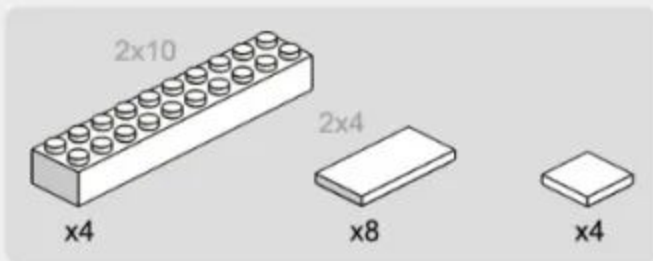

2-3

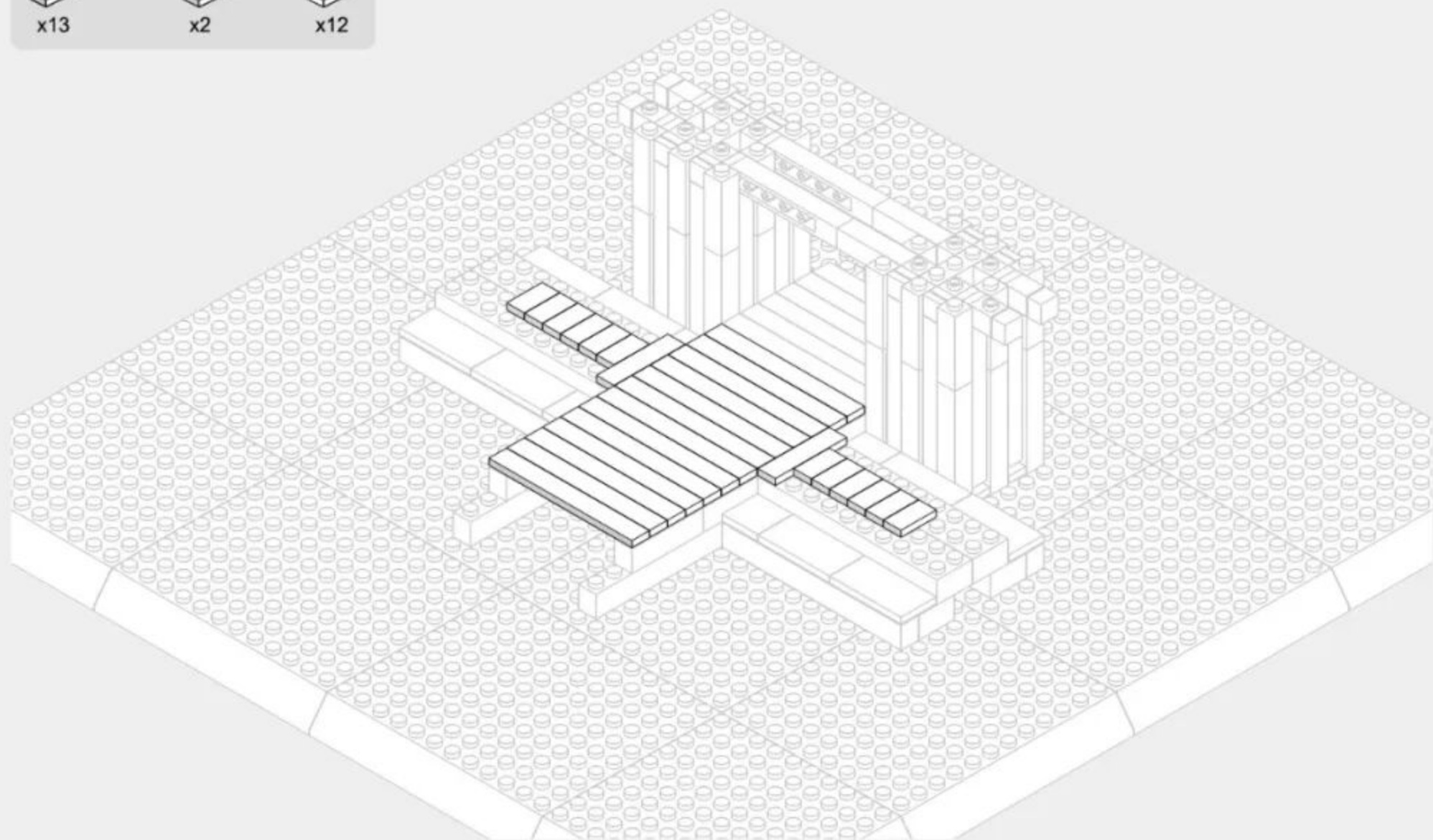
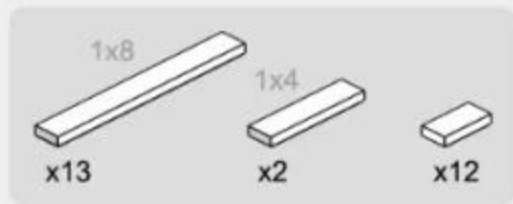

2-4

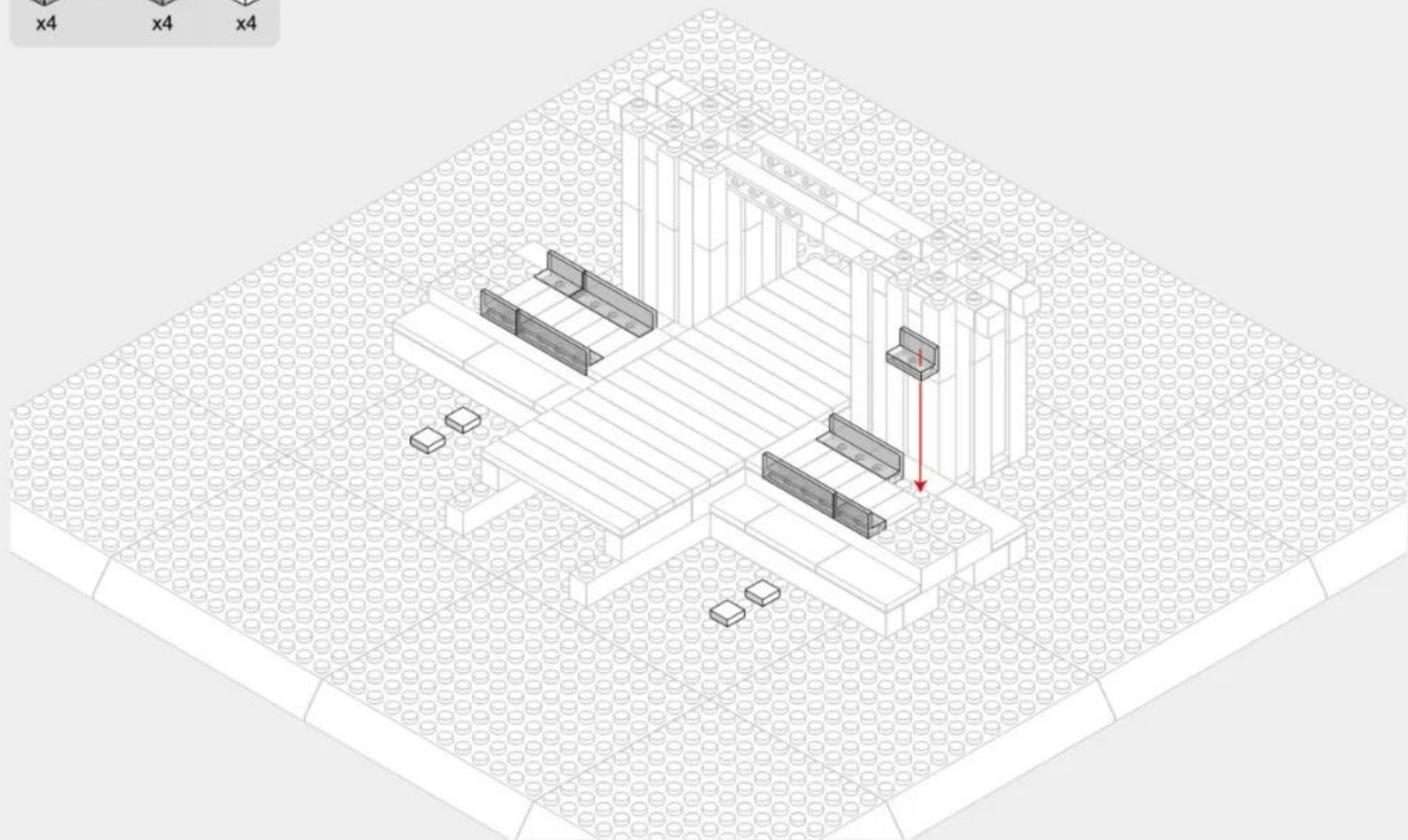

2-5

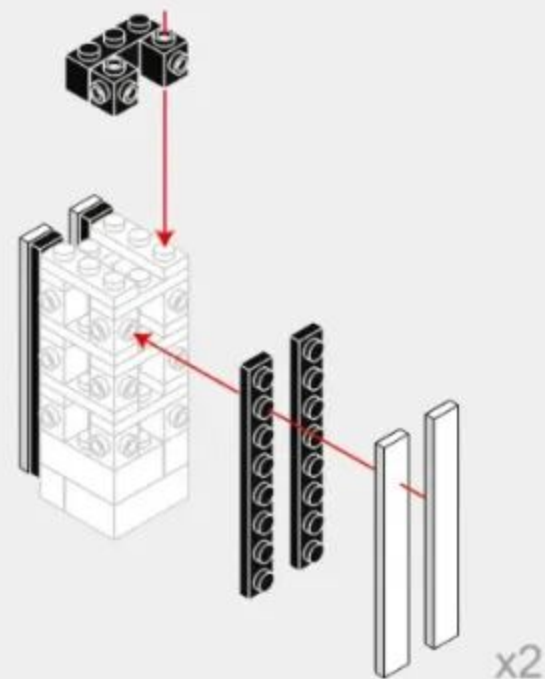
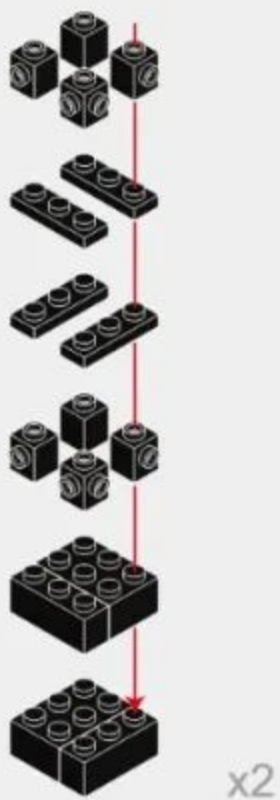
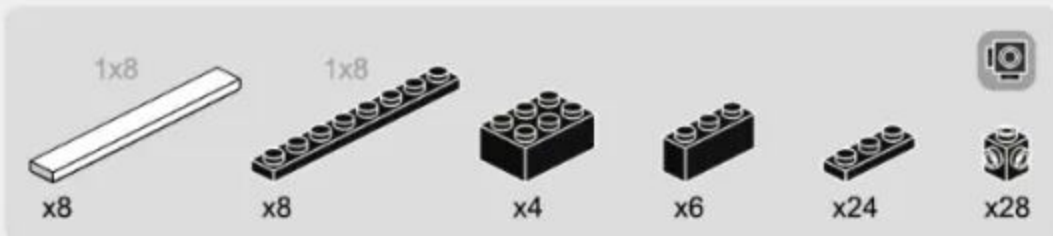

2-6

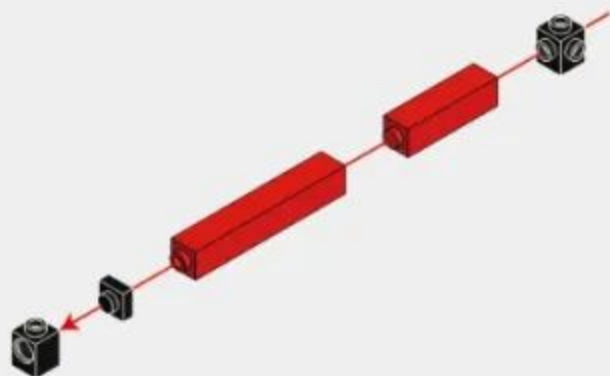

2-7

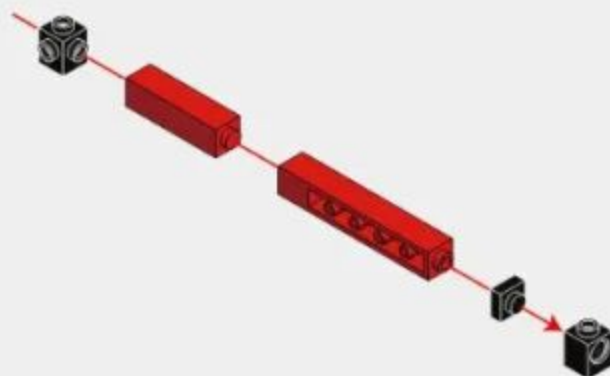

2-8

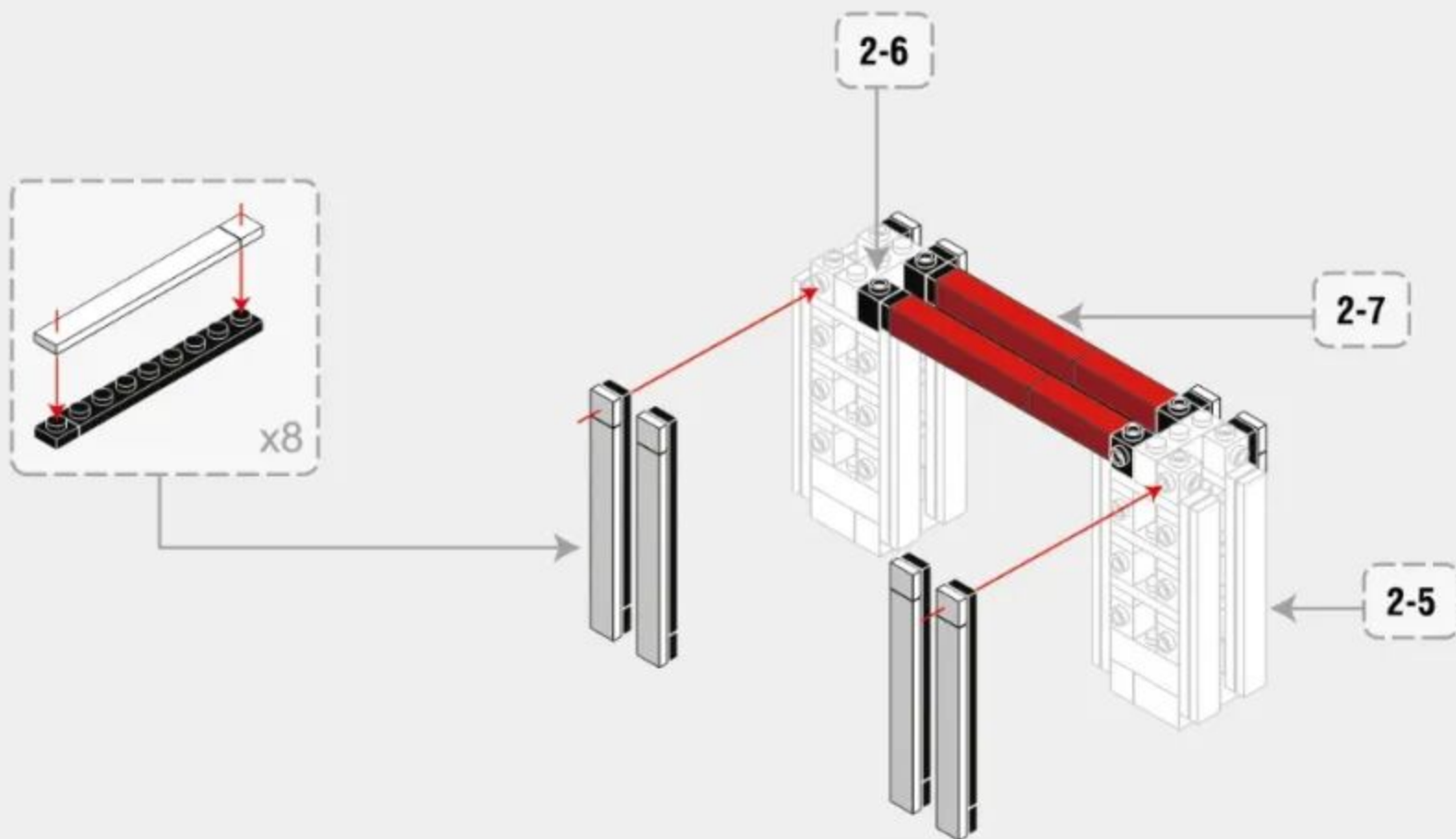

2-9

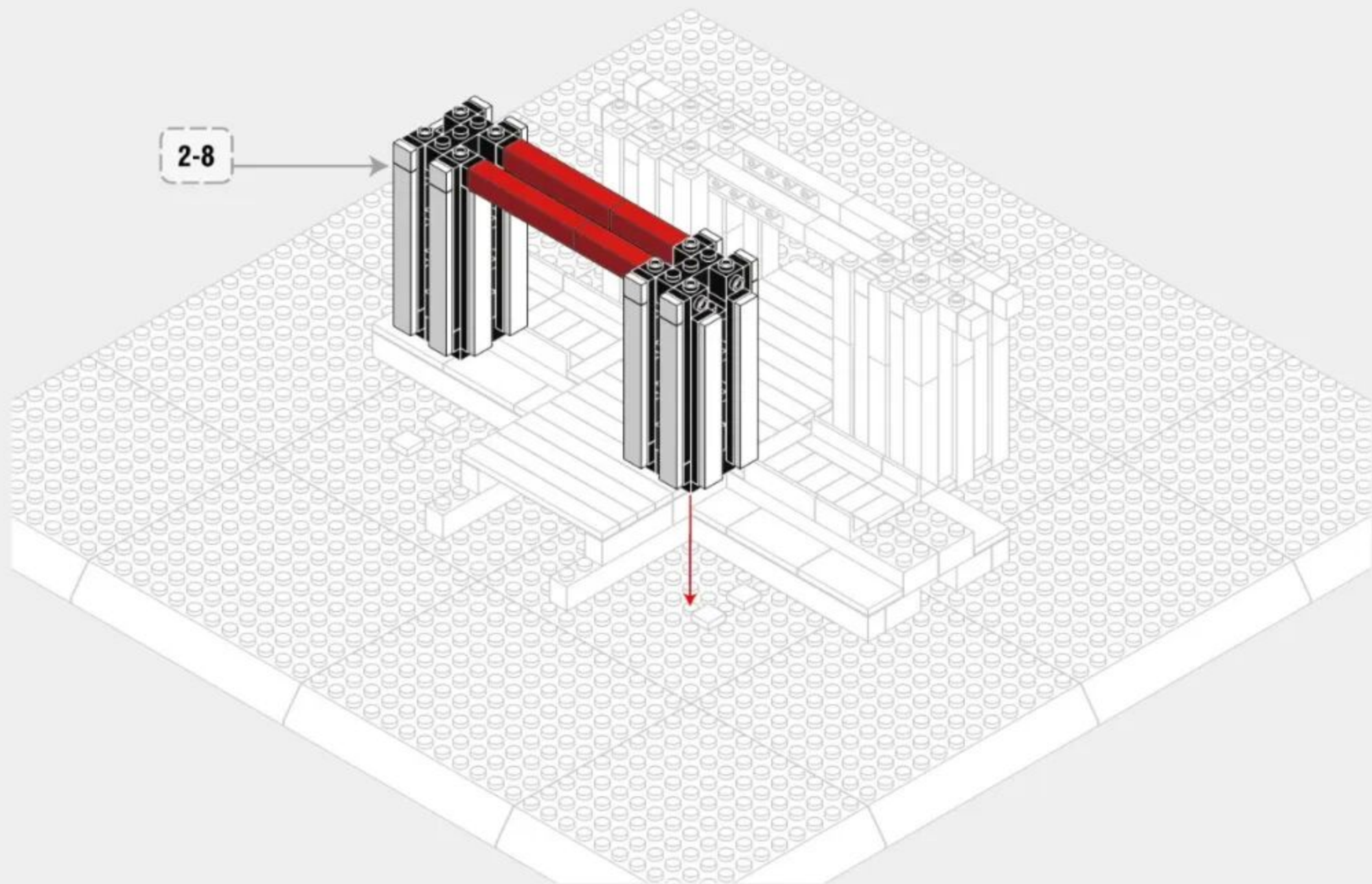

2-8

45

2-10

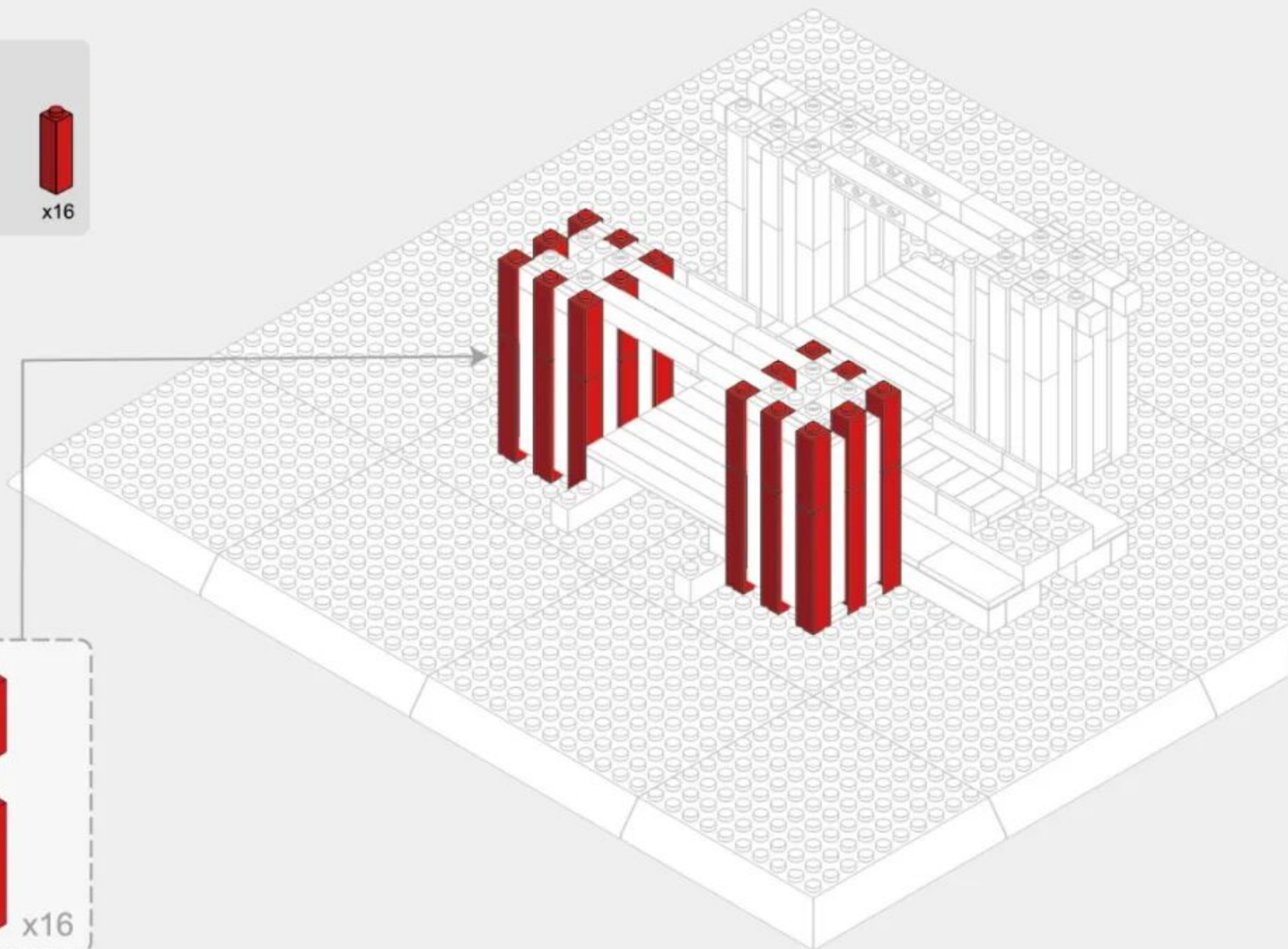
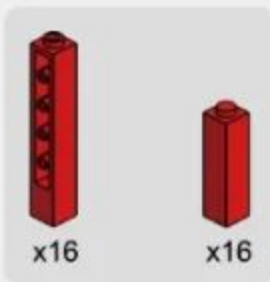

2-11

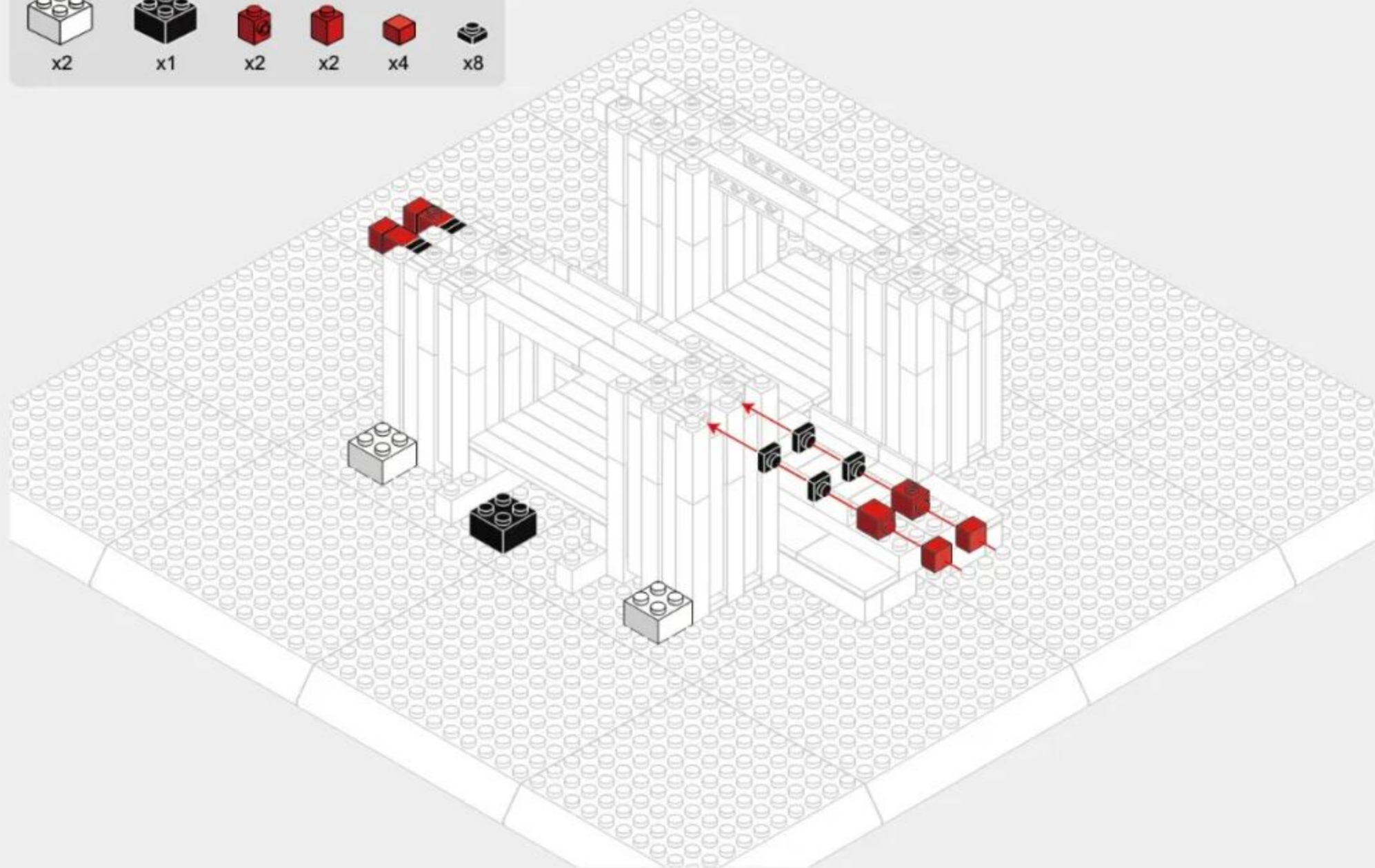

2-12

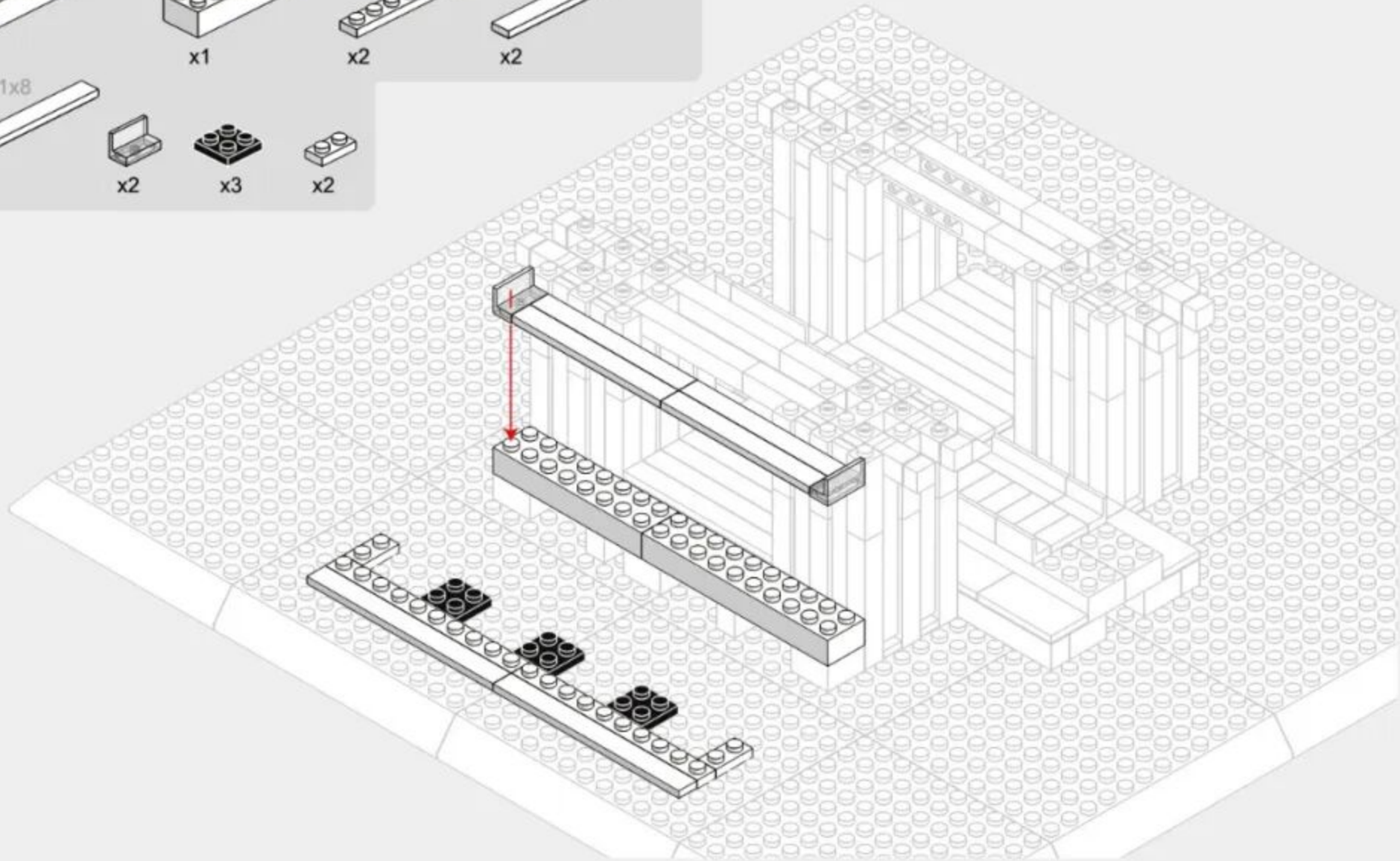
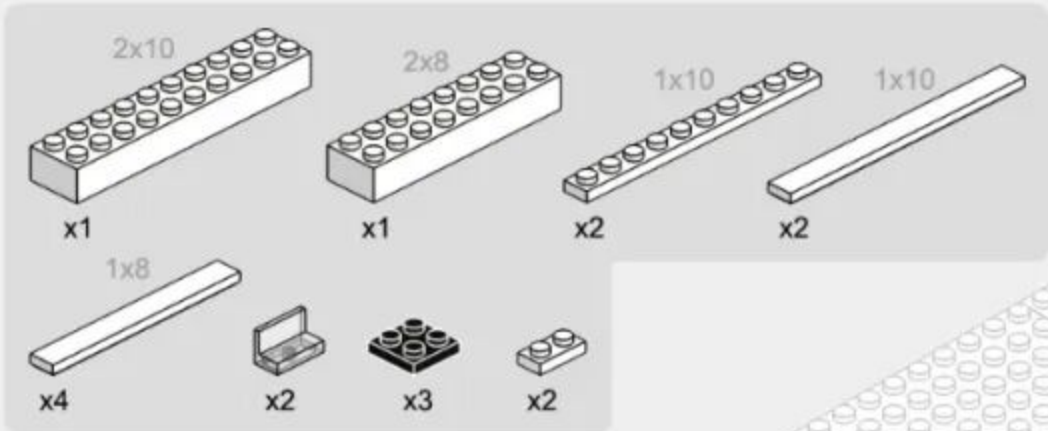

2-13

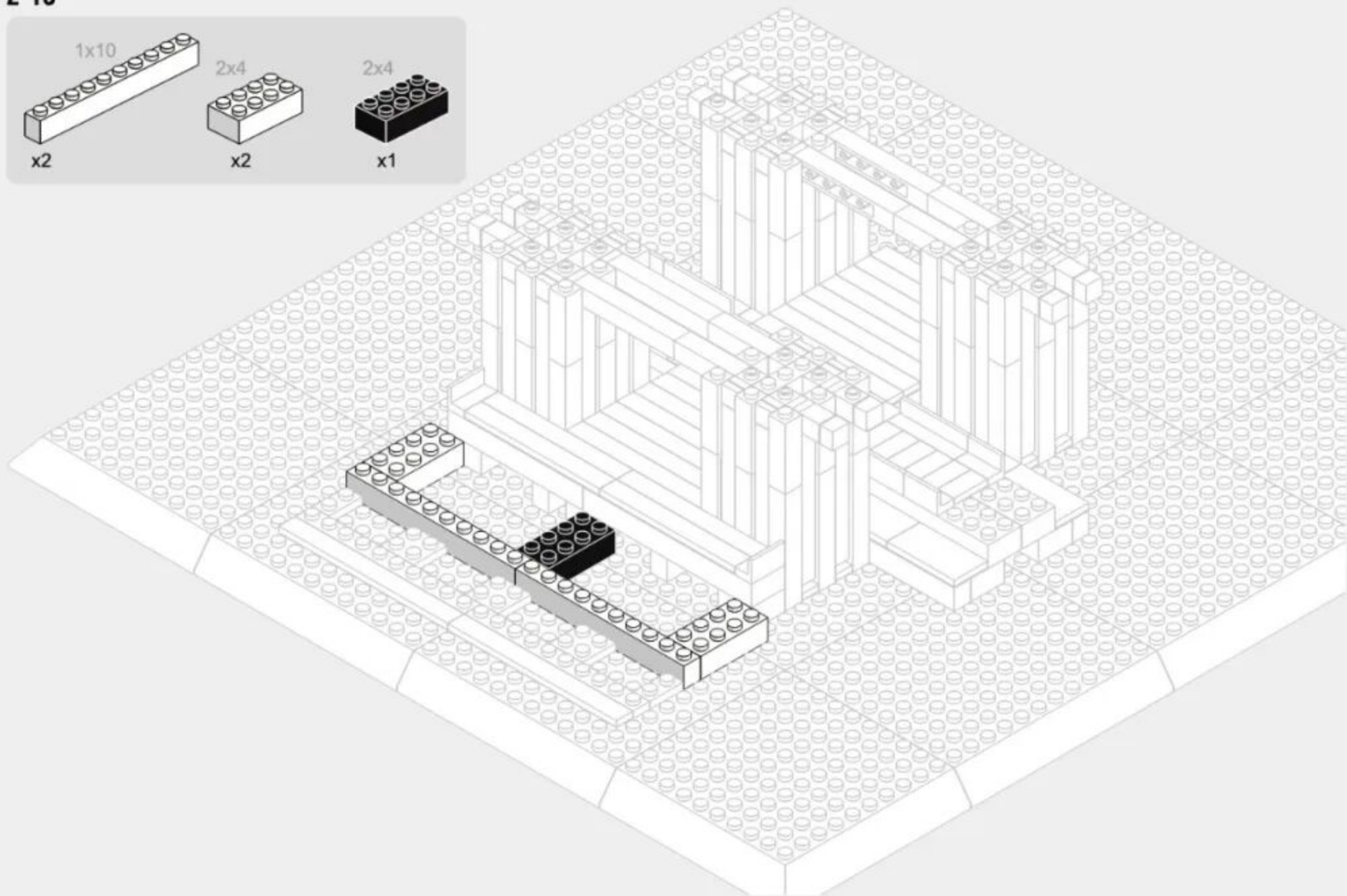
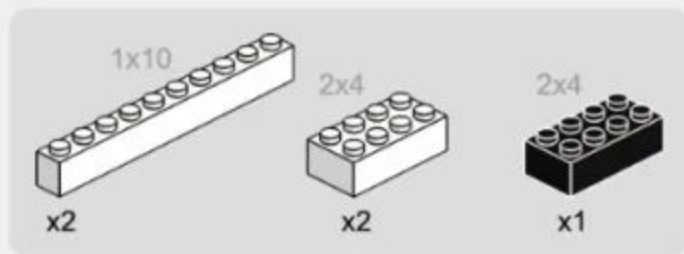

2-14

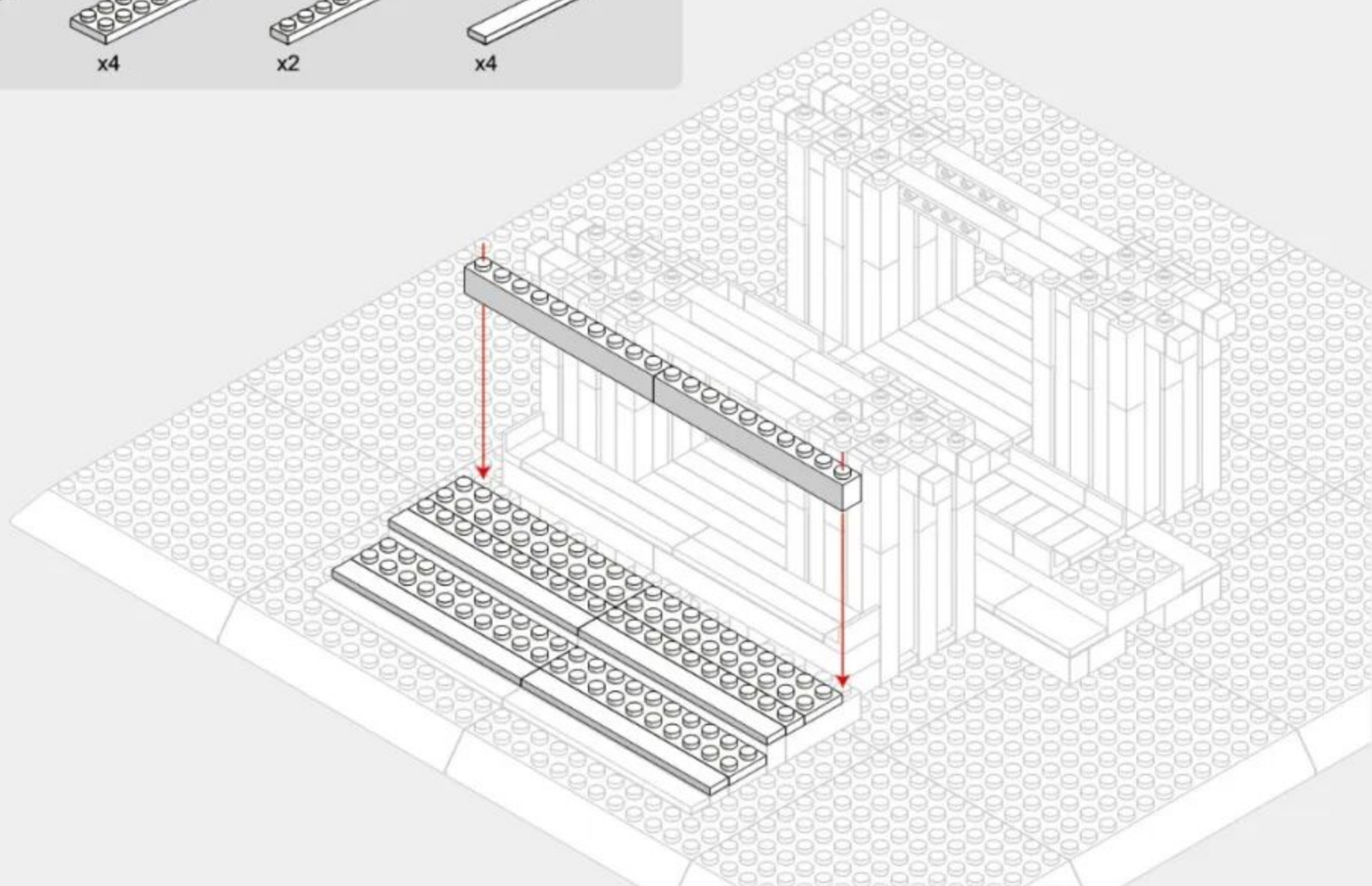
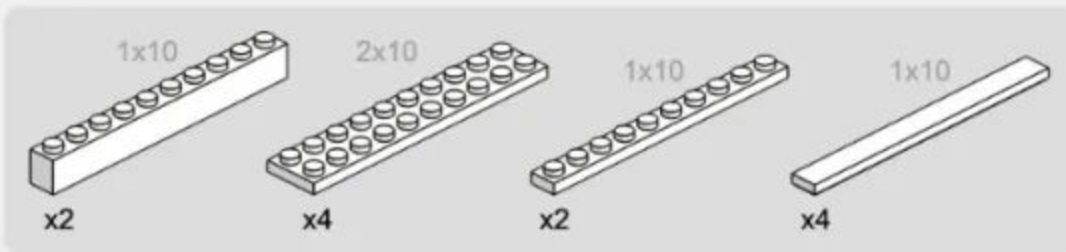

2-15

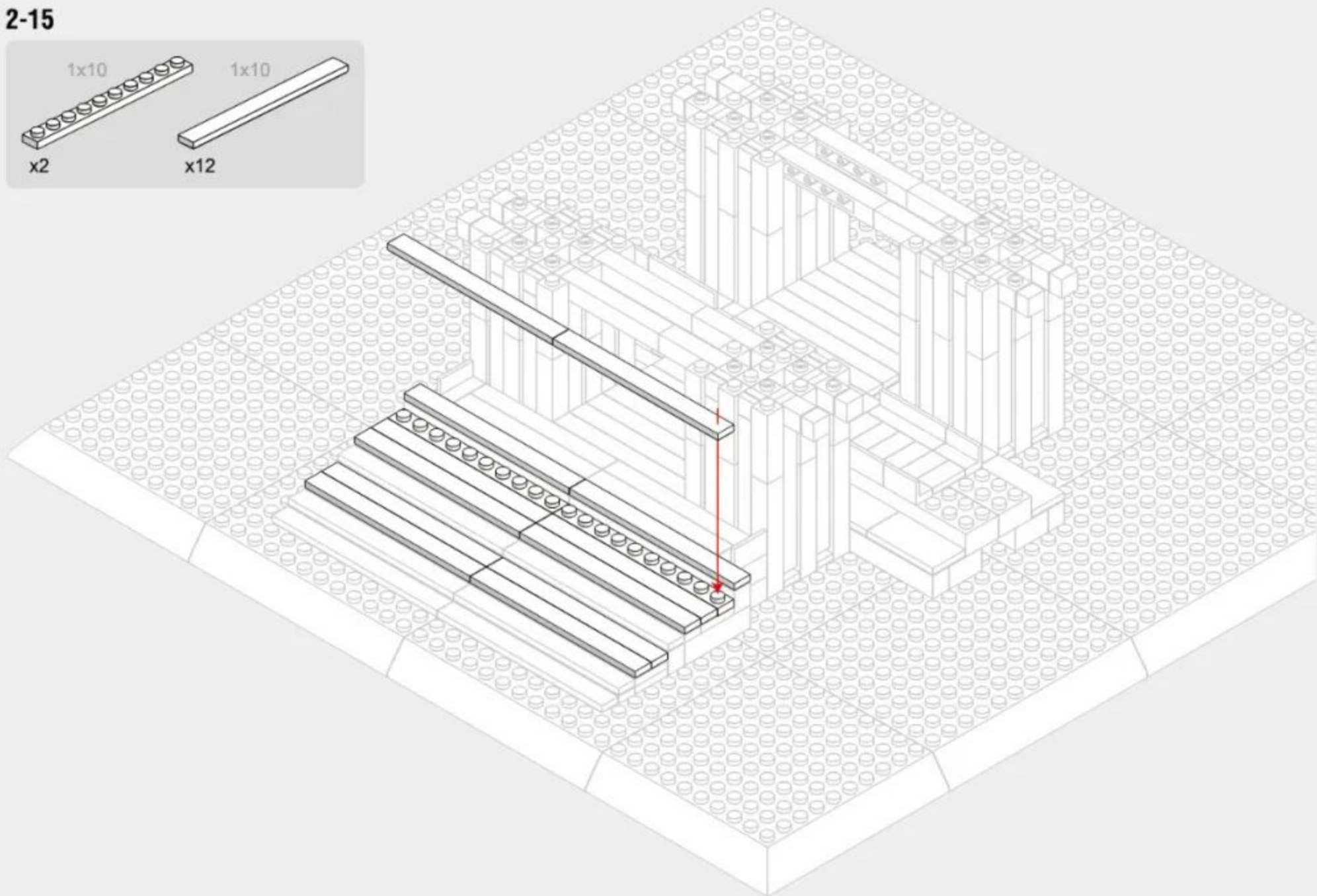
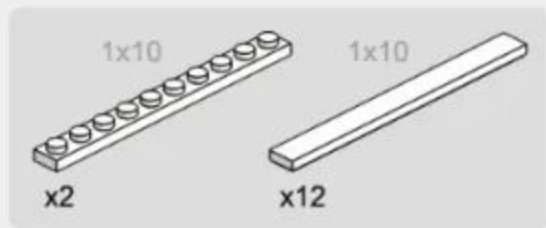



263PCS

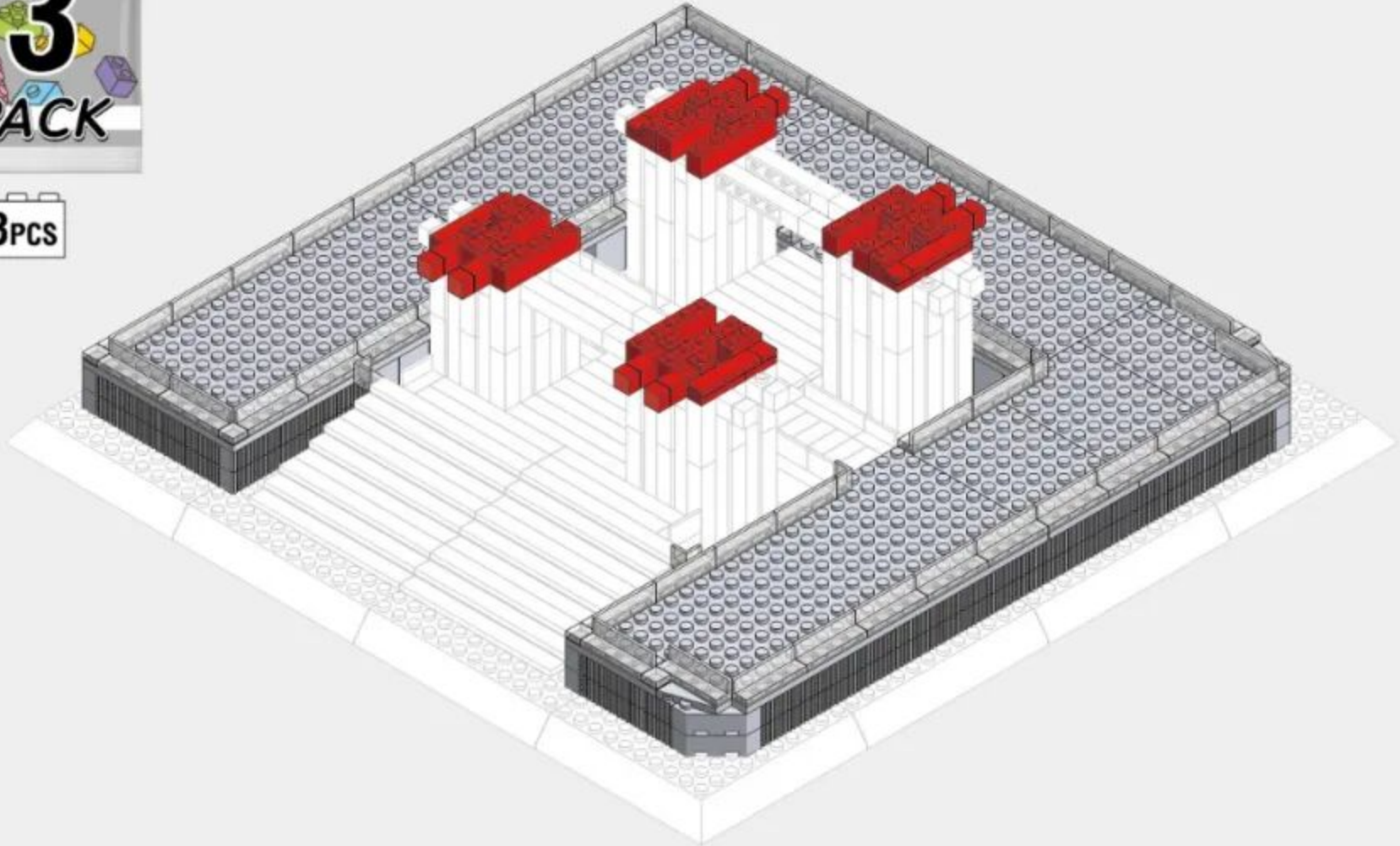

3-1

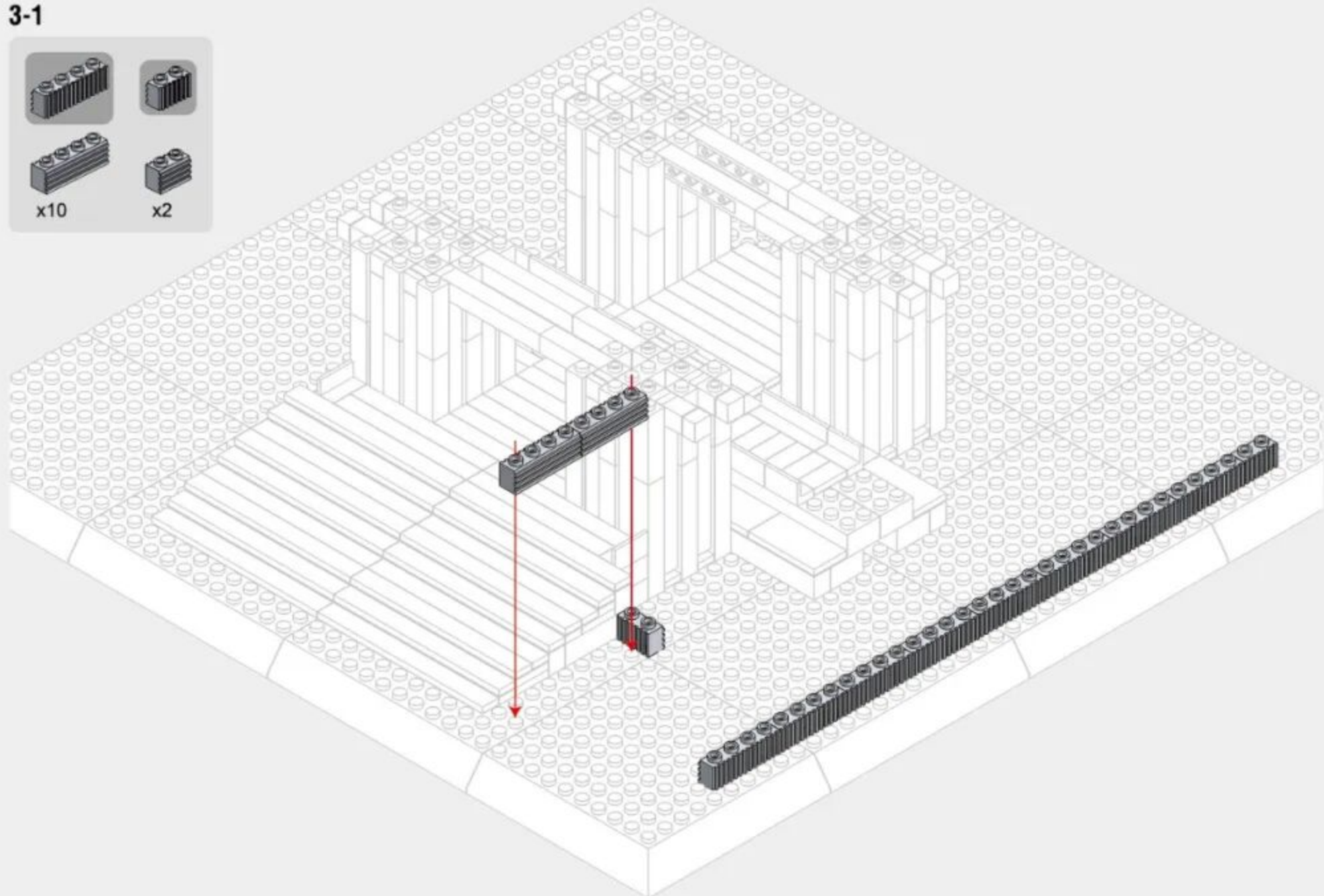
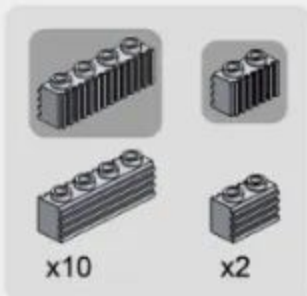

3-2

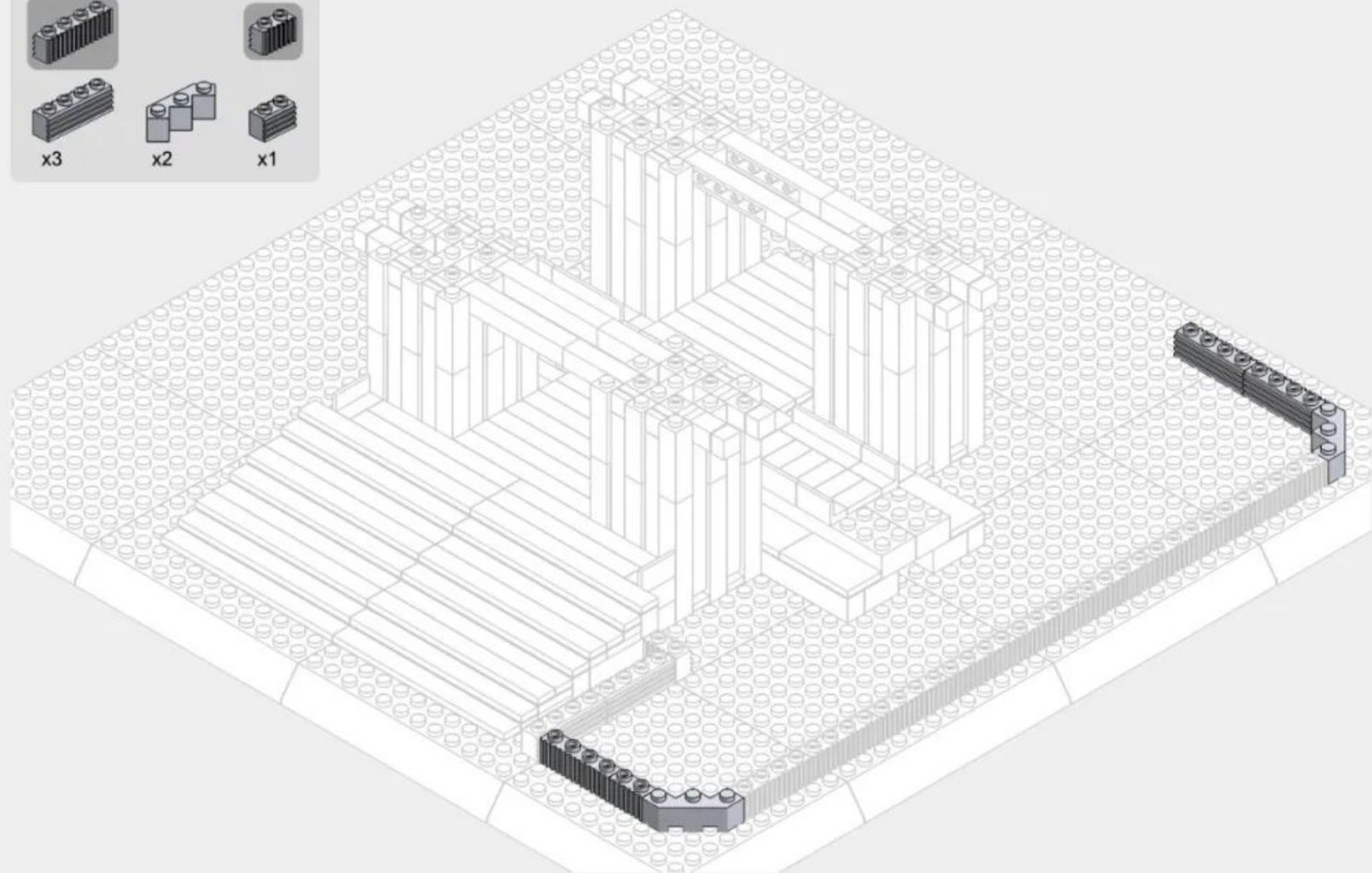
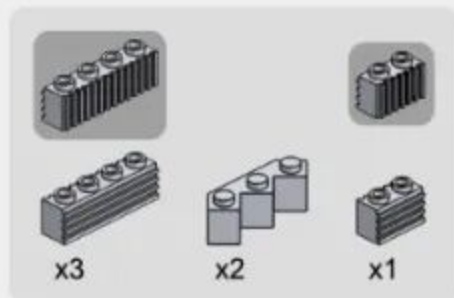

3-3

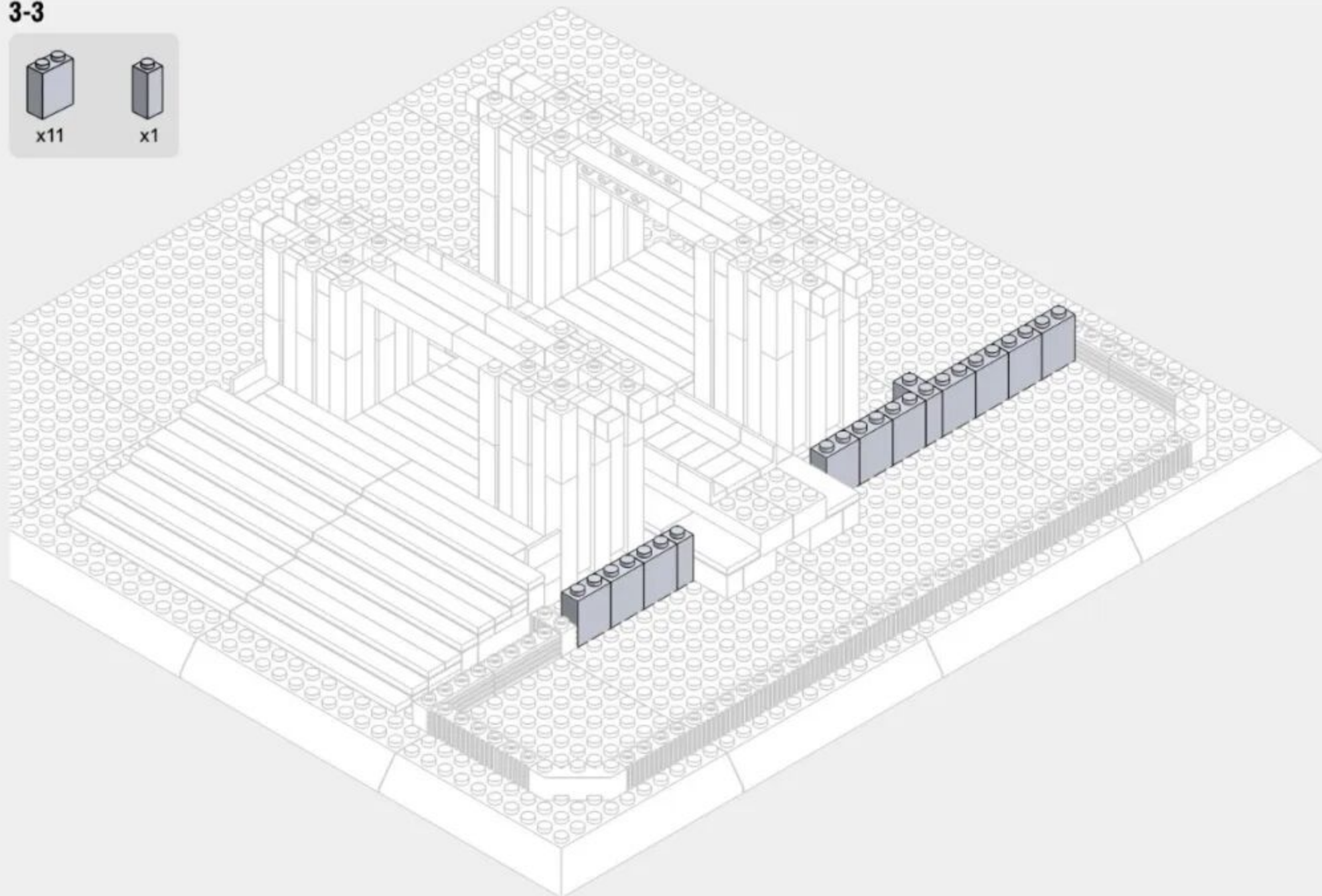
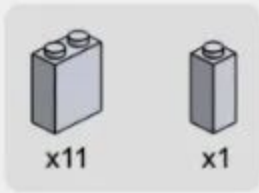

3-4

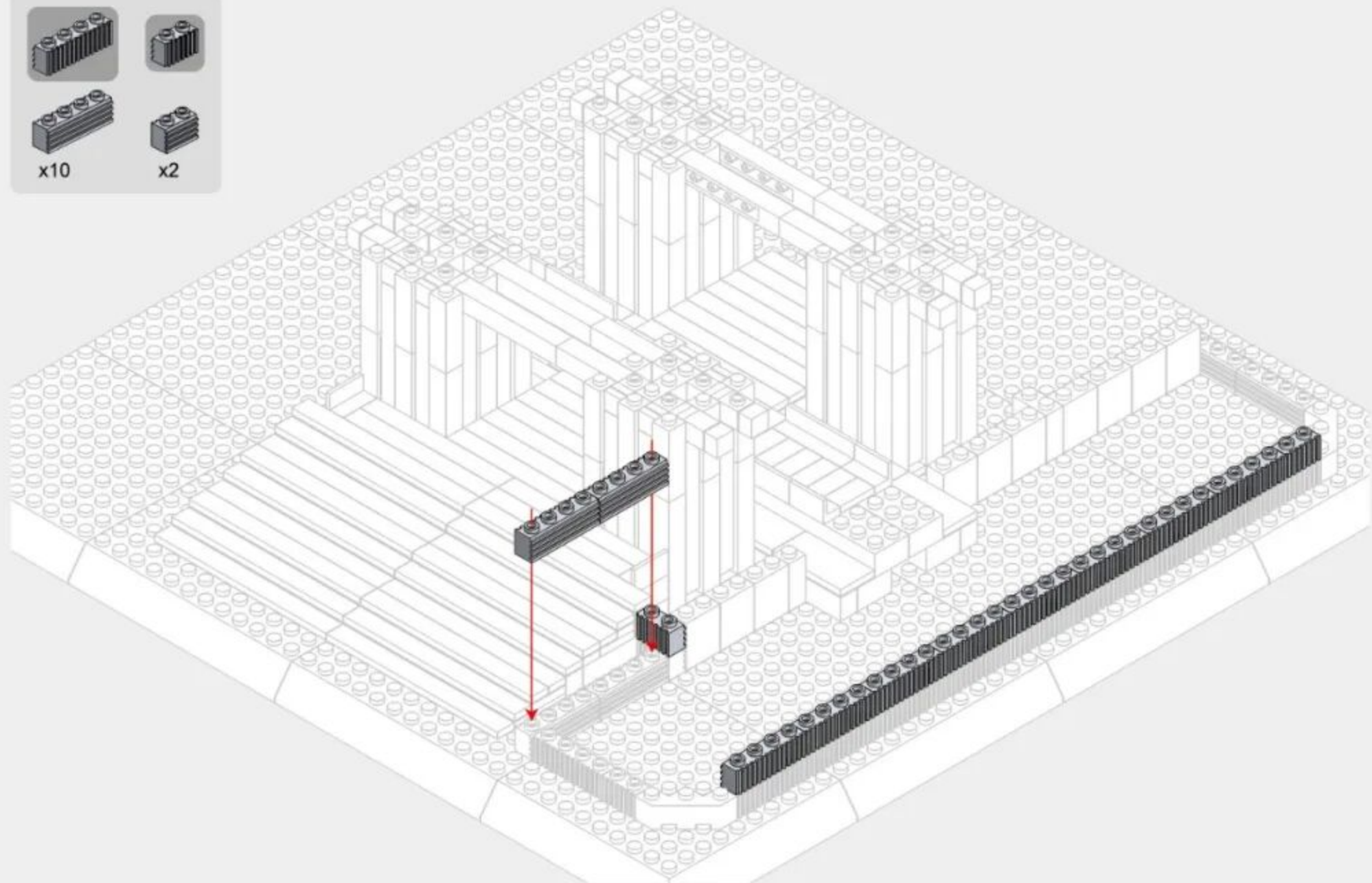
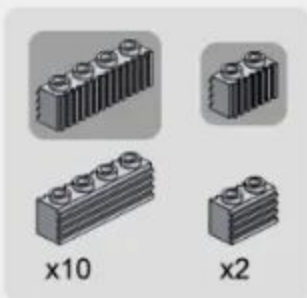

3-5

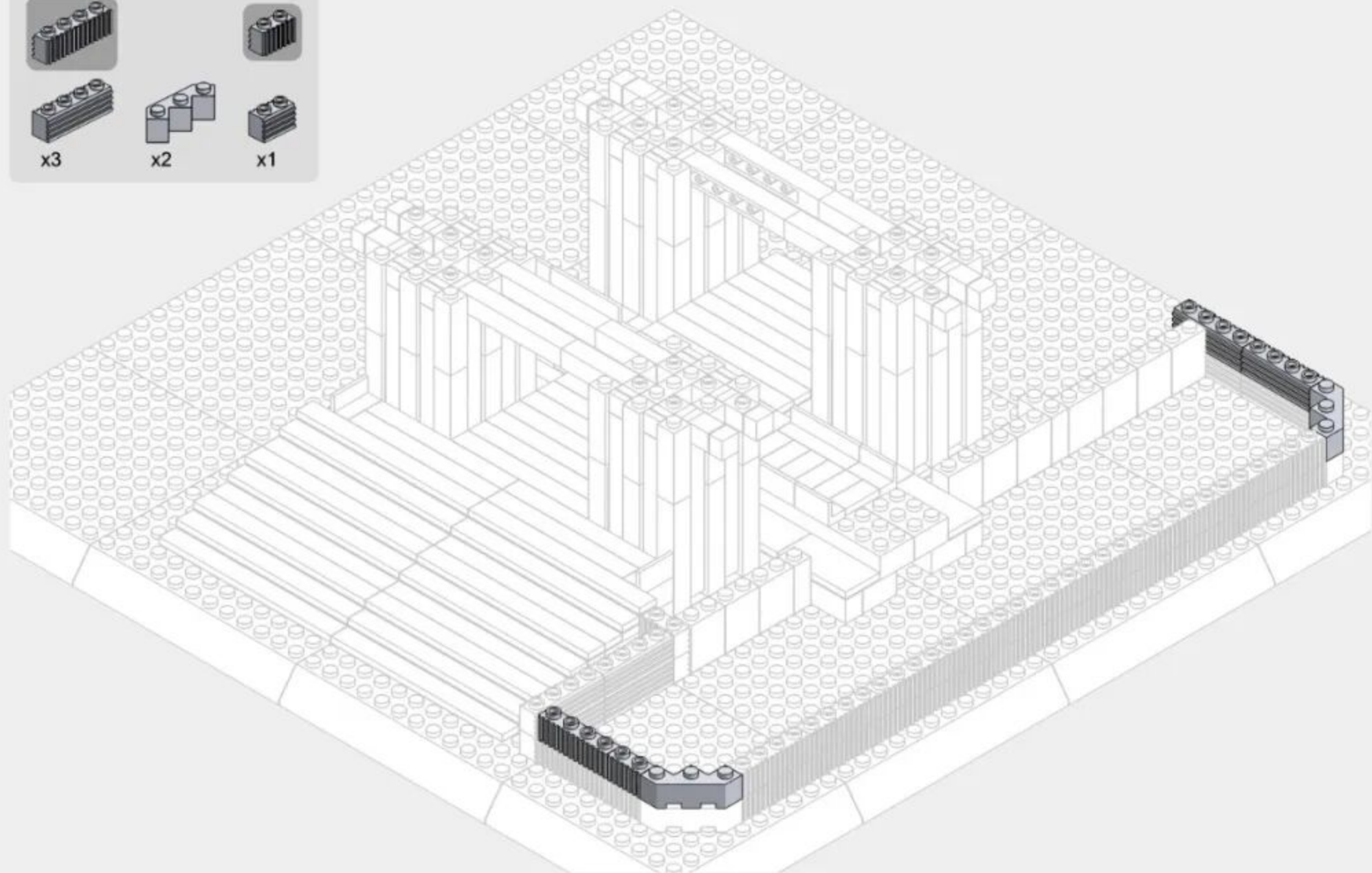
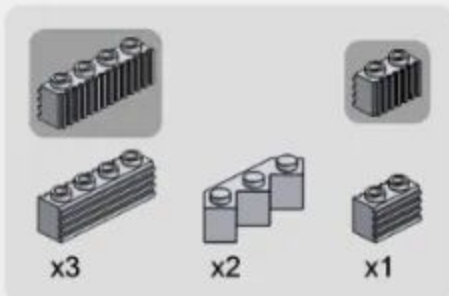

3-6

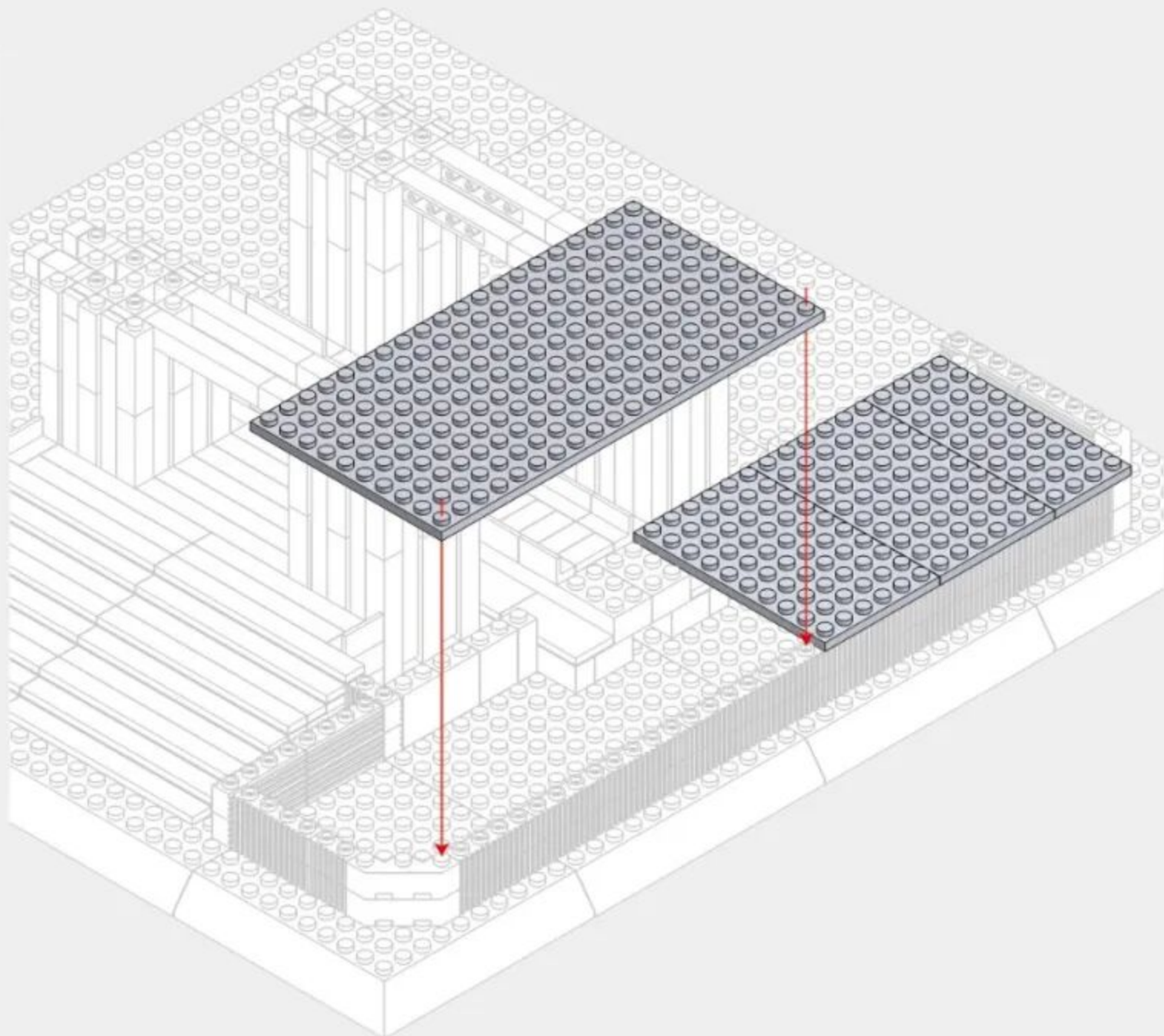
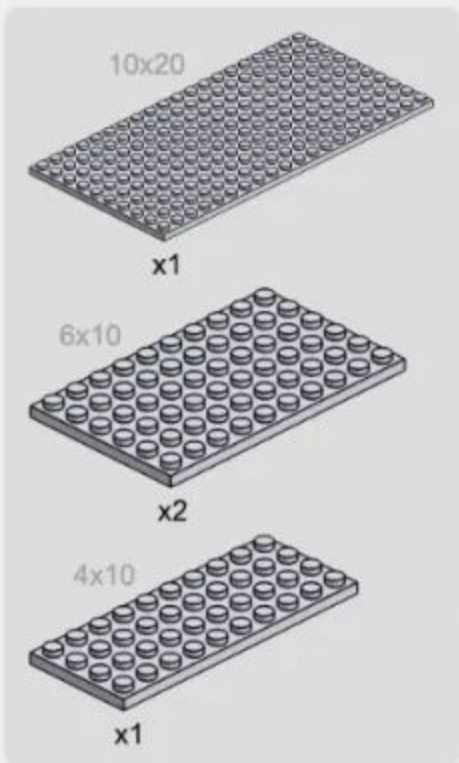

3-7

2x6



x2



x1



x1

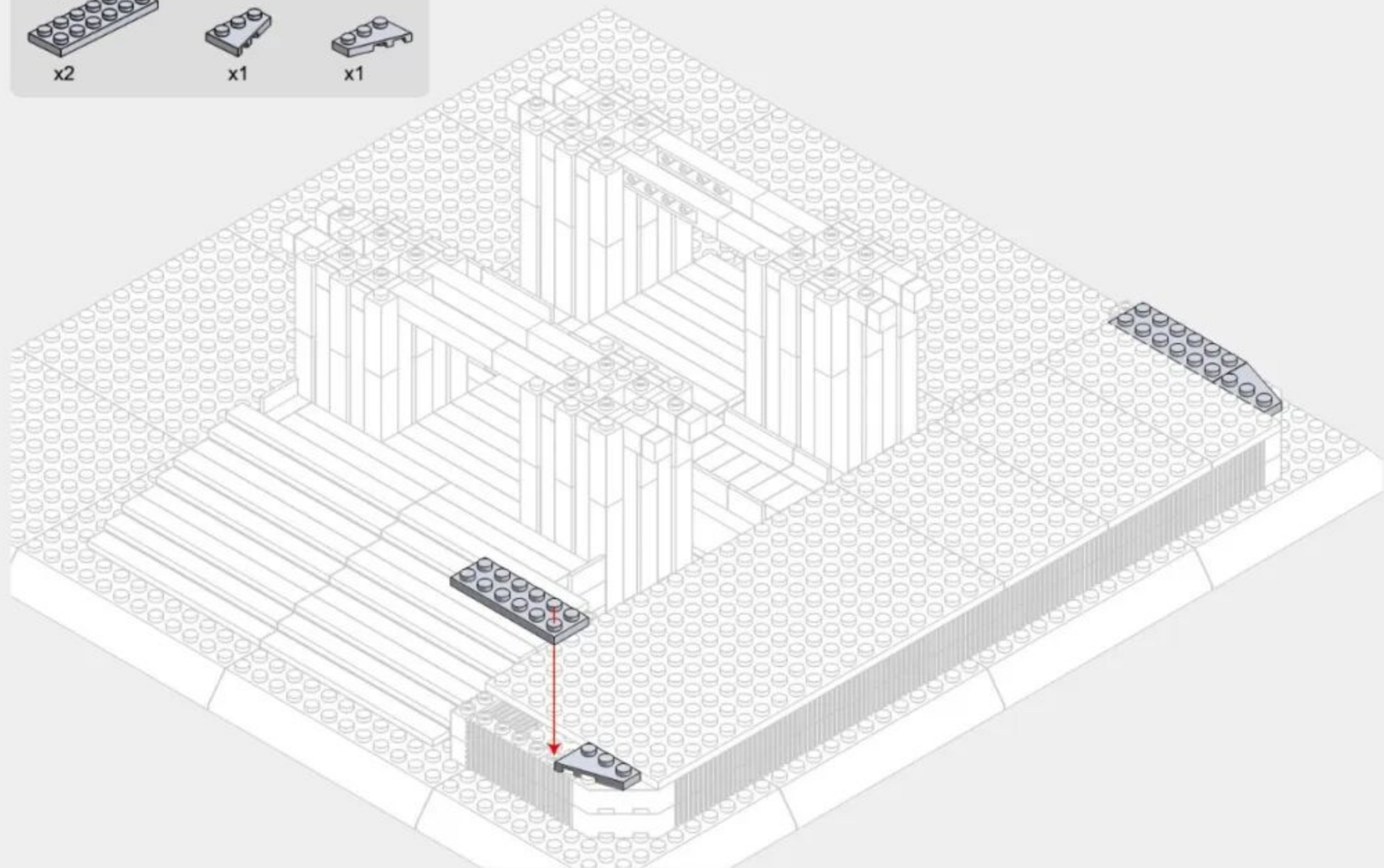

3-8



x1



x3

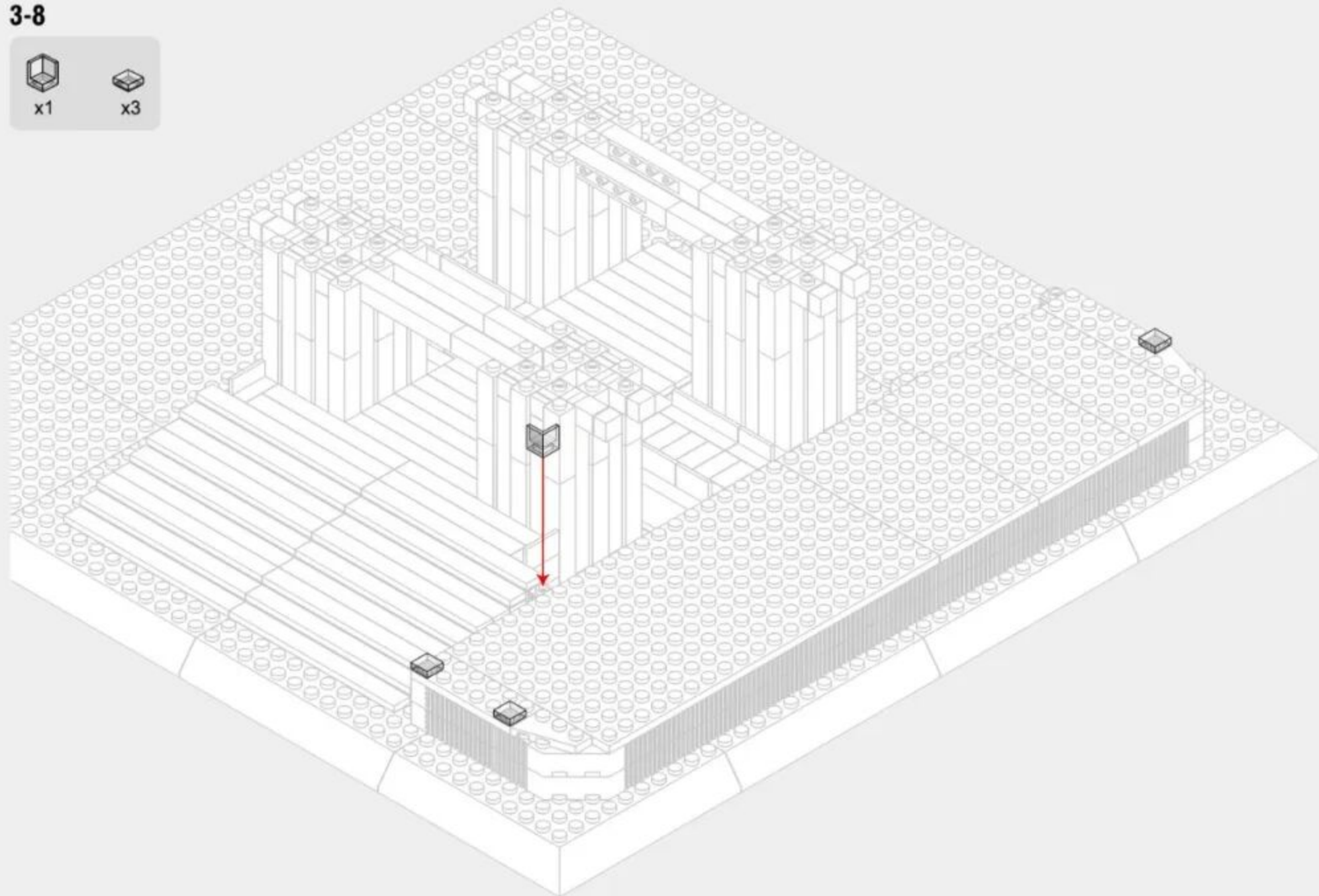

3-9

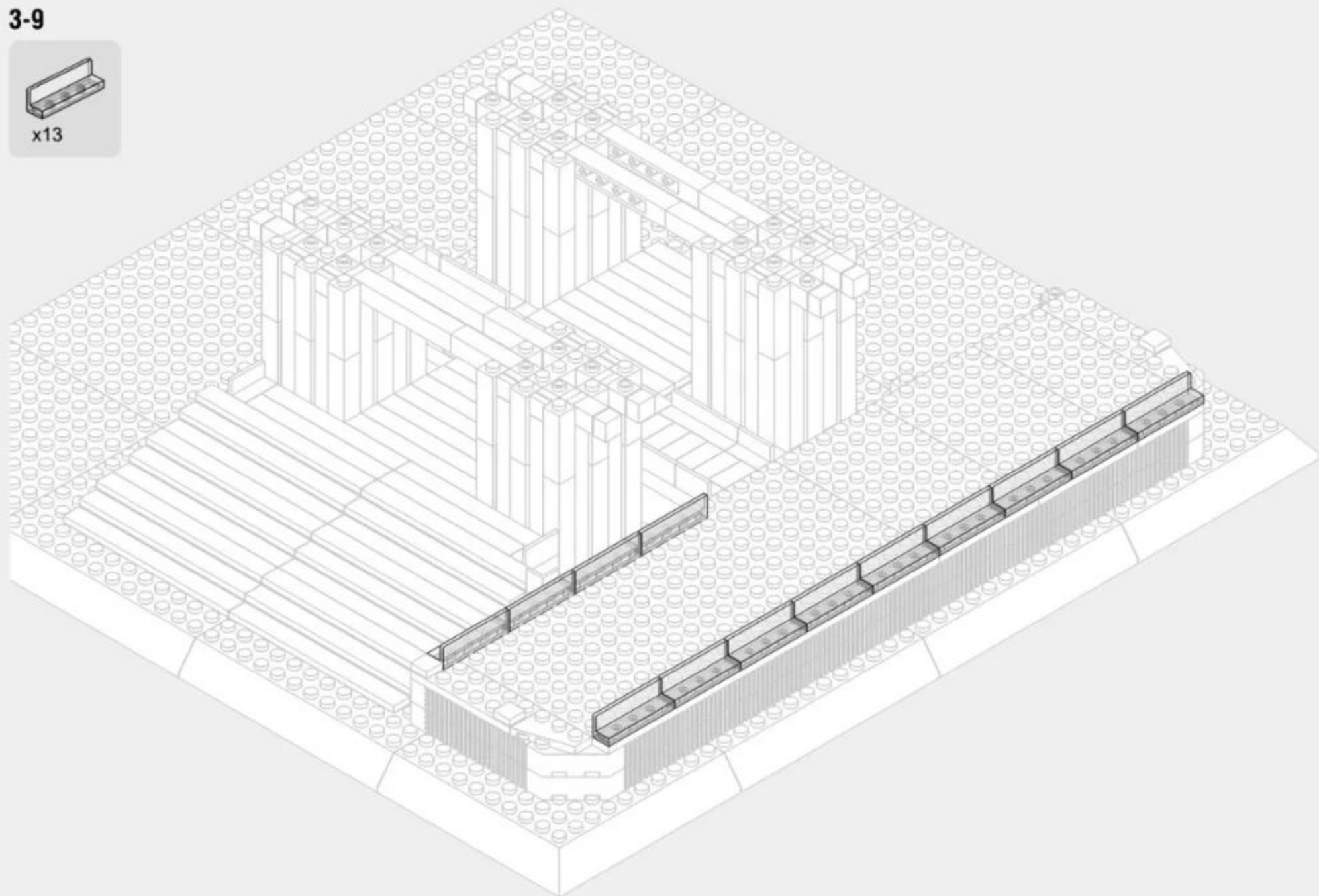

3-10

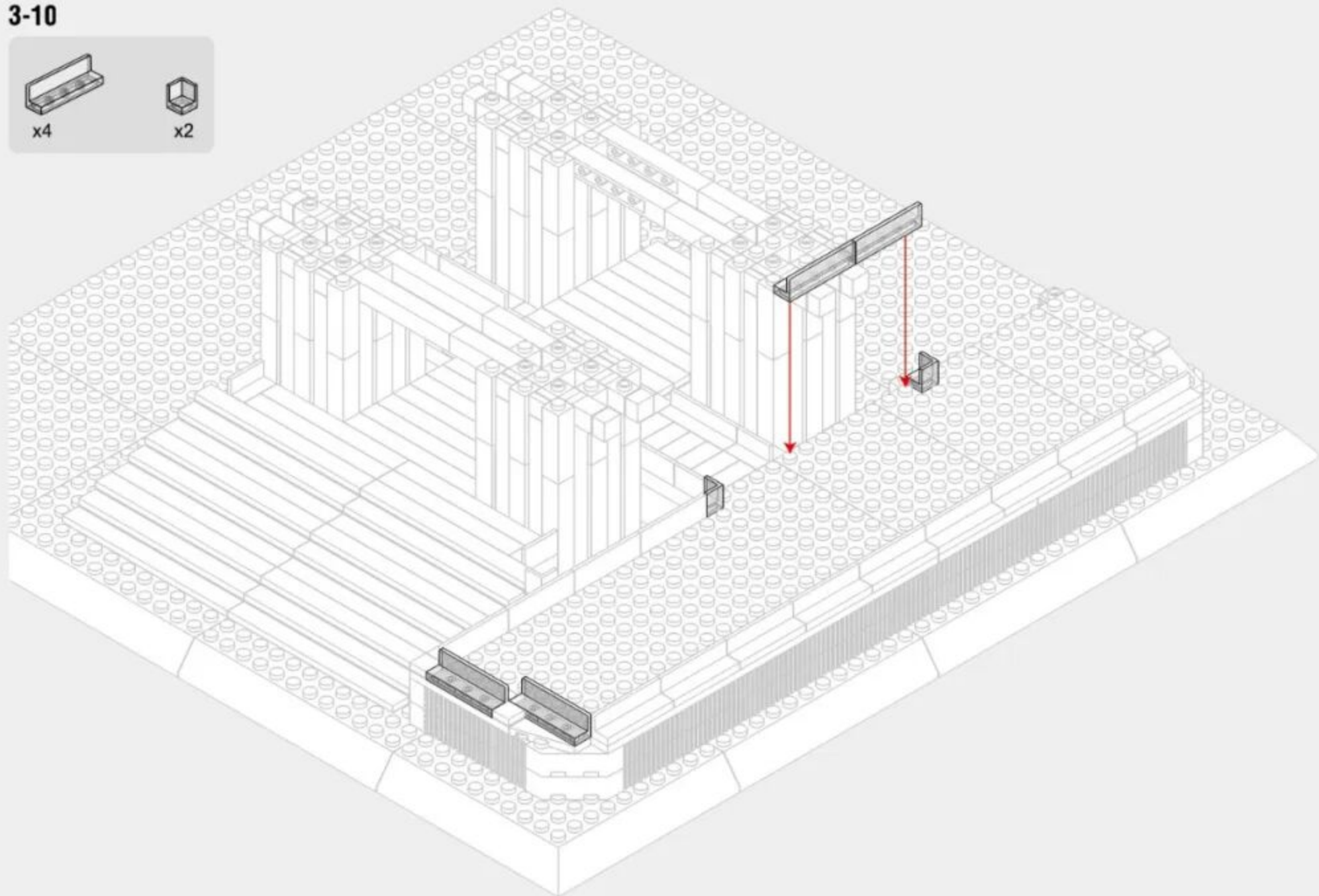

3-11

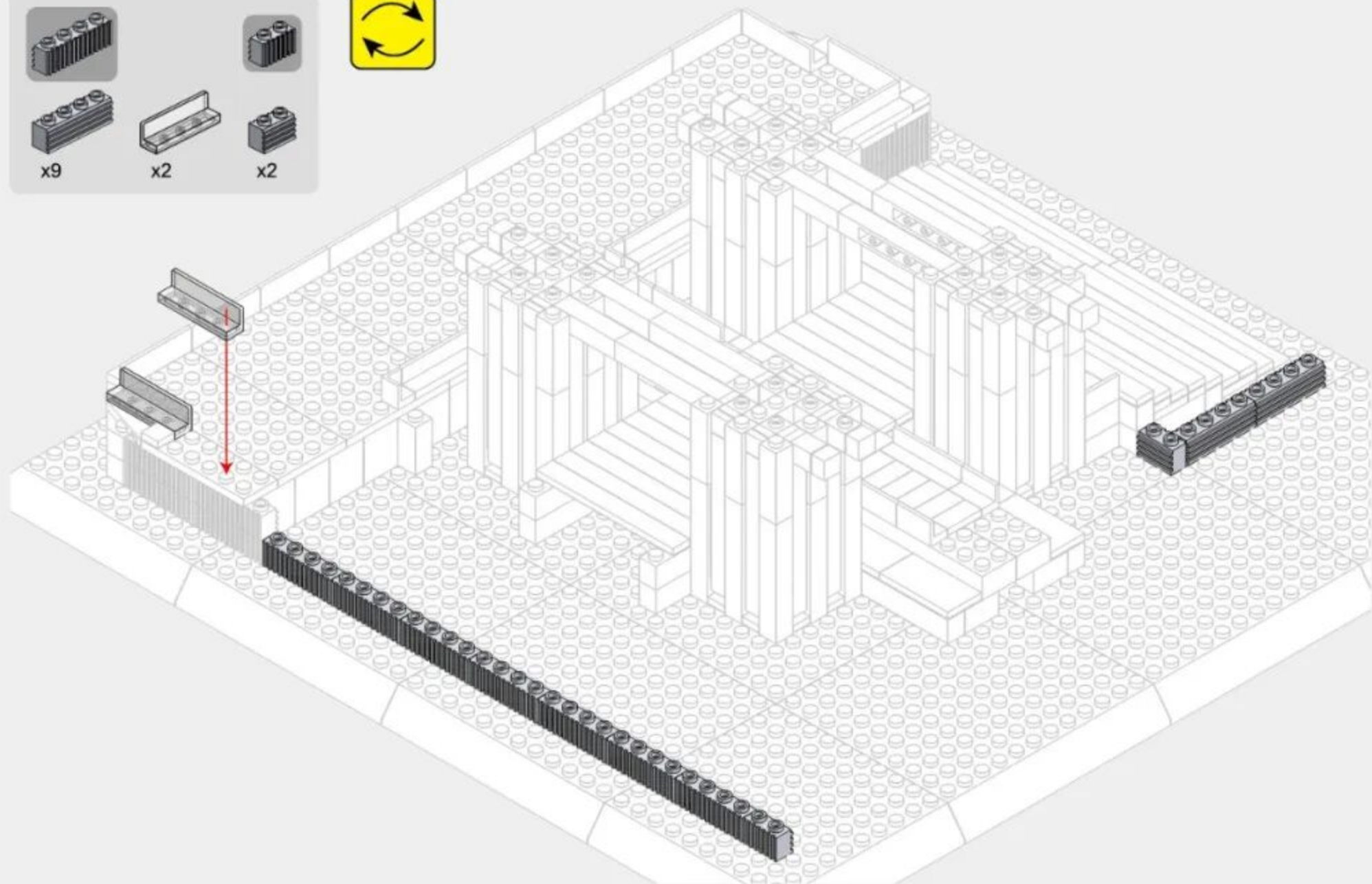
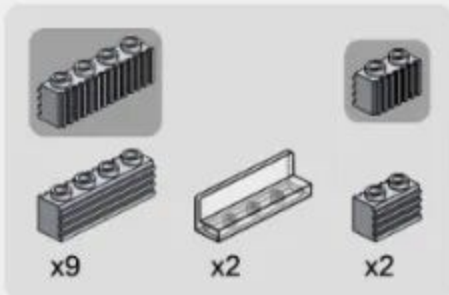

3-12

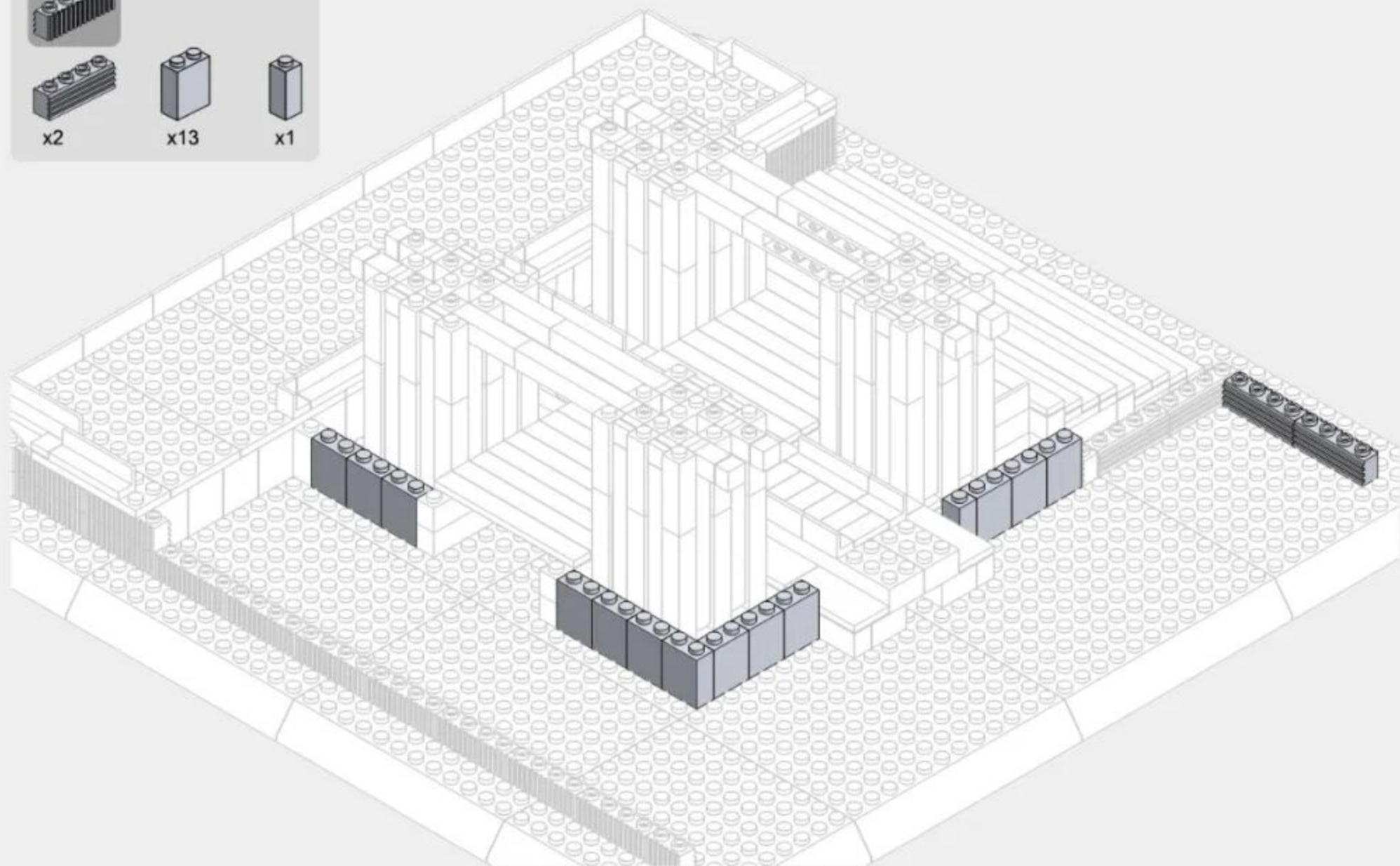
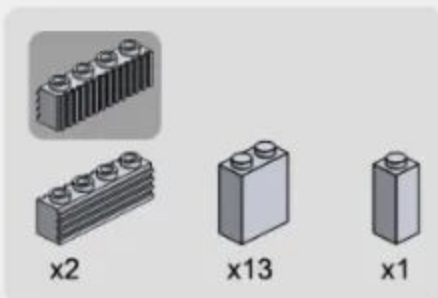

3-13



x10

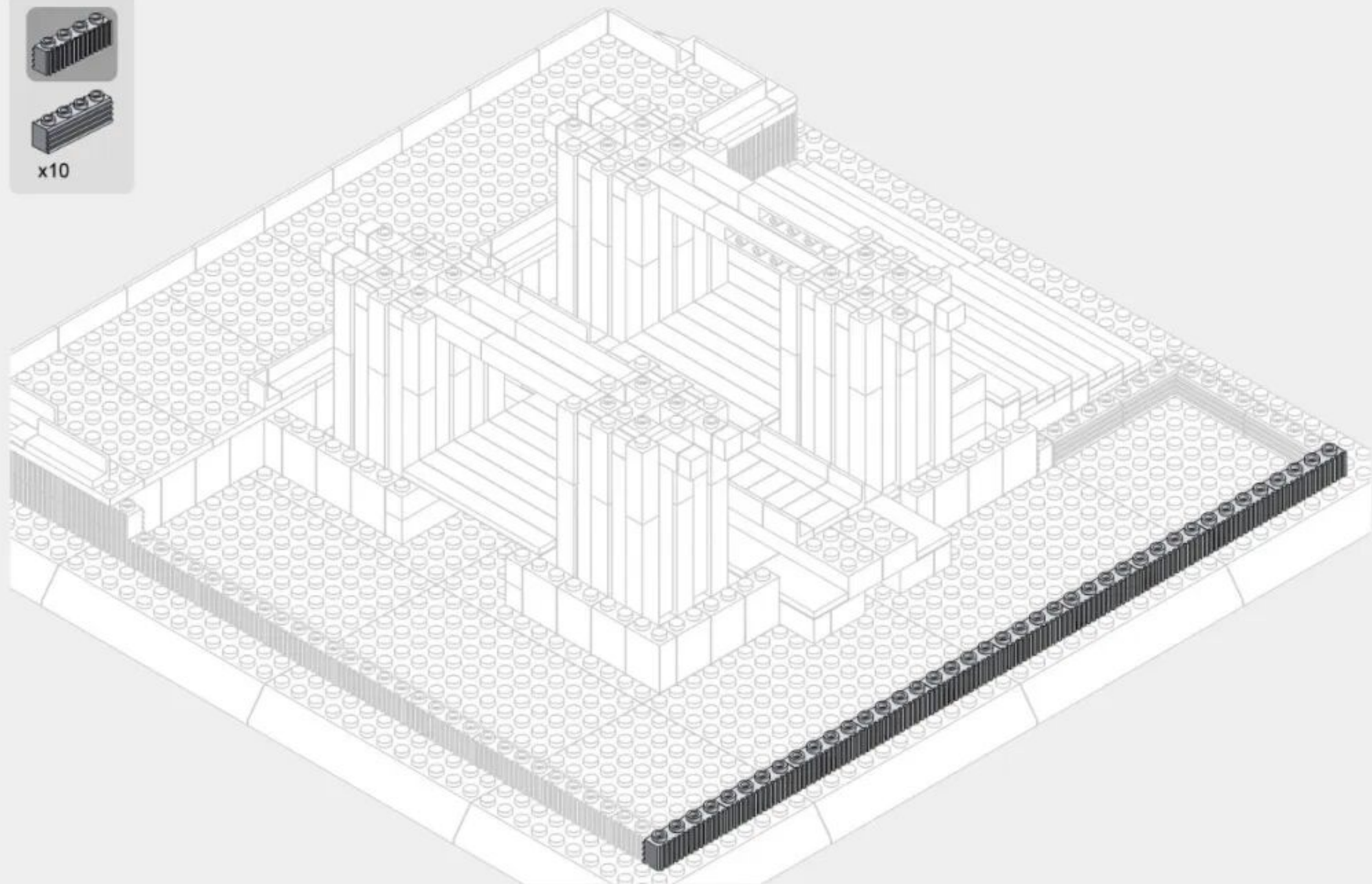

3-14

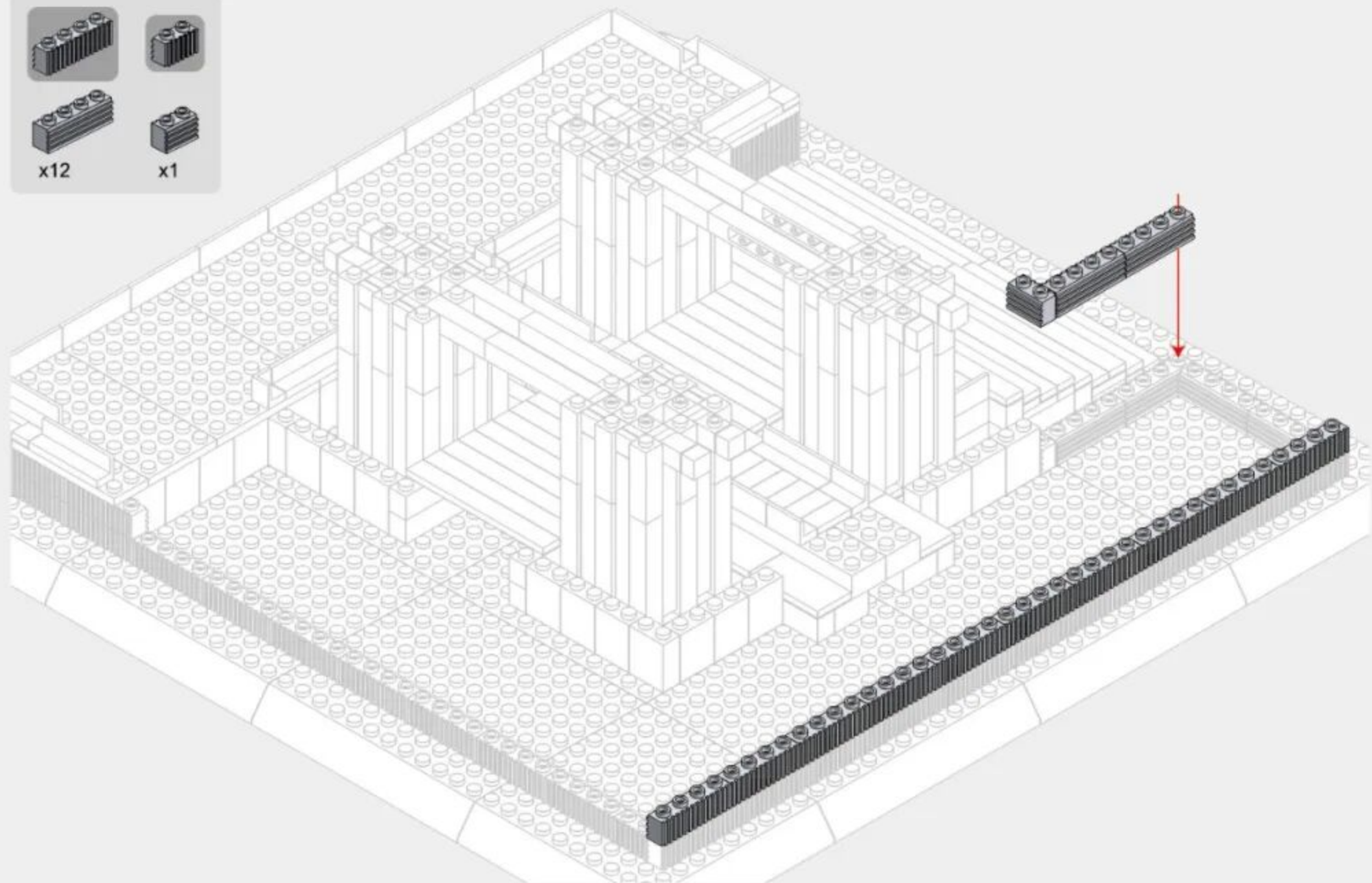
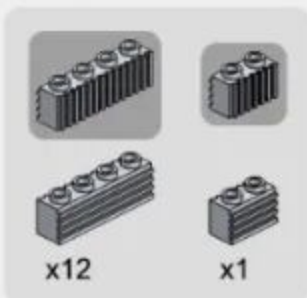

3-15

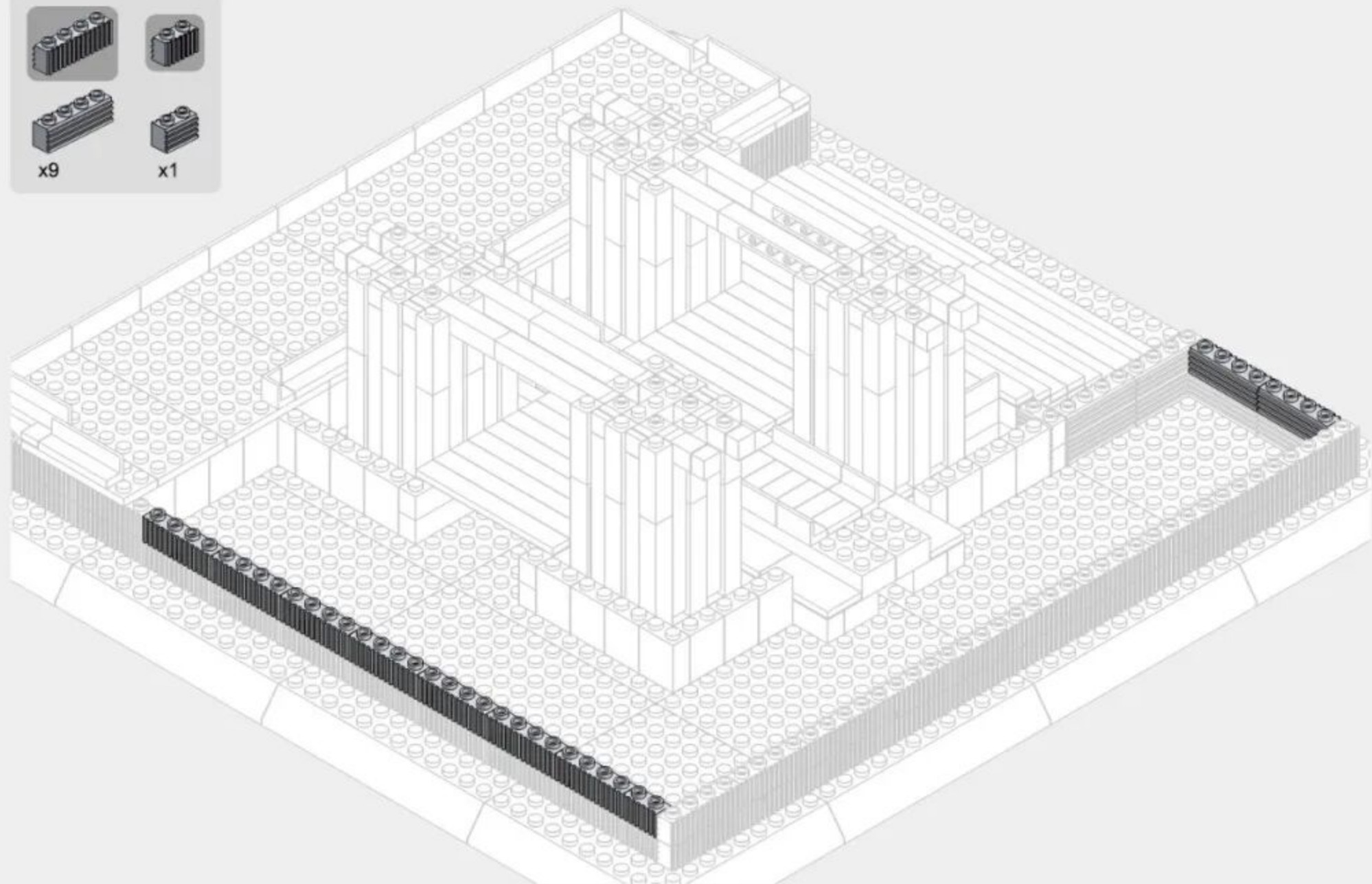
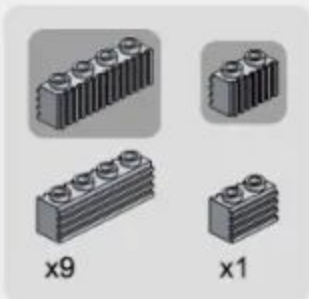

3-16

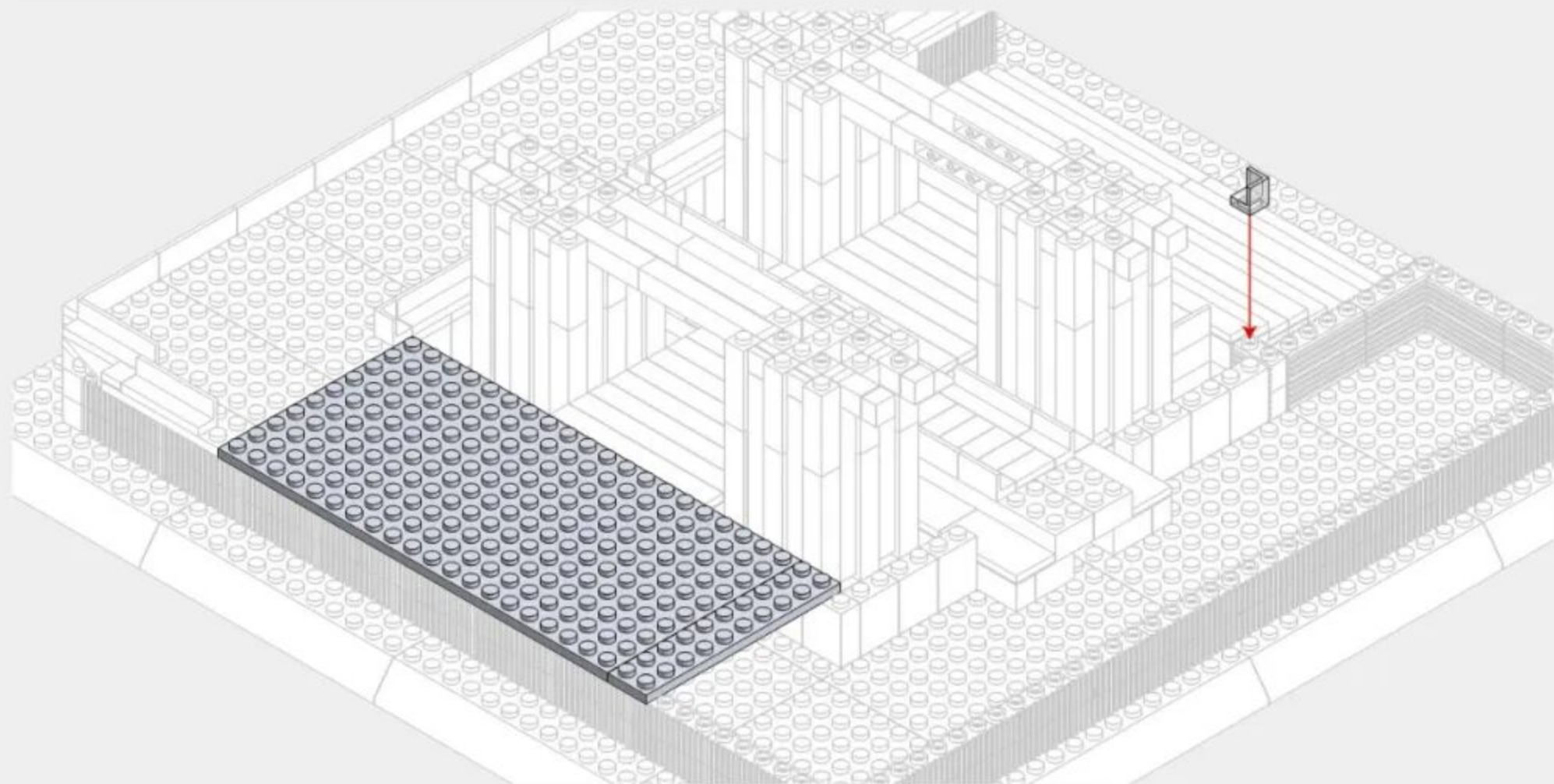
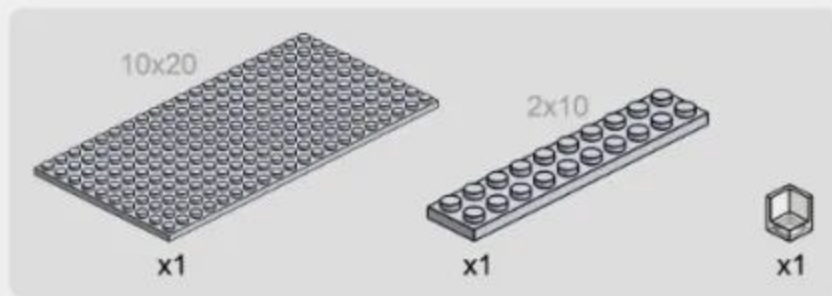

3-17

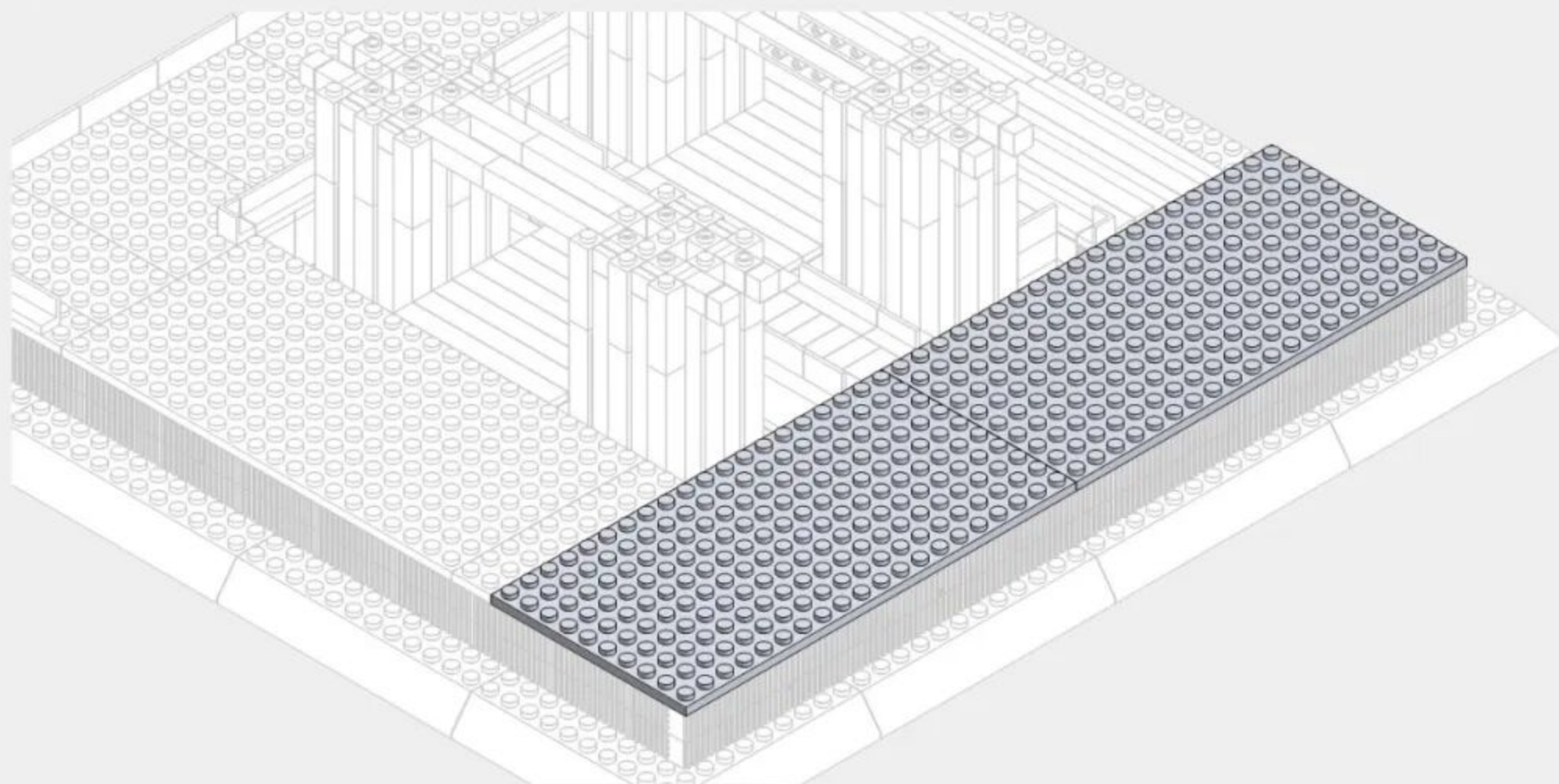
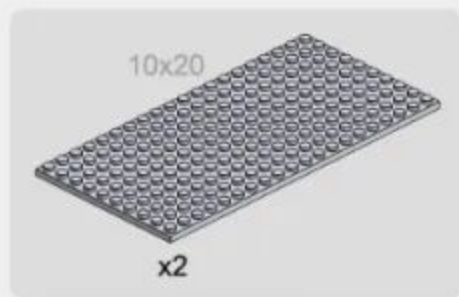

3-18



x8



x3

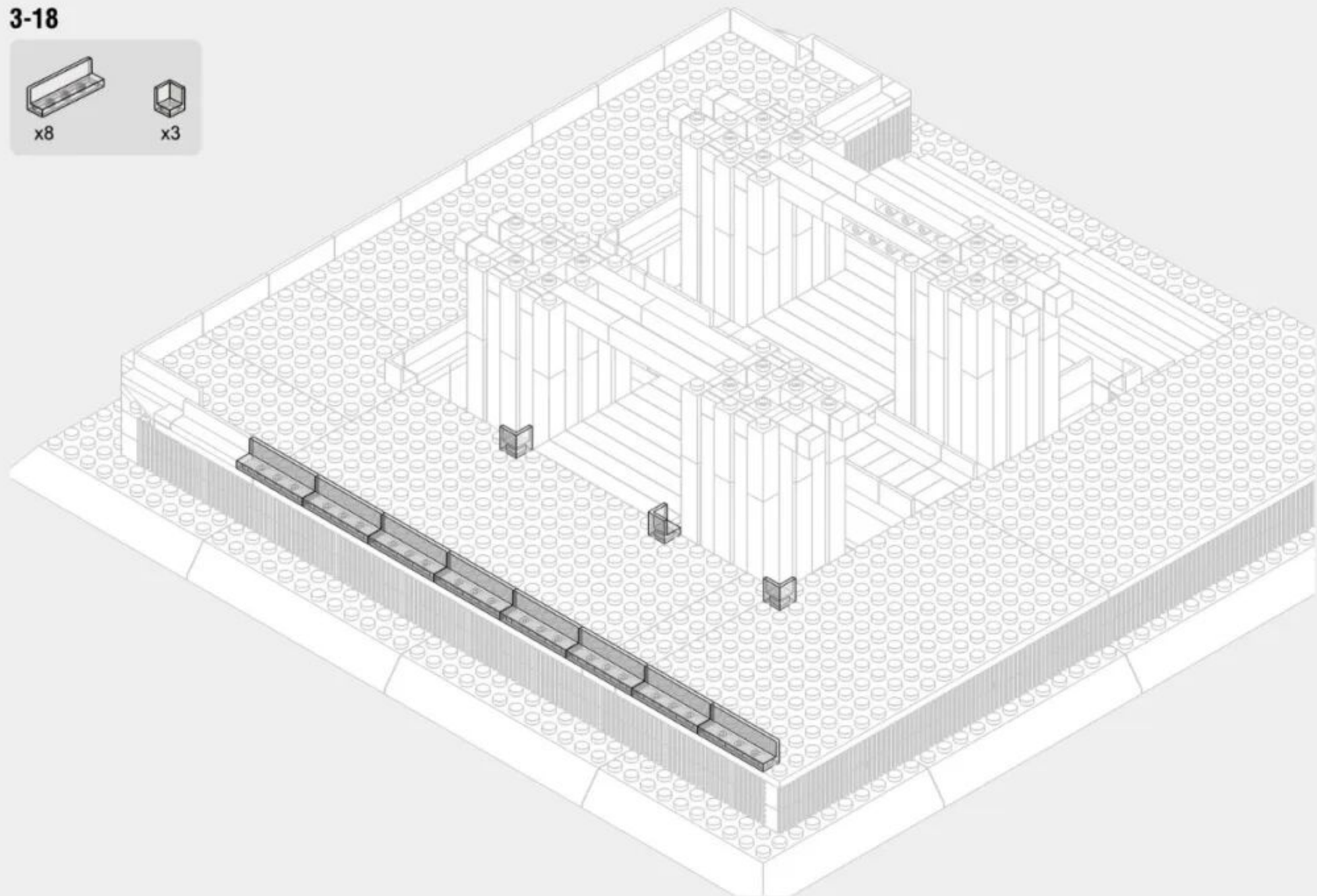

3-19

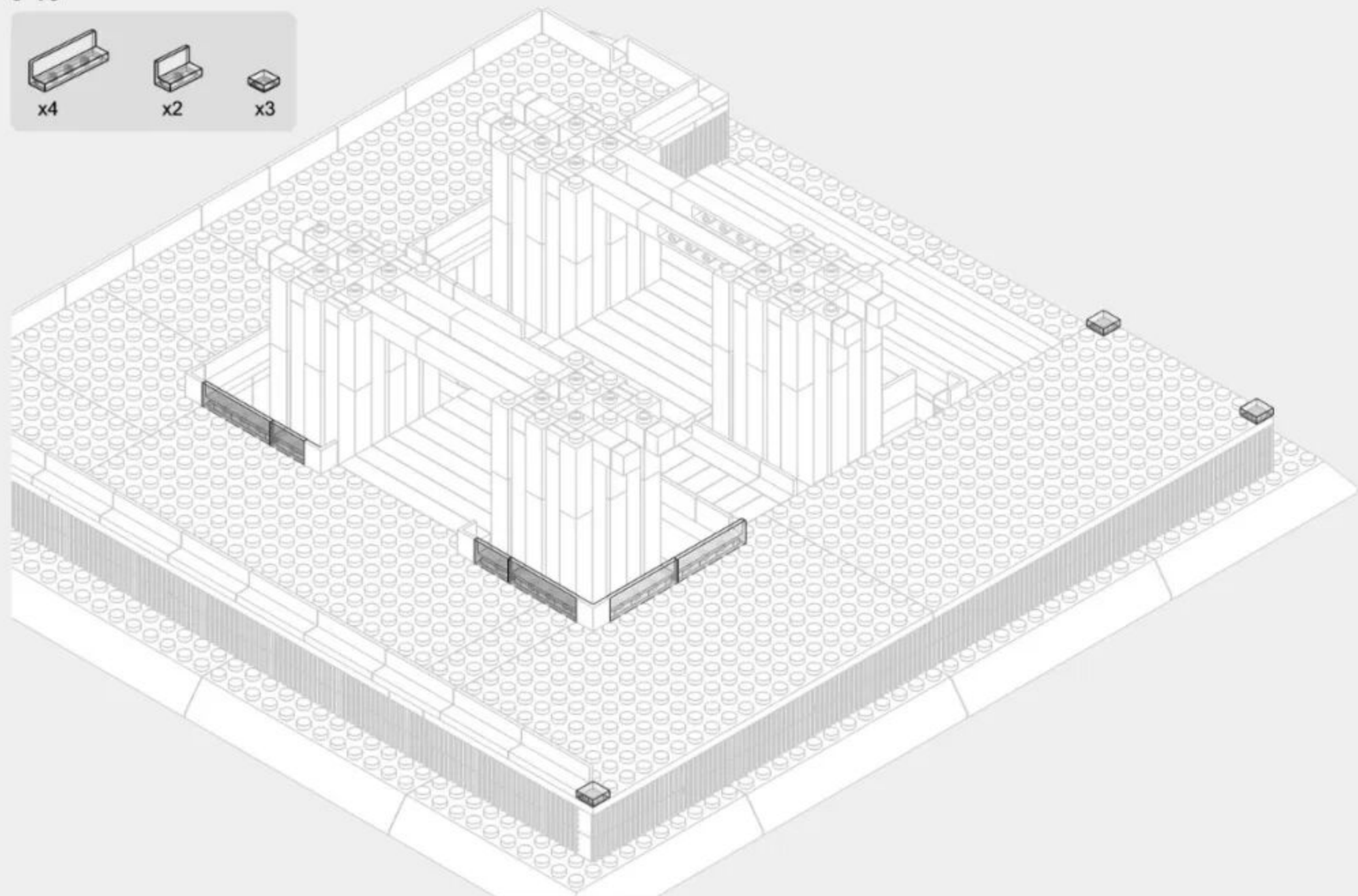
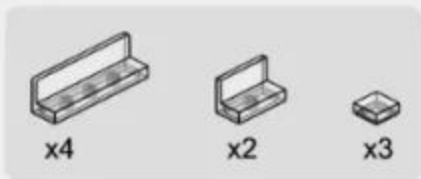

3-20



x13



x1



x1

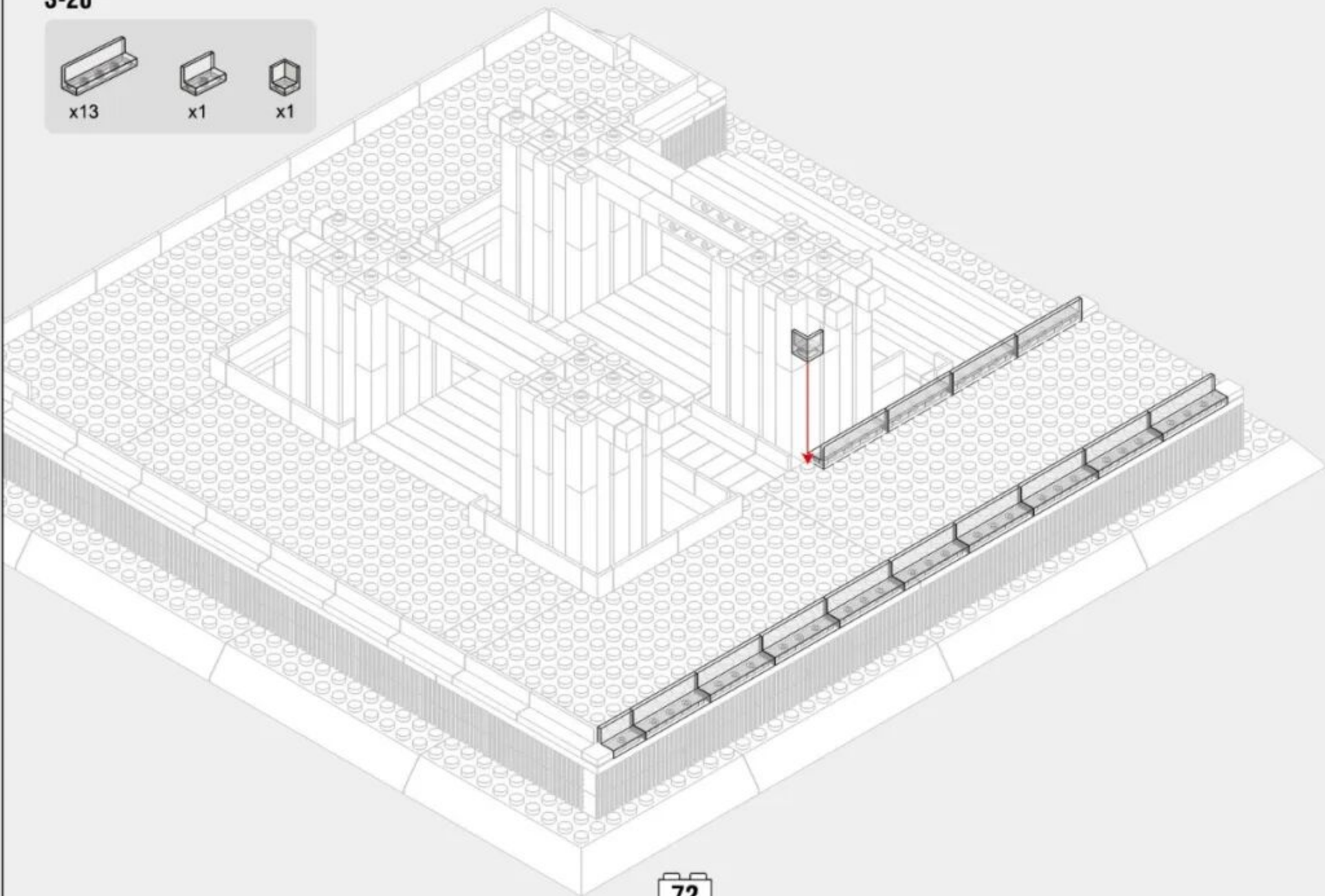

3-21

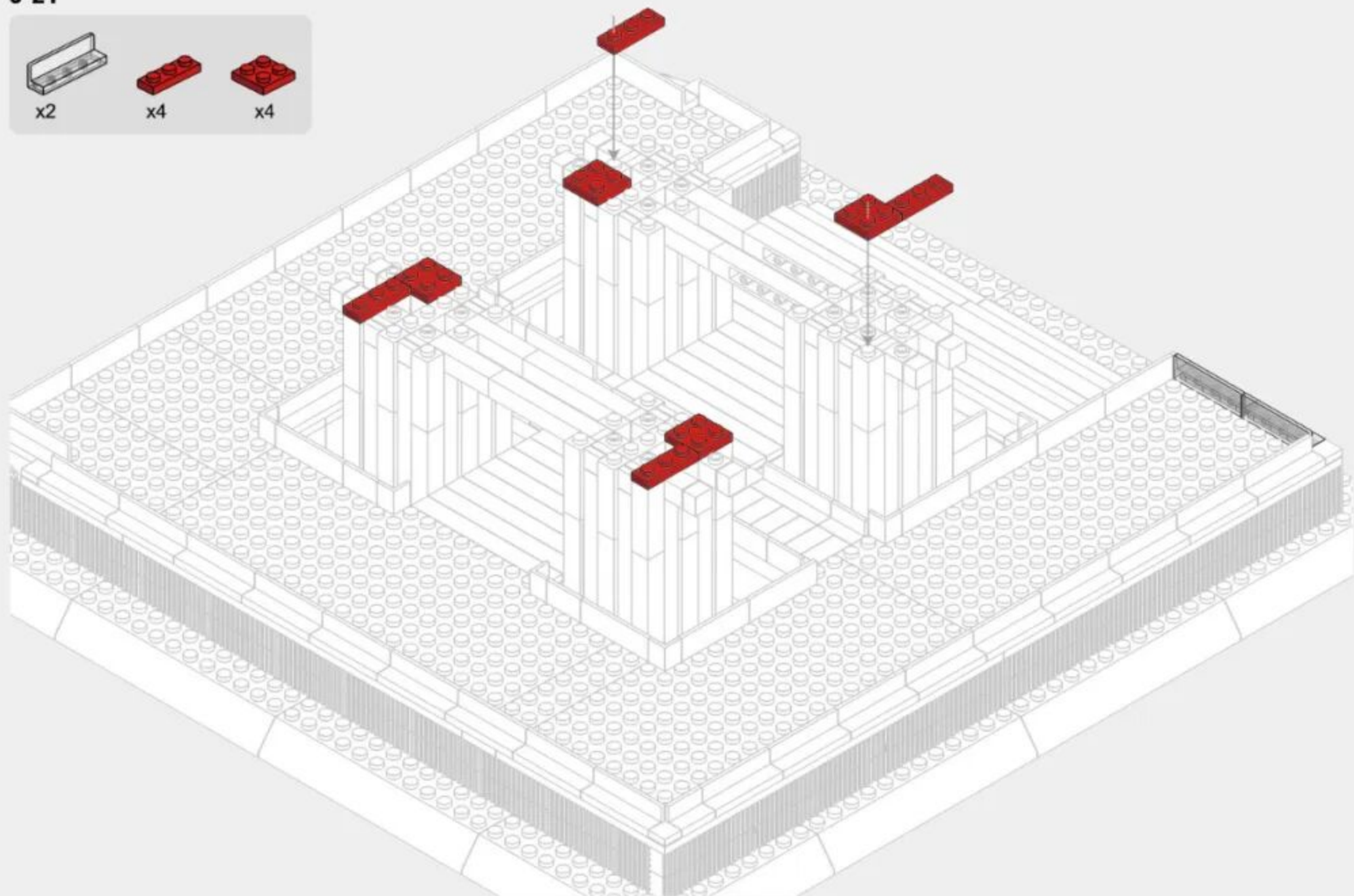
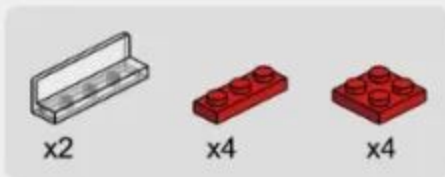

3-22

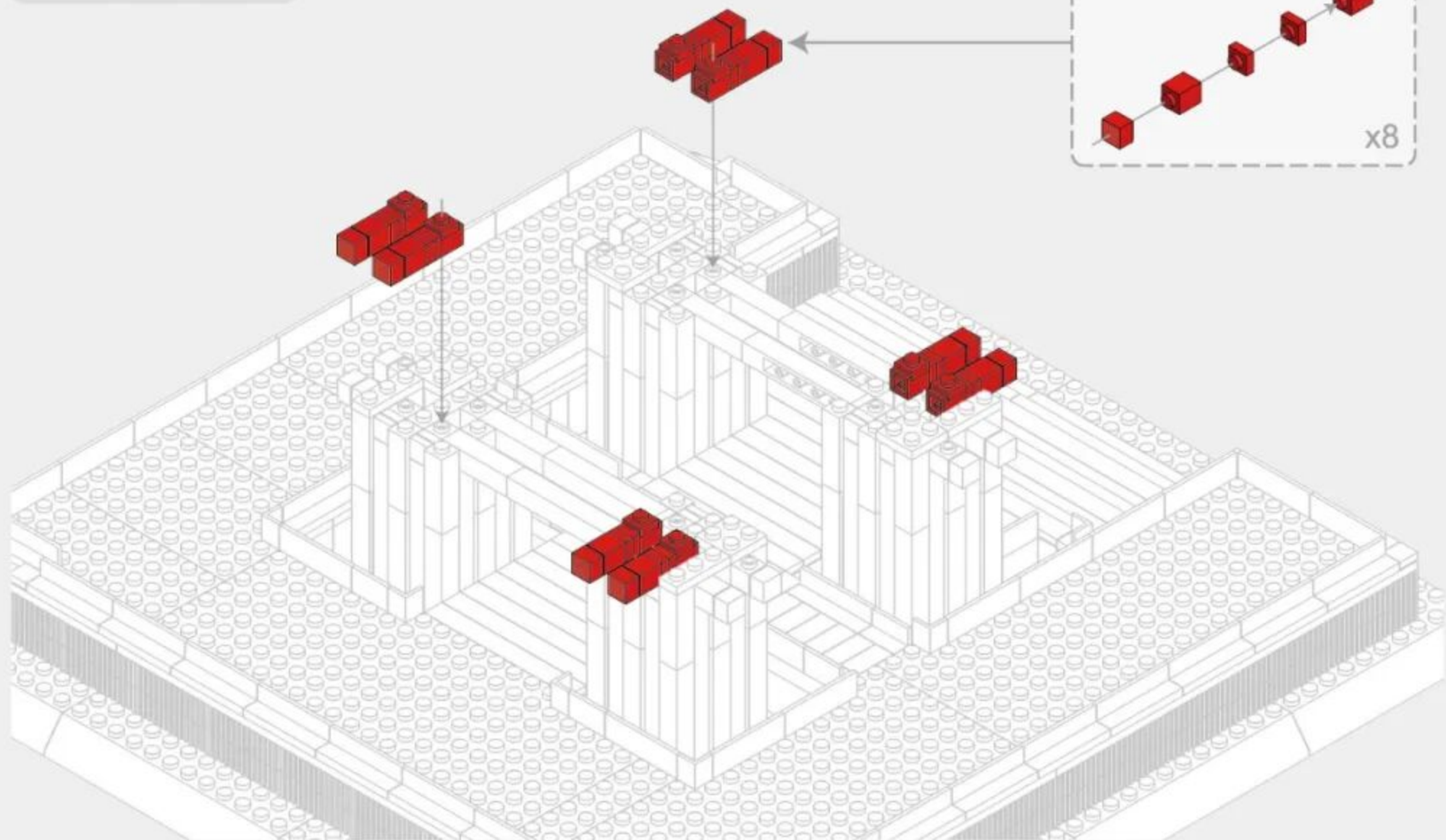

3-23

1x4



x4



x4



x4

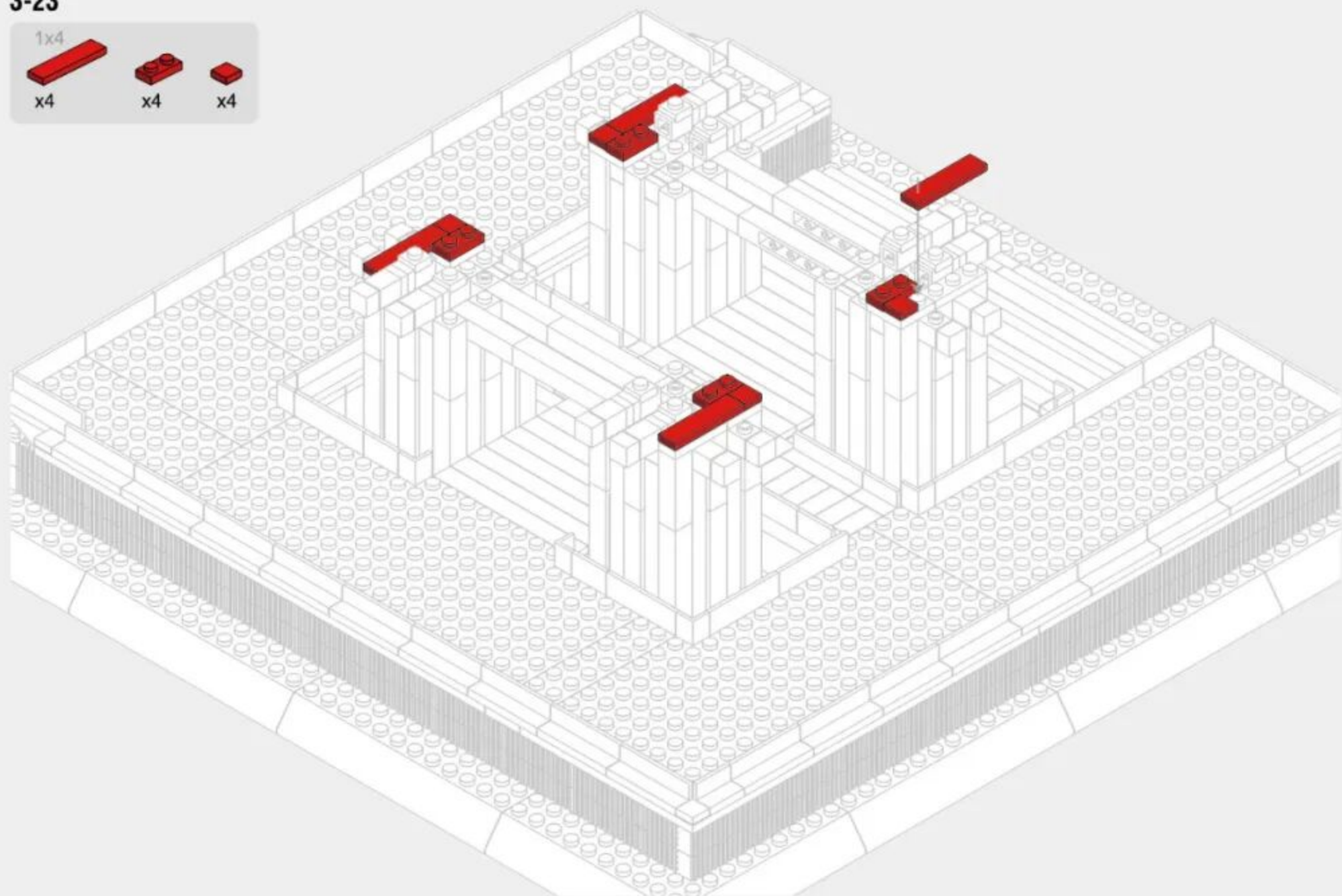

75

3-24

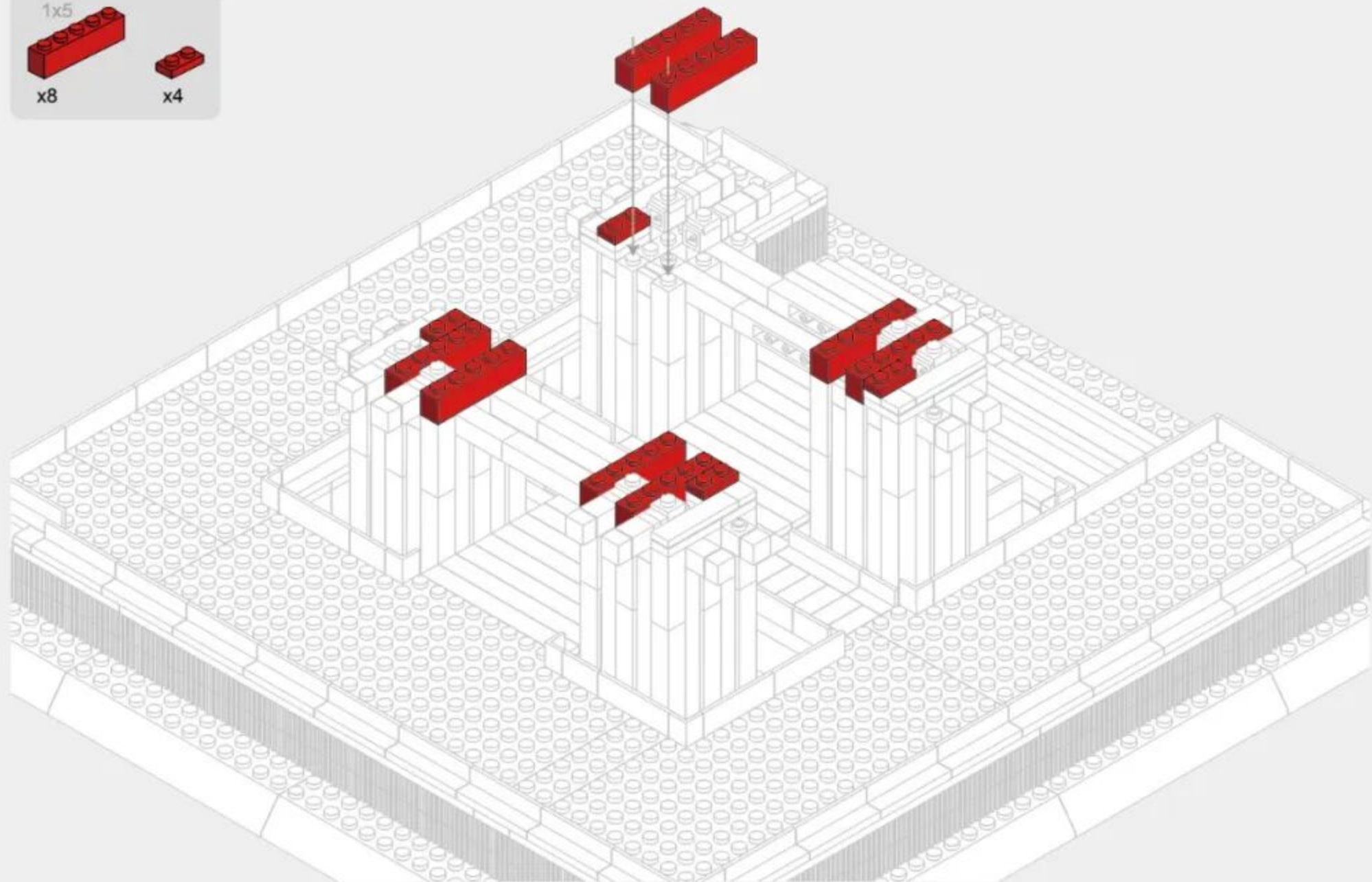
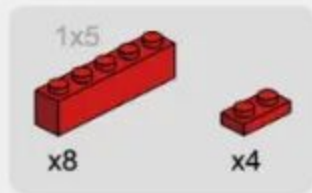



274PCS

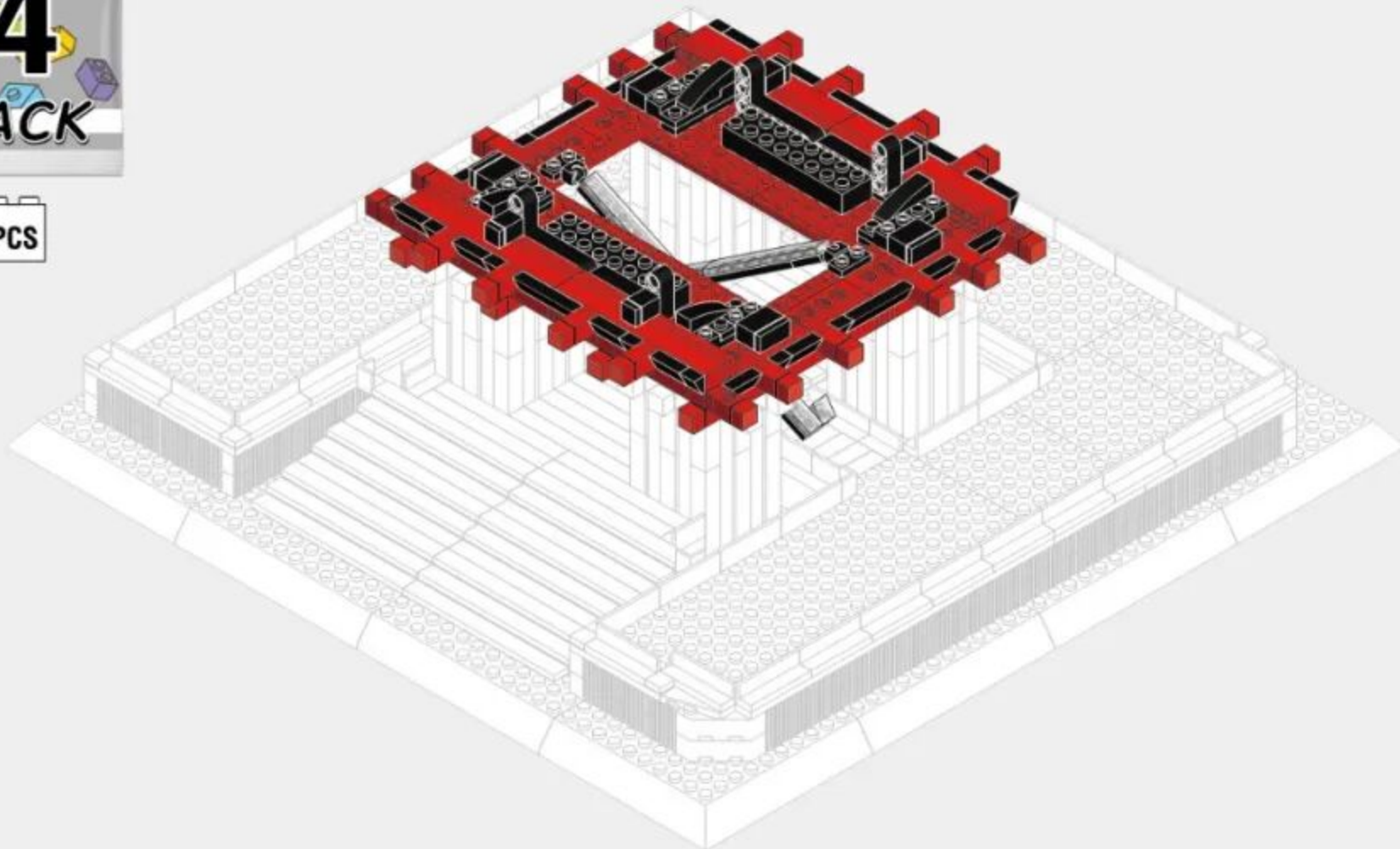

4-1



1

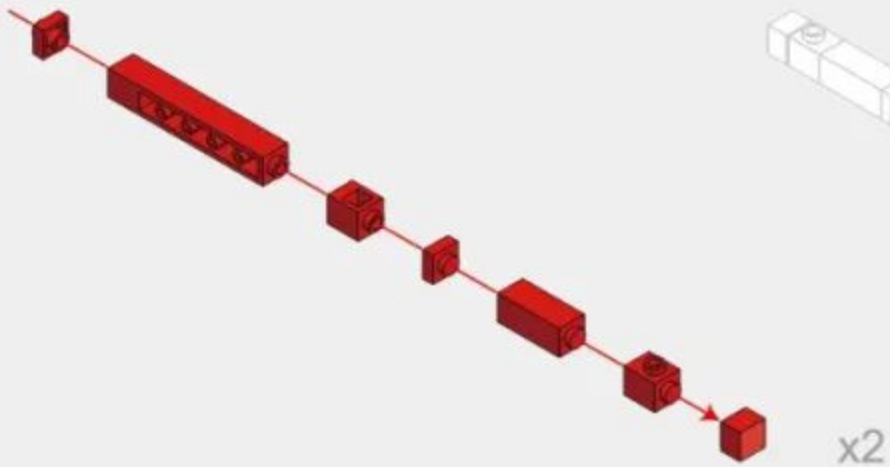

2

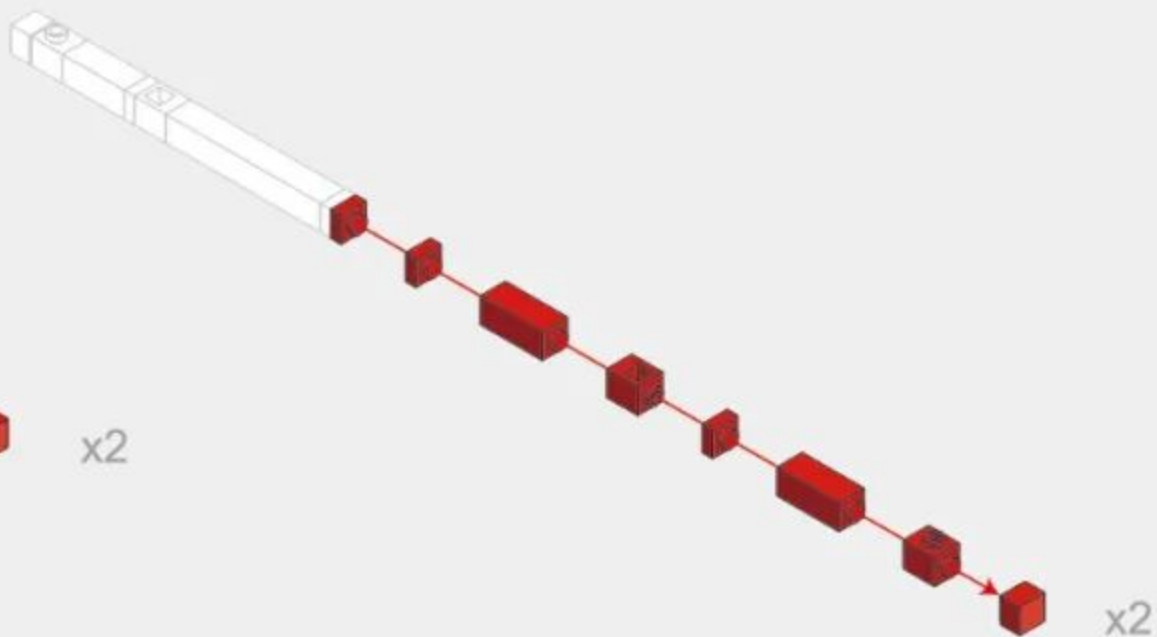

4-2



4-1

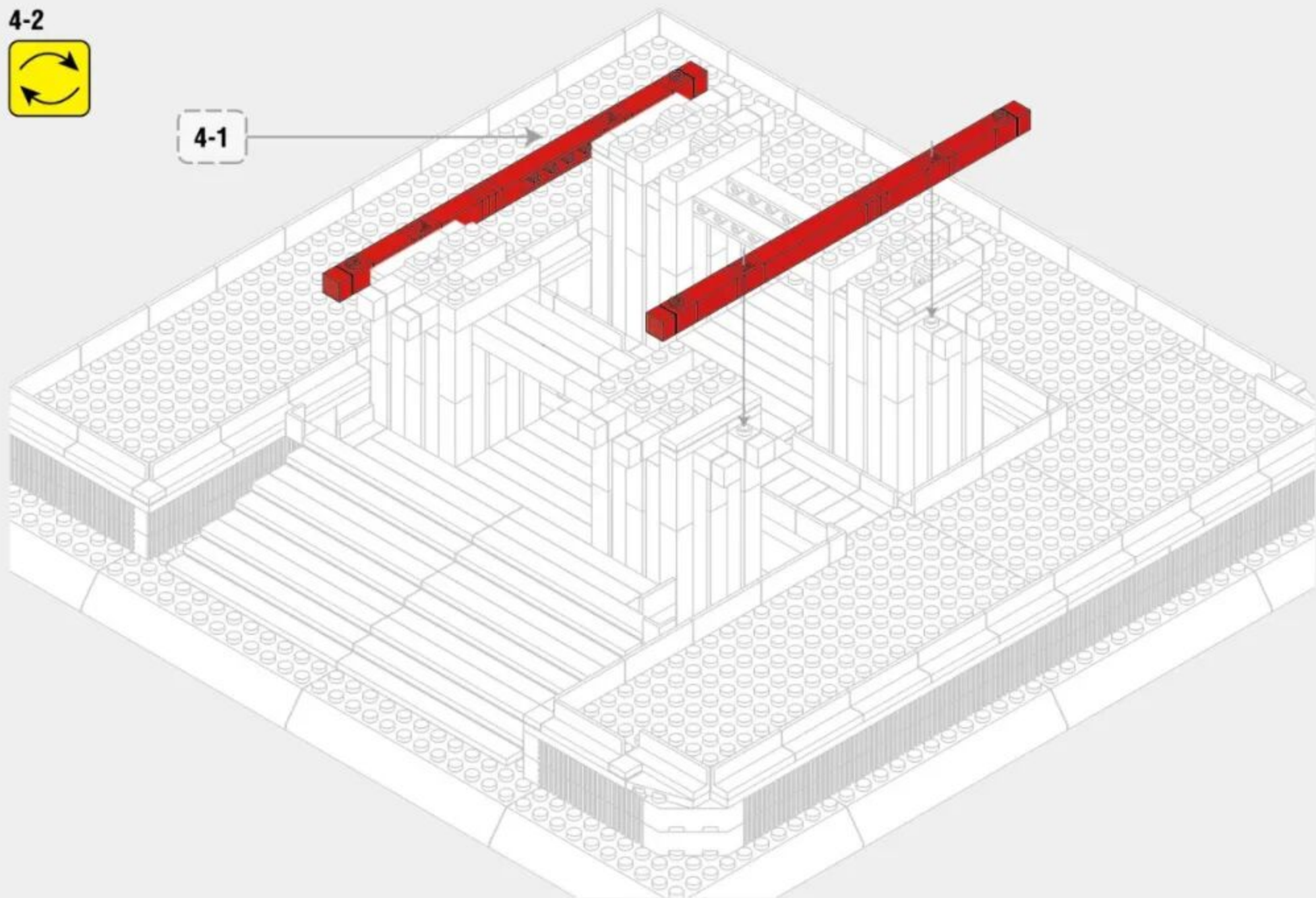

79

4-3

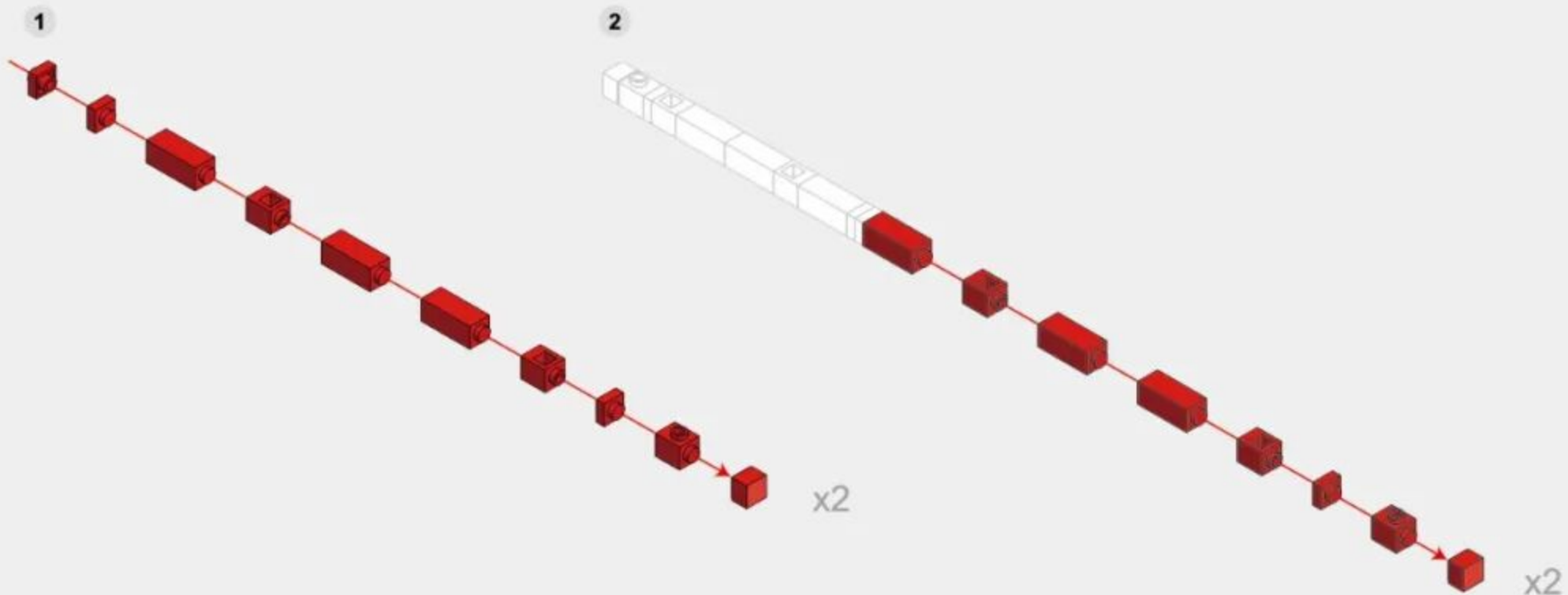
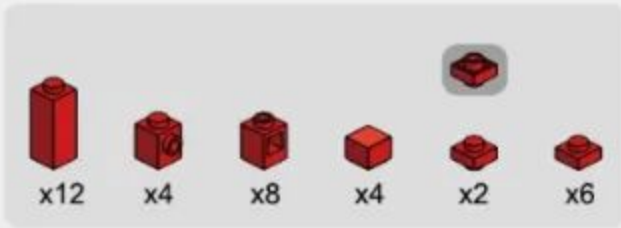

4-4

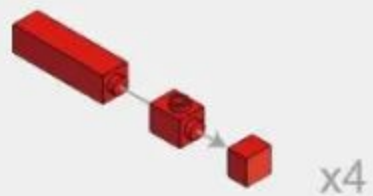

4-5

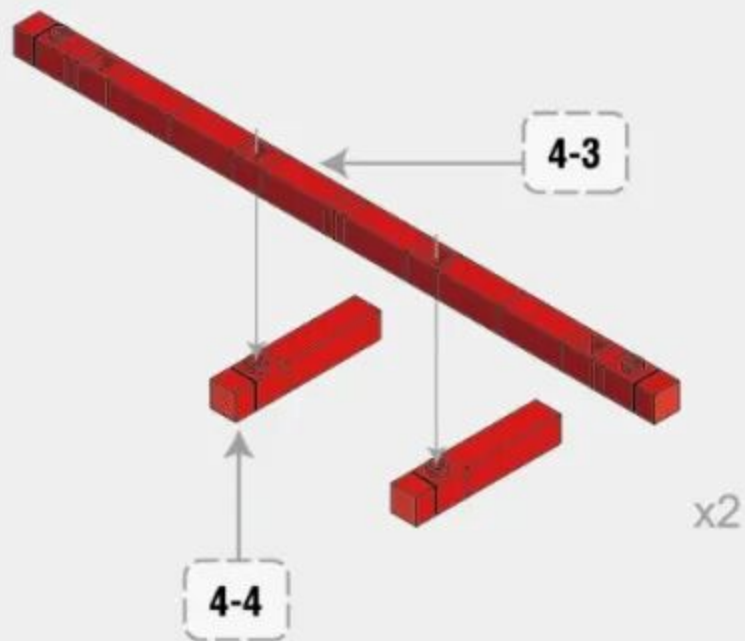

4-6

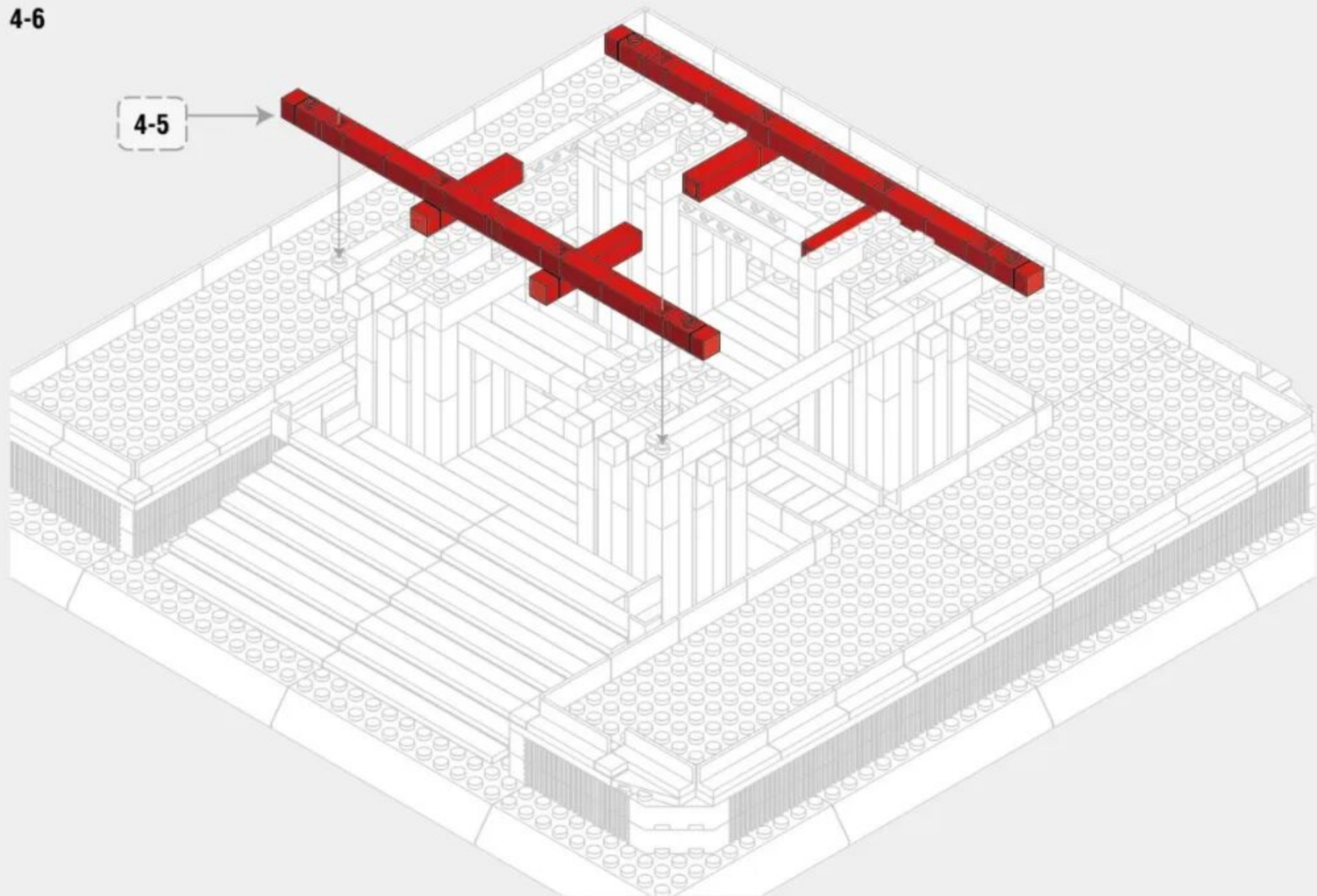

4-5

4-7

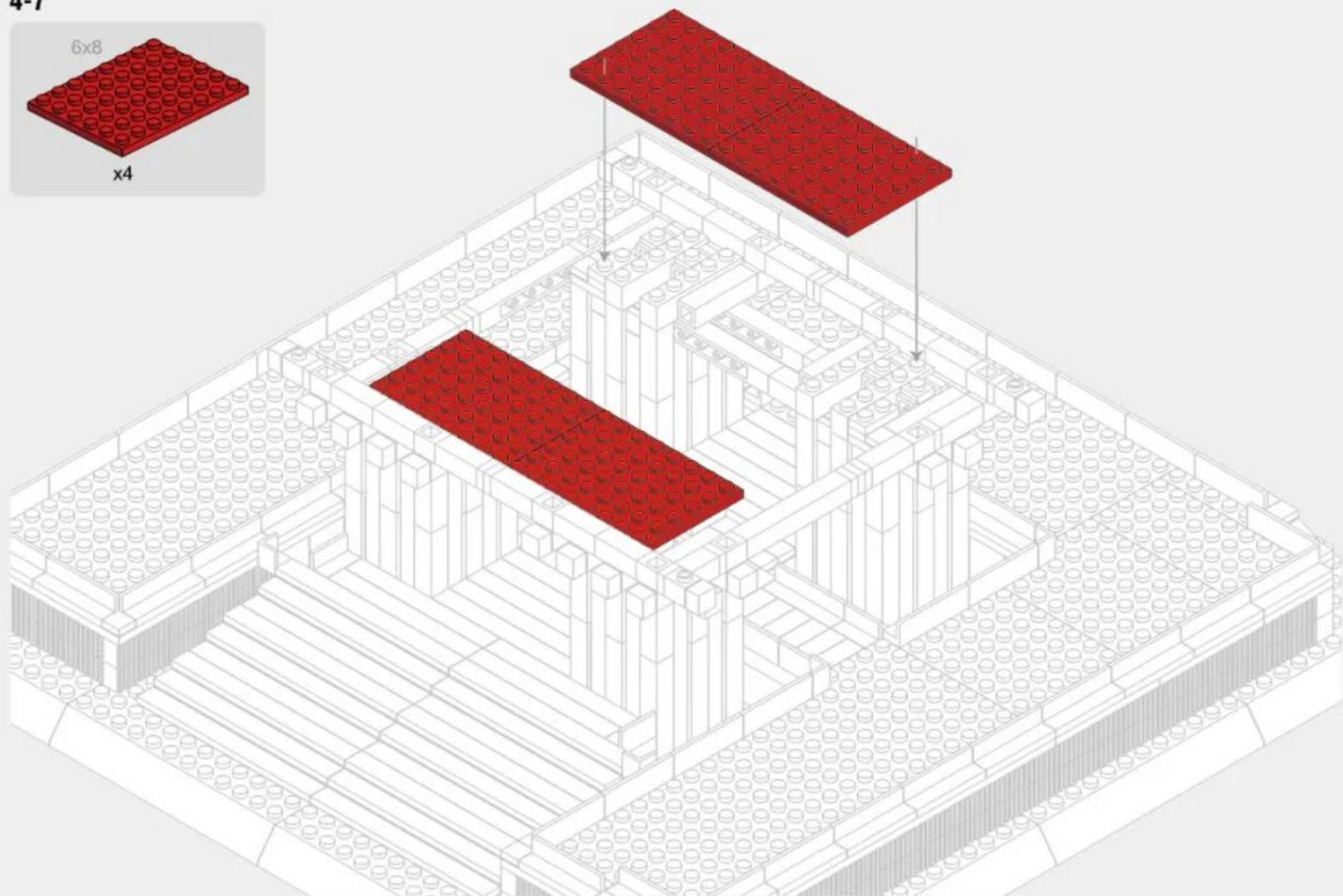
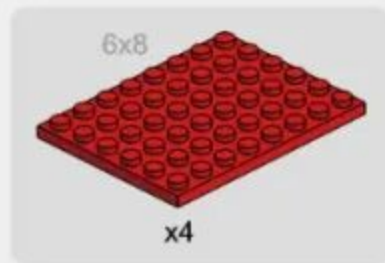

4-8

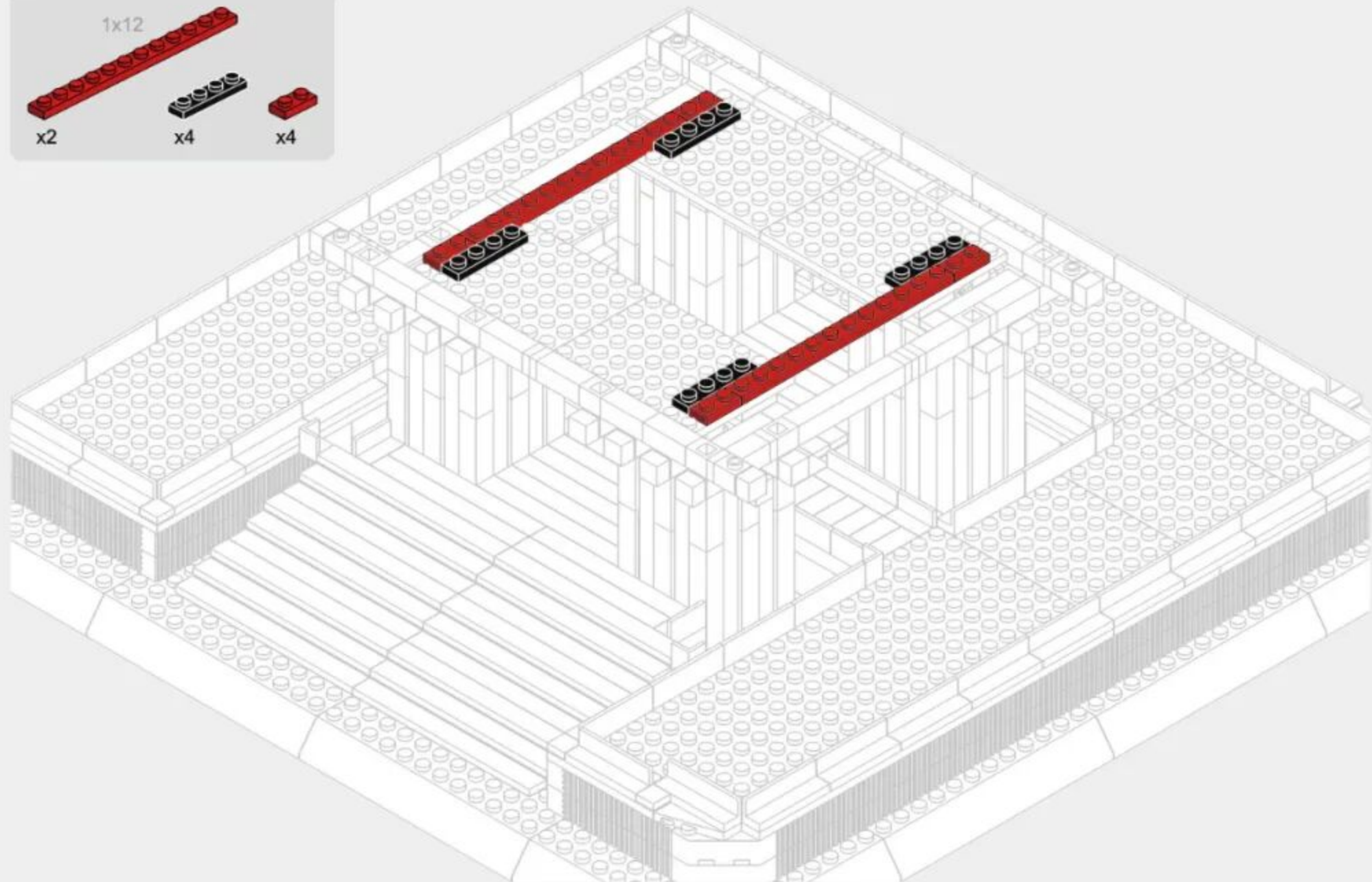
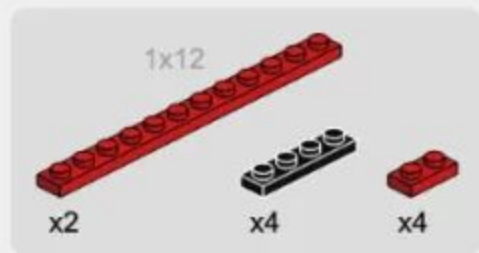

4-9

2x4



x4



x2

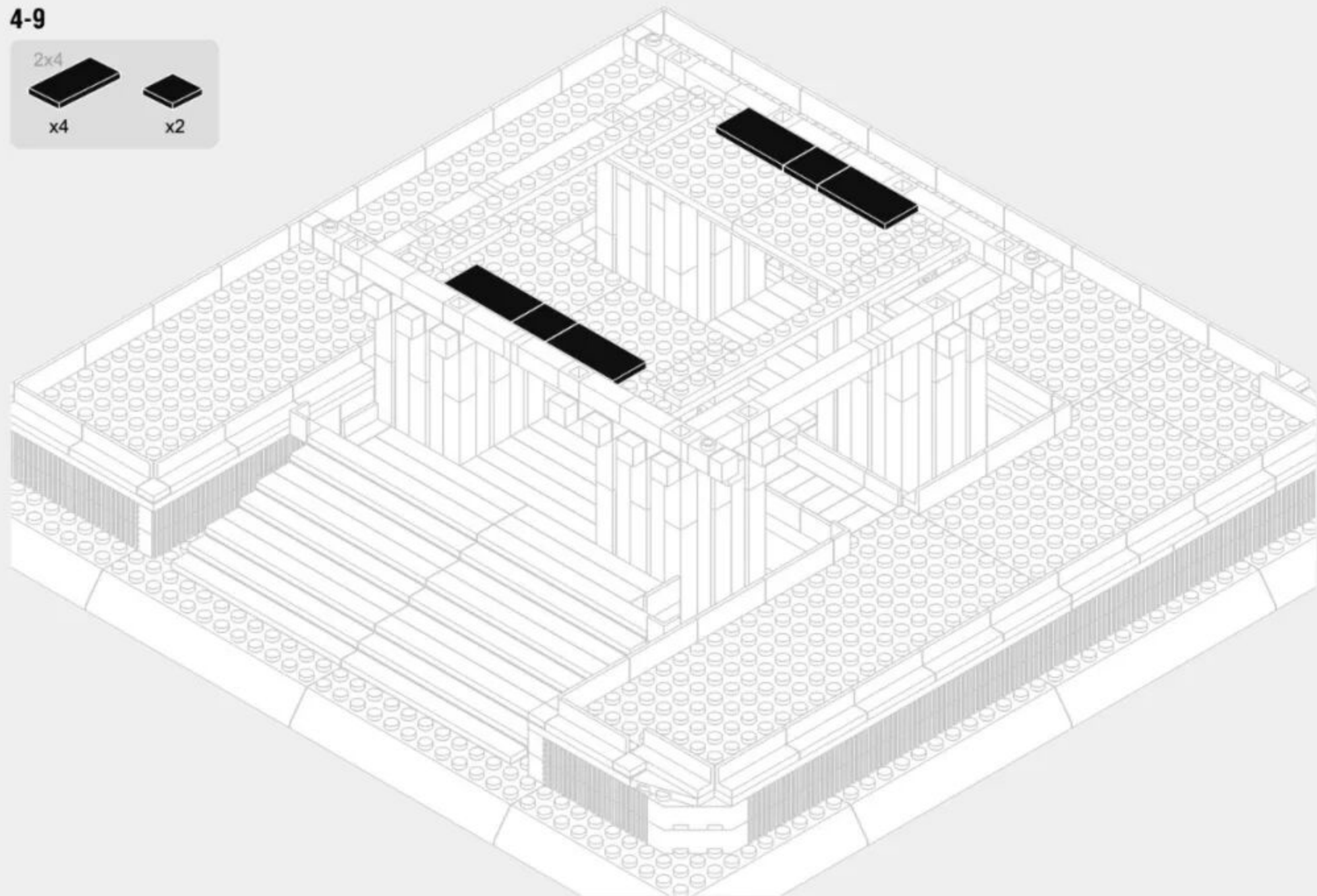

85

4-10

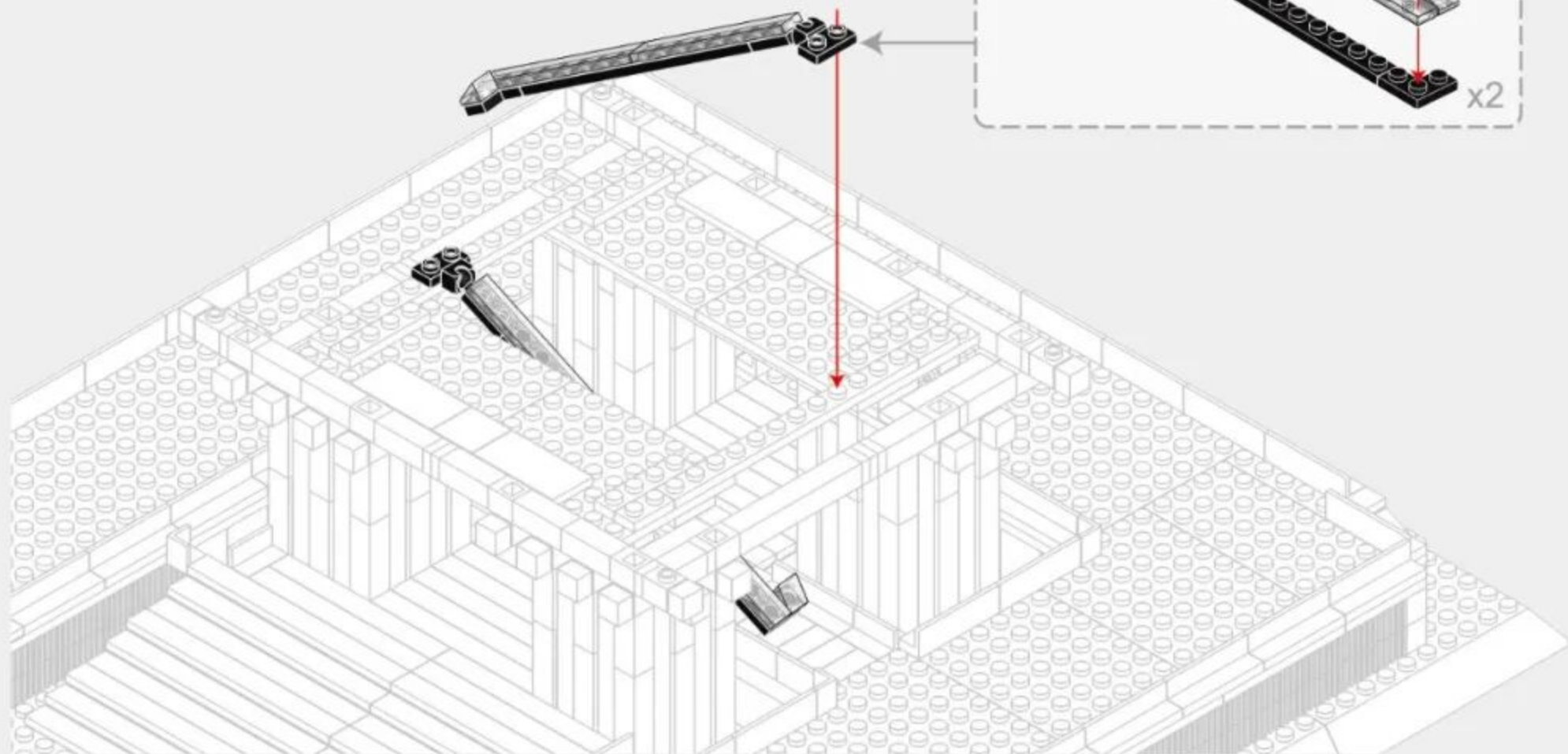

4-11

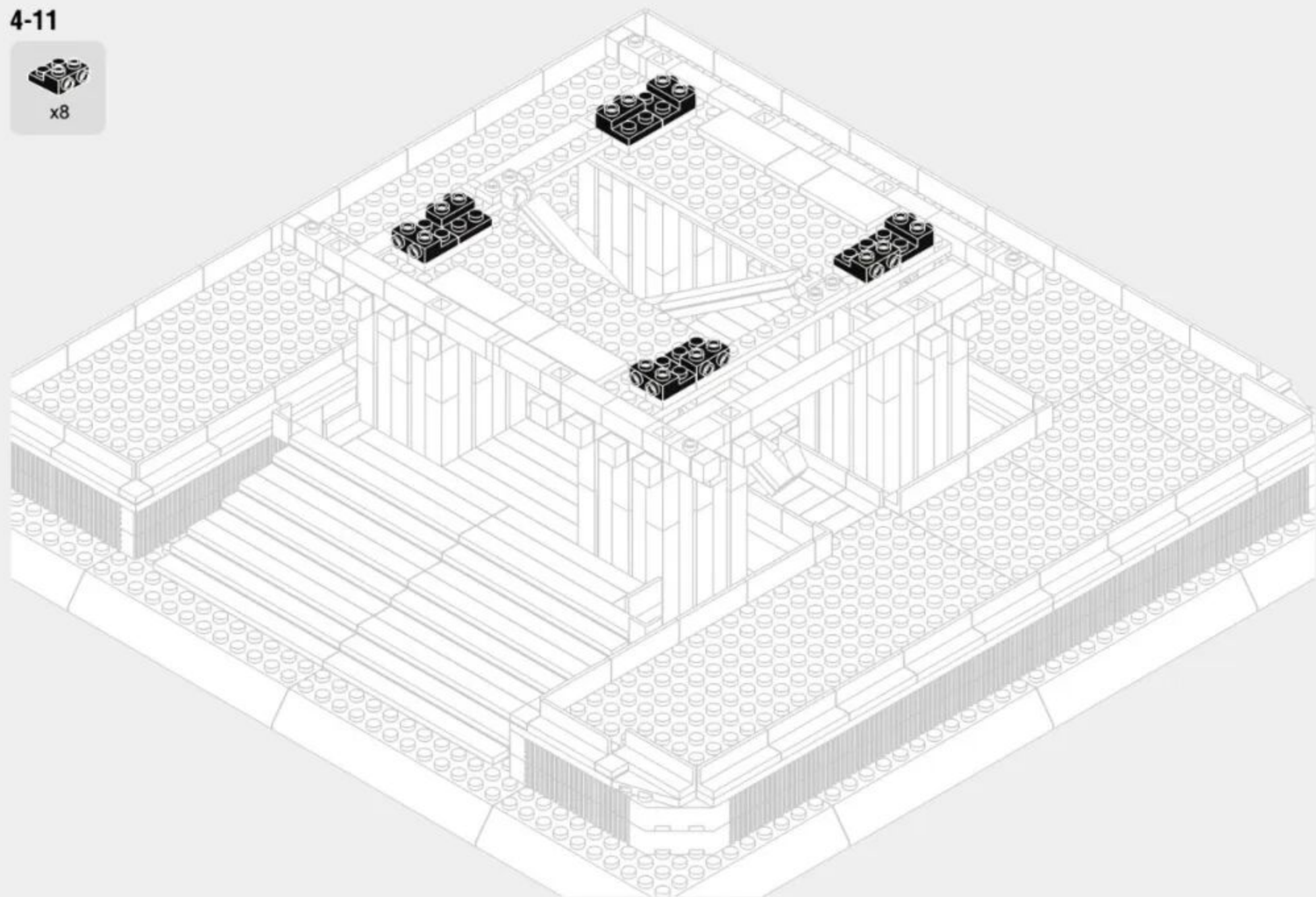

4-12

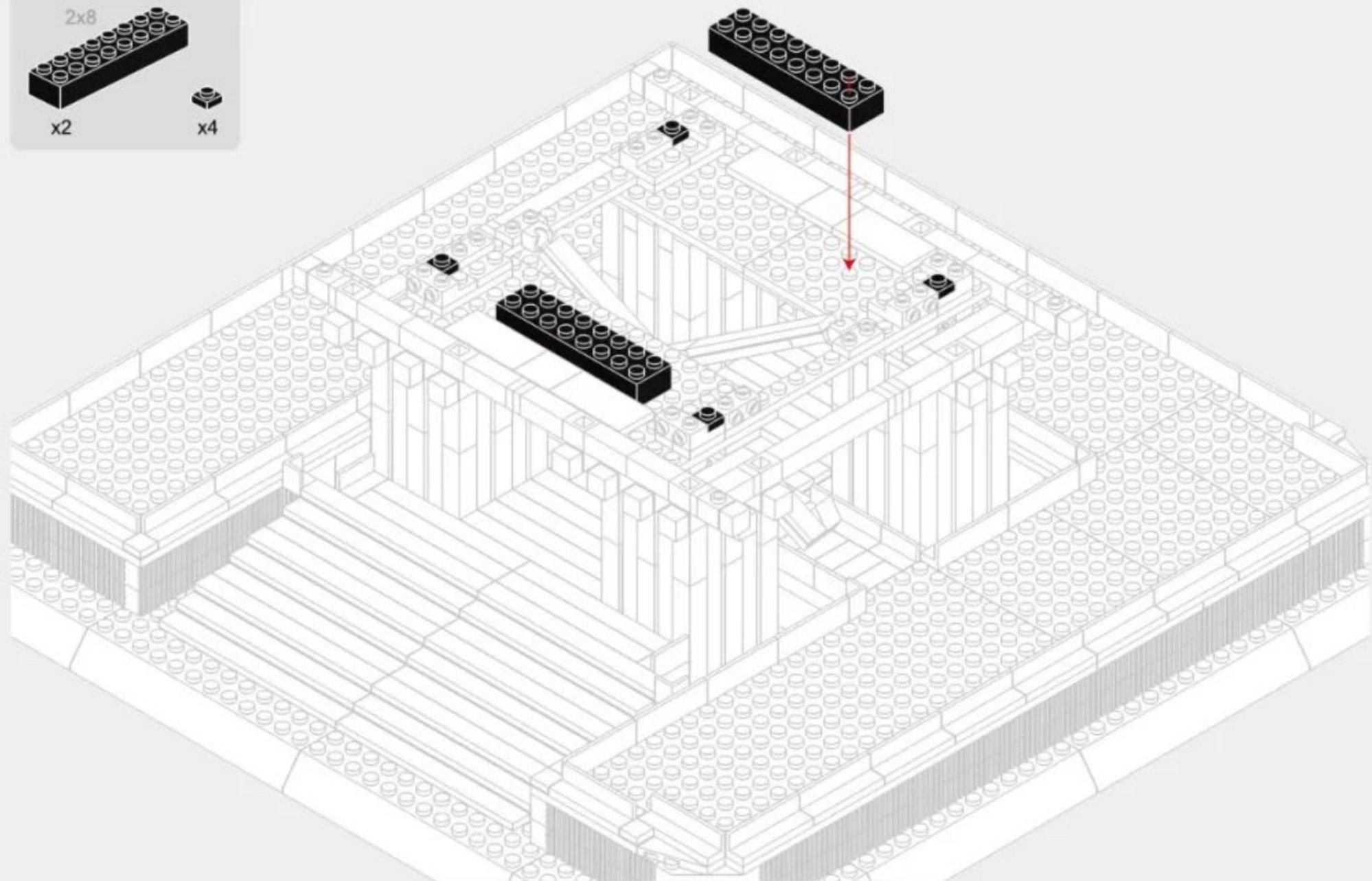
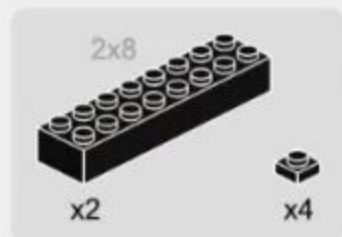

4-13

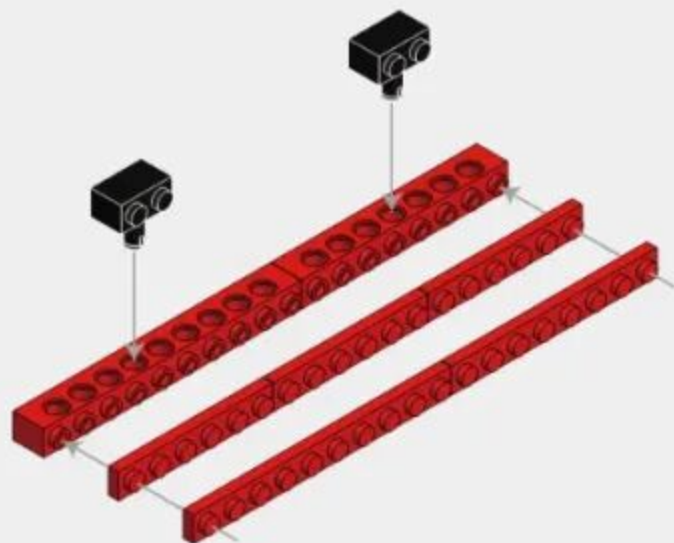
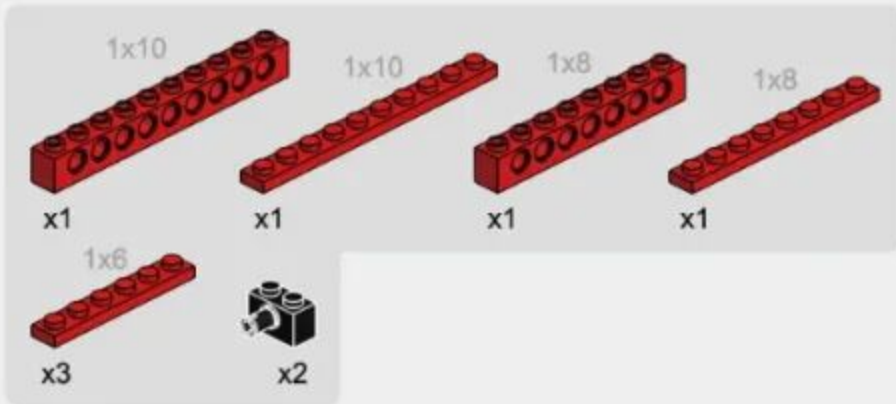

4-14

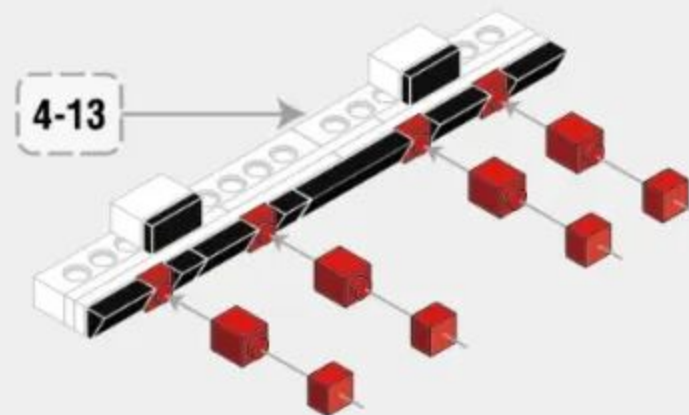

4-15

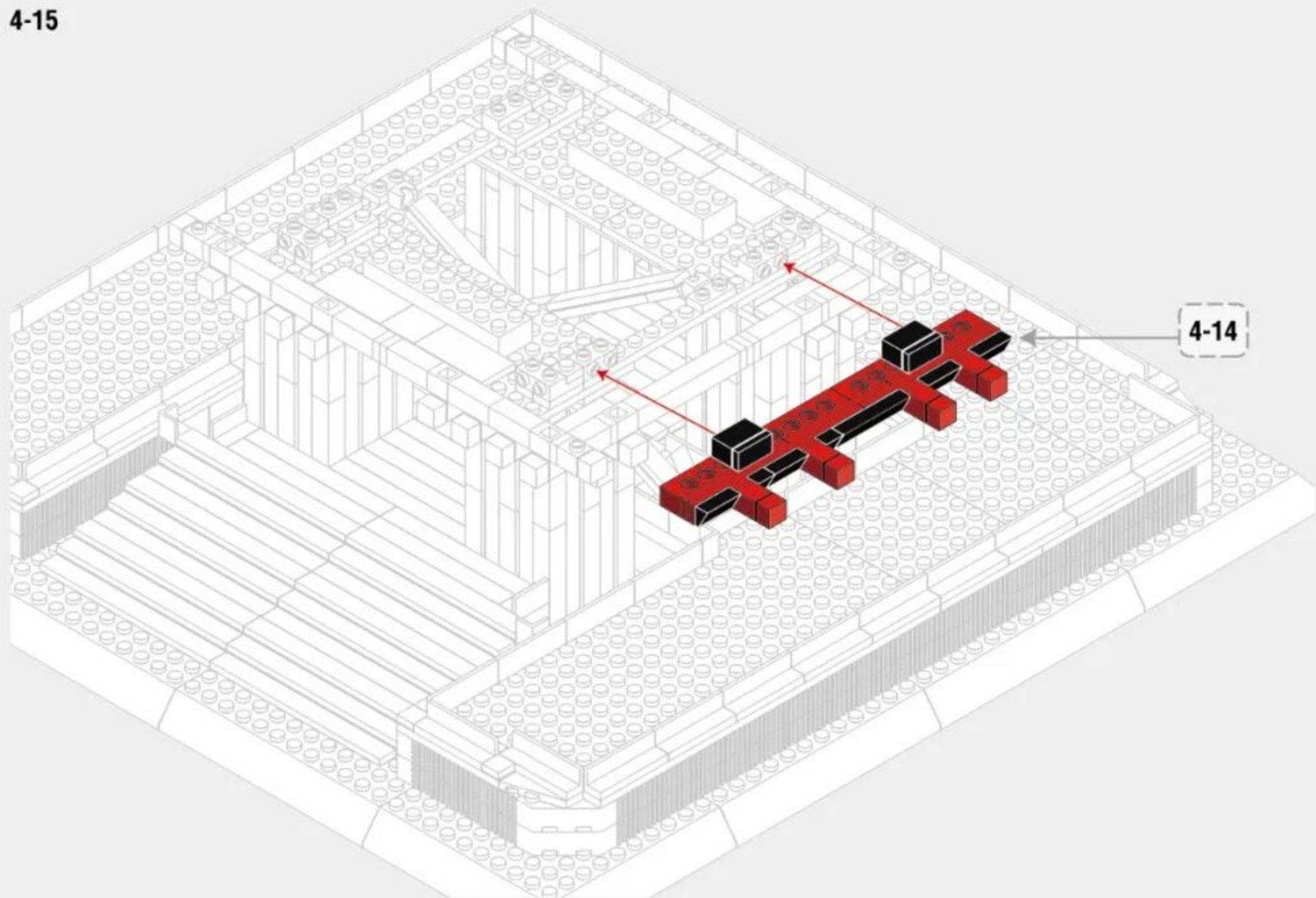

4-14

4-16

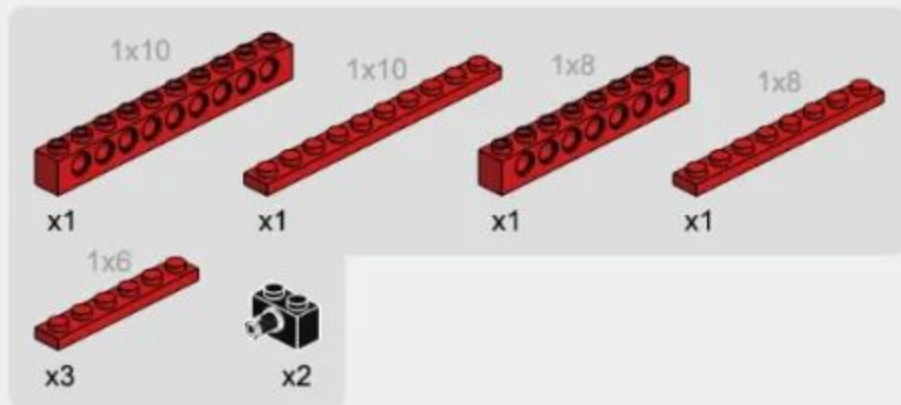

4-17

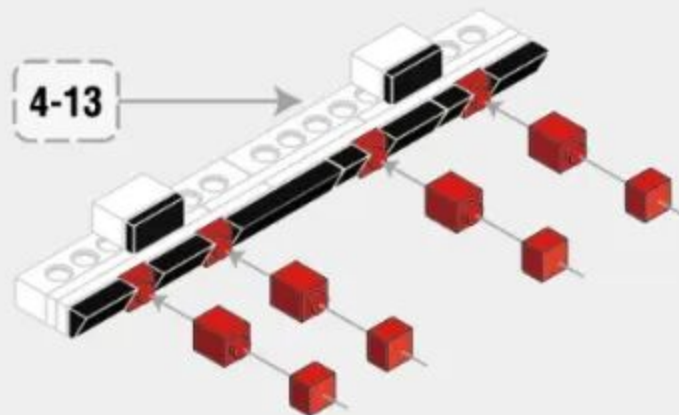

4-18

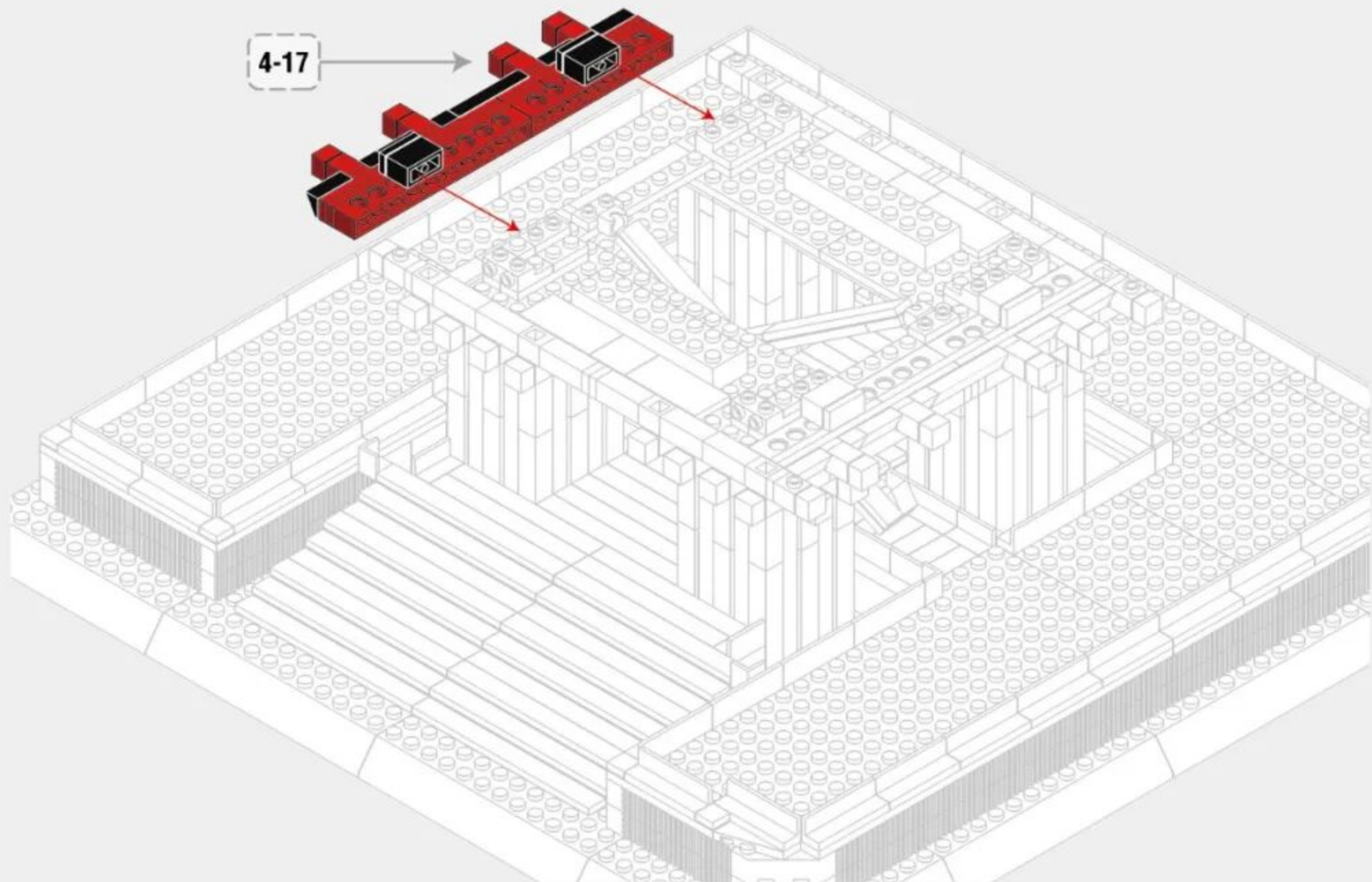

4-19

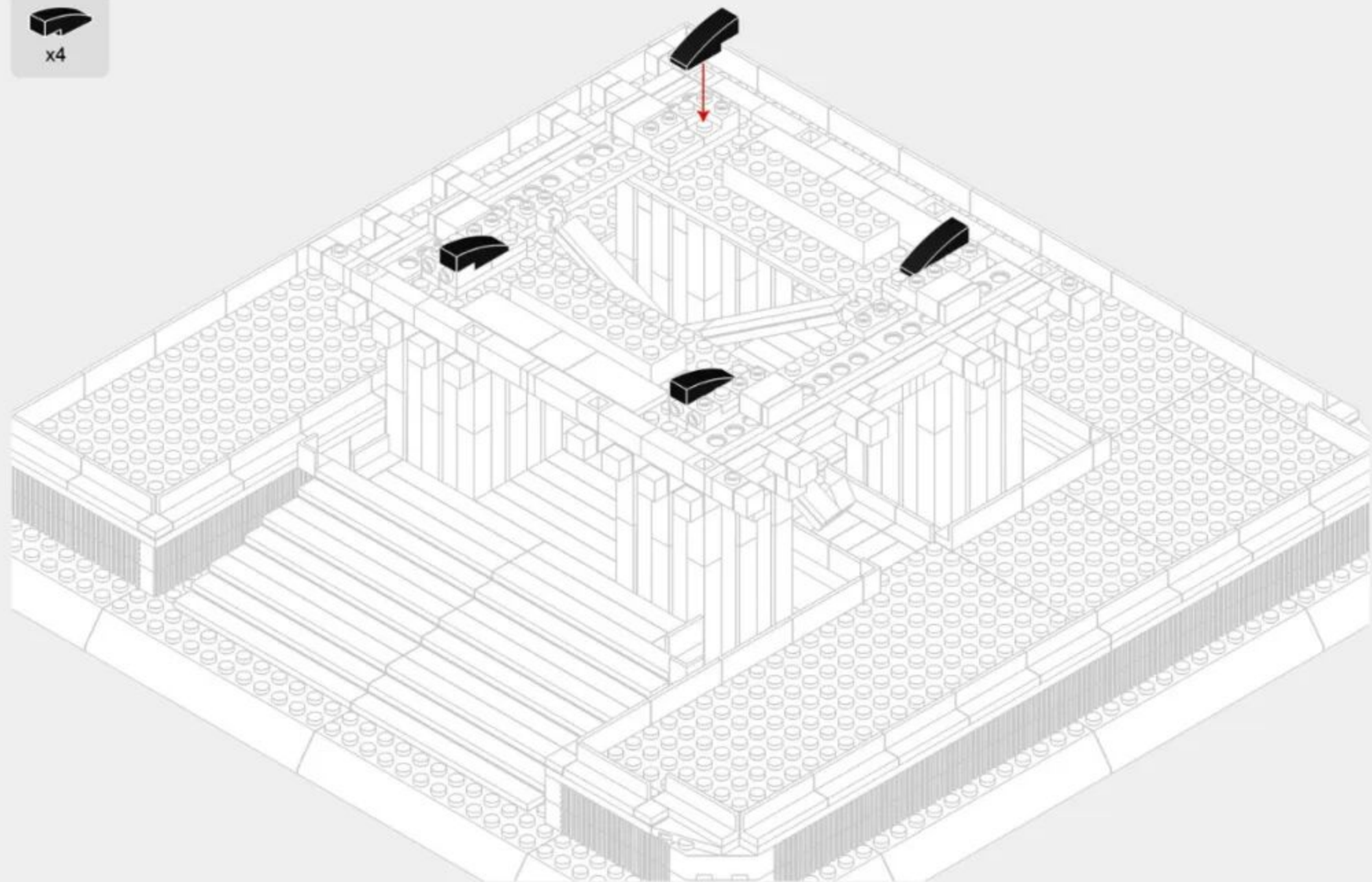

4-20

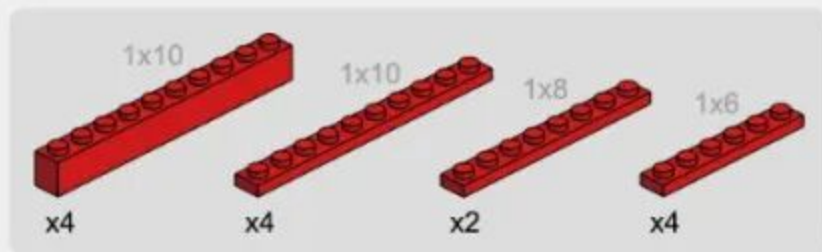

4-21

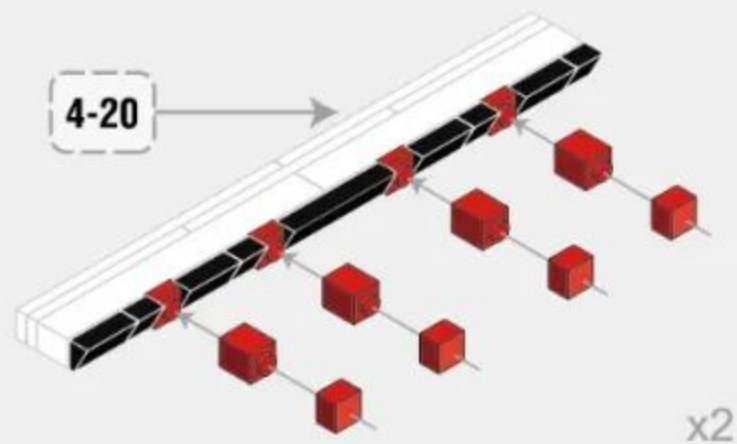

4-22

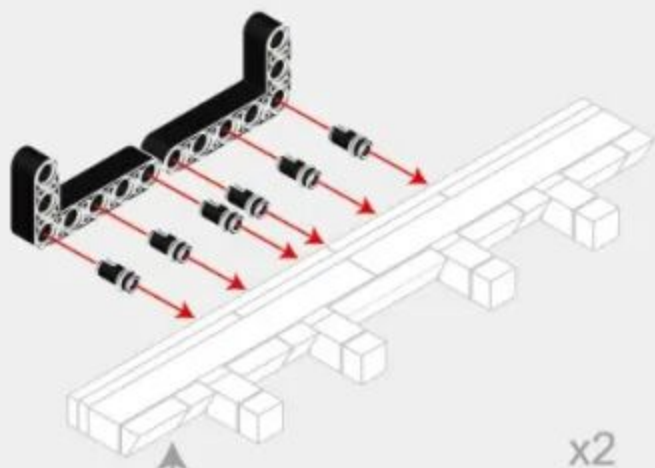

4-21

4-23

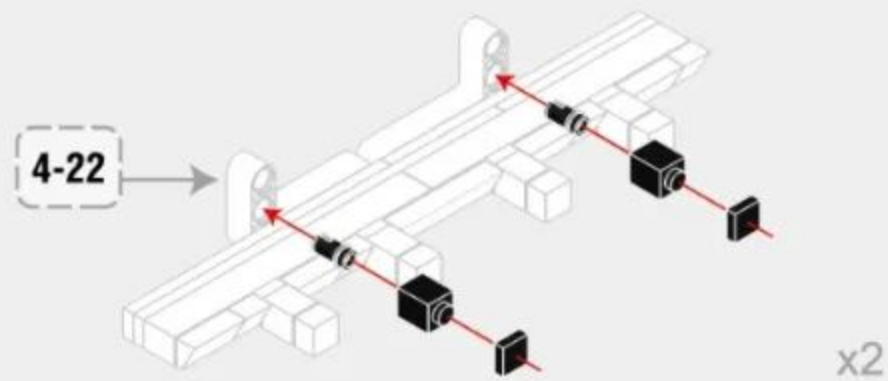

4-22

4-24

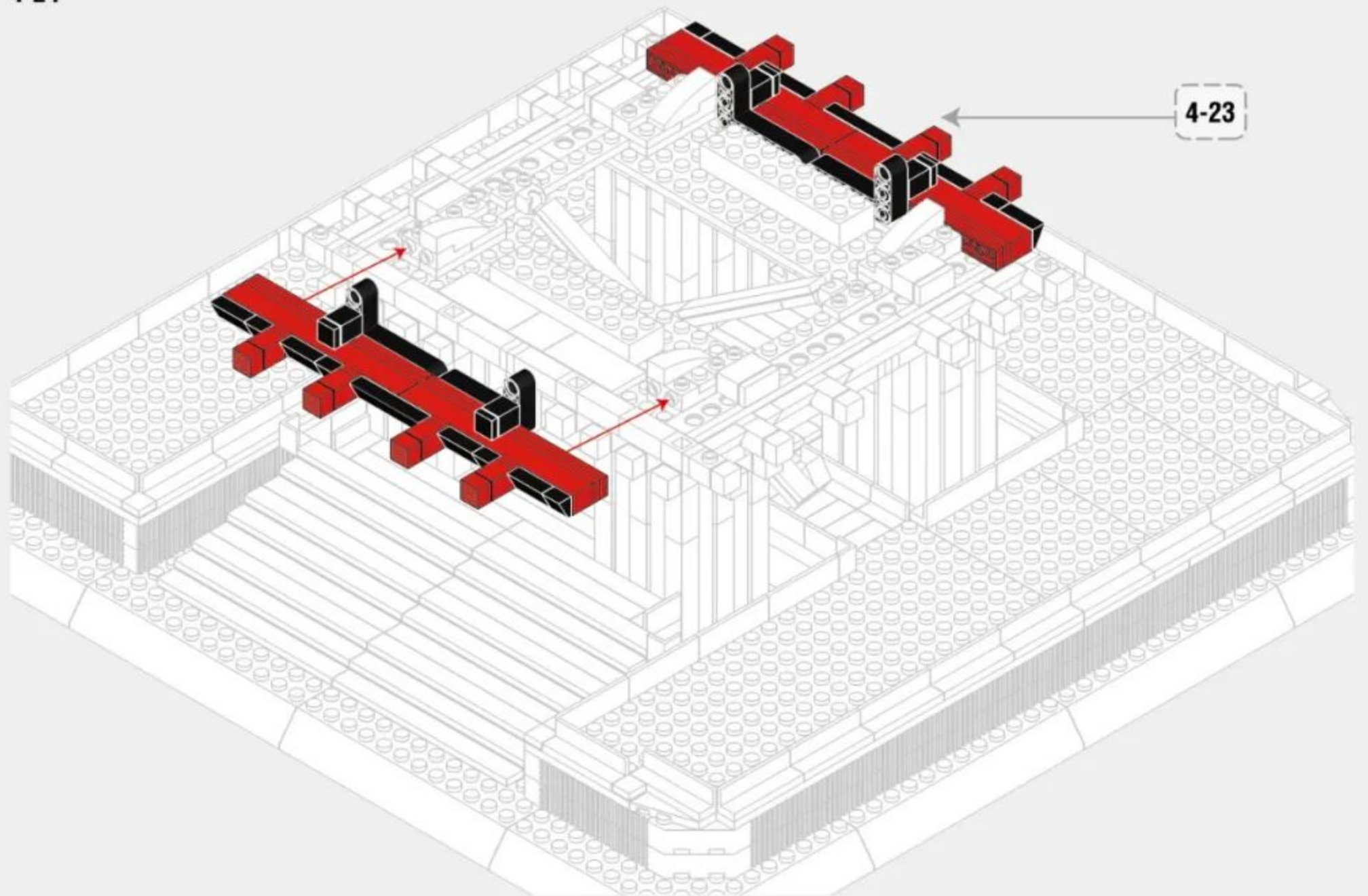

4-23



274PCS

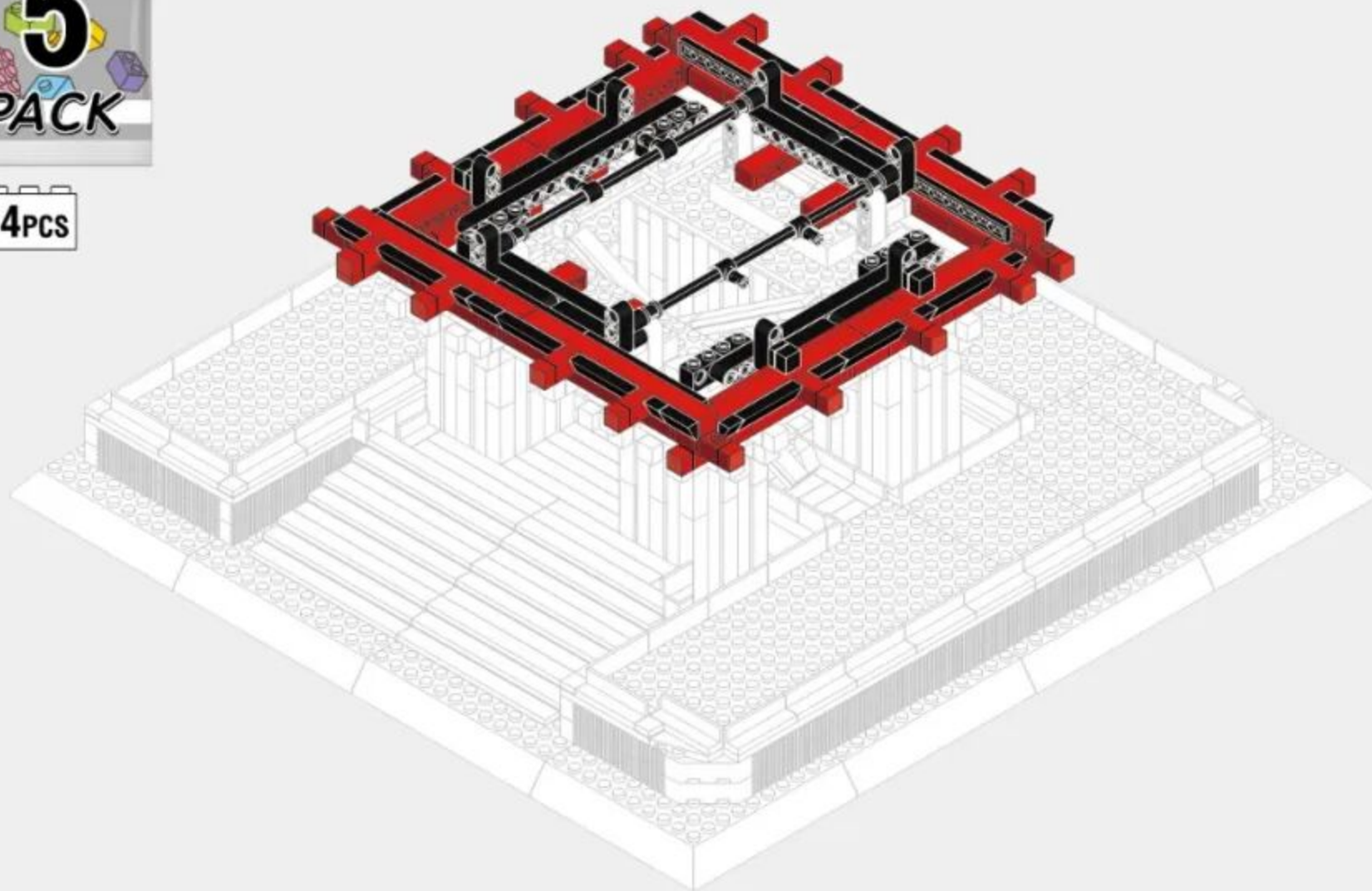

5-1

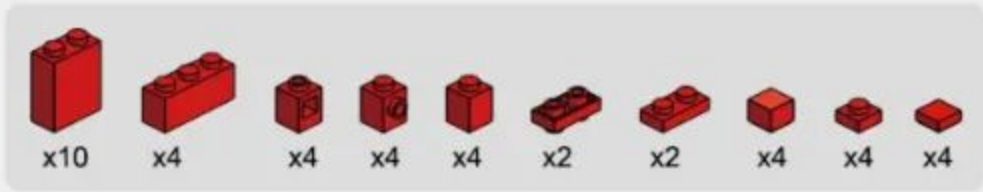

1

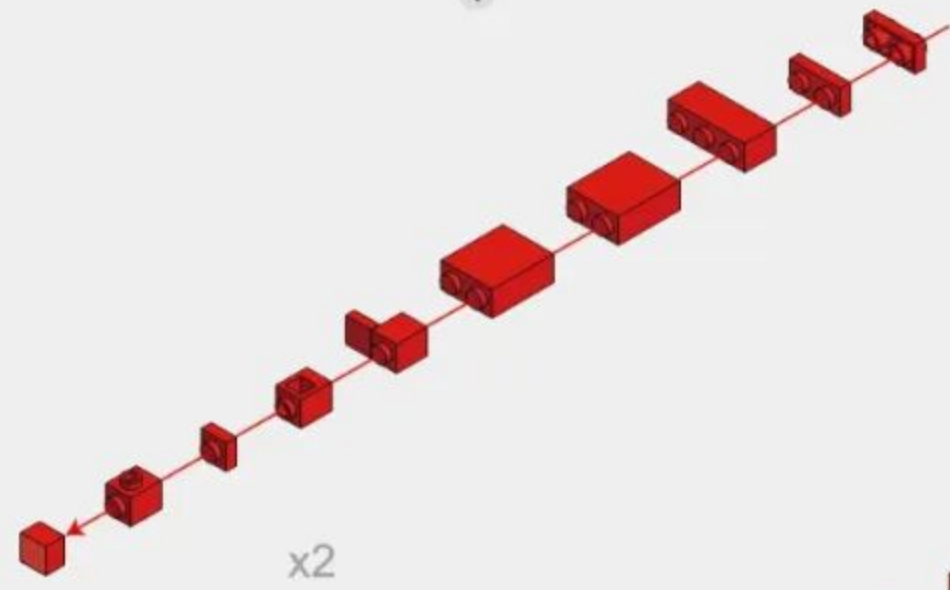

2

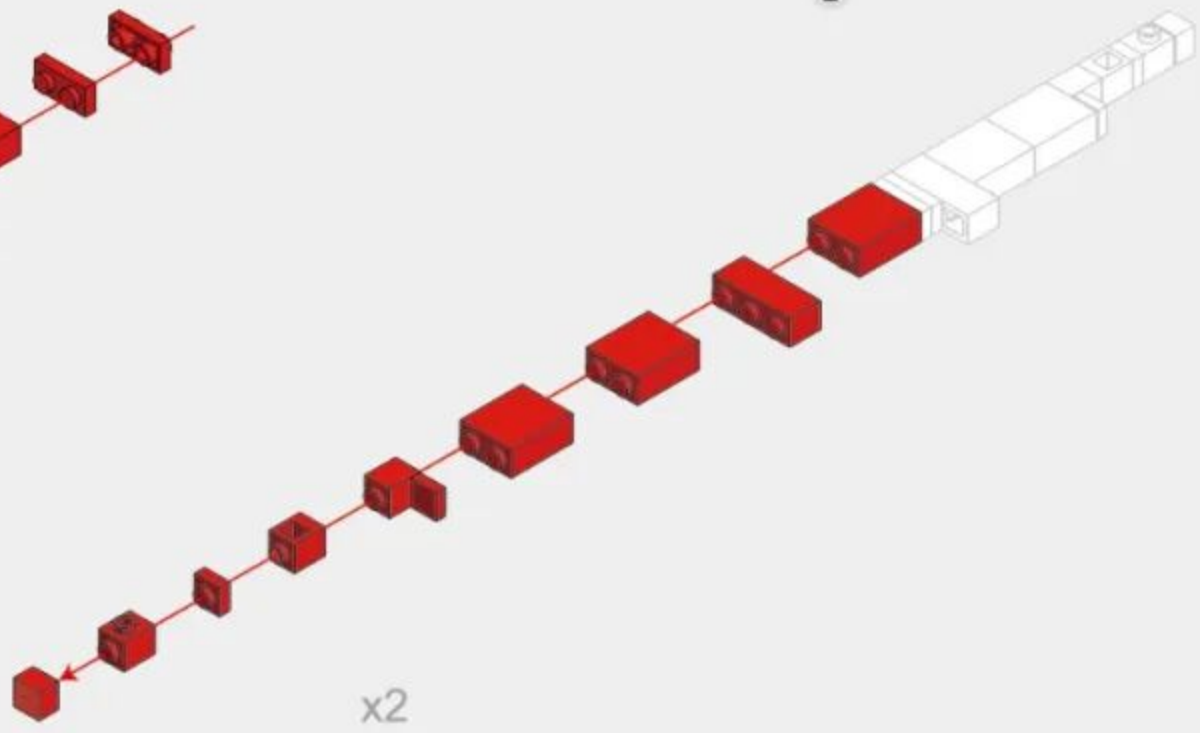

5-2

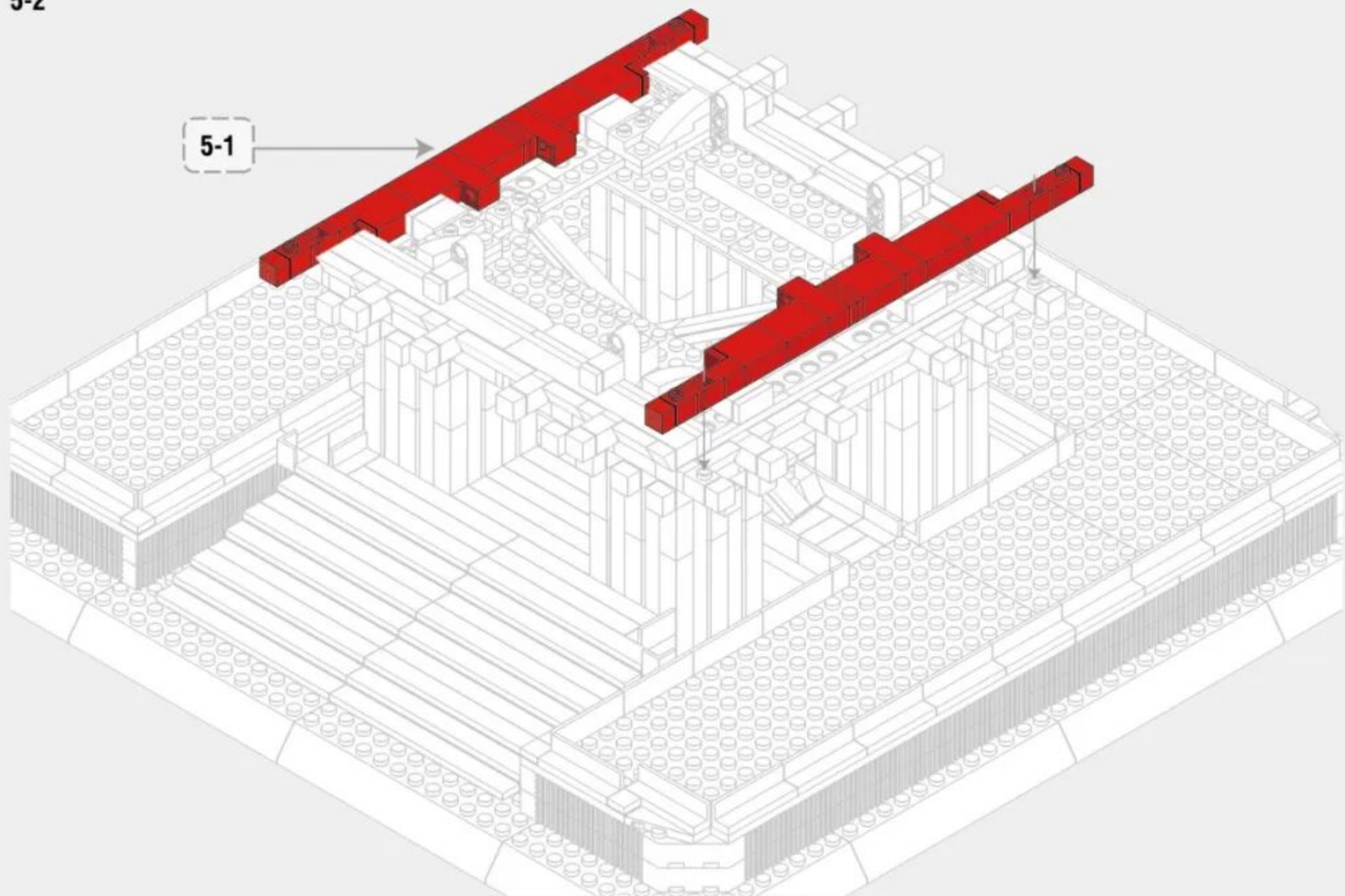

5-3

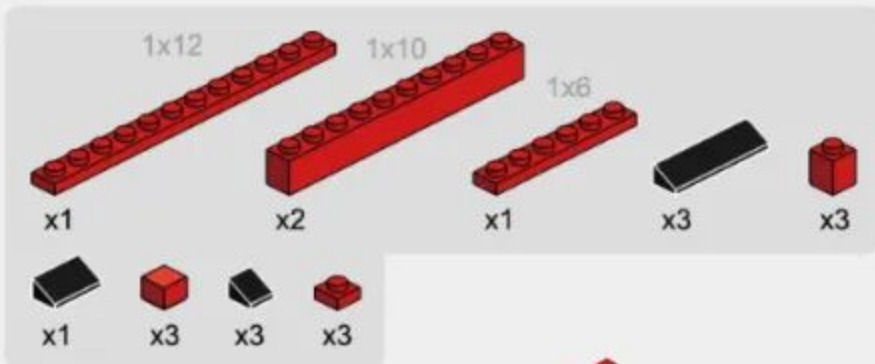

1



2

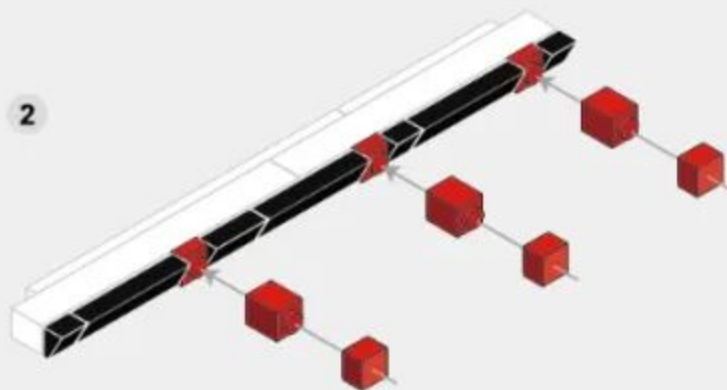

5-4

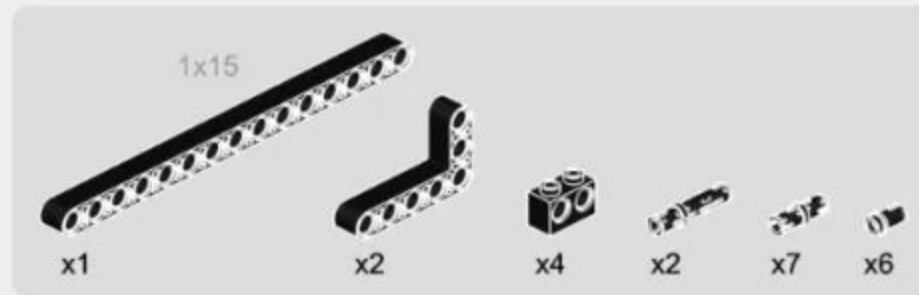

1

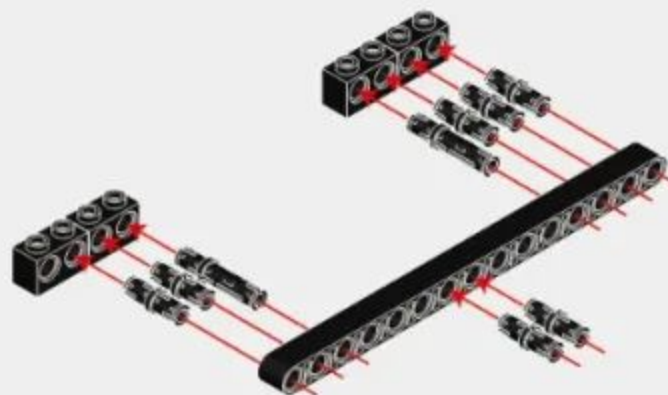

2

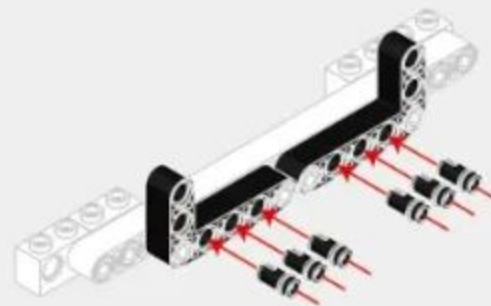

5-5

5-6

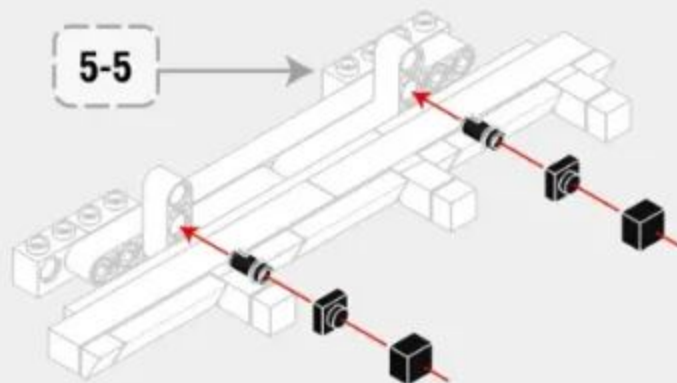
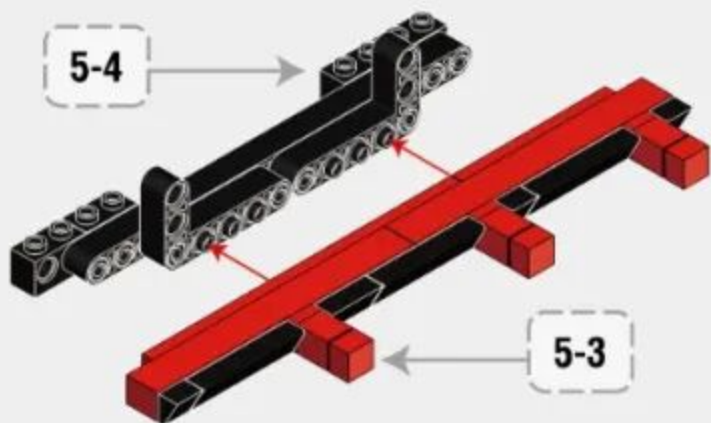

5-7

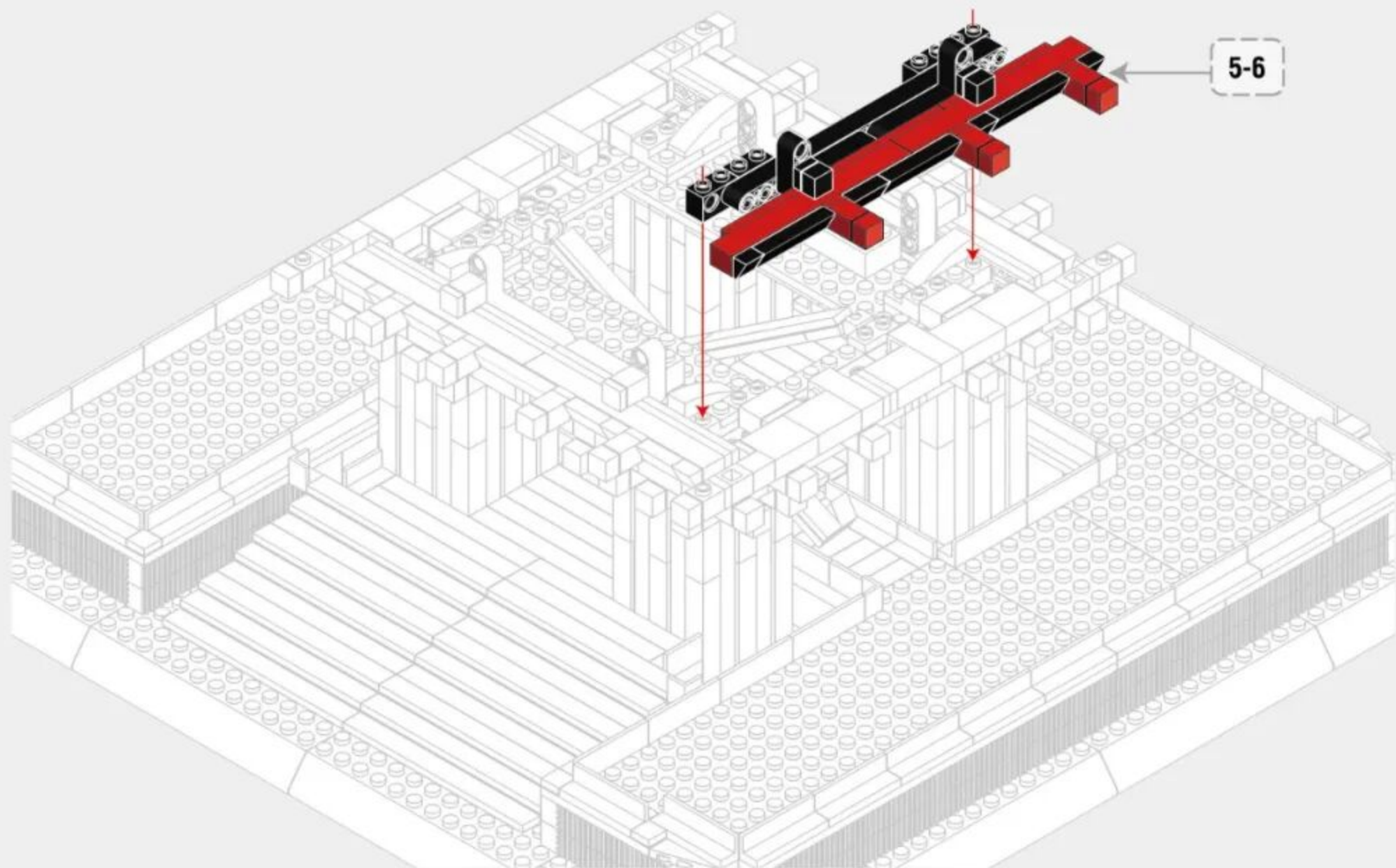

102

5-8

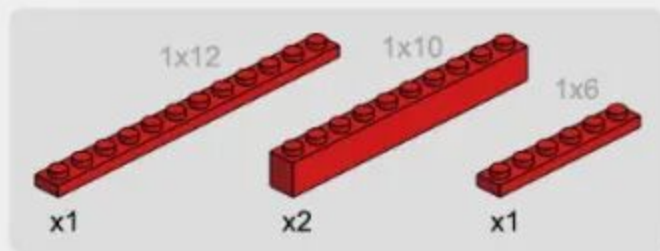

5-9

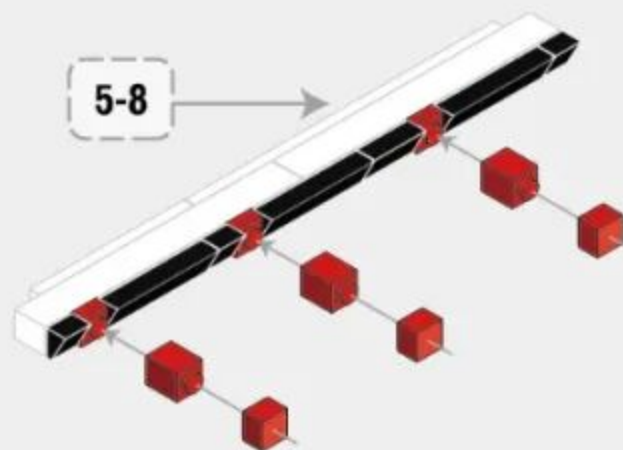

5-10

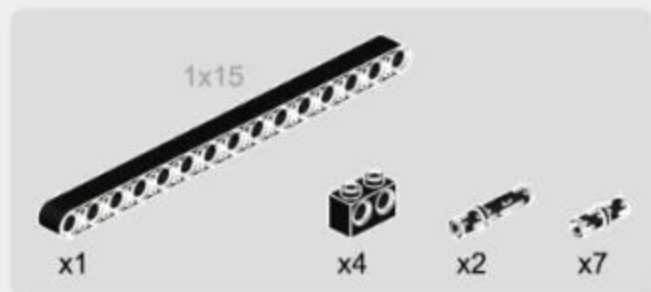

5-11

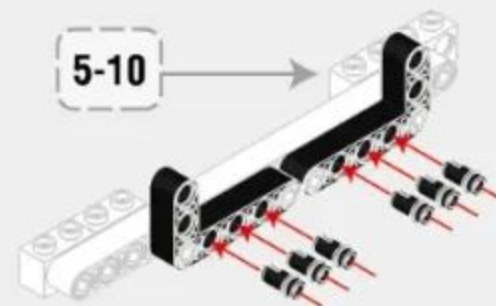
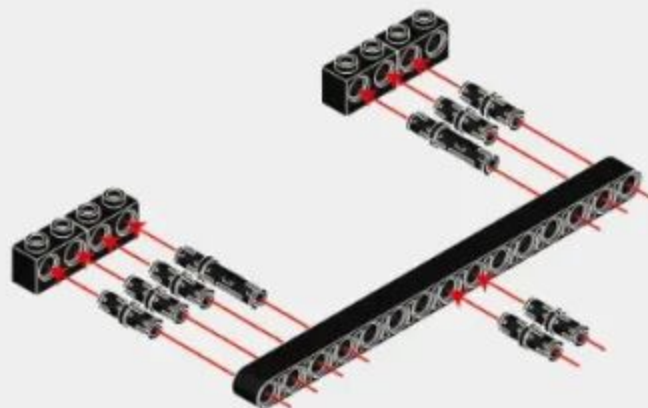

5-12

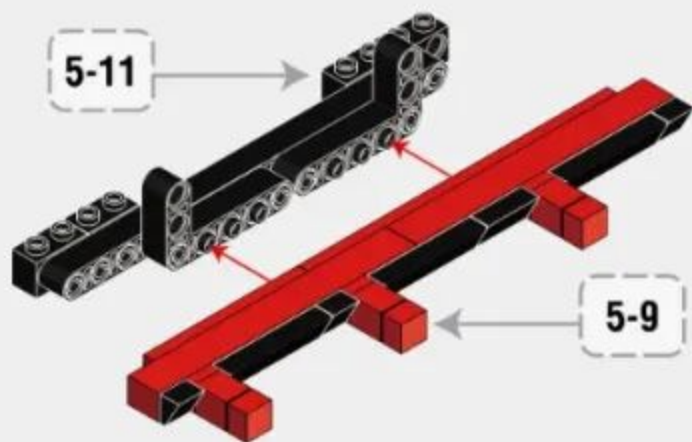

5-13

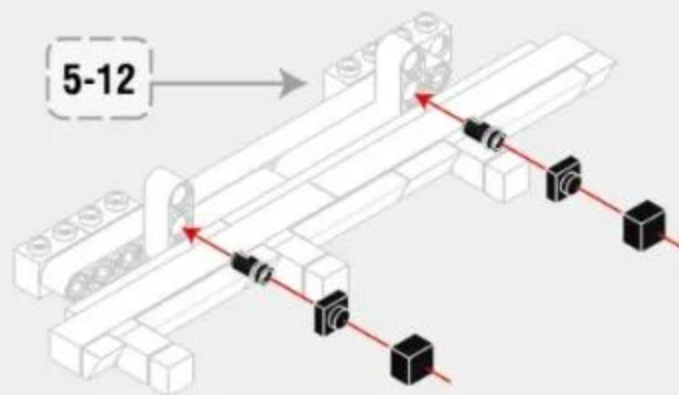

5-14

5-13

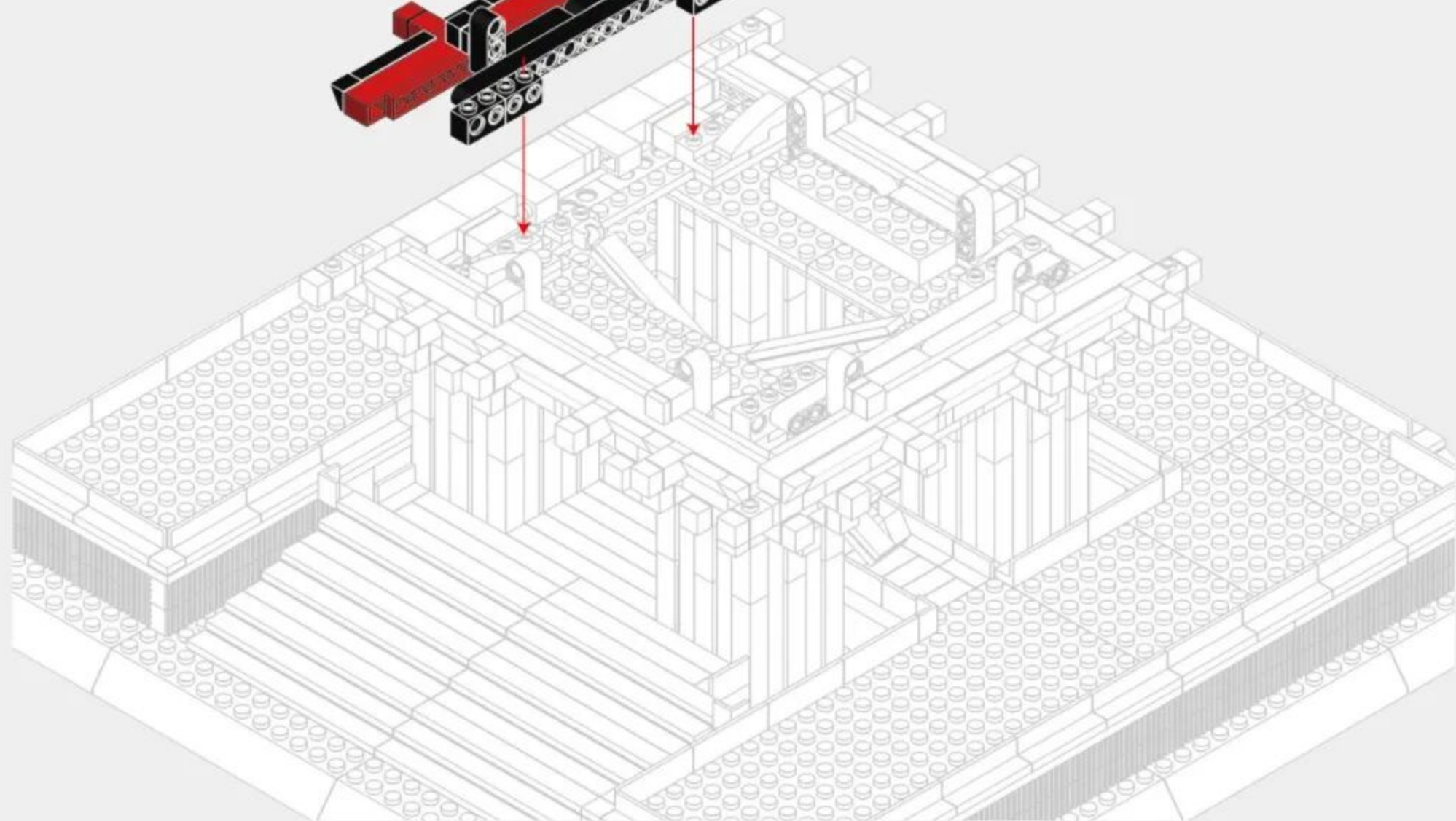
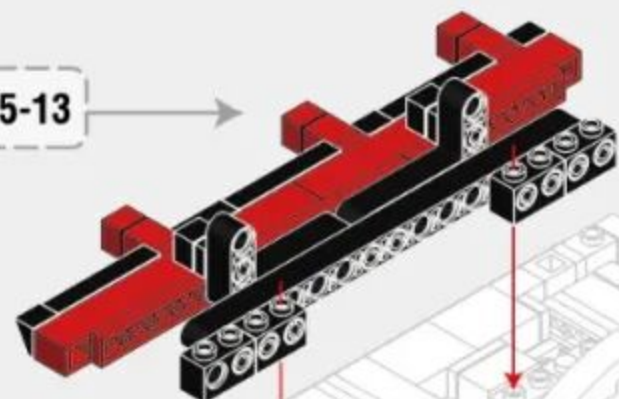

5-15

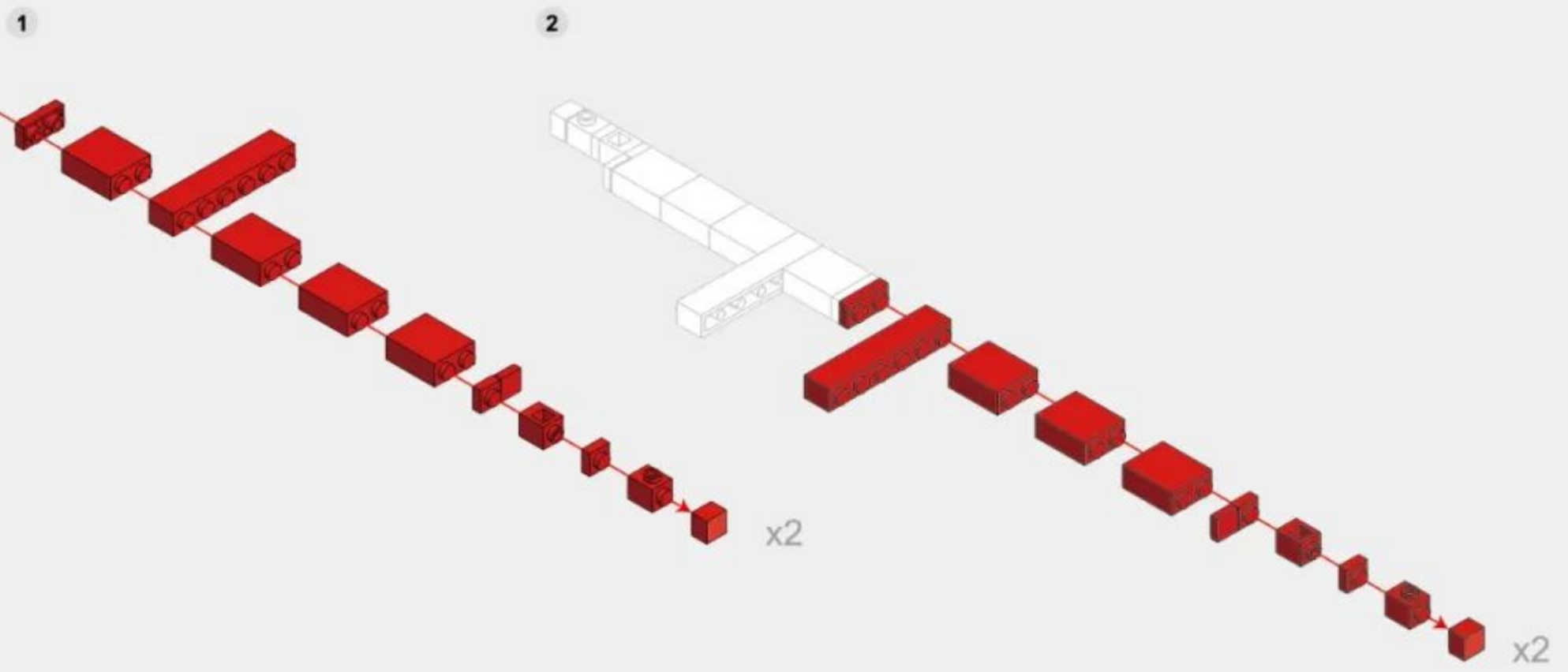

5-16

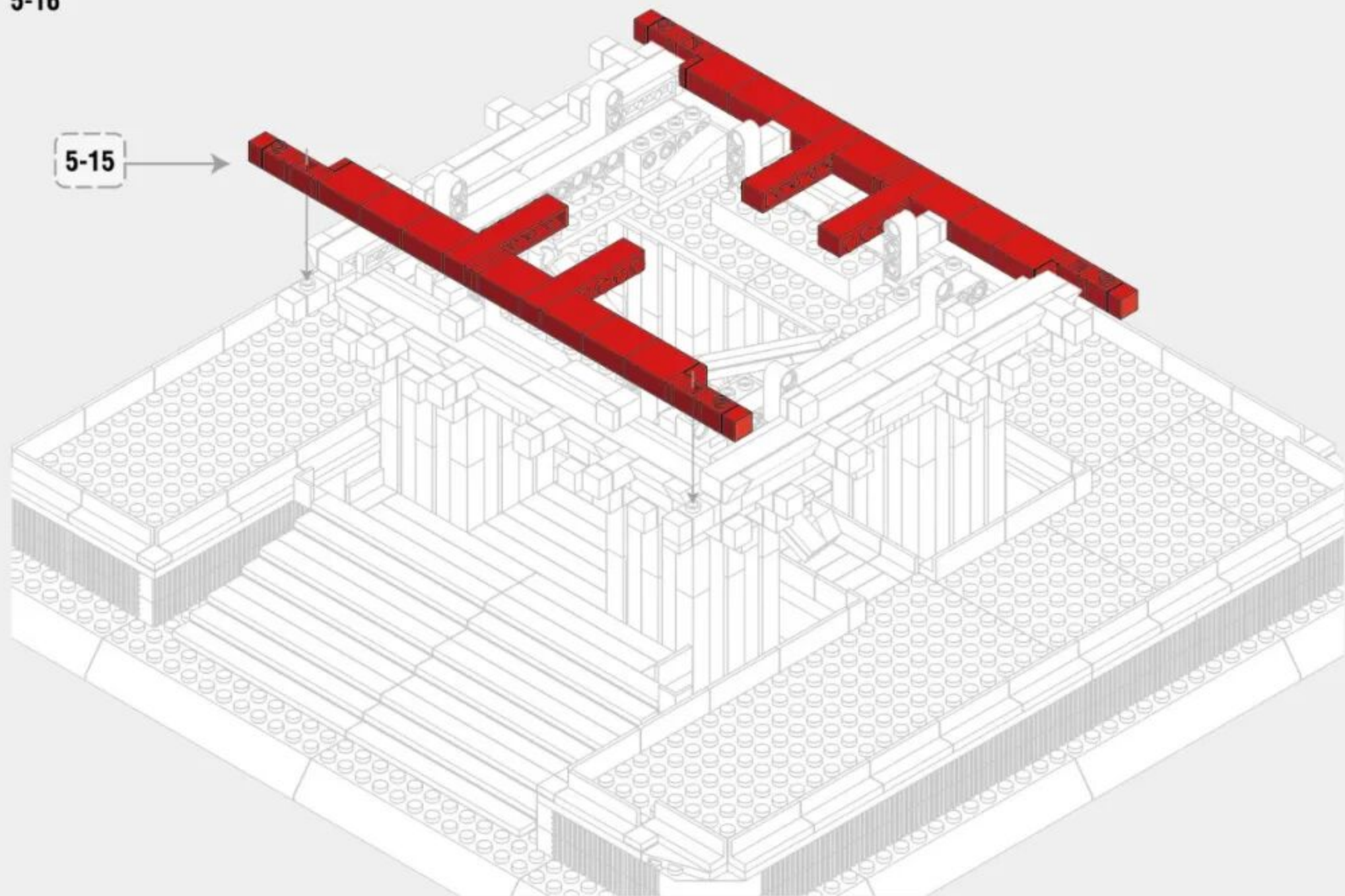

5-15

5-17

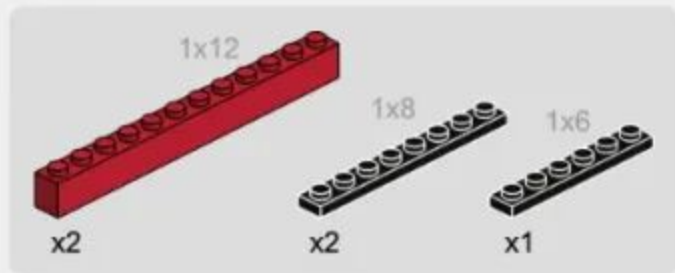

5-18

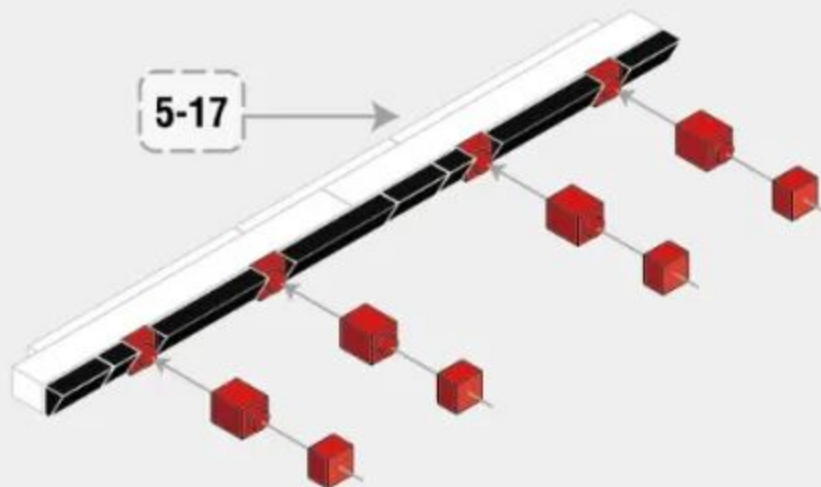

5-19



1



2

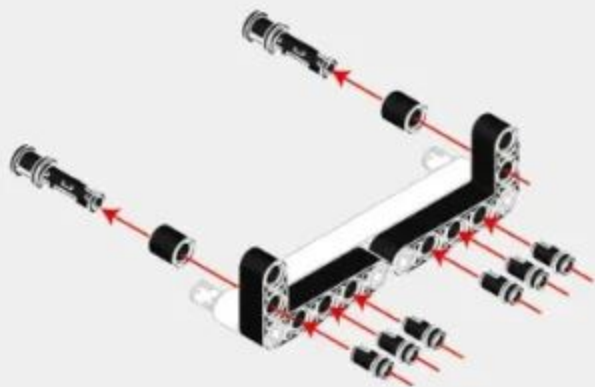

5-20

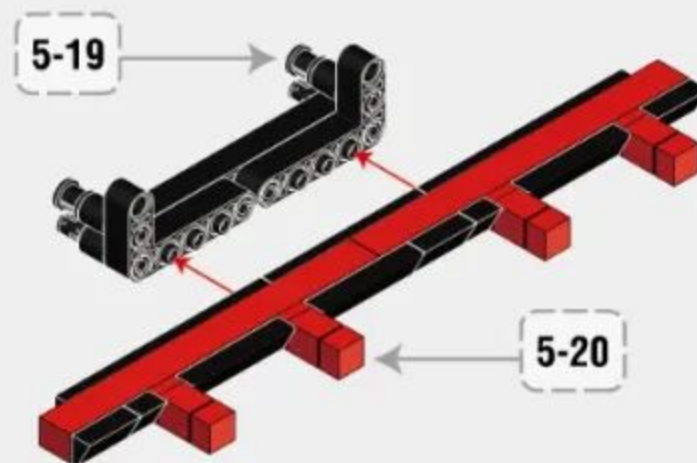

5-21

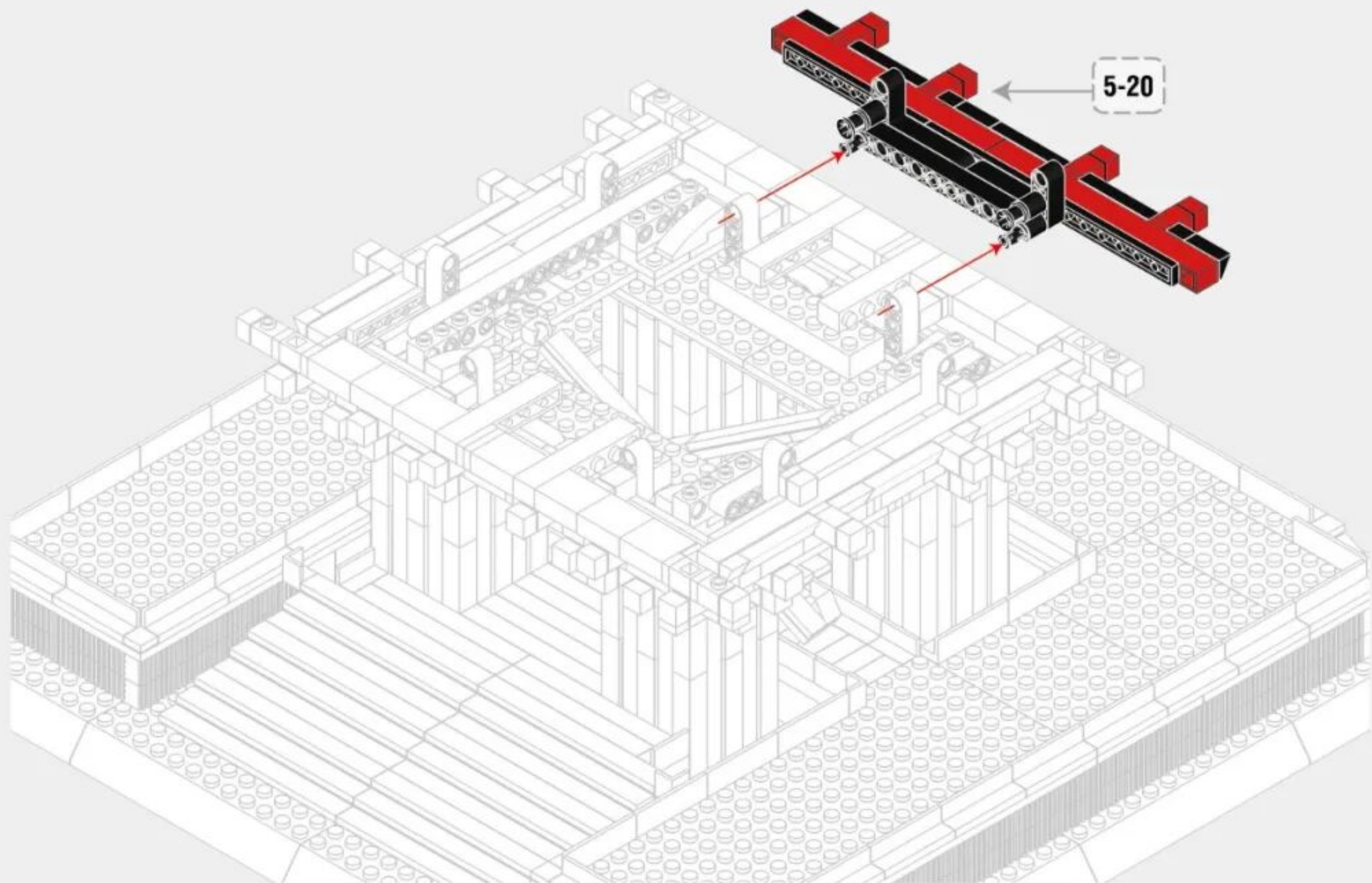

5-22

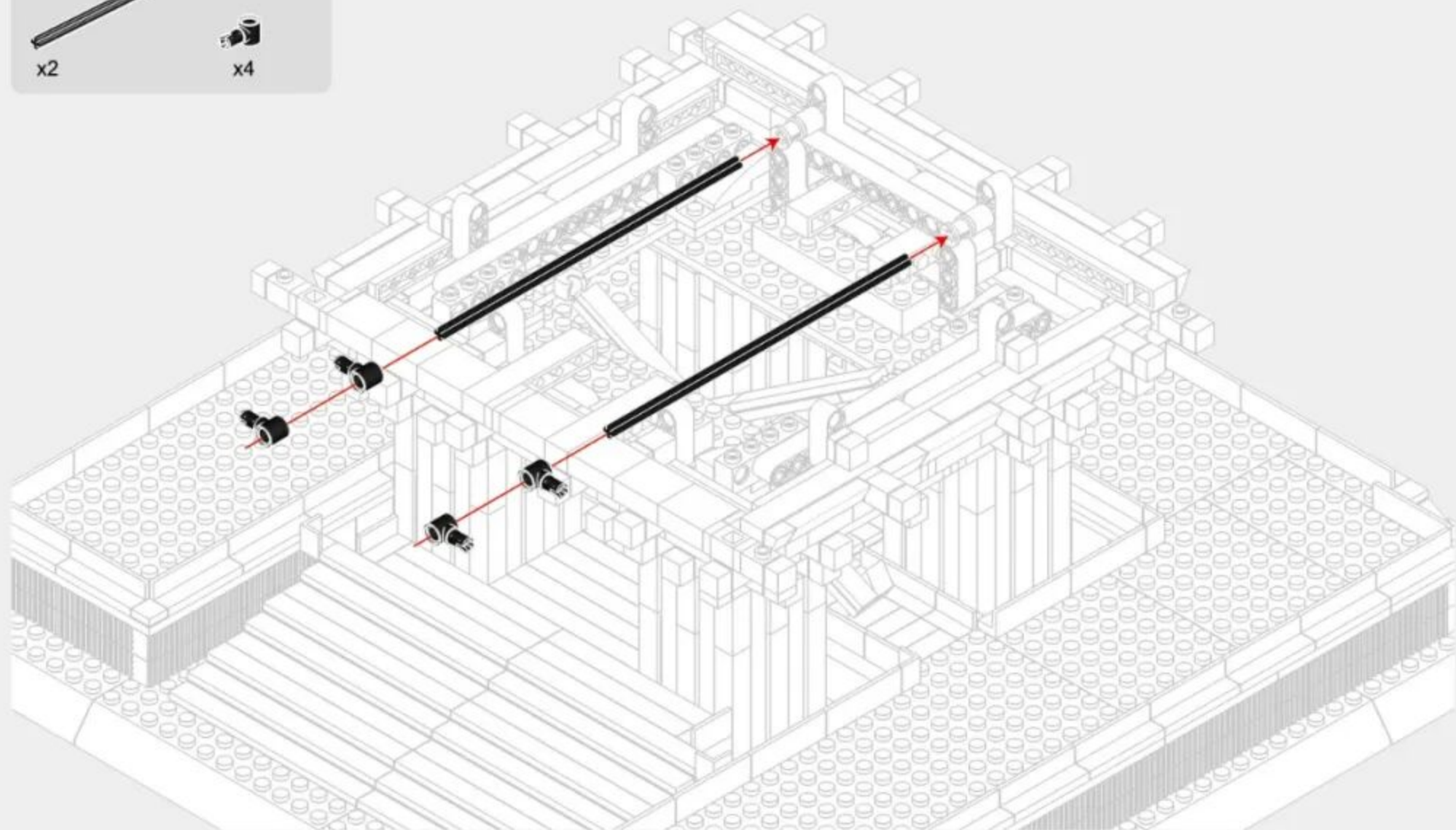

5-23

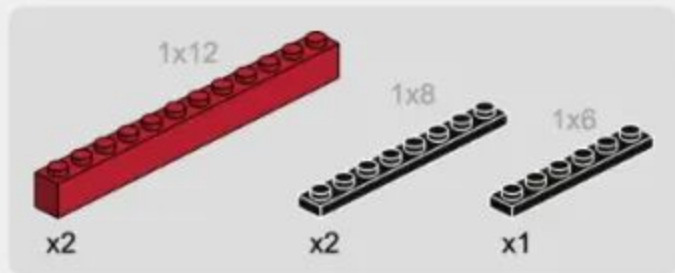

5-24

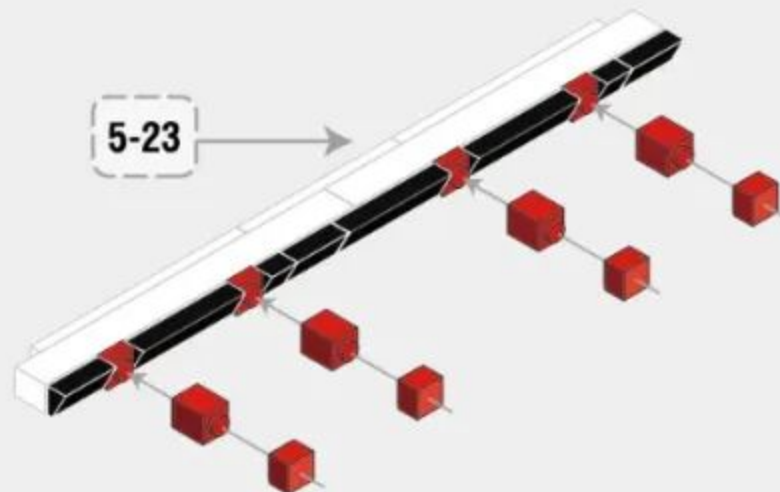

5-25



1



2

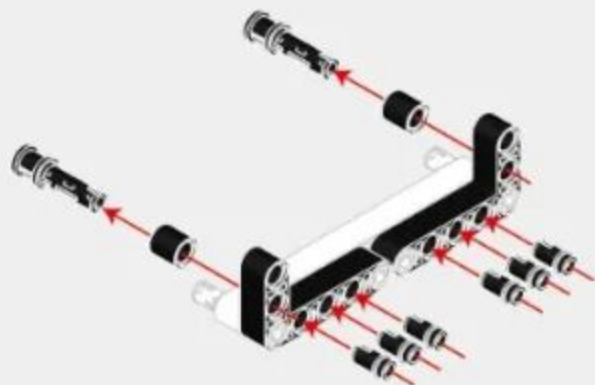

5-26

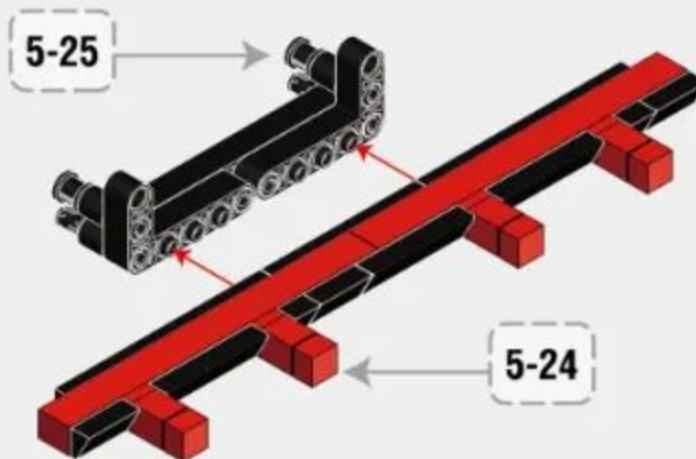

5-27

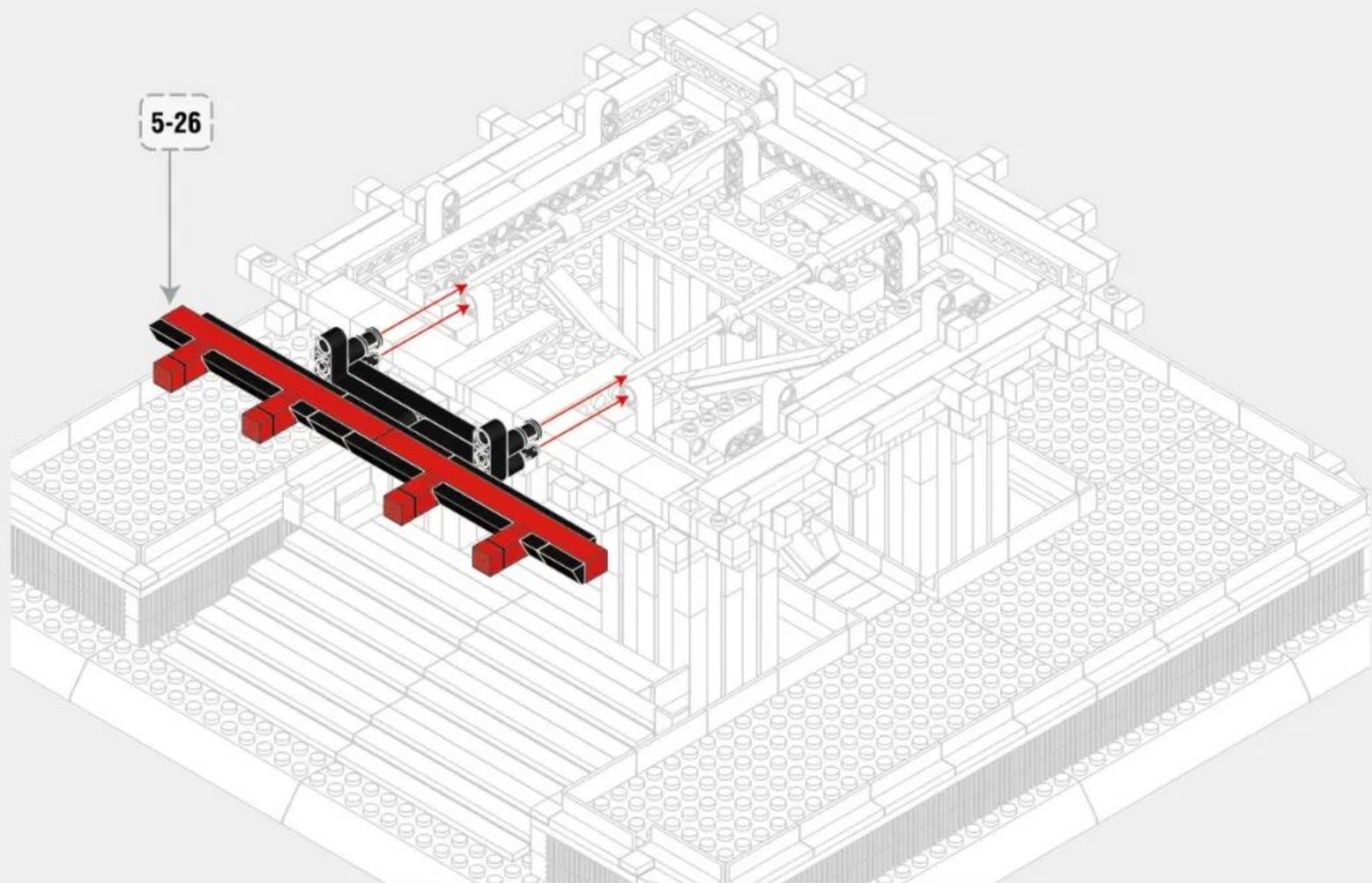



220PCS

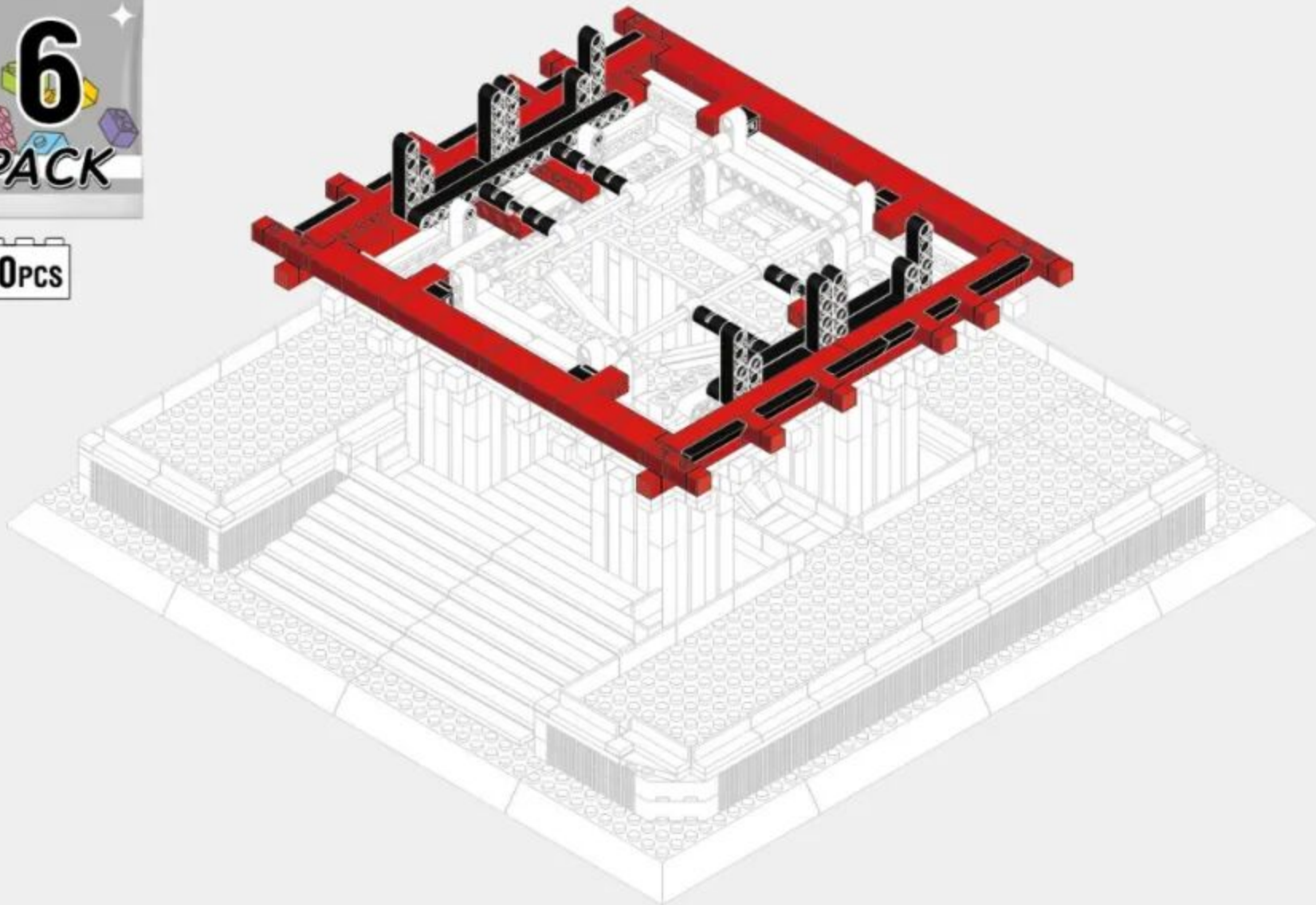

6-1

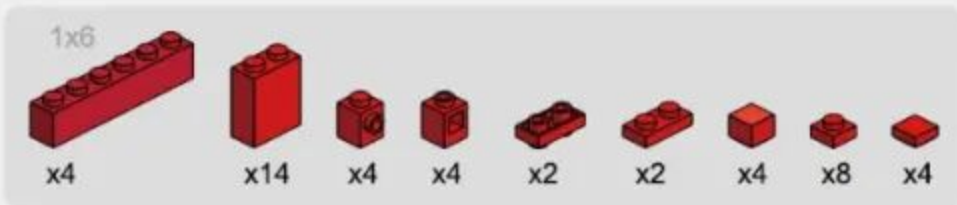

1

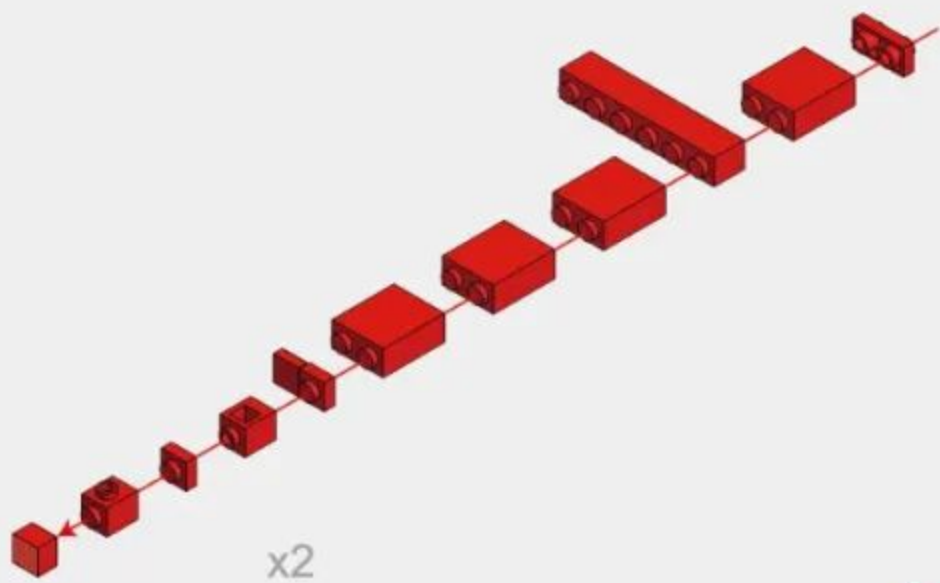

2

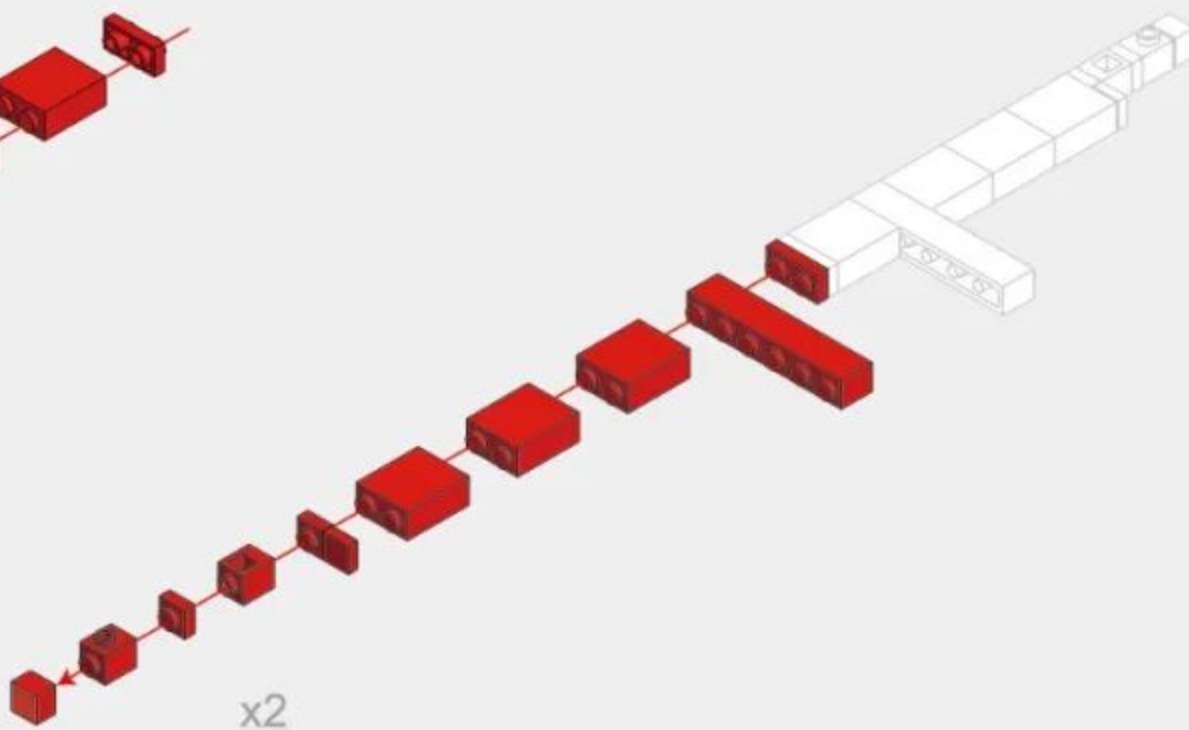

6-2

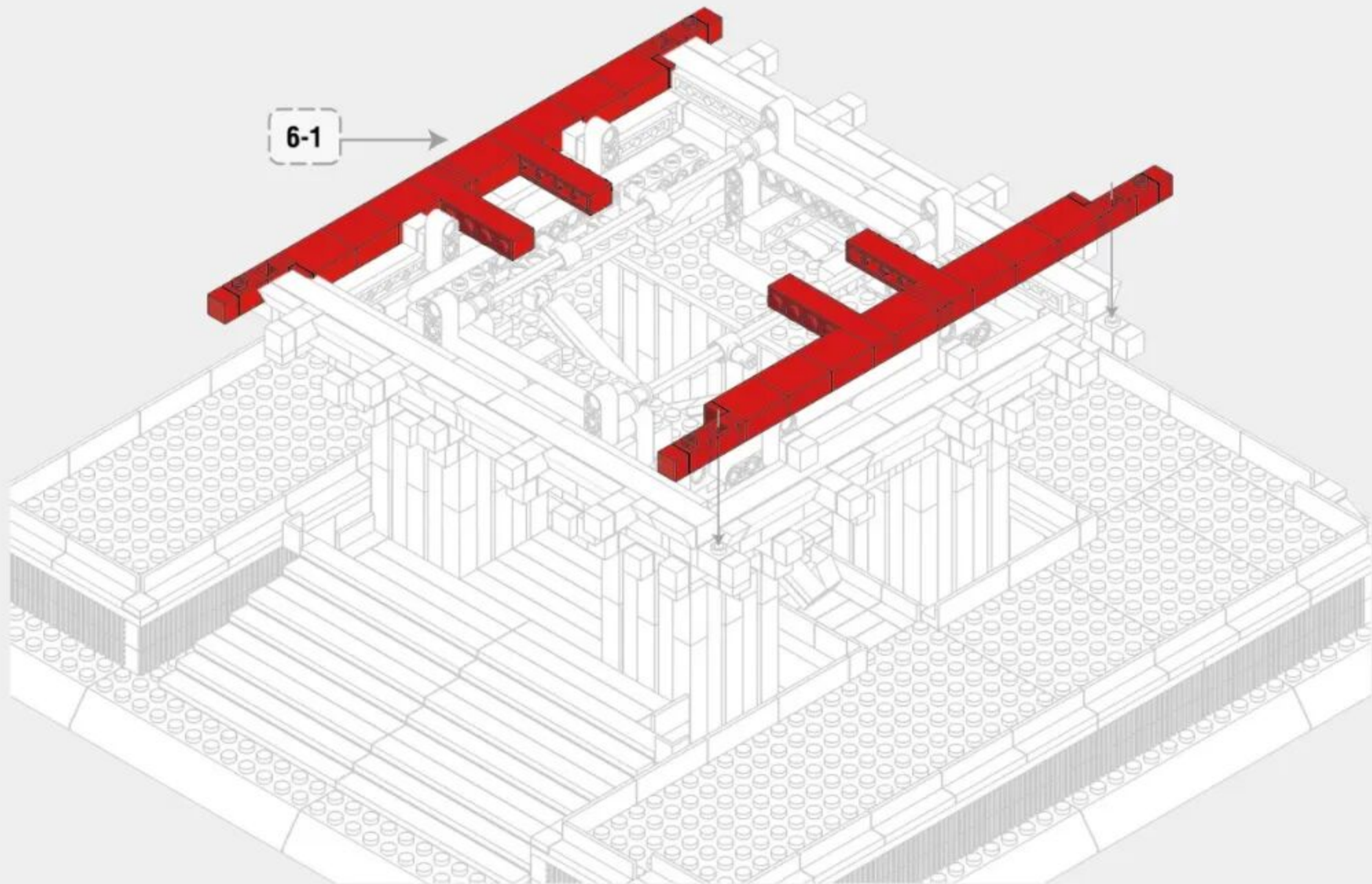

6-3

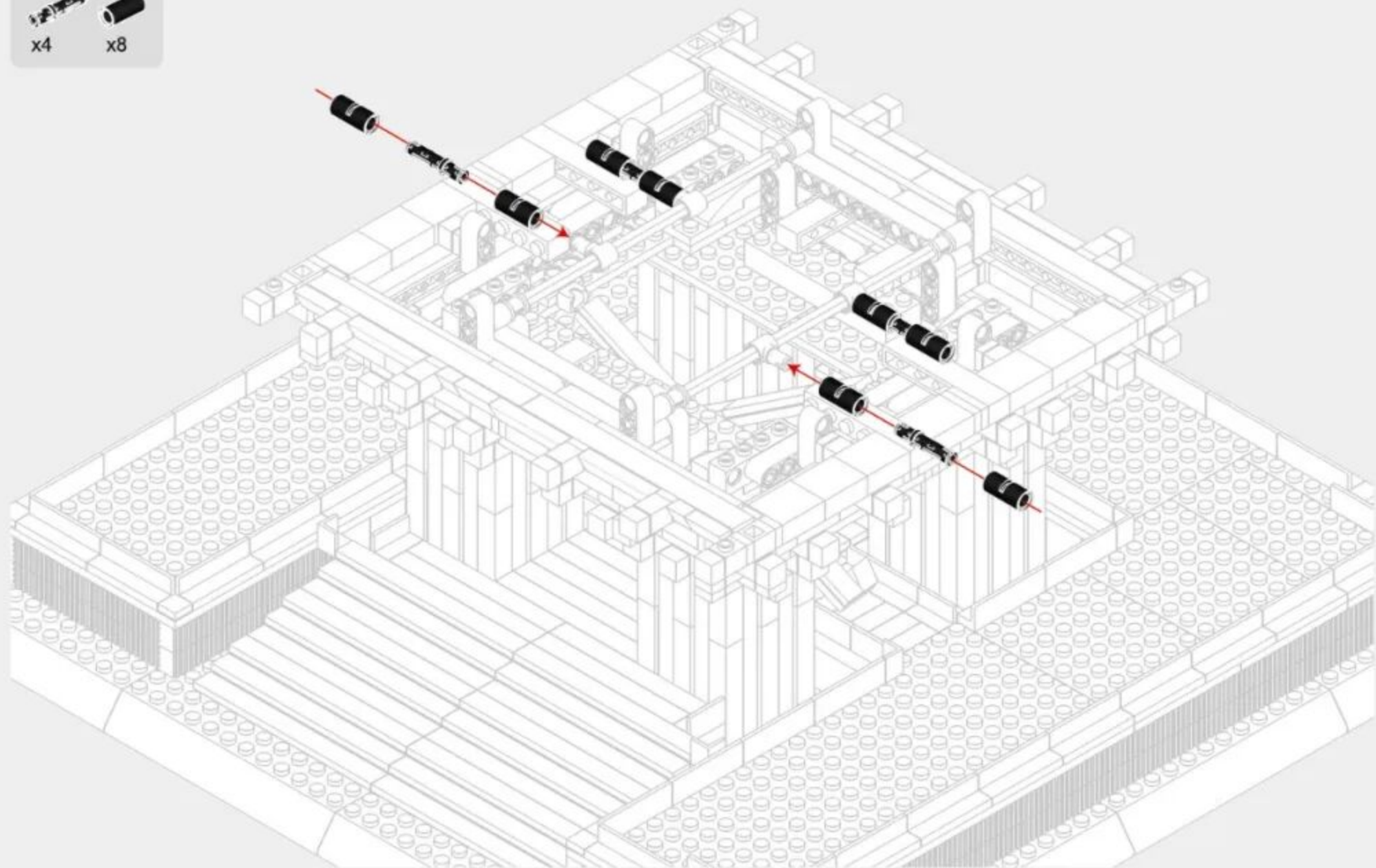

6-4

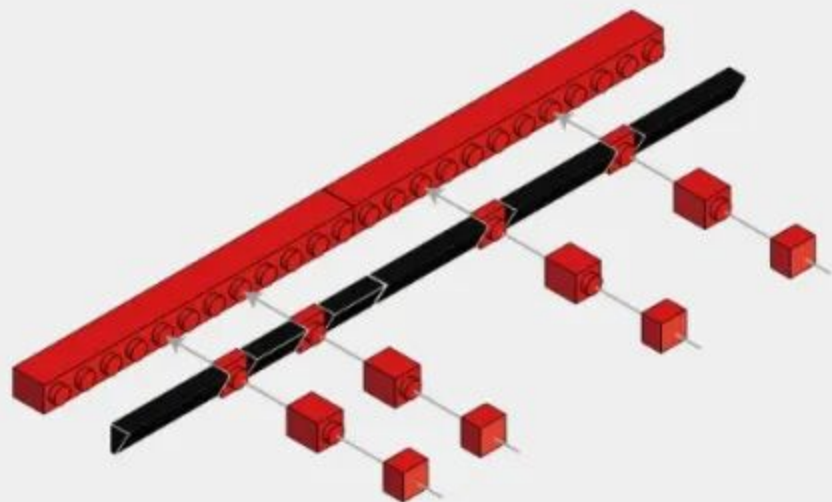
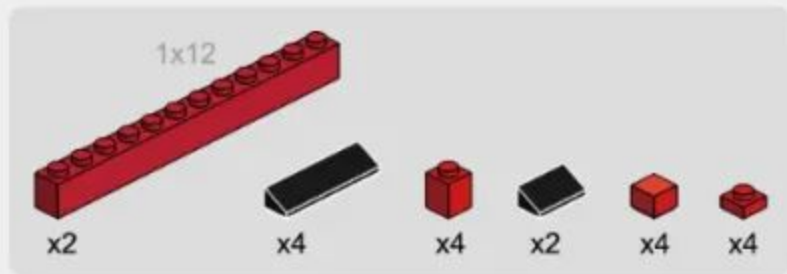

6-5



1



2

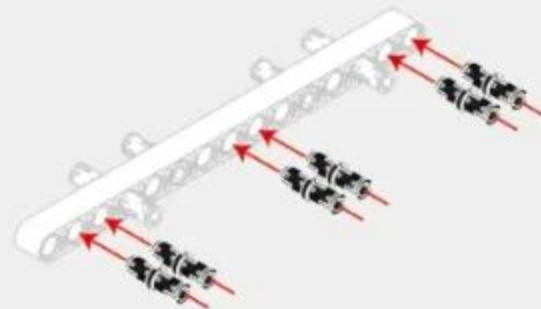

6-6



1

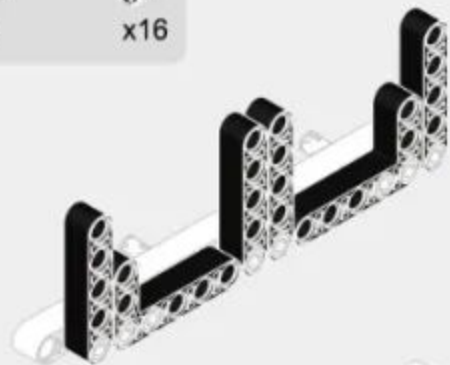

2

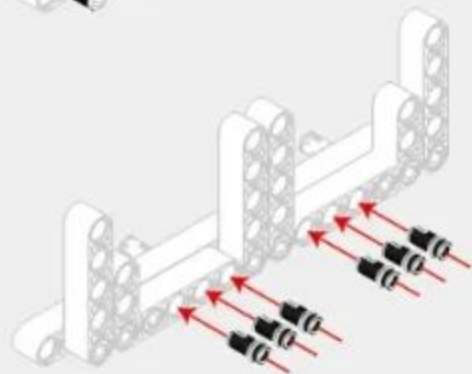

3

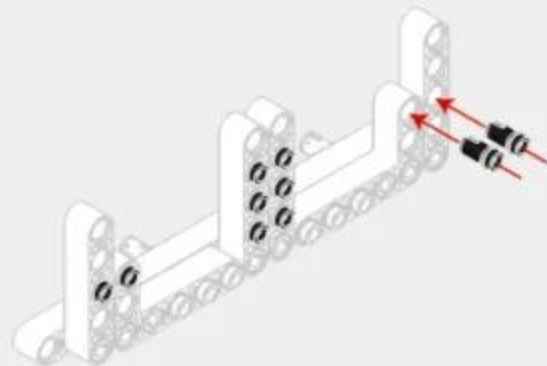

6-7

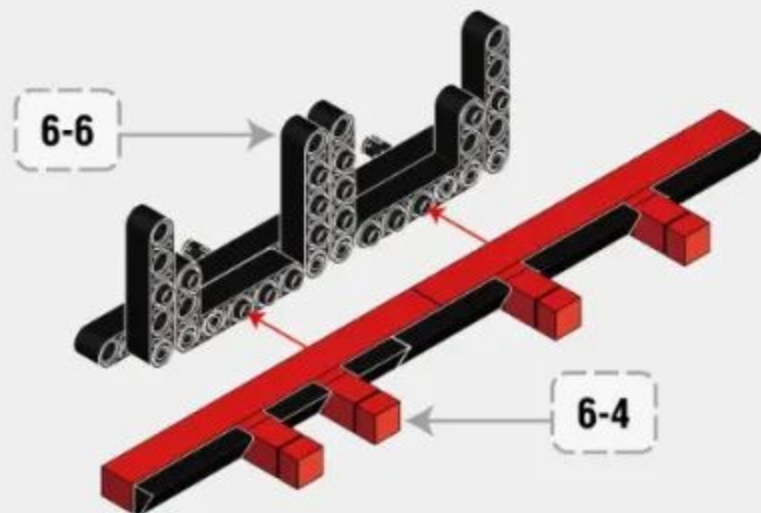

6-8

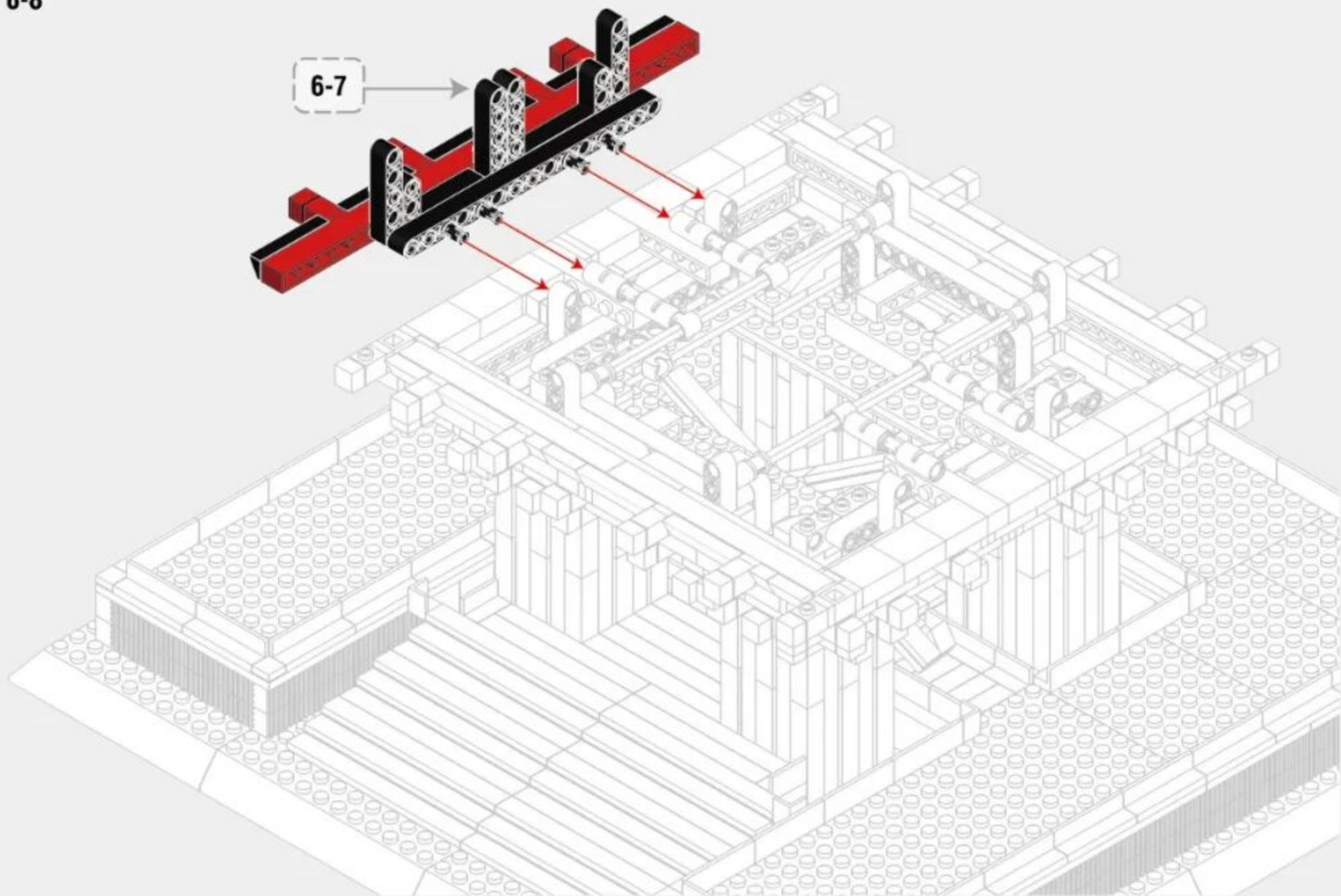

6-9

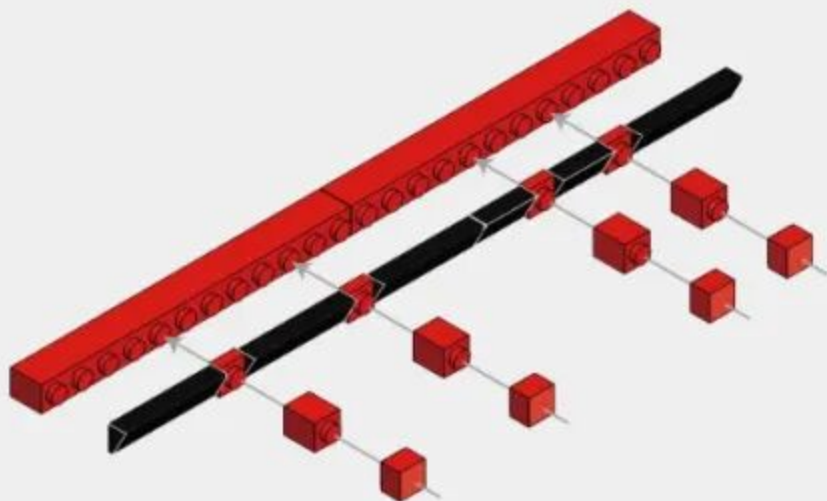
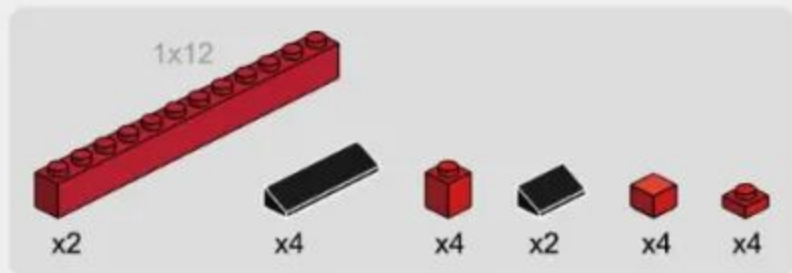

6-10

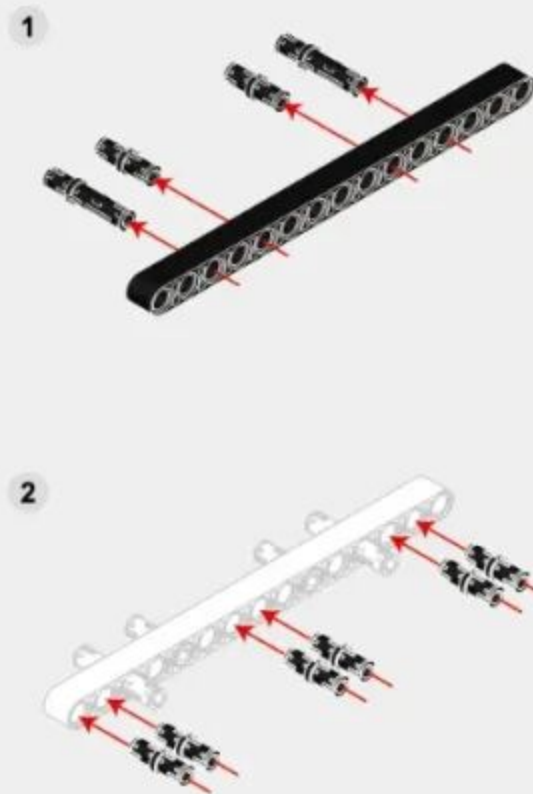
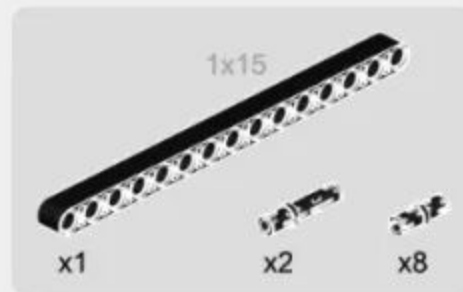

6-11



1

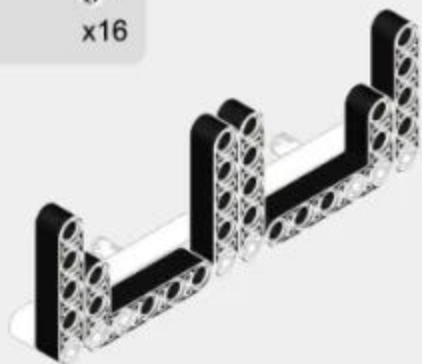

2

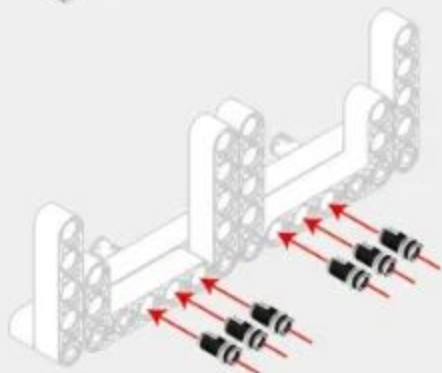

3

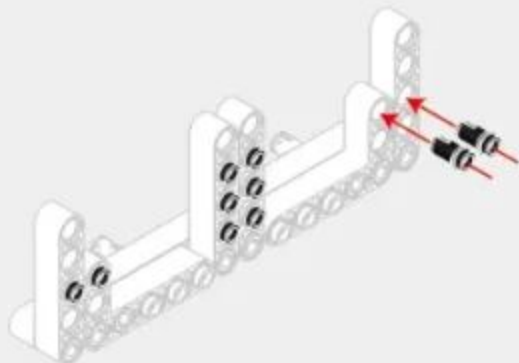

6-12

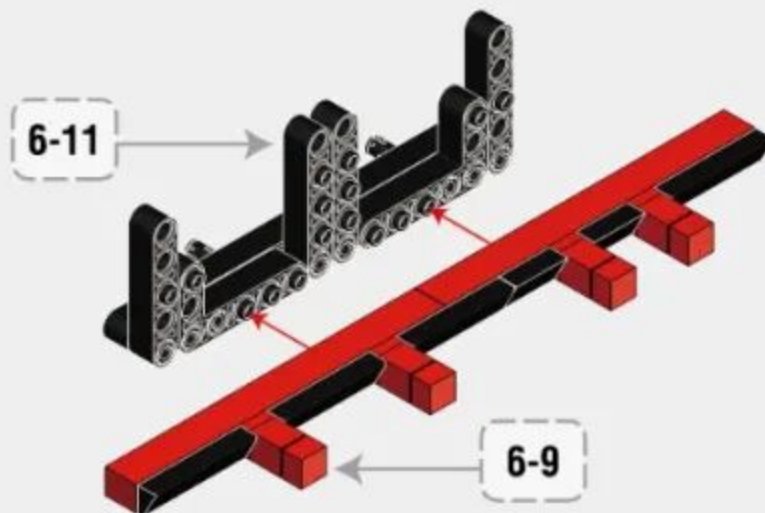

6-13

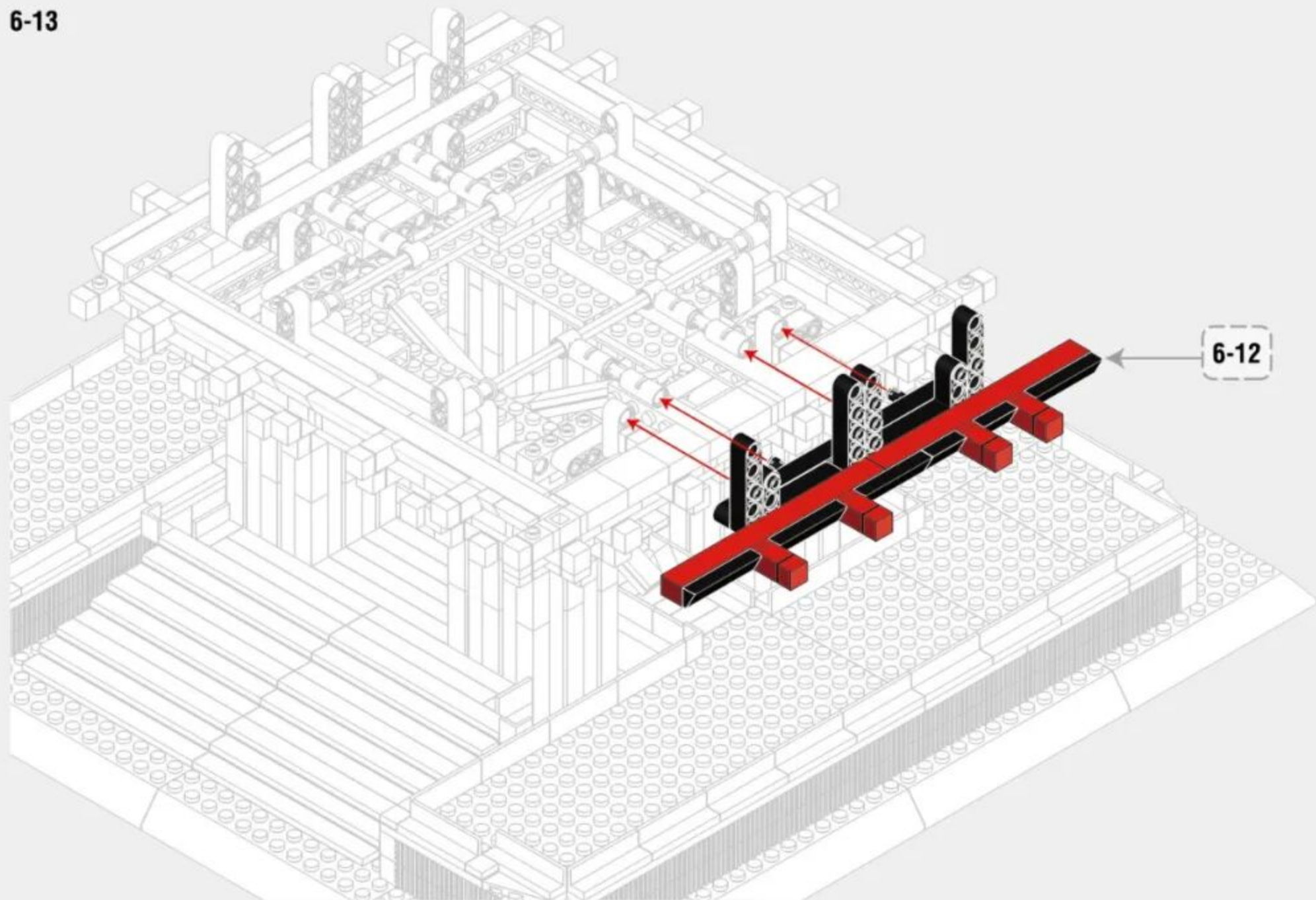

6-12

6-14

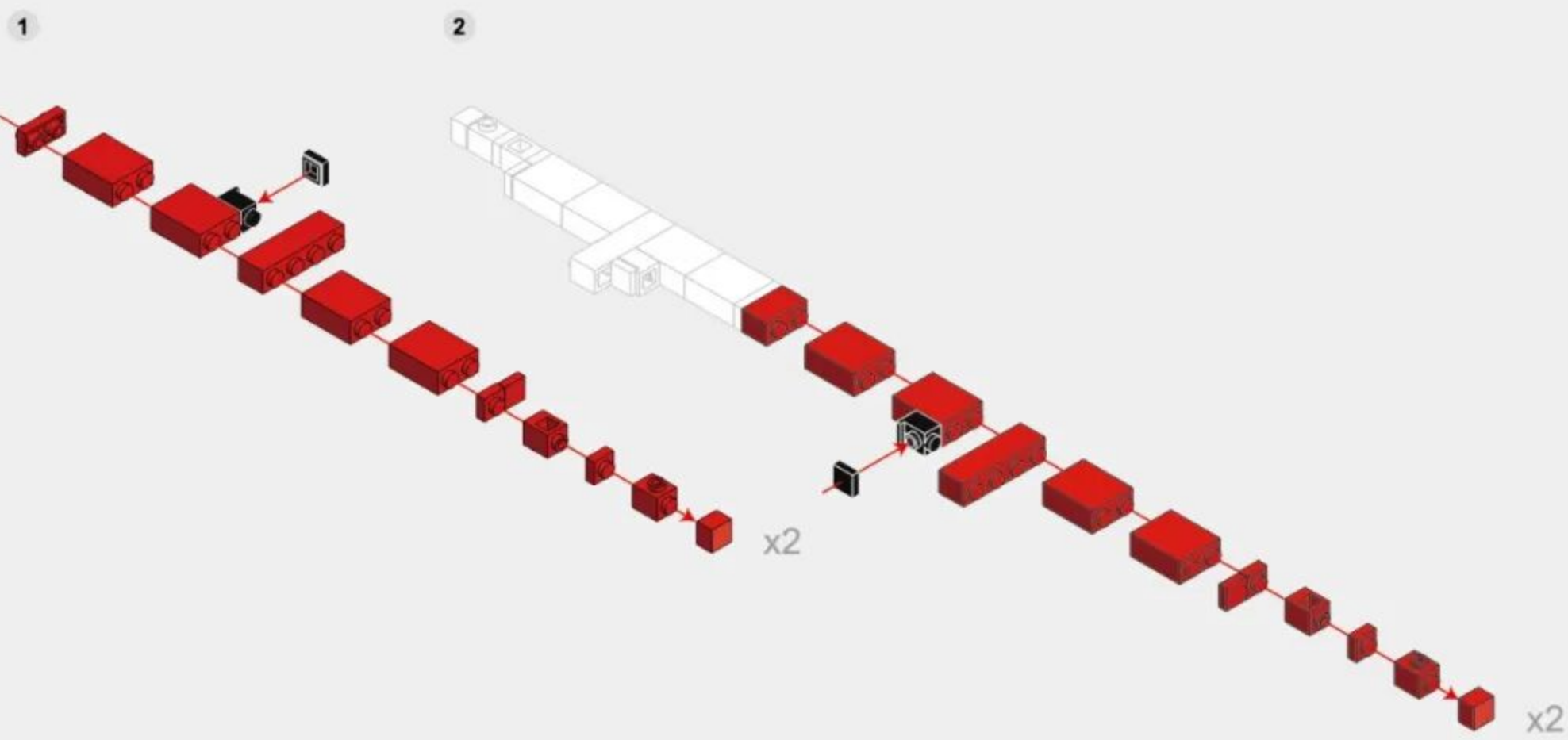

6-15

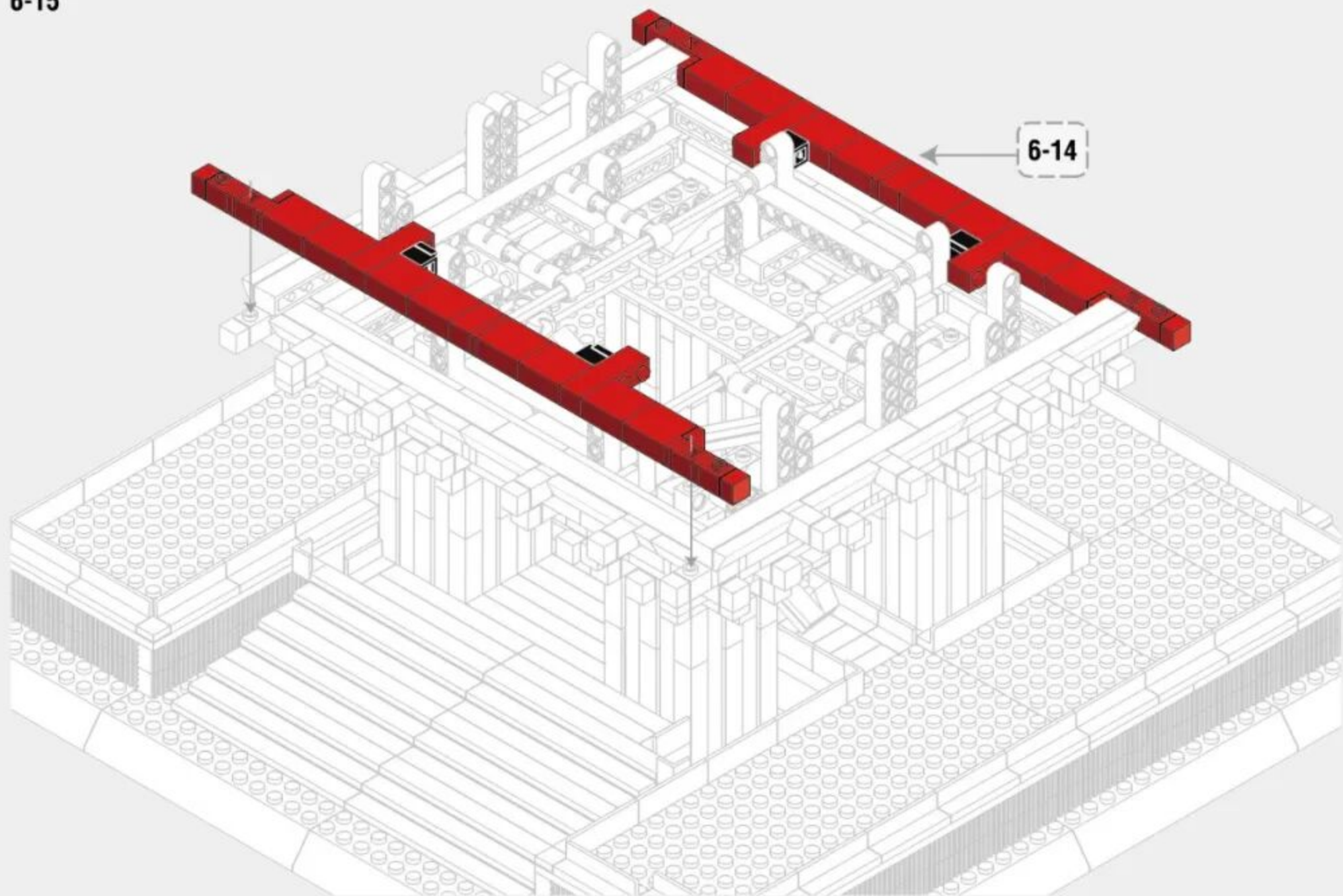



272PCS

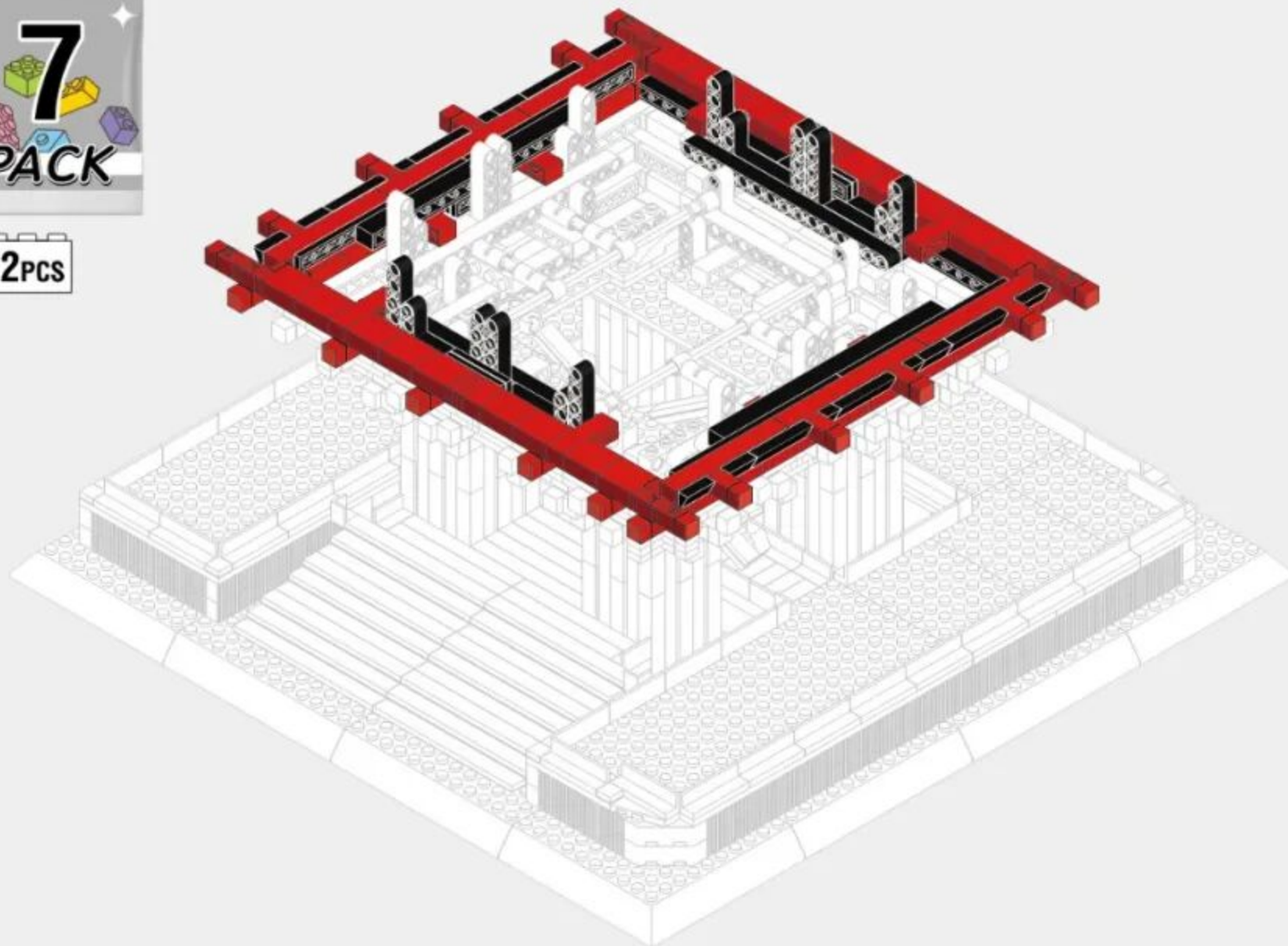

128

7-1

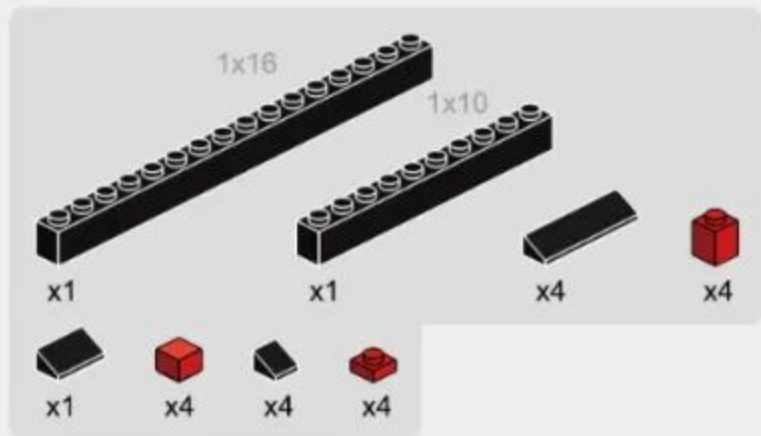

7-2

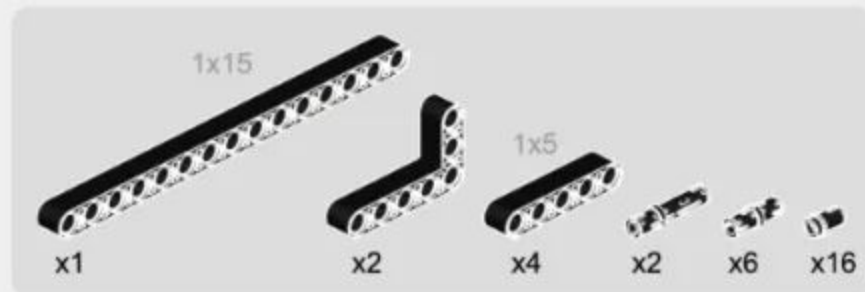

1



2

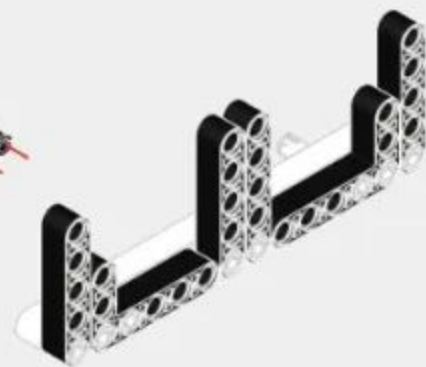

3

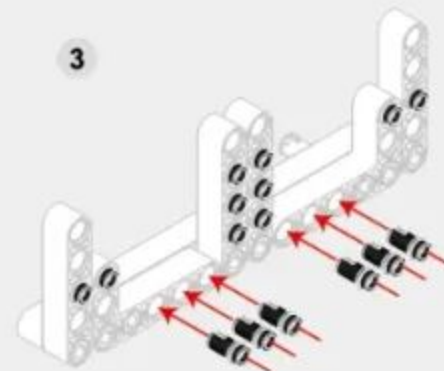

7-3

7-4

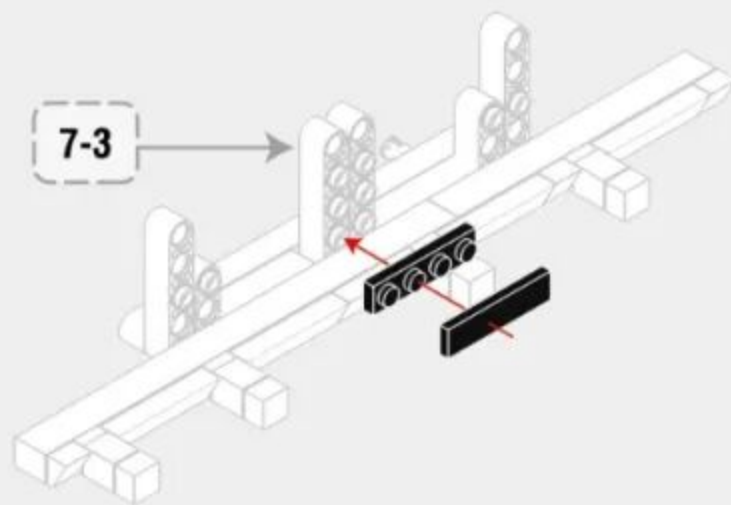
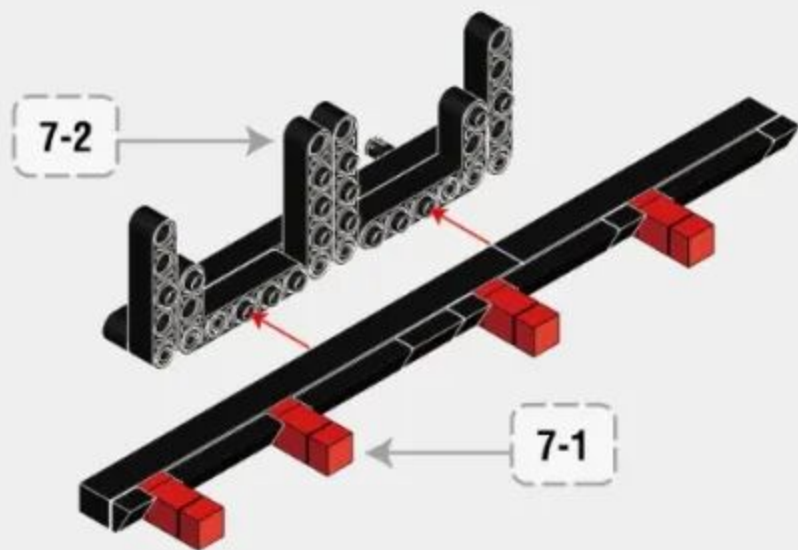

7-5

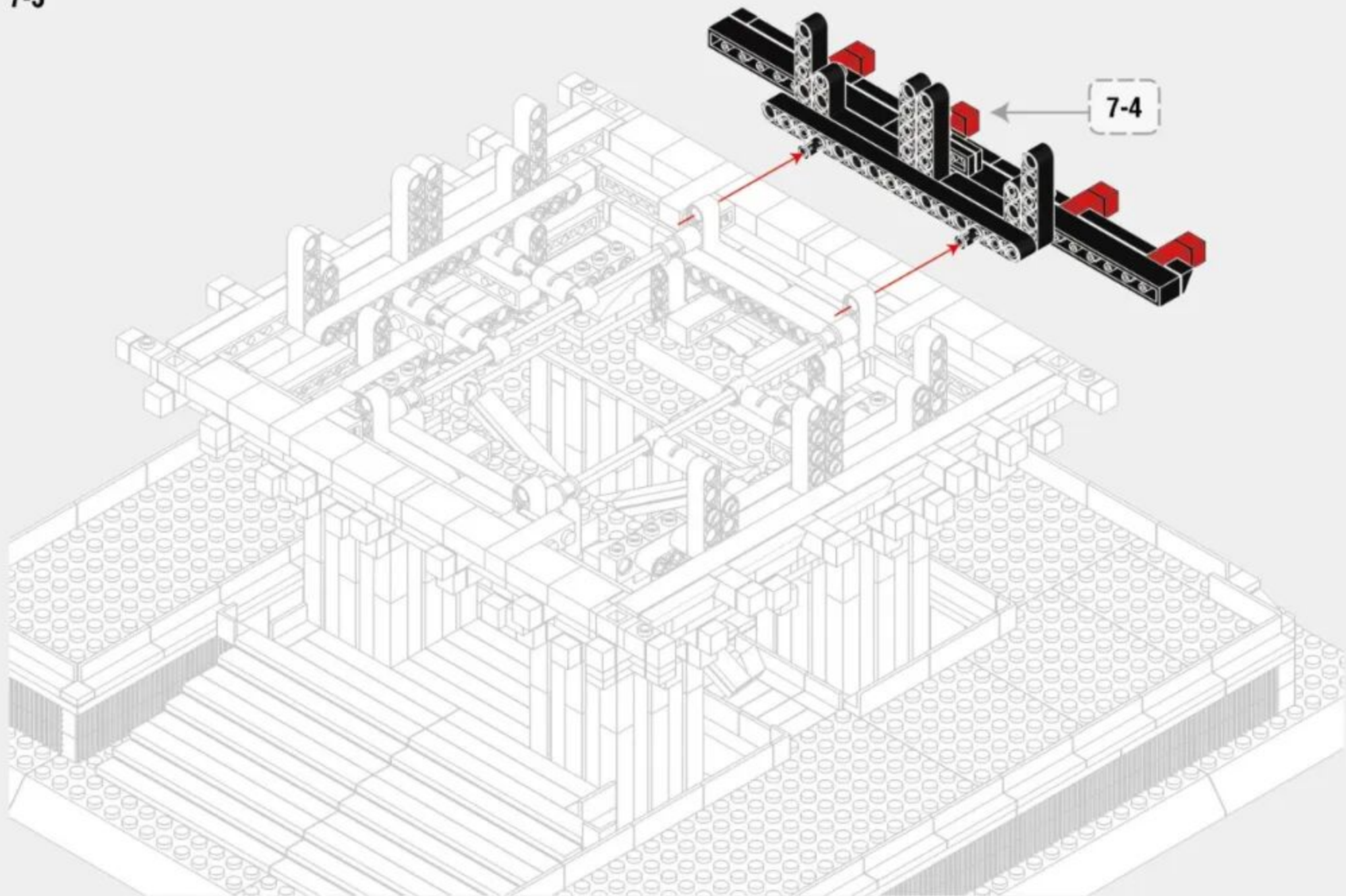

7-6

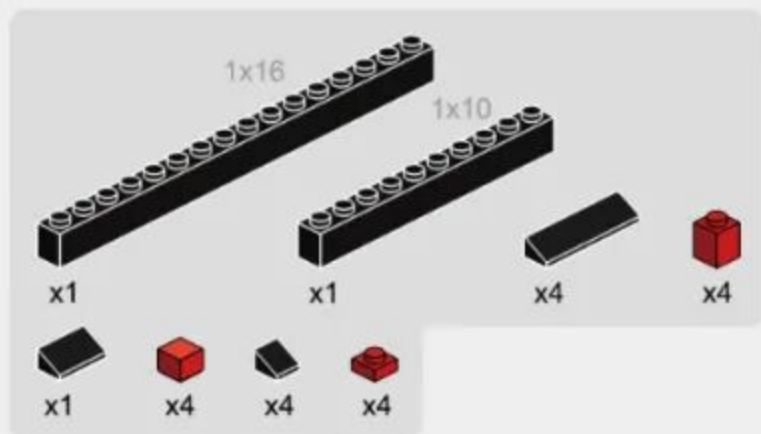

7-7

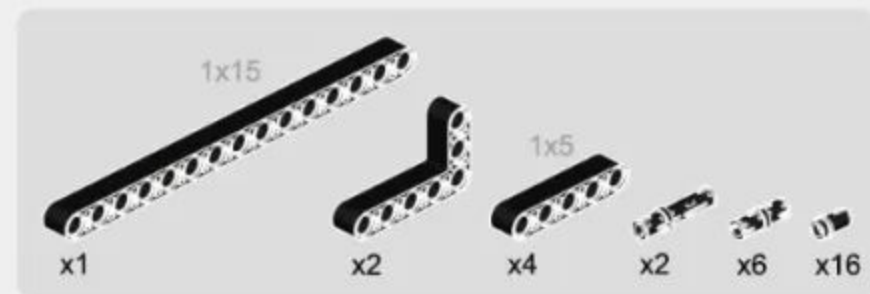

1



2

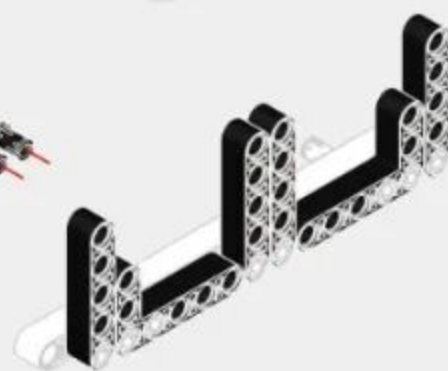

3

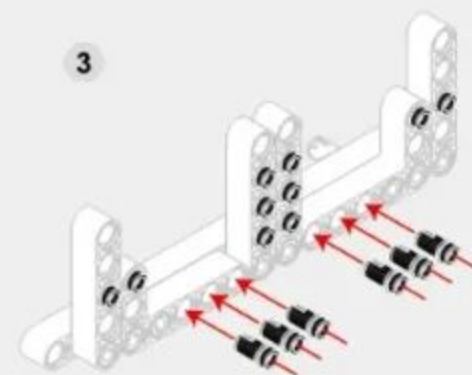

7-8

7-9

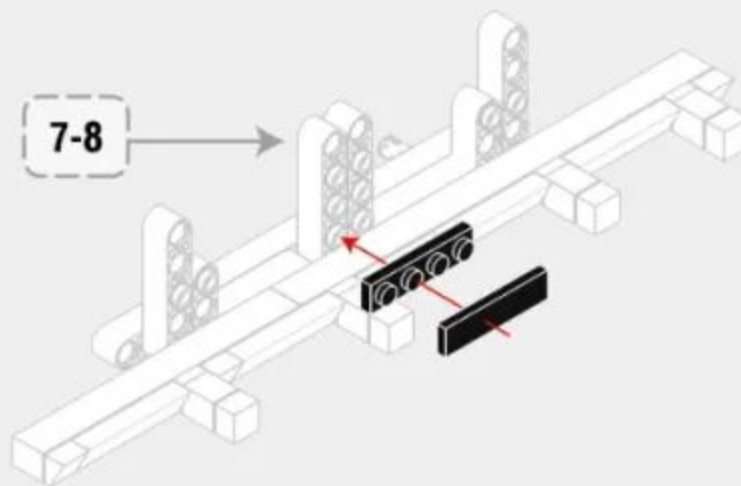
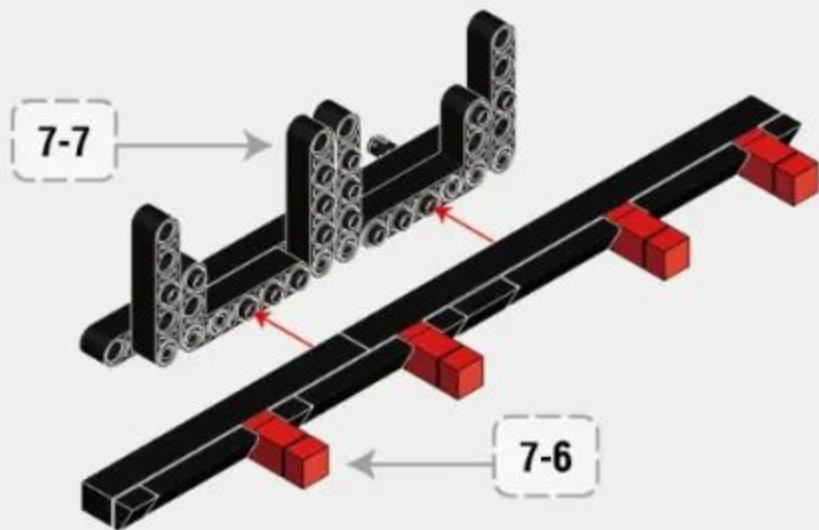

7-10

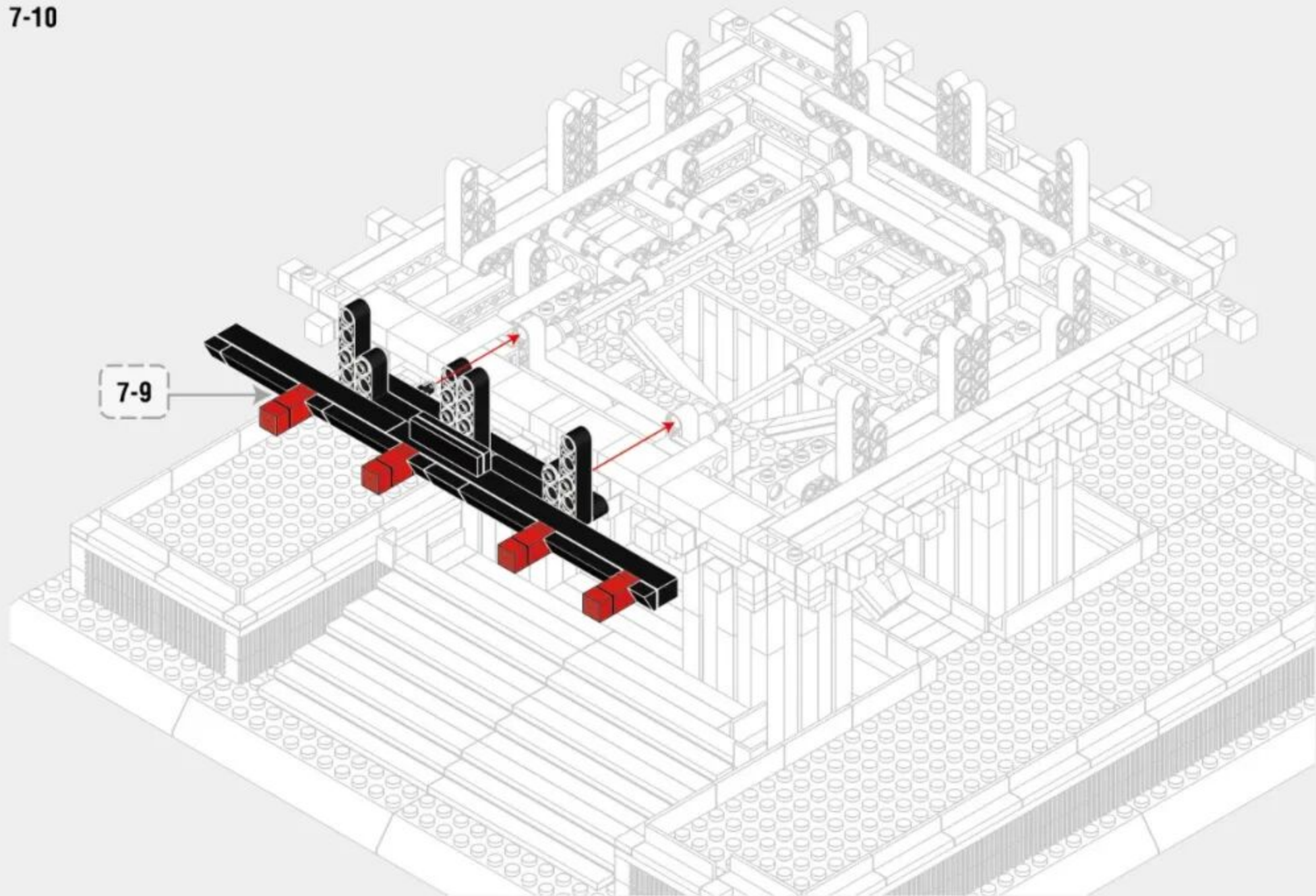

7-9

7-11

1x4

x2

x2

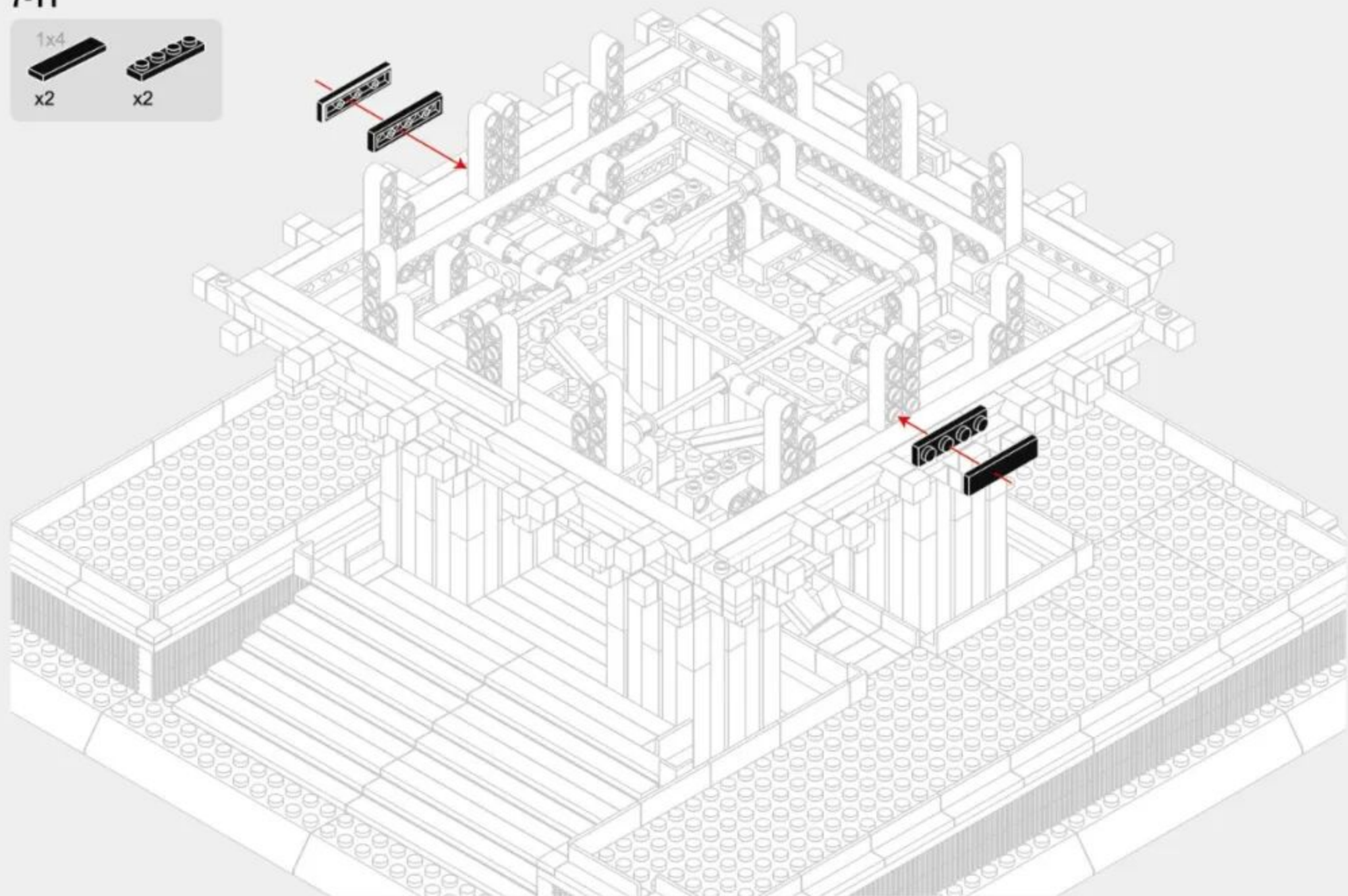

7-12

Parts list for step 7-12:

- Red 1x4 brick with 2 holes: x16
- Red 1x6 brick with 4 holes: x4
- Red 1x2 brick with 2 holes: x2
- Red 1x2 brick with 1 hole: x4
- Red 1x3 brick with 2 holes: x4
- Red 1x2 brick with 1 hole: x2
- Red 1x1 brick with 1 hole: x4
- Red 1x1 brick with 2 holes: x8
- Red 1x1 brick: x4

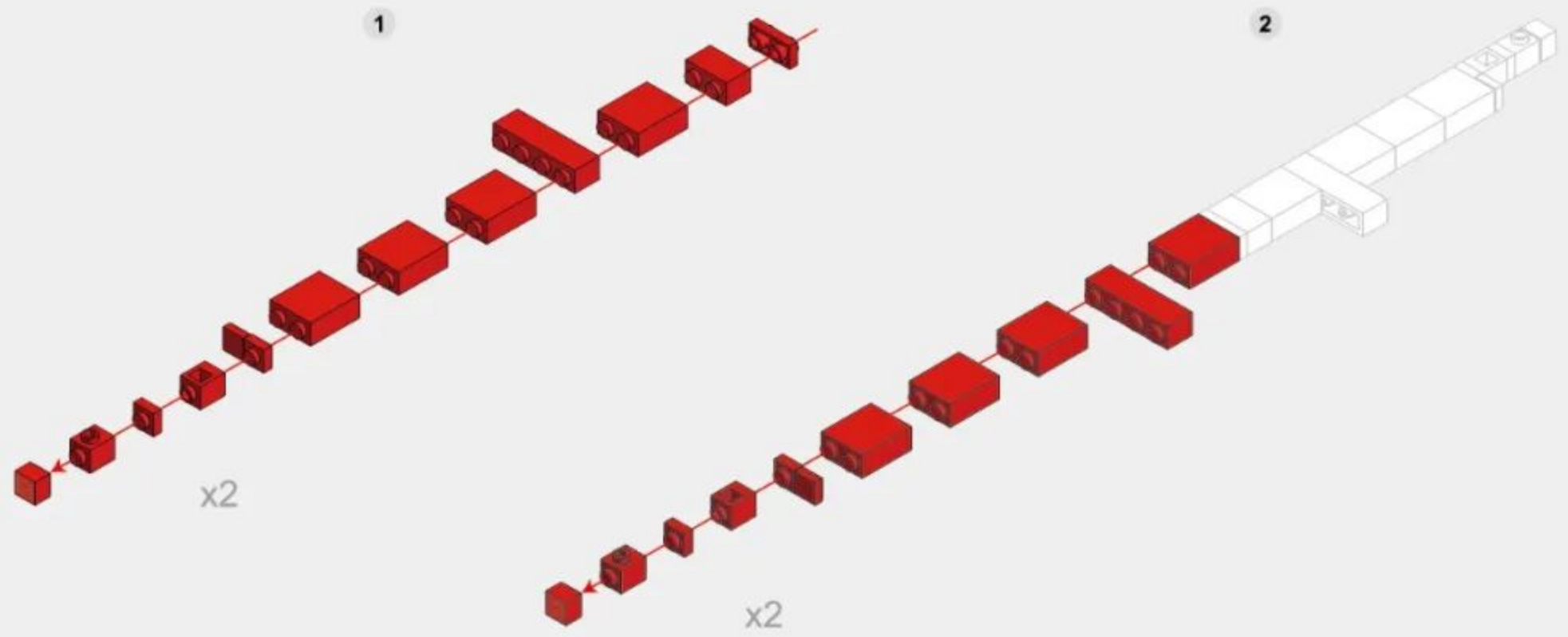

7-13

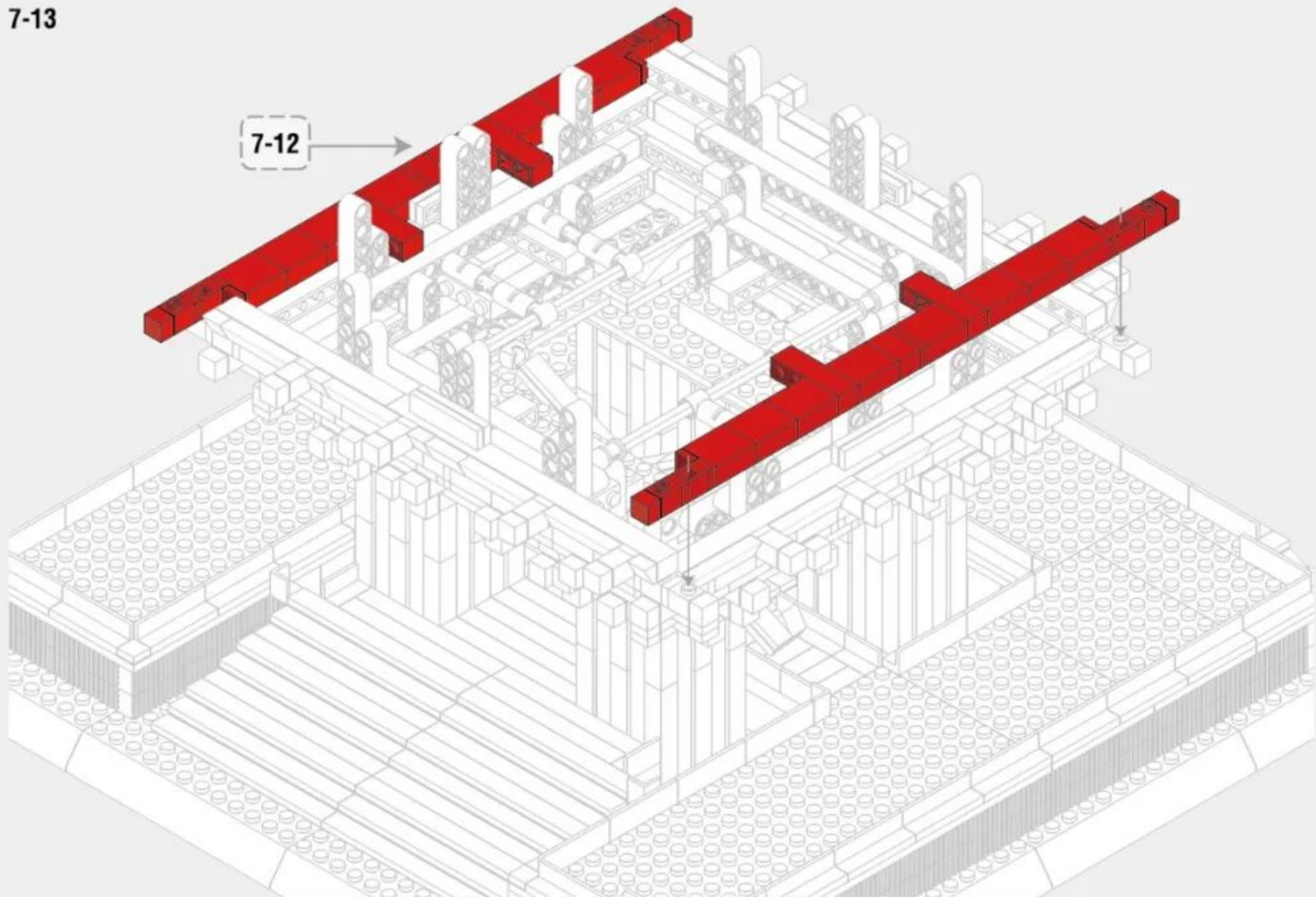

7-14

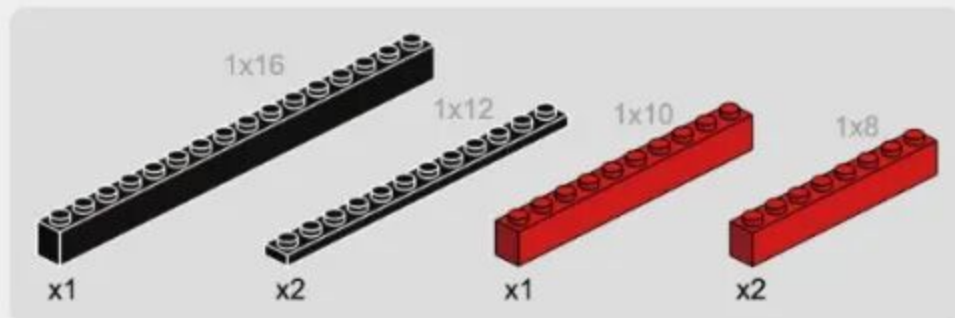

7-15

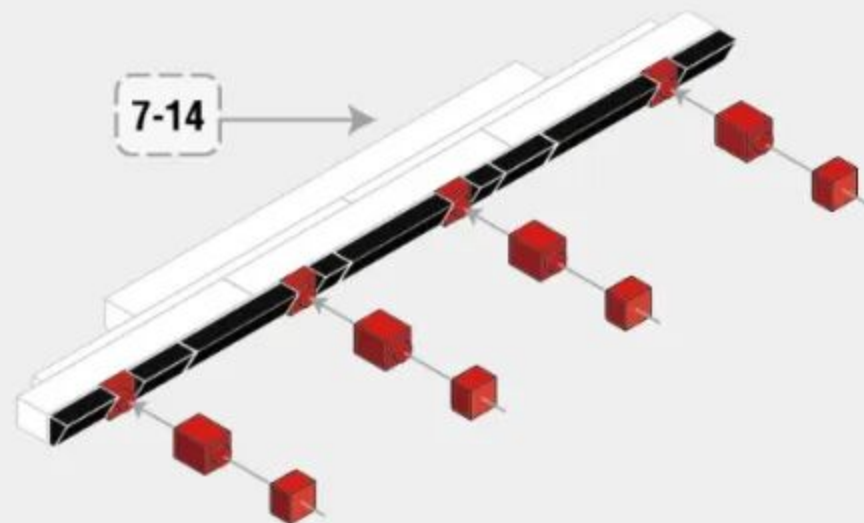

7-16

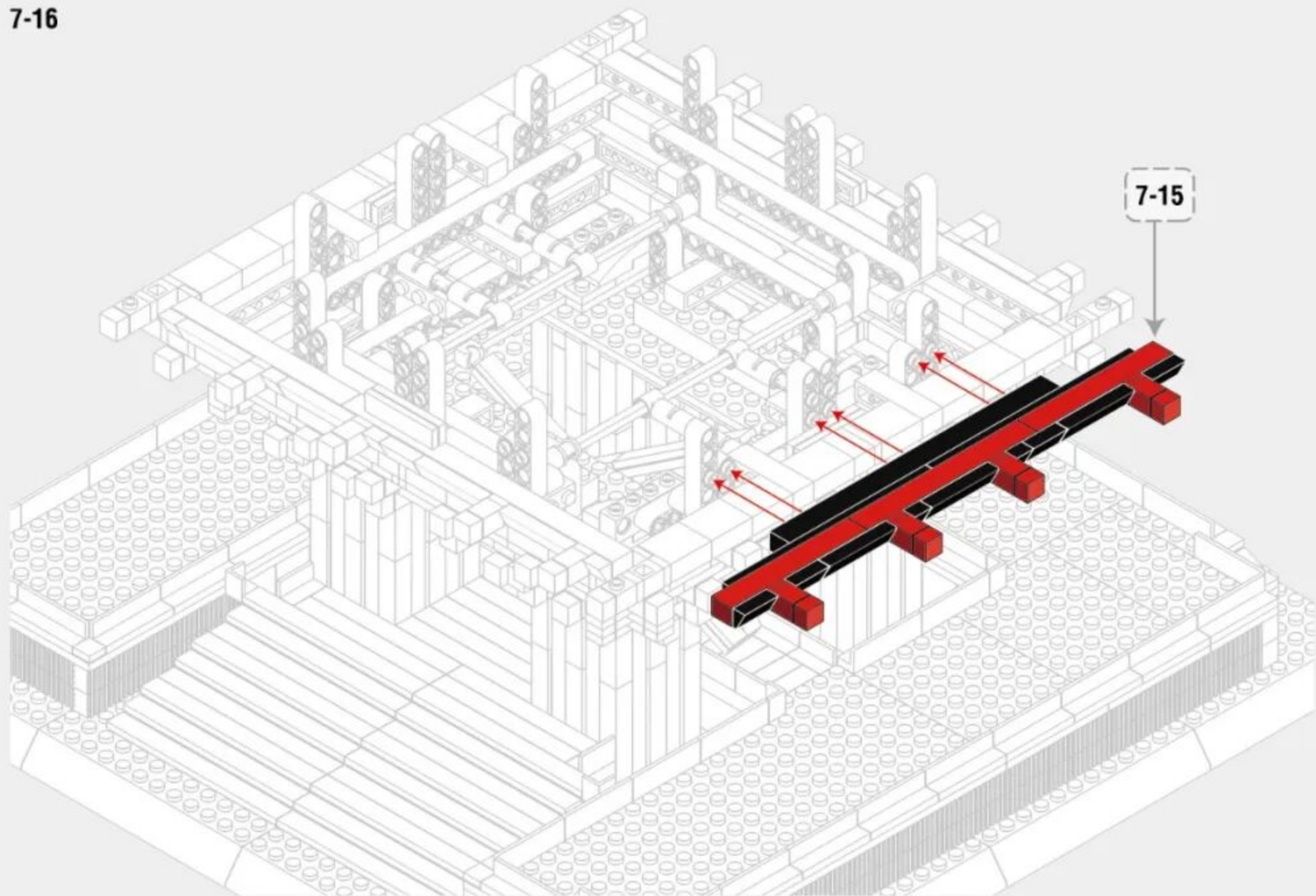

7-15

7-17

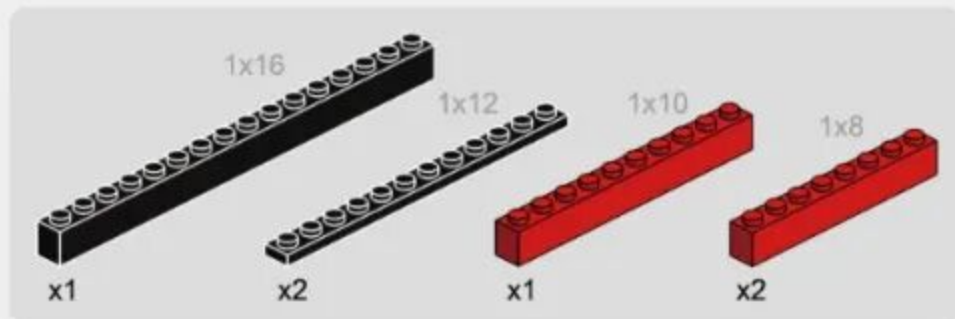

7-18

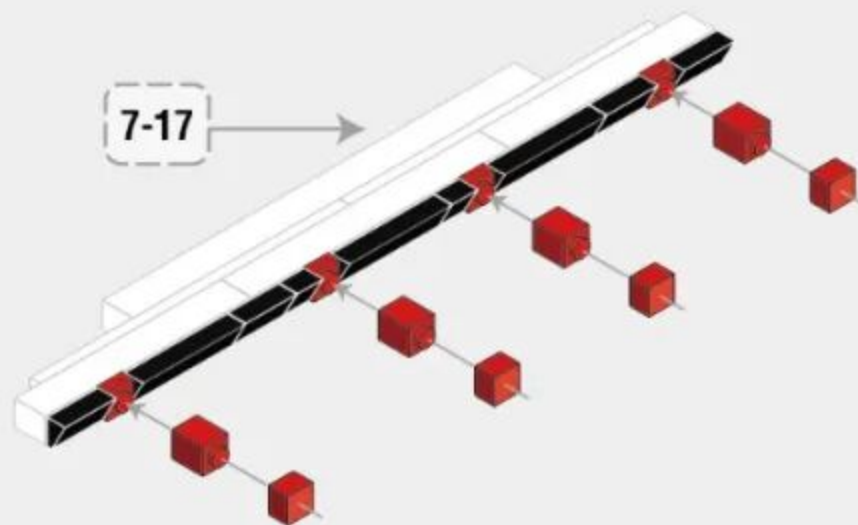

7-19

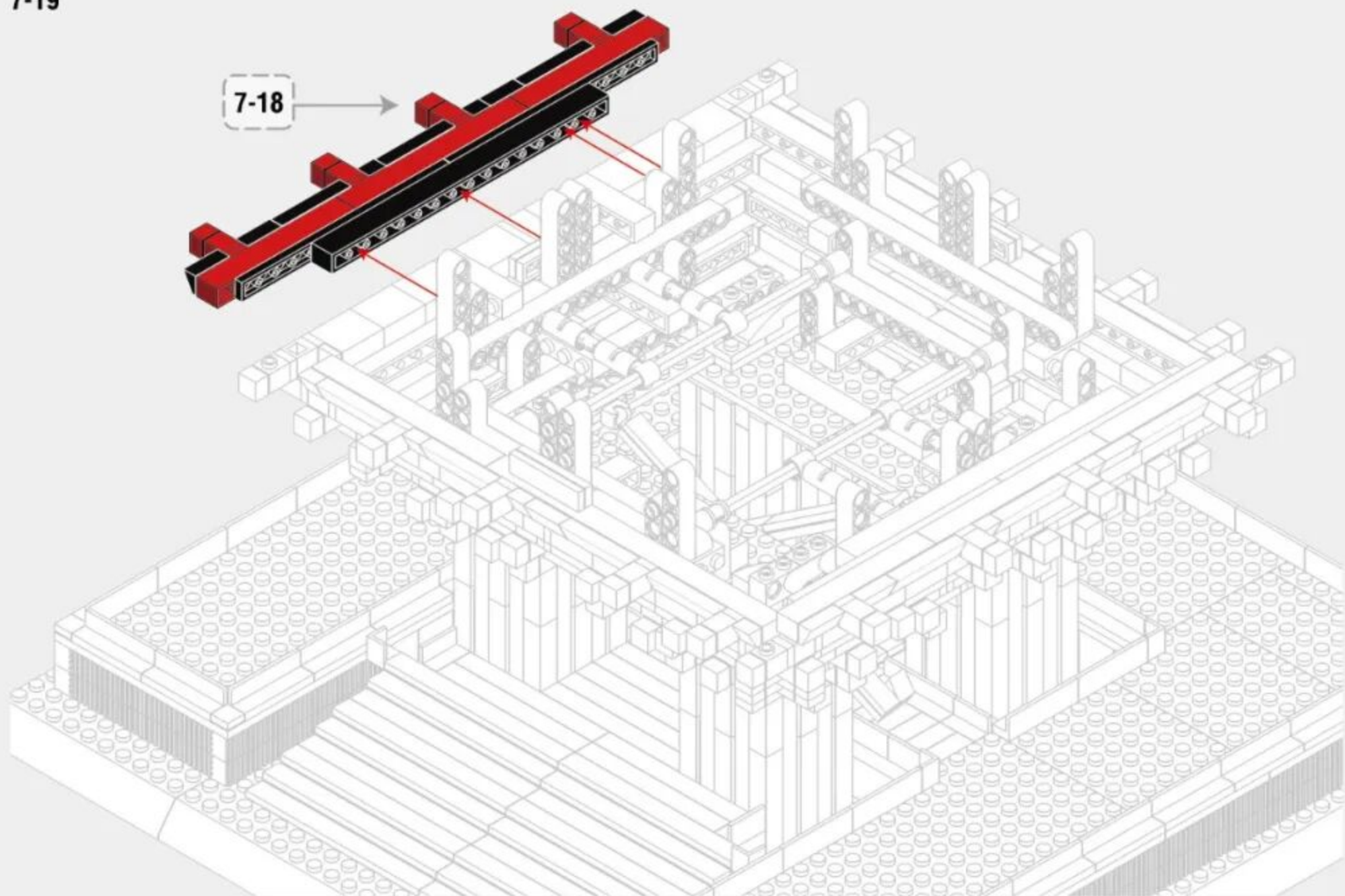

7-21

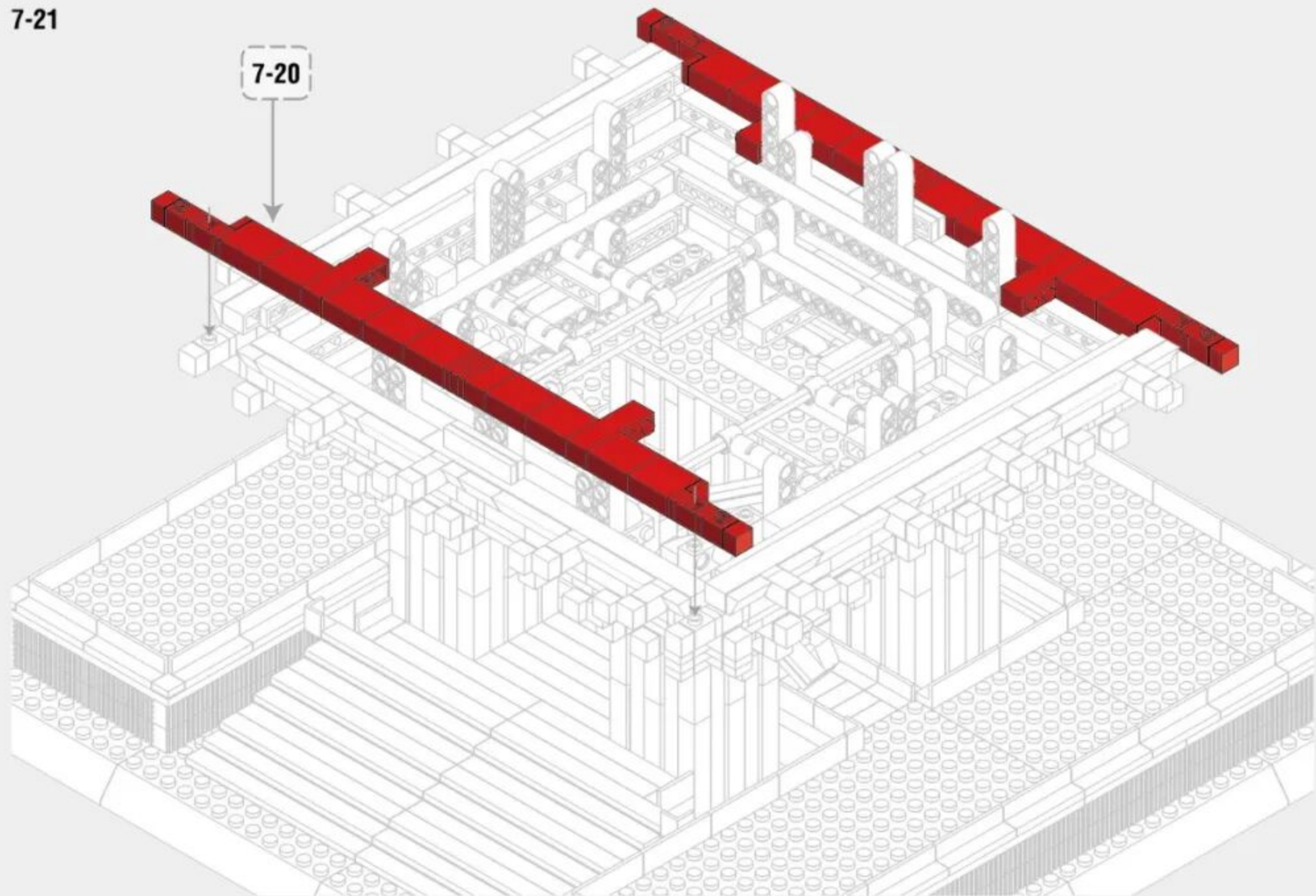



232PCS

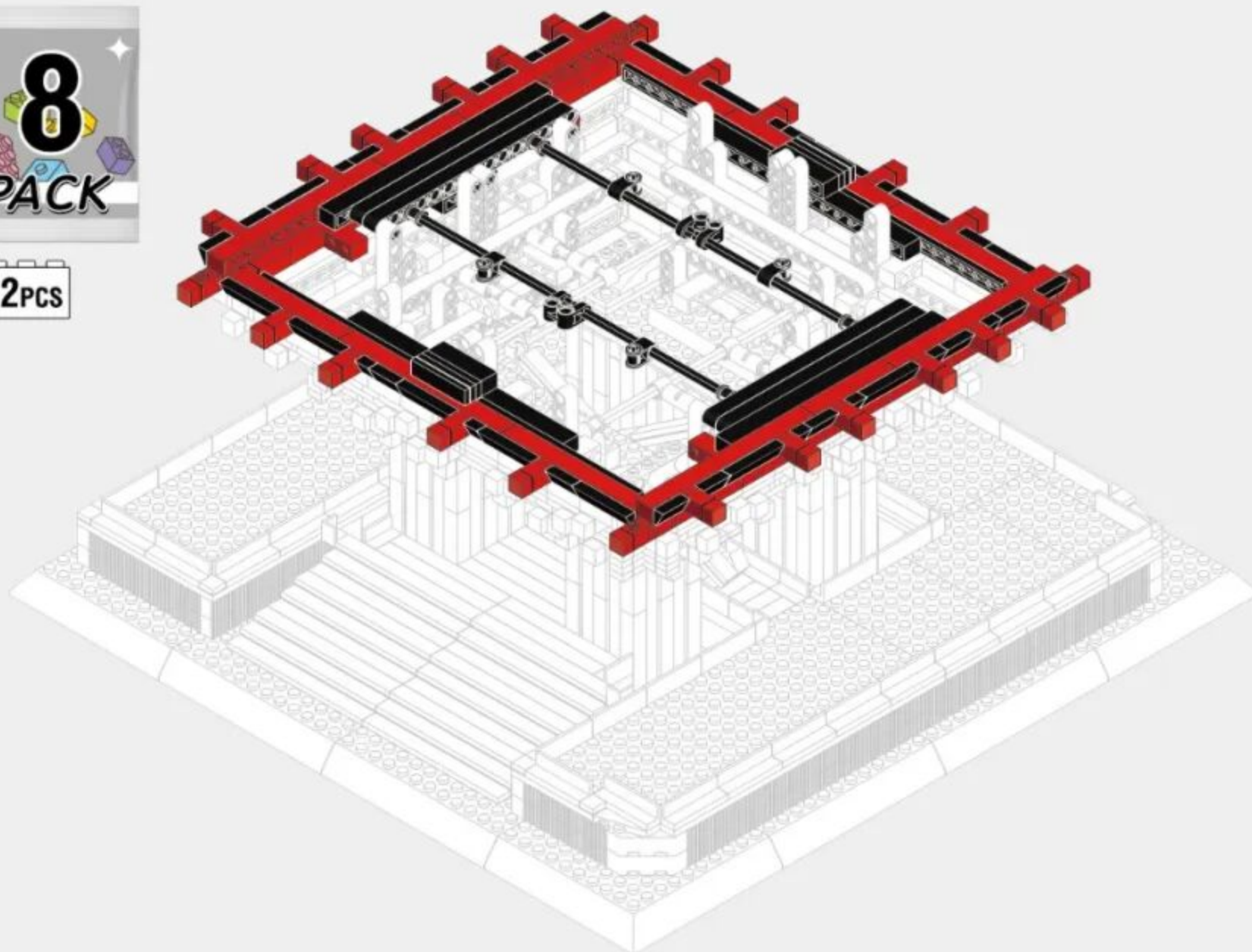

144

8-1

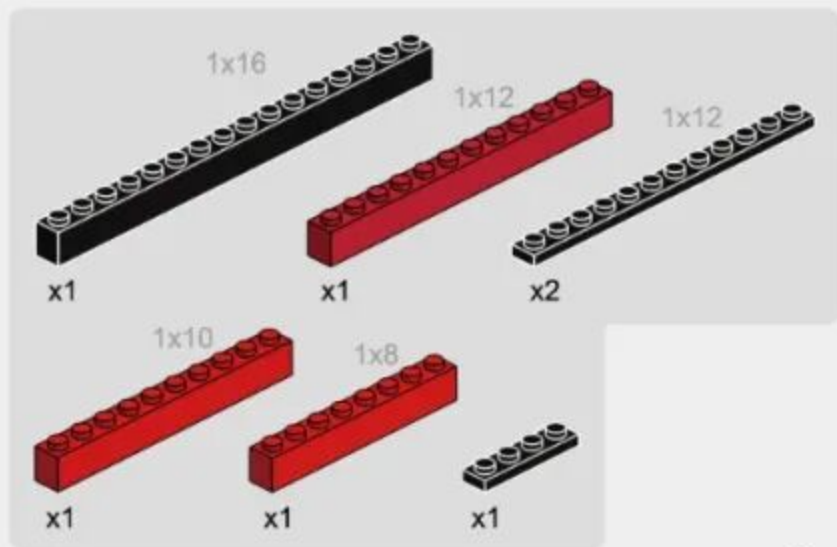

8-2

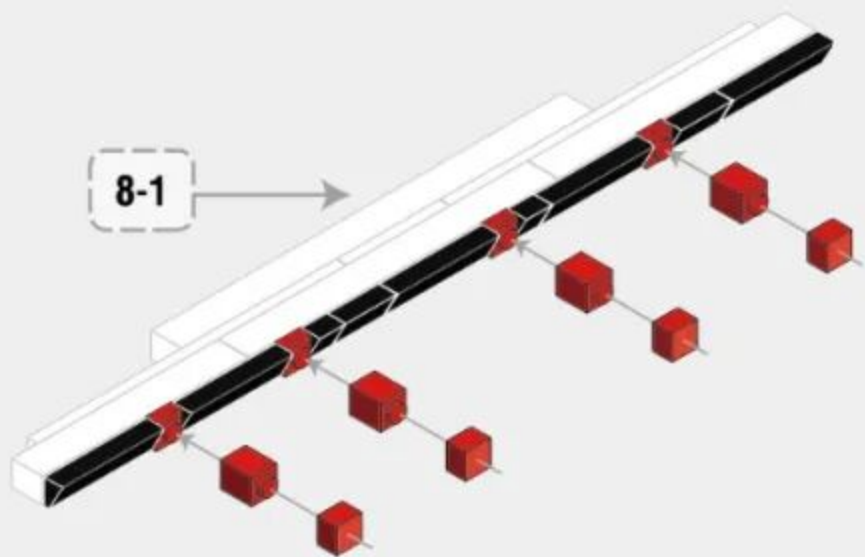

8-3

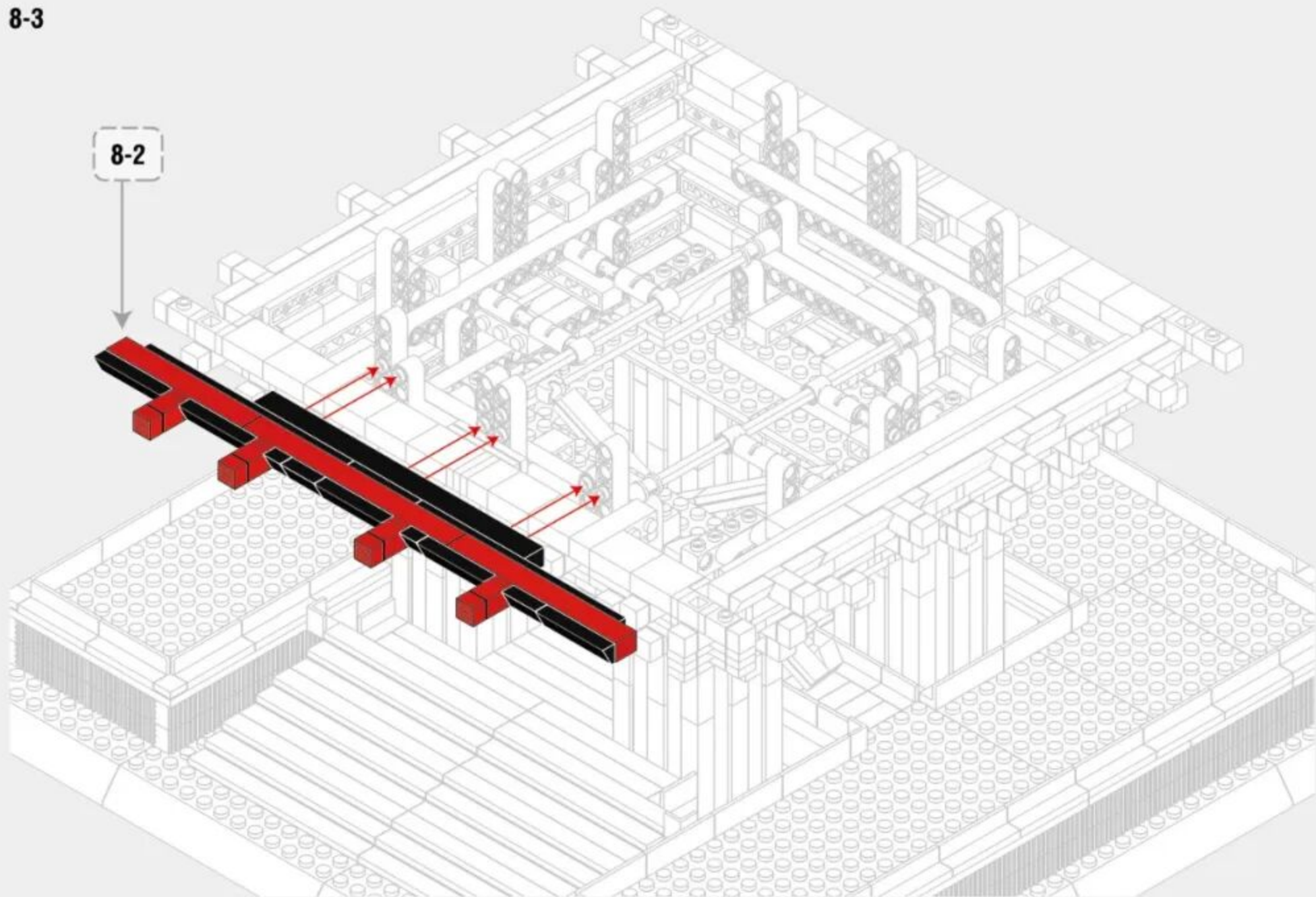

8-4

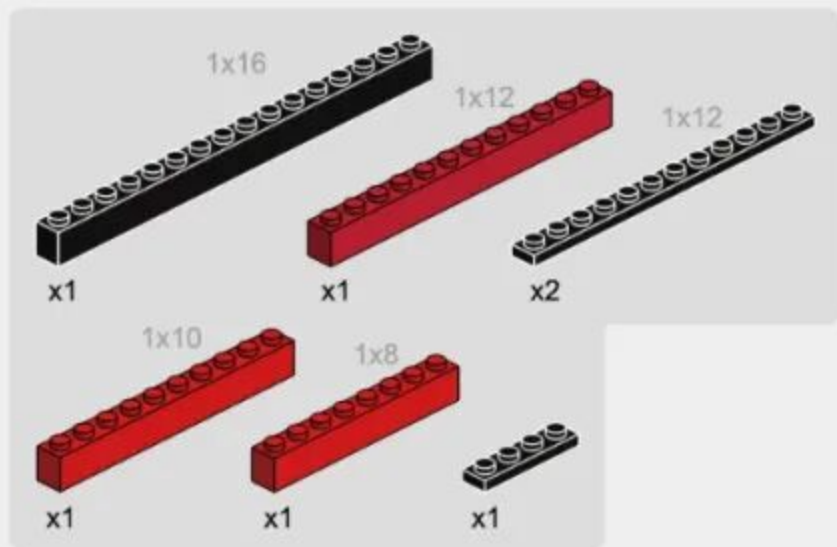

8-5

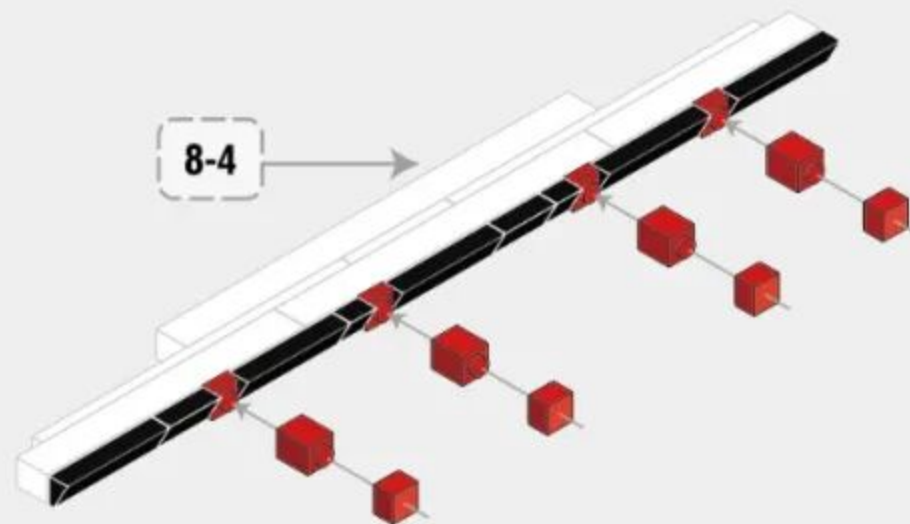

8-6

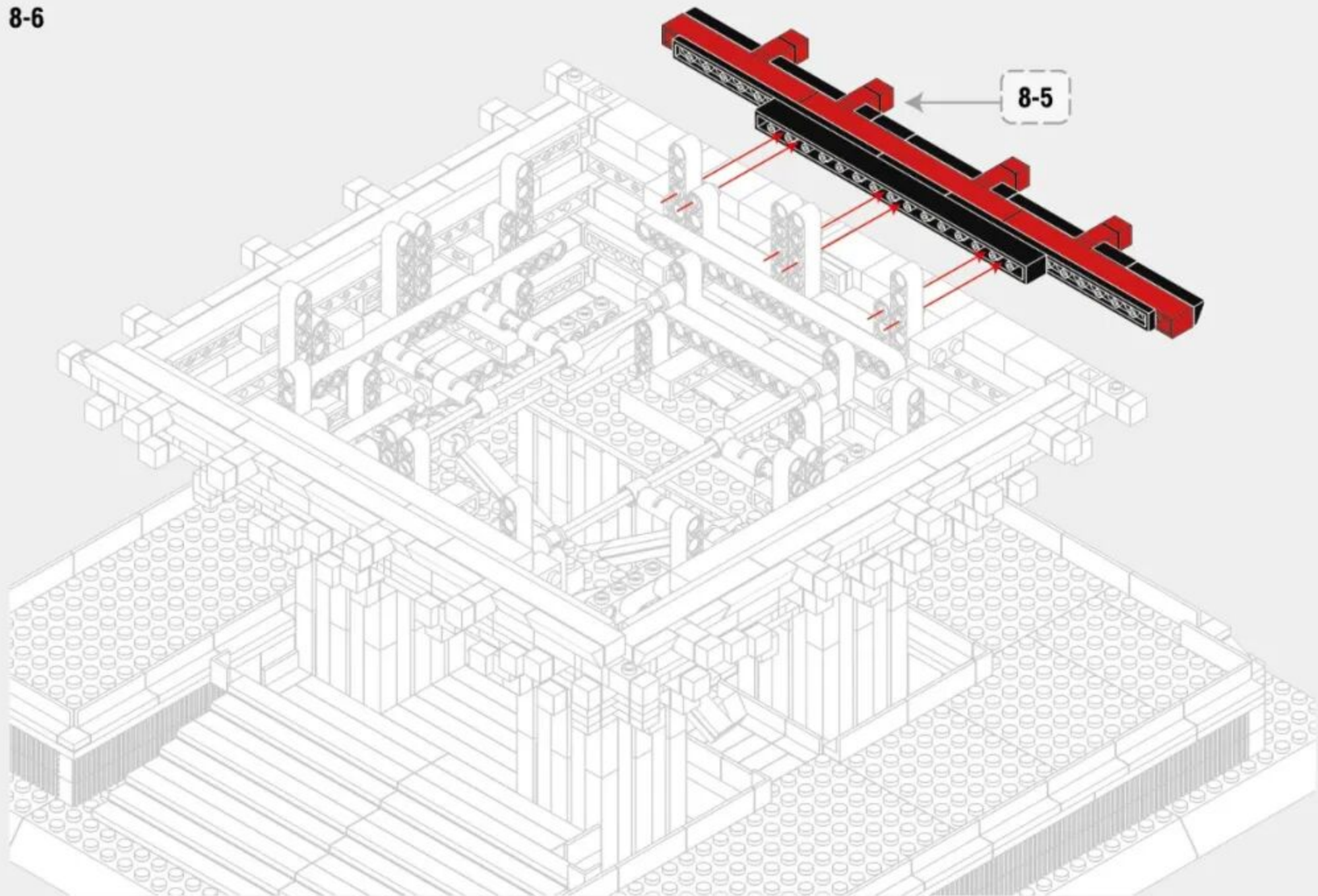

8-7

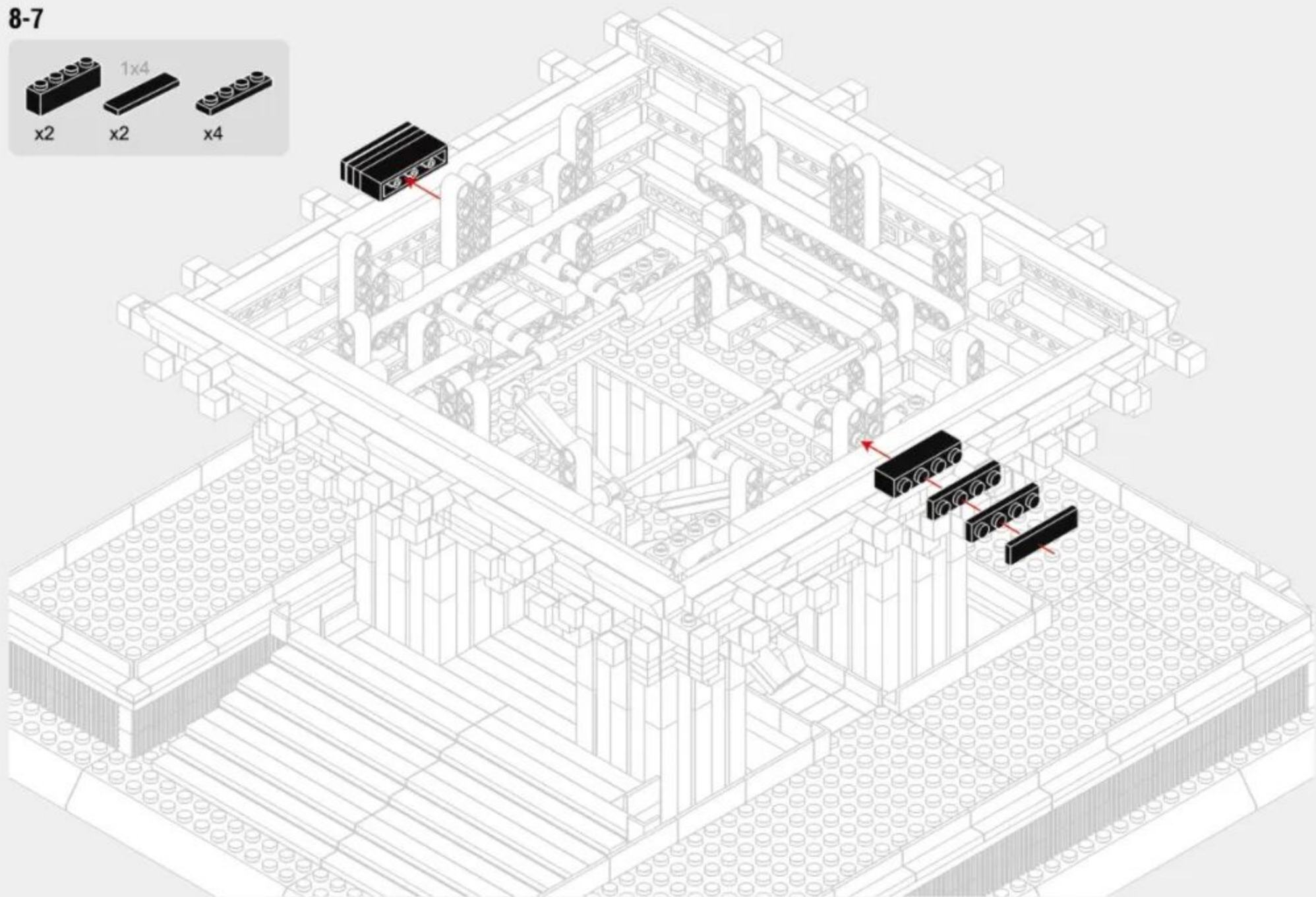
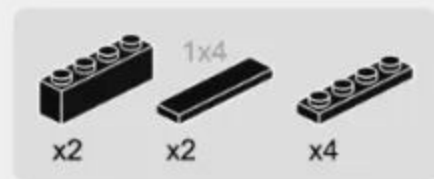

8-8

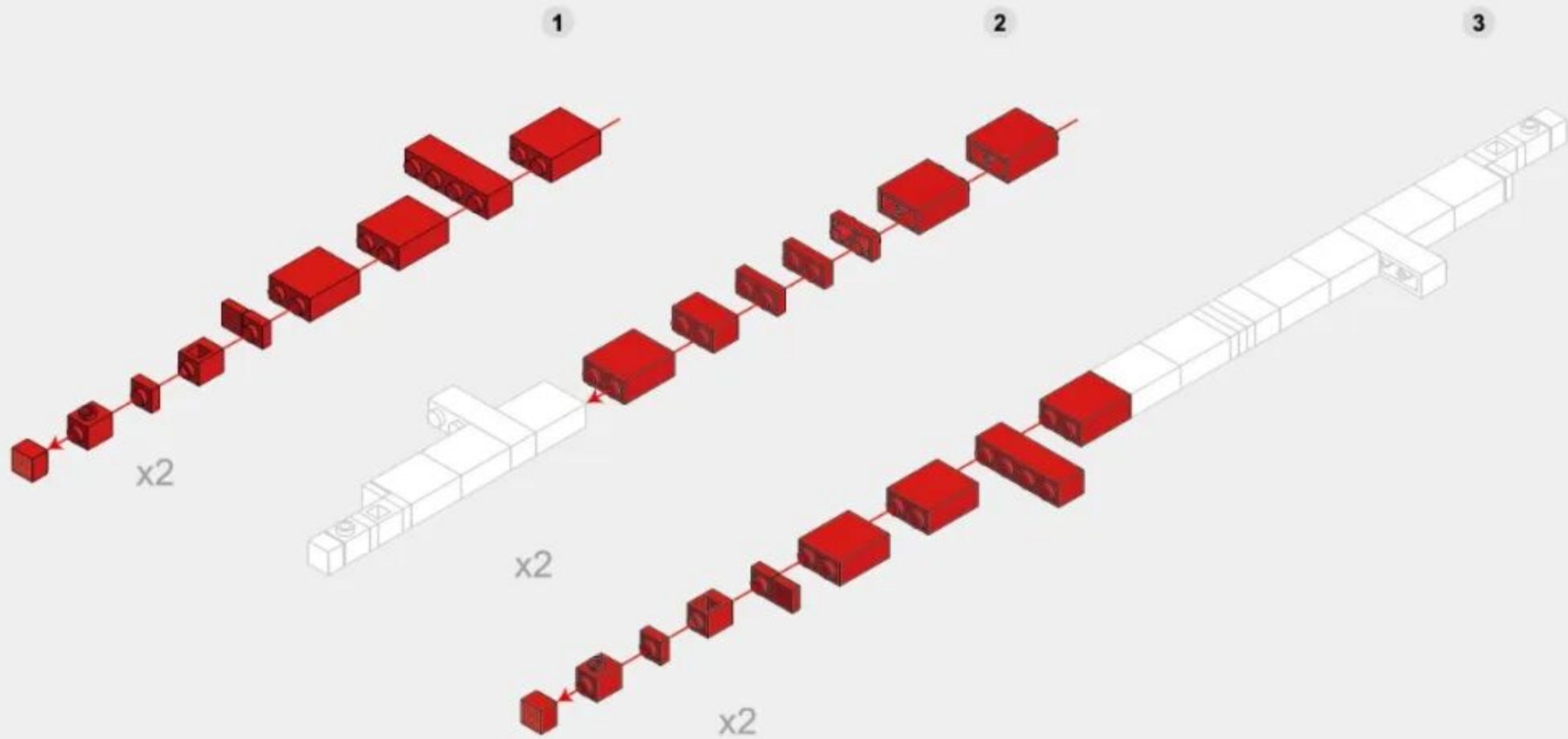

8-9

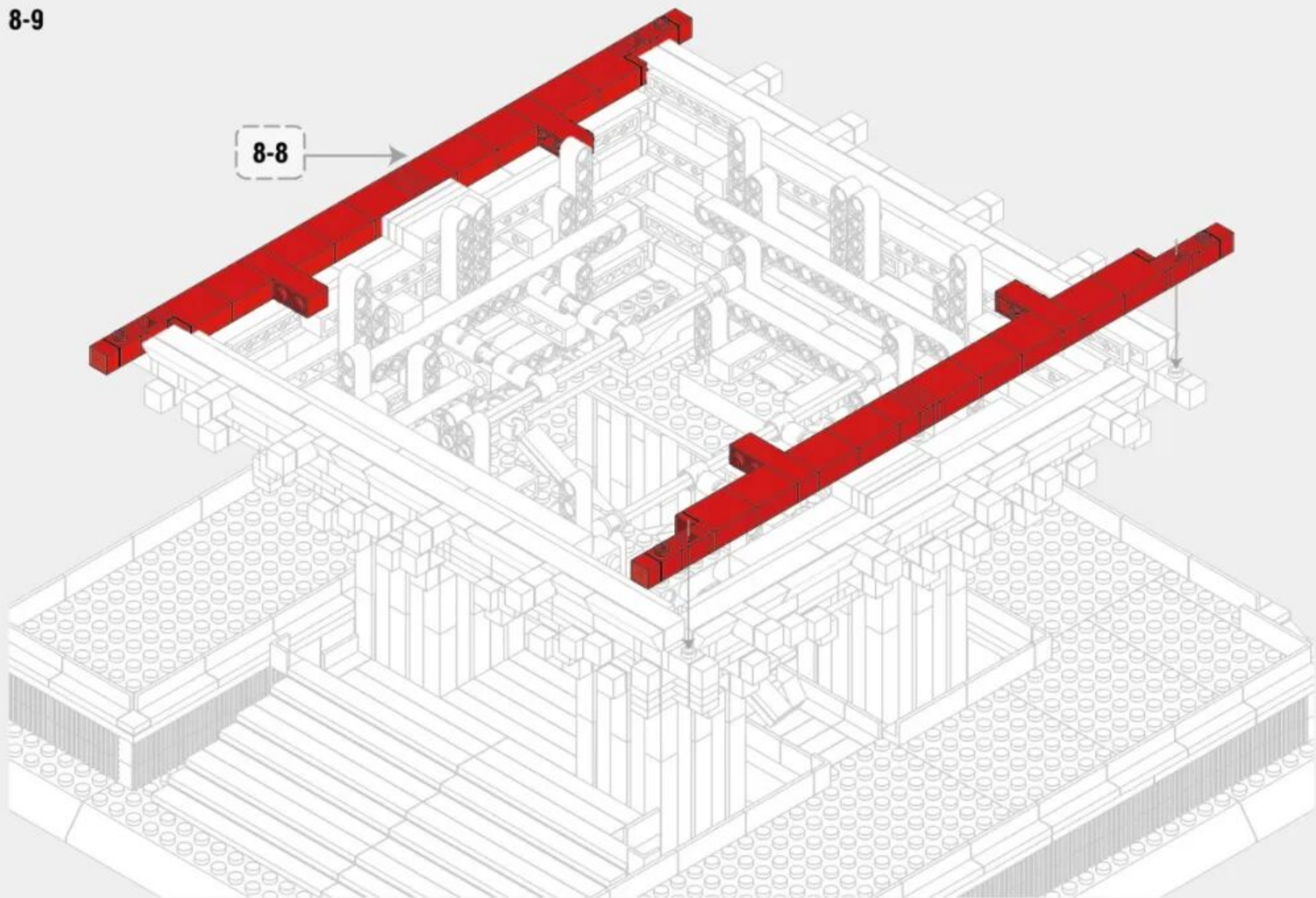

8-11

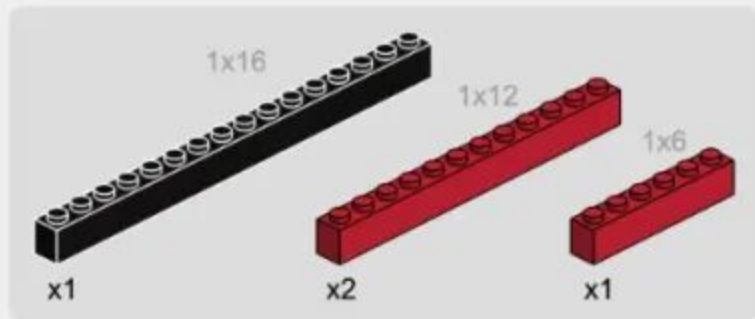

8-12

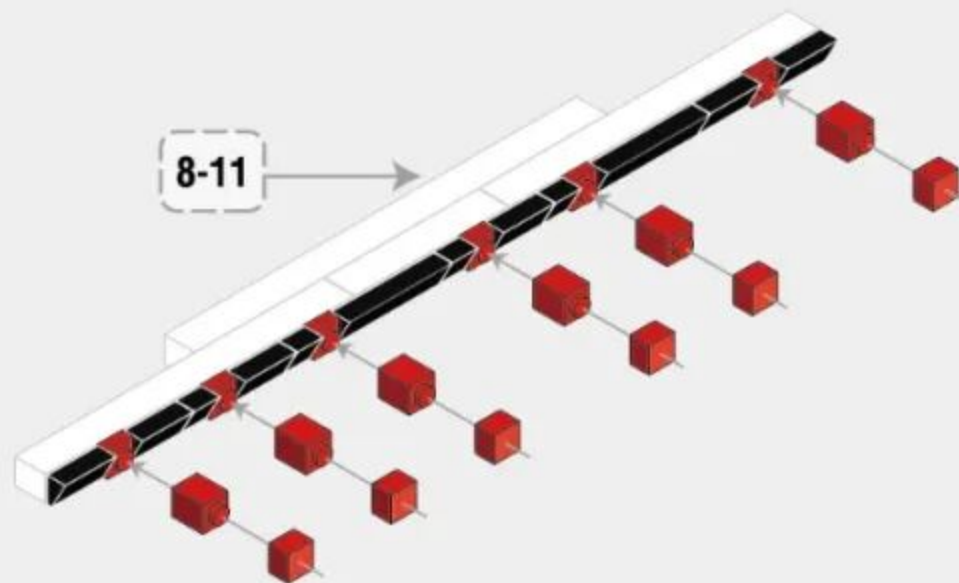

8-13

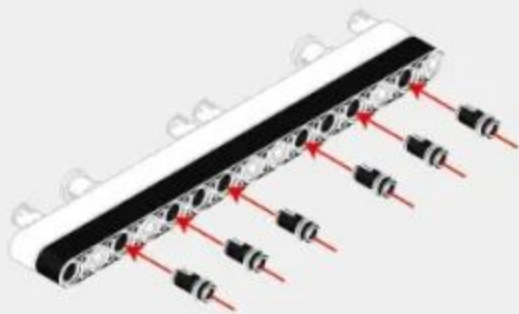
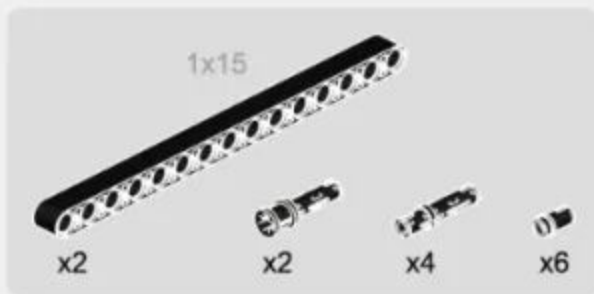

8-14

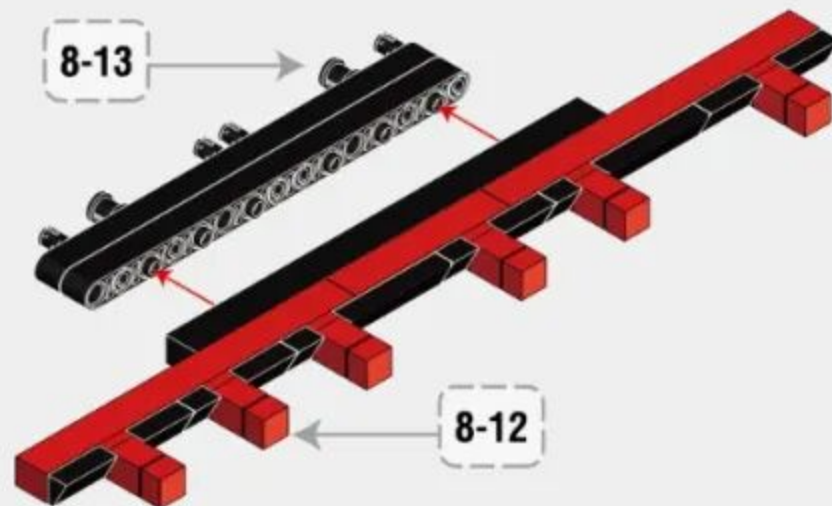

8-15

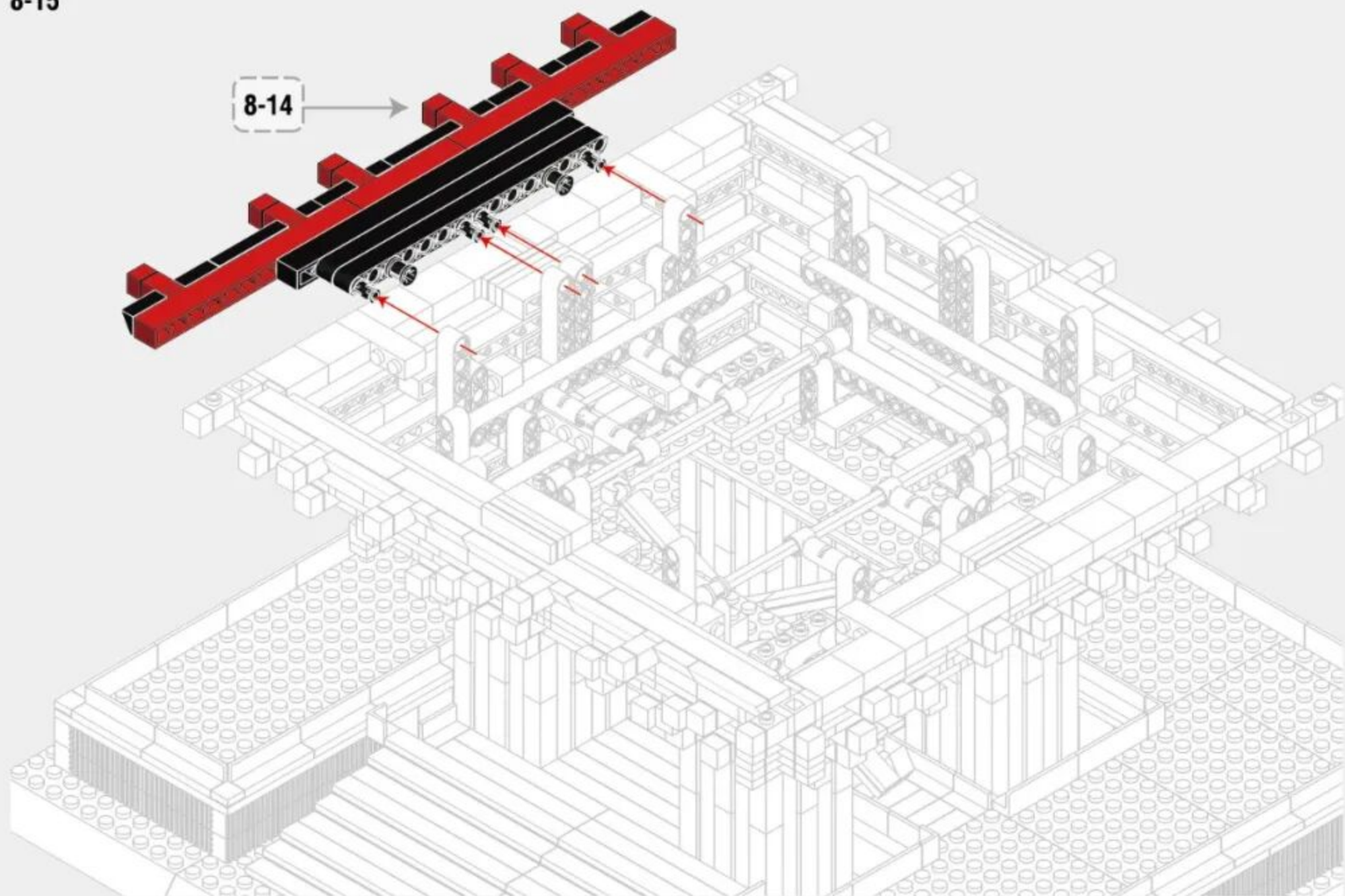

8-14

8-16

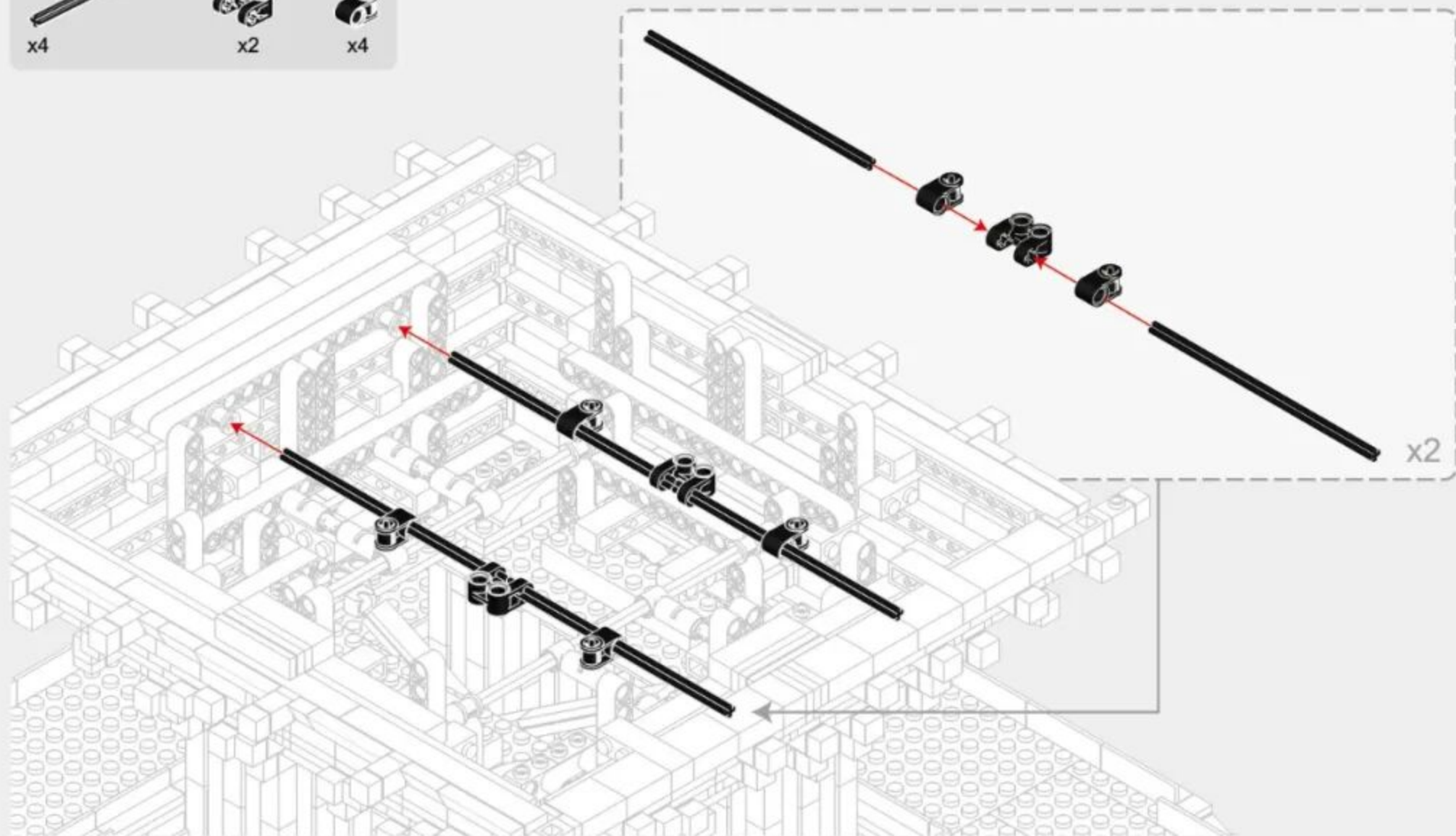

8-17

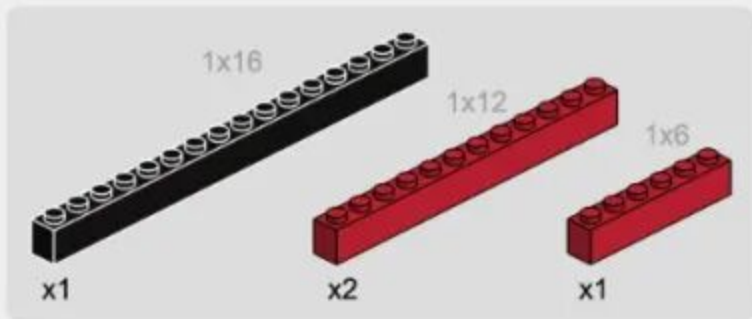

8-18

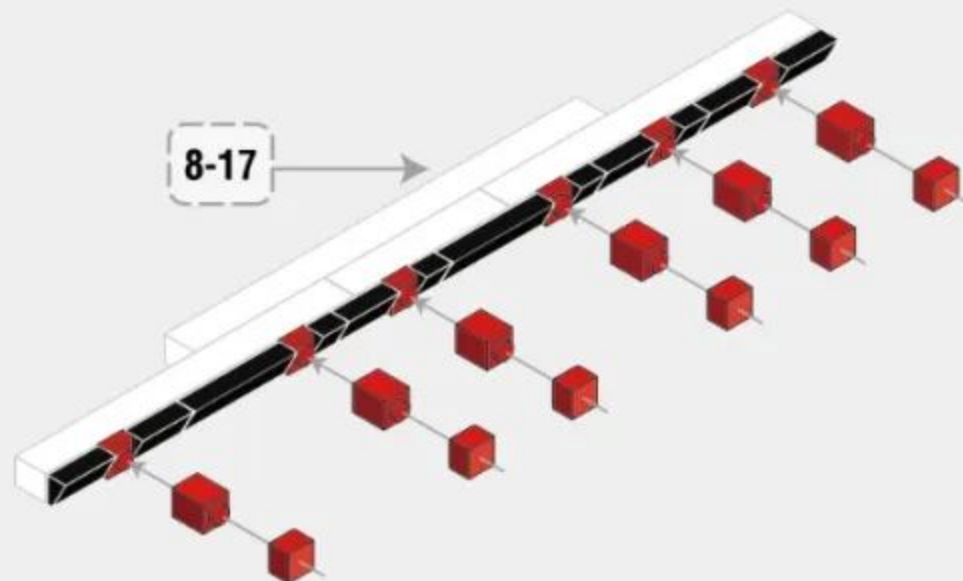

8-19



1



2

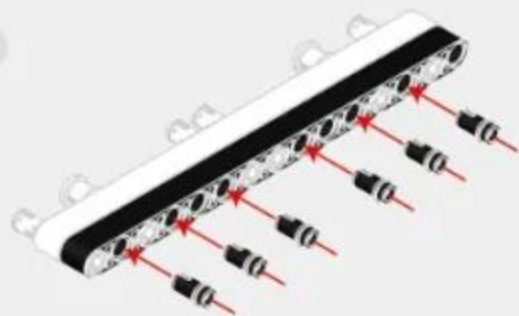

8-20

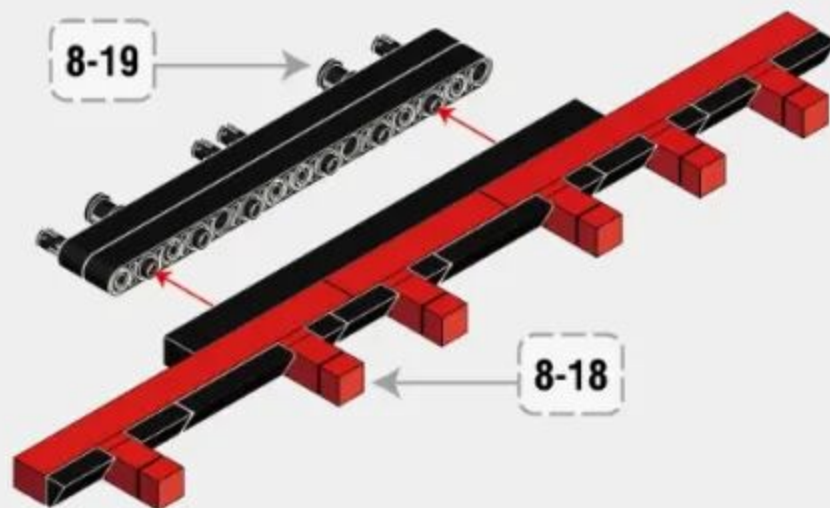

8-21

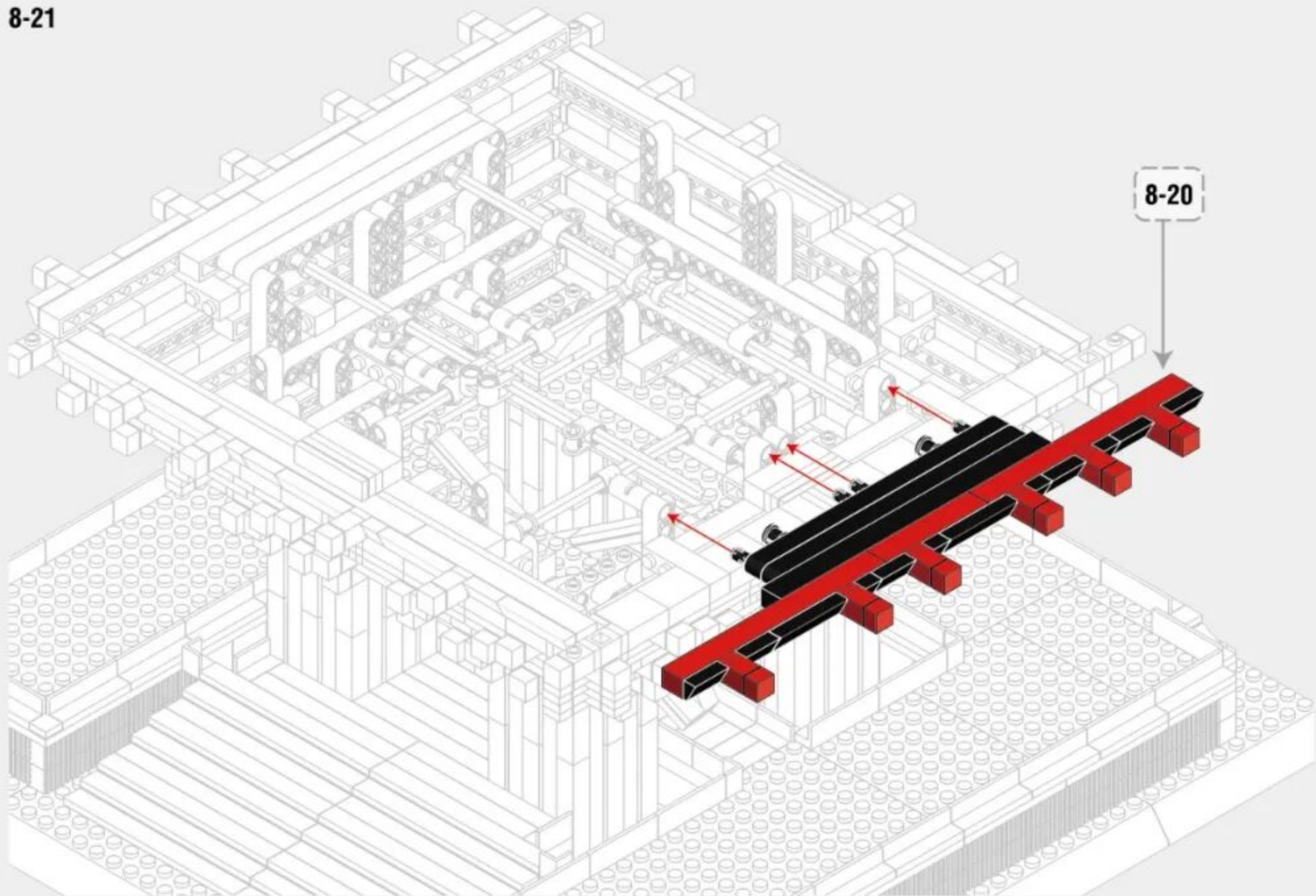

8-20



220PCS

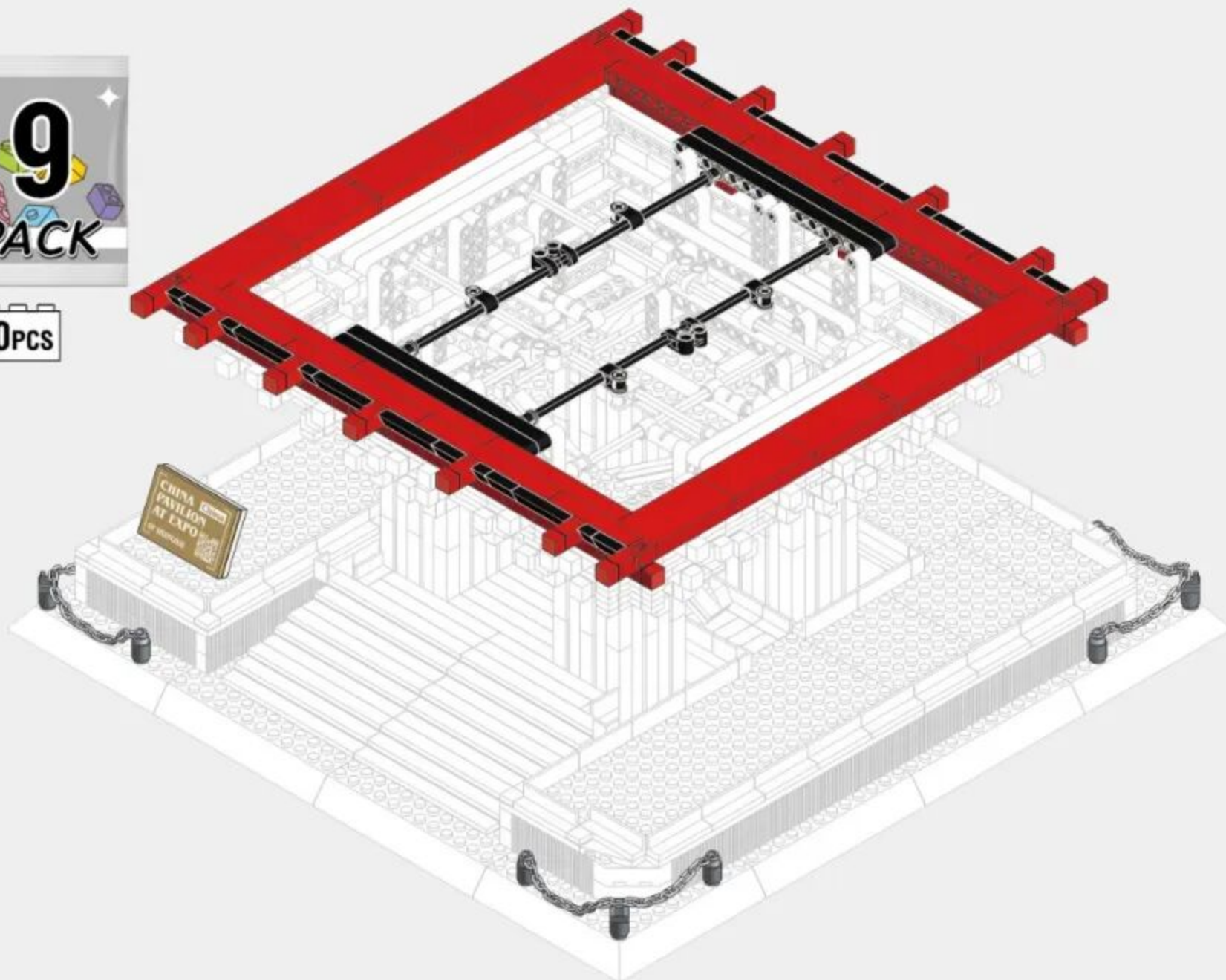

160

9-1

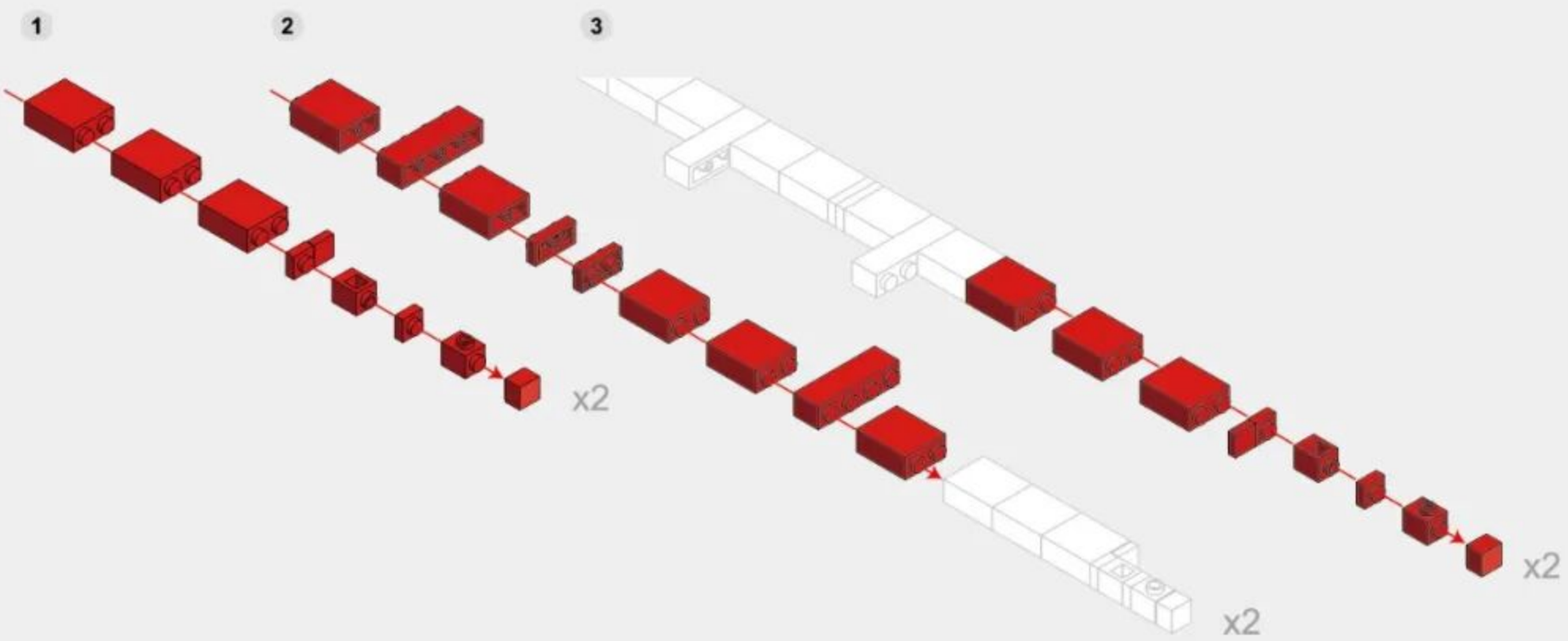

9-2

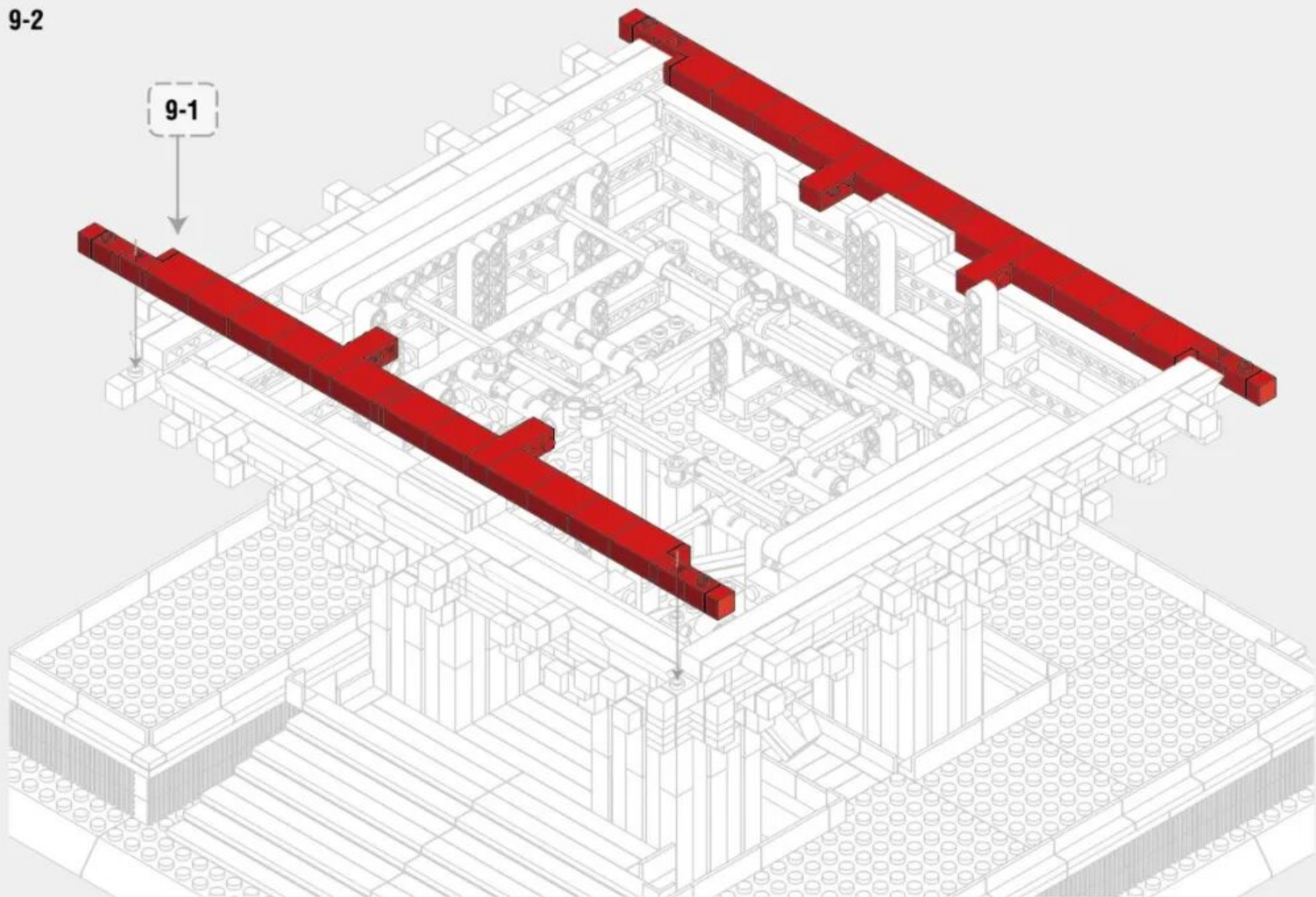

9-3

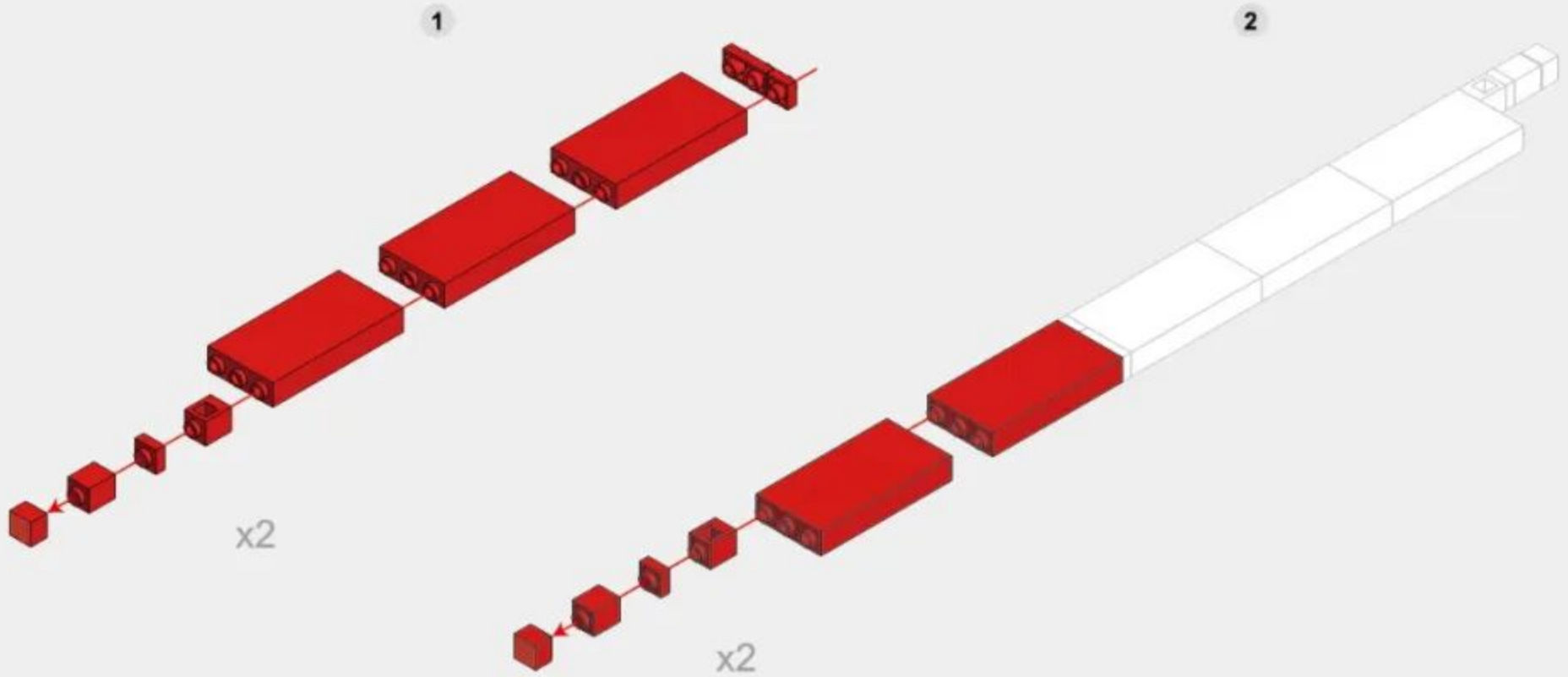
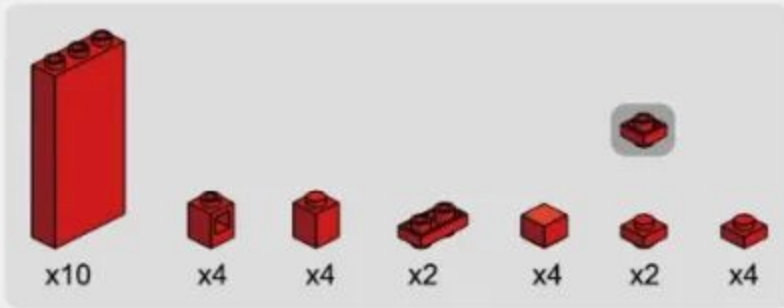

9-4

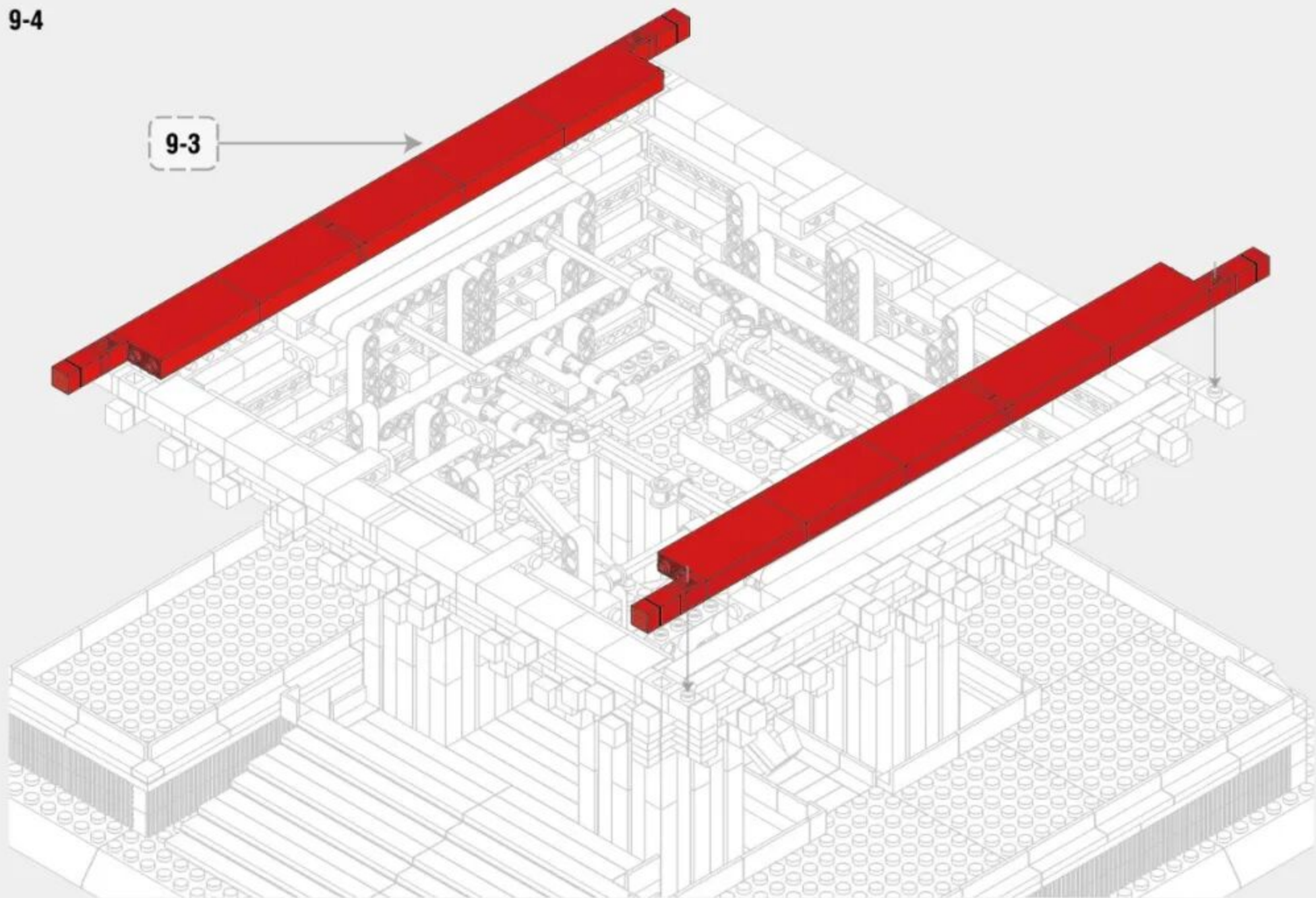

9-3

9-5

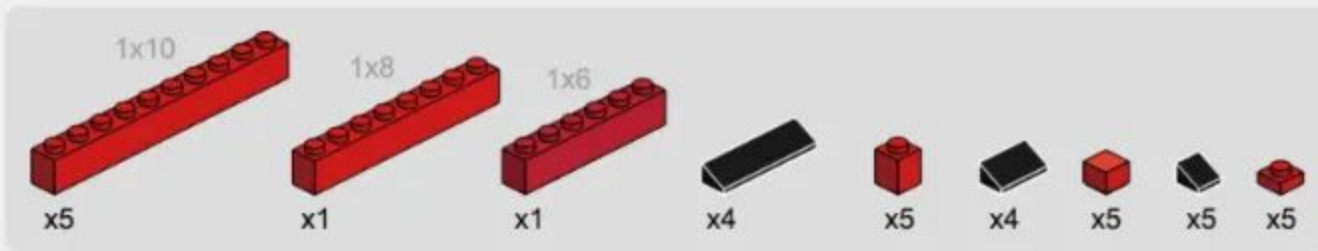

1



2

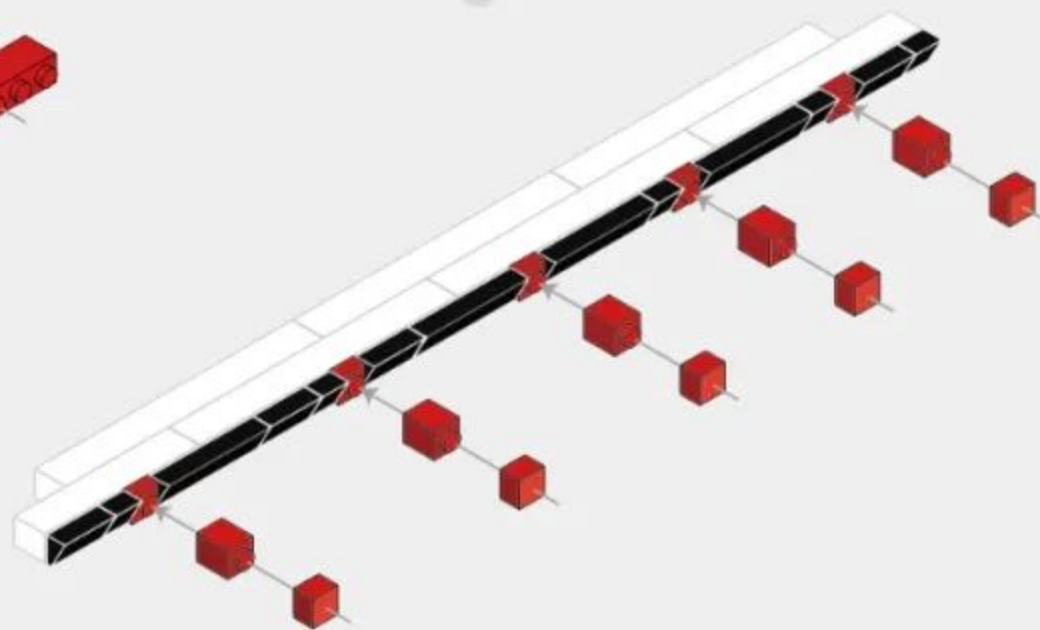

9-6

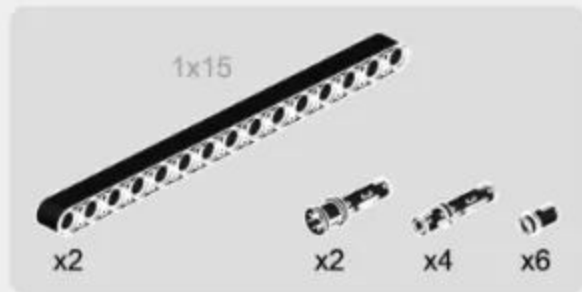

1



2



9-7

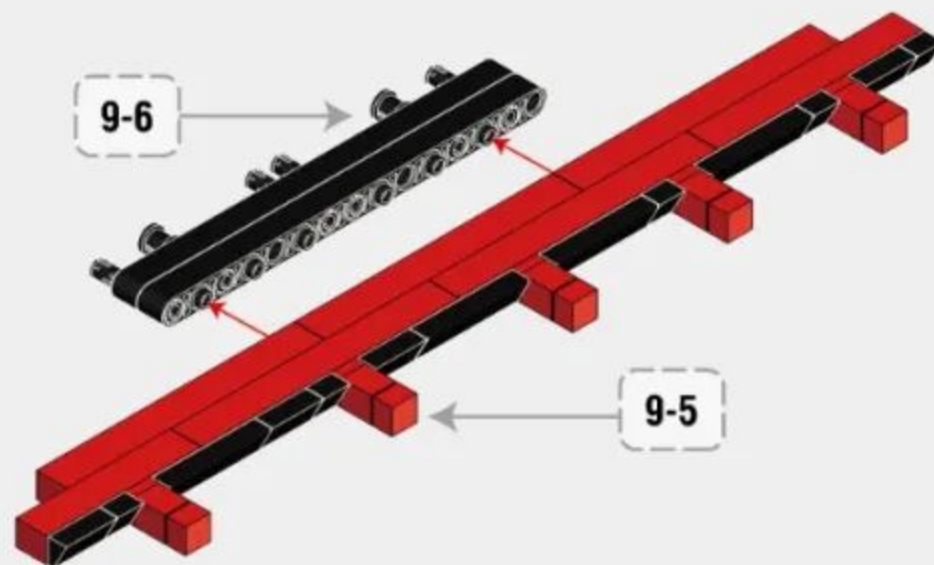

9-8

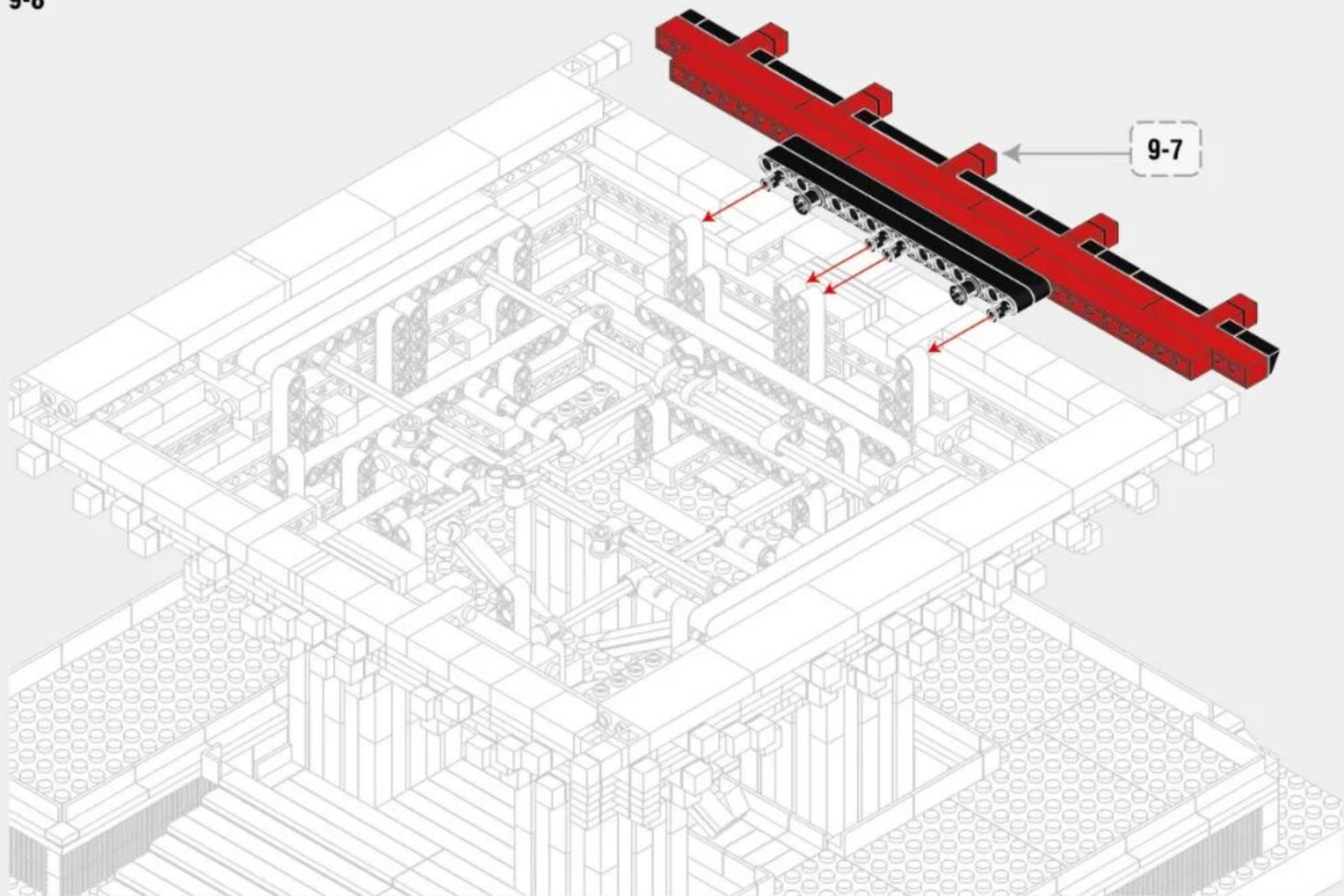

9-7

9-9

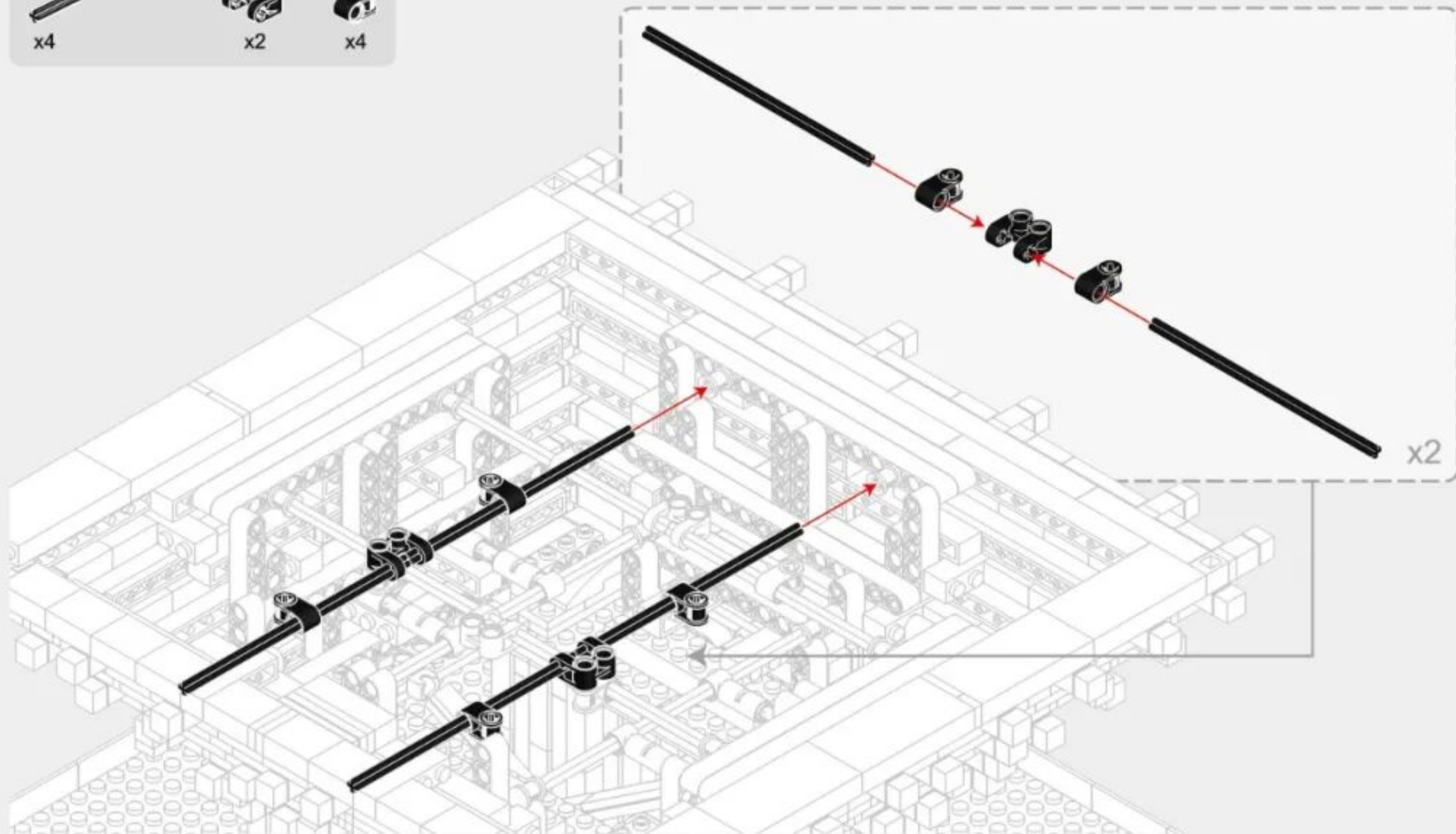

9-10

x4

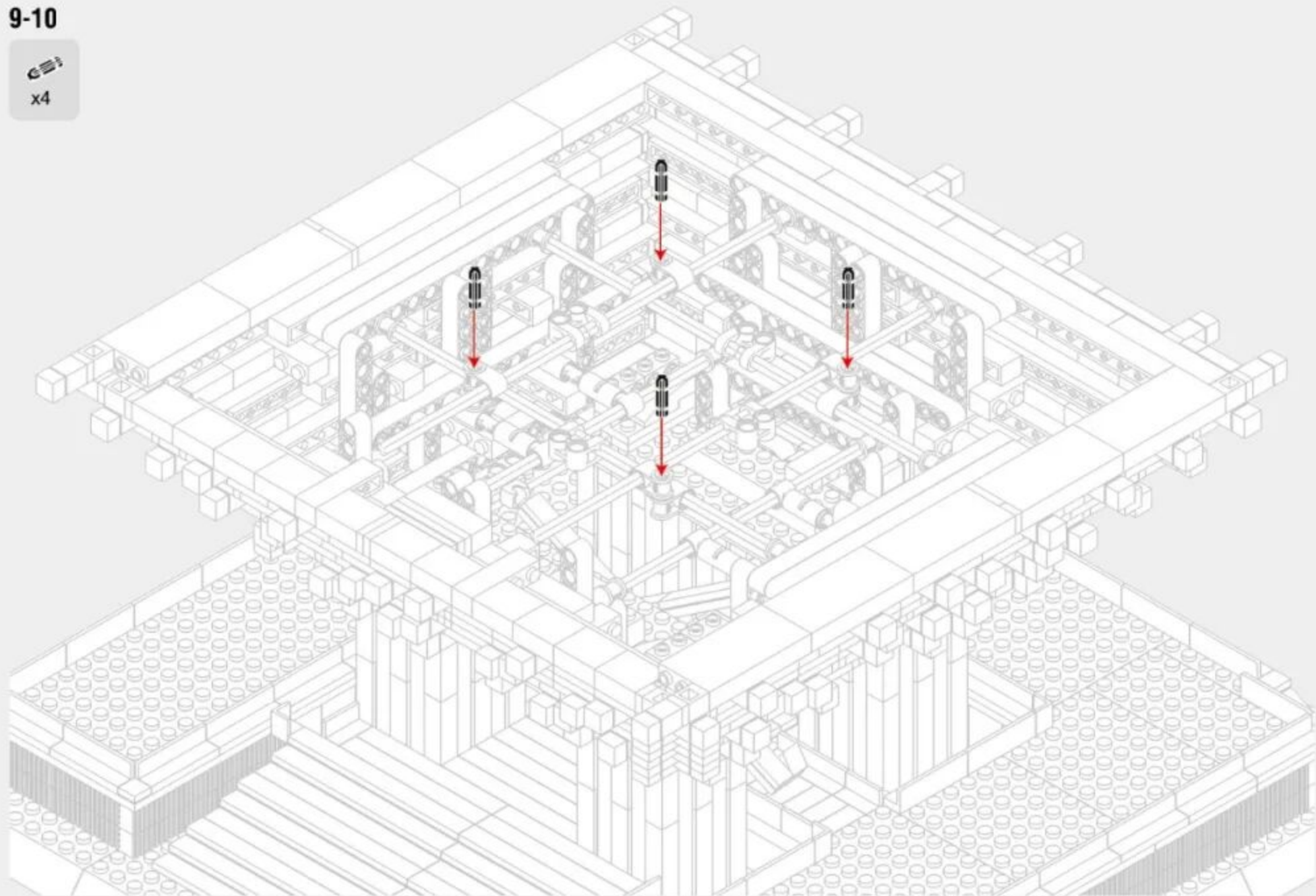

9-11

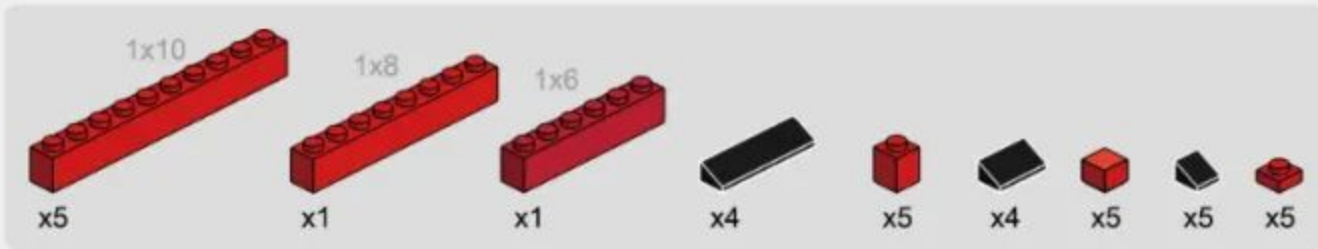

1



2

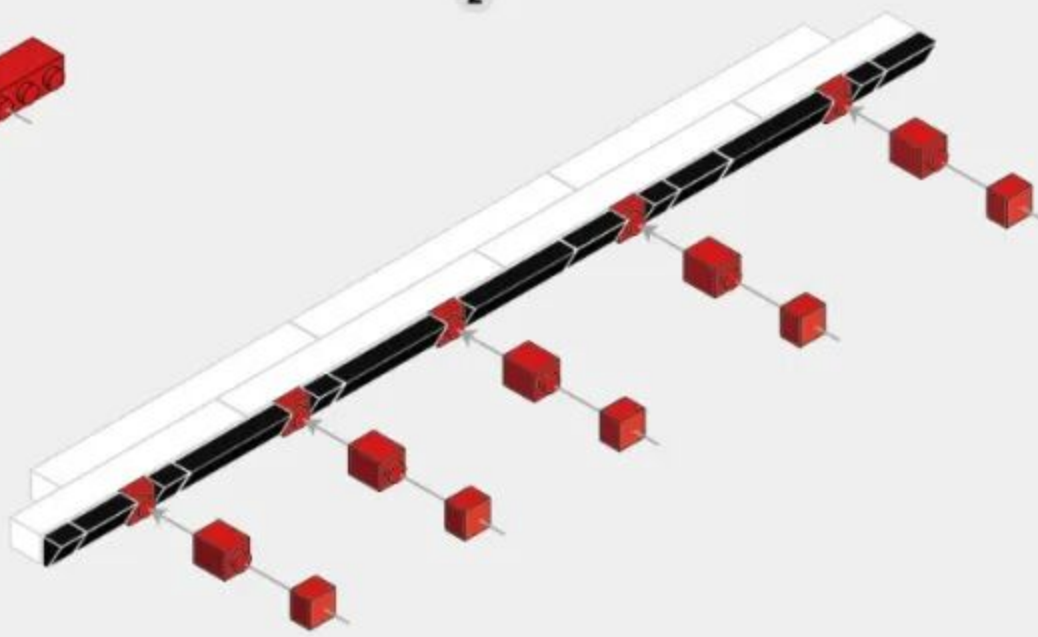

9-12



1



2

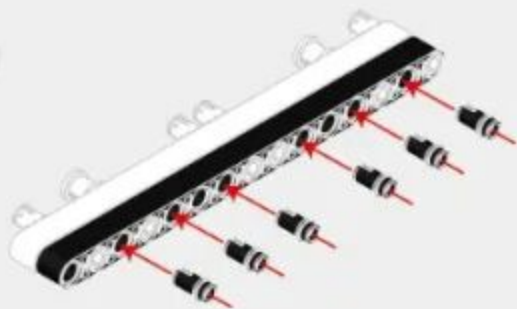

9-13

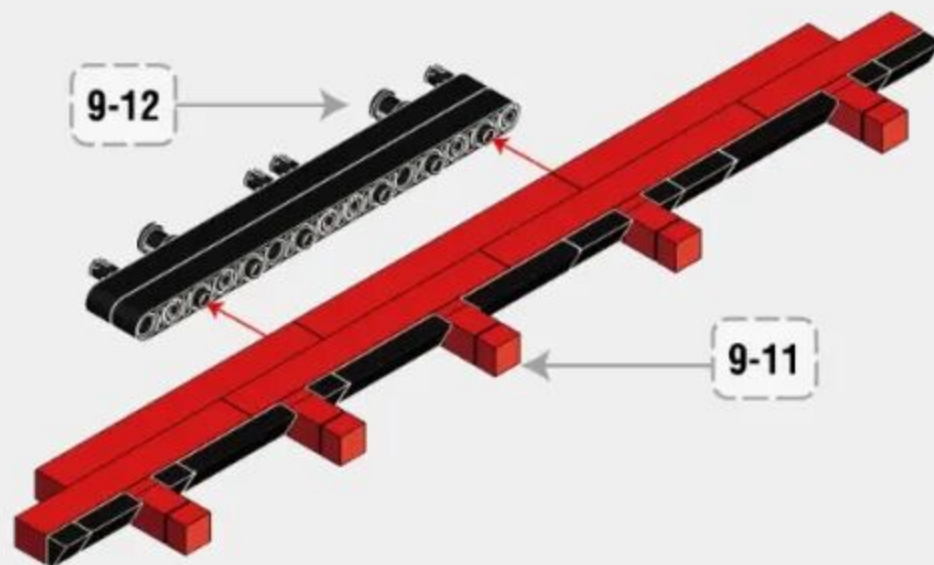

9-14

9-13

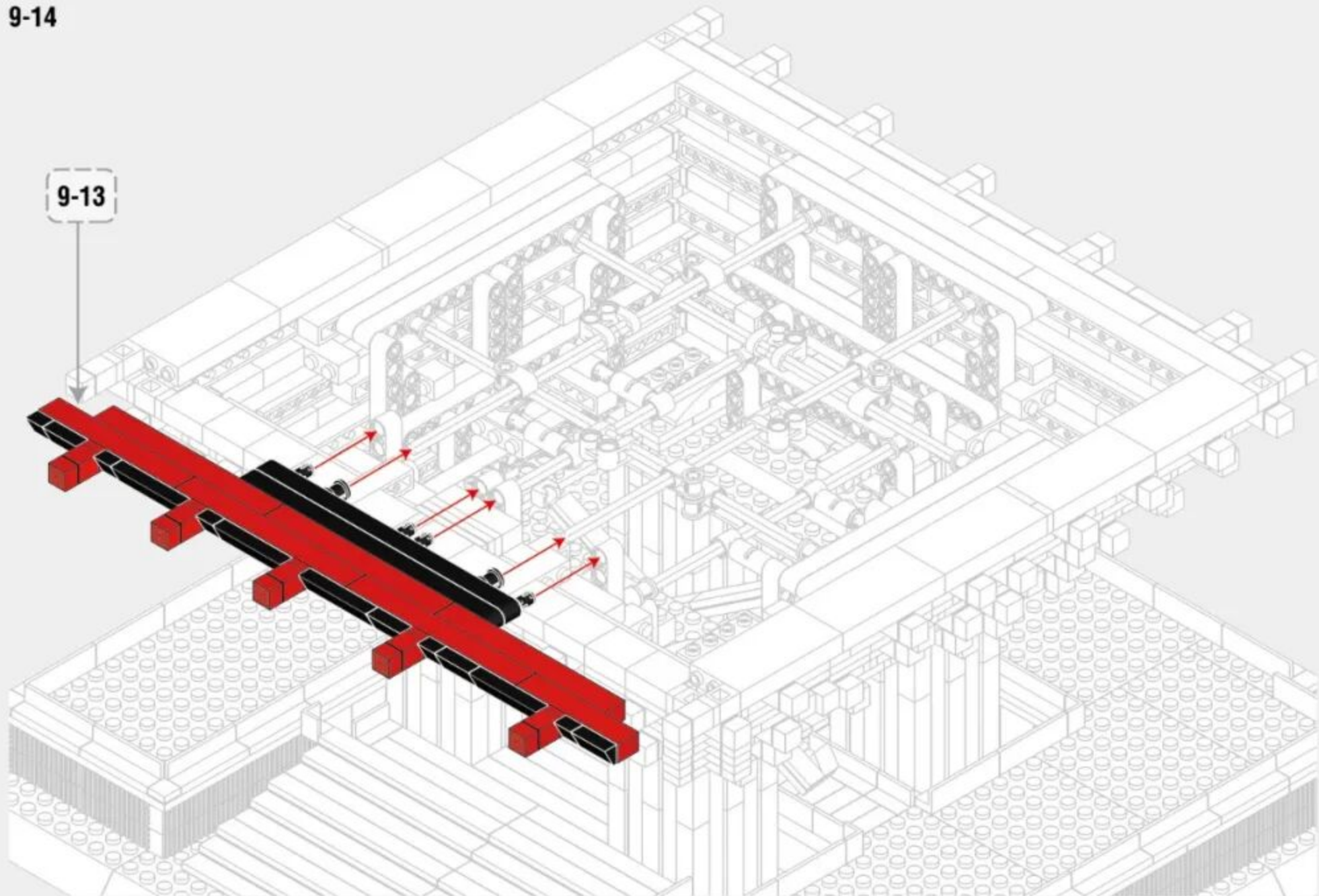

9-15

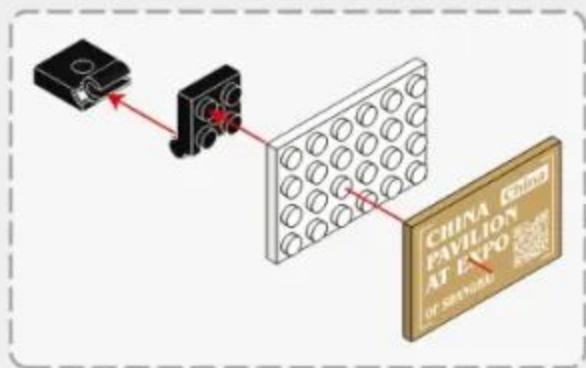
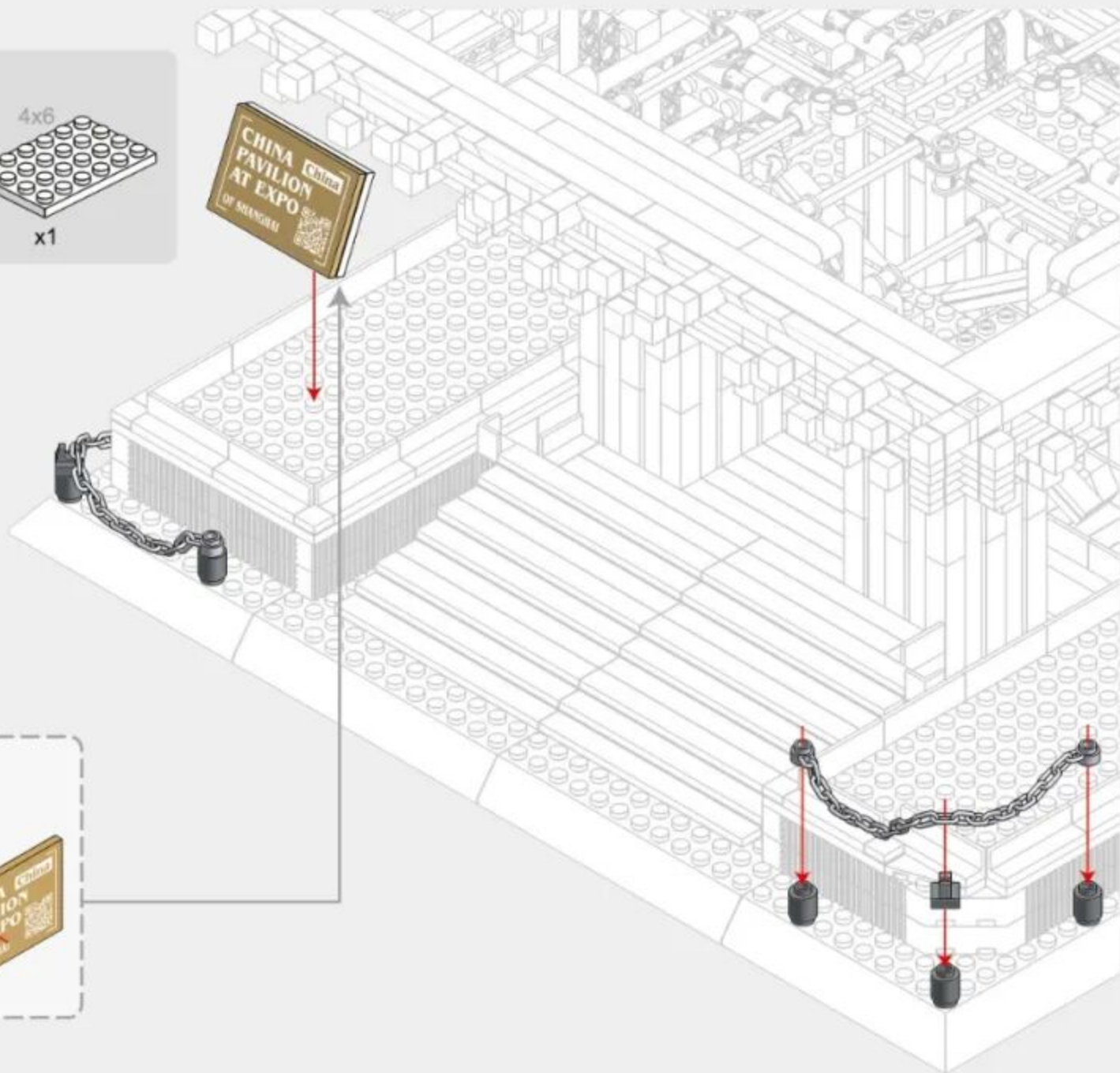
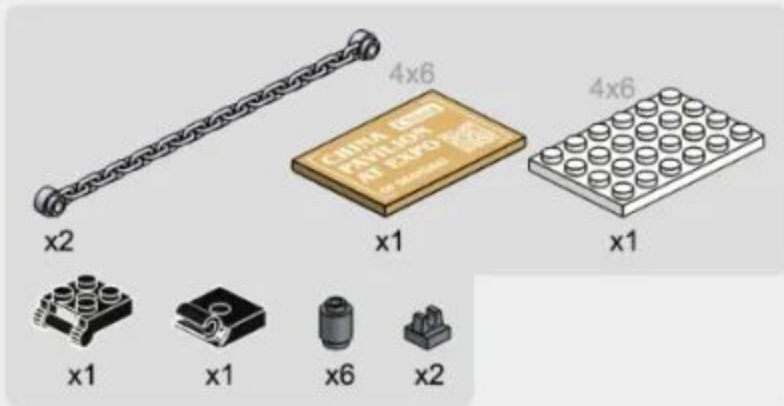

9-16

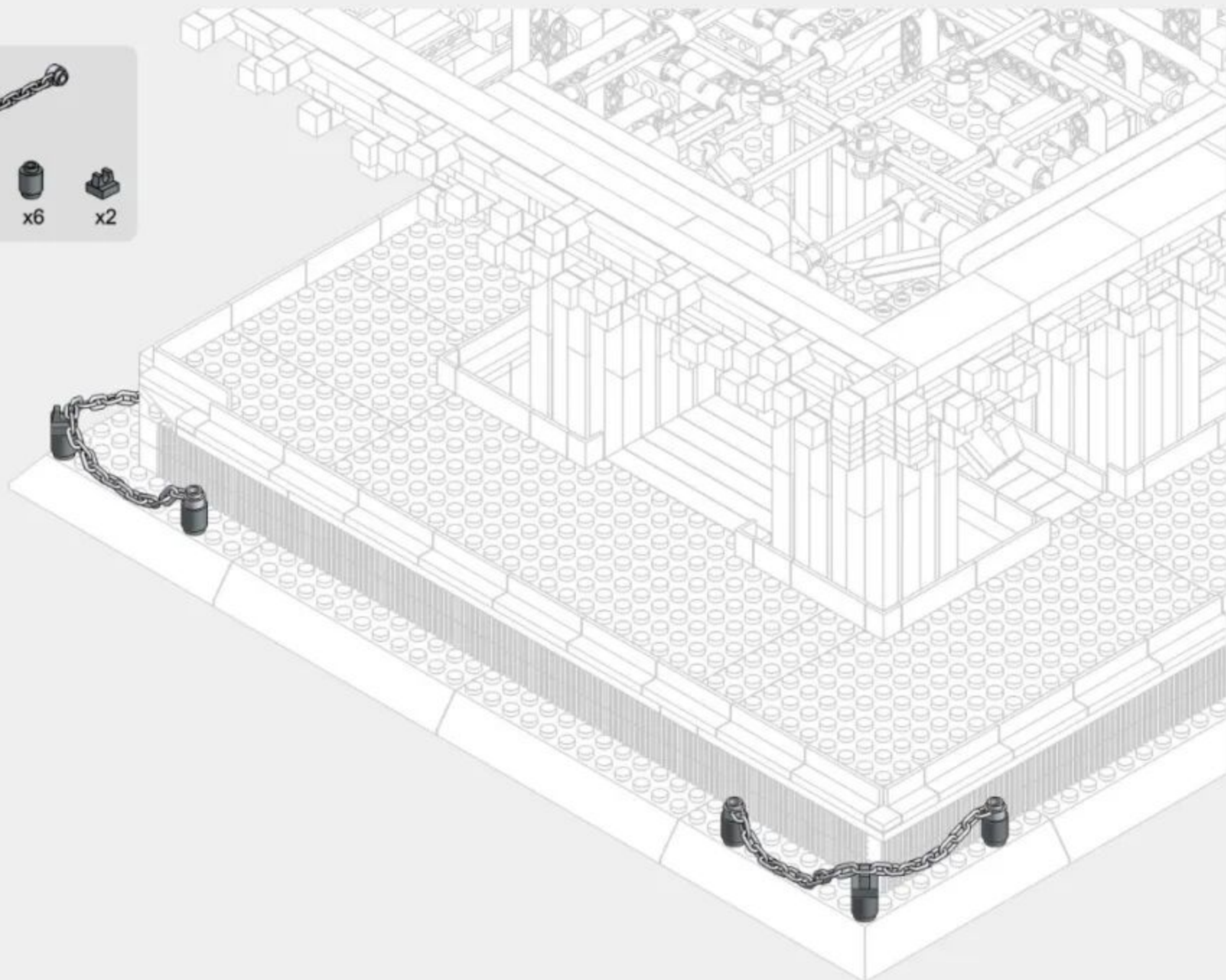



258PCS

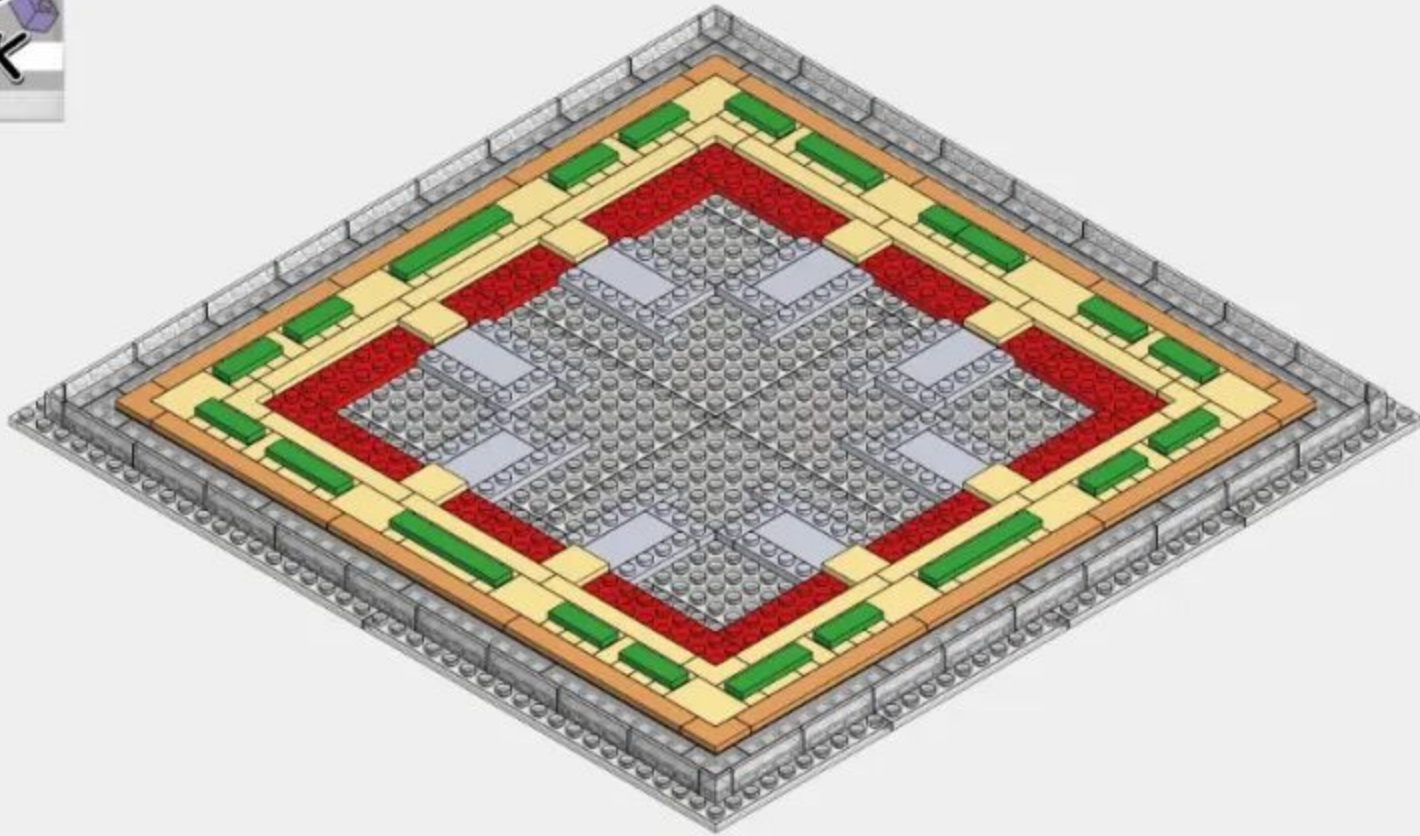

10-1

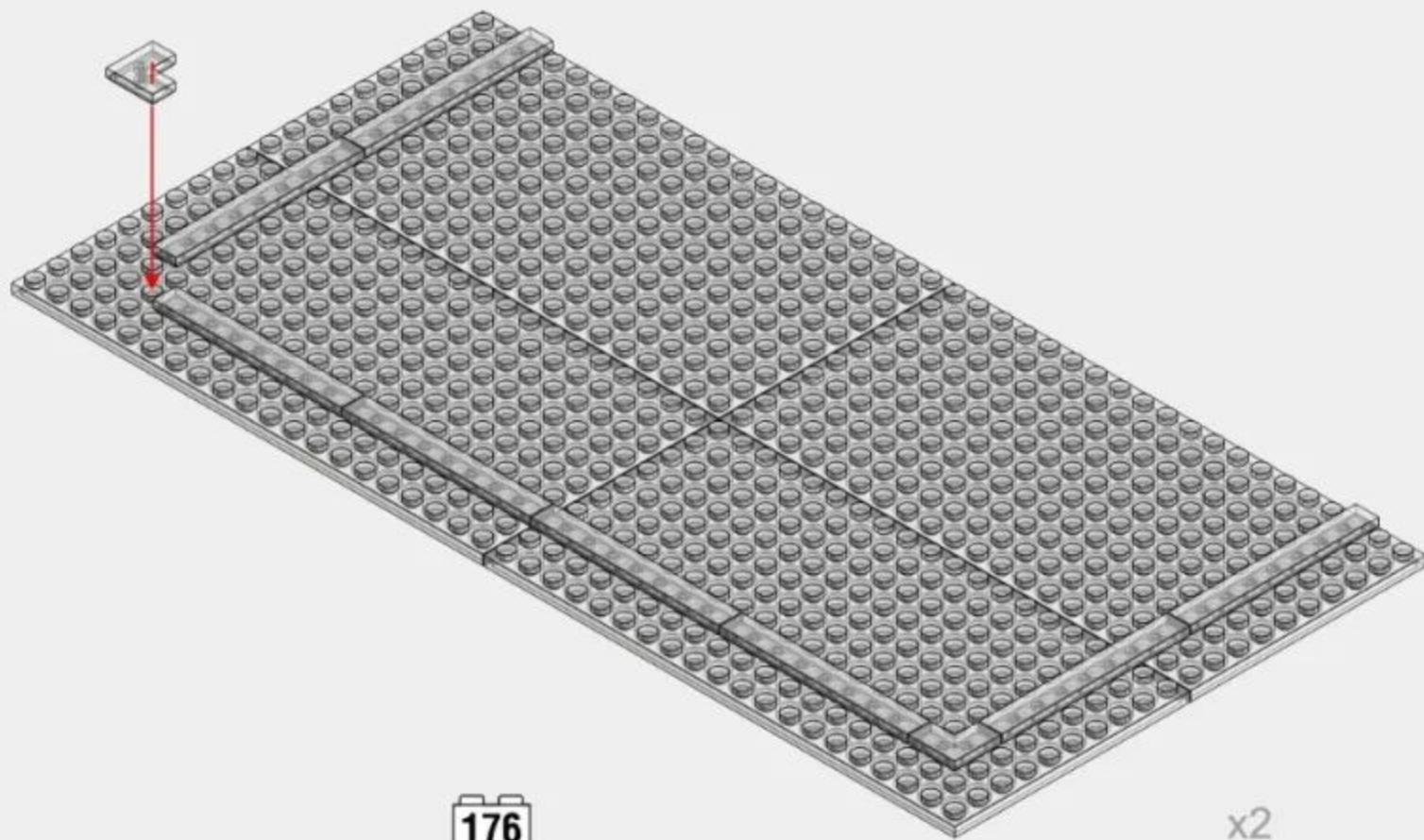
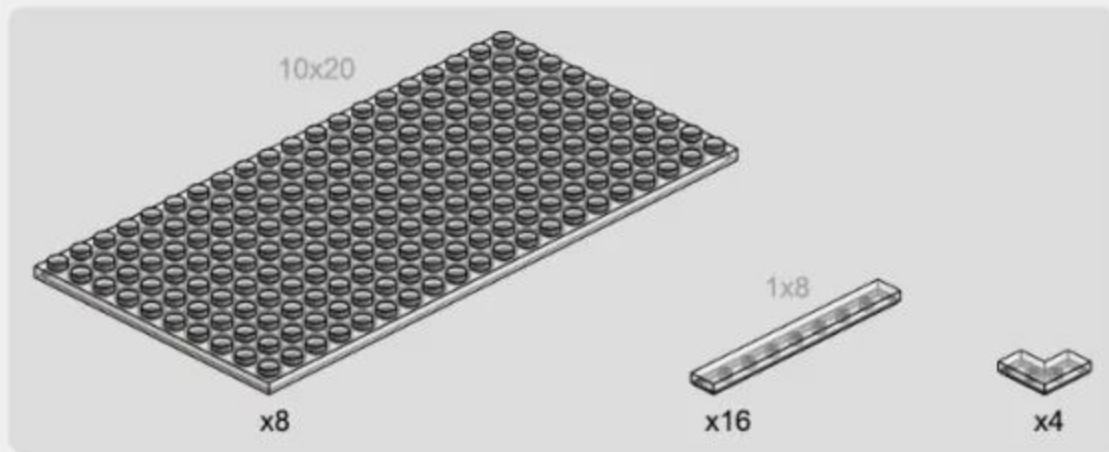

176

10-2

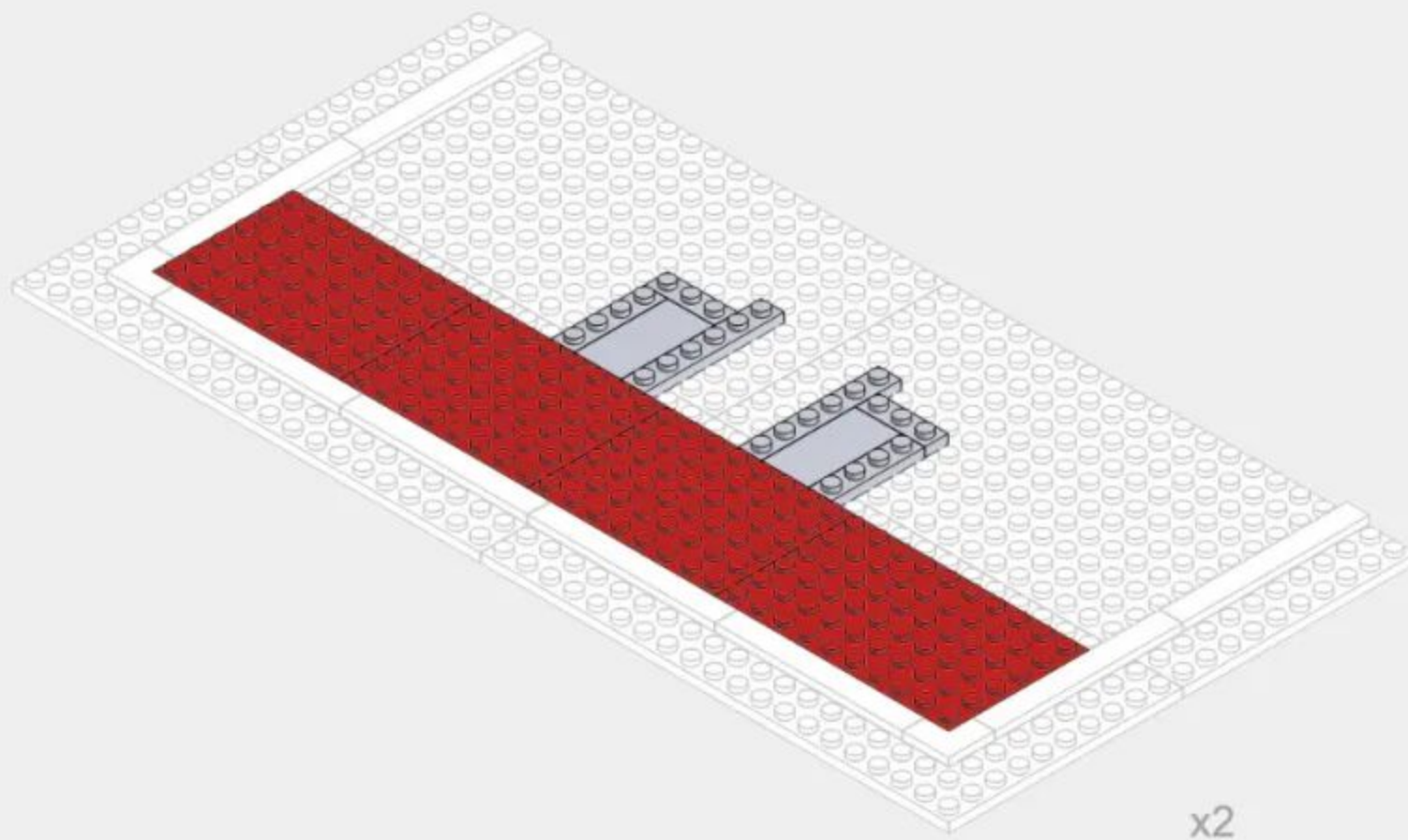
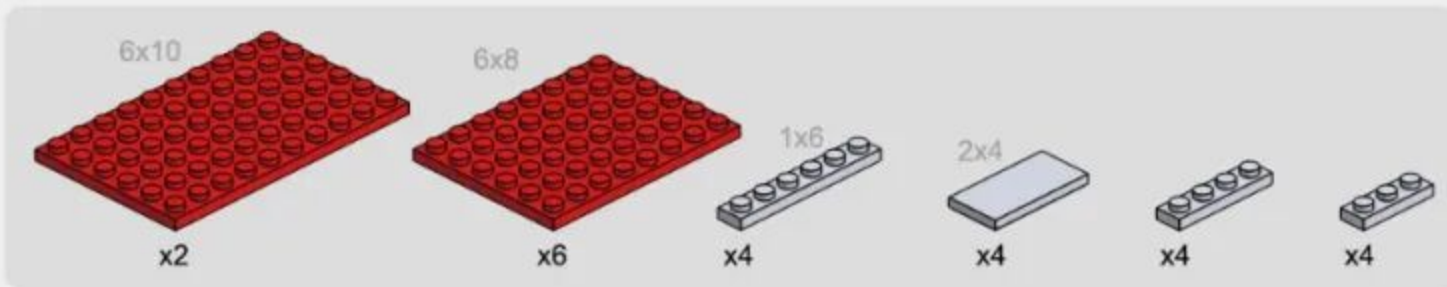

10-3

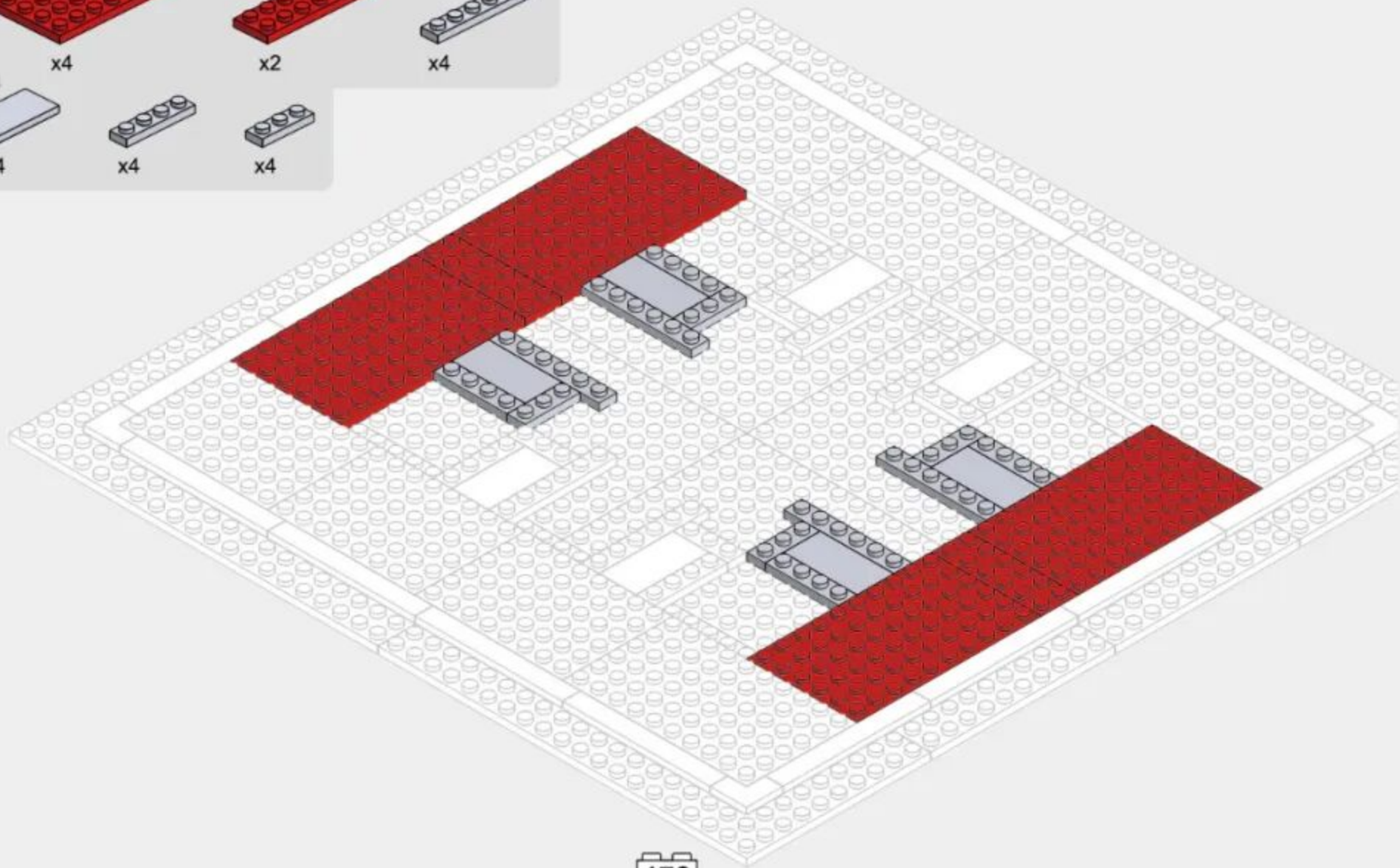
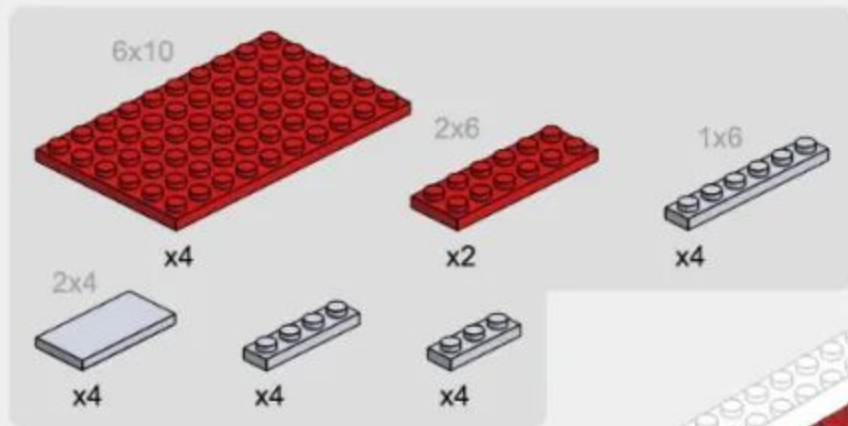

10-4

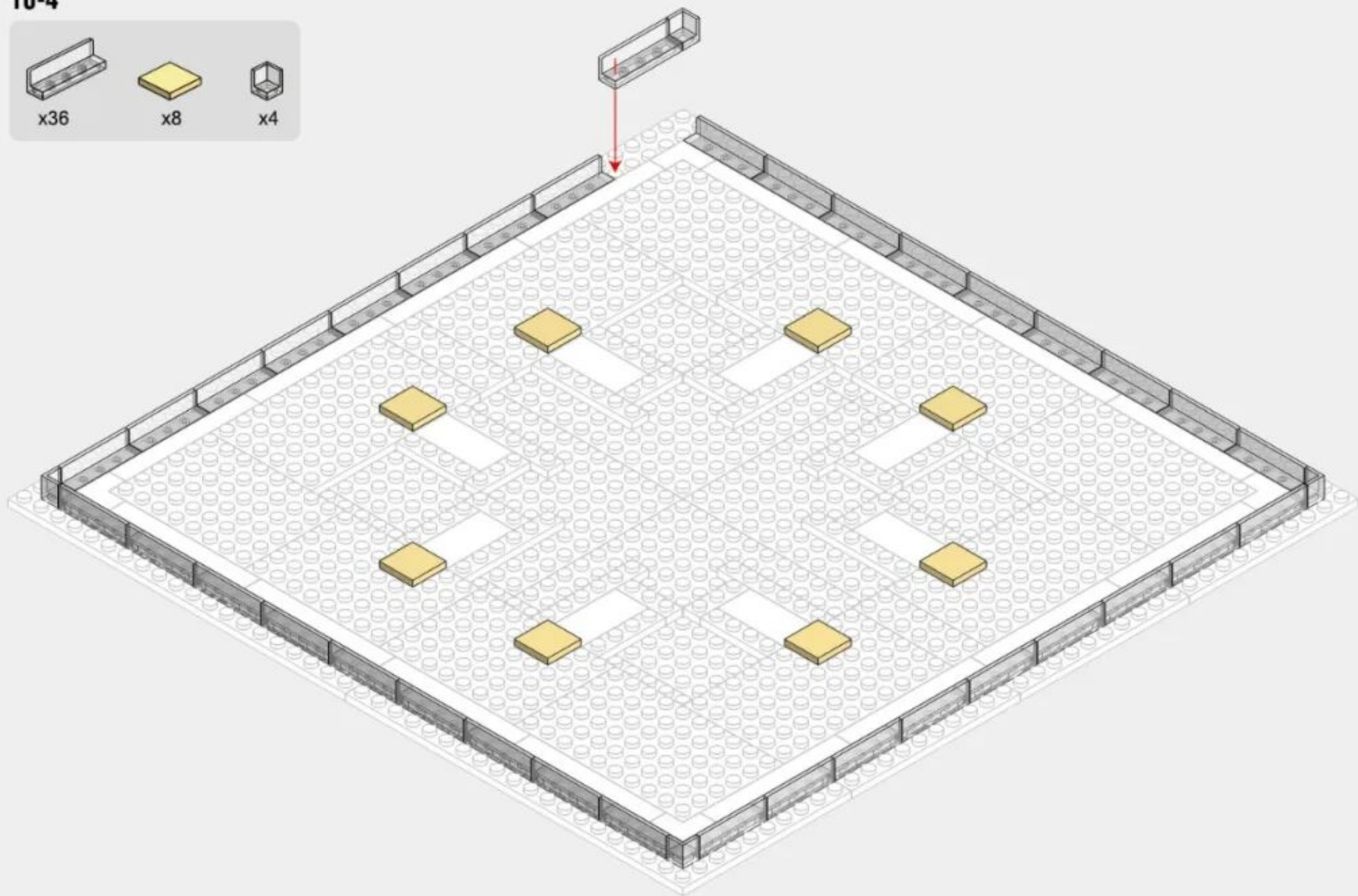
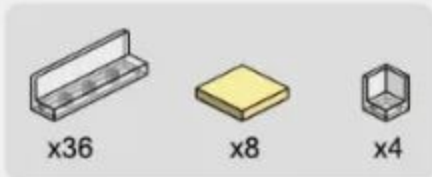

10-5

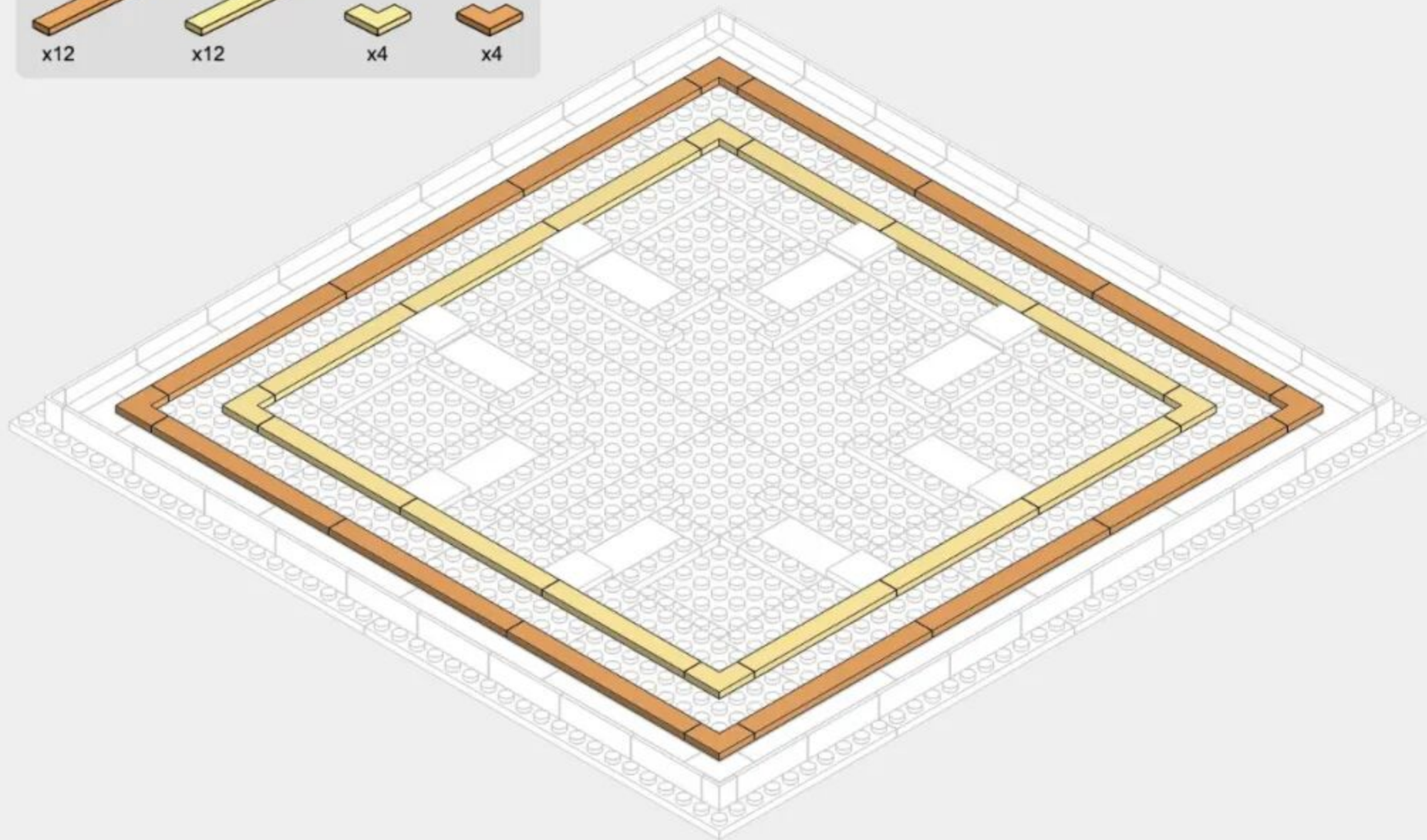
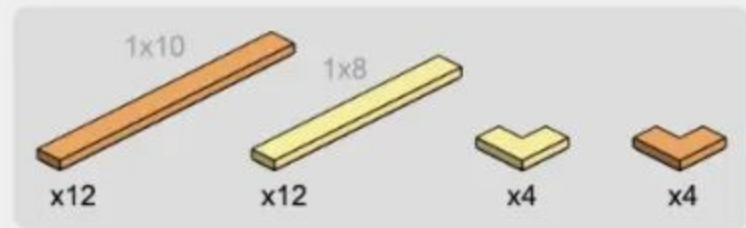

10-6

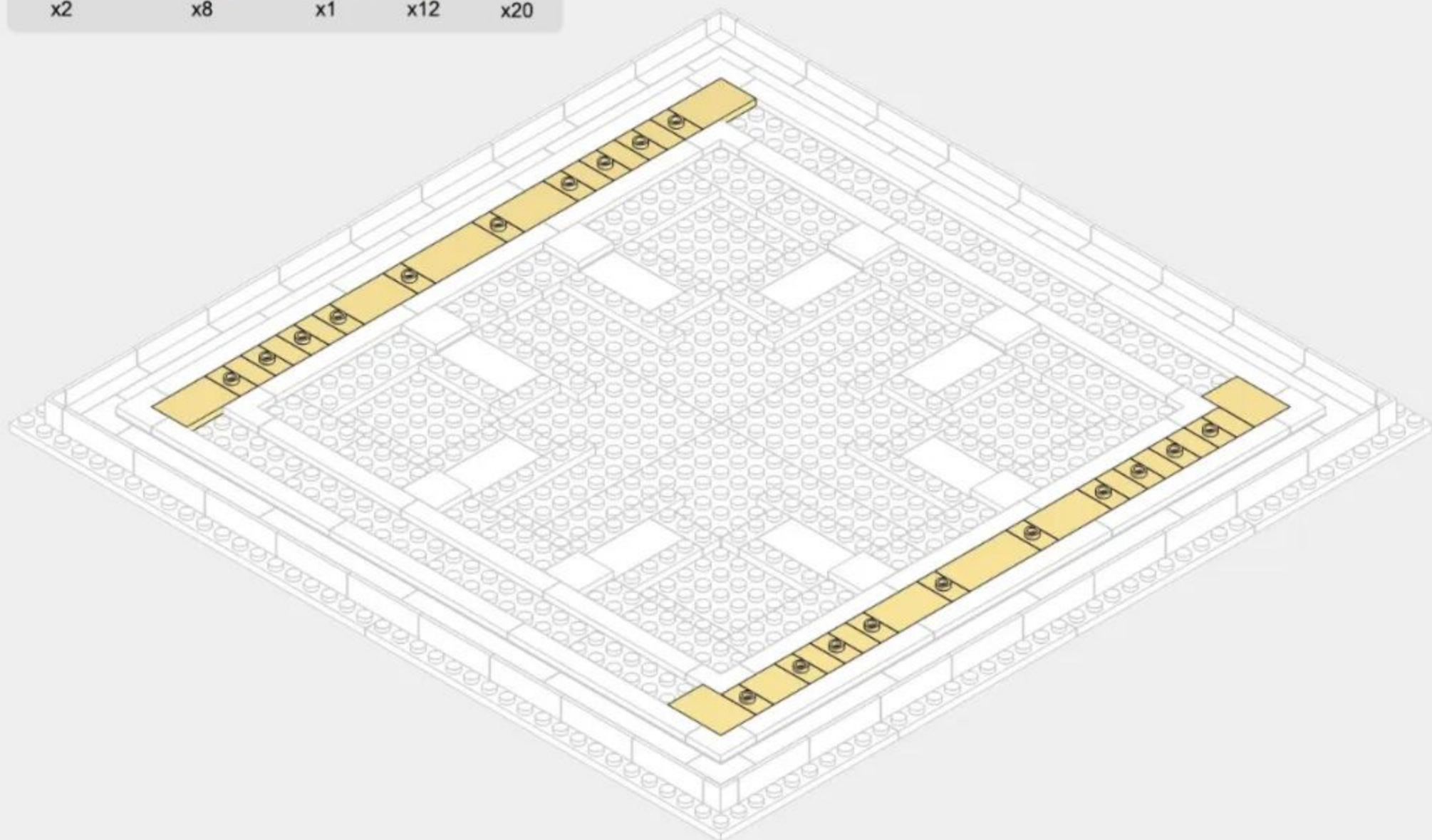
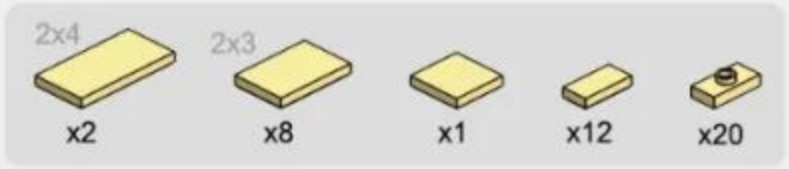

10-7

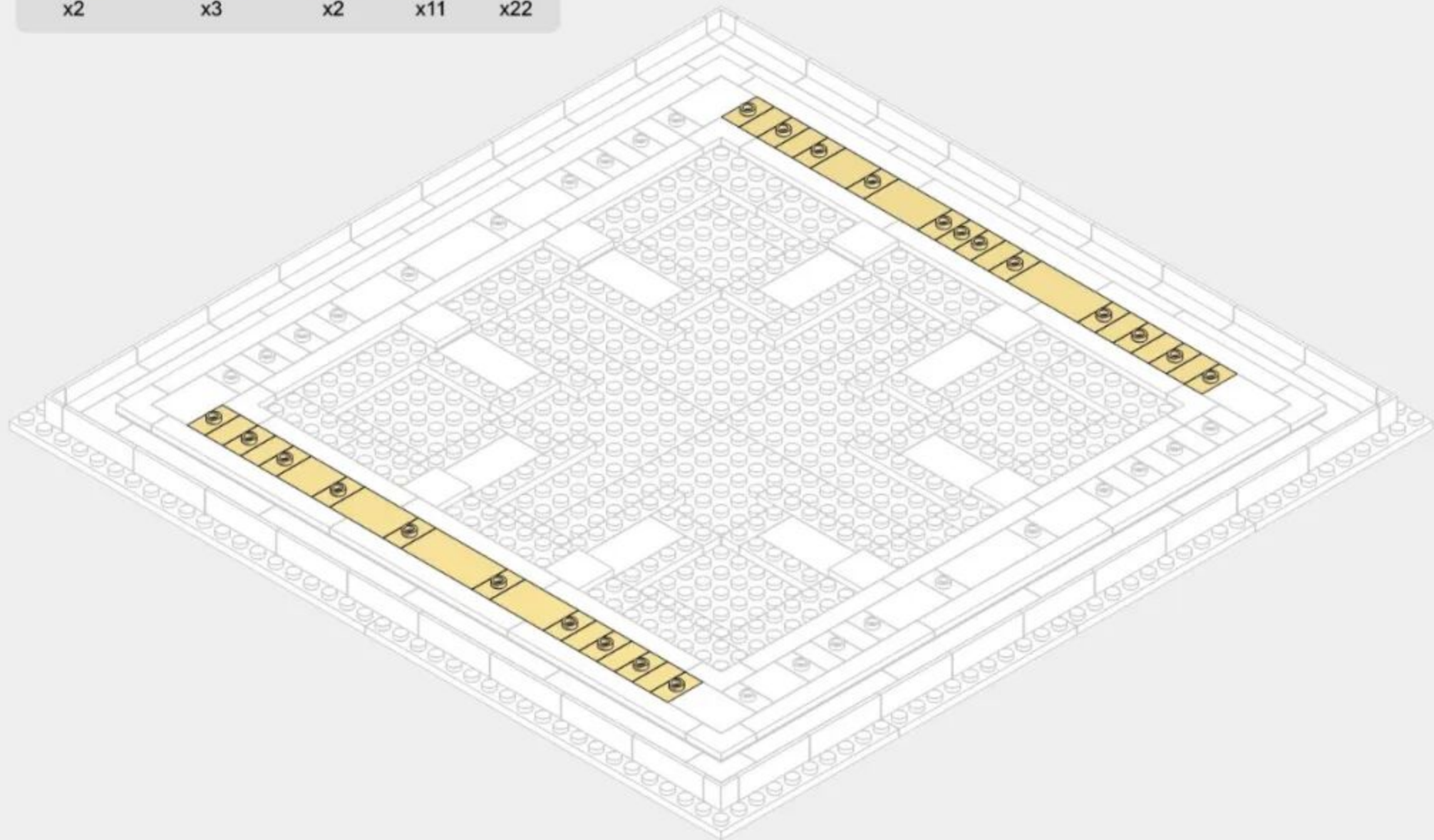
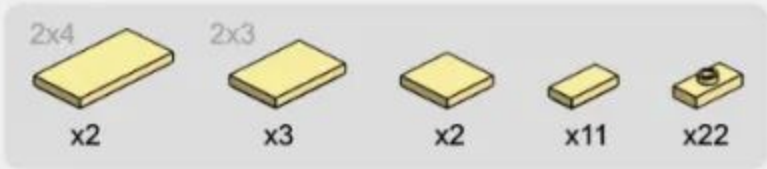

10-8

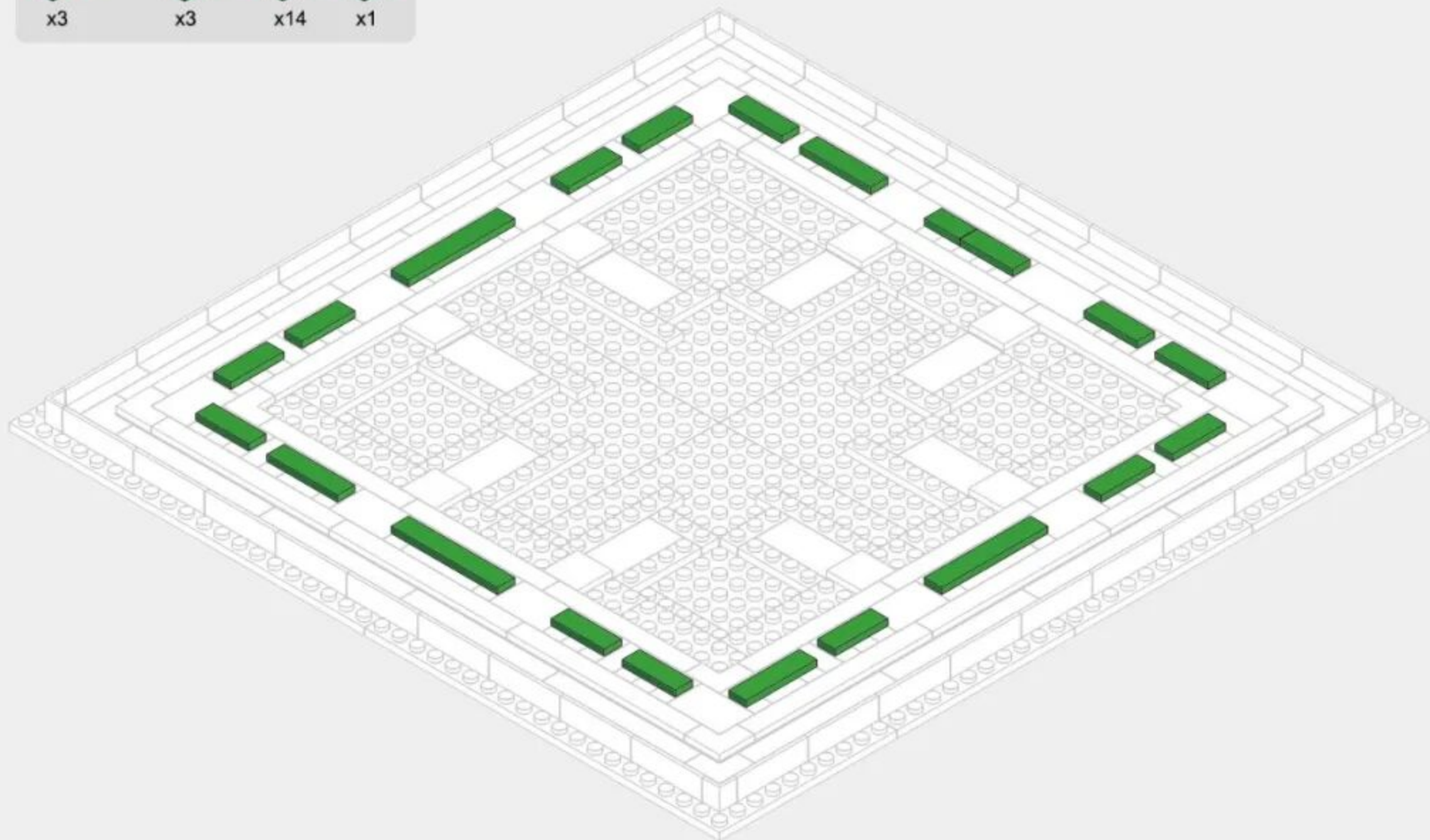
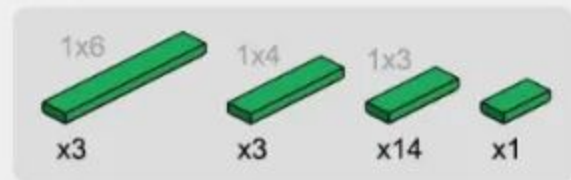



251 PCS

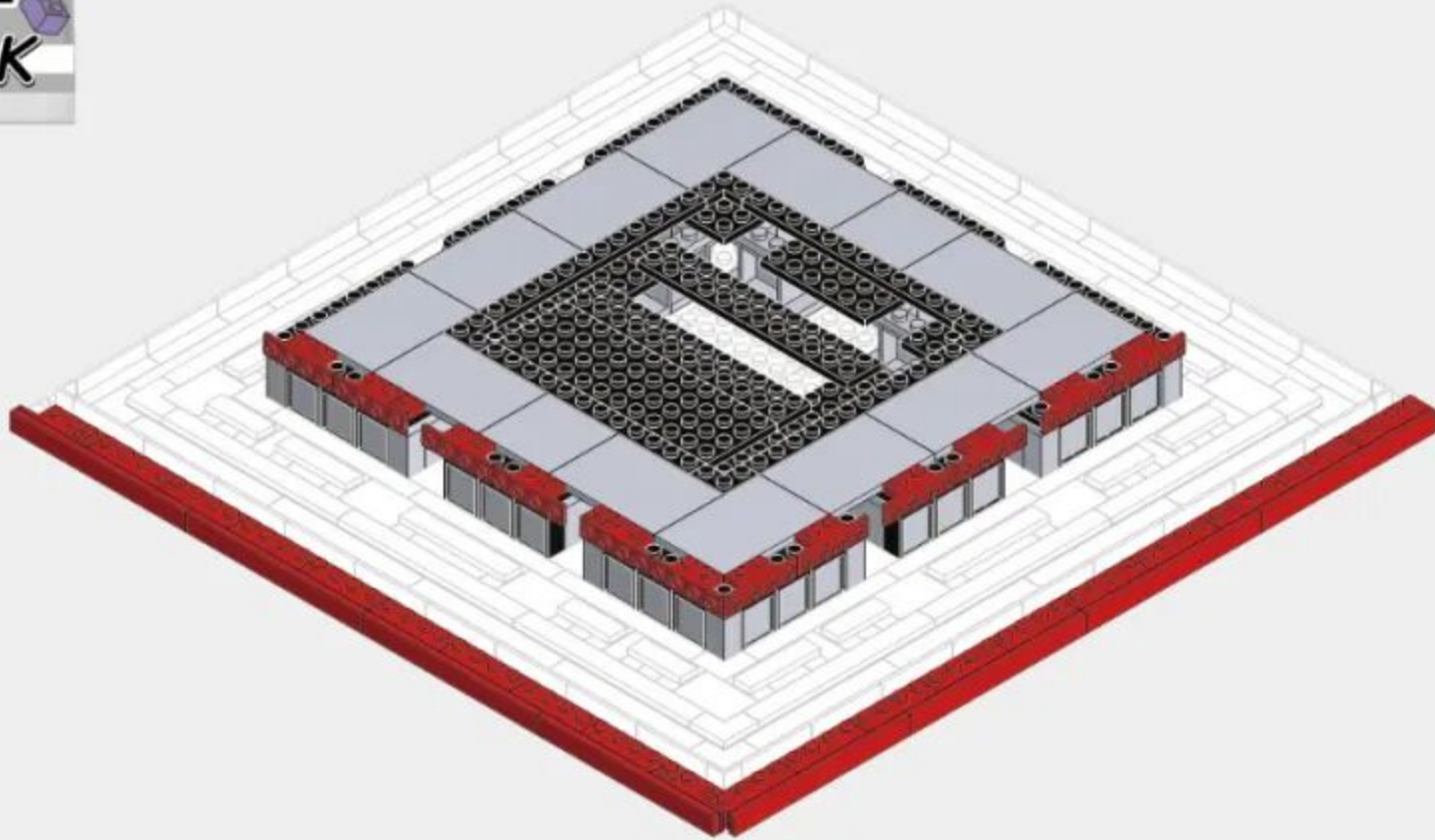

11-1



x36



x18



x2



x12



x36

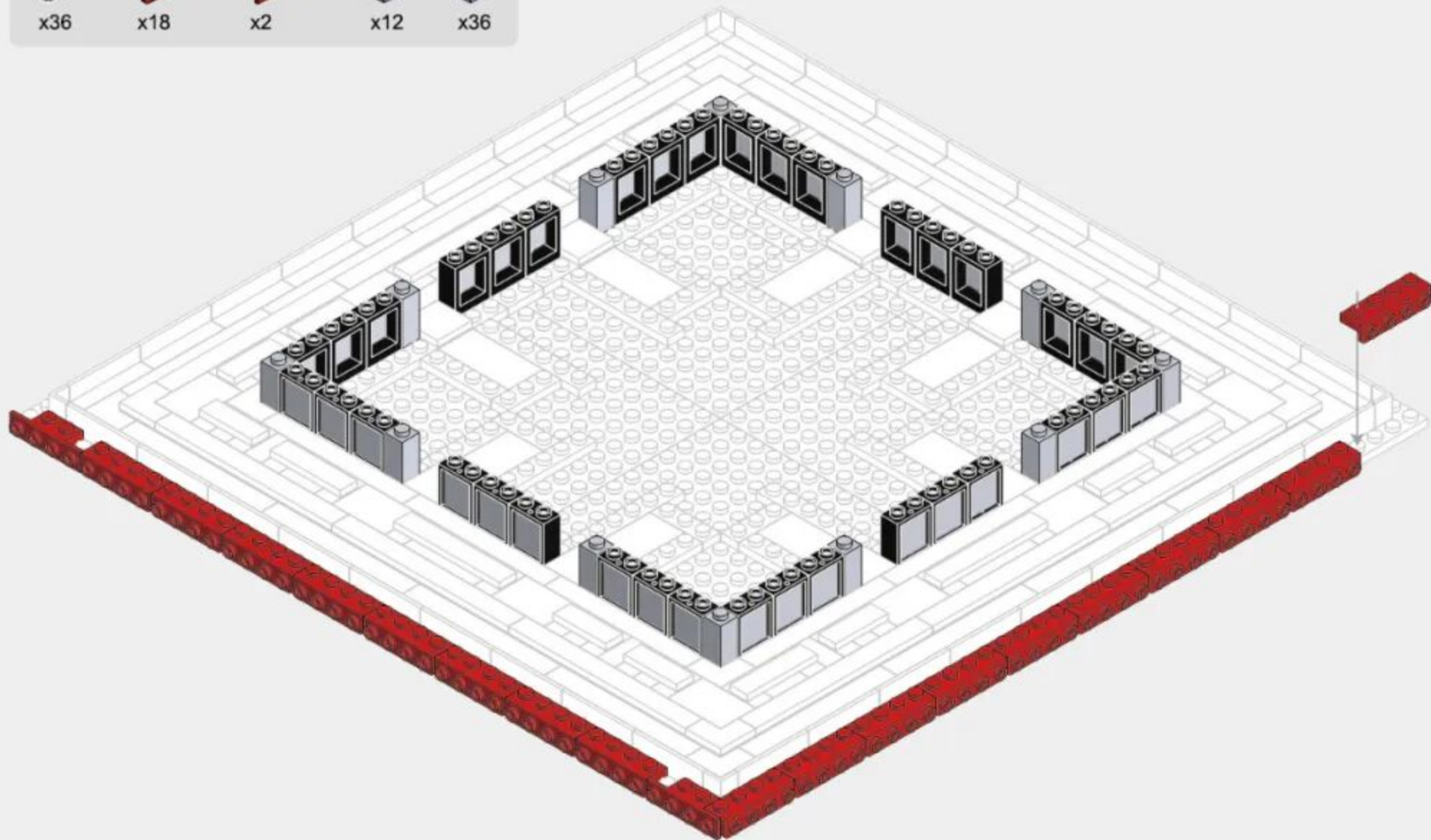

11-2

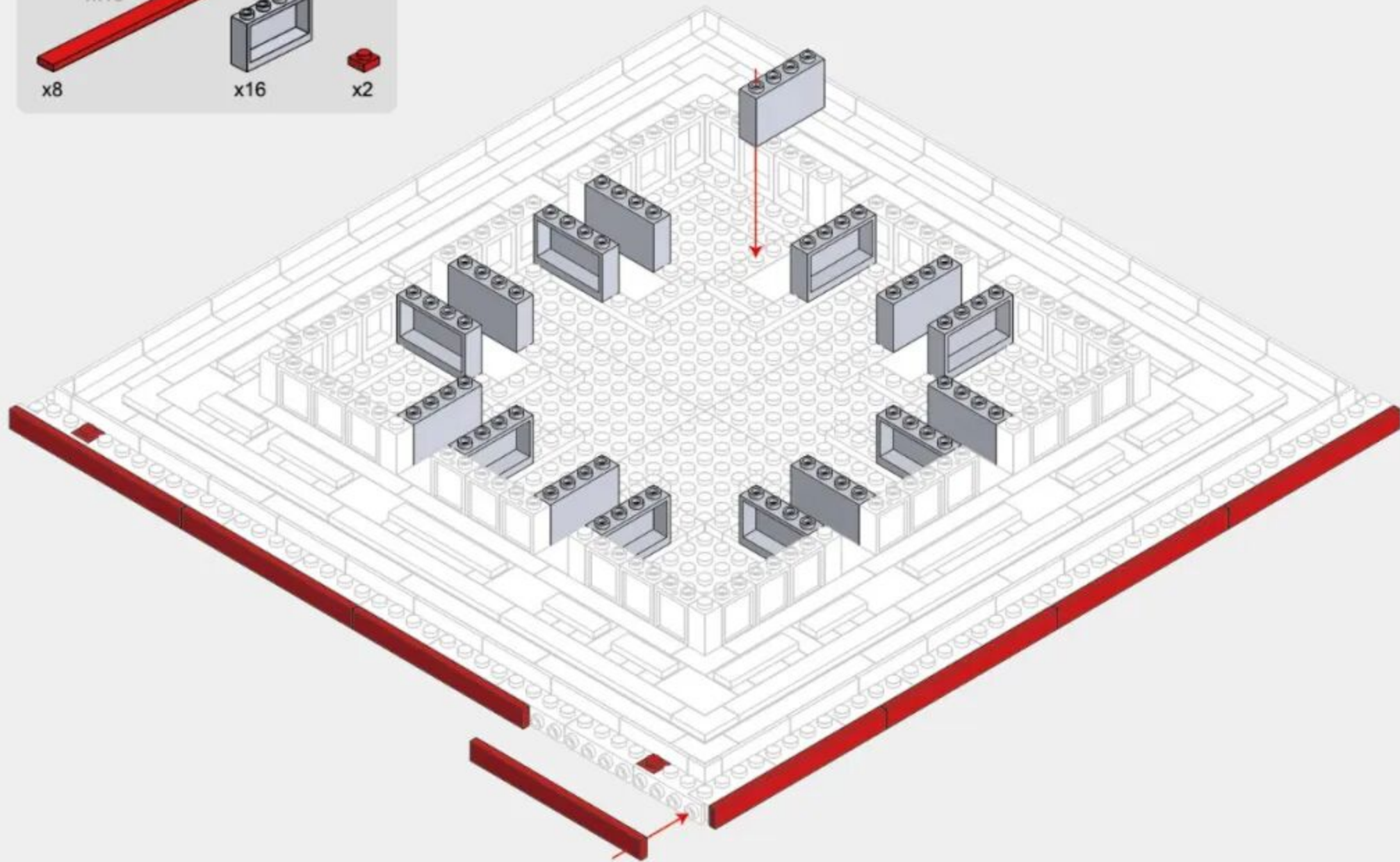
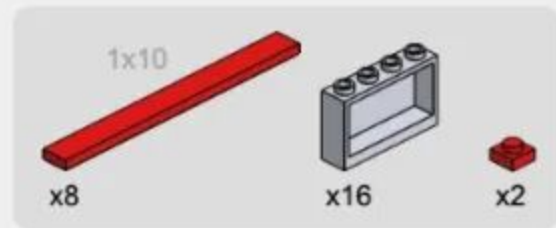

11-3



x24

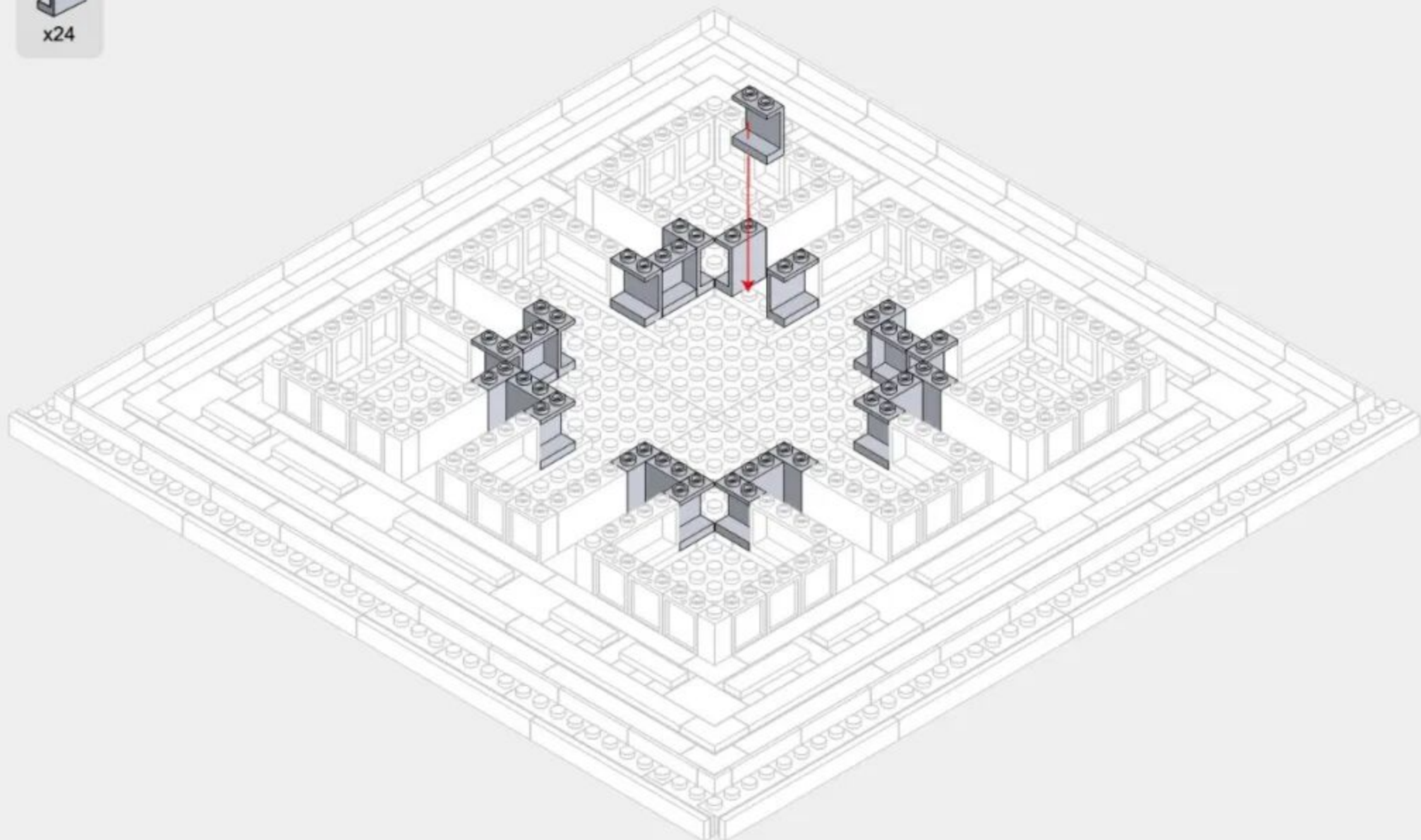

187

11-4



x12



x12

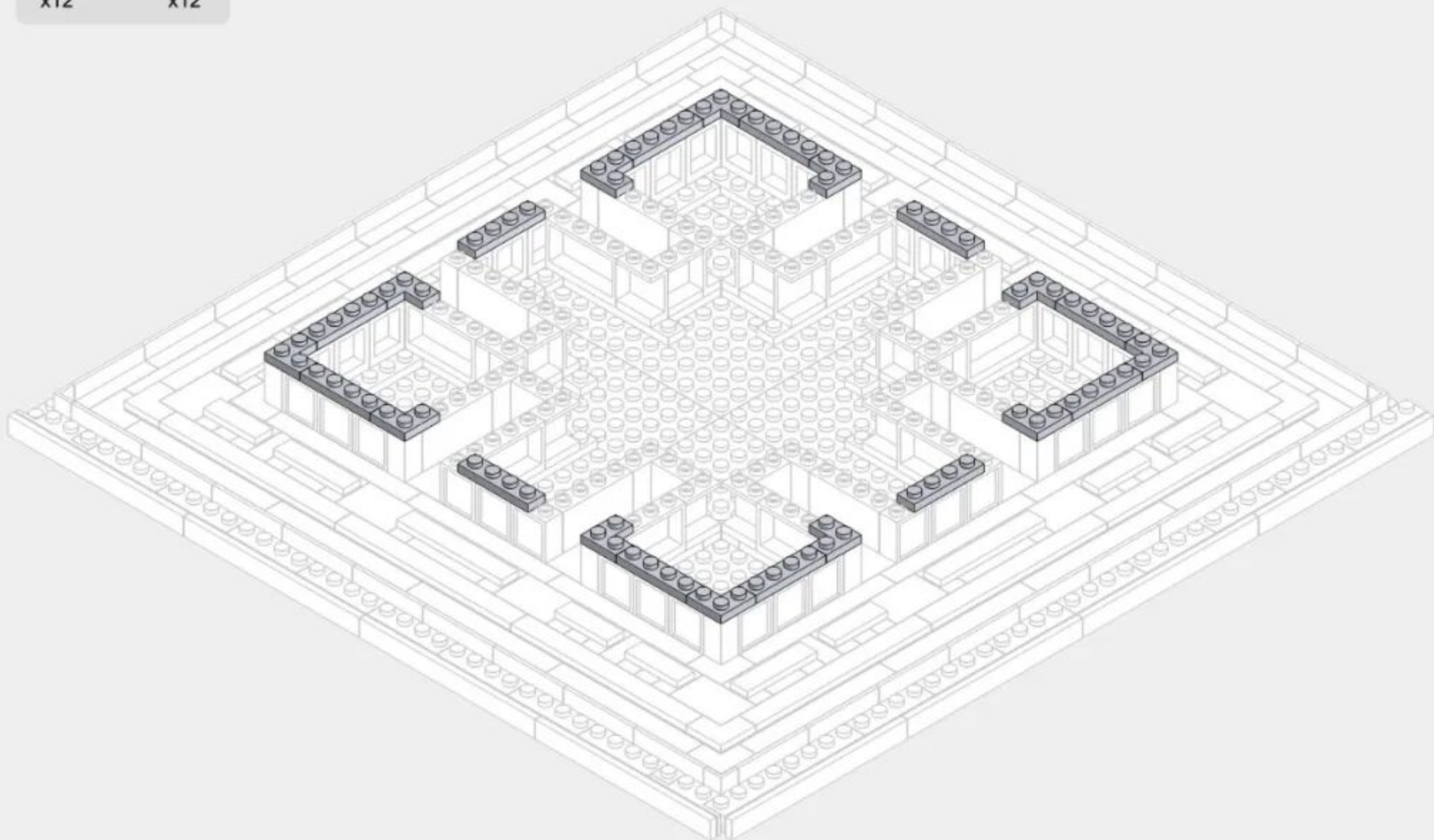

11-5

1x6



x8



x16

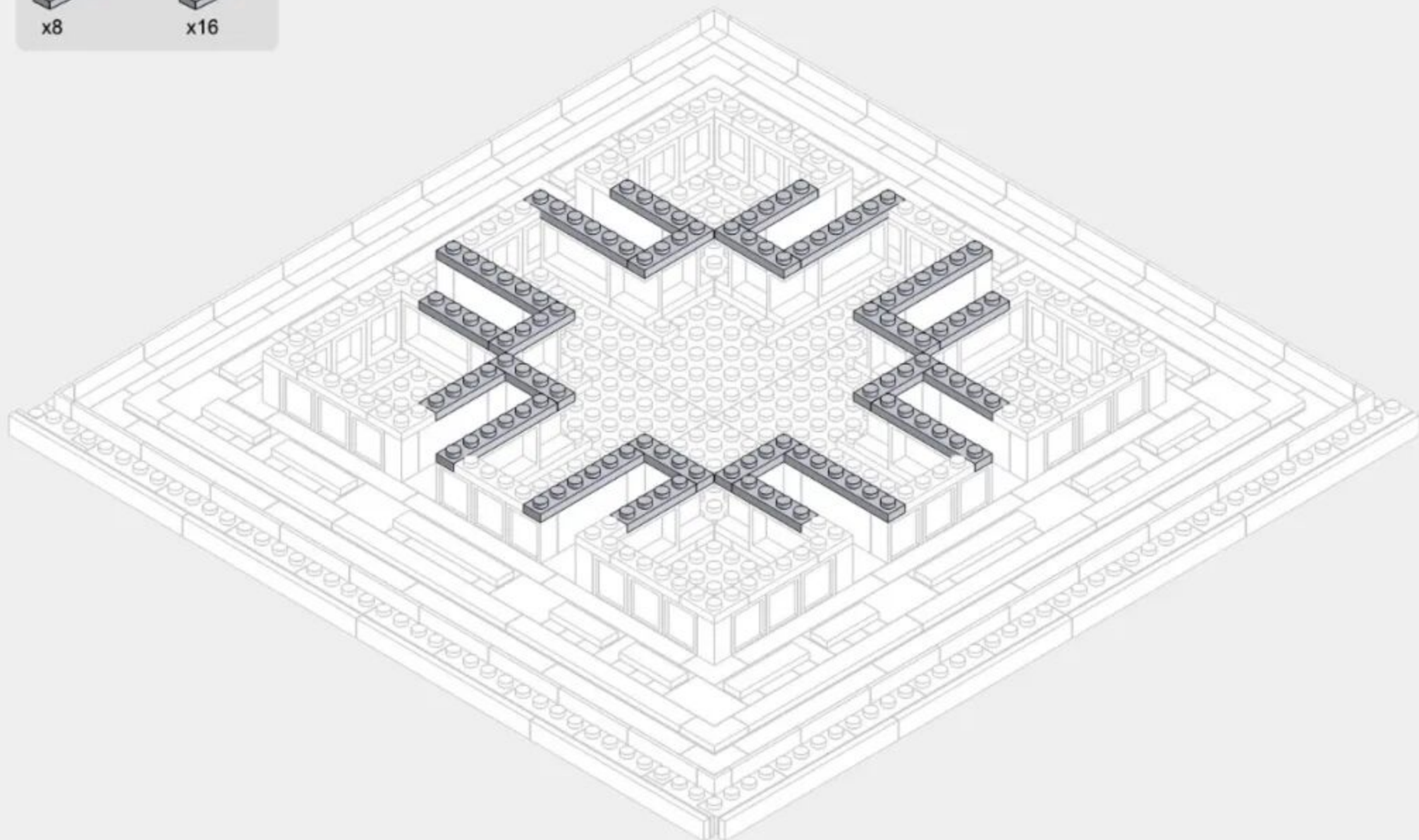

11-6

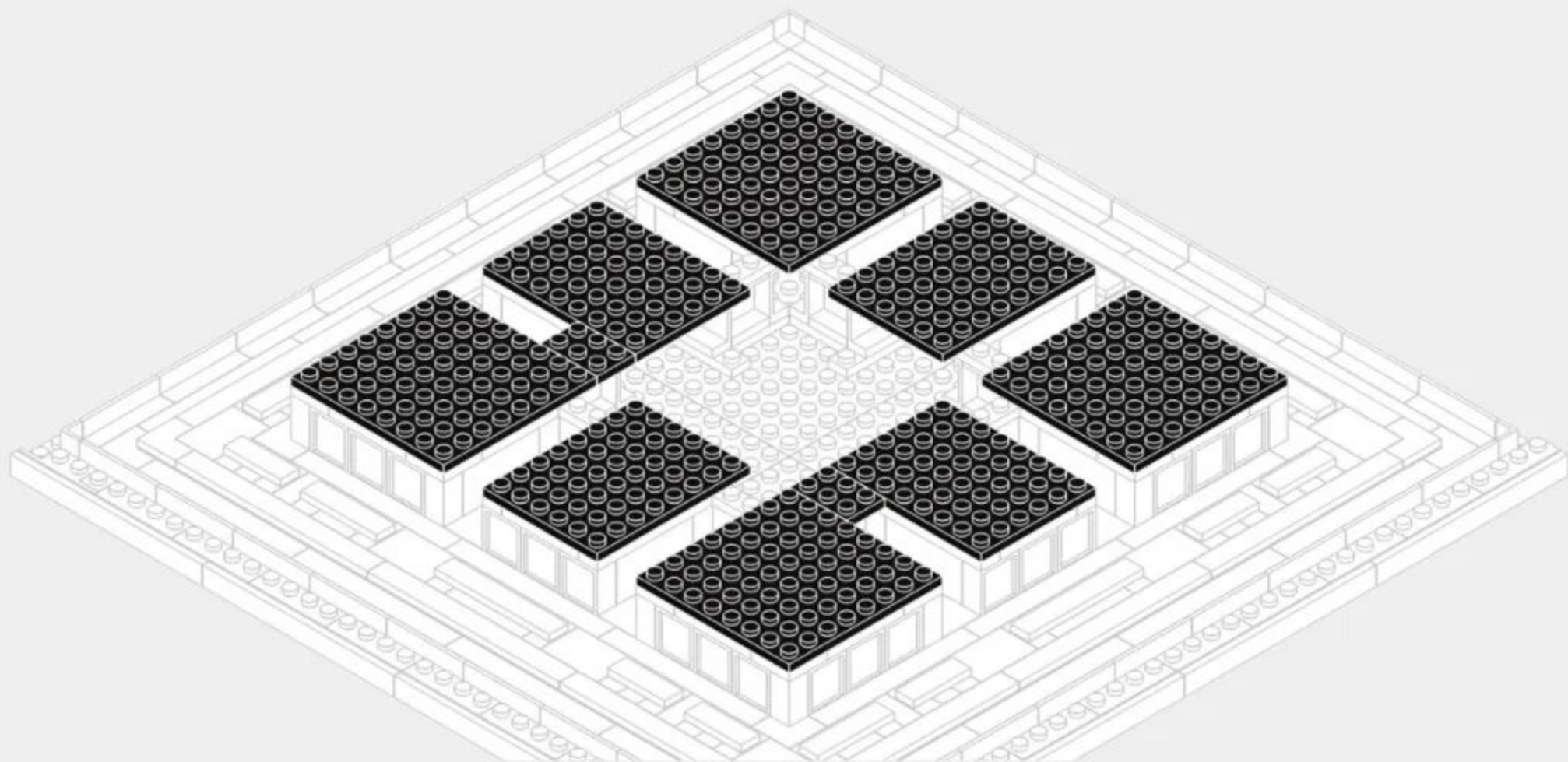
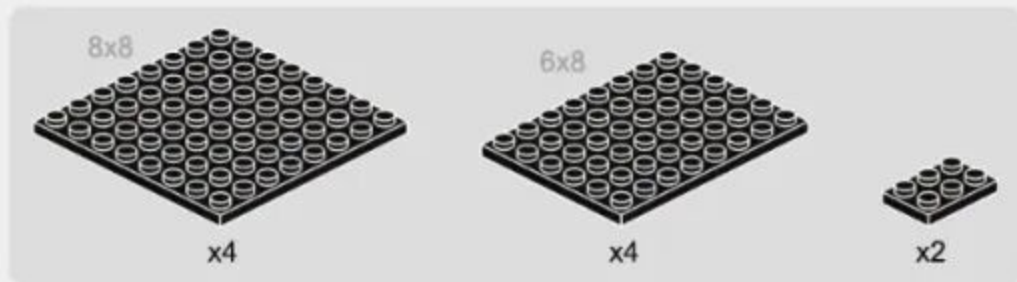

11-7

4x6

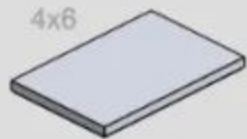

x12

4x4

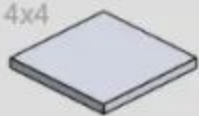

x2

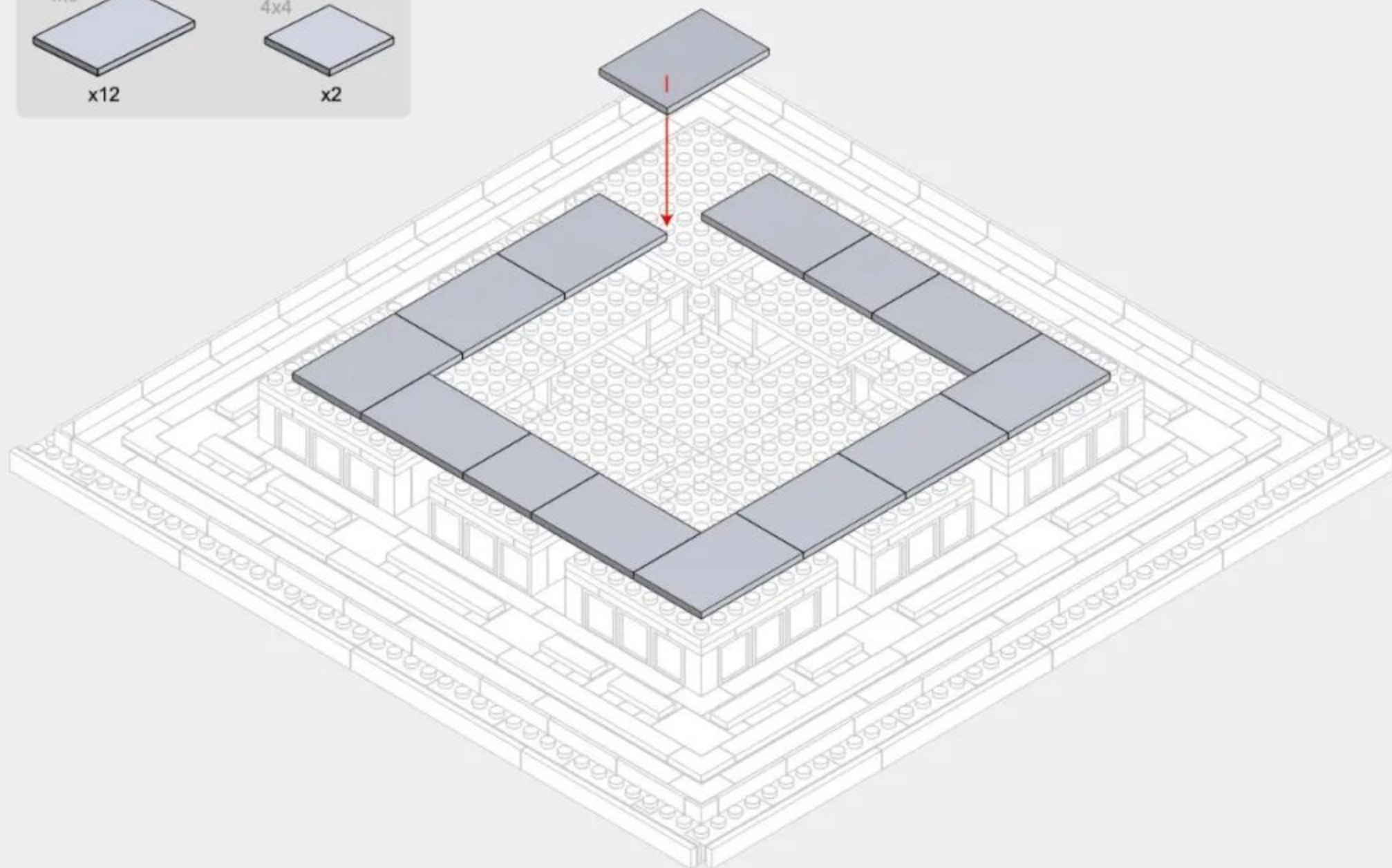

191

11-8

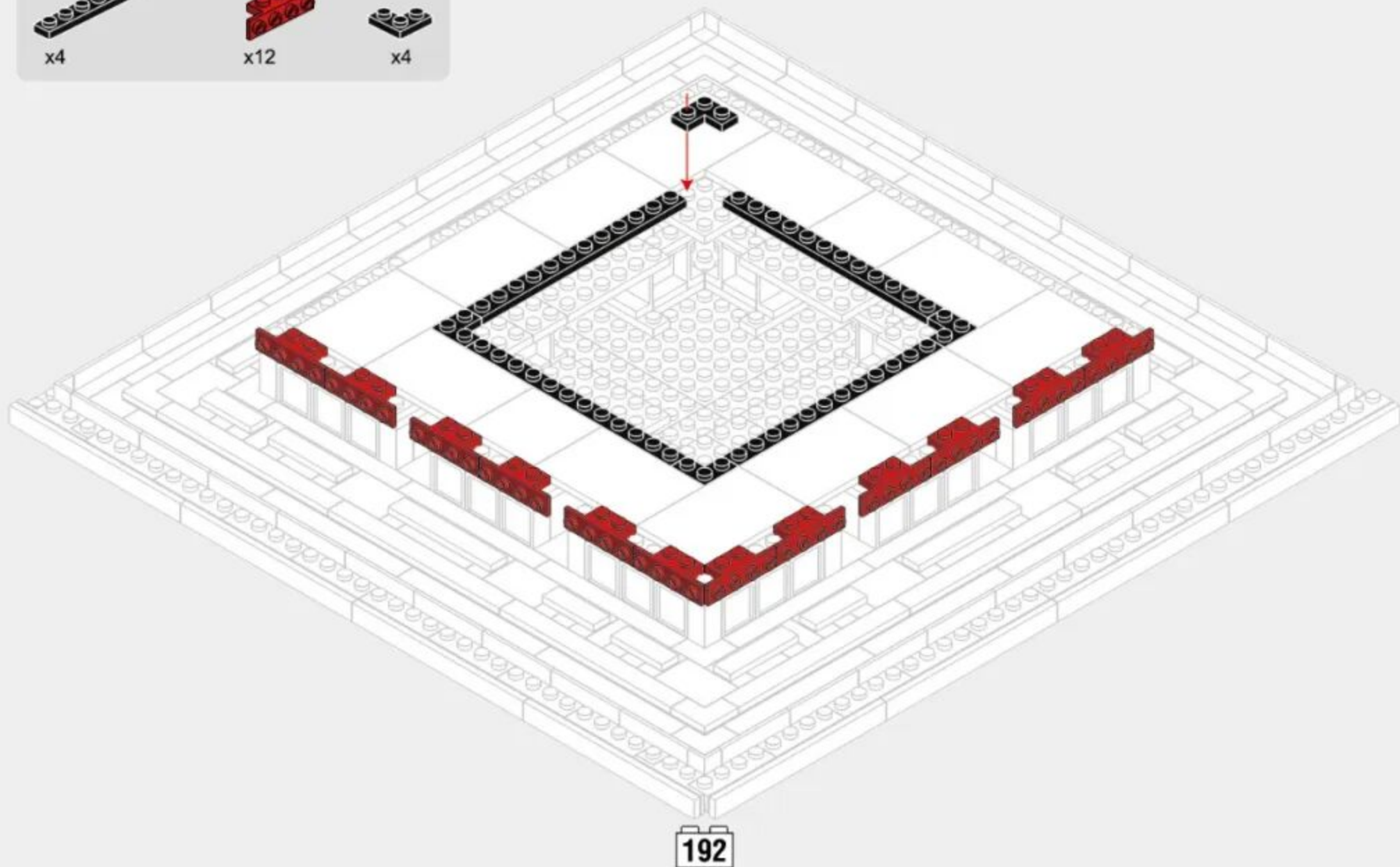

11-9

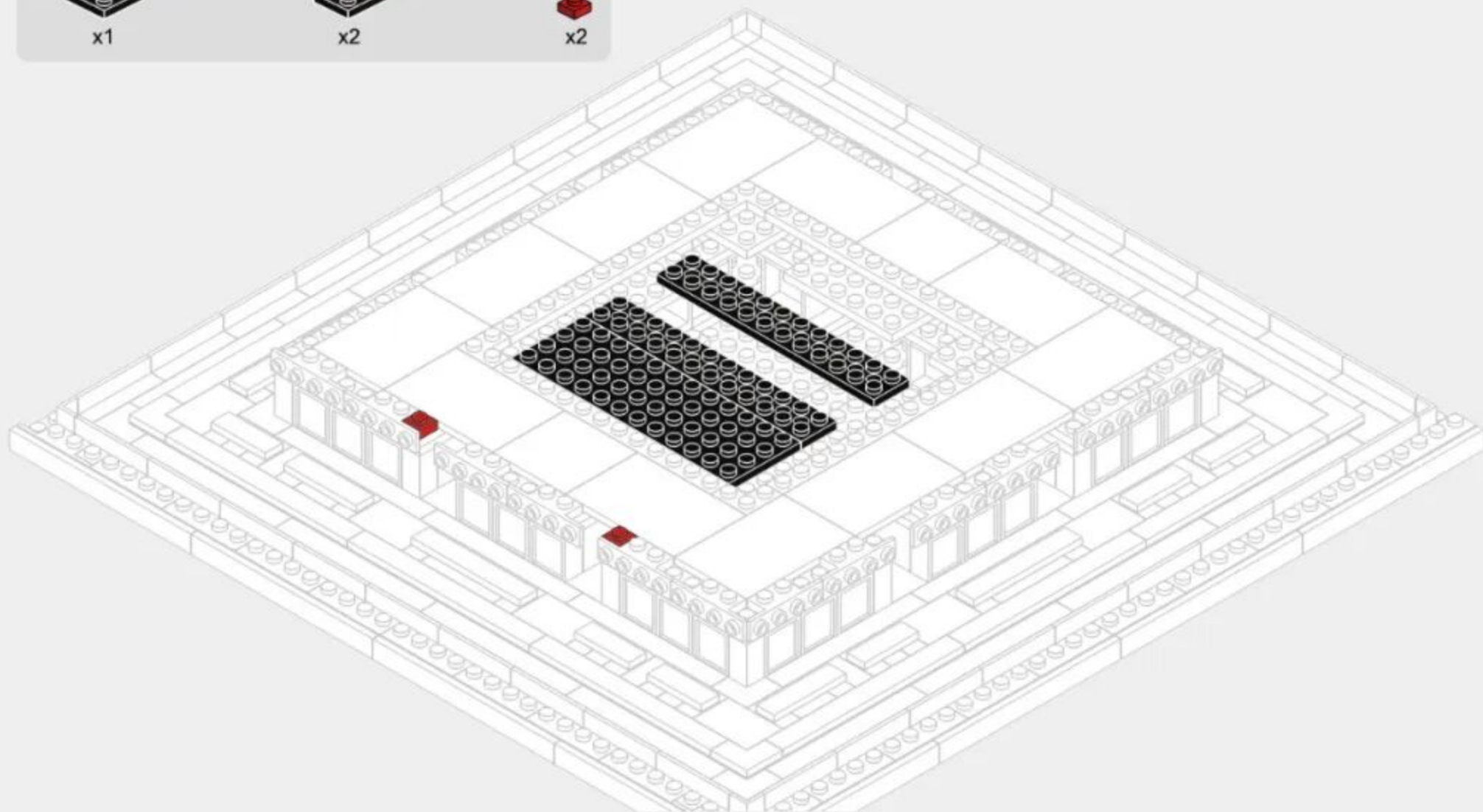
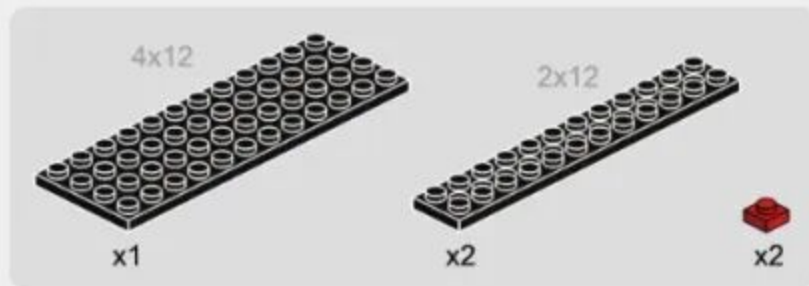



223PCS

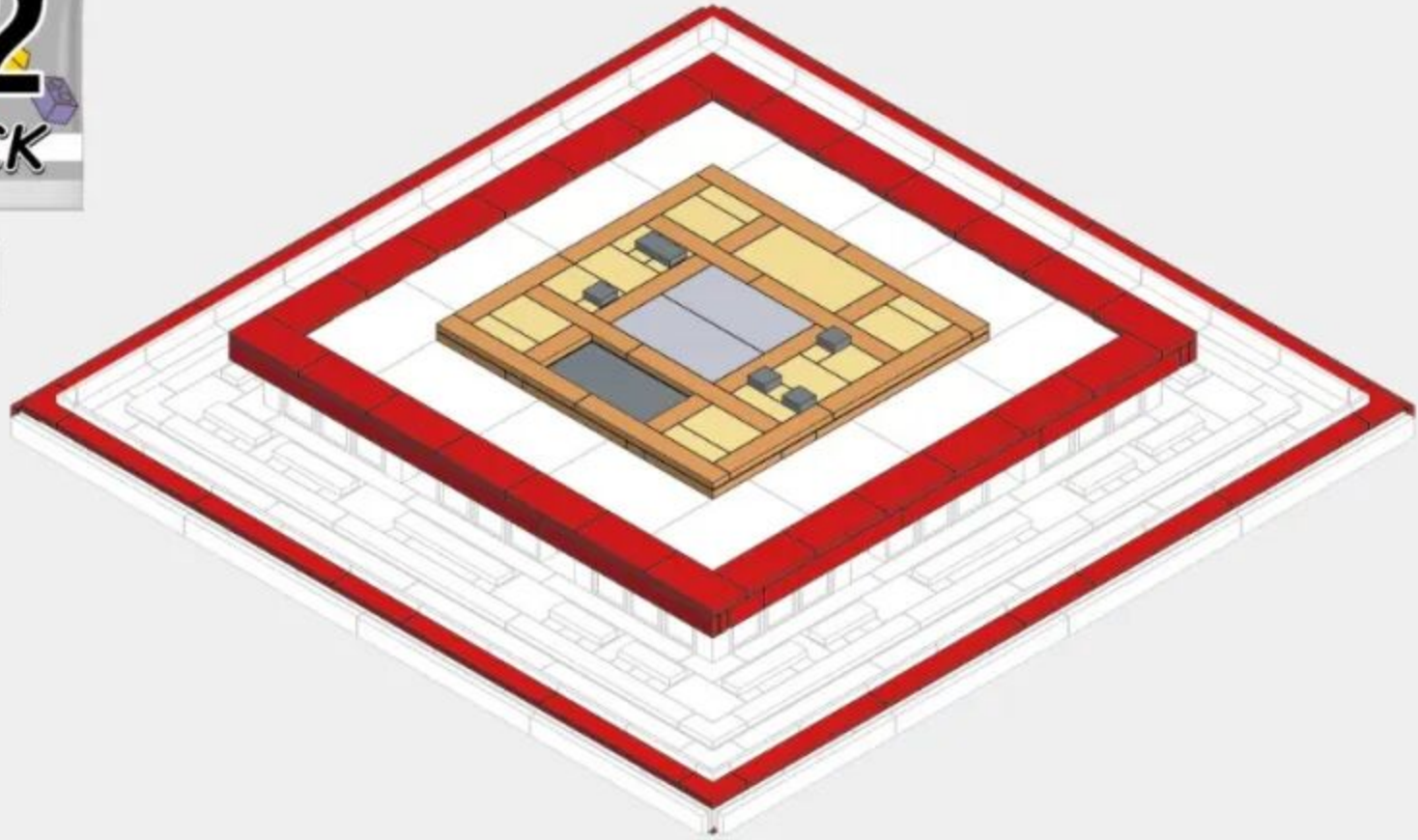

12-1

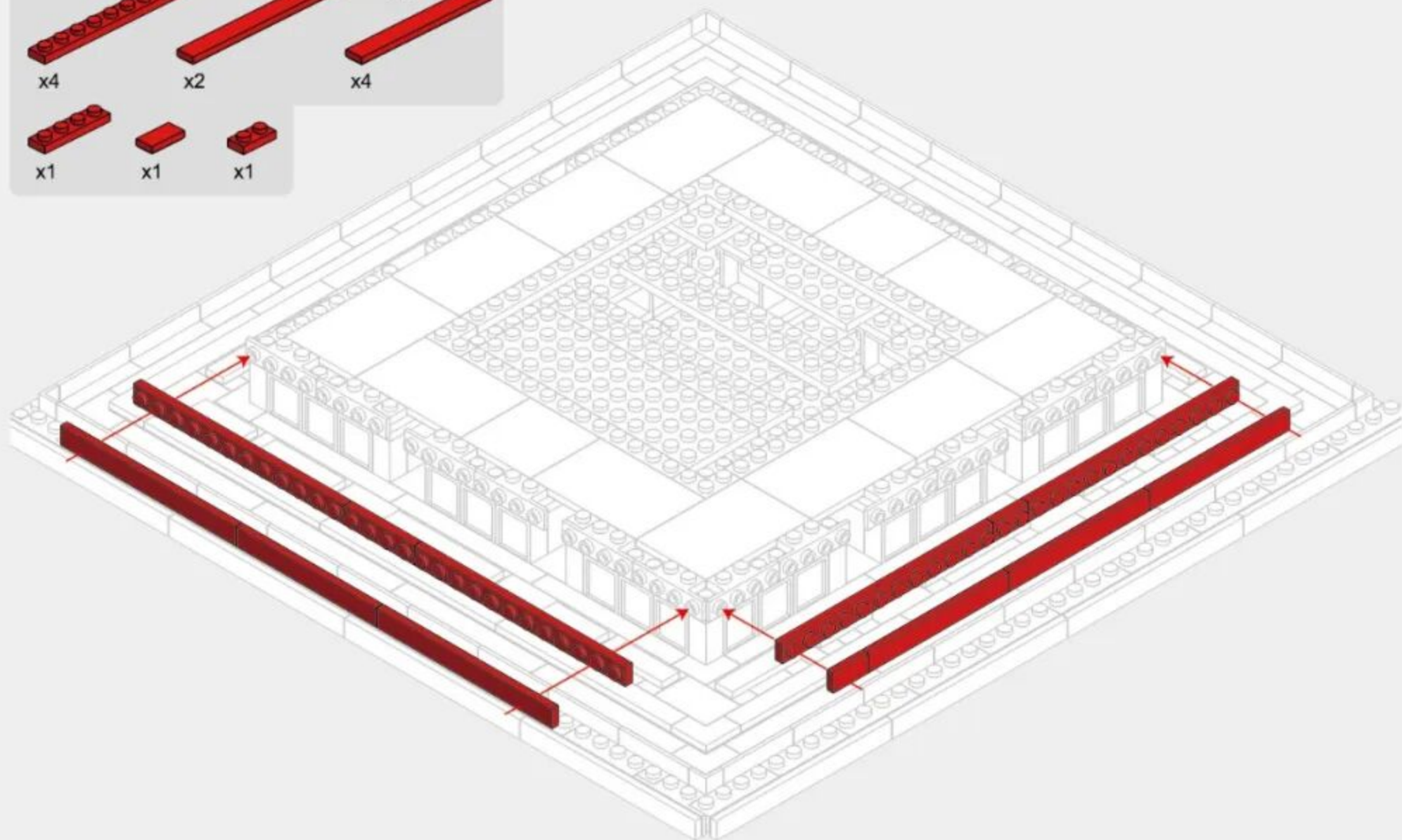
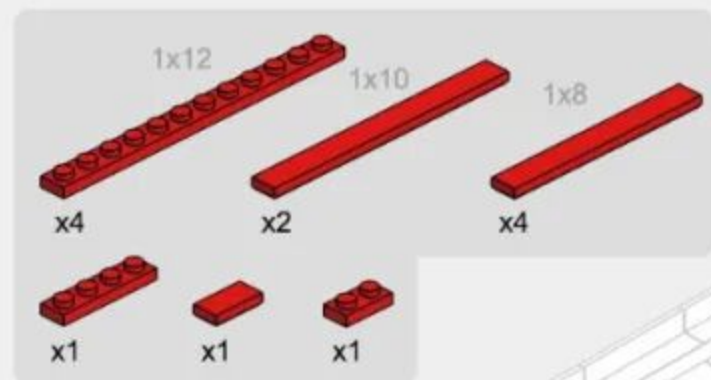

12-2

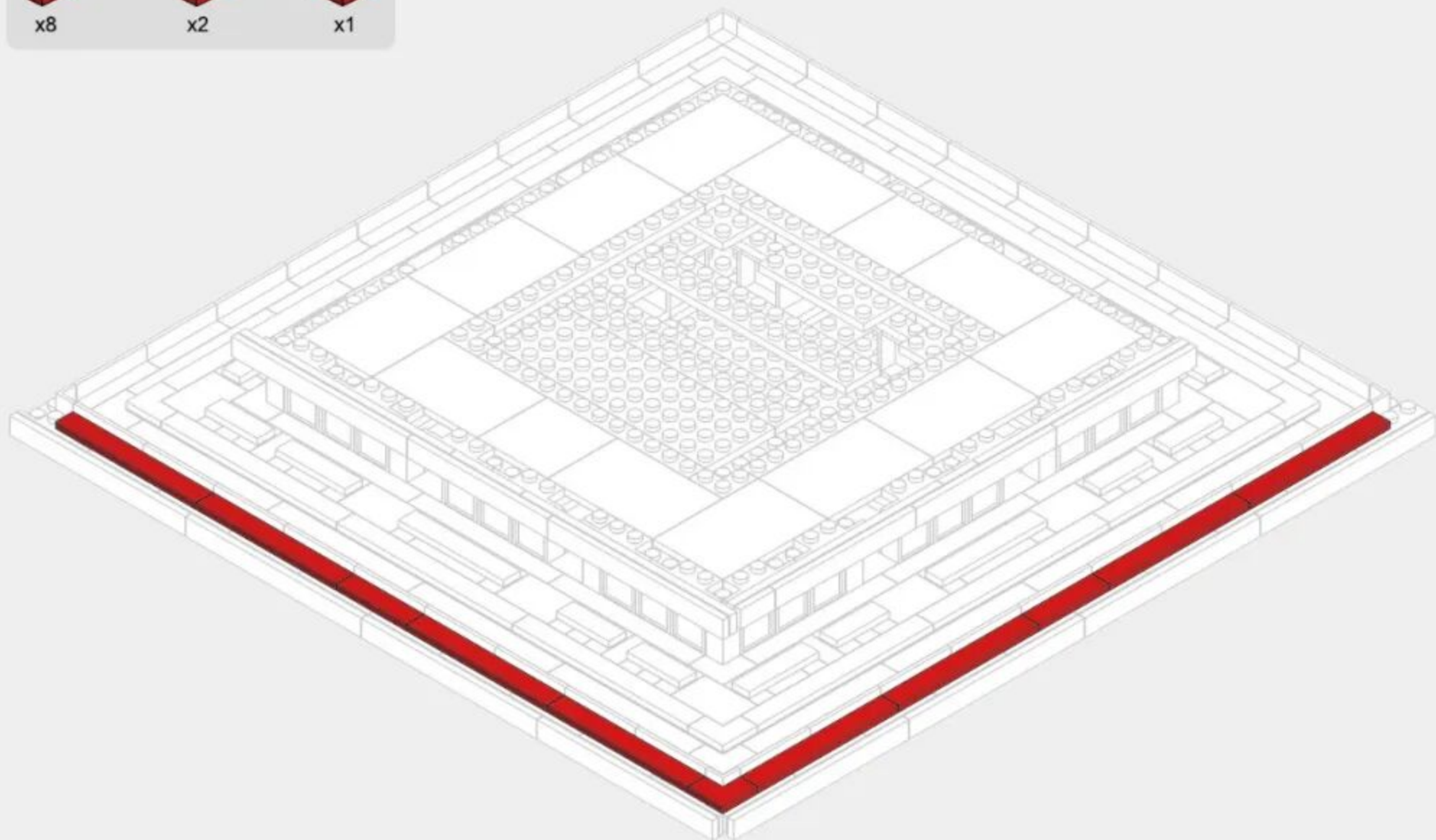
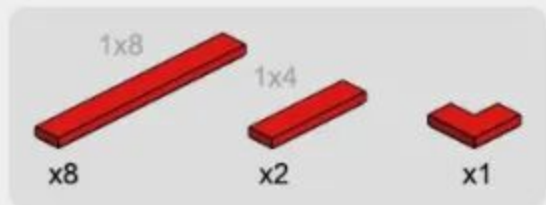

12-3

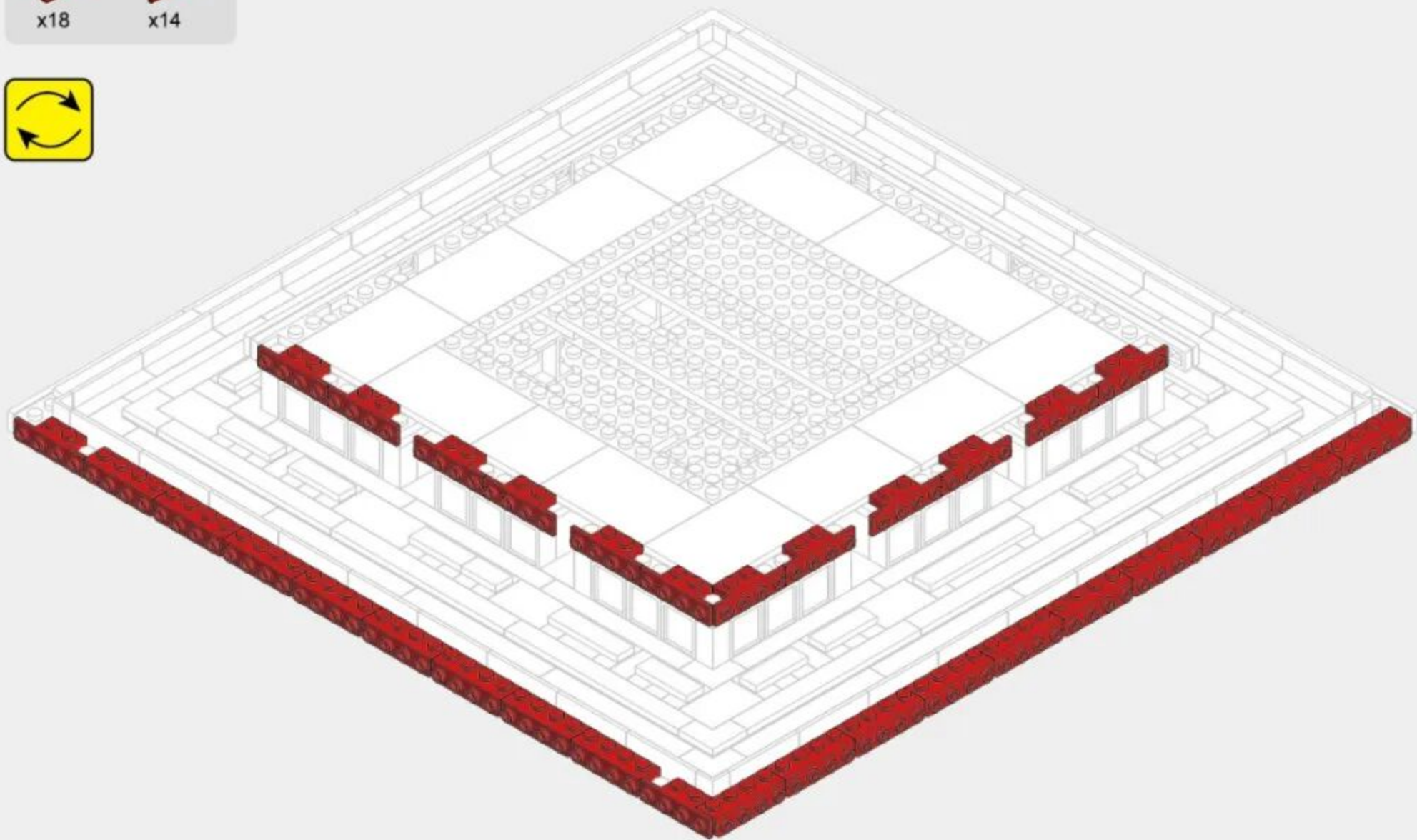

12-4

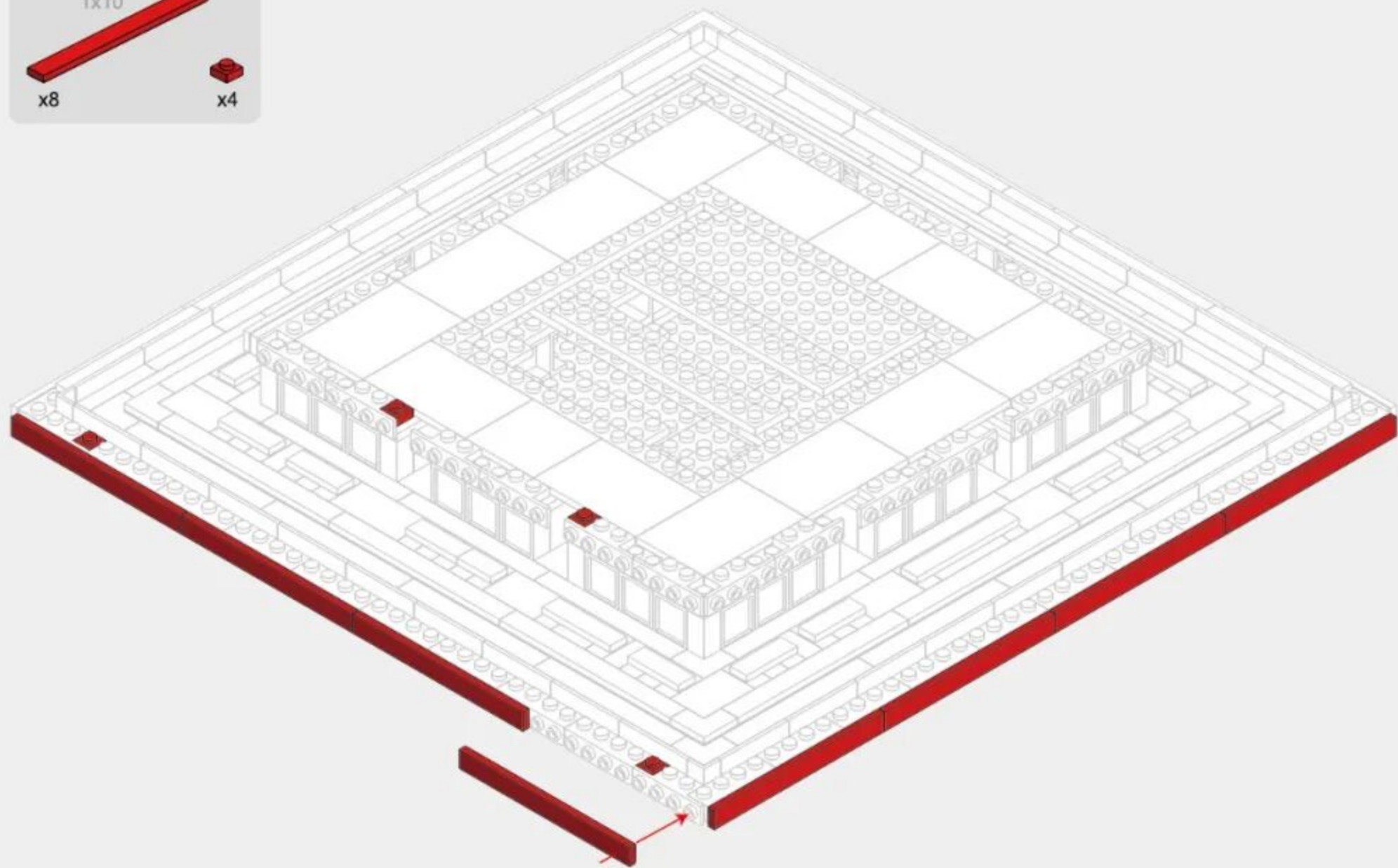

12-5

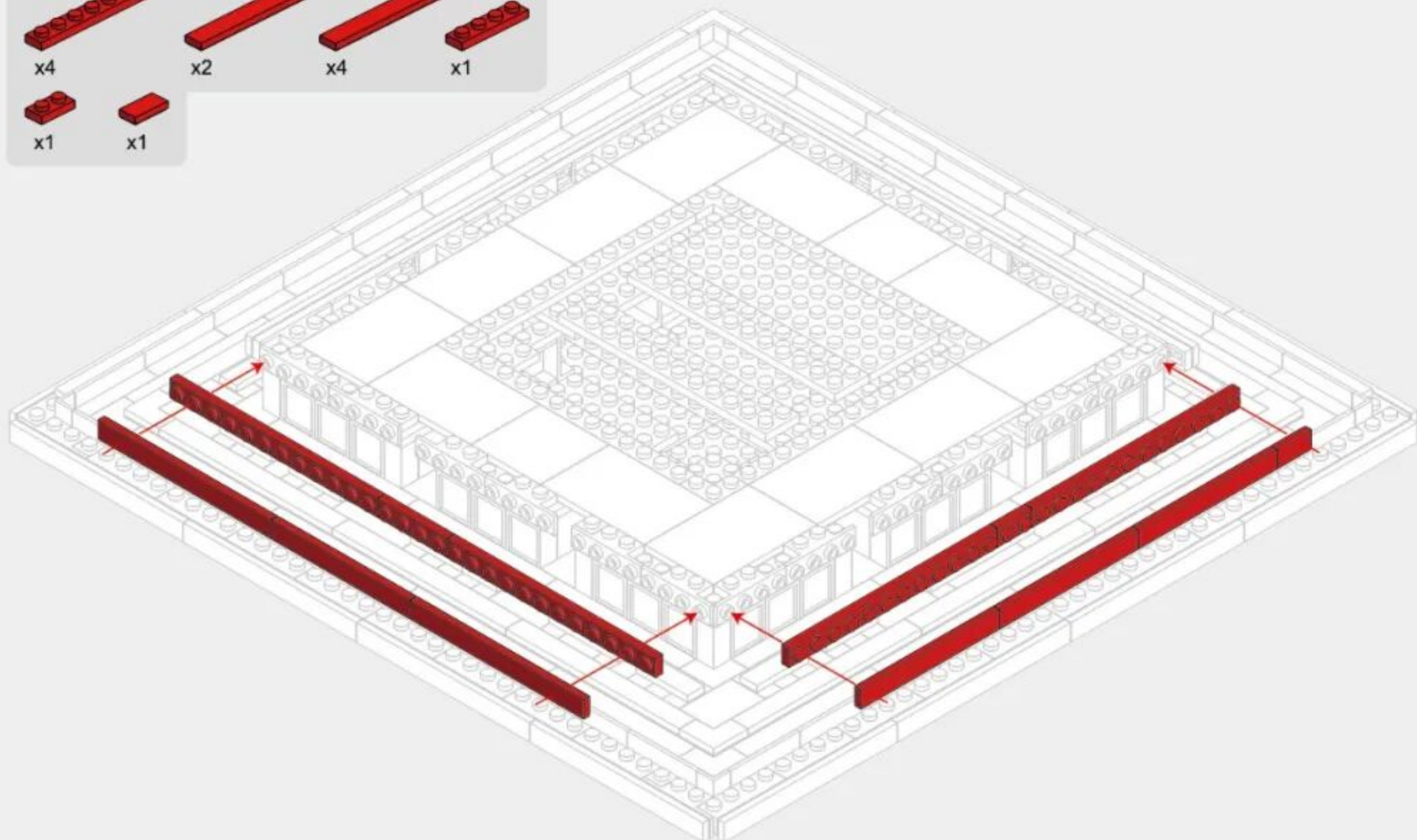
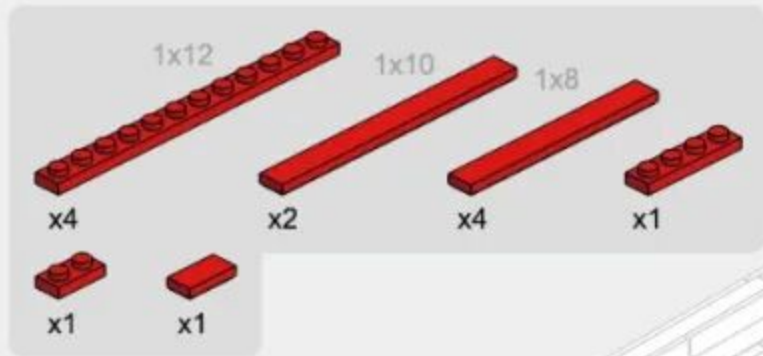

12-6

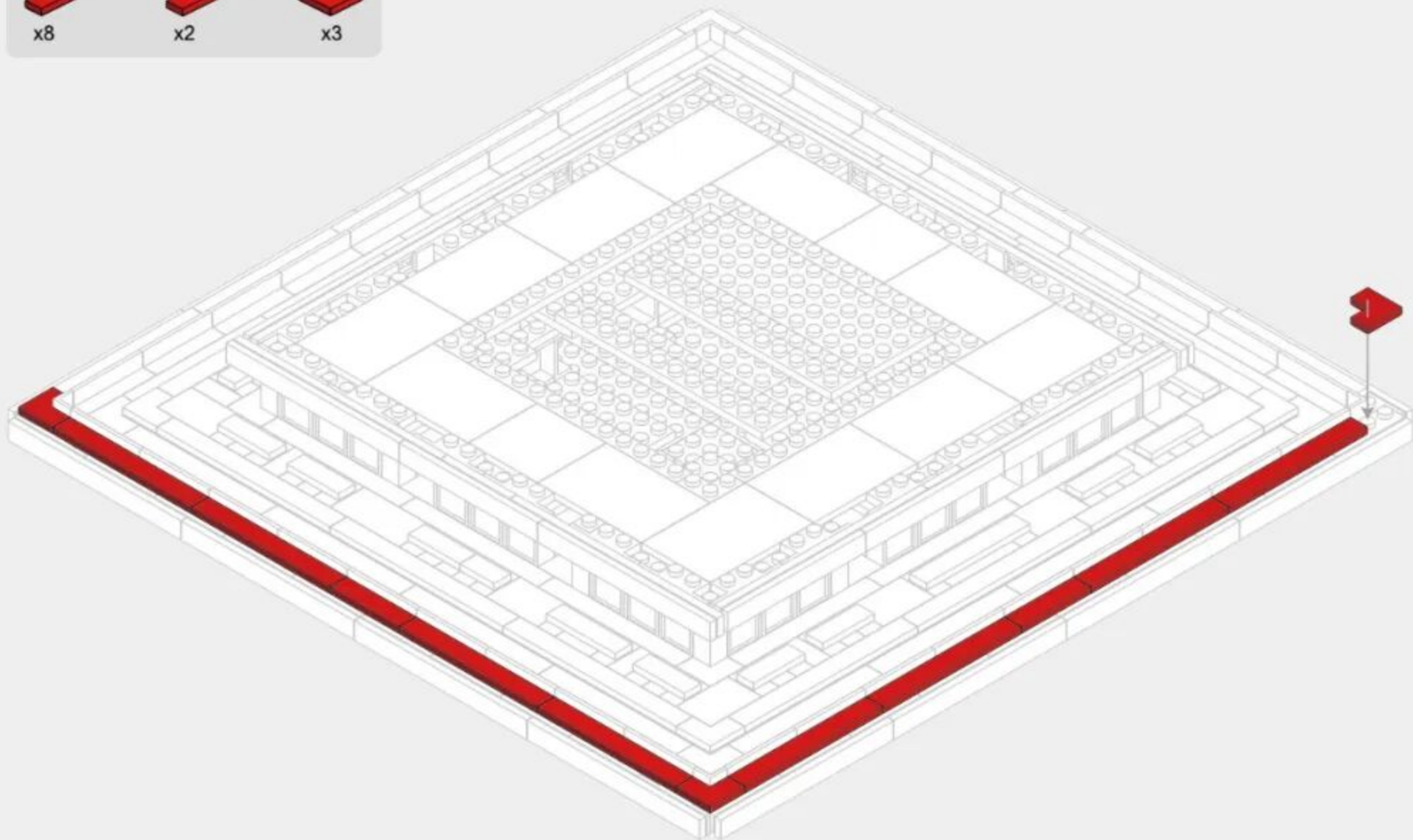
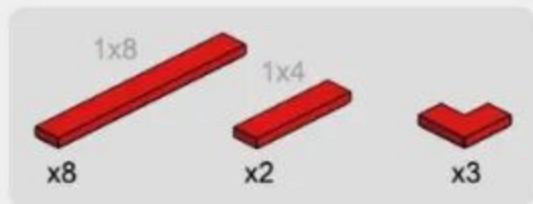

200

12-7

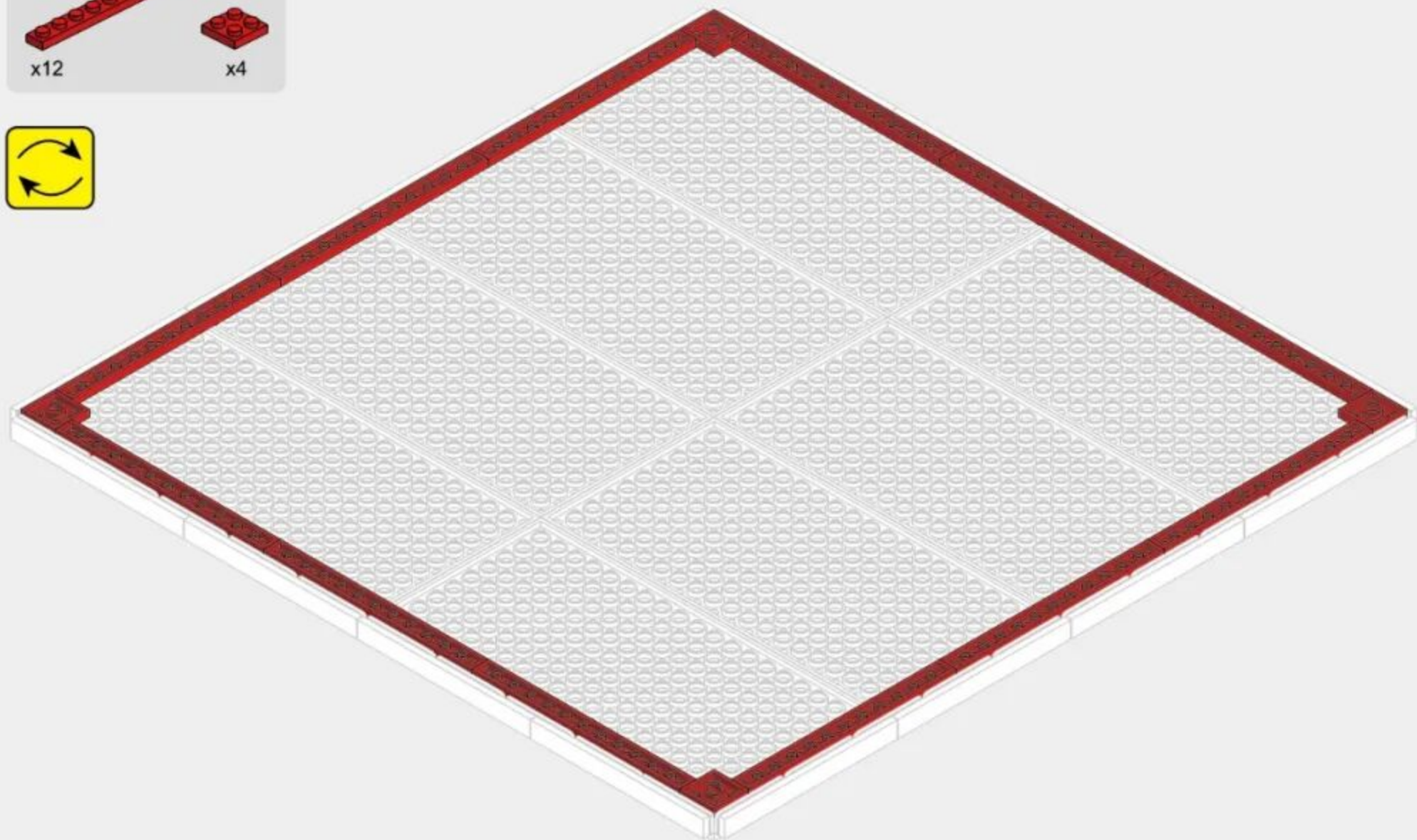
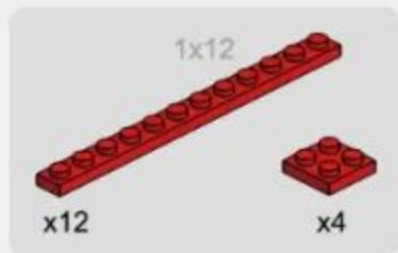

201

12-8

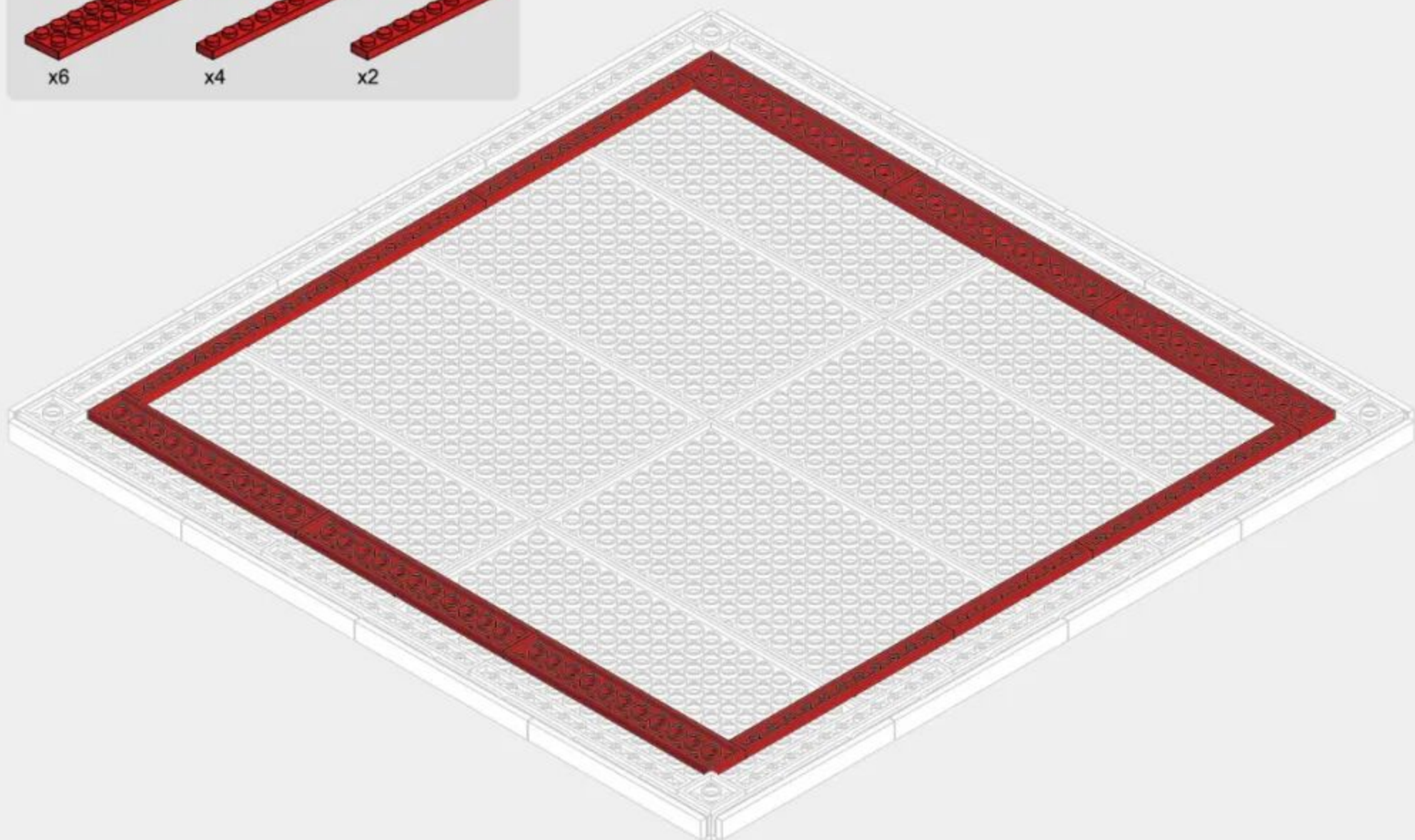
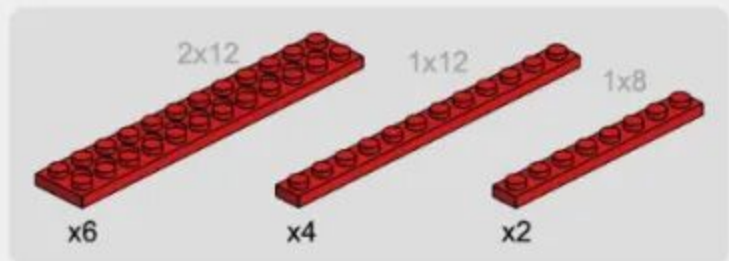

202

12-9

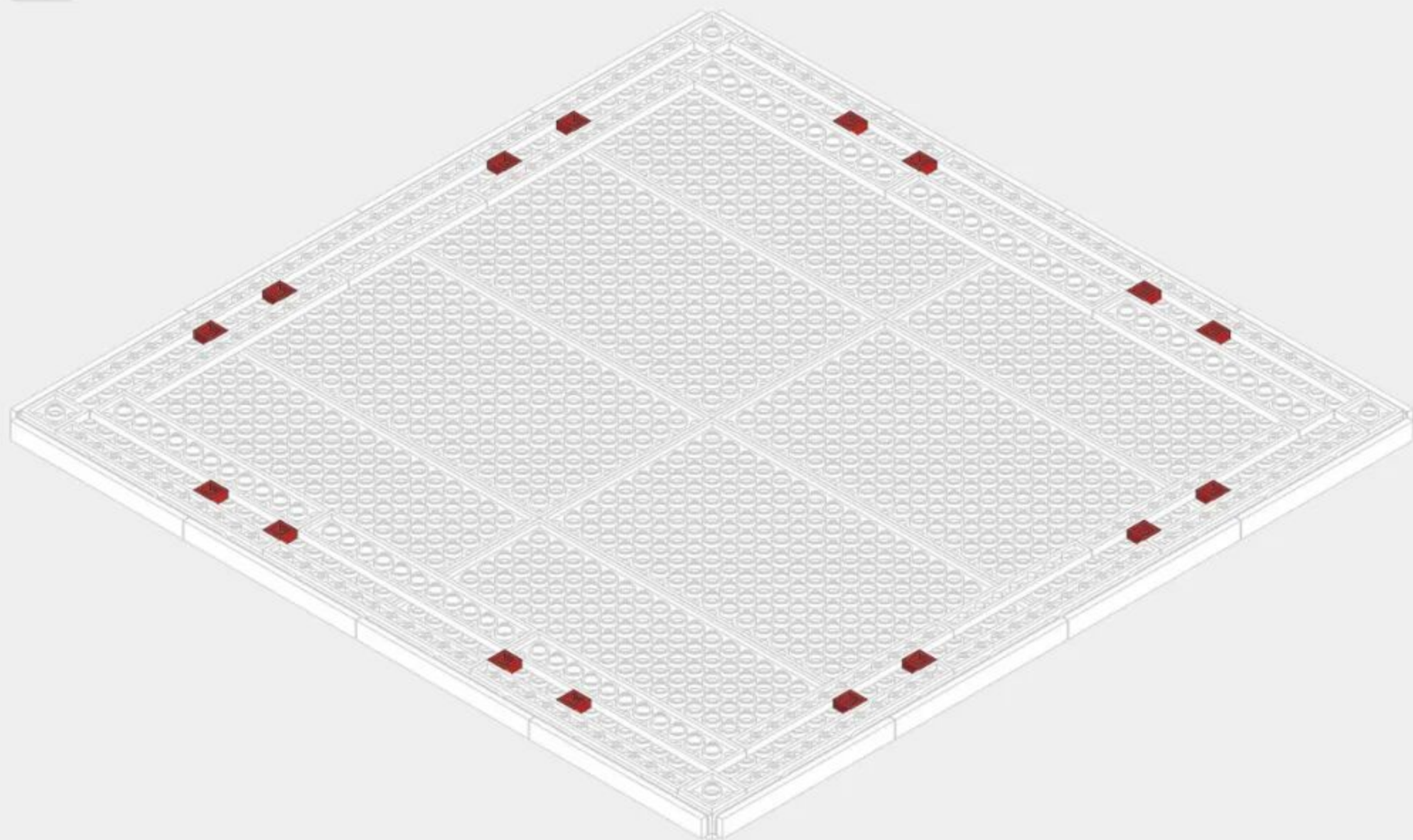

203

12-10

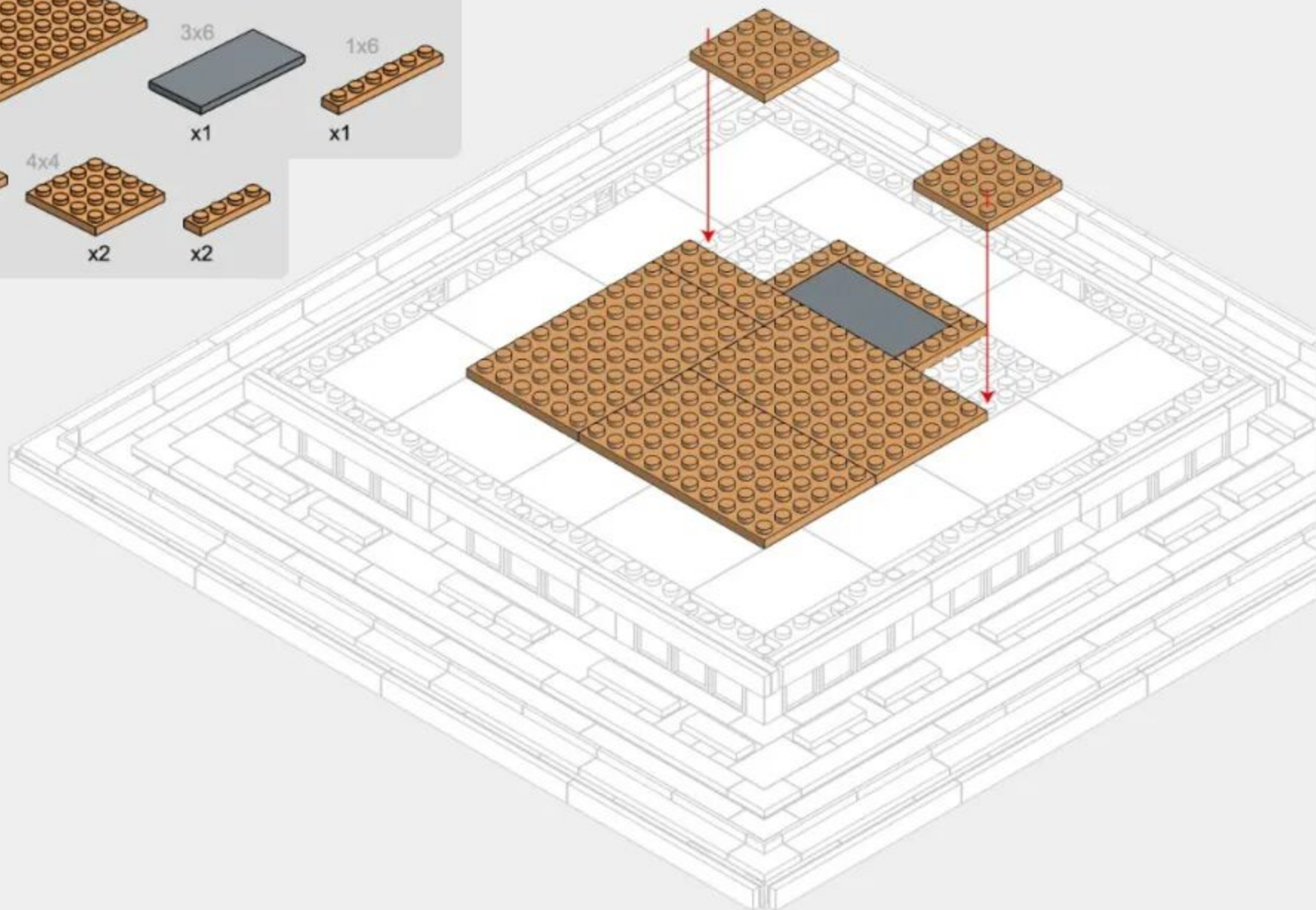
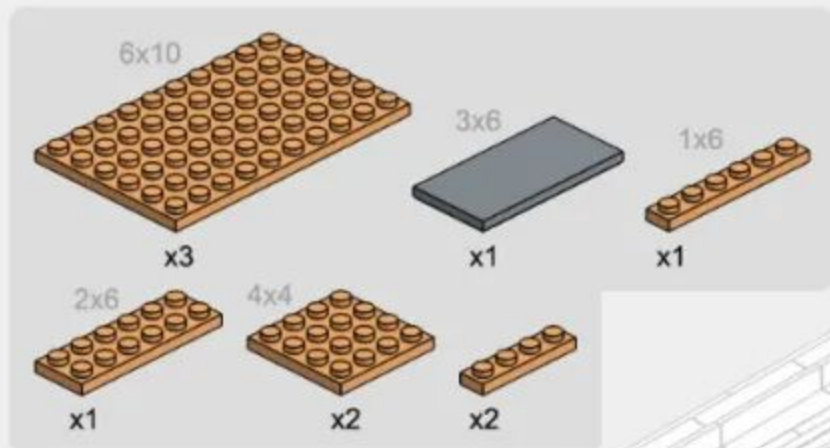

12-11

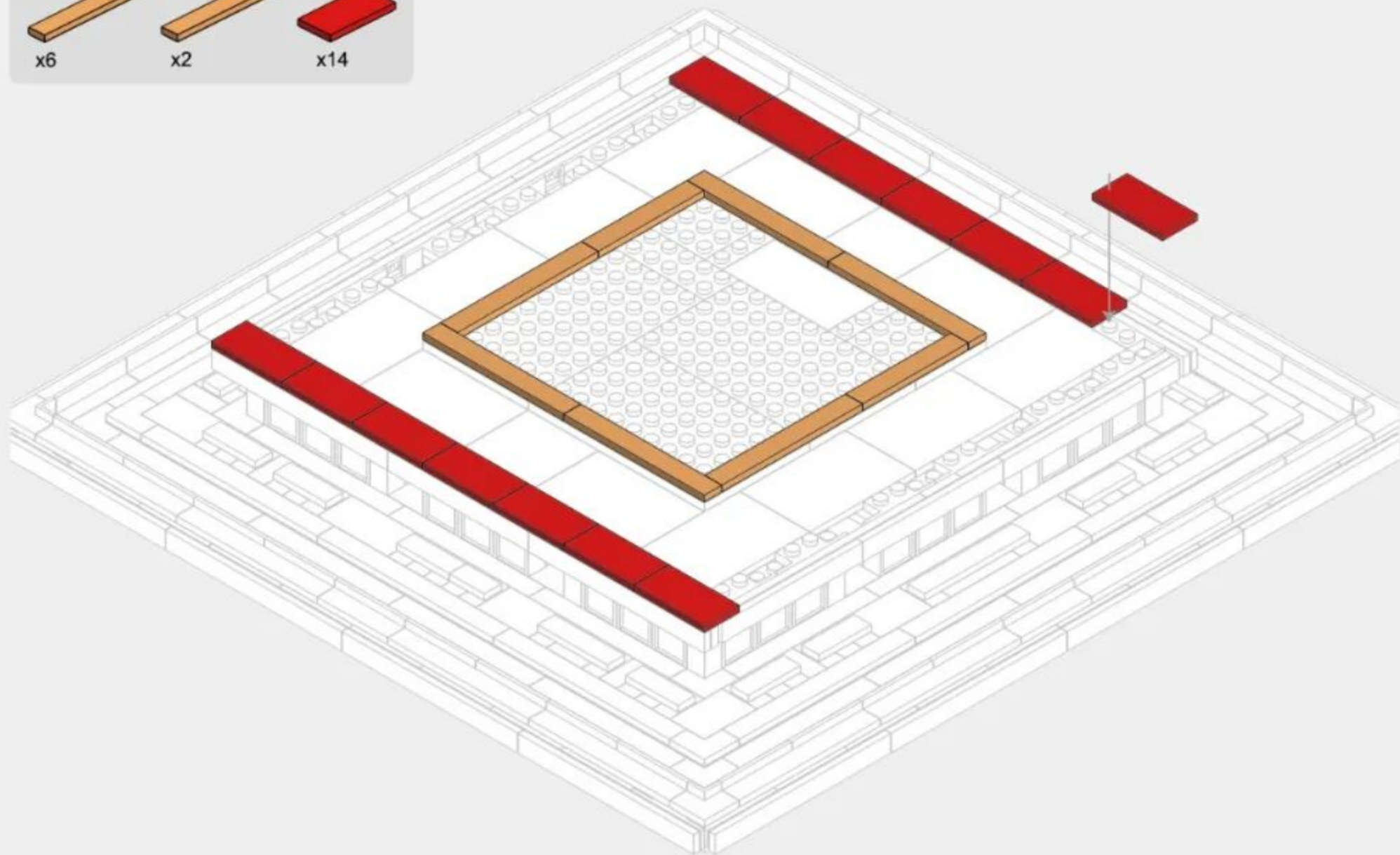
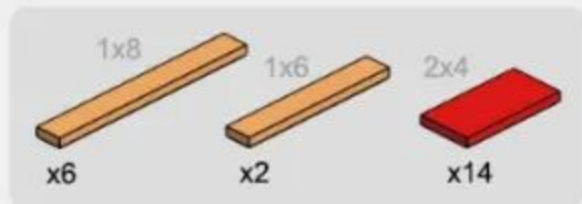

12-12

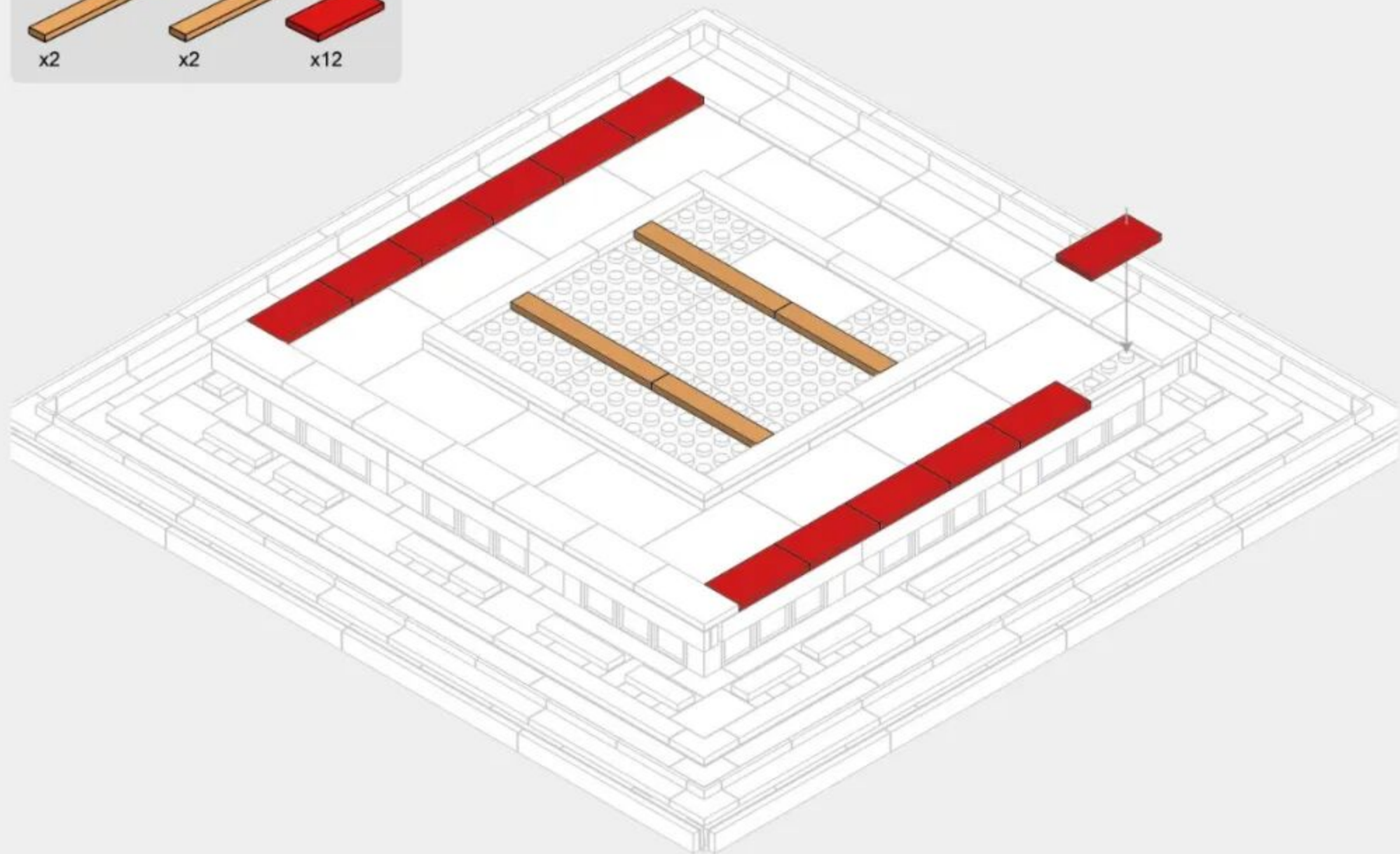
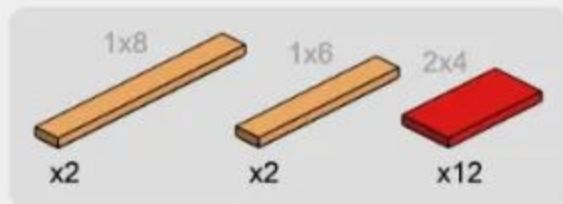

12-13

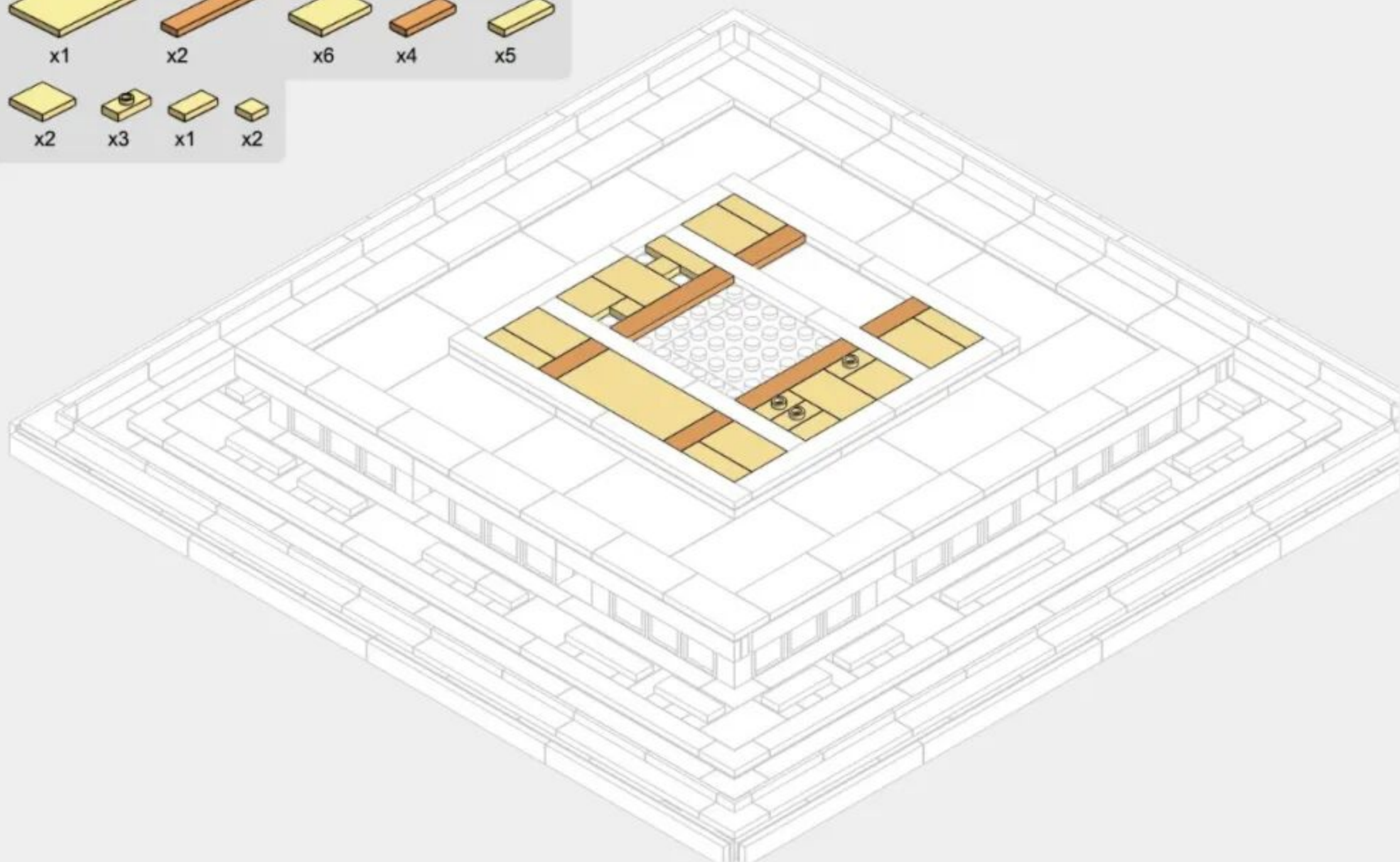
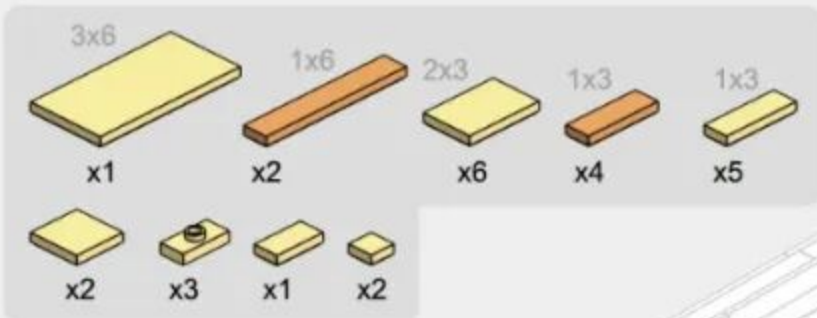

12-14

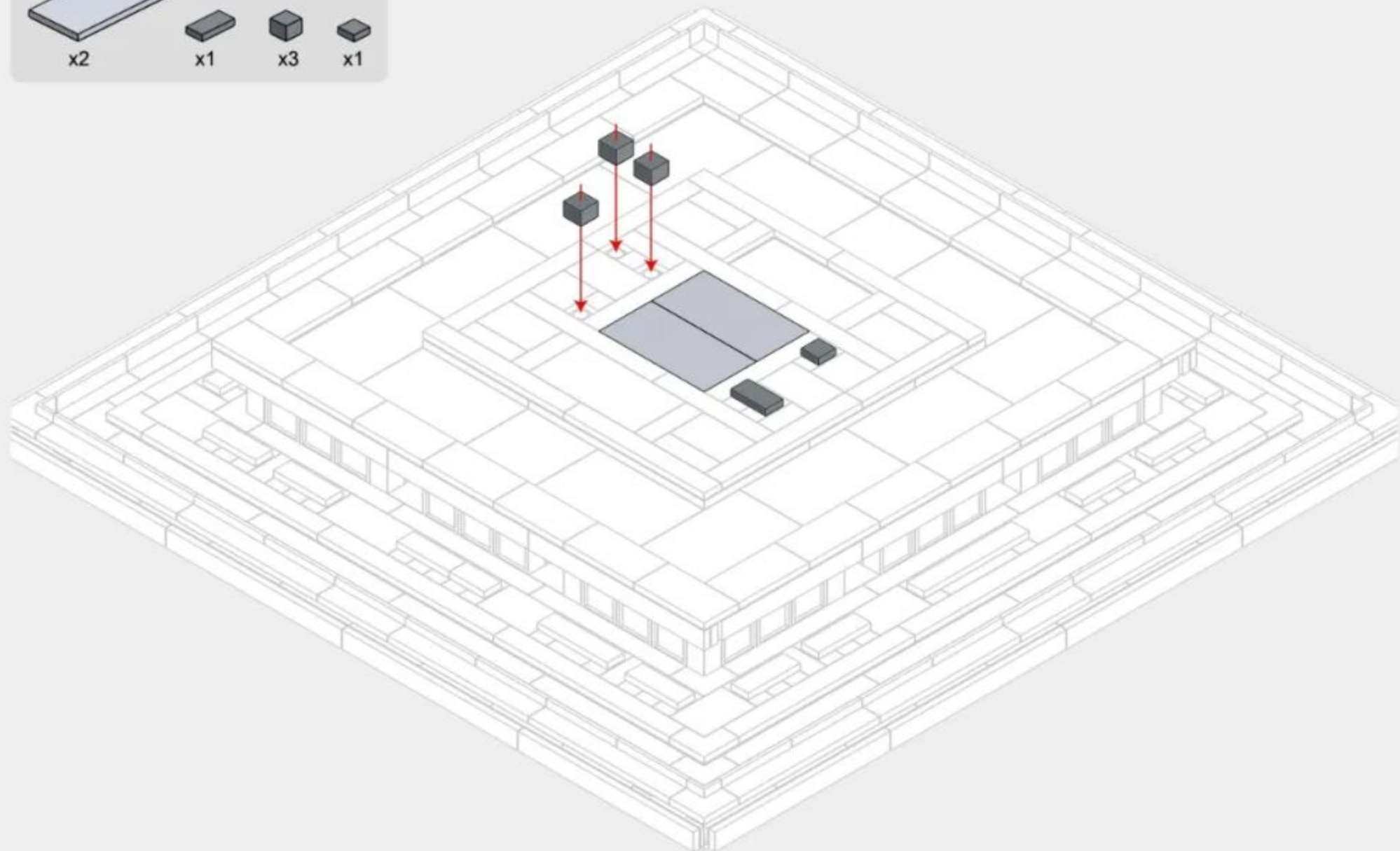
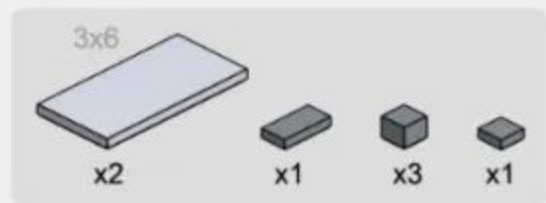

12-15

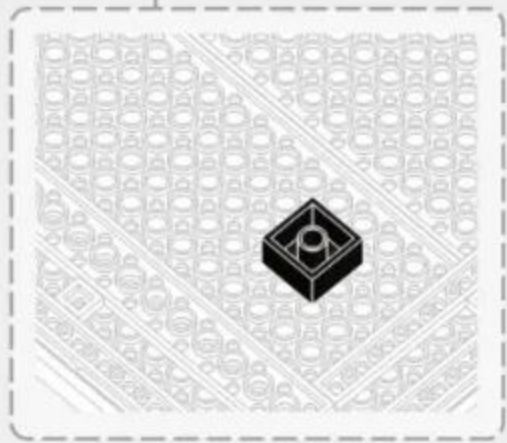
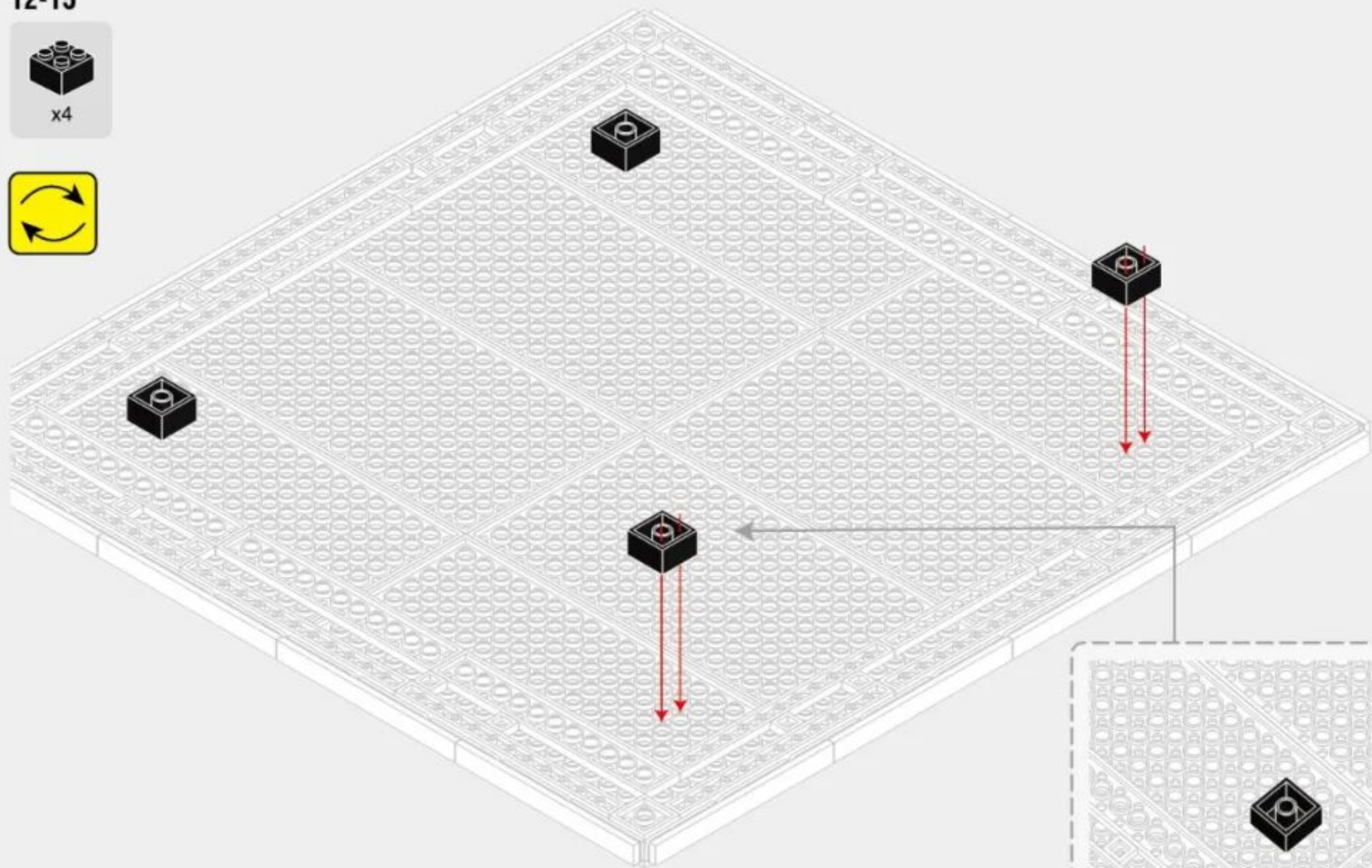

12-16

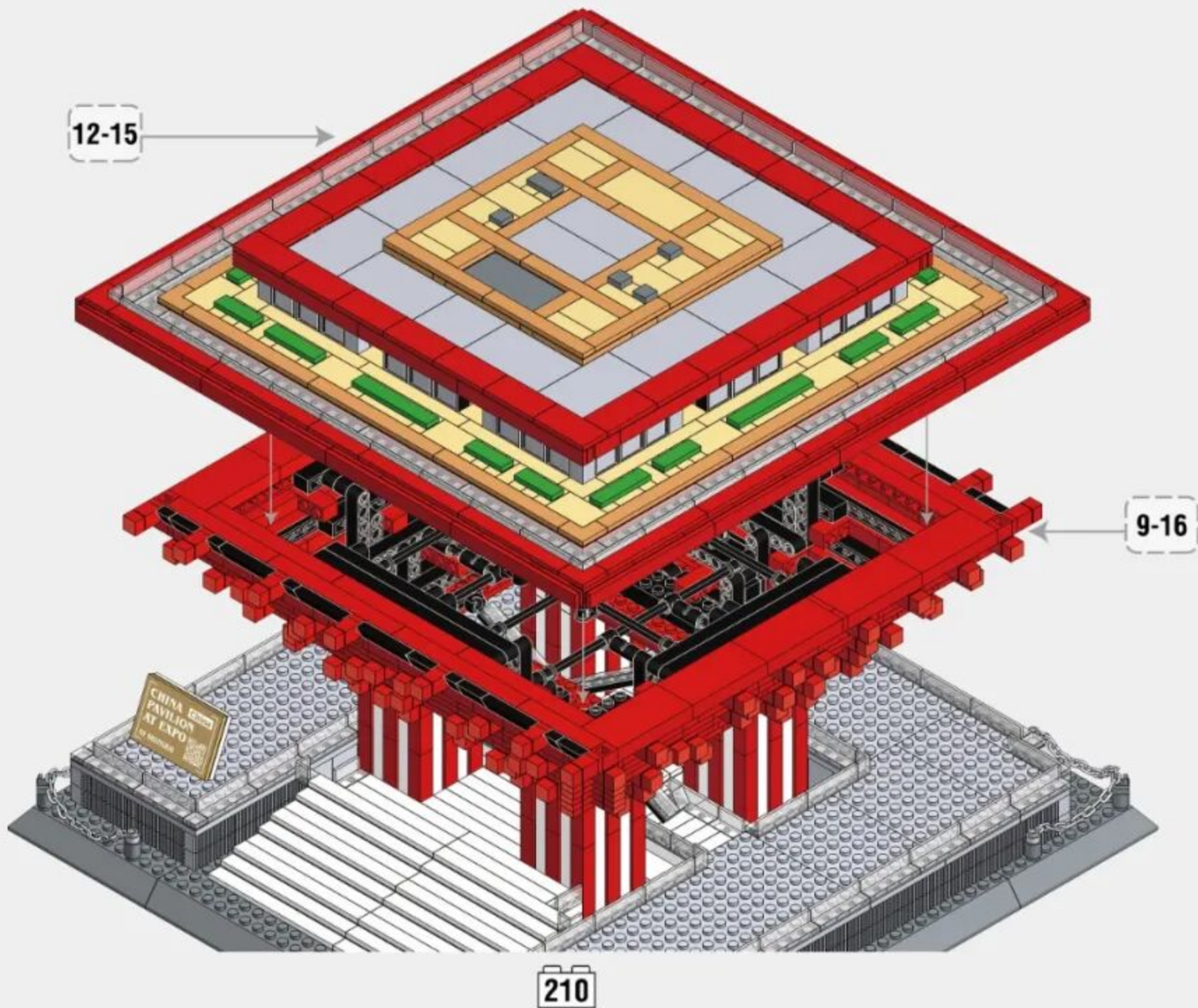

12-17

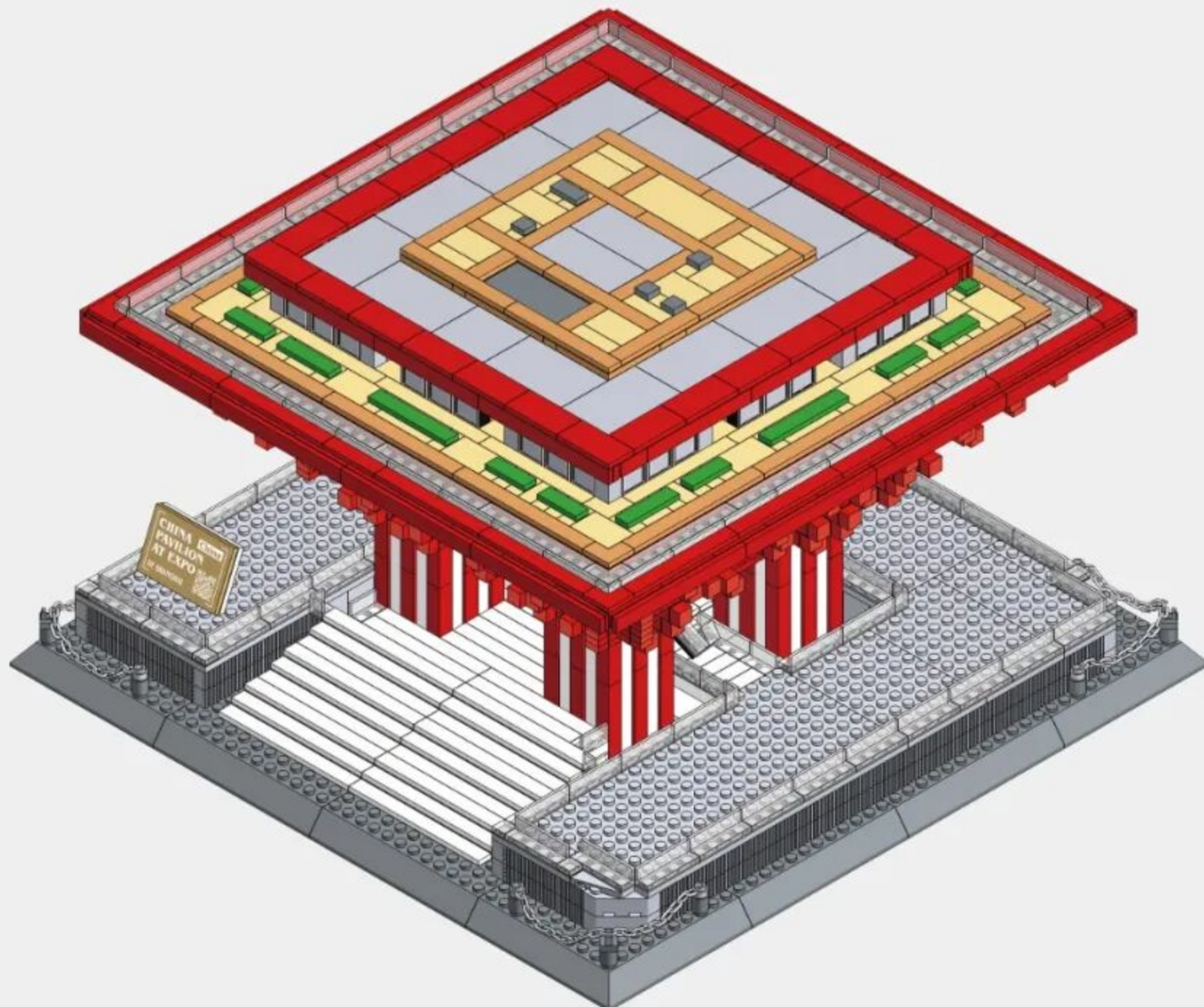

211

CHINA PAVILION AT EXPO

COUNTRY: China
CITY: Shanghai

