



YUEYANG TOWER

中国湖南岳阳楼

Hunan, China

The world's great architecture



6+ / 7211 / 1229PCS
Suitable Age Product Number Parts Total



Architecture

It will be a city...

这将构成一座城市...

ABOUT THE PRODUCT

关于产品

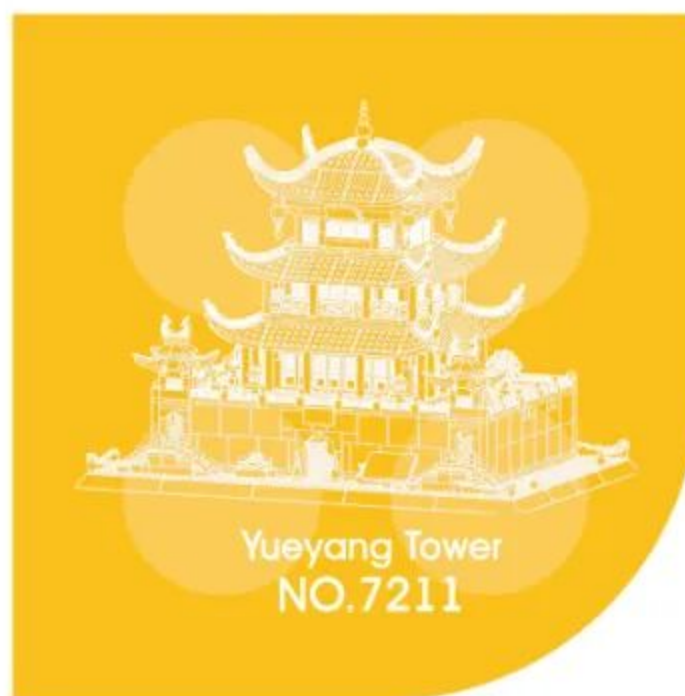
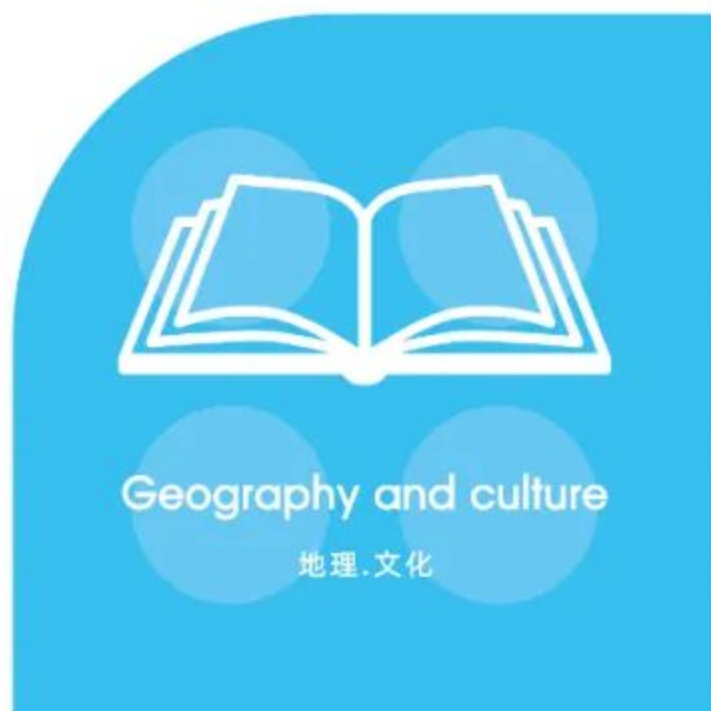

ARCHITECTURE

WANGE The world's great architect since 1991

Yueyang Tower



Yueyang Tower is located on Dongting North Road, Yueyanglou District, Yueyang City, Hunan Province.

Yueyang Tower



Geography and culture

地理·文化



Yueyang Tower is located on the west gate of the ancient city of Yueyang, close to the Dongting Lake, overlooking the Dongting and the Junshan Mountain in the front.

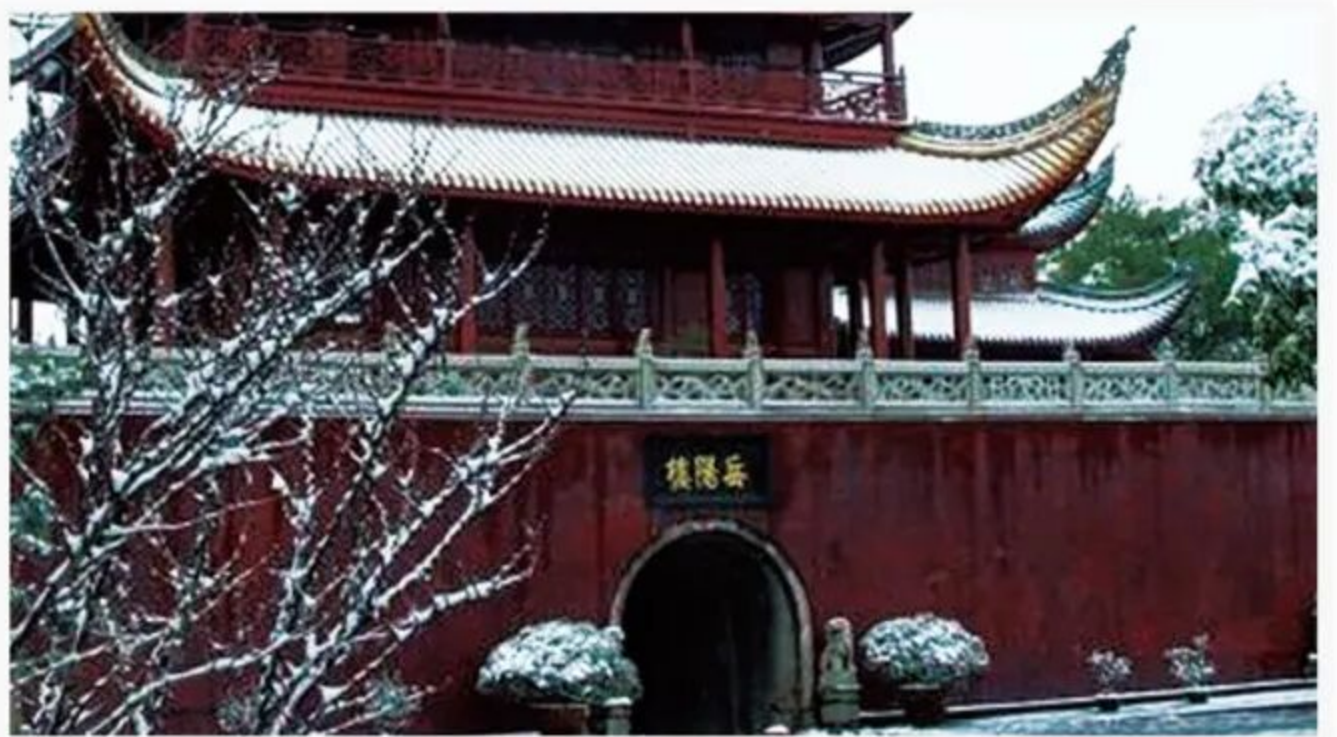



岳阳楼

Yueyang tower

China

The contents of this chapter refer to the Wikipedia website.

本章内容参考维基百科网站，更多资讯可自行查阅。

The world's great architecture

Buildings and layout

■ 建筑物和布局



Yueyang Tower was first built in 215, the 20th year of Jian 'an in the Eastern Han Dynasty. Successive dynasties have repeatedly rebuilt Yueyang Tower. The existing building follows the shape and pattern of the reconstruction in 1880, the sixth year of Guangxu in the Qing Dynasty. Since Teng Zongliang rebuilt Yueyang Tower in the Northern Song Dynasty, he invited his friend Fan Zhongyan to write a book about Yueyang Tower, which made Yueyang Tower famous in the world. Along with Yellow Crane Tower in Wuhan, Hubei Province, and Tengwang Pavilion in Nanchang, Jiangxi Province, it is also known as the "Three famous towers in the South of the Yangtze River". It is one of the "Ten Famous historical and Cultural towers in China" and one of the four famous towers in ancient times, and is known as the "first floor in the world".

岳阳楼始建于东汉建安二十年（215年），历代屡加重修，现存建筑沿袭清光绪六年（1880年）重建时的形制与格局；因北宋滕宗谅重修岳阳楼，邀好友范仲淹作《岳阳楼记》使得岳阳楼著称于世。自古有“洞庭天下水，岳阳天下楼”之美誉，与湖北武汉黄鹤楼、江西南昌滕王阁并称为“江南三大名楼”，是“中国十大历史文化名楼”、古代四大名楼之一，世称“天下第一楼”。



Structure

The main building of Yueyang Tower sits west to east and is rectangular in shape. The main building is 19.42 meters high, 14.54 meters deep and 17.42 meters wide. It is three layers, four columns, eaves, helmeted roof and pure wood structure. Top glaze yellow tile, dignified and generous configuration. The roof of Yueyang Tower is a helmet-like structure supported by overlapping "ruyi brackets", which is unique in the history of ancient Chinese architecture and the most prominent feature of the helmet-like structure of Yueyang Tower.

岳阳楼主楼坐西朝东，为长方形体，主楼高19.42米，进深14.54米，宽17.42米，为三层、四柱、飞檐、盔顶、纯木结构，楼中四根楠木金柱直贯楼顶，周围绕以廊、枋、椽、檩互相榫合，结为整体；顶覆琉璃黄瓦，构型庄重大方。岳阳楼的楼顶为层叠相衬的“如意斗拱”托举而成的盔顶式，这种拱而复翘的古代将军头盔式的顶式结构在古代中国建筑史上是独一无二的，是岳阳楼最突出的盔顶结构特点。



History

Yueyang Tower originated in the Tang Dynasty and flourished in the Song Dynasty. With a history of nearly 1800 years, Yueyang Tower has undergone the evolution from military building to Gate Building to ornamental building. Before the Tang Dynasty, its function was mainly for military purposes. Since the Tang Dynasty, it has gradually become a resort for tourists and romantic scholars to visit and recite poems. In January 1988, Yueyang Tower was announced by The State Council as the third batch of national key cultural relics protection units. In August of the same year, Yueyang Tower was listed as a national key scenic spot reserve. On January 30, 2005, Yueyang Tower was selected as one of the ten cultural heritages in Hunan. In September 2011, Yueyang Tower scenic spot was officially approved as a national AAAA tourist attraction by the National Tourism Scenic Spot Quality Assessment Committee.

岳阳楼兴于唐，盛于宋，传承至今已有近1800年历史，历经了由军事楼—城门楼—观赏楼的演变。唐朝以前，其功能主要作用于军事，自唐始，便逐步成为历代游客和风流雅士游览观光、吟诗作赋的胜地。1988年1月，岳阳楼被国务院公布为第三批全国重点文物保护单位；同年8月，岳阳楼被列为国家重点风景名胜保护区。2005年1月30日，岳阳楼入选湖南十大文化遗产。2011年9月，岳阳楼景区被全国旅游景区质量等级评定委员会正式批准为国家AAAAA级旅游景区。

Force Balance

受力平衡

Physical operations

物理运算

$$F = G \frac{m_1 m_2}{d^2}$$

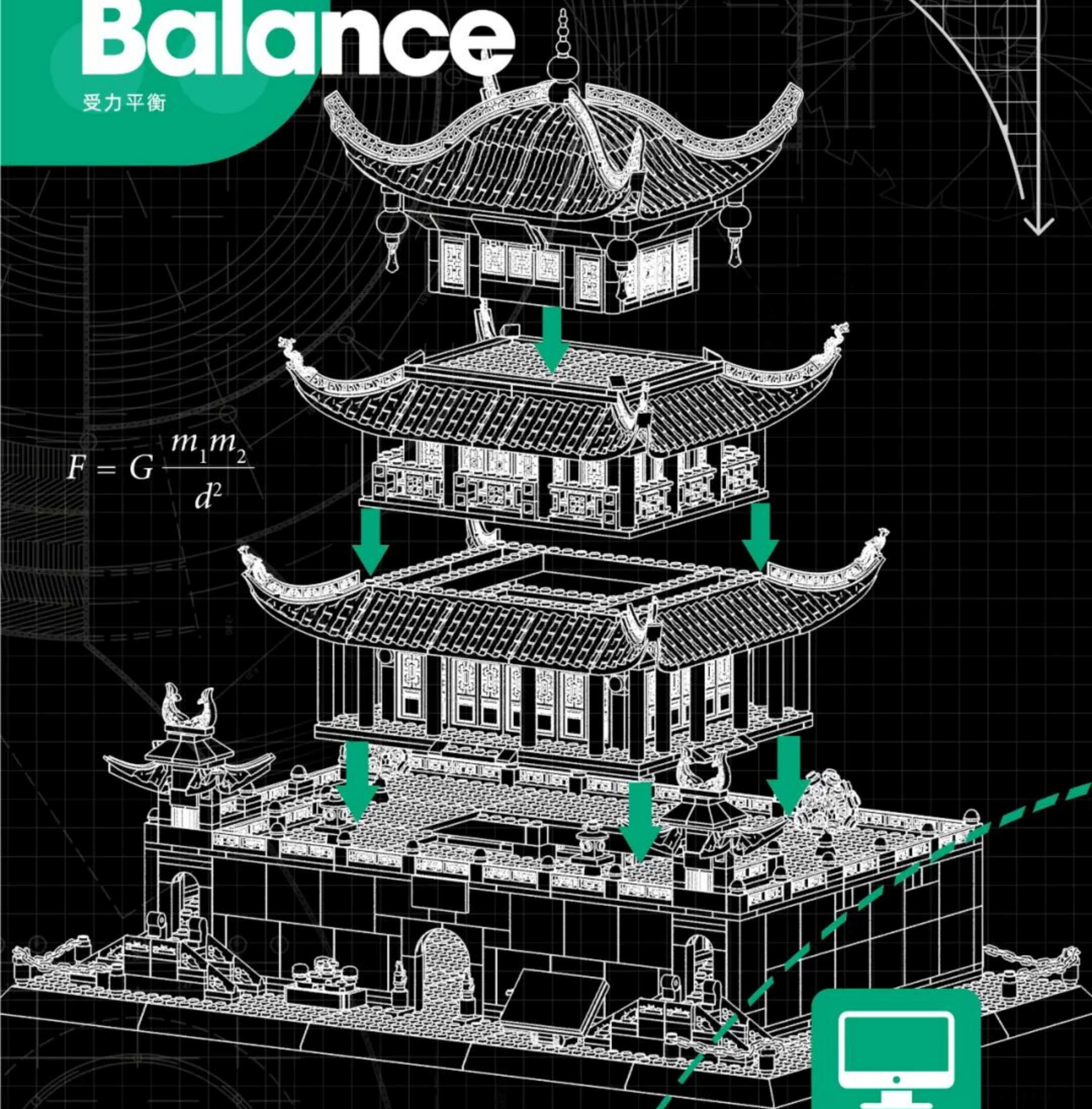

Creation and thinking

创作·思考

08

Special parts

特殊零件的开发利用

$$S=4\pi \cdot r^2$$

$$a^2+b^2=c^2$$



WG1440
翘角屋顶连板



WG1445
屋顶垂脊连板C



WG1445
屋顶垂脊连板B



WG1445
屋顶垂脊连板A

$$\sin^2 a + \cos^2 a = 1$$



features and functions

特点.功能

Main Color Matching

配色方案

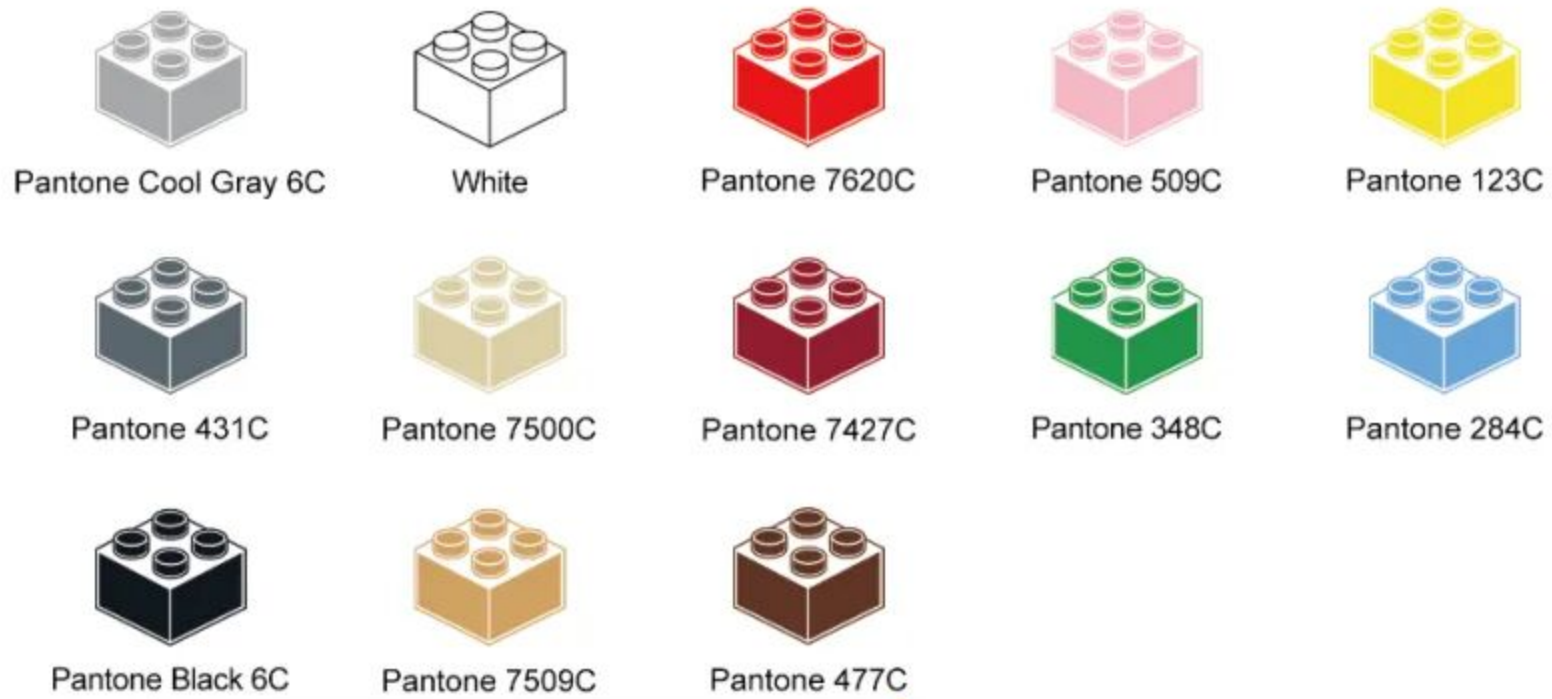

Color matching Adopting 4 main colors, Red, yellow, white and black as the main color, the more reasonable and Green color matching on the original building, making the product more atmospheric and the whole design is more reasonable.

Yueyang Tower

岳阳楼



Front

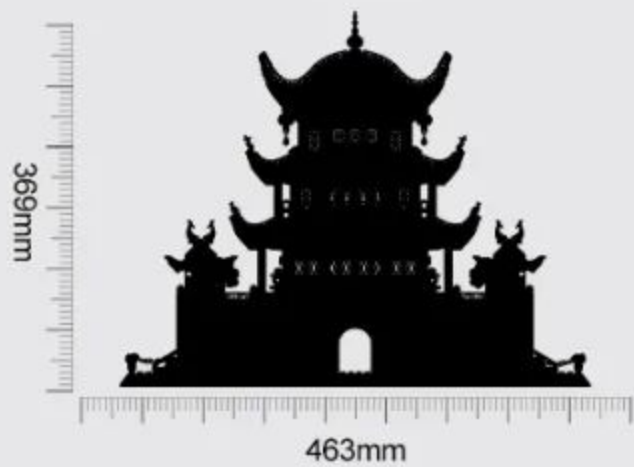

Left

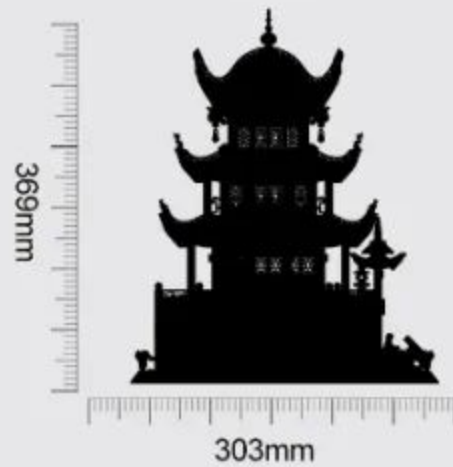

Back

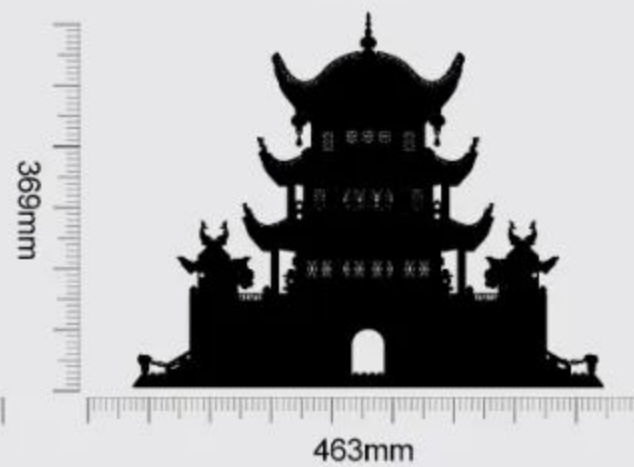

Product Size:463X303X369mm





■ First open the product packaging according to the instructions.

按指导用正确方式拆解产品外包装。



■ Summarize all parts to count the number of familiar accessories.

对照说明书清单确认积木包数量与积木数量。



■ Arranging all accessories by color helps to quickly install the product.

把确认好的积木以类型、颜色进行分类排好以便安装。



■ Carefully install the product and learn about building.

按说明书步骤拼装并完成你的积木模型。



Instructions For Use

积木起件器使用说明
Brickseparator

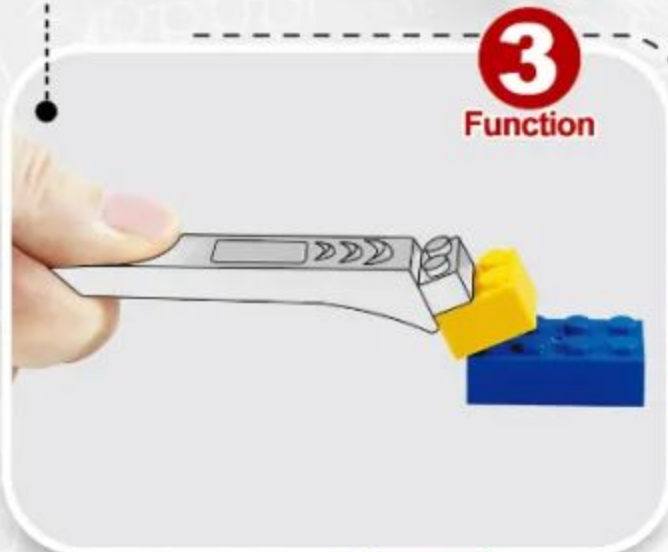
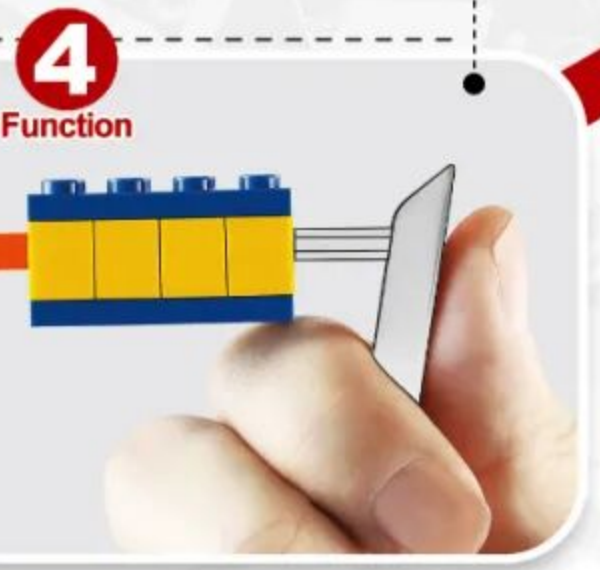
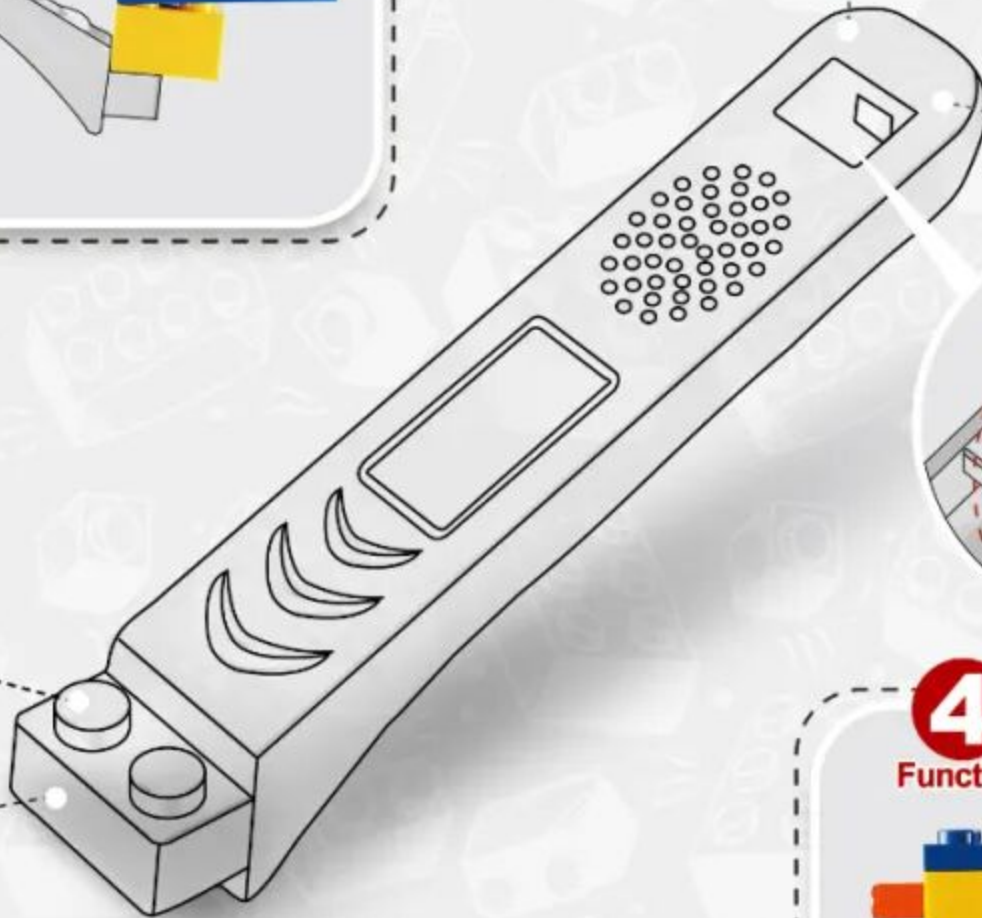
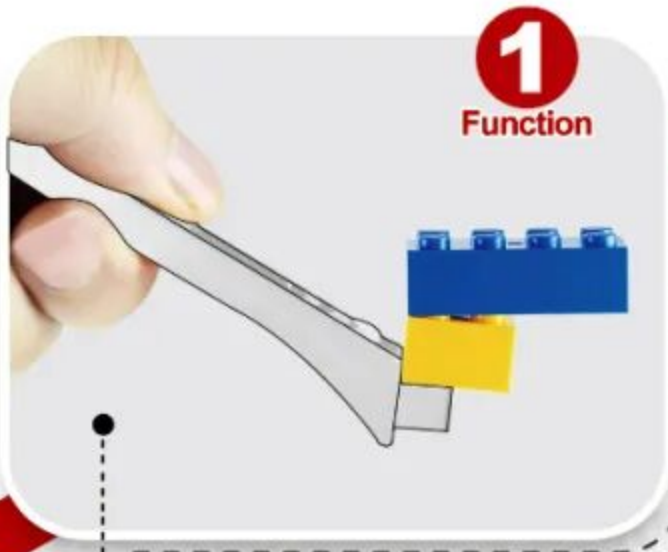

4 ways to make installation easier
让安装更简单

1:1 Physical Reference Table

十字棒配件1:1尺寸参照表



Instructions For Use

让安装更简单



2 $(1 \times 2) = 2$

3 $(1 \times 3) = 3$

4 $(1 \times 4) = 4$

5 $(1 \times 5) = 5$

6 $(1 \times 6) = 6$

7 $(1 \times 7) = 7$

8 $(1 \times 8) = 8$

9 $(1 \times 9) = 9$





















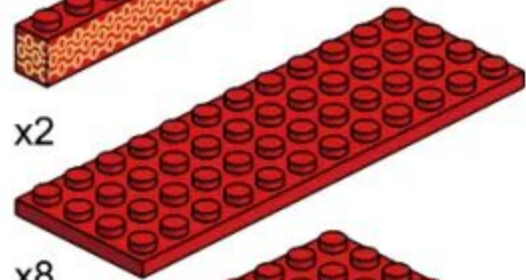















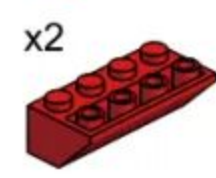



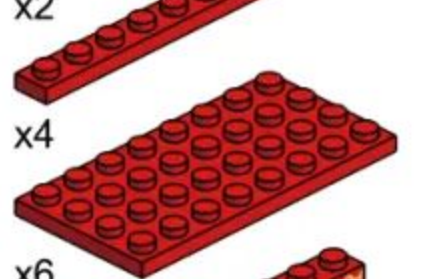





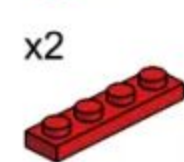

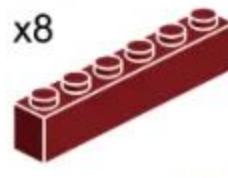

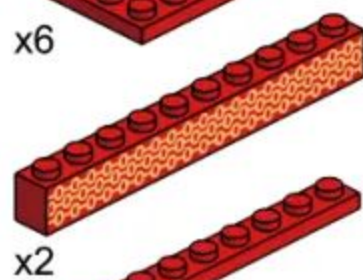
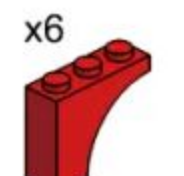

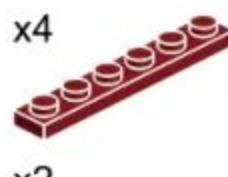

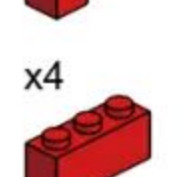



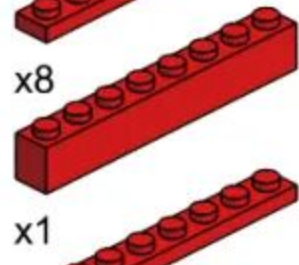
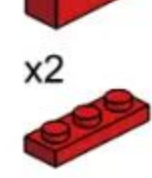



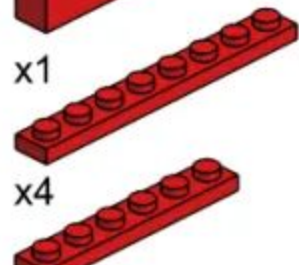

10 $(1 \times 10) = 10$

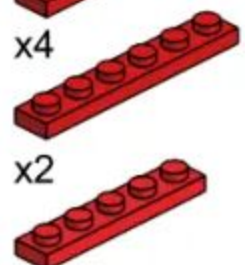
12 $(1 \times 12) = 12$

16 $(1 \times 16) = 16$

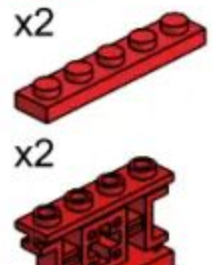
PARTS LIST

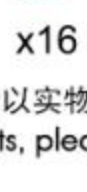
配件清单

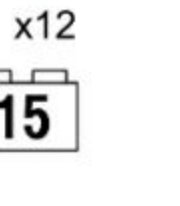
 x4	 x56	 x4	 x16	 x4
 x4	 x1	 x4	 x8	 x6
 x2	 x8	 x8	 x4	 x8
 x8	 x2	 x1	 x2	 x28
 x4	 x2	 x9	 x2	 x16
 x2	 x10	 x4	 x2	 x16
 x4	 x2	 x4	 x8	 x6
 x6	 x6	 x2	 x4	 x4
 x2	 x4	 x20	 x2	 x6
 x2	 x4	 x2	 x14	 x8
 x8	 x4	 x20	 x8	 x8
 x1	 x2	 x2	 x4	 x8
 x4	 x2	 x12	 x16	 x2
 x2	 x1	 x16		 x8
 x2				
 x12				

产品有增补件请以实物为准

If product has additional parts, please in kind prevail.

PARTS LIST

配件清单

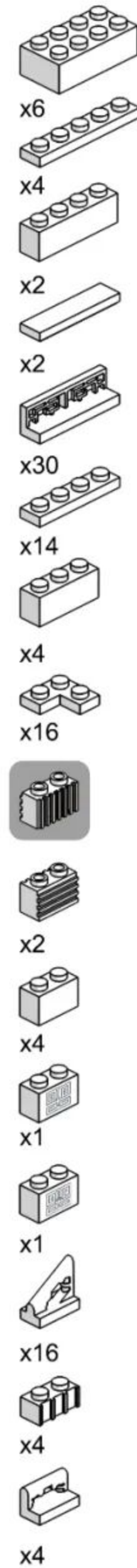
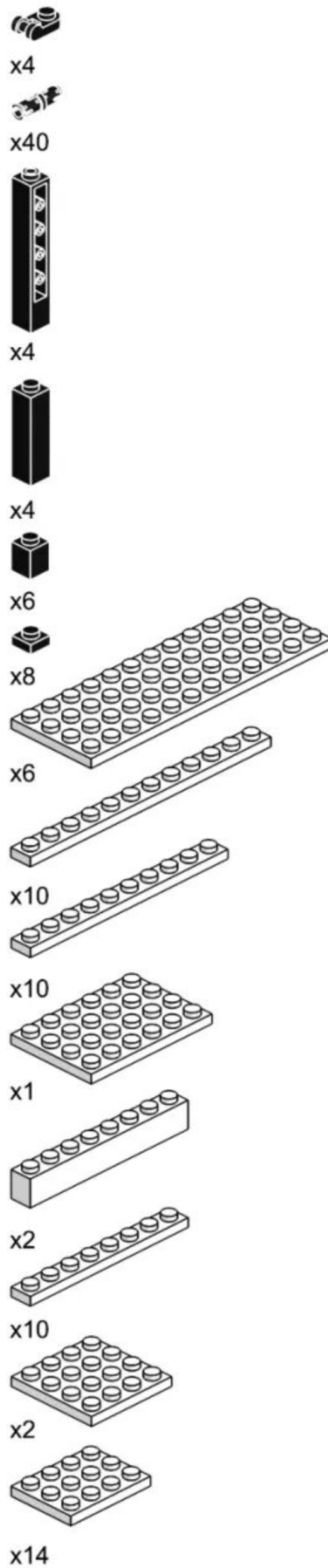
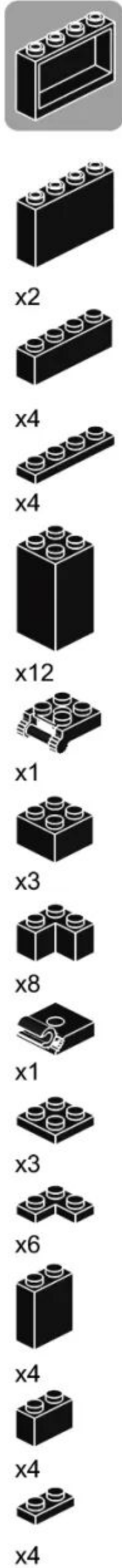
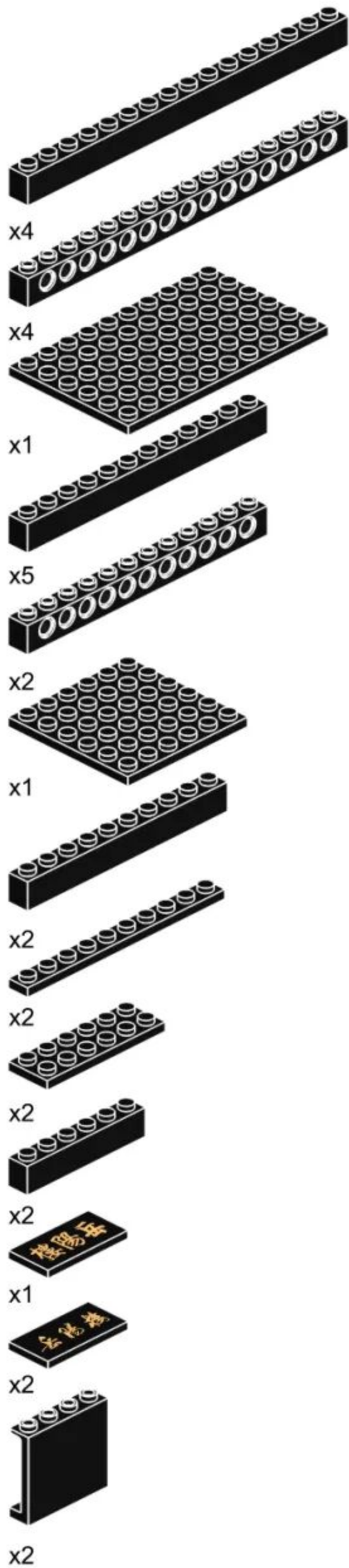

产品有增补件请以实物为准
 If product has additional parts, please in kind prevail.

PARTS LIST

配件清单

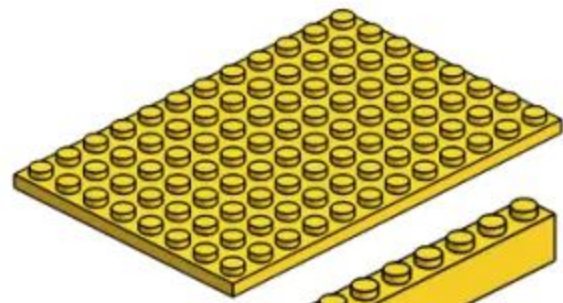

x2

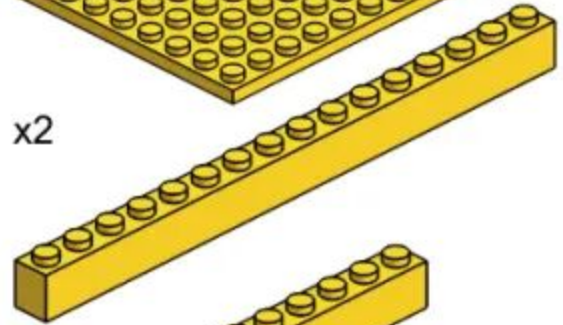

x2

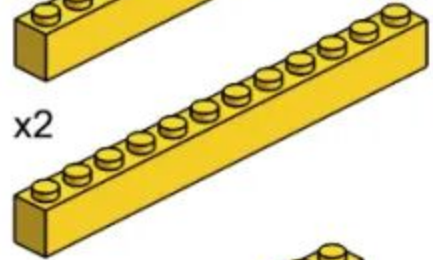

x4

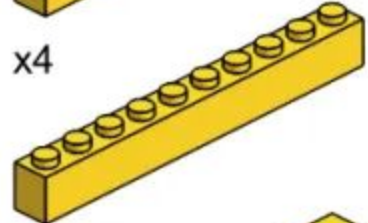

x2

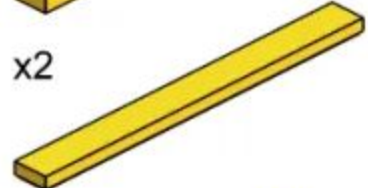

x4

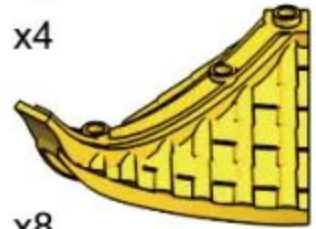

x8

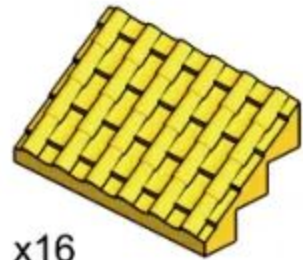

x16

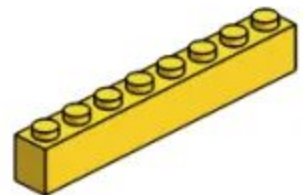

x2

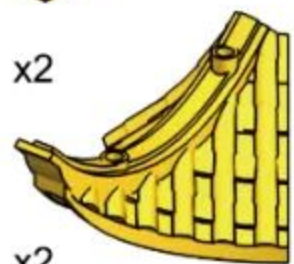

x2



x2



x2



x2

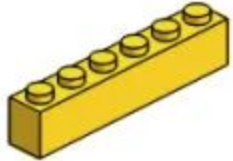

x6



x2



x2



x2



x2



x8



x2



x4



x4



x4



x4



x4



x4



x4



x4



x4

x1



x1



x1



x4



x2



x2



x2



x2



x4



x2



x2



x1

产品有增补件请以实物为准

If product has additional parts, please in kind prevail.

PARTS LIST

配件清单



x6

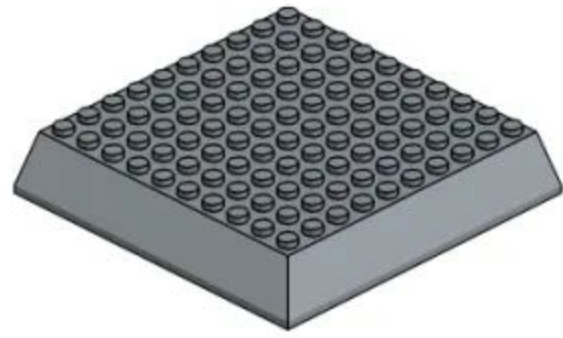

x4



x14

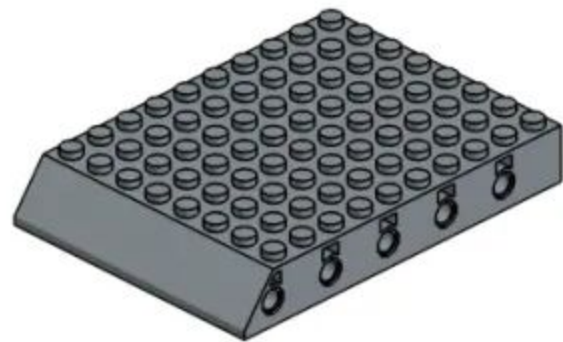

x4



x1



x1



x4



x2



x8



x8



x4



x2



x6



x2



x4



x12



x10



x2



x6



x2



x2



x2



x2



x6



x68



x2



x2



x2

产品有增补件请以实物为准
If product has additional parts, please in kind prevail.



246PCS

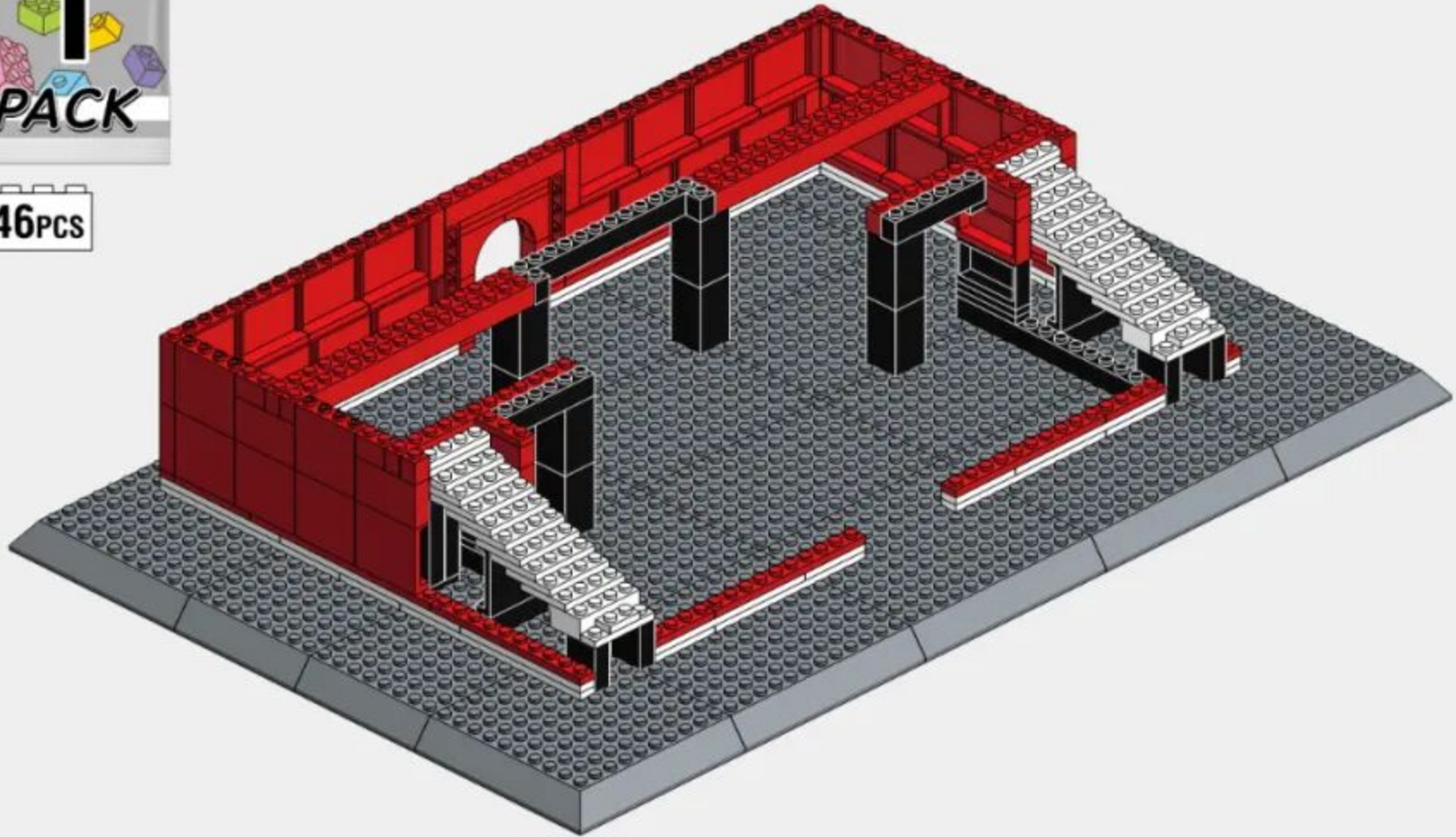

1-1

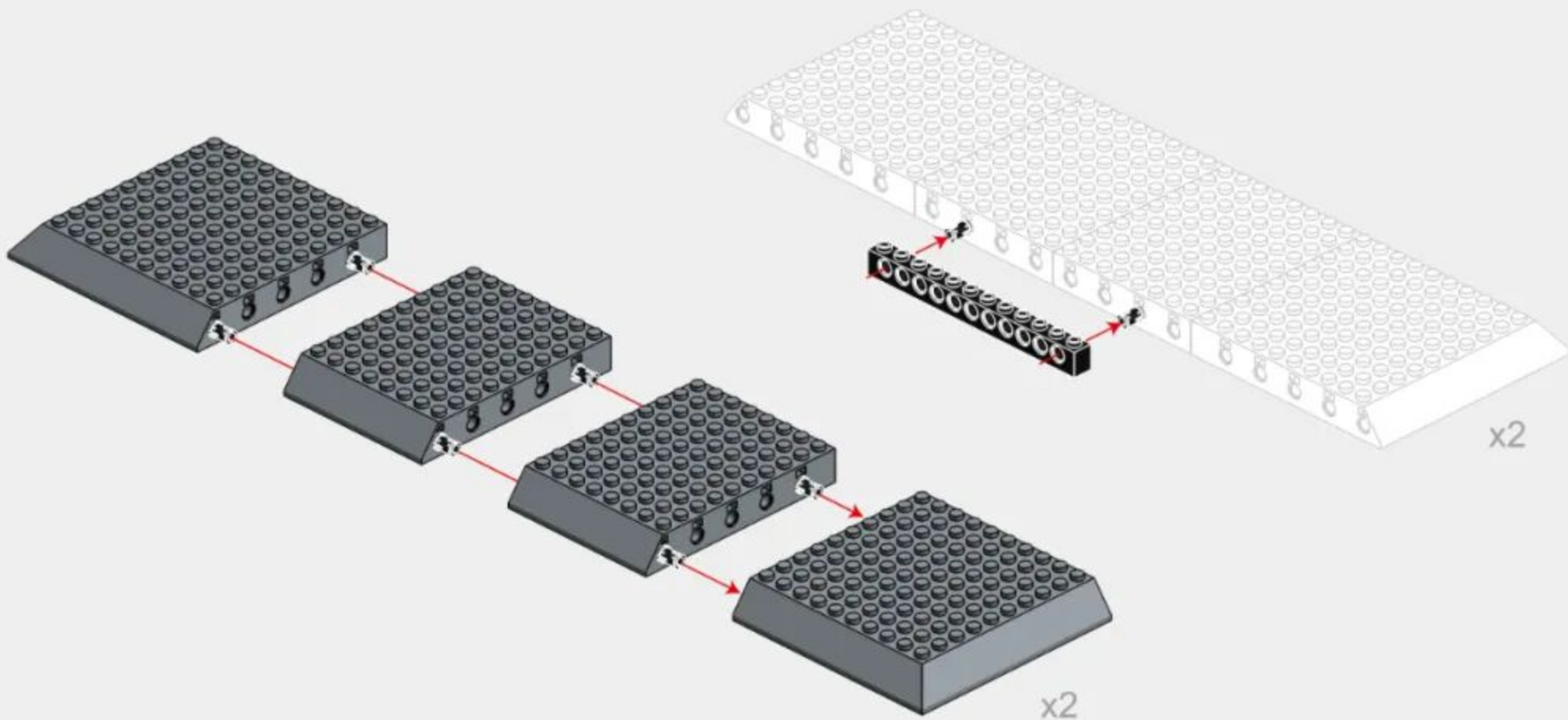
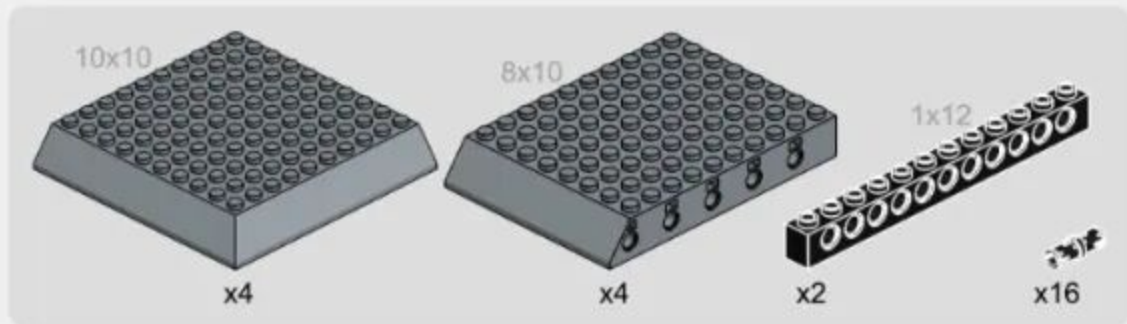

20

1-2

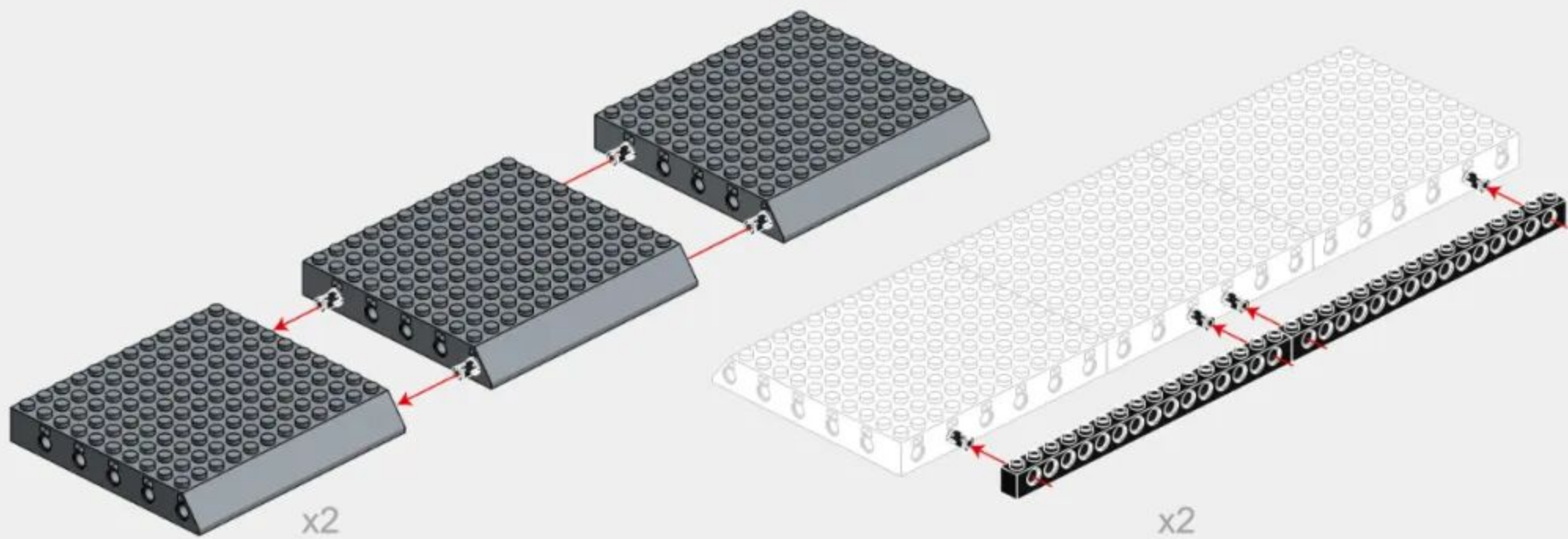
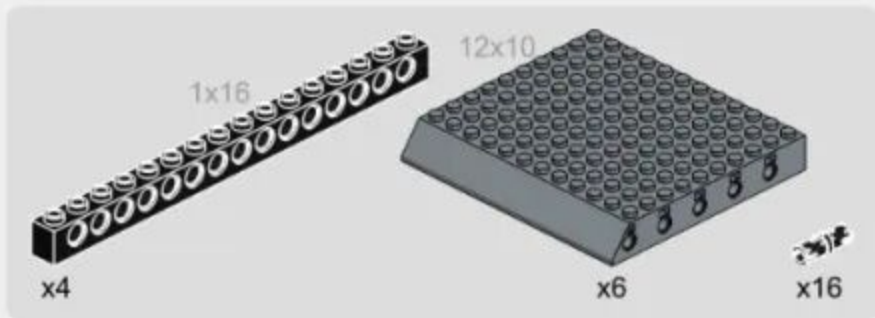

1-3

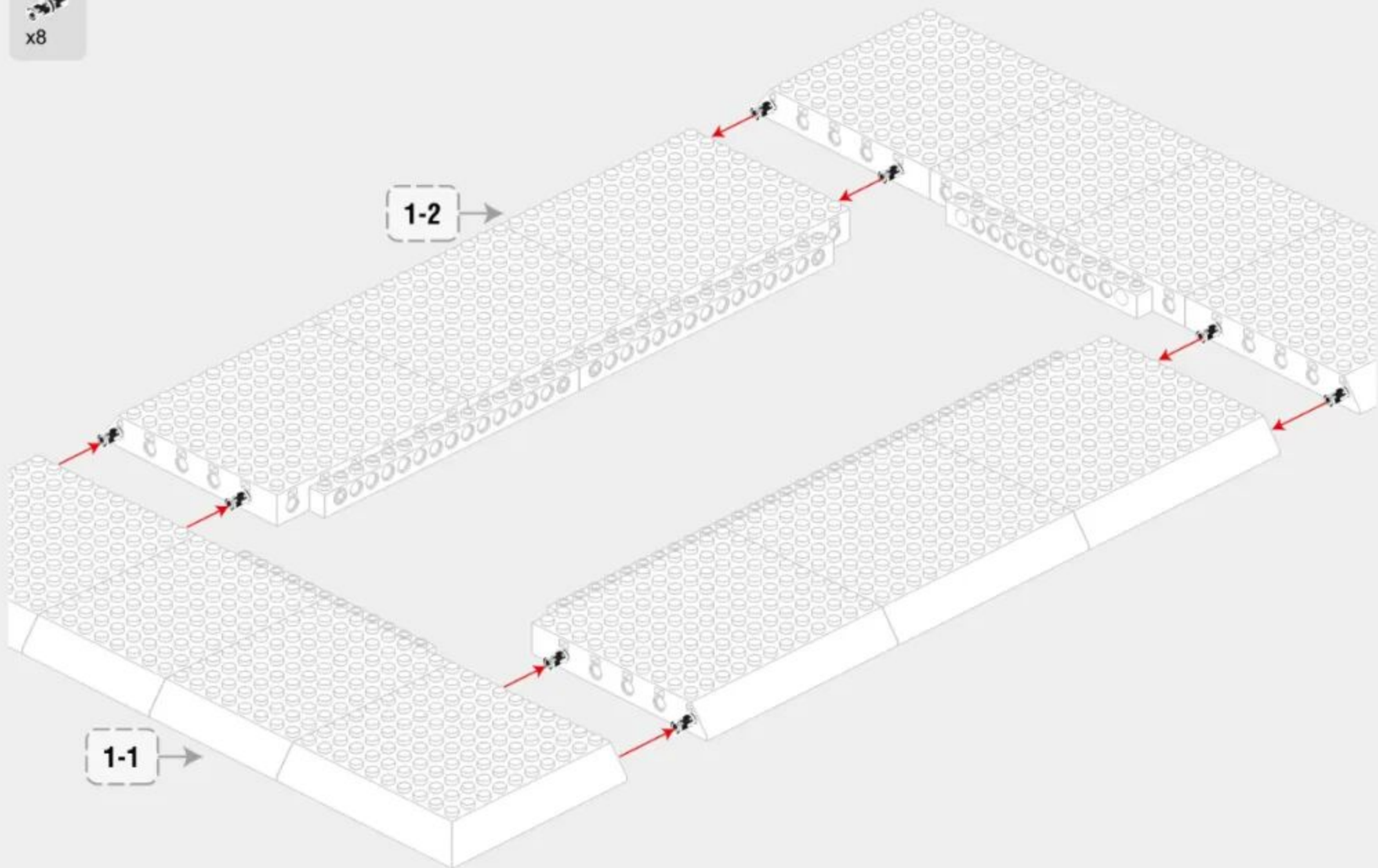

1-4

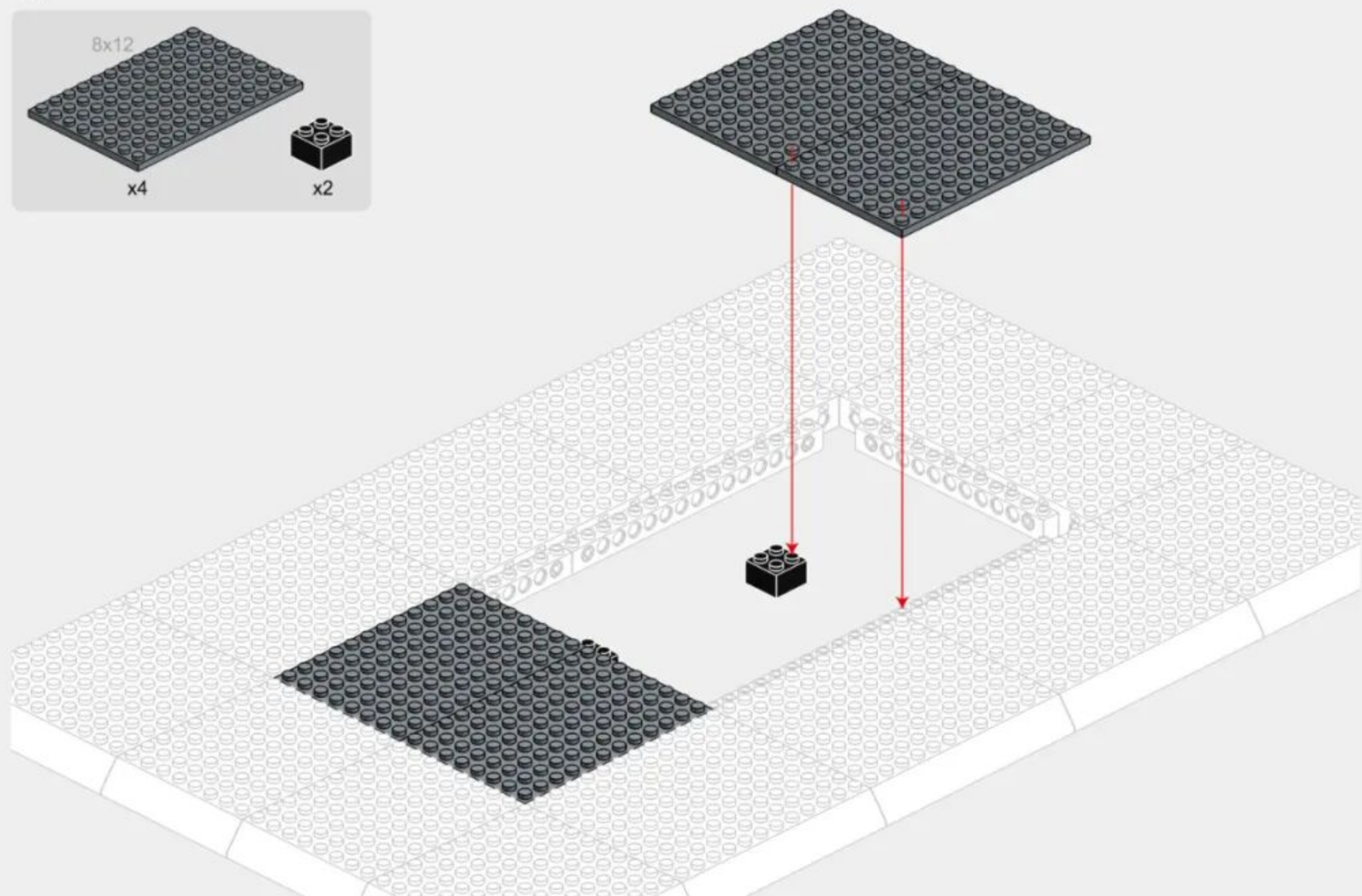
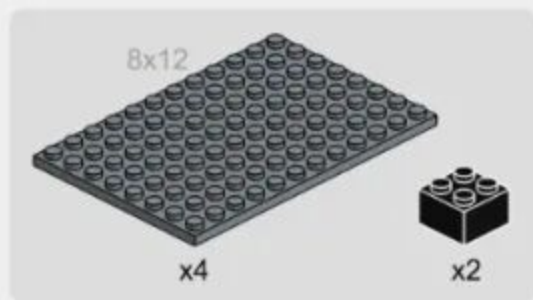

1-5

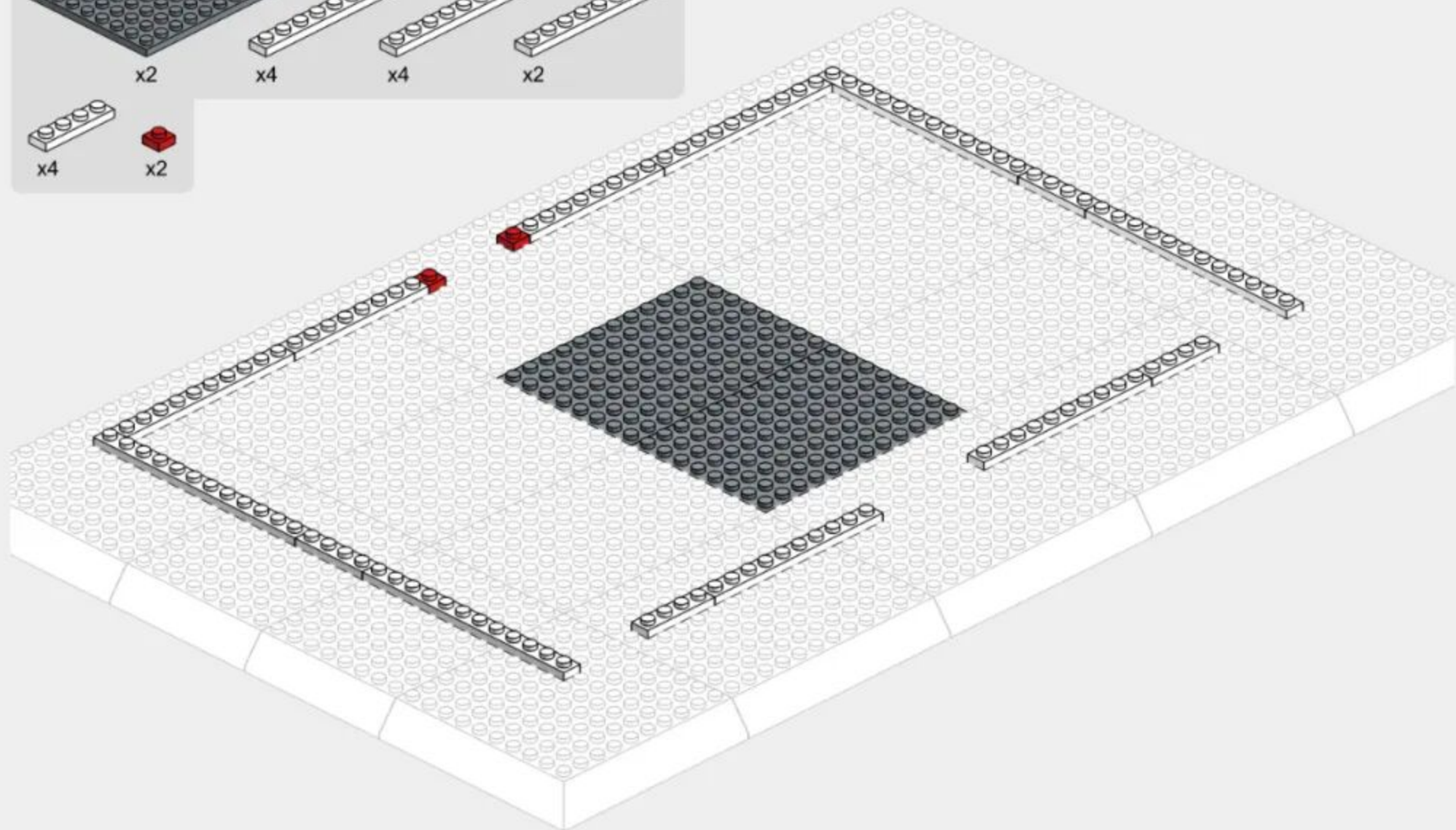
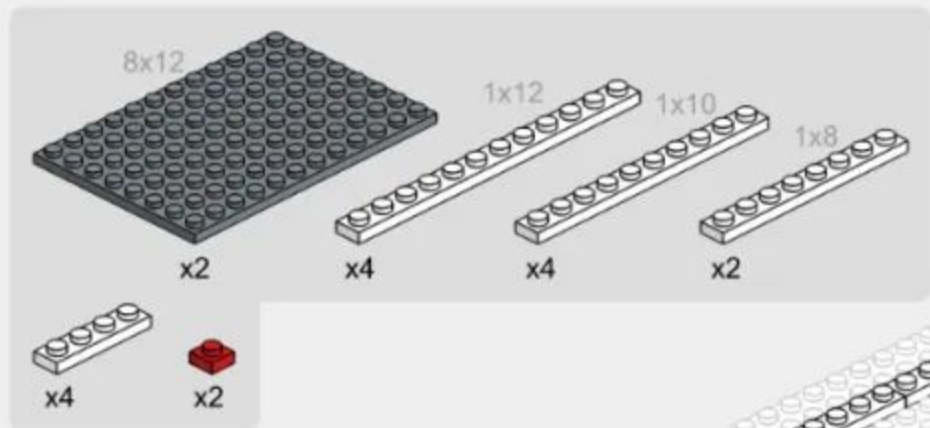

1-6

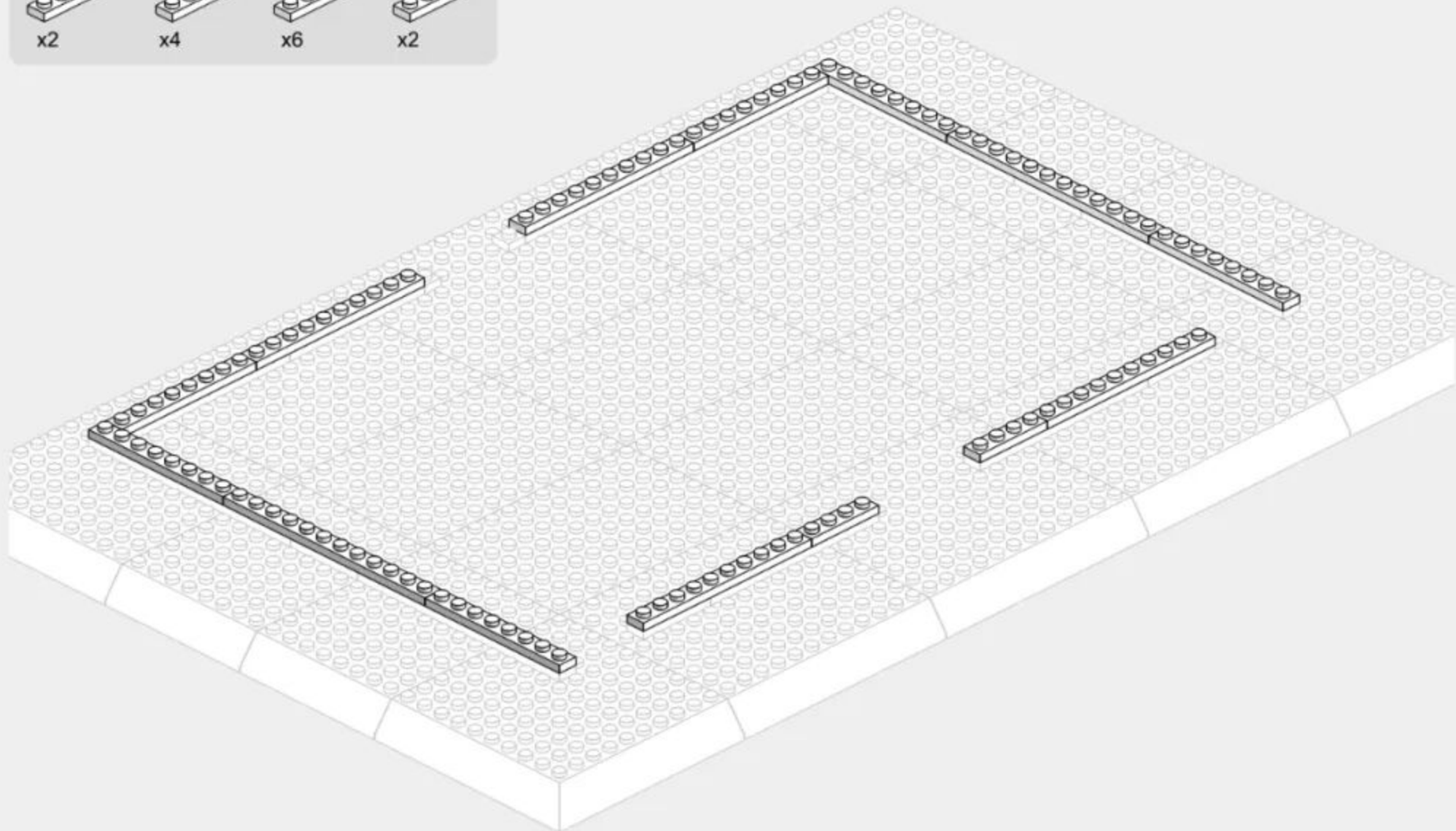
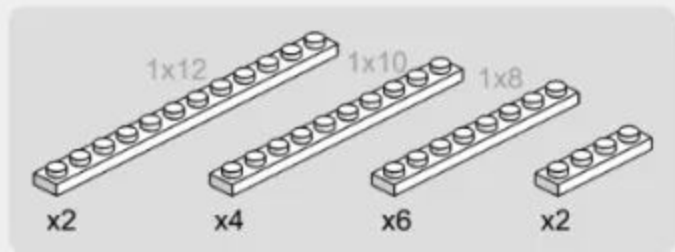

1-7

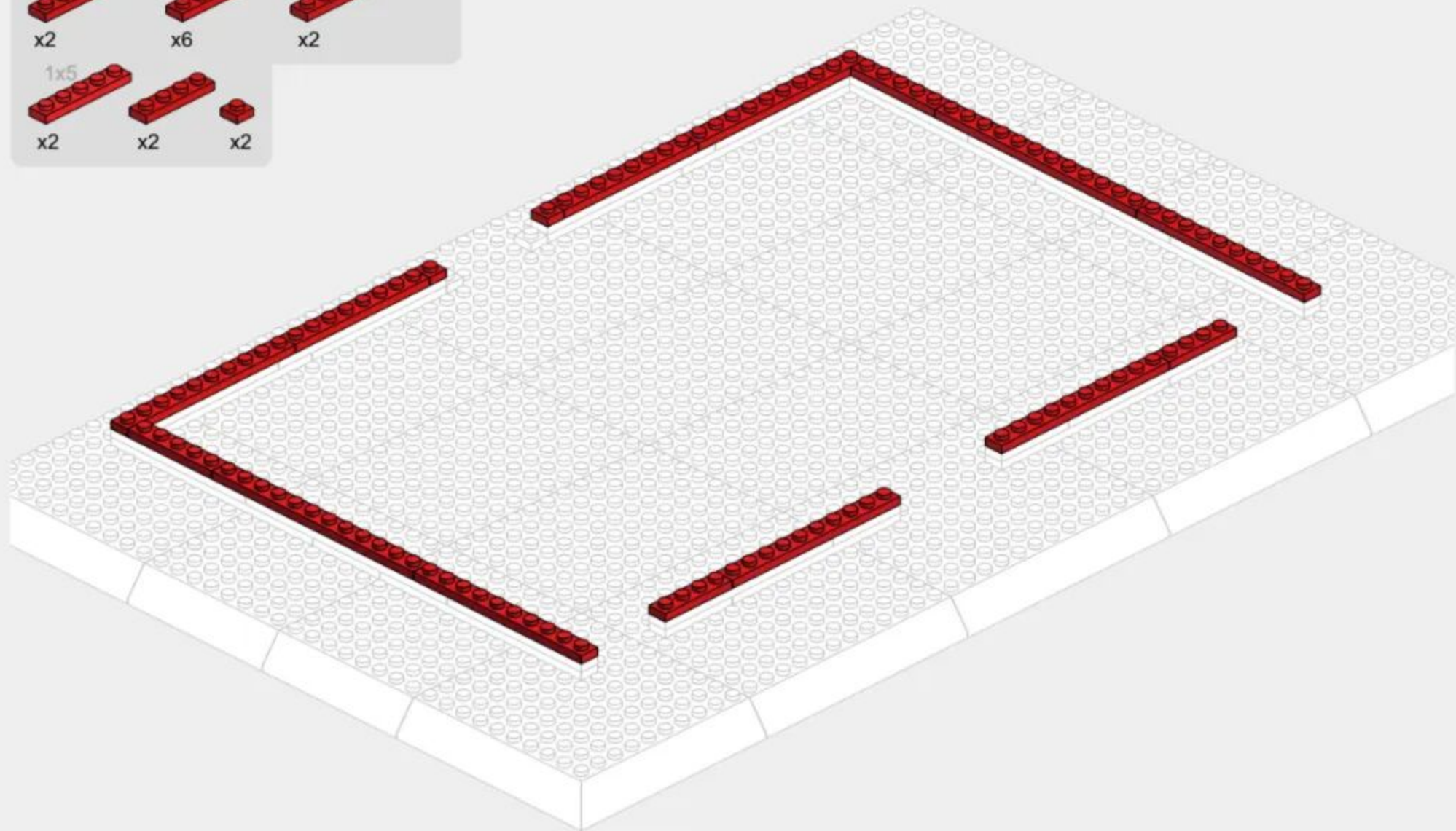
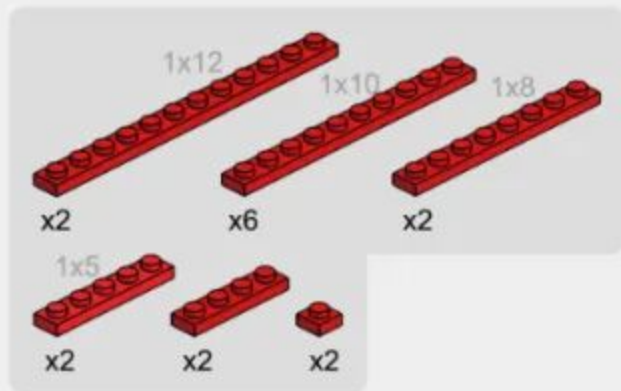

1-8

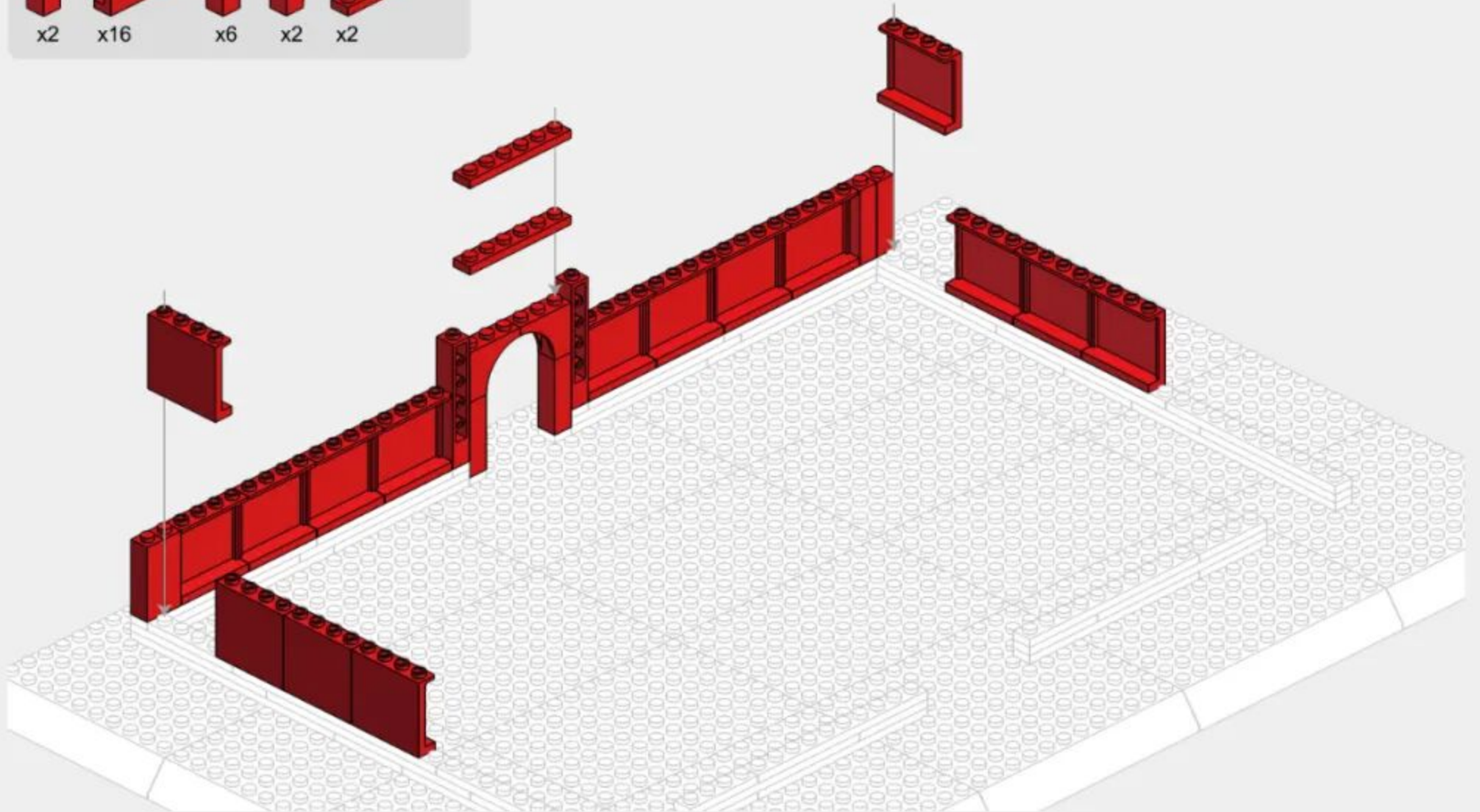
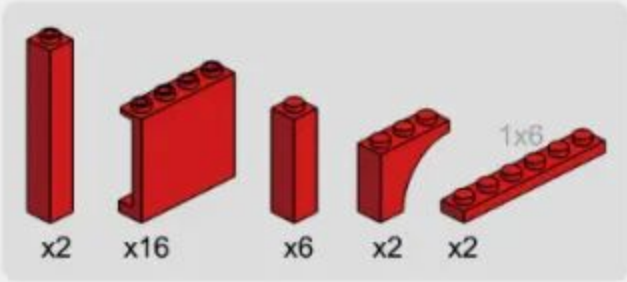

1-10

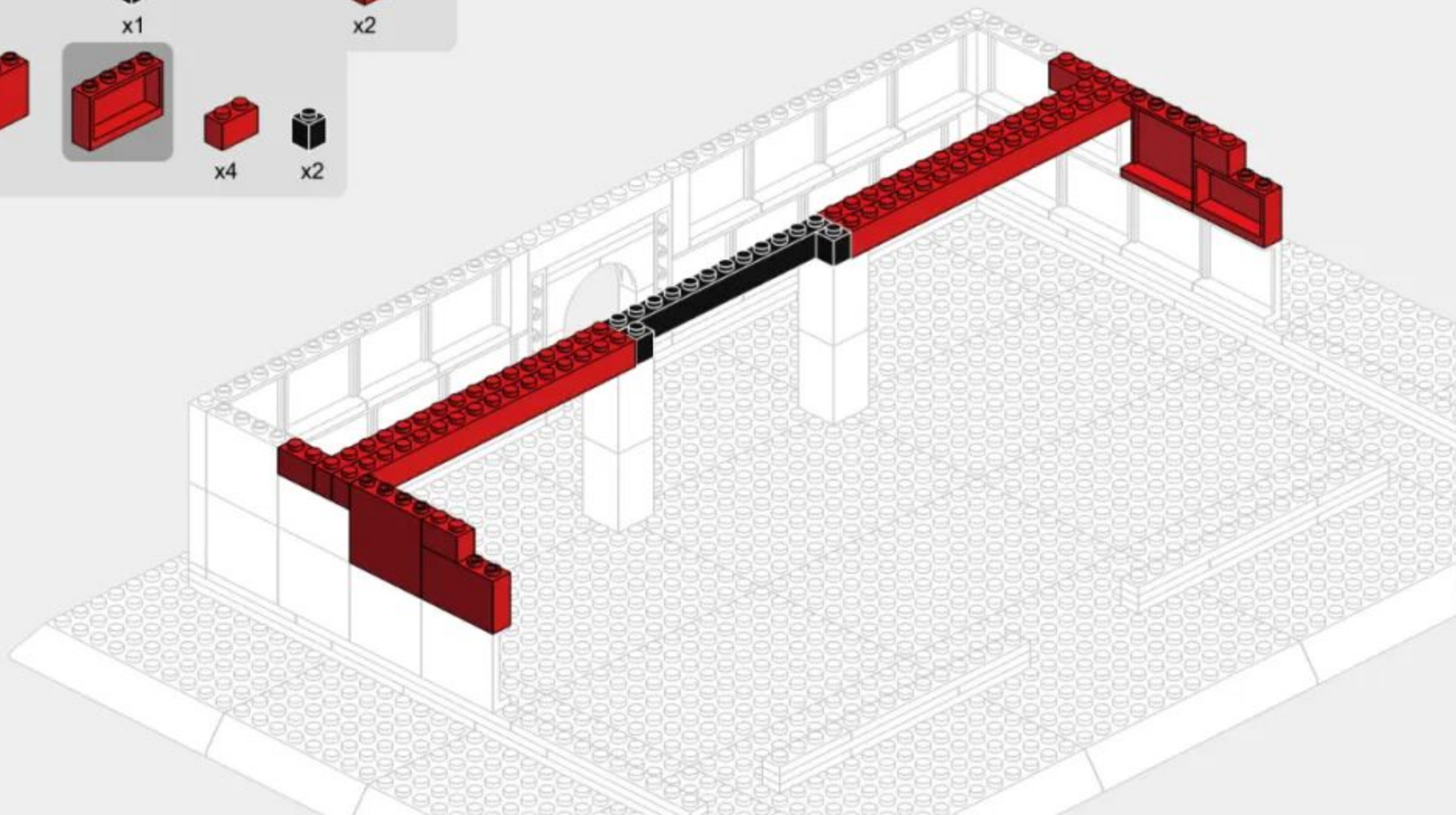
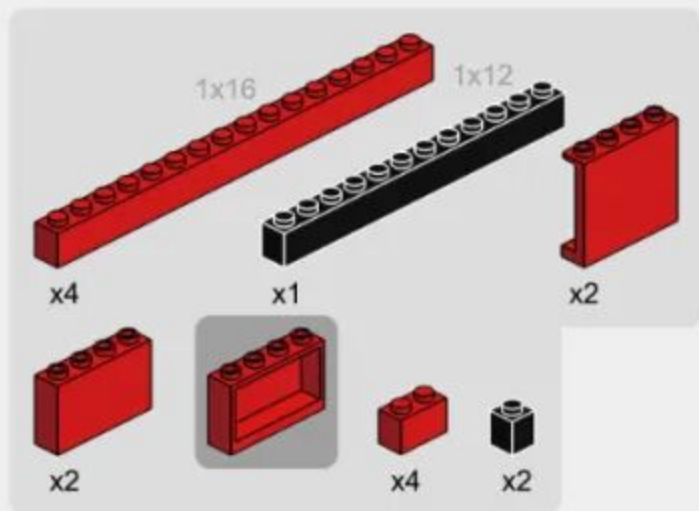

1-11

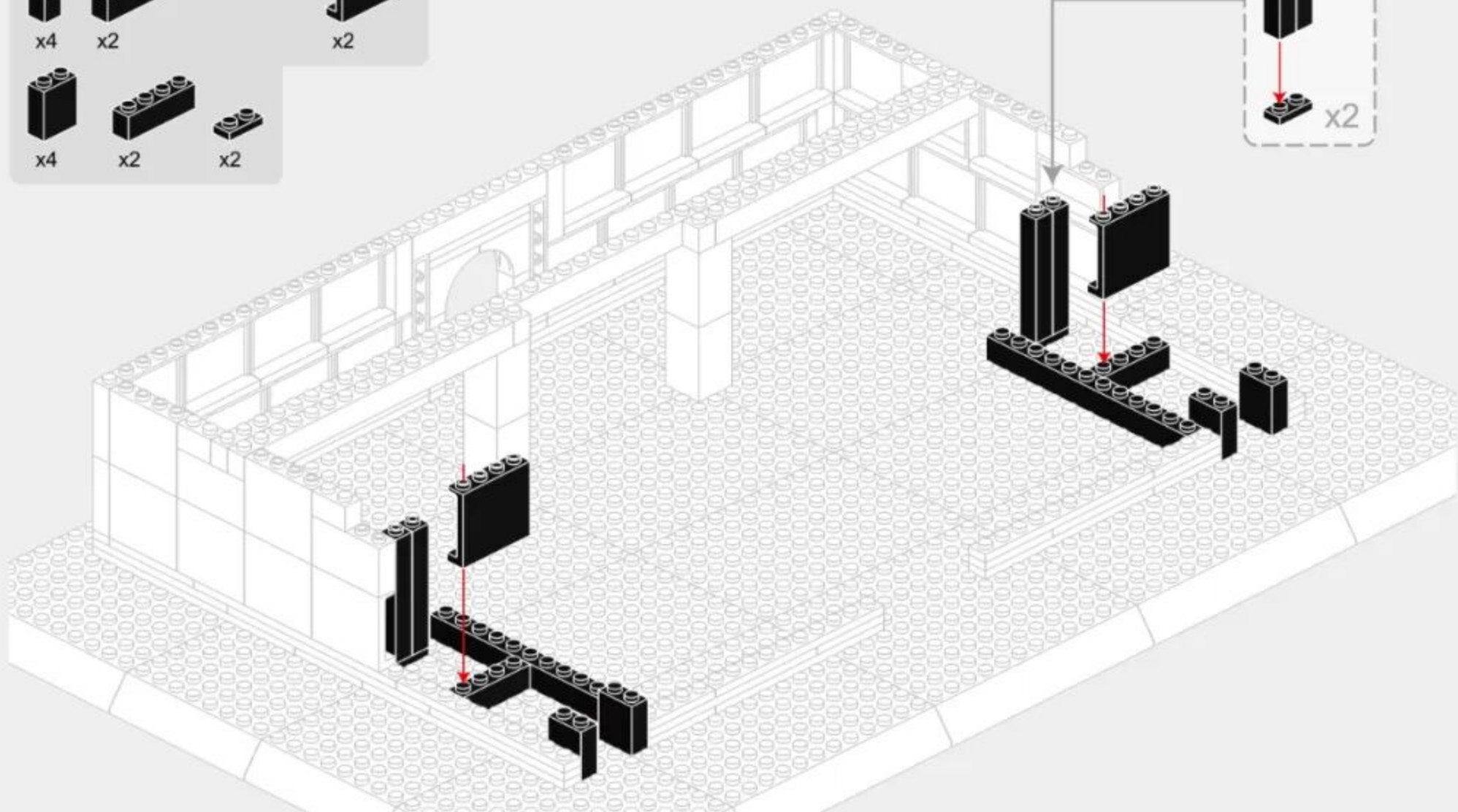
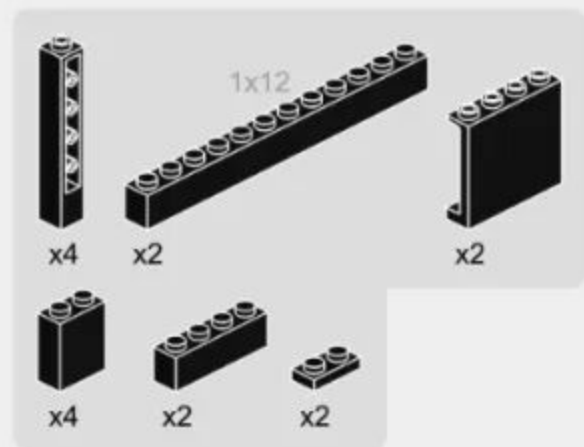

1-12

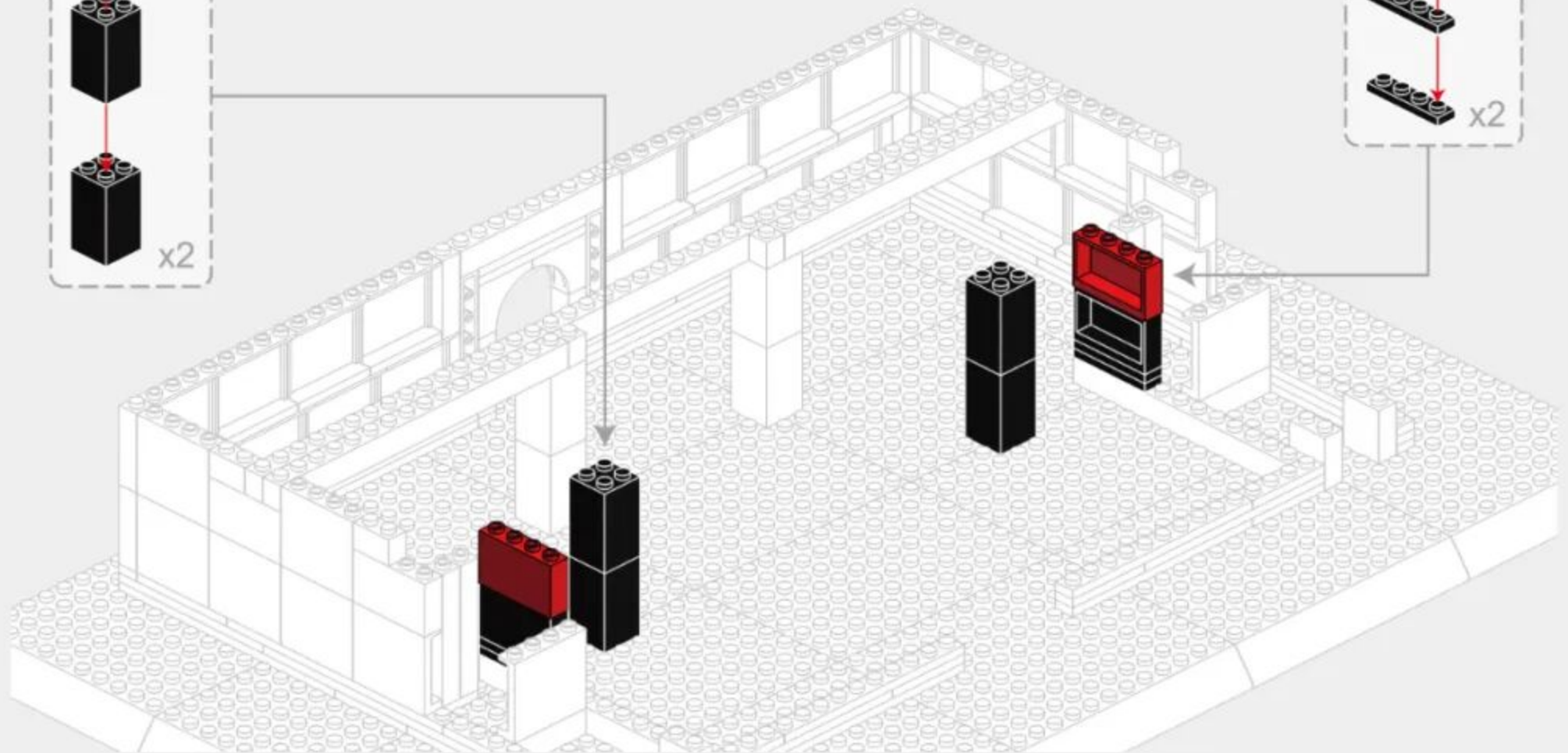
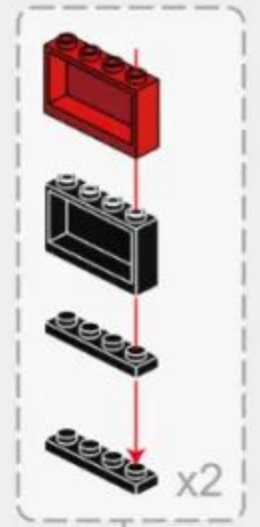
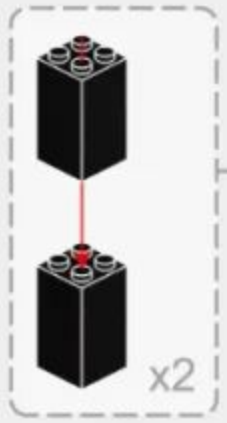
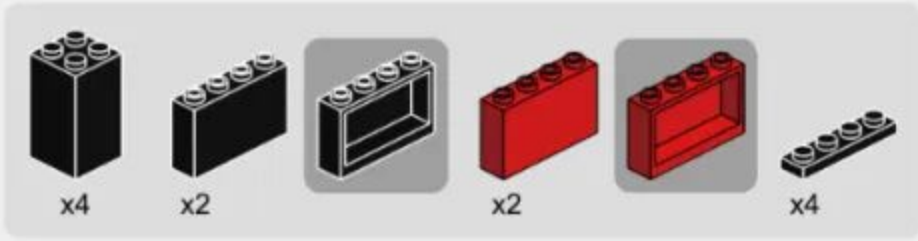

1-13

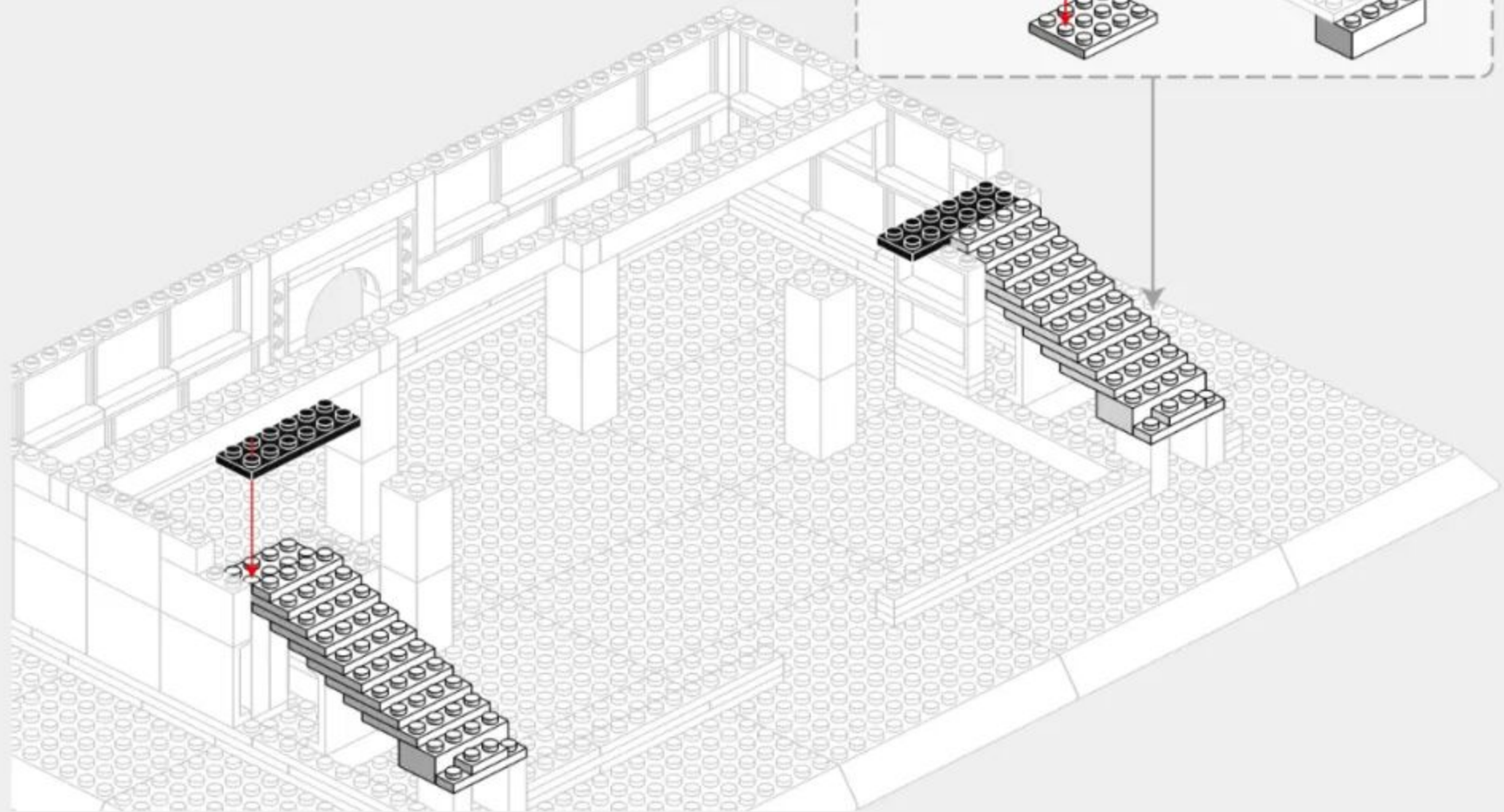
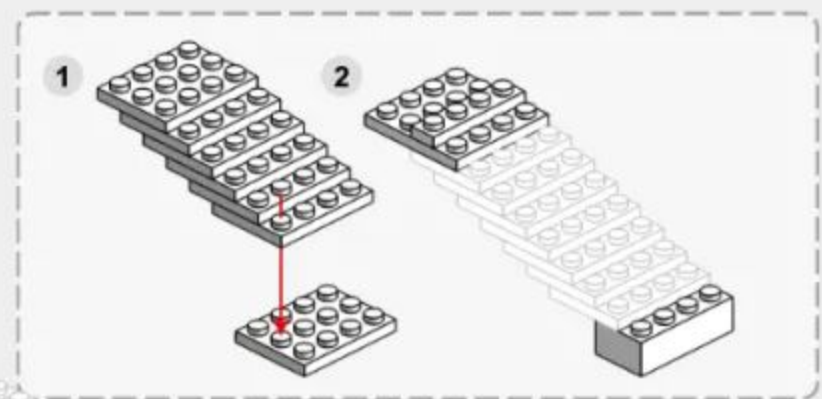
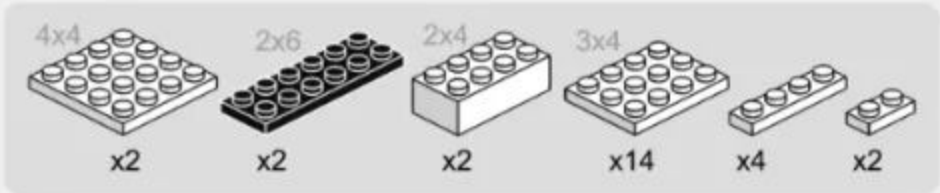

1-14

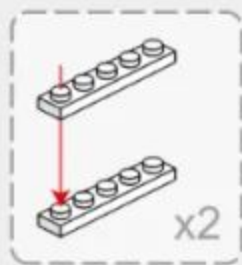
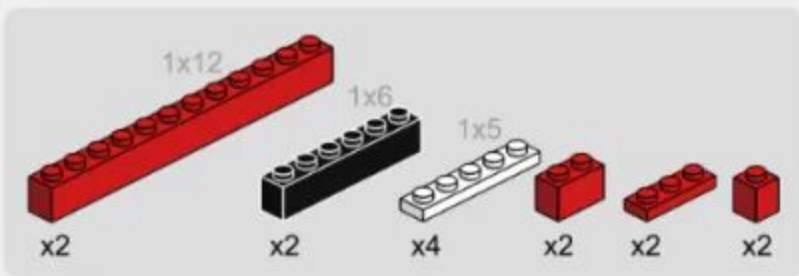



211 PCS



34

2-1

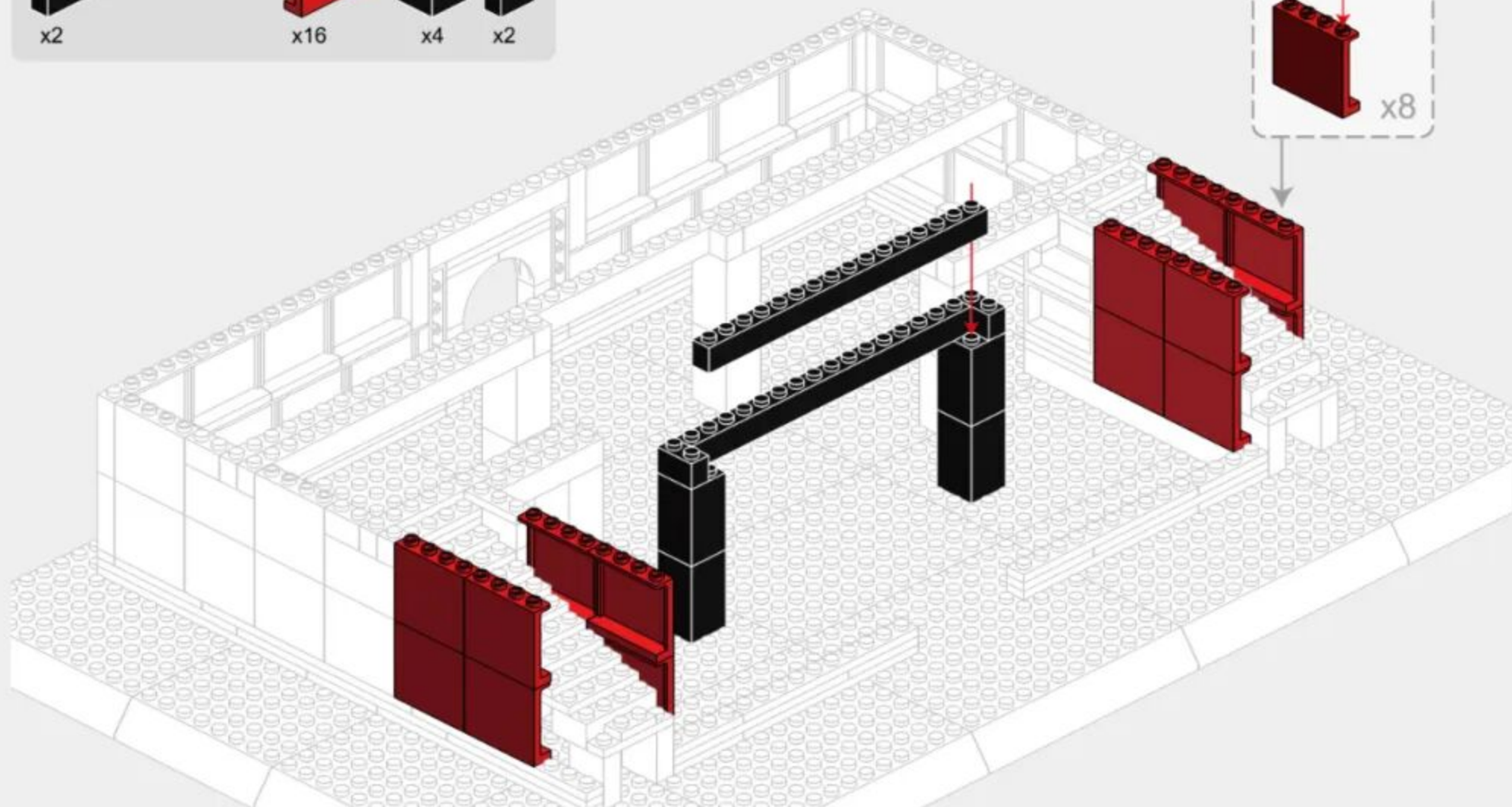
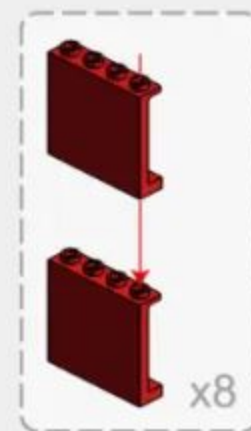
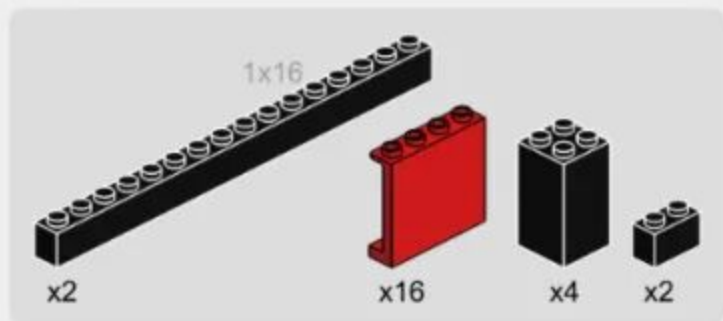

2-2

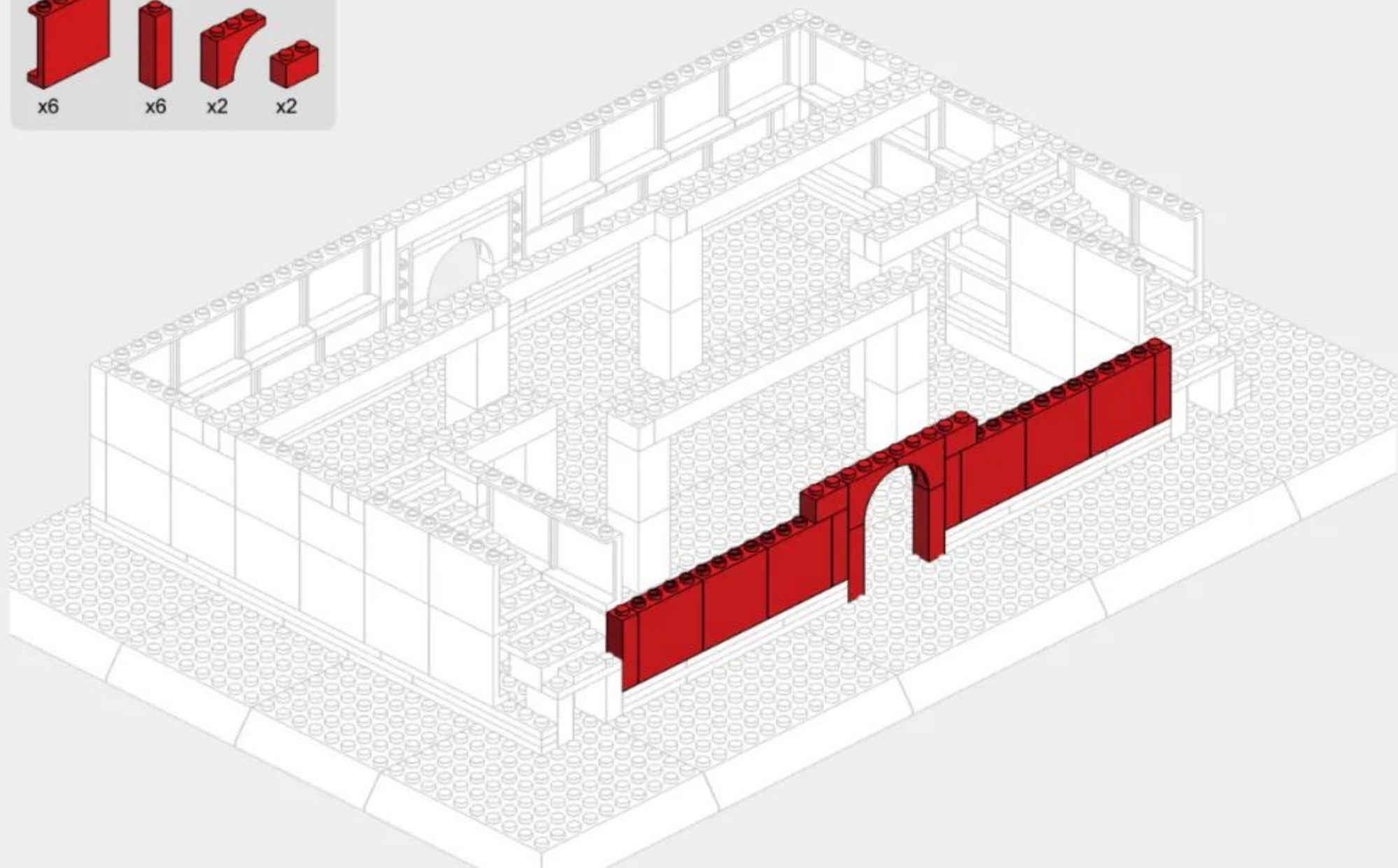
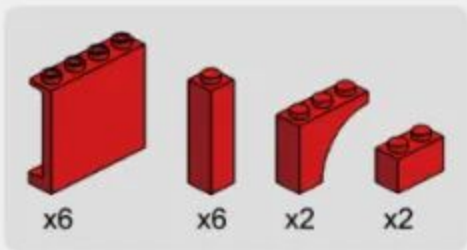

2-5

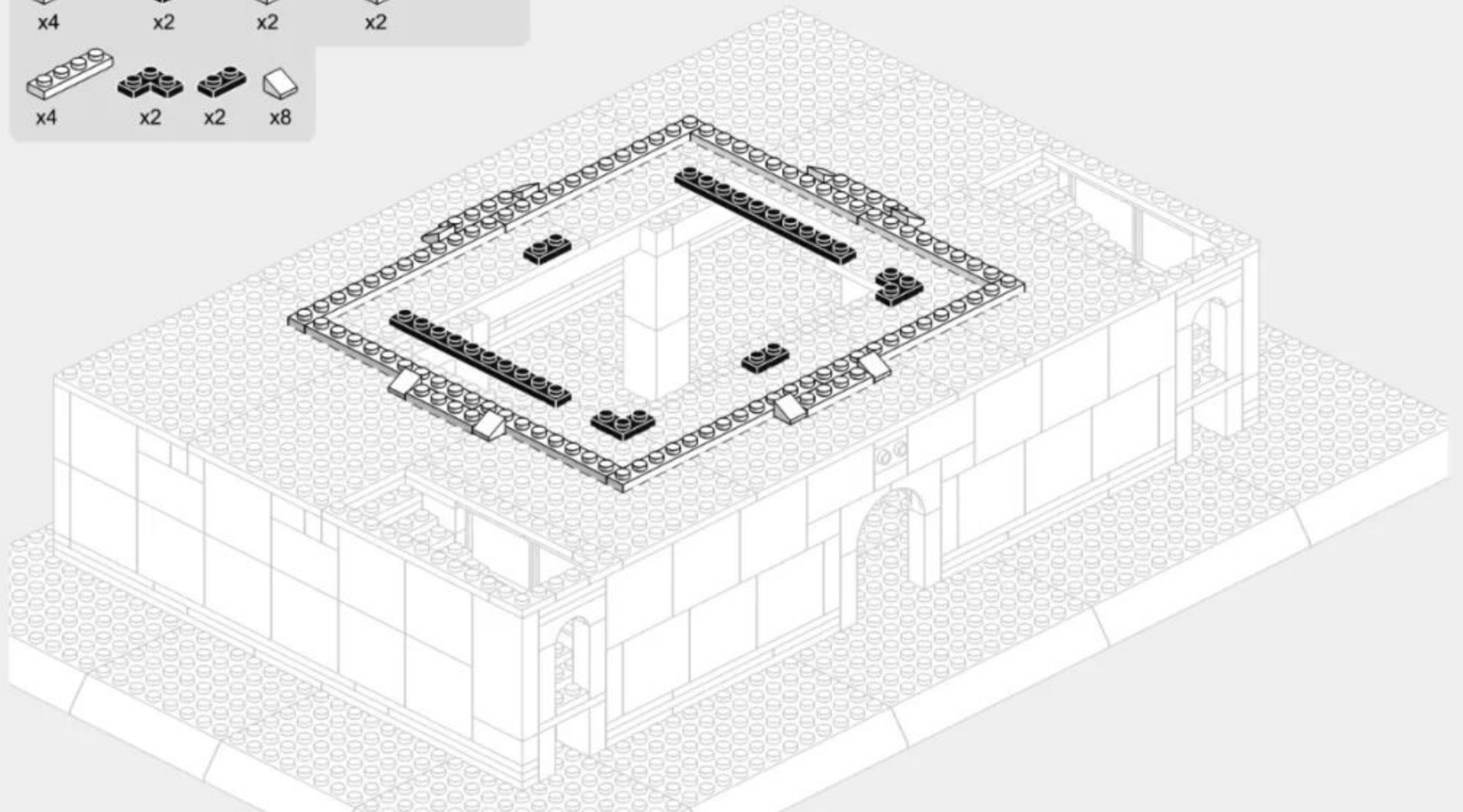
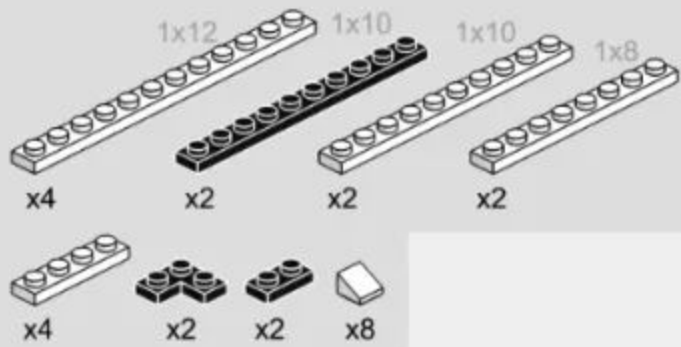

2-6

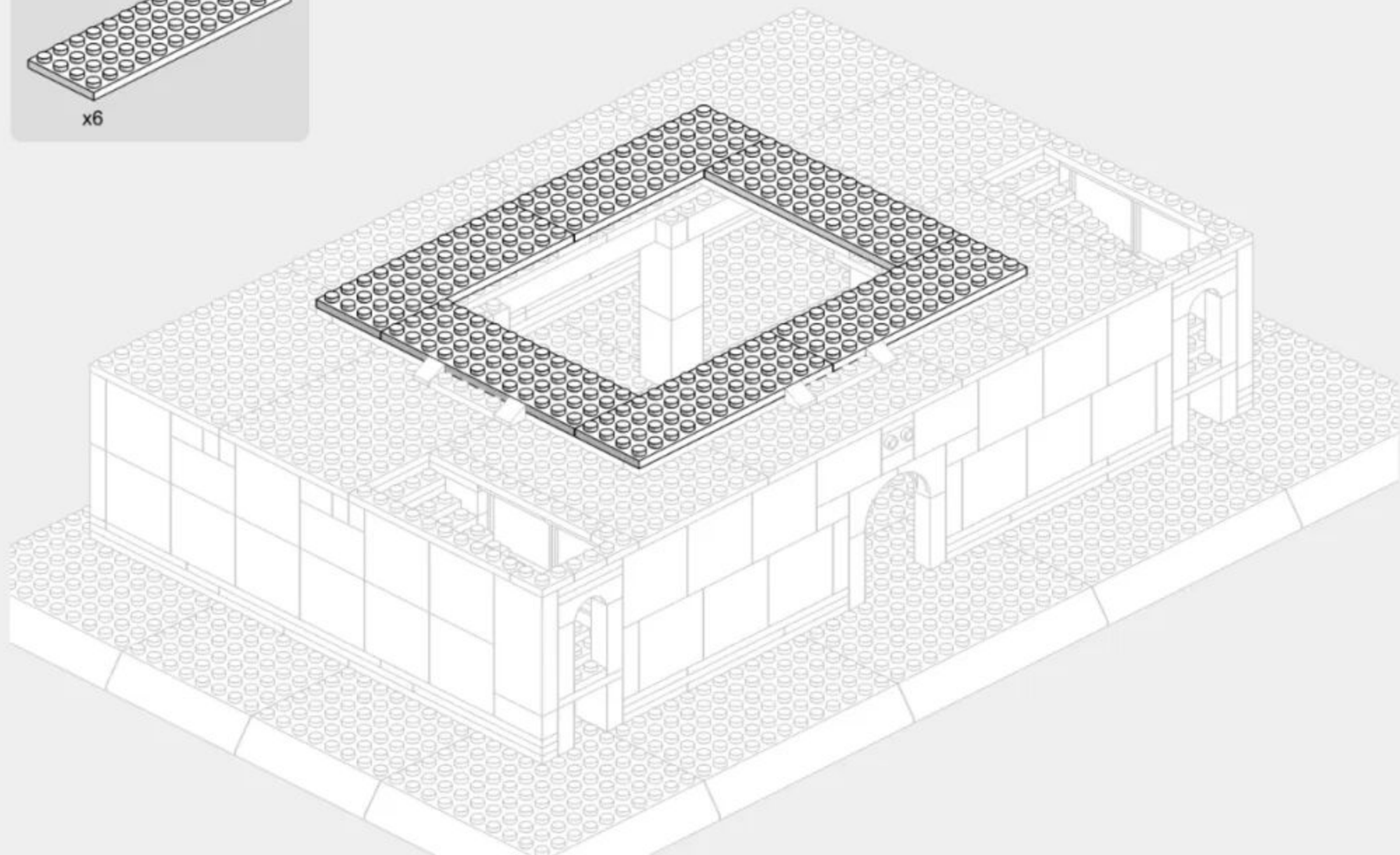
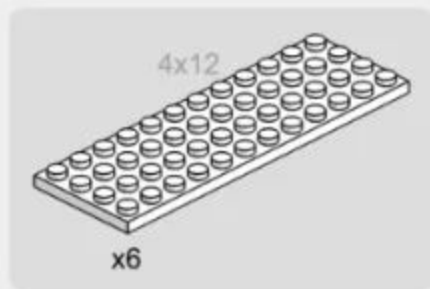

2-7

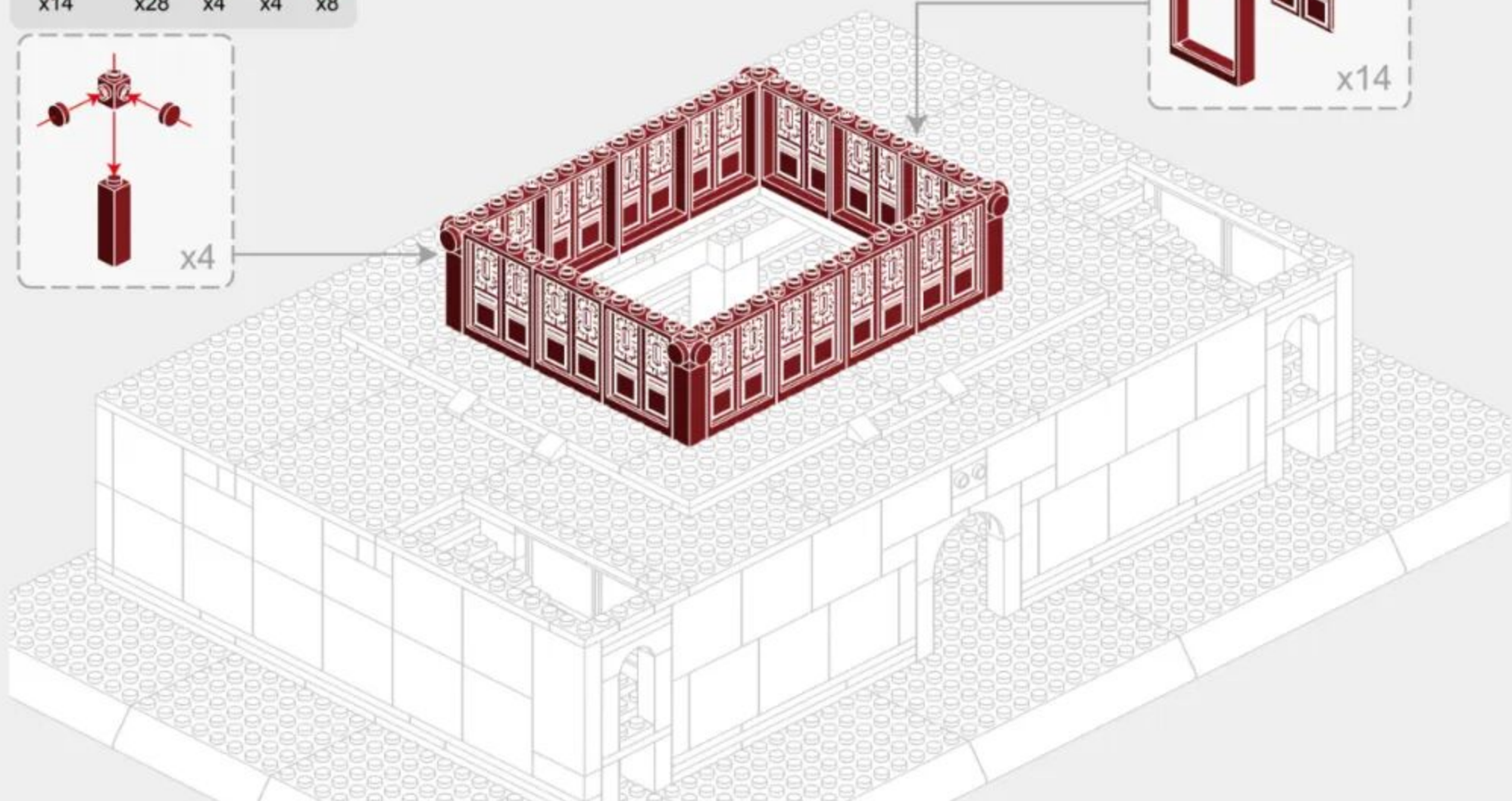

2-8

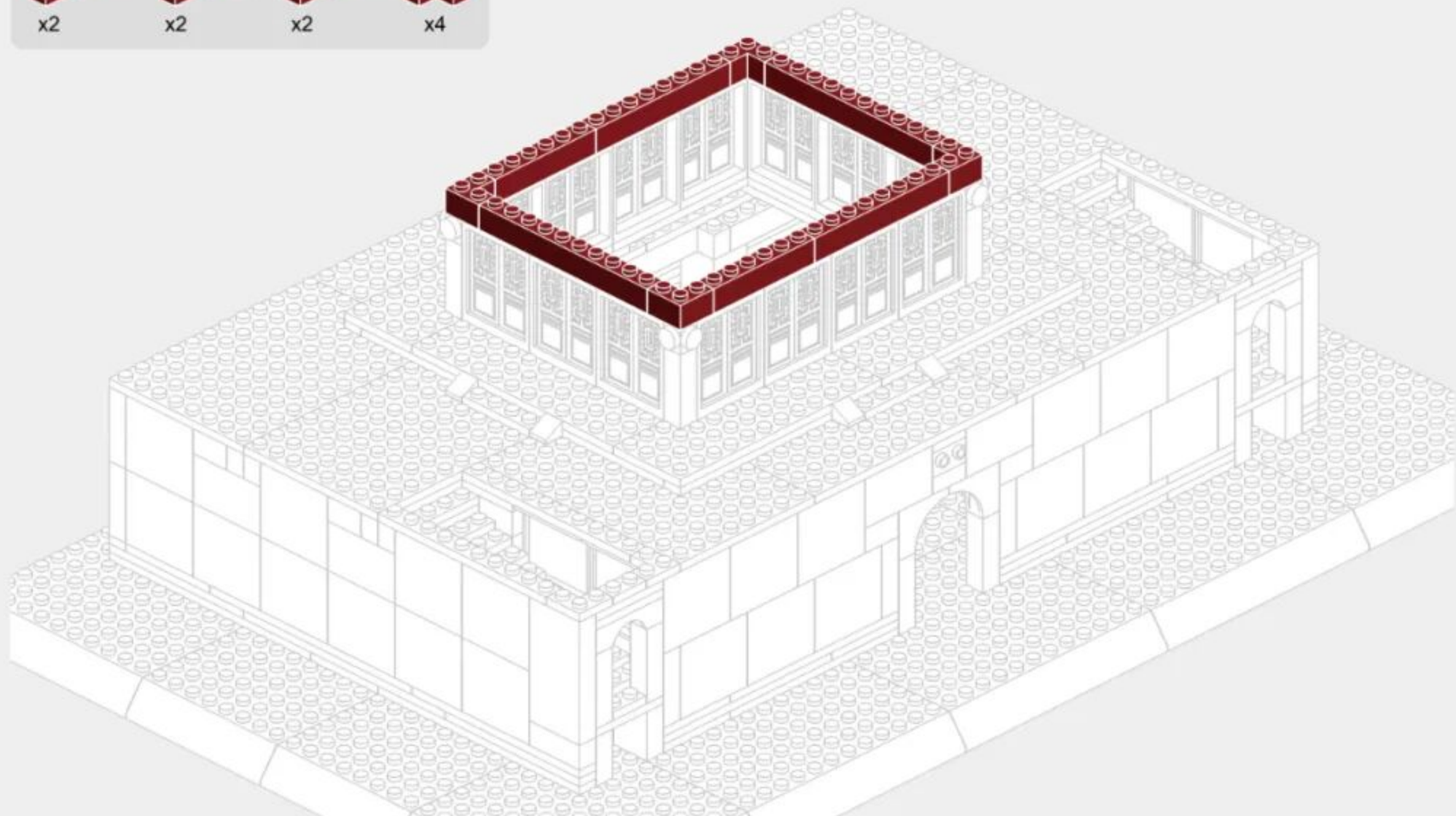
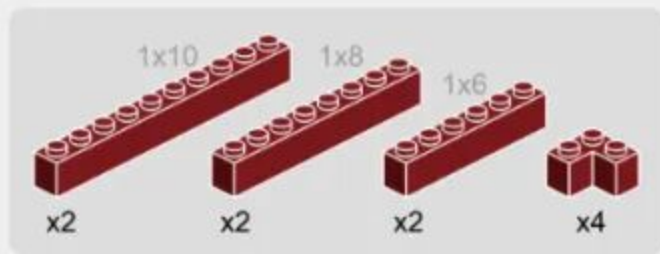

2-9

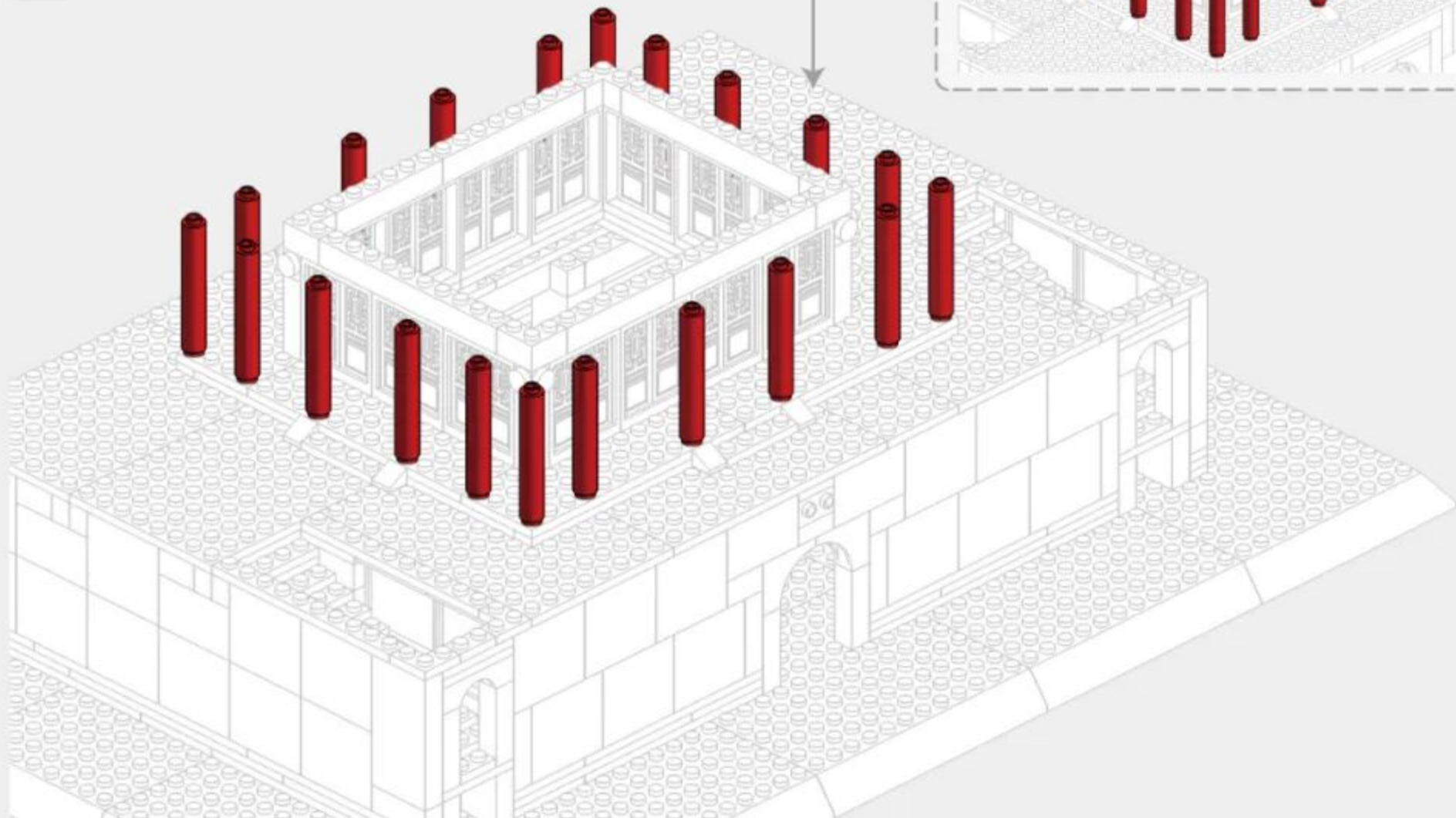

2-10

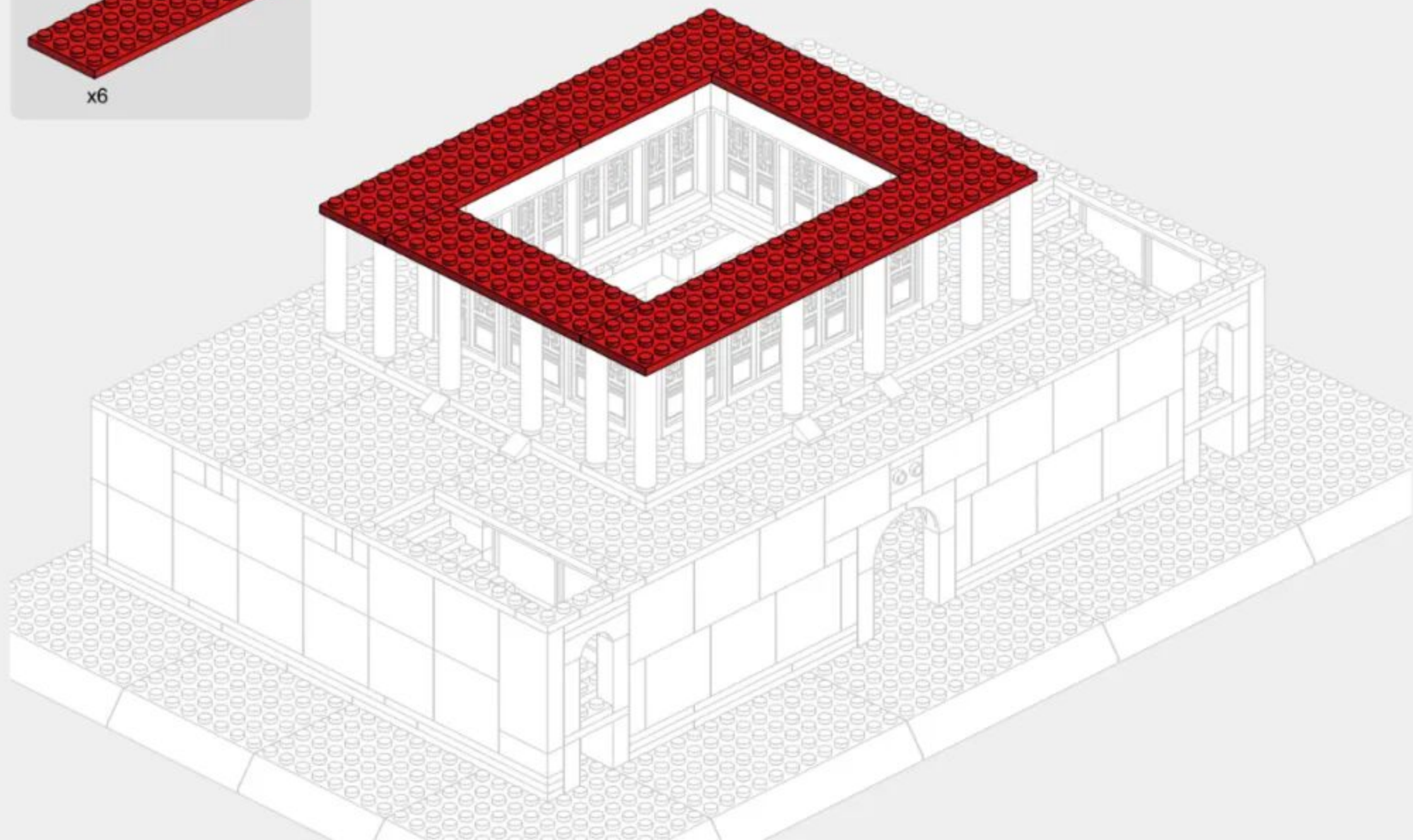



226PCS

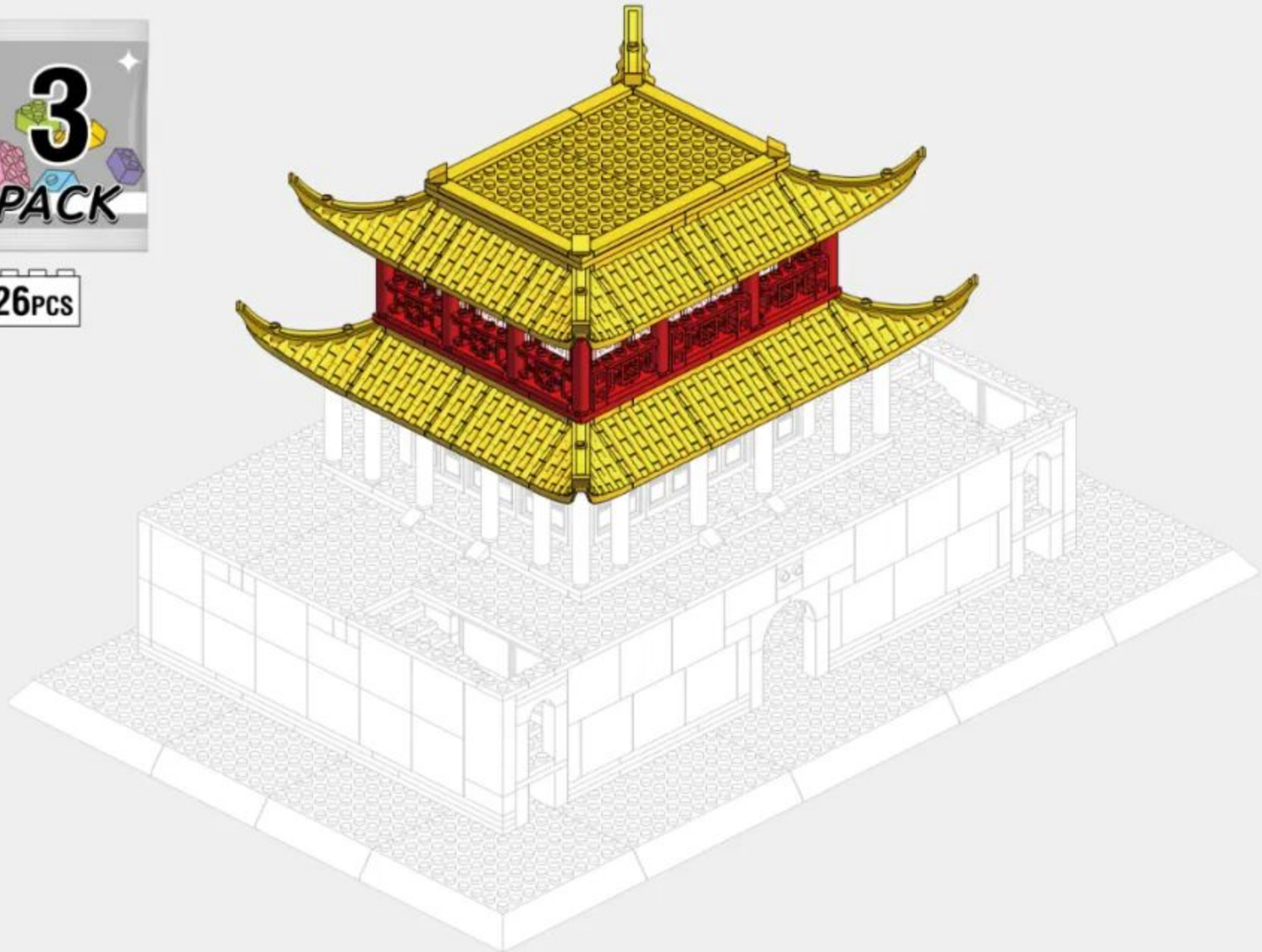

45

3-1

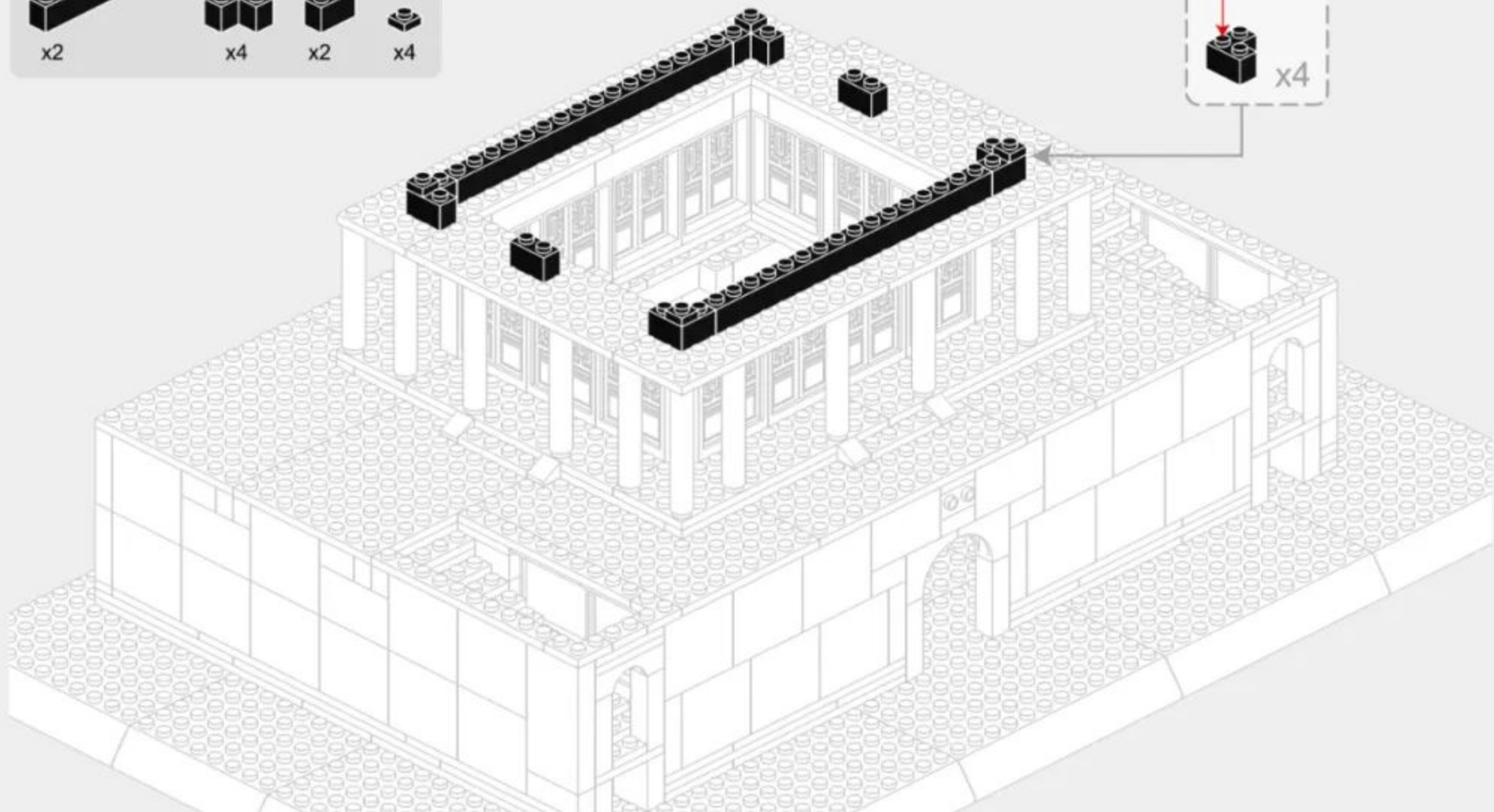
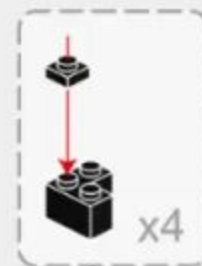
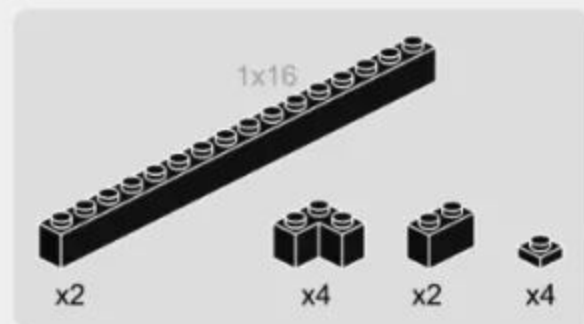

3-2

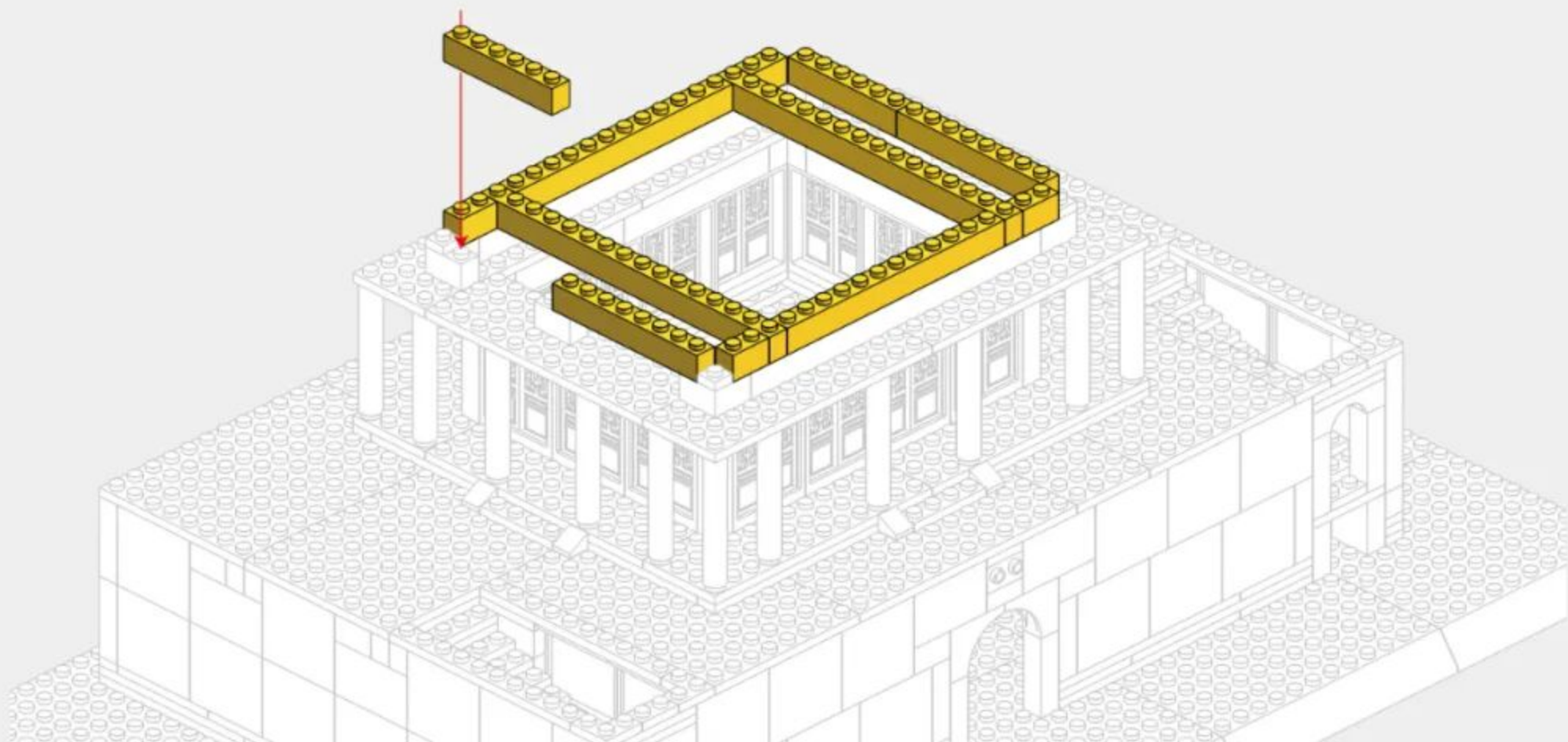
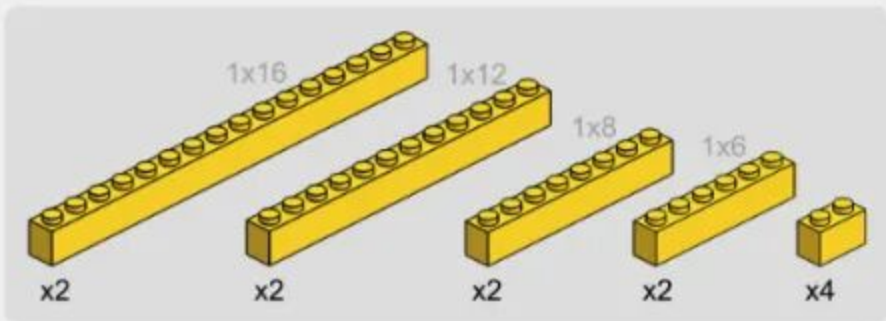

3-3

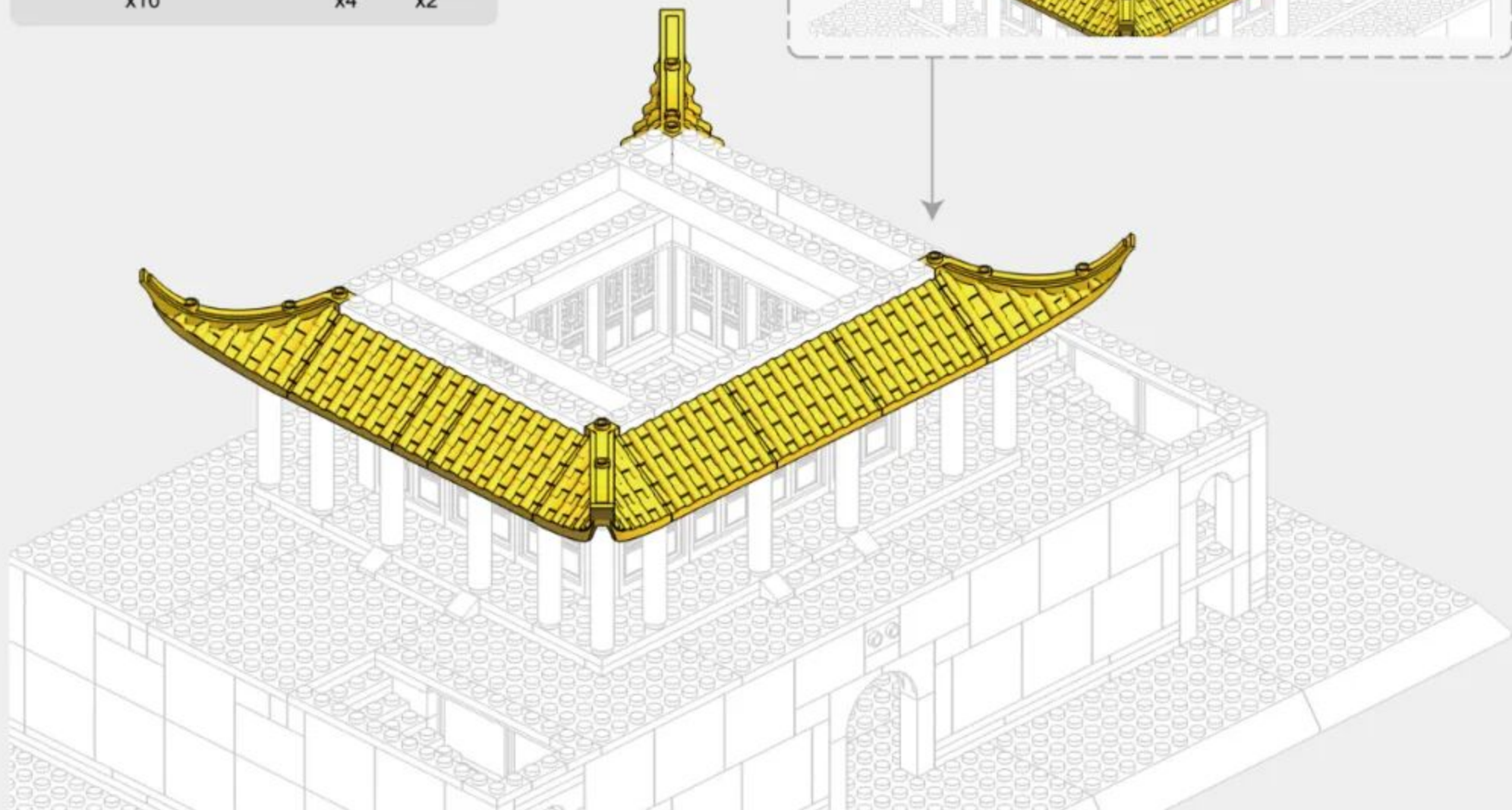
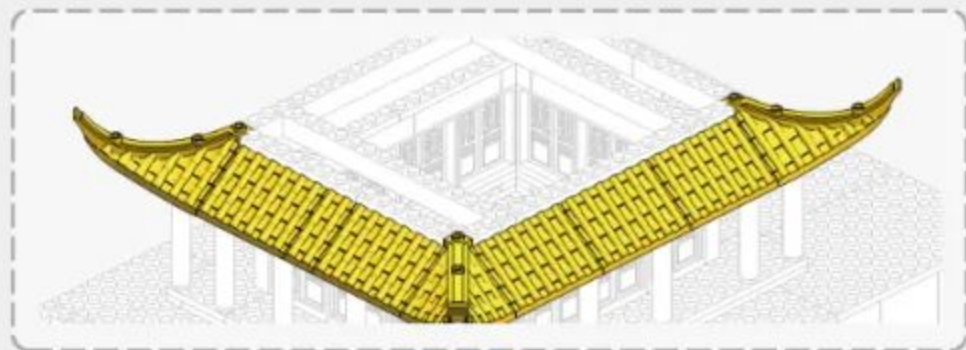
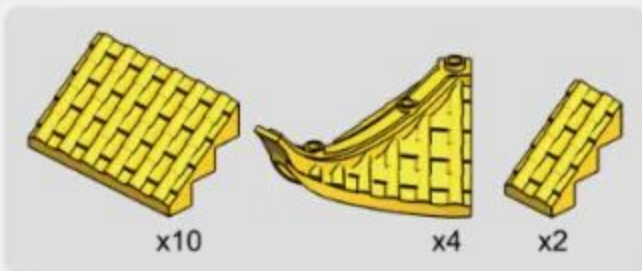

3-4

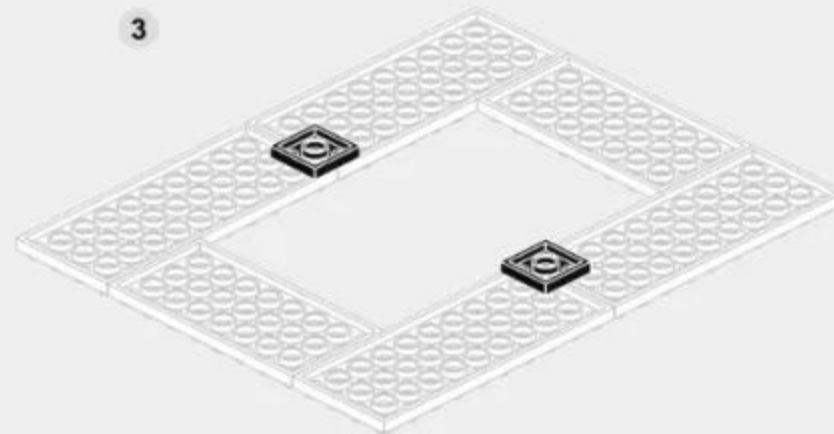
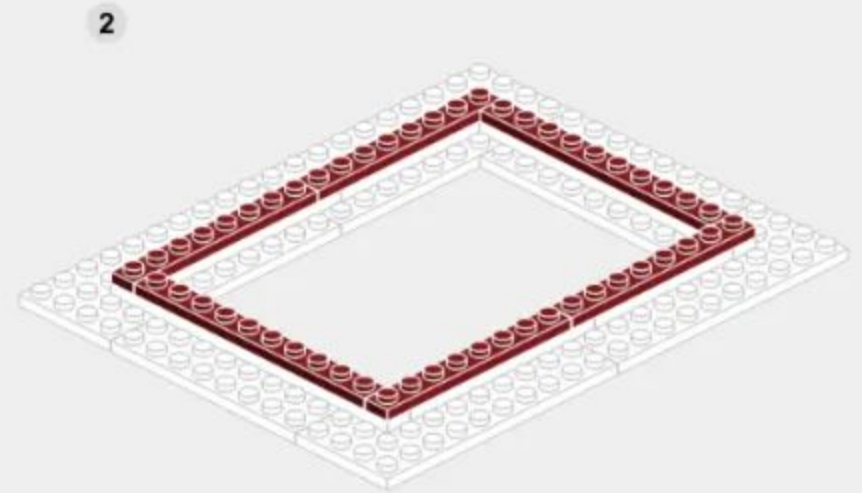
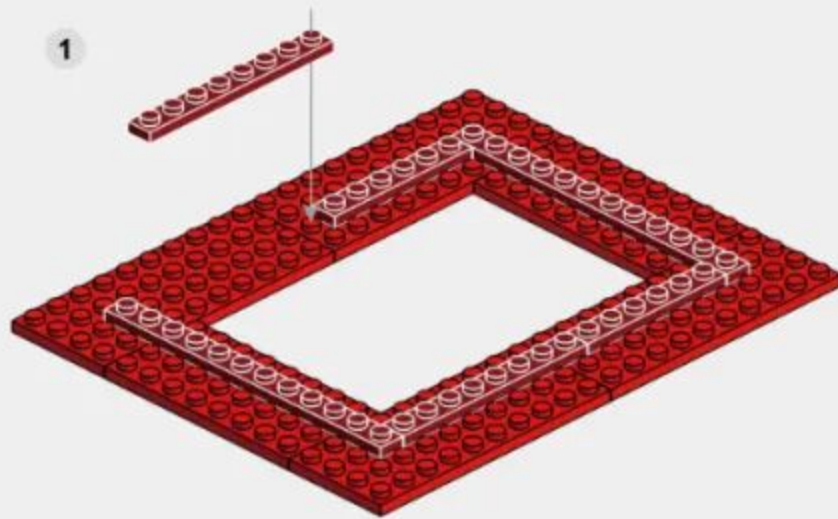
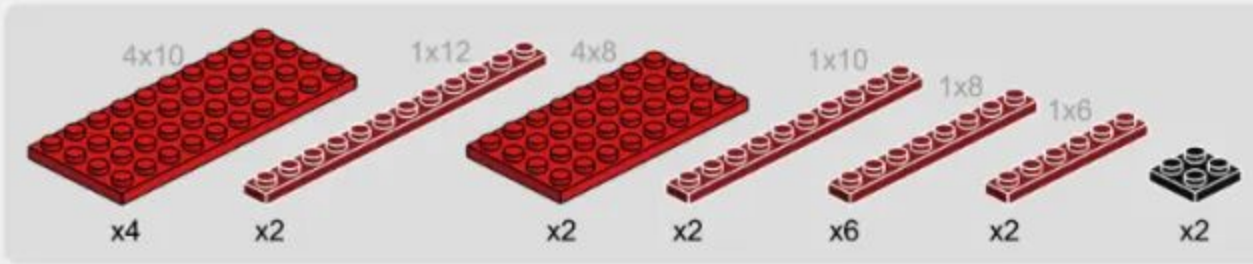

3-5

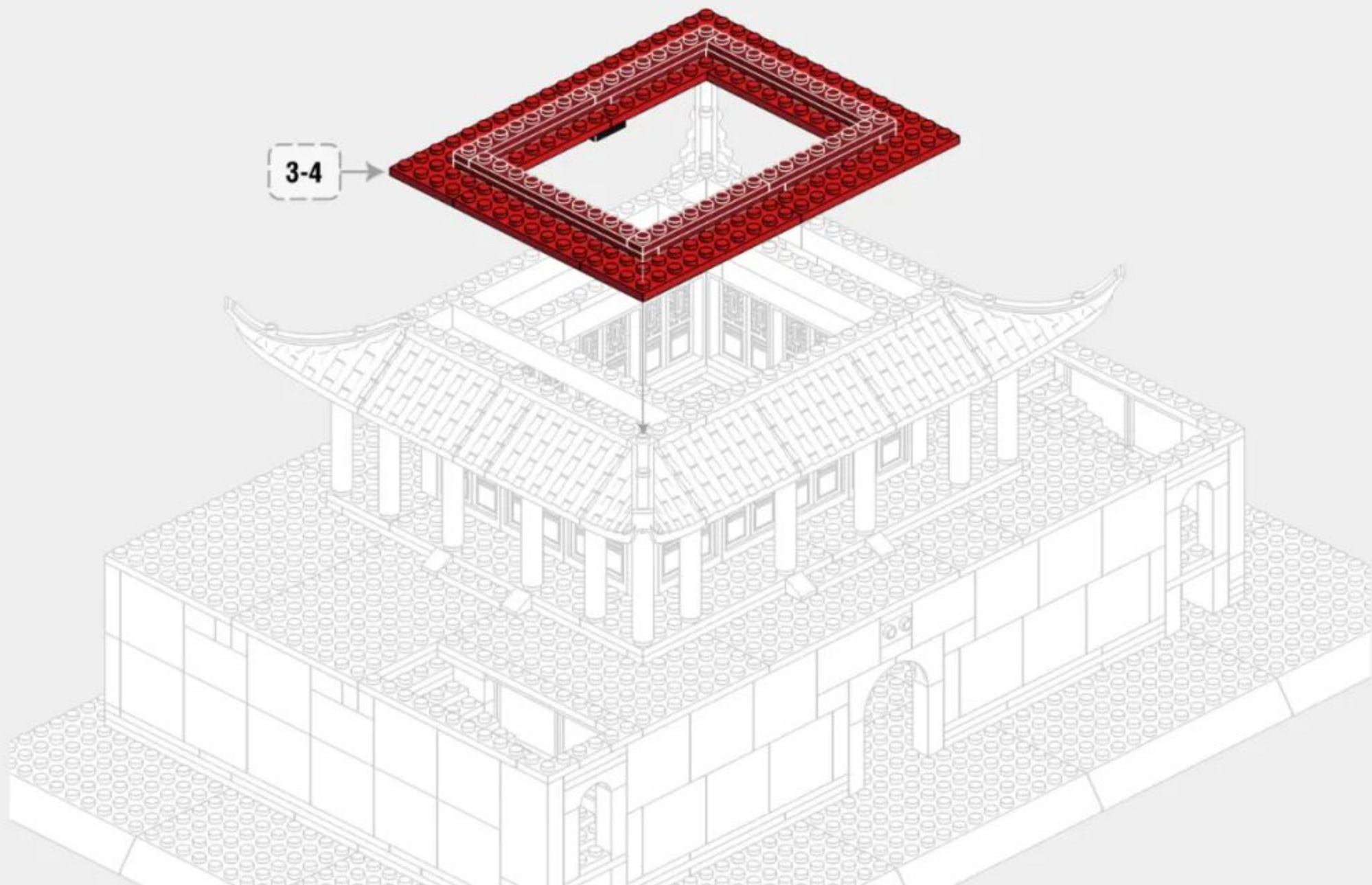

50

3-6

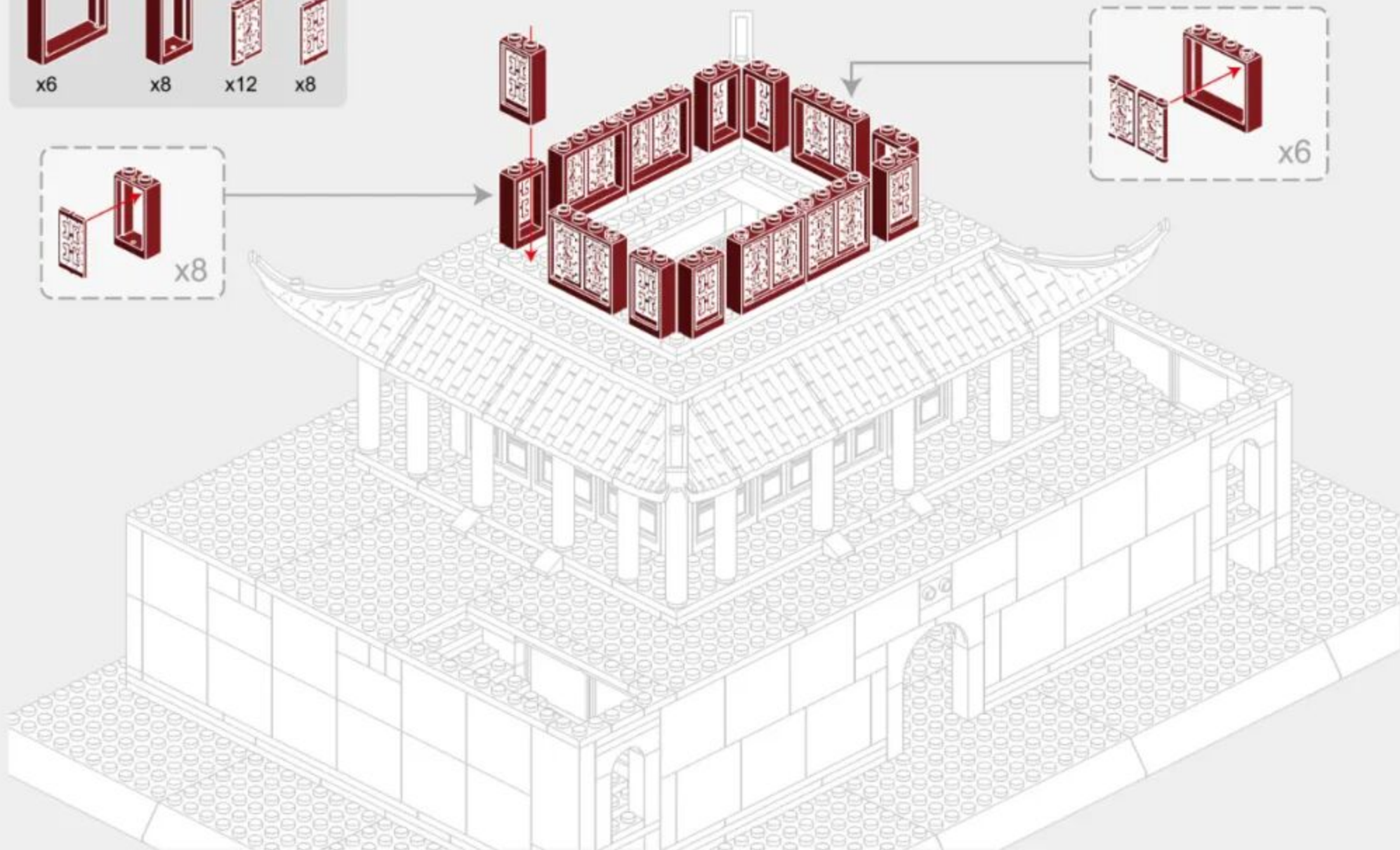
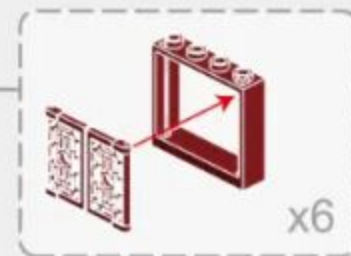

3-7

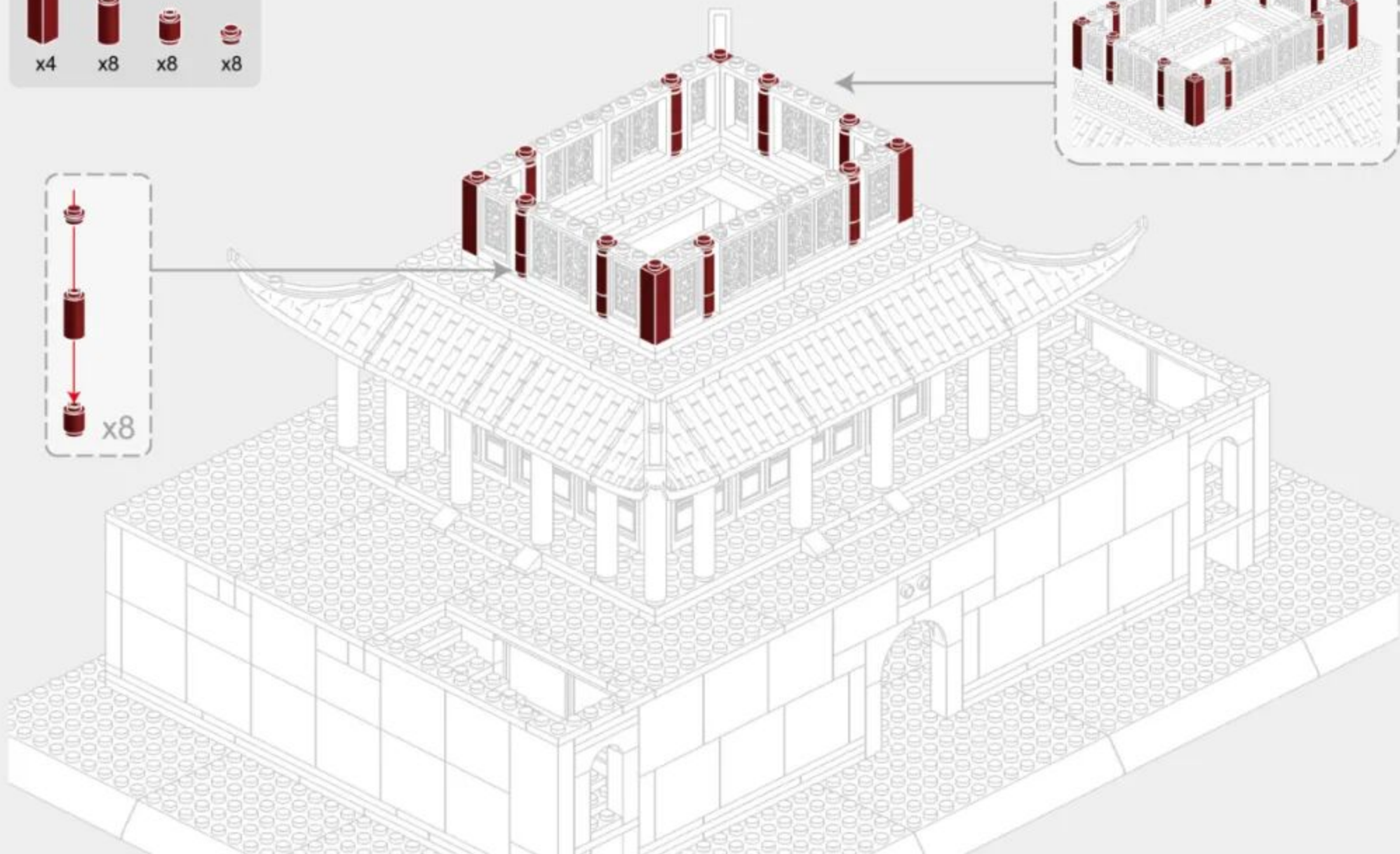

3-8

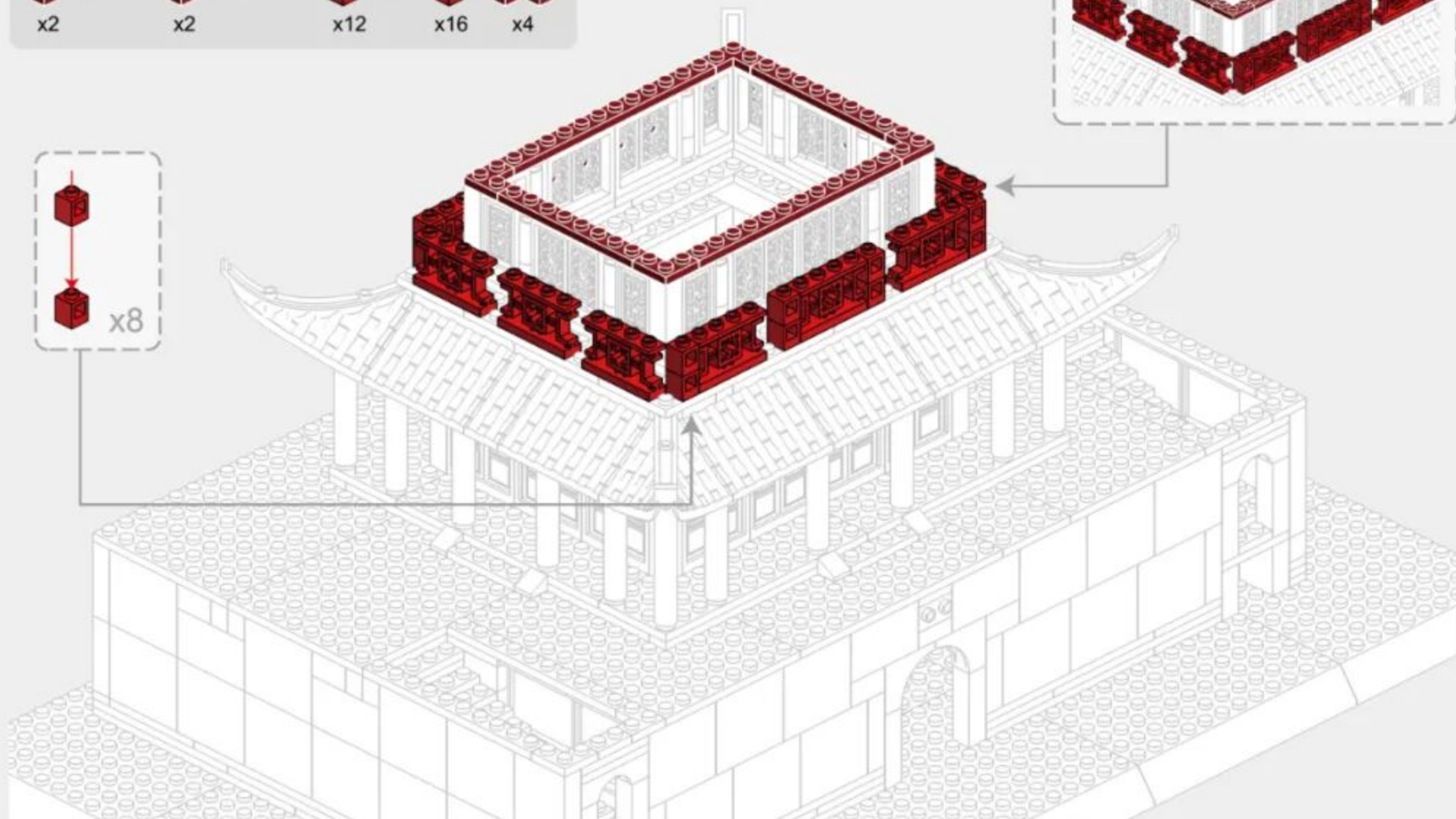
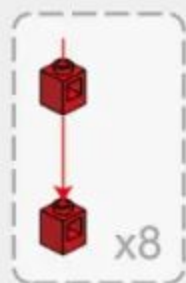
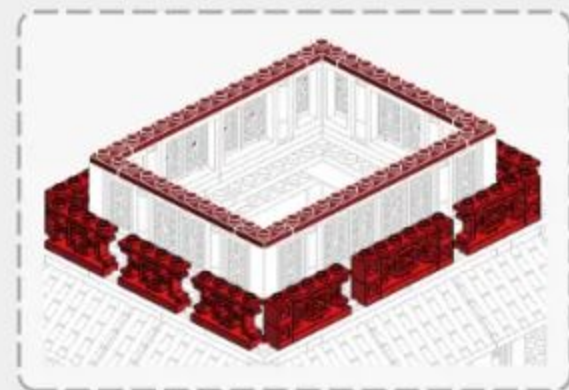
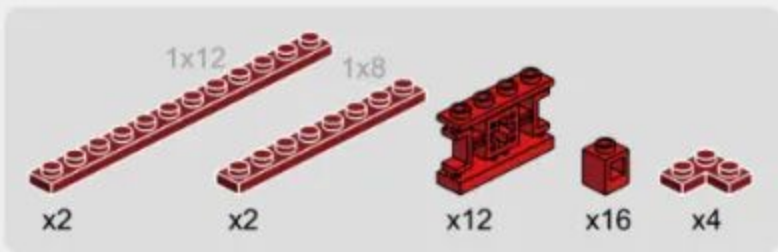

3-9



x12

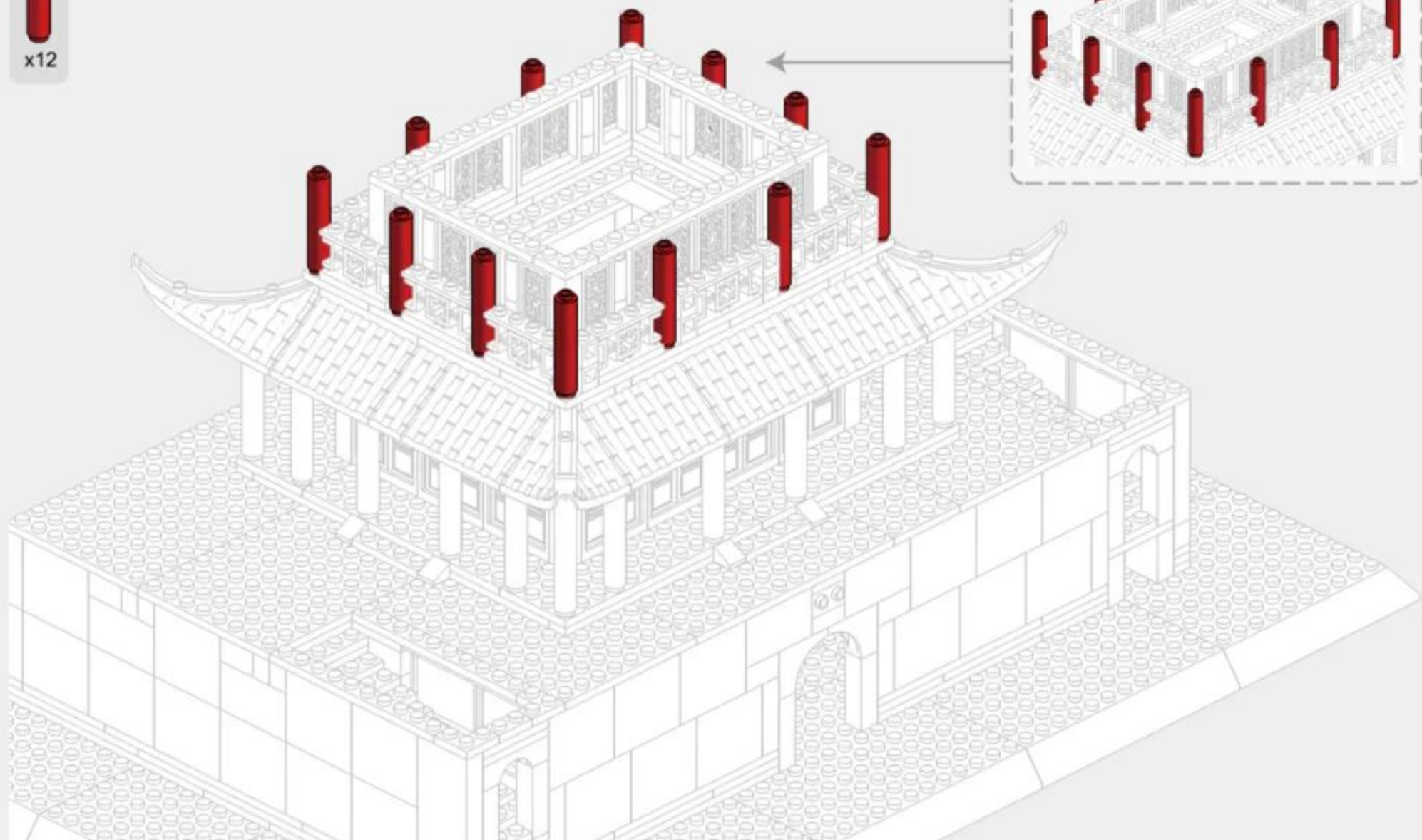

3-10

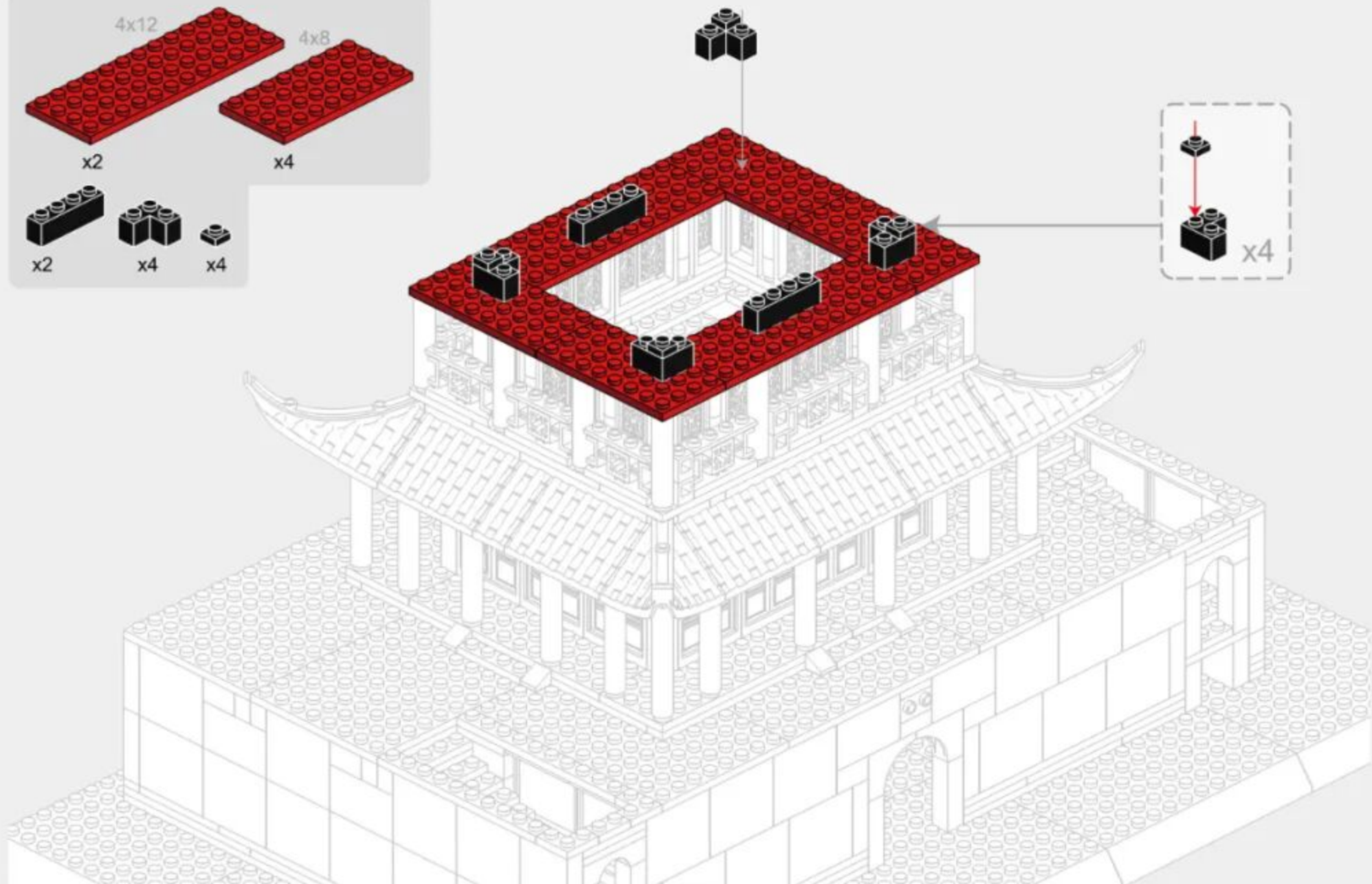
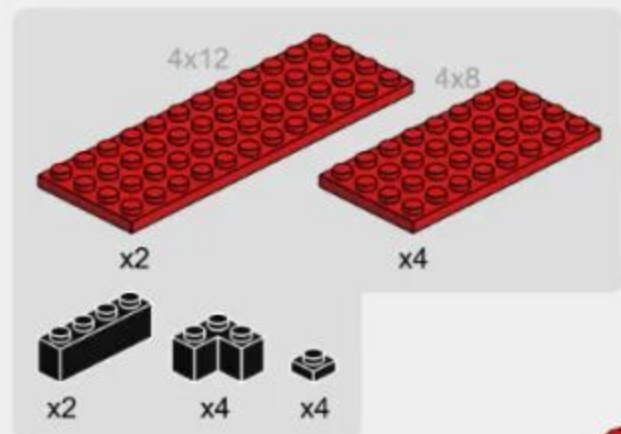

3-11

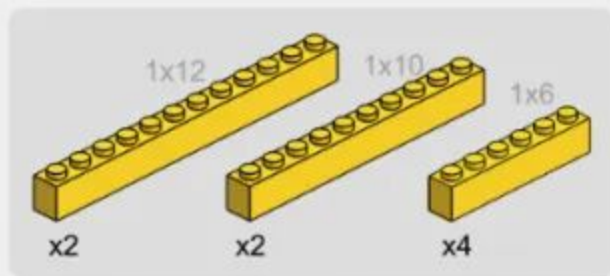

3-12

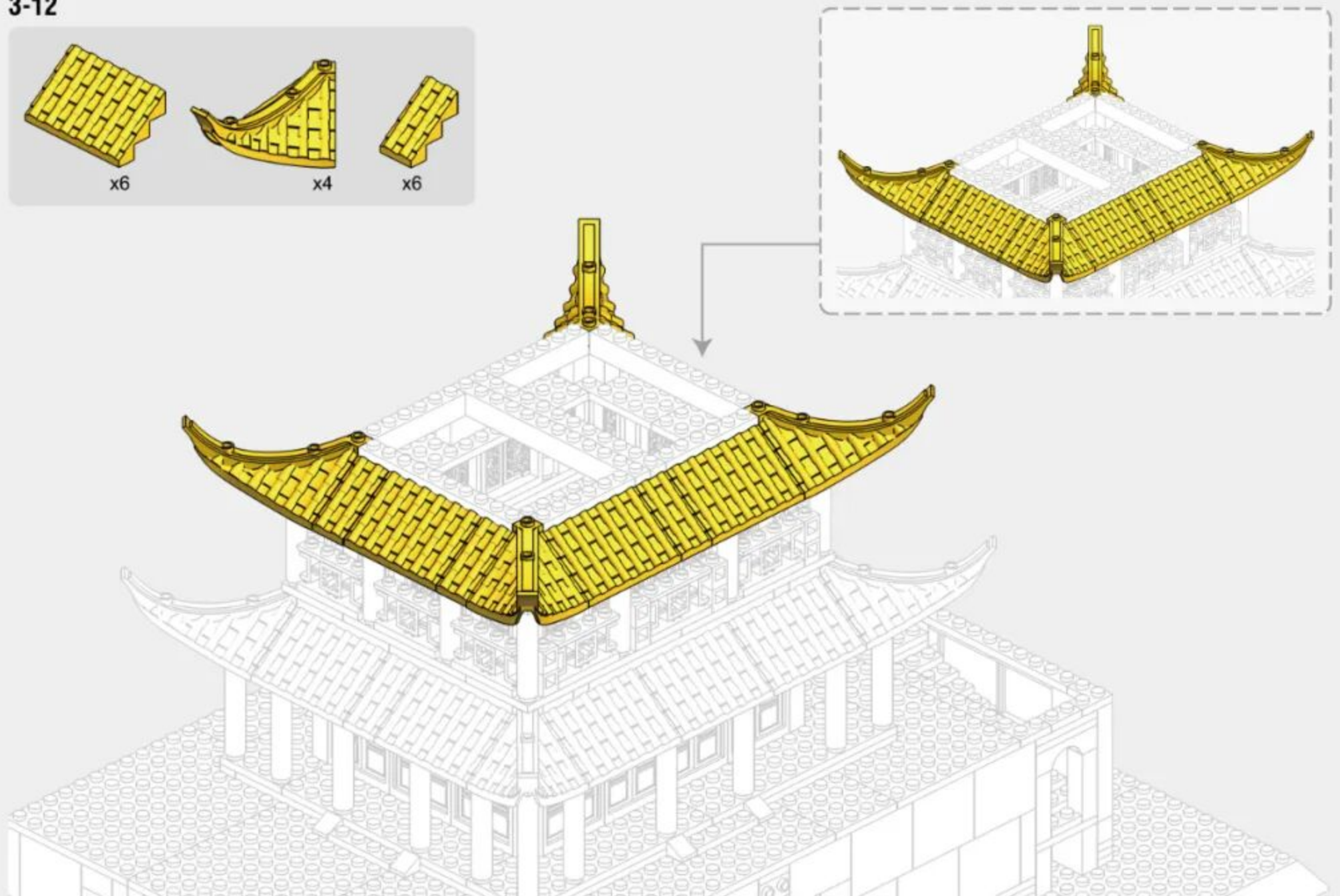
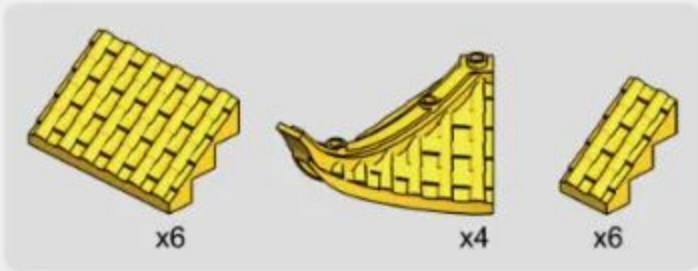

3-13

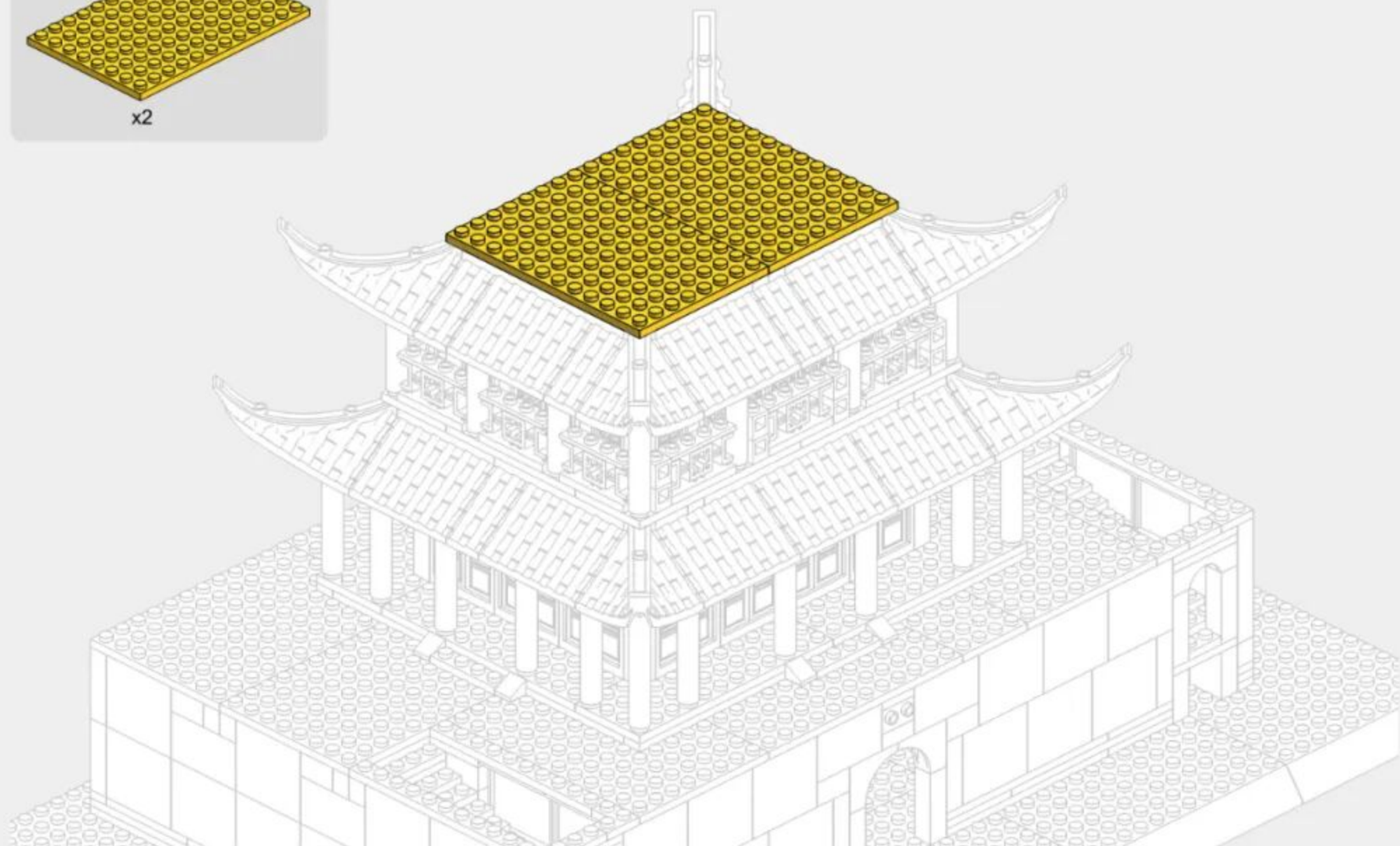
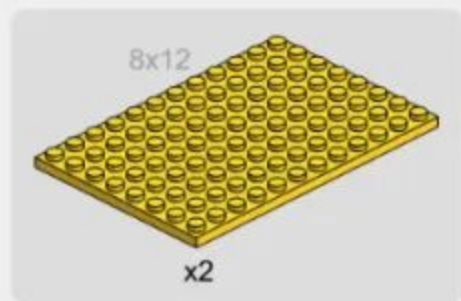

3-14

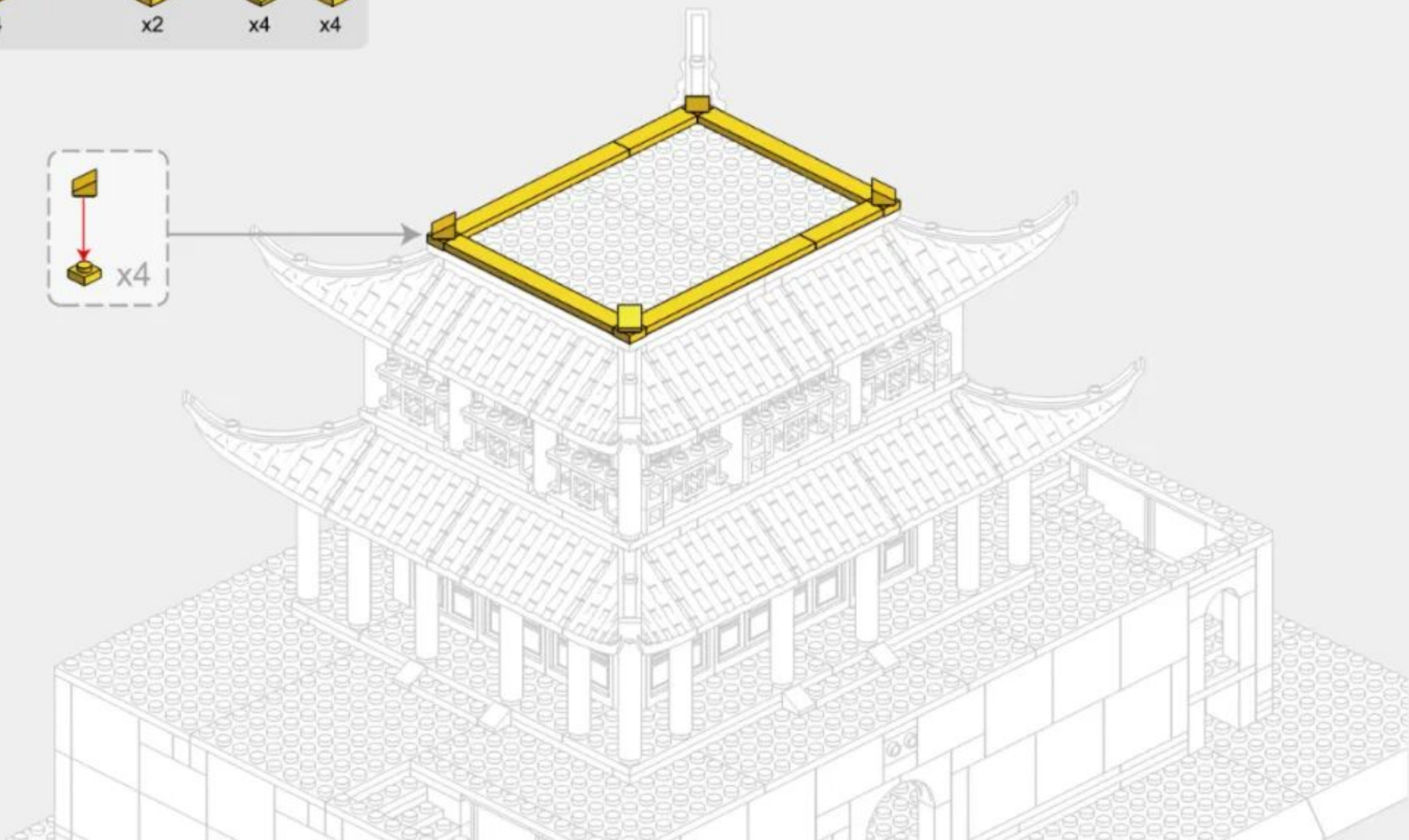
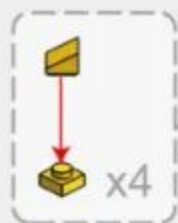
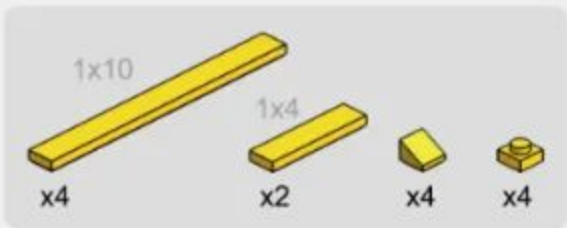



267PCS

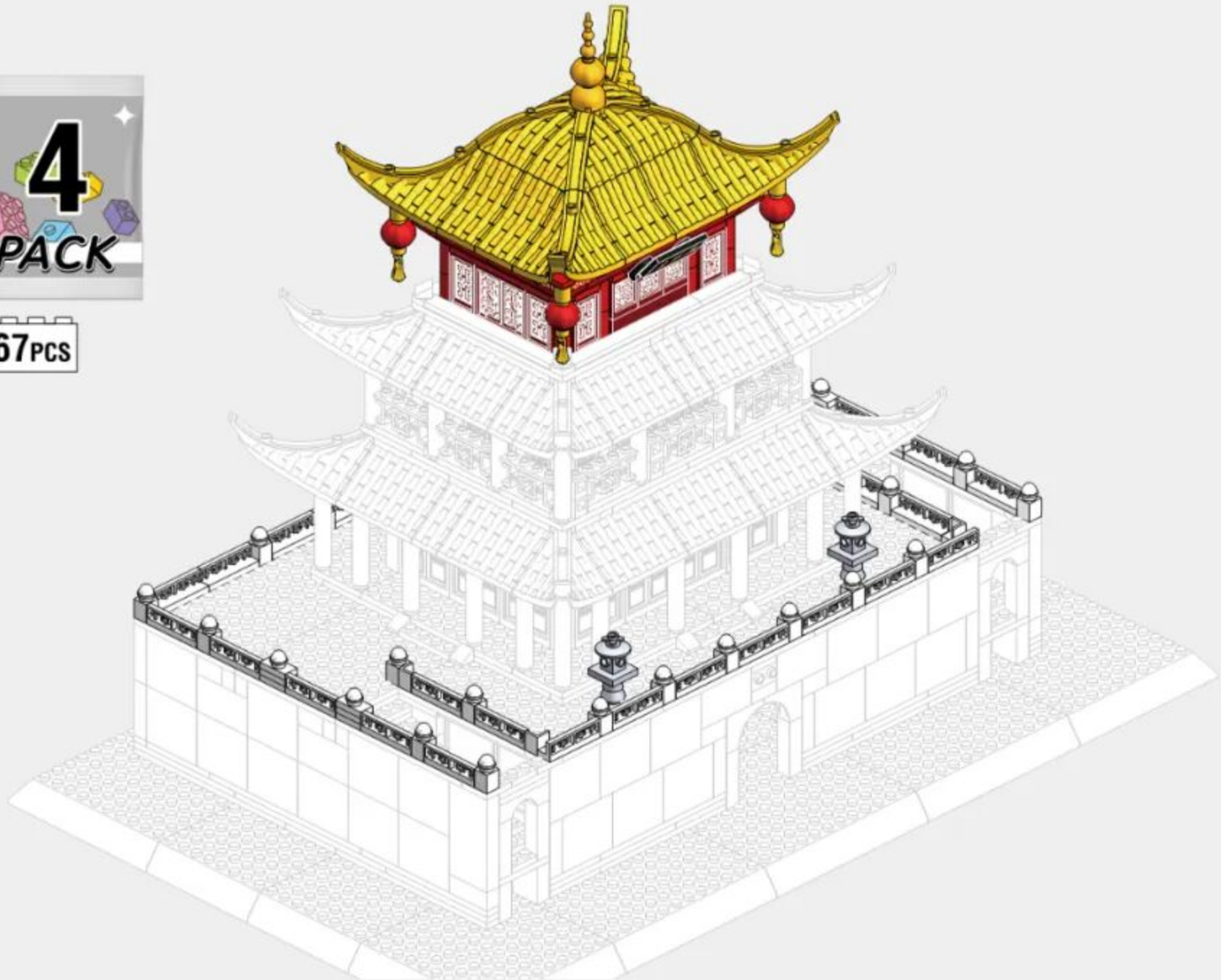

60

4-1

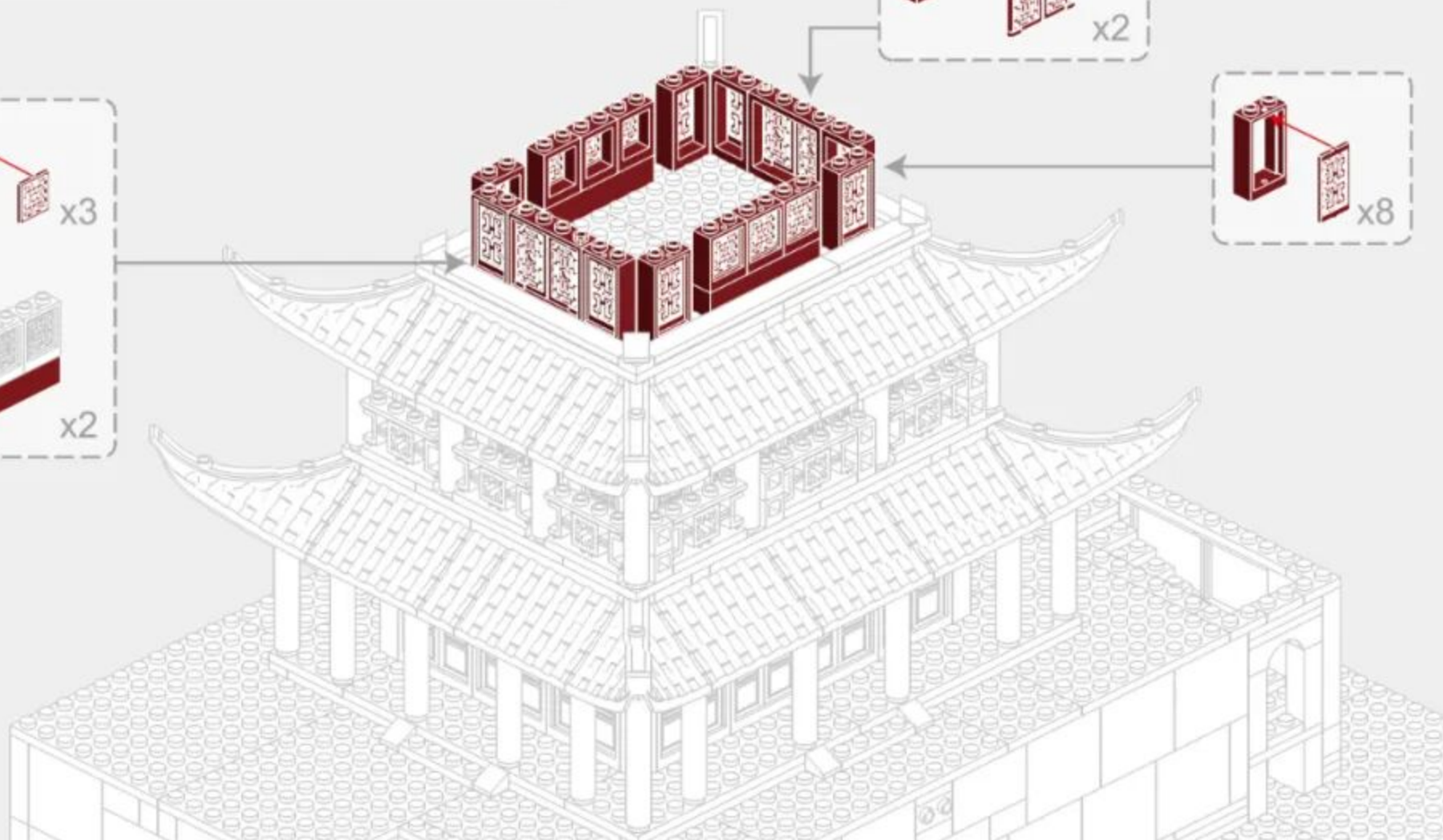
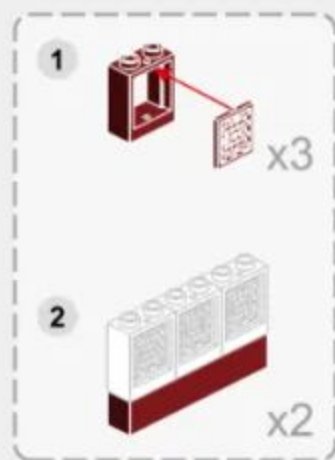
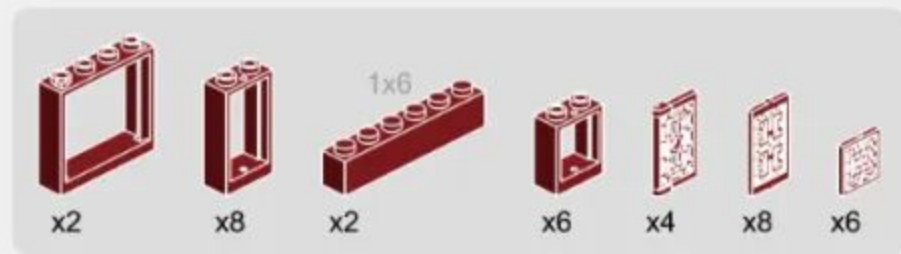

4-2

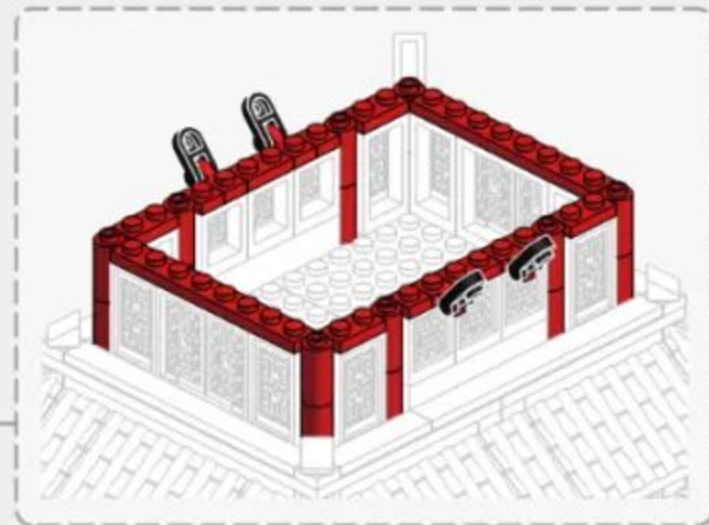
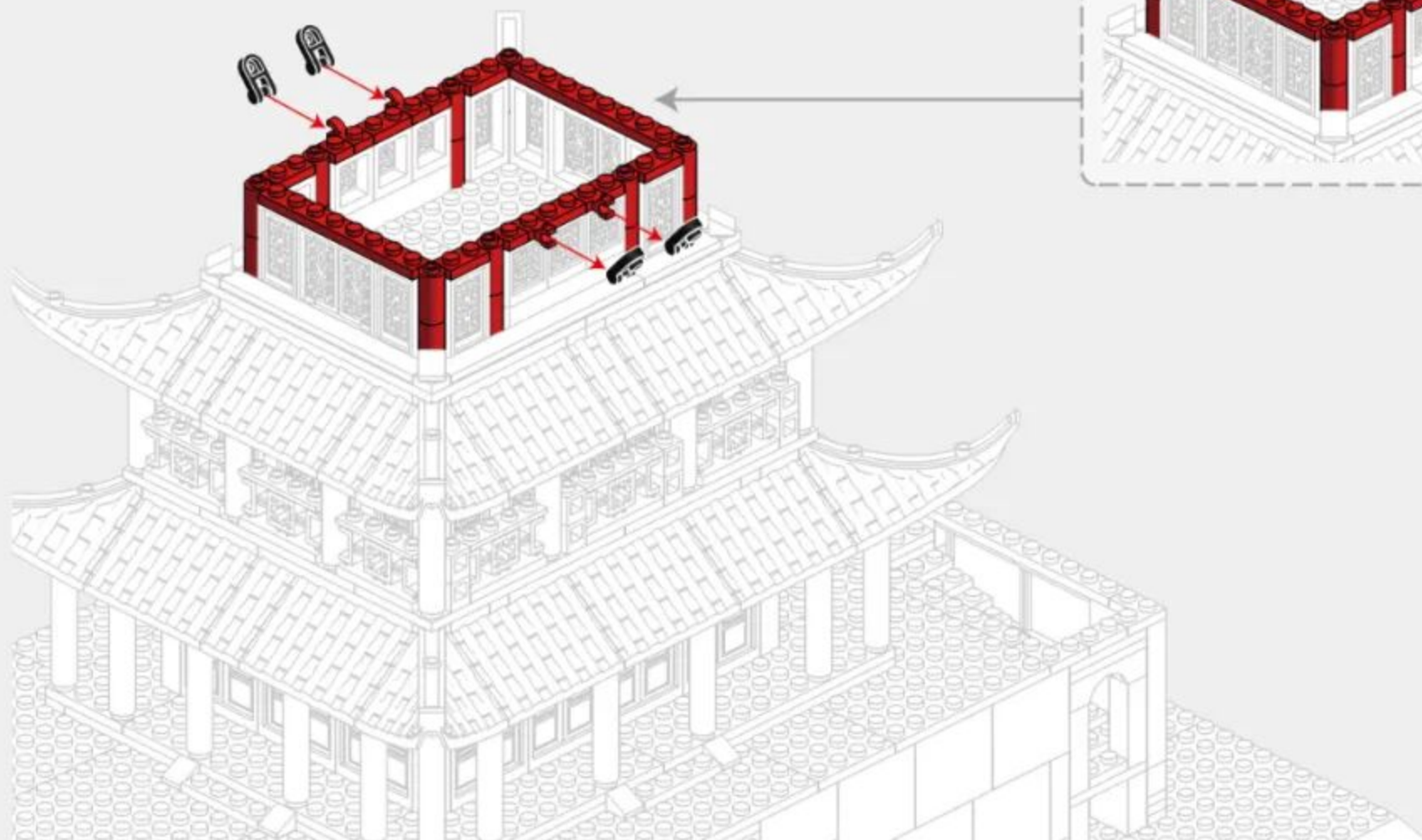

4-3



x10



x4

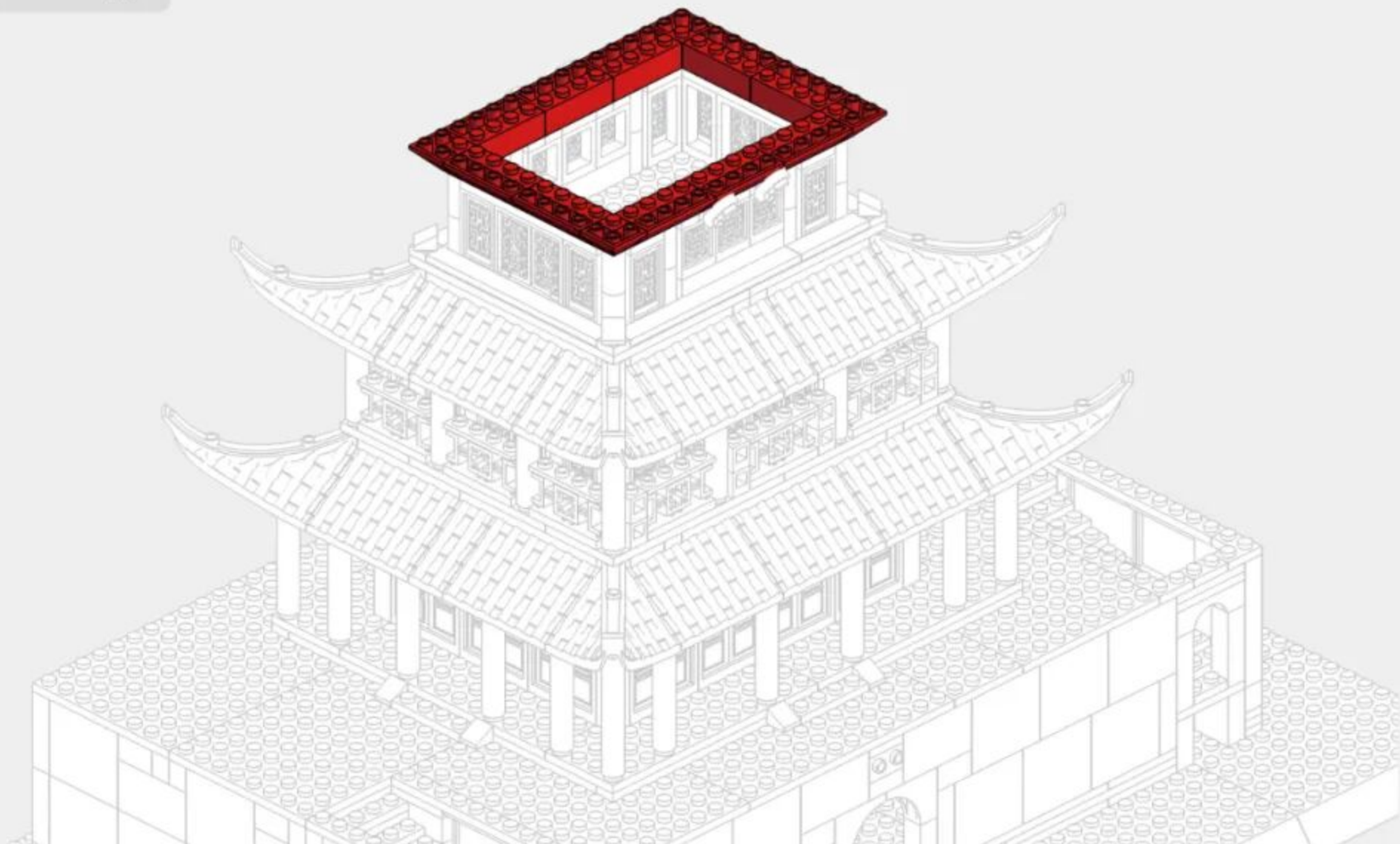

4-4

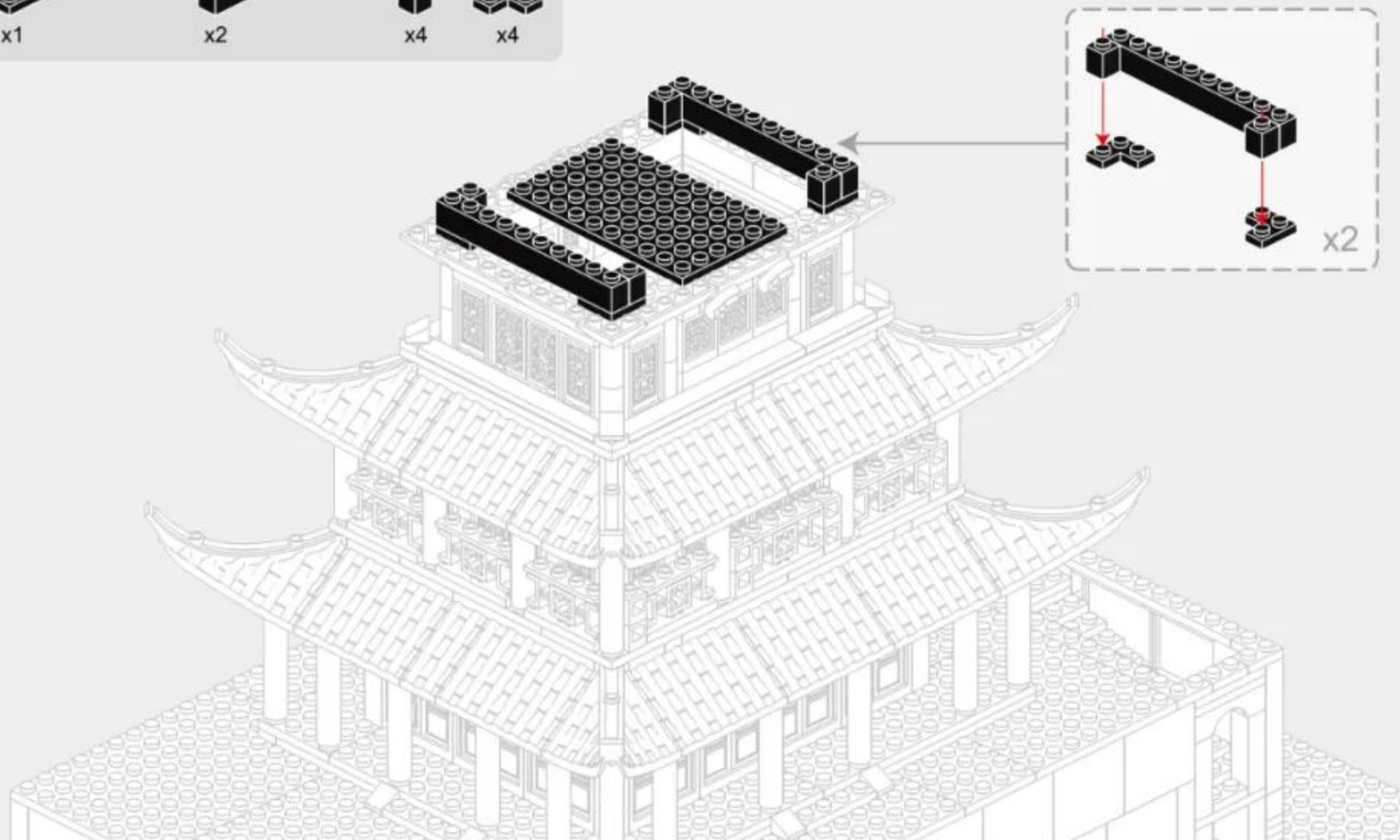
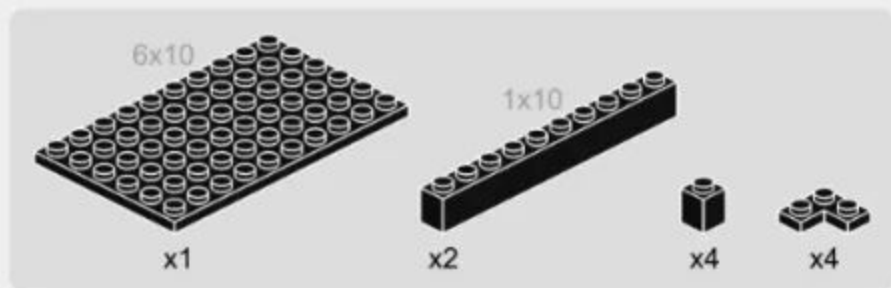

4-5

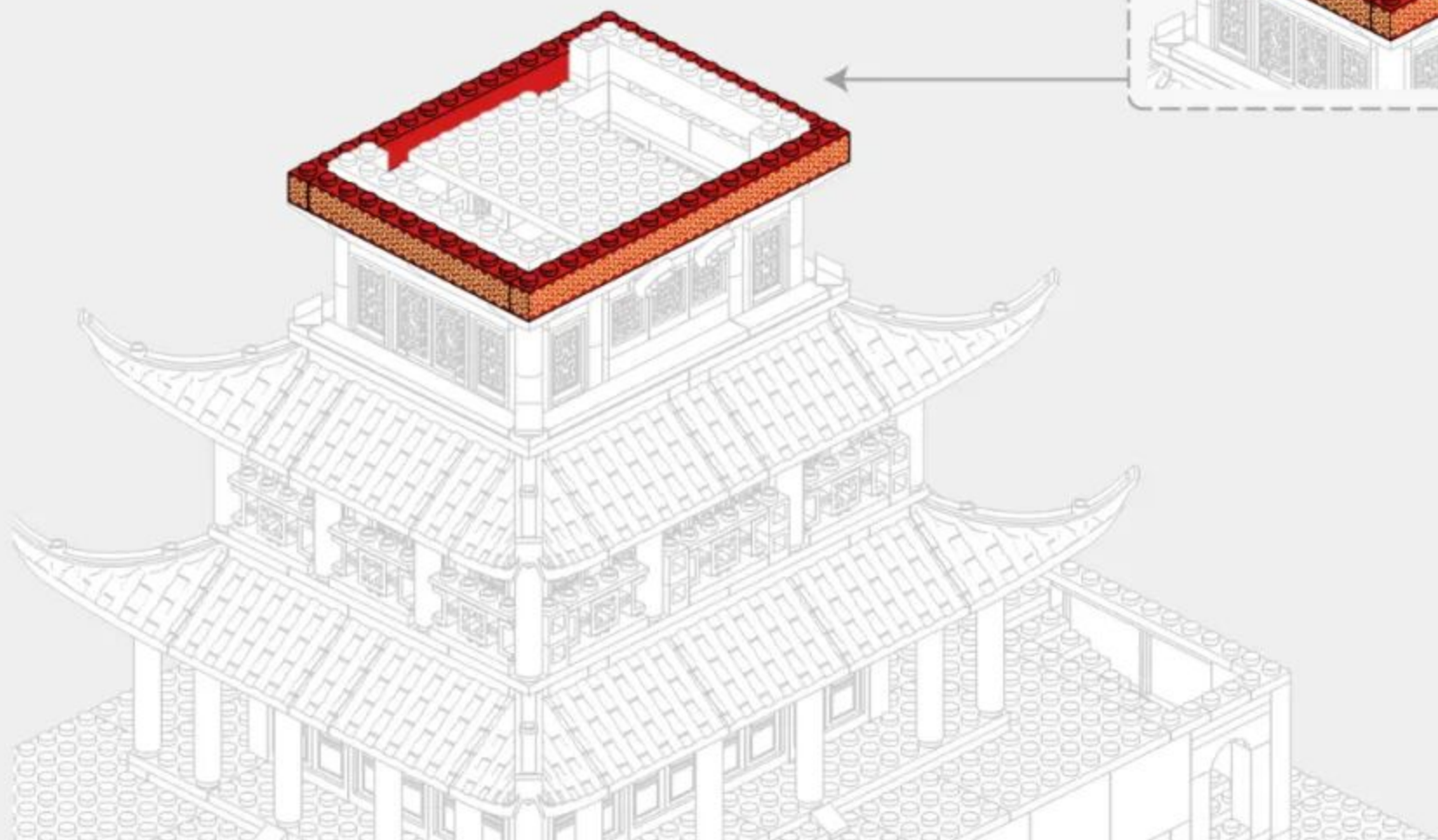
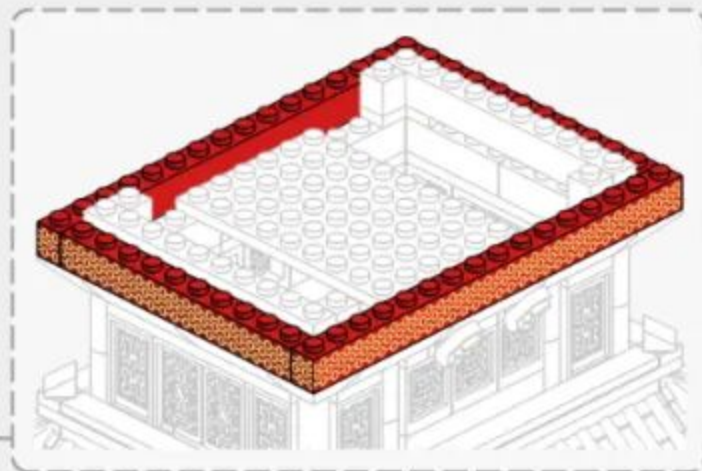
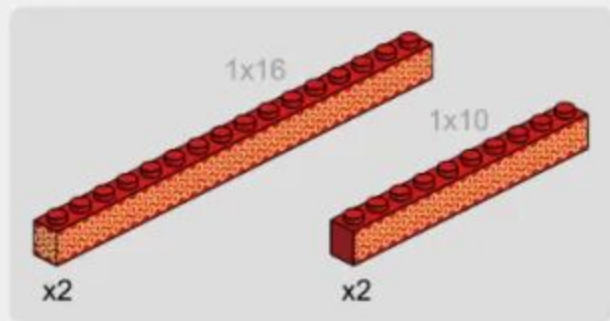

4-6

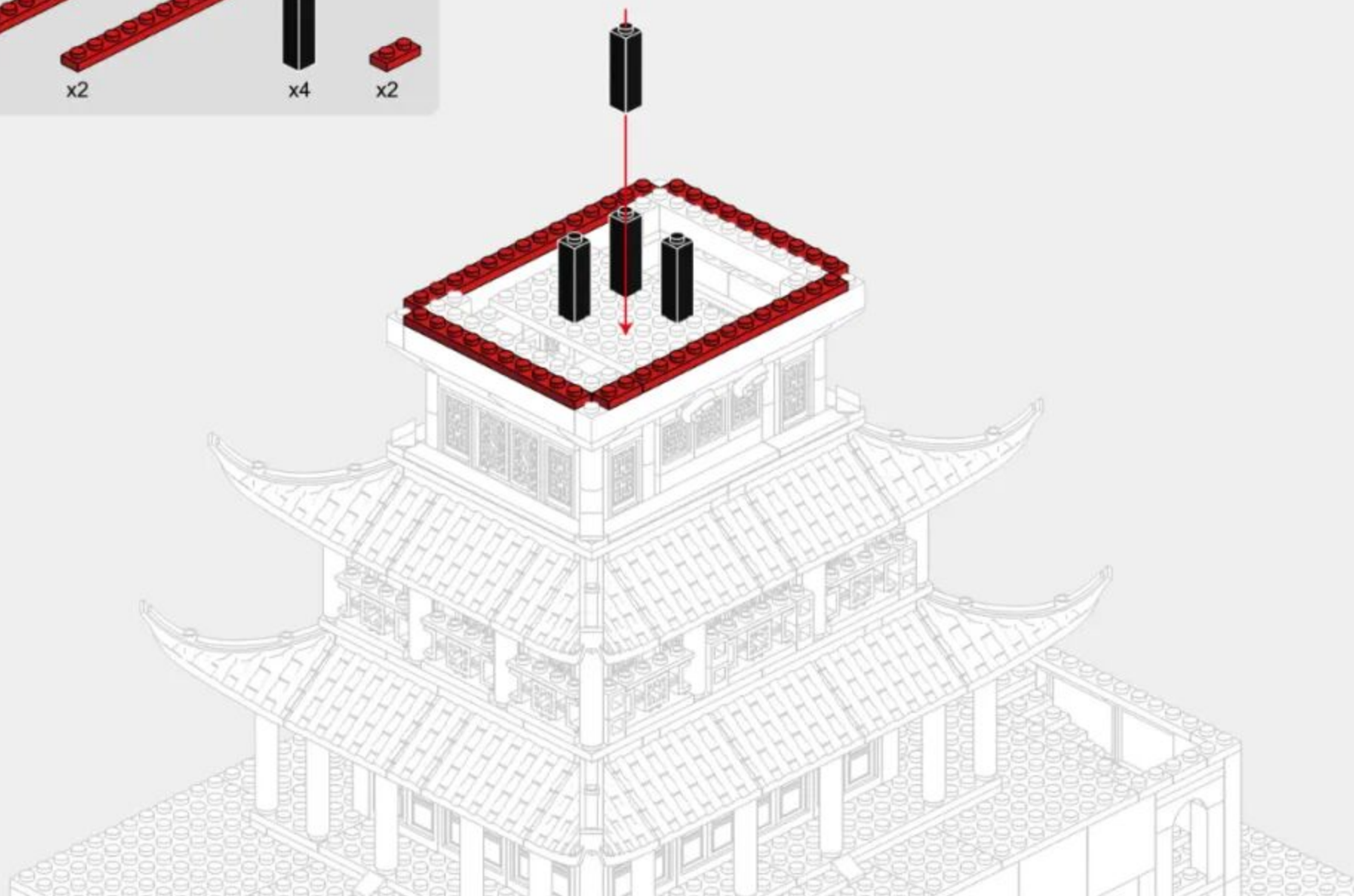
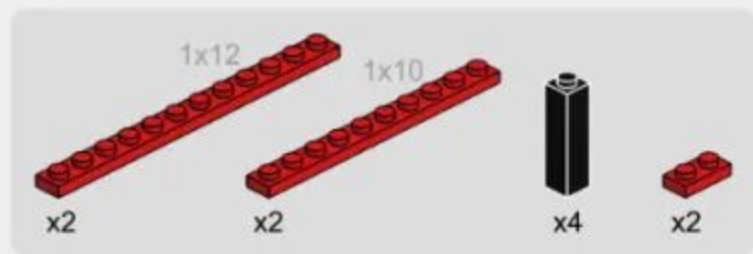

4-7

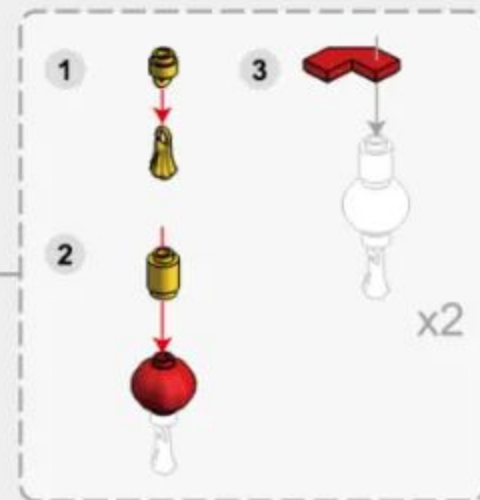
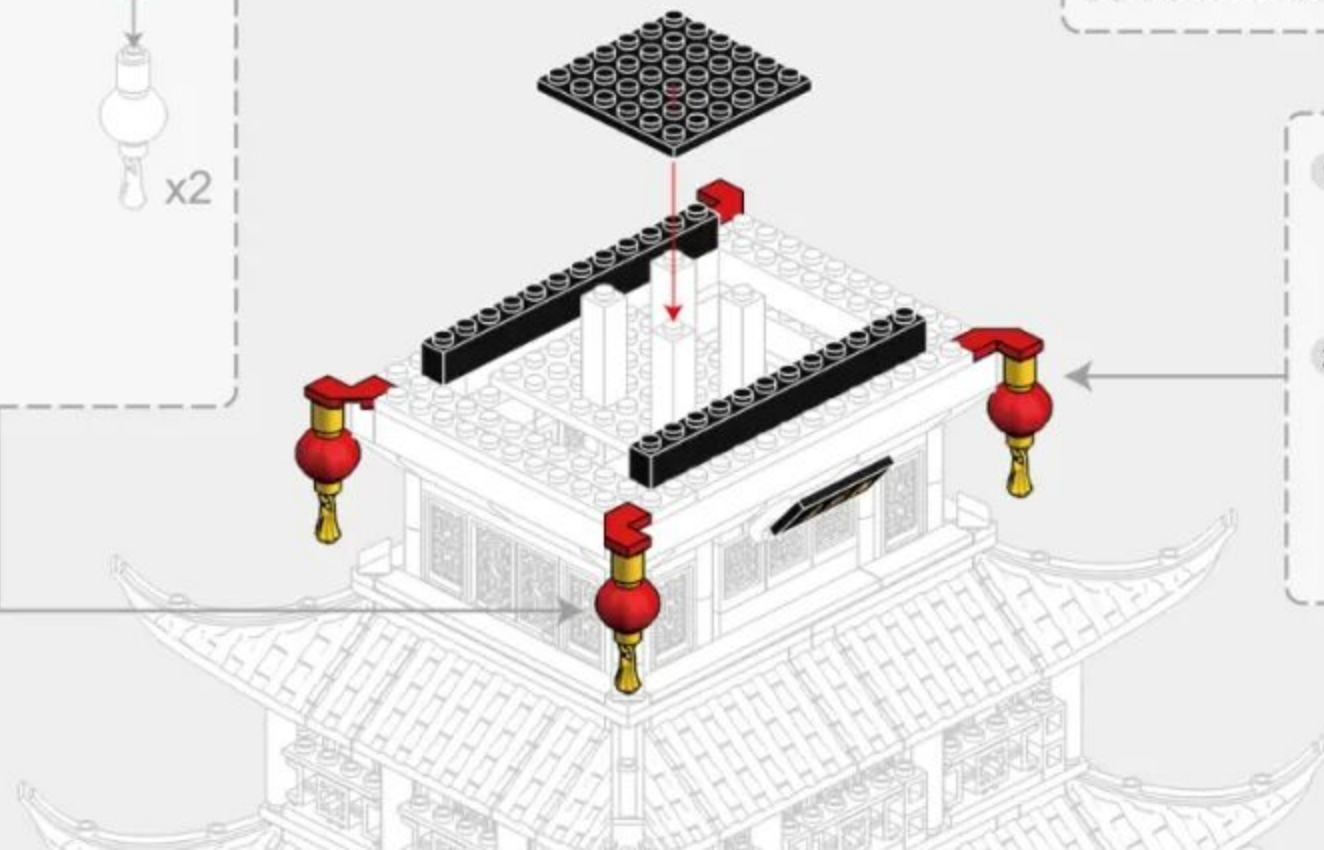
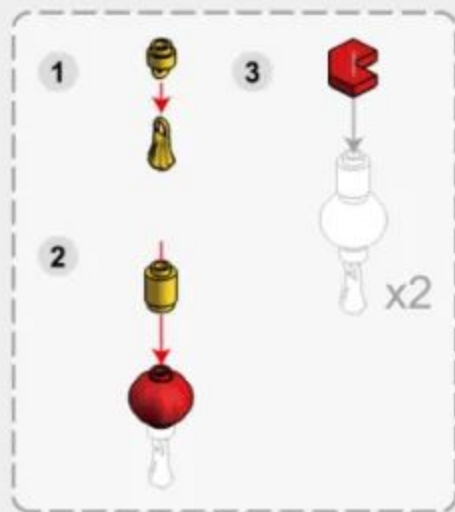
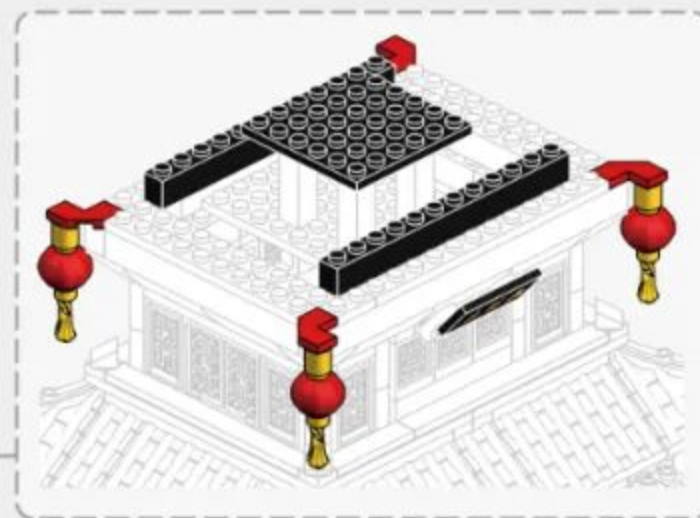
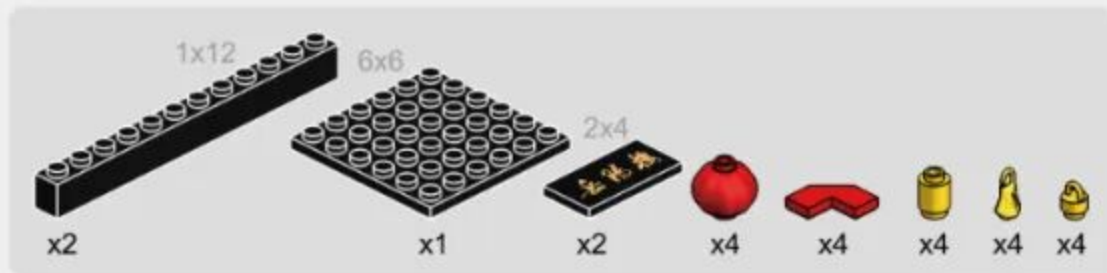

4-8

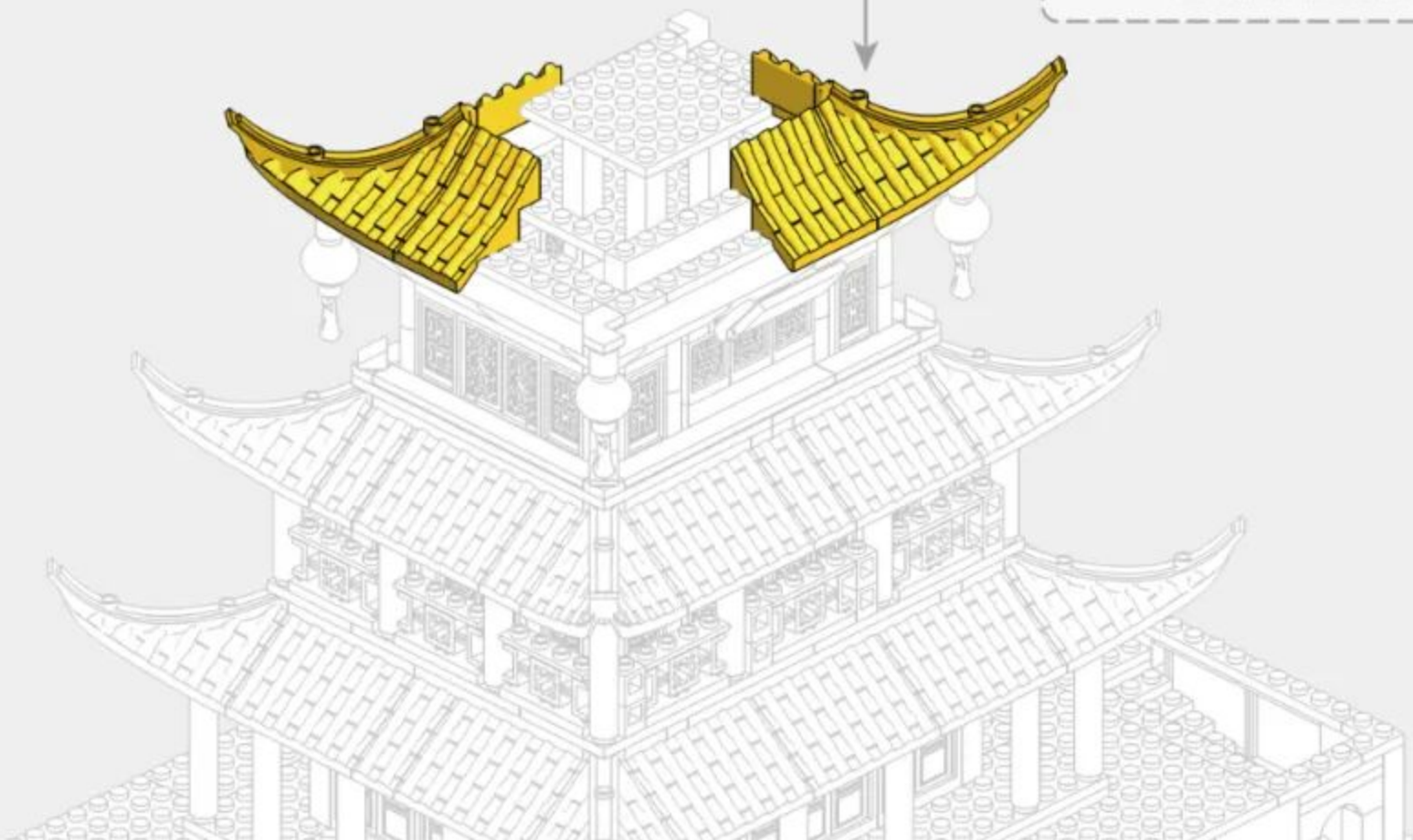
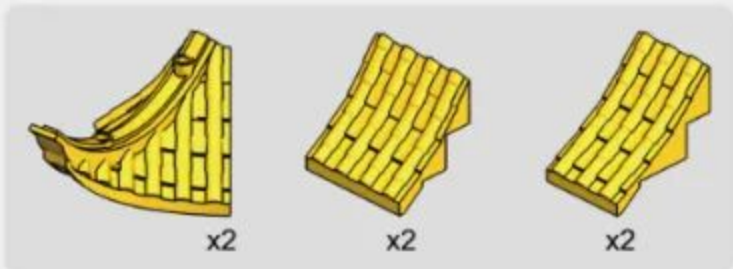

4-9

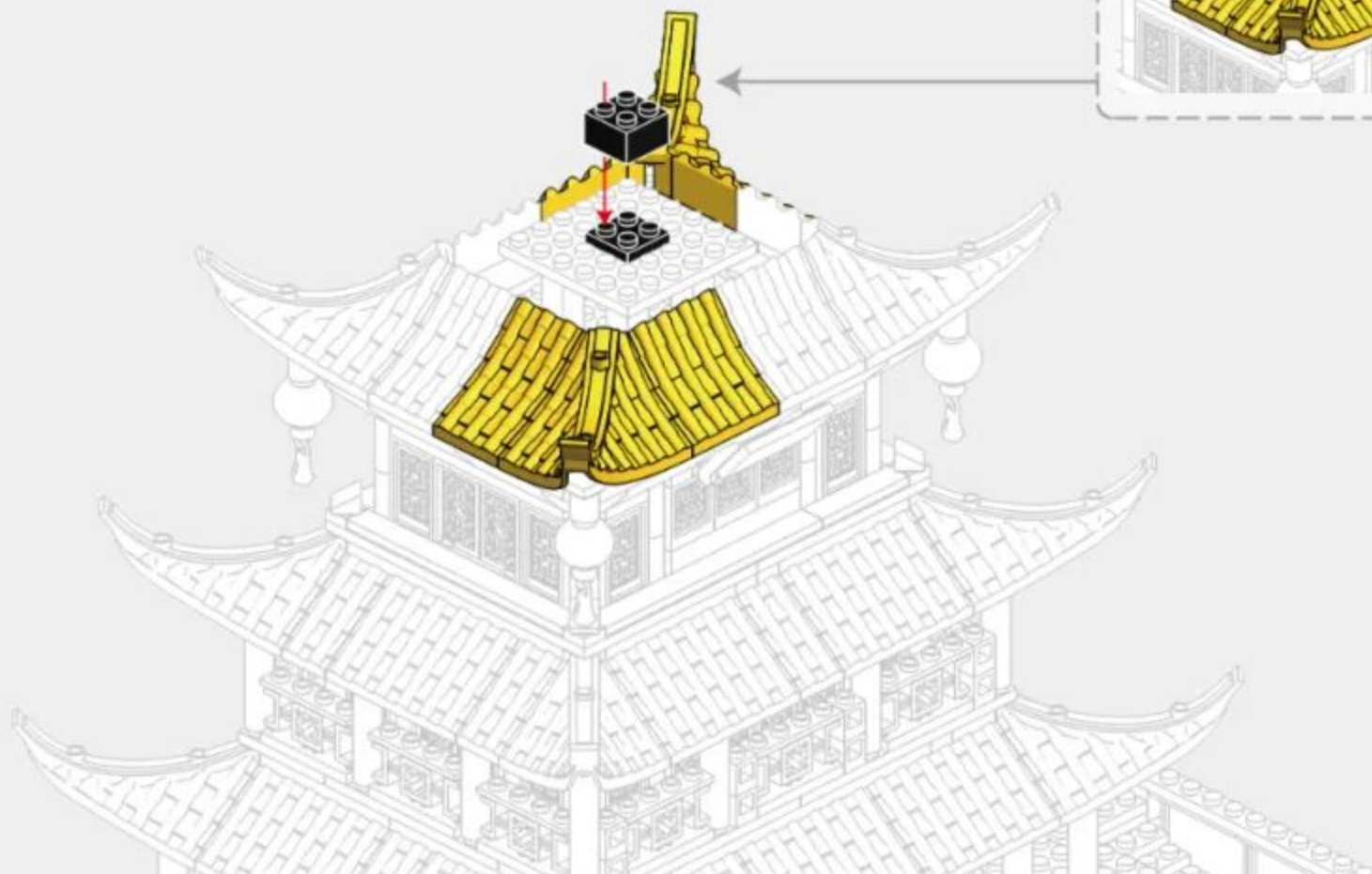
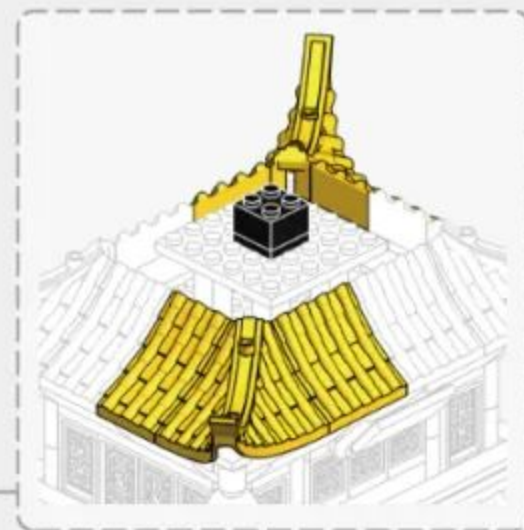
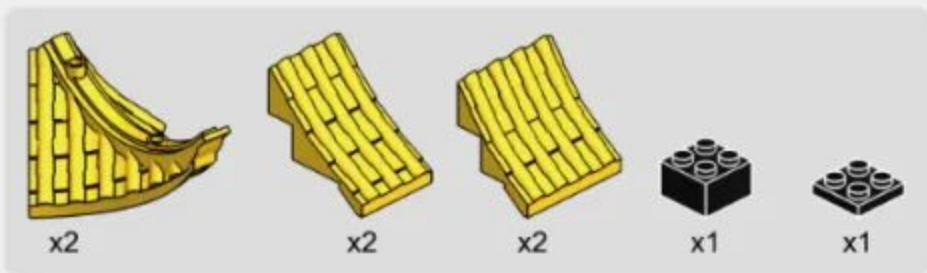

4-10



4-11

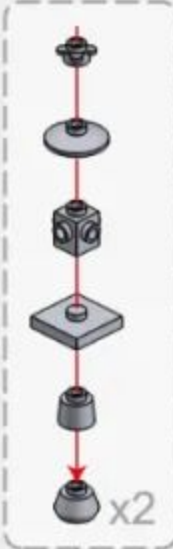

4-12



x11



x10



x4



x10

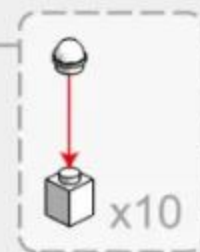
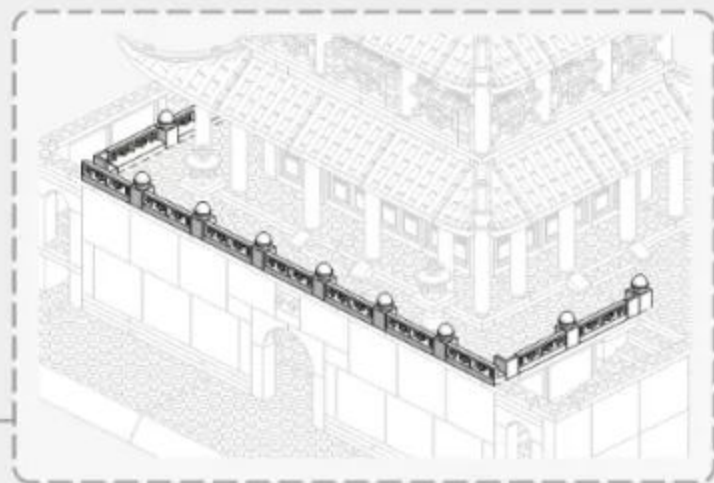
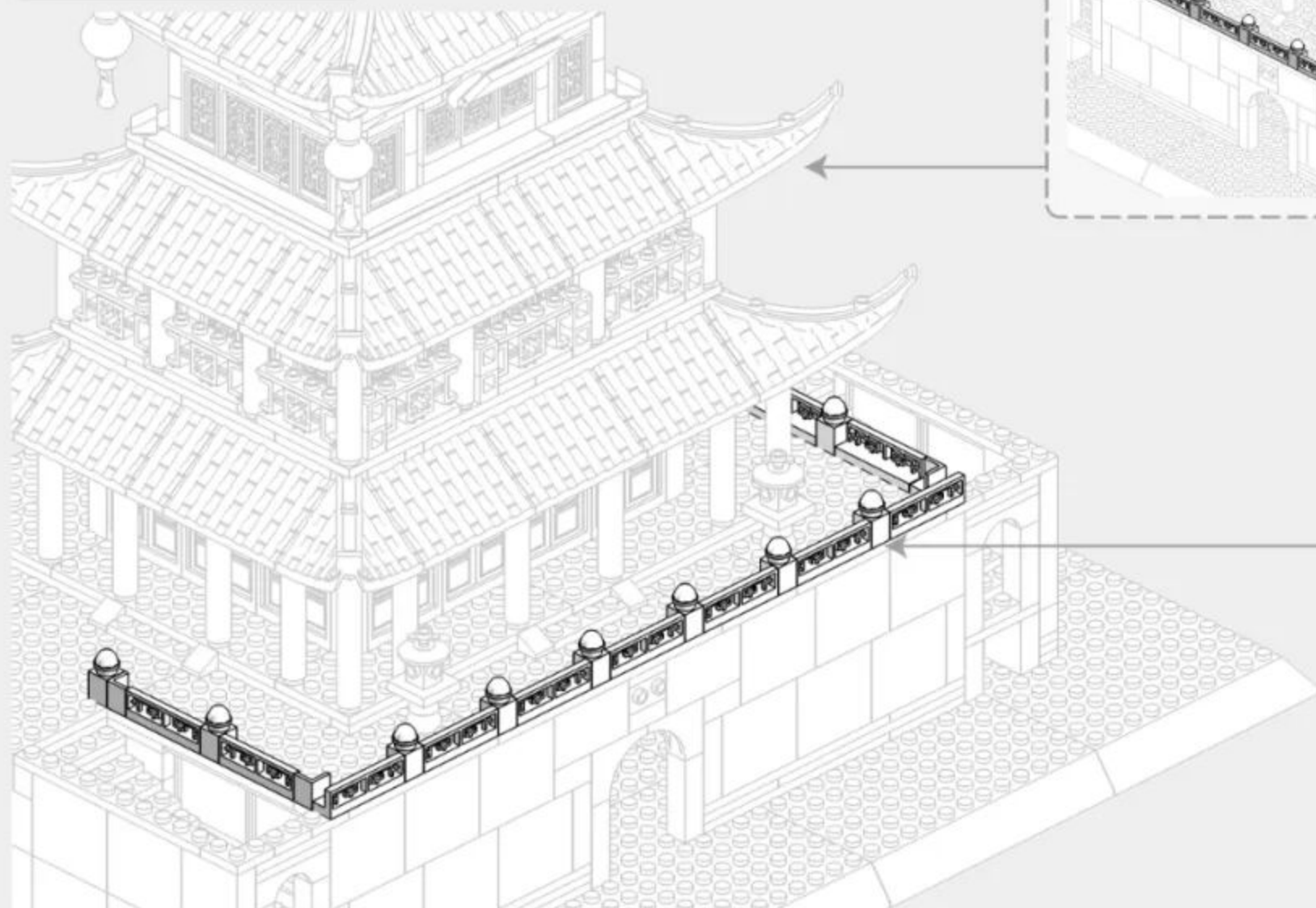

4-13



x19



x14



x12



x18

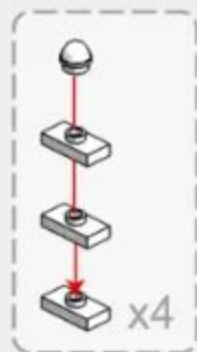

x4



x14

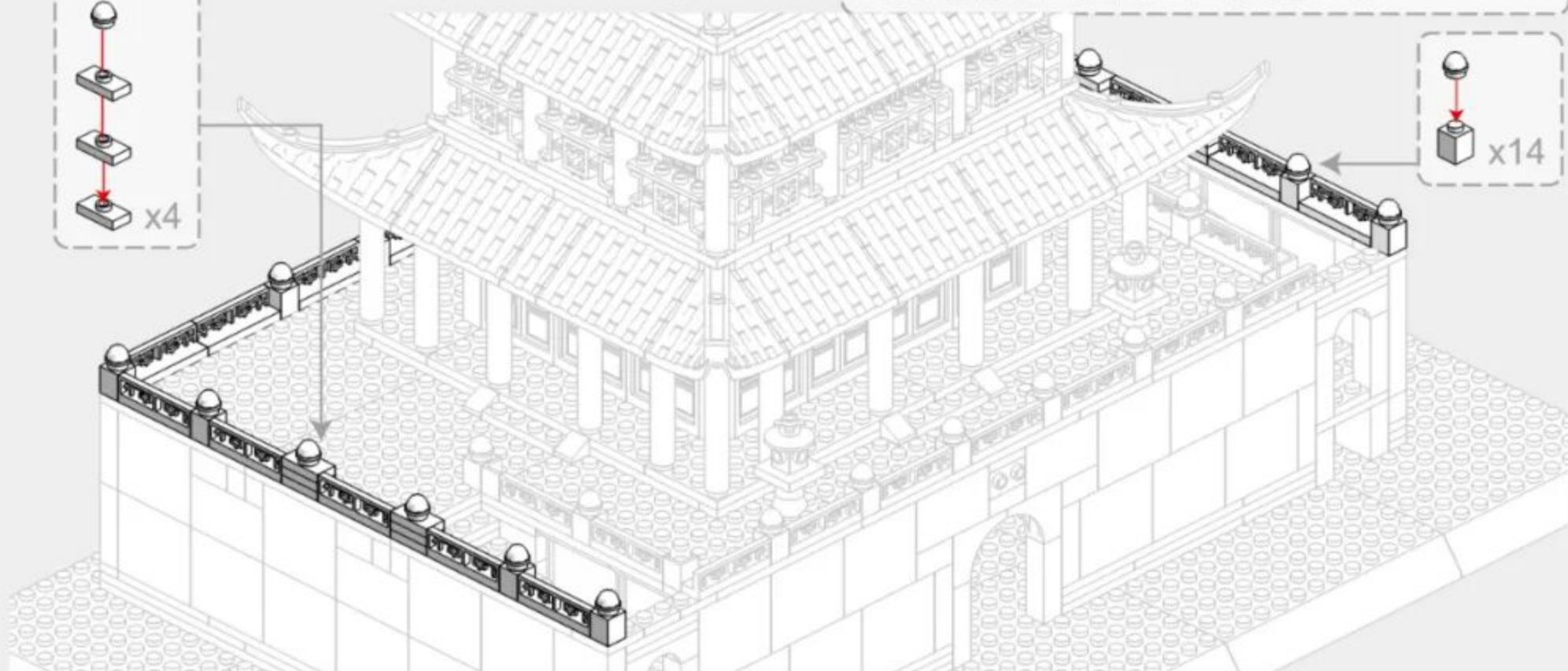



279PCS



74

5-1



1

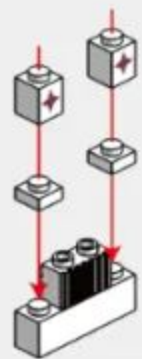

2

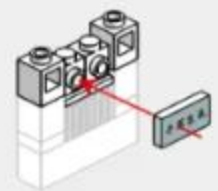

3



4

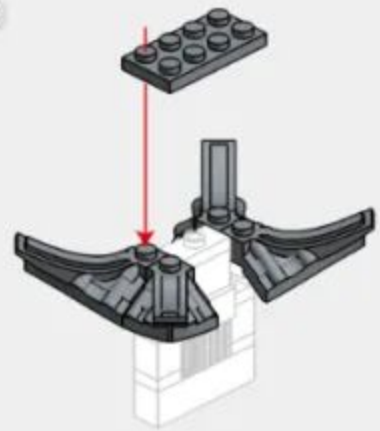

5

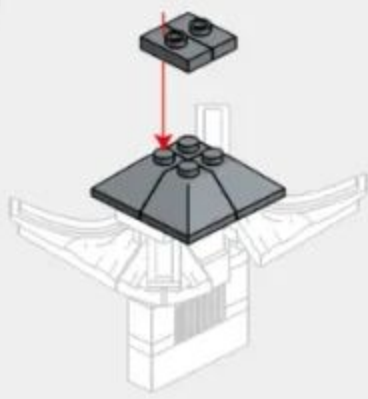

6



5-2



1

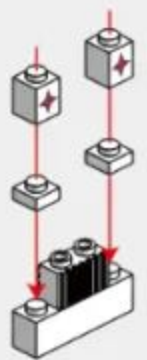

2

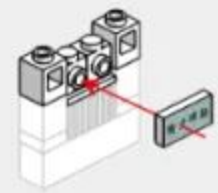

3



4

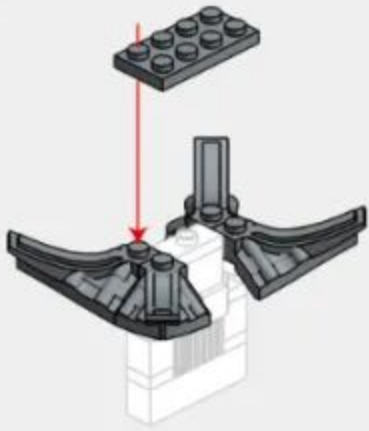

5

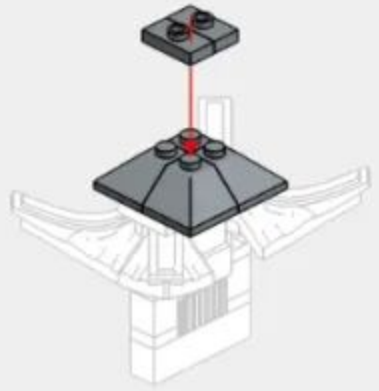

6



5-3

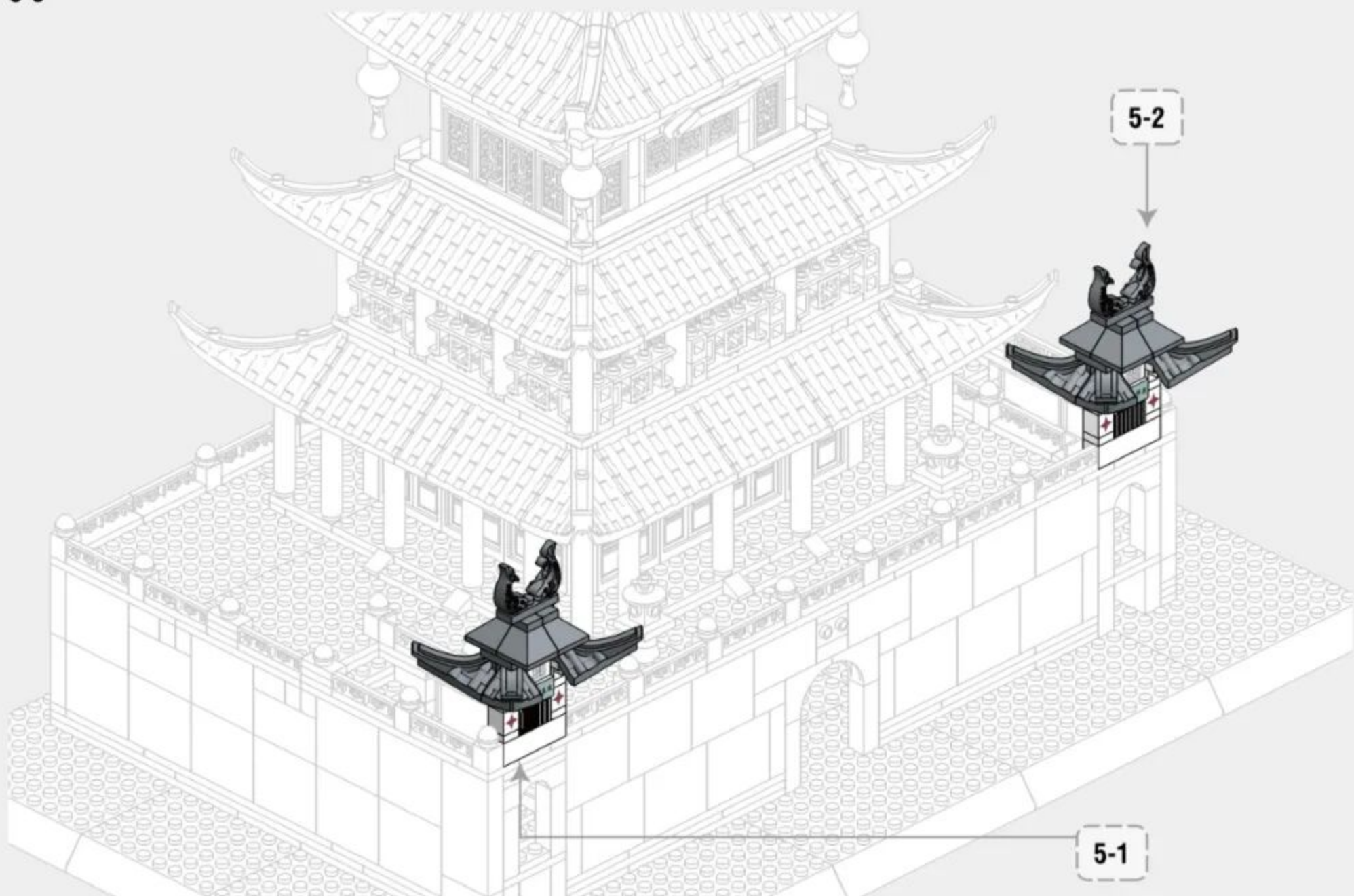

5-4

- 2x4 (black) x1
- 1x4 (white) x4
- 1x2 (brown) x2
- 1x4 (brown) x4
- 1x2 (grey) x2
- 1x2 (grey) x2
- 1x4 (grey) x4
- 1x8 (grey) x8
- 1x2 (grey) x2
- 1x4 (grey) x4

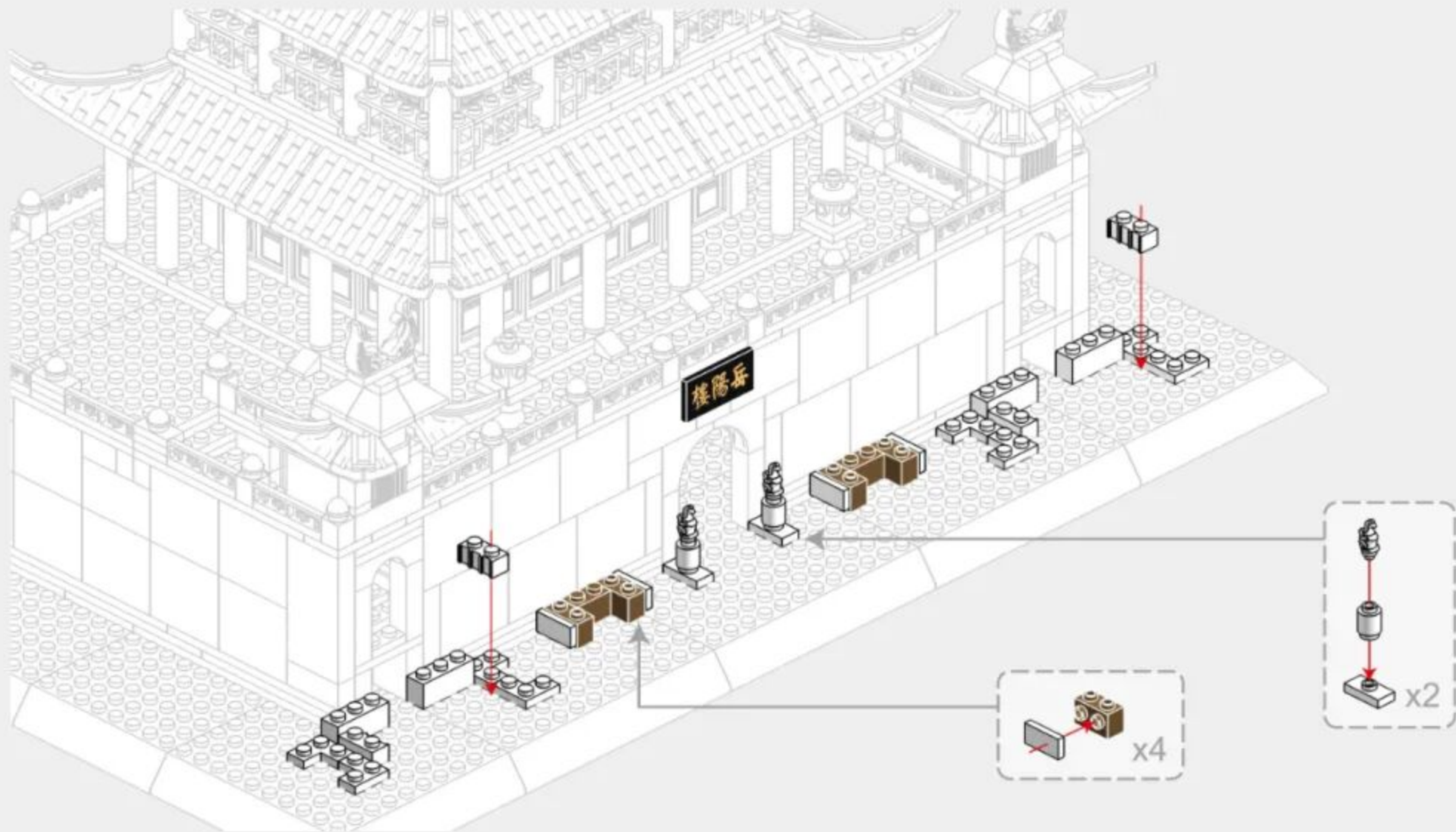

5-5

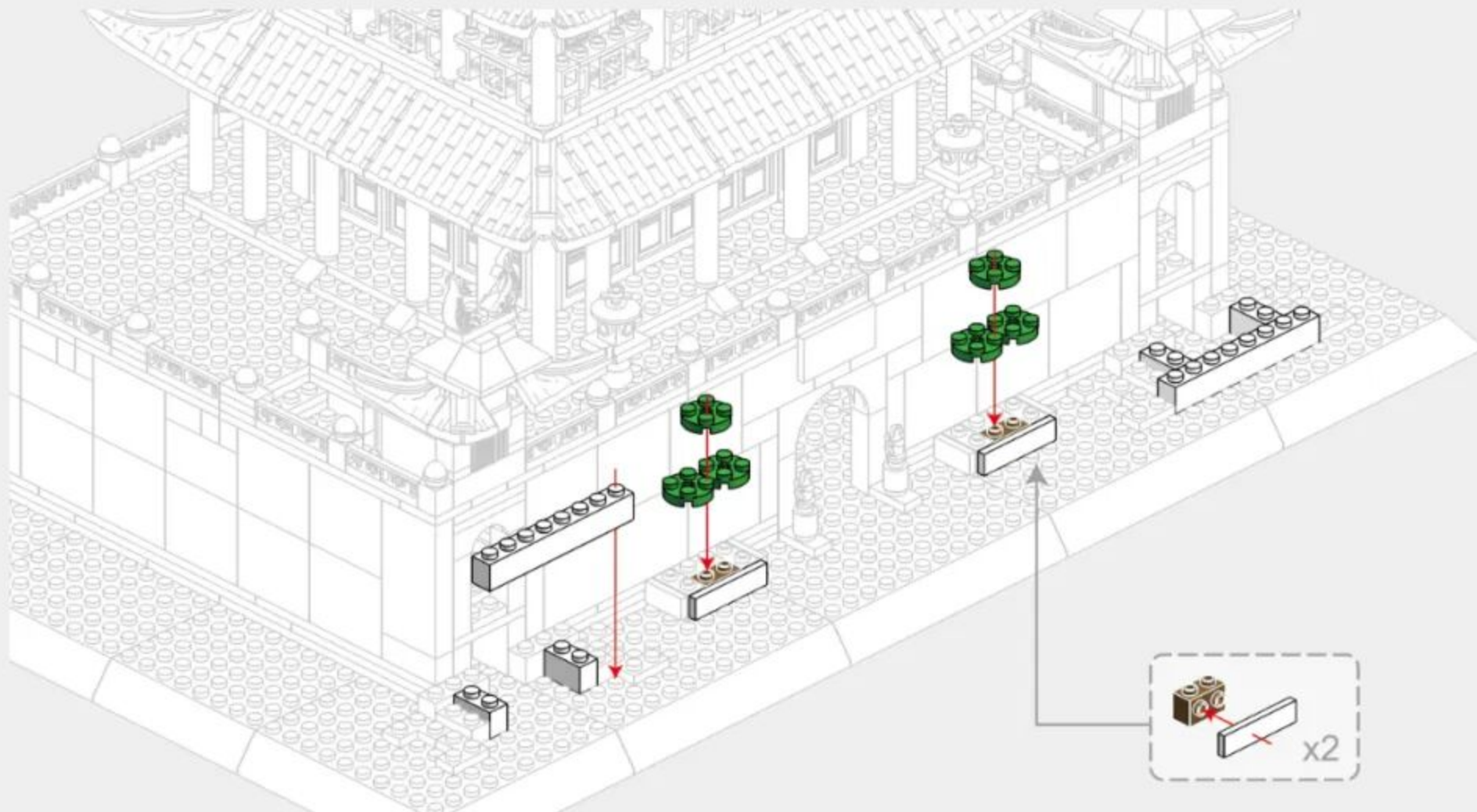
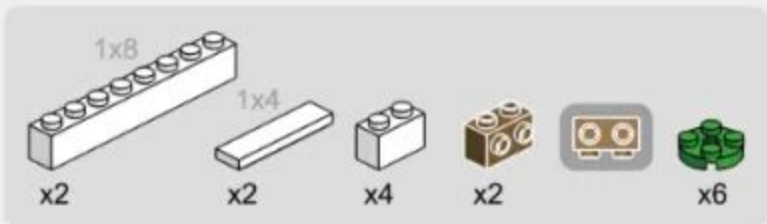

5-6

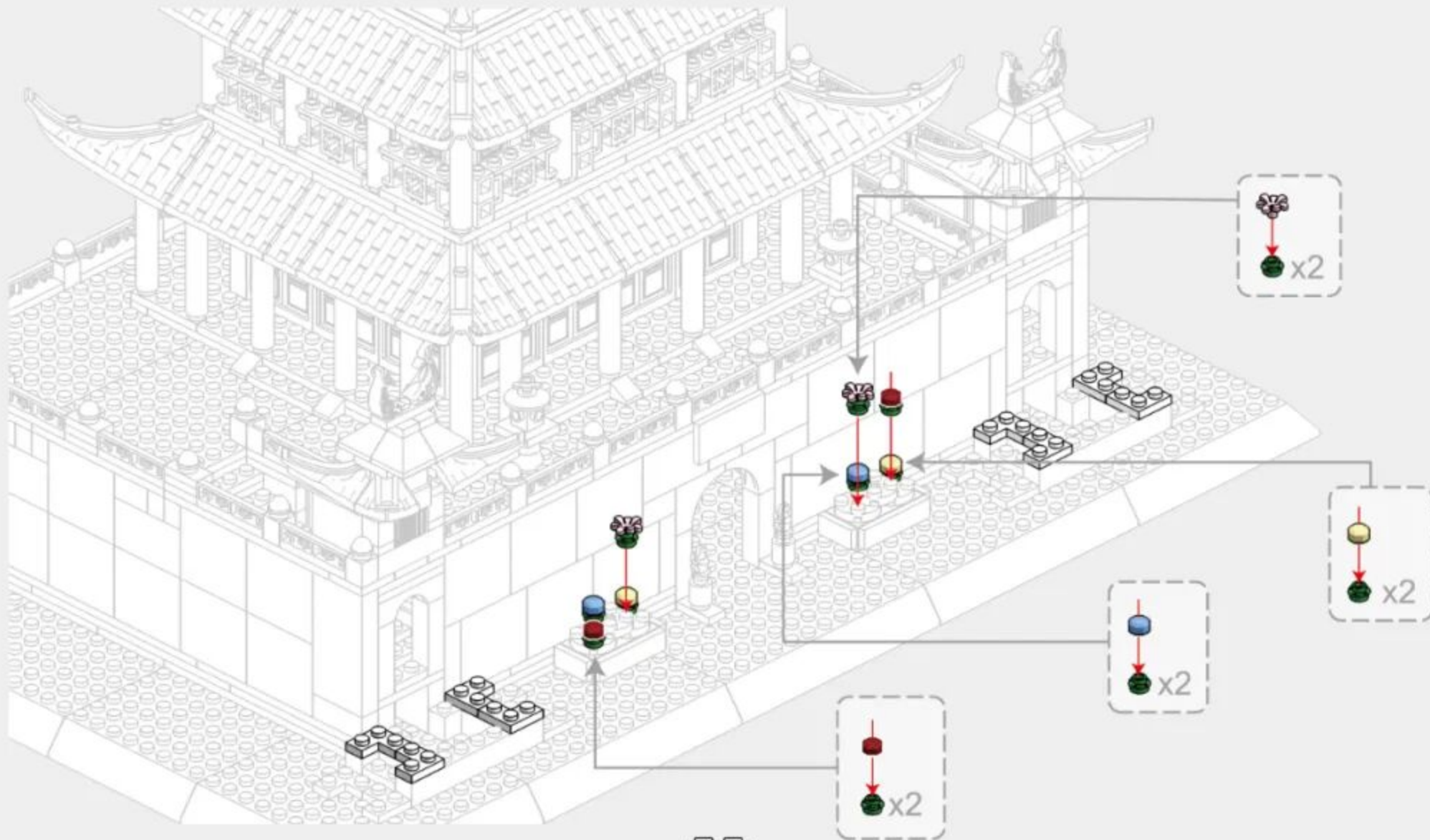
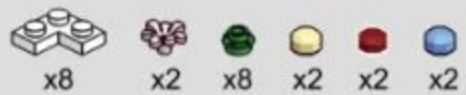

5-7

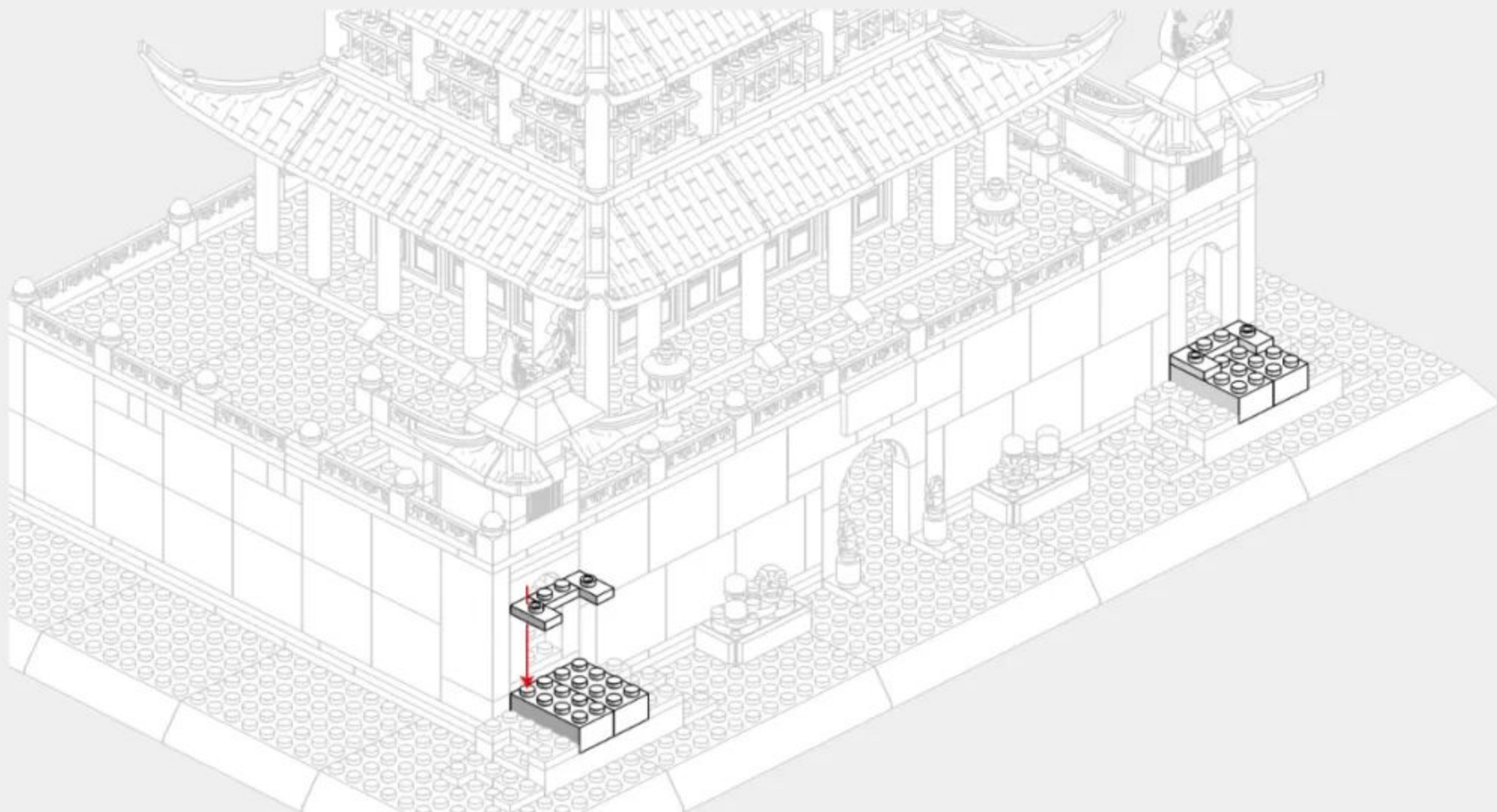
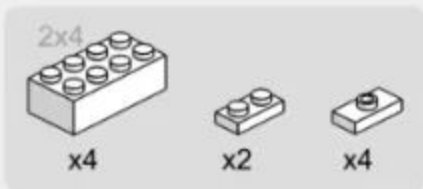

5-8

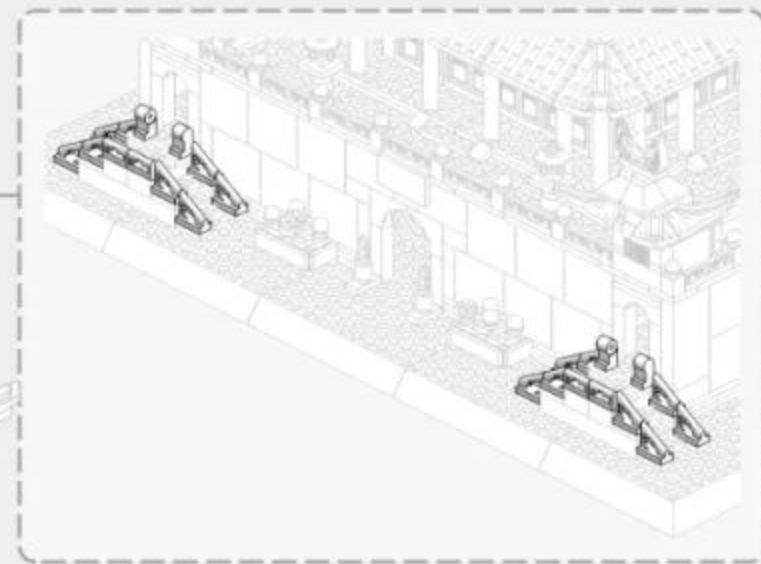
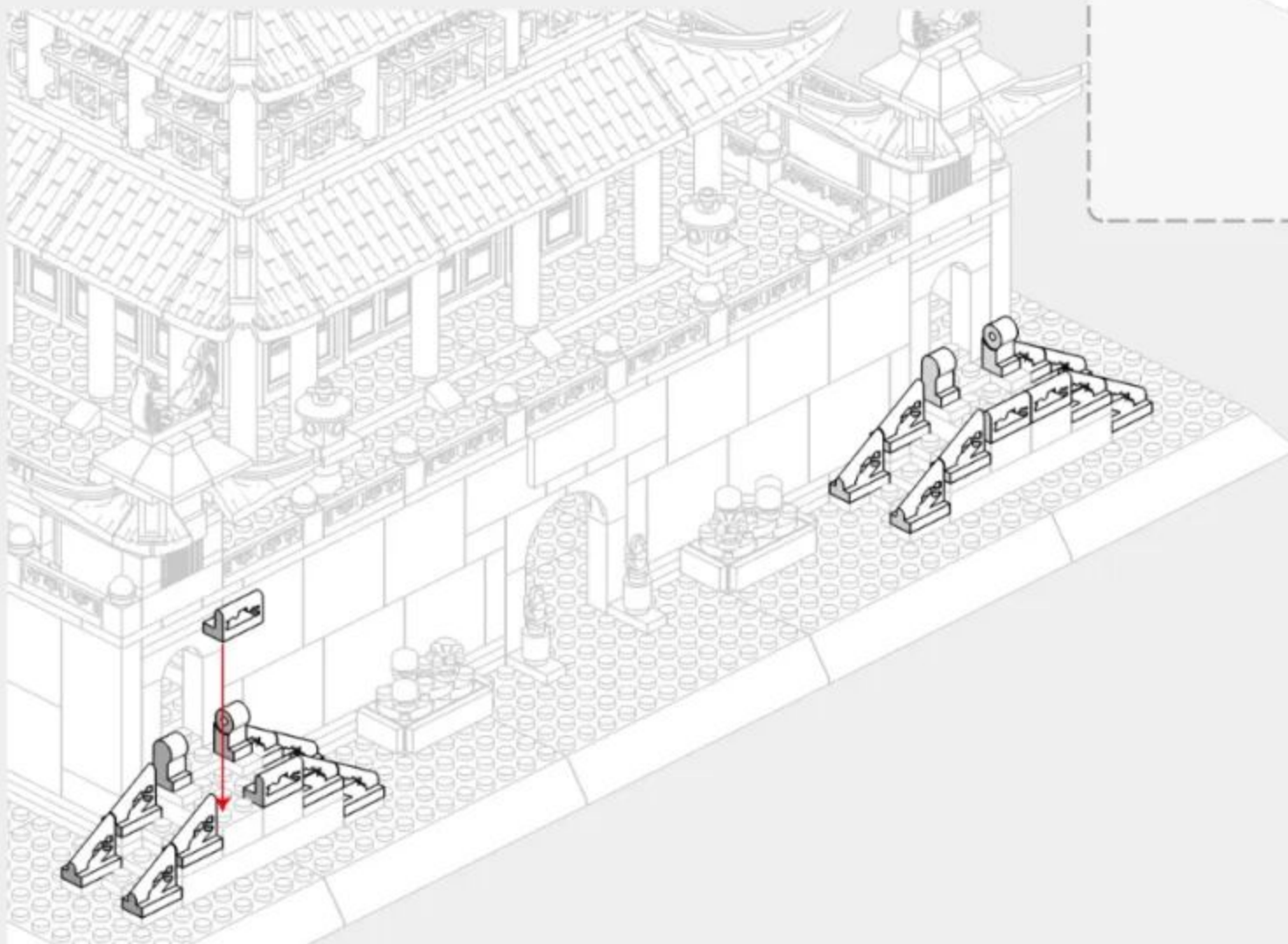

5-9

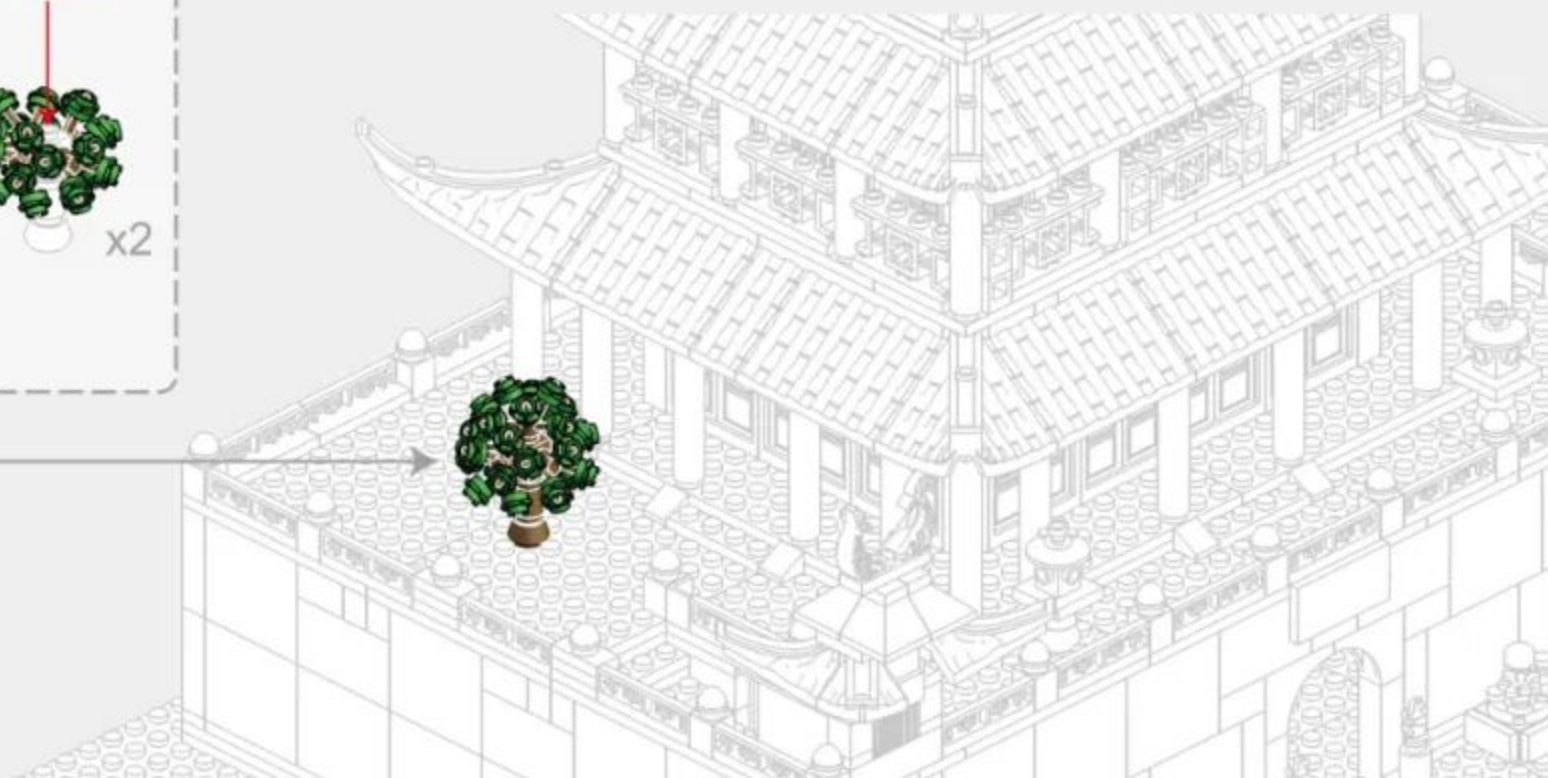
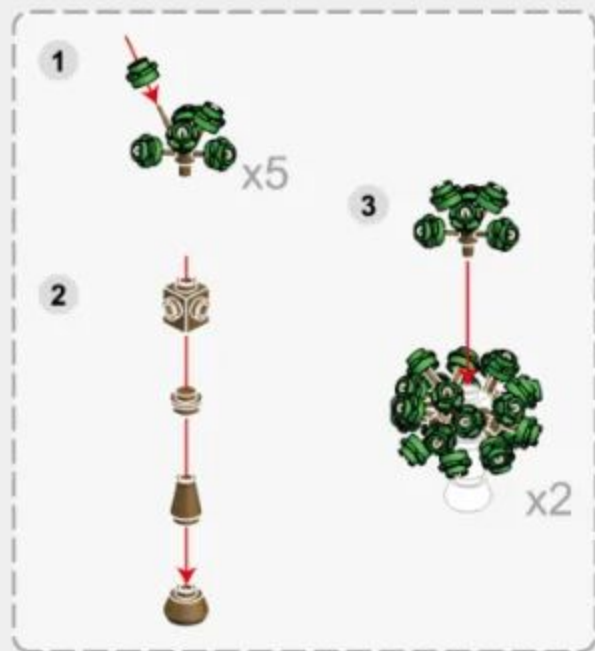

5-10

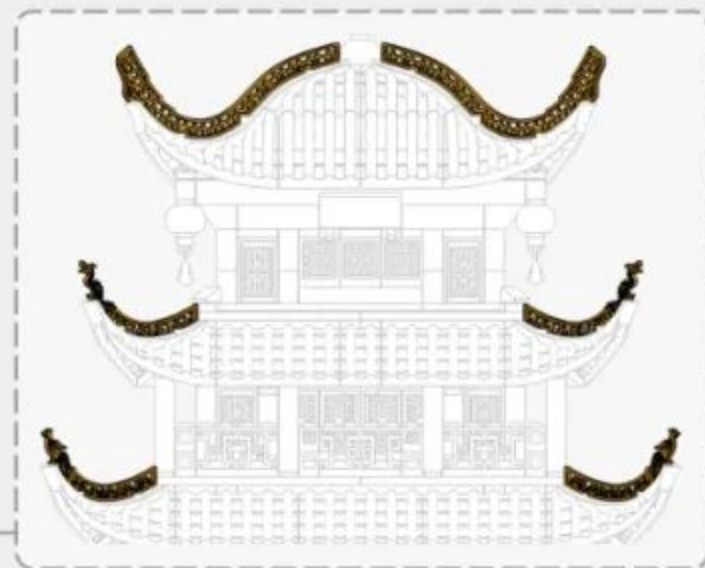
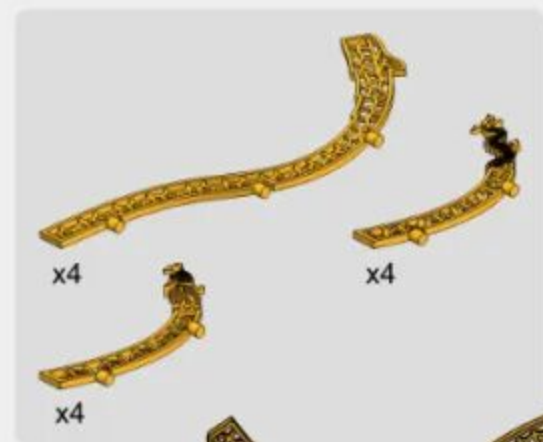

5-11

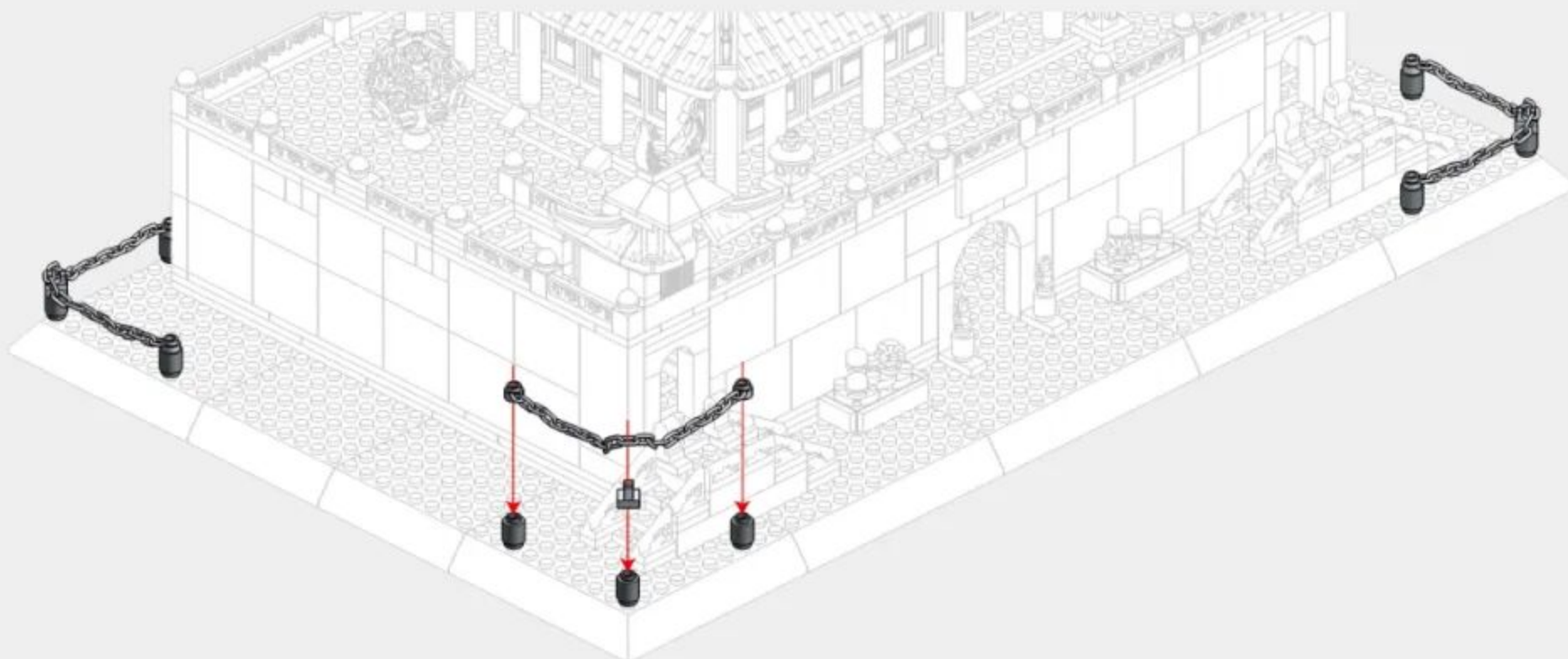
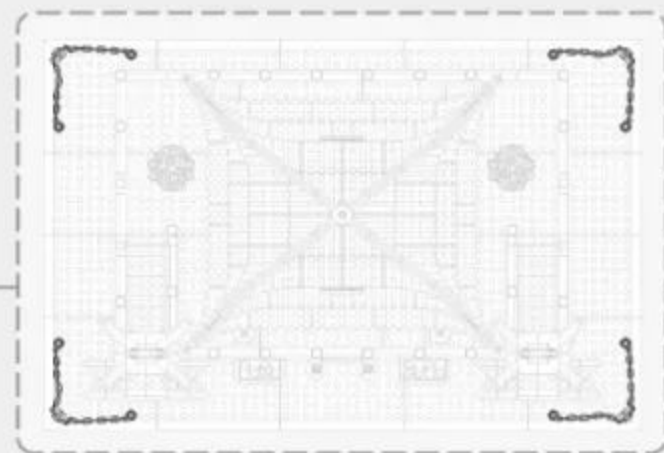

5-12

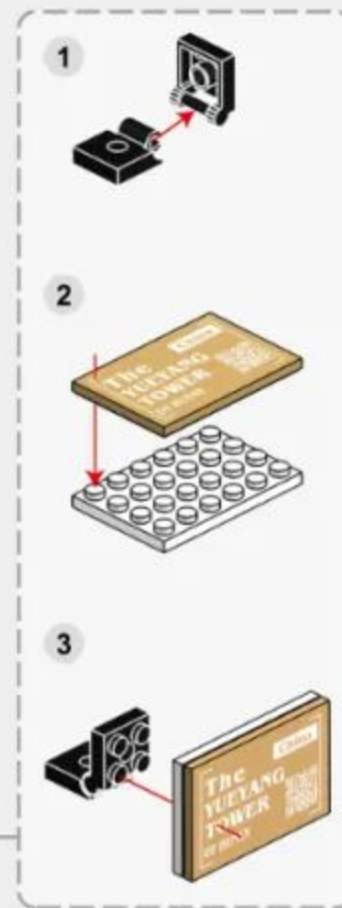
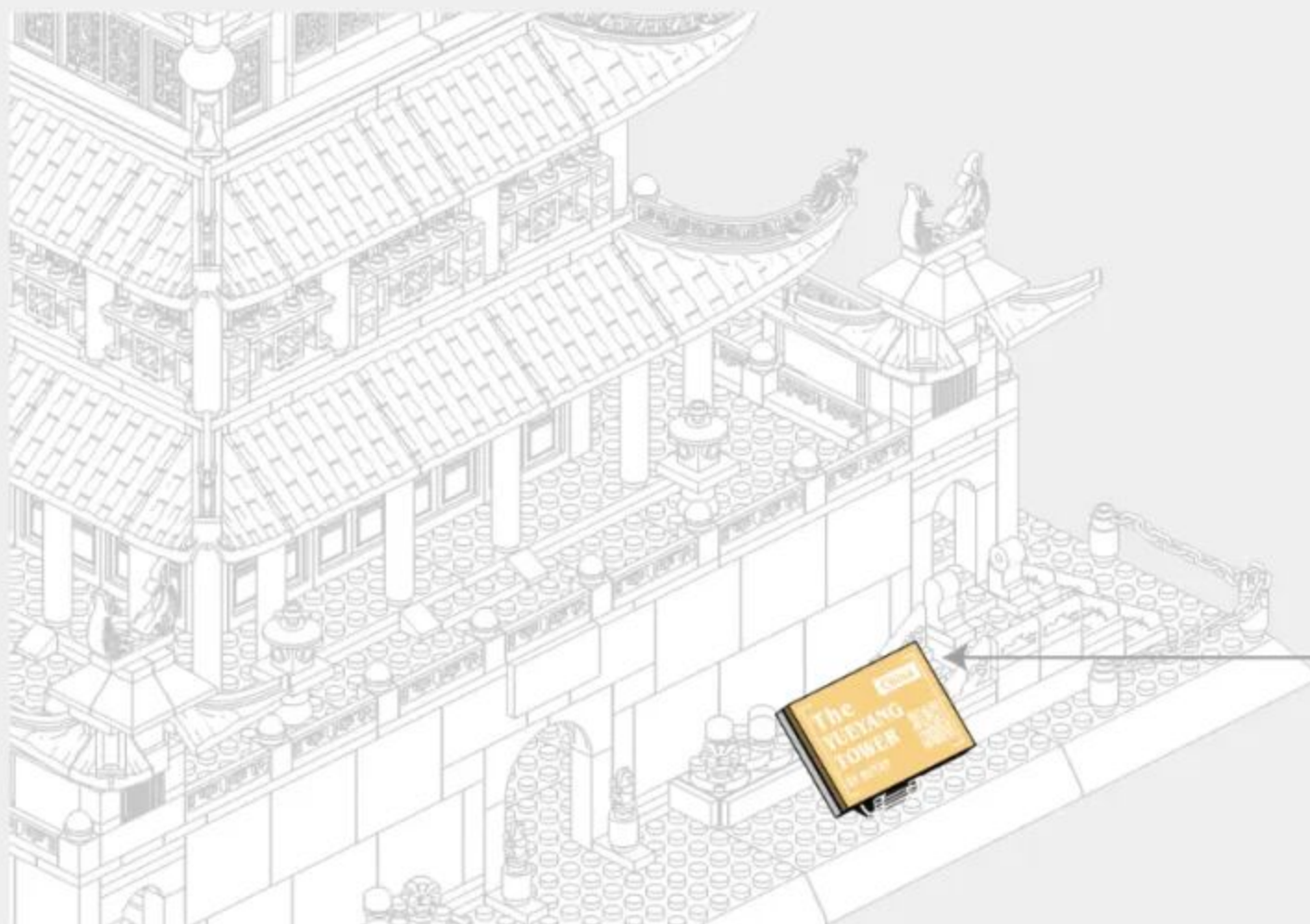
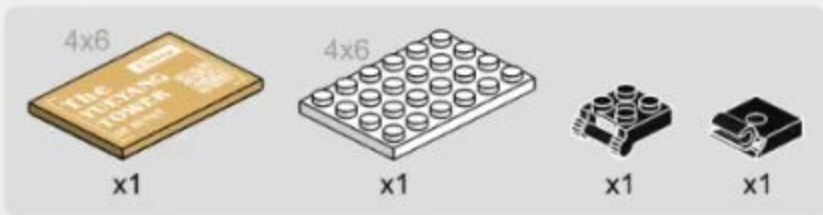



ARCHITECTURE

The World's great architecture



6224 英国伦敦白金汉宫
BUCKINGHAM PALACE-LONDON,ENGLAND

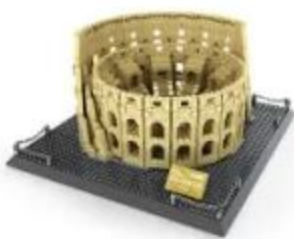

5225 意大利罗马斗兽场
COLOSSEUM-ROME,ITALY



5226 日本东京帝国饭店
IMPERIAL HOTEL-TOKYO,JAPAN



6211 德国柏林勃兰登堡门
BRANDENBURG GATE-BERLIN, GERMANY



6222 中国甘肃长城-嘉峪关
JIAYU PASS-GANSU,CHINA



6212 日本京都清水寺仁王门
NIOMON GATE OF KIYOMIZU-DERA-KYOTO,JAPAN



6214 中国武汉黄鹤楼
YELLOW CRANE TOWER-WUHAN,CHINA



6215 英国伦敦眼
LONDON EYE-LONDON,ENGLAND



6221 中国北京故宫-太和殿
HALL OF SUPREME HARMONY-BEIJING,CHINA



6213 俄罗斯莫斯科瓦西里大教堂
SAINT BASIL'S CATHEDRAL-MOSCOW,RUSSIA



6220 沙特阿拉伯麦加大清真寺
GREAT MOSQUE OF MECCA,SAUDI ARABIA



6219 美国纽约联合国大厦
UNITED NATIONS HEADQUARTERS-NEW YORK,AMERICA



4214 美国华盛顿白宫
WHITE HOUSE-WASHINGTON D.C.,AMERICA



4212 意大利罗马许愿池
TREVI FOUNTAIN-ROME,ITALY



4213 法国巴黎卢浮宫
MUSÉE DU LOUVRE-PARIS,FRANCE



4218 新加坡-鱼尾狮
MERLION,SINGAPORE



4210 埃及开罗吉萨金字塔
GREAT PYRAMID OF GIZA-CAIRO,EGYPT



4219 英国伦敦双子塔桥
TOWER BRIDGE-LONDON,ENGLAND



4216 美国华盛顿林肯纪念堂
LINCOLN MEMORIAL-WASHINGTON D.C.,AMERICA



4217 新加坡-金沙酒店
MARINA BAY SANDS,SINGAPORE



7210 中国上海世博会中国馆
CHINA PAVILION AT EXPO-SHANGHAI, CHINA



4221 加拿大渥太华国会山庄
PARLIAMENT BUILDINGS-OTTAWA, CANADA



4211 英国伦敦伊丽莎白塔
ELIZABETH TOWER-ENGLAND



4220 美国纽约熨斗大厦
FLATIRON BUILDING-NEW YORK, AMERICA



5227 美国纽约自由女神像
STATUE OF LIBERTY-NEW YORK, AMERICA



4215 加拿大多伦多电视塔
THE CN TOWER-CANADA



4222 阿联酋迪拜哈利法塔
THE BURJ KHALIFA TOWER-DUBAI, UAE



5224 中国上海东方明珠广播电视塔
ORIENTAL PEARL TOWER-SHANGHAI, CHINA



5212 美国纽约帝国大厦
EMPIRE STATE BUILDING-NEW YORK, AMERICA



5213 马来西亚吉隆坡石油双塔
PETRONAS TWIN TOWERS-KUALA LUMPUR, MALAYSIA



5214 意大利托斯卡纳比萨斜塔
LEANING TOWER OF PISA-TUSCANY, ITALY



5216 英国伦敦伊丽莎白塔
ELIZABETH TOWER-LONDON, ENGLAND



5219 俄罗斯莫斯科克里姆林宫钟楼
SPASSKAYA TOWER-MOSCOW, RUSSIA



5220 阿联酋迪拜卓美亚帆船酒店
BURJ AL ARAB HOTEL-DUBAI, UAE



5217 法国巴黎埃菲尔铁塔
EIFFEL TOWER-PARIS, FRANCE



5221 中国台北101大楼
TAIPEI 101-TAIPEI, CHINA



6223 中国武汉长江大桥
WUHAN YANGTZE RIVER BRIDGE



5210 法国巴黎圣母院大教堂
CATHÉDRALE NOTRE-DAME DE PARIS-PARIS, FRANCE



5223 法国巴黎凯旋门
ARC DE TRIOMPHE-PARIS, FRANCE



5211 印度阿格拉泰姬陵
TAJ MAHAL-AGRA, INDIA



5215 英国伦敦双子塔桥
TOWER BRIDGE-LONDON,ENGLAND



5222 中国北京天坛祈年殿
HALL OF PRAYER FOR GOOD HARVESTS-BEIJING,CHINA



6210 美国旧金山金门大桥
GOLDEN GATE BRIDGE-SAN FRANCISCO,AMERICA



6216 中国北京万里长城（八达岭）
THE GREAT WALL-BEIJING,CHINA



5218 中国北京天安门
TIANANMEN TOWER-BEIJING,CHINA



6217 中国西藏布达拉宫
POTALA PALACE-TIBET,CHINA



6218 芬兰罗瓦涅米圣诞老人办公室
SANTA CLAUS OFFICE-ROVANIEMI,FINLAND



6225 墨西哥库库尔坎玛雅金字塔
EL CASTILLO-KUKULKAN,MEXICO



6226 德国巴伐利亚新天鹅堡
SCHLOSS NEUSCHWANSTEIN-BAYERN, DEUTSCHLAND



5228 美国芝加哥威利斯大厦
WILLIS TOWER-CHICAGO, AMERICA



5229 土耳其伊斯坦布尔其少女塔
MAIDEN TOWER-ISTANBUL,TURKEY



5230 中国湖南长沙爱晚亭
AIWAN TING PAVILION-HUNAN,CHINA



5231 巴西里约热内卢救世基督像
CRISTO REDENTOR-RIO DE JANEIRO, BRASIL



5232 美国宾夕法尼亚州流水别墅
FALLINGWATER-PENNSYLVANIA, AMERICA



5233 美国芝加哥范斯沃斯住宅
FARNSWORTH HOUSE-CHICAGO, AMERICA



5234 美国华盛顿唐人街
CHINA TOWN-WASHINGTON, D.C., AMERICA



3210 美国纽约自由女神像
STATUE OF LIBERTY-NEW YORK,AMERICA



4223 中国北京清华园
TSINGHUA CAMPUS-CHINA,BEIJING



7211 中国湖南岳阳楼
YUEYANG TOWER-CHINA,HUNAN

YUEYANG TOWER

COUNTRY: China

CITY: Hunan



微信扫一扫
补料更简单

