



YELLOW CRANE TOWER

中国湖北武汉黄鹤楼

Wuhan, China

The world's great architecture

Construction Difficulty

★★★★☆



Creativity Interaction Observation Thinking Practicality

6+ / 7217 / 2545 PCS
Suitable Age Product Number Parts Total



Architecture

It will be a city...

这将构成一座城市...

ABOUT THE PRODUCT

关于产品



ARCHITECTURE

WANGE The world's great architect since 1991

Yellow Crane Tower



It is situated on Snake Hill , one kilometer away from the original site, on the banks of the Yangtze River in Wuchang District.

Yellow Crane Tower



Geography and culture

地理.文化



Yellow Crane Tower is a traditional Chinese tower located in Wuhan.



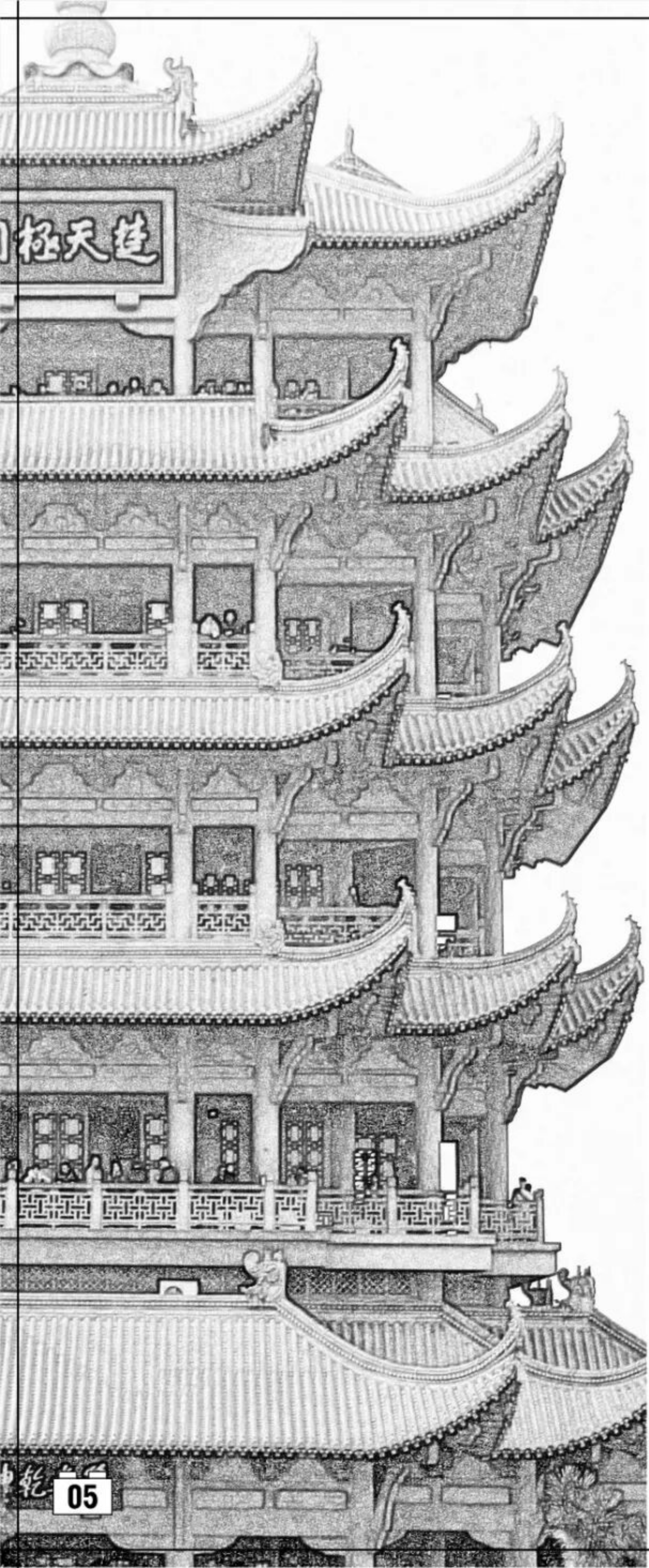

中国湖北武汉黄鹤楼

Yellow ■ Crane Tower

China

The contents of this chapter refer to the Wikipedia website.

本章内容参考维基百科网站，
更多资讯可自行查阅。

The world's great architecture

Buildings and layout

■ 建筑物和布局



黄鹤楼，位于湖北省武汉市武昌区，地处蛇山之巔，濒临万里长江，为武汉市地标建筑；始建于三国吴黄武二年（223年），历代屡加重修，现存建筑以清代“同治楼”为原型设计，重建于1985年；因唐代诗人崔颢登楼所题《黄鹤楼》一诗而名扬四海。自古有“天下绝景”之美誉，与晴川阁、古琴台并称为“武汉三大名胜”，与湖南岳阳岳阳楼、江西南昌滕王阁并称为“江南三大名楼”，是“武汉十大景”之首、中国古代四大名楼之一、“中国十大历史文化名楼”之一，世称“天下江山第一楼”。

THE Yellow Crane Tower Of WuHan is a traditional Chinese tower located in Wuhan. The current structure was built in 1981, but the tower has existed in various forms from as early as AD 223. The current Yellow Crane Tower is 51.4 m (169 ft) high and covers an area of 3,219 m² (34,650 sq ft). It is situated on Snake Hill , one kilometer away from the original site, on the banks of the Yangtze River in Wuchang District.



Design and Legends

关于黄鹤楼的得名，有“因山”、“因仙”两种说法。因仙说分两种。一说是曾有仙人驾鹤经此，遂此得名。一说是曾有道士在此地辛氏酒楼的墙上画了一只跳舞的黄鹤，店家生意因此大为兴隆；十年后道士重来，用笛声招下黄鹤，乘鹤飞去，辛氏遂出资建楼，称黄鹤楼。

Notwithstanding the tower's current location on Snake Hill being unrelated to its original location one kilometre away, the two popular legends related to it invoke the hill. In the first, an Immortal named Wang Zi'an rode away from Snake Mountain on a yellow crane and a tower was later built in commemoration of this story. In the second legend, Fei Yi becomes immortal and rides a yellow crane, often stopping on Snake Hill to take a rest. The tower is also a sacred site of Taoism. Lü Dongbin is said to ascend to heaven from here. There is a small cave in the hill beneath the tower with Lü Dongbin statue. The cave is been called Lü Zu Dong, literally means cave of Lü Dongbin.



History

三国吴黄武二年（223年），吴大帝孙权修筑夏口城，于城西南角黄鹄矶建军事楼一座，用于瞭望守戍，即黄鹤楼。南朝宋大明六年（462年），文学家鲍照首作《登黄鹄矶》诗于黄鹤楼；泰始五年（469年），祖冲之撰成志怪小说《述异记》讲述有江陵人荀环在黄鹤楼遇见仙人驾鹤并之交谈的故事，为黄鹤楼称谓最早出现的文字记载。南朝梁普通七年（526年），史学家萧子显撰《南齐书》称黄鹤楼神话中驾鹤仙人为王子安，使黄鹤楼更具现实色彩。

The Yuanhe Maps and Records of Prefectures and Counties, written almost 600 years after the construction of the tower, notes that after Sun Quan, founder of the kingdom of Eastern Wu, built the fort of Xiakou in 223, a tower was constructed at/on the Yellow Crane Jetty, west of Xiakou, and hence its name. The tower has been destroyed twelve times, both by warfare and by fire, in the Ming and Qing dynasties and was repaired on ten separate occasions. The last tower at the original site was built in 1868 and destroyed in 1884. In 1907, a new tower was built near the site of the Yellow Crane Tower. Zhang Zhidong proposed '奥略楼' (Aoliaolou Tower) as the name for this tower and wrote an antithetical couplet for it. In 1957, the Wuhan Yangtze River Bridge was built with one trestle of the bridge on the Yellow Crane Tower's site. In 1981, the Wuhan City Government commenced reconstruction of the tower at a new location, about 1 km (0.62 mi) from the original site, and it was completed in 1985.

Force Balance

受力平衡

Physical operations

物理运算

$$F = G \frac{m_1 m_2}{d^2}$$

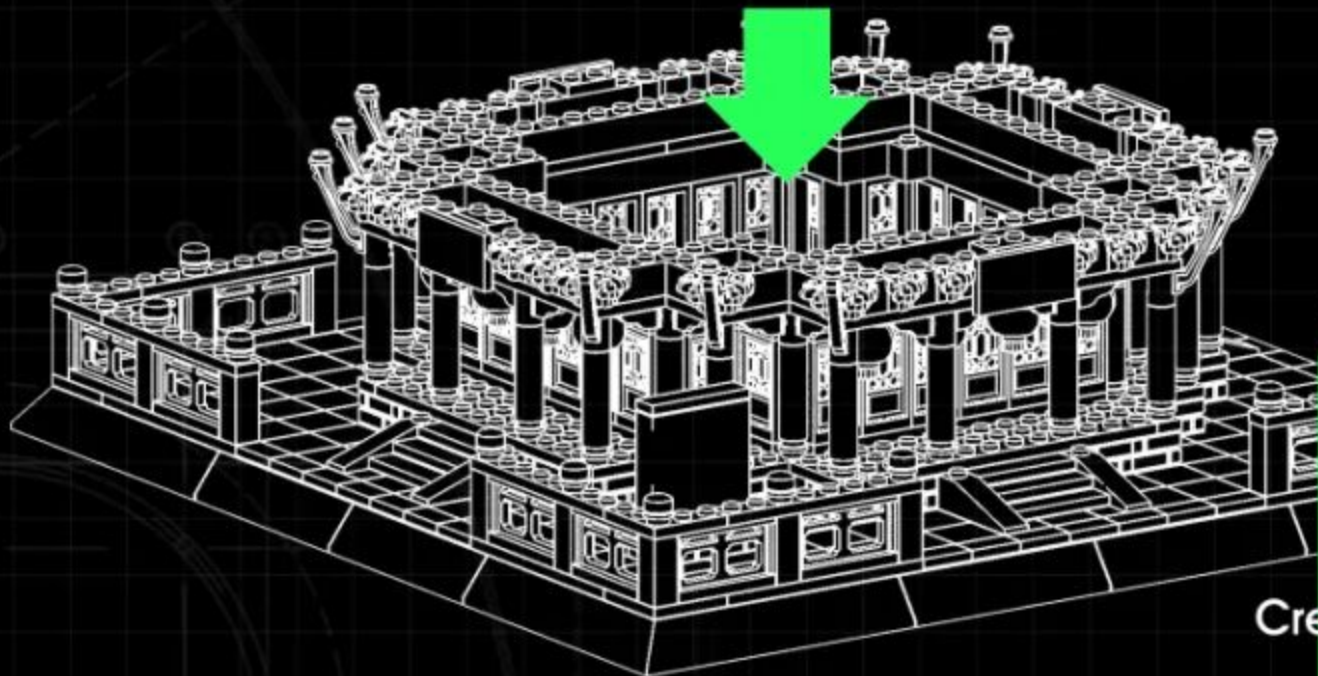
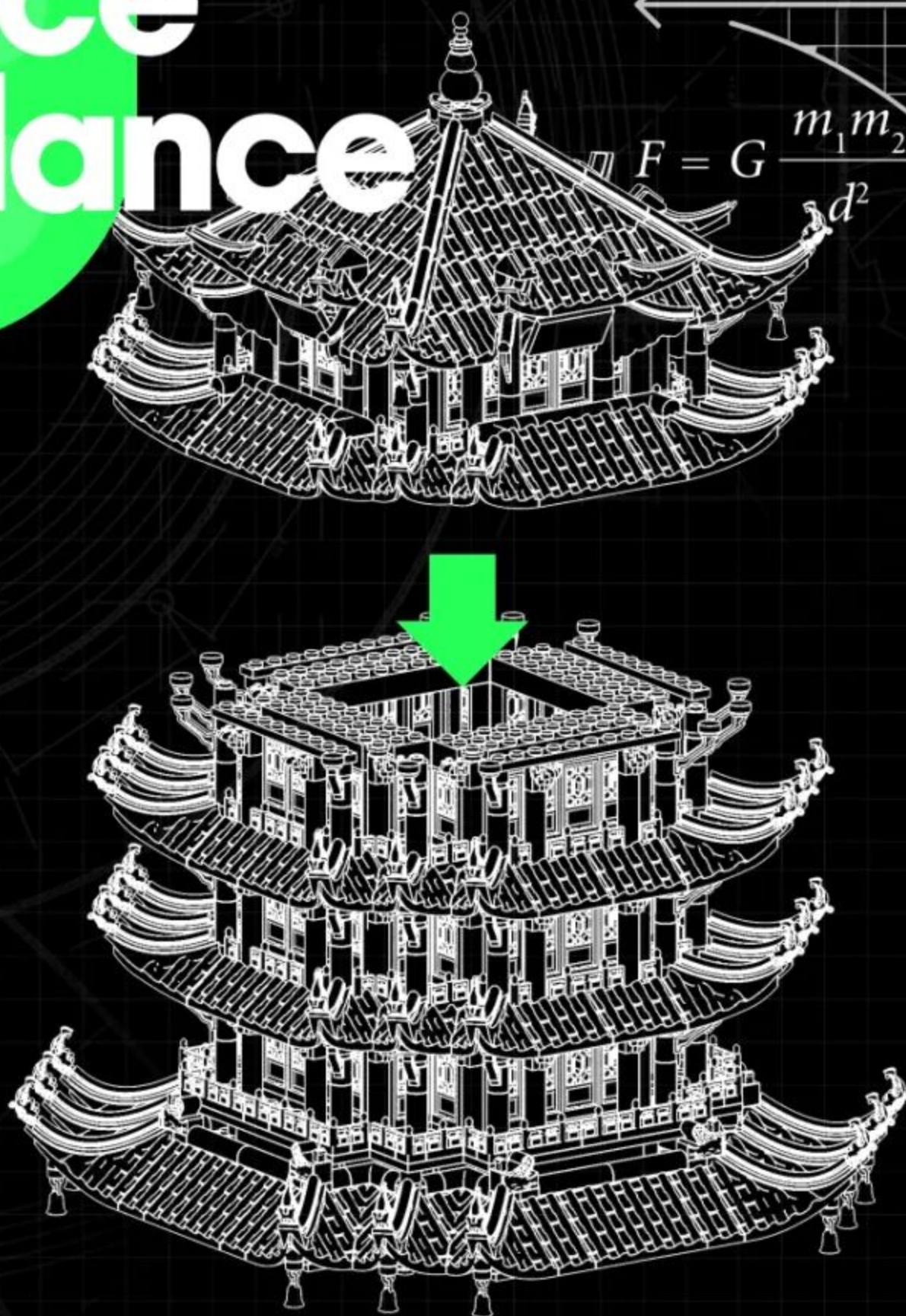

Creation and thinking

创作·思考

$$S=4\pi \cdot r^2$$

Special parts

特殊零件的开发利用

$$a^2+b^2=c^2$$

WG1809

25.6mm弯角支柱



WG1812

黄鹤楼二板

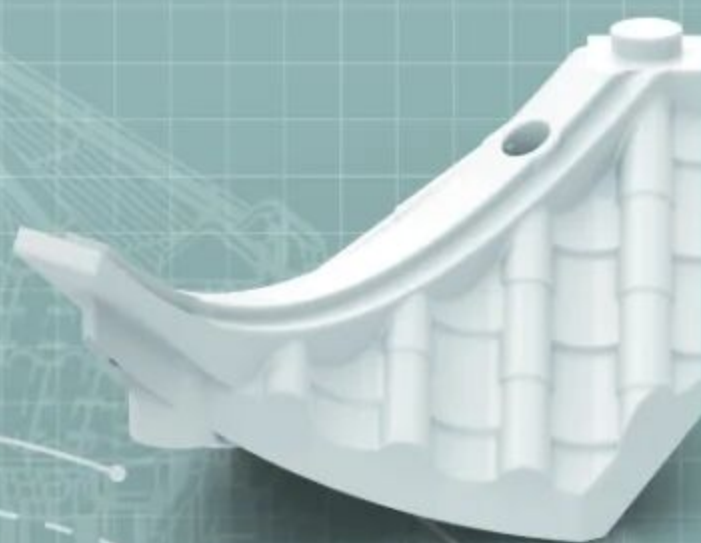

WG1794

转角斗拱



WG1811

黄鹤楼一板



WG1814

黄鹤楼四板



WG1816

鳌鱼脊兽



WG1813

黄鹤楼三板

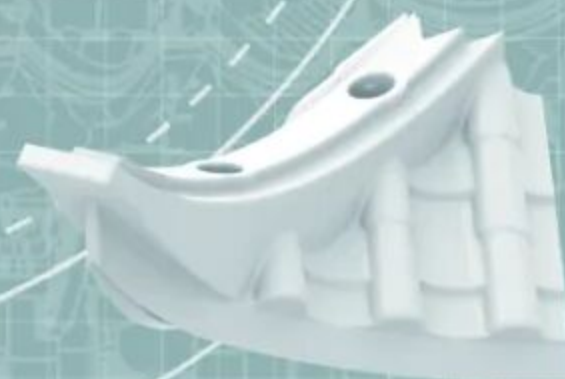

WG1815

黄鹤楼五板



WG1810

翅柱3高



features and functions

特点.功能

Main Color Matching

配色方案



White



Pantone Cool Gray 6C



Pantone Black 6C



Pantone 477C



Pantone 7550C



Pantone 1575C



Pantone 109C



Pantone 123C



Pantone 7427C



Pantone 7620C



Pantone 7717C



Color matching

Adopting 3 main colors, Orange, Red and Blue Green as the main color, the more reasonable and bold color matching on the original building, making the product more atmospheric and the whole design is more reasonable.

Yellow Crane Tower

中国湖北武汉黄鹤楼



Front

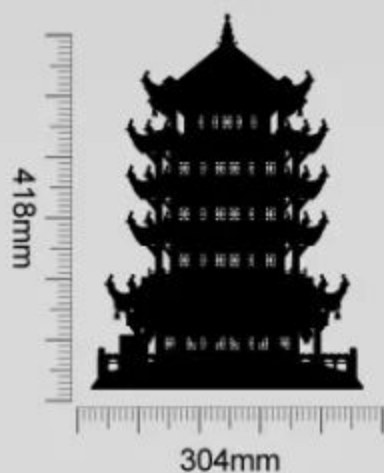

Left

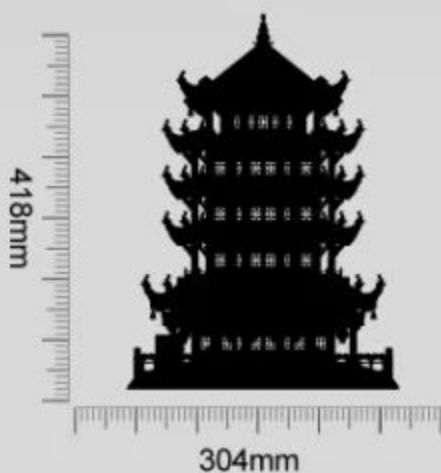

Back



Product Size:304X304X418mm



小提示：积木包分为底板包、整版配件包及普通配件包，底板包标识为A/B/C...，普通配件包编码与说明书对应，整版配件包无标识。
Tip: Building block packs are divided into baseplate packs, runner accessory packs, and standard accessory packs. Baseplate packs are labeled A/B/C..., regular accessory packs have codes that correspond to the instructions, and runner accessory packs have no labels.



- Open the product packaging correctly and classify the building block packs by type.

用正确方式拆解产品外包装,按积木包类型进行分类。



- Confirm the quantity of building block packs and cross-check them with the pack identifiers and the instructions.

确认积木包数量,对照积木包标识和说明书步骤。



- Open the building block packs according to the pack identifier steps. Sort them in order by type and color for easier assembly.

按积木包标识步骤拆开积木包,按顺序以类型、颜色进行分类以便搭建。



- Assemble your building block model following the steps in the instruction manual.

按说明书步骤拼装并完成你的积木模型。



1:1 Physical Reference Table

十字棒配件1:1尺寸参照表



Instructions For Use

让安装更简单



2 $(1 \times 2) = 2$



3 $(1 \times 3) = 3$

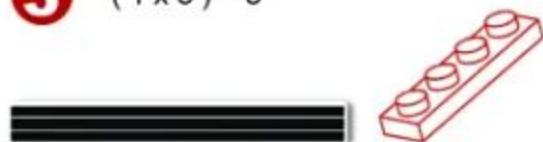

4 $(1 \times 4) = 4$



5 $(1 \times 5) = 5$



6 $(1 \times 6) = 6$



7 $(1 \times 7) = 7$



8 $(1 \times 8) = 8$



9 $(1 \times 9) = 9$



10 $(1 \times 10) = 10$



12 $(1 \times 12) = 12$



16 $(1 \times 16) = 16$



PARTS LIST

配件清单

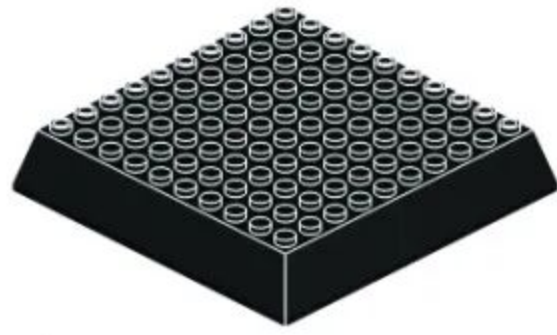

x4



x8



x2



x1



x4



x6



x8



x4



x4



x10



x12



x5



x4



x4



x10

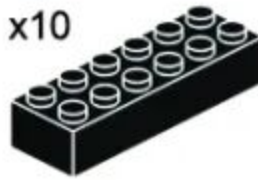

x4



x5



x6



x10



x4



x4

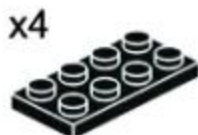

x8



x1



x1



x1



x1



x1



x1



x1



x1



x4



x24



x1



x2



x1



x36



x11



x4



x12



x4



x4



x12



x10



x4



x24



x4



x4



x12

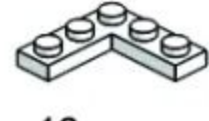

x16

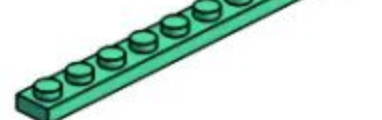

x12



x16



x8



x16













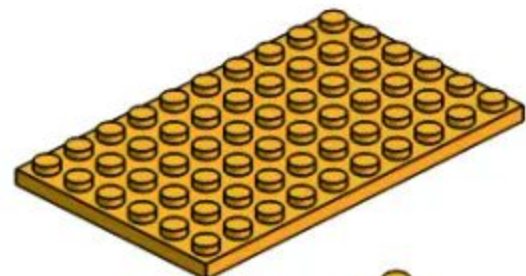



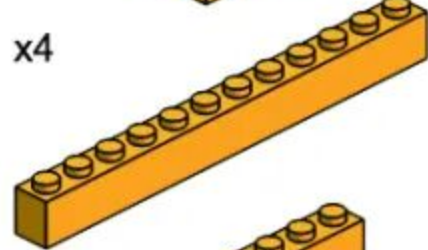







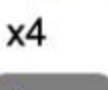

































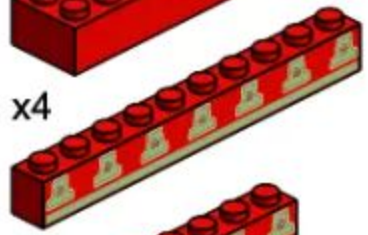

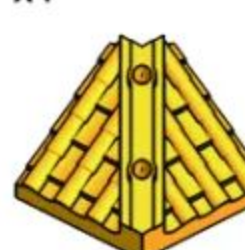

















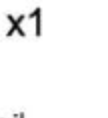

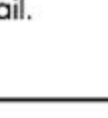

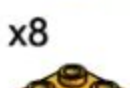

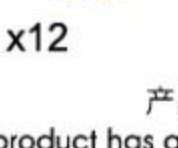
x16

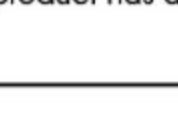
产品有增补件请以实物为准

If product has additional parts, please in kind prevail.

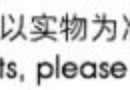









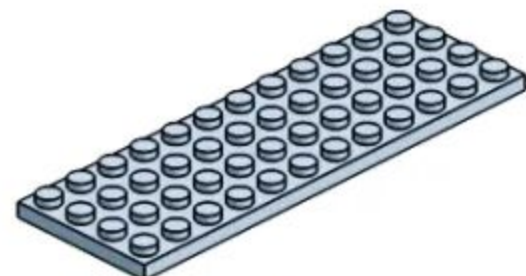

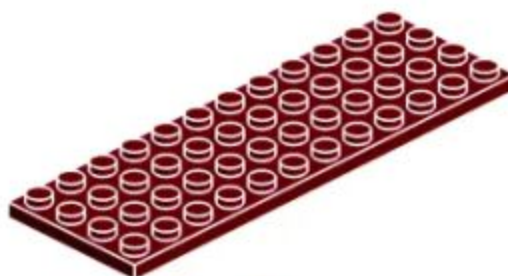

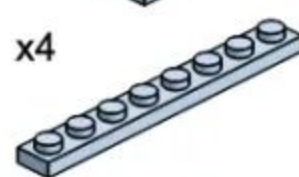
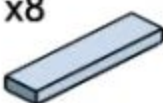



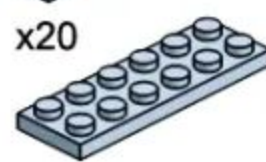



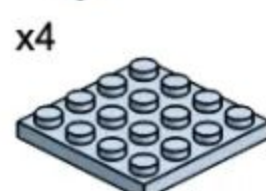

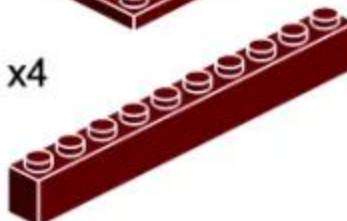







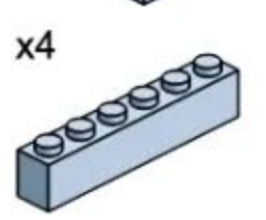
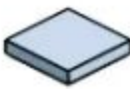









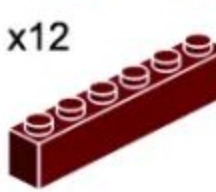

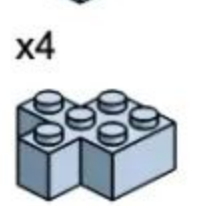



















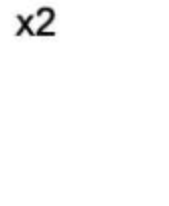

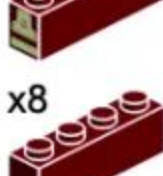
PARTS LIST

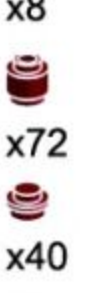
配件清单

- | | | | | |
|-------------------------------------------------------------------------------------|-------------------------------------------------------------------------------------|---------------------------------------------------------------------------------------|----------------------------------------------------------------------------------------|---------------------------------------------------------------------------------------|
|  |  |  |  |  |
| x4 | x4 | x4 | x8 | x8 |
|  |  |  |  |  |
| x4 | x12 | x24 | x4 | x52 |
|  |  |  |  |  |
| x2 | x16 | x12 |  | x8 |
|  |  |  |  |  |
| x4 | x4 | x8 | x16 | x24 |
|  |  |  |  |  |
| x4 | x24 | x8 |  | x1 |
|  |  |  |  |  |
| x4 | x8 | x12 | x8 | x1 |
|  |  |  |  |  |
| x8 | x4 | x12 | x8 | x16 |
|  |  |  |  |  |
| x4 | x8 | x4 |  | x4 |
|  |  |  |  |  |
| x4 | x12 | x4 |  | x4 |
|  |  |  |  |  |
| x4 | x12 | x8 |  | x12 |
| |  |  |  |  |
| x4 | x8 | x4 |  | x16 |
| |  |  |  |  |
| x4 | x12 | x4 |  | x8 |
| |  |  |  |  |
| x4 | x12 | x4 |  | x12 |
| |  |  |  |  |
| x4 | x12 | x4 | | x4 |
| |  |  | |  |
| x4 | x12 | x4 | | x16 |
| |  |  | |  |
| x4 | x12 | x4 | | x124 |
| | |  | |  |
| x4 | x12 | x16 | | x1 |
| | |  | |  |
| x4 | x12 | x16 | | x1 |
| | |  | |  |
| x4 | x12 | x16 | | x1 |
| | |  | | |
| x4 | x12 | x16 | | x1 |
| | | | | |
| x4 | x12 | x16 | | x1 |
| | | | | |
| x4 | x12 | x16 | | x1 |
| | | | | |
| x4 | x12 | x16 | | x1 |
| | | | | |
| x4 | x12 | x16 | | x1 |
| | | | | |
| x4 | x12 | x16 | | x1 |
| | | | | |
| x4 | x12 | x16 | | x1 |
| | | | | |
| x4 | x12 | x16 | | x1 |
| | | | | |
| x4 | x12 | x16 | | x1 |
| | | | | |
| x4 | x12 | x16 | | x1 |
| | | | | |
| x4 | x12 | x16 | | x1 |
| | | | | |
| x4 | x12 | x16 | | x1 |
| | | | | |
| x4 | x12 | x16 | | x1 |
| | | | | |
| x4 | x12 | x16 | | x1 |
| | | | | |
| x4 | x12 | x16 | | x1 |
| | | | | |
| x4 | x12 | x16 | | x1 |
| | | | | |
| x4 | x12 | x16 | | x1 |
| | | | | |
| x4 | x12 | x16 | | x1 |
| | | | | |
| x4 | x12 | x16 | | x1 |
| | | | | |
| x4 | x12 | x16 | | x1 |
| | | | | |
| x4 | x12 | x16 | | x1 |
| | | | | |
| x4 | x12 | x16 | | x1 |
| | | | | |
| x4 | x12 | x16 | | x1 |
| | | | | |
| x4 | x12 | x16 | | x1 |
| | | | | |
| x4 | x12 | x16 | | x1 |
| | | | | |
| x4 | x12 | x16 | | |

PARTS LIST

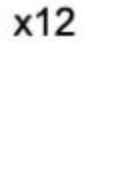
配件清单

				
x4	x8	x4	x20	x40
				
x4	x12	x4	x36	x64
				
x20	x4	x4	x16	x8
				
x4	x8	x4	x8	x12
				
x4	x12	x4	x4	x28
				
x4	x117	x12	x4	x28
				
x4	x4	x12	x12	x8
				
x4	x12	x12	x8	x8
				
x16	x2	x4	x16	x80
				
x4	x36	x24	x4	x48
				
x8		x24	x124	x28
				
x16	x8	x16	x16	x60
				
x2	x20	x8	x28	x8
				
	x48	x4	x32	x72
		x8		
	x20		x12	x40
				x52

产品有增补件请以实物为准

If product has additional parts, please in kind prevail.



280PCS

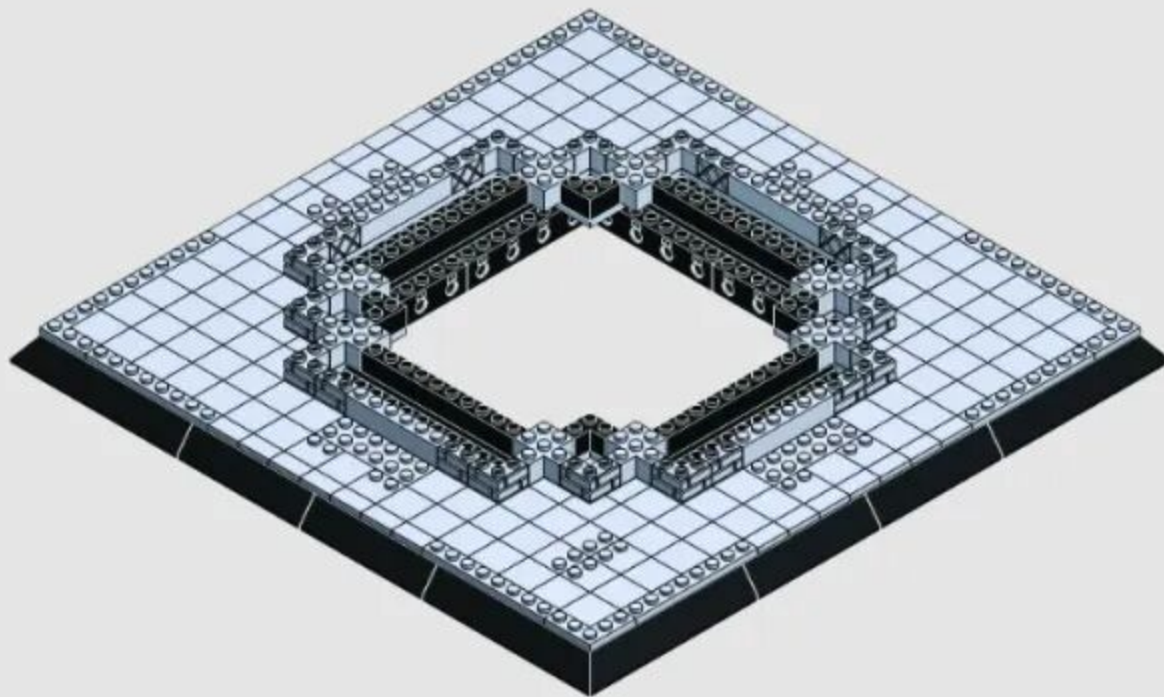

1-1

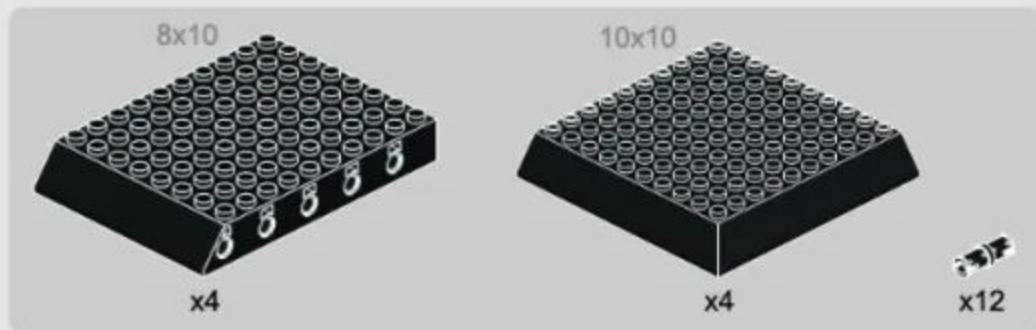

微信扫一扫
补件更简单

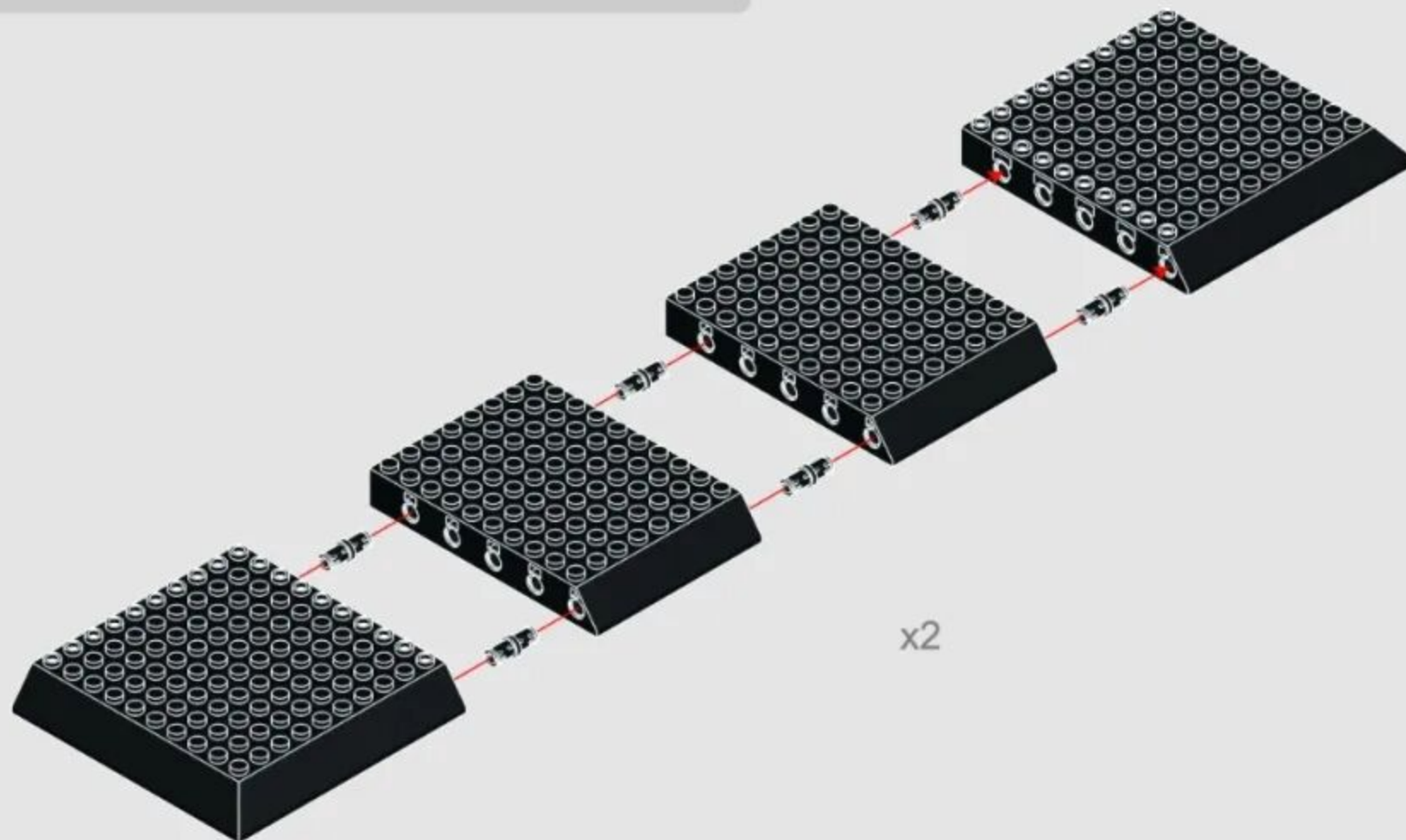

1-2

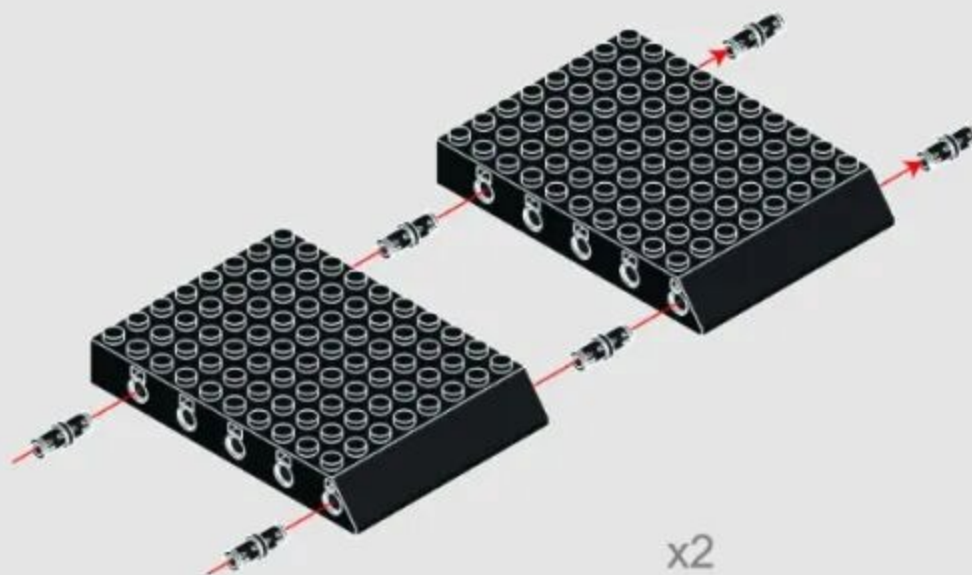
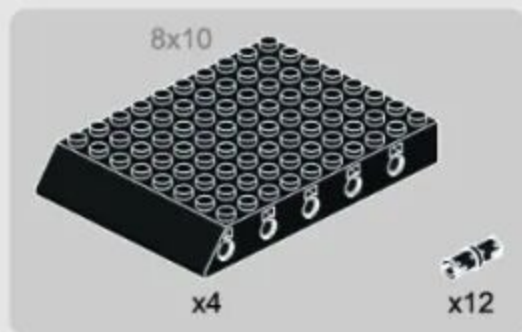

1-3

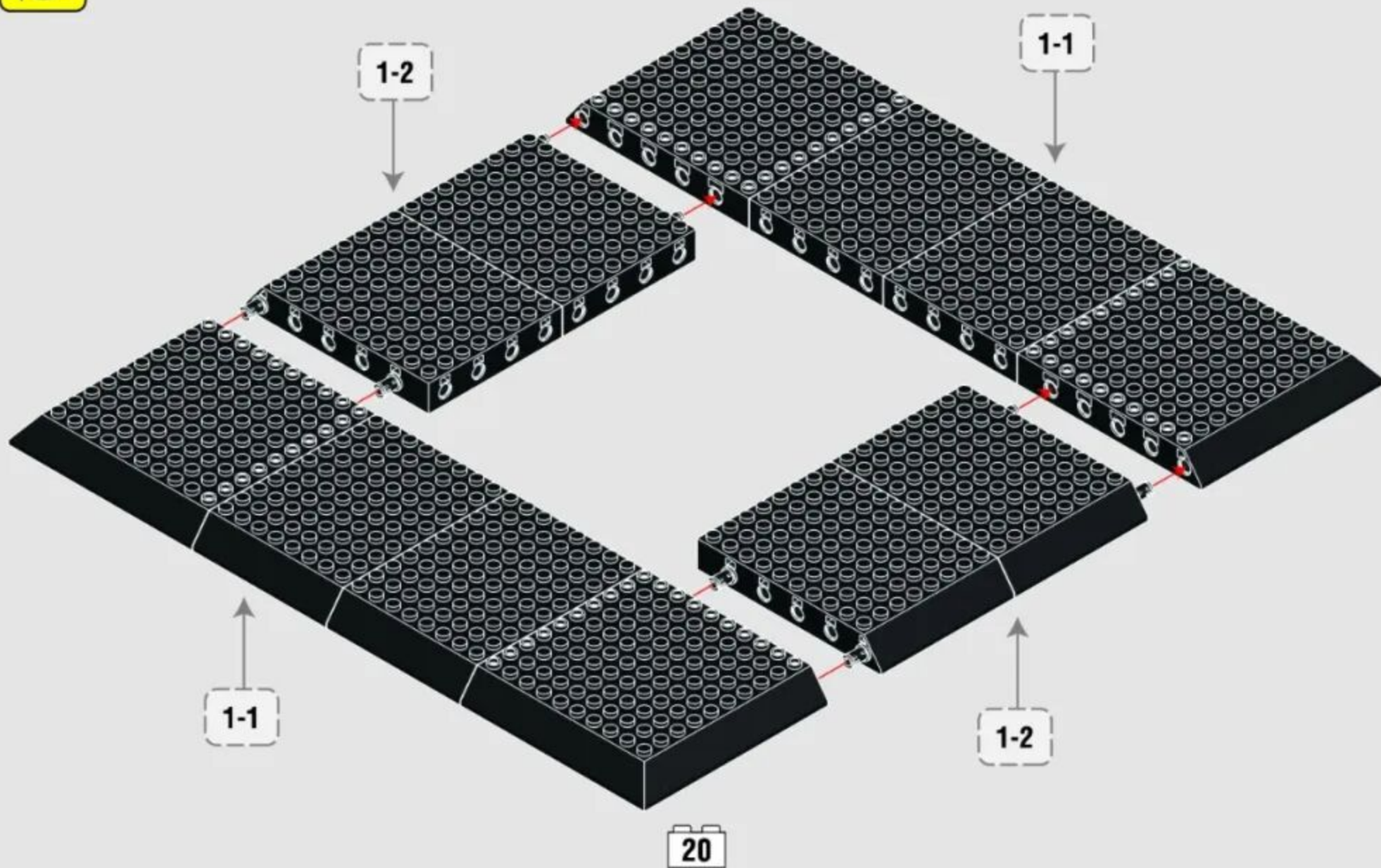

1-4

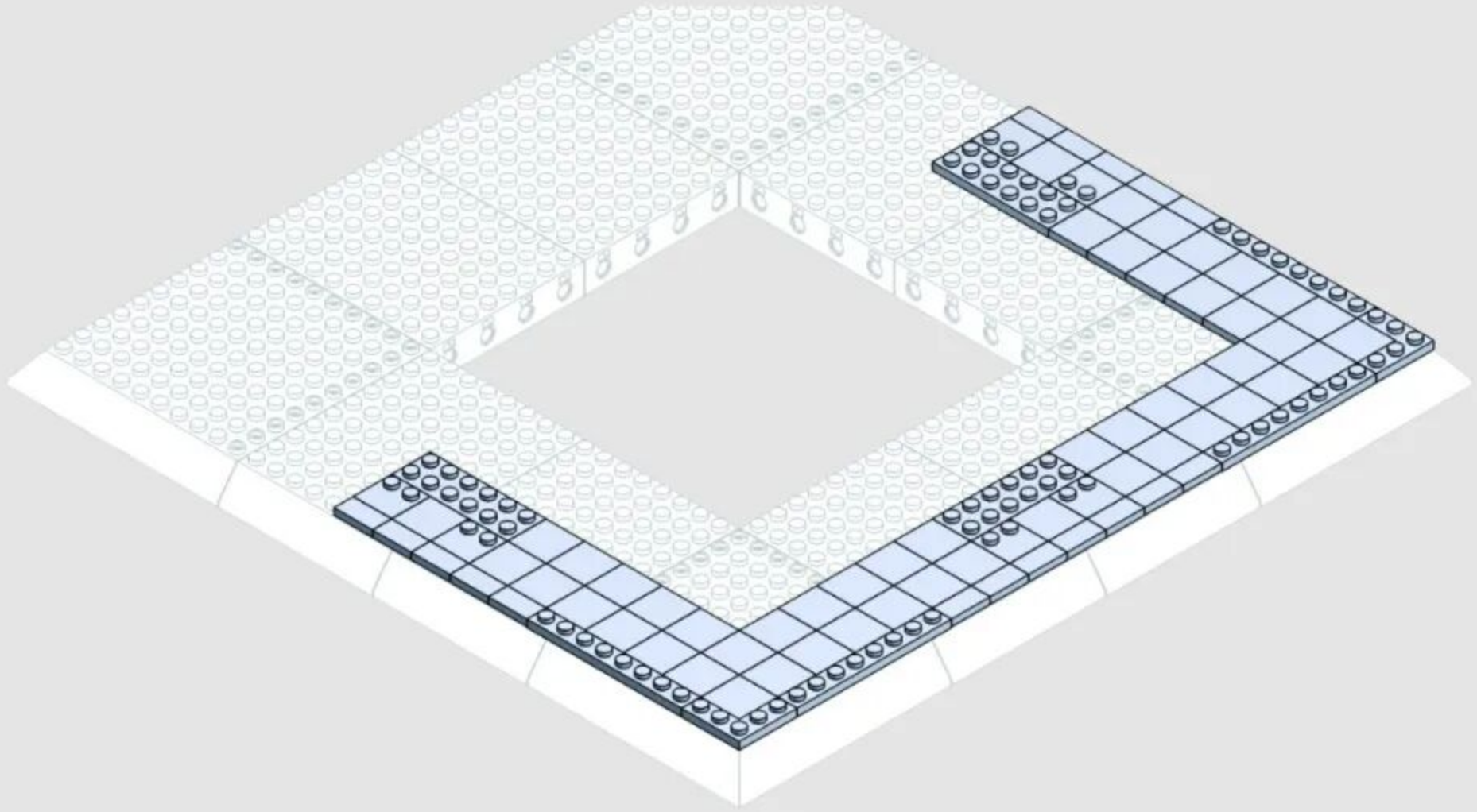
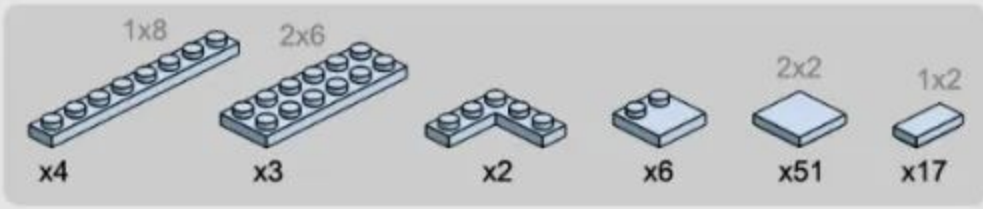

1-5

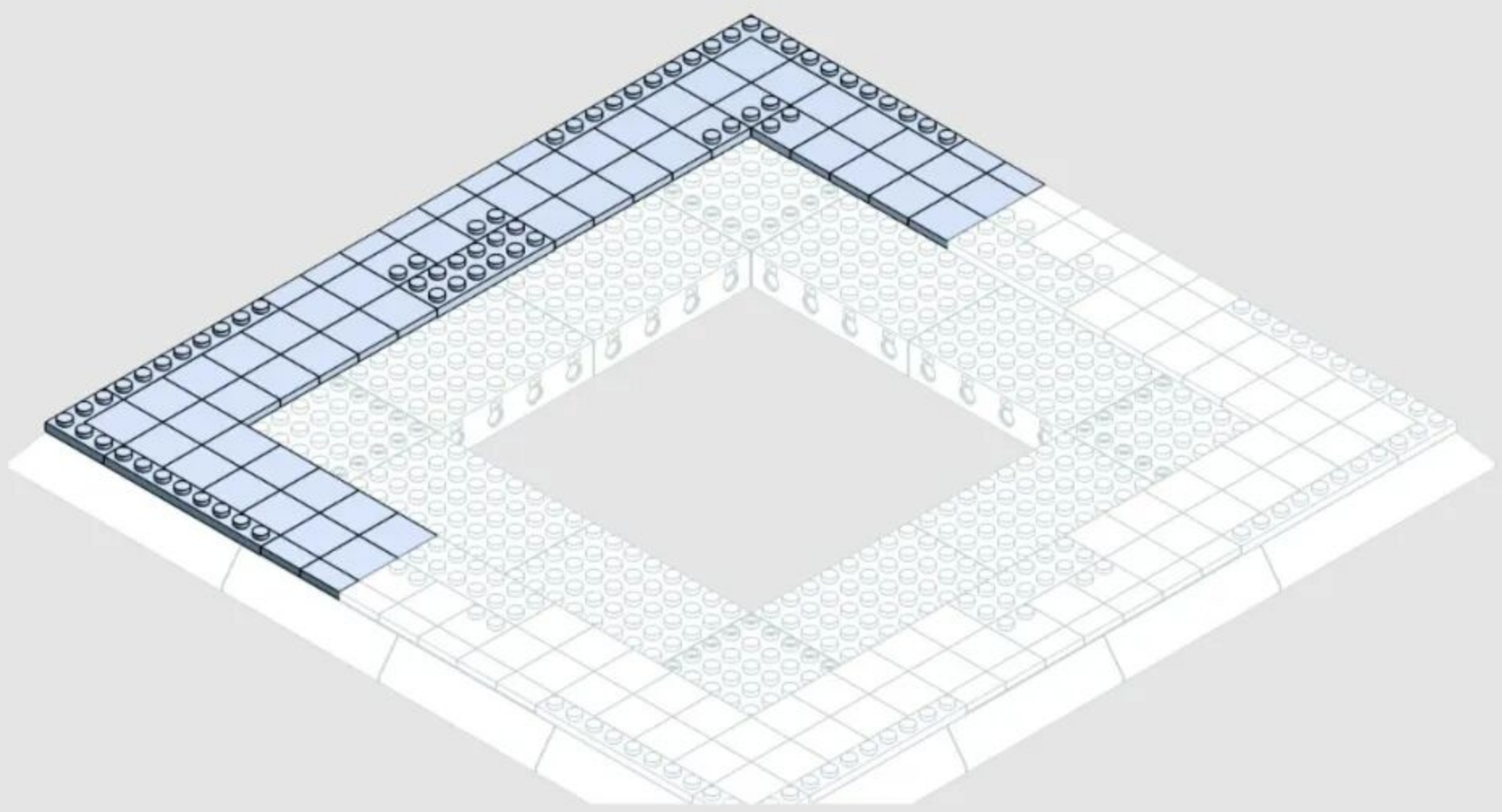
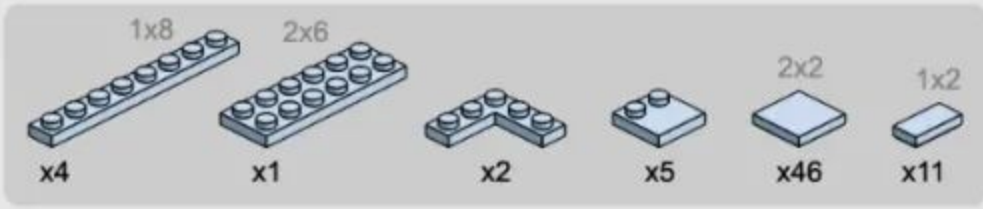

1-6

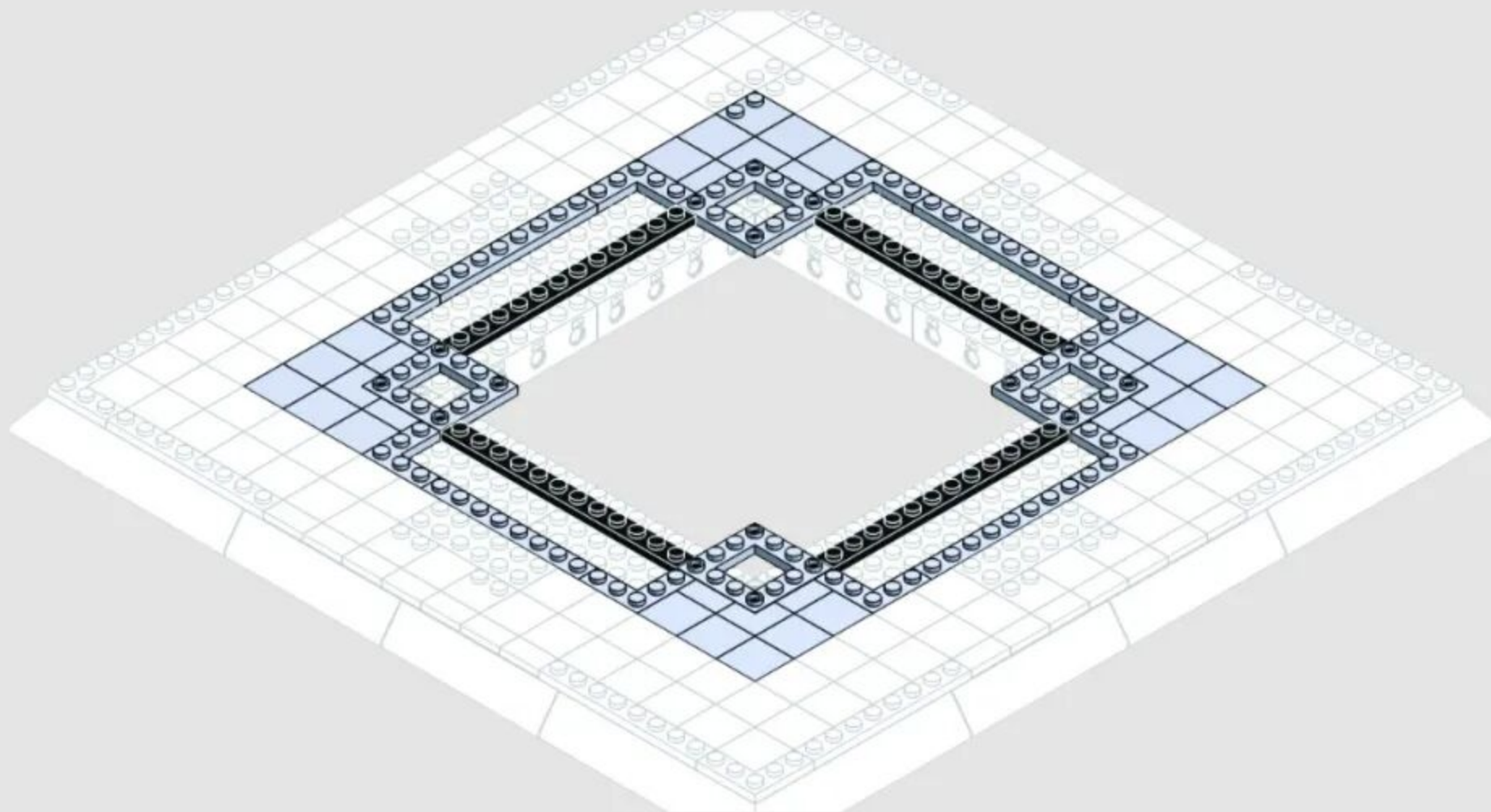
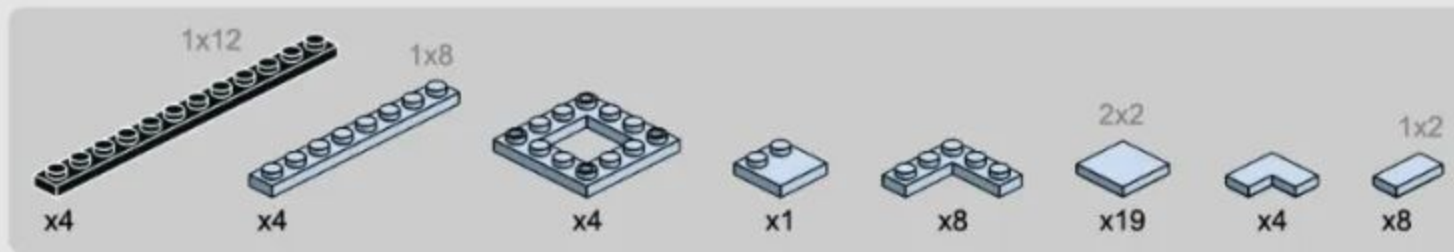

1-7

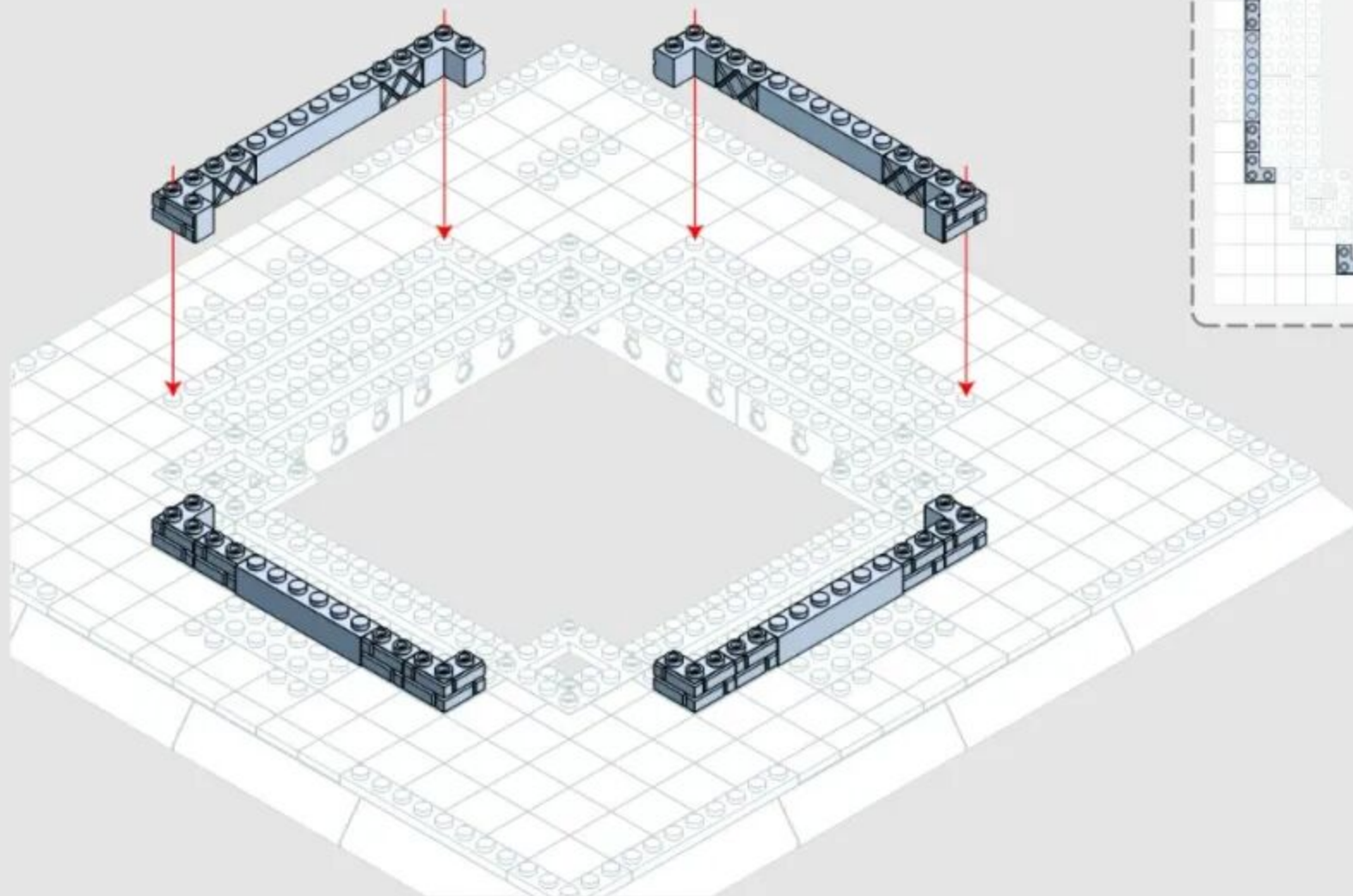

1-8

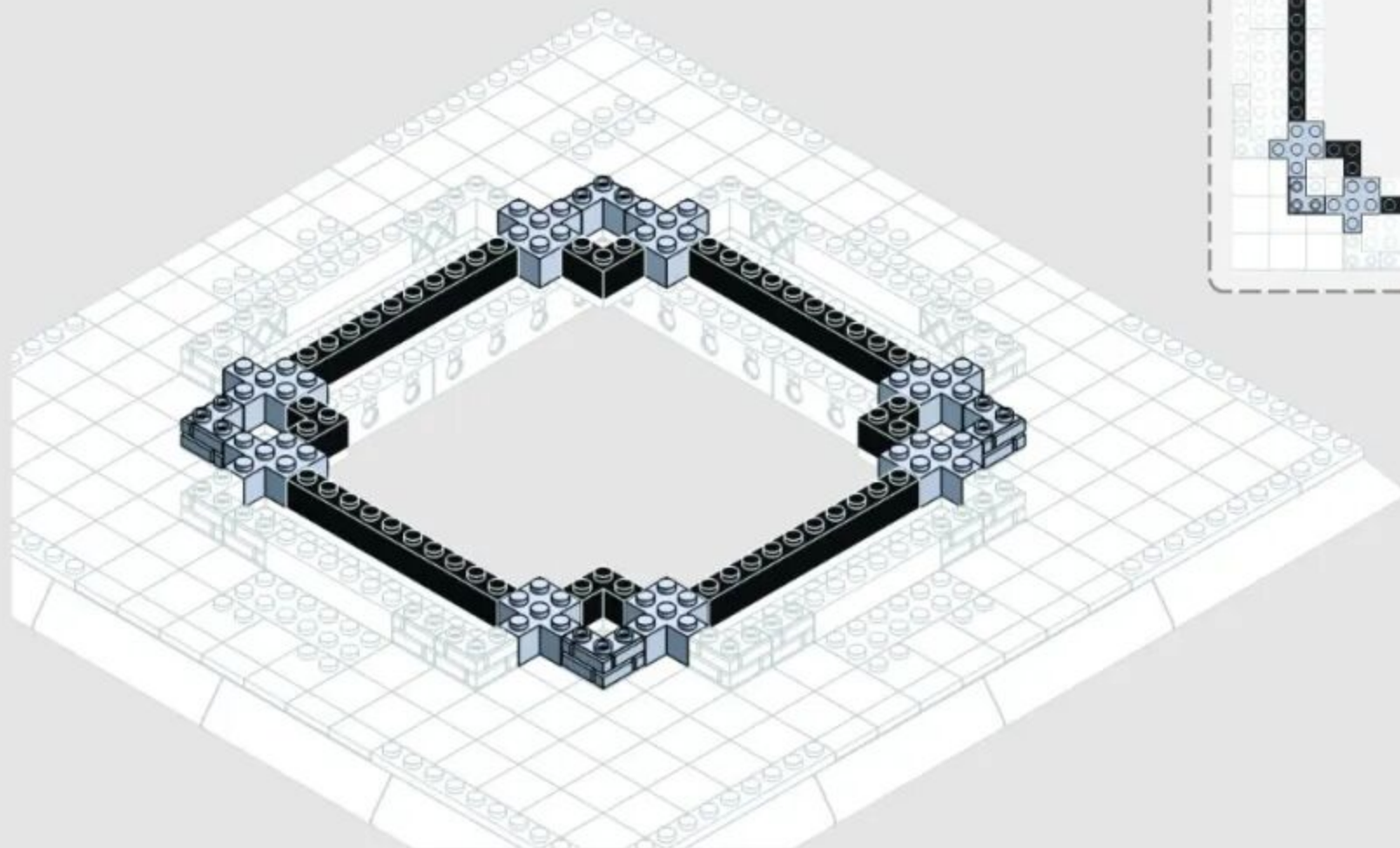
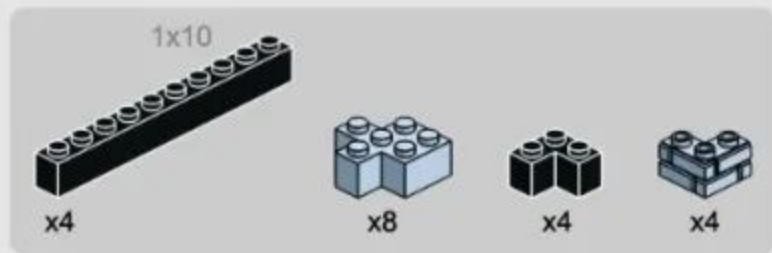



228PCS

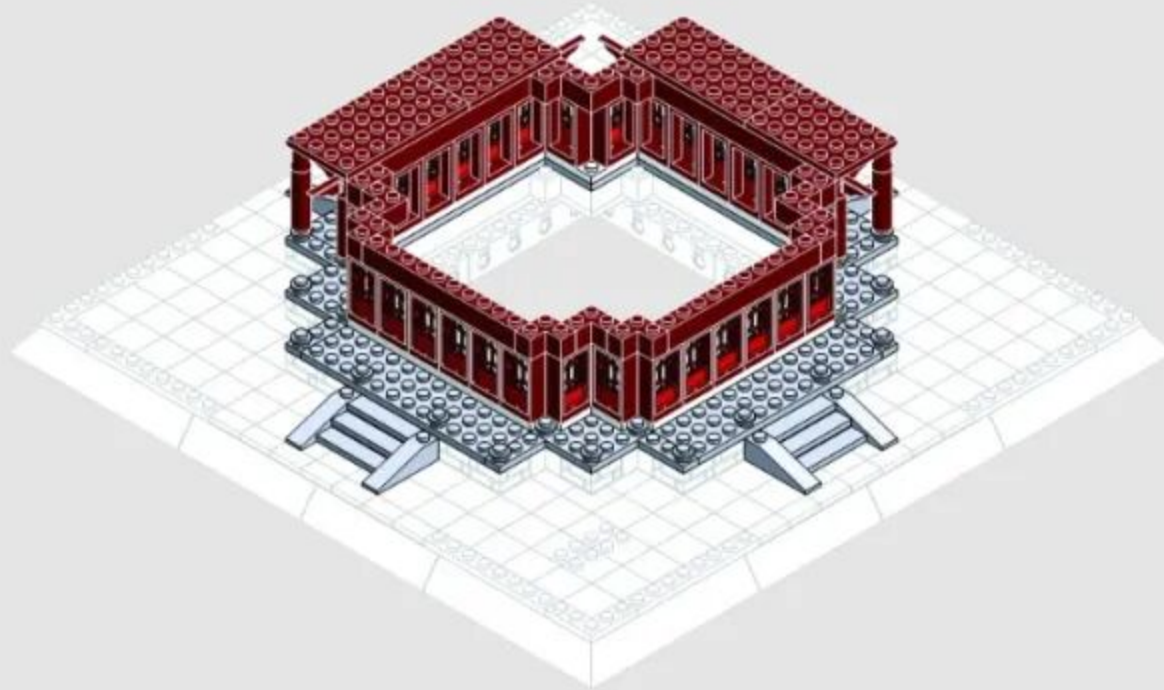

2-1

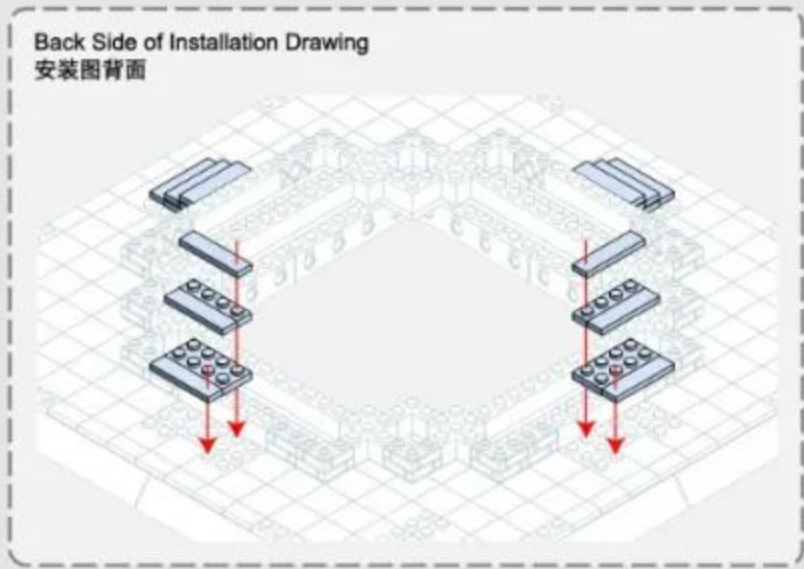
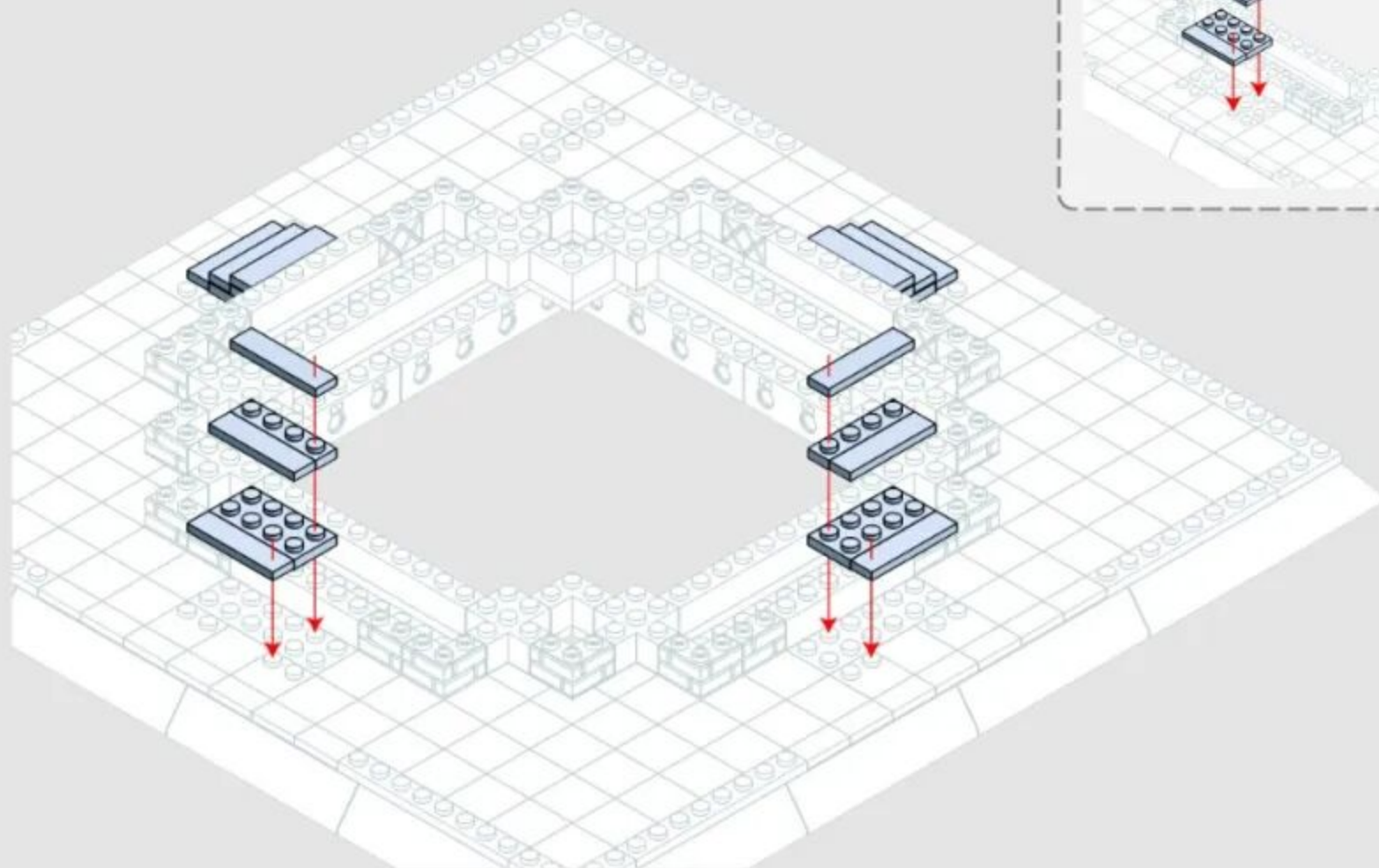
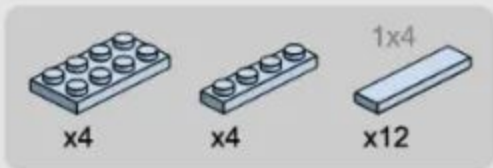

2-2

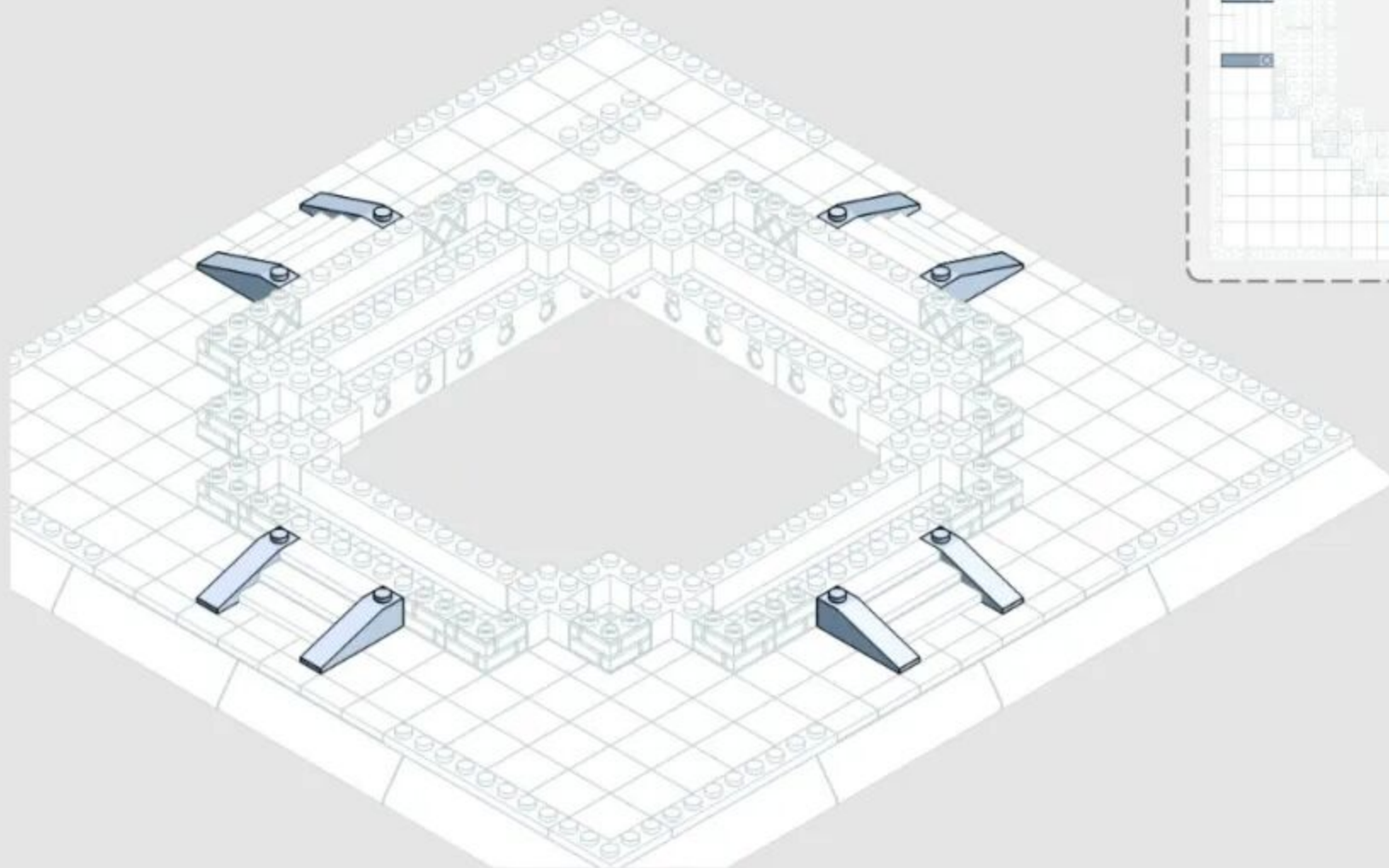

Vertical View of Installation Drawing
安装图顶面

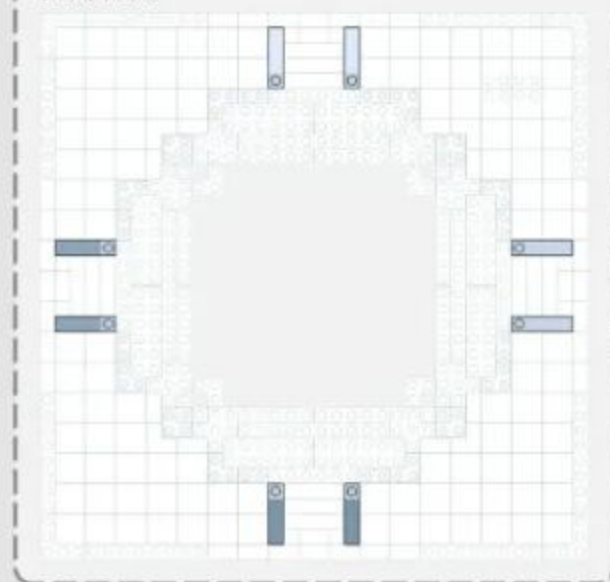

2-3

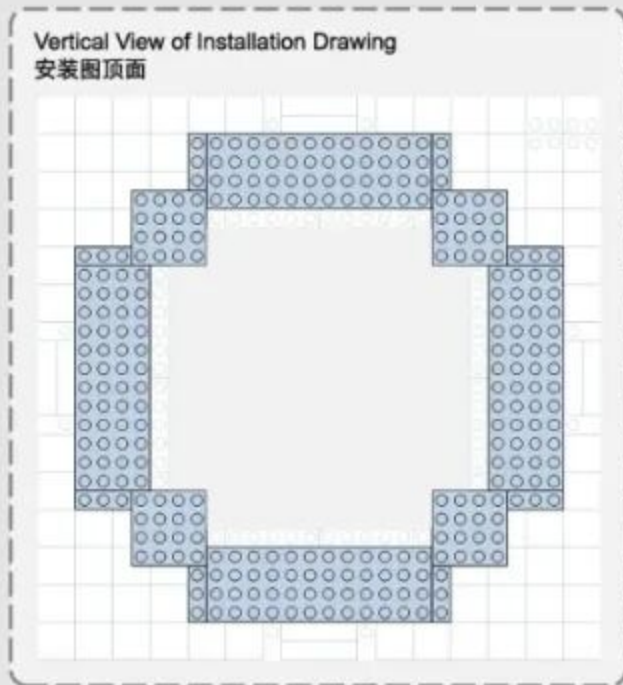
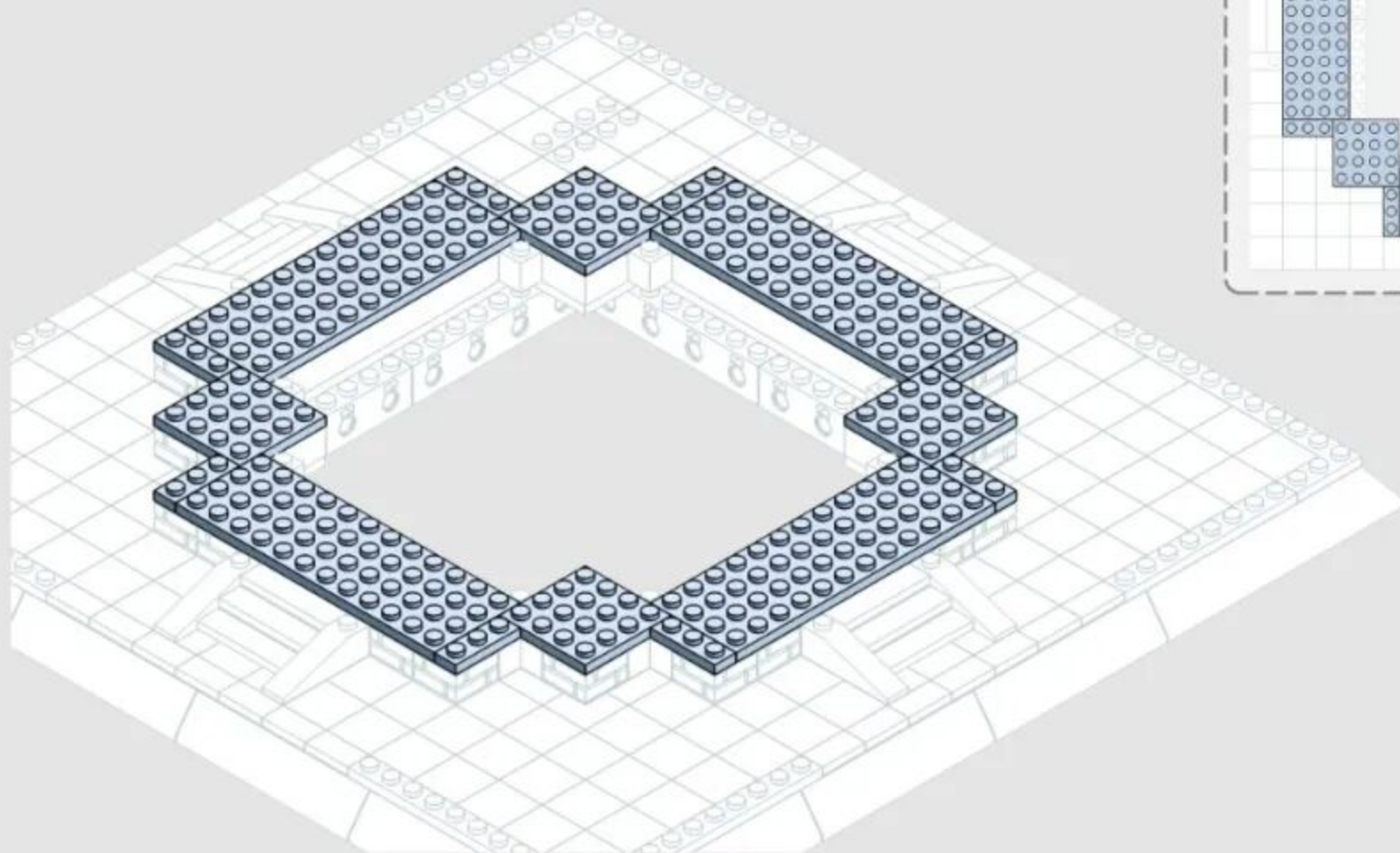
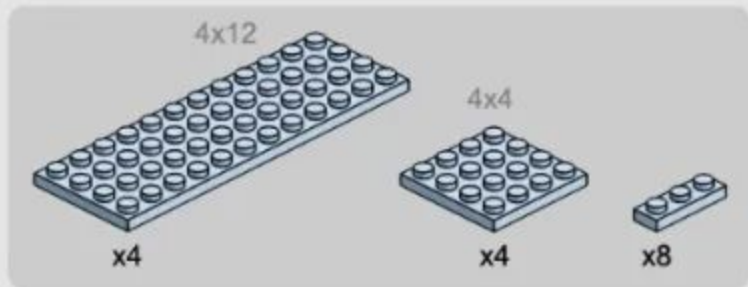

2-4

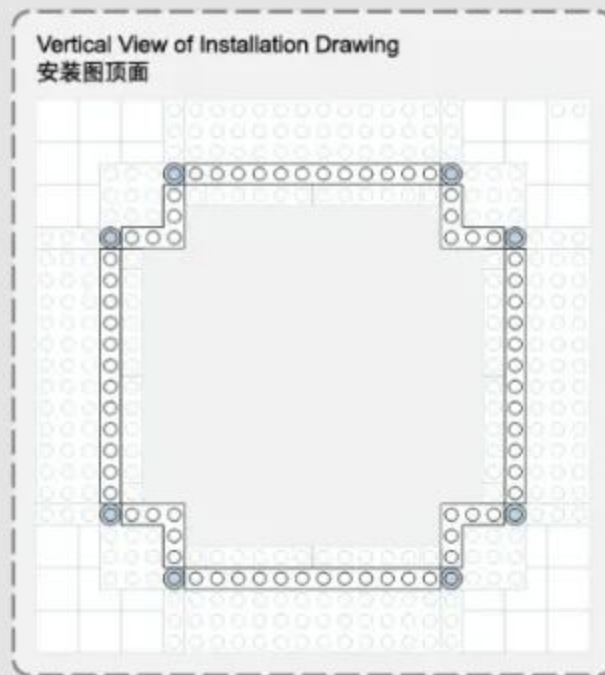
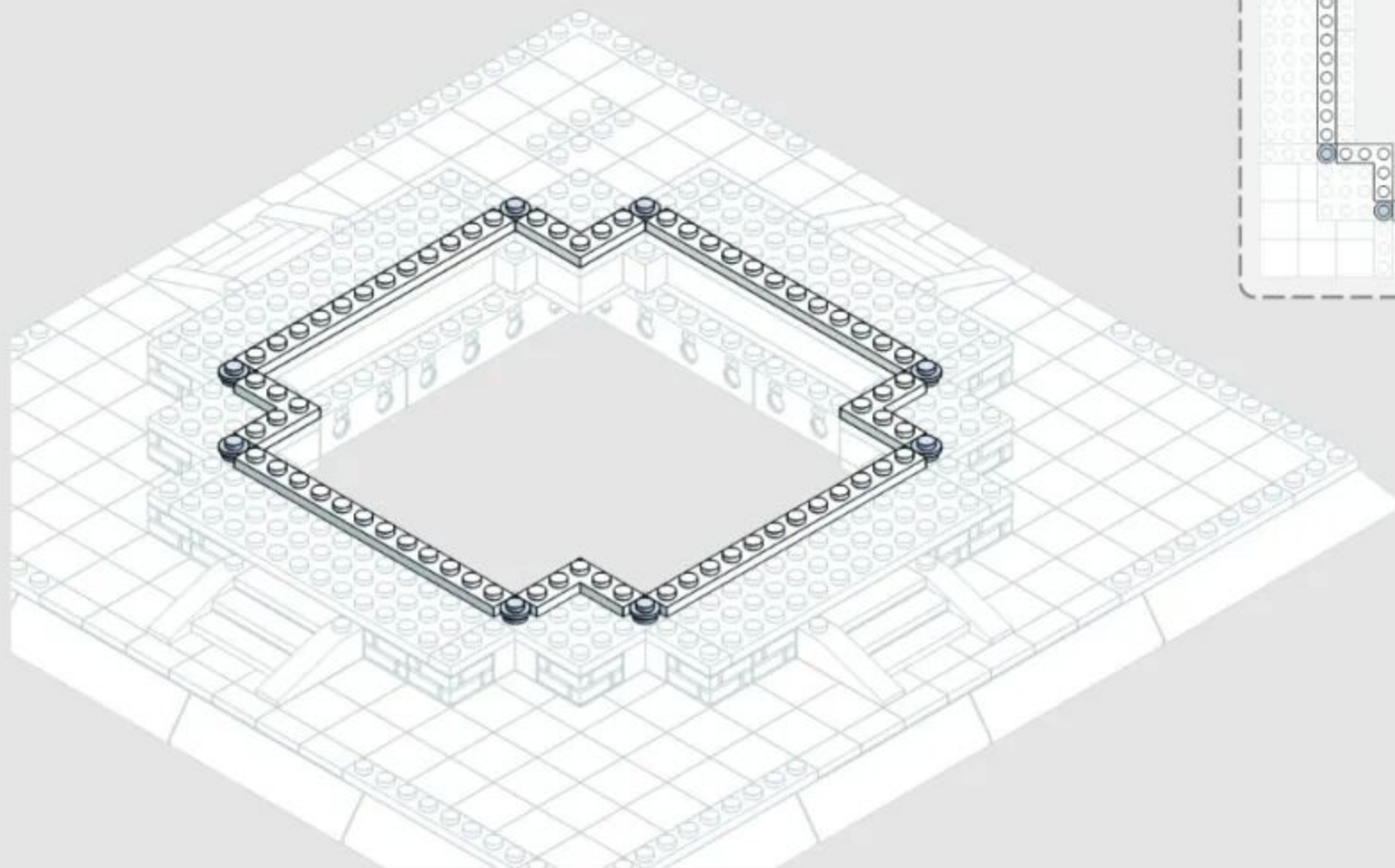
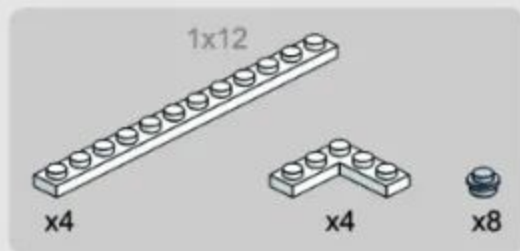

2-5



x20

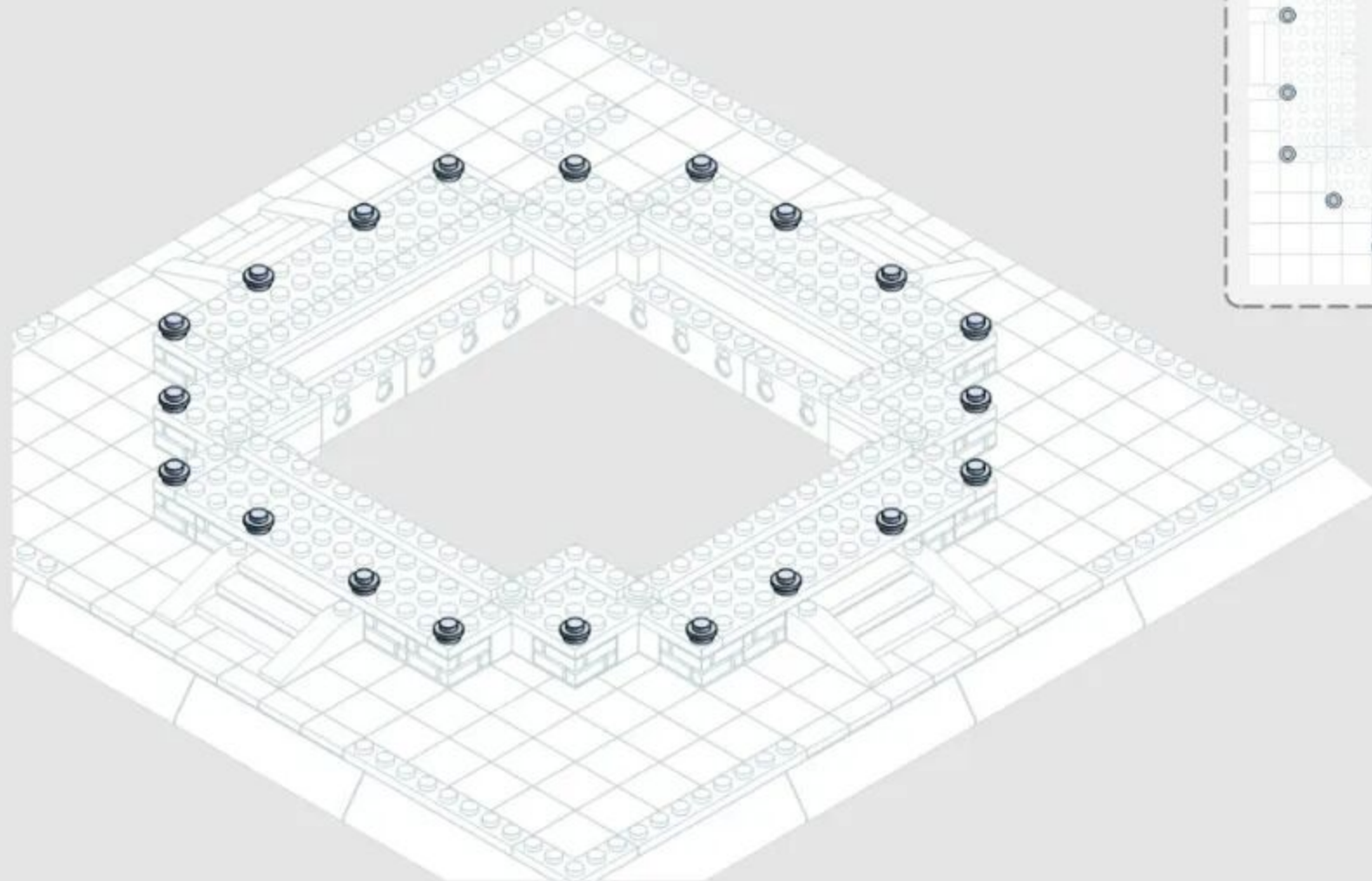

Vertical View of Installation Drawing
安装图顶面

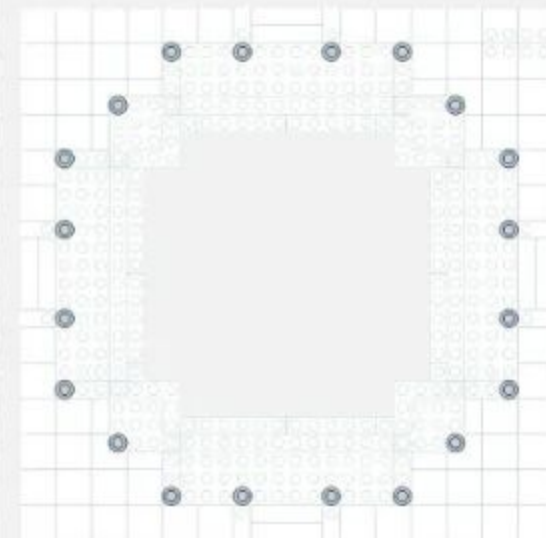

2-6

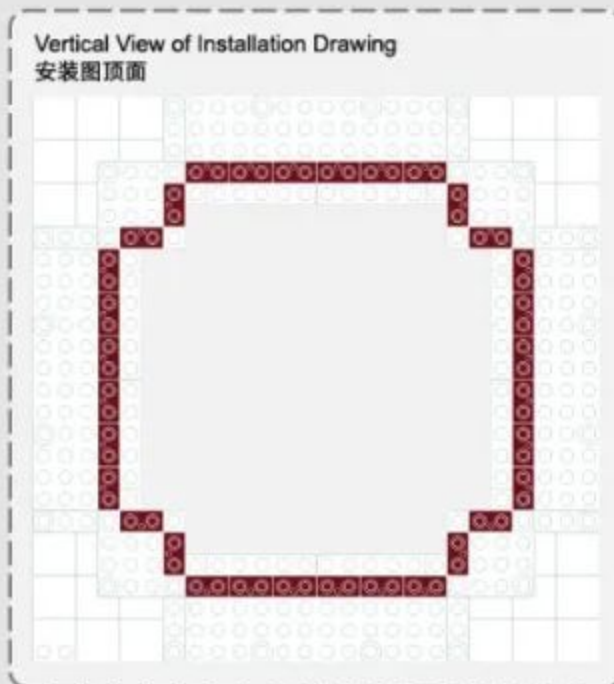
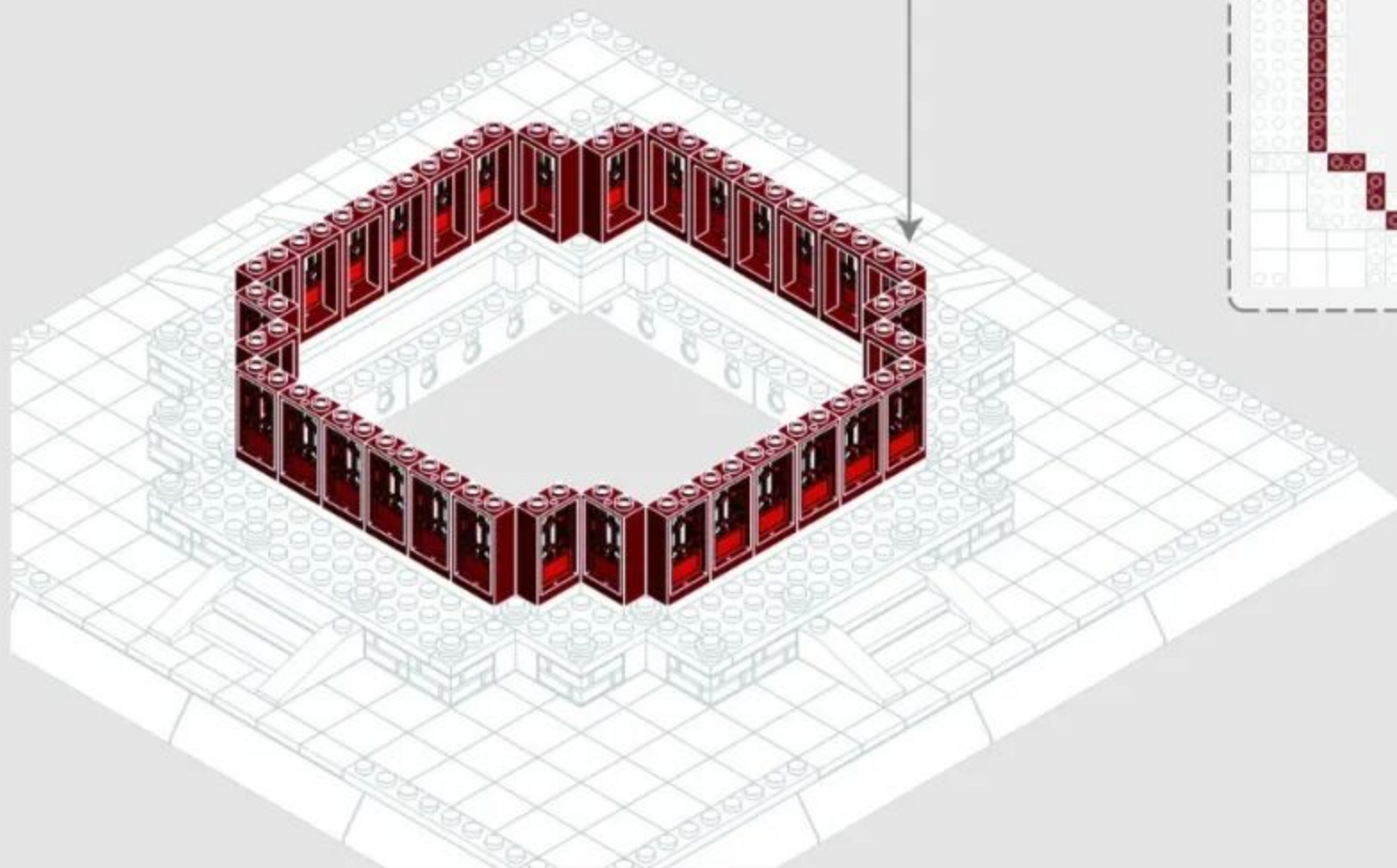

2-7

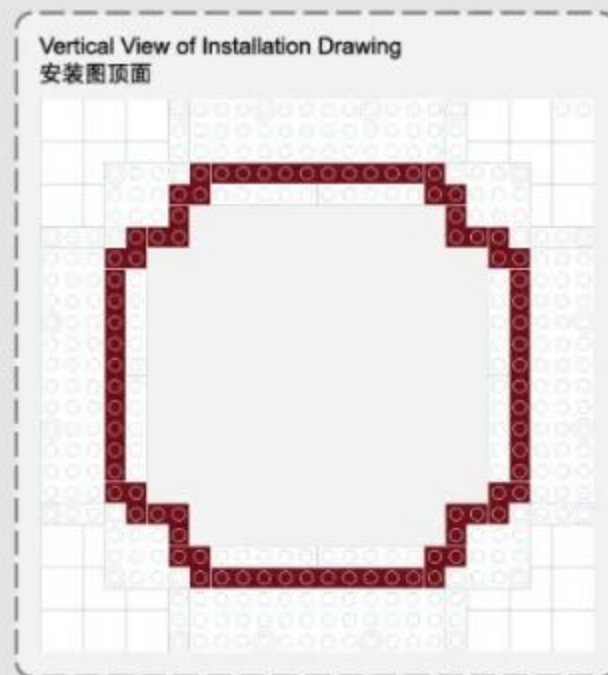
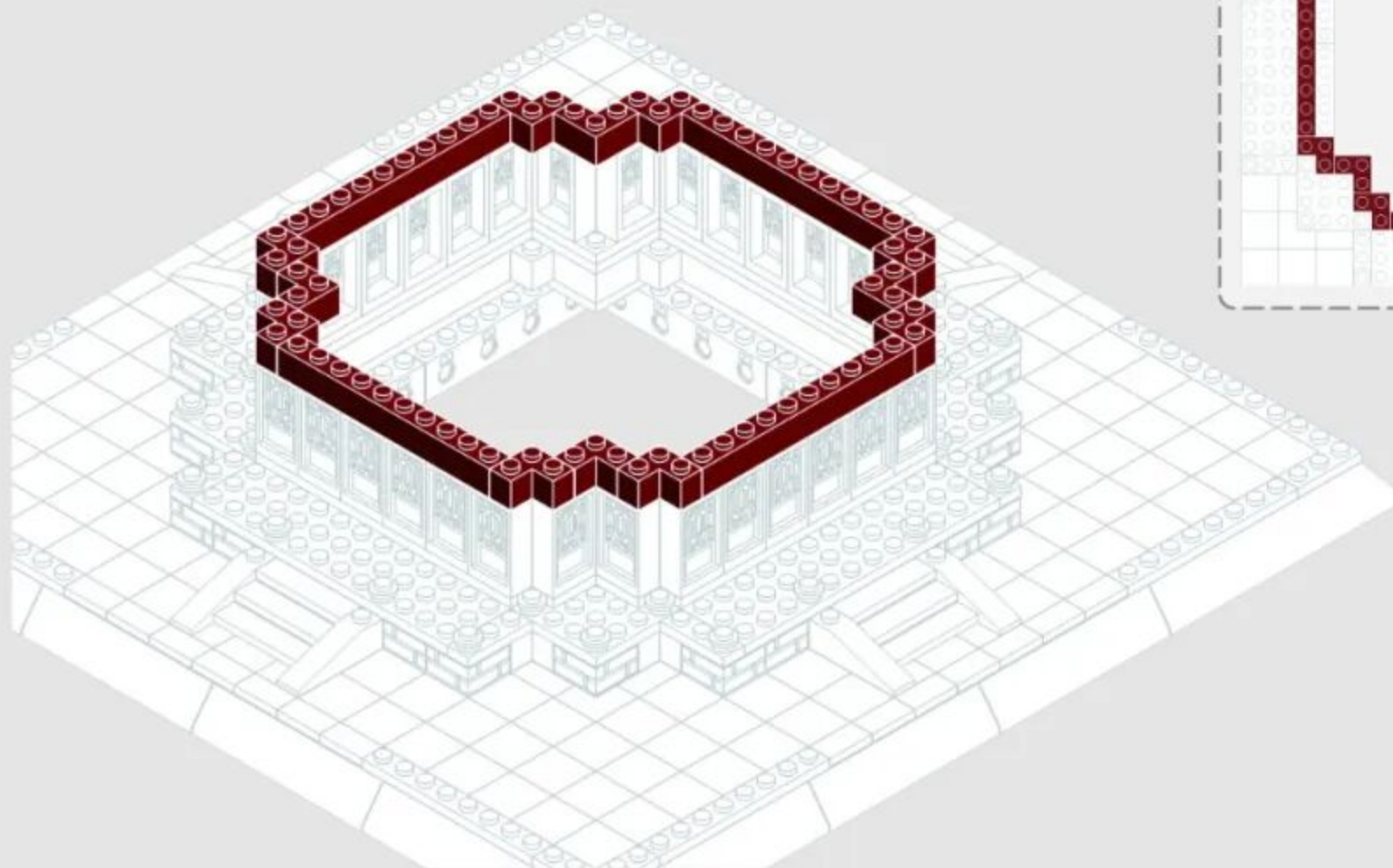
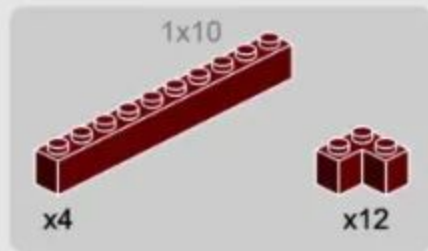

2-8

1x3



x4



x4



x8

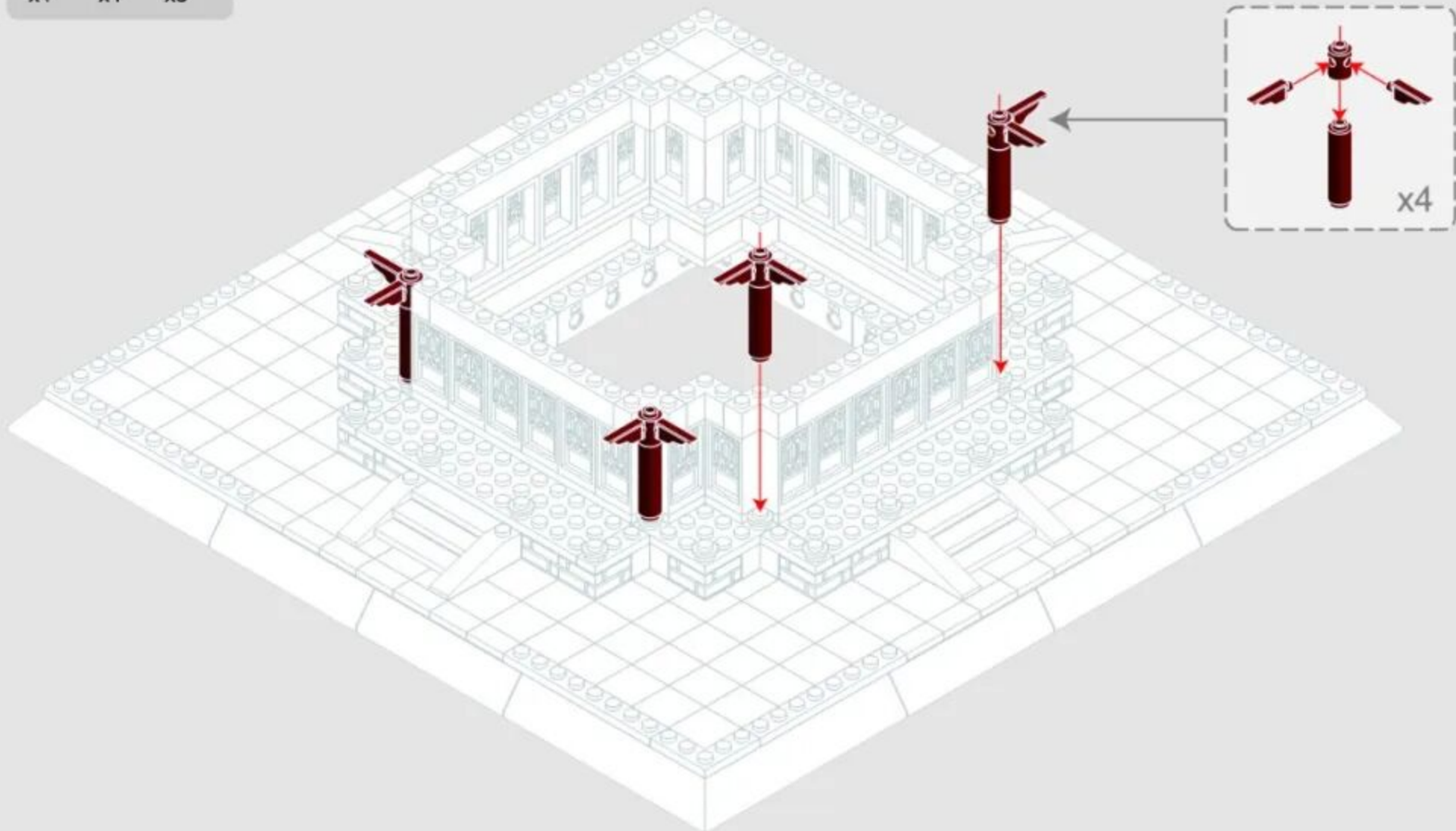

2-9

1x3



x8



x8



x8

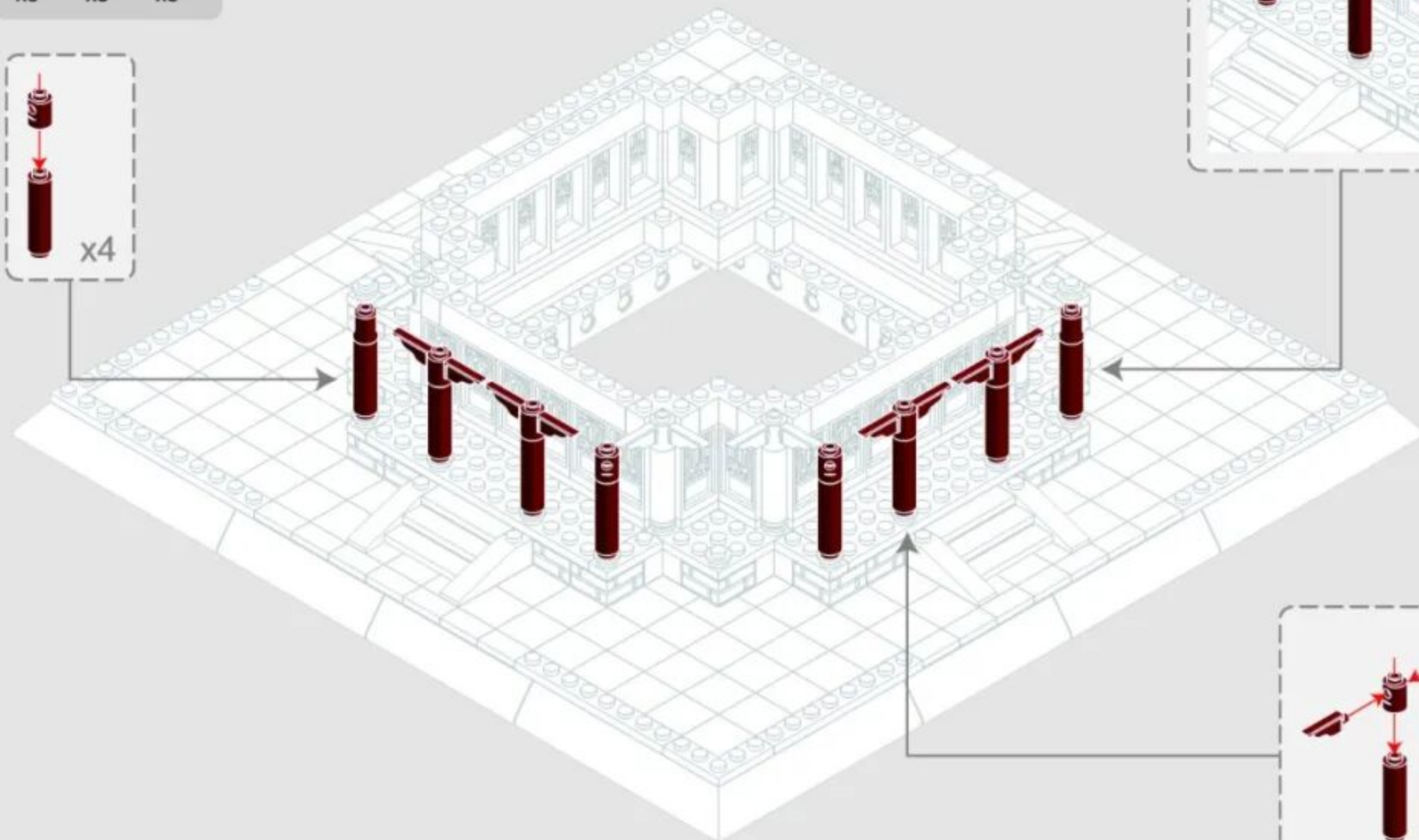
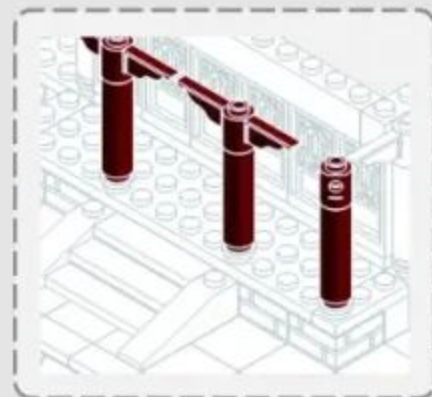

2-10

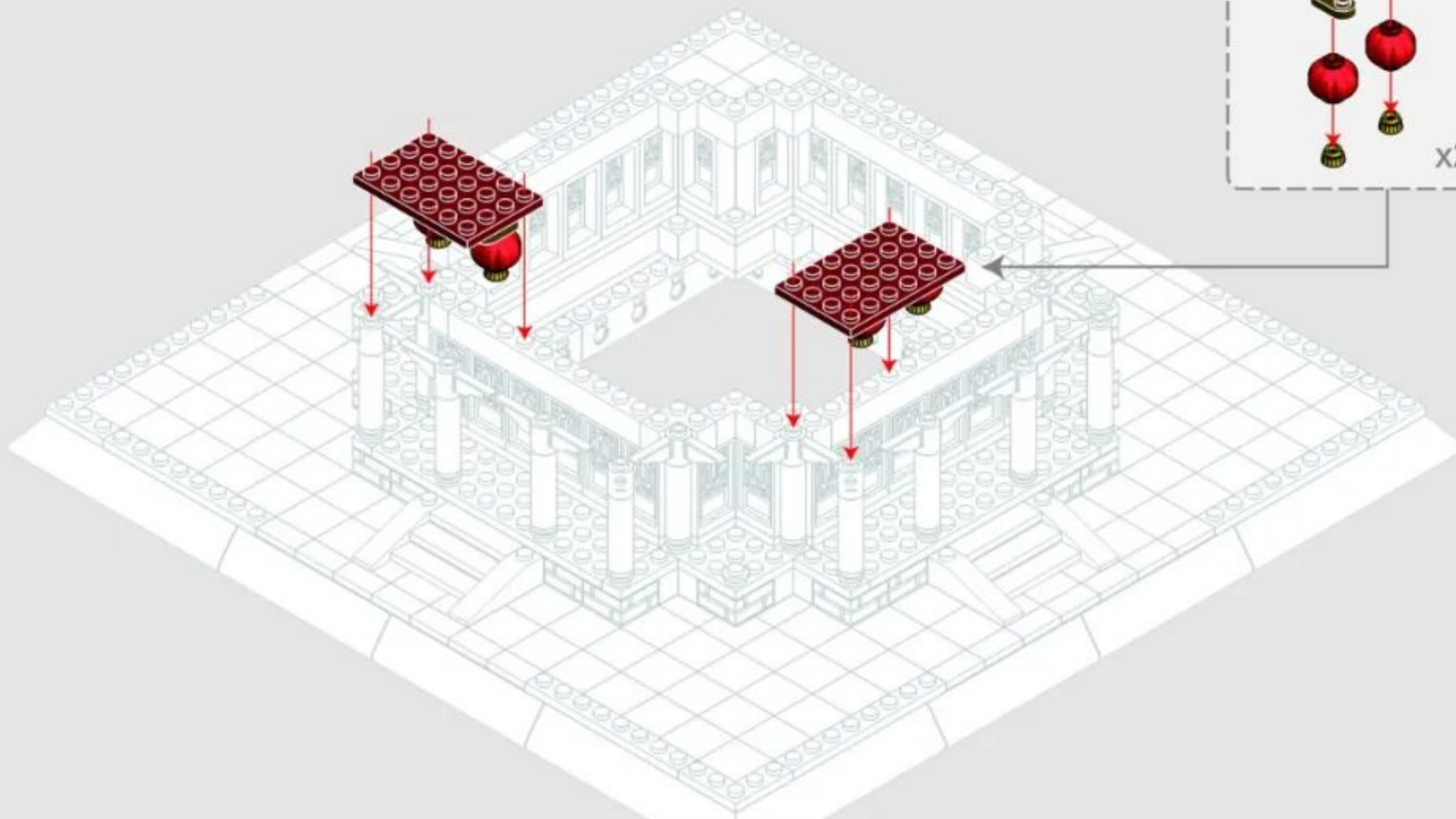
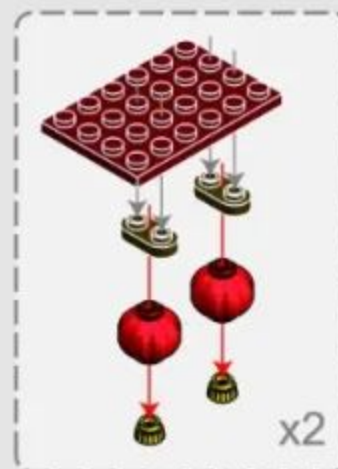
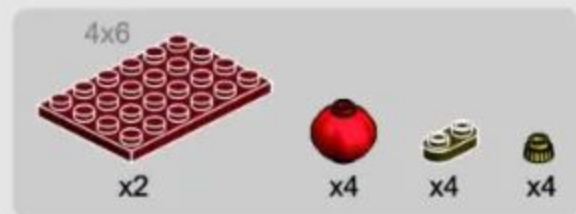

2-11

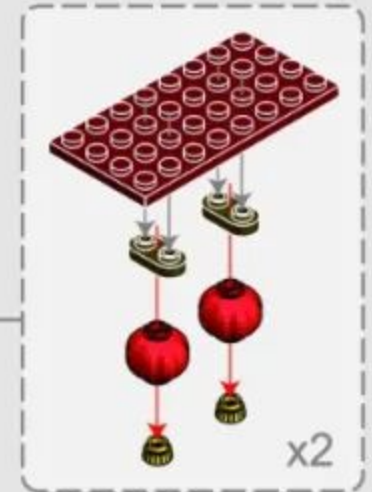
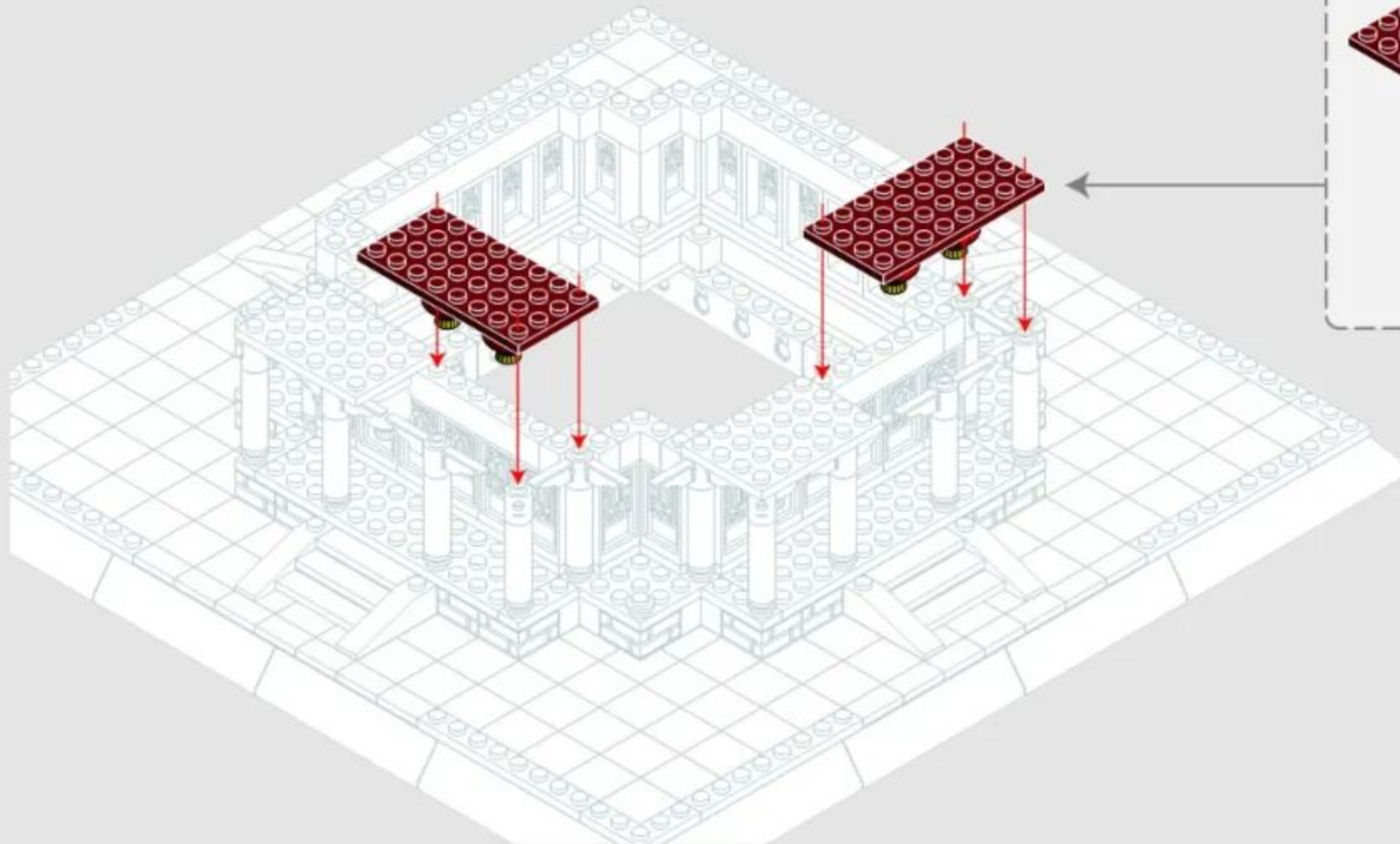
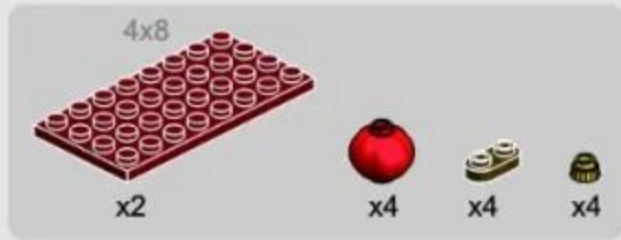



282PCS

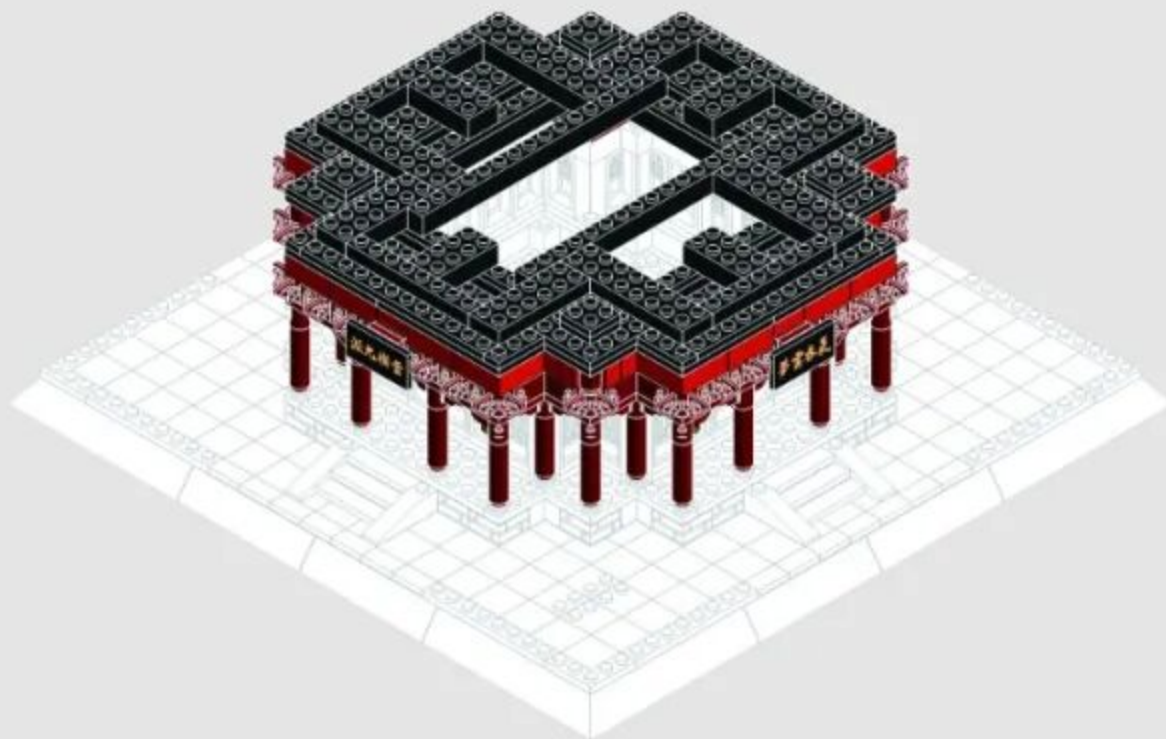

3-1

1x3



x4



x4



x8

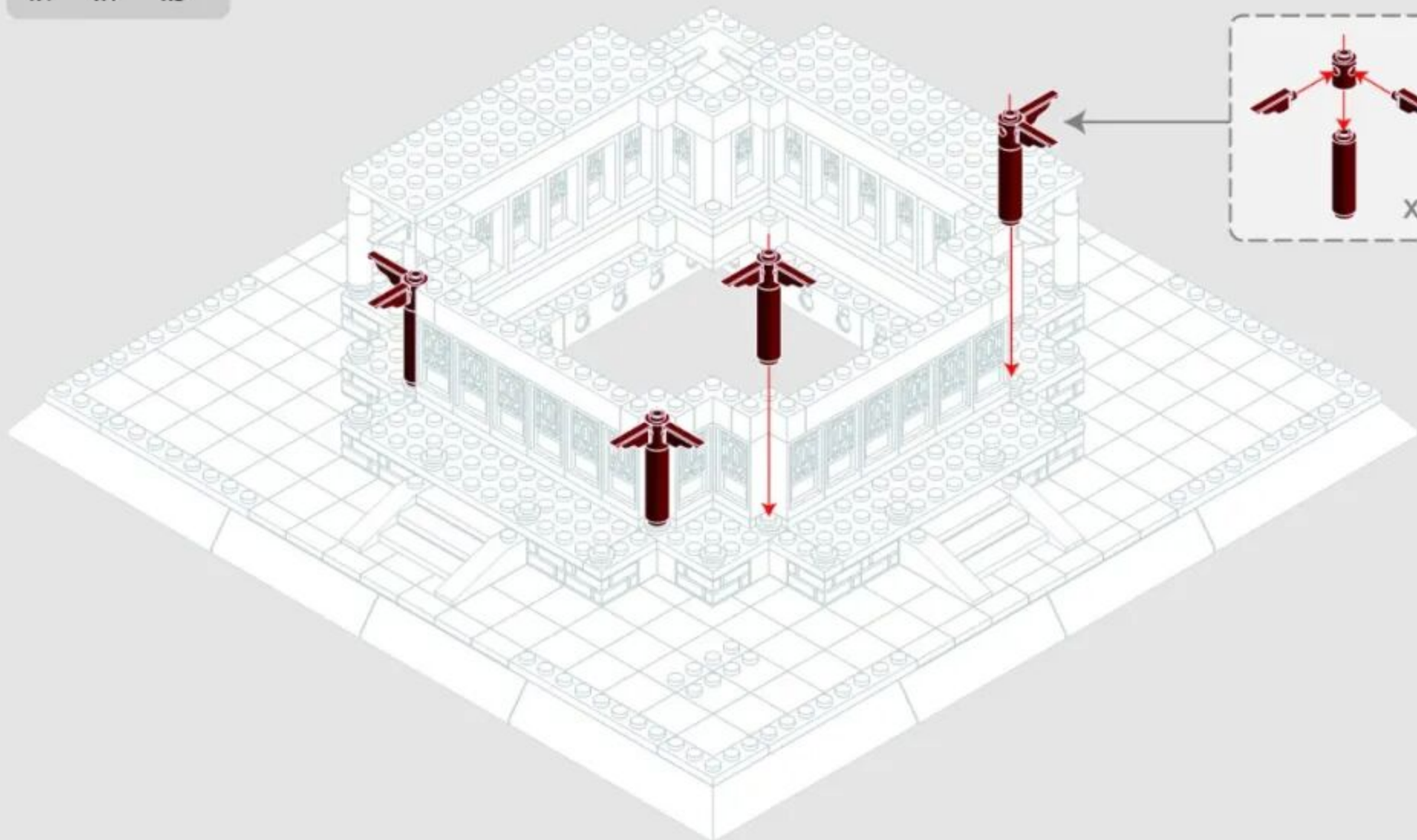

3-2

1x3



x8



x8



x8

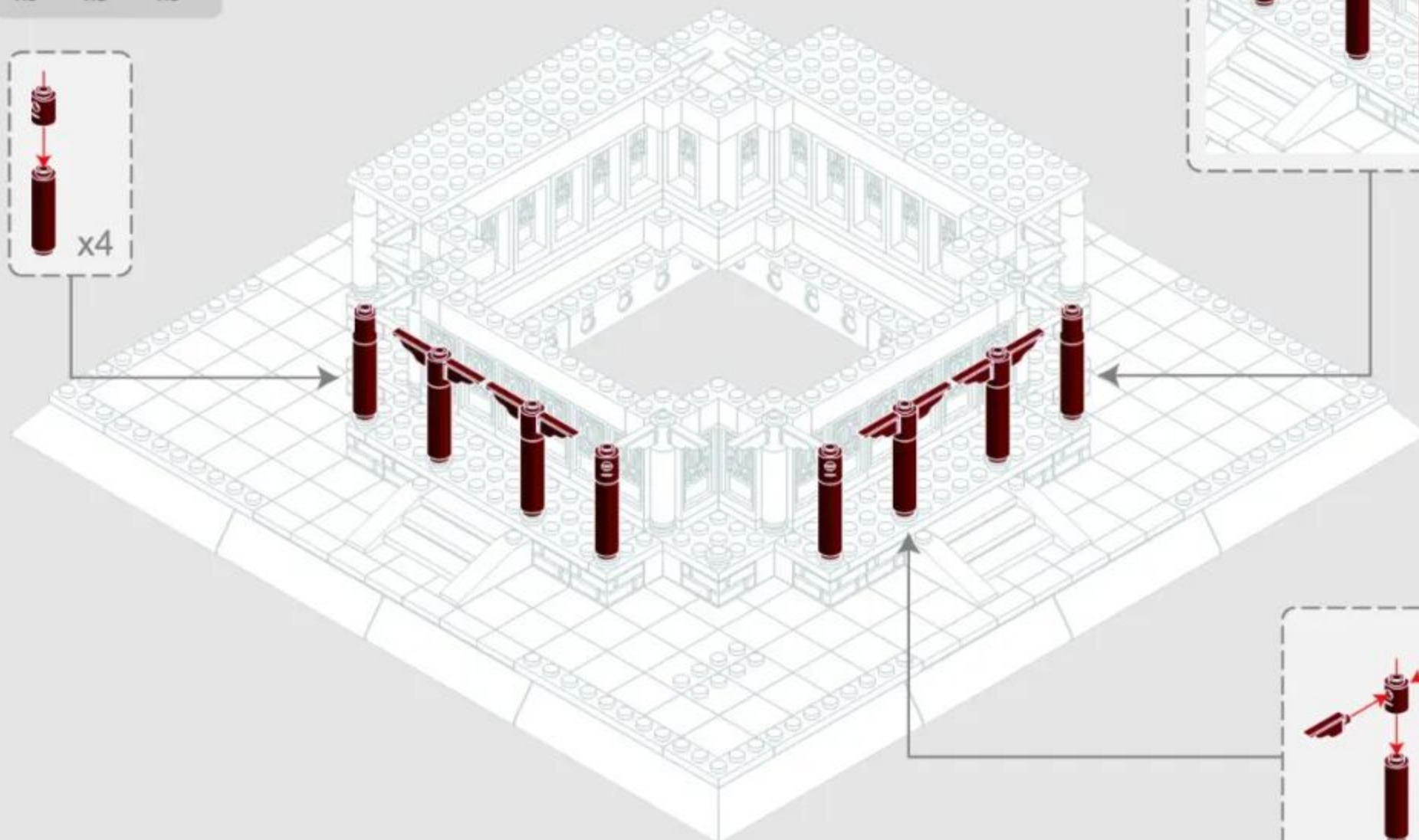
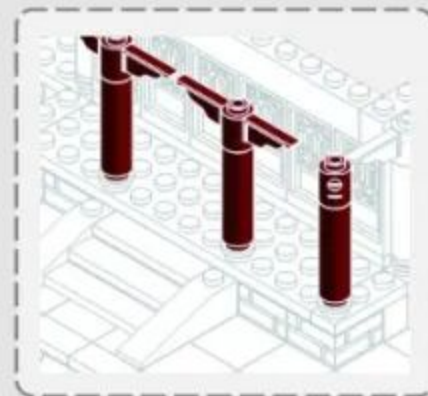

40

3-3

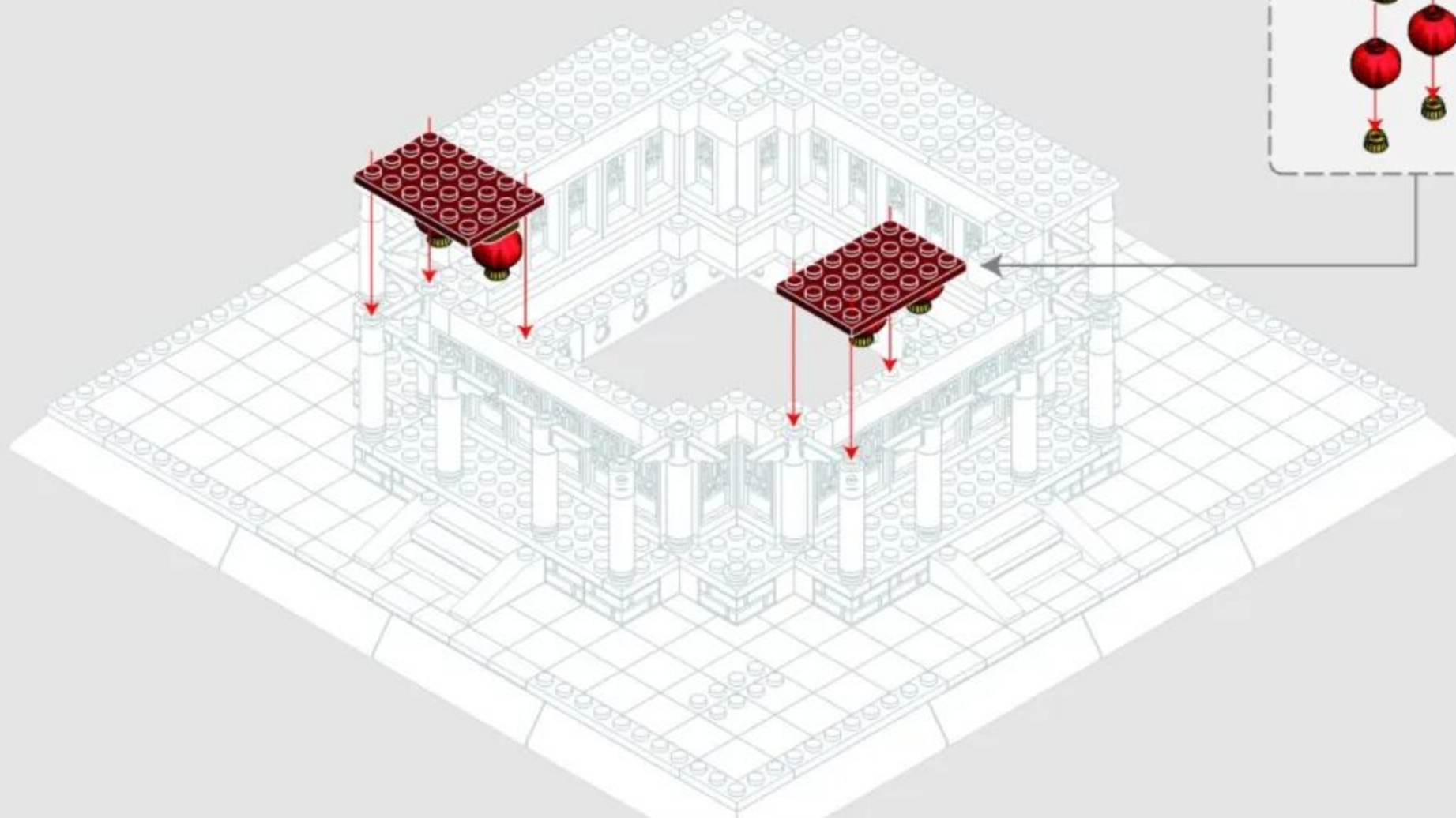
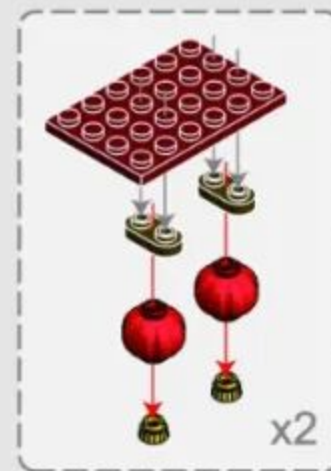

3-4

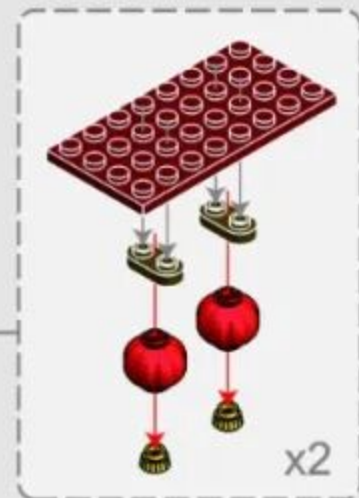
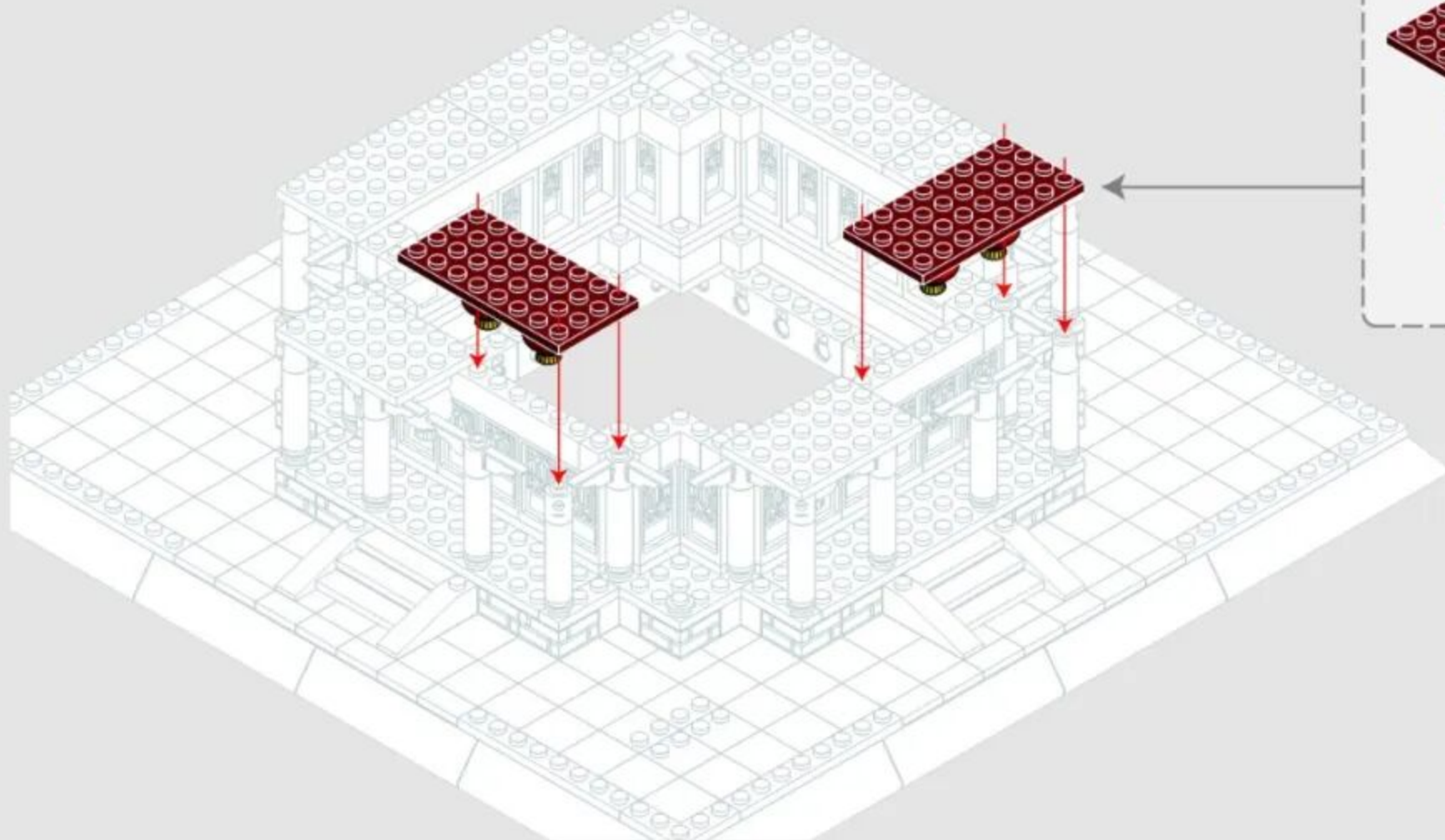
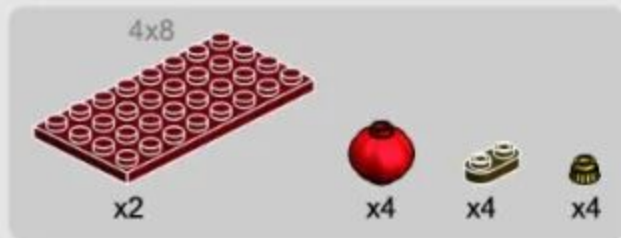

3-5

1x3



x4



x8



x4

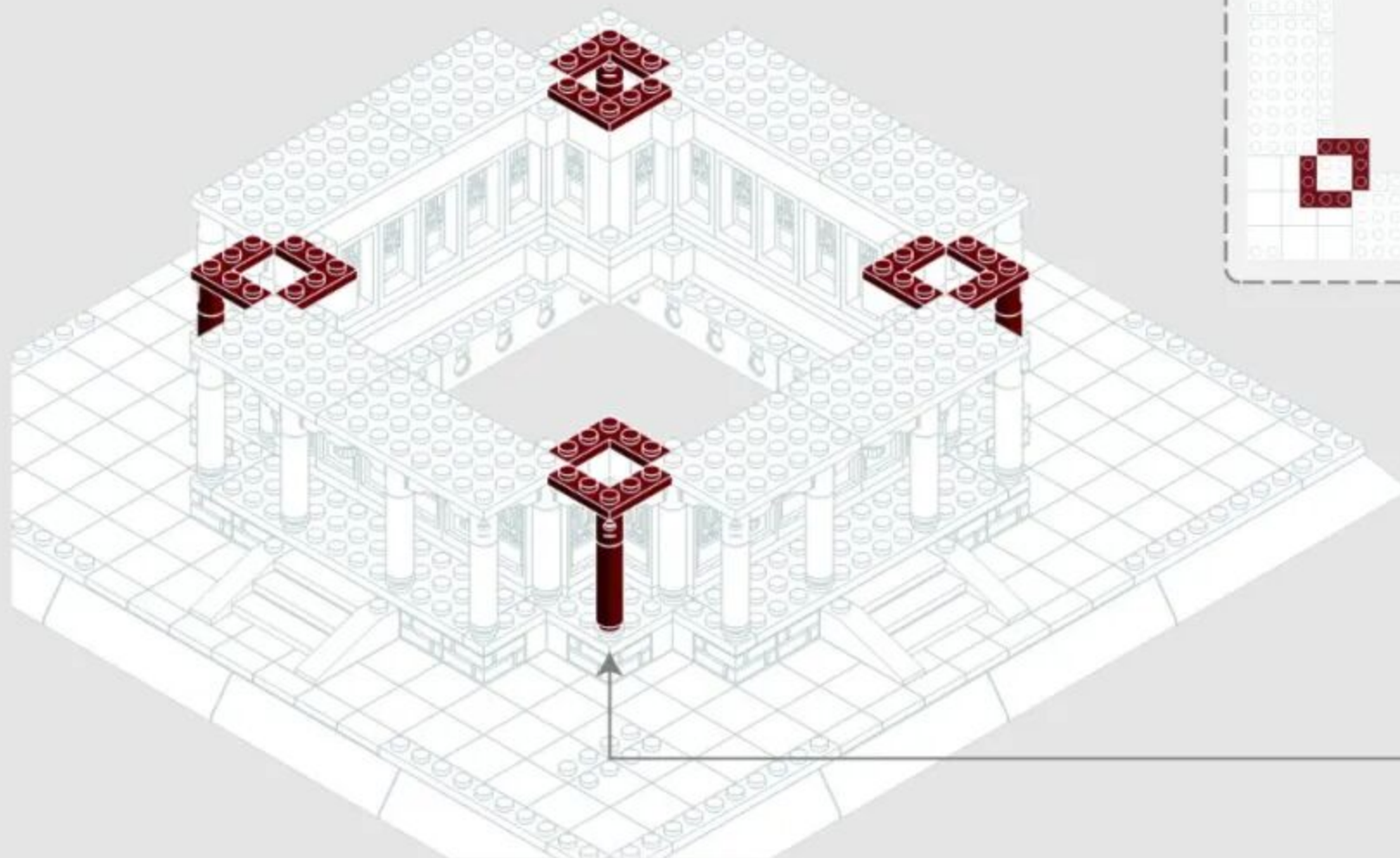

Vertical View of Installation Drawing
安装图顶面

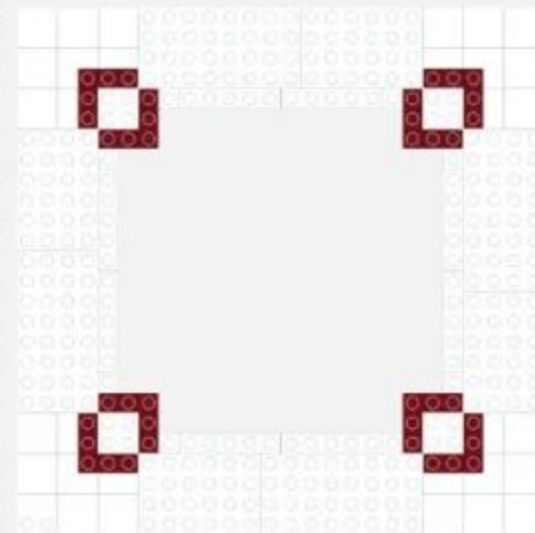

x4

3-6

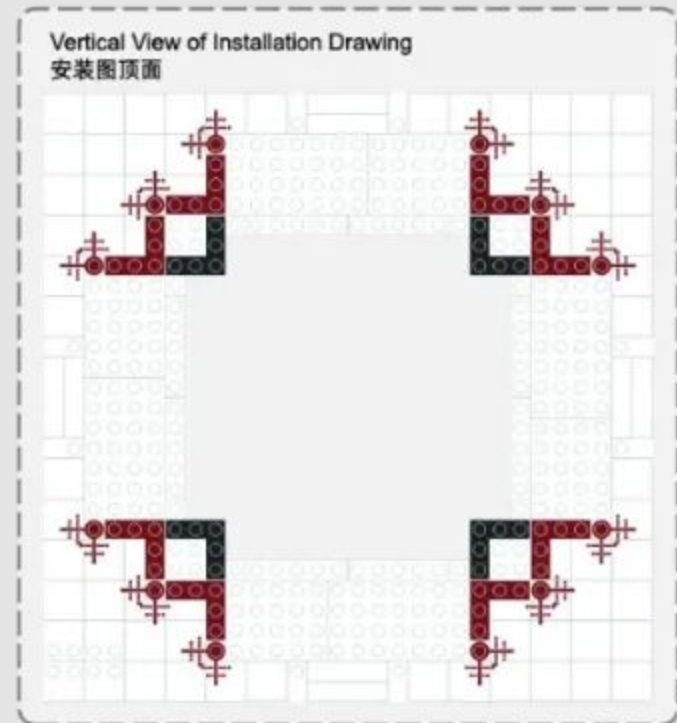

3-7

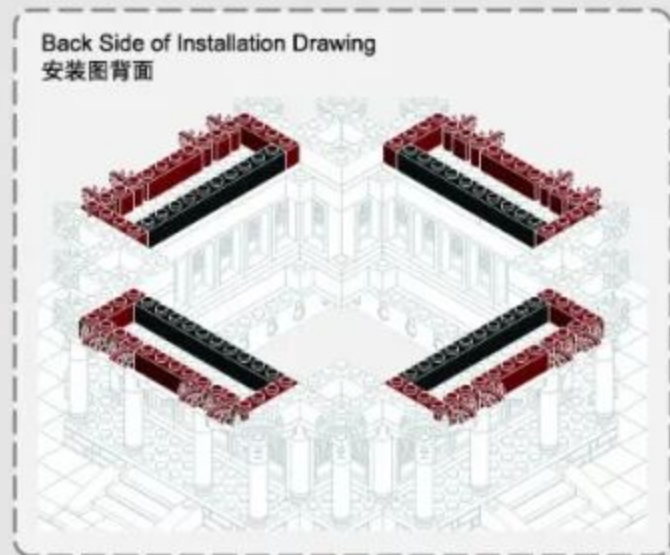
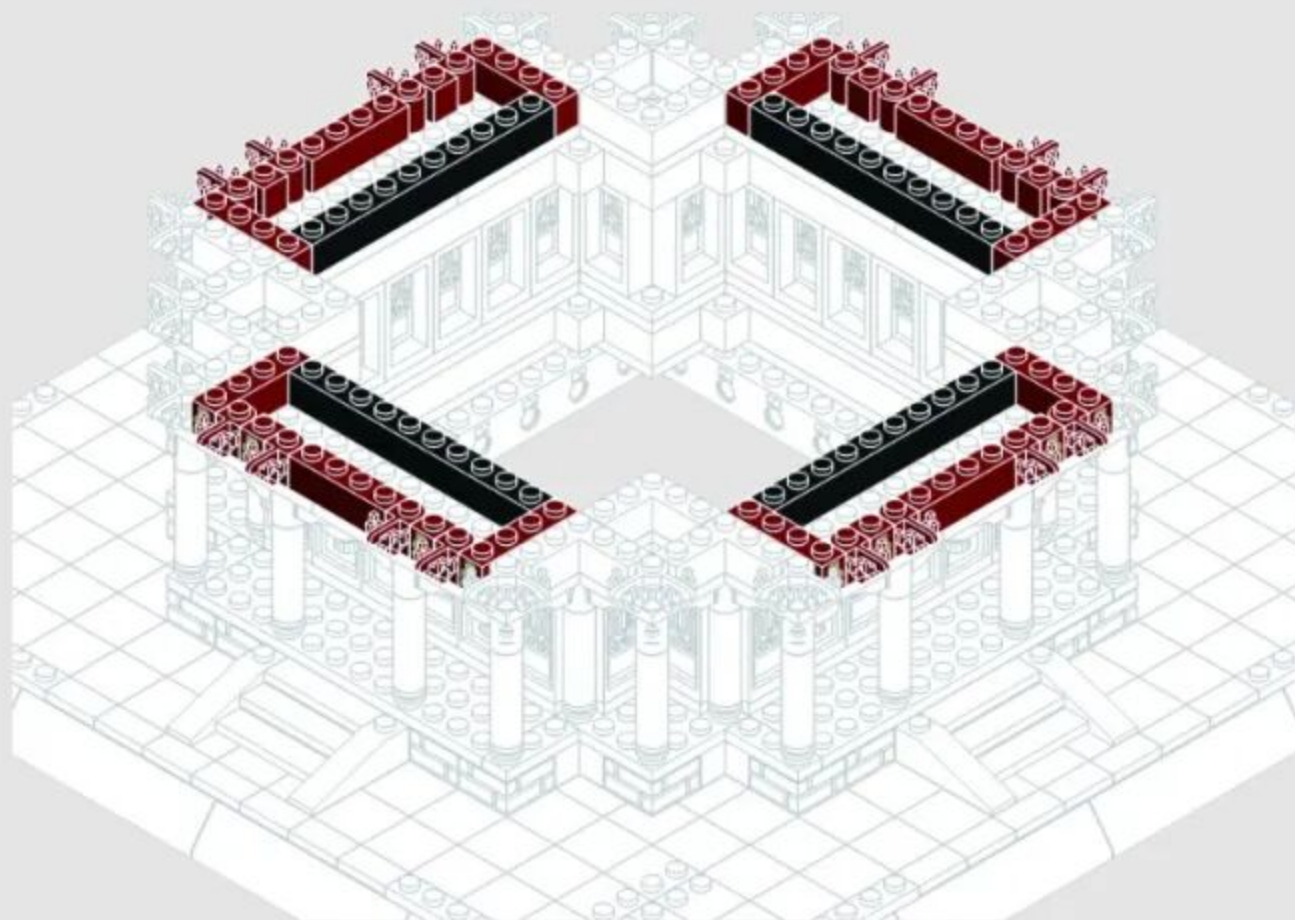
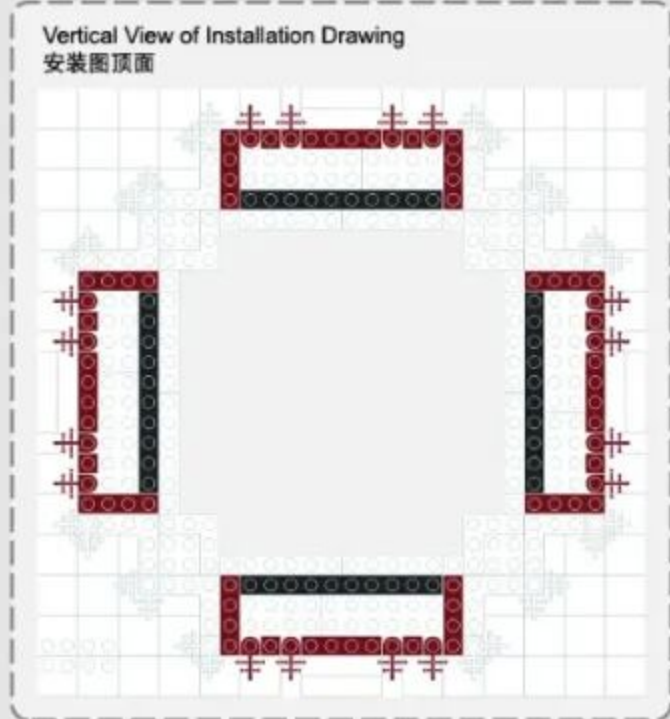
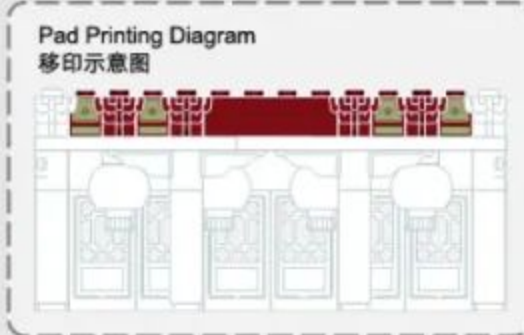
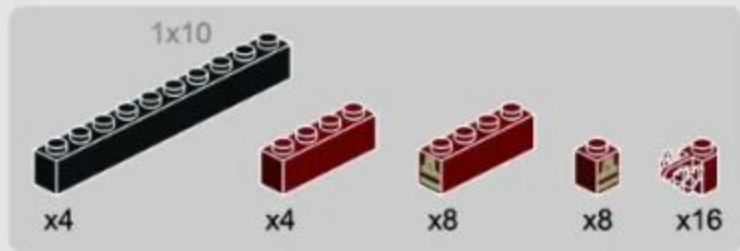

3-8

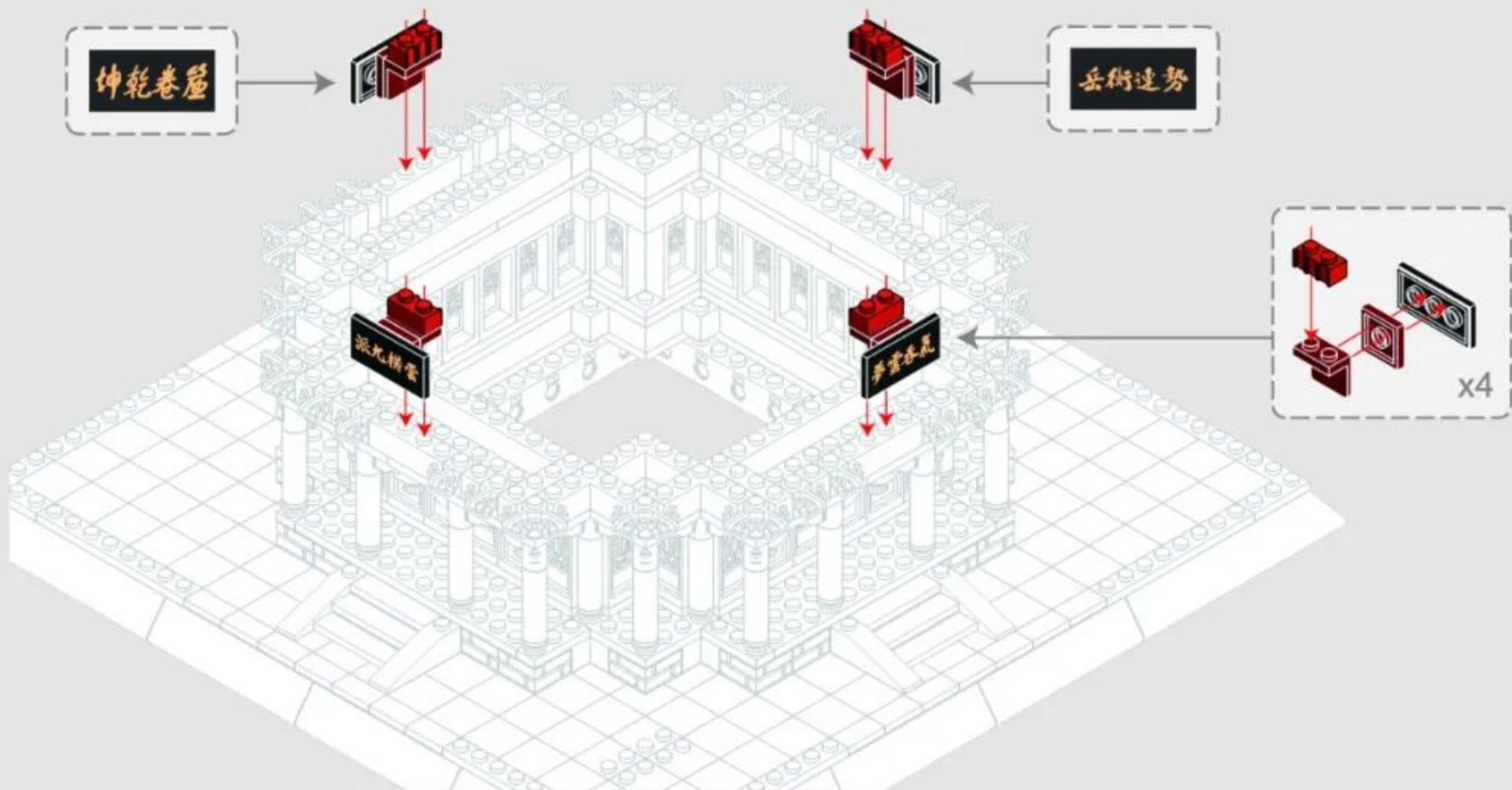

3-9

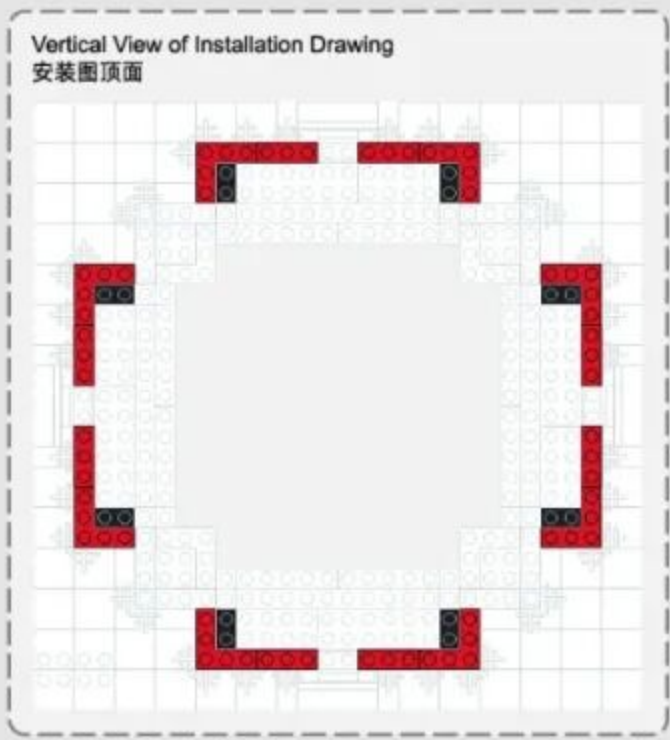
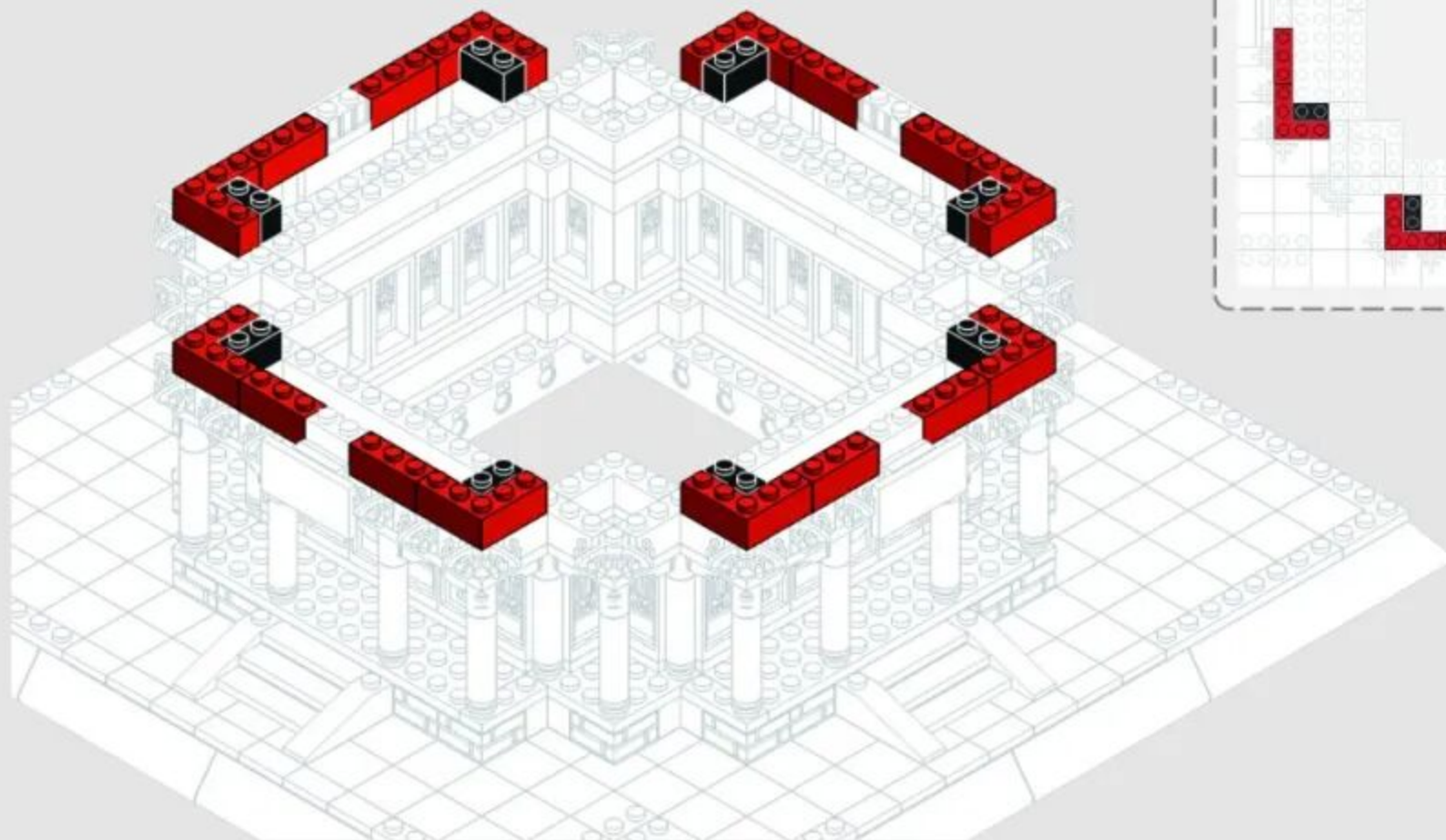
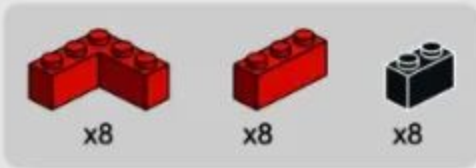

3-10

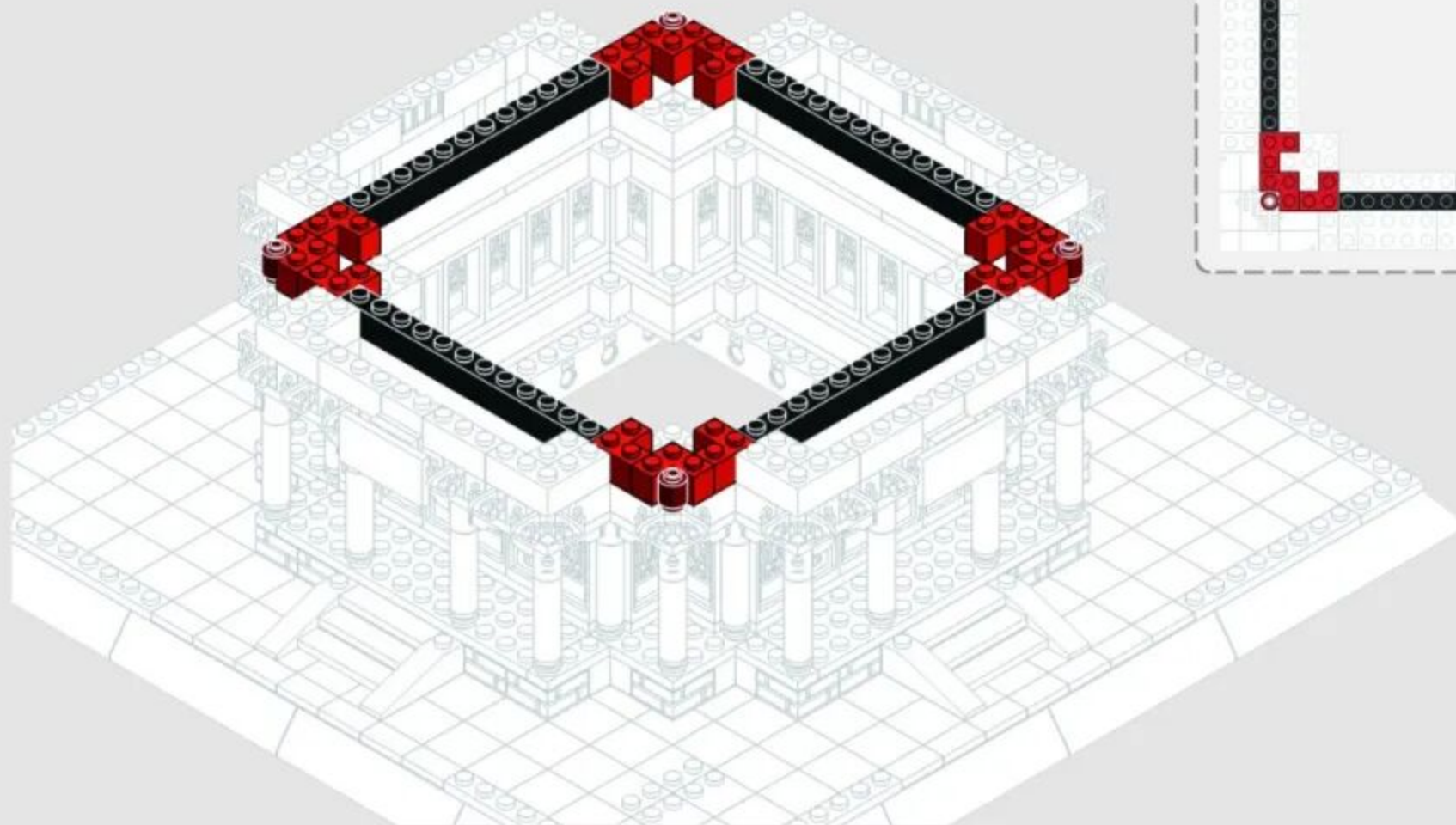
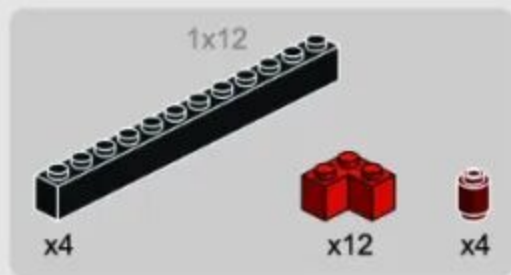

3-11

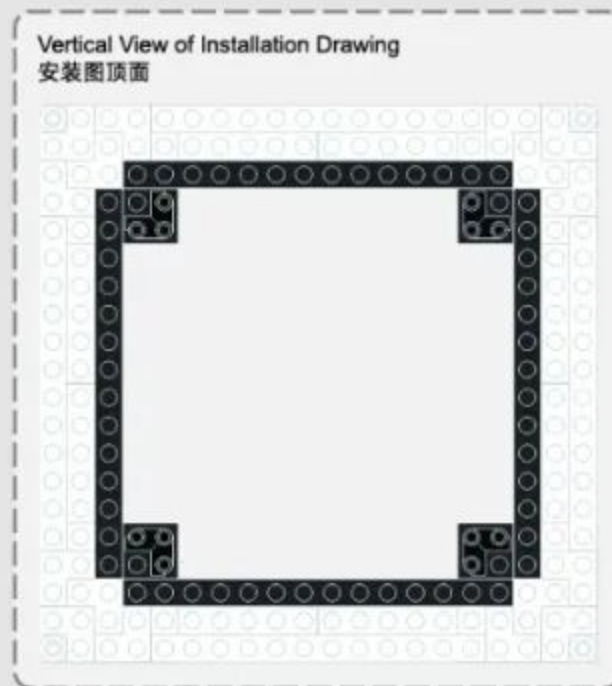
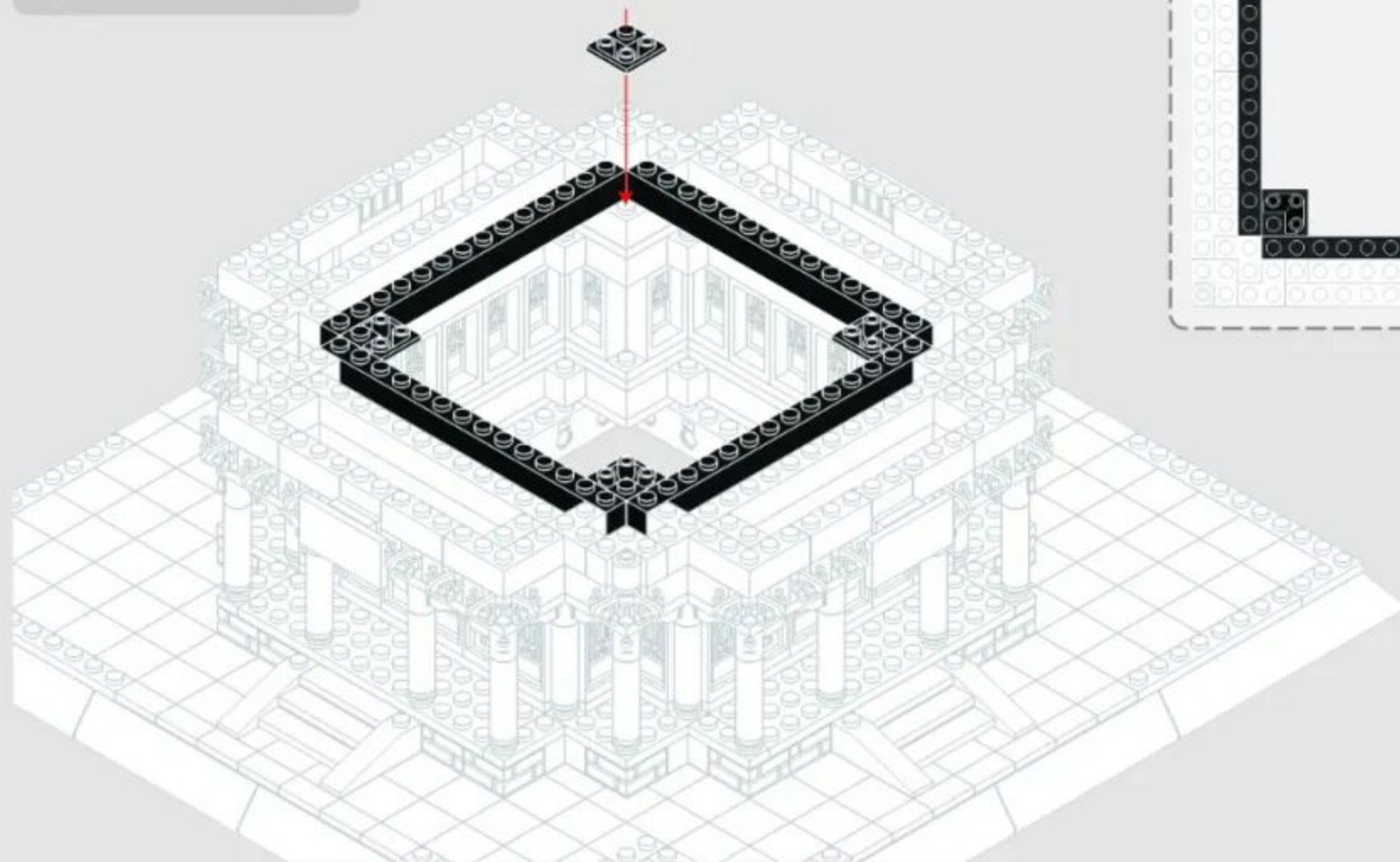
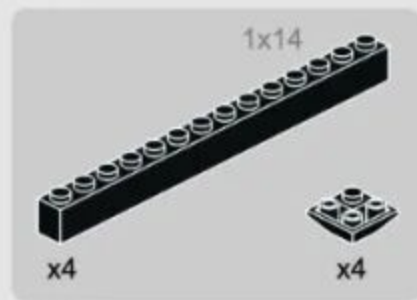

3-12

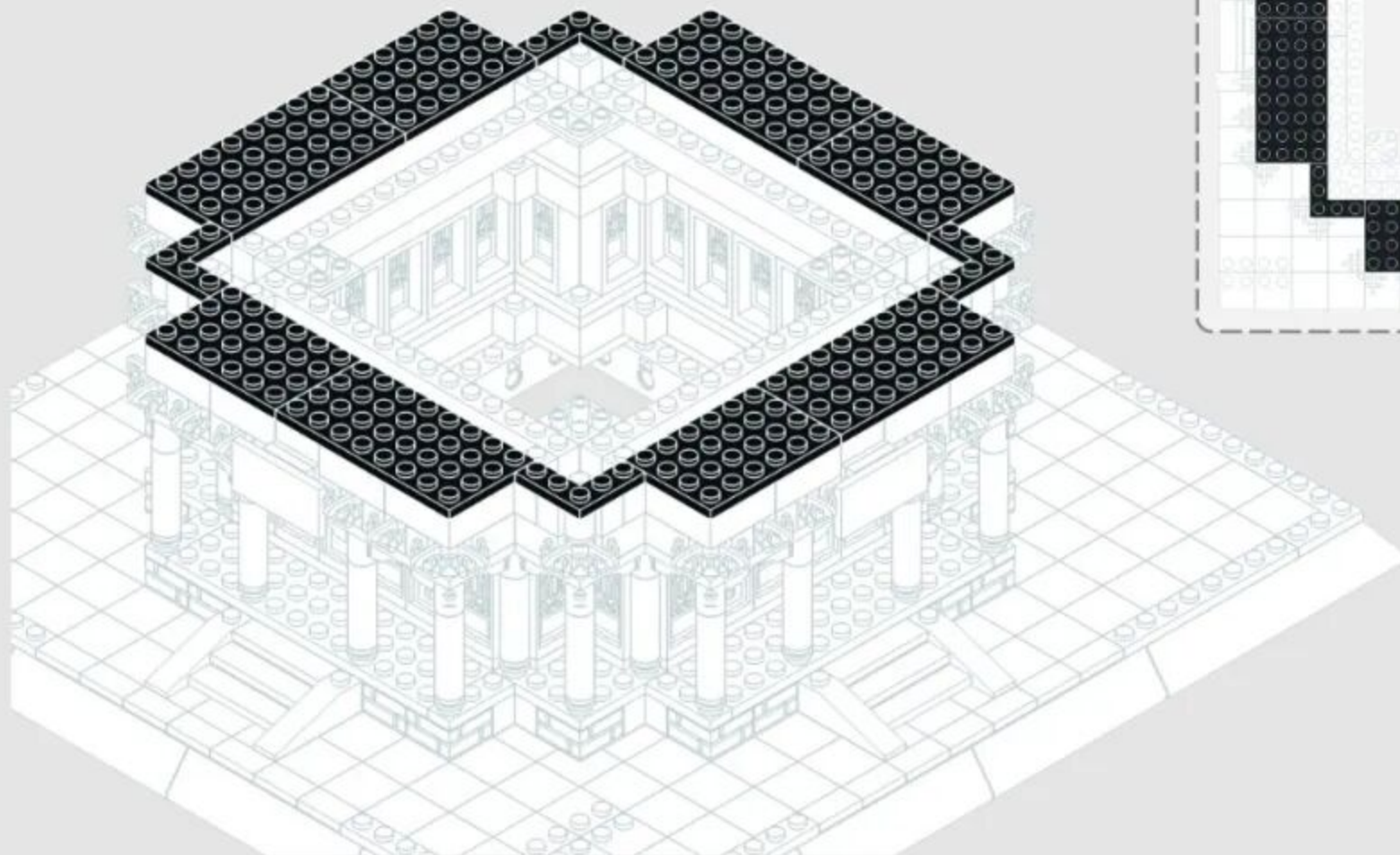
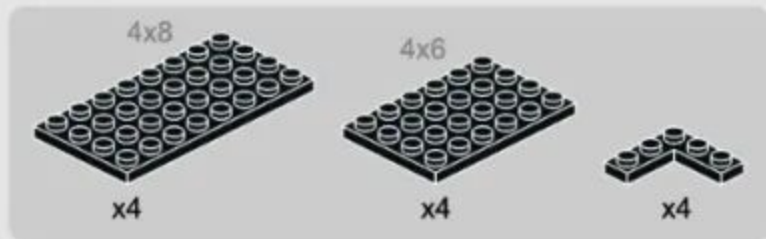

Vertical View of Installation Drawing
安装图顶面

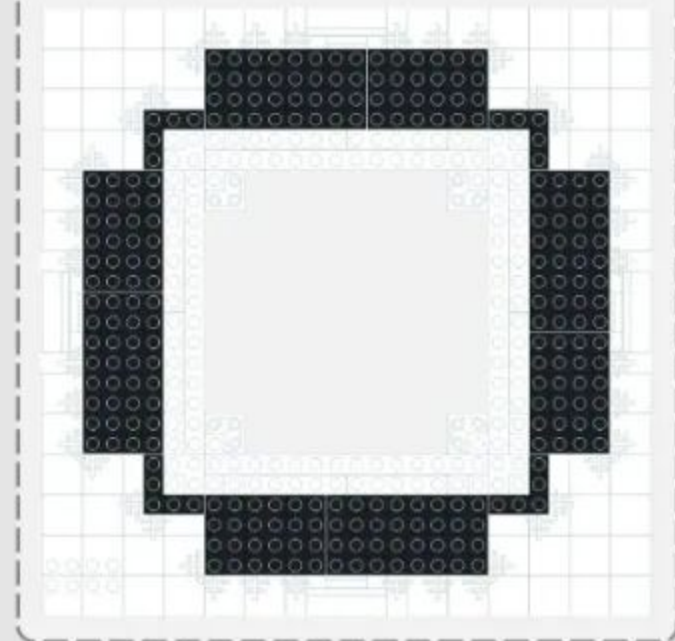

3-14

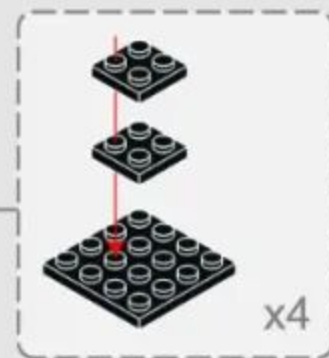
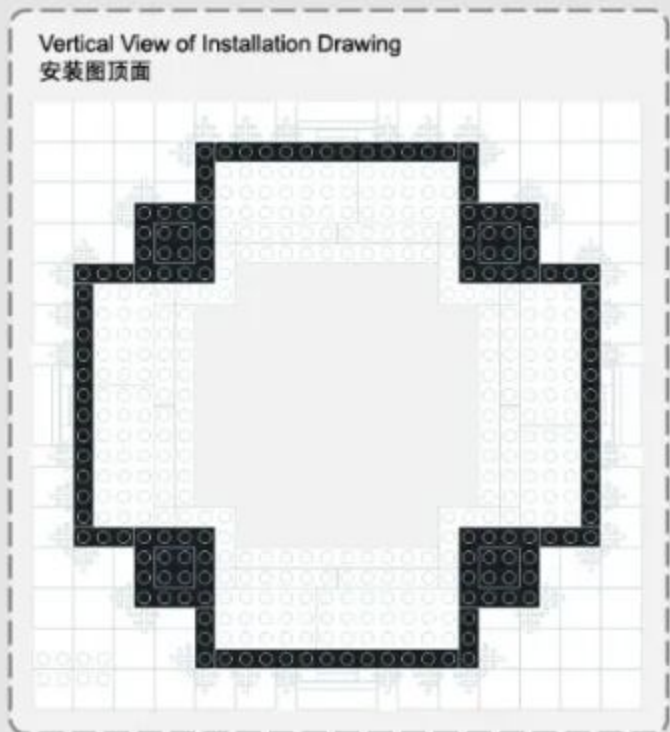
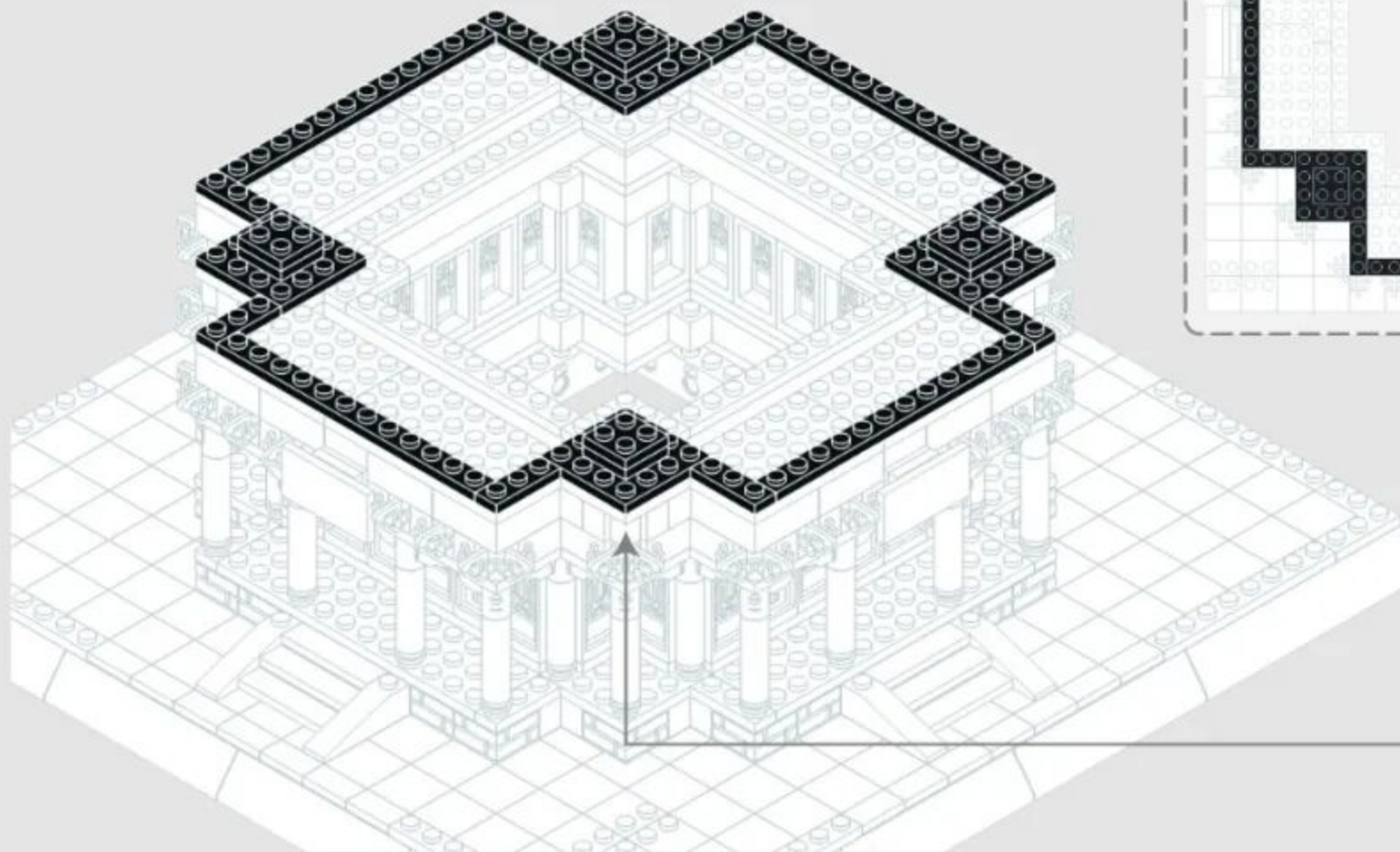
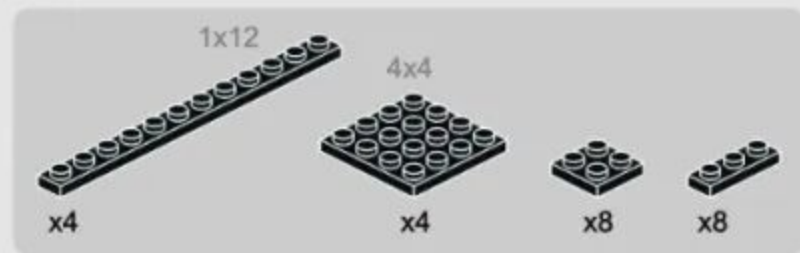

3-15

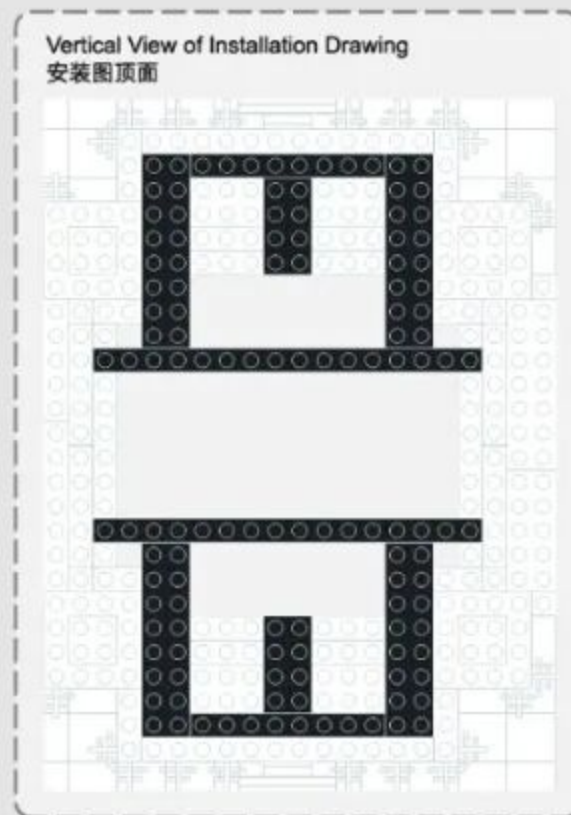
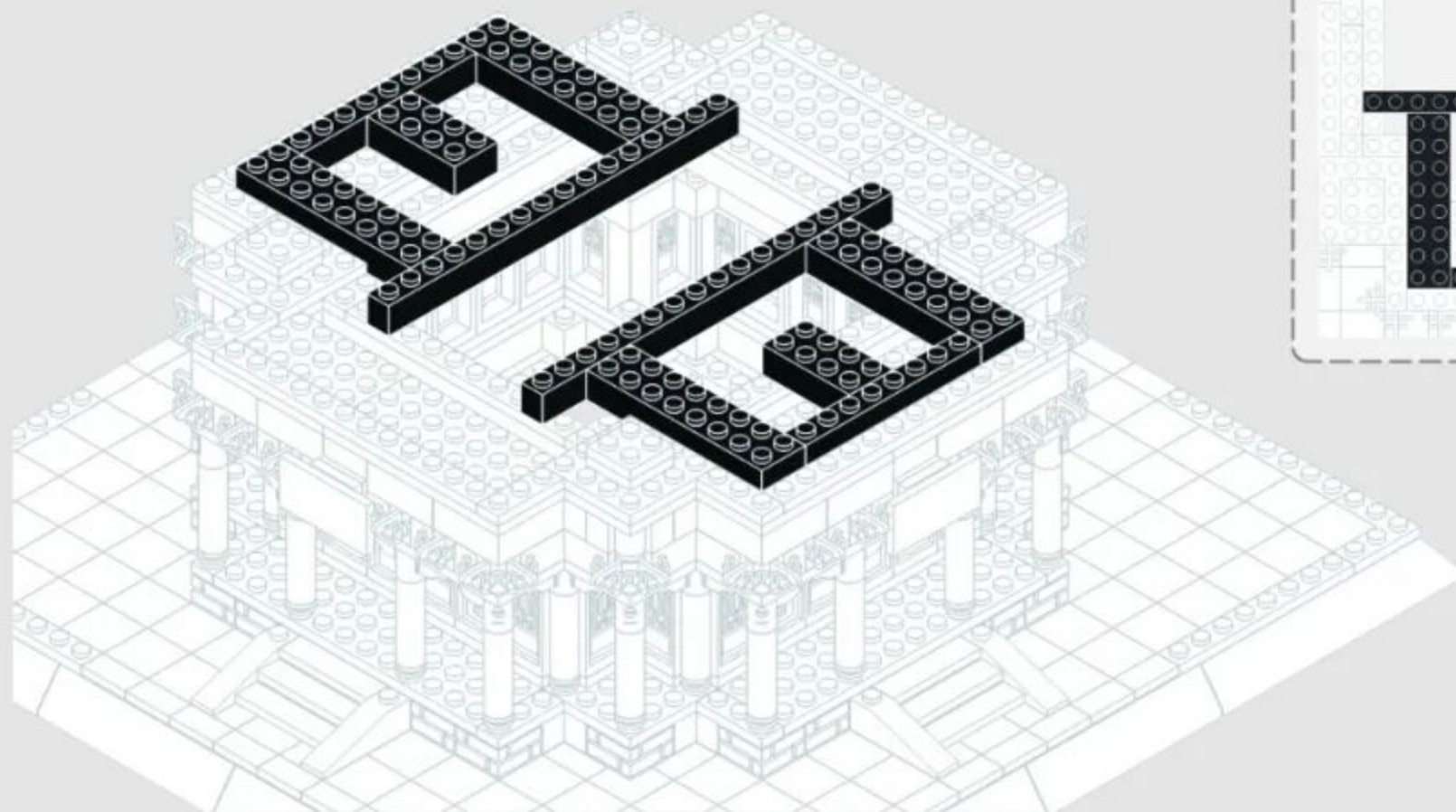
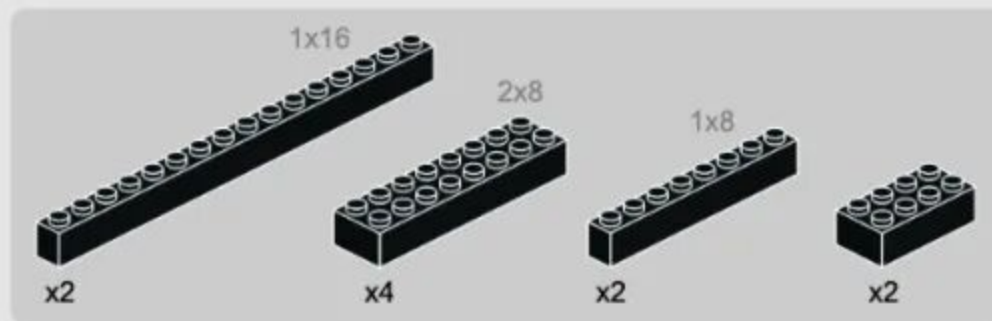

3-16

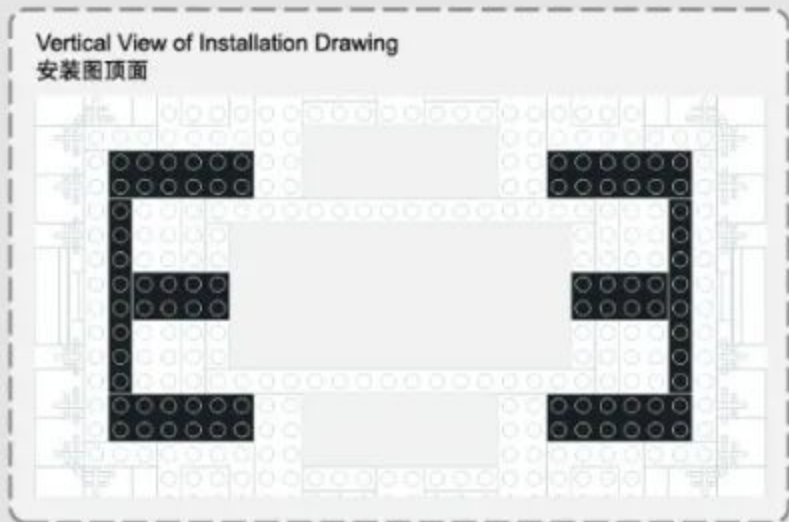
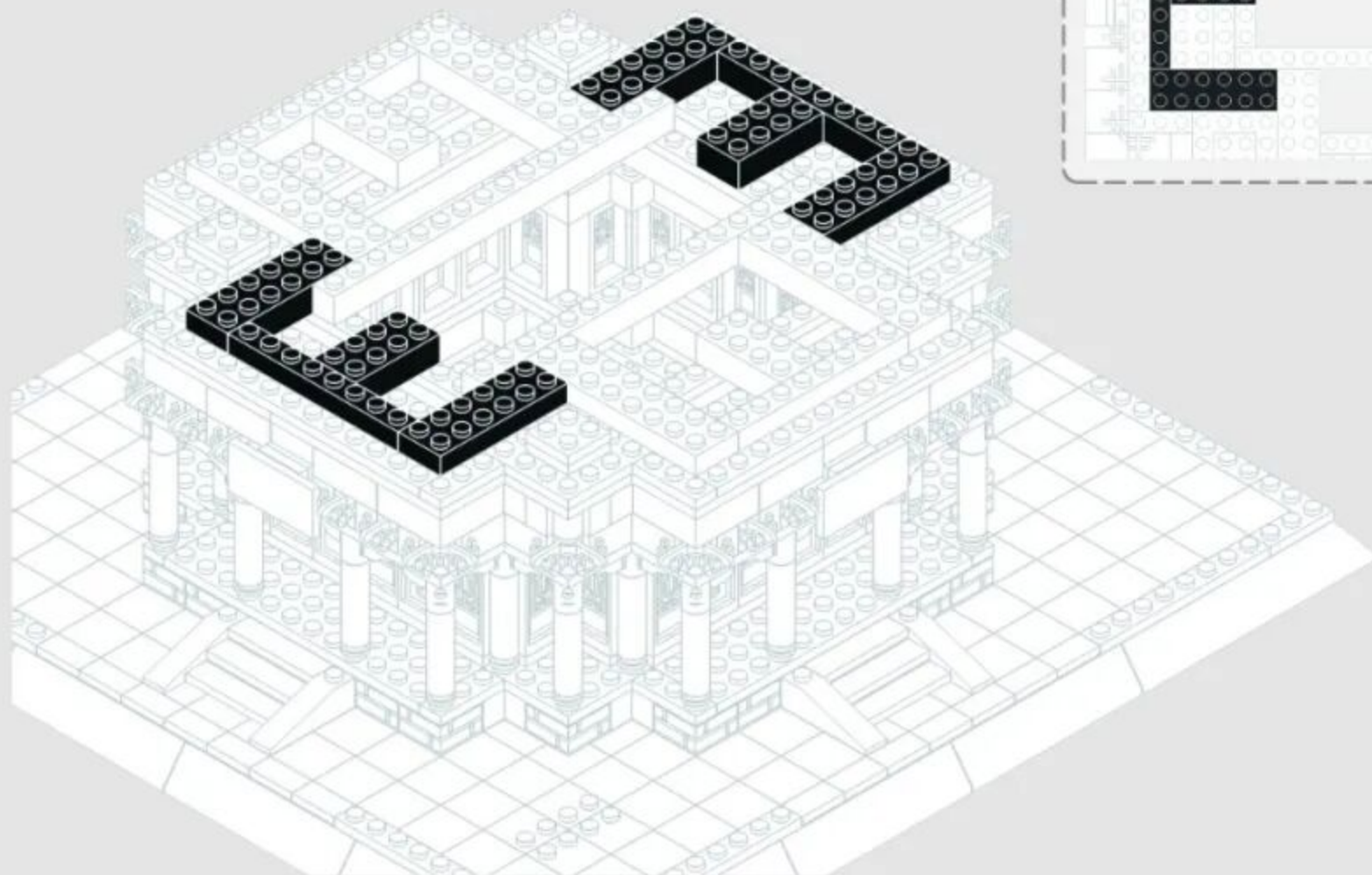
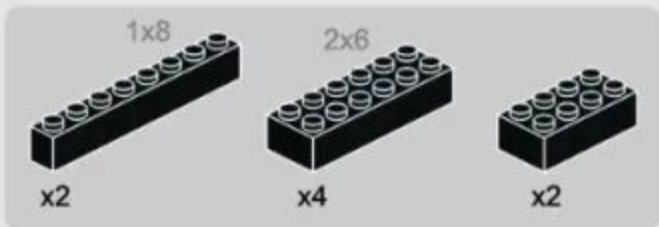



276PCS

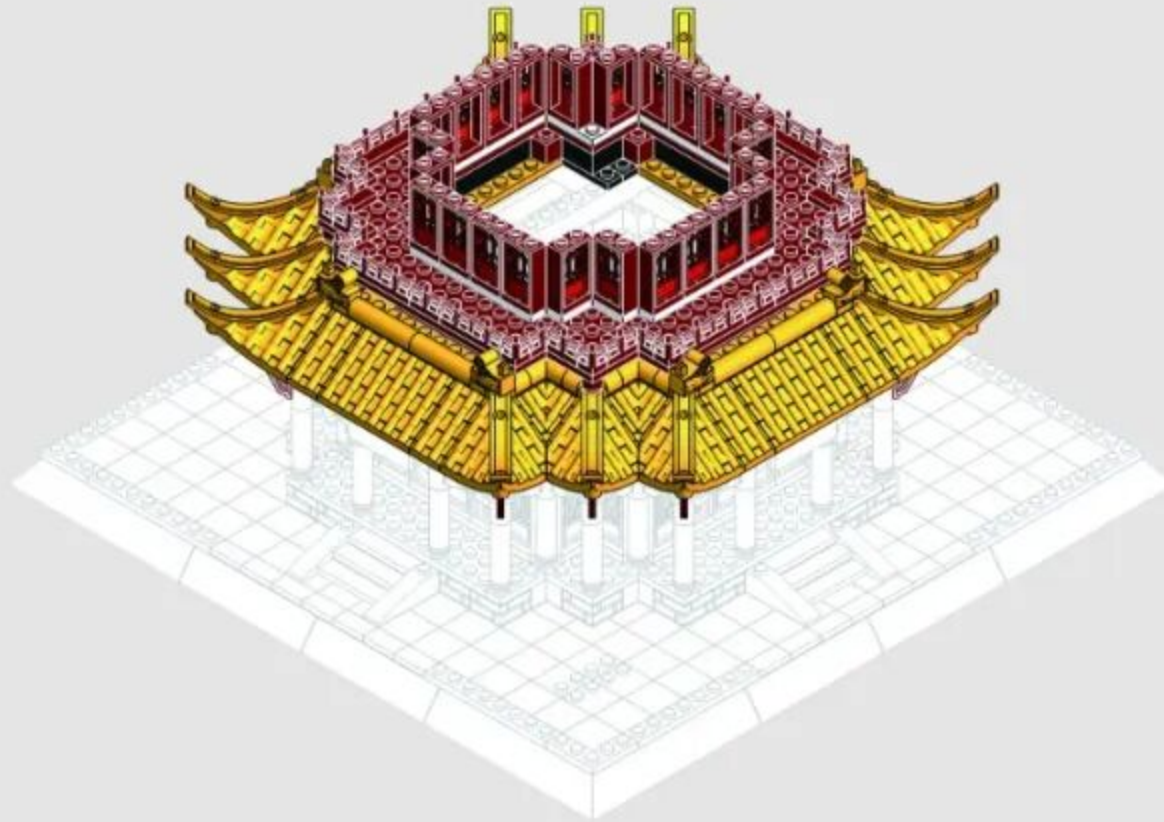

4-1

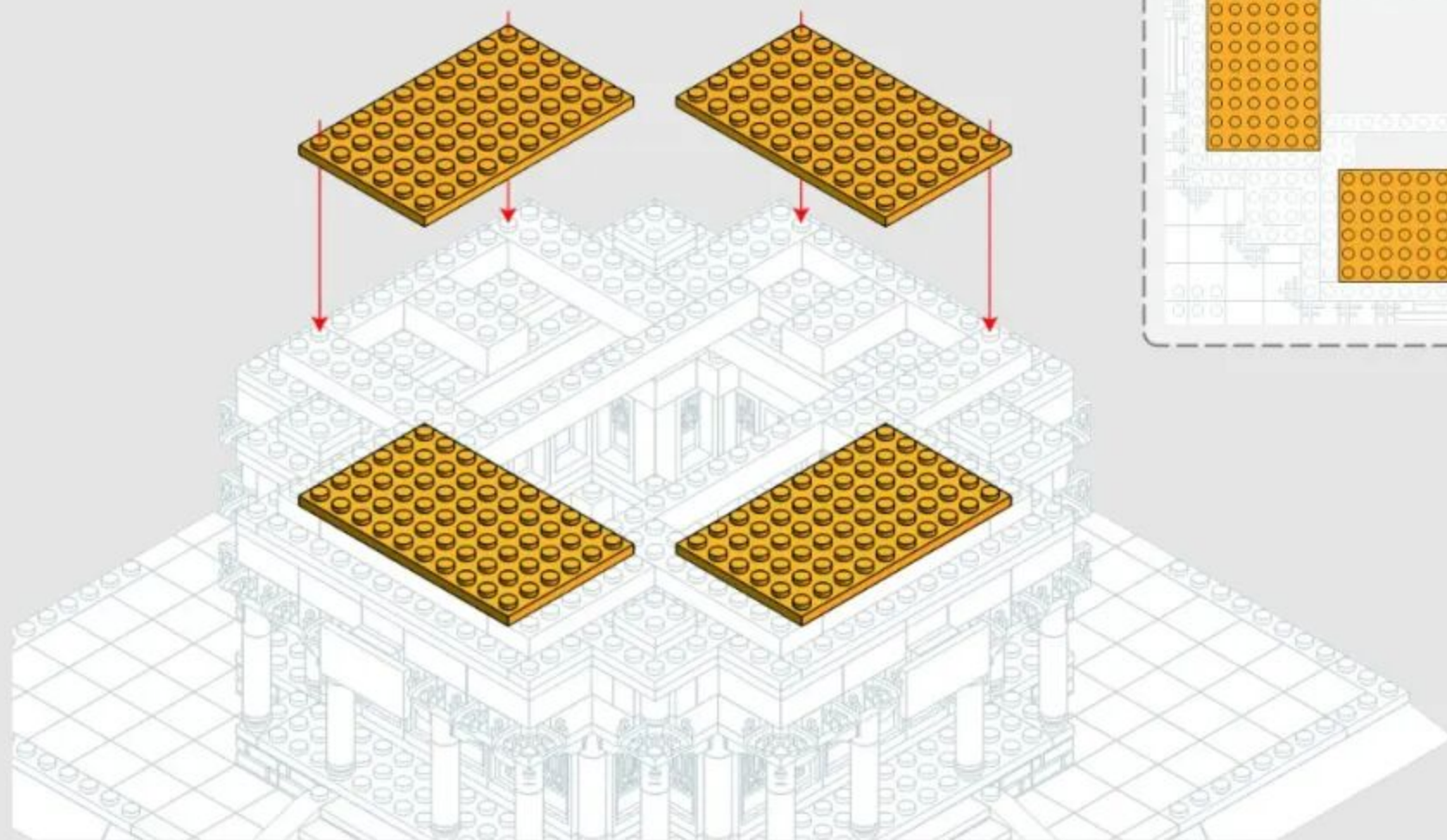
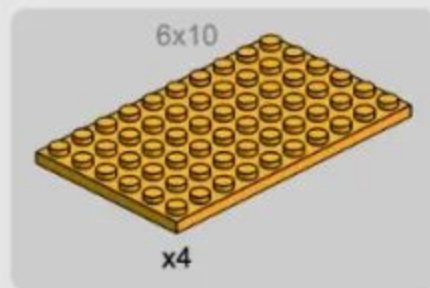

4-2

3x3



x4

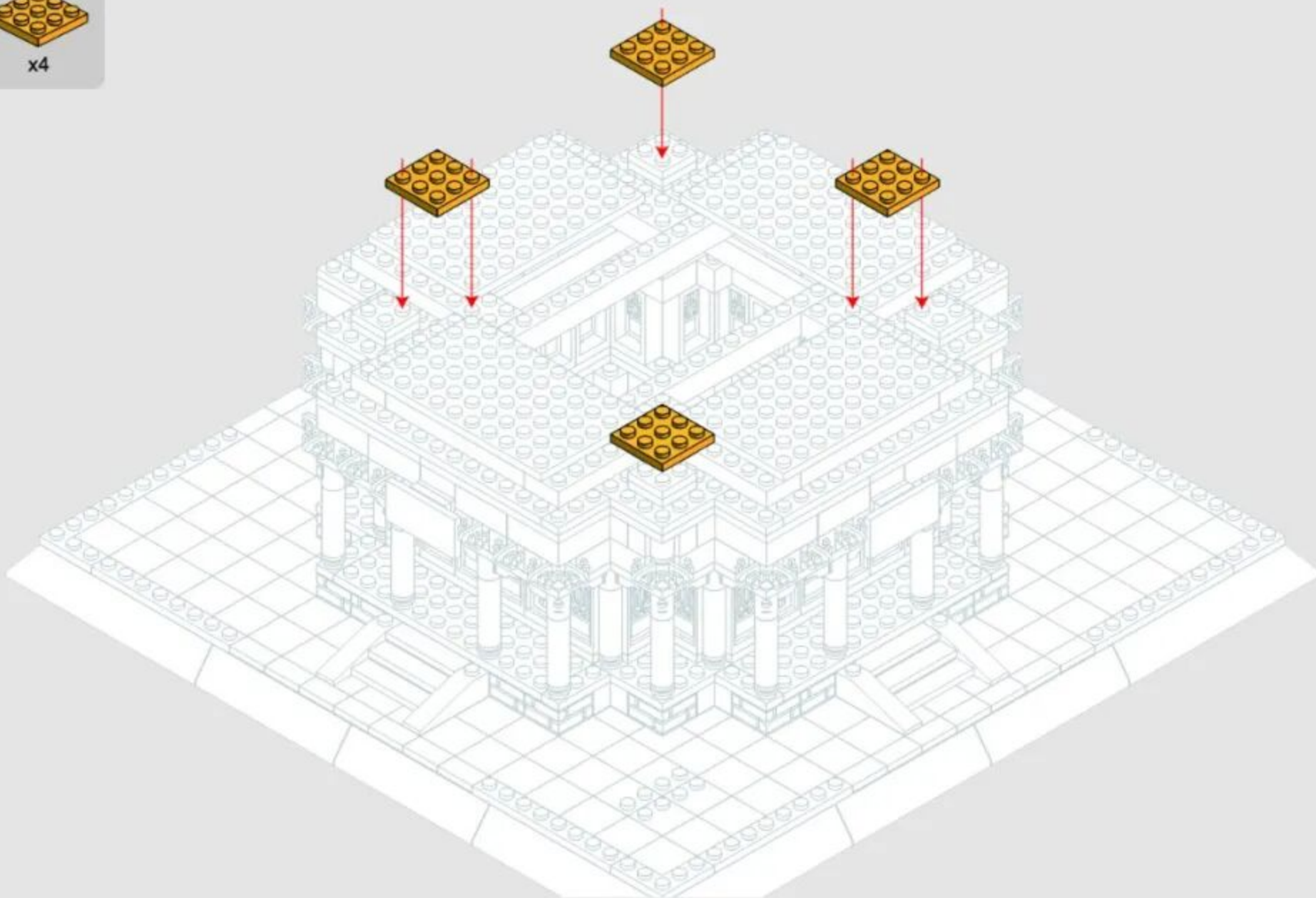

4-3



x8



x4



x4



4-4

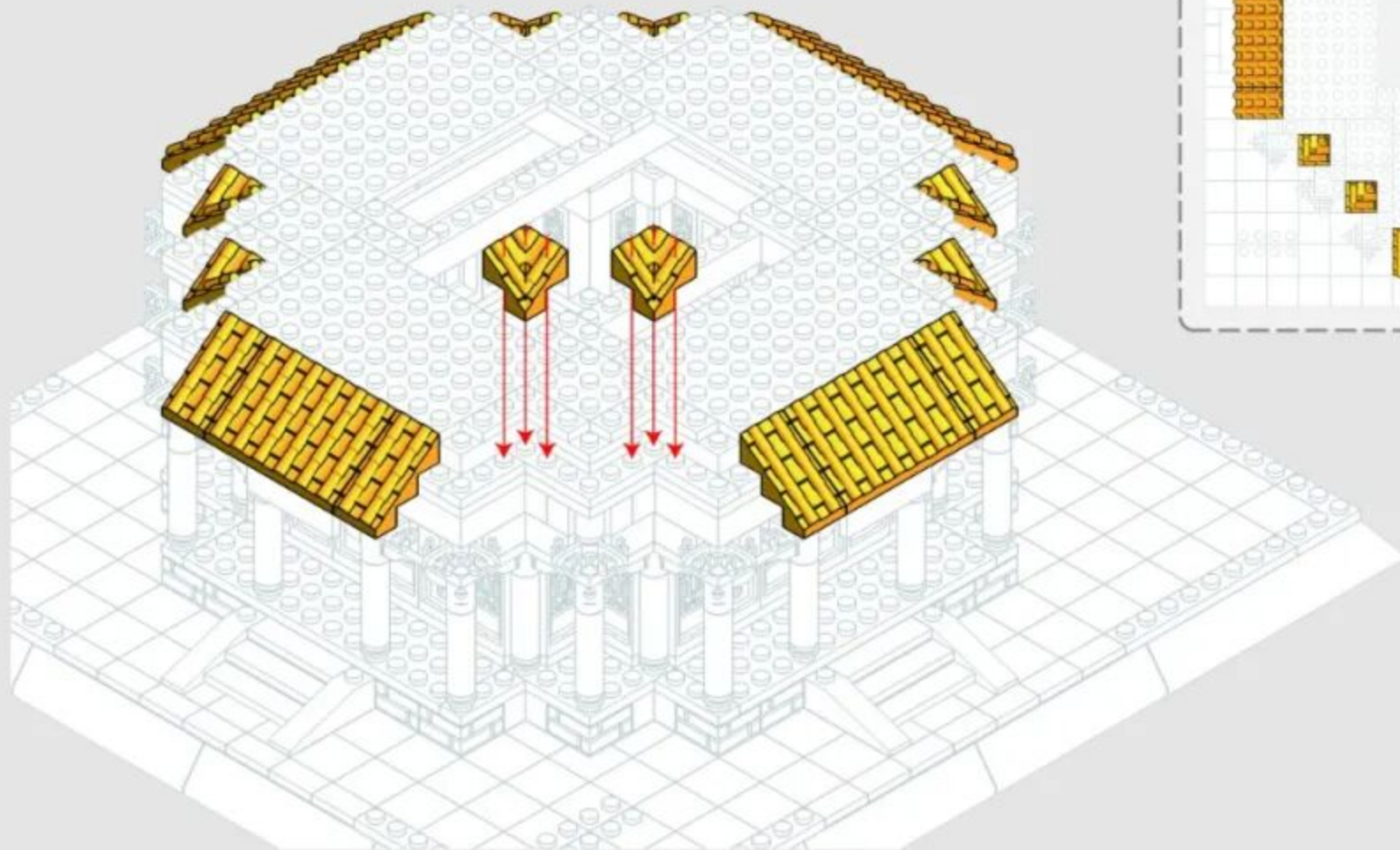
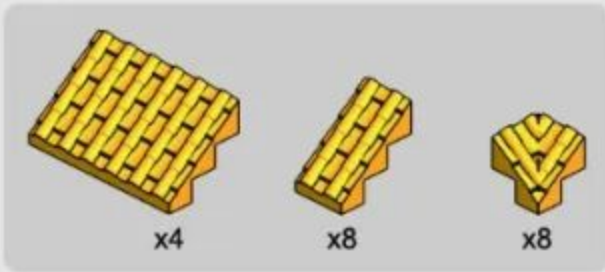

4-5

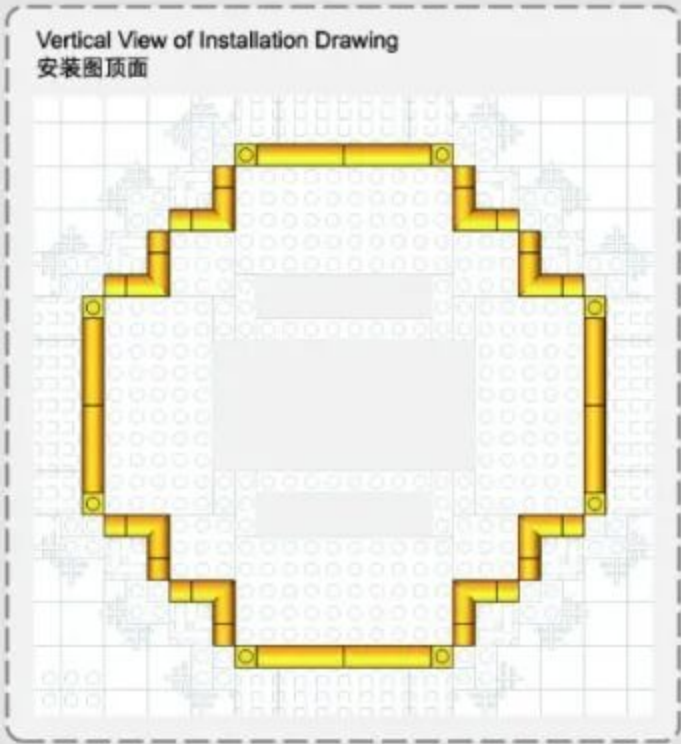
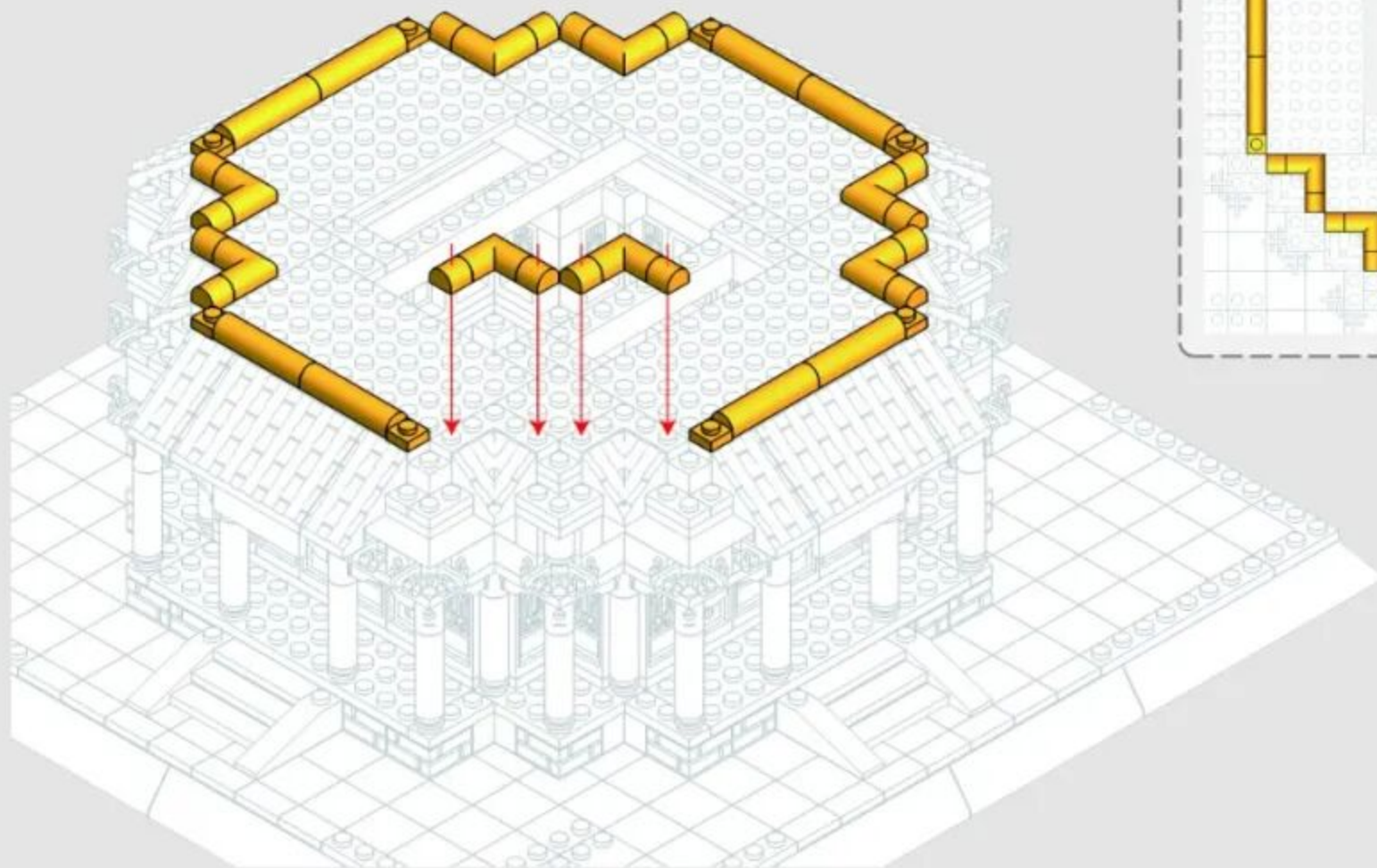

4-6

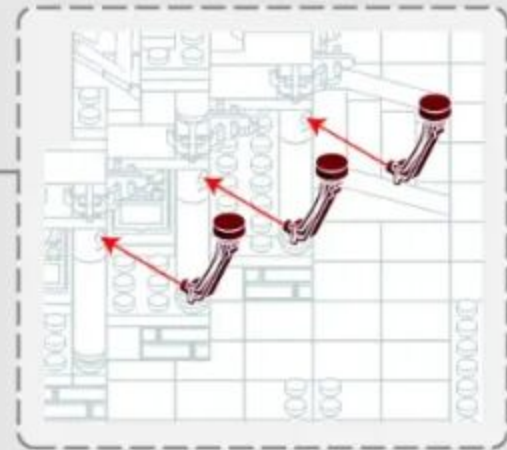
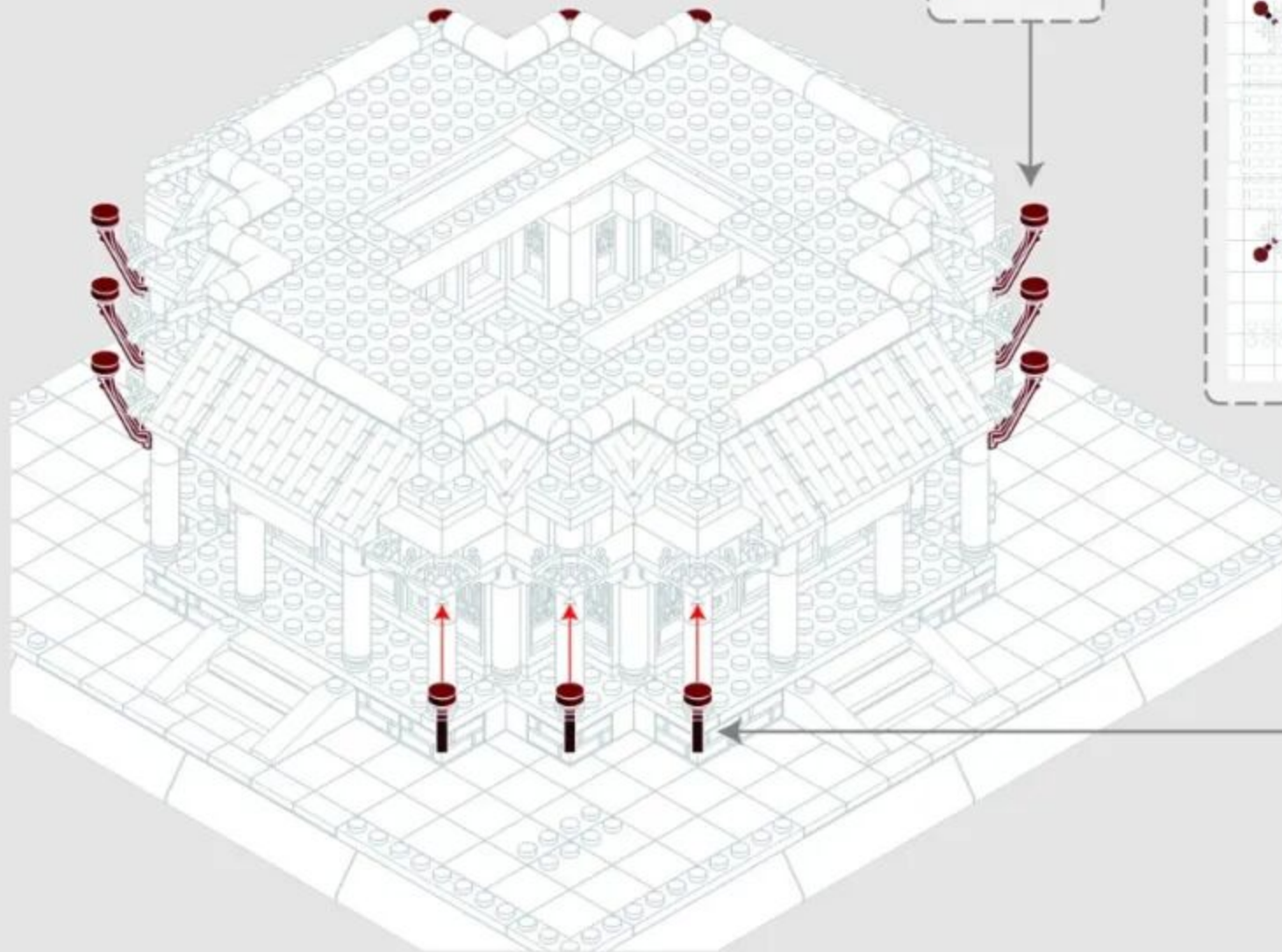

4-7

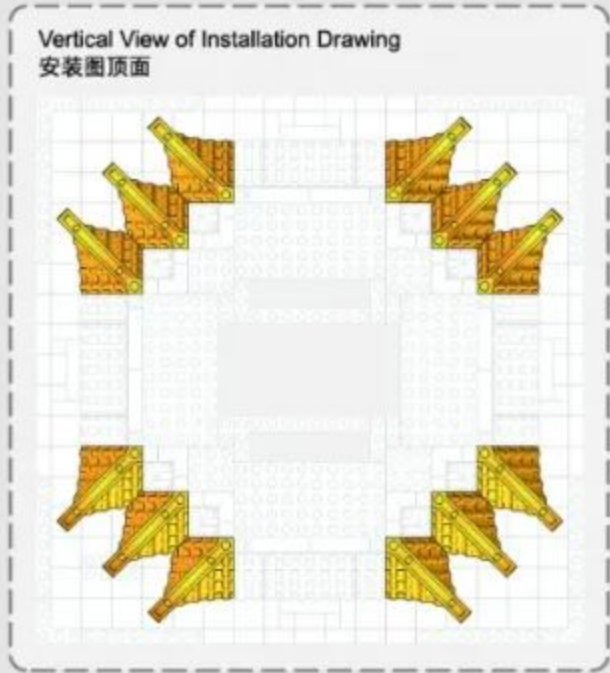
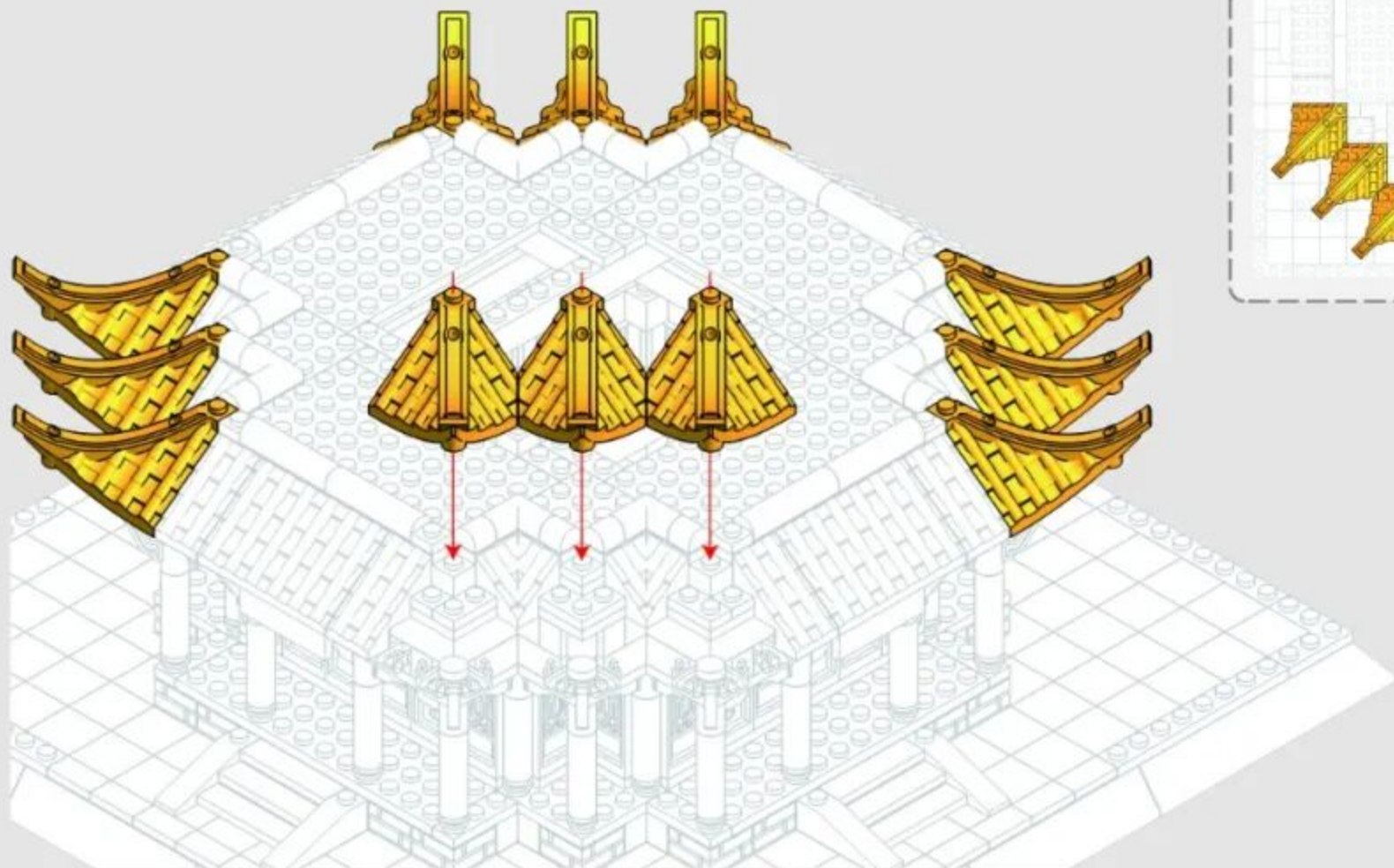
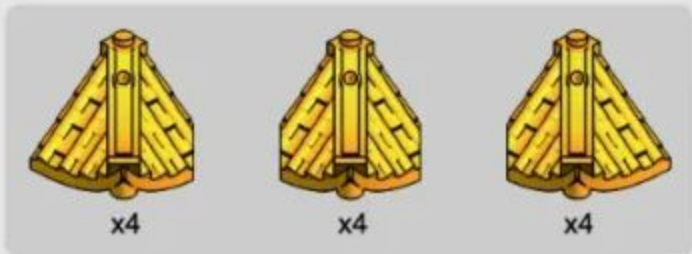

4-8

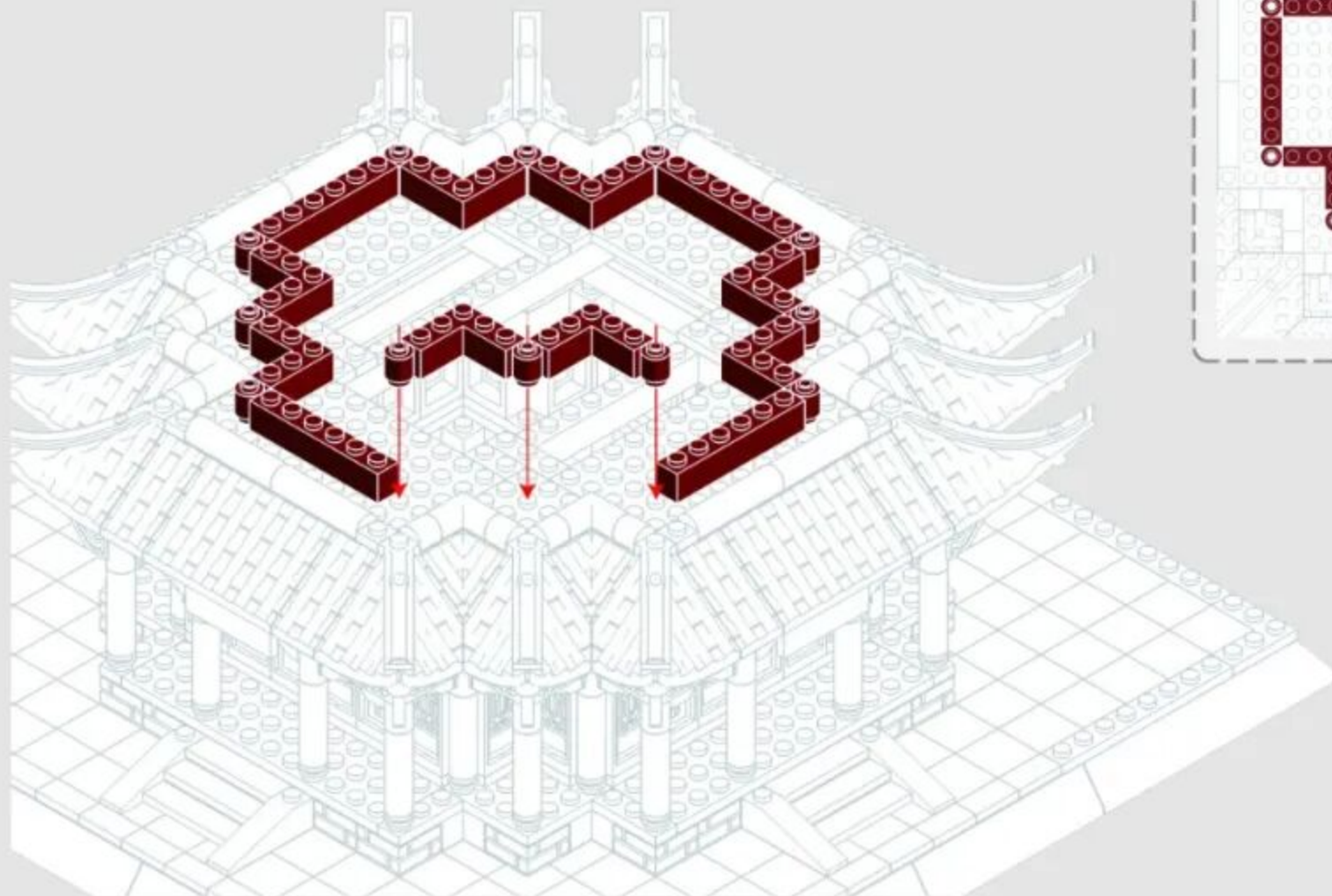
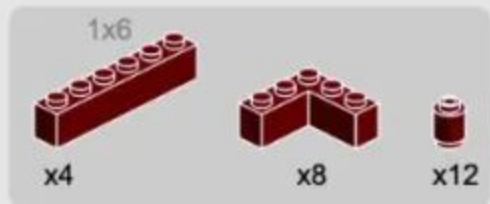

Vertical View of Installation Drawing
安装图顶面

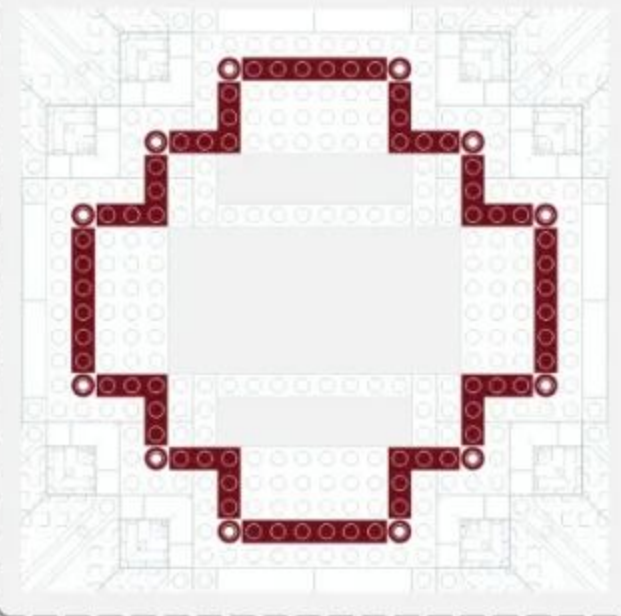

4-9

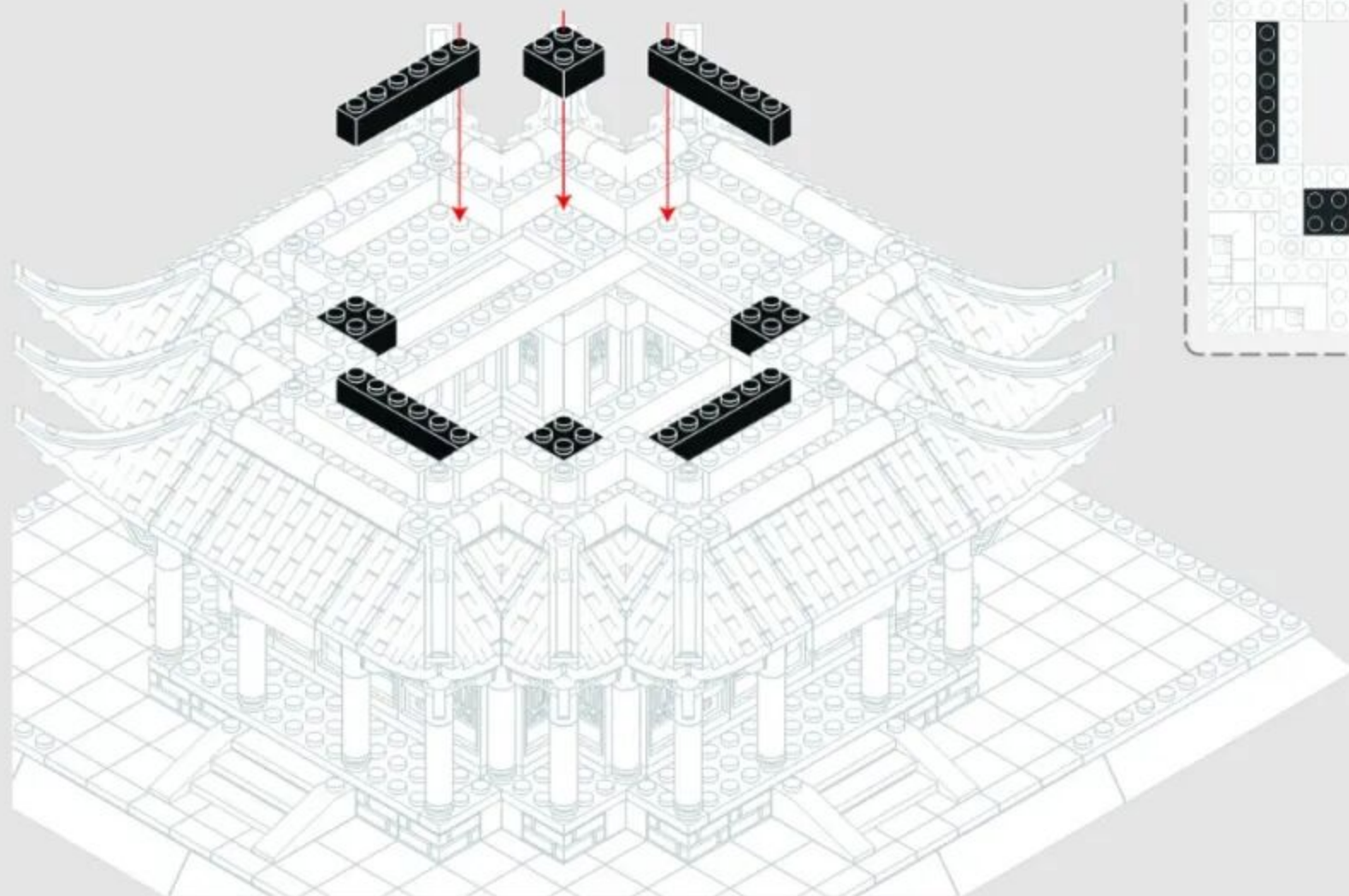

4-10

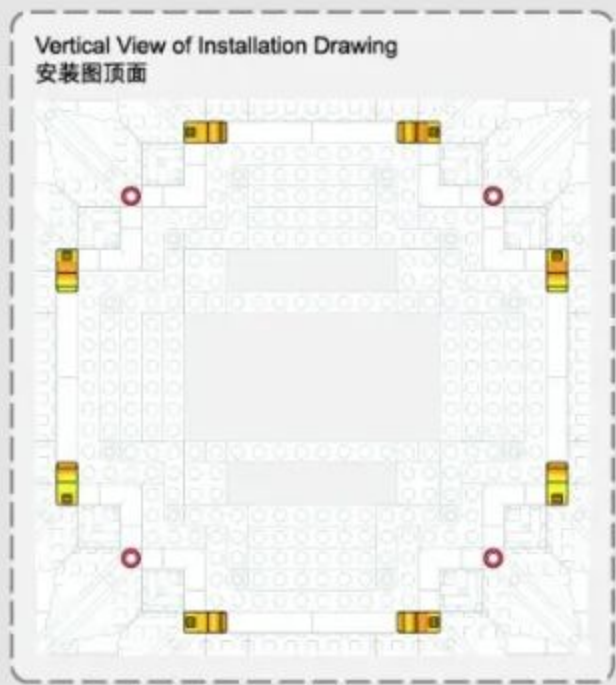

4-11

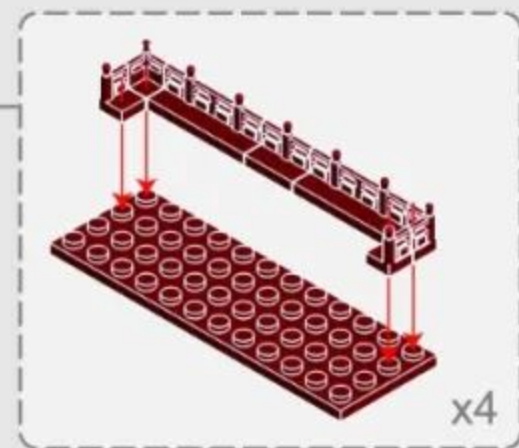
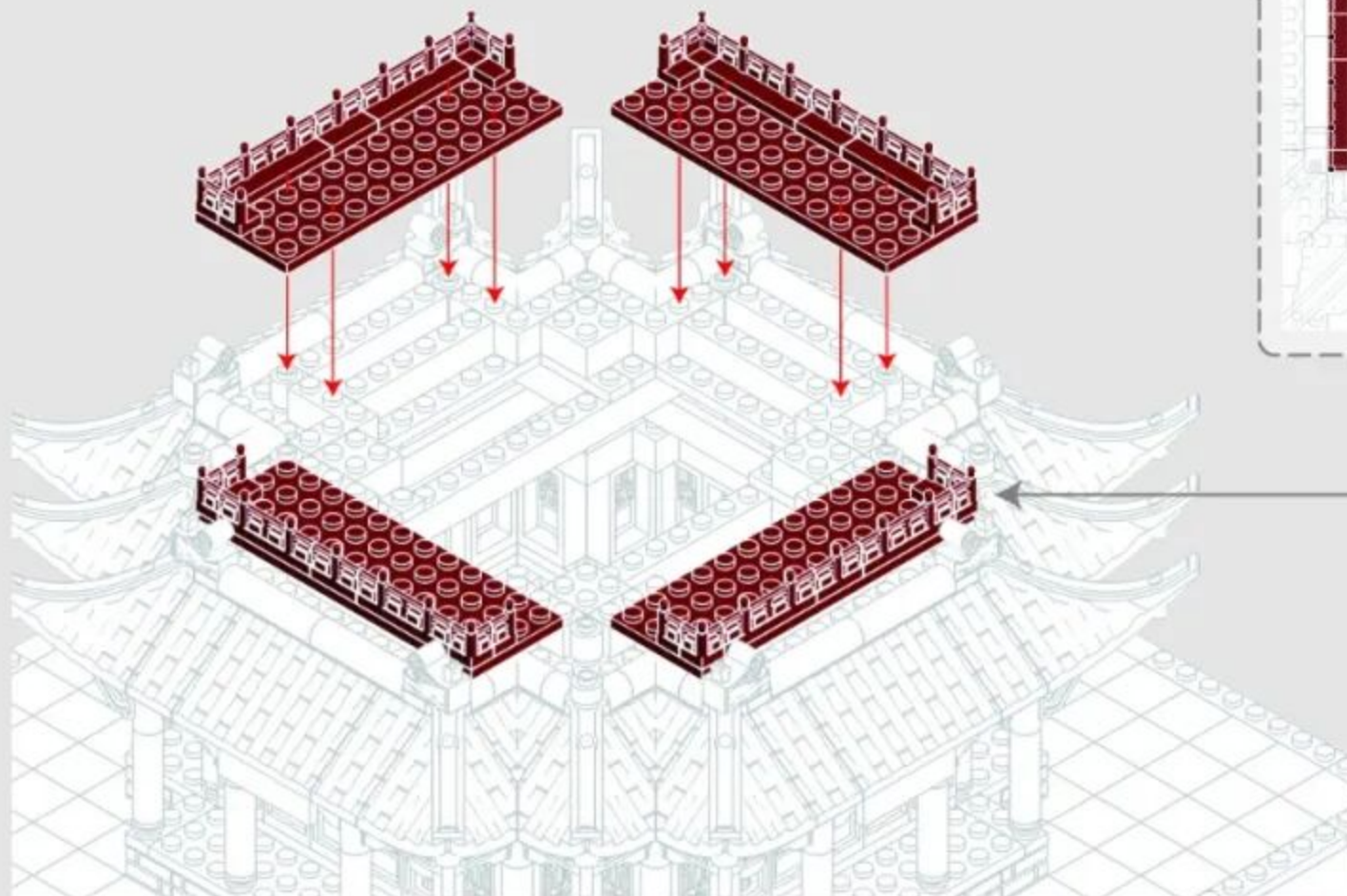
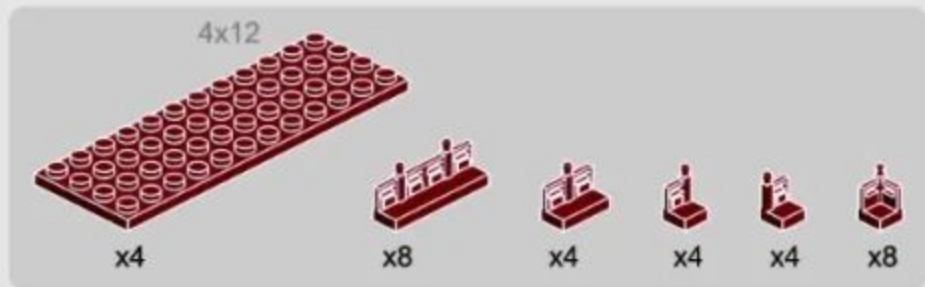

4-12

3x3



x4



x8



x4



x4



x4

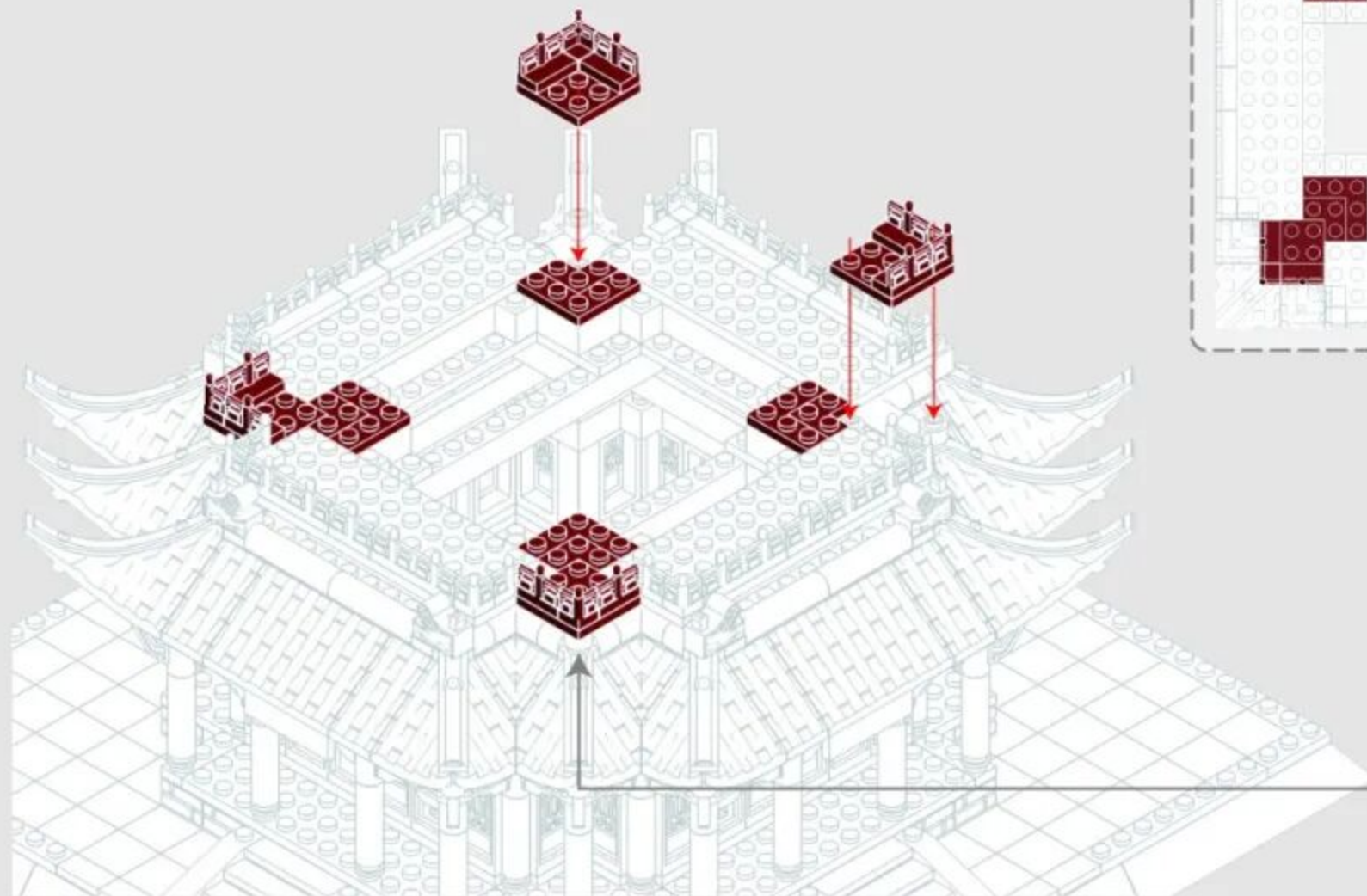

Vertical View of Installation Drawing
安装图顶面

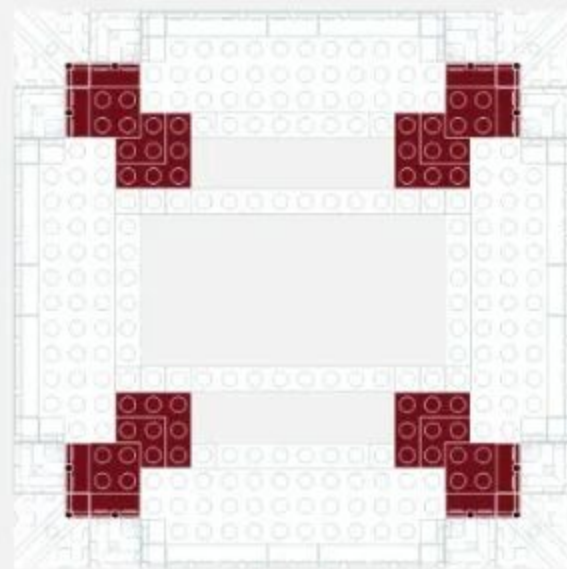

4-13

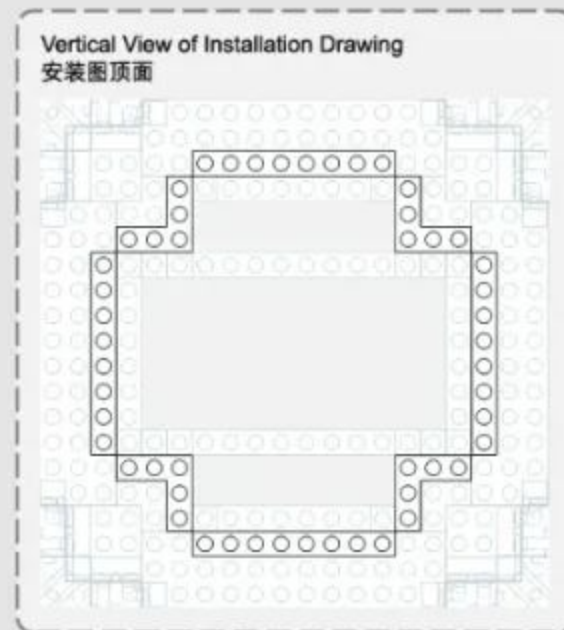
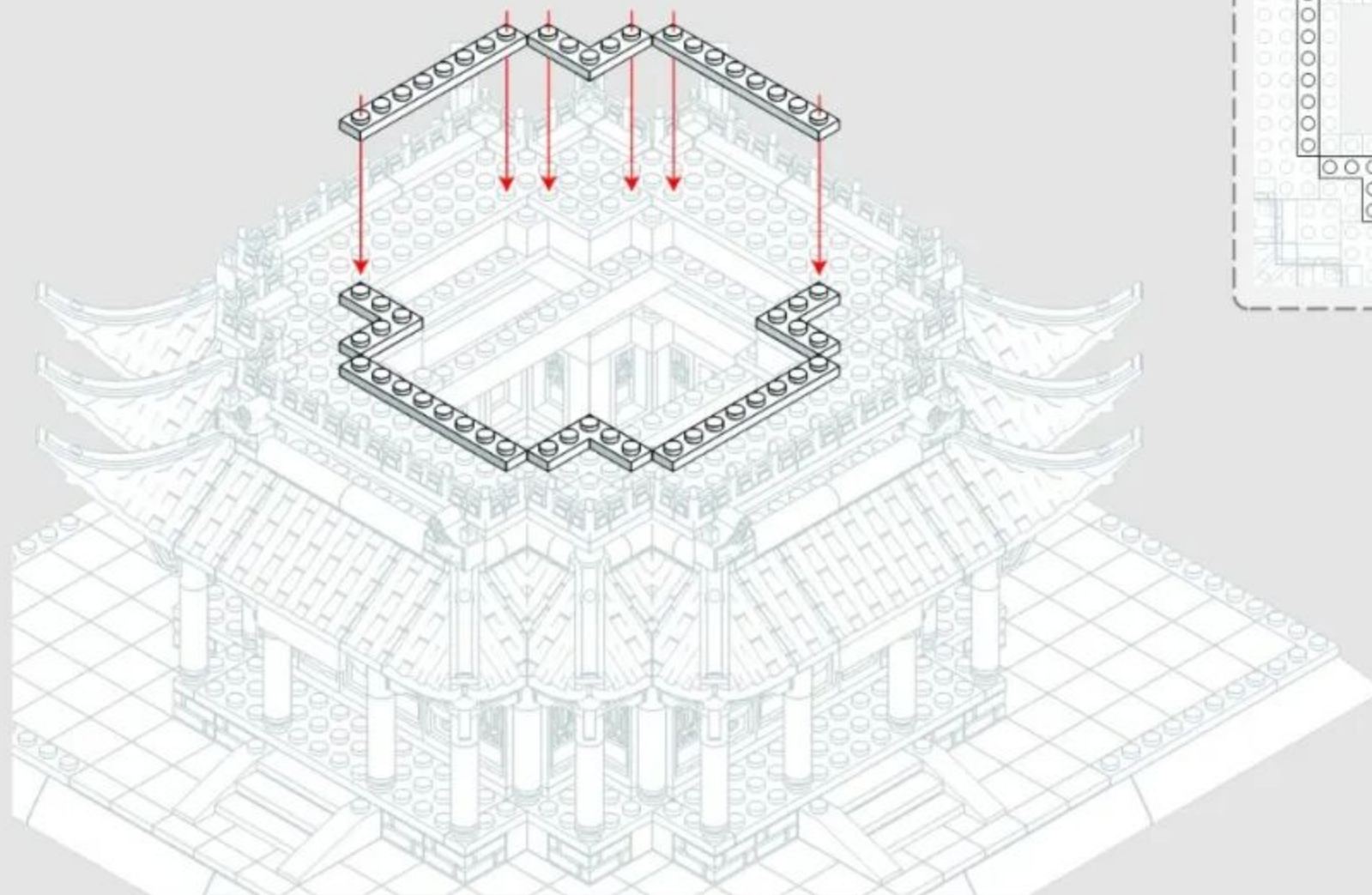
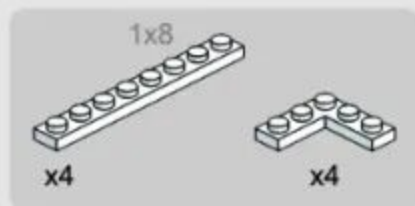

4-14

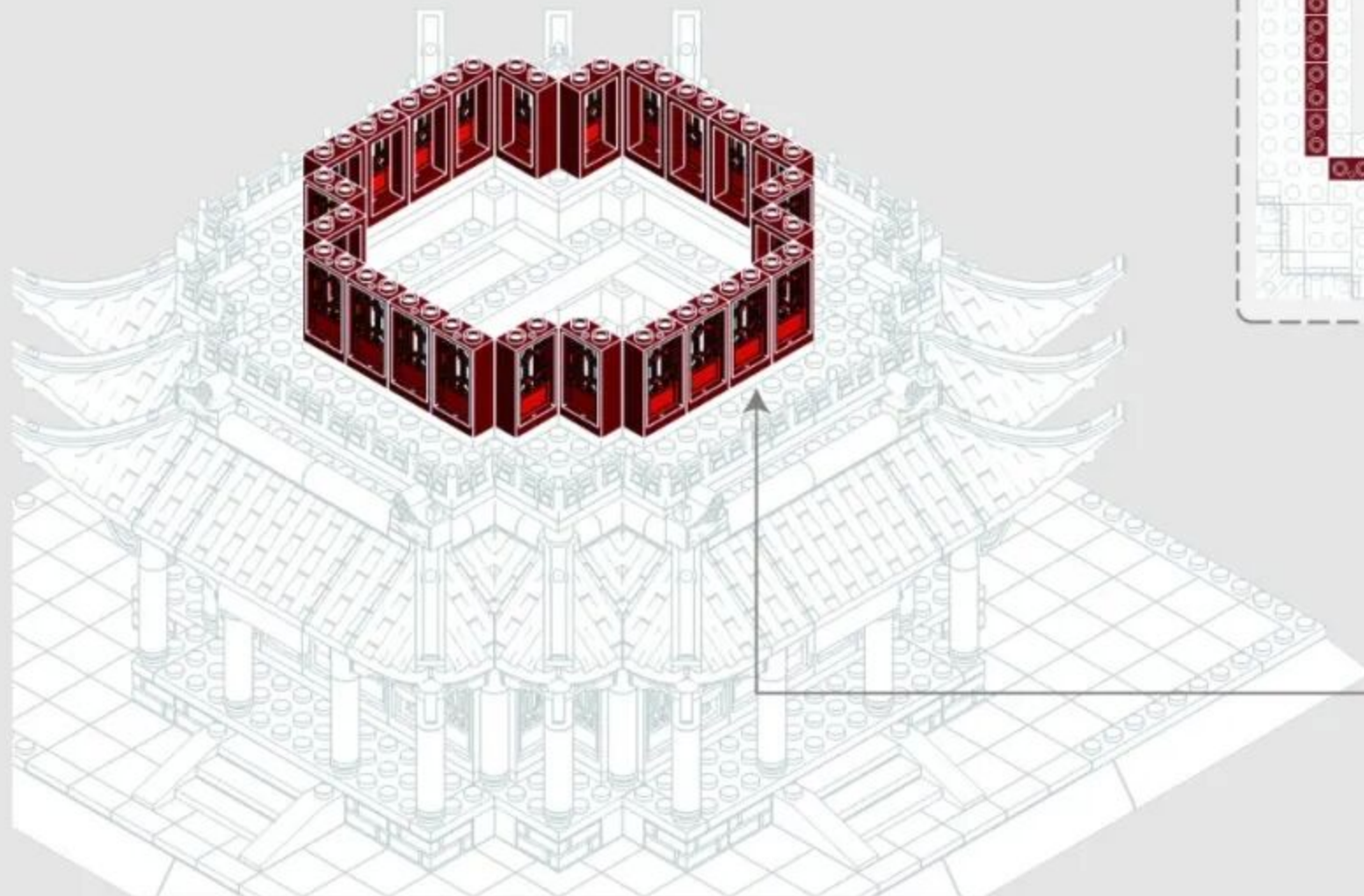

Vertical View of Installation Drawing
安装图顶面

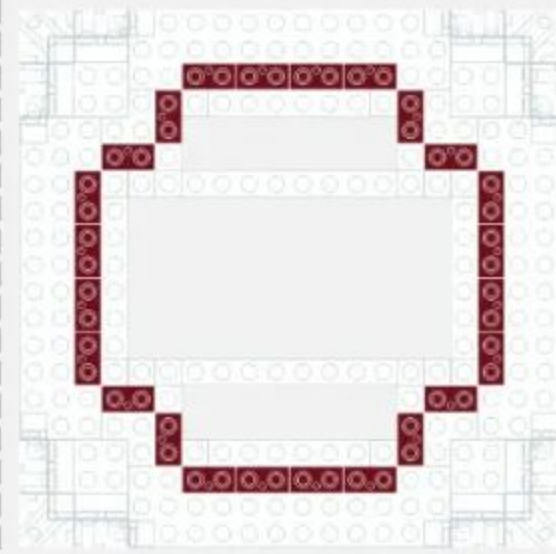



264PCS

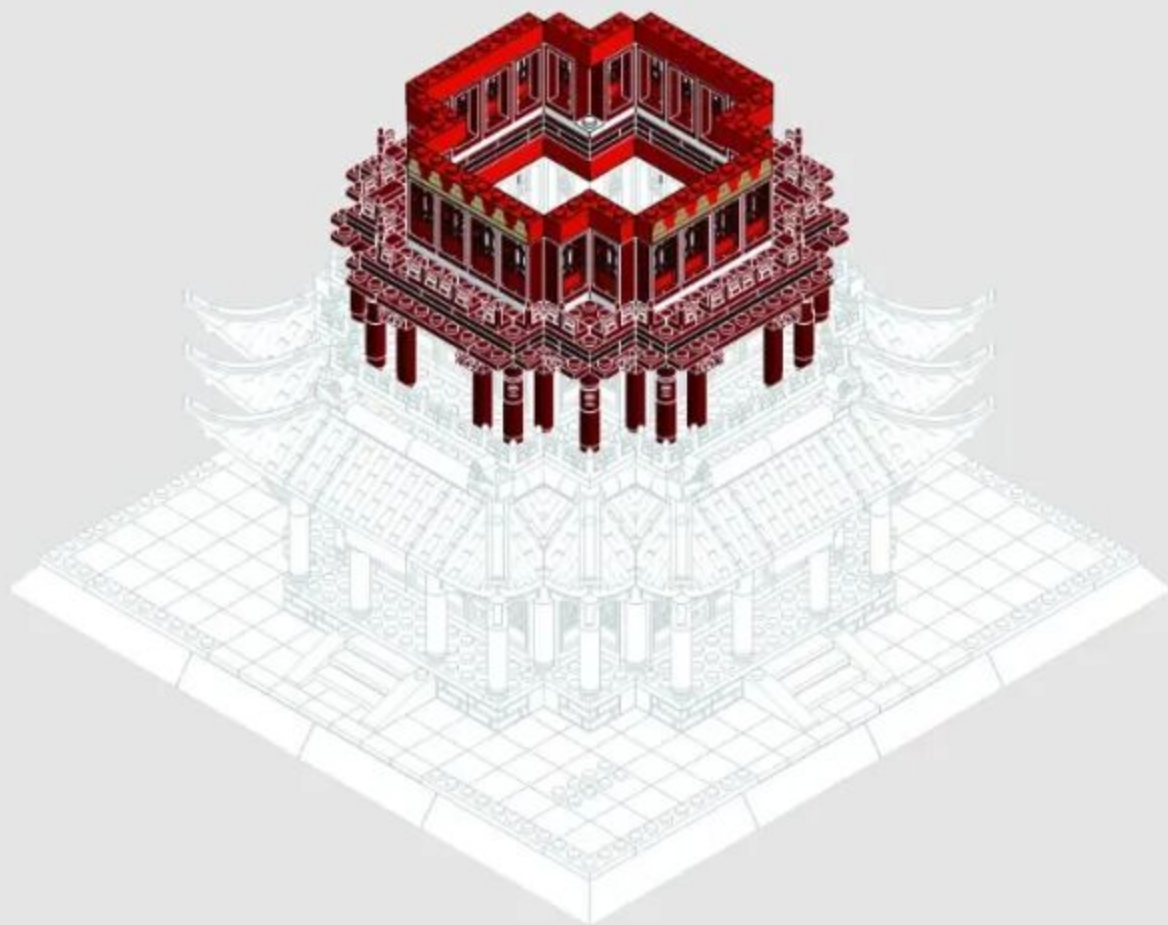

70

5-1

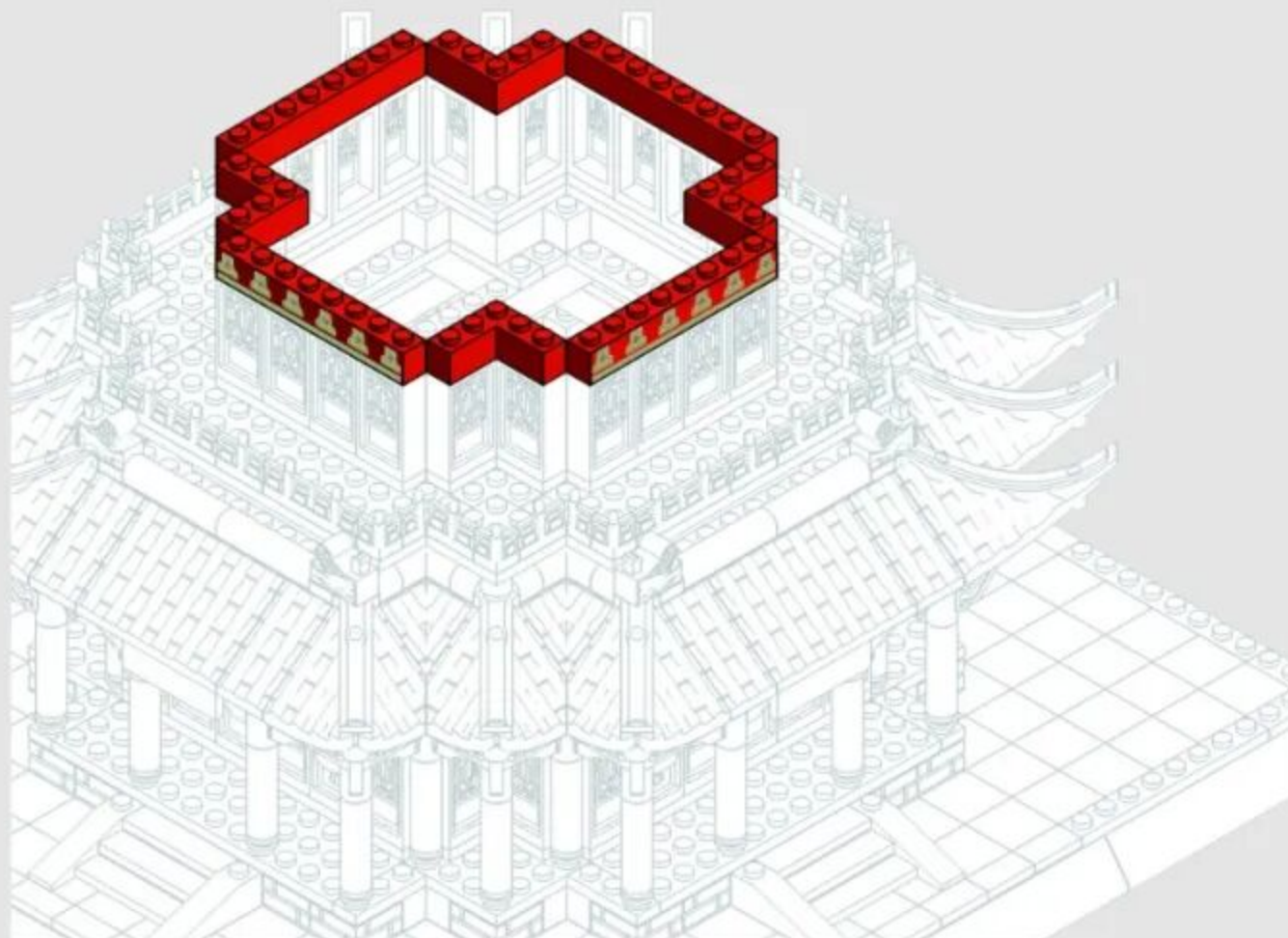
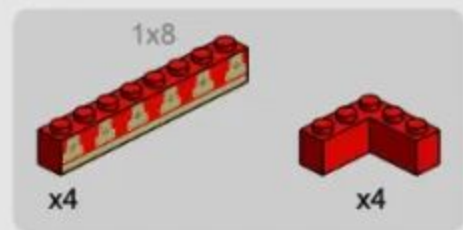

Vertical View of Installation Drawing
安装图顶面

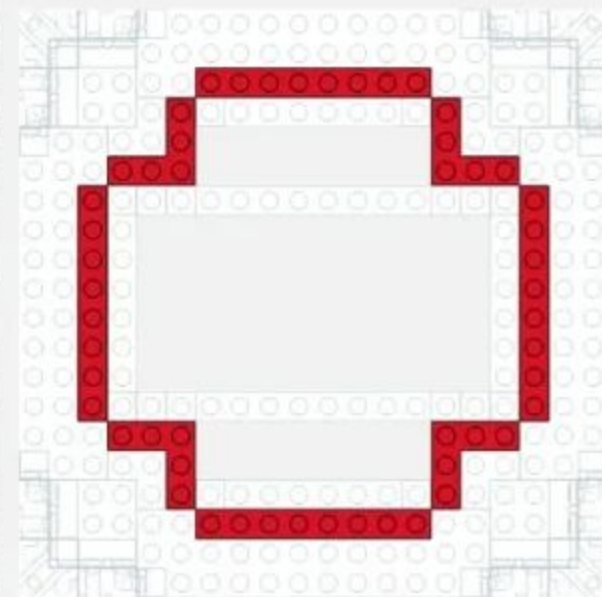

Back Side of Installation Drawing
安装图背面

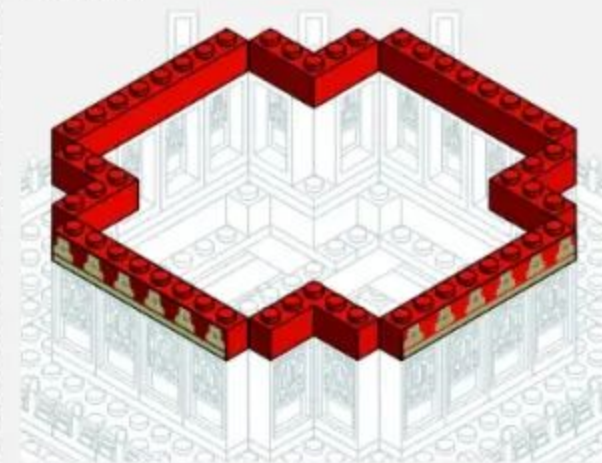

5-2

1x3



x8



x8



x8

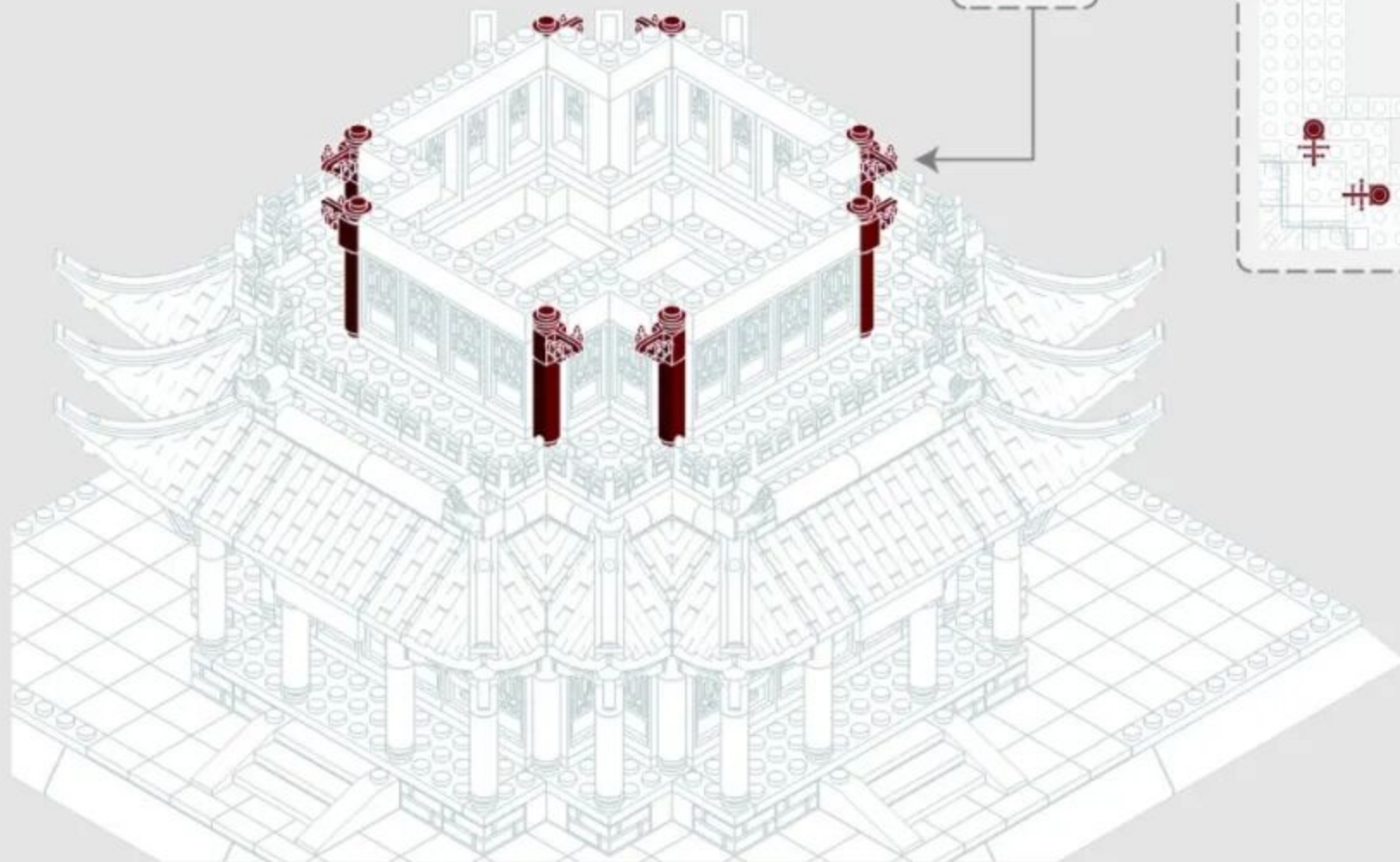

Vertical View of Installation Drawing
安装图顶面

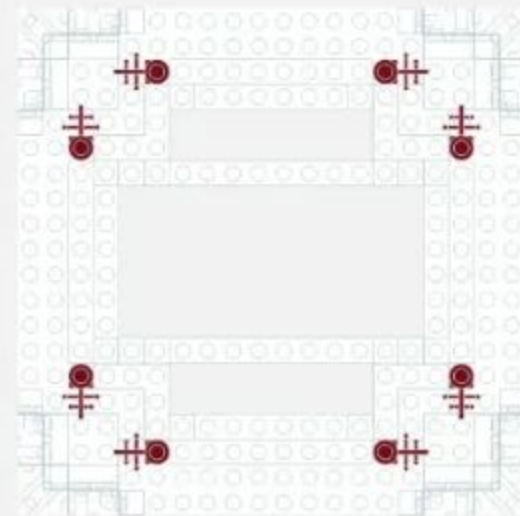

5-3

- 1x3 x8
- 1x2 x8
-  x8
-  x8
-  x16

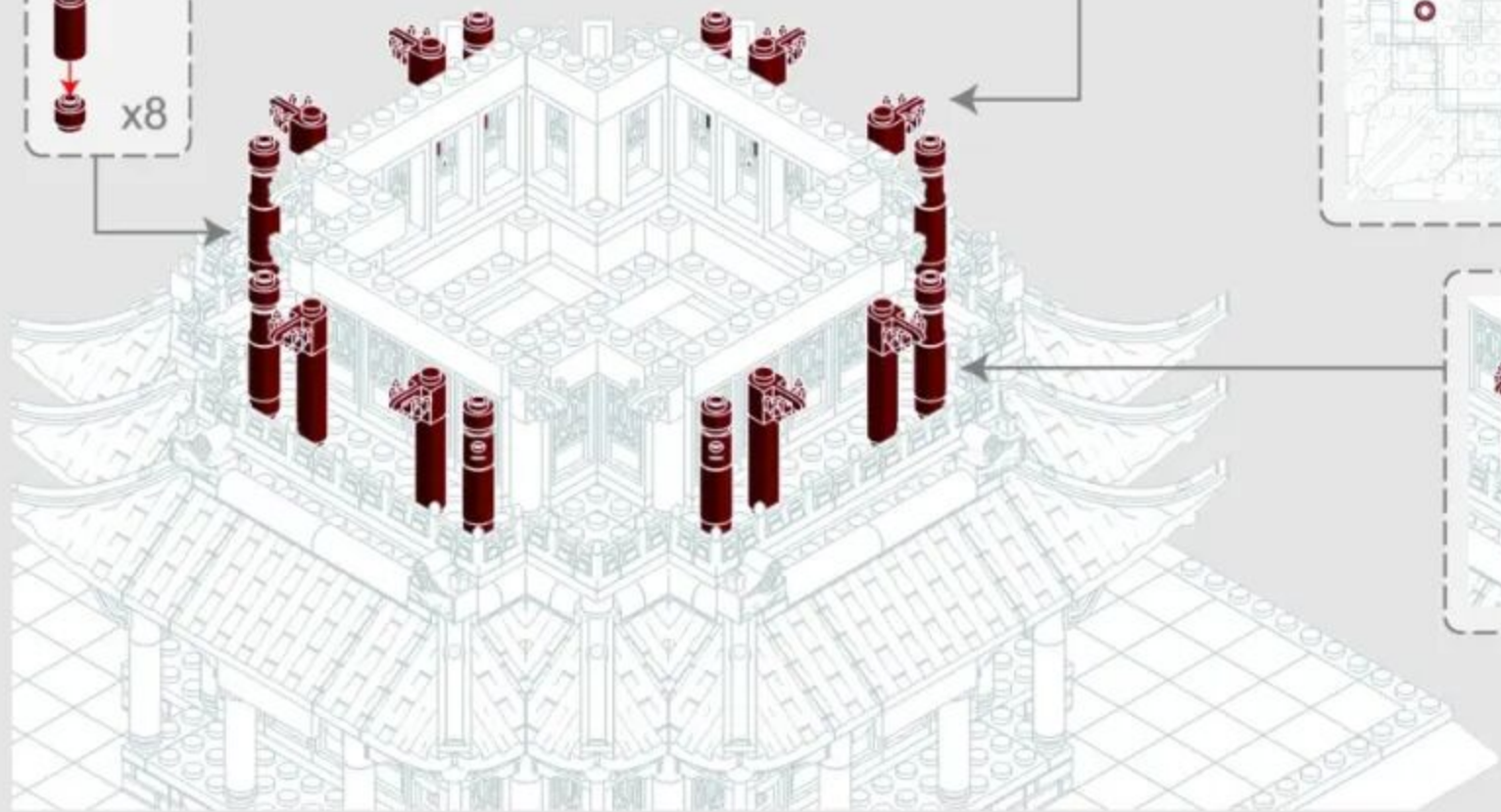
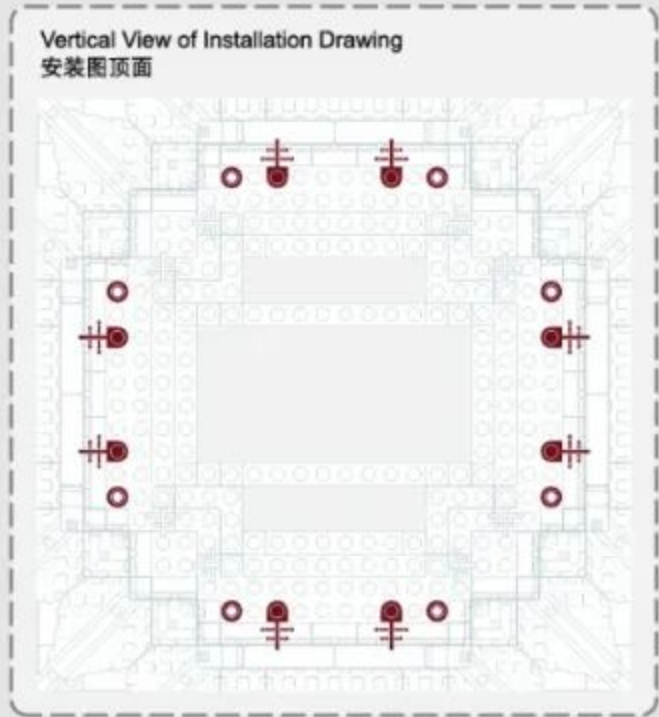
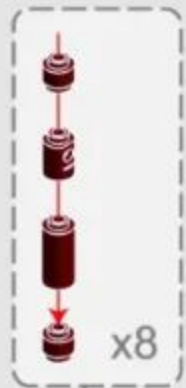

5-4

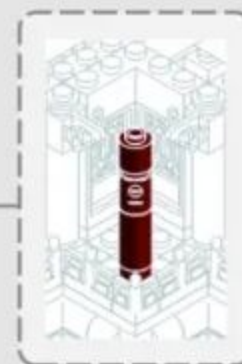
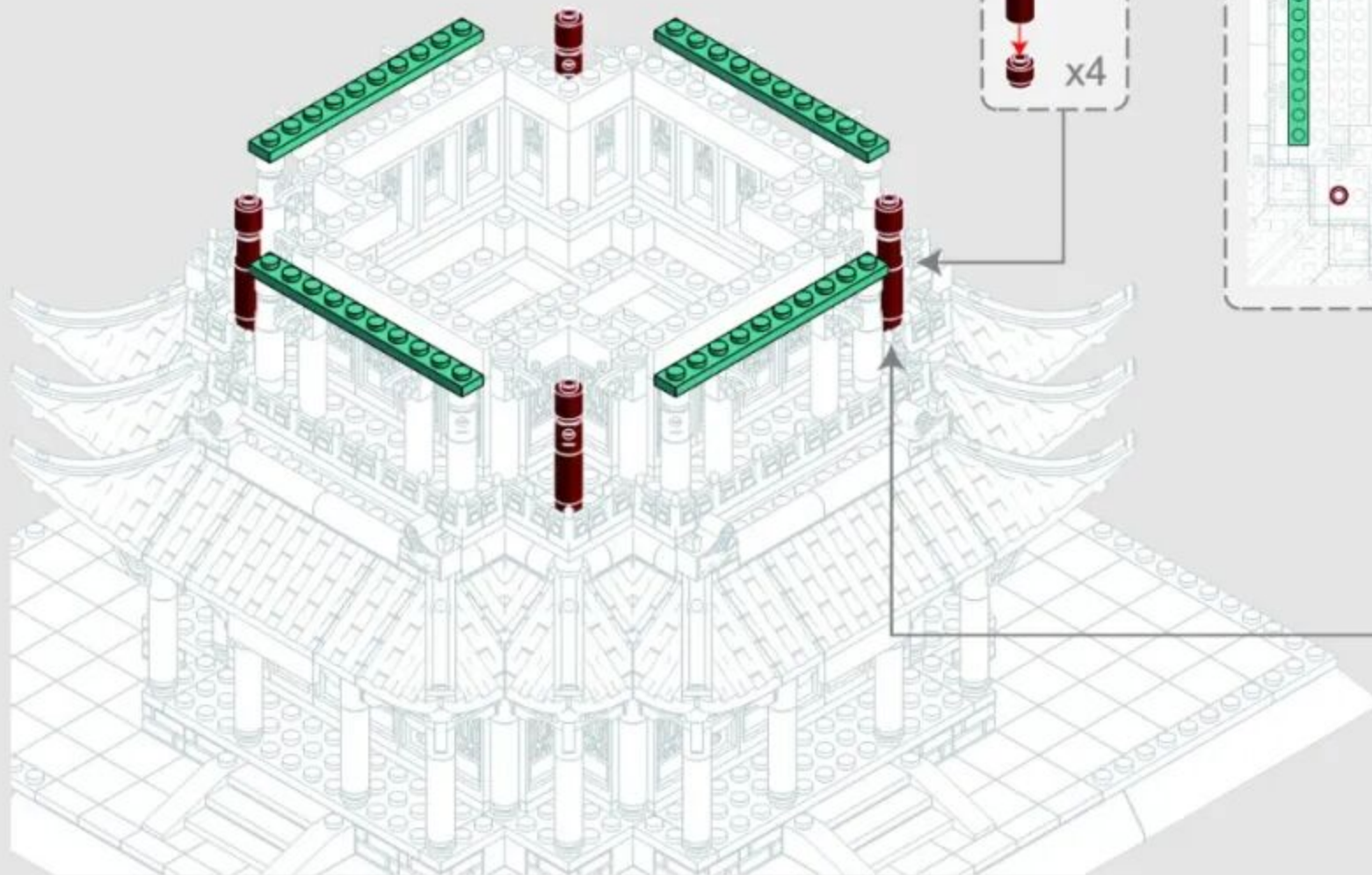
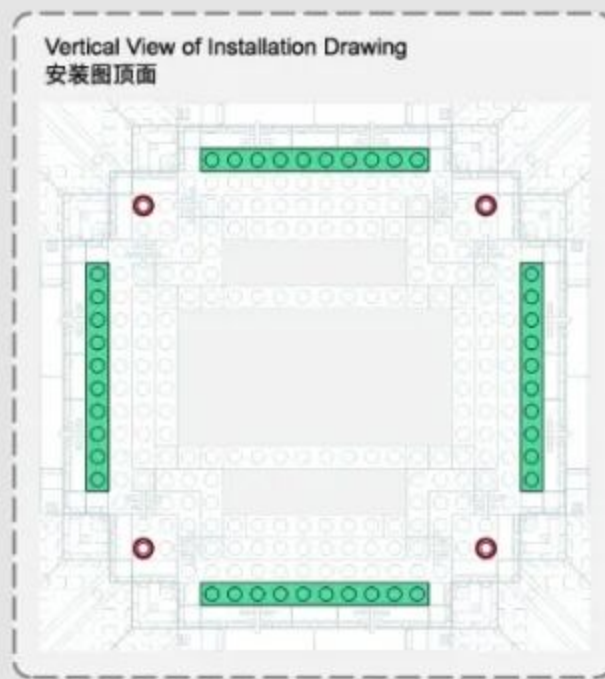

5-5

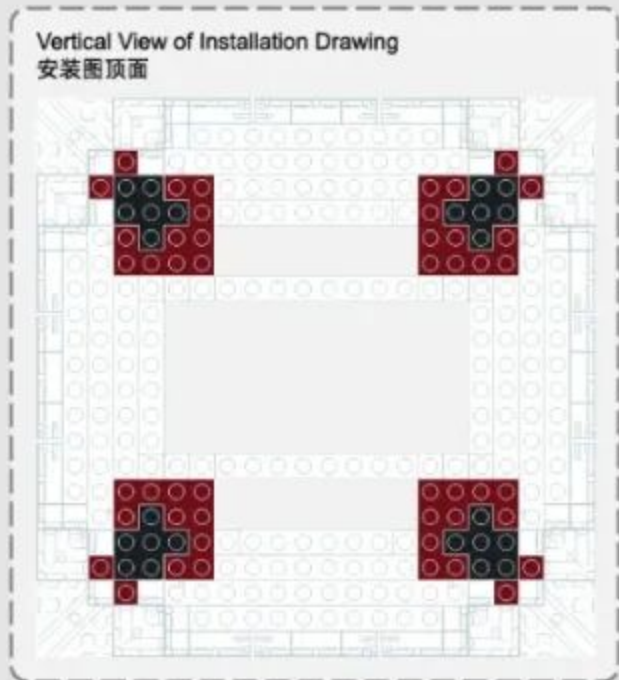
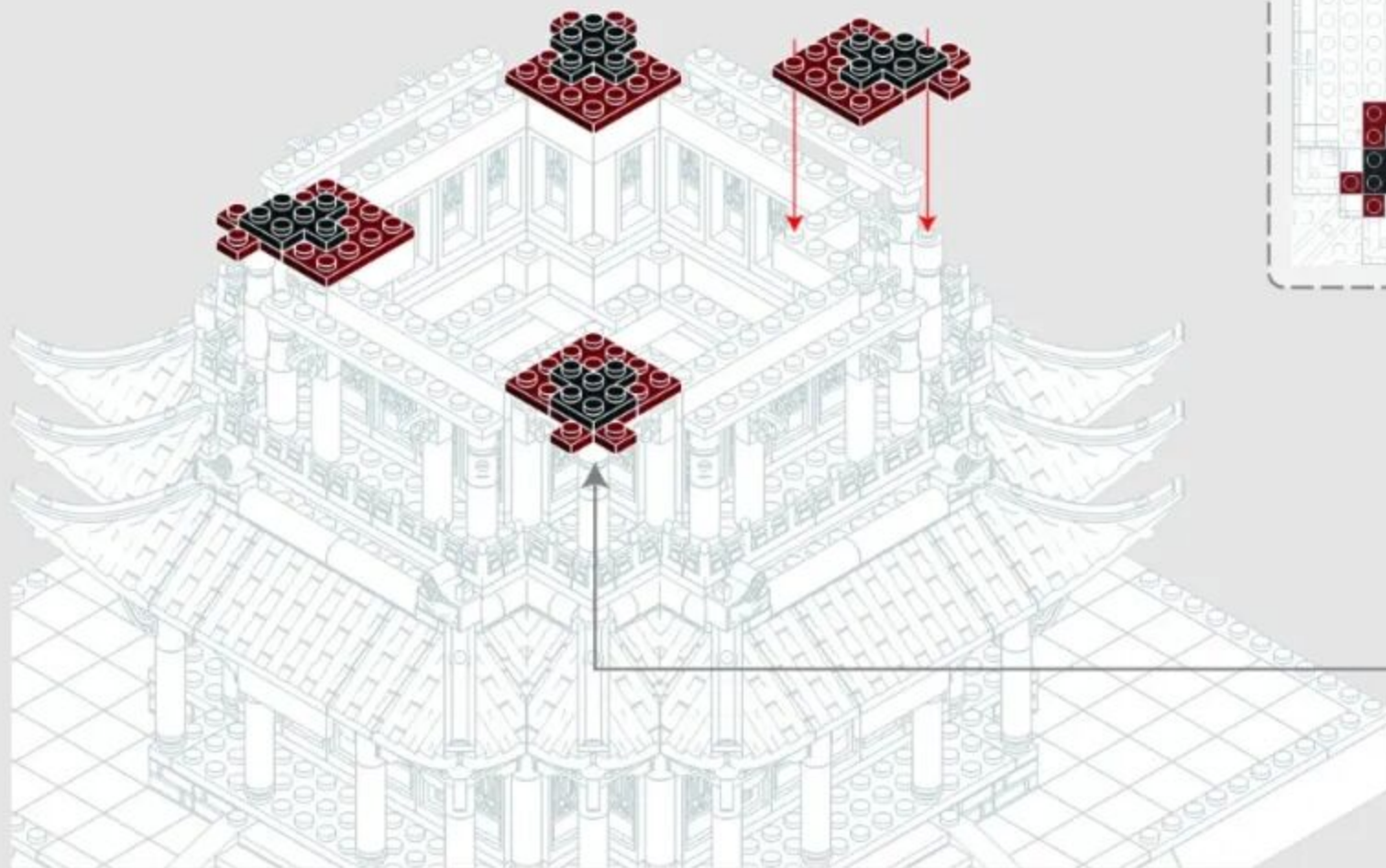

5-6

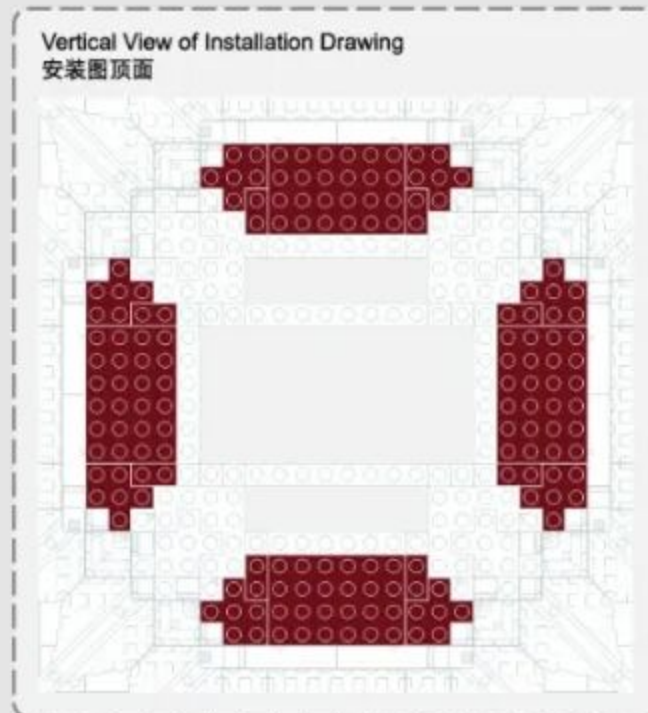
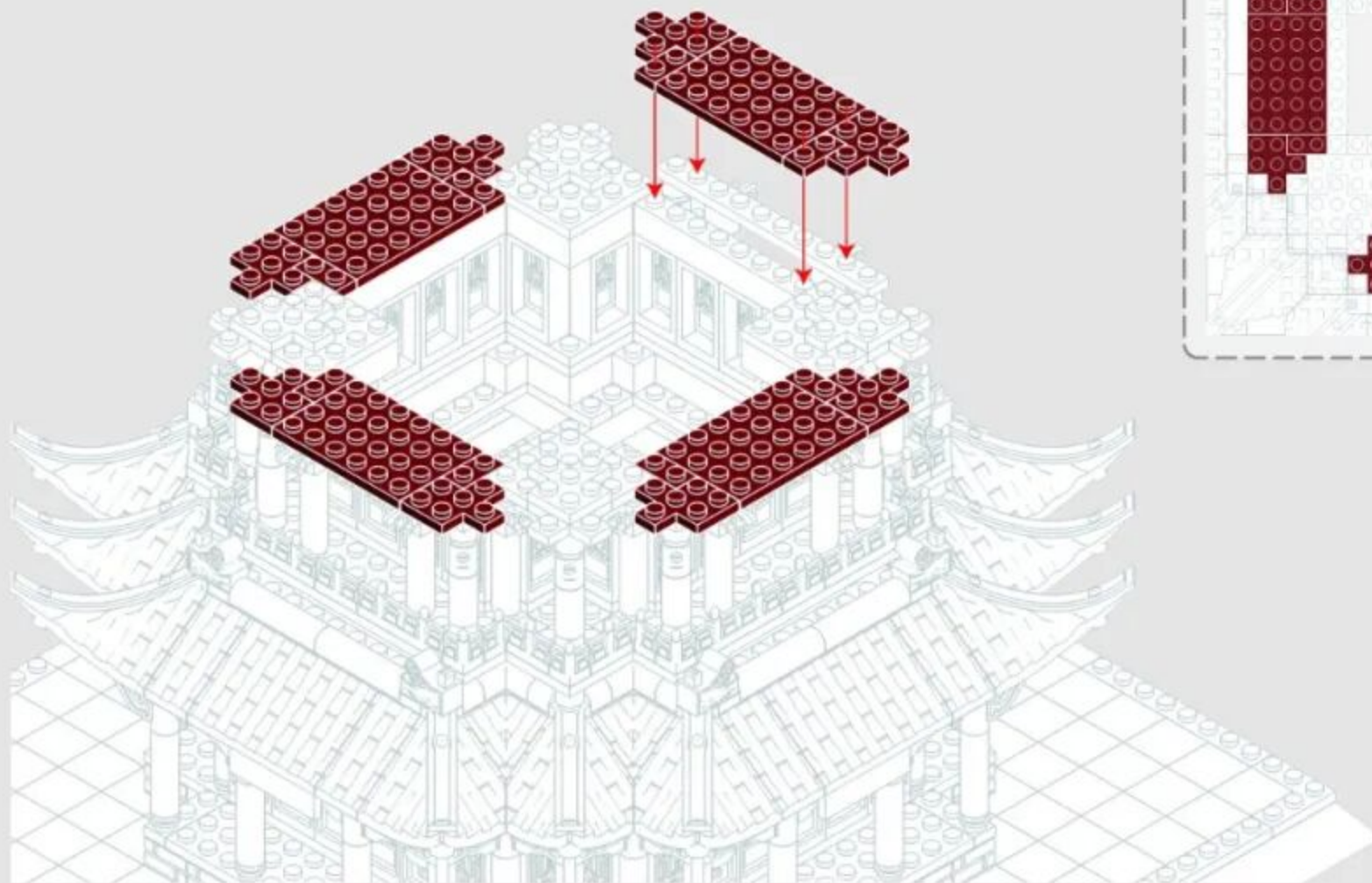
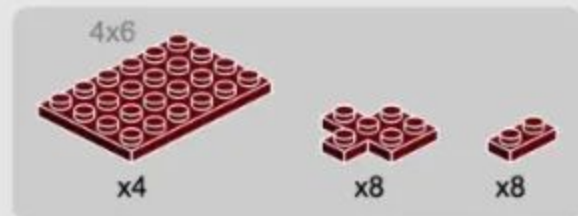

5-7

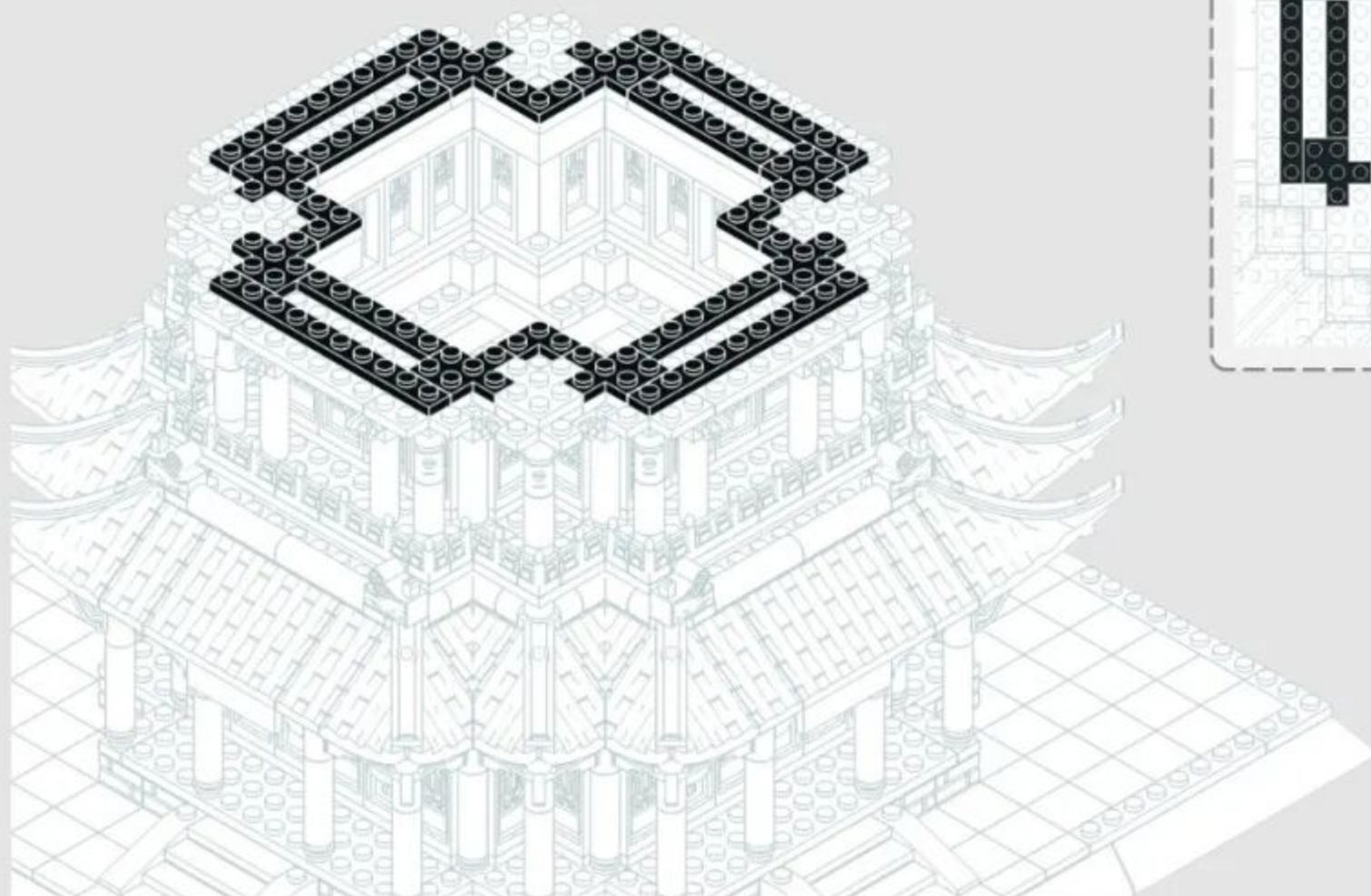

Vertical View of Installation Drawing
安装图顶面

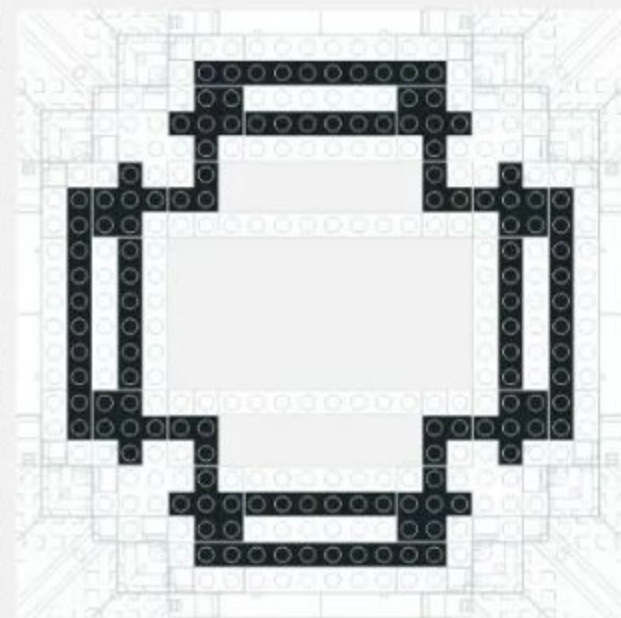

5-8

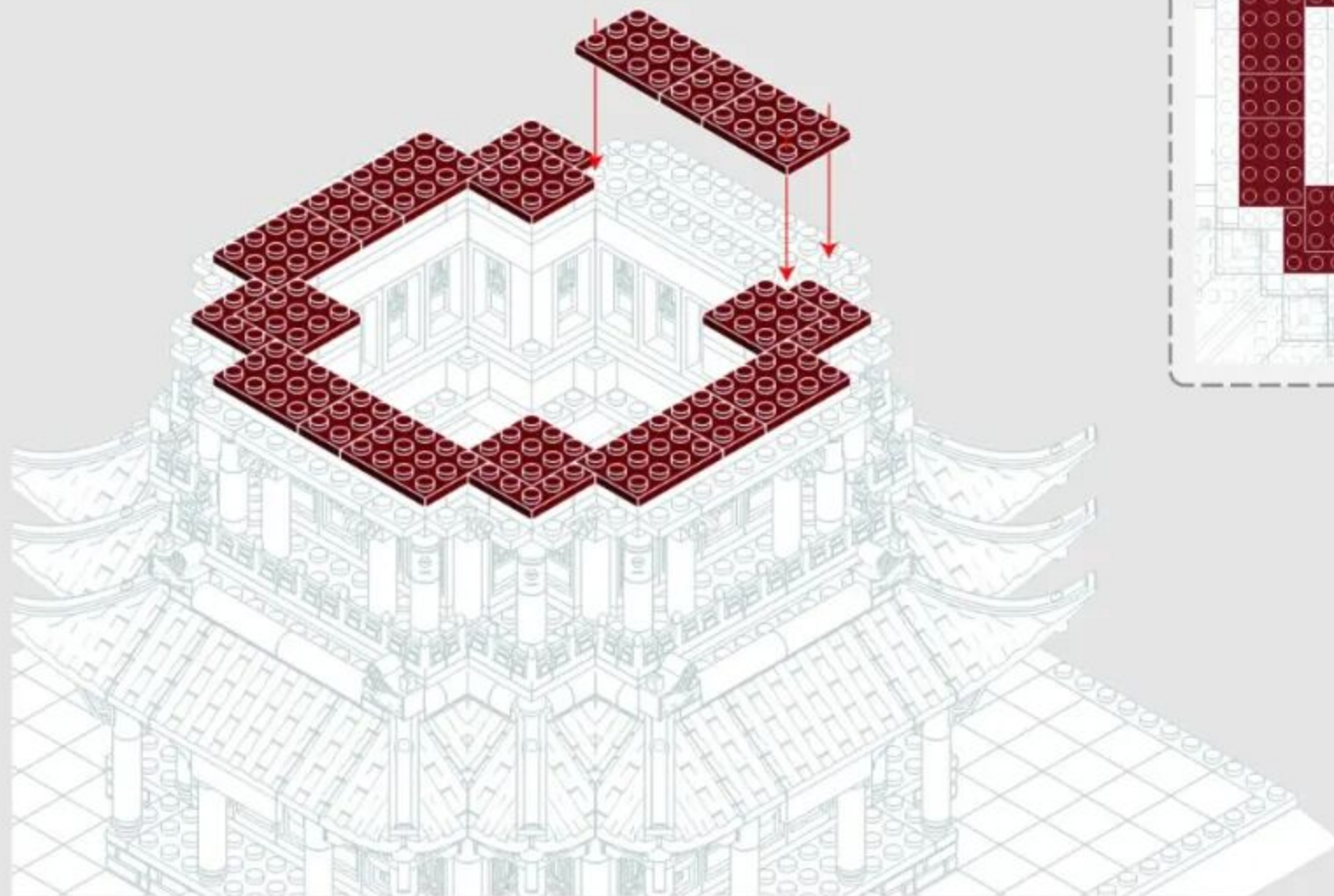

5-9

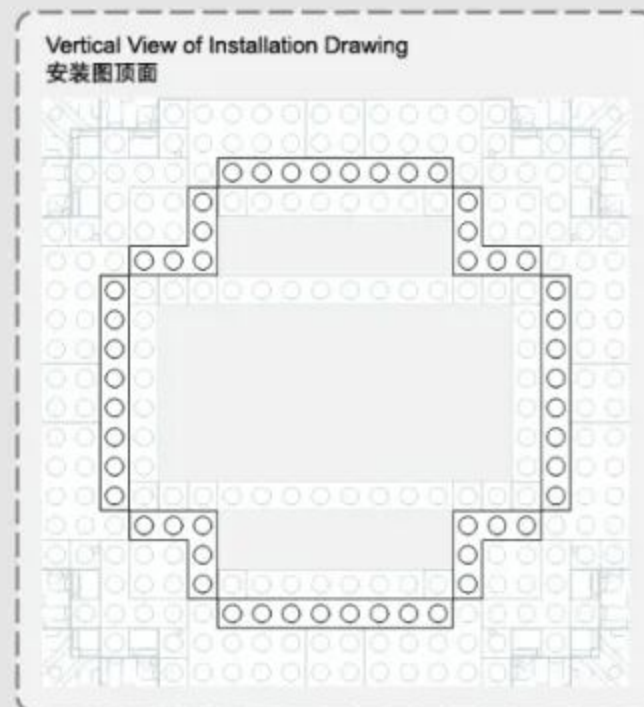
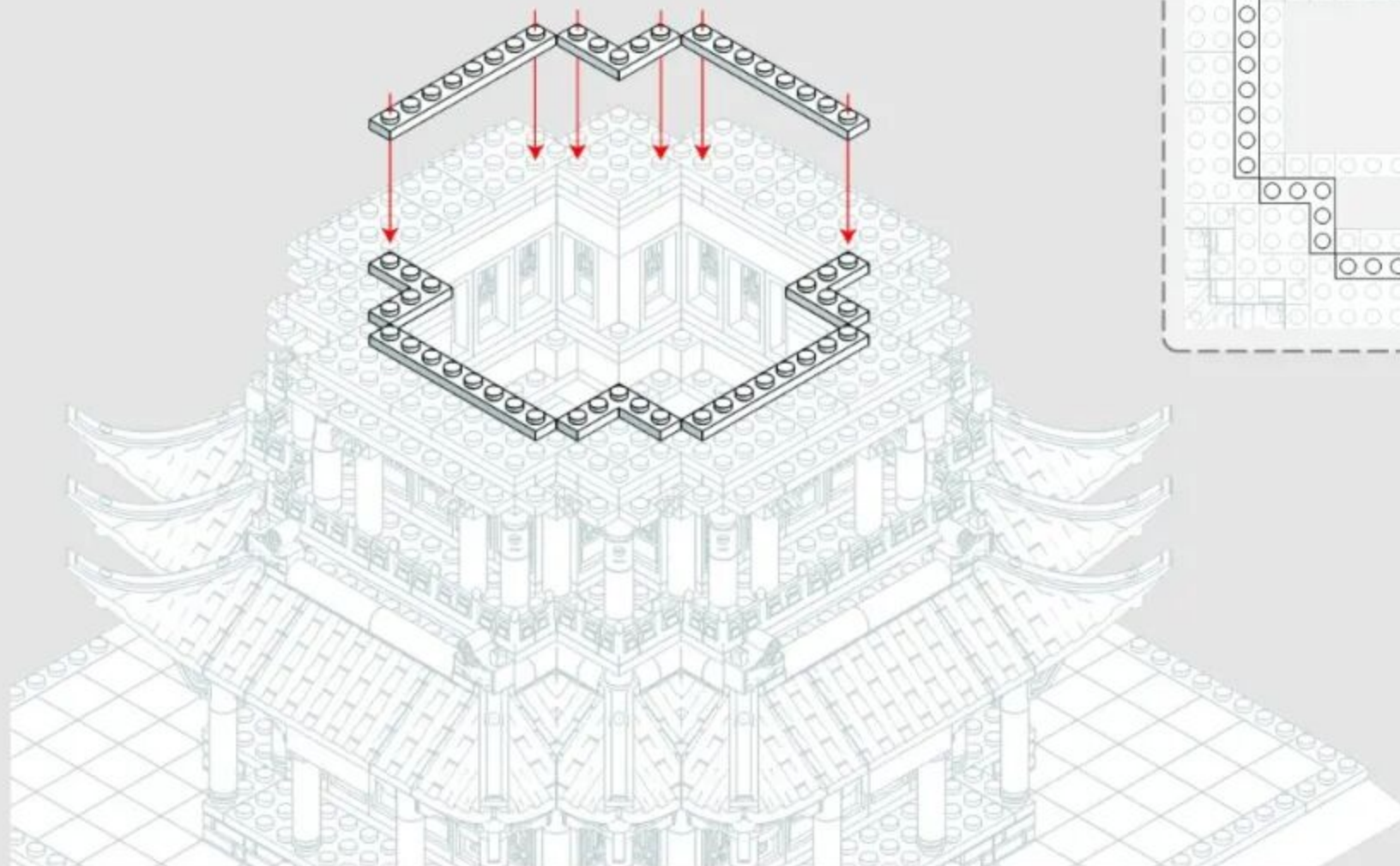
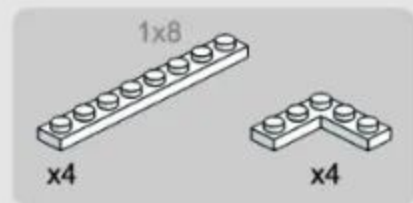

5-10

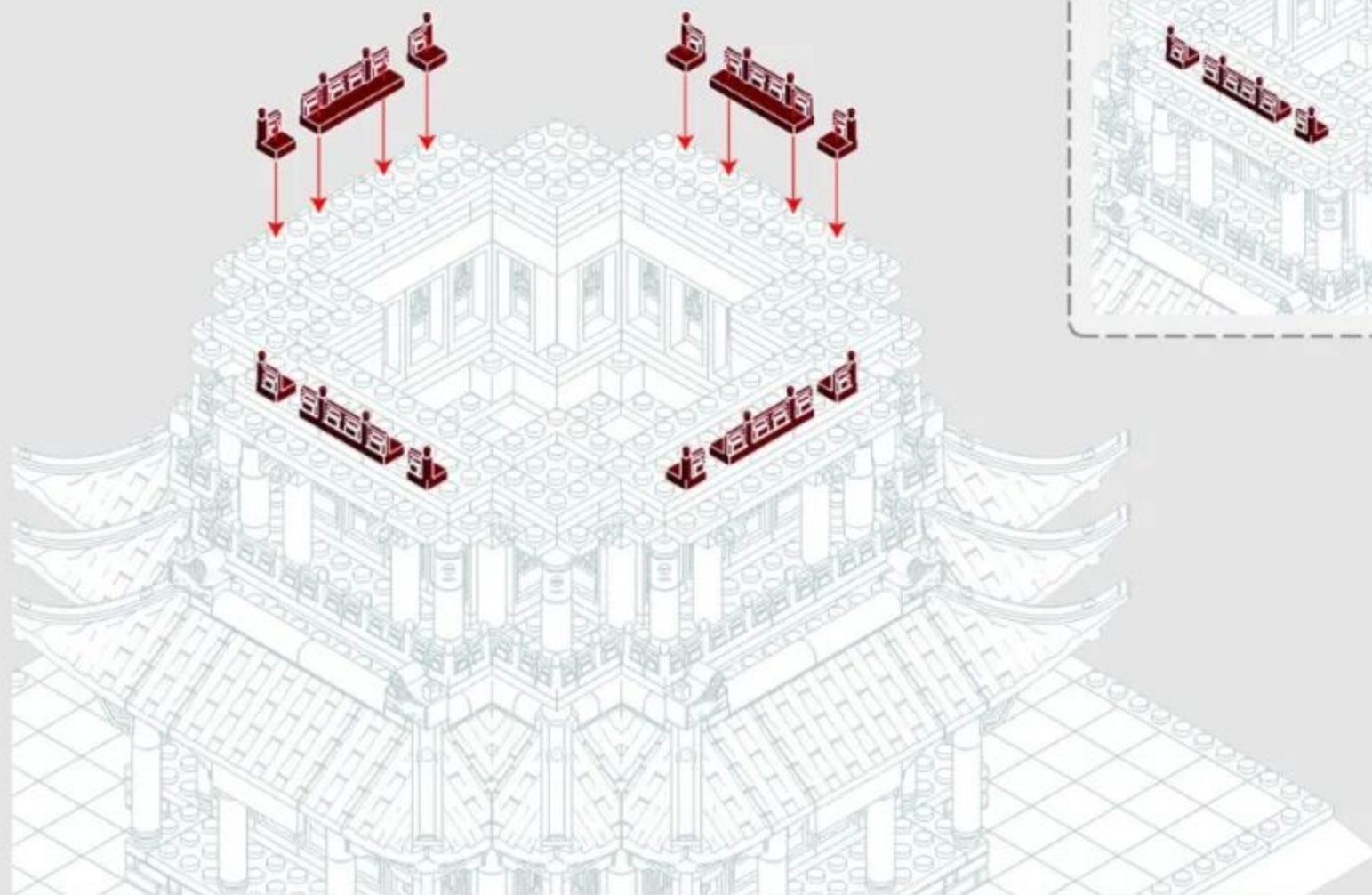

Back Side of Installation Drawing
安装图背面

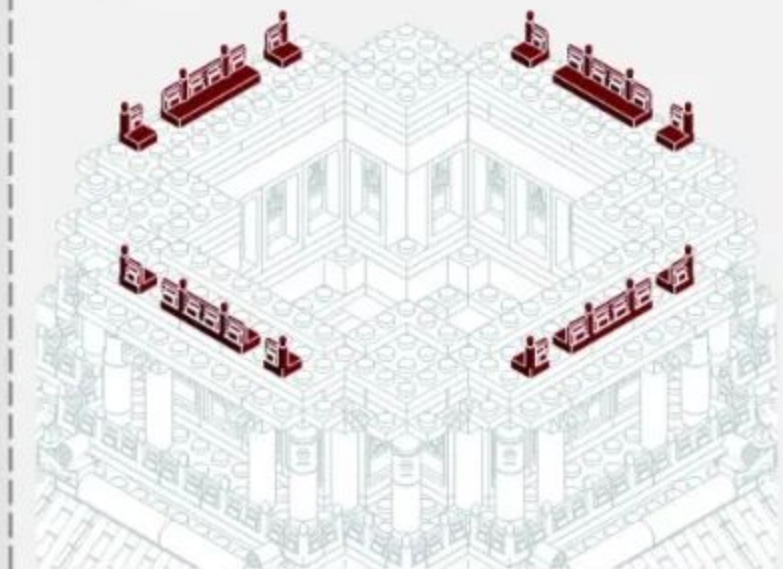

5-11



x8



x4



x4

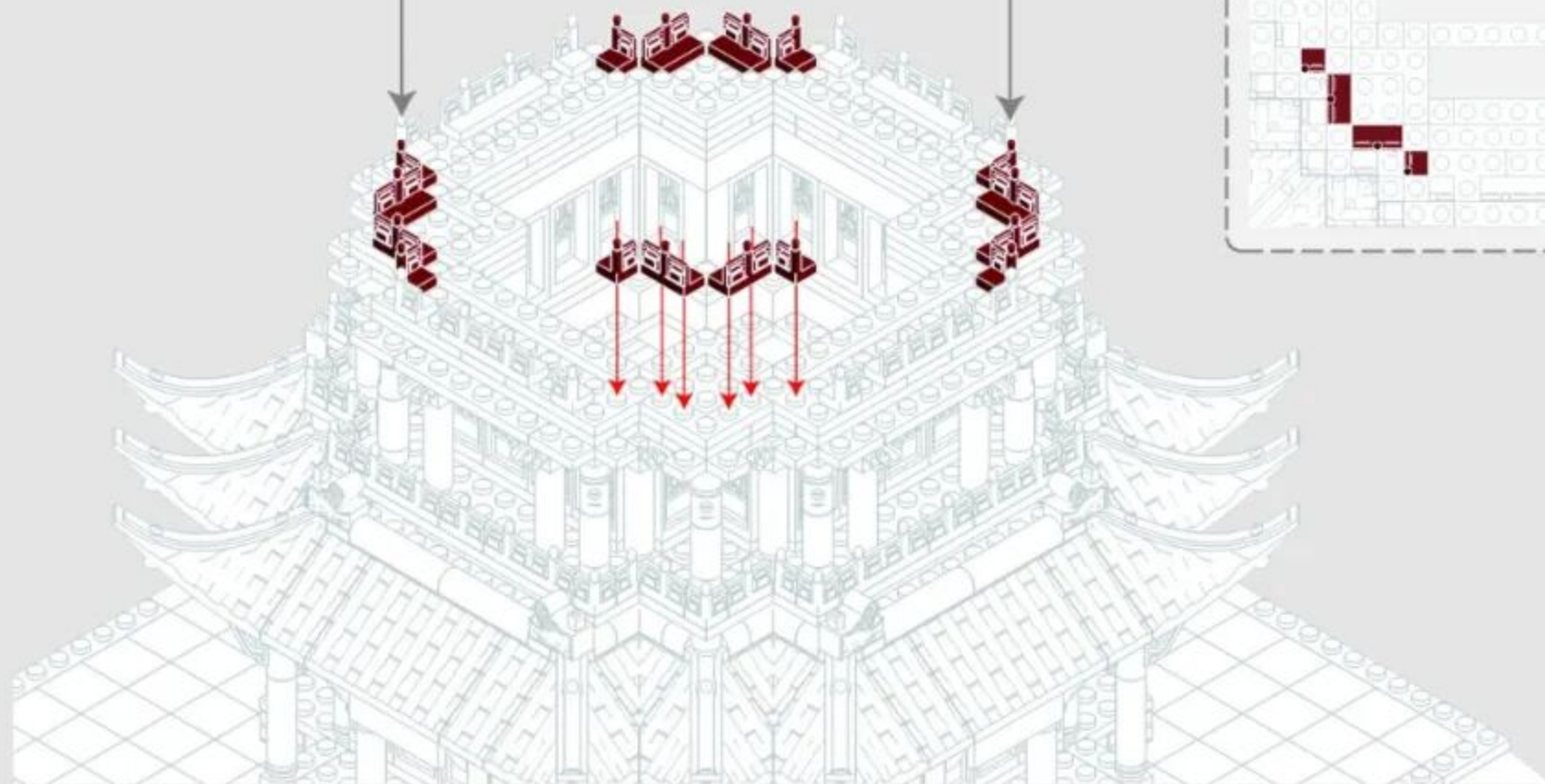
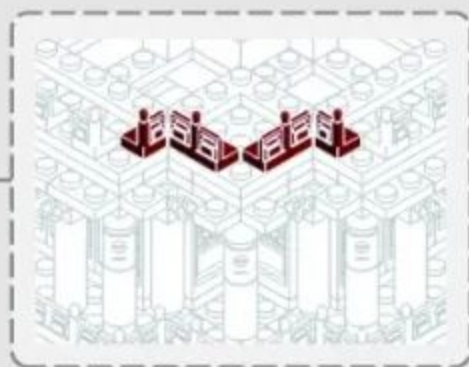

Vertical View of Installation Drawing
安装图顶面

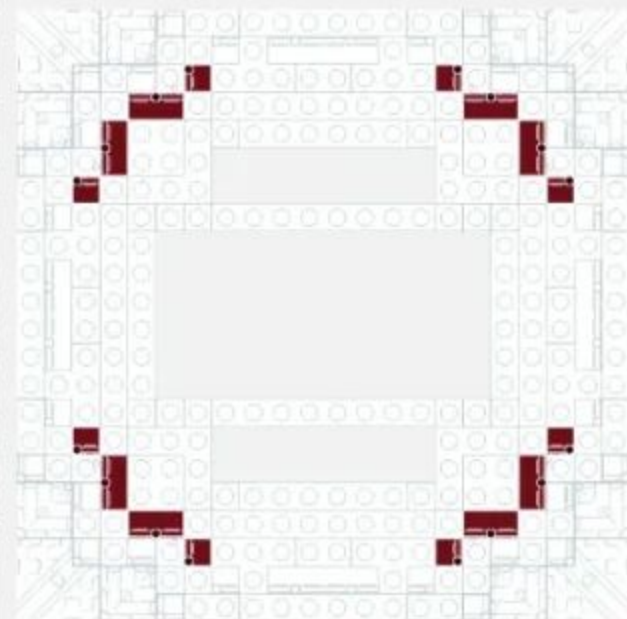

5-12

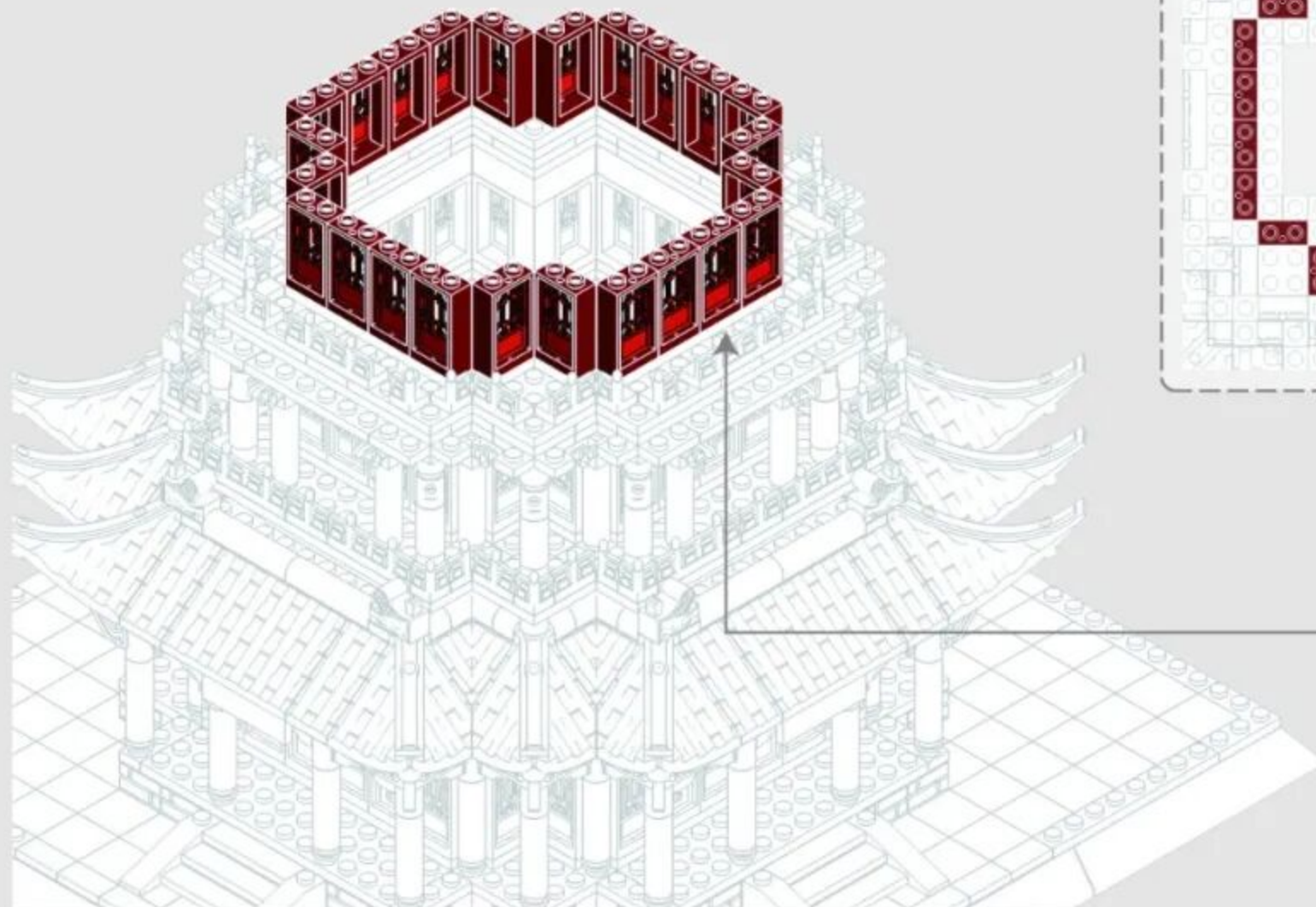

Vertical View of Installation Drawing
安装图顶面

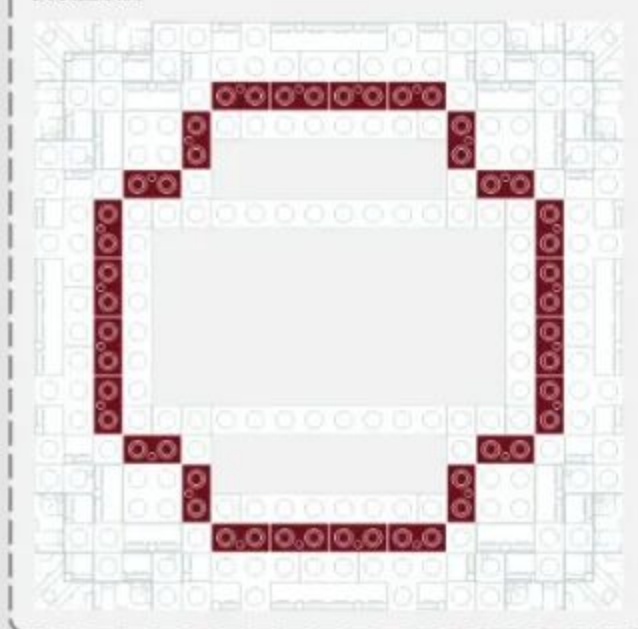

5-13

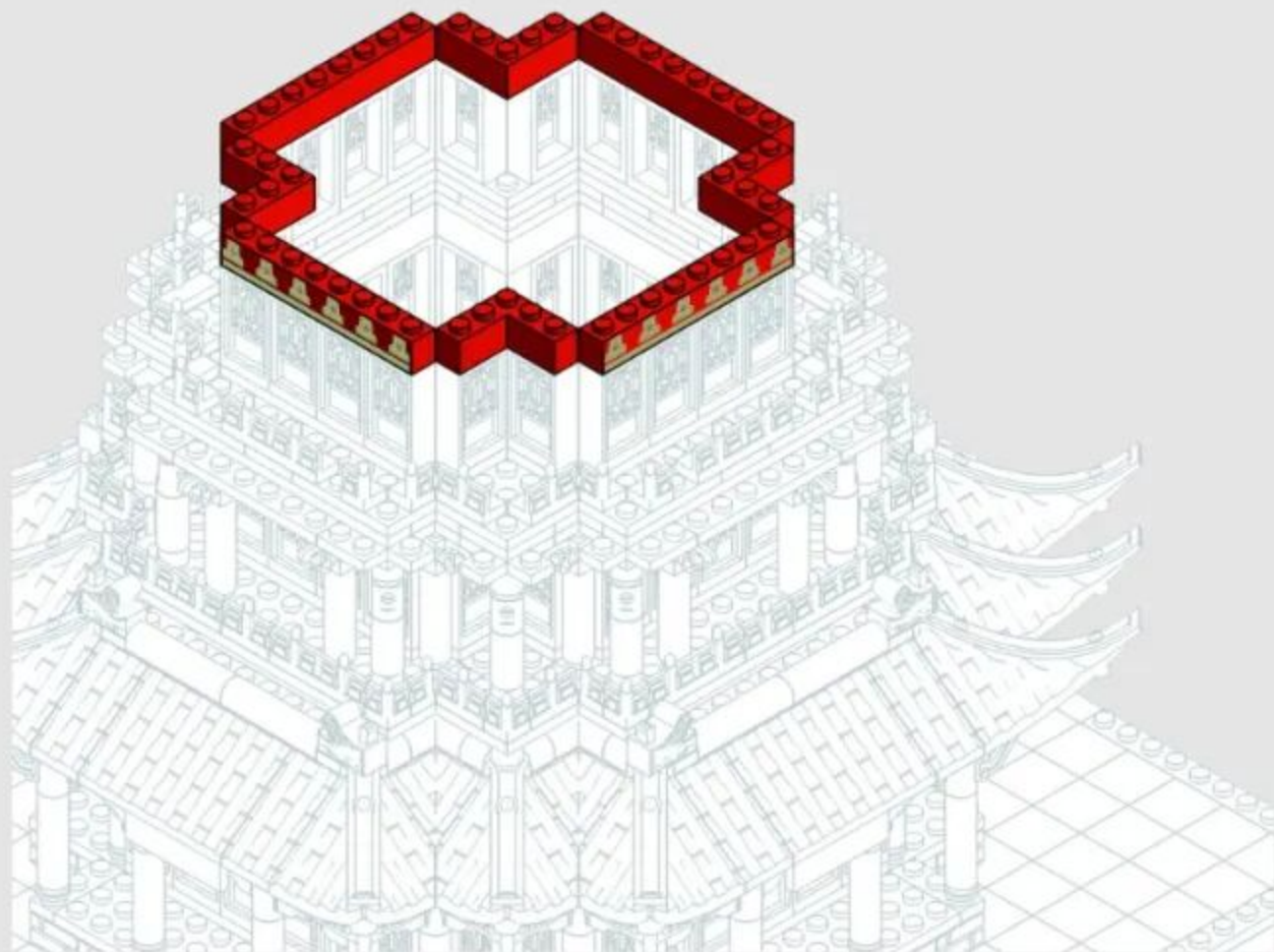
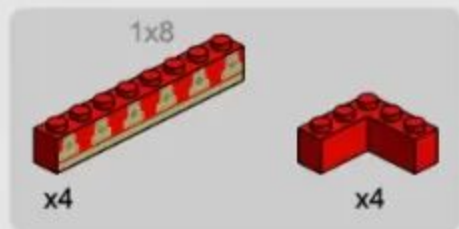

Vertical View of Installation Drawing
安装图顶面

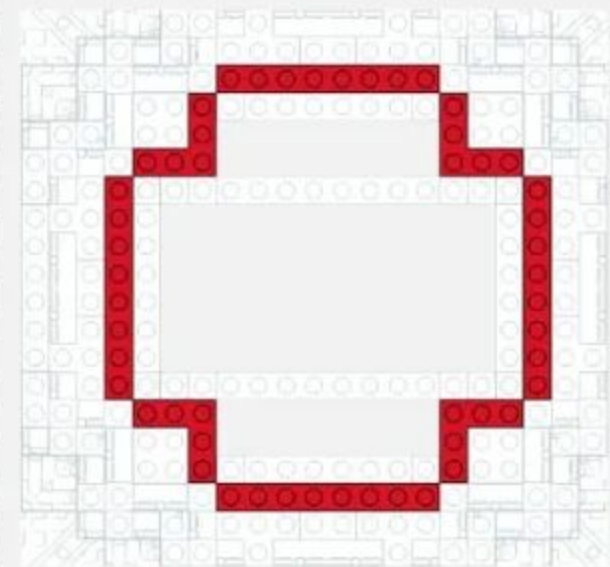

Back Side of Installation Drawing
安装图背面

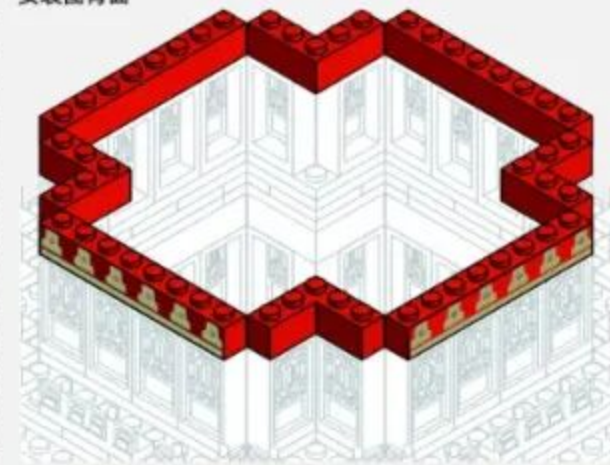



280PCS

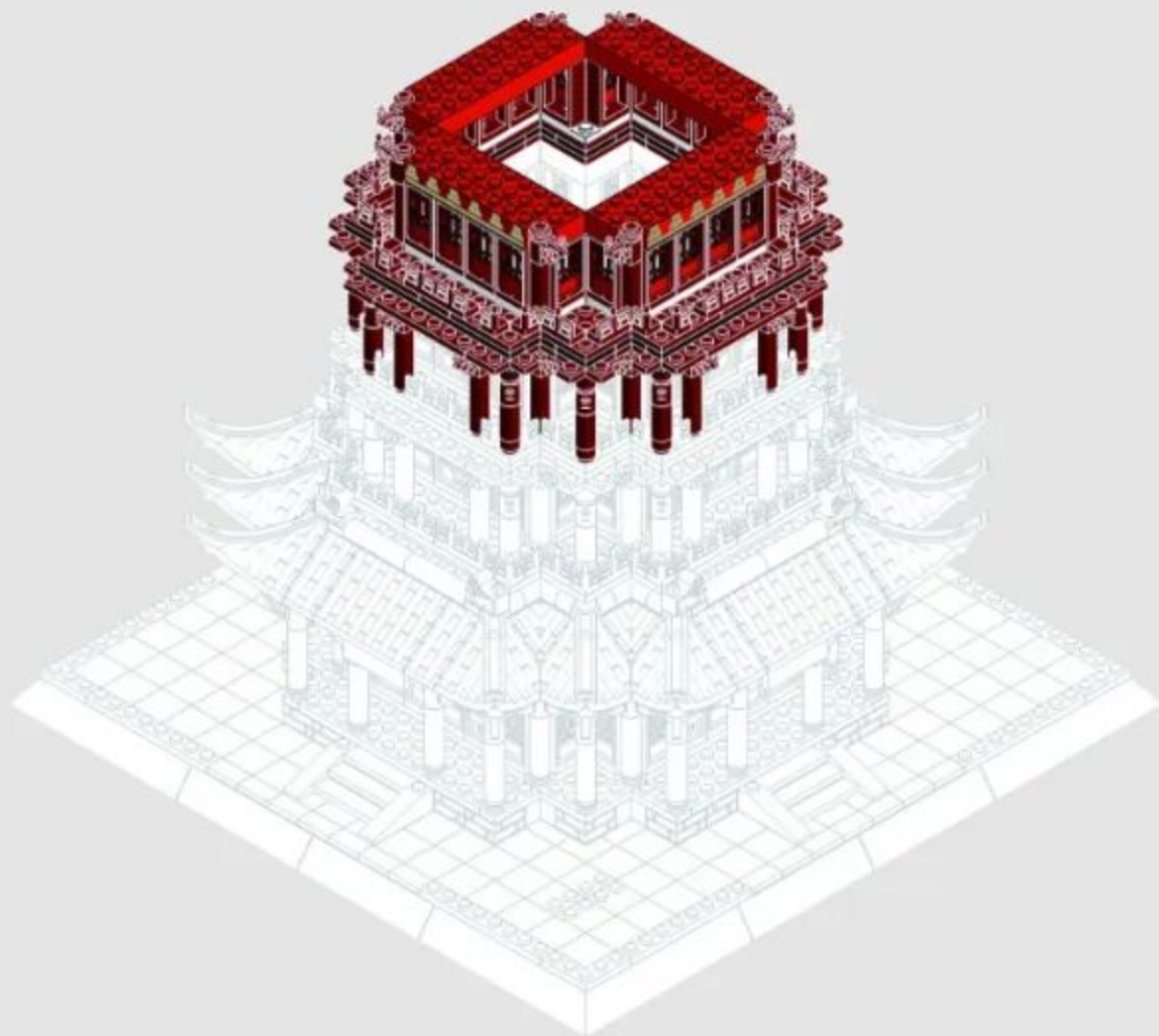

6-1

1x3



x8



x8



x8

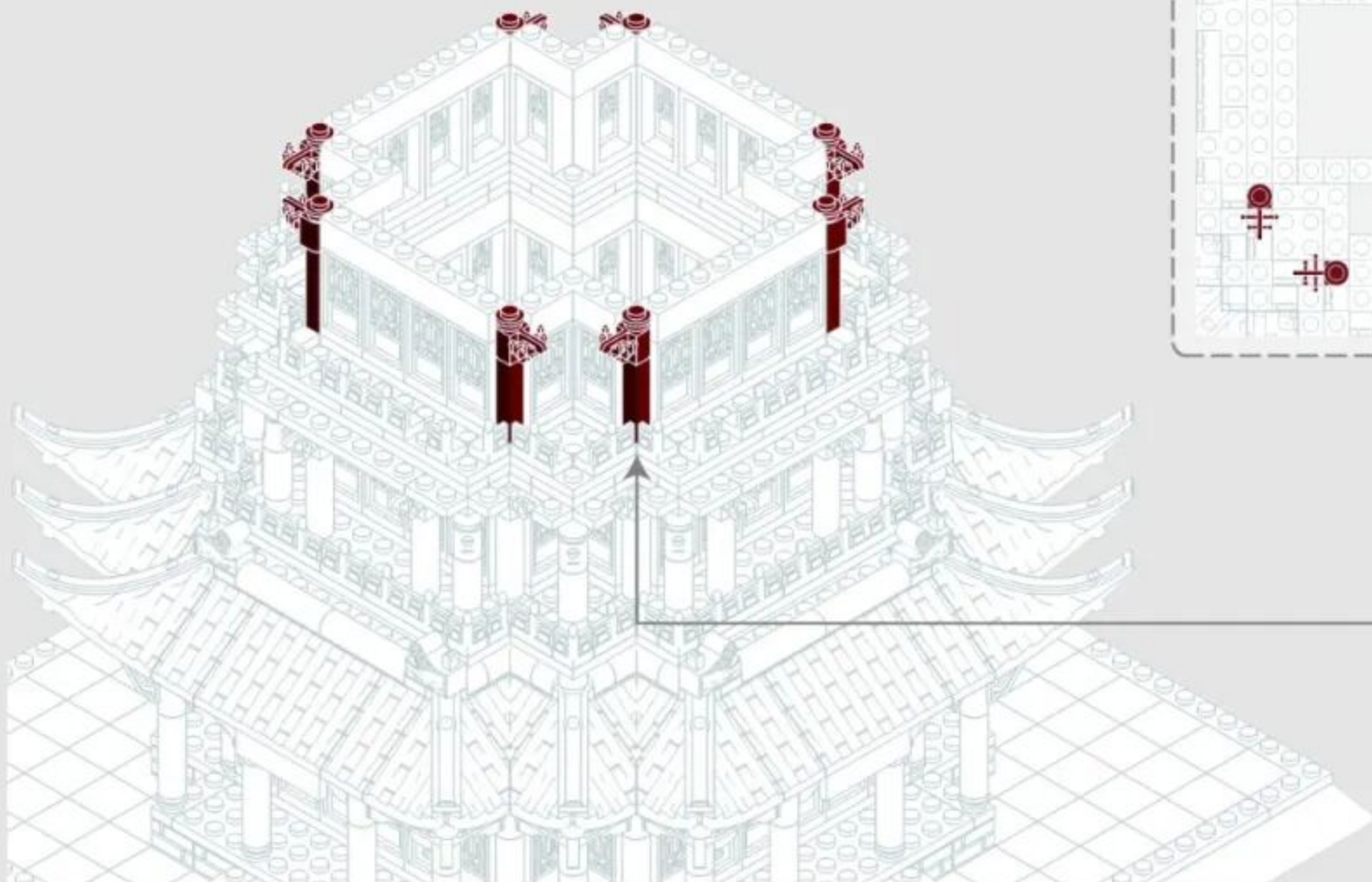

Vertical View of Installation Drawing
安装图顶面

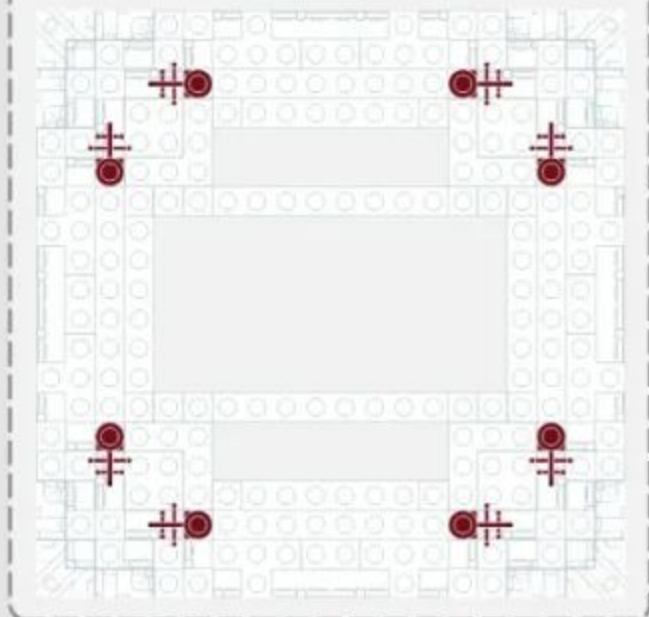

6-2

- 1x3 x8
- 1x2 x8
- x8
- x8
- x16

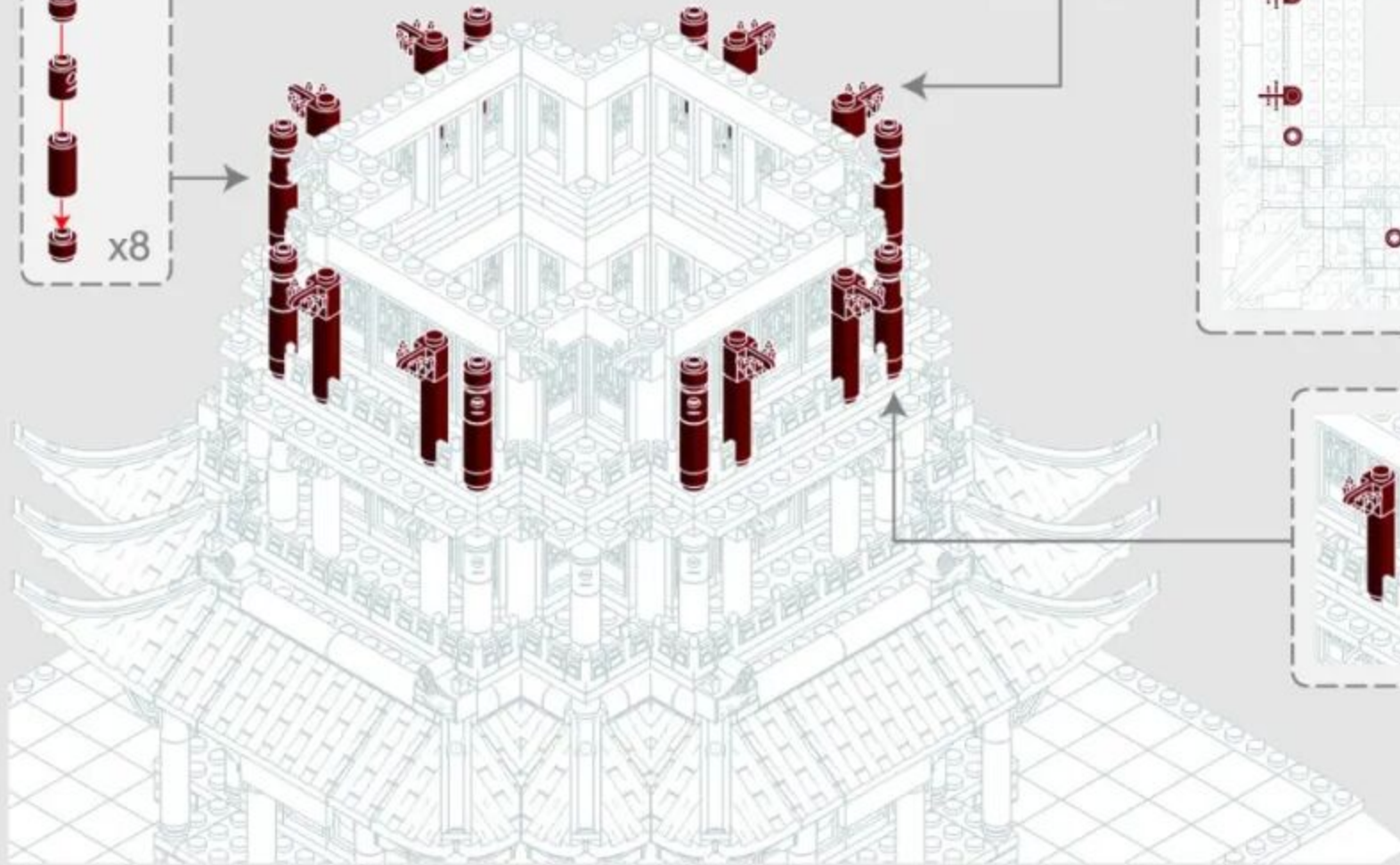
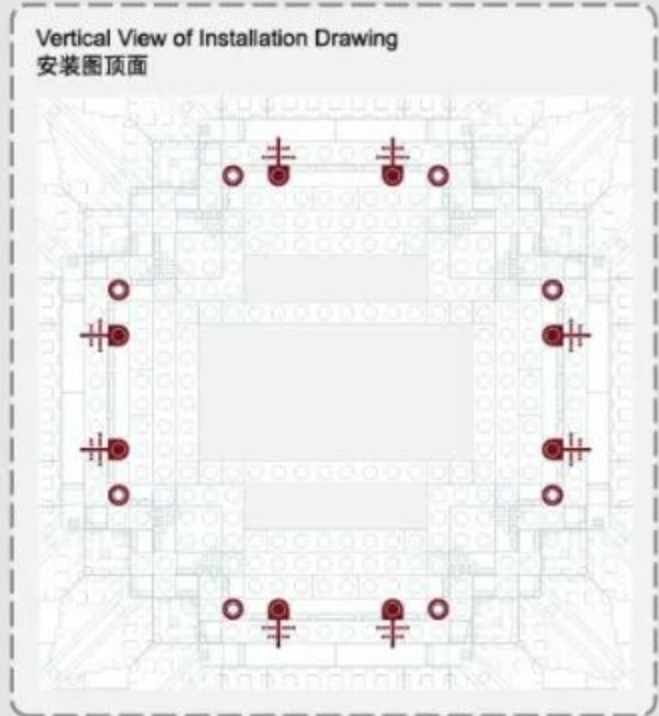
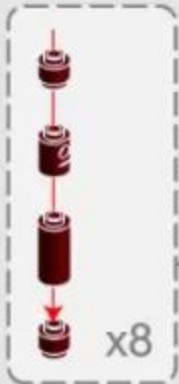

6-3

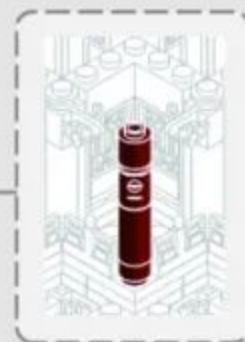
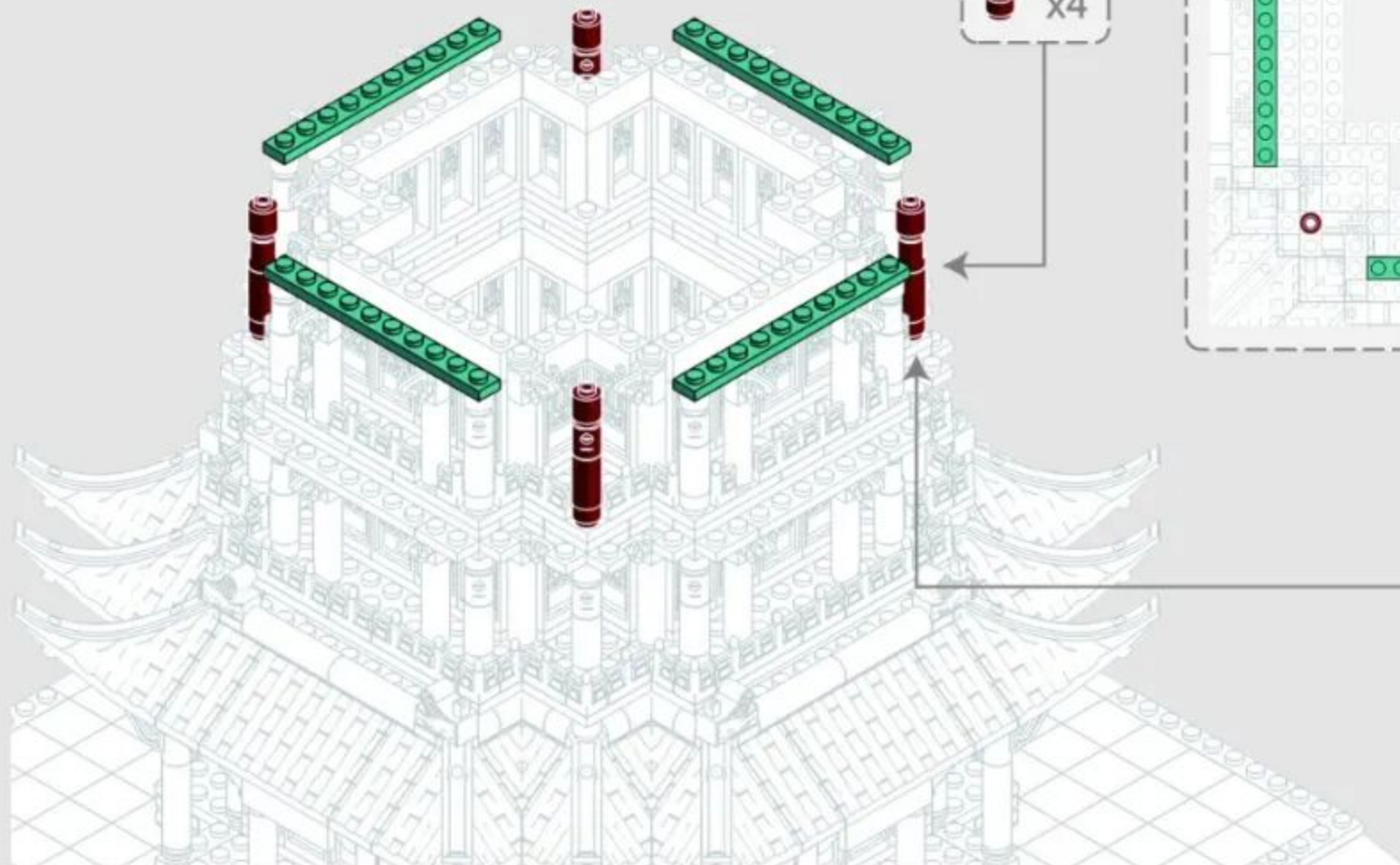
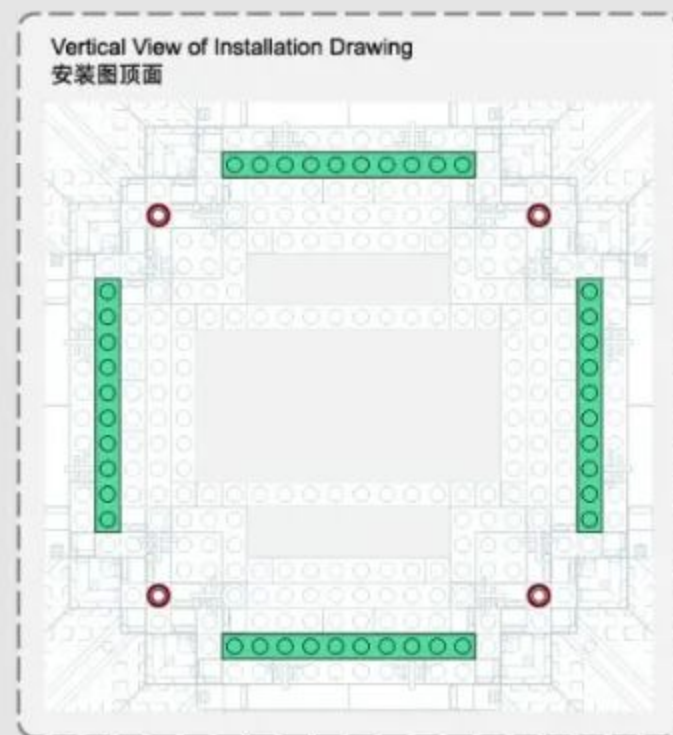
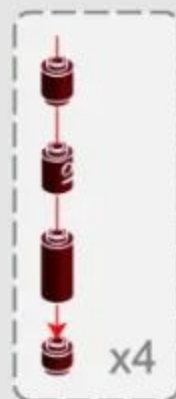

6-4

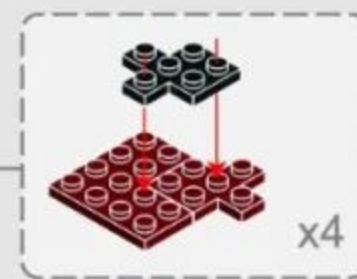
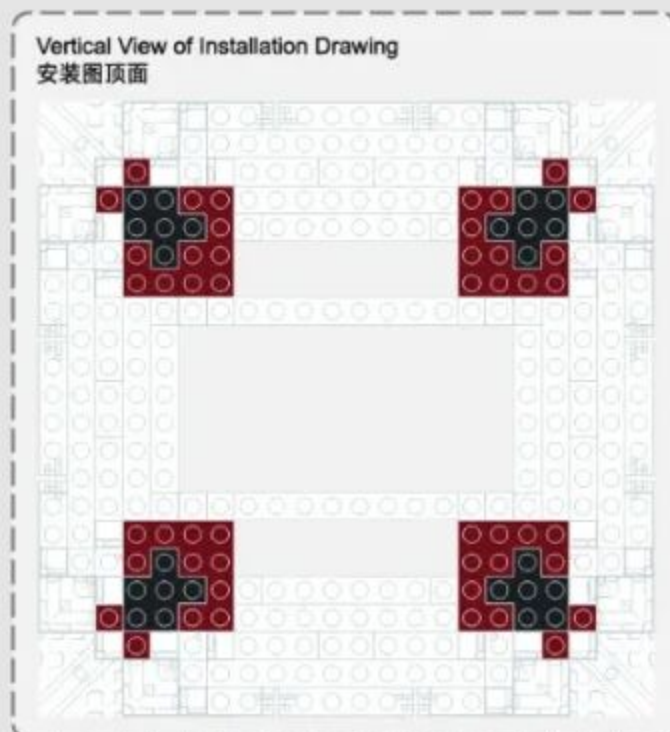
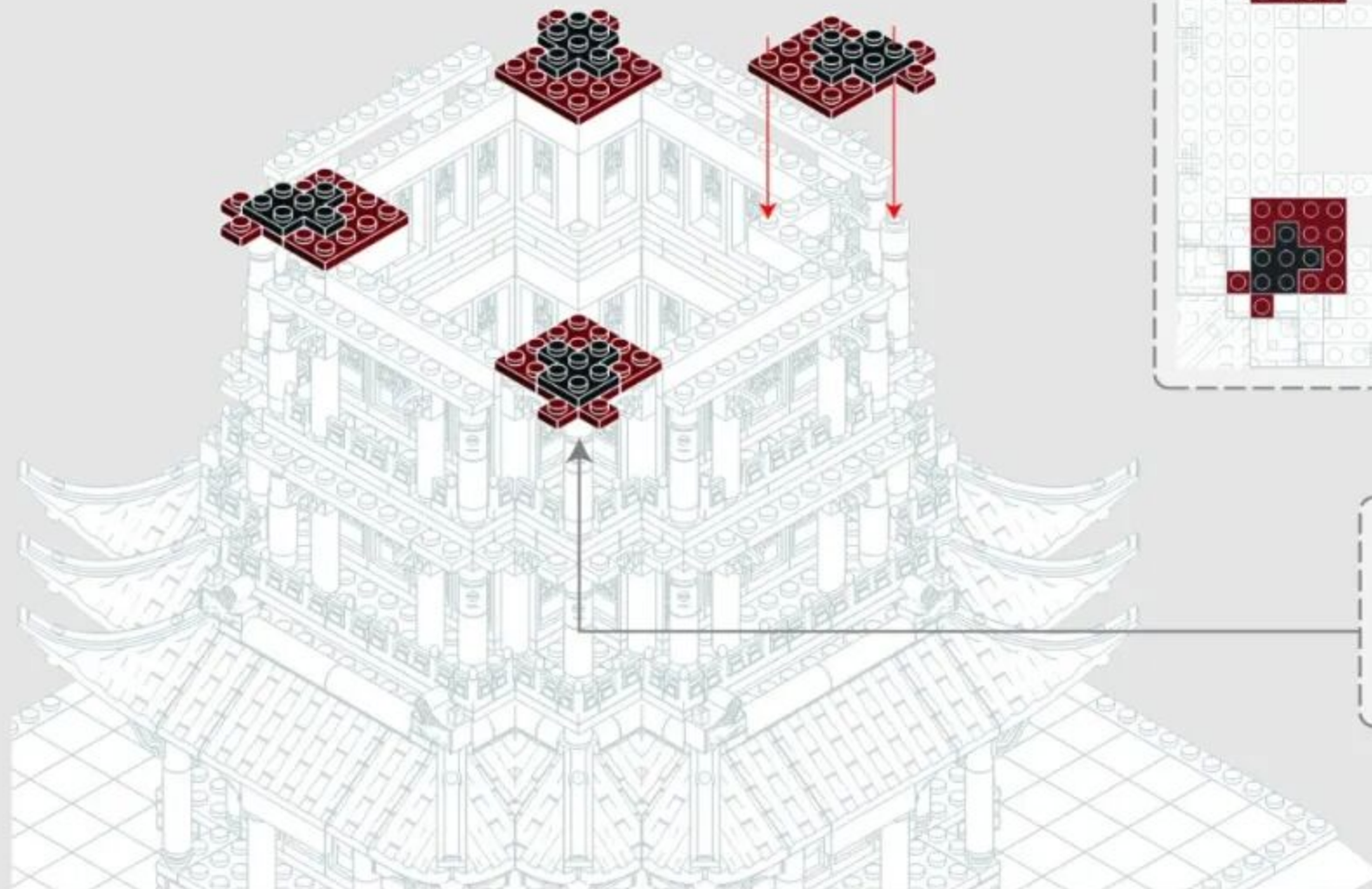

6-5

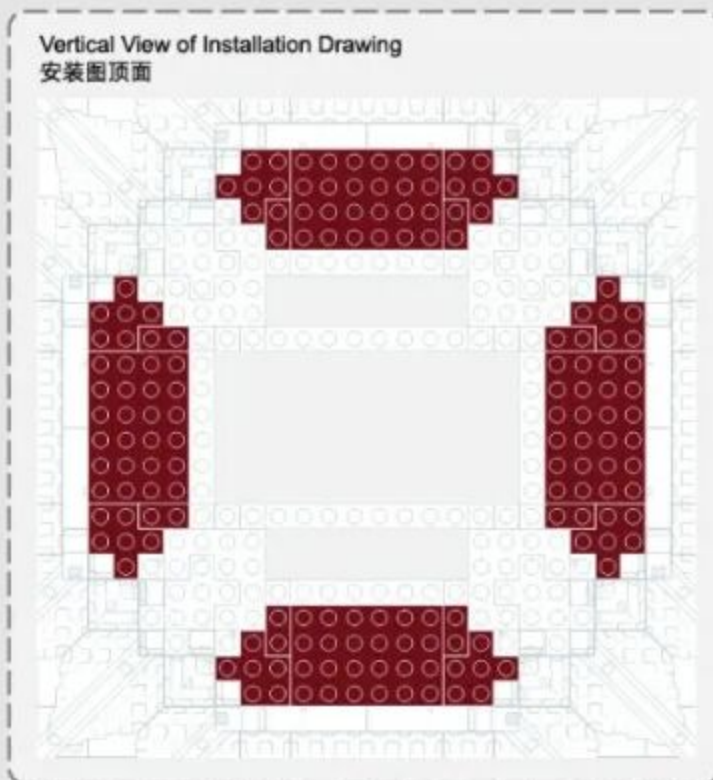
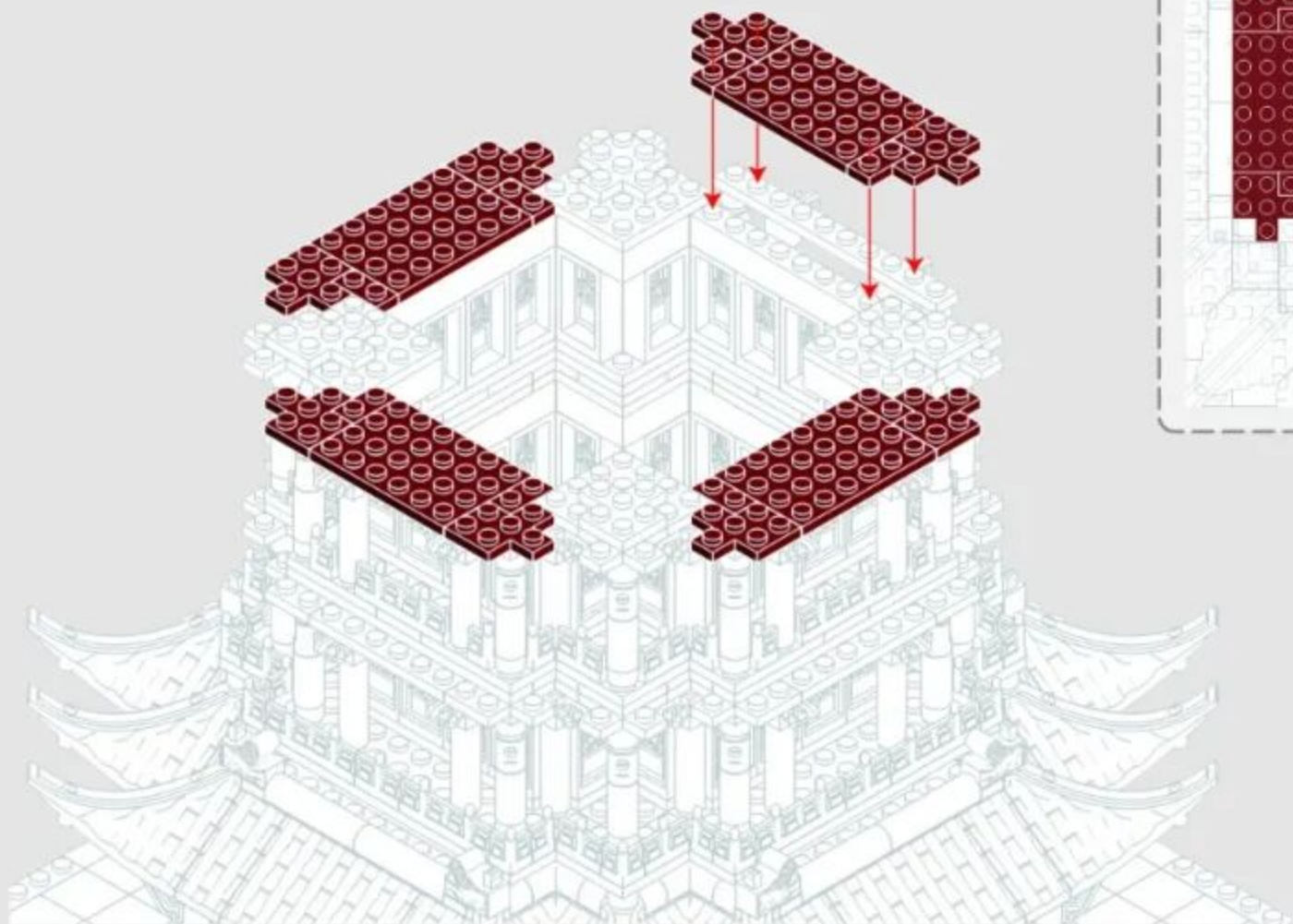
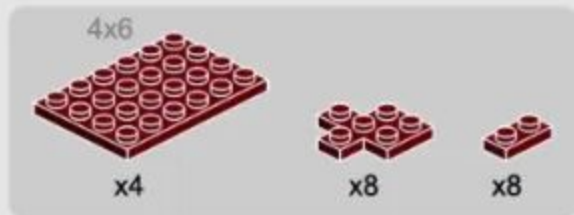

6-6

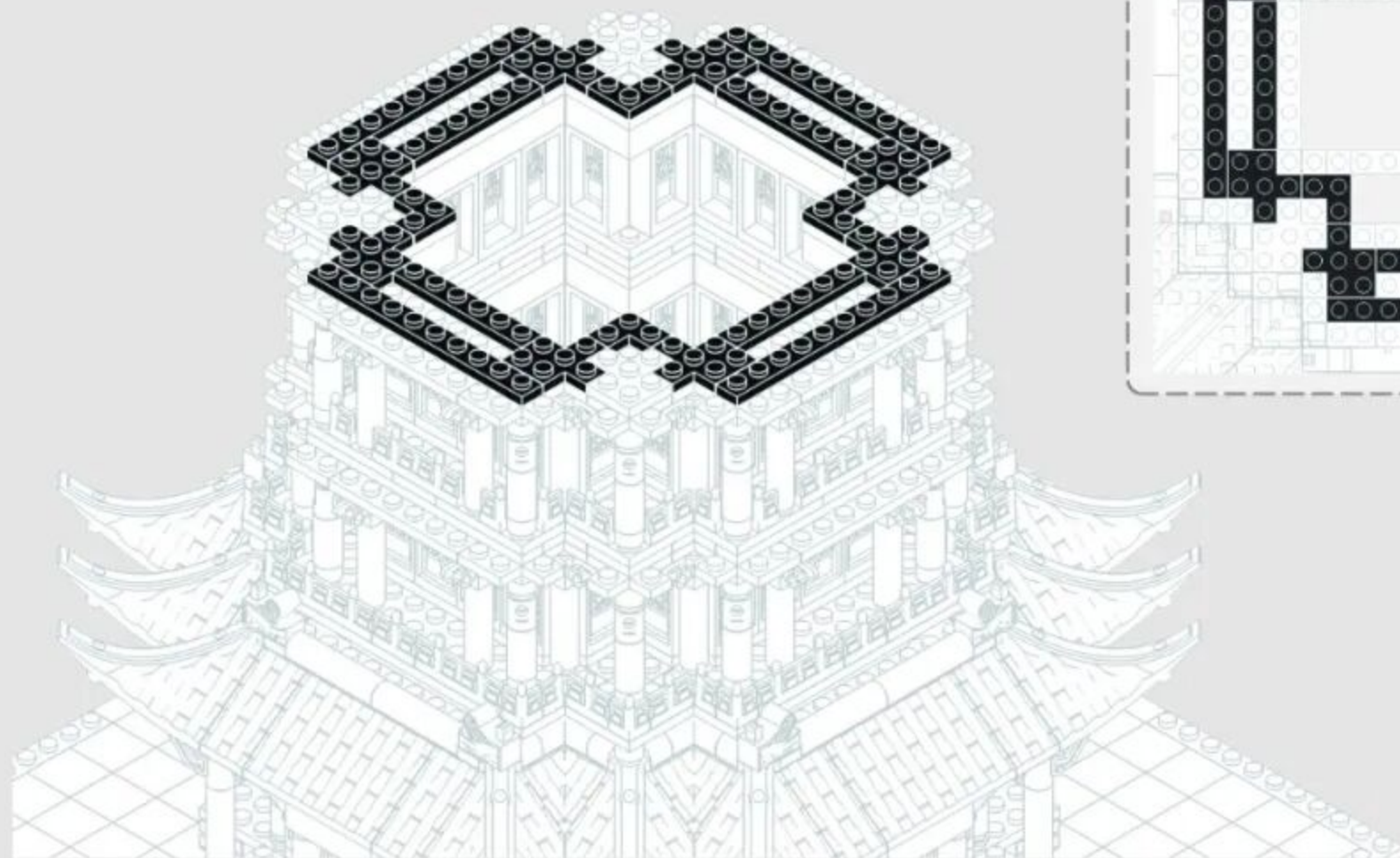

Vertical View of Installation Drawing
安装图顶面

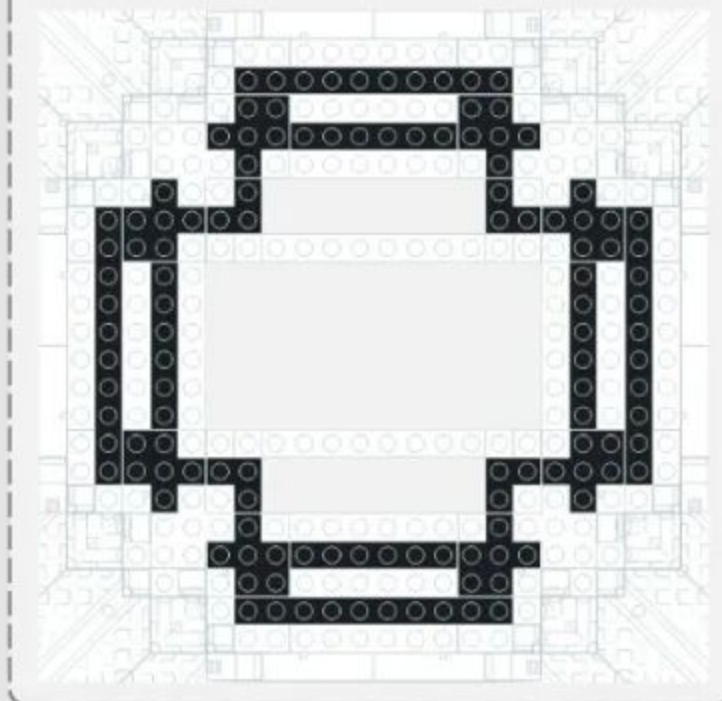

6-7

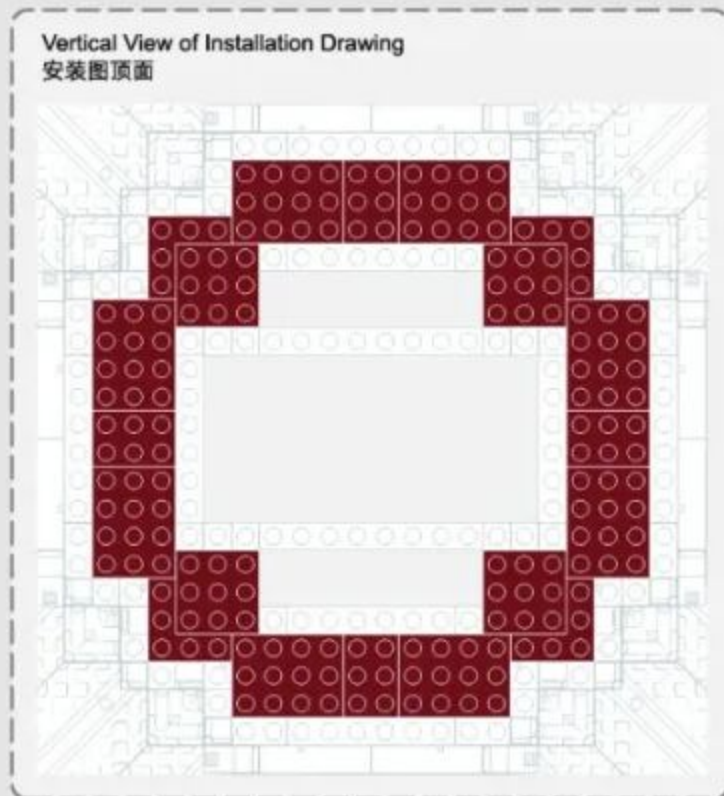
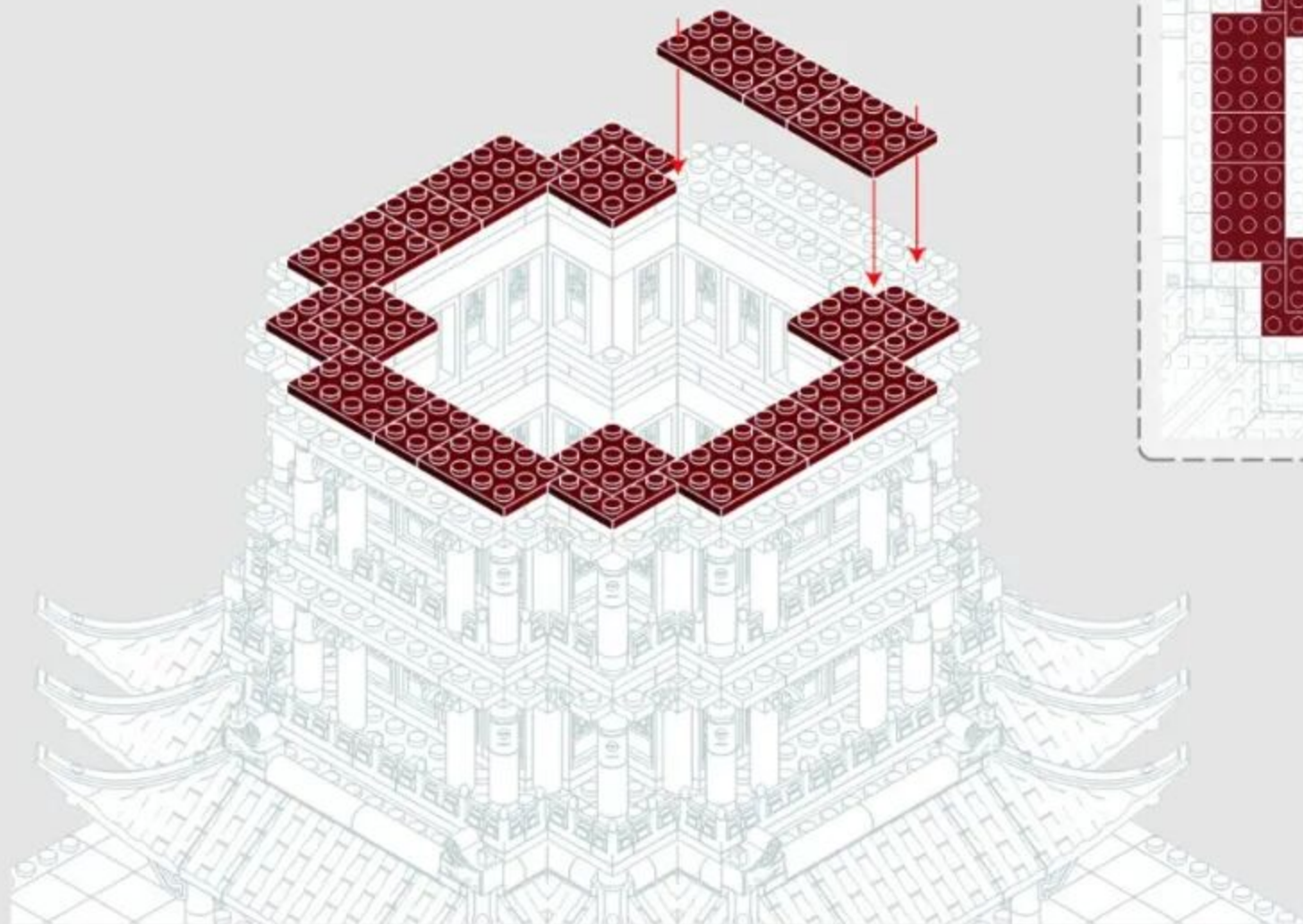

6-8

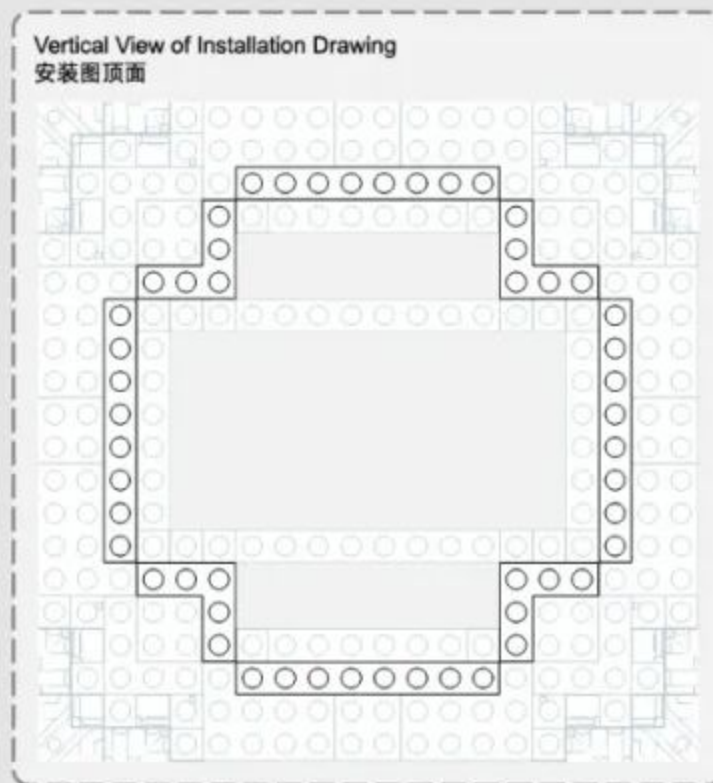
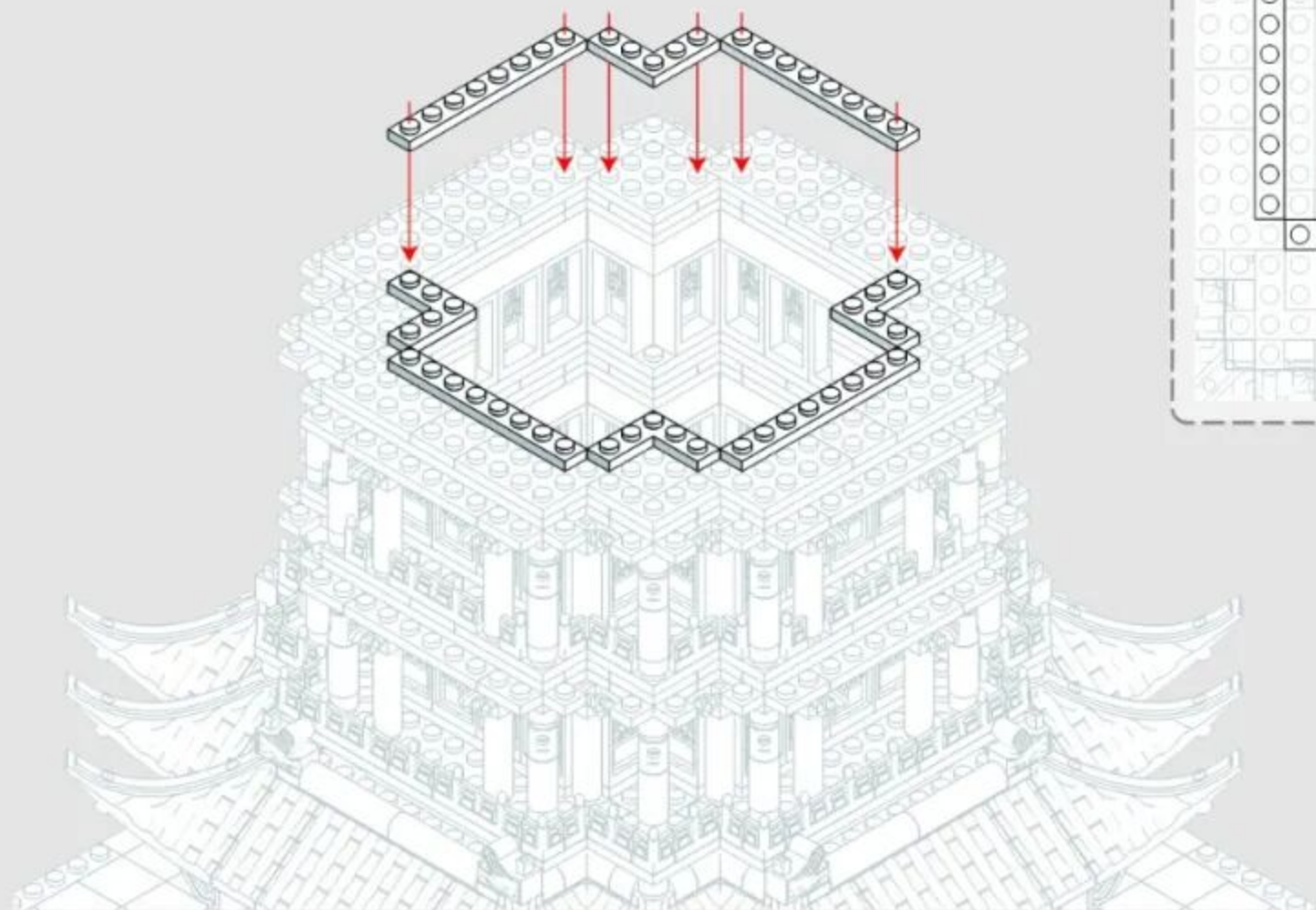
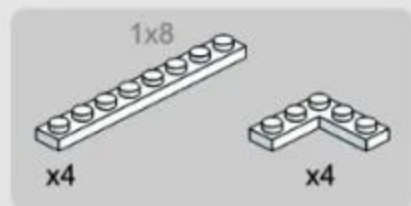

6-9

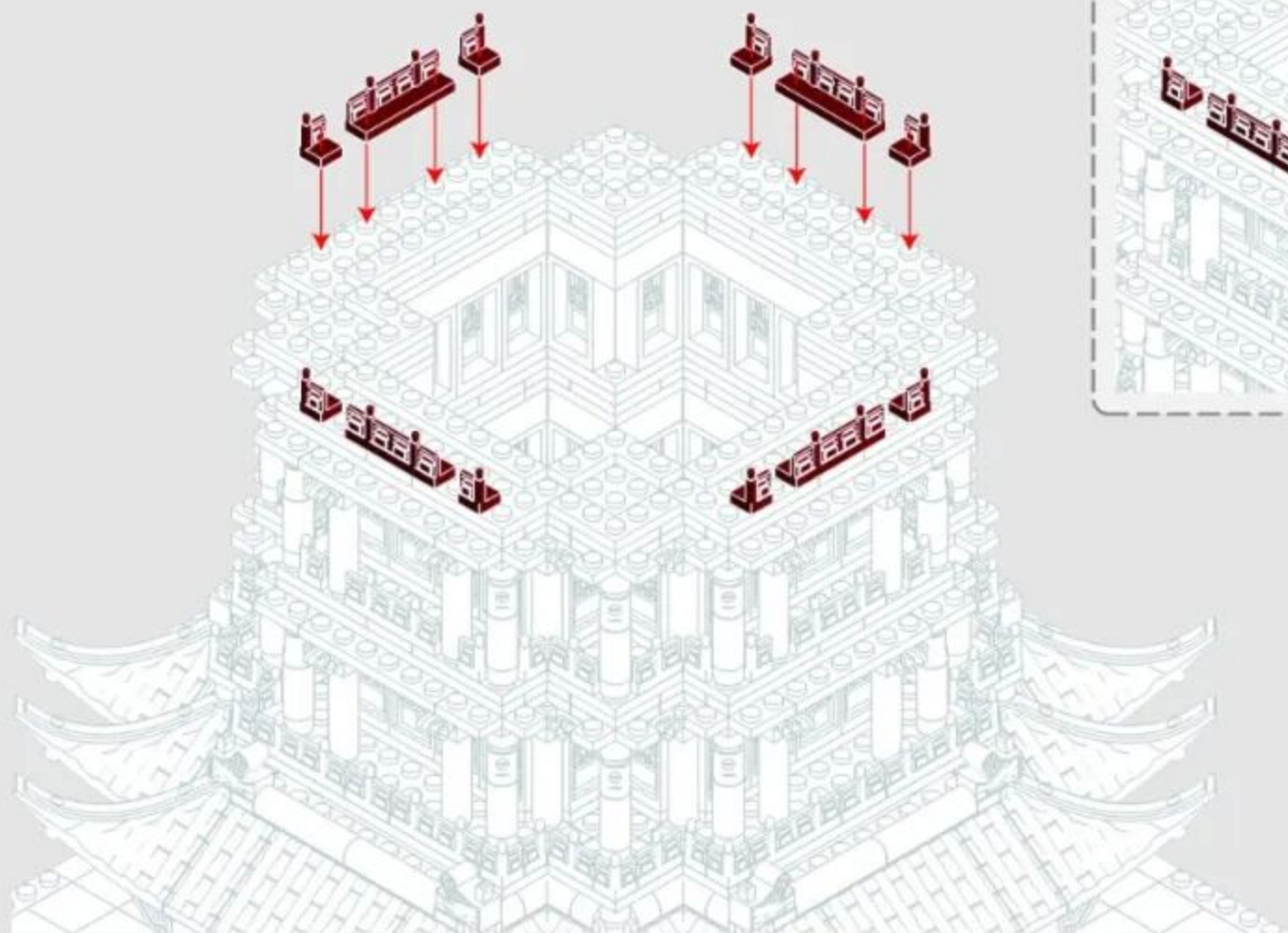

Back Side of Installation Drawing
安装图背面

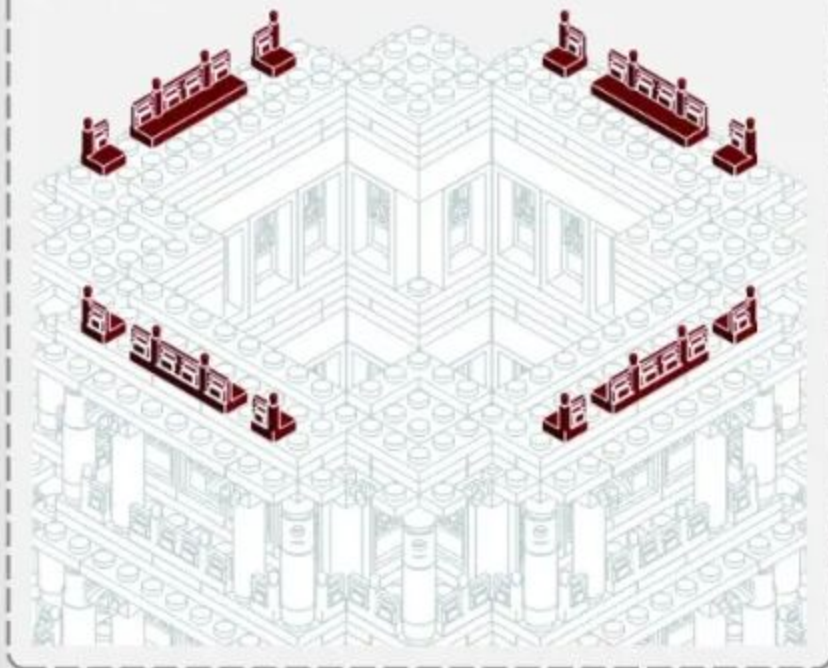

6-10

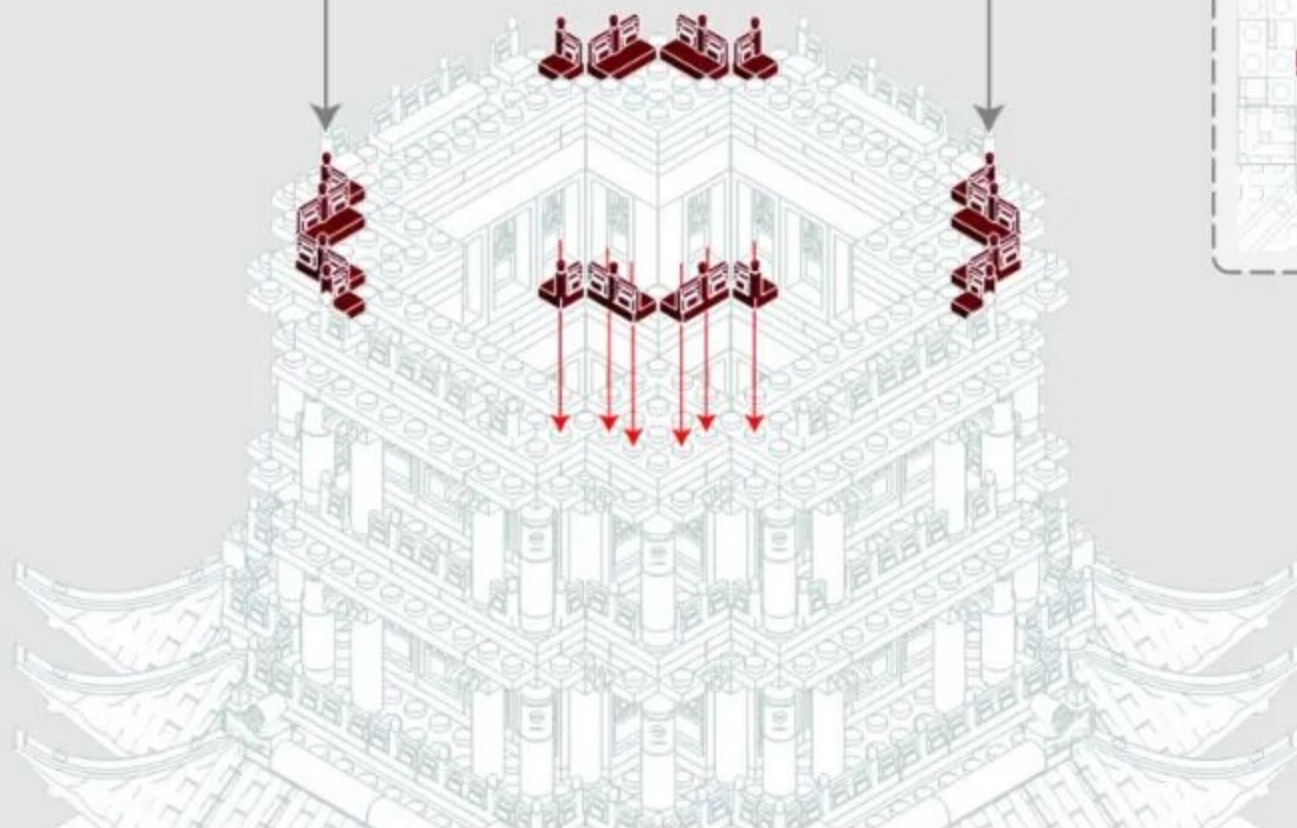
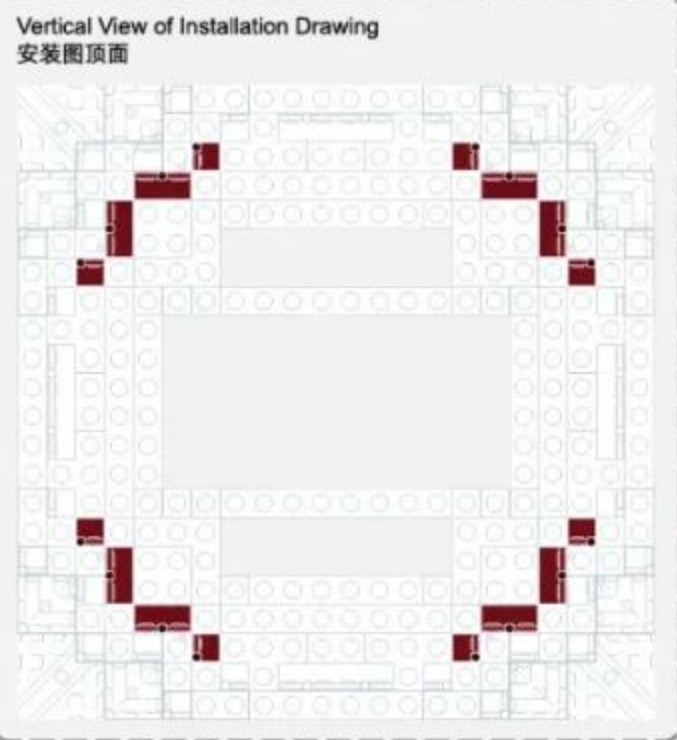
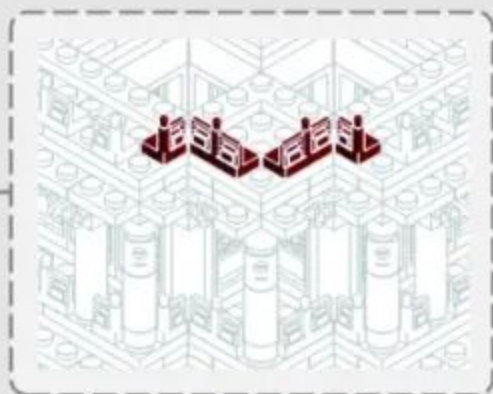

6-11

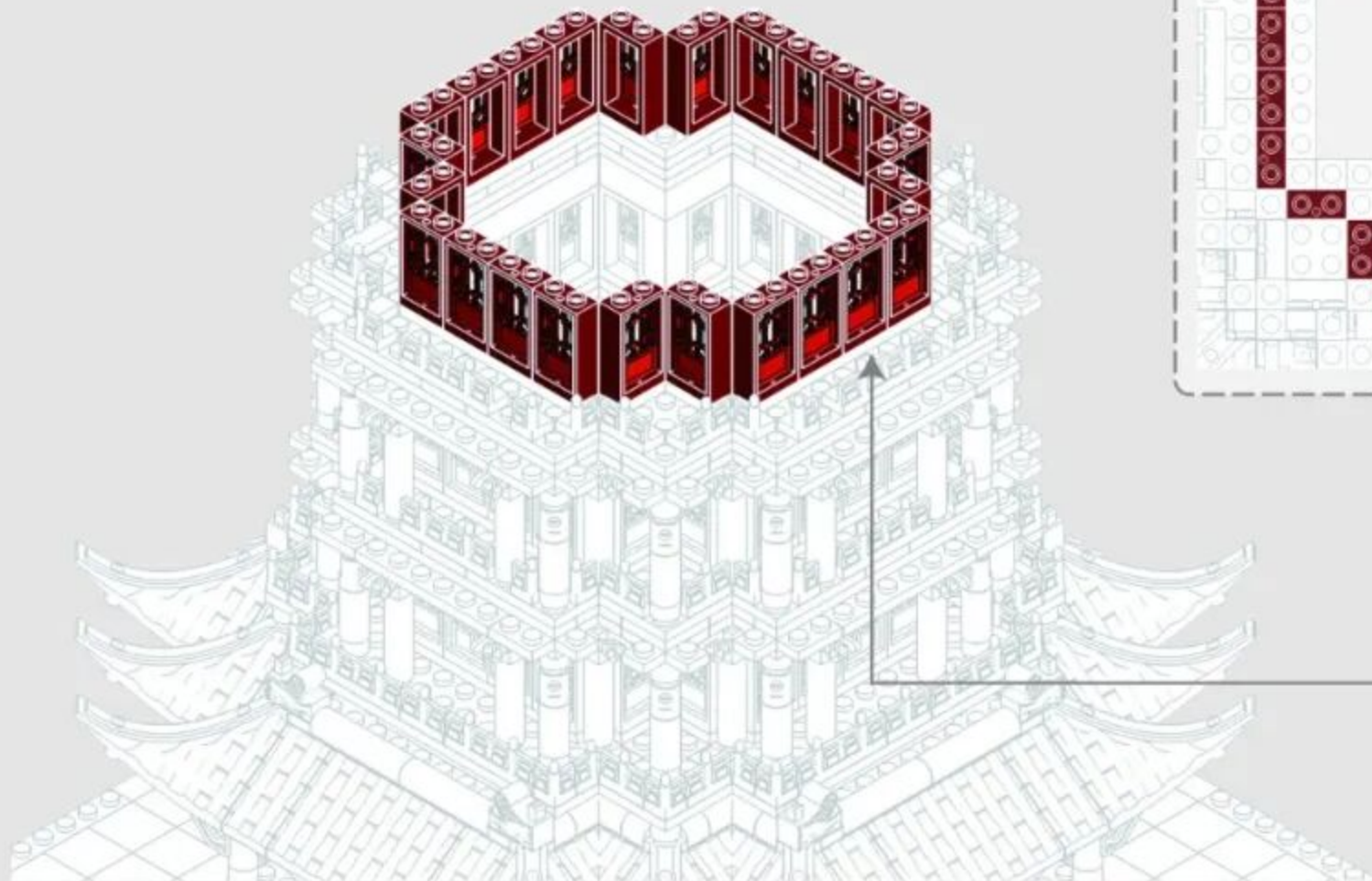

Vertical View of Installation Drawing
安装图顶面

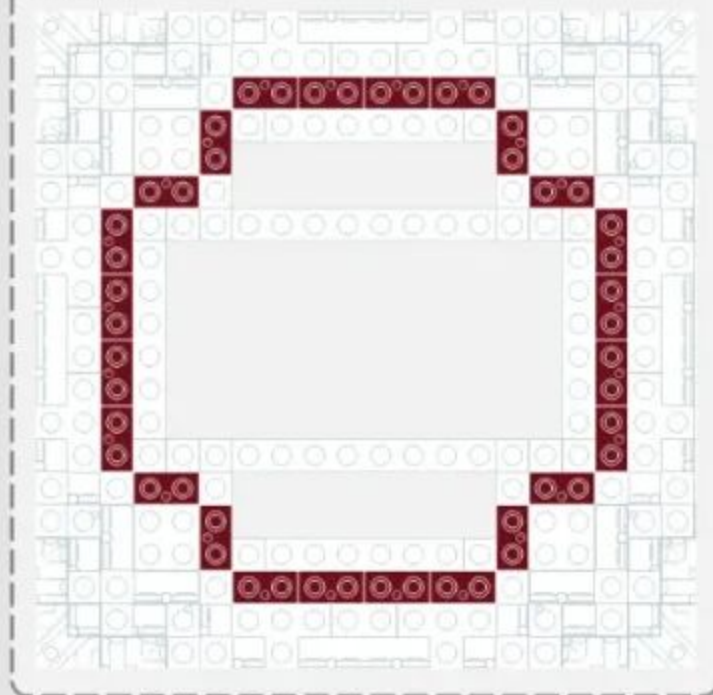

6-12

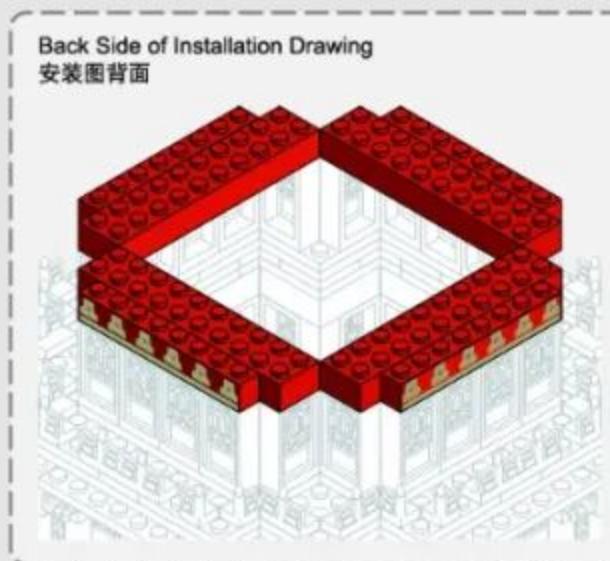
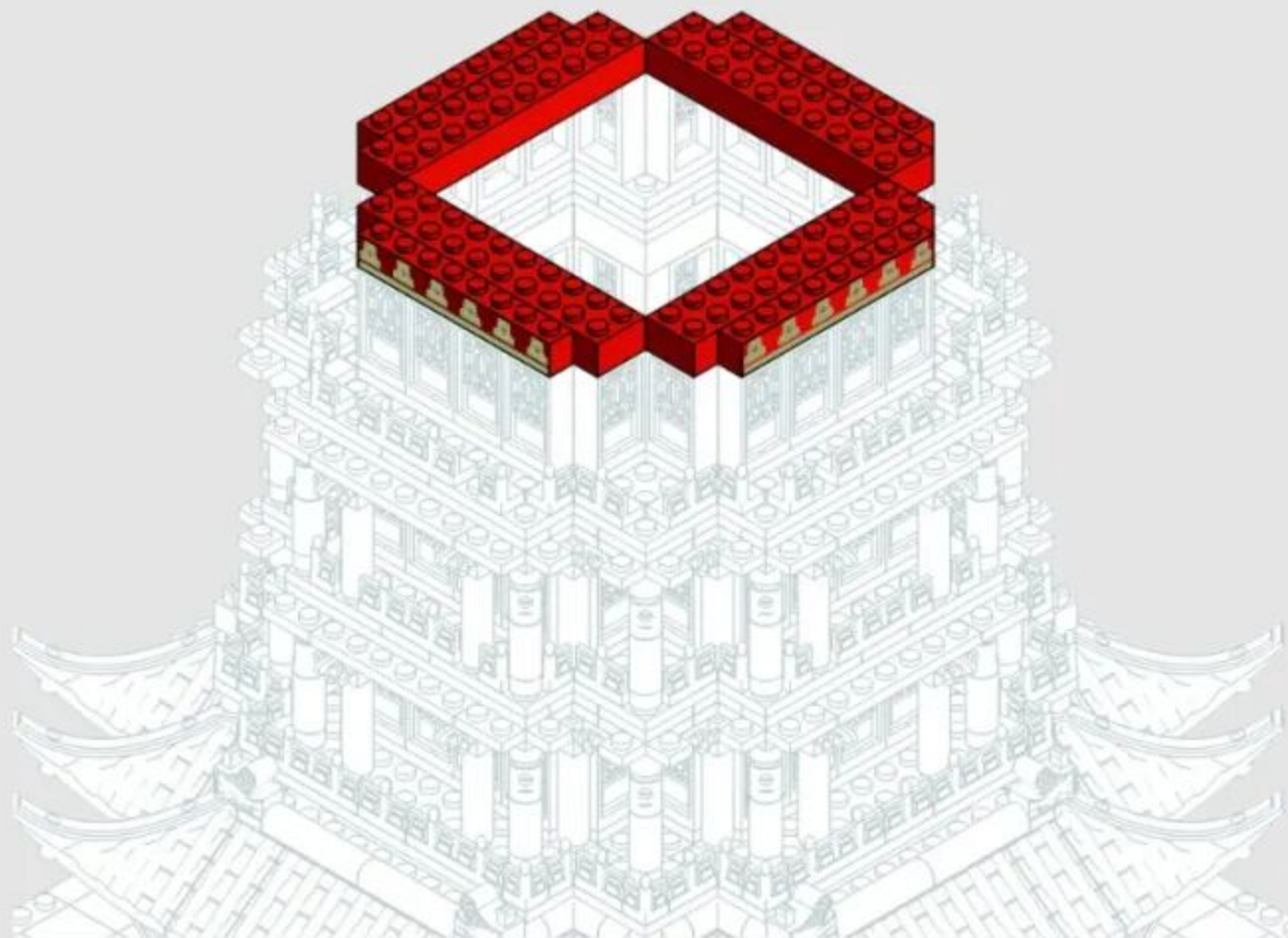
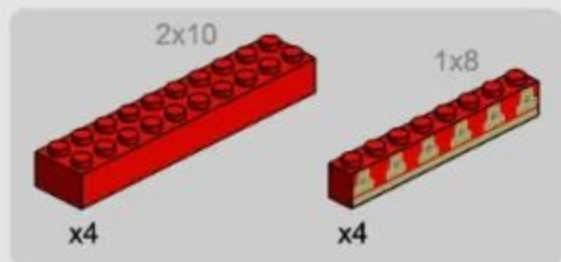

6-13

1x3



x8



x8



x8

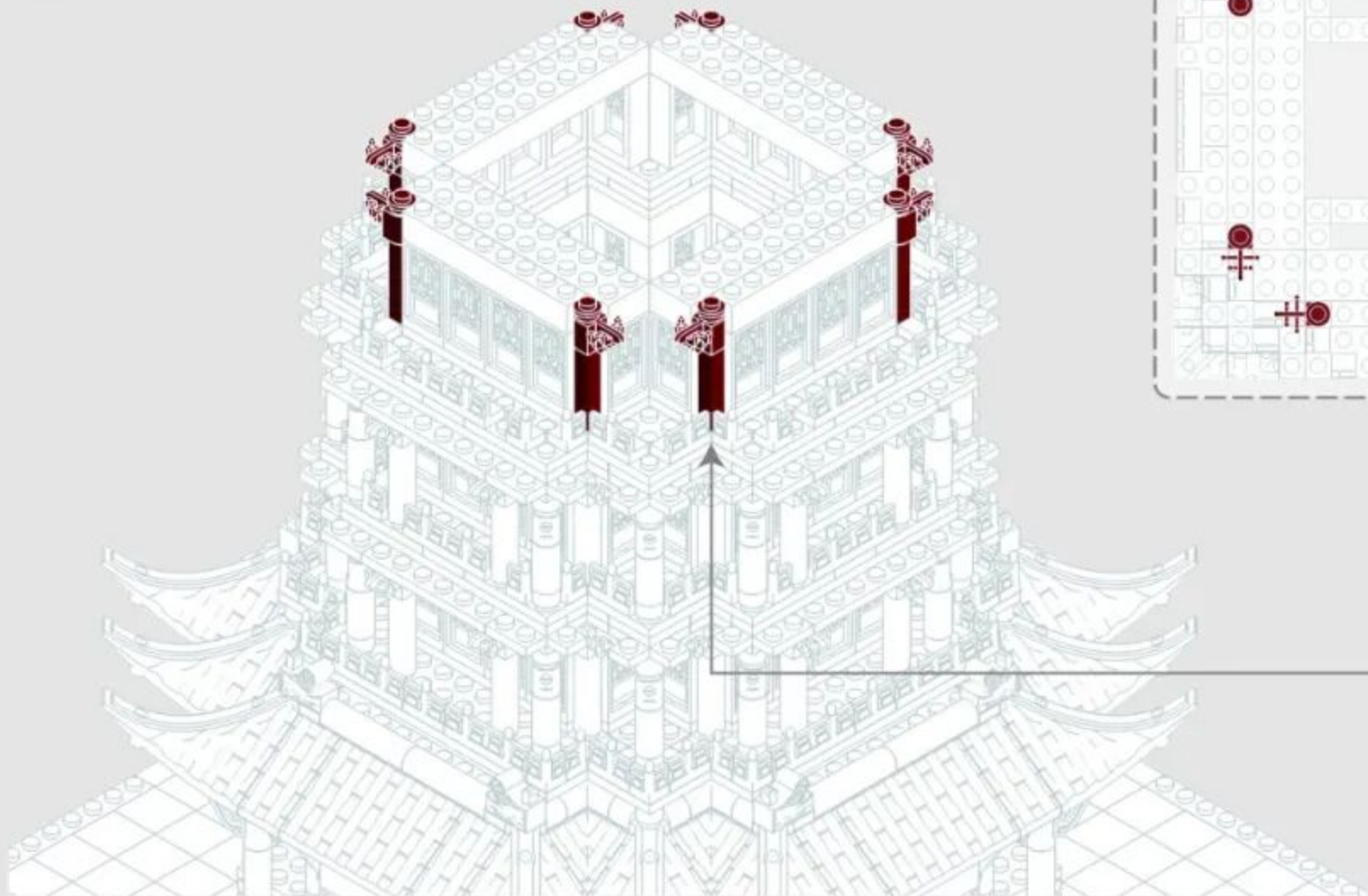

Vertical View of Installation Drawing
安装图顶面

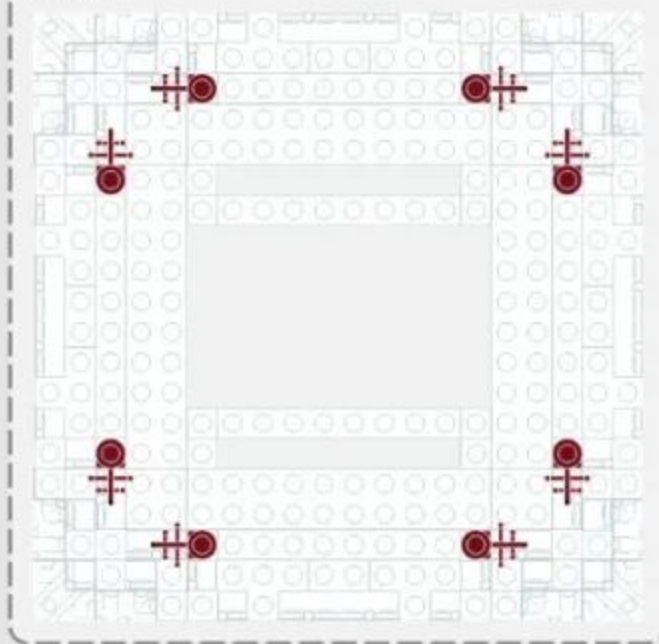



240PCS



7-1

1x3
x8

1x2
x8

x8

x8

x8

x16

x8

x8

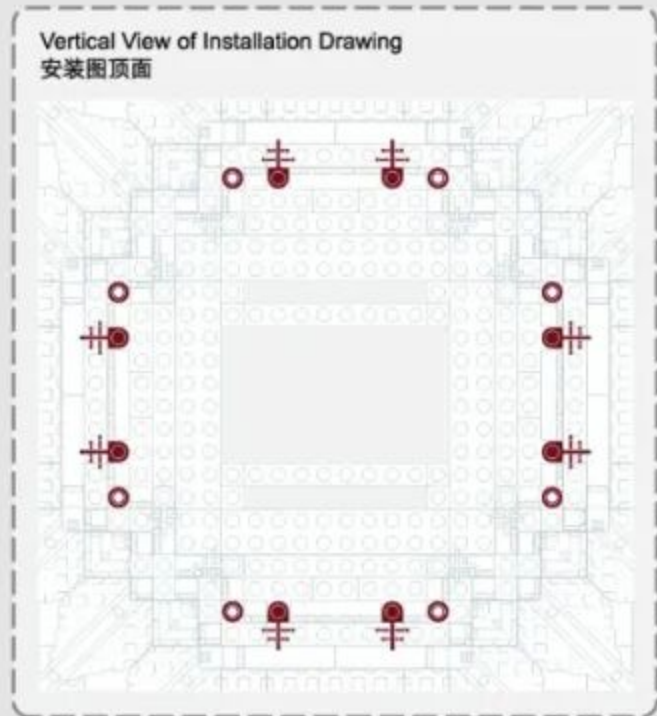

7-2

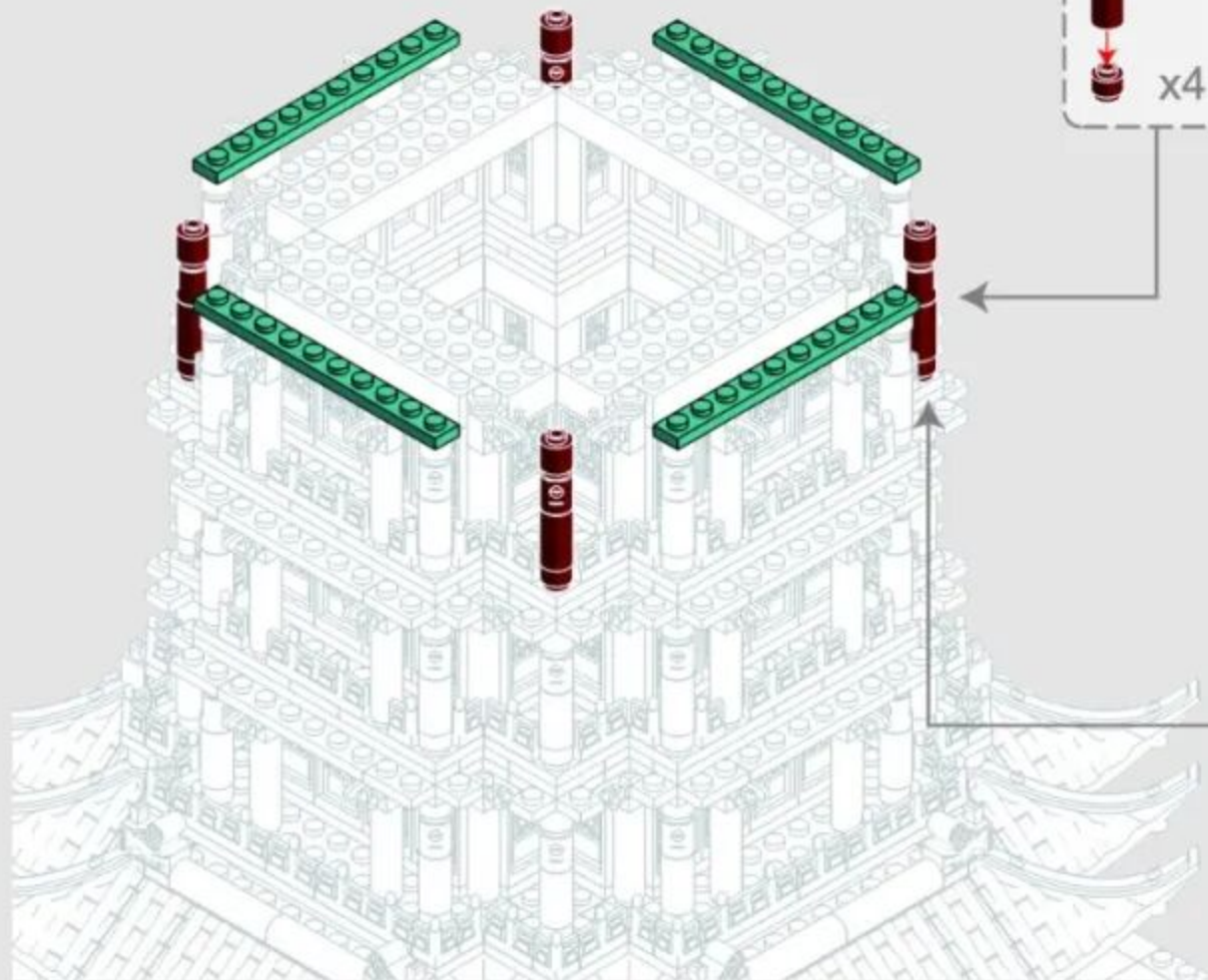
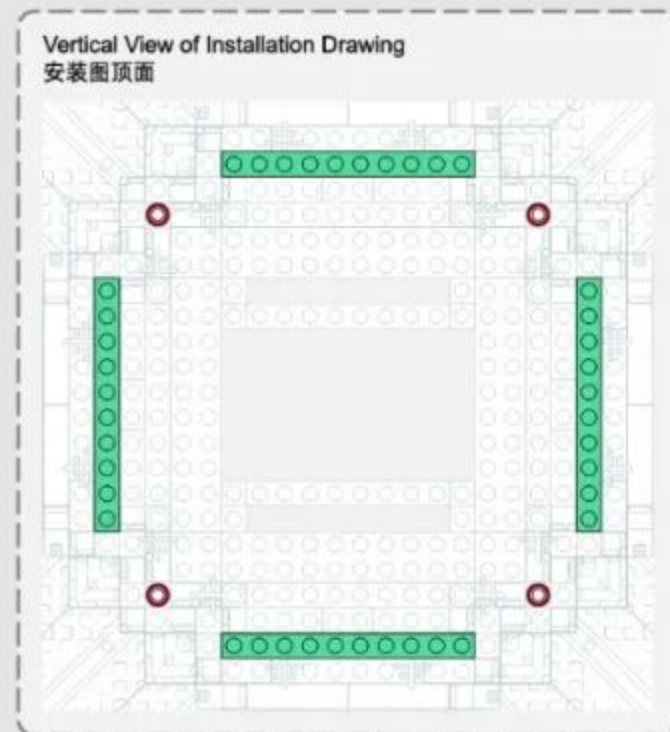

7-3

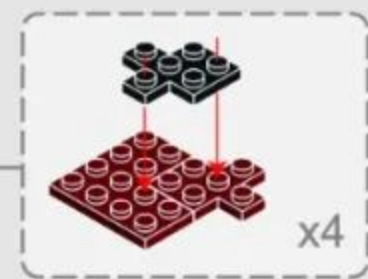
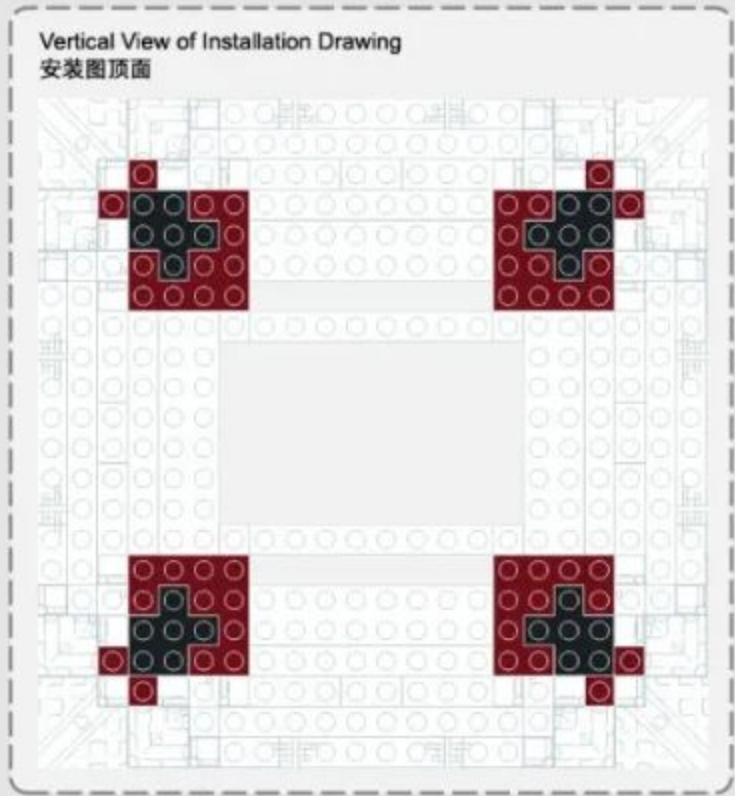
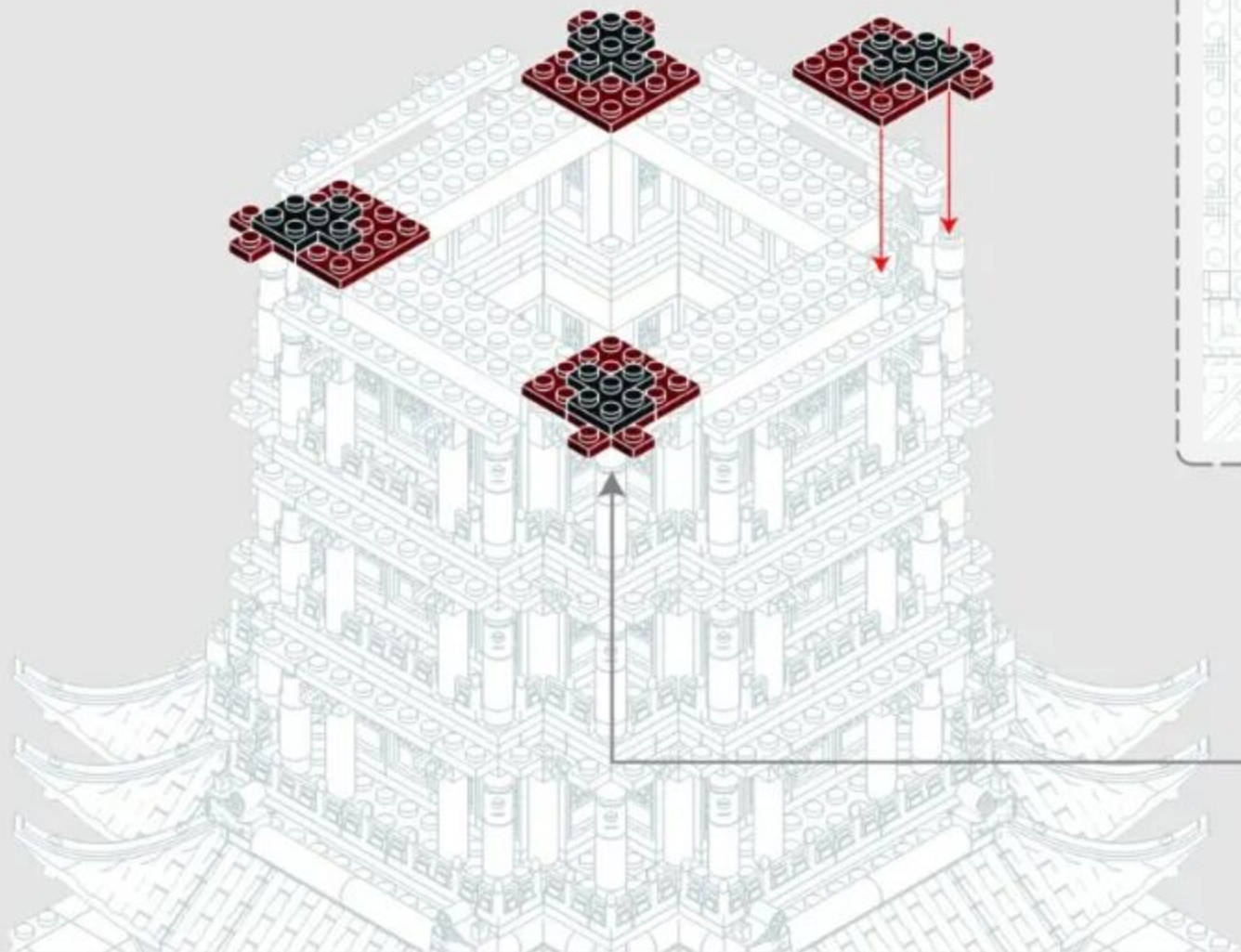

7-4

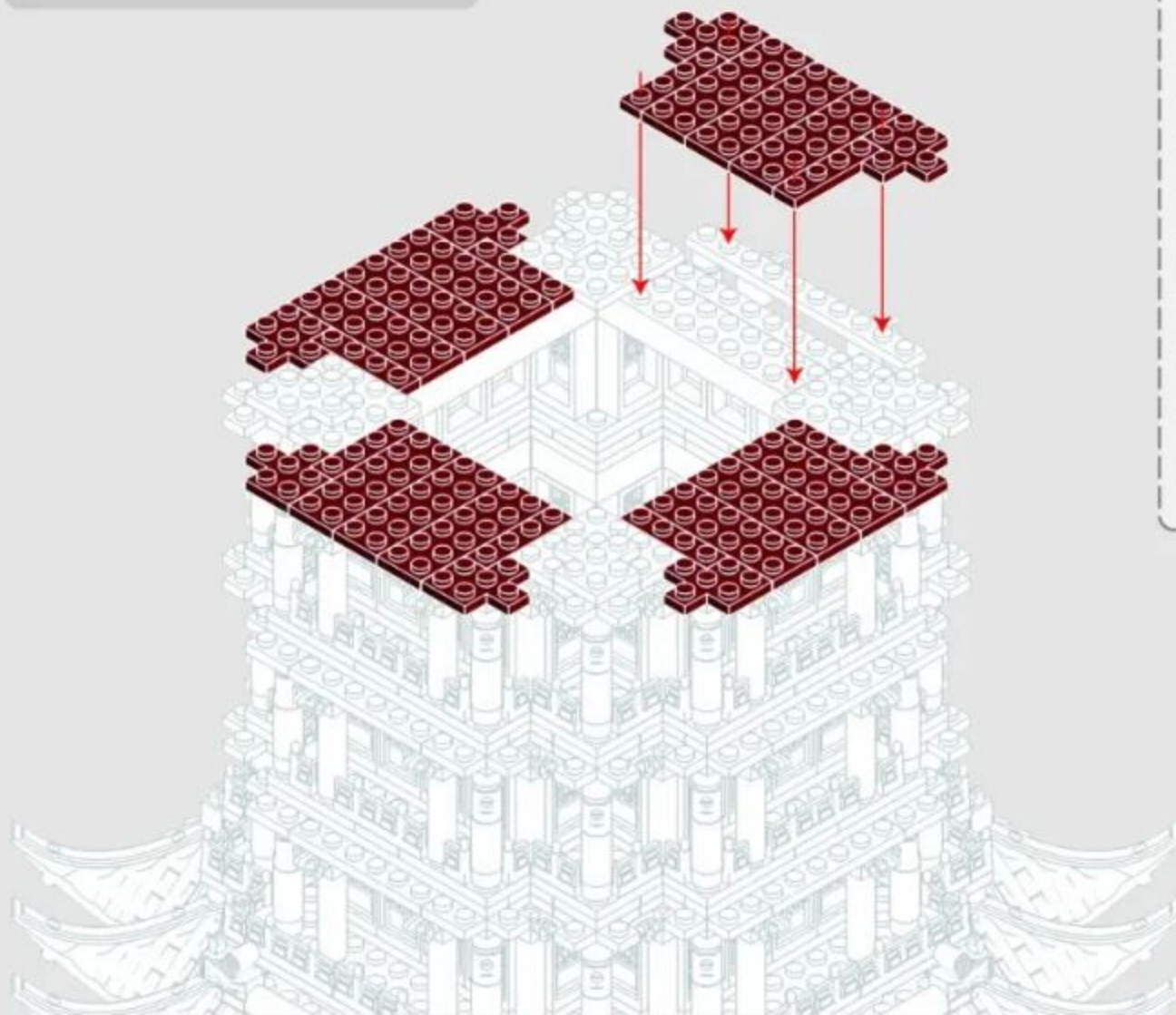
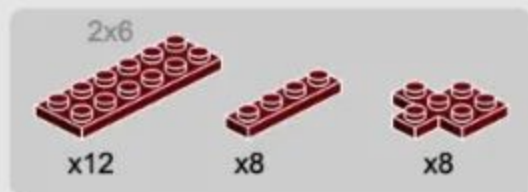

Vertical View of Installation Drawing
安装图顶面

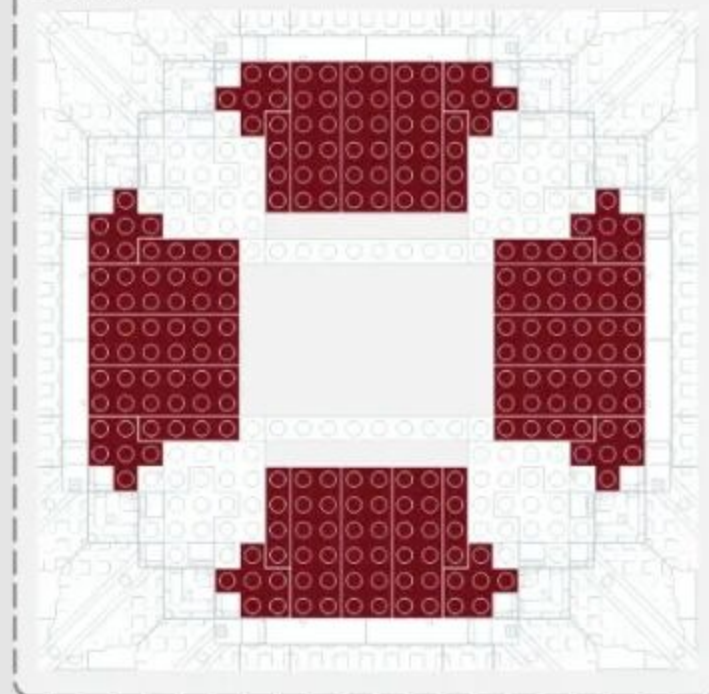

7-5

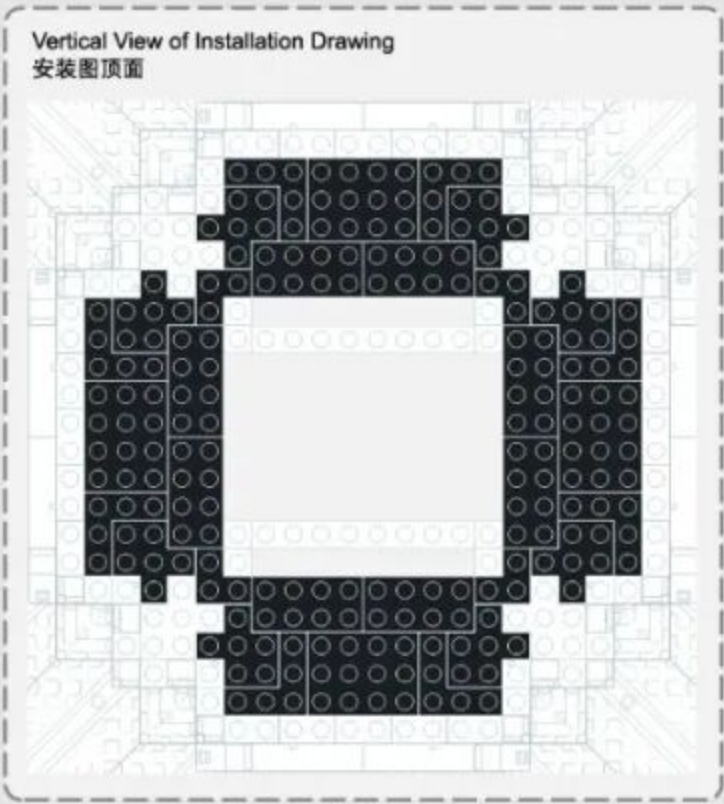
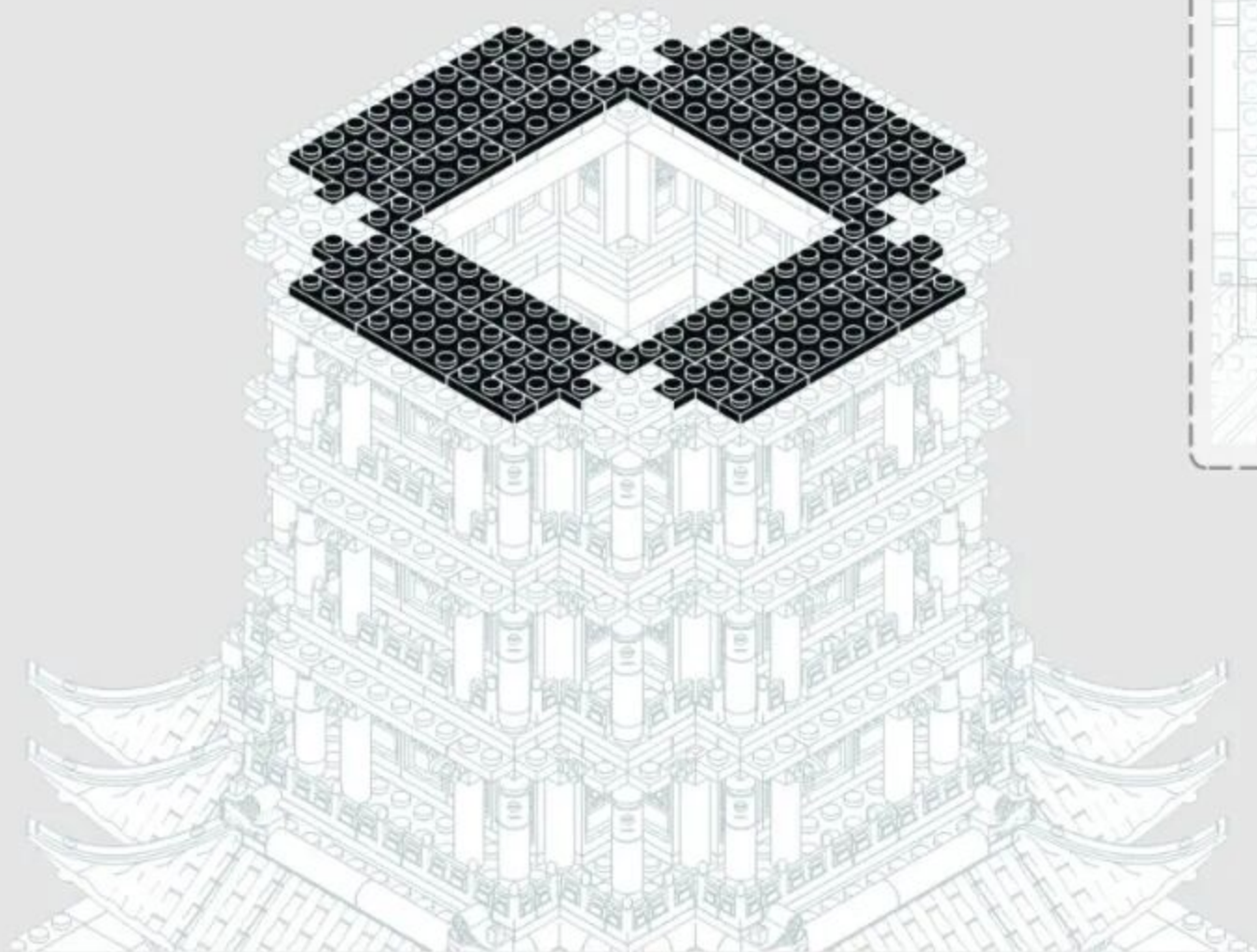

7-6

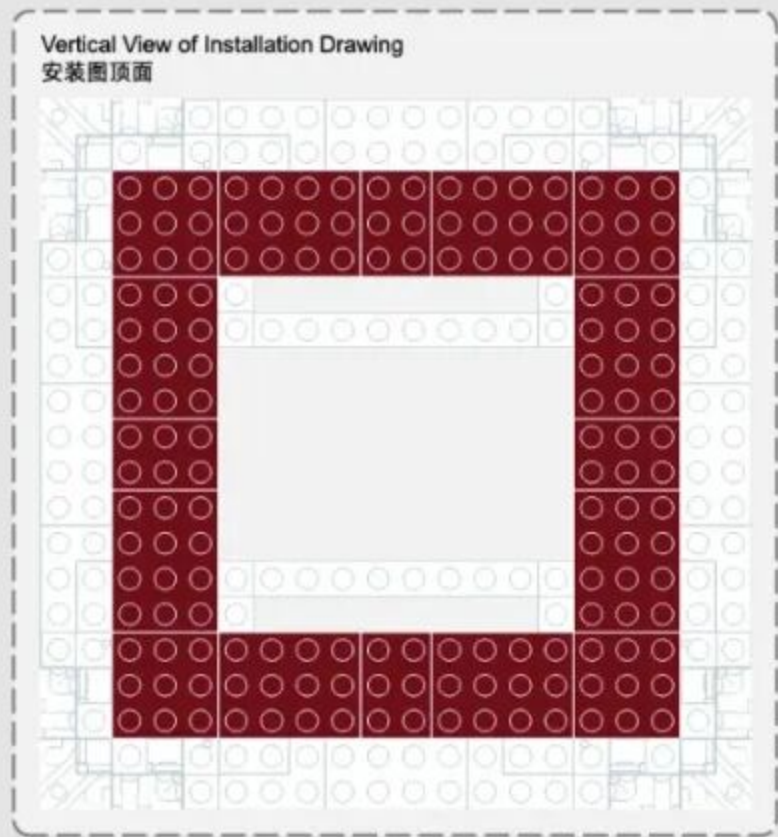
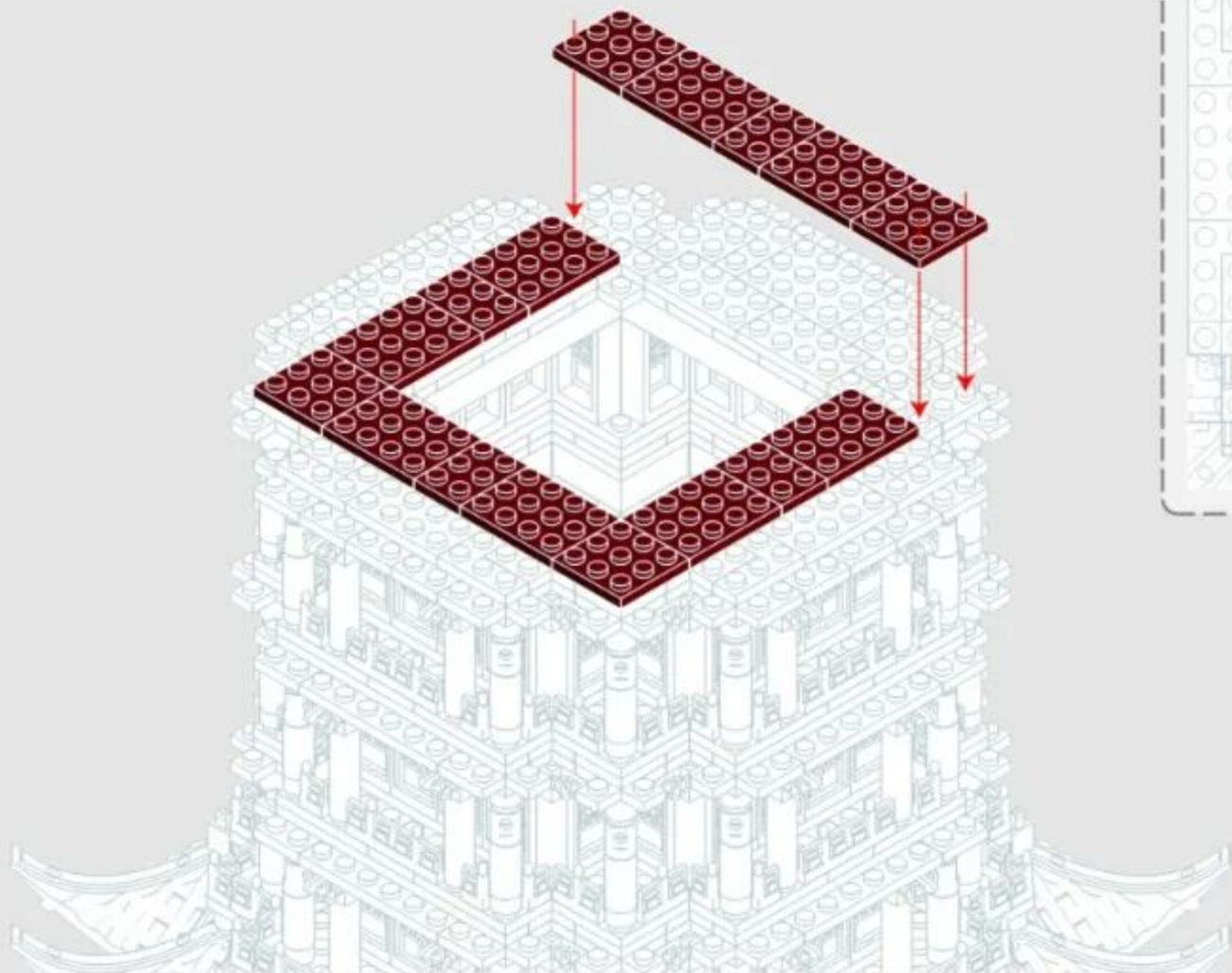

7-7

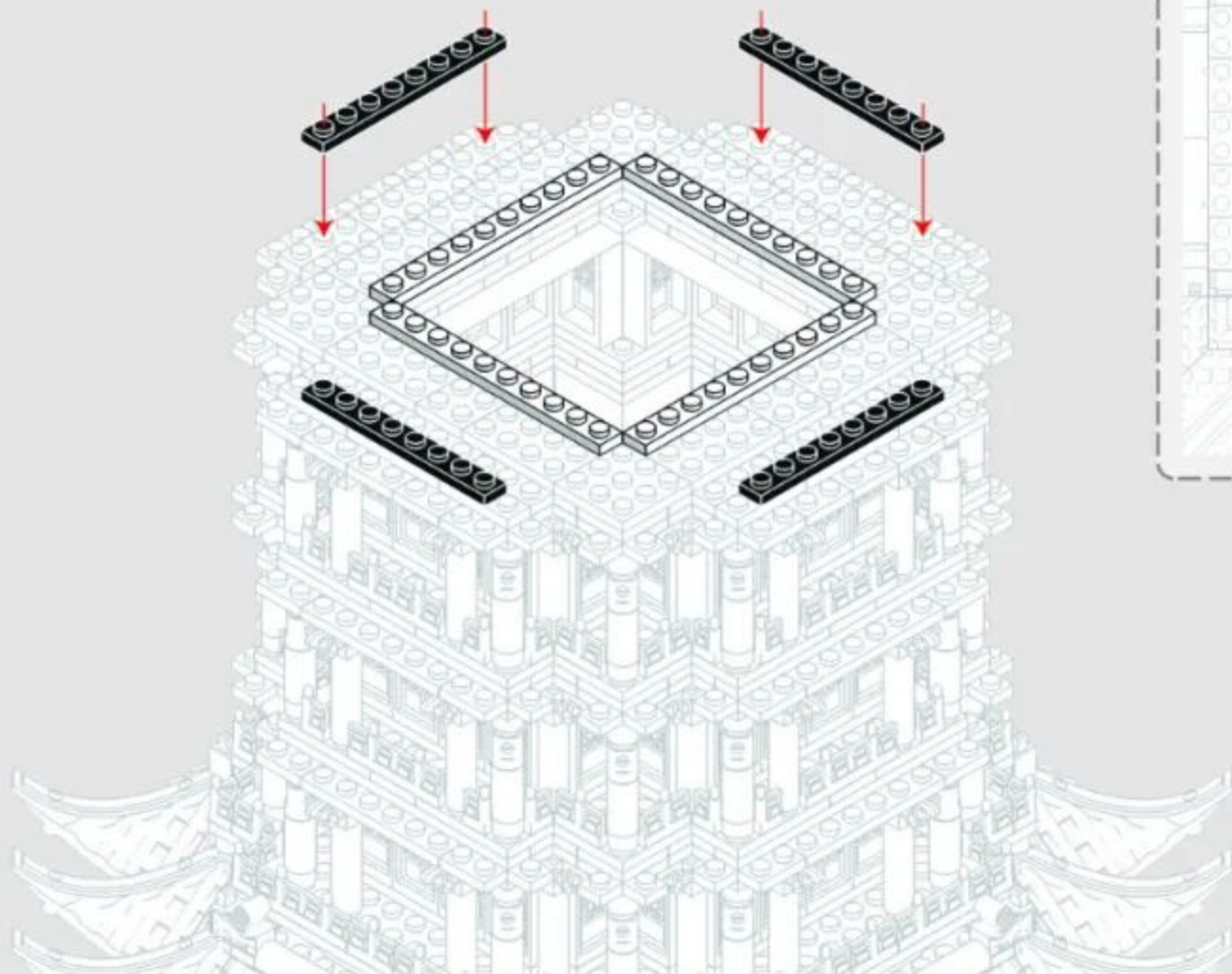
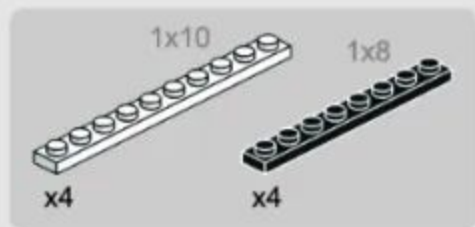

Vertical View of Installation Drawing
安装图顶面

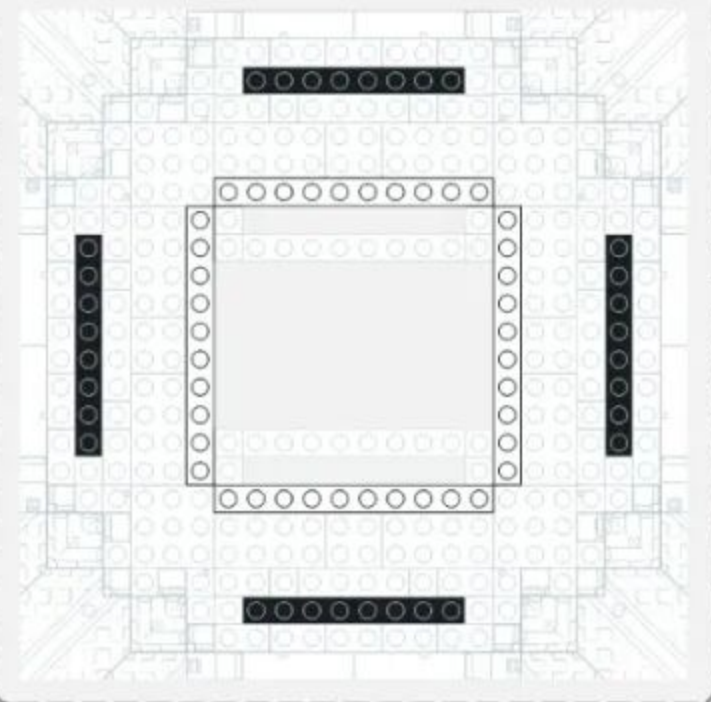

7-8

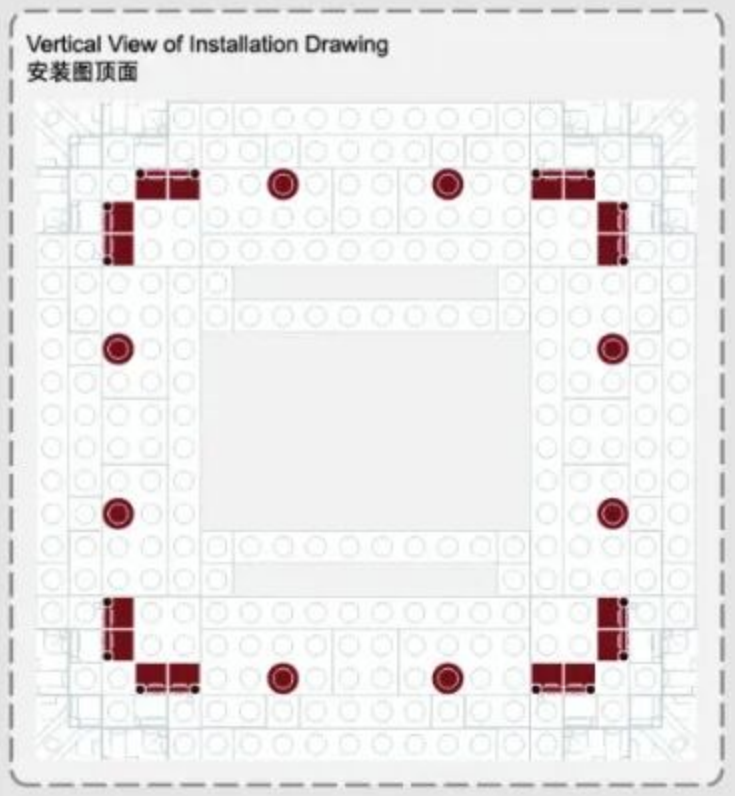
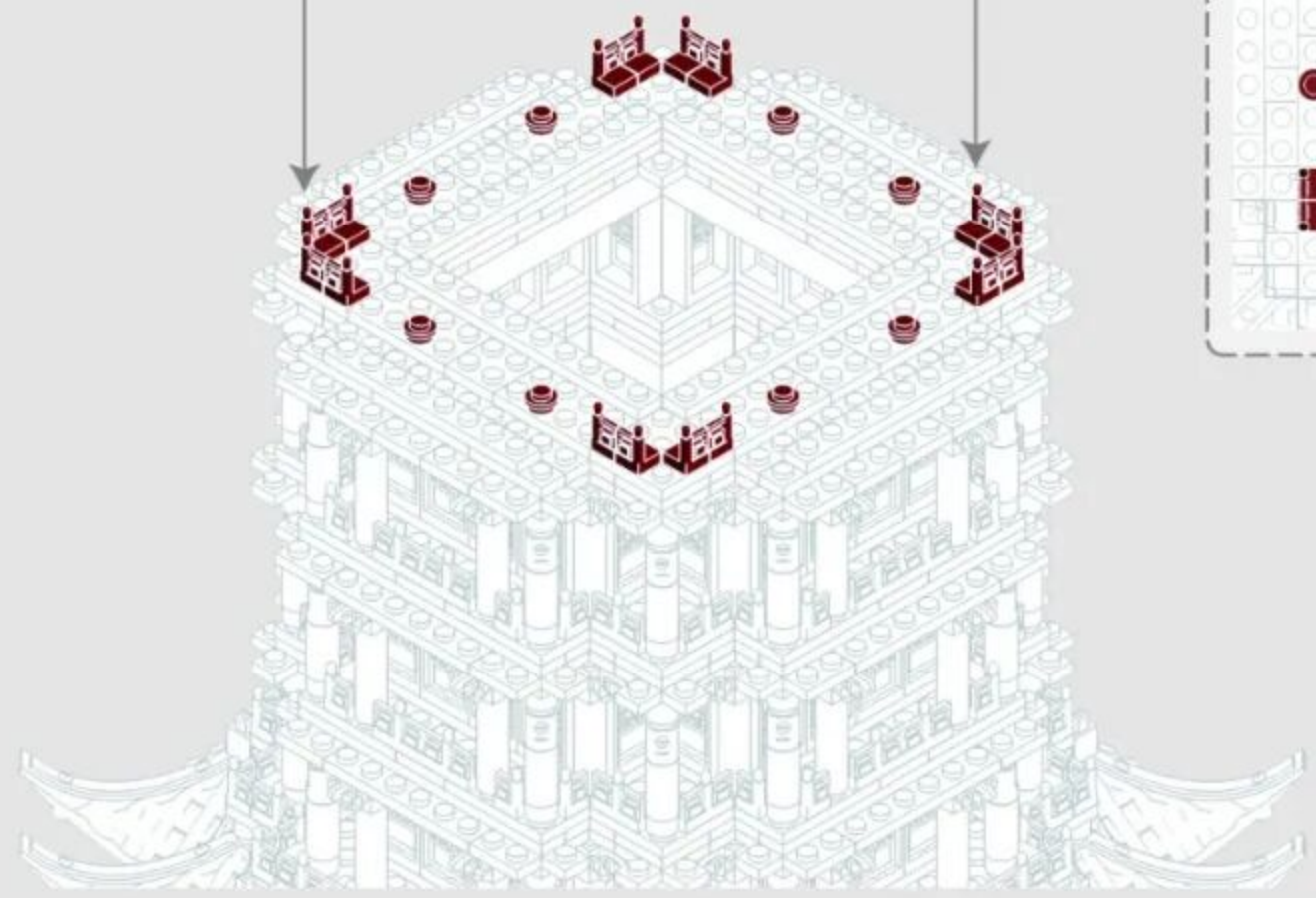

7-9

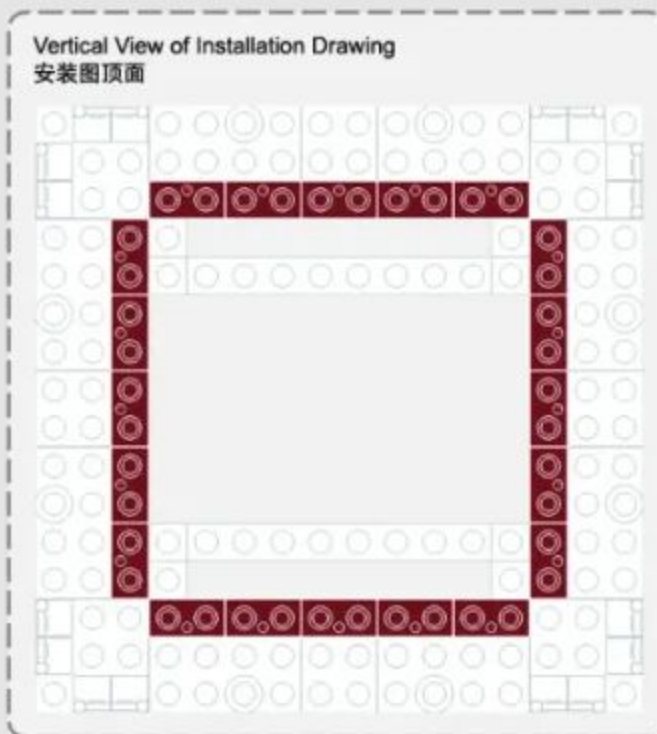
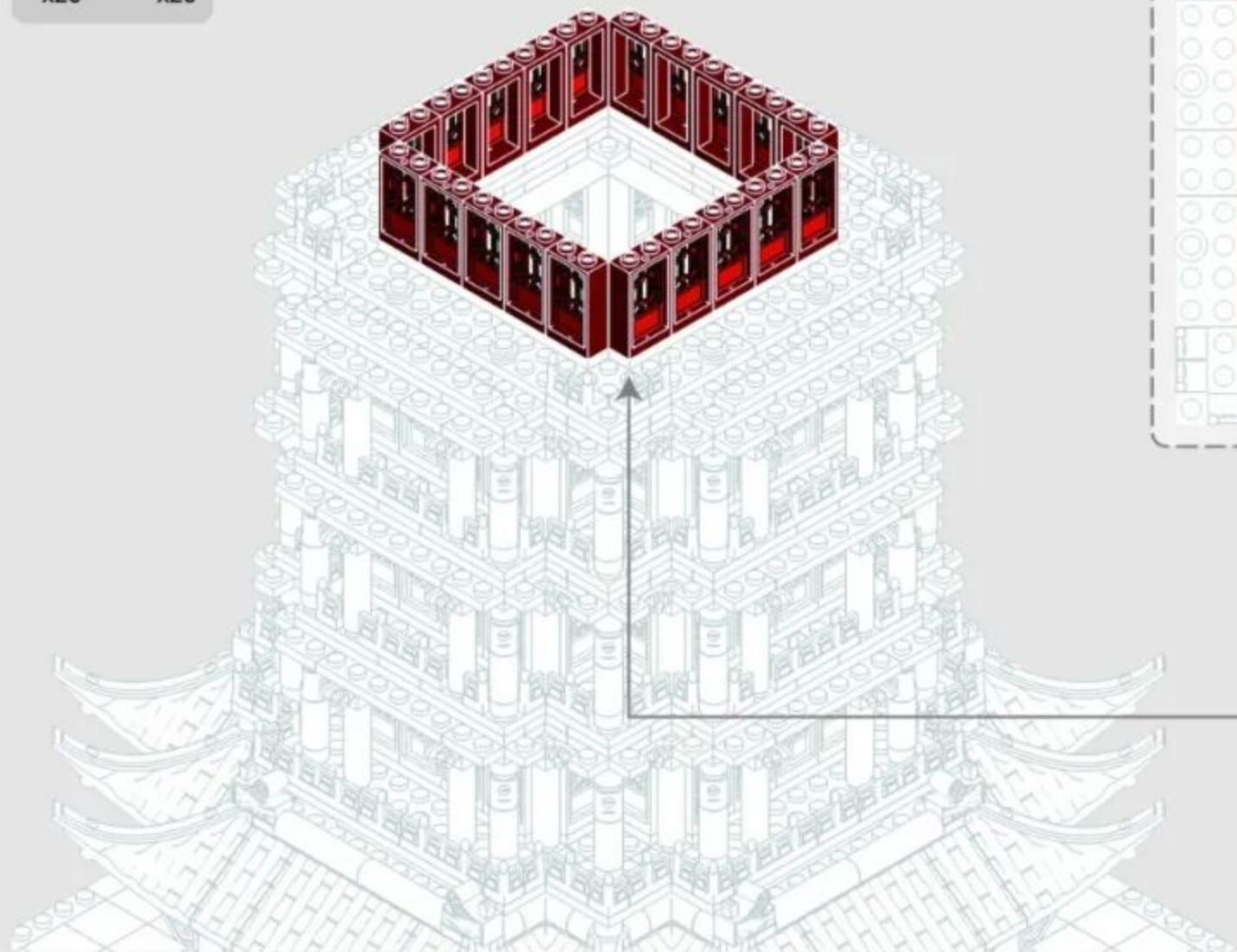

7-10

1x10

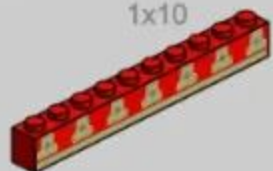

x4

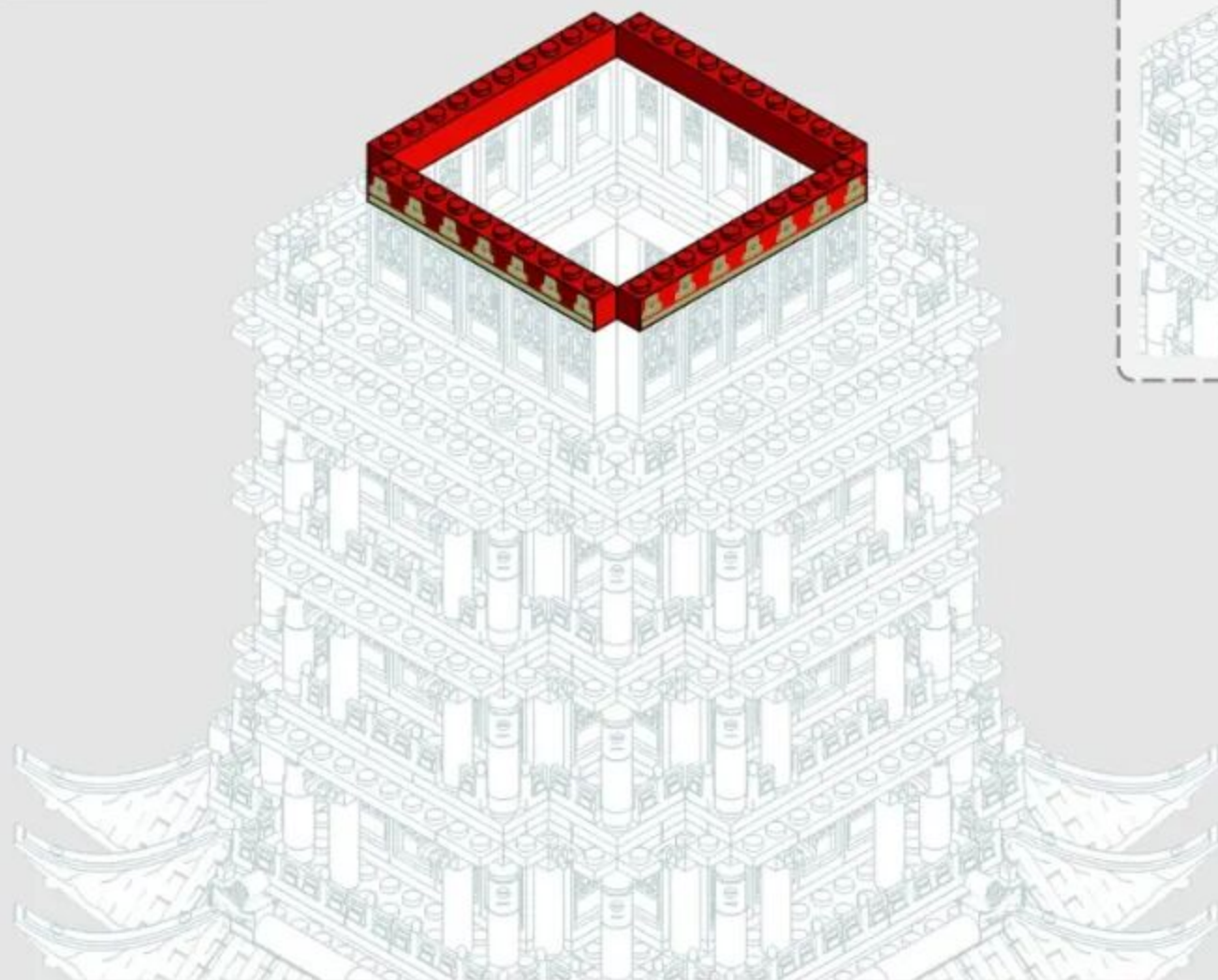

Back Side of Installation Drawing
安装图背面

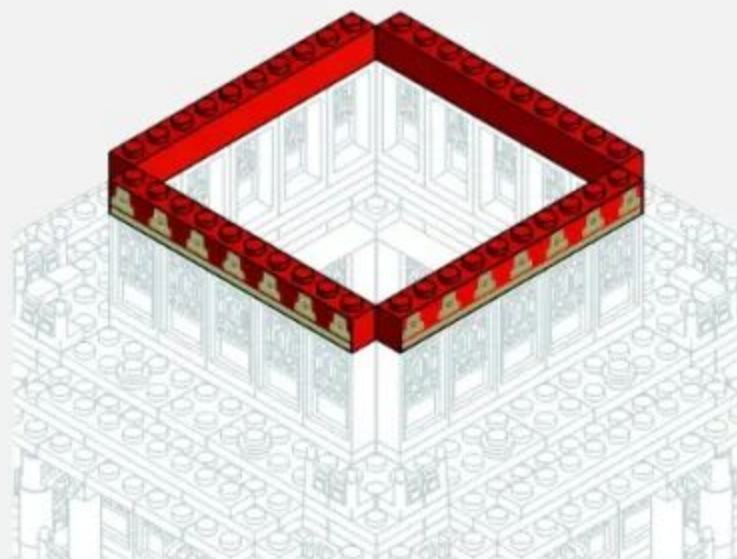

7-11

1x3



x4



x4

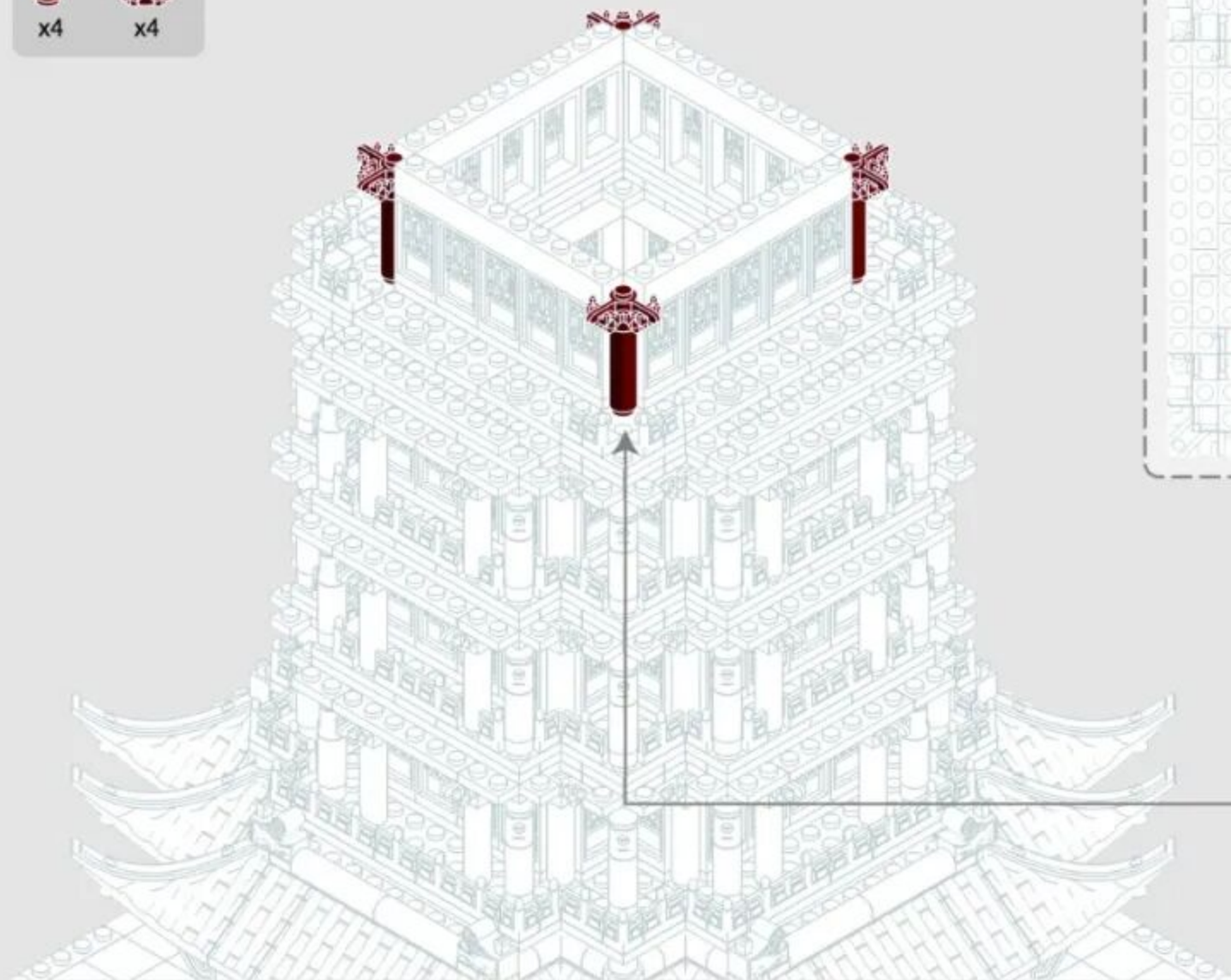

Vertical View of Installation Drawing
安装图顶面

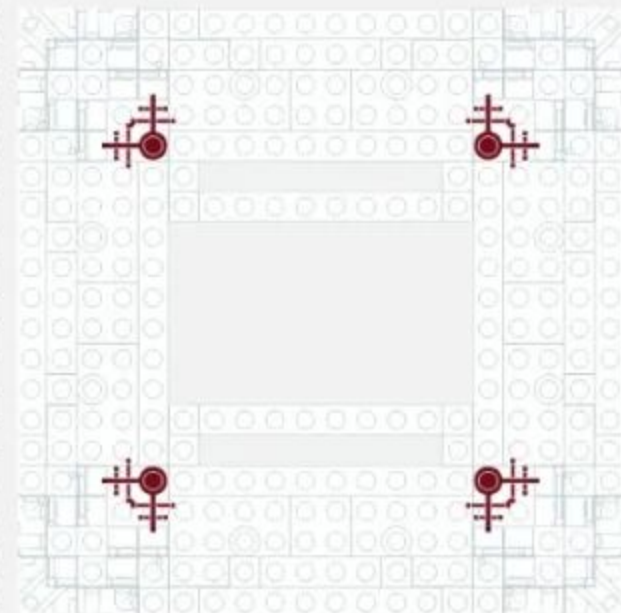



279PCS



110

8-1

- 1x4 x8
- 1x2 x4
- x4
- x8
- x8

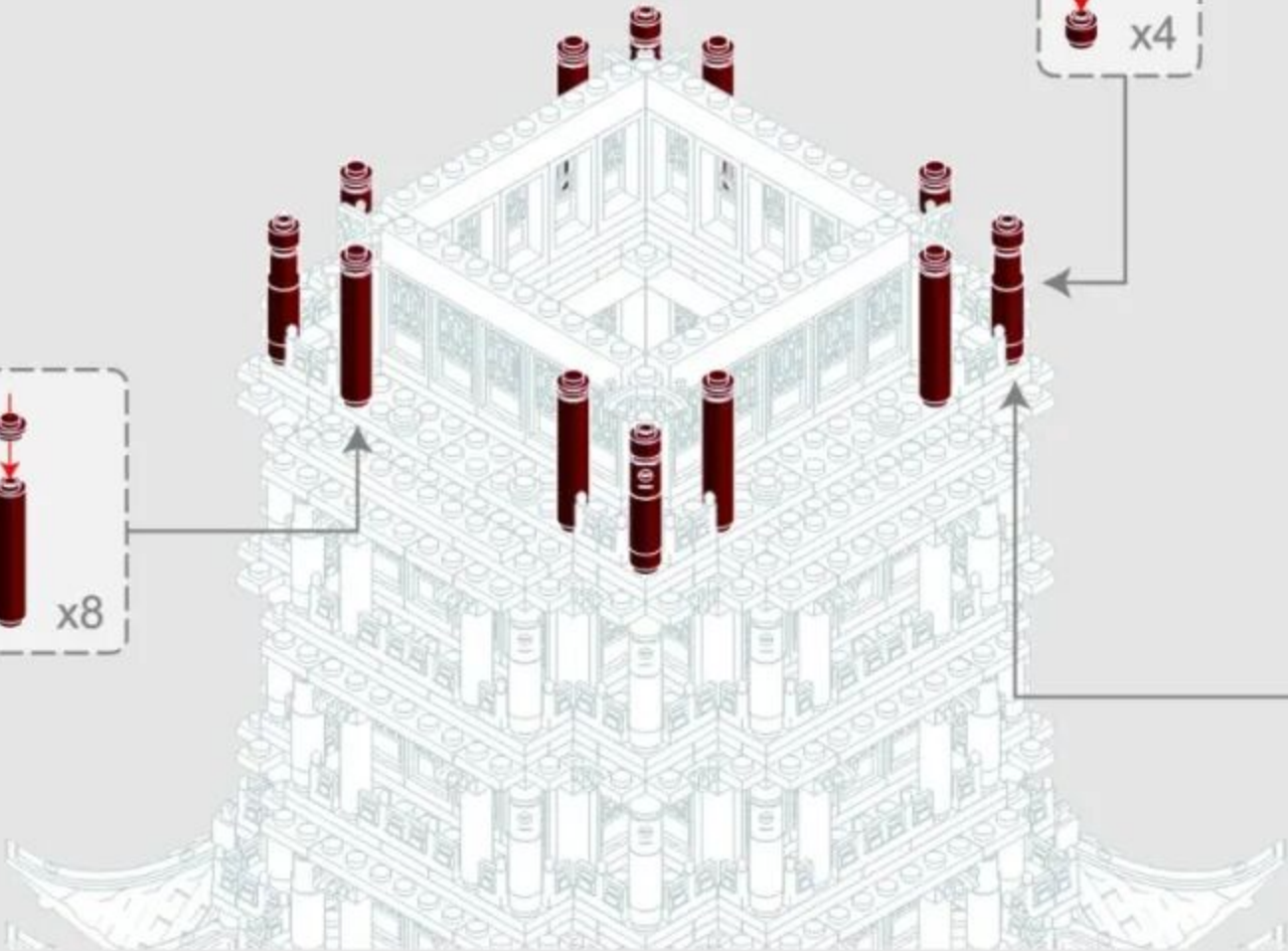
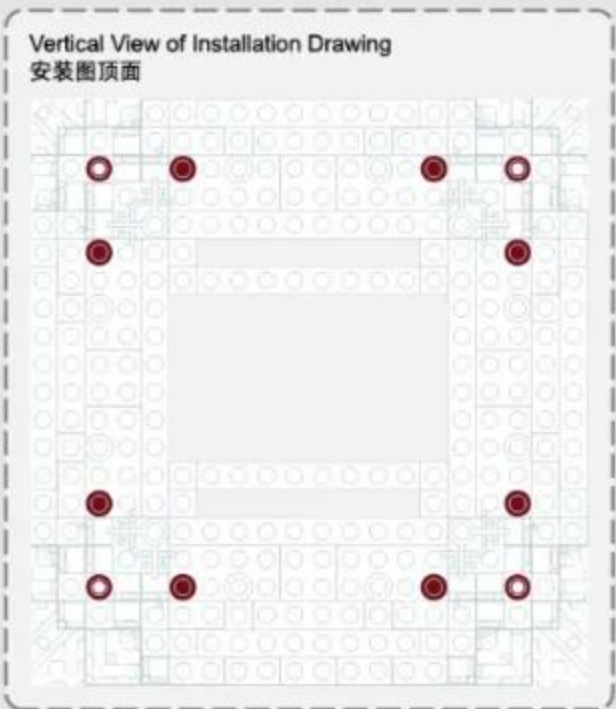

8-2

3x3



x4

1x2



x8

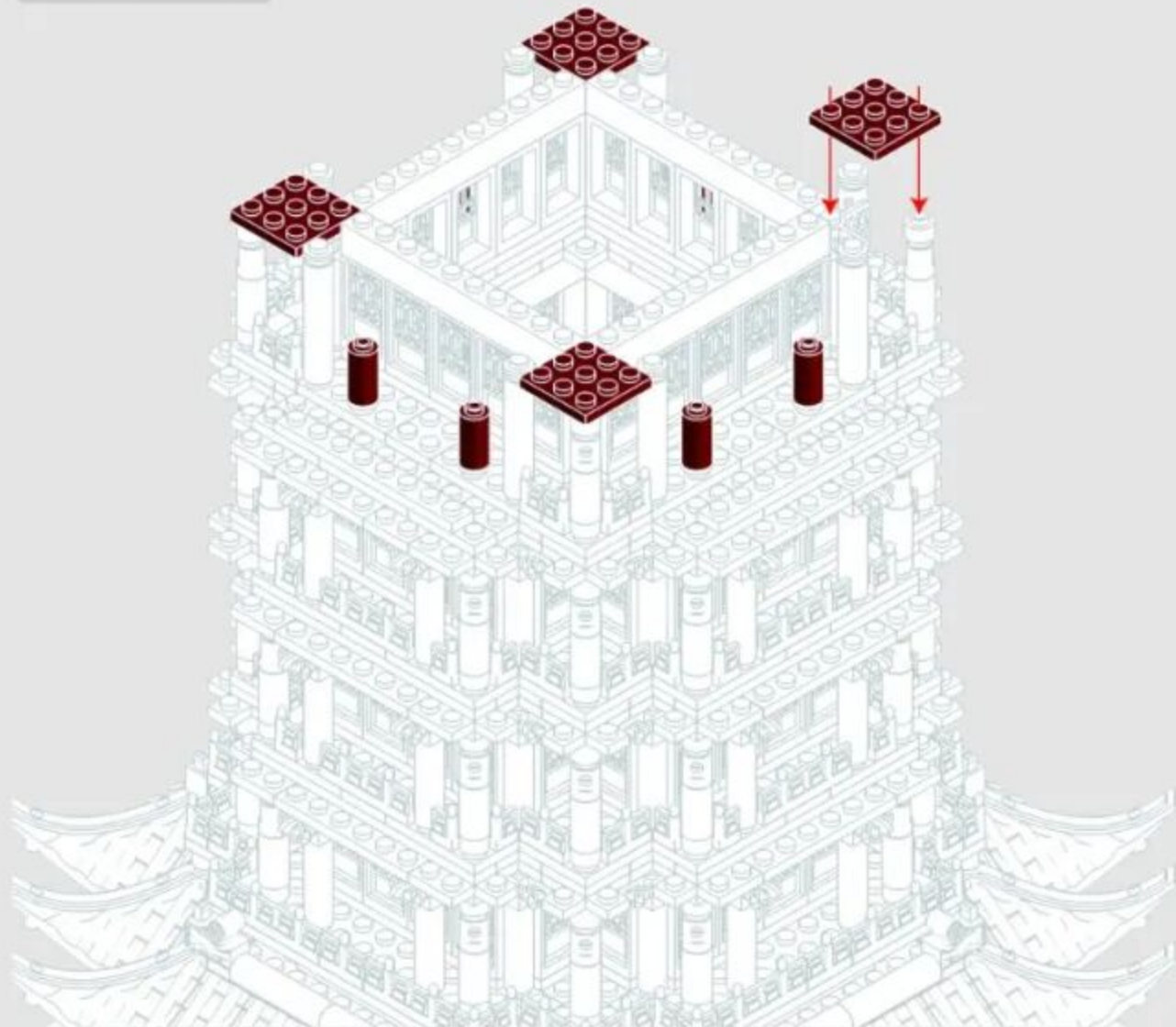

Vertical View of Installation Drawing
安装图顶面

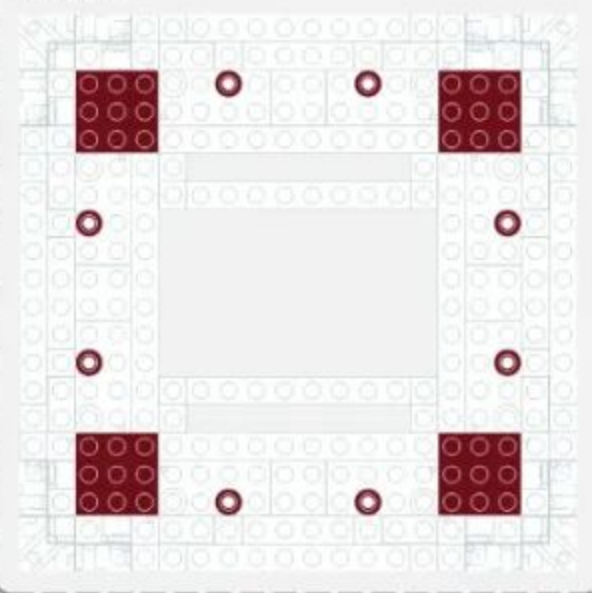

Back Side of Installation Drawing
安装图背面

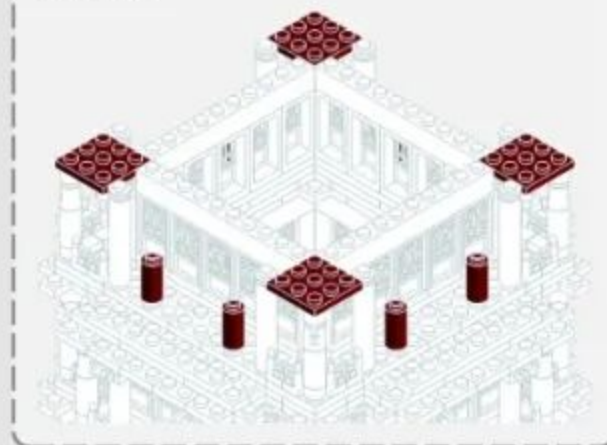

8-3

3x3



x4



x8



x4

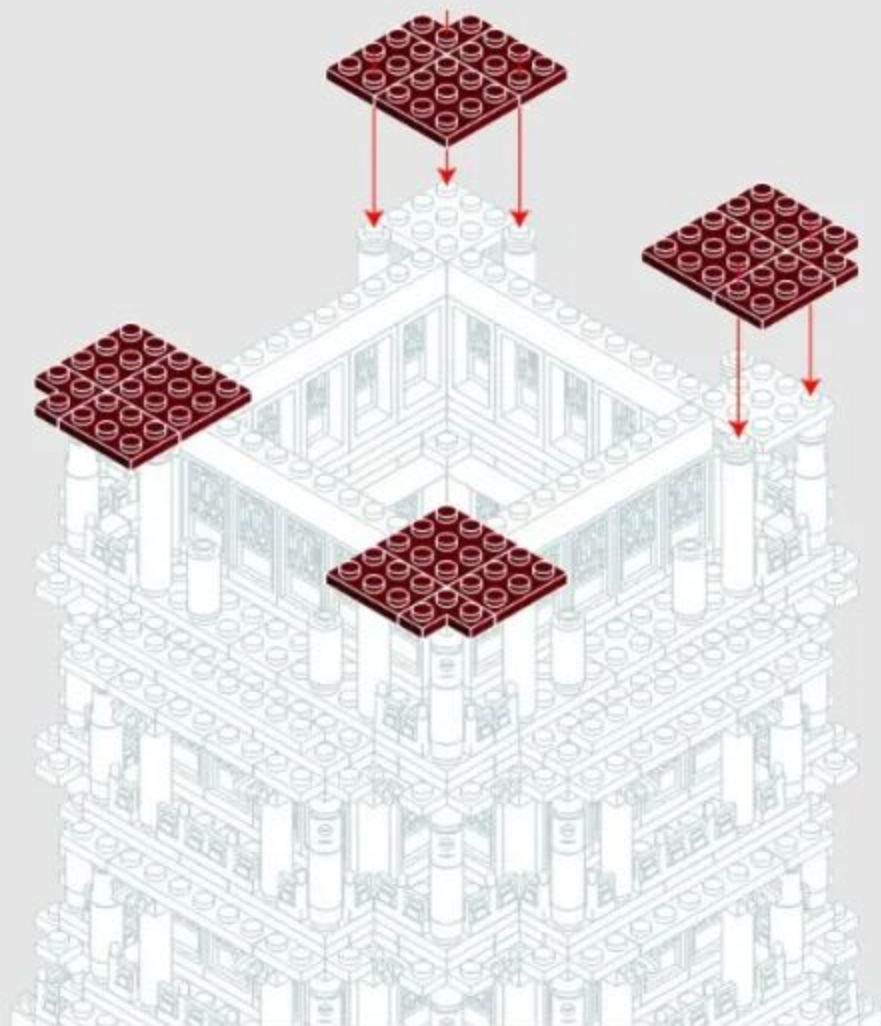

Vertical View of Installation Drawing
安装图顶面

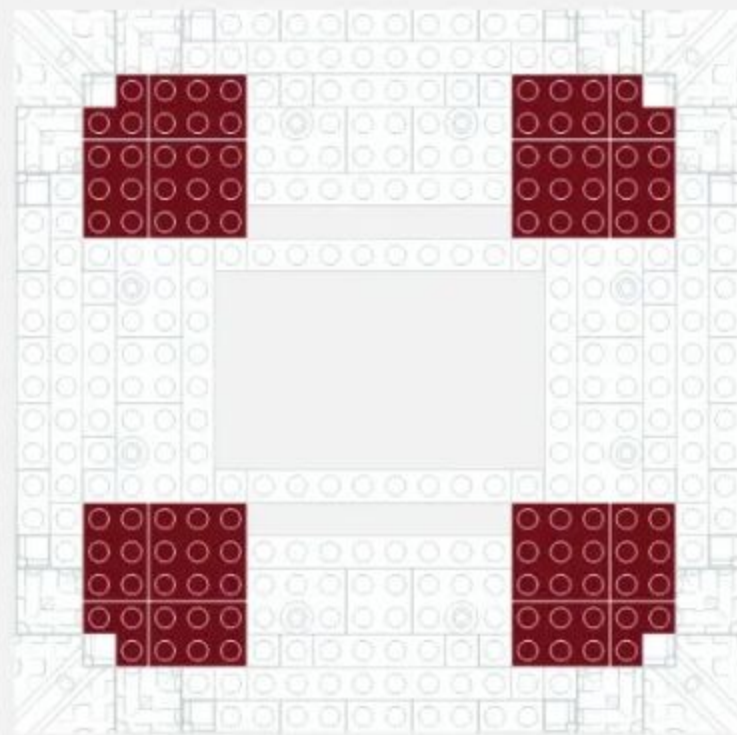

8-4

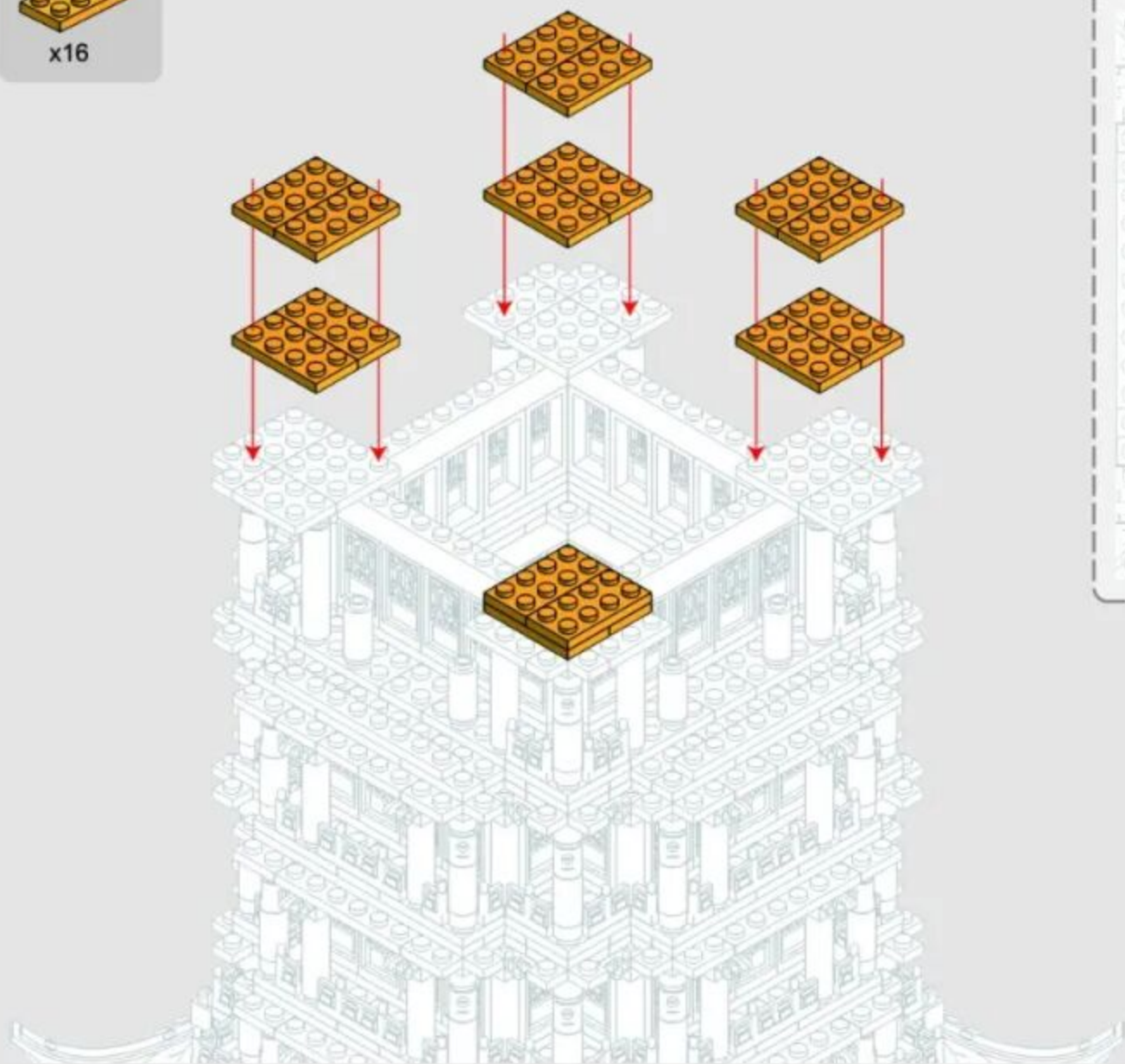

Vertical View of Installation Drawing
安装图顶面

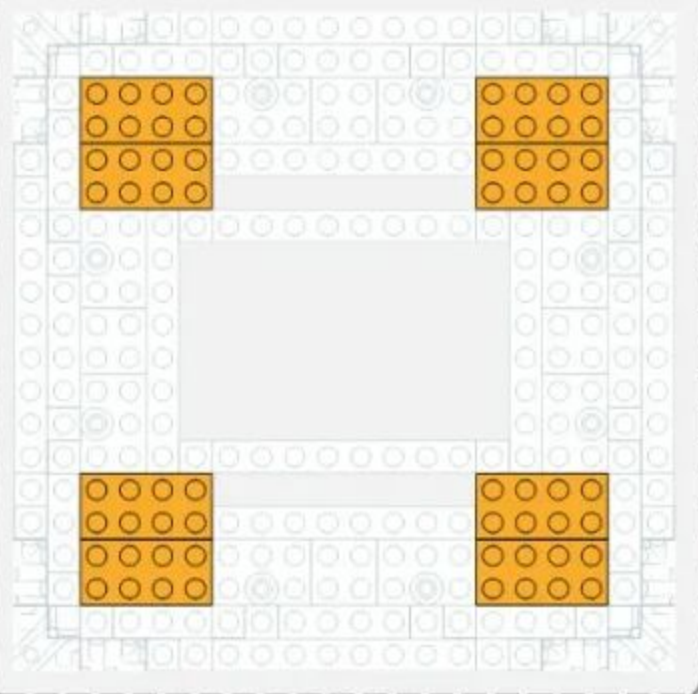

8-5

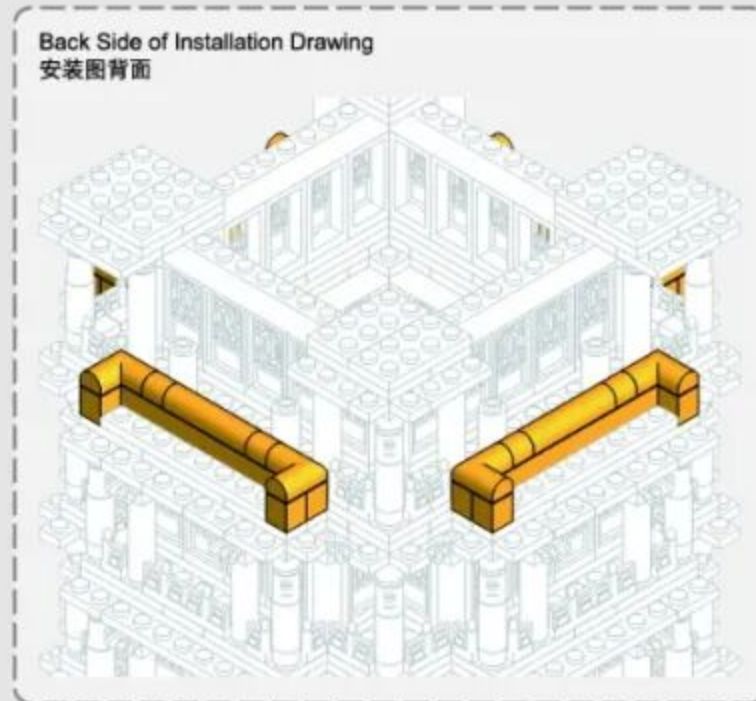
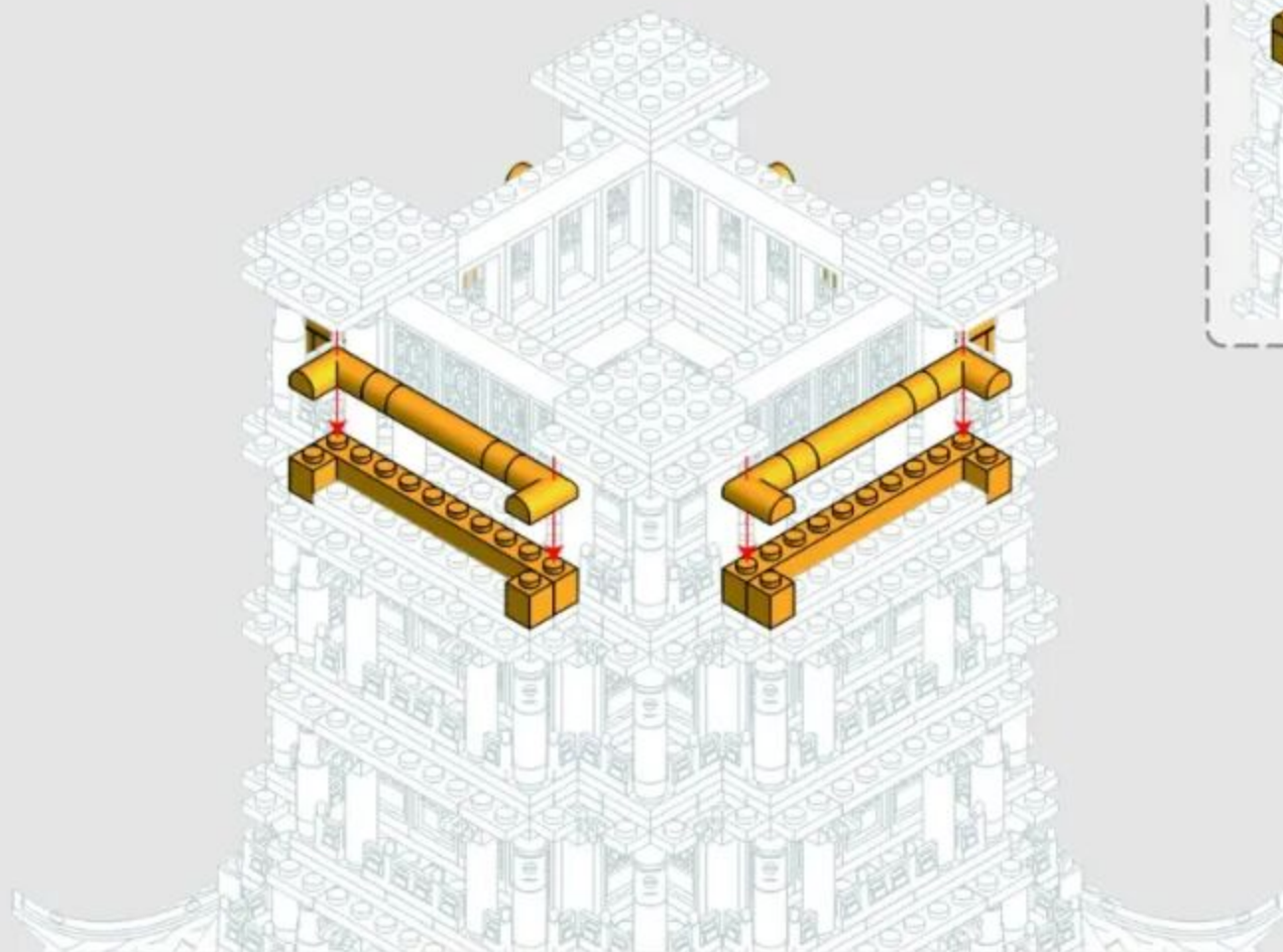
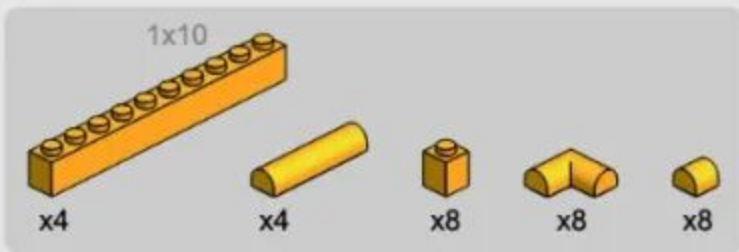

8-6

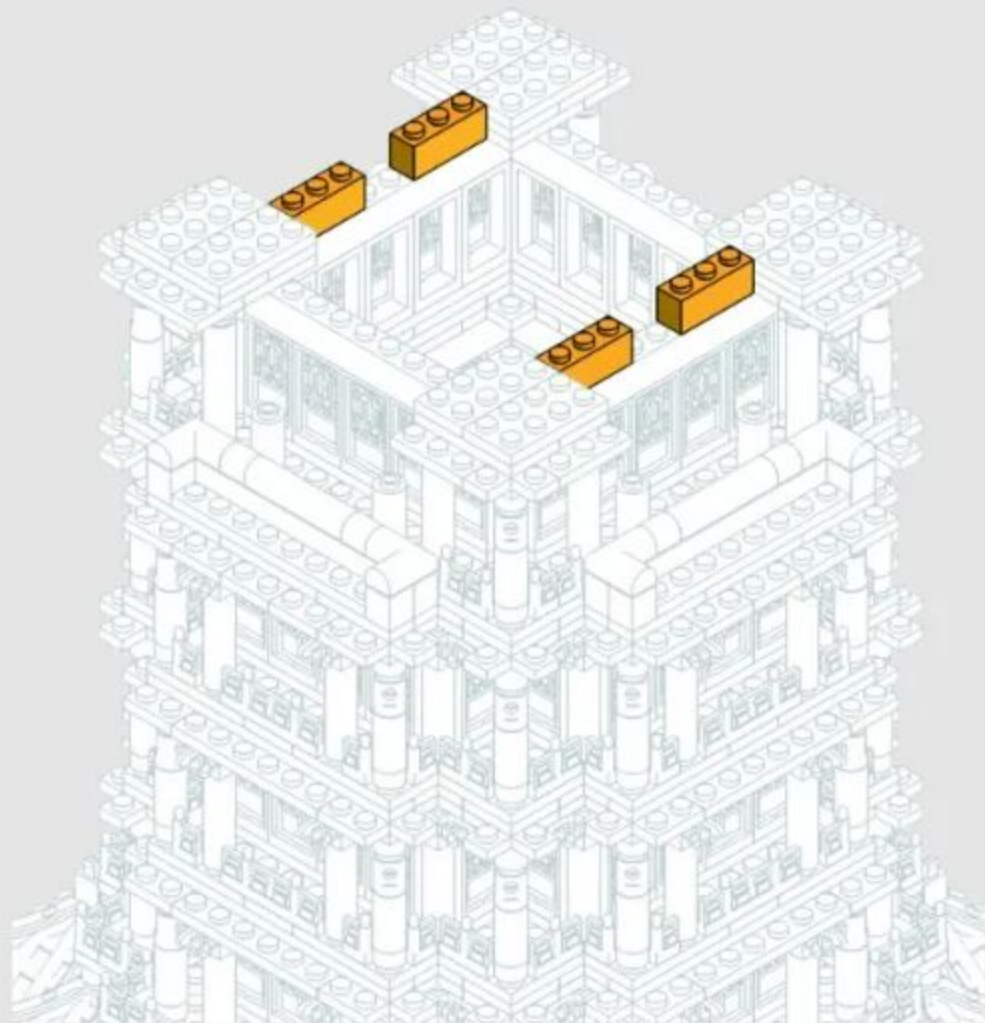

8-7

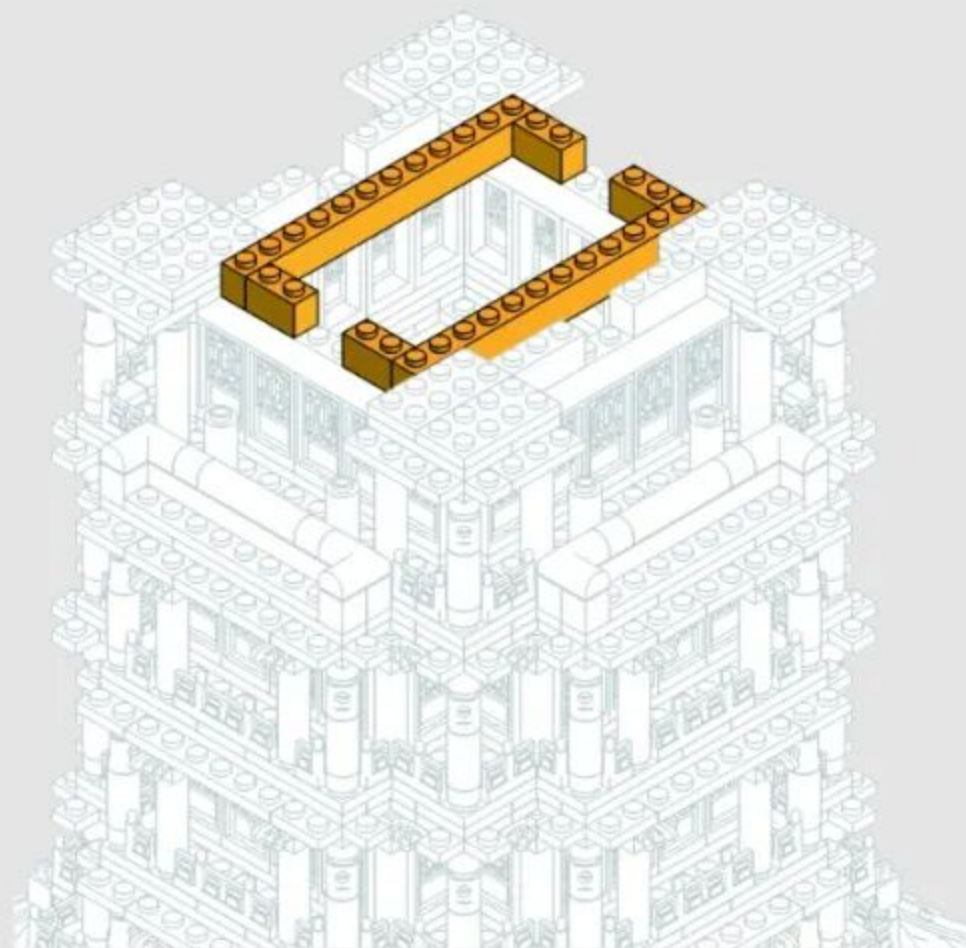
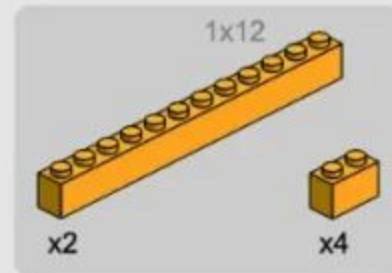

8-8

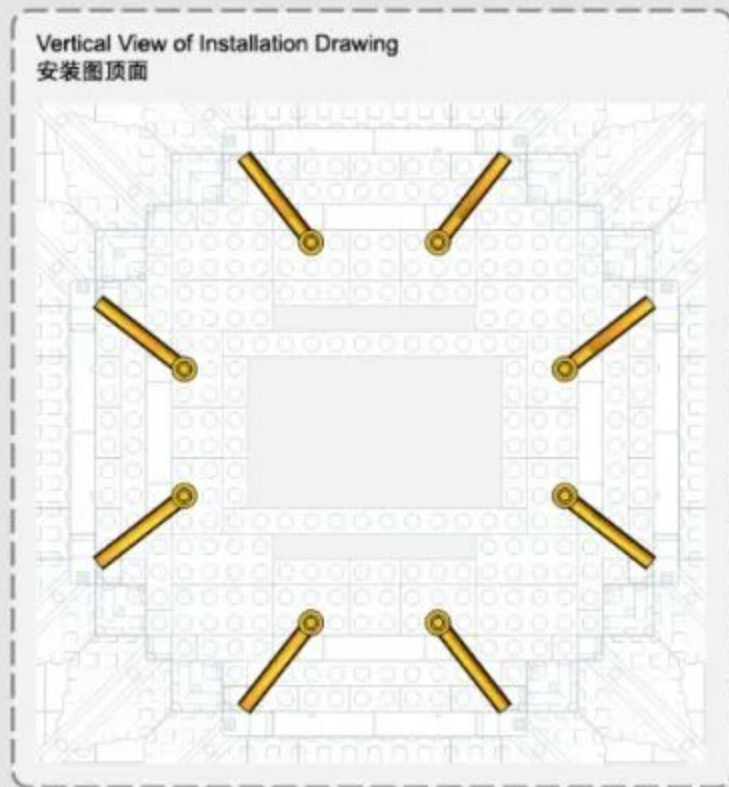
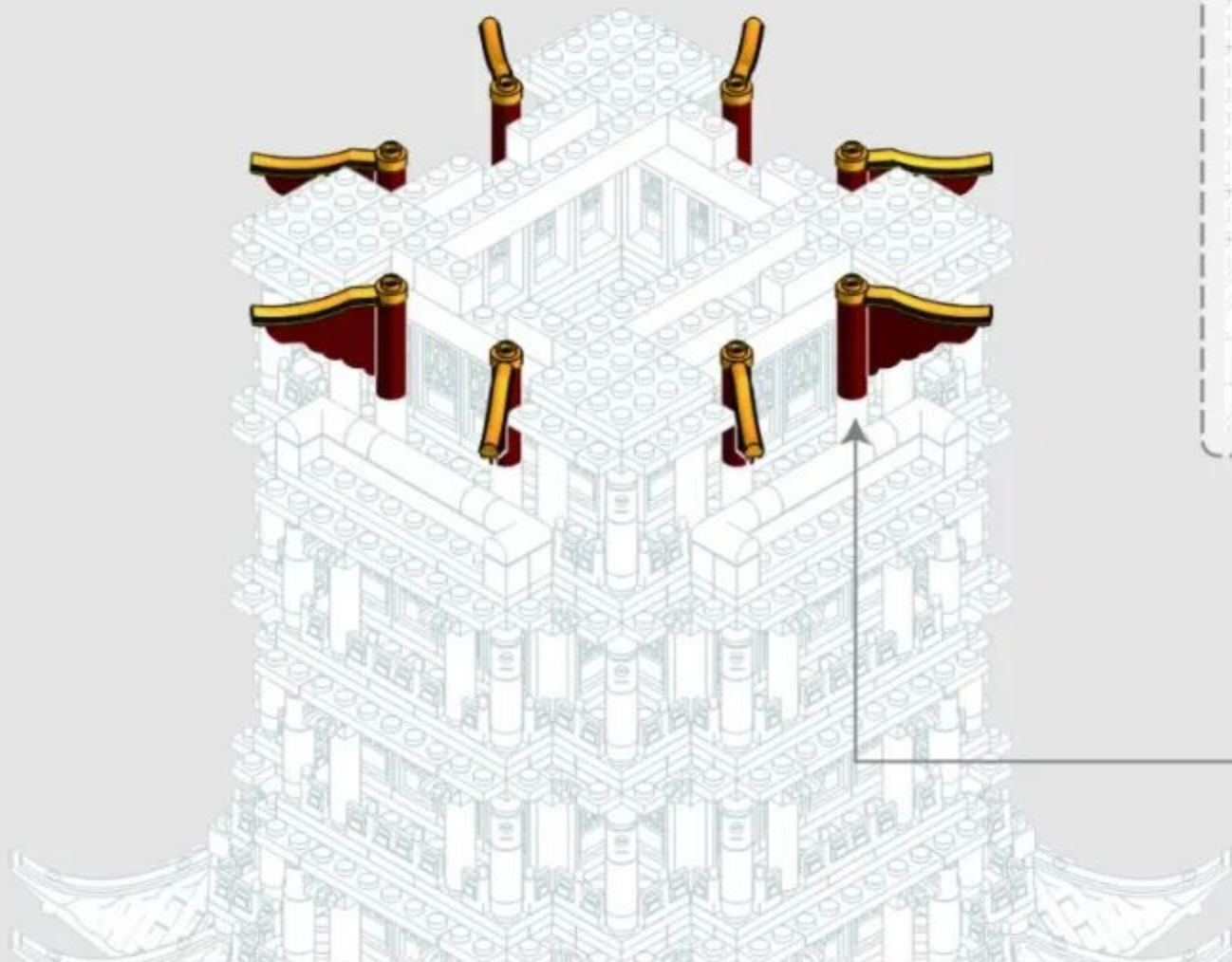

8-9

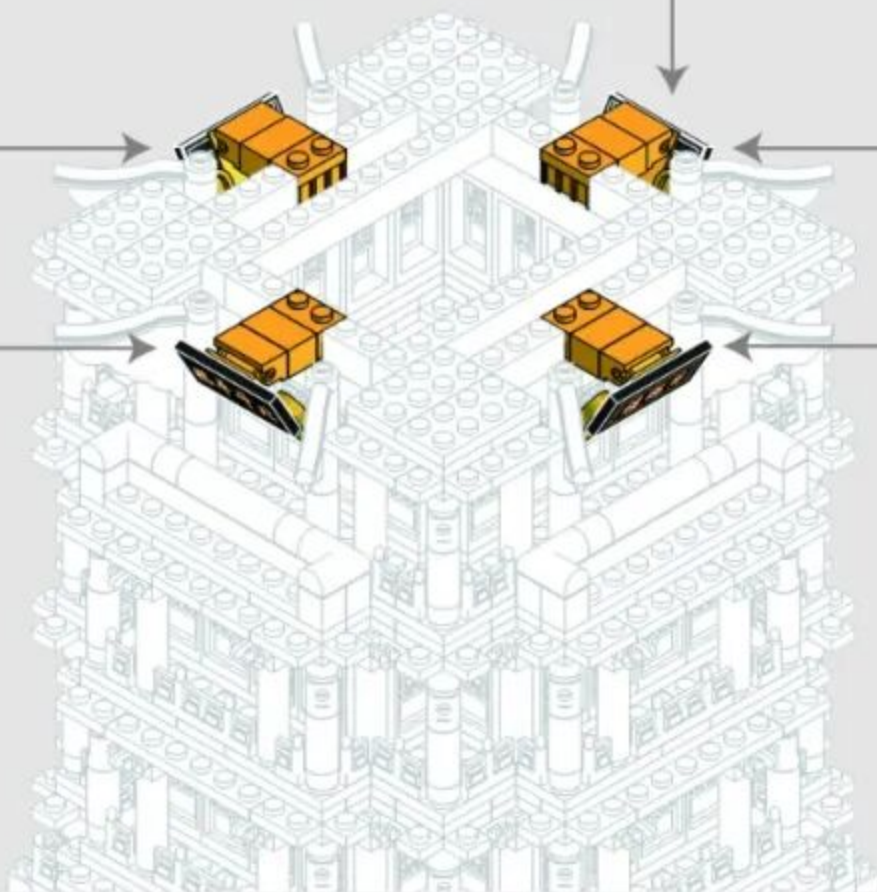
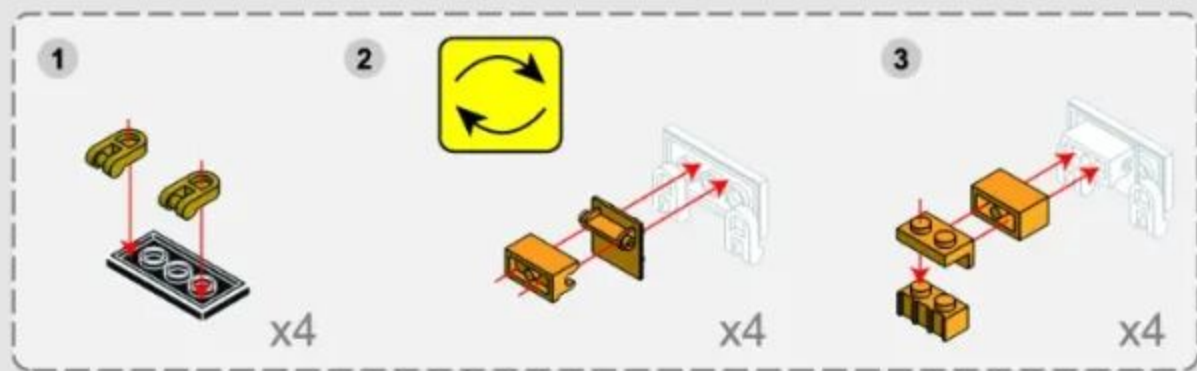

8-10

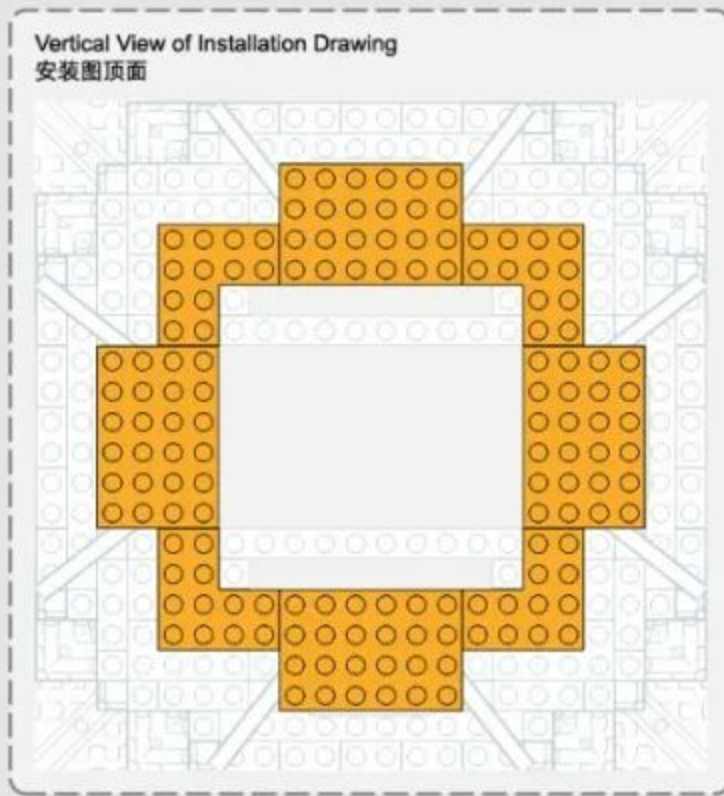
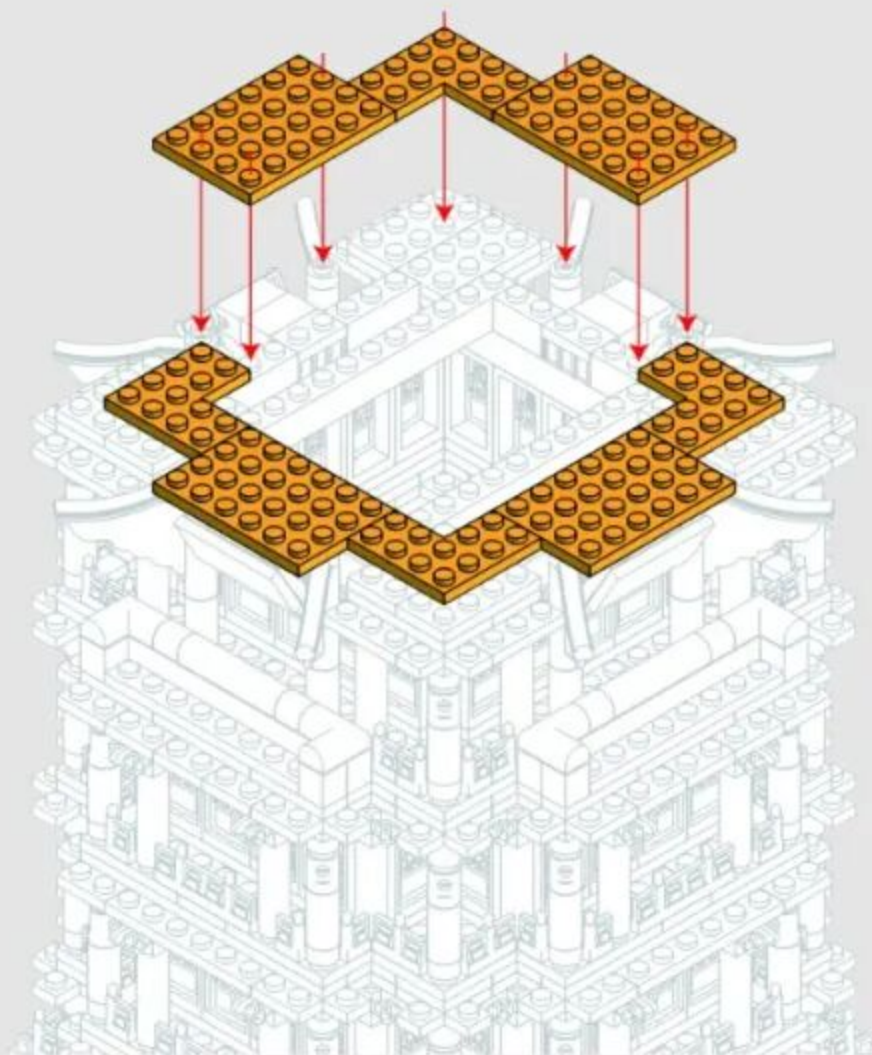

8-11

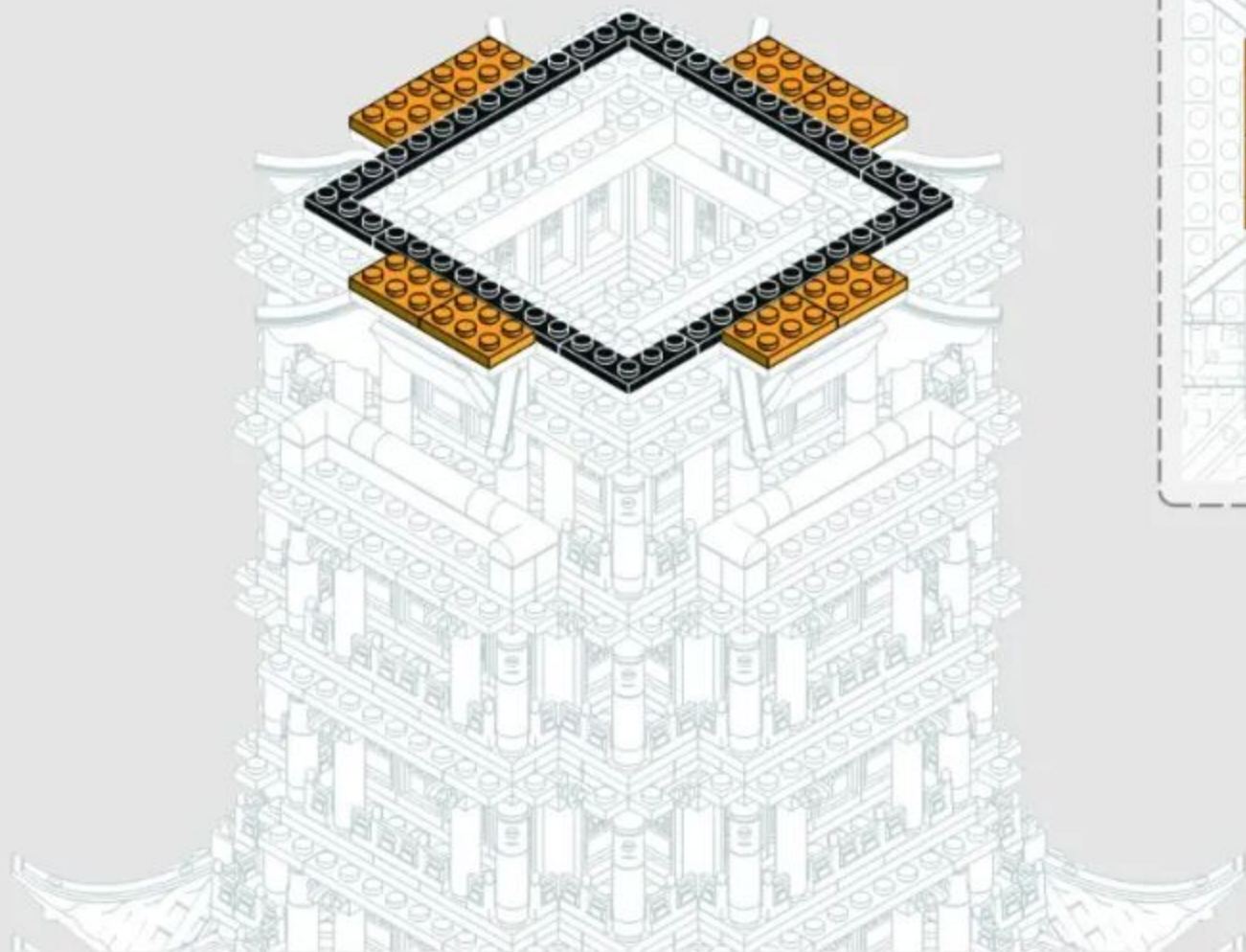

8-12

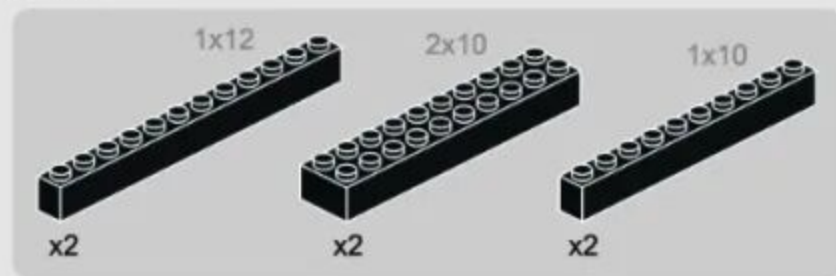

Vertical View of Installation Drawing
安装图顶面

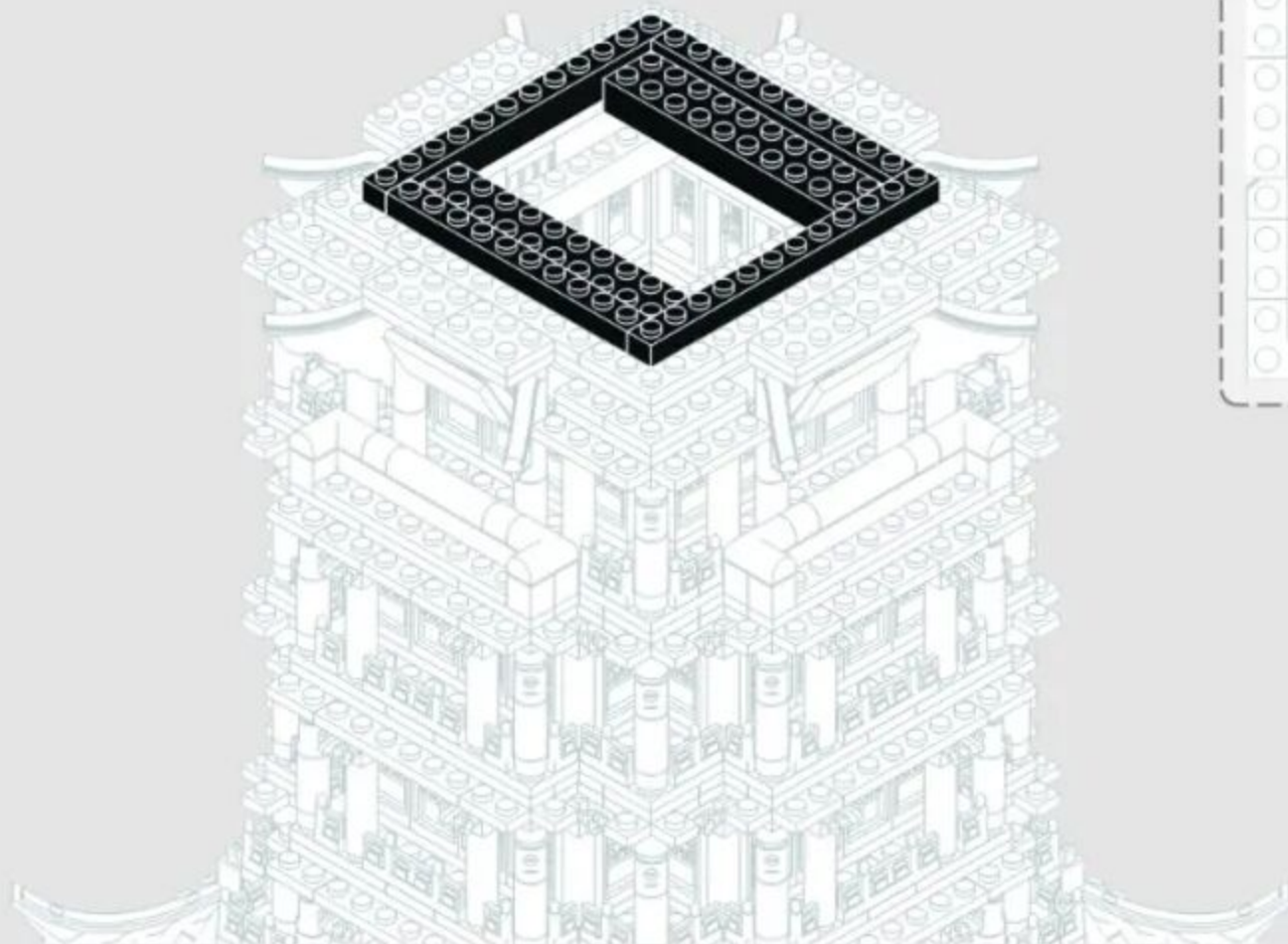
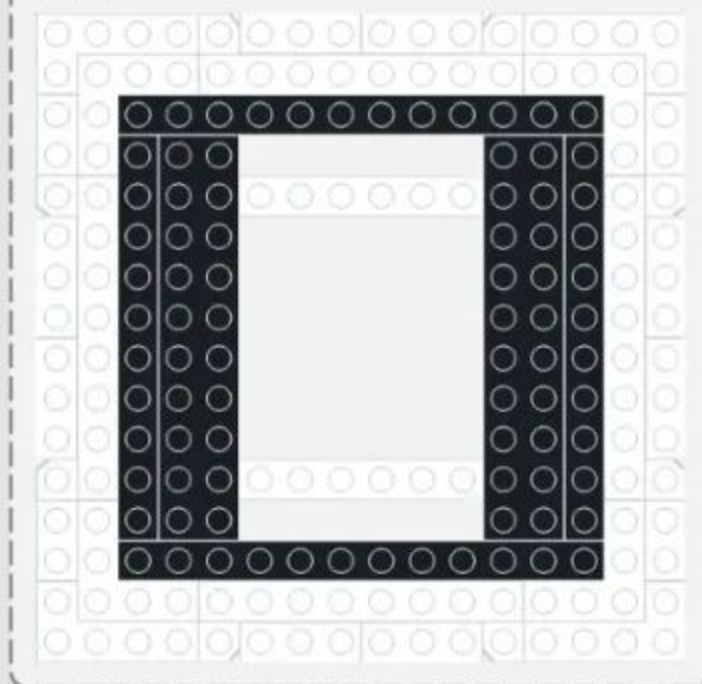

8-13



x4



x4



x8

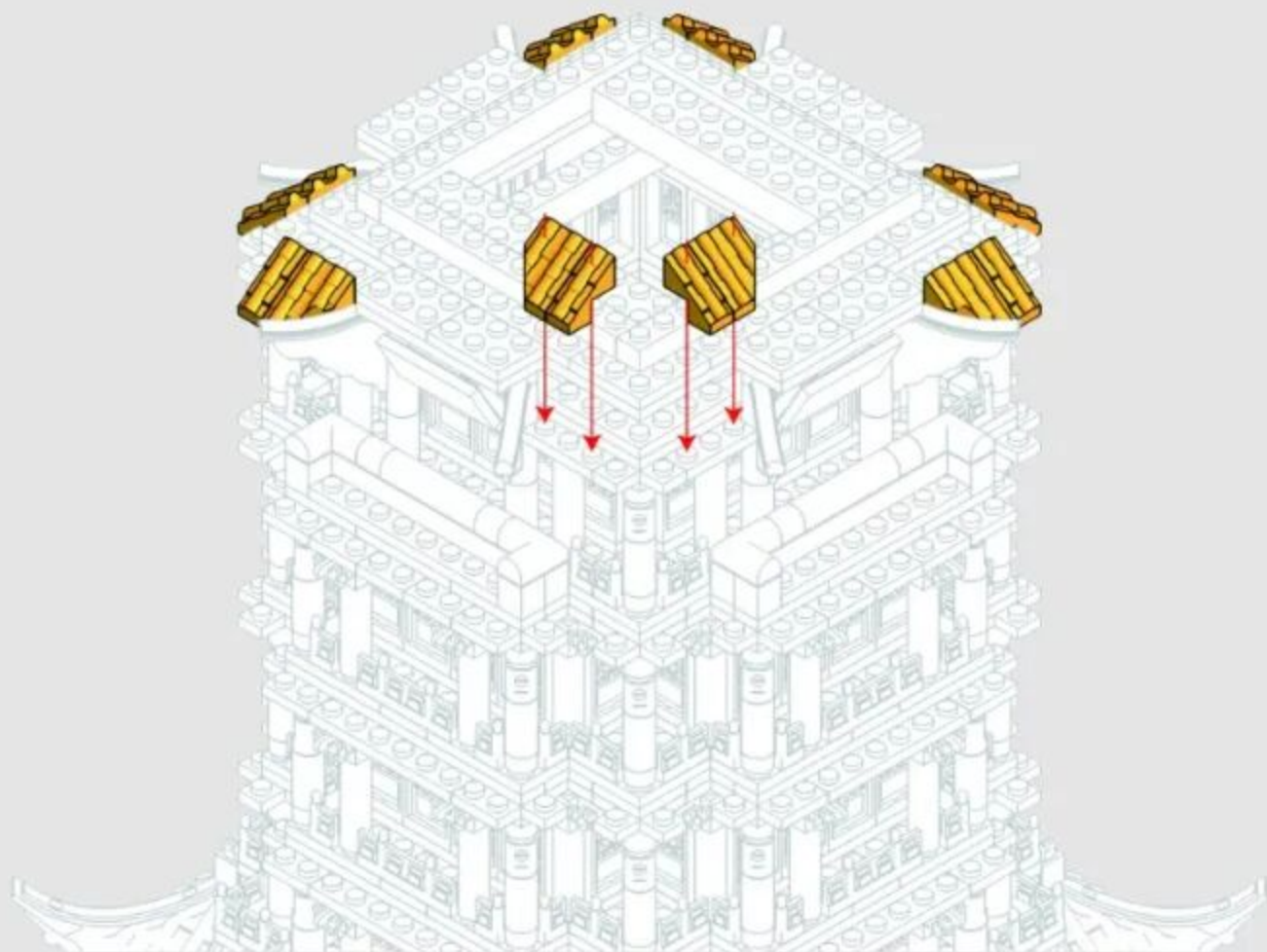

Vertical View of Installation Drawing
安装图顶面

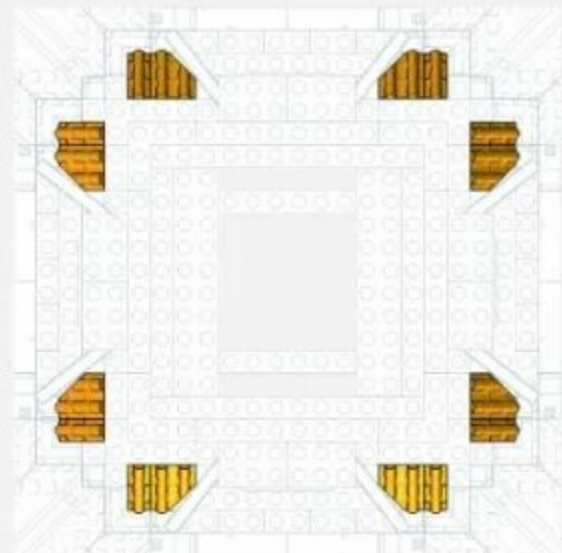

Back Side of Installation Drawing
安装图背面



8-14

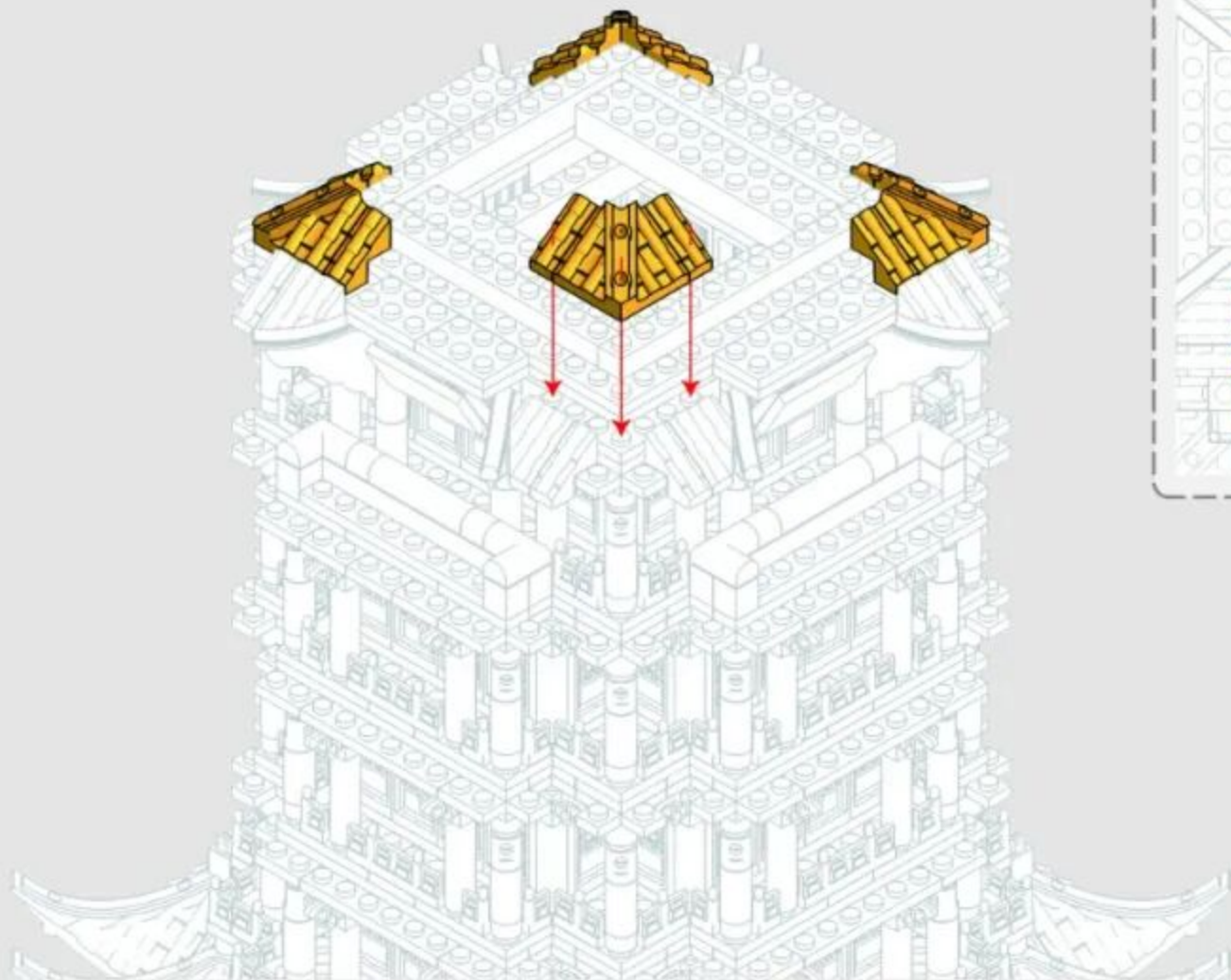

8-15



x8



x8



x8

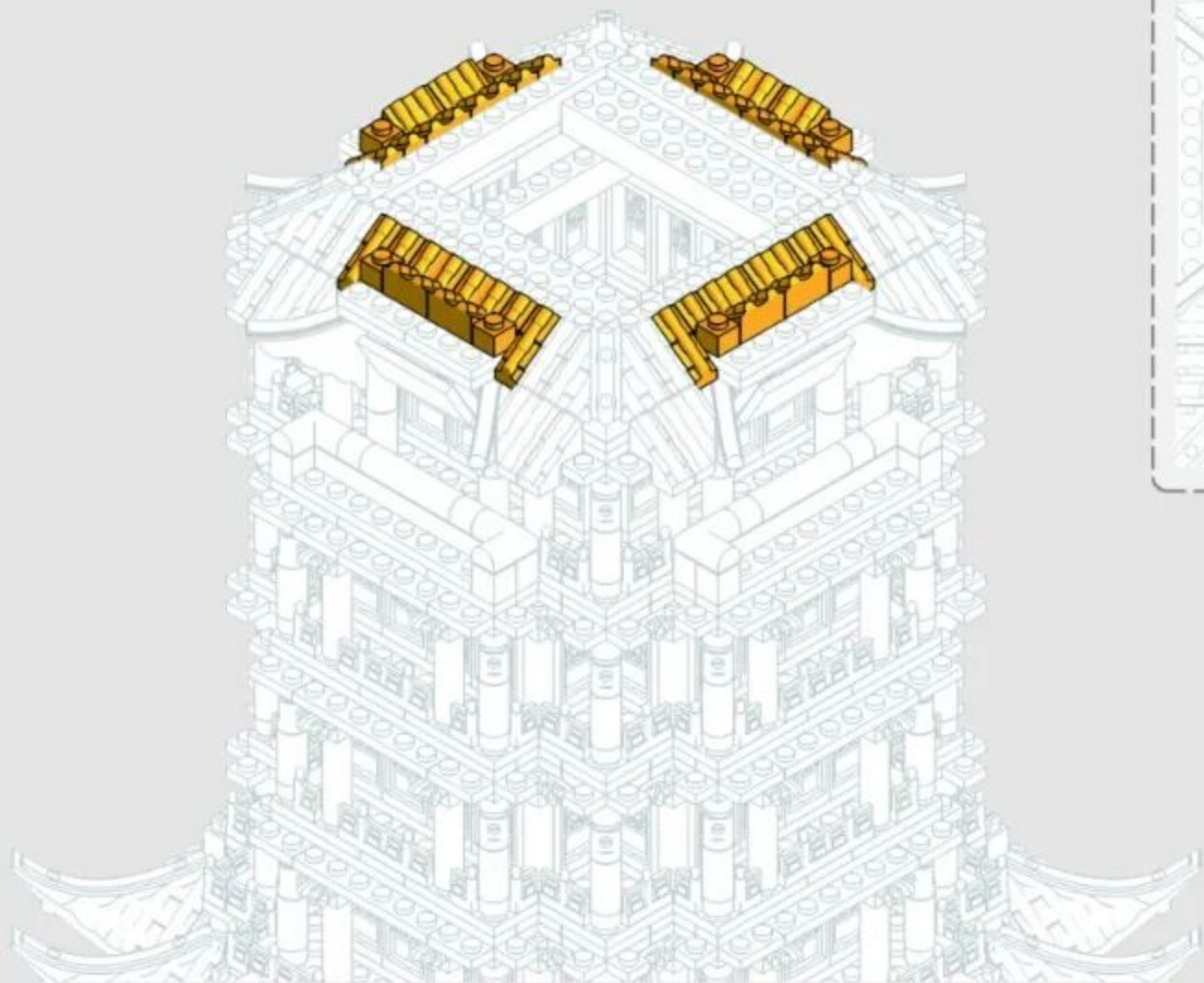

Vertical View of Installation Drawing
安装图顶面

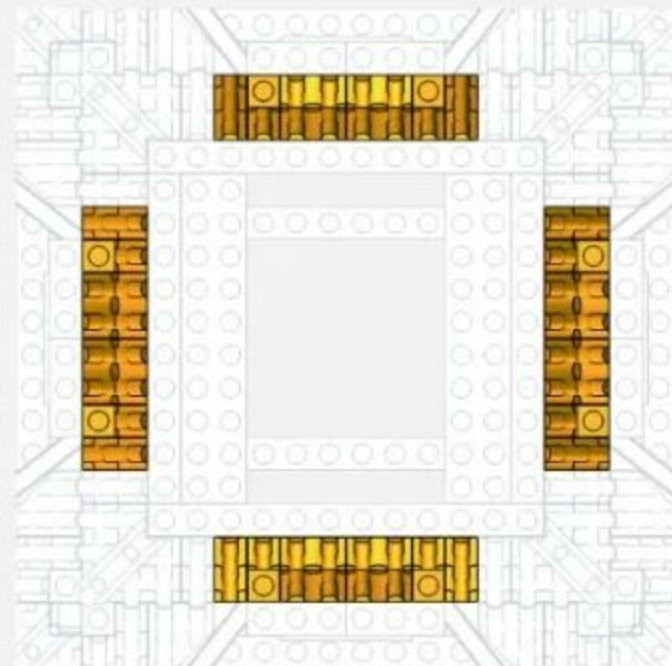

8-16

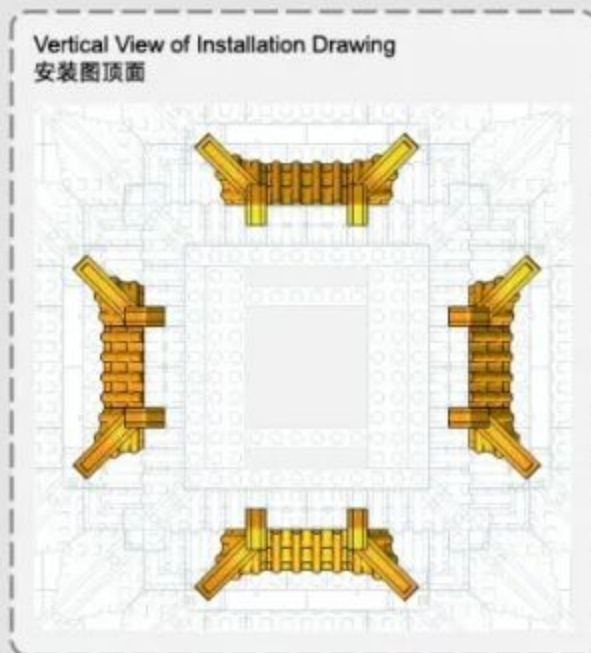
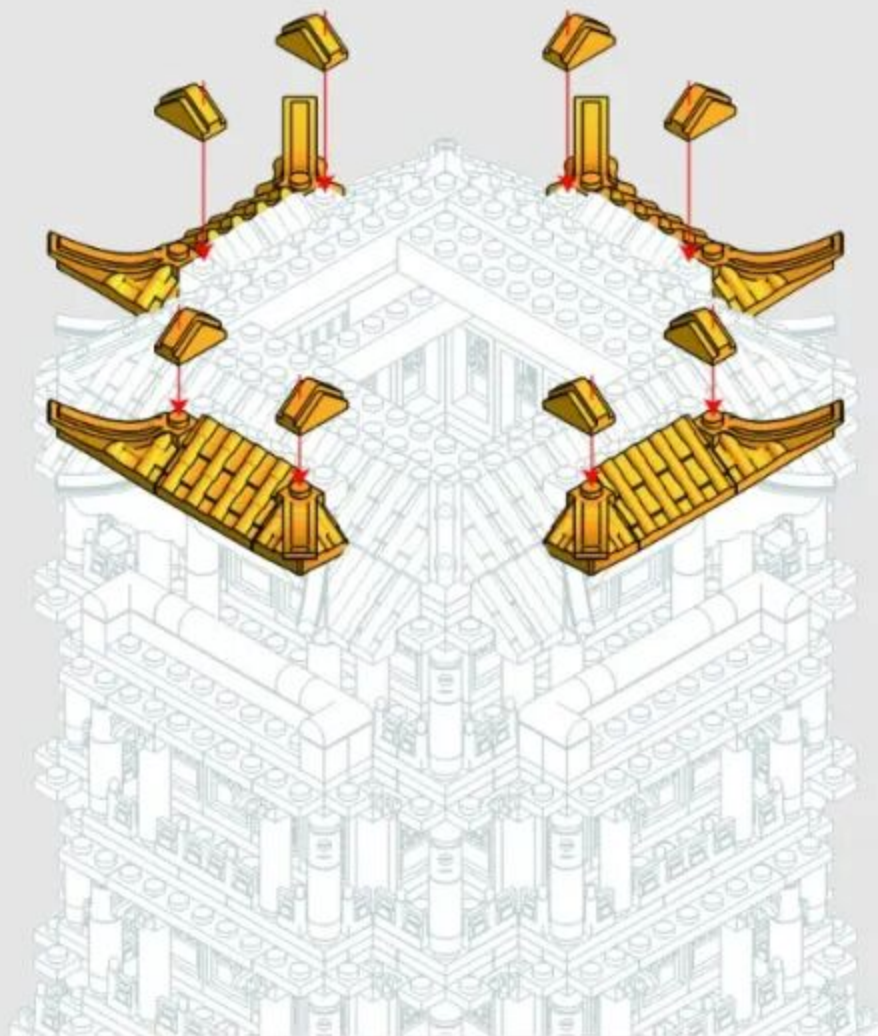

8-17

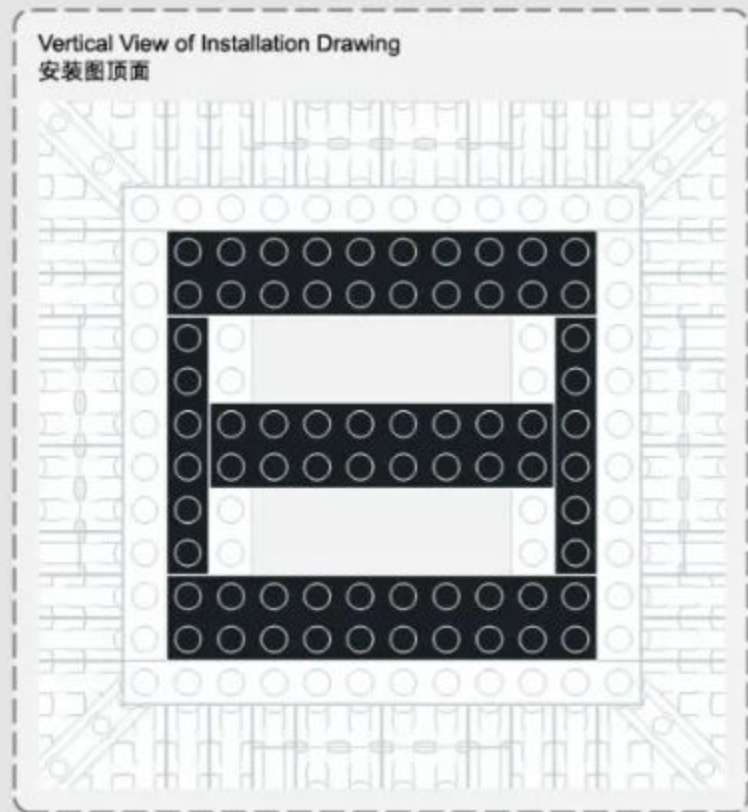
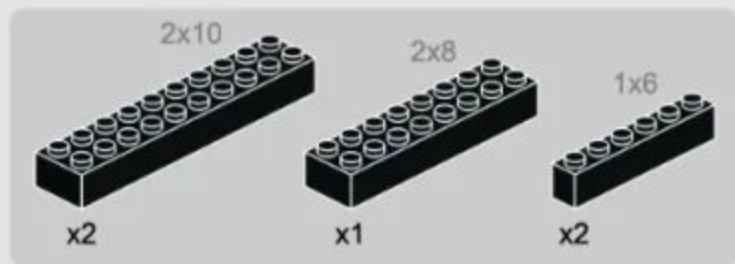

8-18

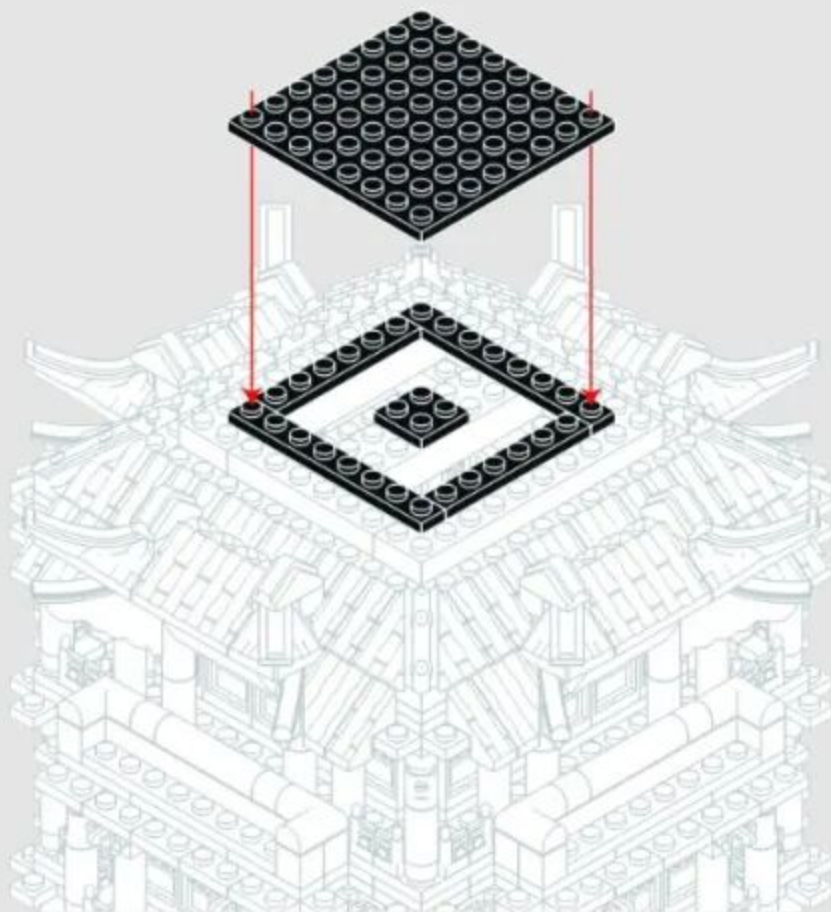
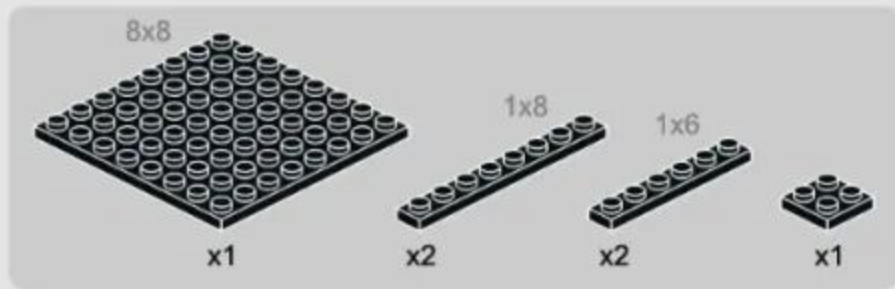

Vertical View of Installation Drawing
安装图顶面

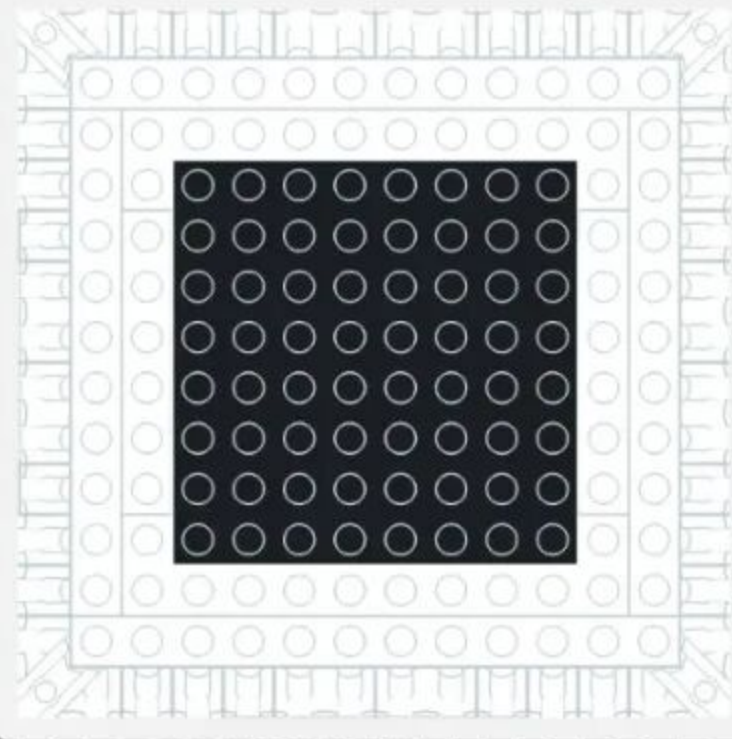



273PCS



128

9-1



x4



x4



x4

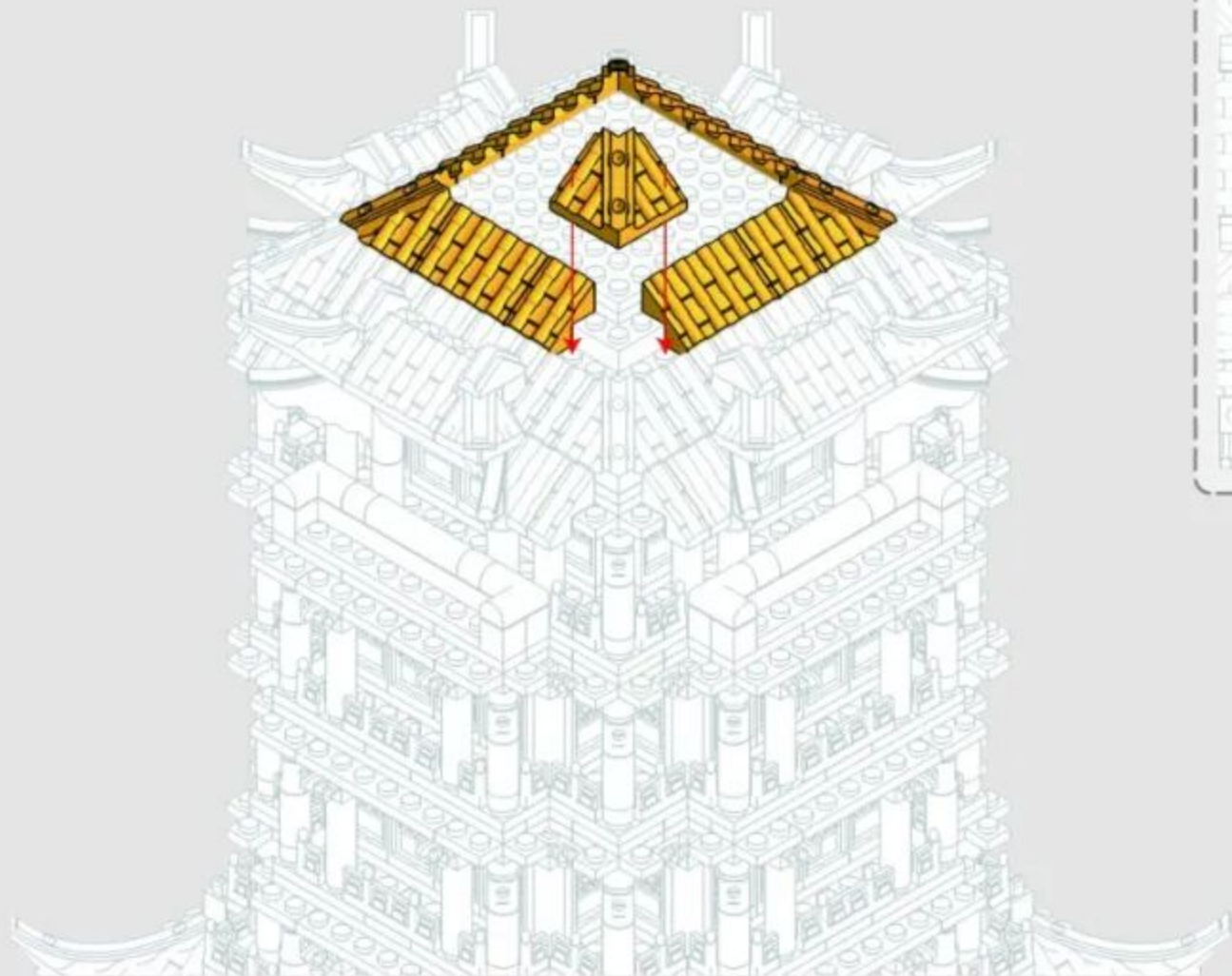

Vertical View of Installation Drawing
安装图顶面

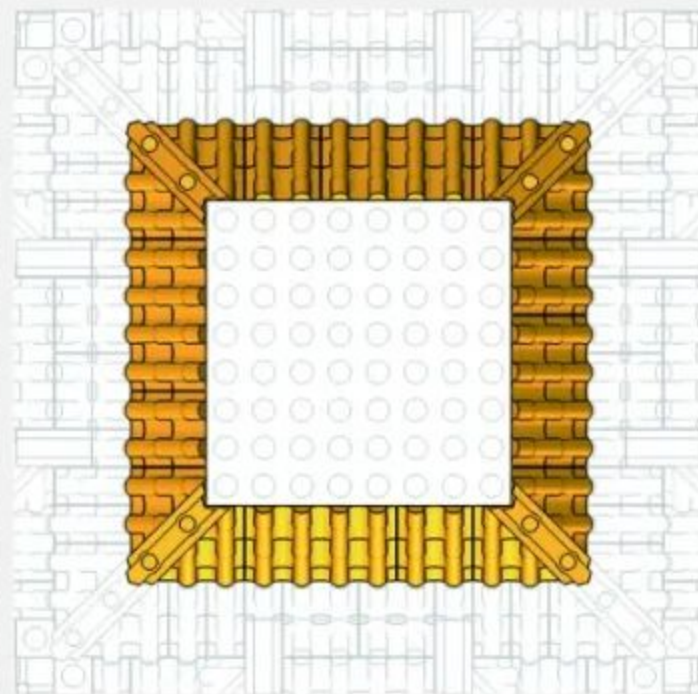

9-2

4x4



x1



x2



x1



x2



x2

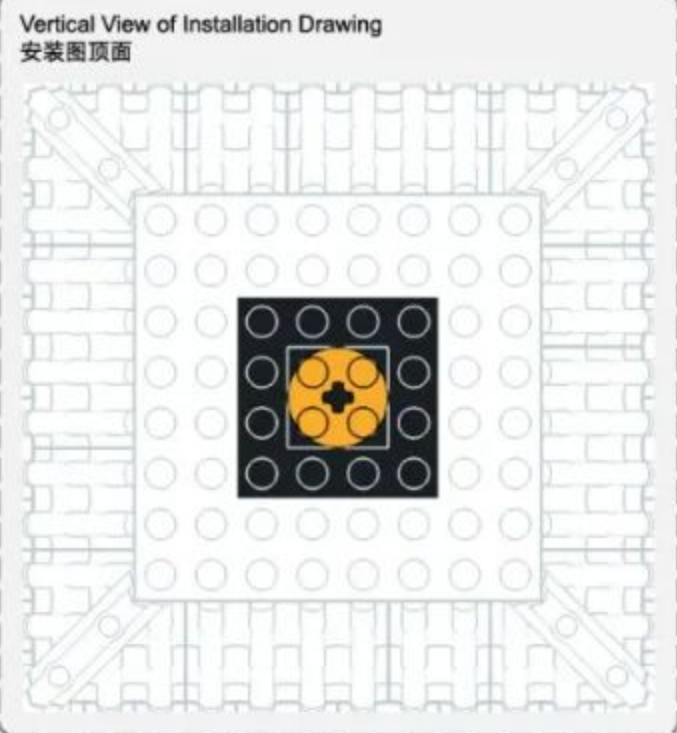
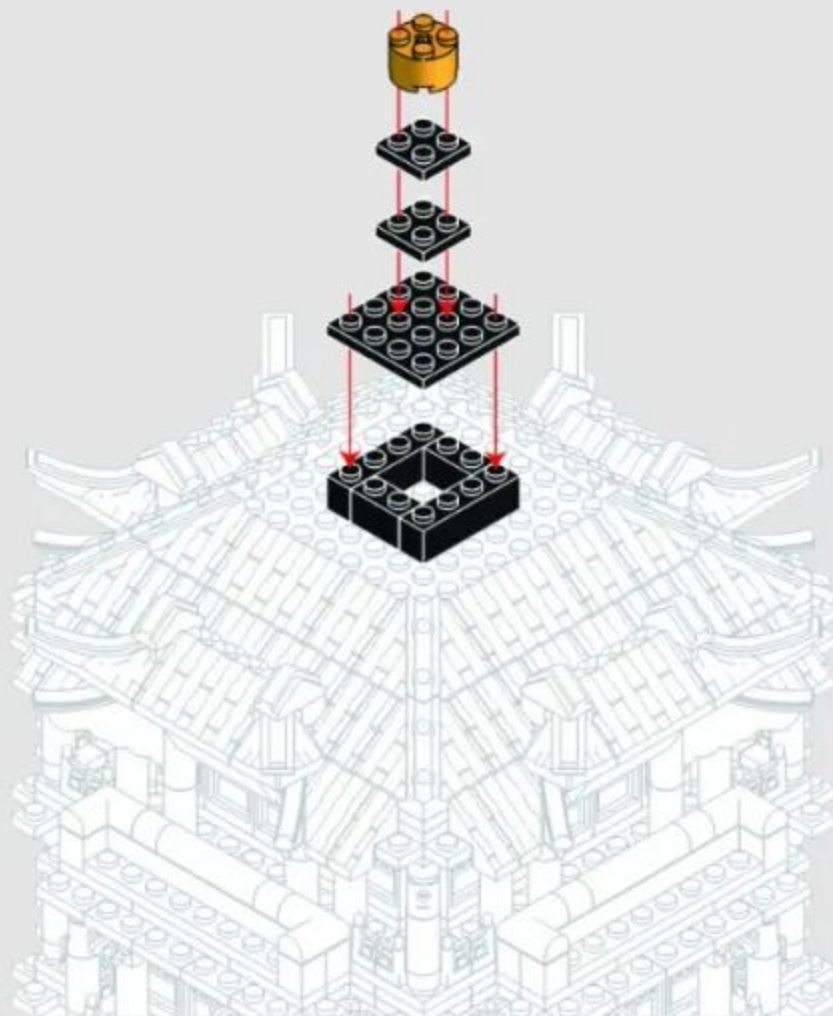

9-3

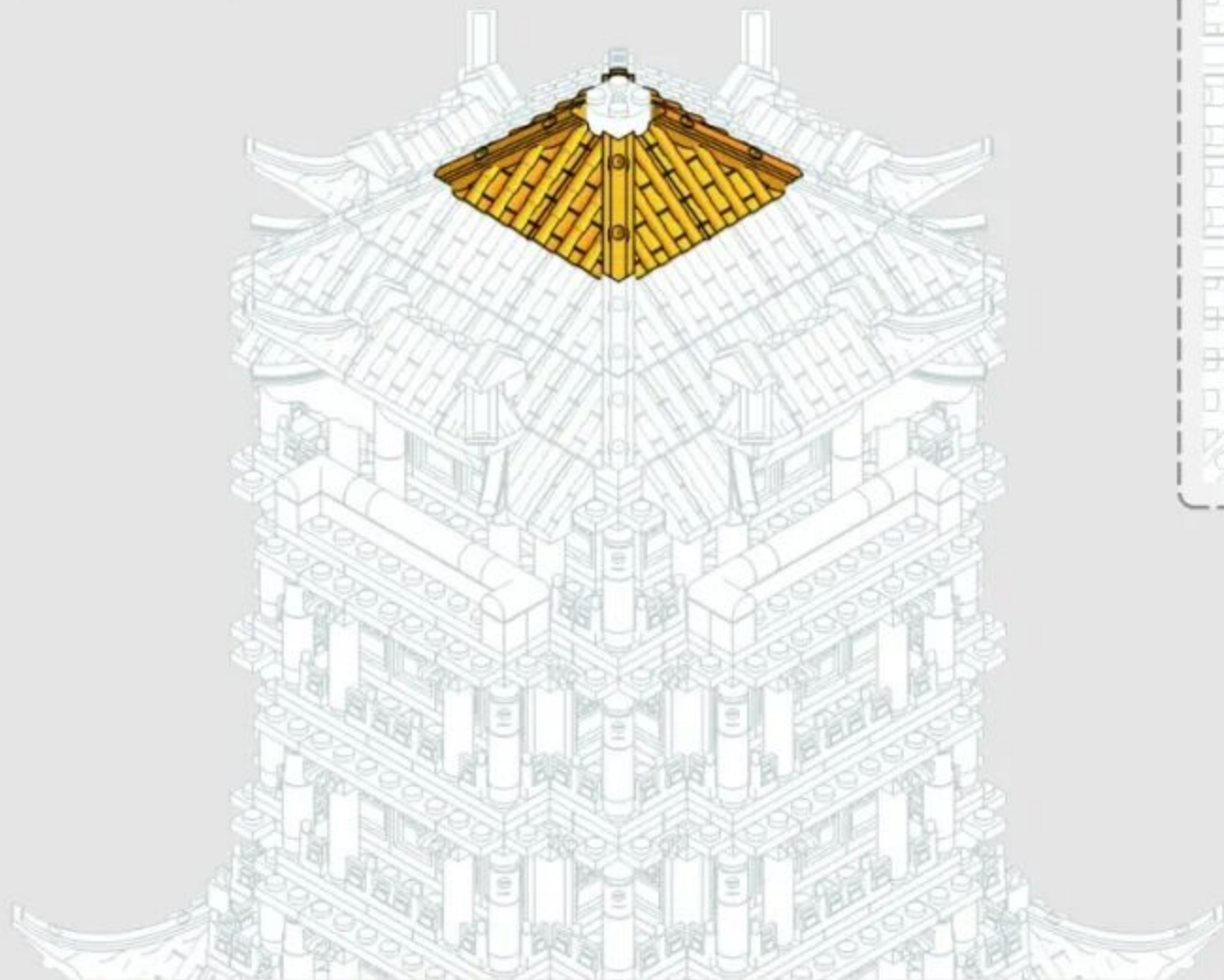

Vertical View of Installation Drawing
安装图顶面

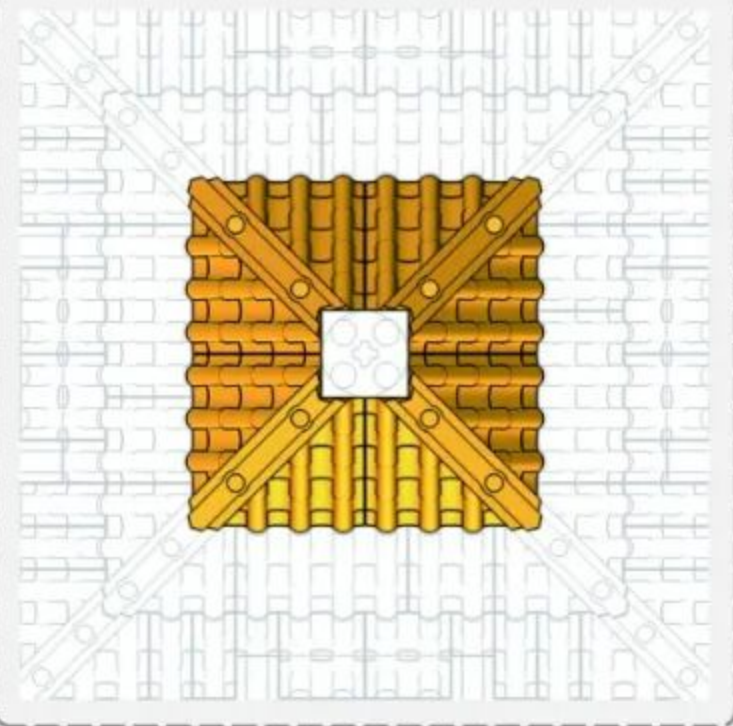

9-4

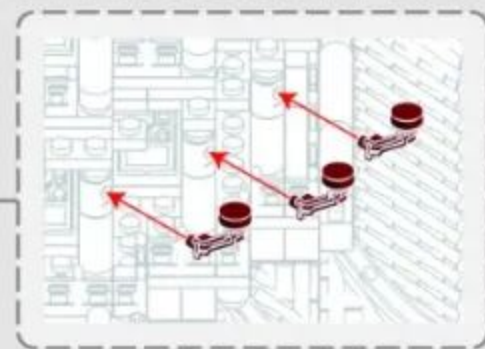
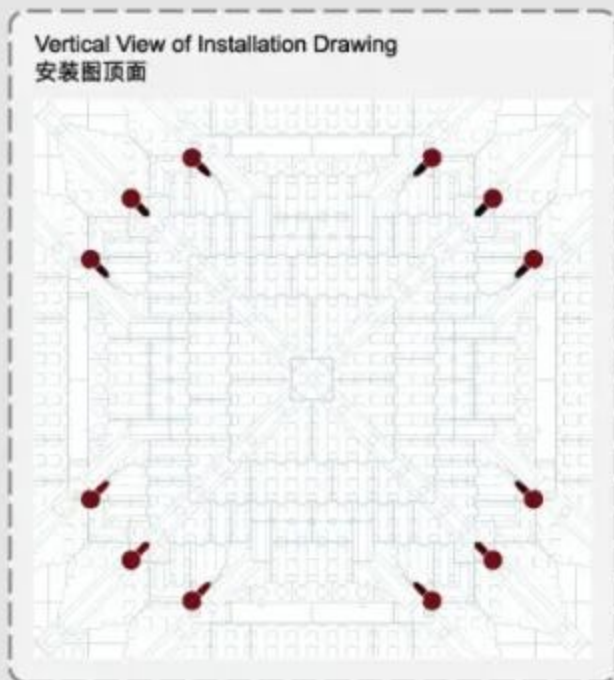
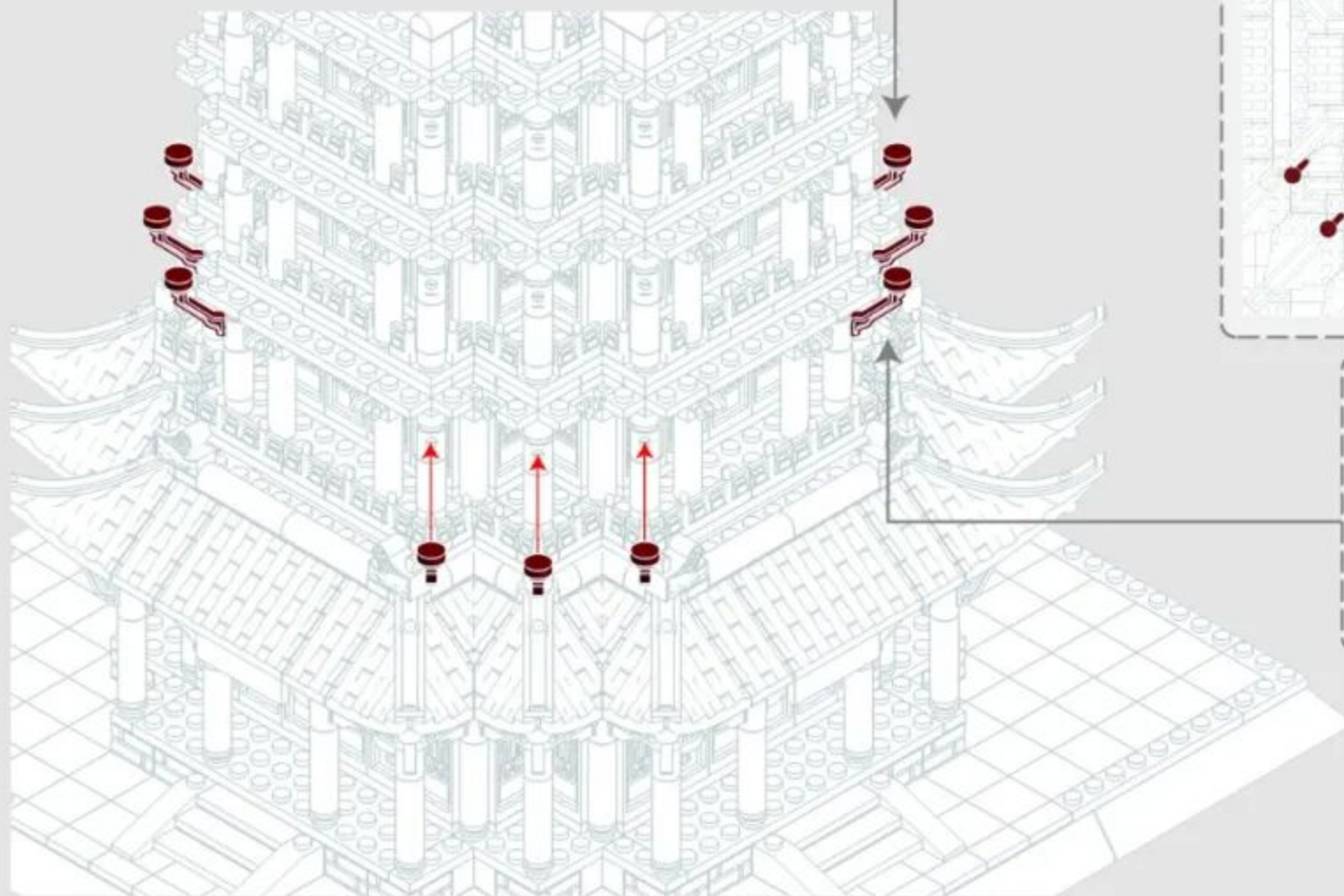

9-5

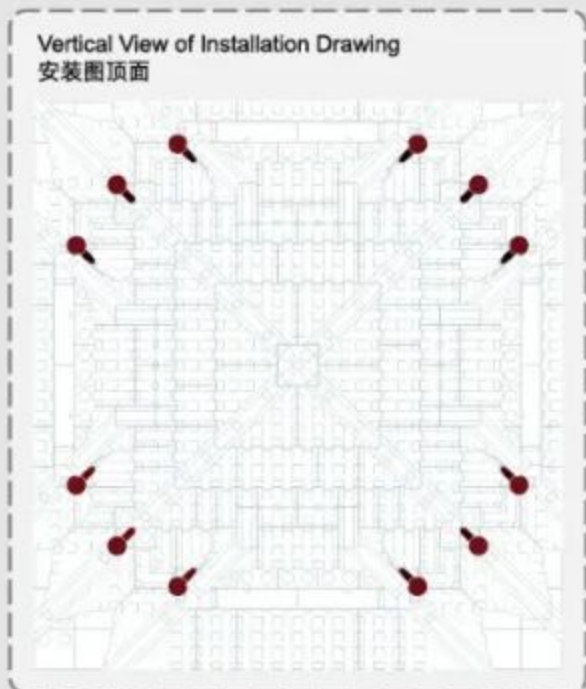
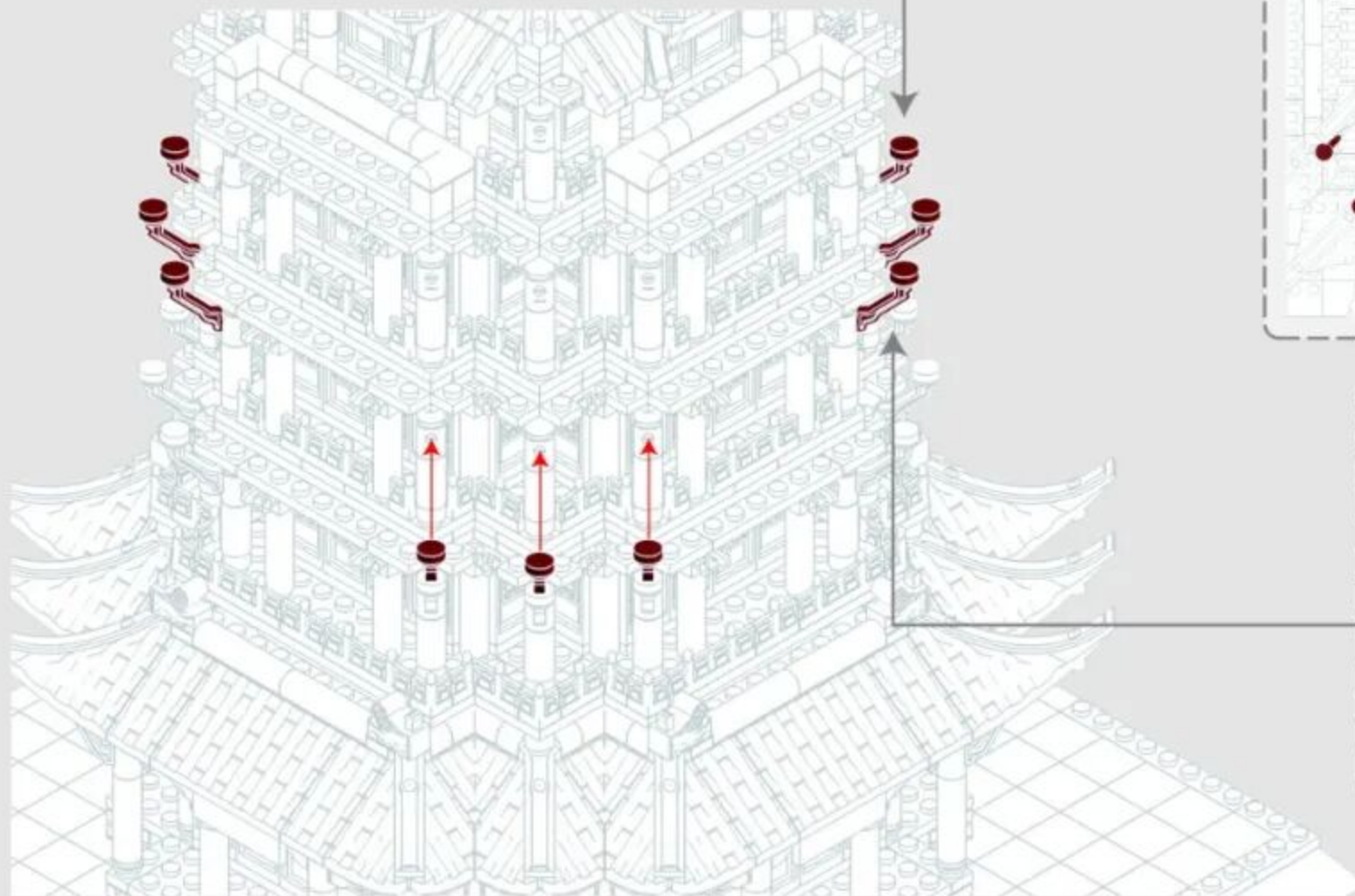

9-6

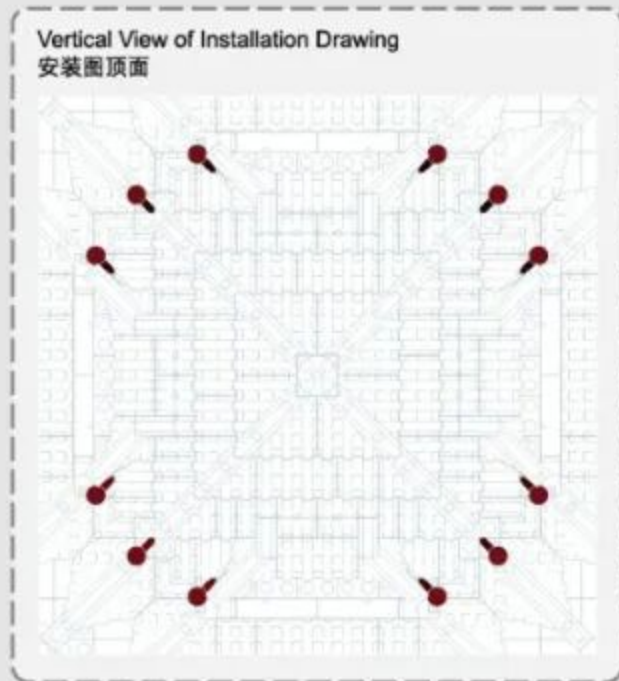
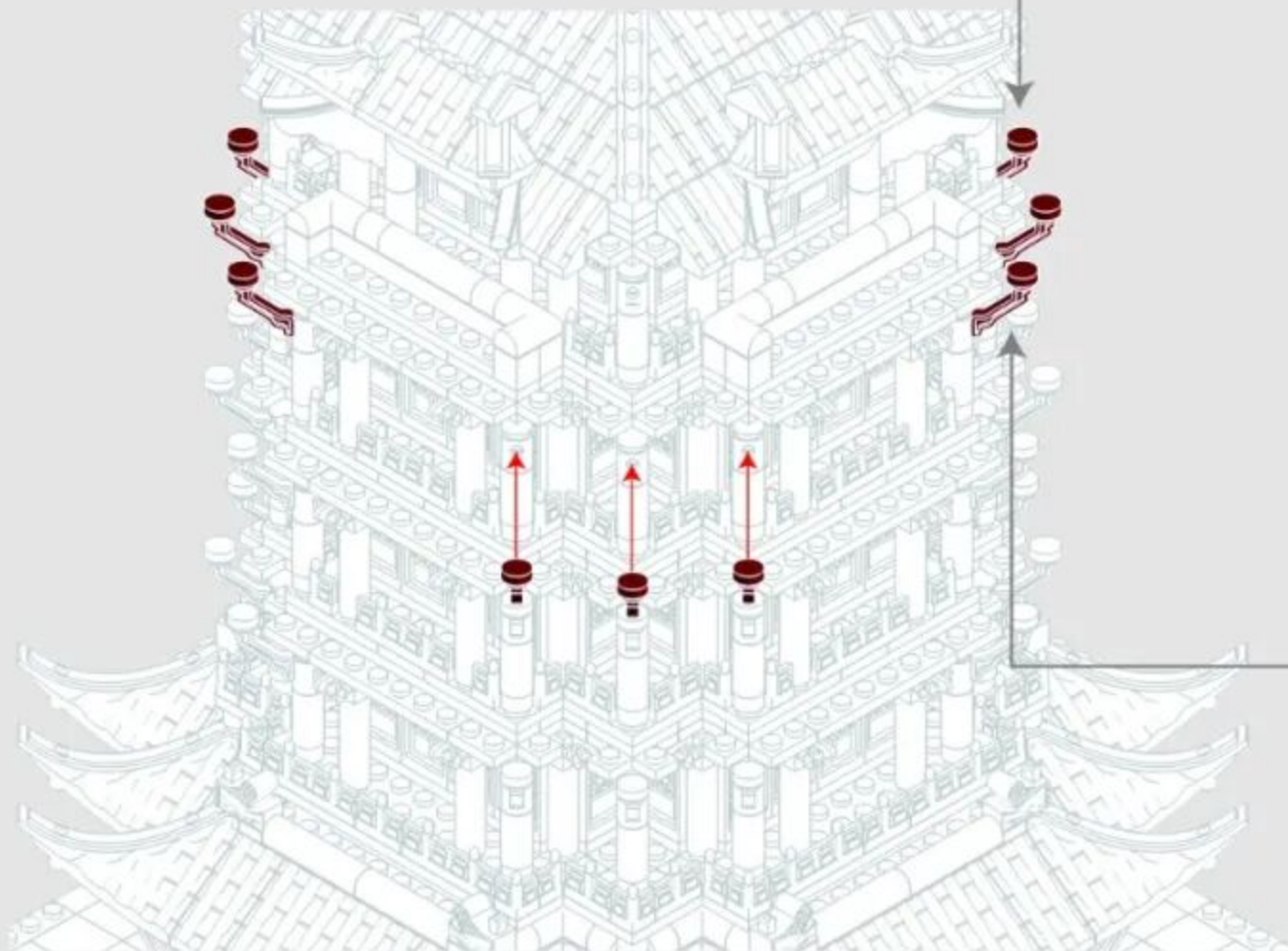

9-7

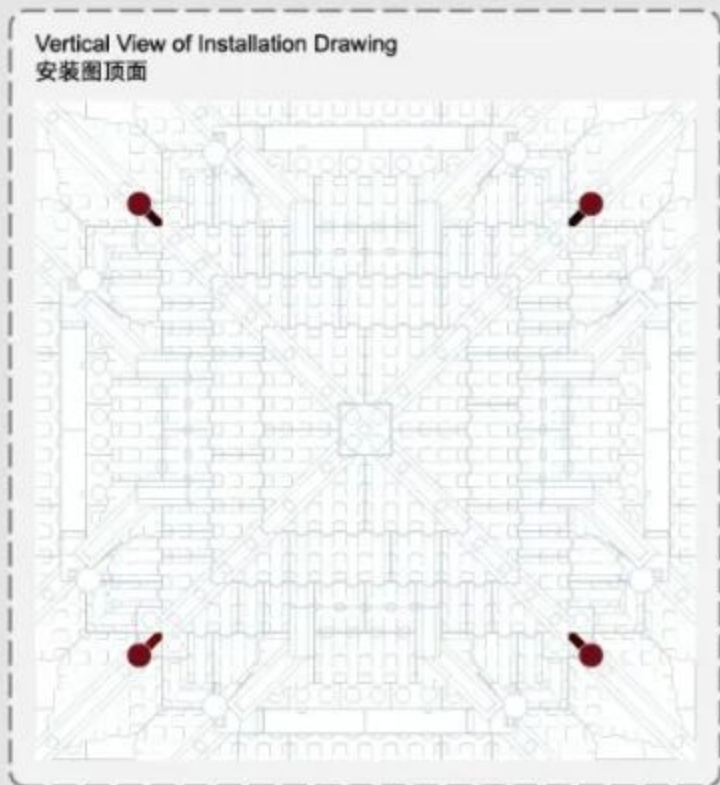
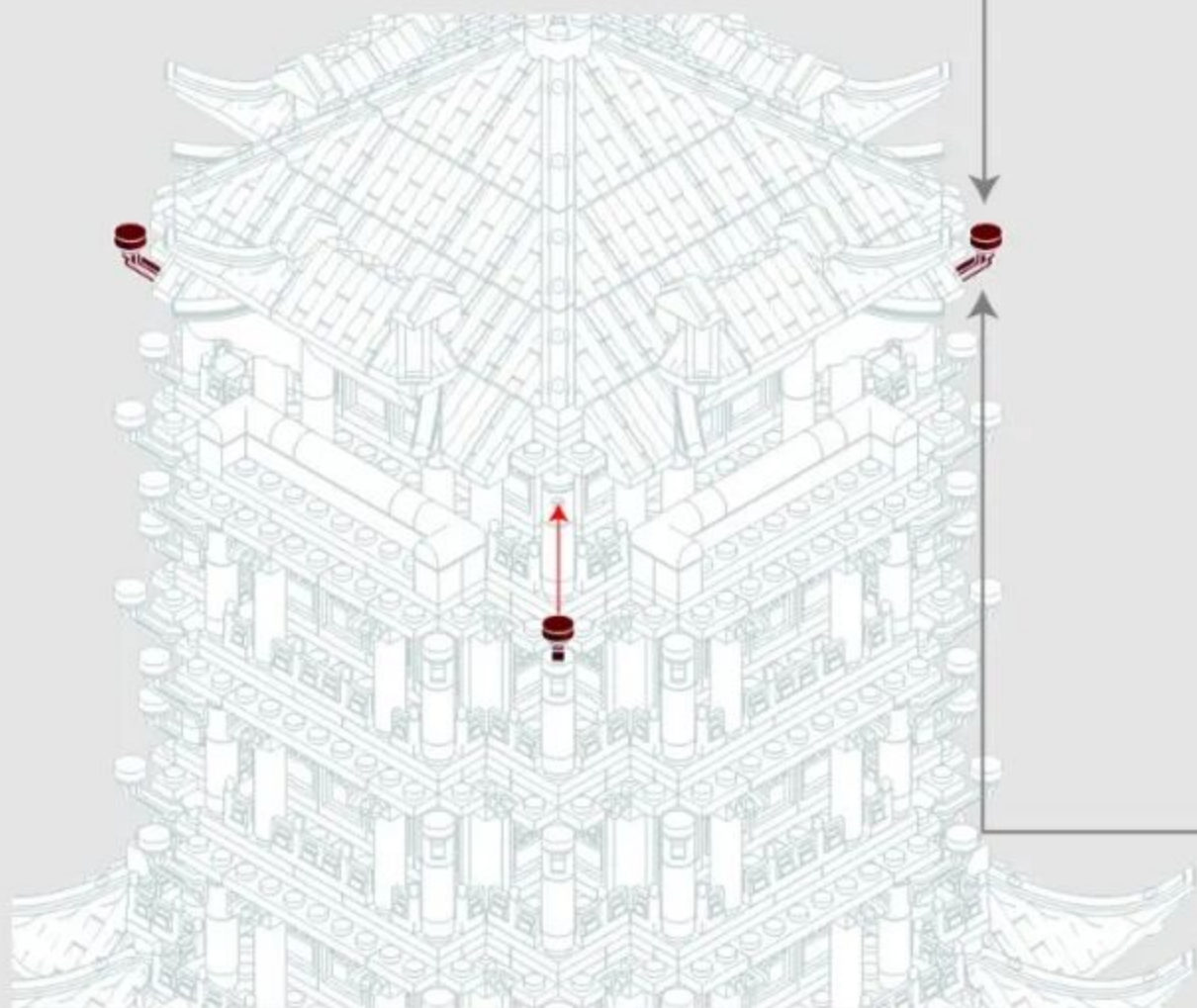

9-8



9-9

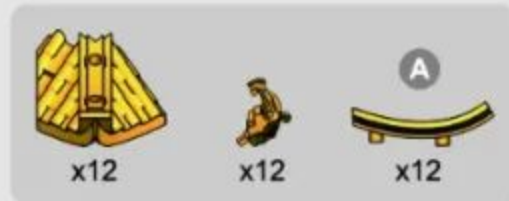

9-10



x12



x12



x12

1



x12

2



x12



9-11



9-8

9-9

9-10

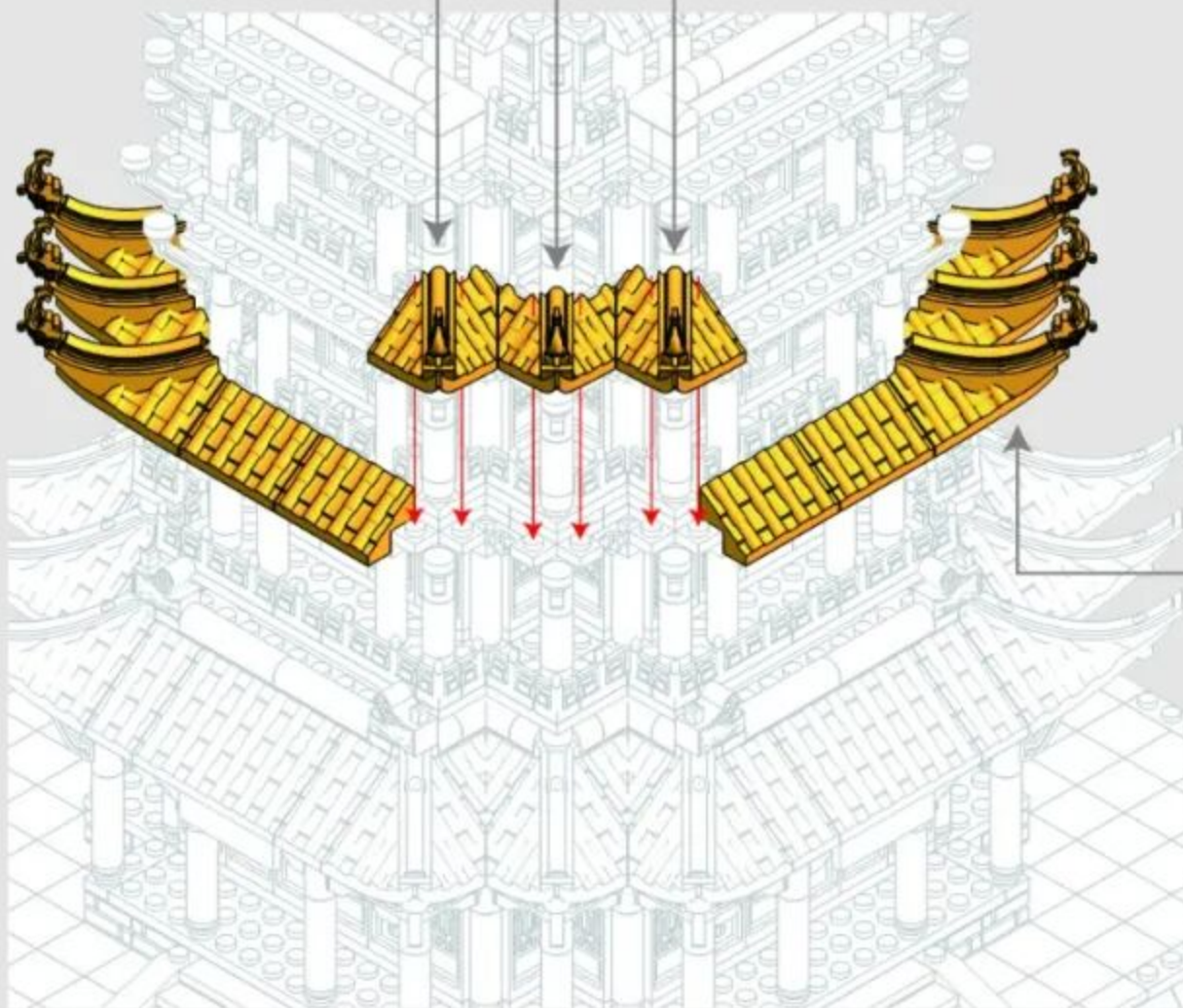

Back Side of Installation Drawing
安装图背面

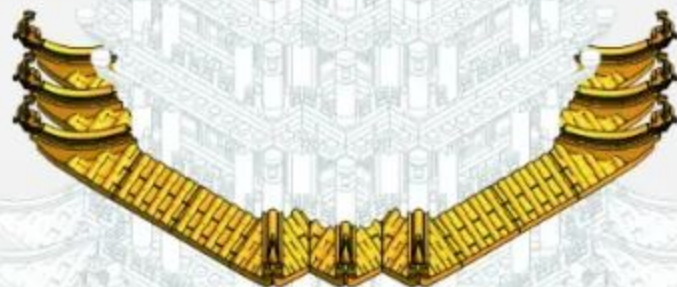

9-7

9-12



9-8

9-9

9-10

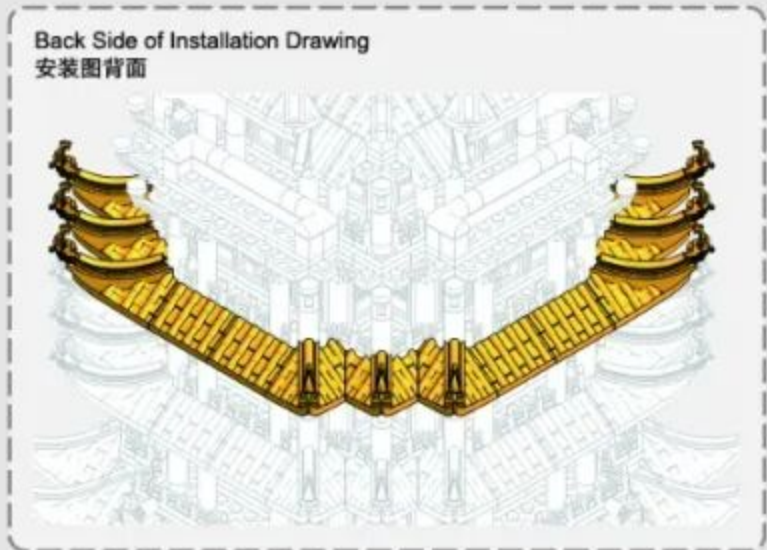
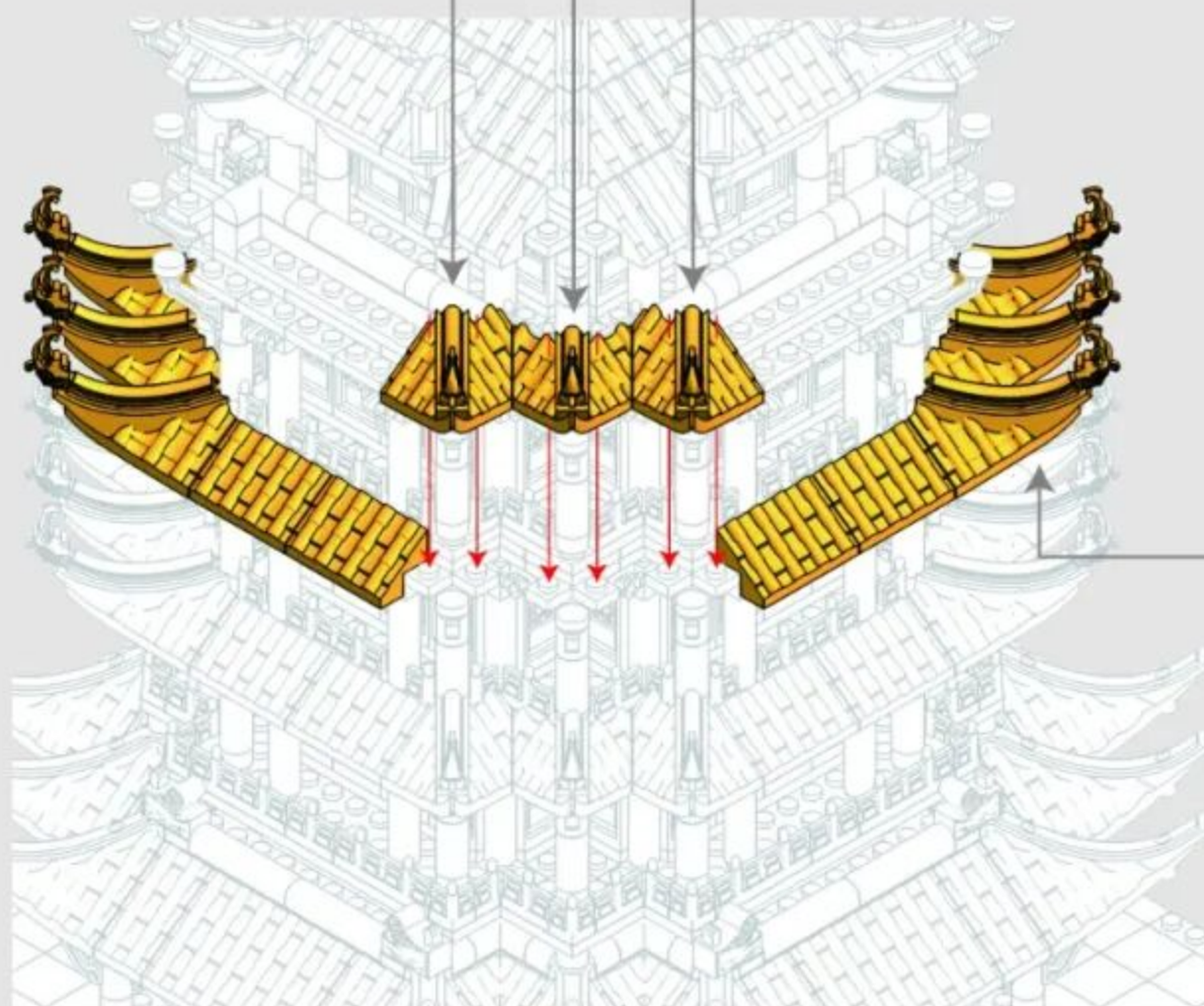

9-7

9-13

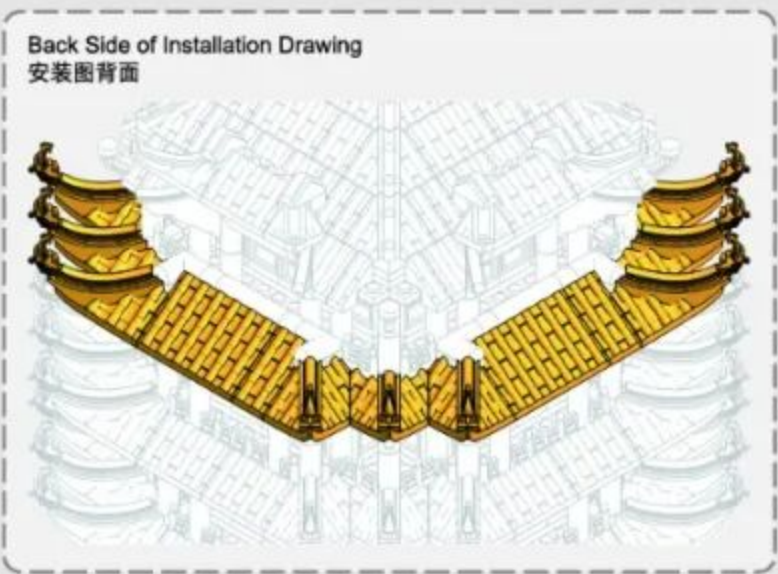
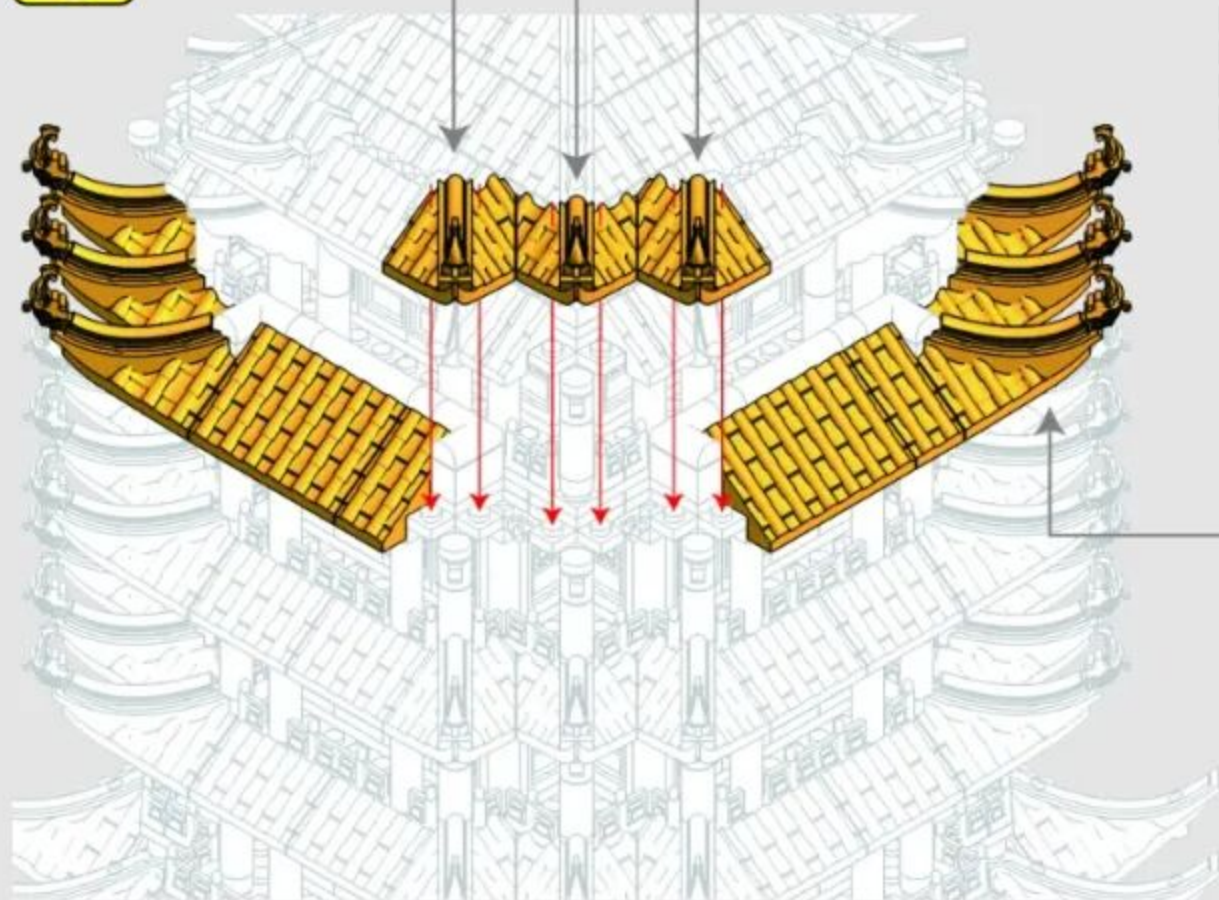
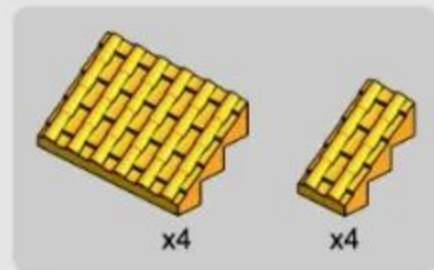

9-7

9-14

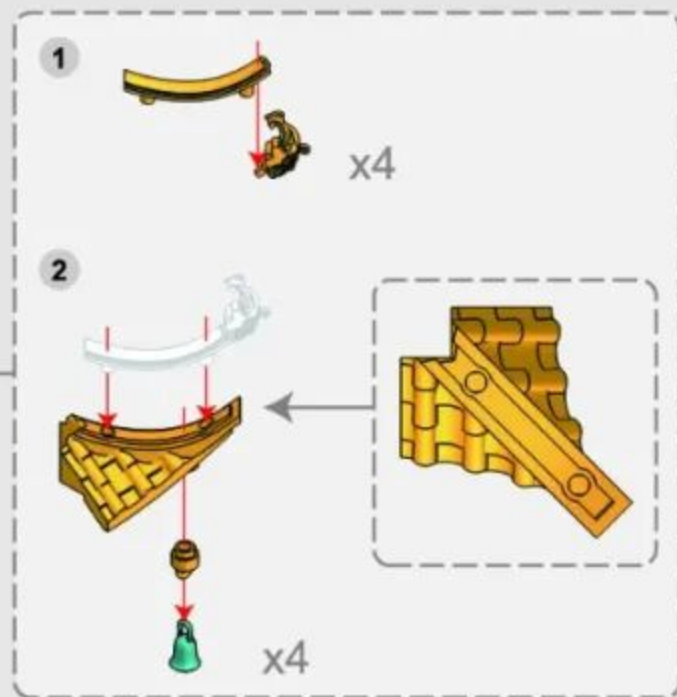
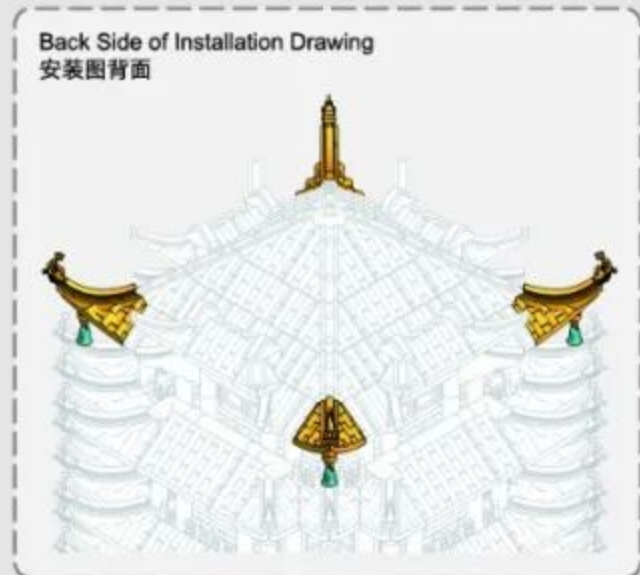
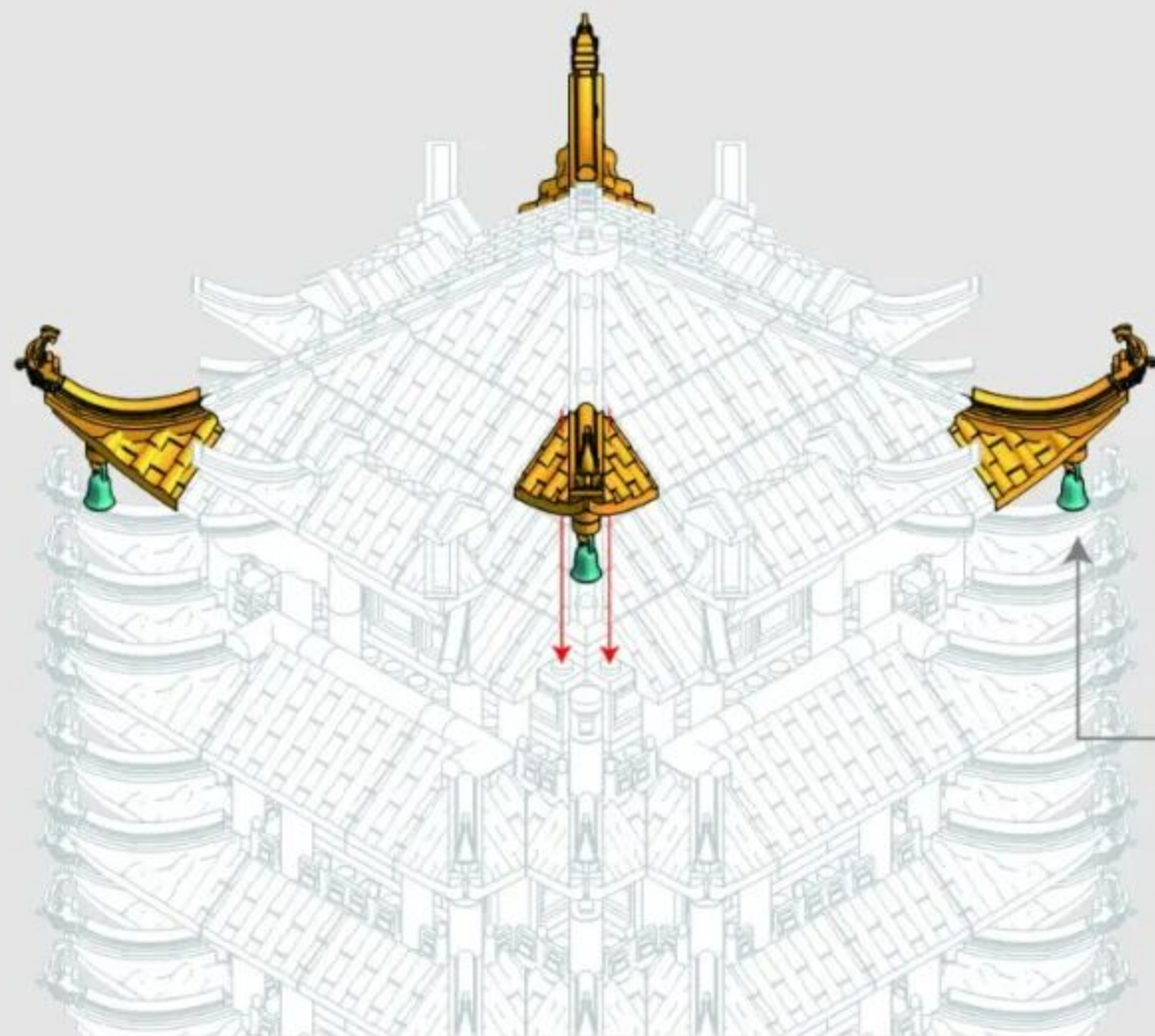
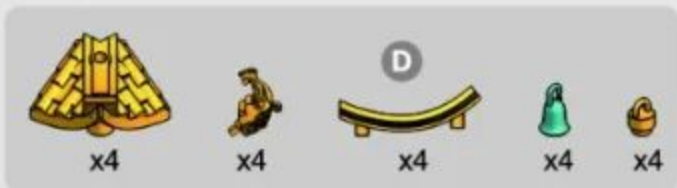

9-15

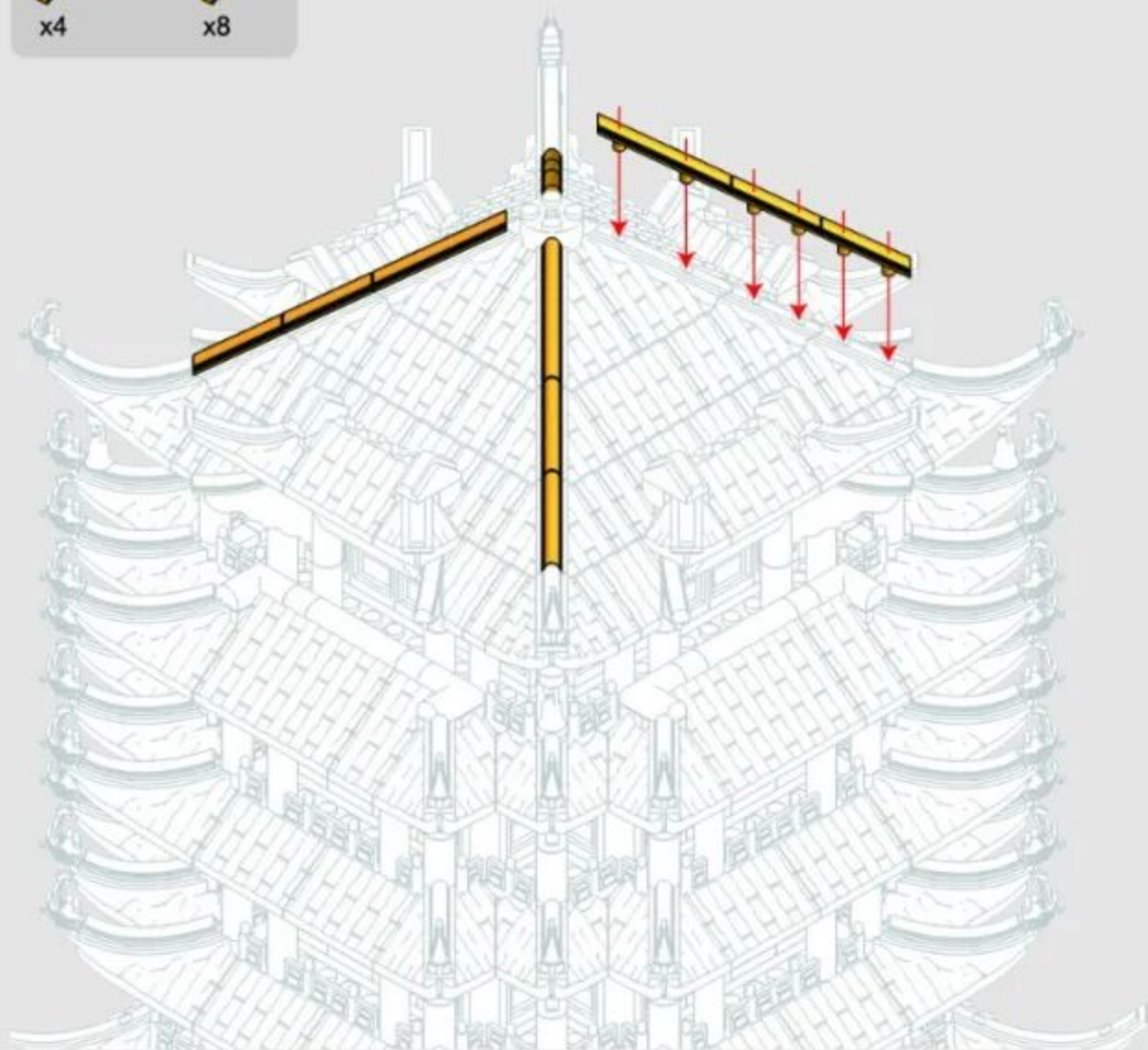
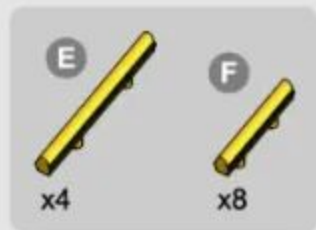

Vertical View of Installation Drawing
安装图顶面

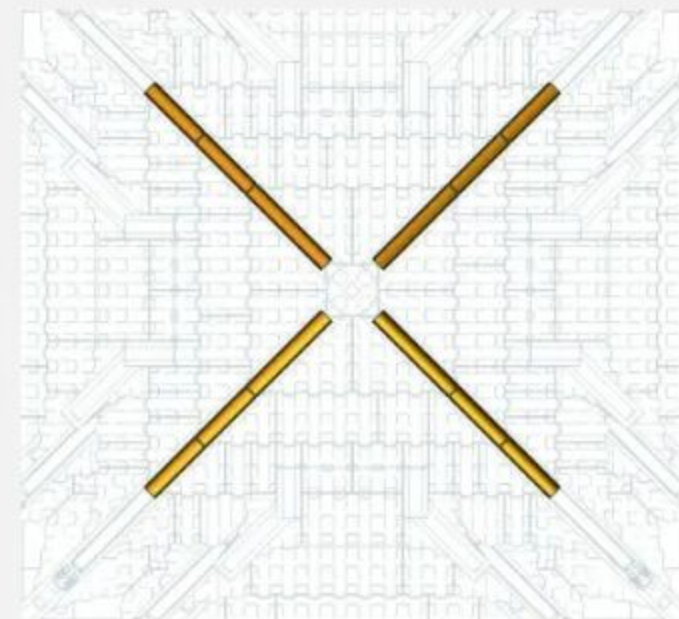

9-16



x1



x1



x1



x1



x1

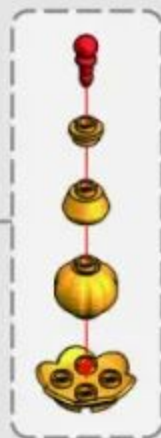
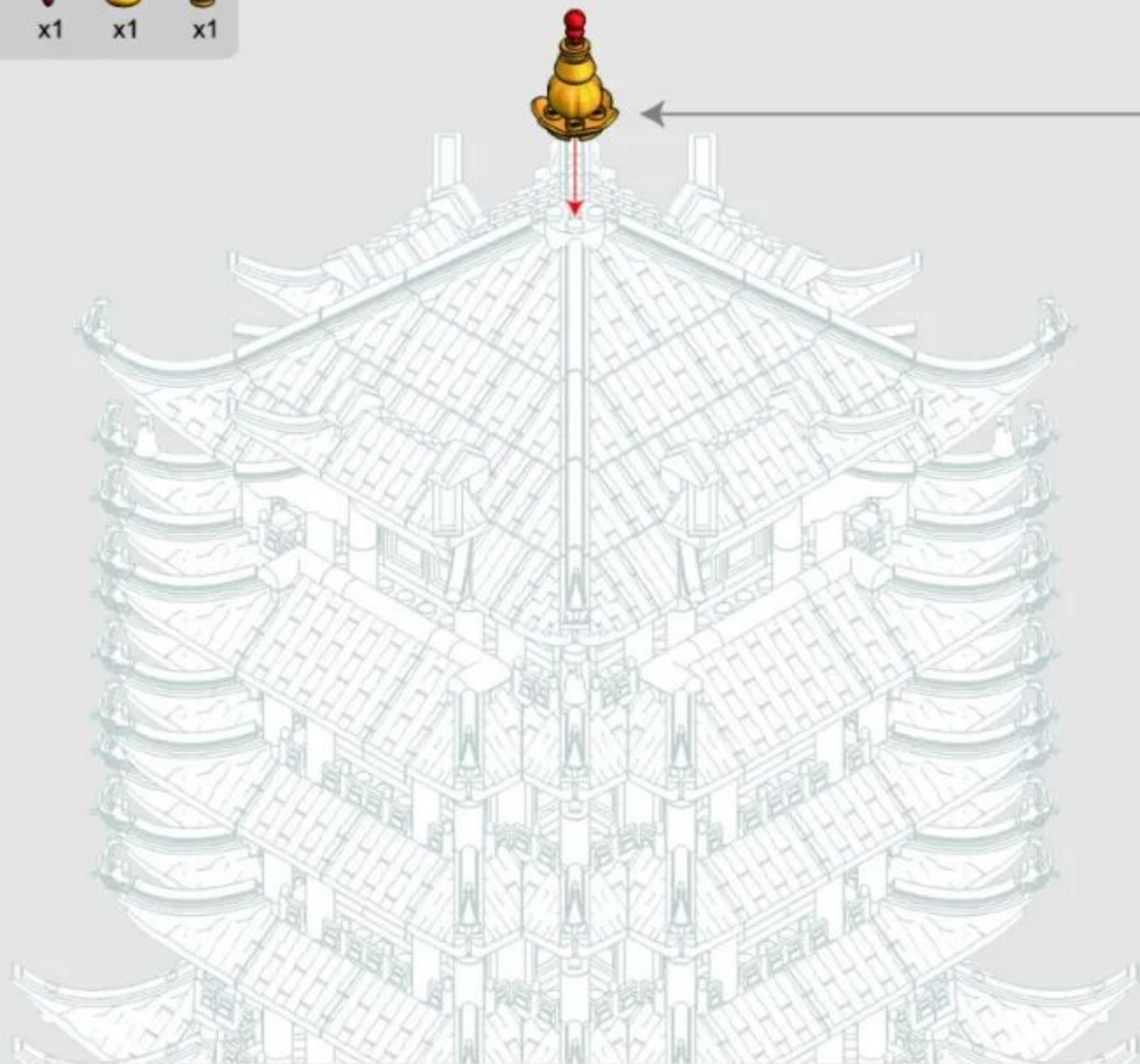

10
PACK

143PCS



144

10-1

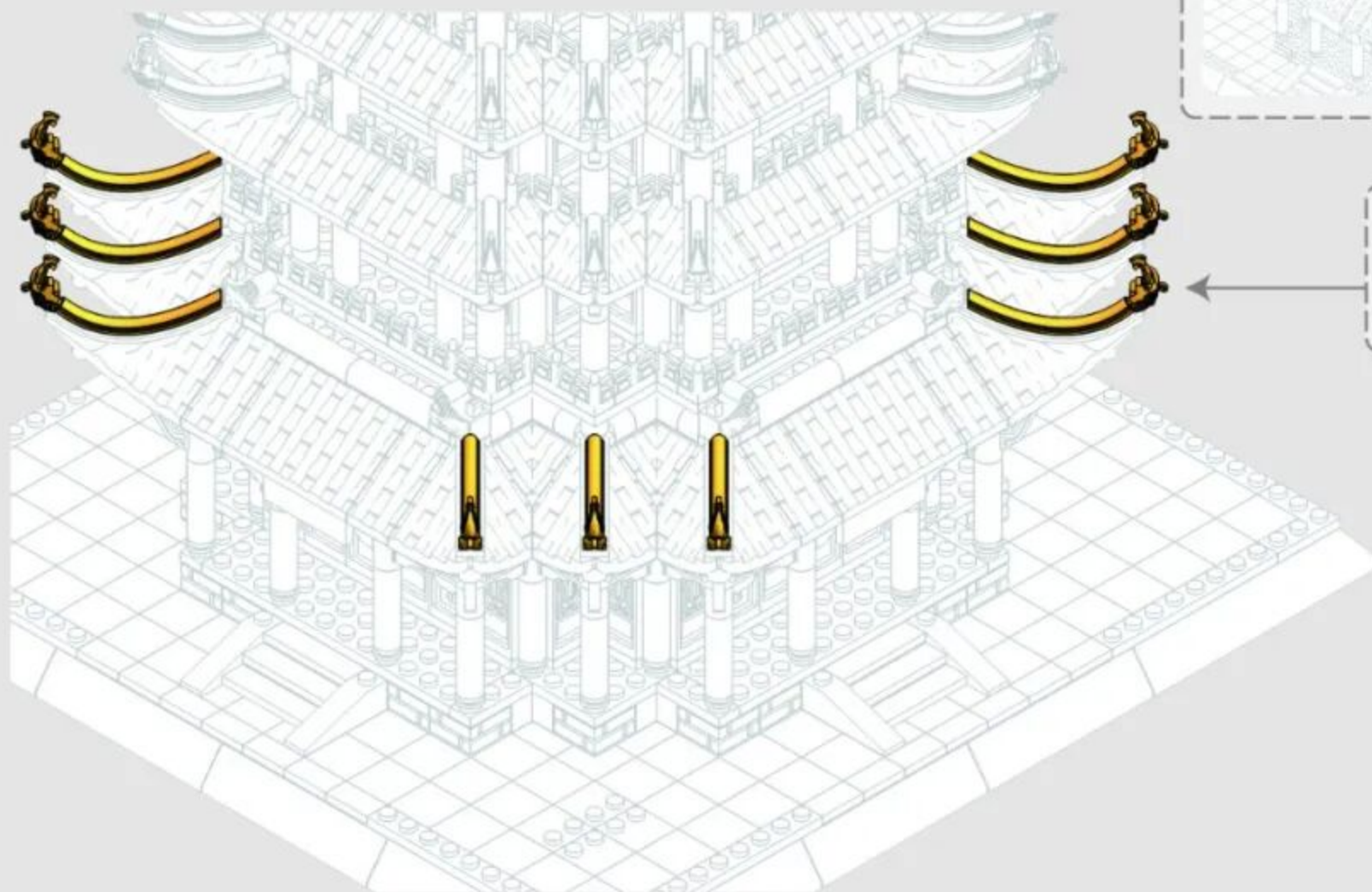

10-2



x12



x12

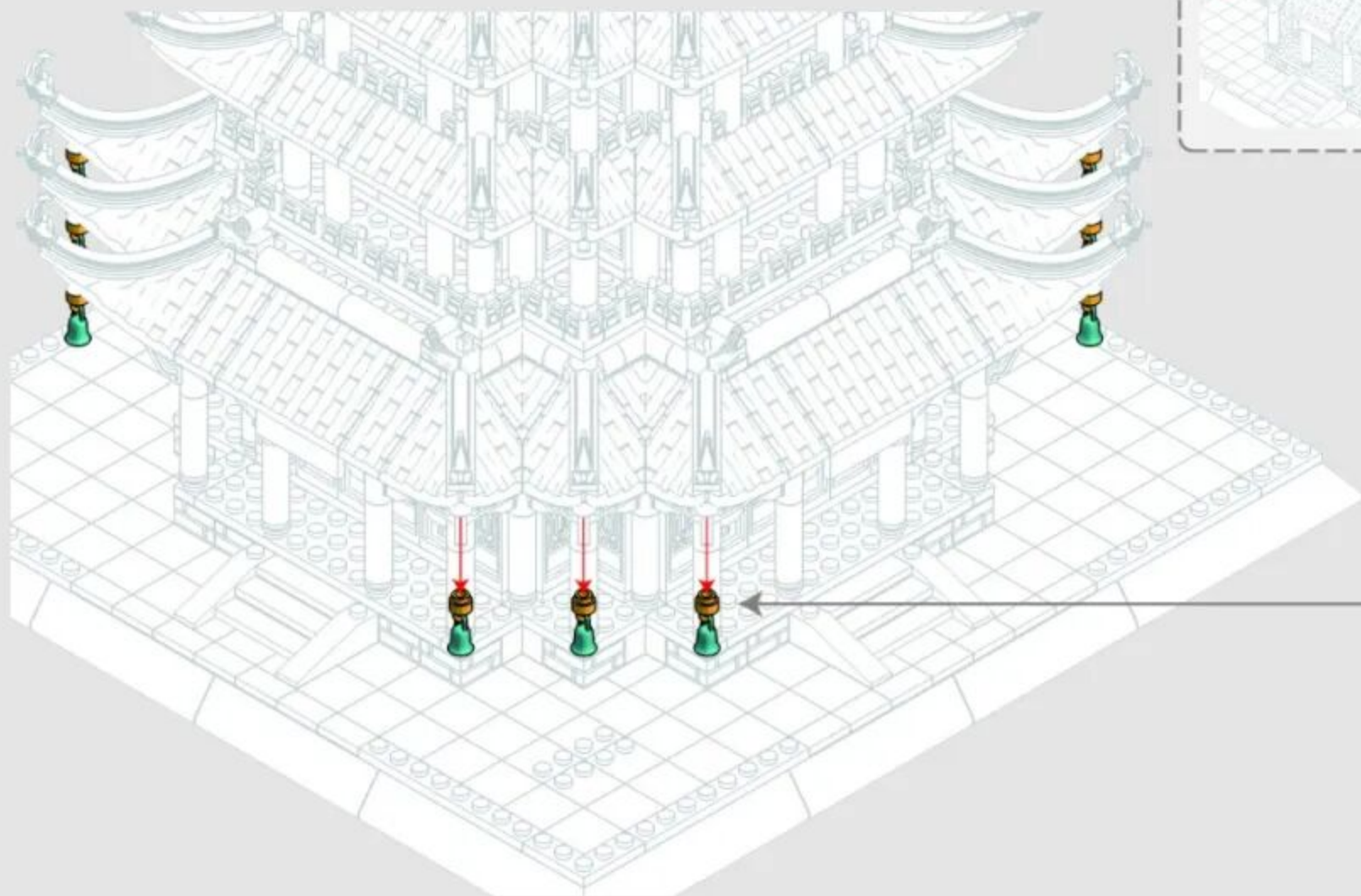

Back Side of Installation Drawing
安装图背面



x12

10-3

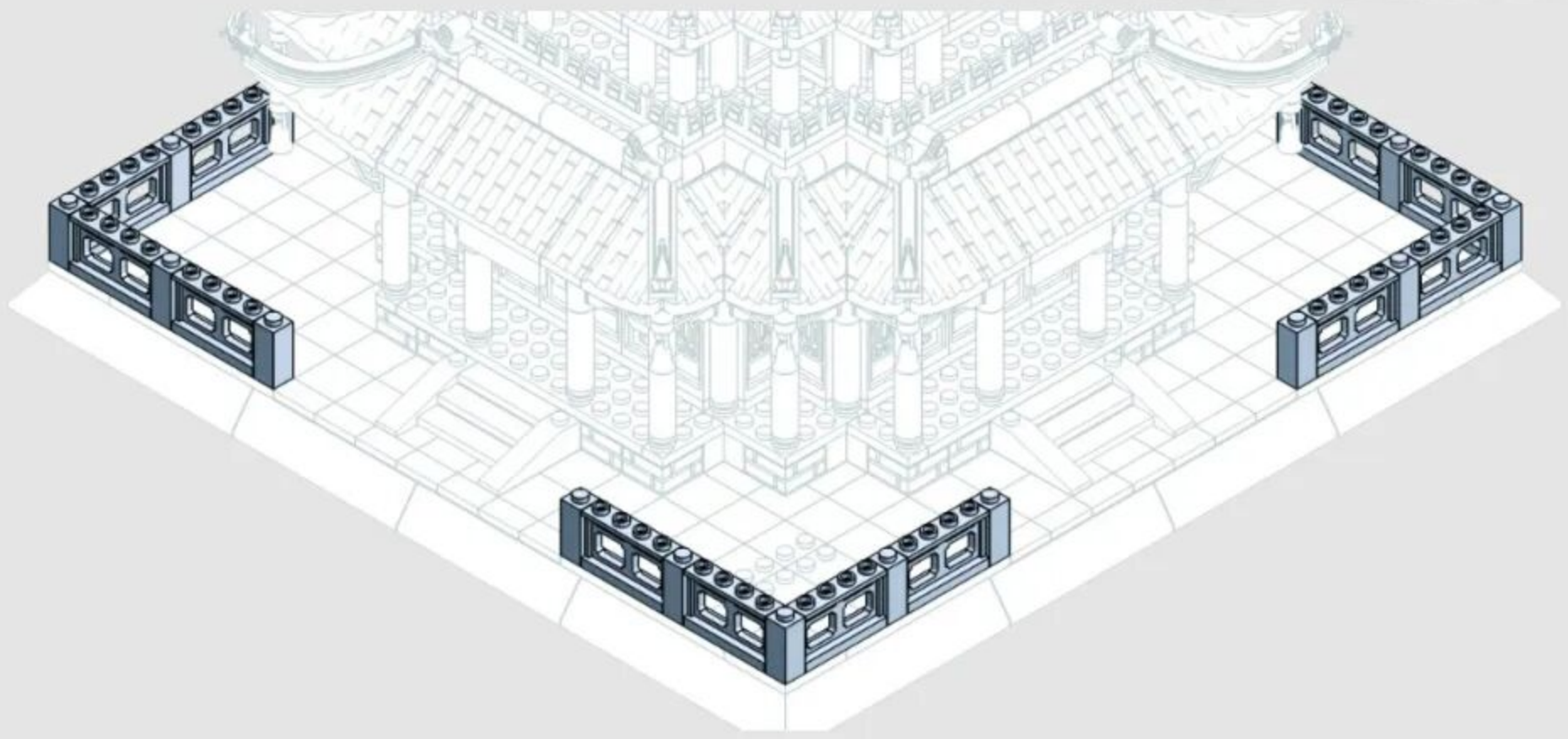
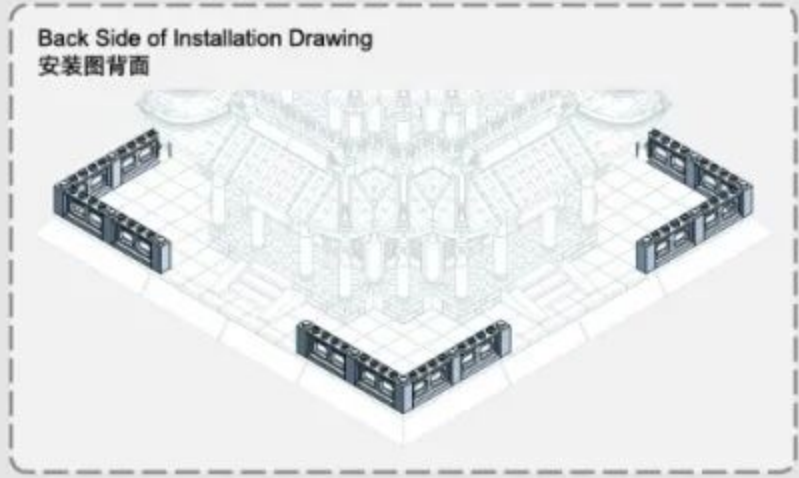

10-4

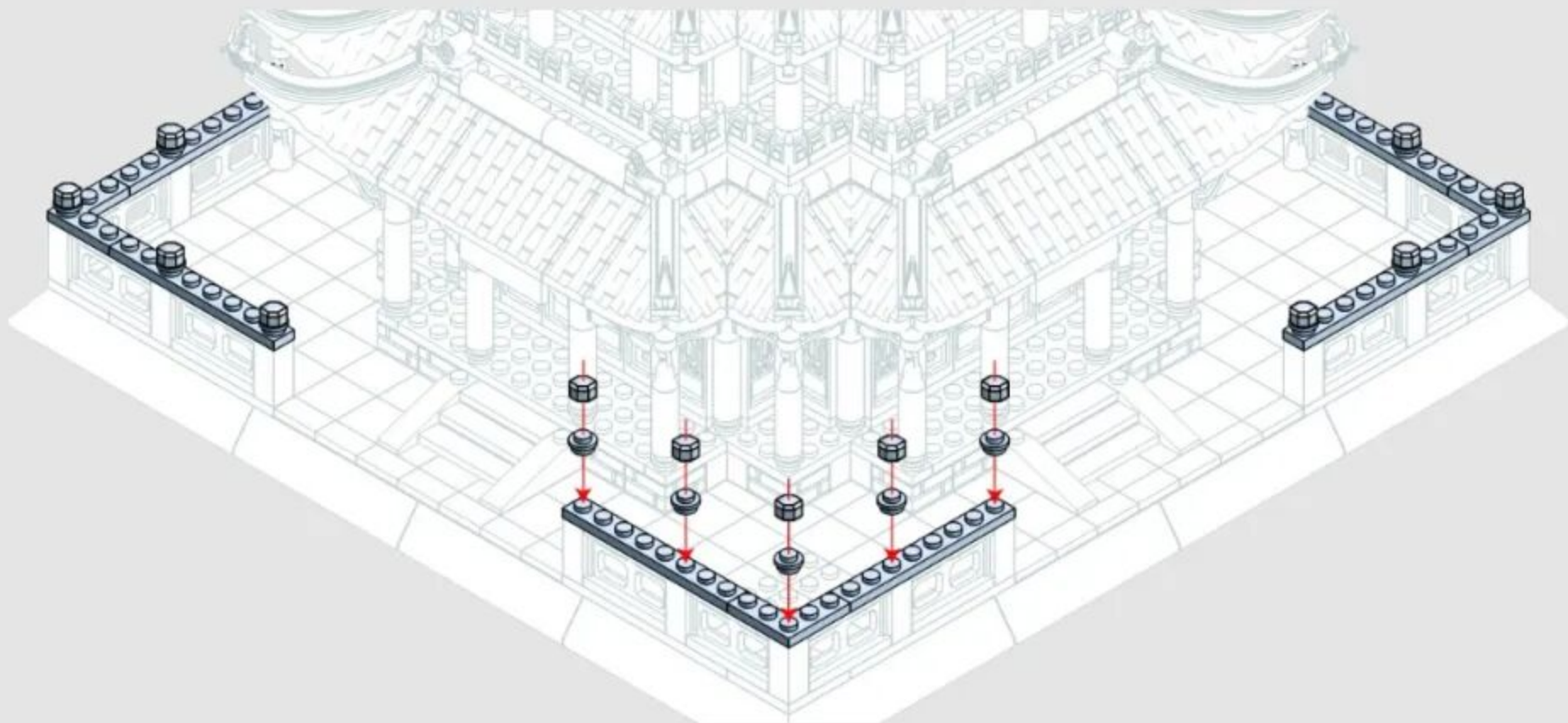
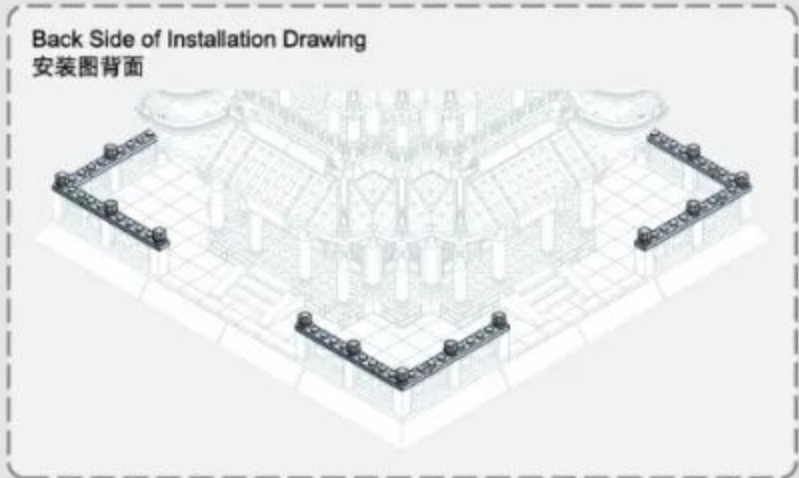
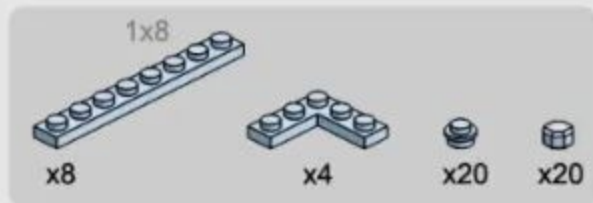

10-5

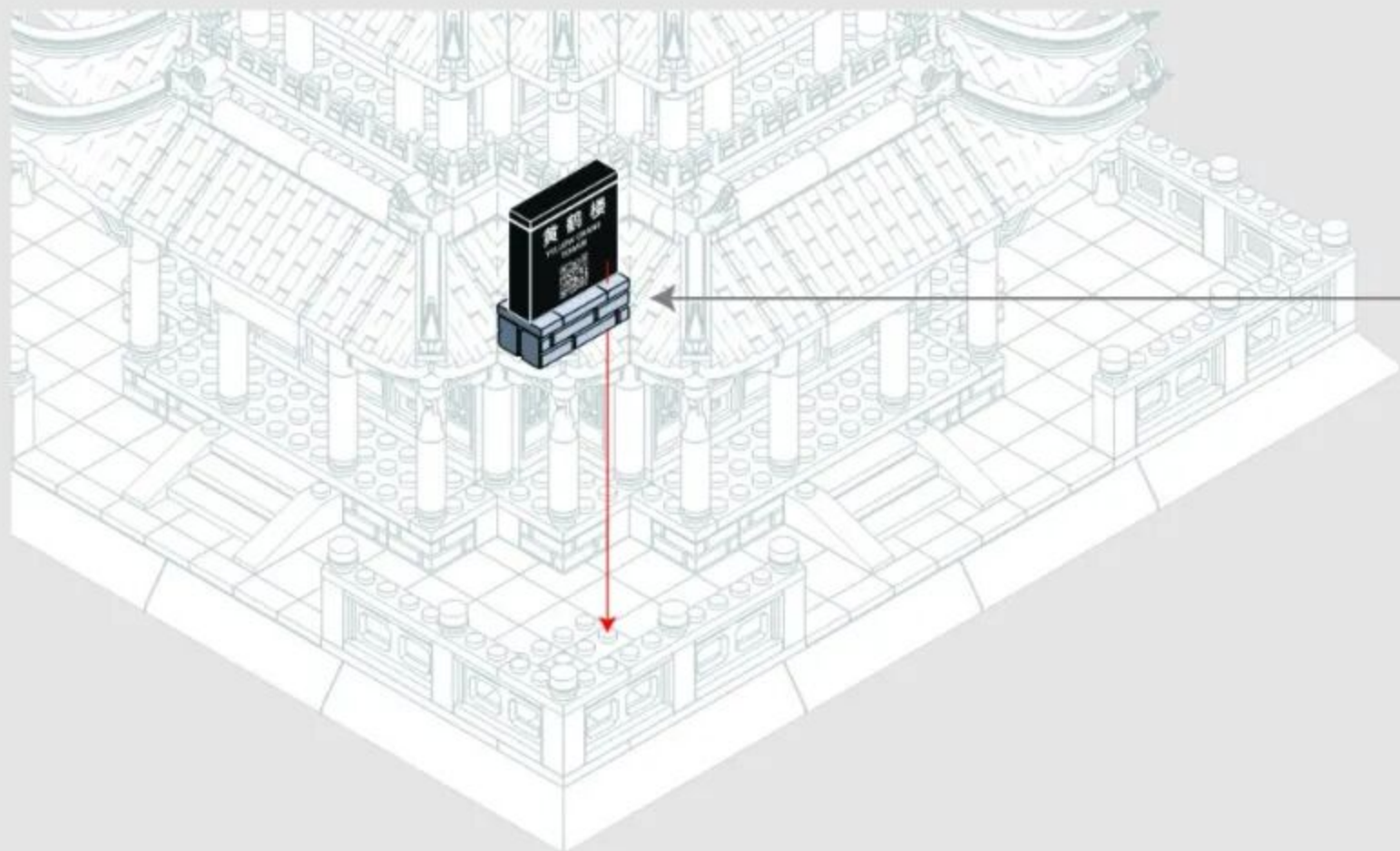

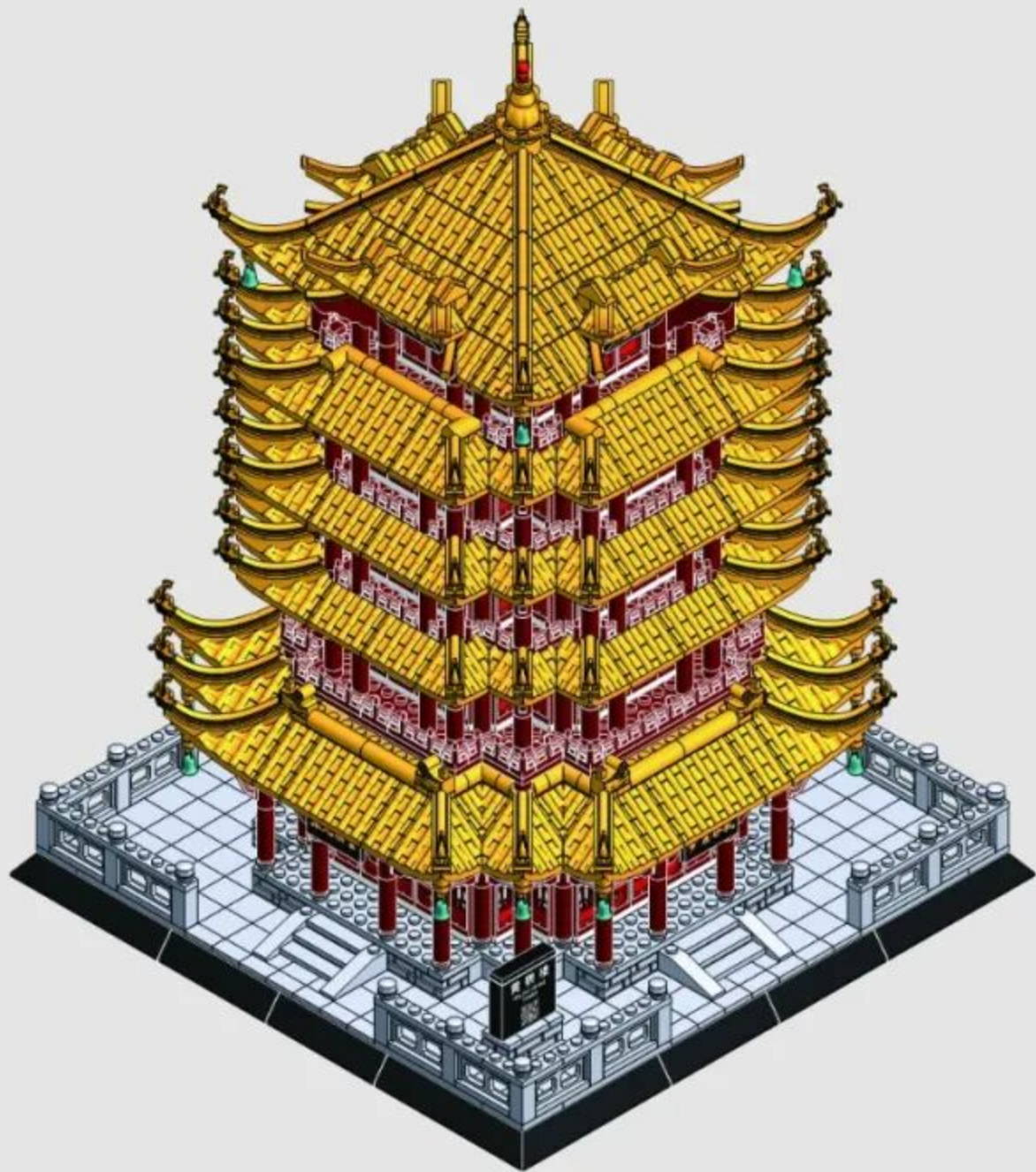

YELLOW CRANE TOWER

中国湖北武汉黄鹤楼

Wuhan, China

The world's great architecture

Construction Difficulty



INTRODUCTION

黄鹤楼，位于湖北省武汉市武昌区，地处蛇山之巅，濒临万里长江，为武汉市地标建筑；始建于三国吴黄武二年（223年），历代屡加重修，现存建筑以清代“同治楼”为原型设计，重建于1985年；因唐代诗人崔颢登楼所题《黄鹤楼》一诗而名扬四海。自古有“天下绝景”之美誉，与晴川阁、古琴台并称为“武汉三大名胜”，与湖南岳阳岳阳楼、江西南昌滕王阁并称为“江南三大名楼”，是“武汉十大景”之首、中国古代四大名楼之一、“中国十大历史文化名楼”之一，世称“天下江山第一楼”。

Yellow Crane Tower is a traditional Chinese tower located in Wuhan. The current structure was built in 1981, but the tower has existed in various forms from as early as AD 223. The current Yellow Crane Tower is 51.4 m (169 ft) high and covers an area of 3,219 m² (34,650 sq ft). It is situated on Snake Hill, one kilometer away from the original site, on the banks of the Yangtze River in Wuchang District. The Yuanhe Maps and Records of Prefectures and Counties, written almost 600 years after the construction of the tower, notes that after Sun Quan, founder of the kingdom of Eastern Wu, built the fort of Xiakou in 223, a tower was constructed at/on the Yellow Crane Jetty, west of Xiakou, and hence its name. The tower has been destroyed twelve times, both by warfare and by fire, in the Ming and Qing dynasties and was repaired on ten separate occasions. The last tower at the original site was built in 1868 and destroyed in 1884. In 1907, a new tower was built near the site of the Yellow Crane Tower. Zhang Zhidong proposed 'Aoliao Hall' as the name for this tower and wrote an antithetical couplet for it. In 1957, the Wuhan Yangtze River Bridge was built with one trestle of the bridge on the Yellow Crane Tower's site. In 1981, the Wuhan City Government commenced reconstruction of the tower at a new location, about 1 km (0.62 mi) from the original site, and it was completed in 1985. On January 31, 2018, Theresa May, Prime Minister of the United Kingdom, visited Wuhan and took pictures at the Yellow Crane Tower.