



CHENGQI EARTH BUILDING

中国福建土楼(承启楼)

Fujian, China

The world's great architecture



6+ / 8211 / 3317 PCS
Suitable Age Product Number Parts Total

CHENGQI EARTH BUILDING

COUNTRY: China

CITY: Longyan





Architecture

It will be a city...

这将构成一座城市...

ABOUT THE PRODUCT

关于产品

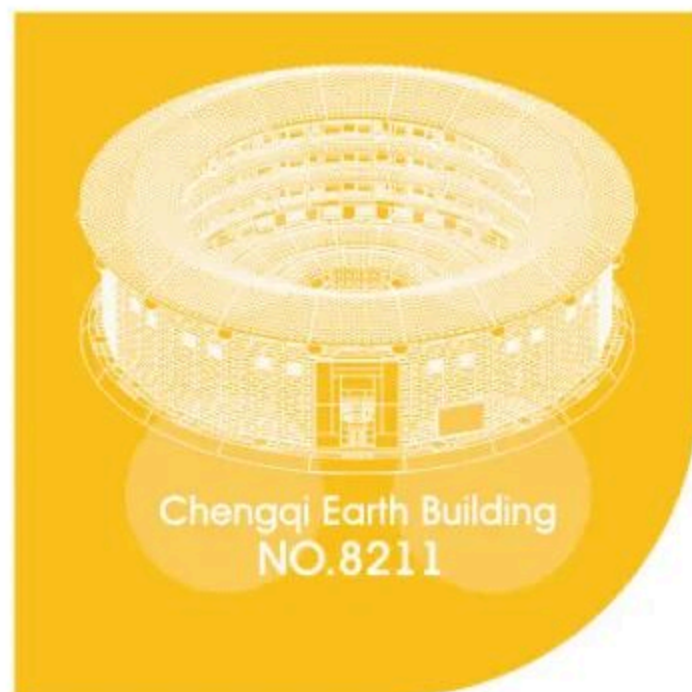
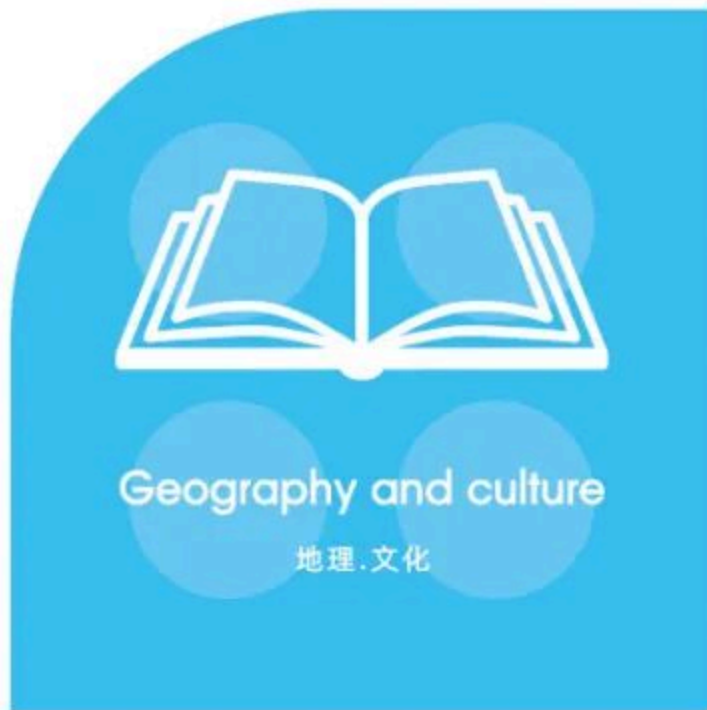

ARCHITECTURE

WANGE The world's great architect since 1991

Chengqi Earth Building

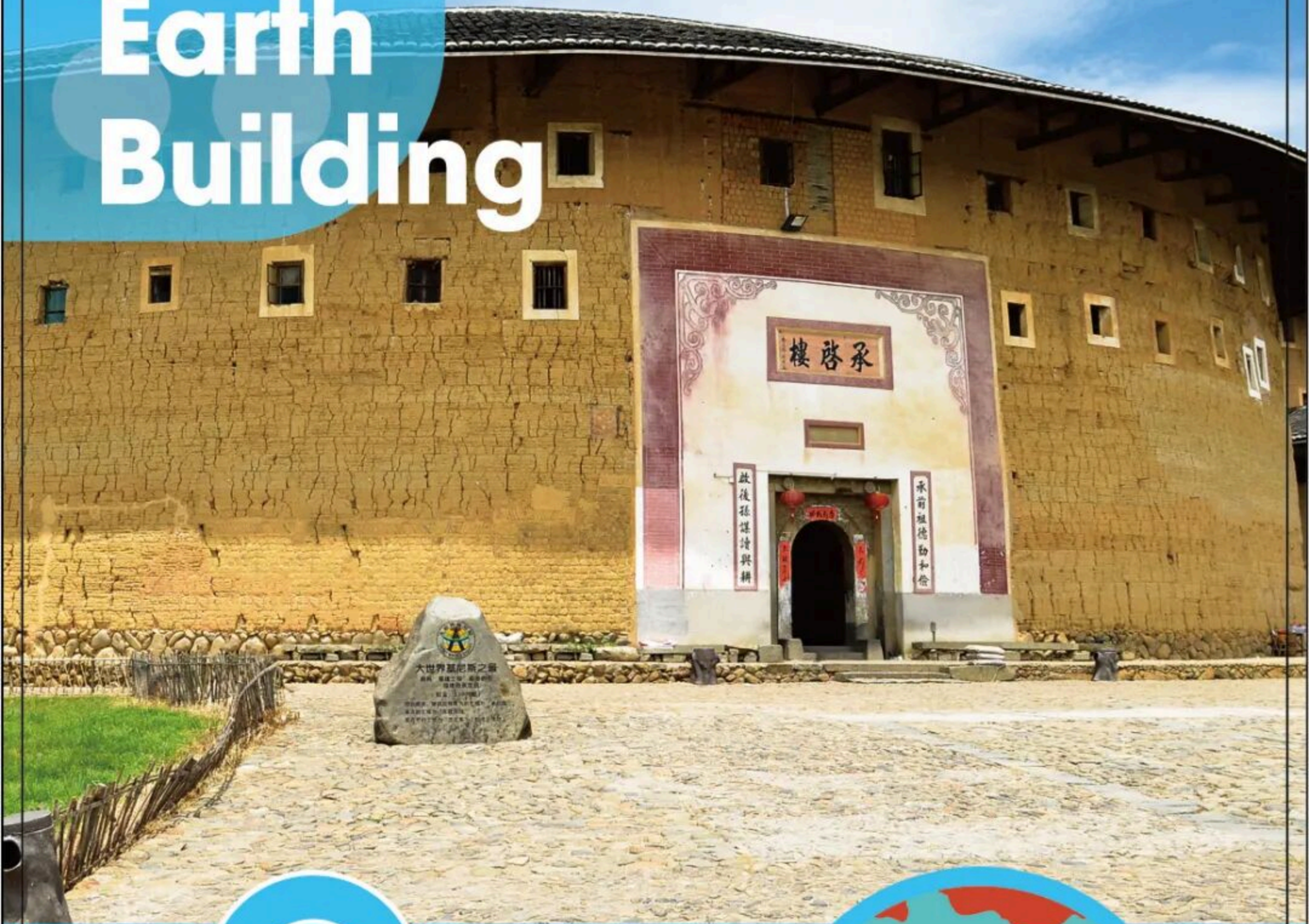

Chengqi Earth Building, is a remarkable architectural complex located in Fujian, China. It was initially constructed during the Ming Dynasty, dating back to the Chongzhen Era, and completed in the 48th year of the Kangxi Era in the Qing Dynasty, around 1709.

Chengqi Earth Building



Geography and culture

地理·文化



Chengqi Earth Building harmoniously integrates natural surroundings and cultural significance, creating an architectural masterpiece that brilliantly combines the rugged with the refined.





中国福建土楼(承启楼)

Chengqi ■ Earth Building China

The contents of this chapter refer to the Wikipedia website.

本章内容参考维基百科网站，更多资讯可自行查阅。

The world's great architecture

Buildings and layout

■ 建筑物和布局



承启楼被誉为“圆楼之王”，它是永定客家土楼群中的一部分。这座建筑坐北朝南，占地面积约5376.17平方米，直径为73米。规模宏大，建筑风格独特，古朴而充满历史文化的底蕴。在这座楼的夯墙施工期间，当地天气宜人，众人将其称为“天助楼”以表达对上天帮助的感激之情。1986年，中国邮电部发行了一套“中国民居”邮票，其中1元面值的邮票上展示的是一座环环相连的土楼，而这座土楼正是承启楼。这些邮票通常被称为“国家的名片”，具有深远的影响。

Chengqi Earth Building is renowned as the "King of Round Buildings." It is an integral part of the Yongding Hakka Tulou Cluster. Situated in a north-south orientation, this architectural wonder covers an area of approximately 5,376.17 square meters, with a diameter of 73 meters. known for its vast scale, unique architecture, and rich historical and cultural heritage. The building's distinctive design is a testament to the clever combination of natural and cultural elements. During its construction, favorable weather conditions prevailed, which led to its popular nickname, "Heaven-Assisted Building."

In 1986, the Chinese Ministry of Posts and Telecommunications issued a set of postage stamps featuring "Chinese Residential Buildings," with the 1-yuan denomination featuring a round interconnected earthen building, which is none other than Chengqi Earth Building. Often referred to as a "national calling card," these stamps have had a lasting impact.

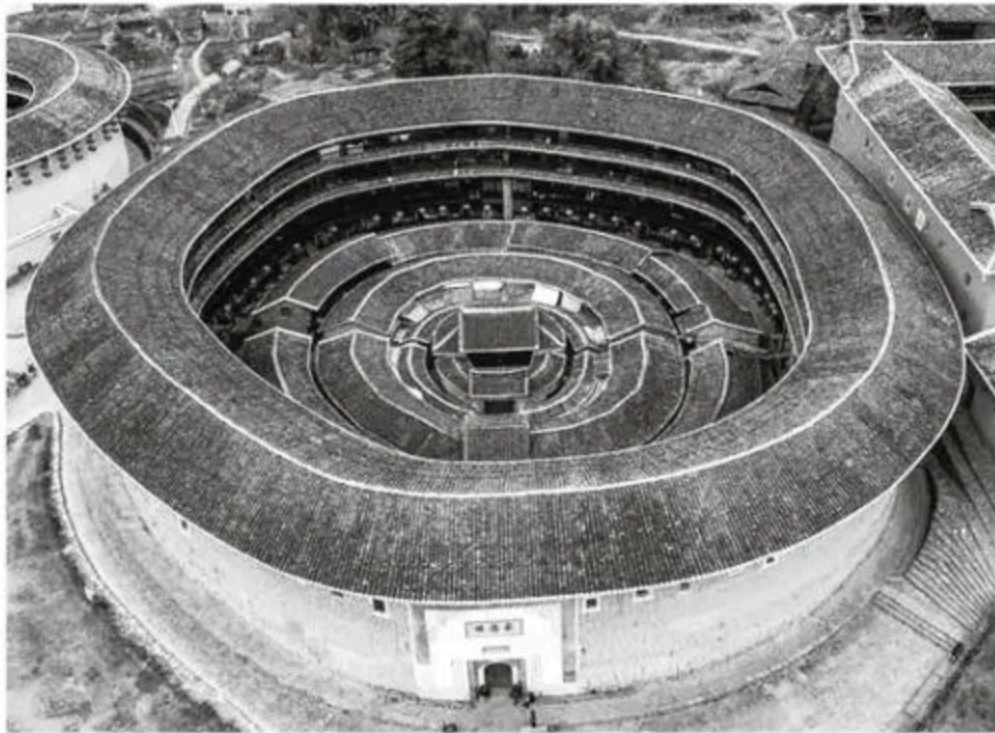

Symbolism

承启楼由四个同心圆的环形建筑组成。最外围的圆形建筑有四层，高16.4米，每层有72个房间。第二环有两层，每层40个房间，第三环是单层，有32个房间。整座建筑的中心是祖堂，包括四座三间两堂的祠堂，全楼共有402个房间。这座独特的建筑常被形容为“高四层，楼四圈，上上下下四百间；圆中圆，圈套圈，历经沧桑三百年”。

Chengqi Earth Building is composed of four concentric circular structures. The outermost circle consists of four stories, reaching a height of 16.4 meters, with 72 rooms on each floor. The second circle comprises two stories with 40 rooms per floor, while the third circle has a single story with 32 rooms. At the heart of this complex stands the ancestral hall, consisting of four separate three-bay two-hall ancestral temples, bringing the total number of rooms in the building to 402.

This extraordinary structure is often described as “four stories, four circles, four hundred rooms inside and out, concentric circles within circles, and a history spanning three hundred years.”



Design and construction

整座建筑有三个同心环形楼层相互叠加，中心的祖堂高耸入云。外环楼有四层，每层用抬梁式木构架和泥砖将房间分隔成72个开间。最外圈的第一和第二层没有外部窗户，只在内墙上有小窗户，通过中庭采光。第一层是厨房，第二层是粮仓，而第三和第四层则是卧室。每层都有一条向内凹的环形通道，并设有四组楼梯，对称分布在建筑的四个方向。

第二环有两层，每层40个房间，而第三环则只有一层，包括32个房间，中心是祖堂。这第三环就像三位大将守护着祖堂，突显出土楼之王的威严，庄重而壮观。

The entire structure consists of three concentric circular floors stacked atop each other, with the central ancestral hall towering above. The outermost circle features four stories, each with 72 open bays, using a raised-beam wooden structure and mud bricks to separate the rooms. The first and second floors of this section have no external windows, relying on small inner windows to provide light. The first floor serves as the kitchen, the second as the granary, and the third and fourth as bedrooms. Each floor is connected by an inward-jutting circular passage and features four sets of staircases symmetrically distributed in four directions inside the building.

The second circle consists of two stories with 40 rooms on each floor, while the third circle has a single story with 32 rooms, all centered around the ancestral hall. The third circle stands as the guardian of the ancestral hall, emphasizing the grandeur of this Tulou king—majestic and dignified.

Force Balance

受力平衡

Physical operations

物理运算

$$F = G \frac{m_1 m_2}{d^2}$$

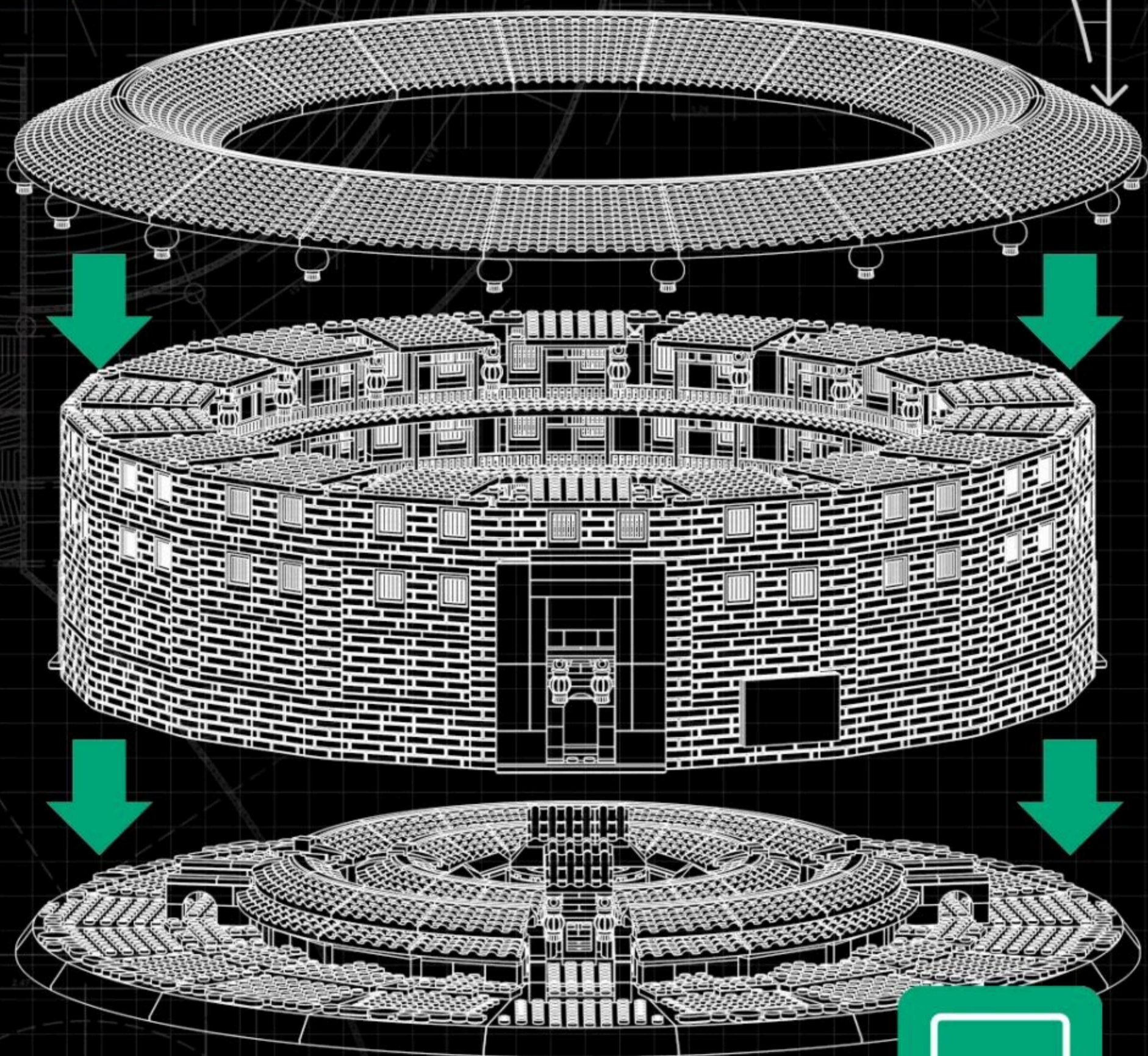

Creation and thinking

创作·思考

Special parts

特殊零件的开发利用

$$a^2 + b^2 = c^2$$



WG1576

中國弧瓦片55X16

$$S = 4\pi \cdot r^2$$



WG1580

大圆弧外屋顶91X52



WG1573

弧形4孔墙砖



WG1557

4孔3高围栏



WG1574

圆弧栏杆38X26

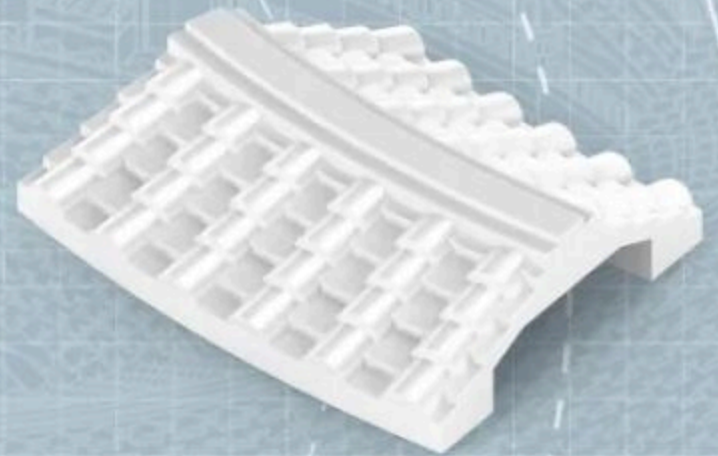

WG1578

中圆弧双面屋顶53X42



WG1575

大圆弧瓦片61X18

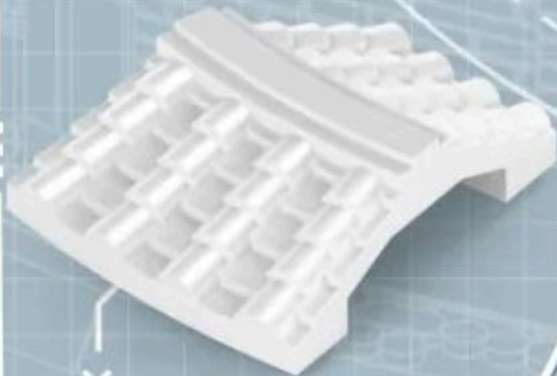

WG1577

小圆弧双面屋顶36X41



$$\sin^2 a + \cos^2 a = 1$$

WG1579

大圆弧内屋顶75X50



features and functions

特点.功能

Main Color Matching

配色方案



Pantone 7427C



Pantone 7620C



Pantone 7509C



Pantone 2310C



Pantone 123C



Pantone 7500C



Pantone Black 6C



Pantone 477C



Pantone 431C

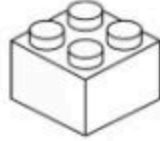

White



Pantone Cool Gray 6C

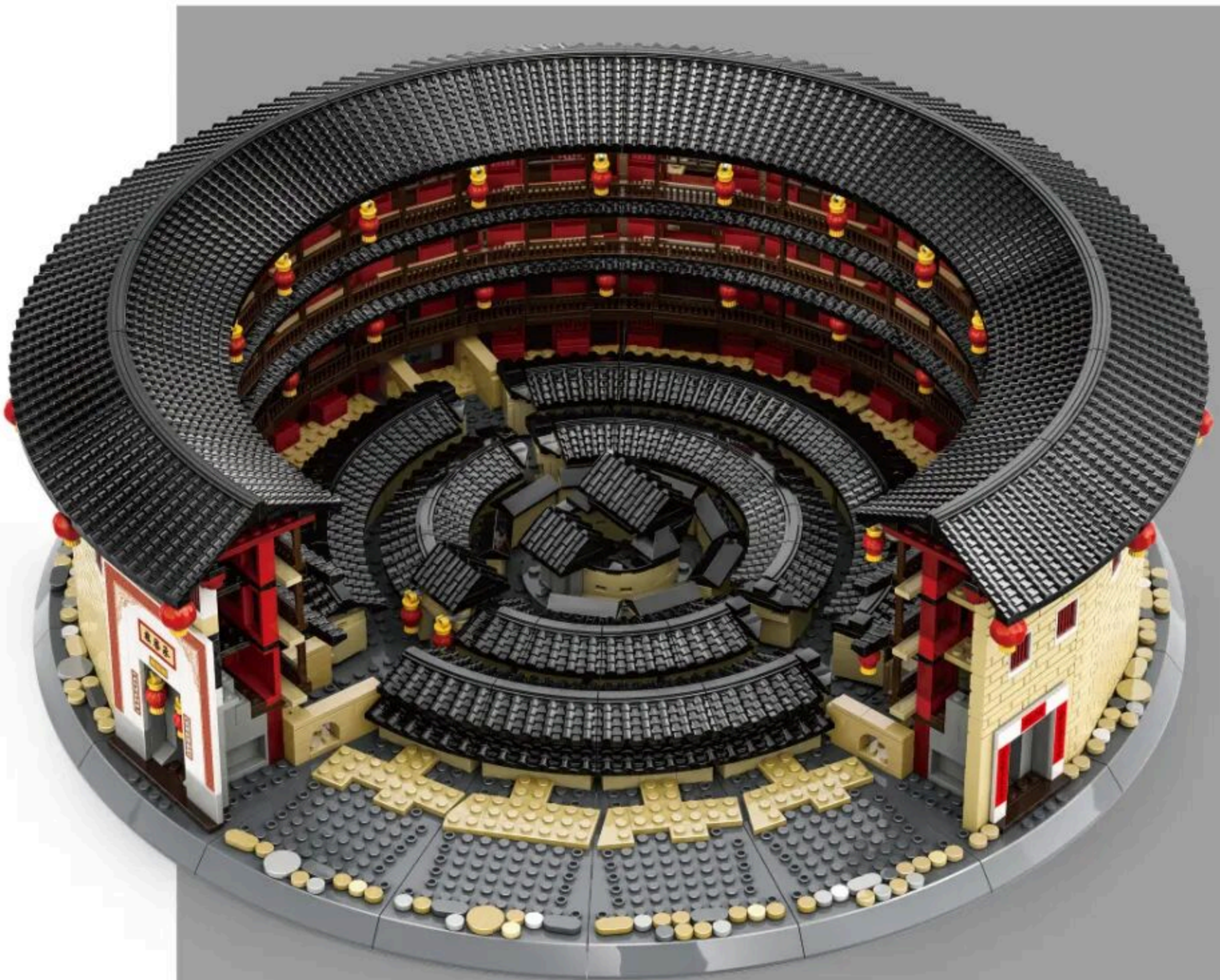

Color matching

Adopting 11 main colors, beige, black, brown and red as the main color, the more reasonable and bold color matching on the original building, making the product more atmospheric and the whole design is more reasonable.

Chengqi Earth Building

中国福建龙岩土楼(承启楼)



Front

Left

Back

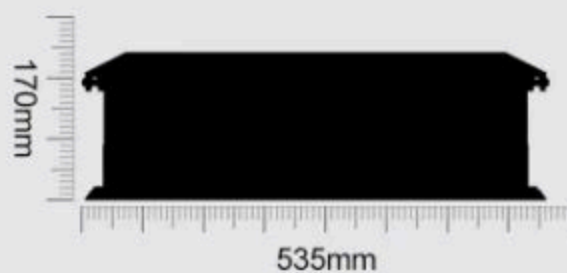

Product Size:535X530X170mm



Instructions For Use

积木起件器使用说明
Brickseparator

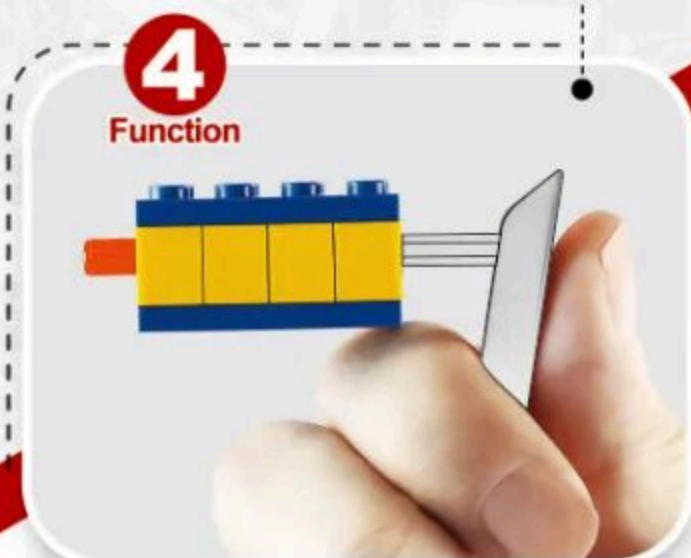
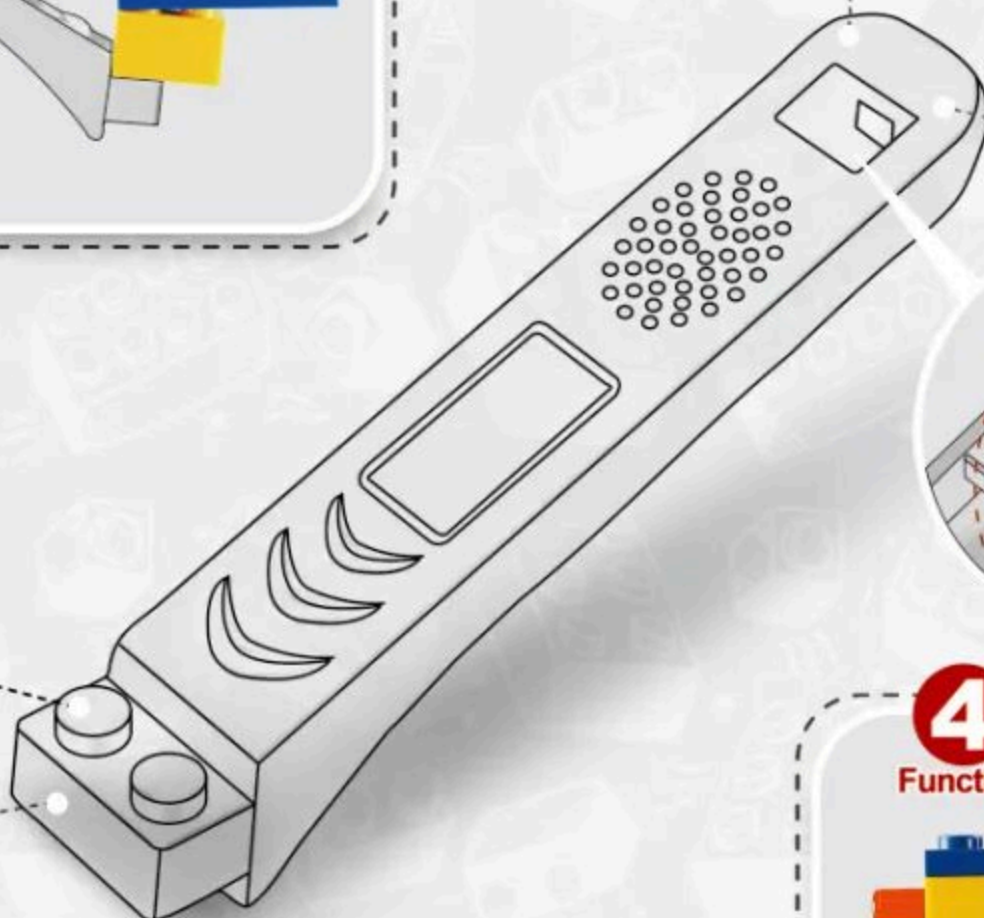
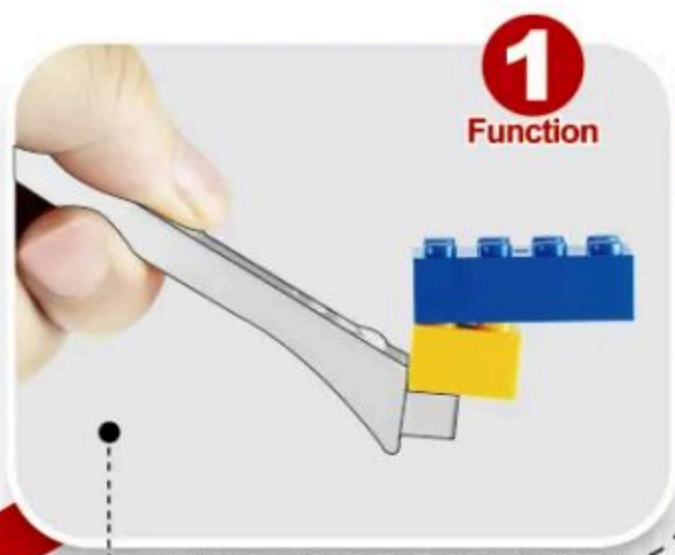

4 ways to make installation easier
让安装更简单



■ First open the product packaging according to the instructions.

按指导用正确方式拆解产品外包装。



■ Summarize all parts to count the number of familiar accessories.

对照说明书清单确认积木包数量与积木数量。



■ Arranging all accessories by color helps to quickly install the product.

把确认好的积木以类型、颜色进行分类排好以便安装。



■ Carefully install the product and learn about building.

按说明书步骤拼装并完成你的积木模型。



INSTALLATION
TIPS

1:1 Physical Reference Table

十字棒配件1:1尺寸参照表



Instructions For Use

让安装更简单

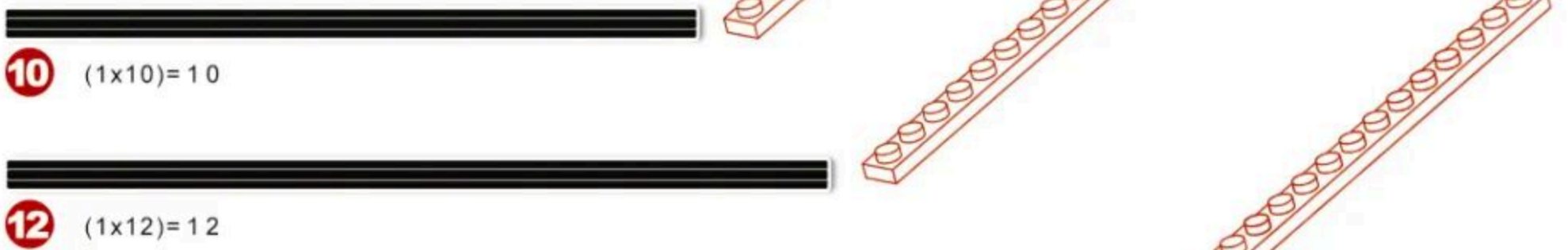
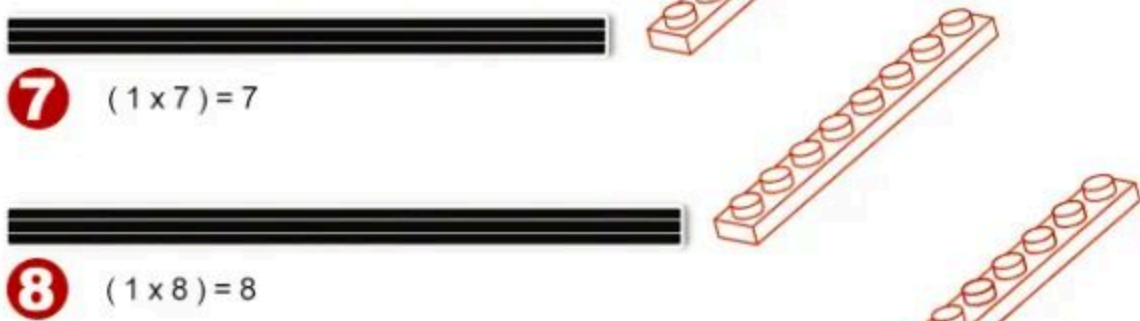
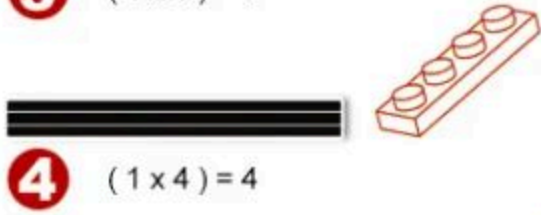
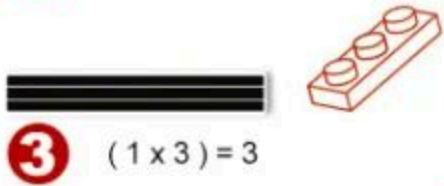
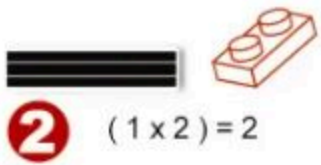

PARTS LIST

配件清单

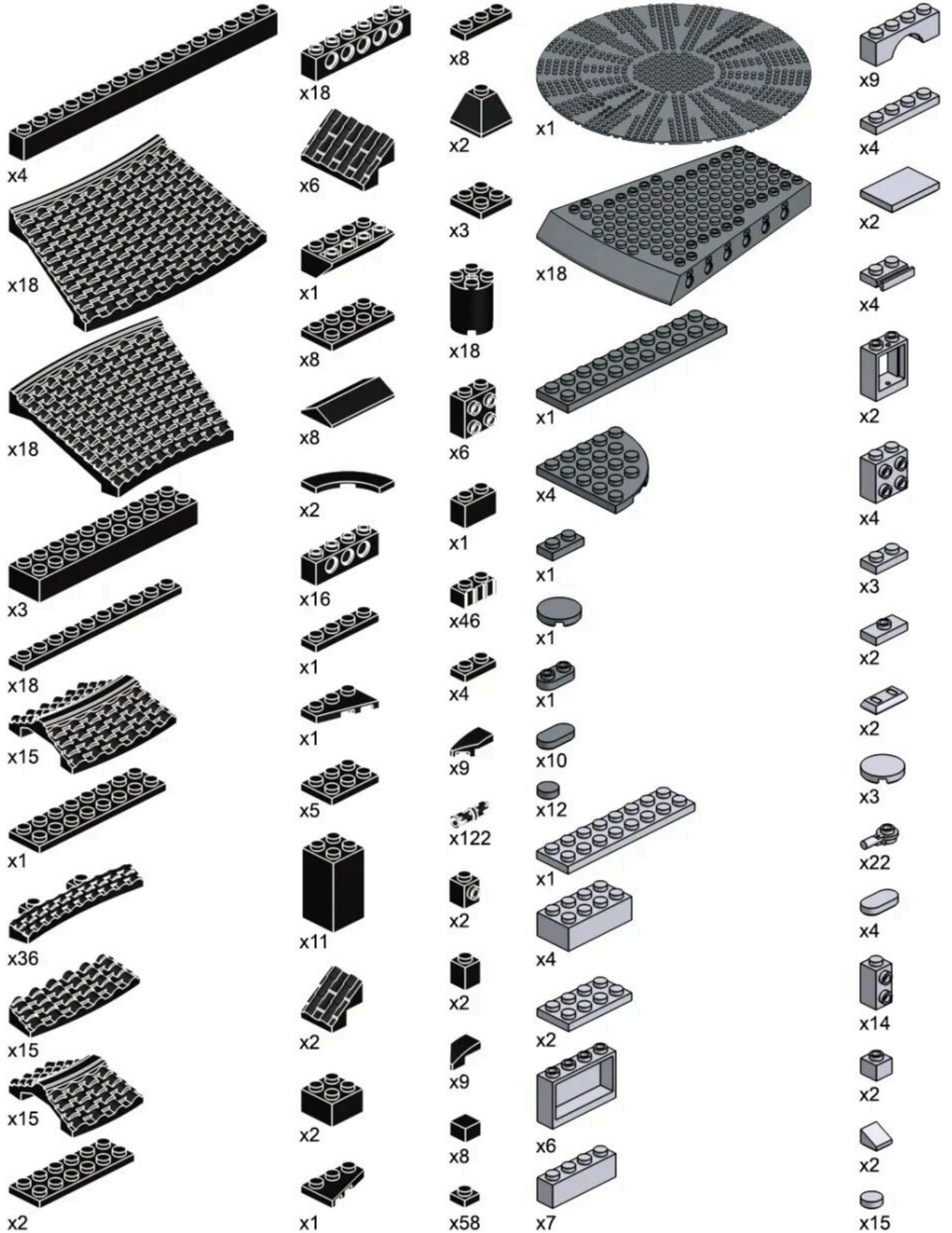

PARTS LIST

配件清单

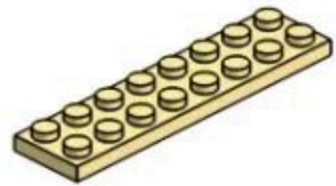

x41

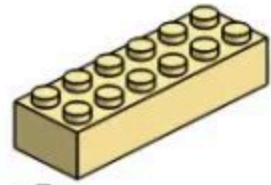

x5



x33



x54



x15



x4



x6



x12



x60



x36



x1



x23



x99



x8



x2

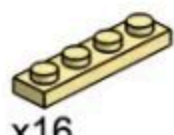

x16



x18

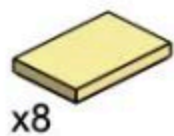

x8

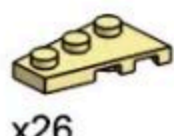

x26



x4

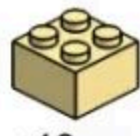

x10



x14



x20



x54



x2



x2



x10



x8



x35



x25



x198



x172



x6



x46



x16



x14



x8



x4



x18



x4



x14



x1

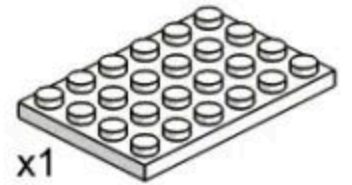

x1



x2



x4



x1

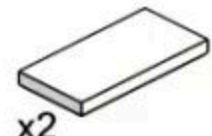

x2

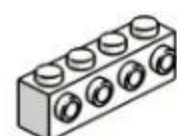

x2



x1



x1



x6



x70



x1



x6



x10

产品有增补件请以实物为准

If product has additional parts, please in kind prevail.

PARTS LIST

配件清单



x18



x1



x1



x104

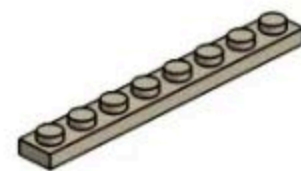

x4



x18



x22



x11



x12

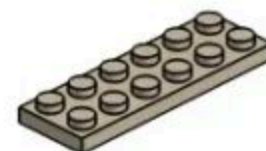

x18



x19



x104



x1



x12



x2



x3



x4



x18



x122



x54



x6



x6



x12



x11



x3



x144



x22



x10



x8



x3



x36



x18



x2



x3



x8



x70



x144



x4



x9



x2



x22



x40



x54



x4



x4



x58



x3



x6



x15

产品有增补件请以实物为准

If product has additional parts, please in kind prevail.



248PCS

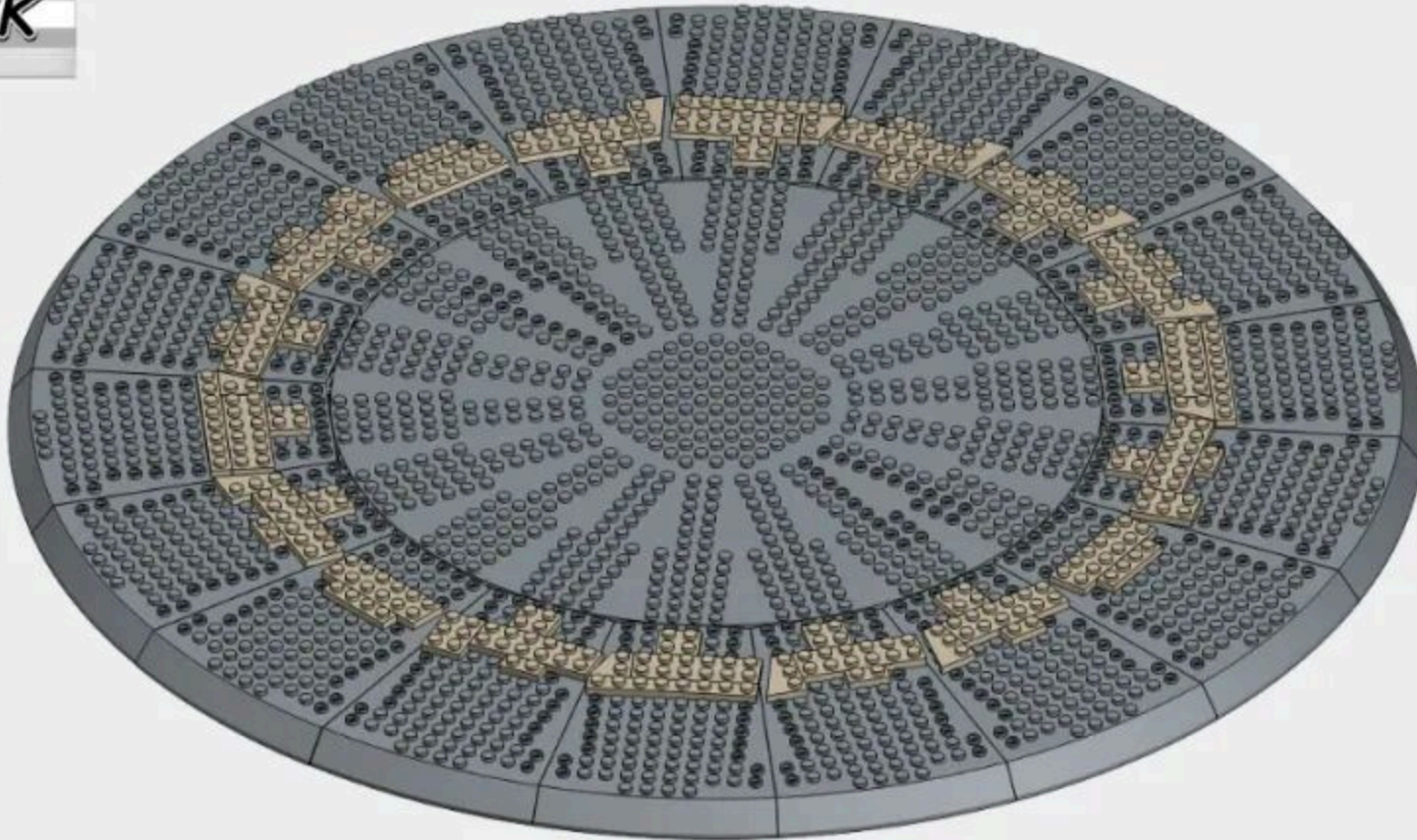

1-1

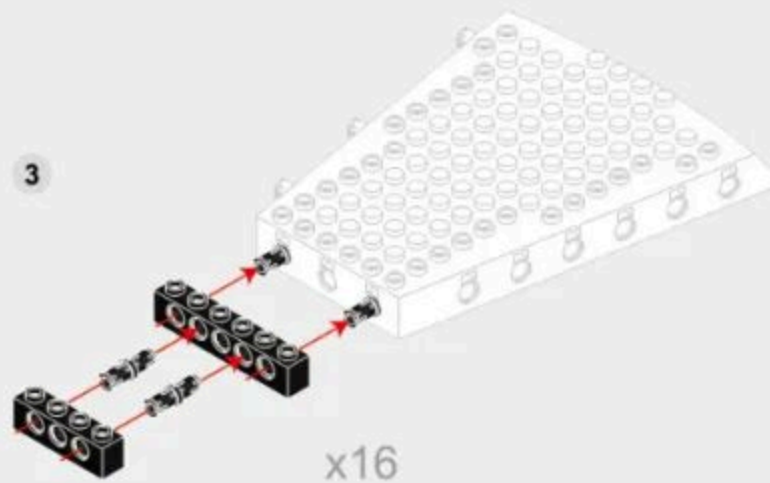
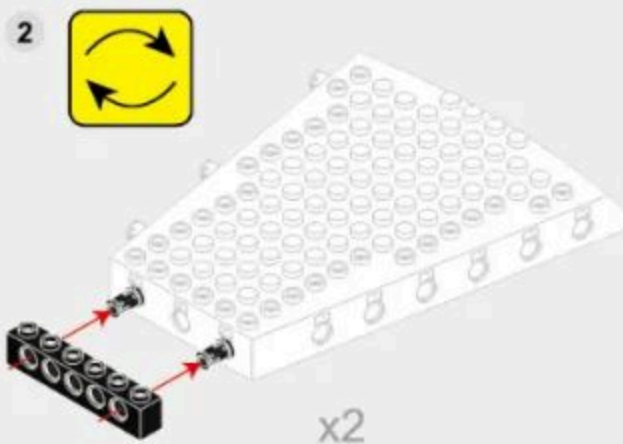
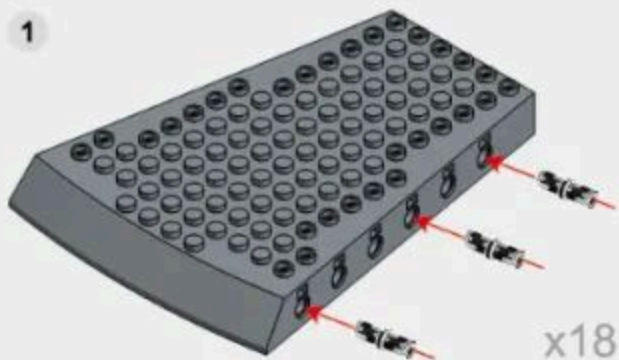
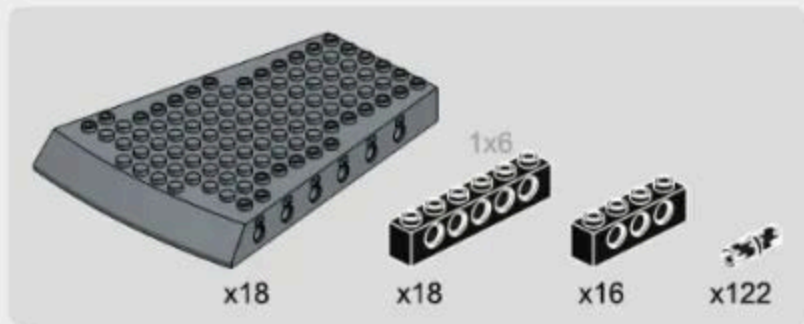

1-2

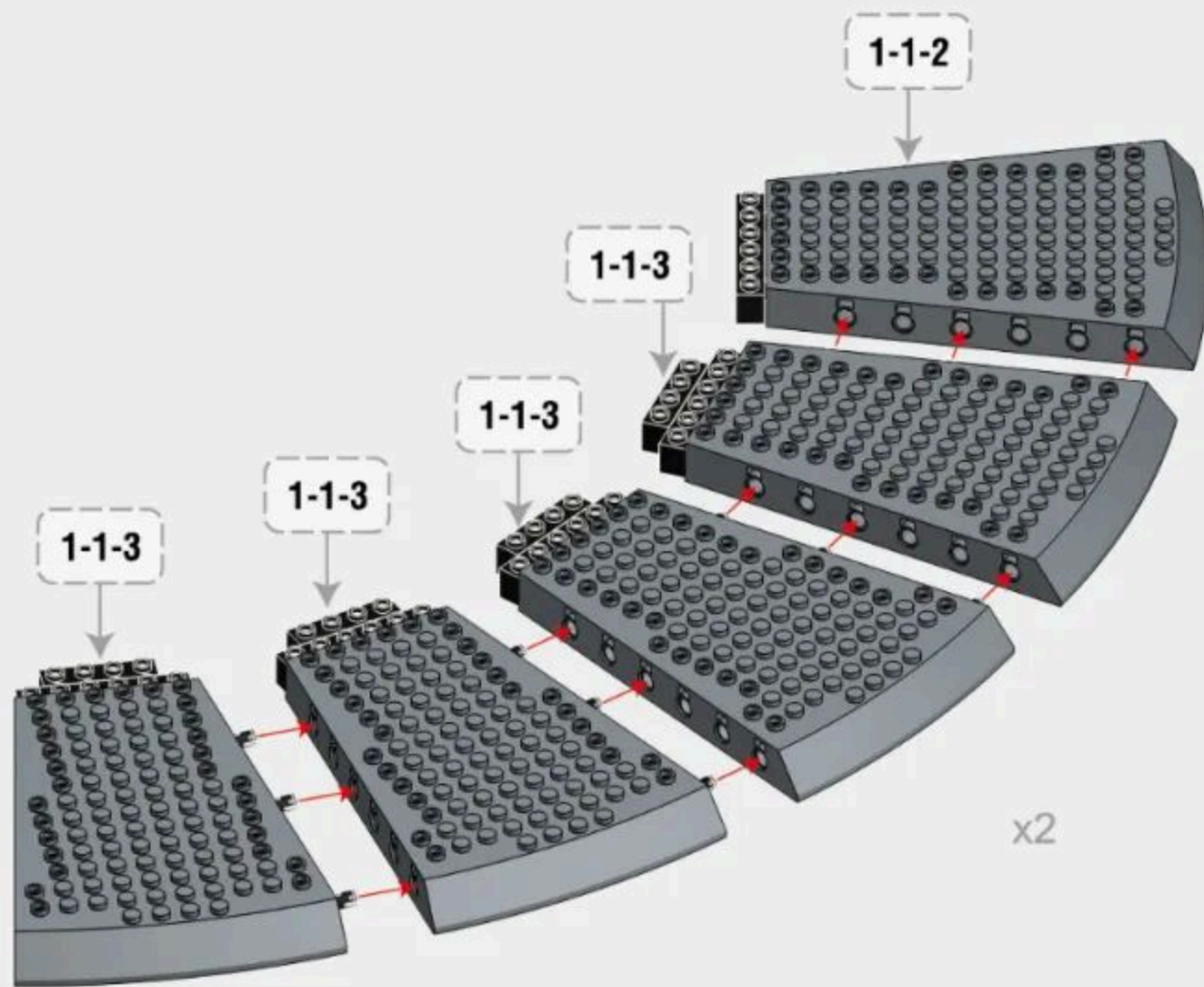

1-3

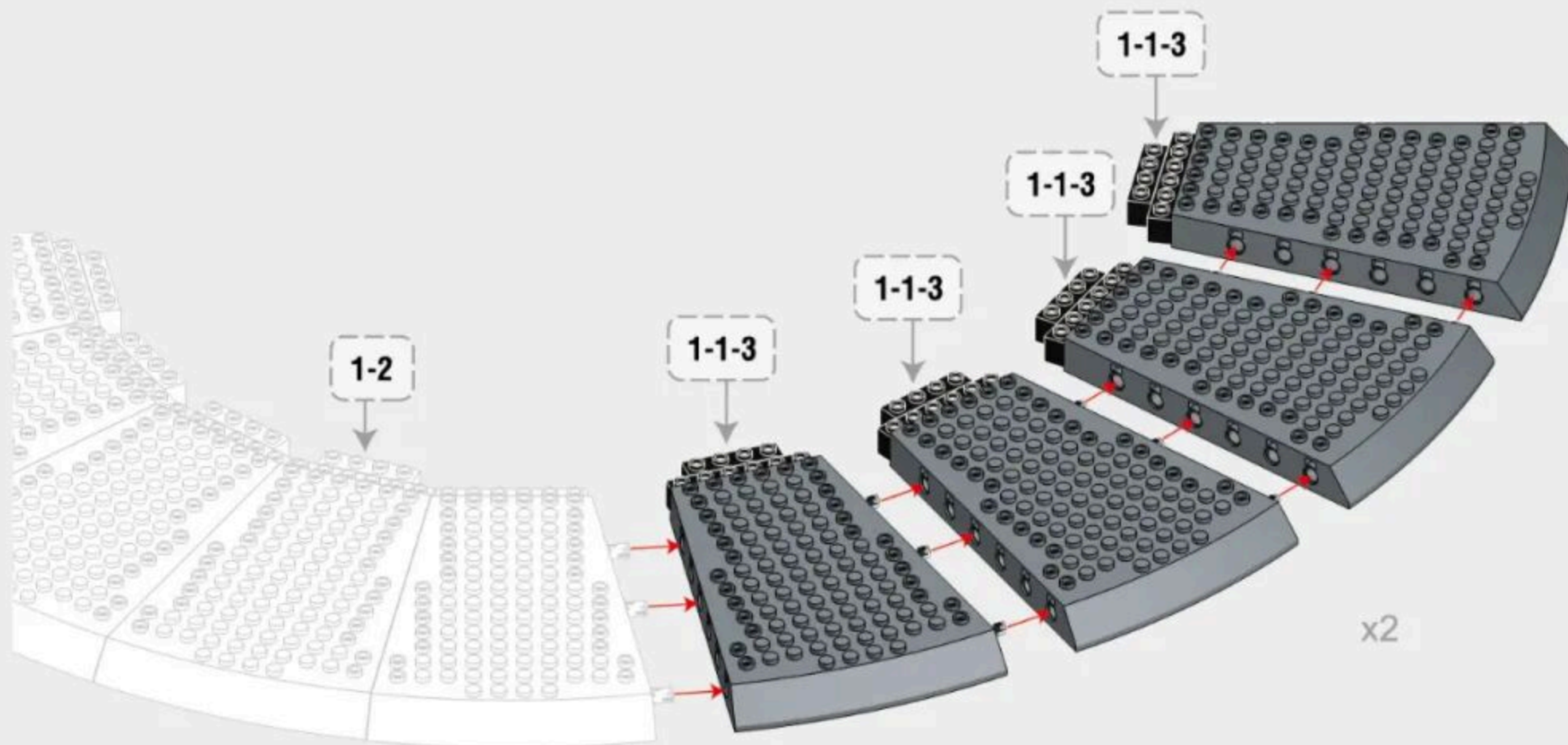

1-4

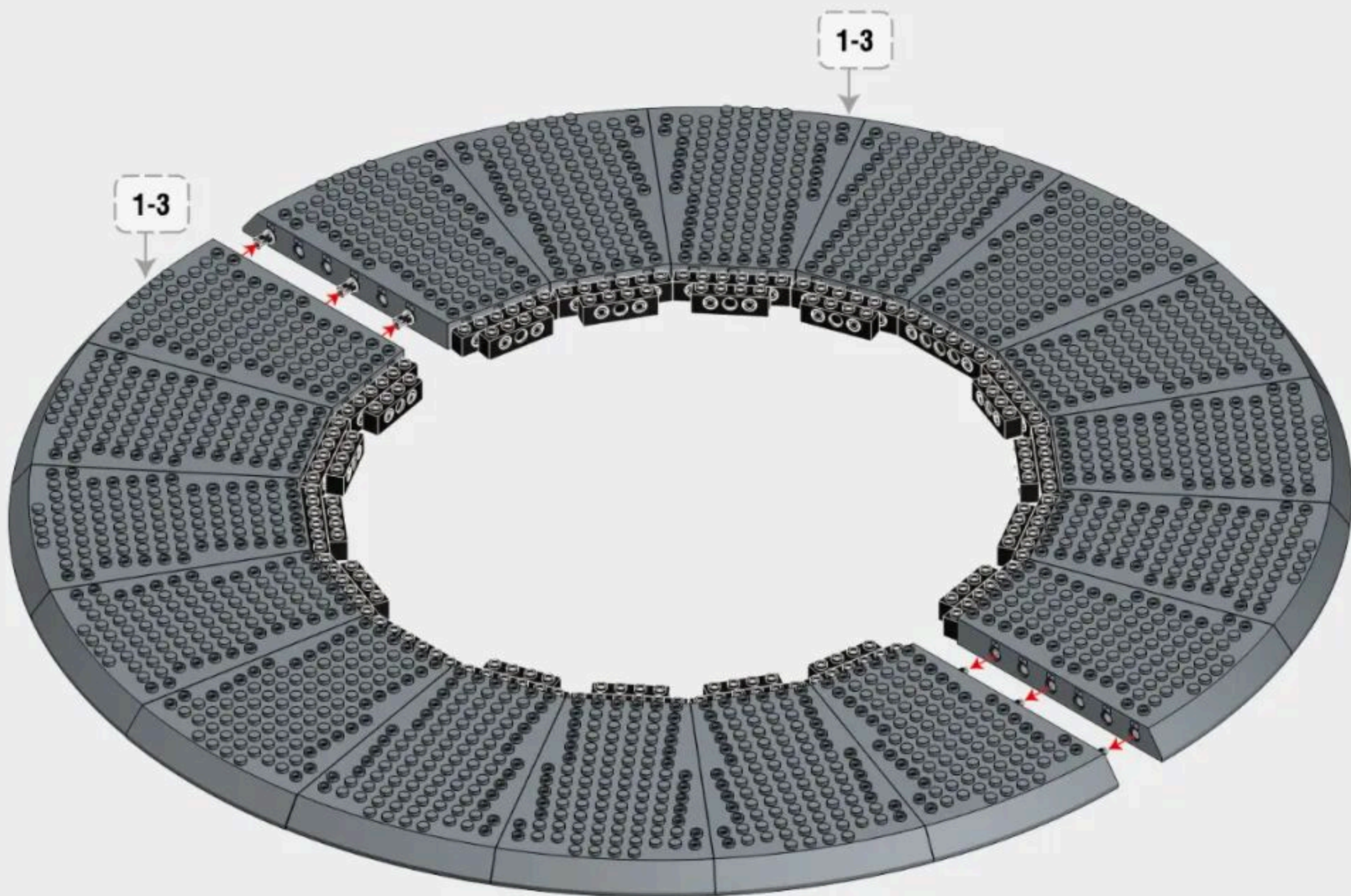

1-5

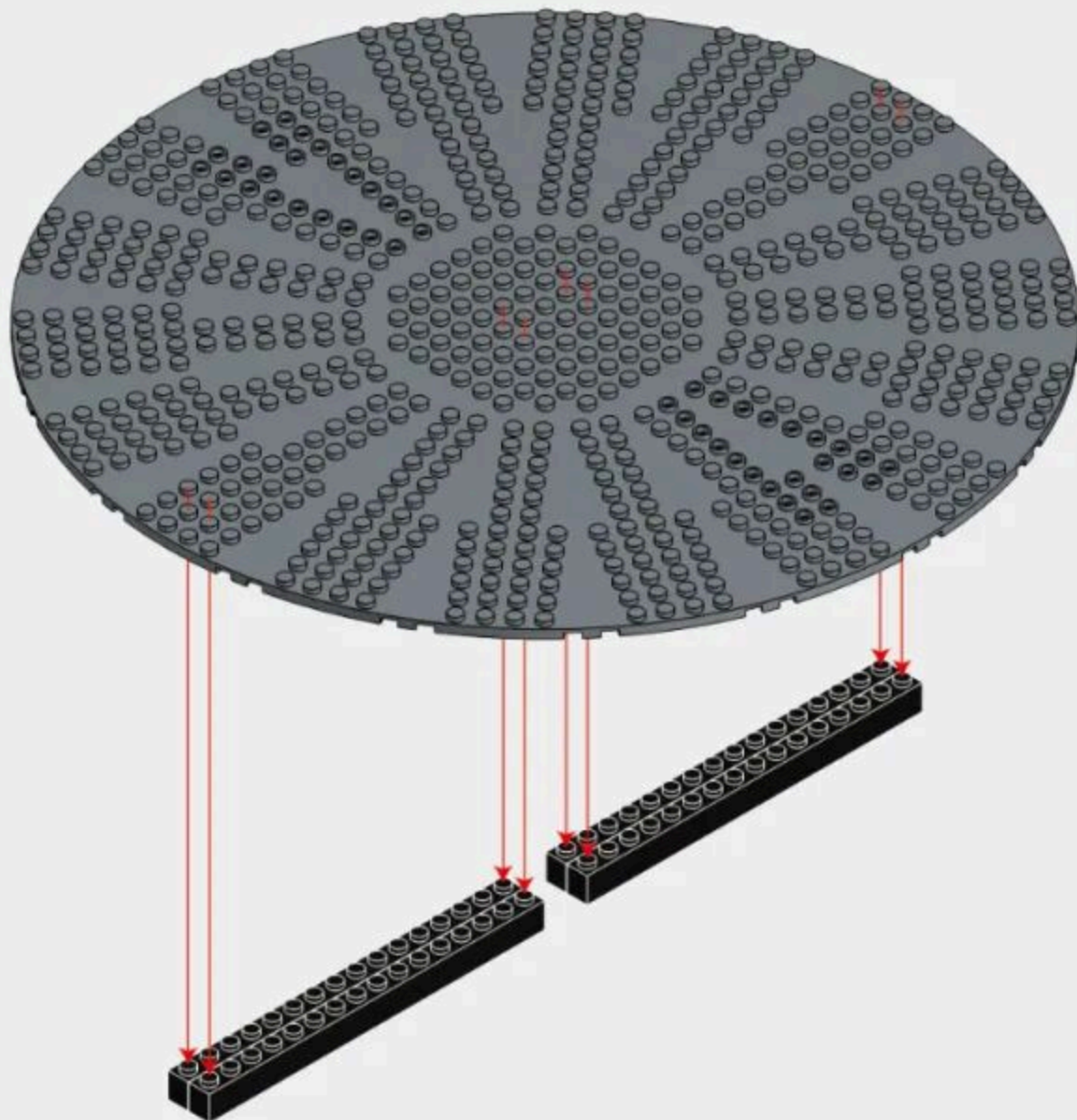
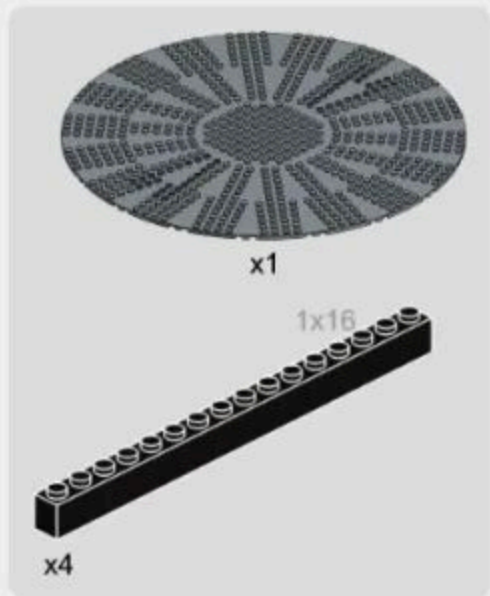

1-6

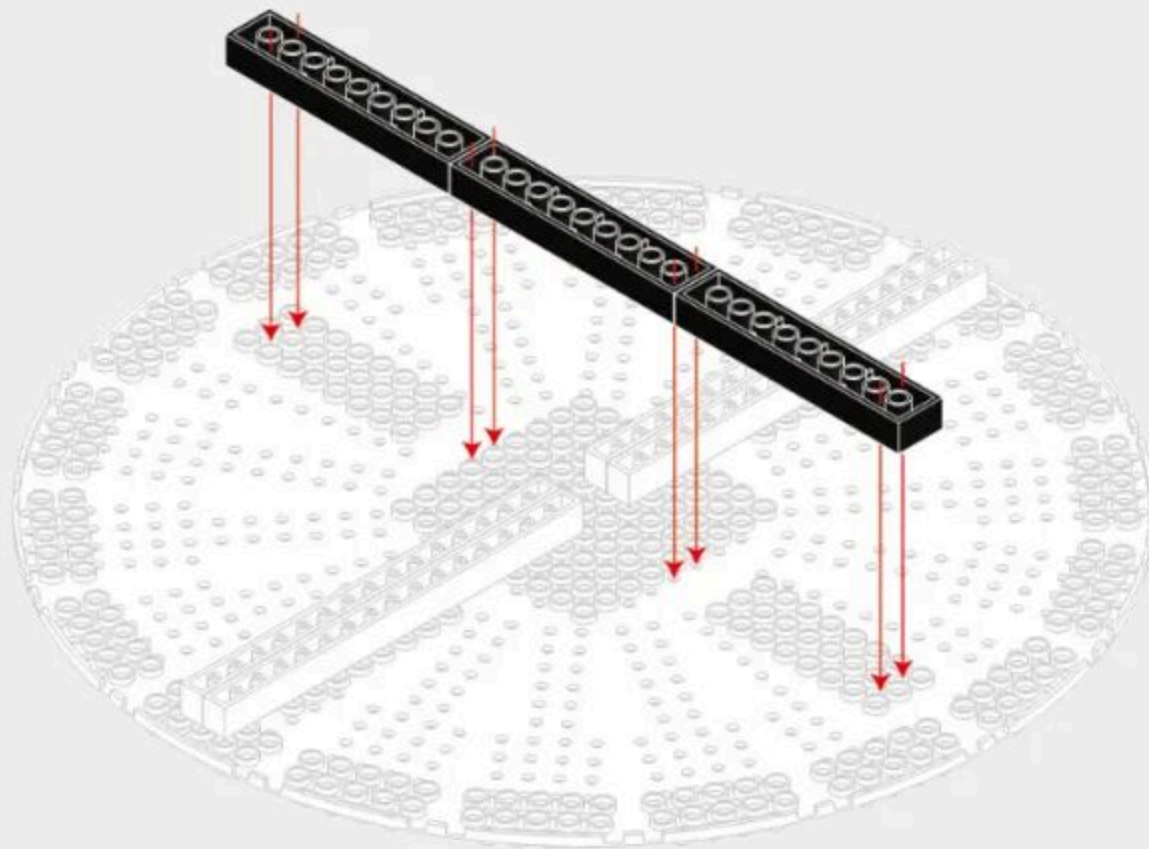
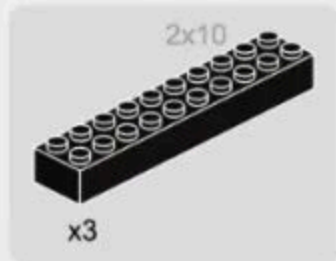

1-7

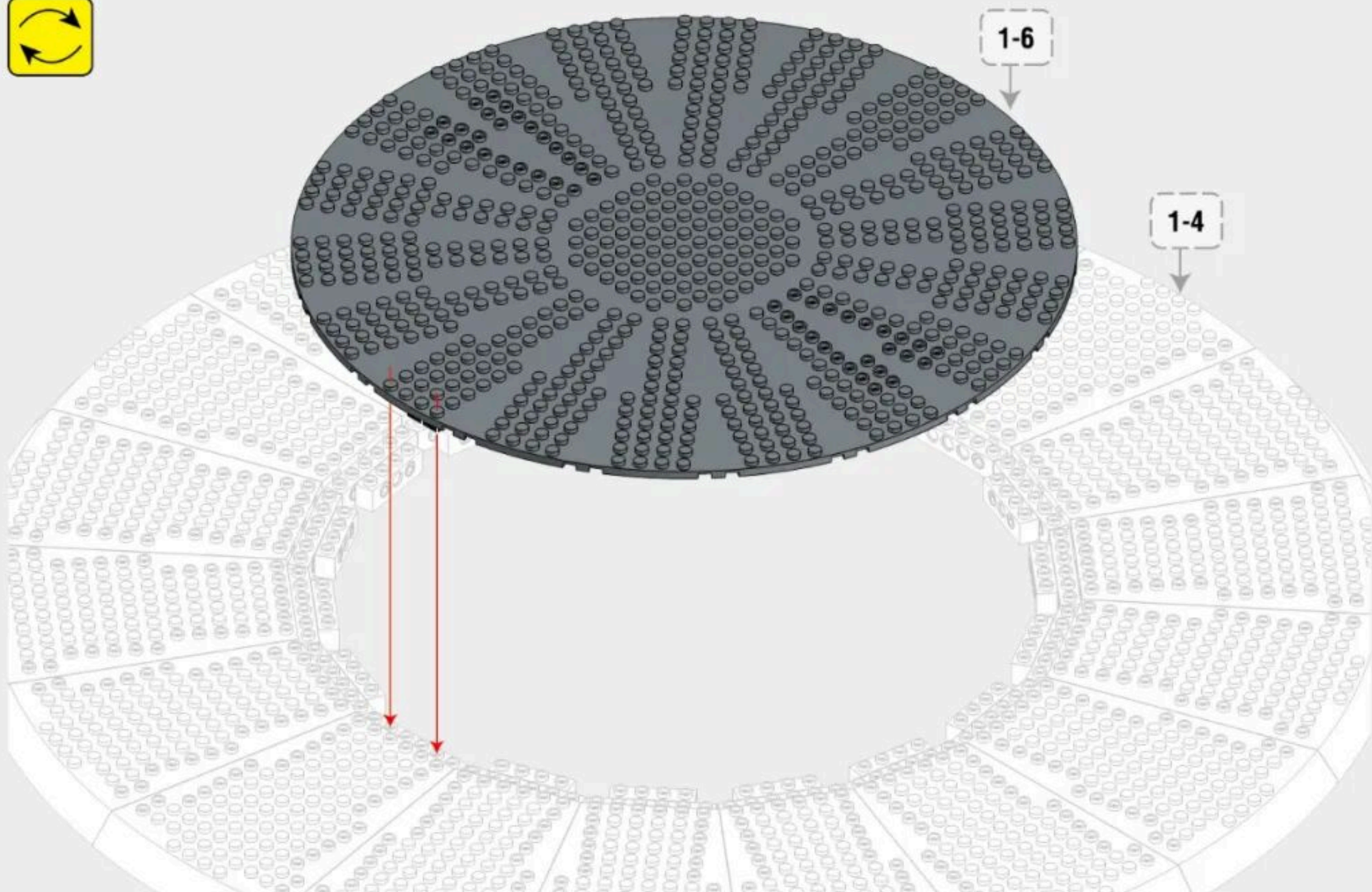

1-8

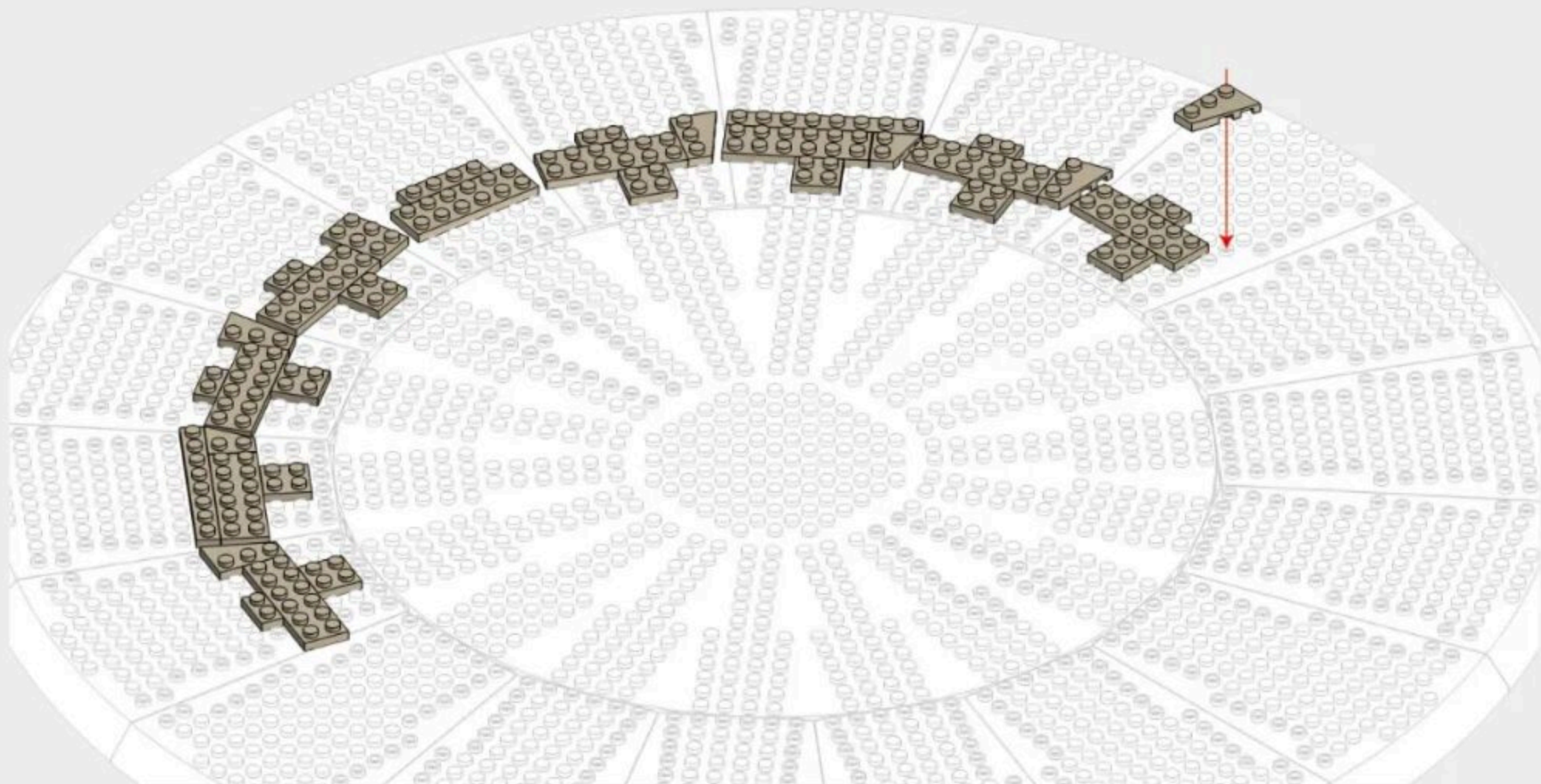
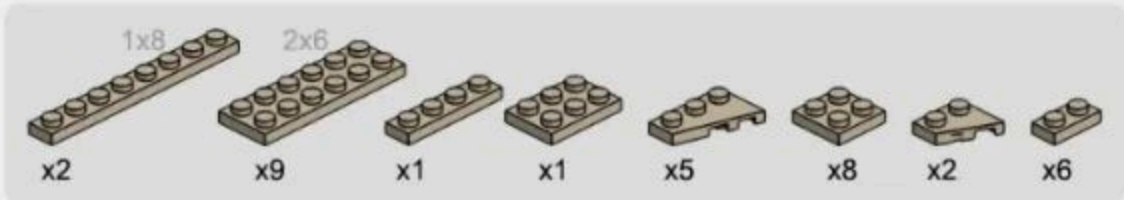

1-9

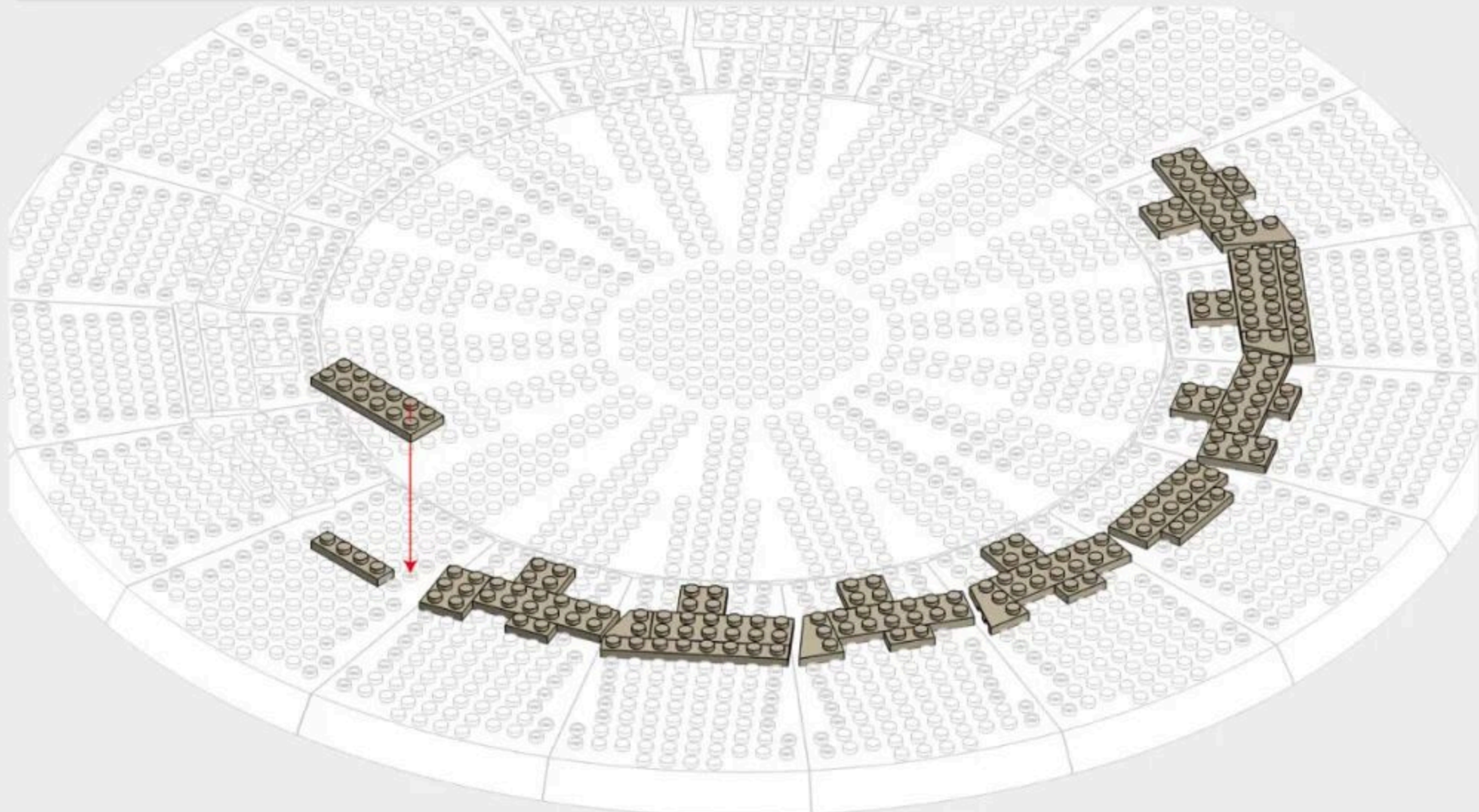



259PCS

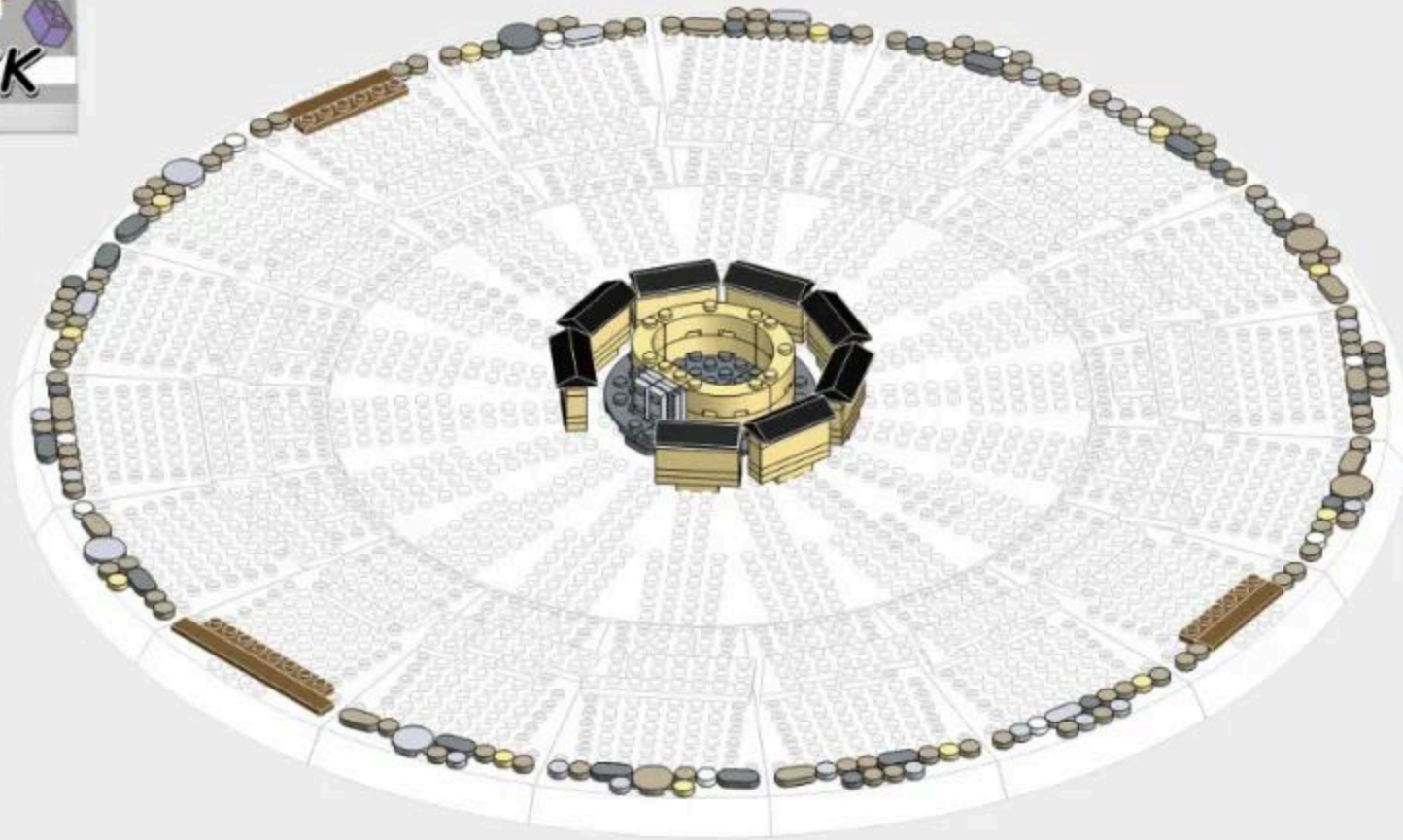

2-1

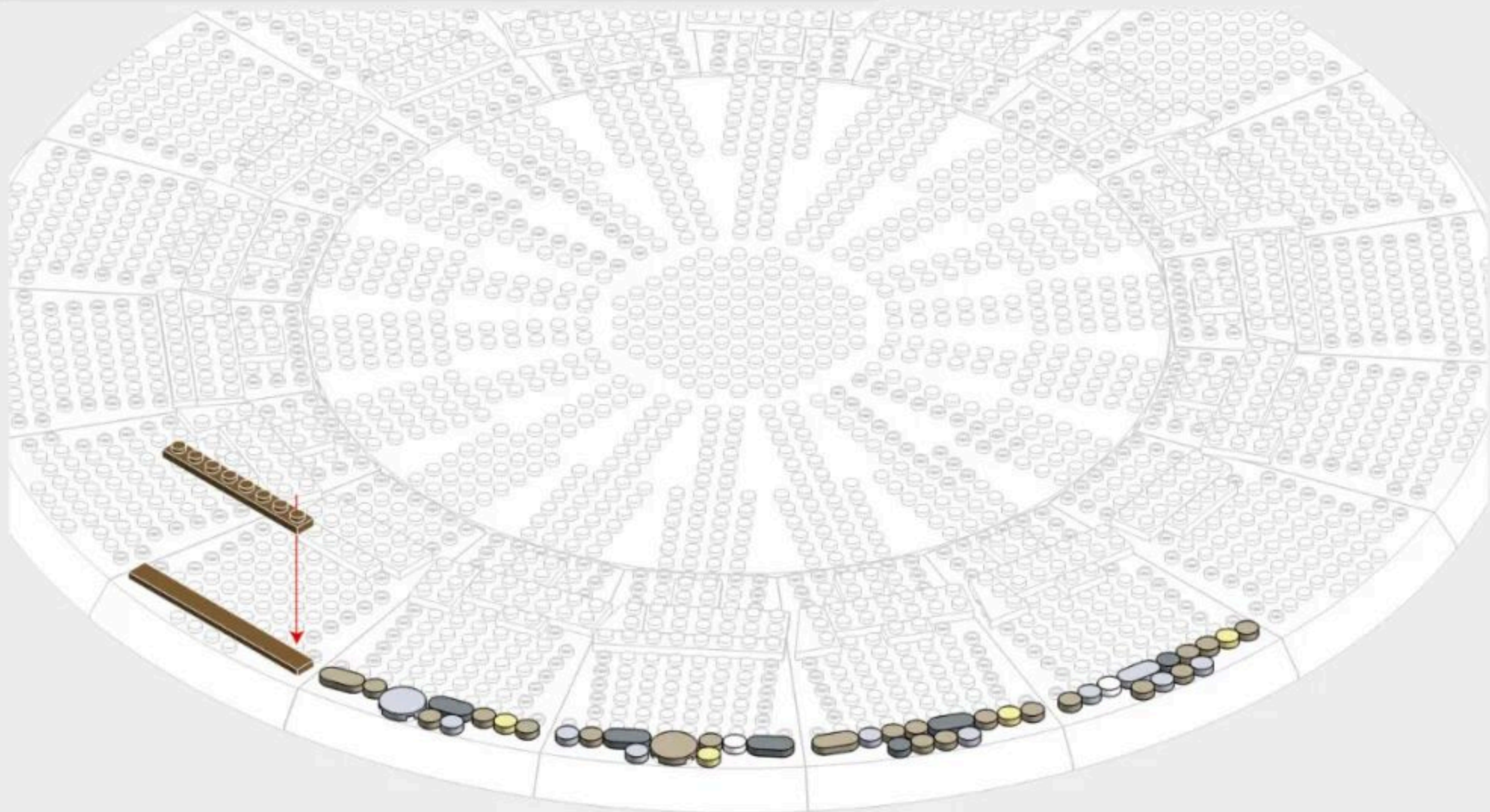
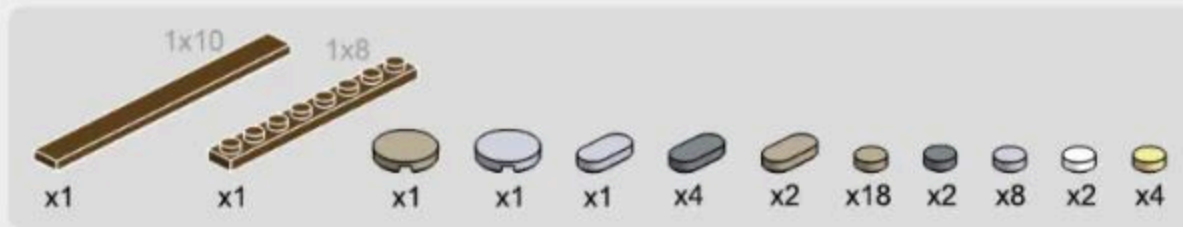

2-2

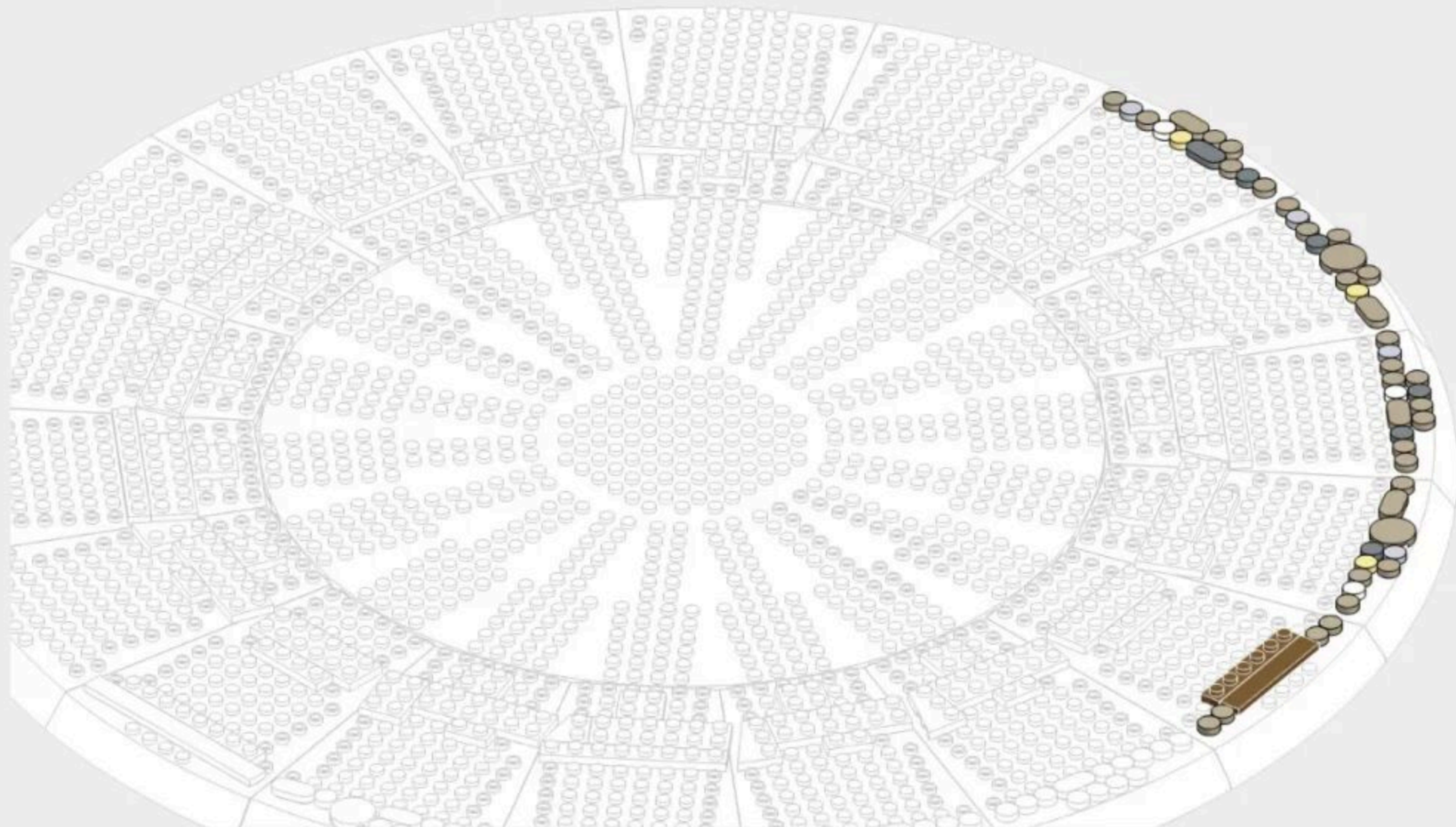

2-3

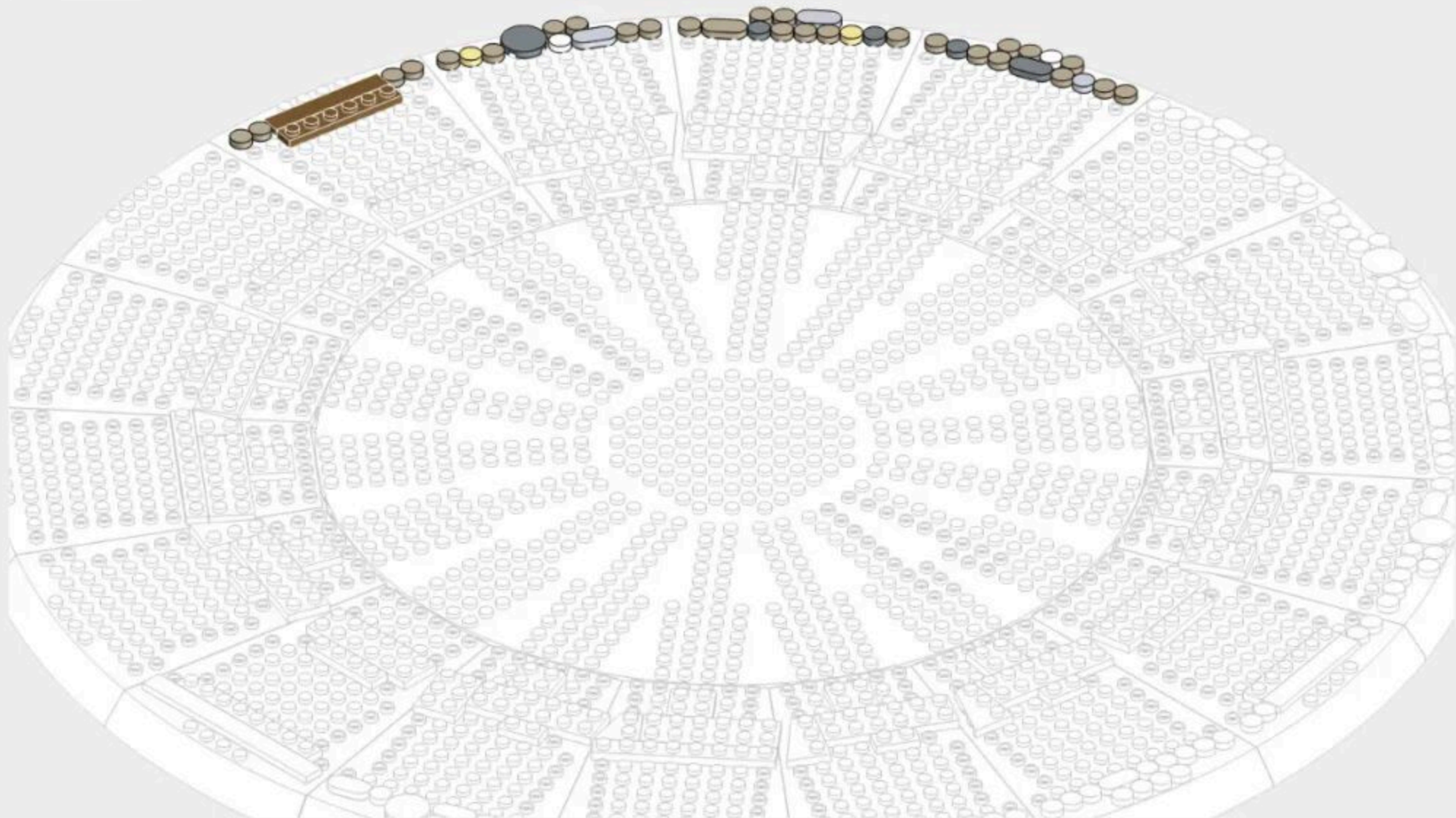
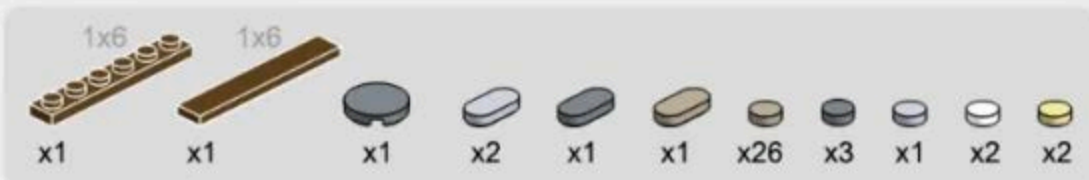

2-4

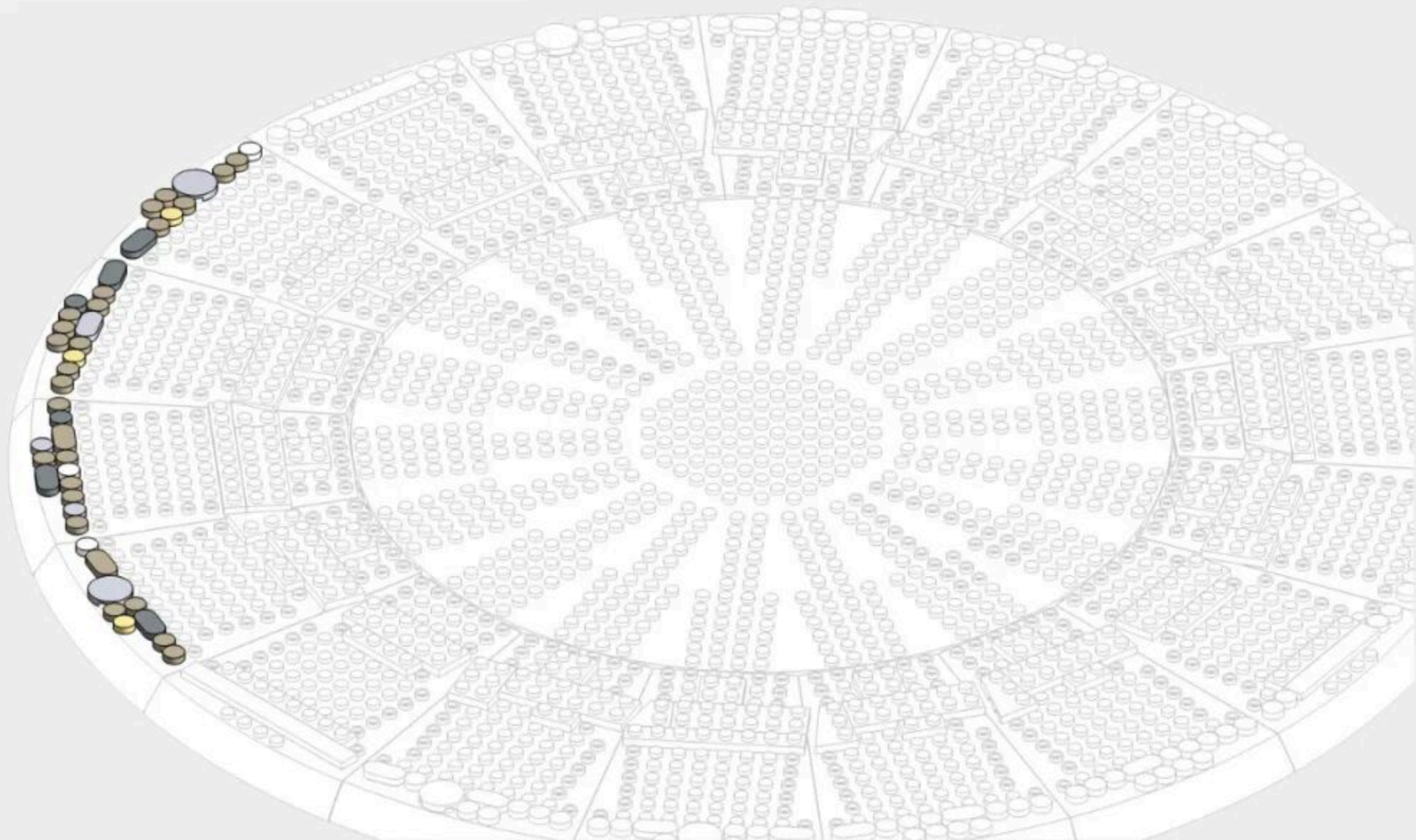

2-5

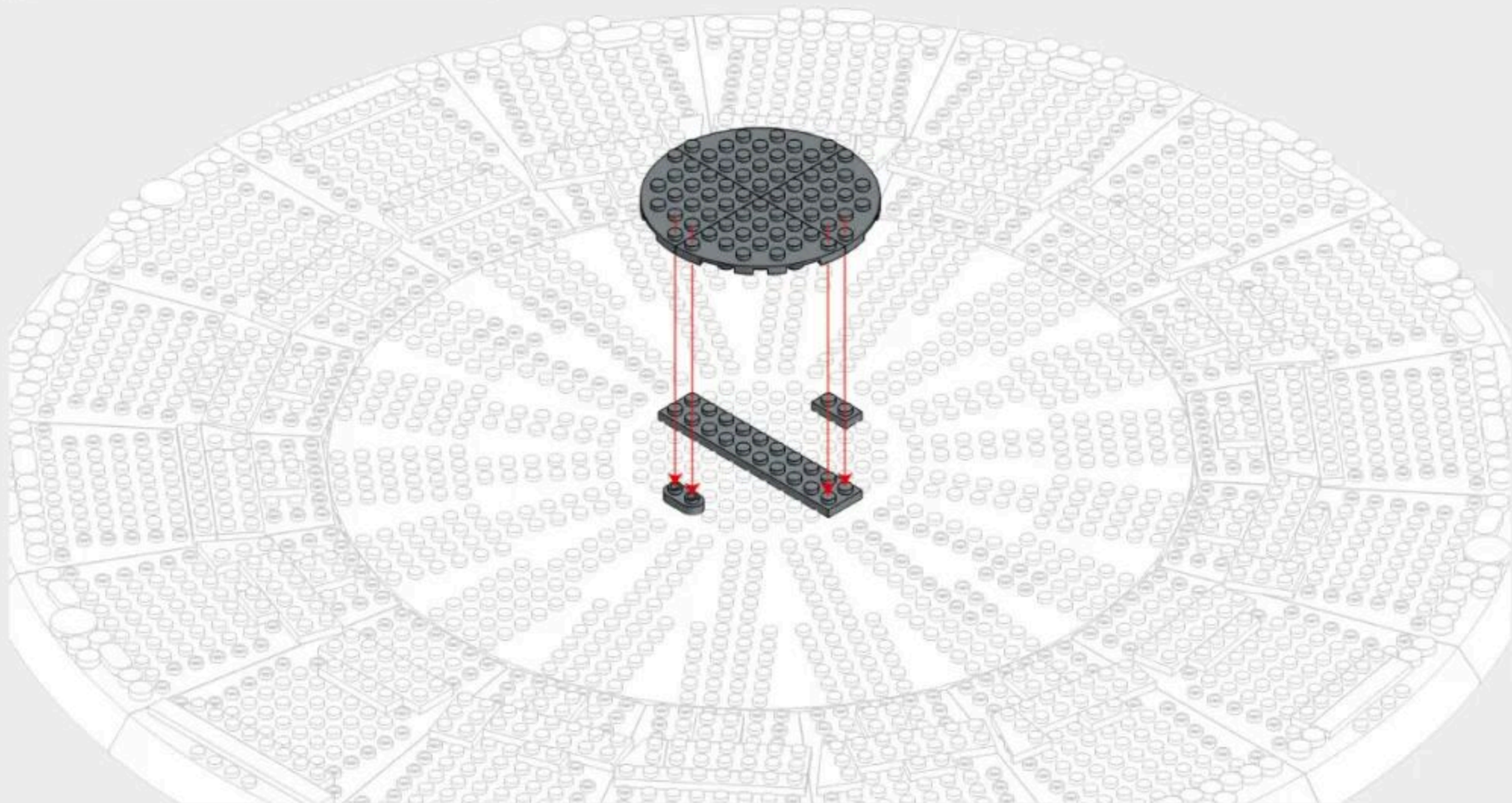
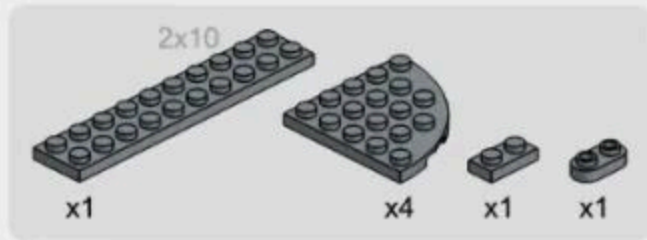

2-6



x4



x4



x1



x4



x1



x2

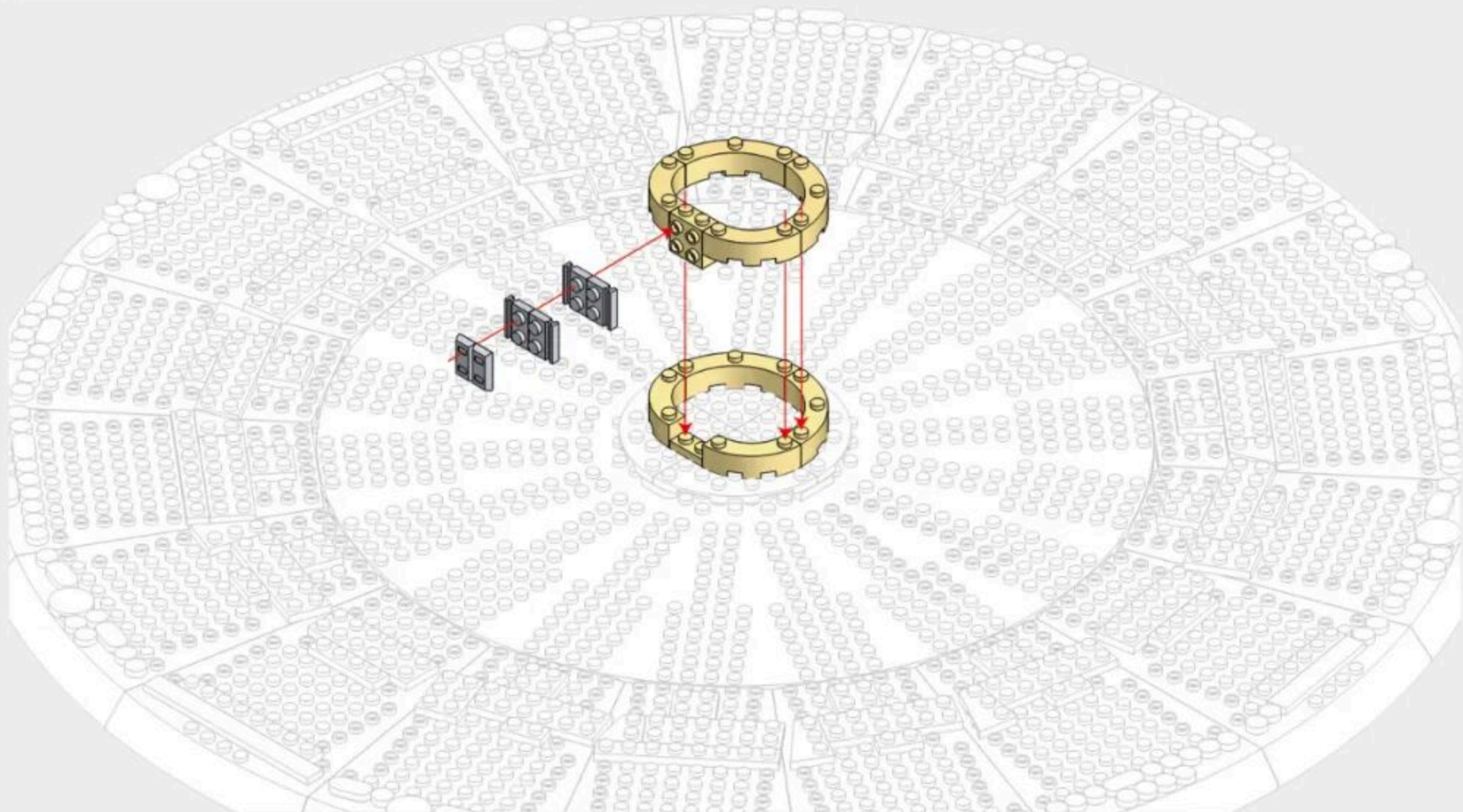

2-7



Vertical View of Installation Drawing
安装图顶面

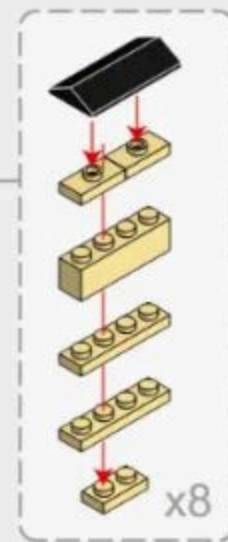
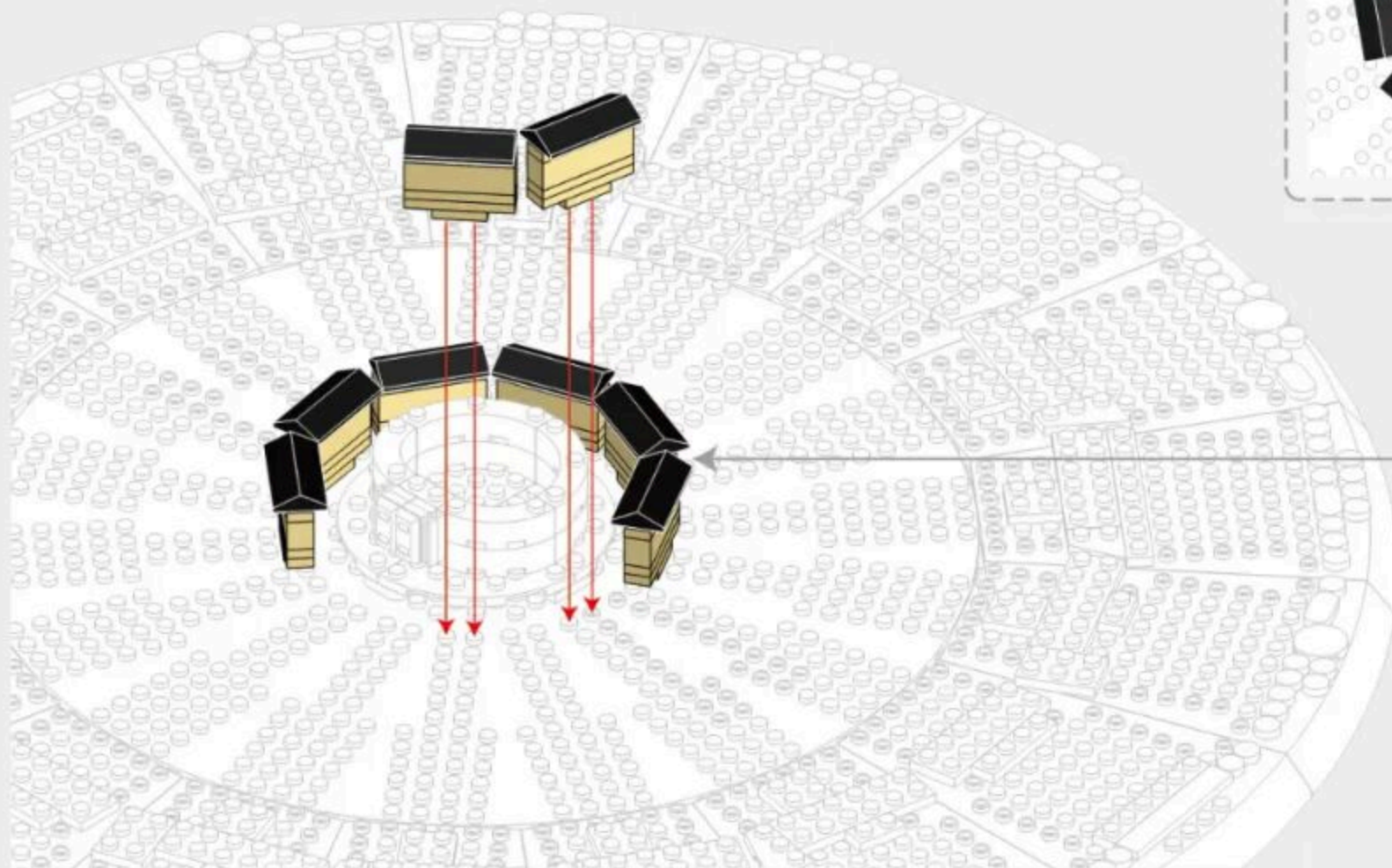
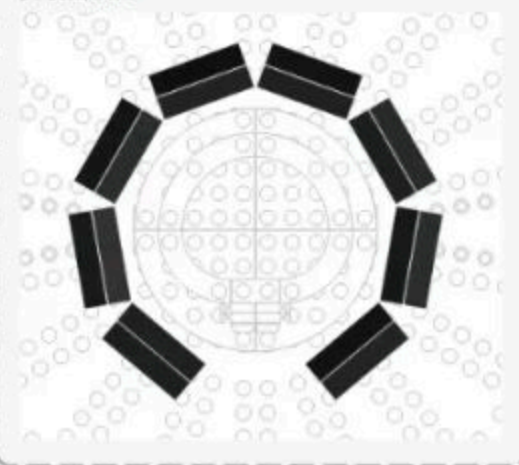



243PCS

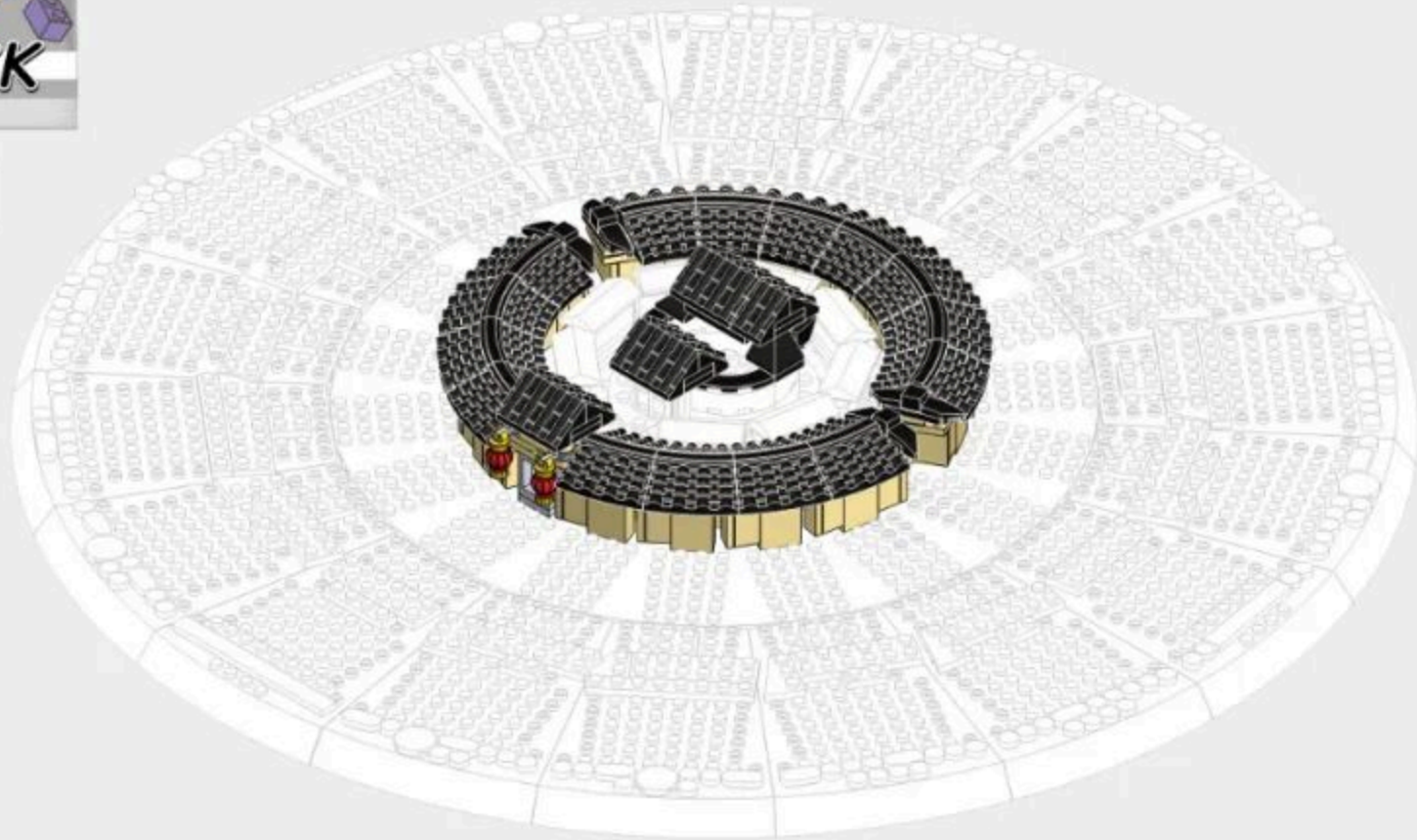

3-1



x2



x2



x1



x1

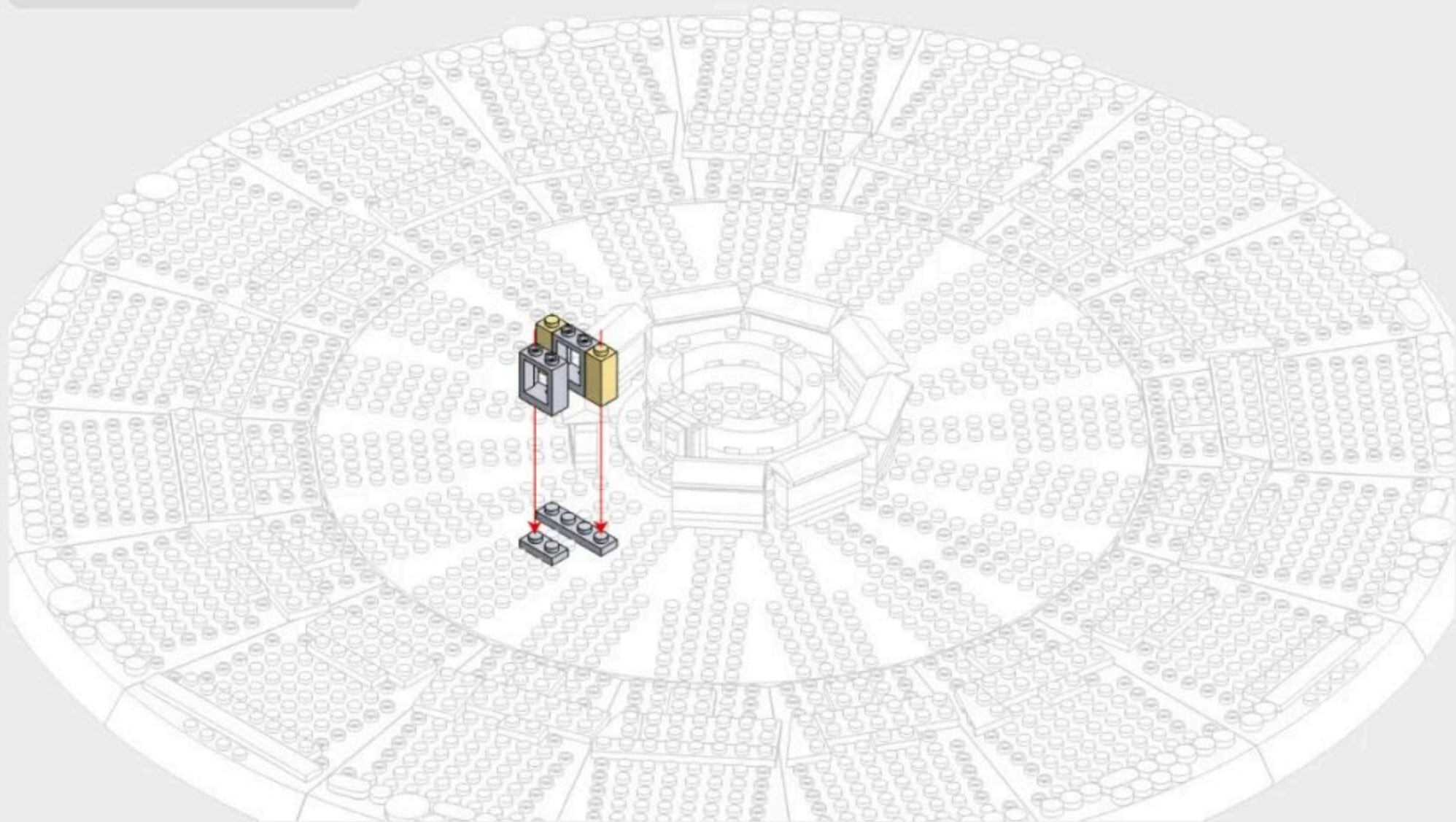

3-3

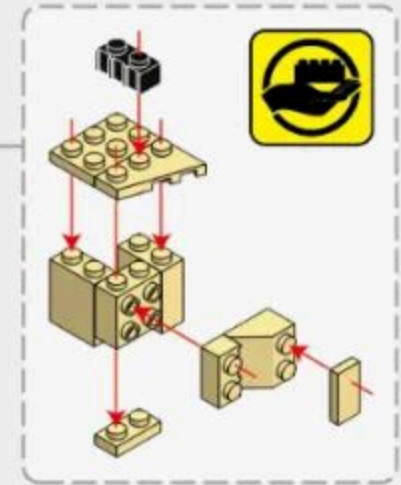
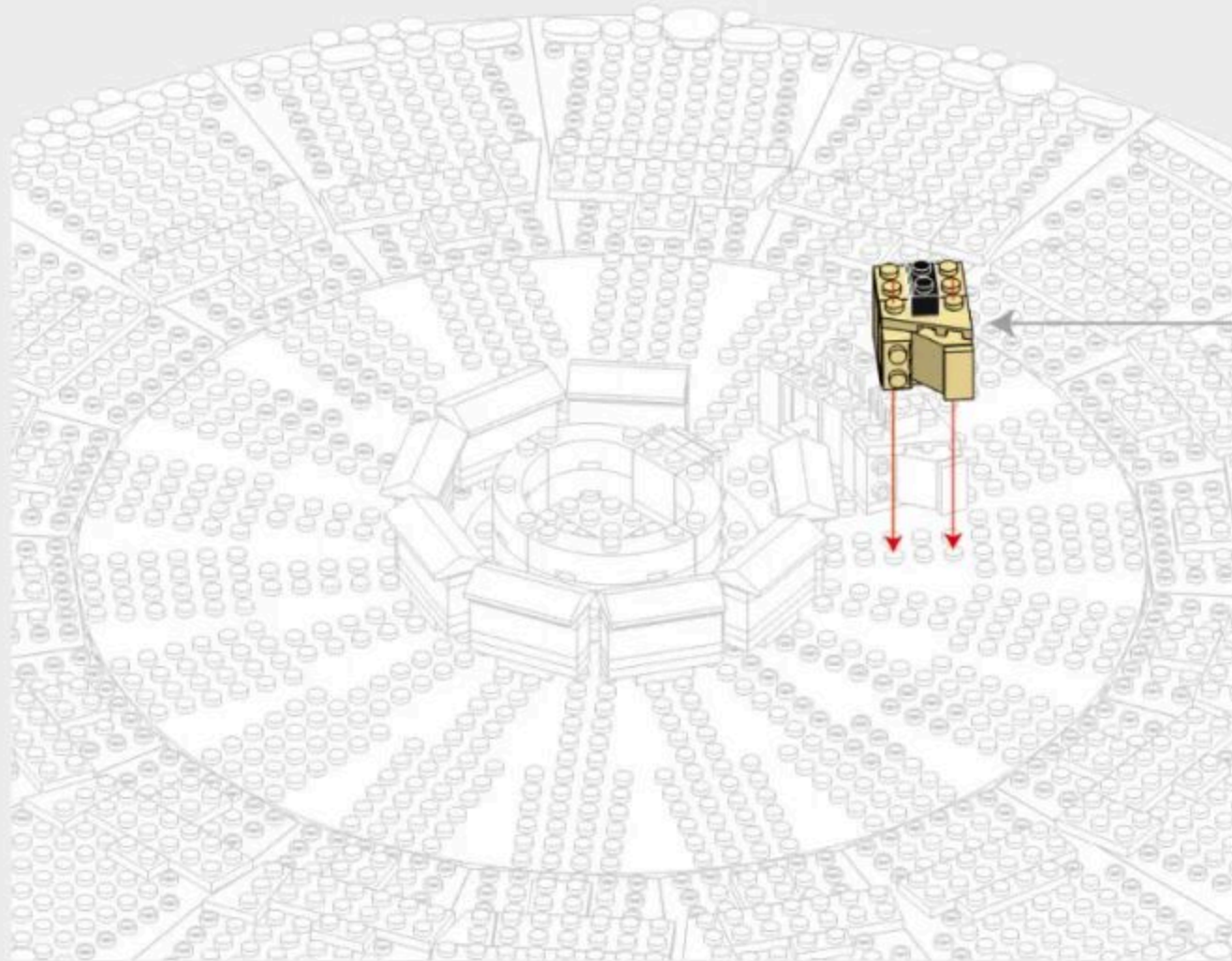
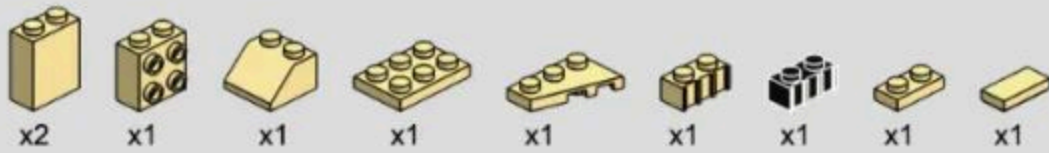

3-4

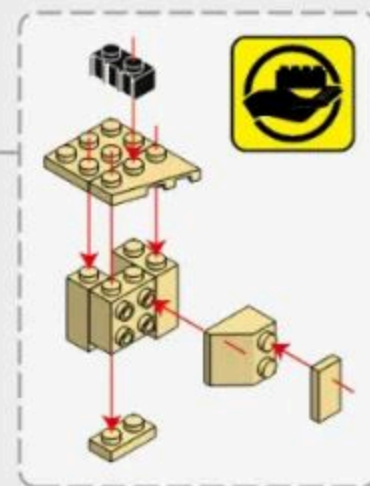
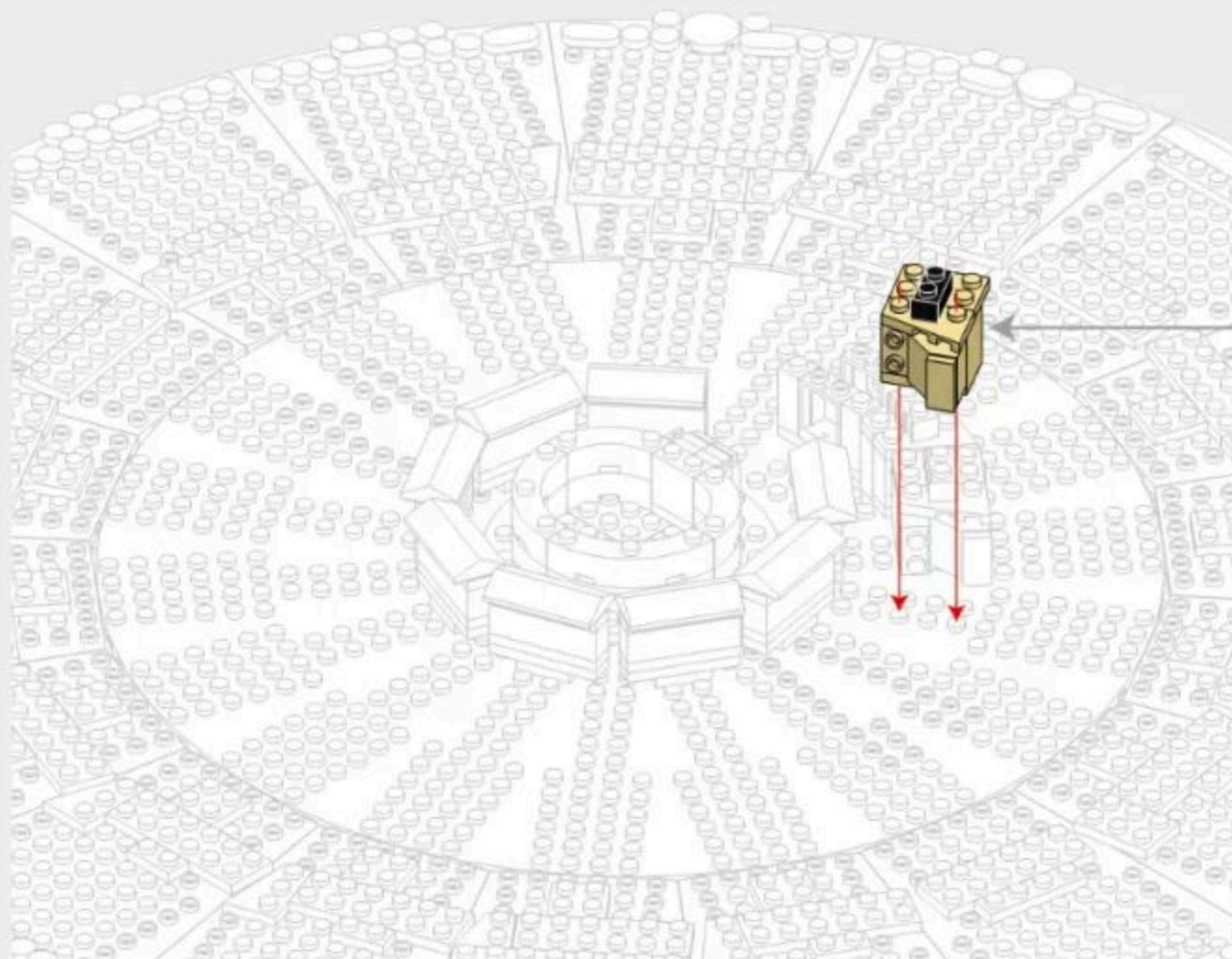

3-6

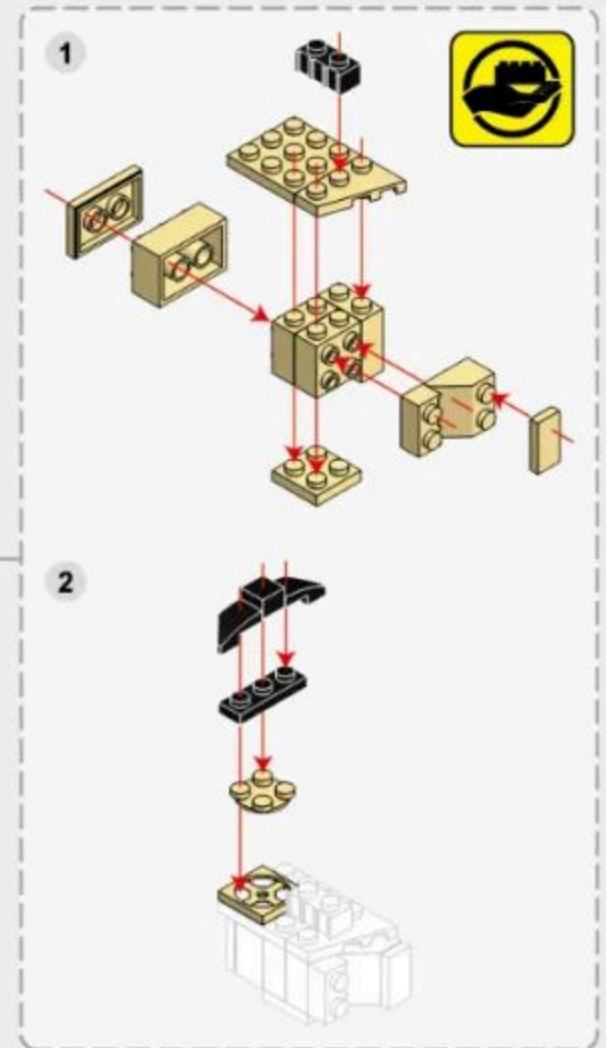
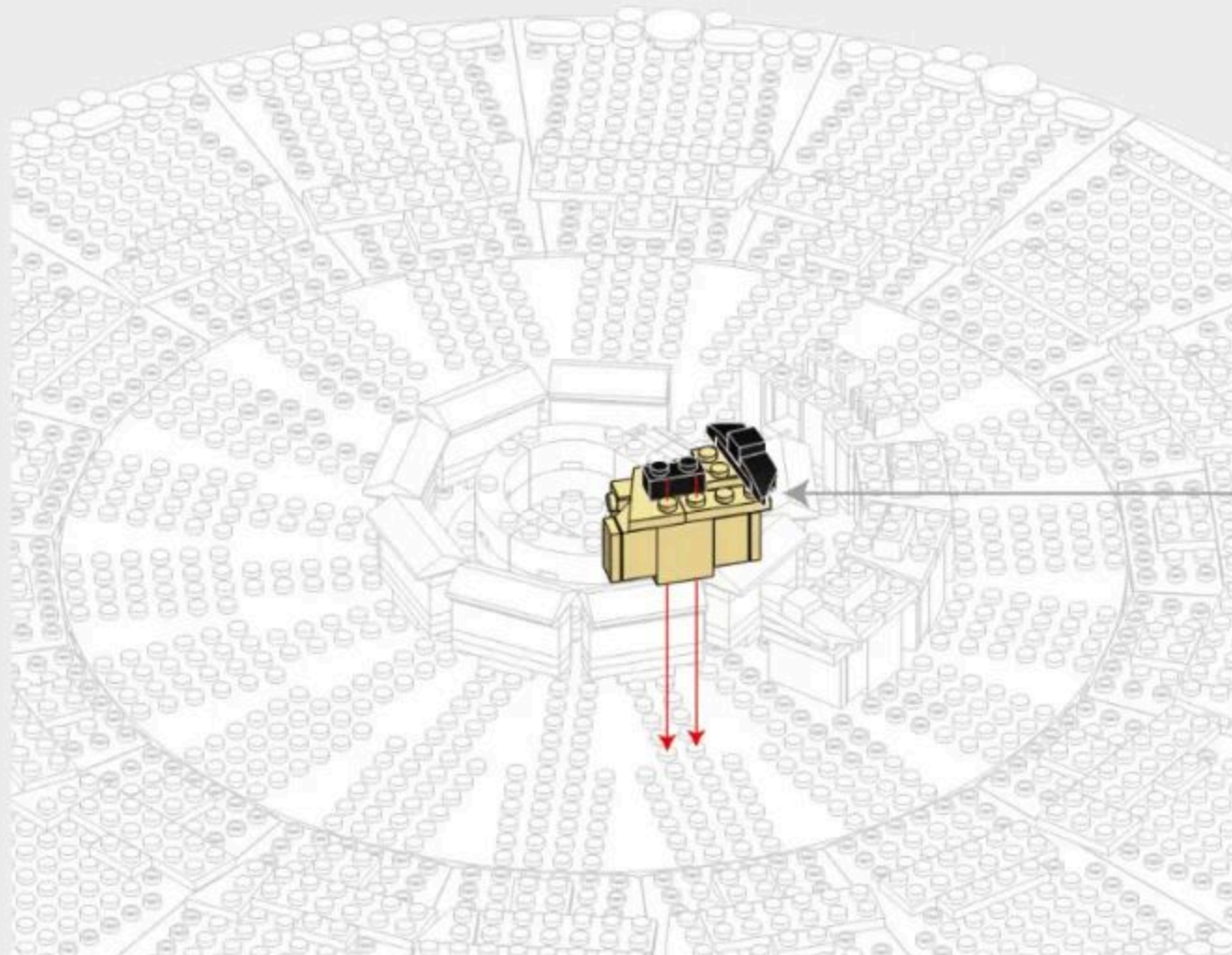

3-7

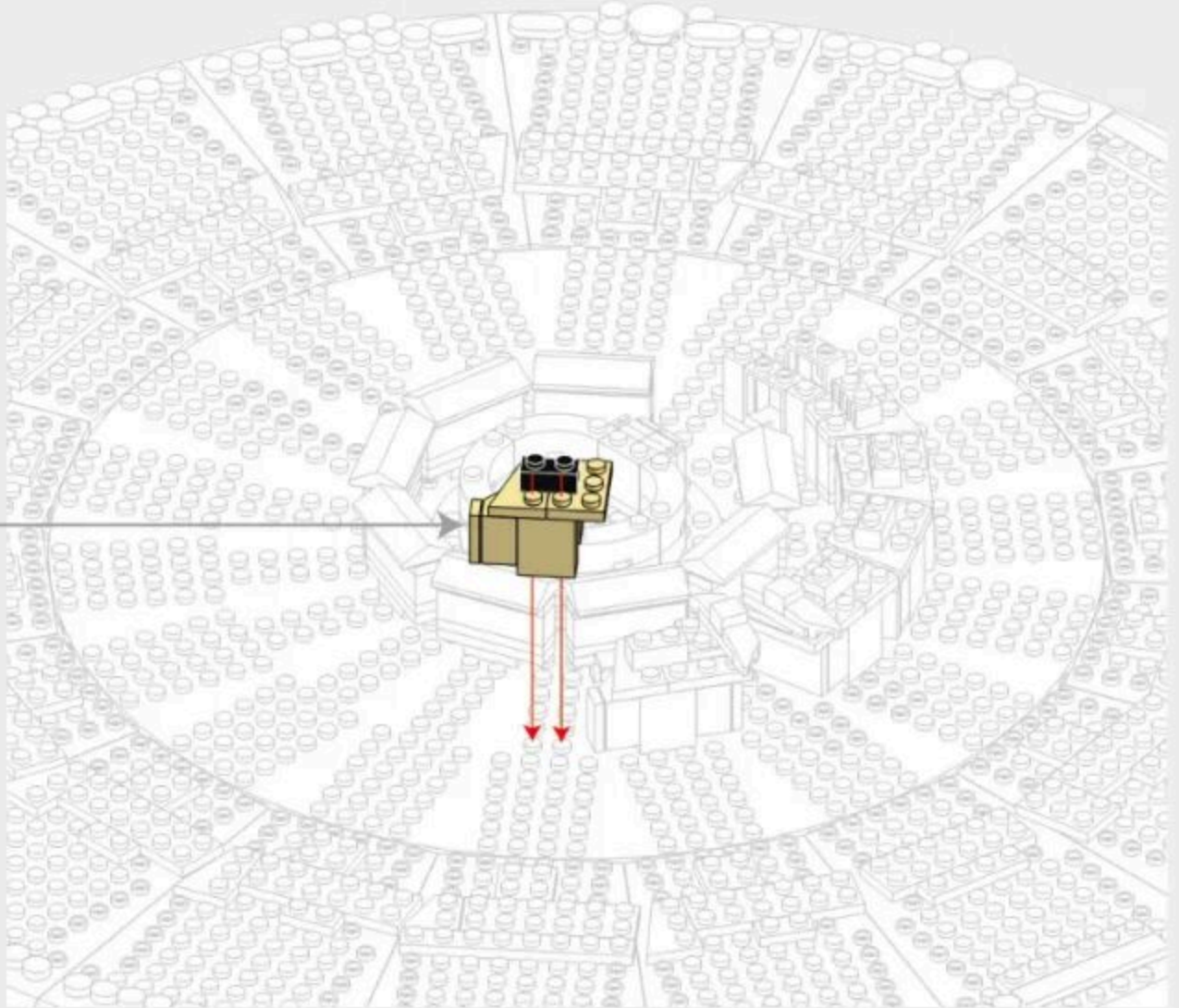
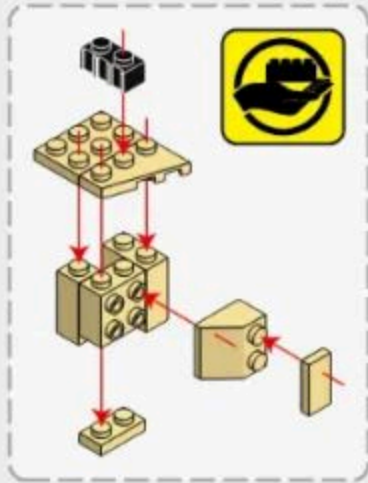

3-8

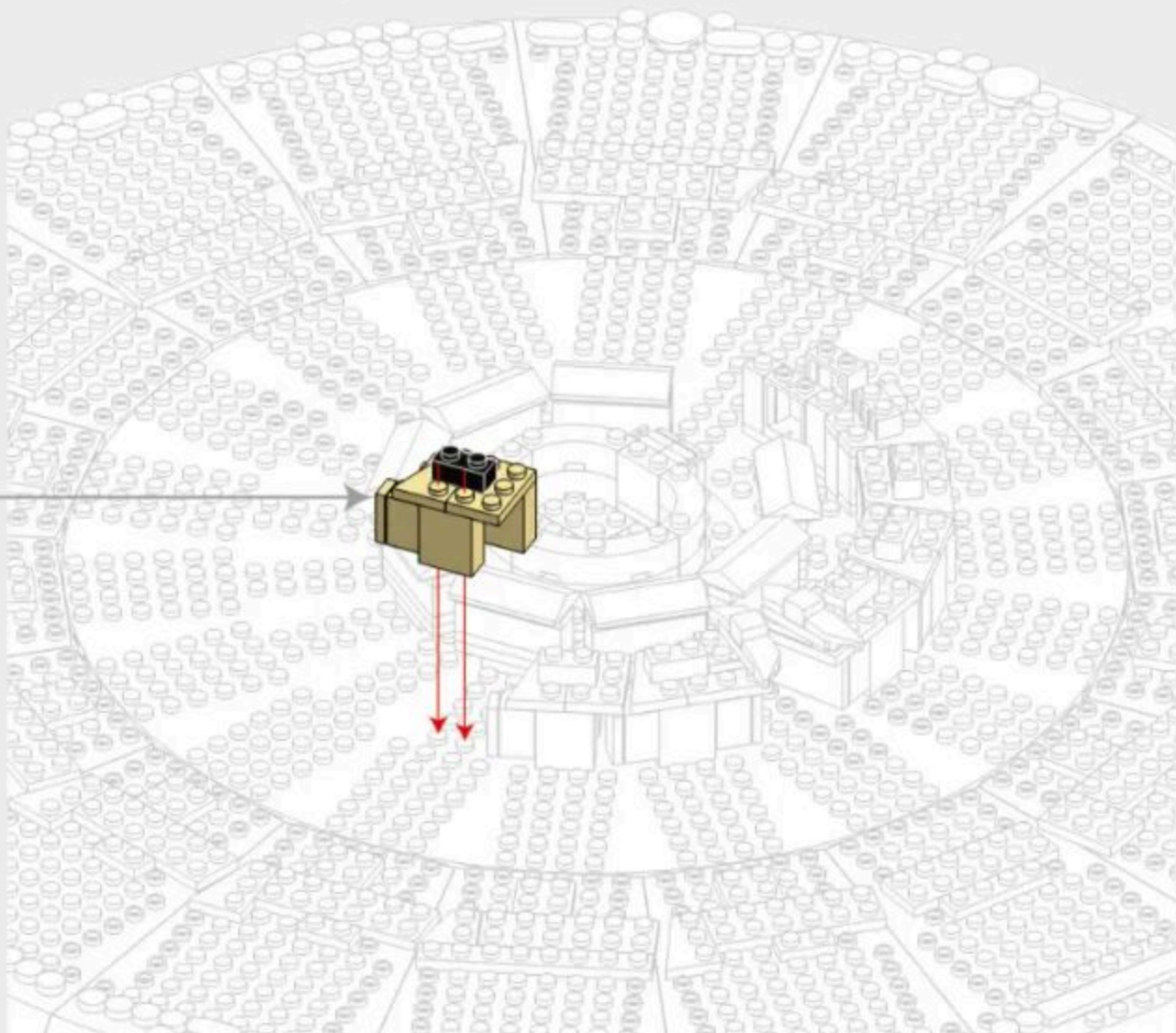
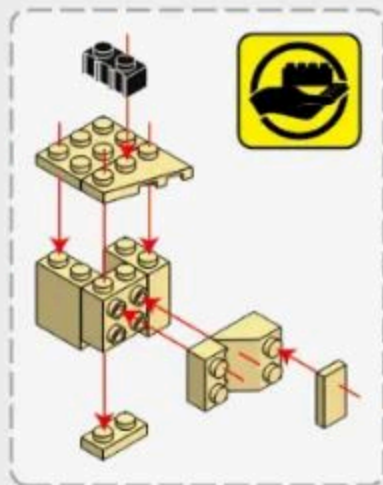
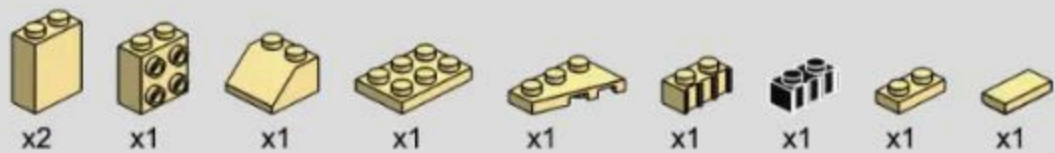

3-9

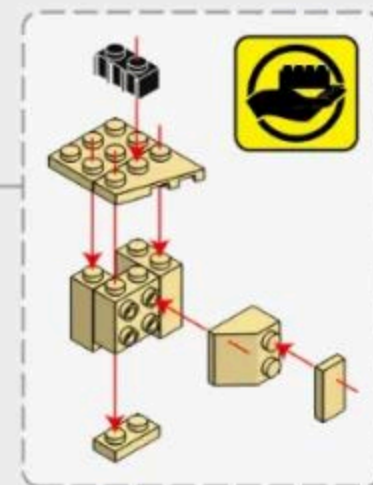
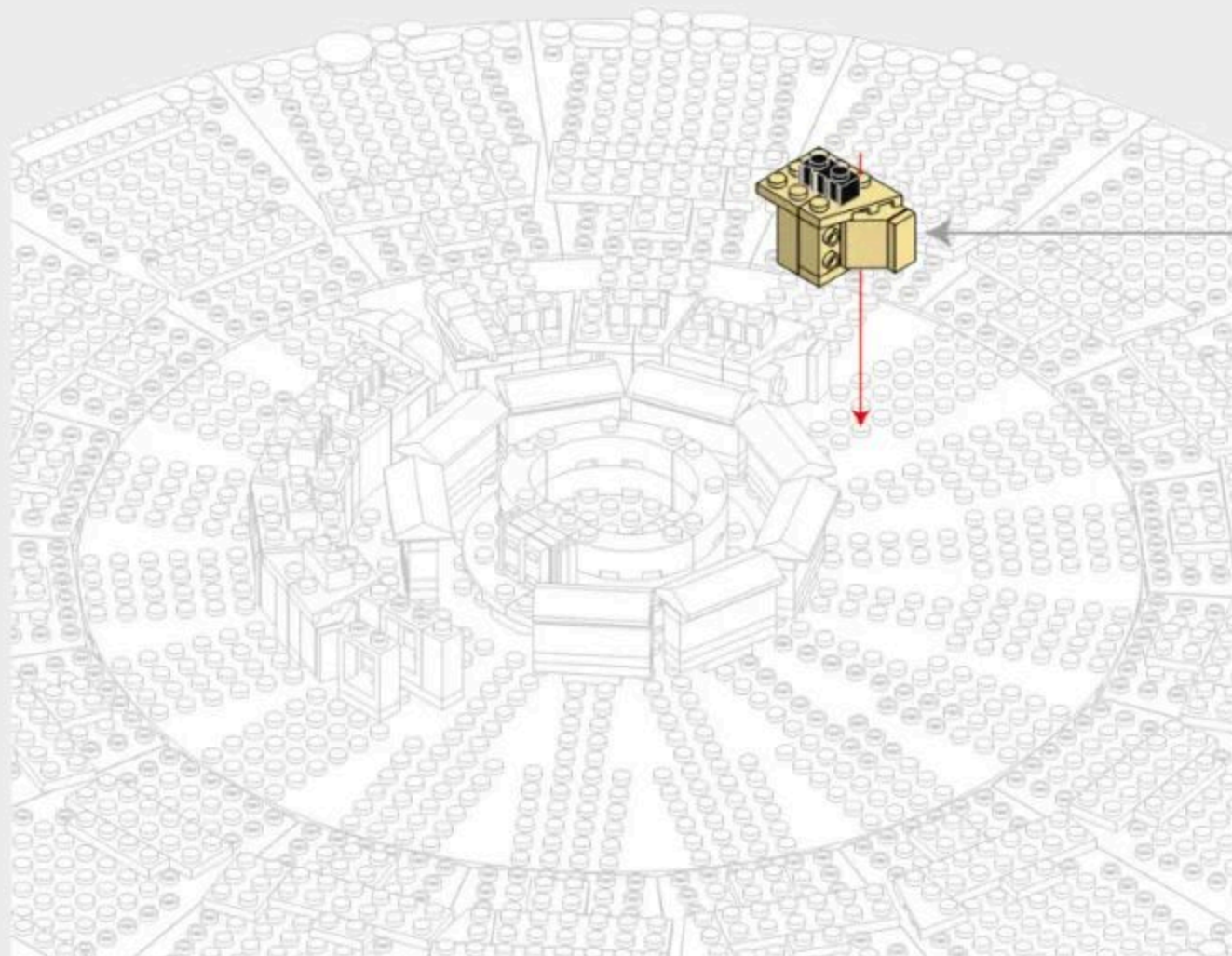

3-10

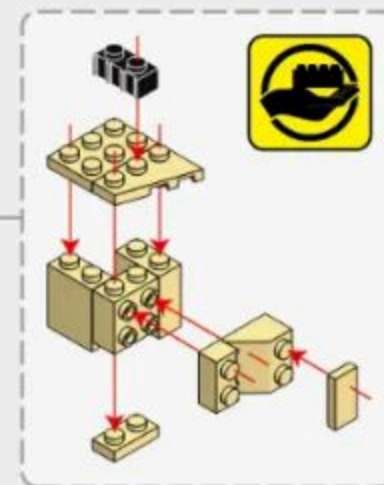
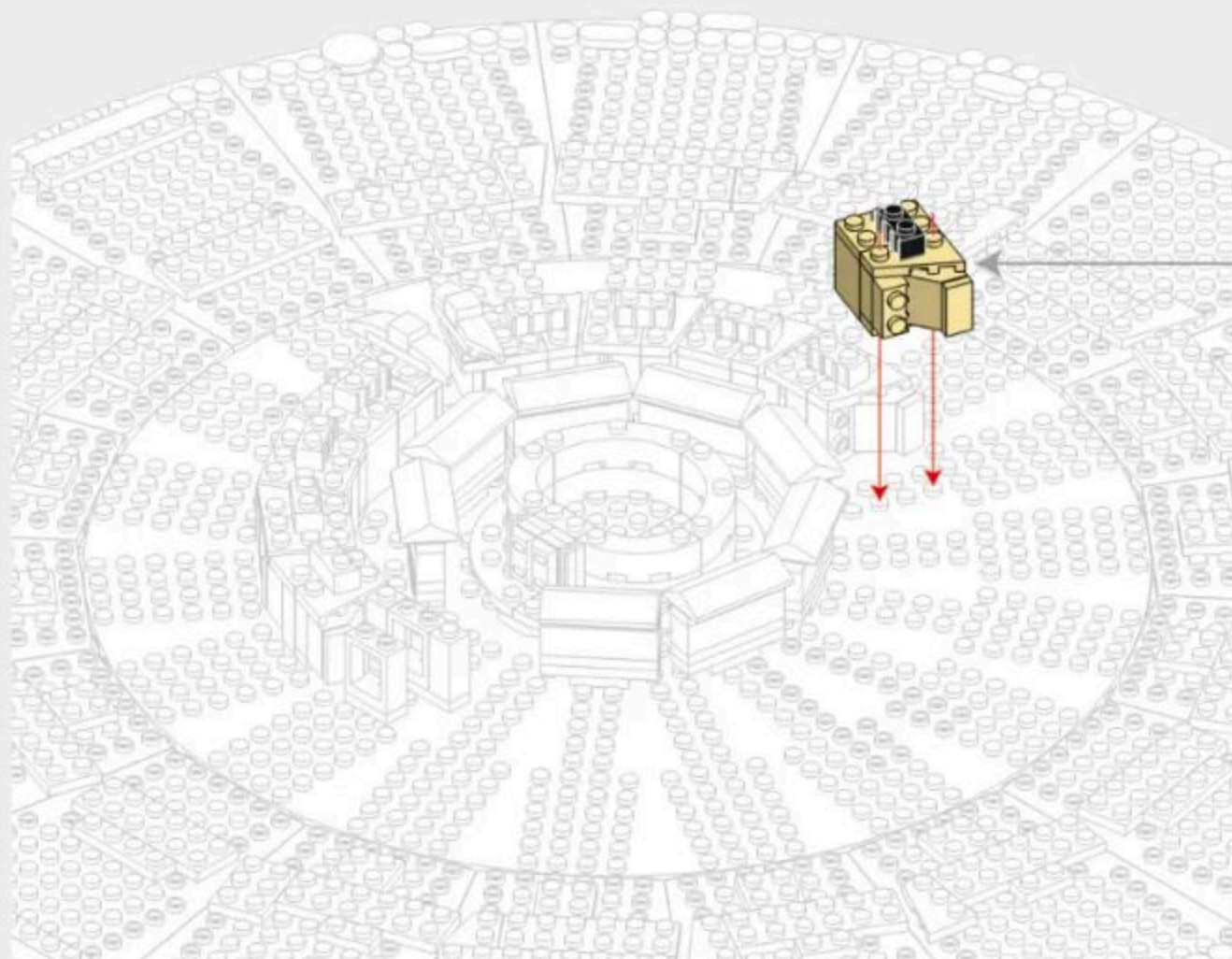
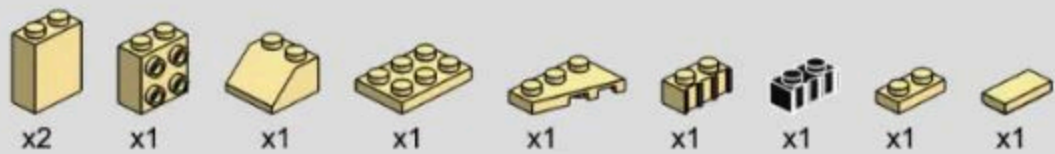

3-11

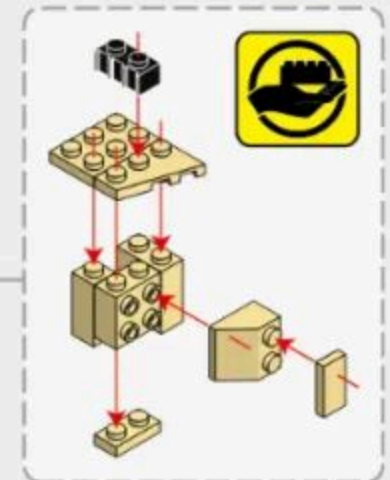
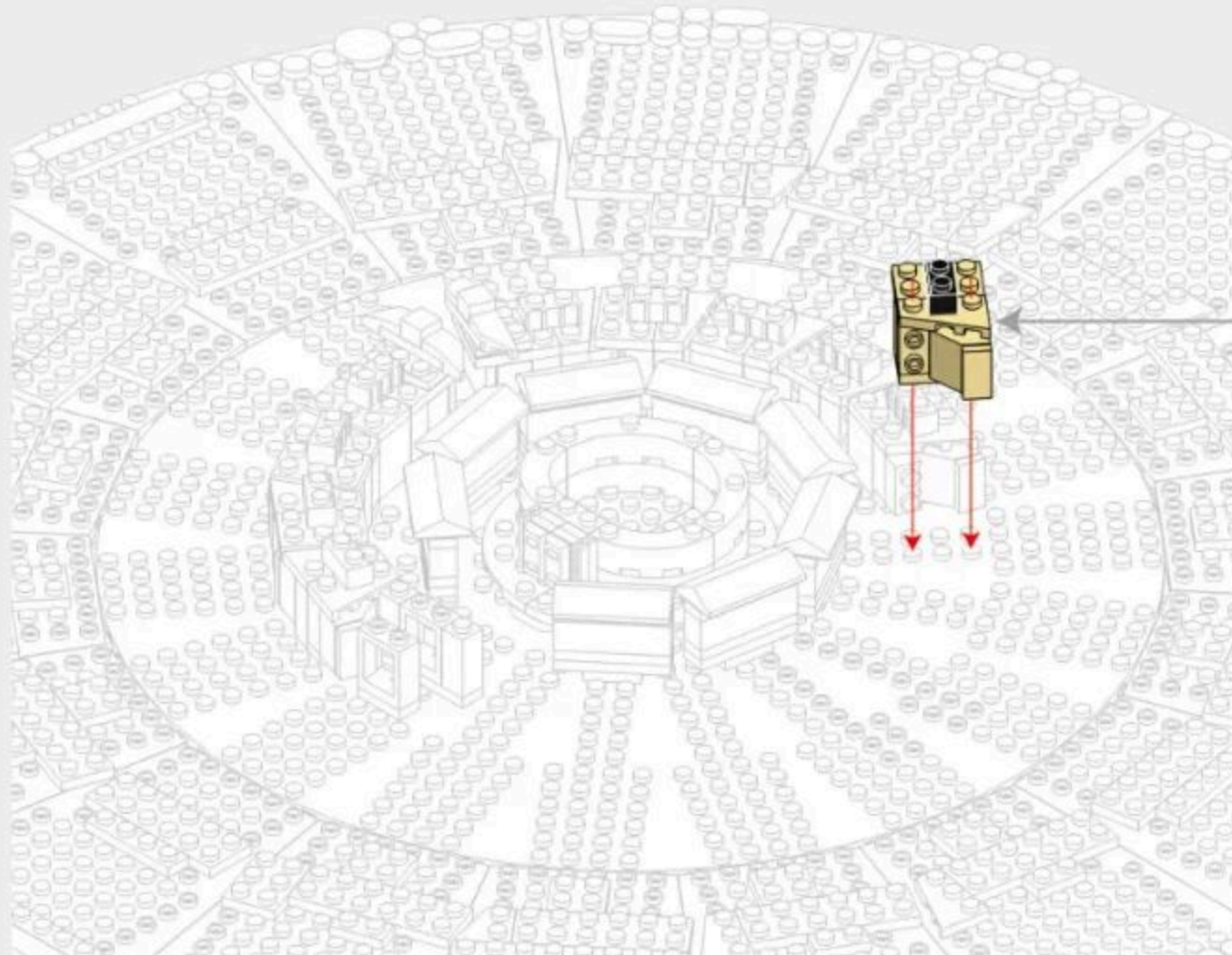

3-12

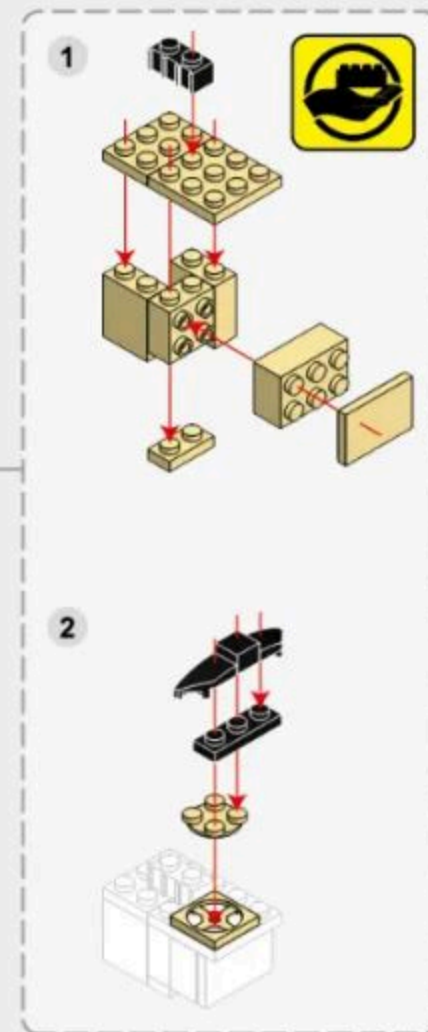
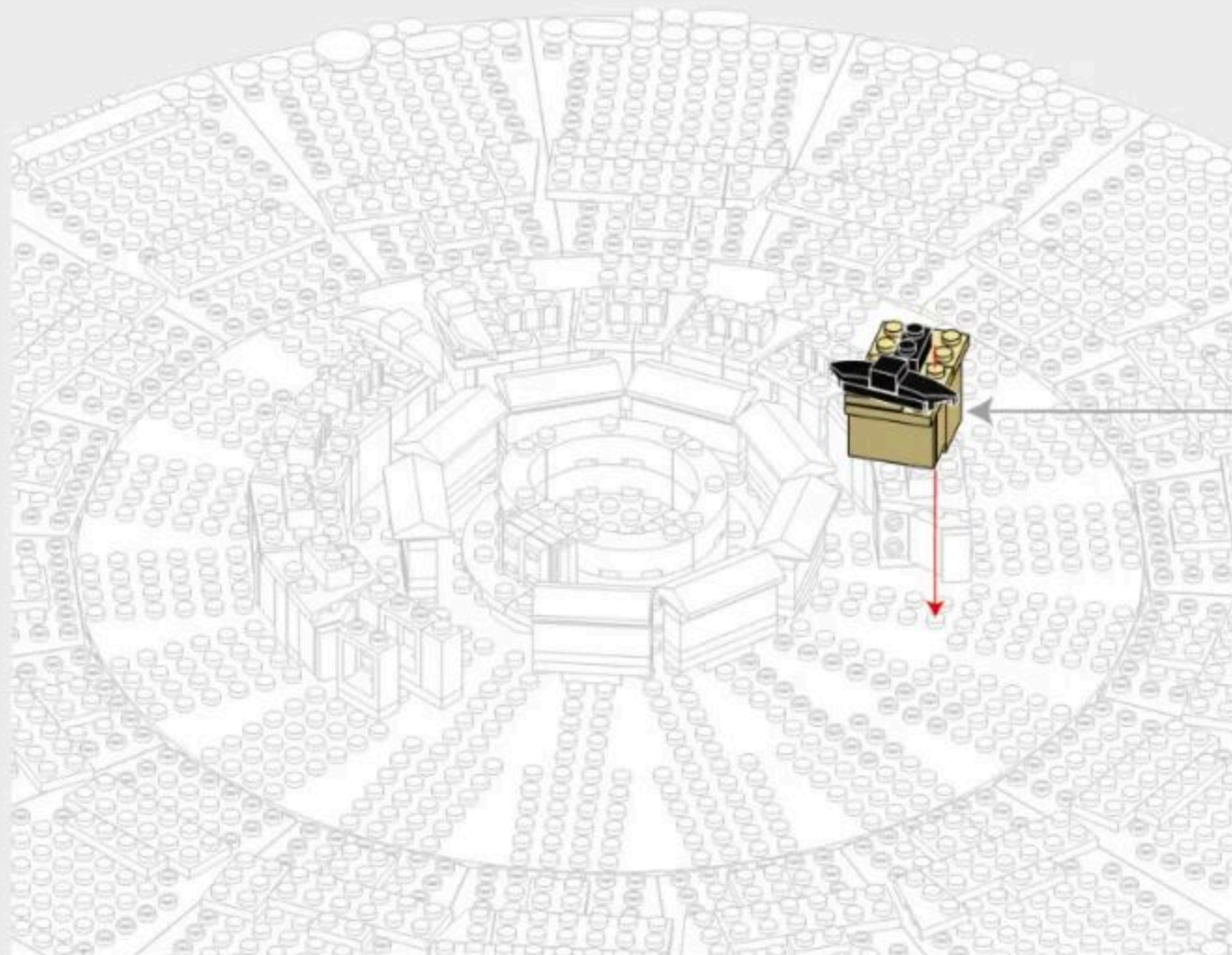

3-13

- x1
- x1
- x2
- x1
- x1
- x1
- x1
- x1
- x1
- x1
- x1
- x1
- x1
- x1
- x1
- x1
- x1
- x1
- x1

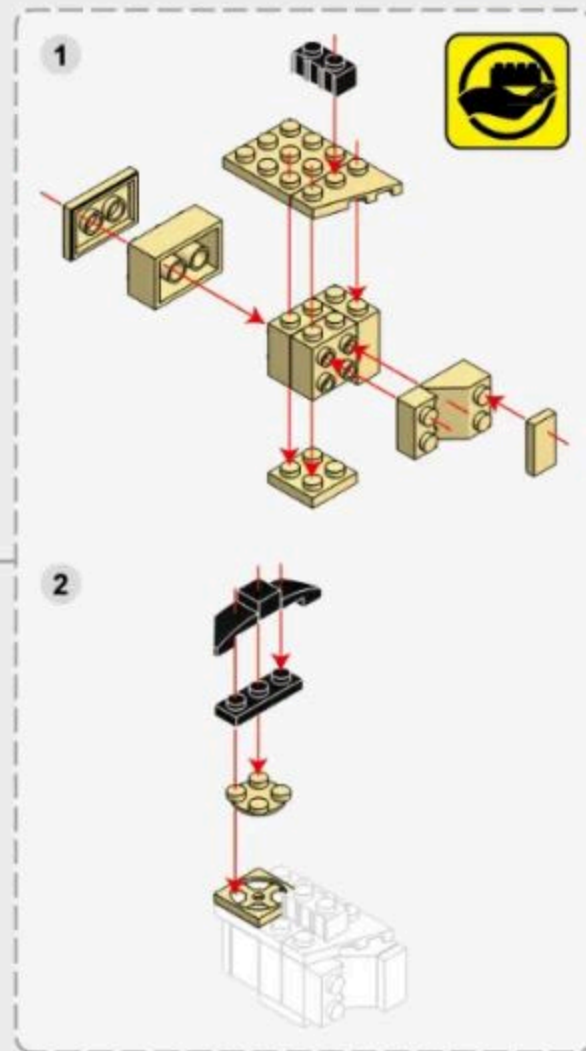
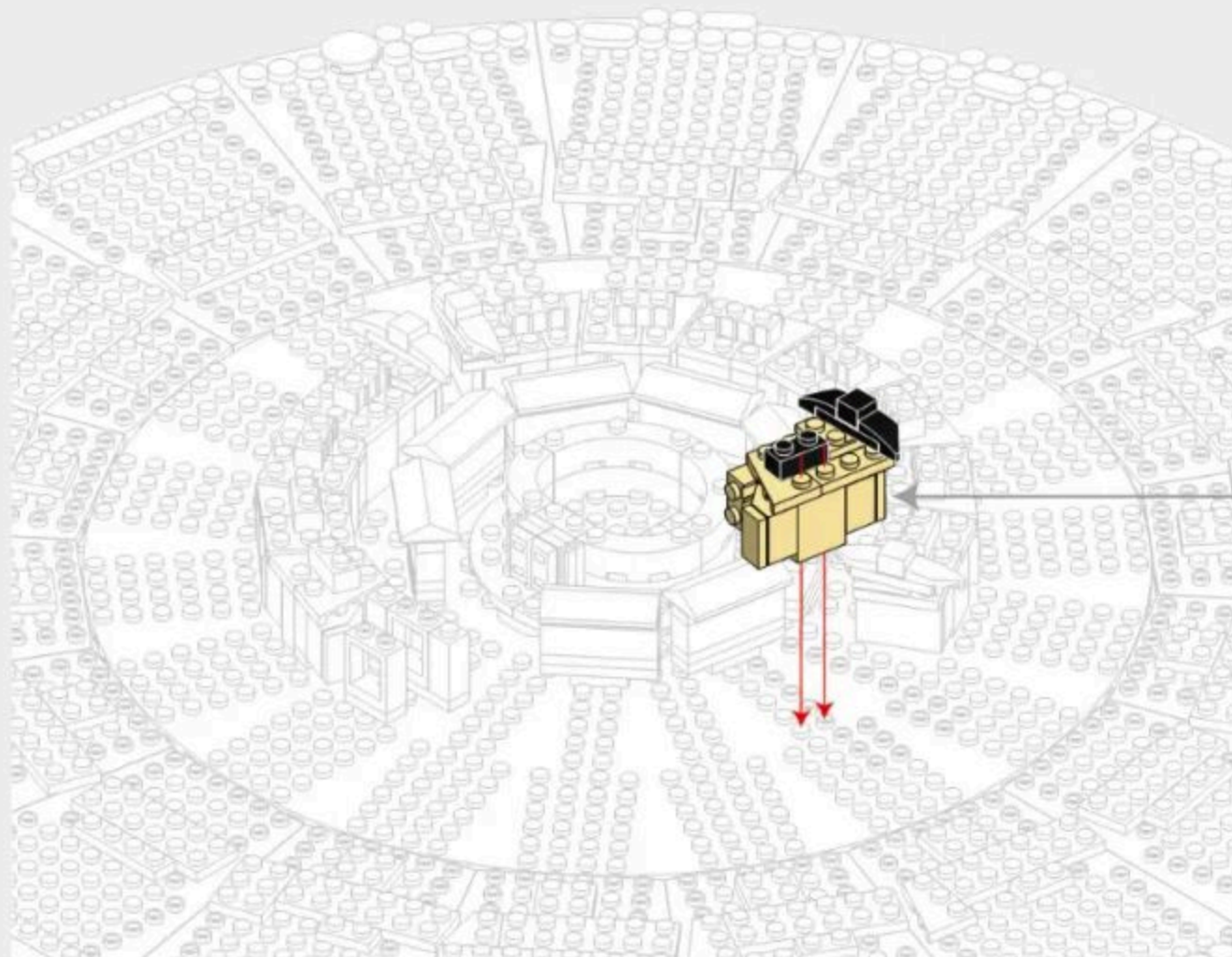

3-14

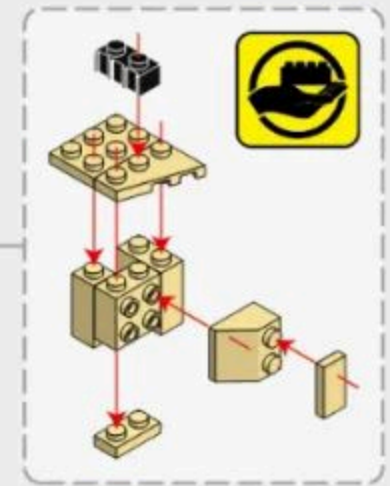
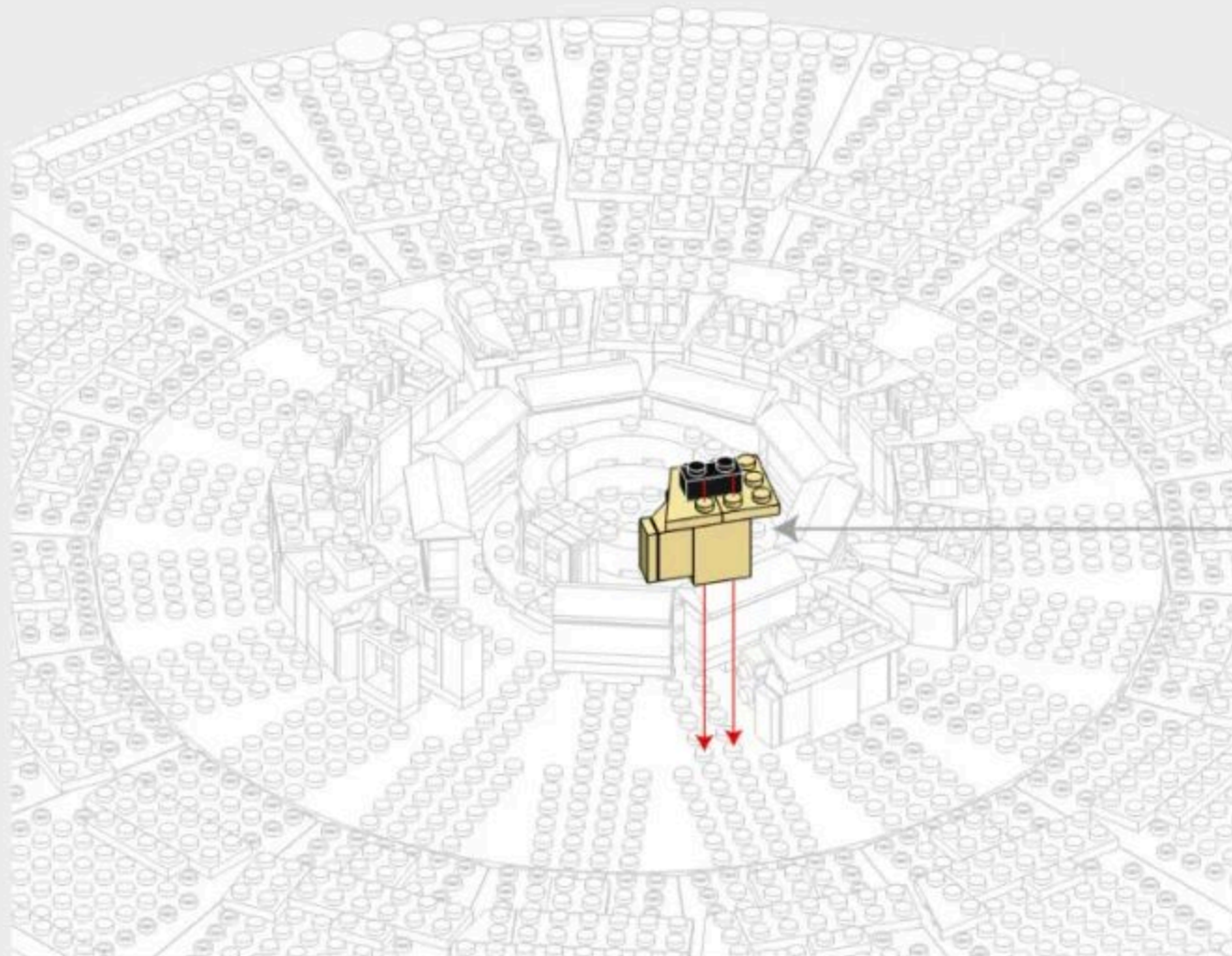

3-15

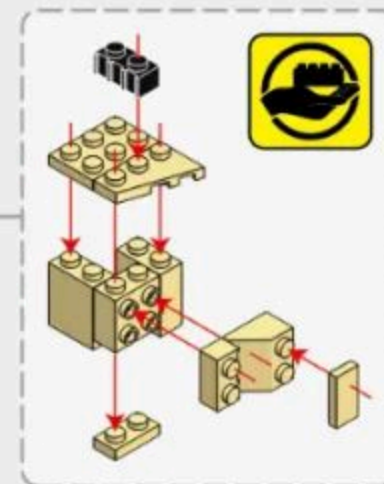
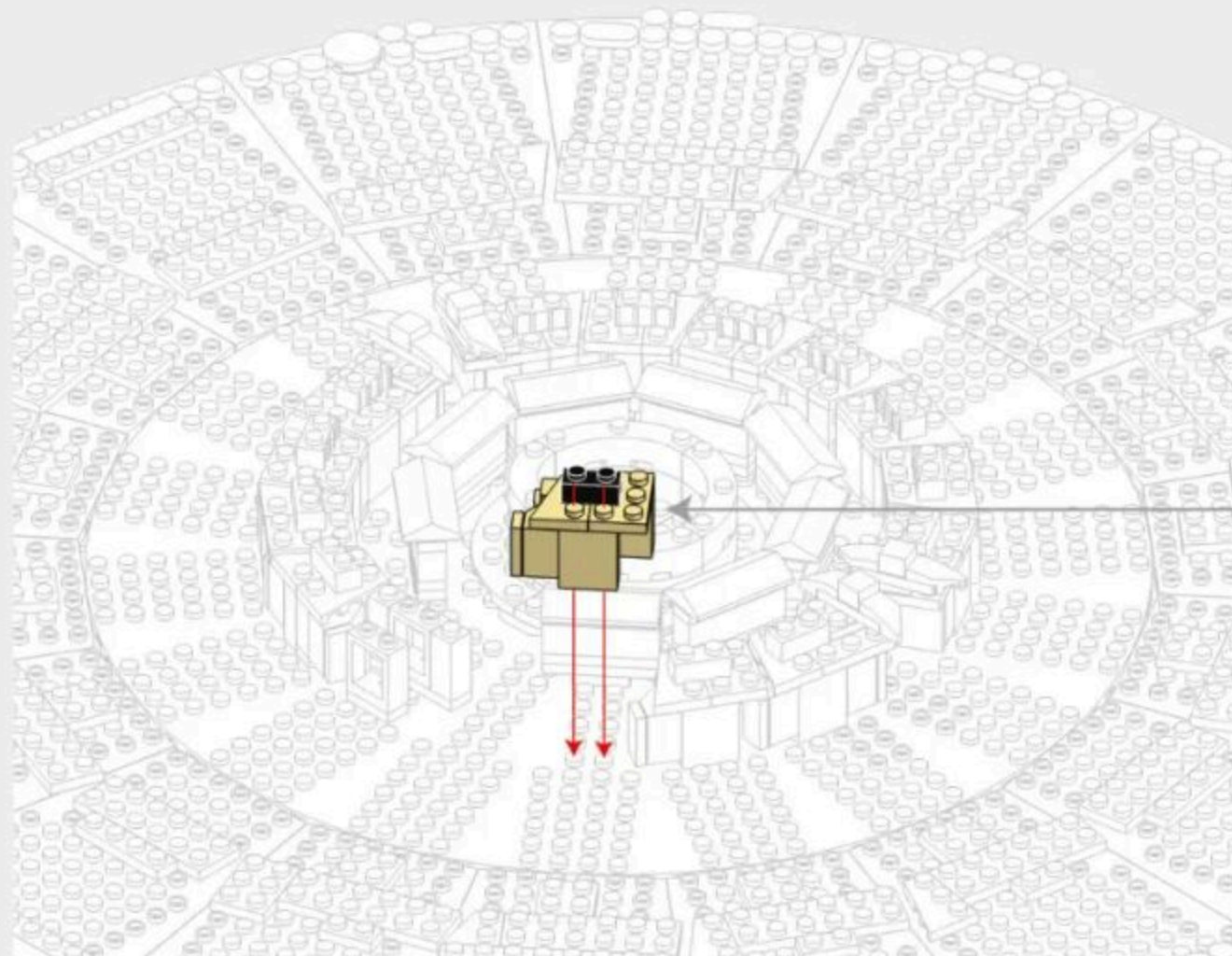
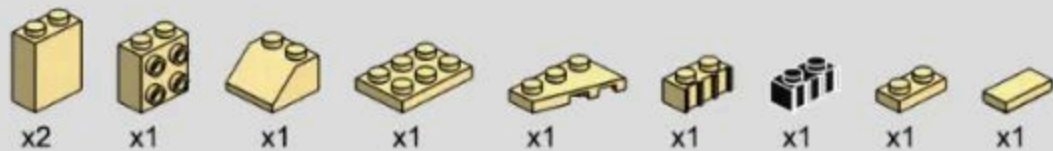

3-16

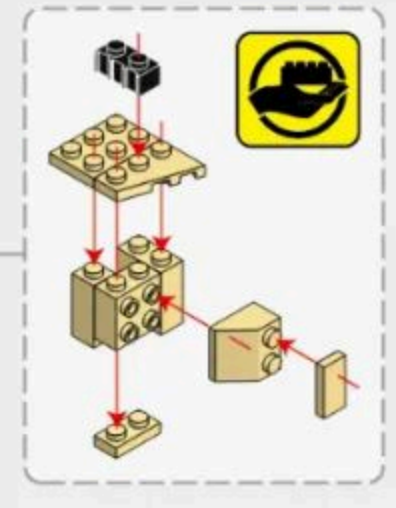
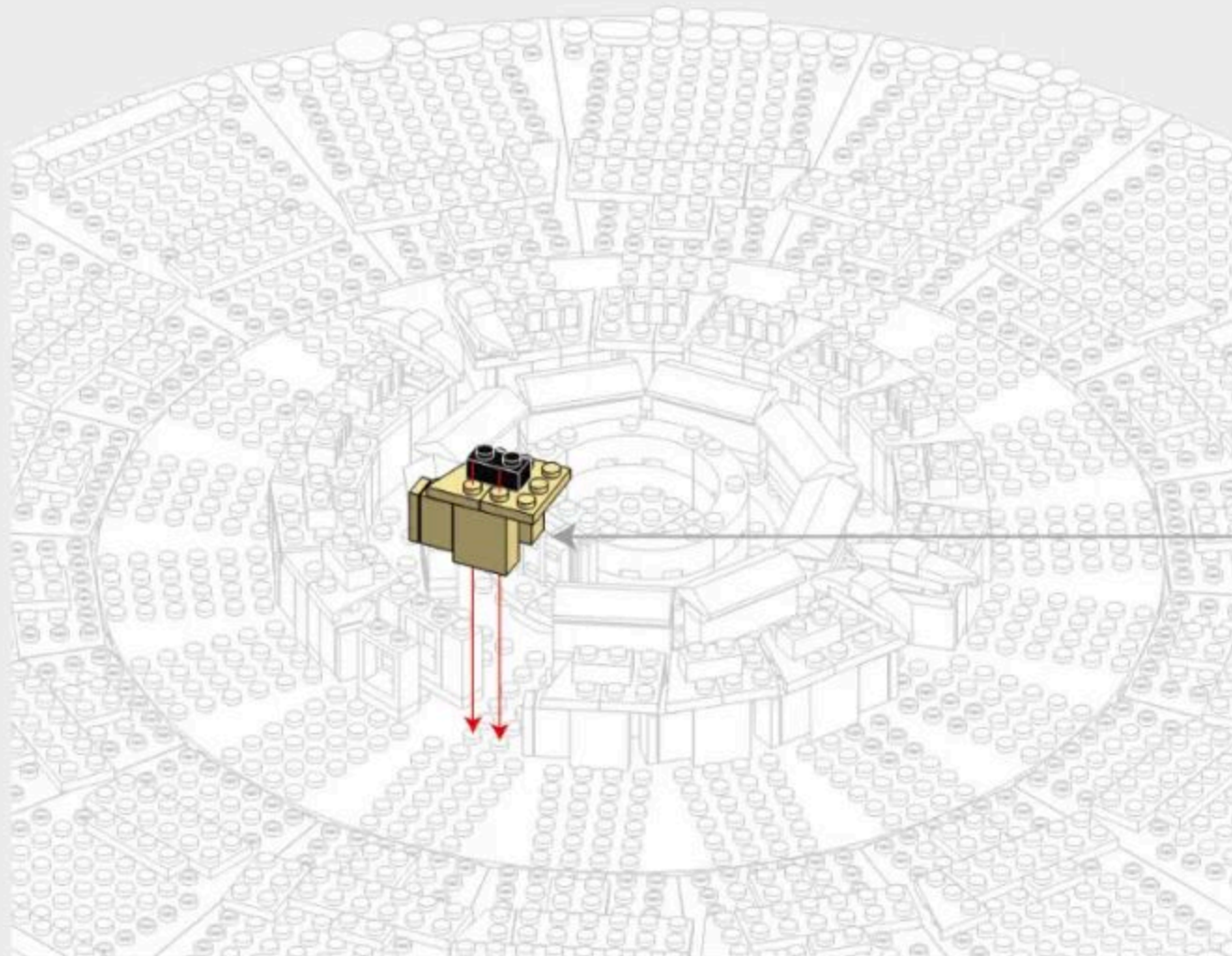

3-17

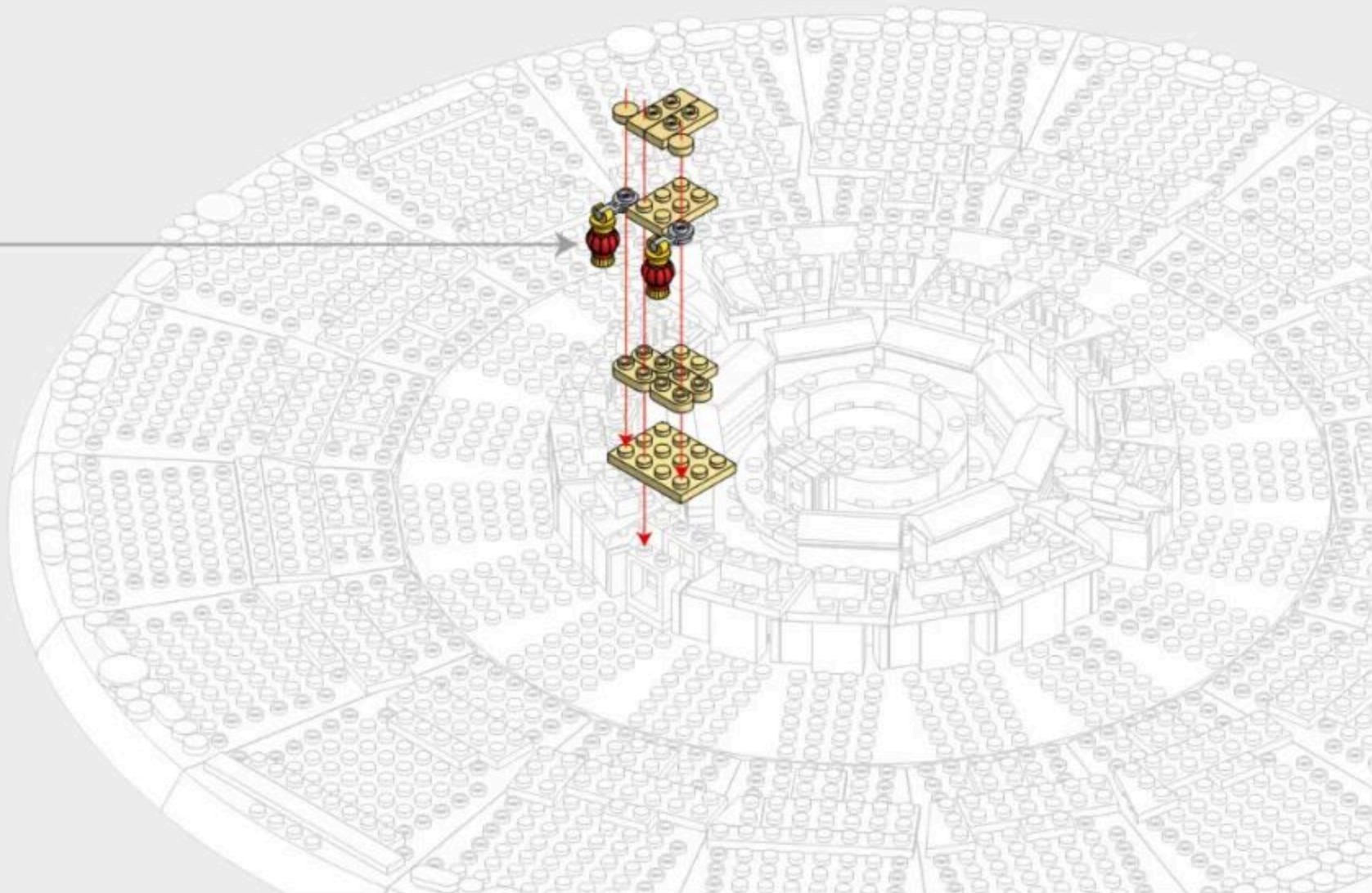

3-18

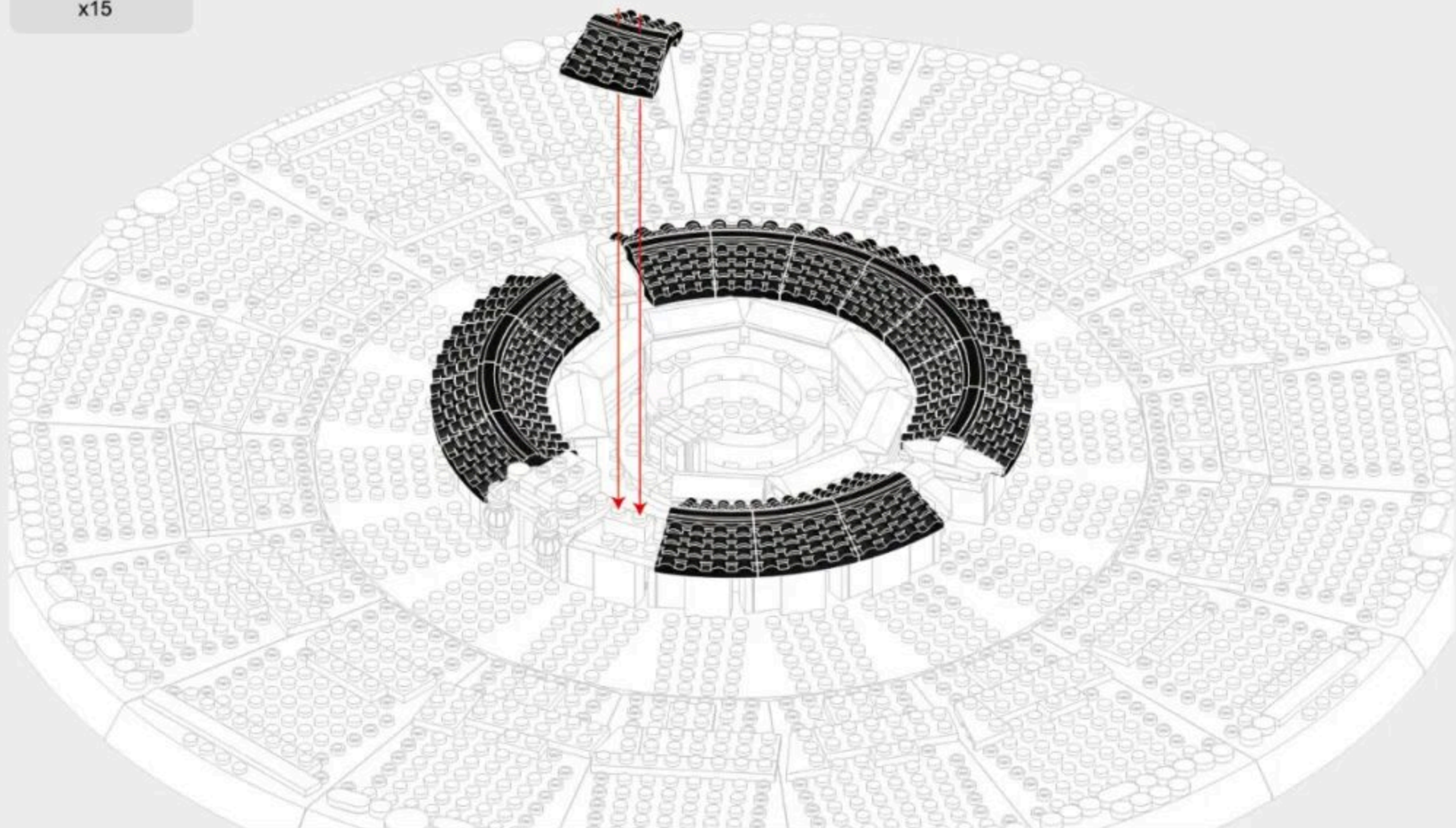

3-19

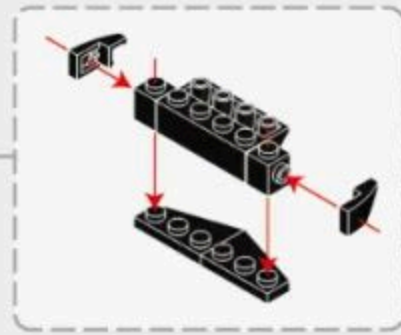
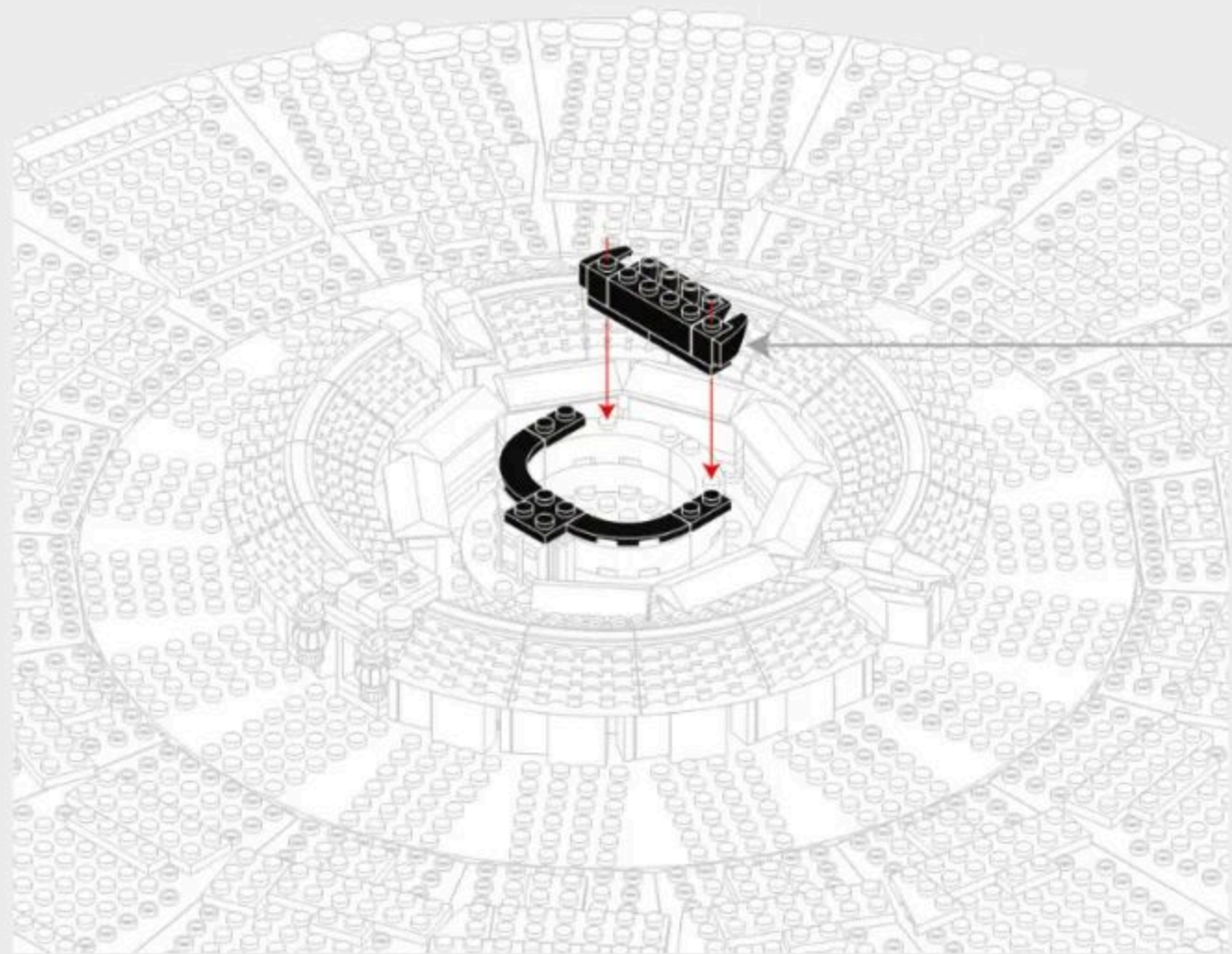

3-20

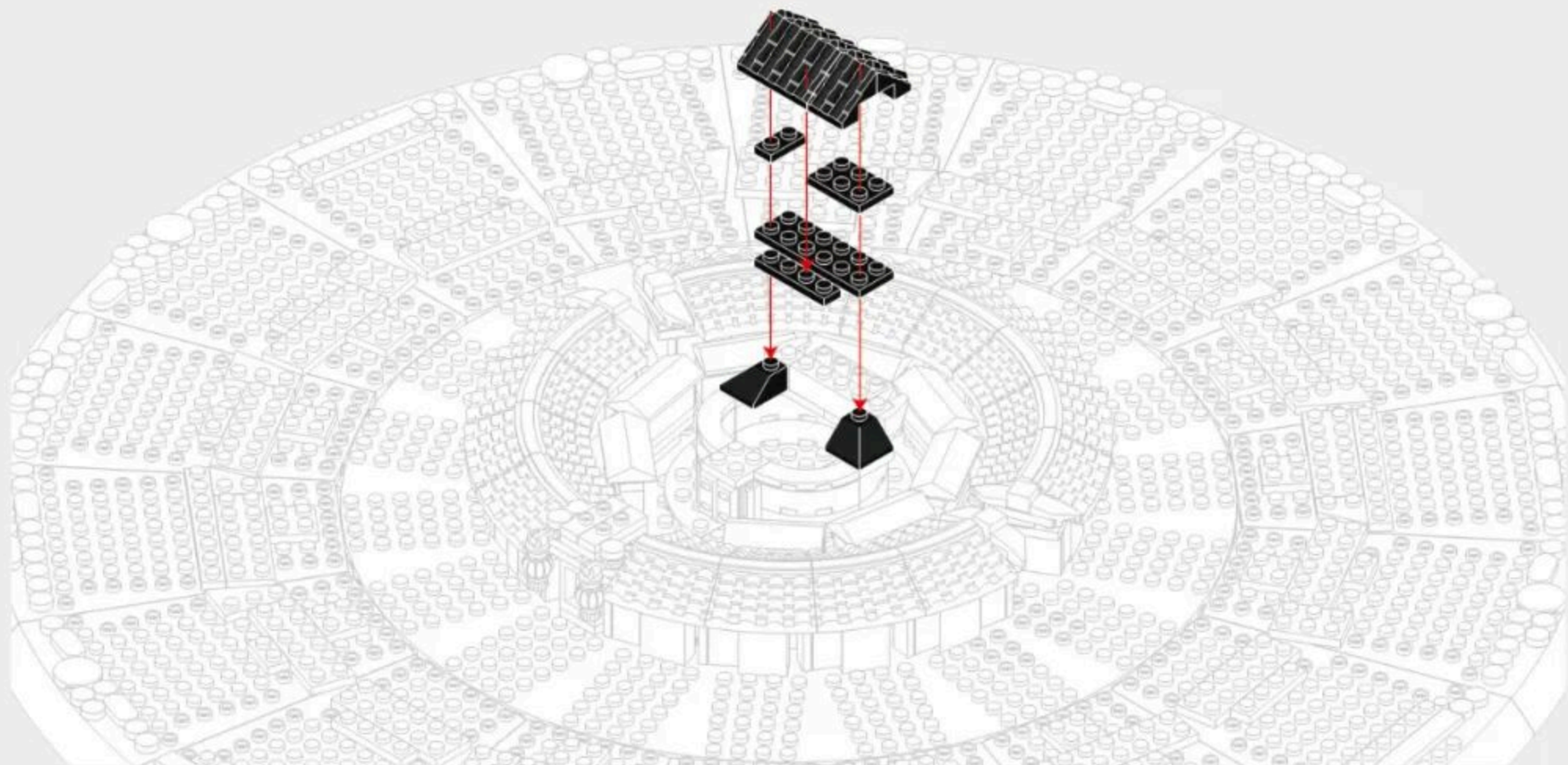

3-21

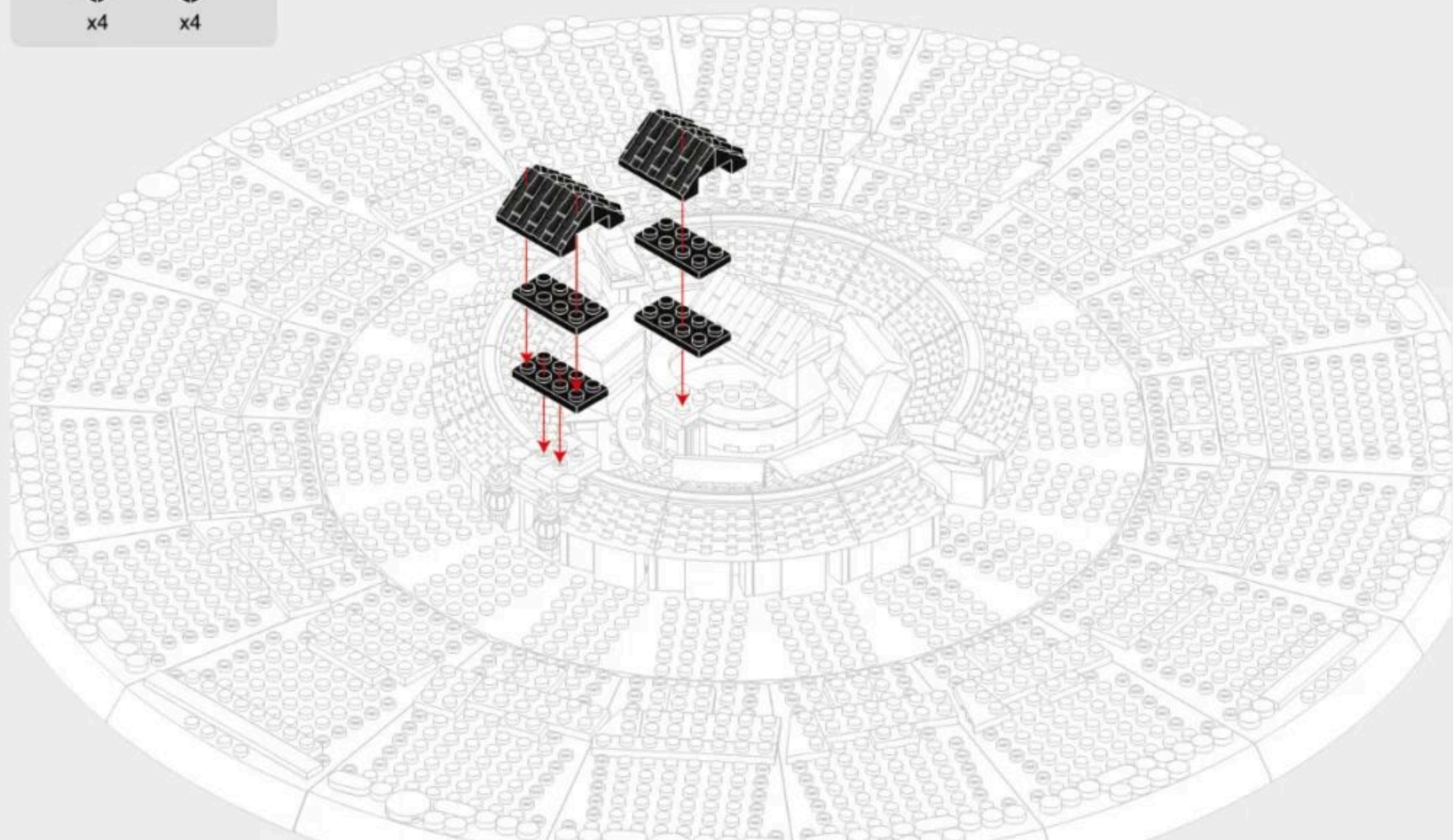
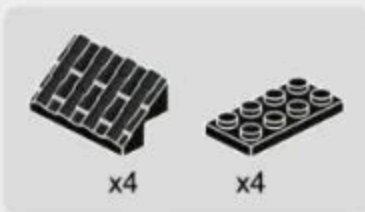



273PCS

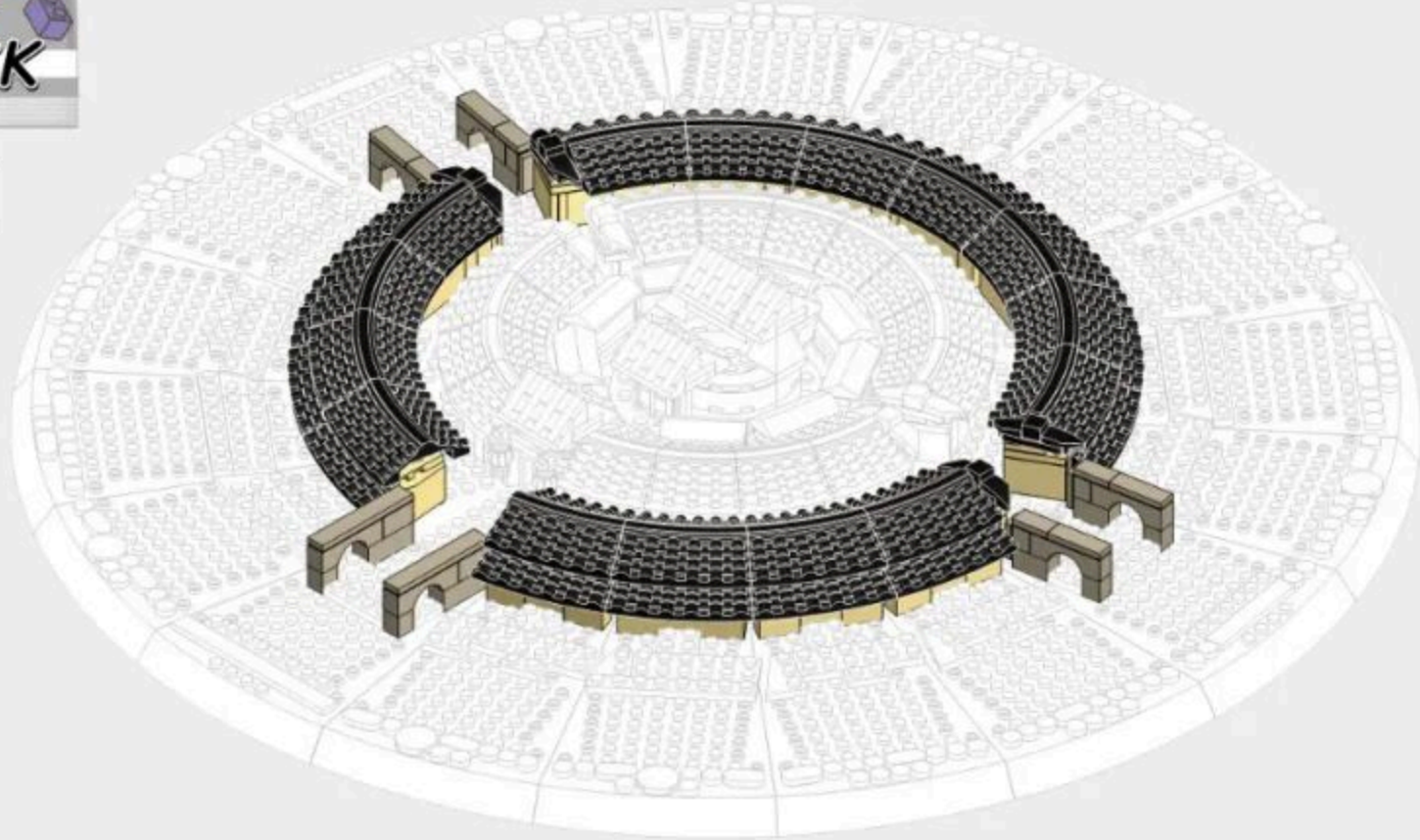

4-1

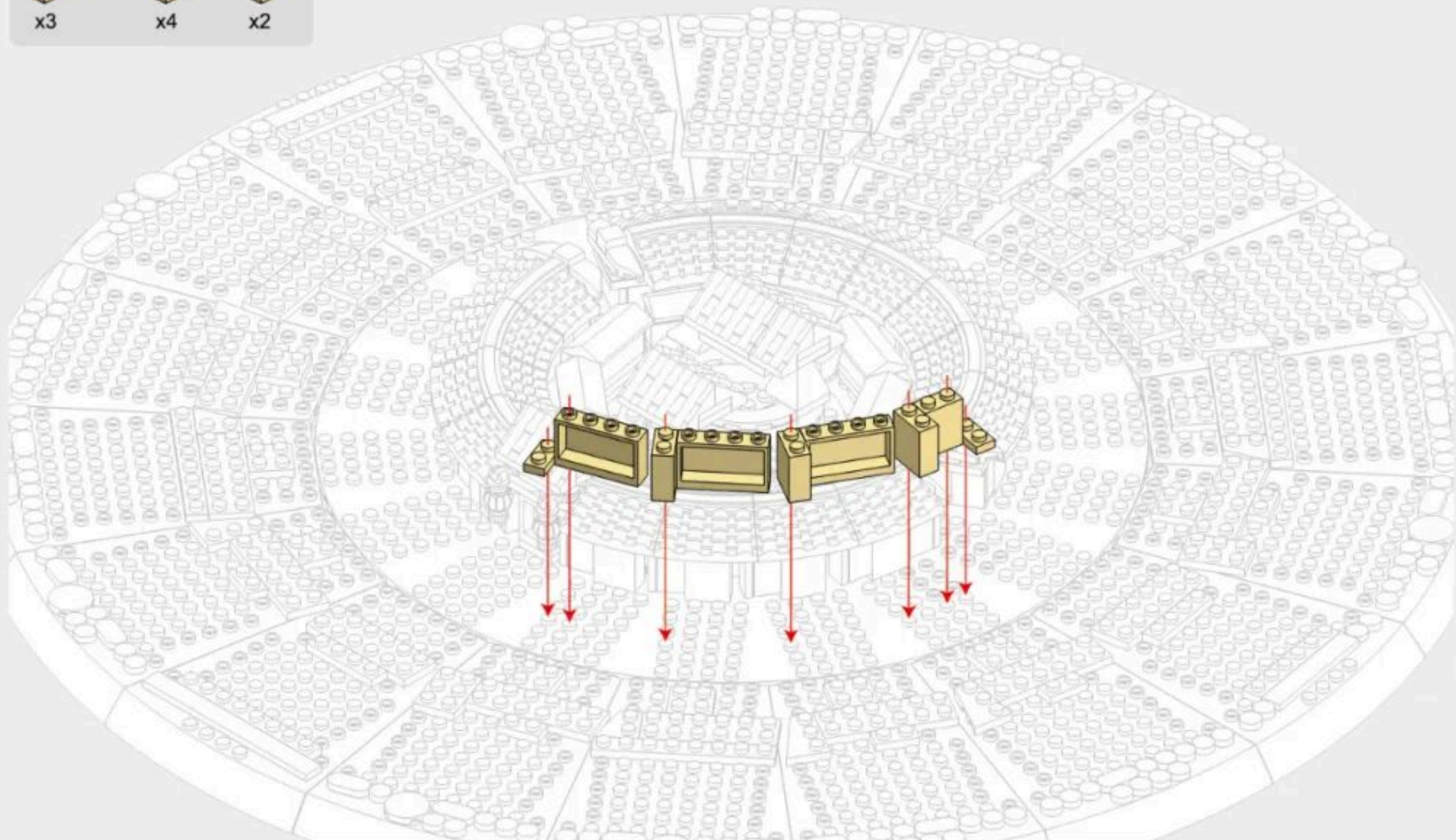
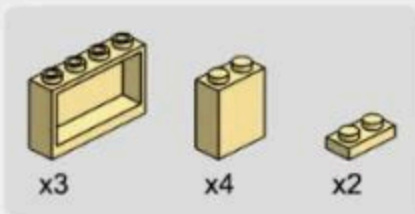

4-2

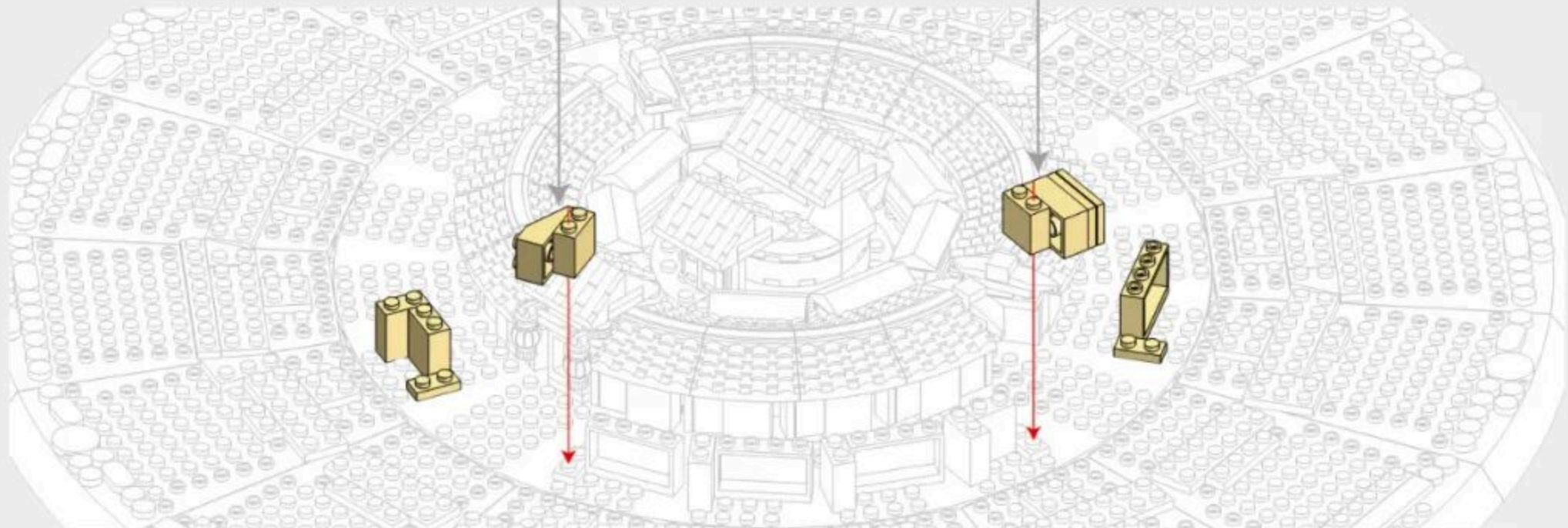
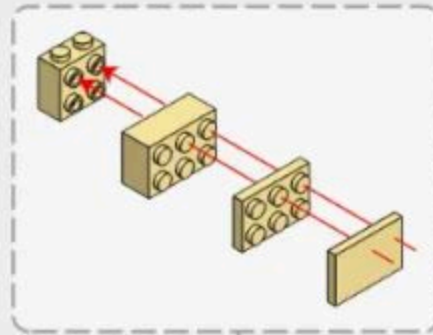
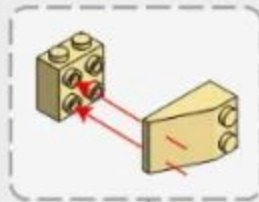
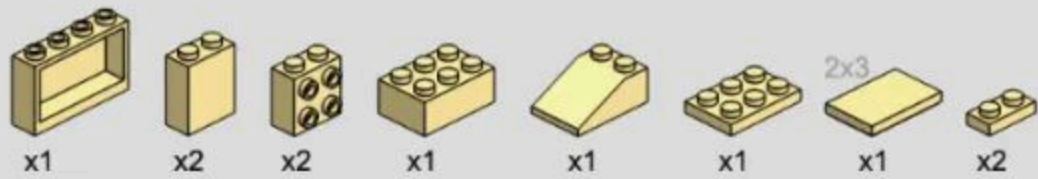

4-3

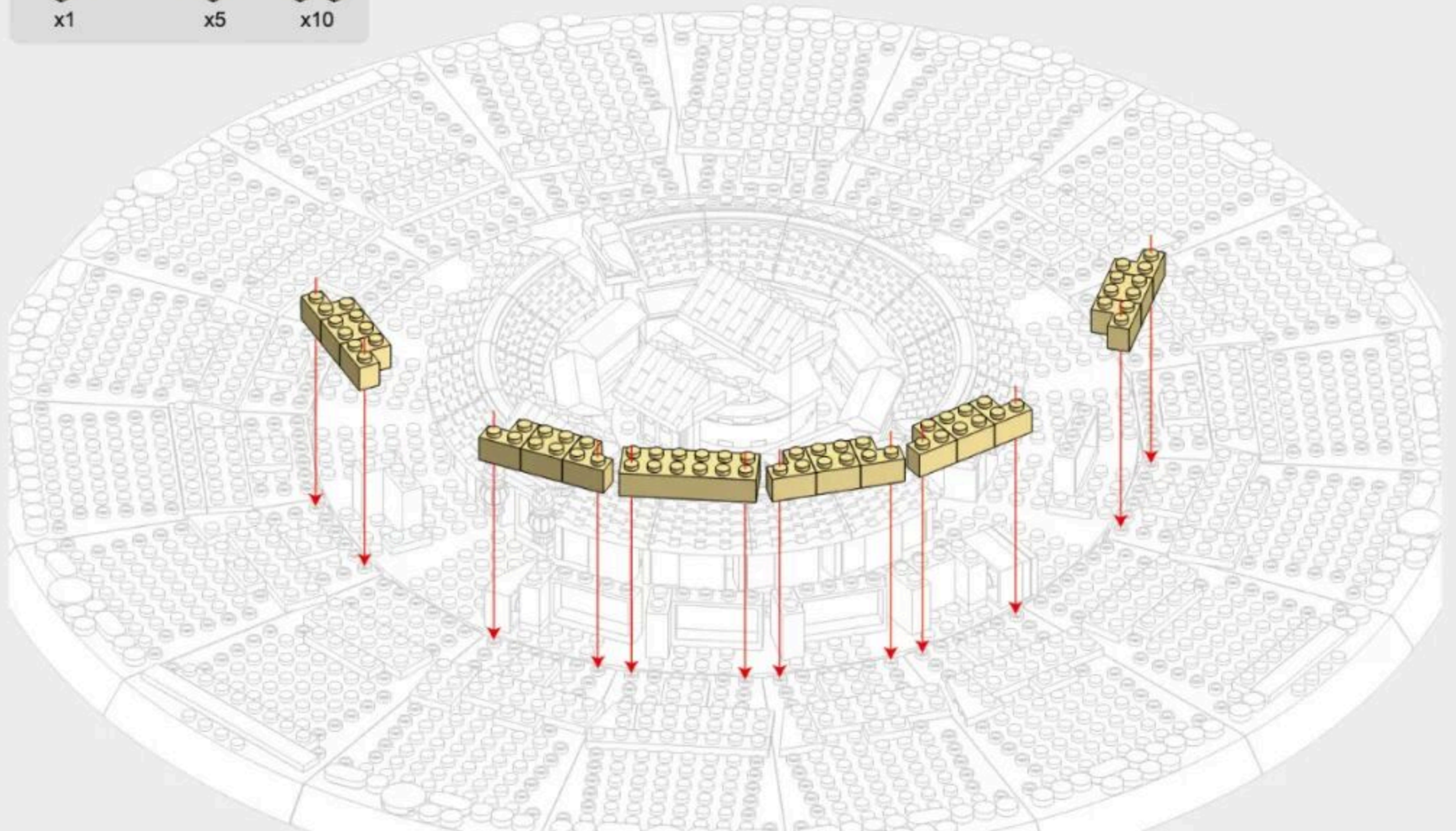
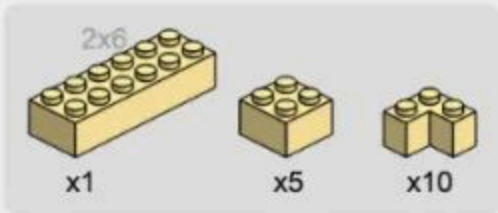

4-4

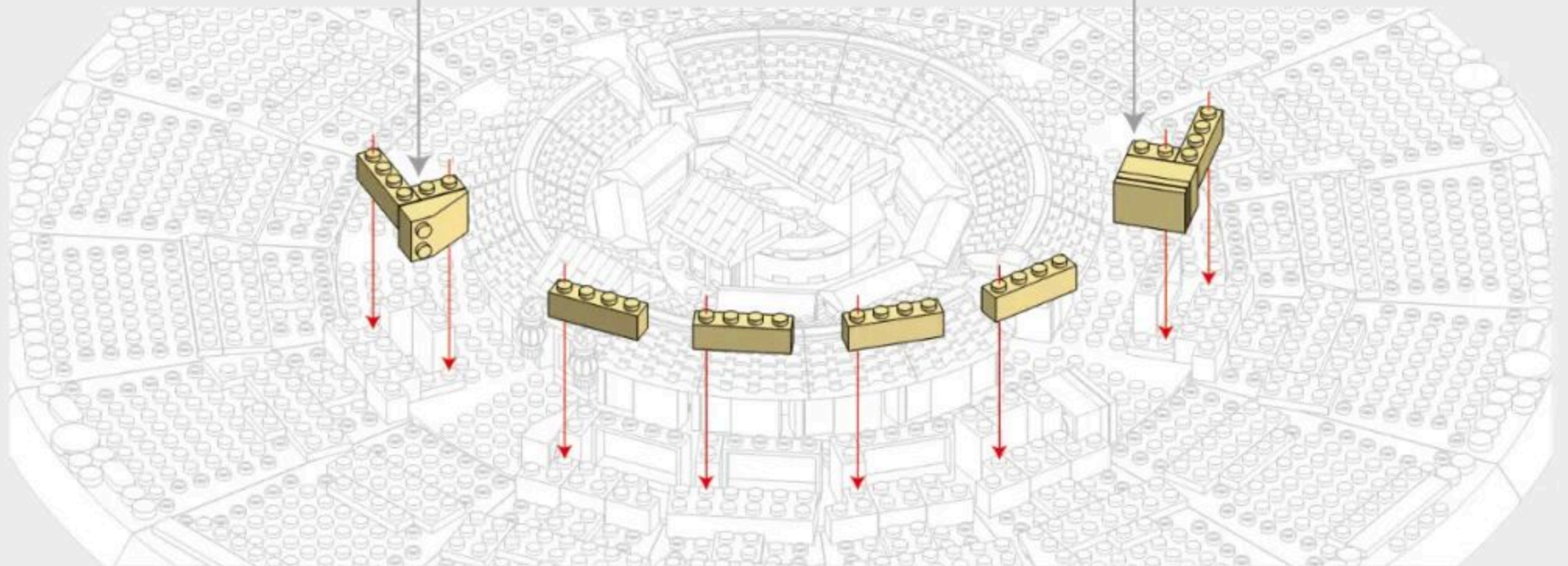
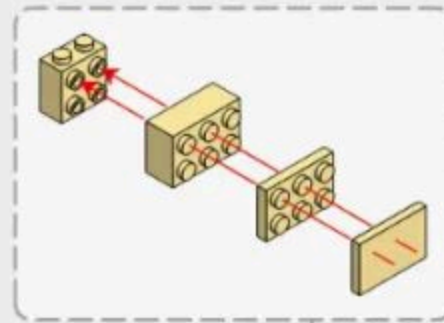
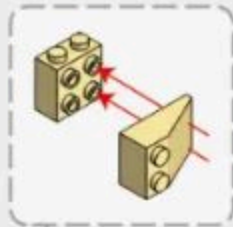

4-5

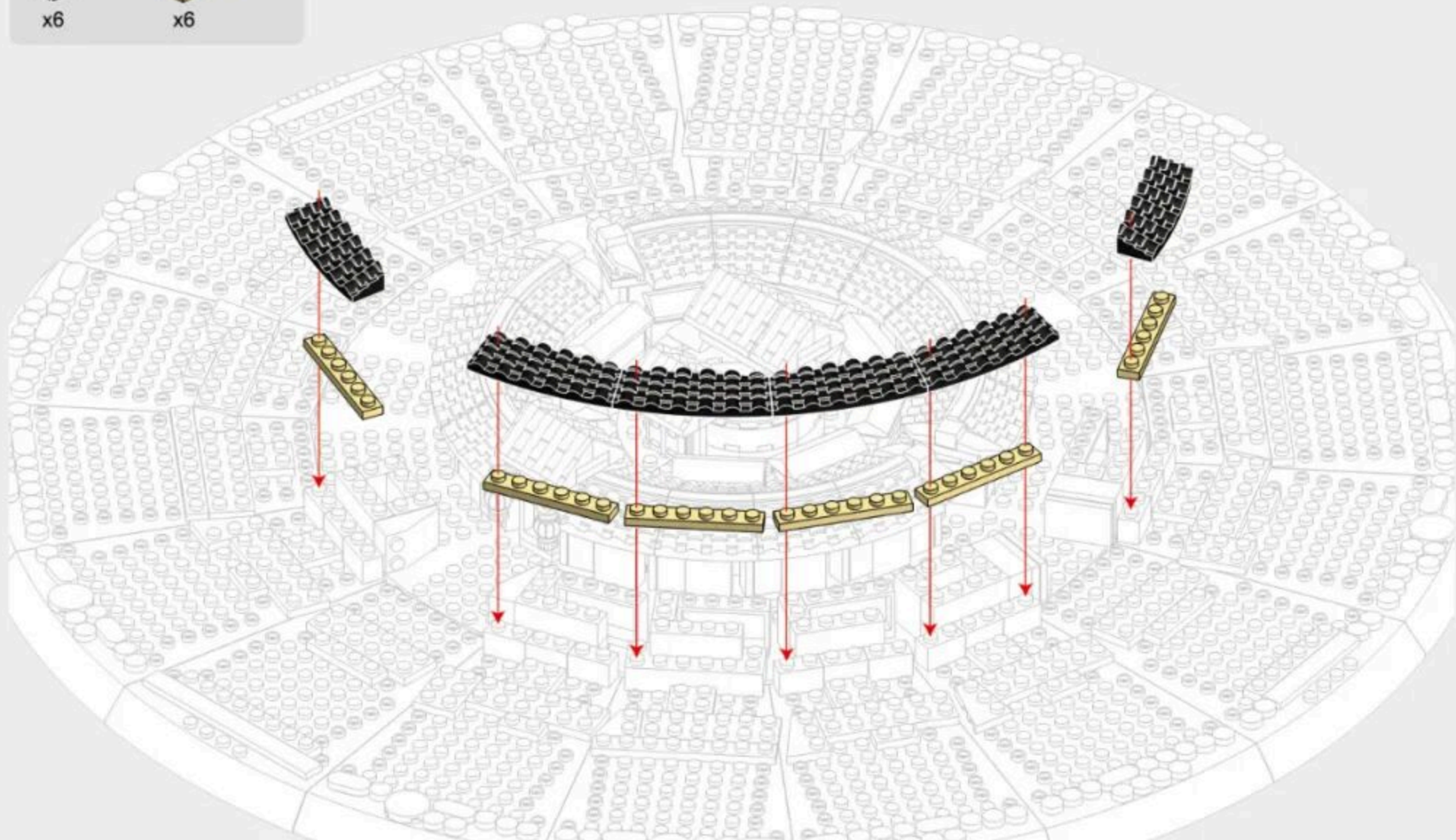
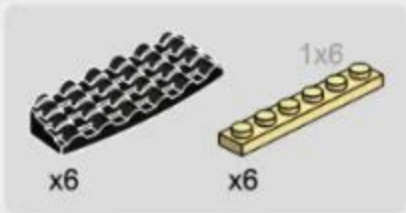

4-6

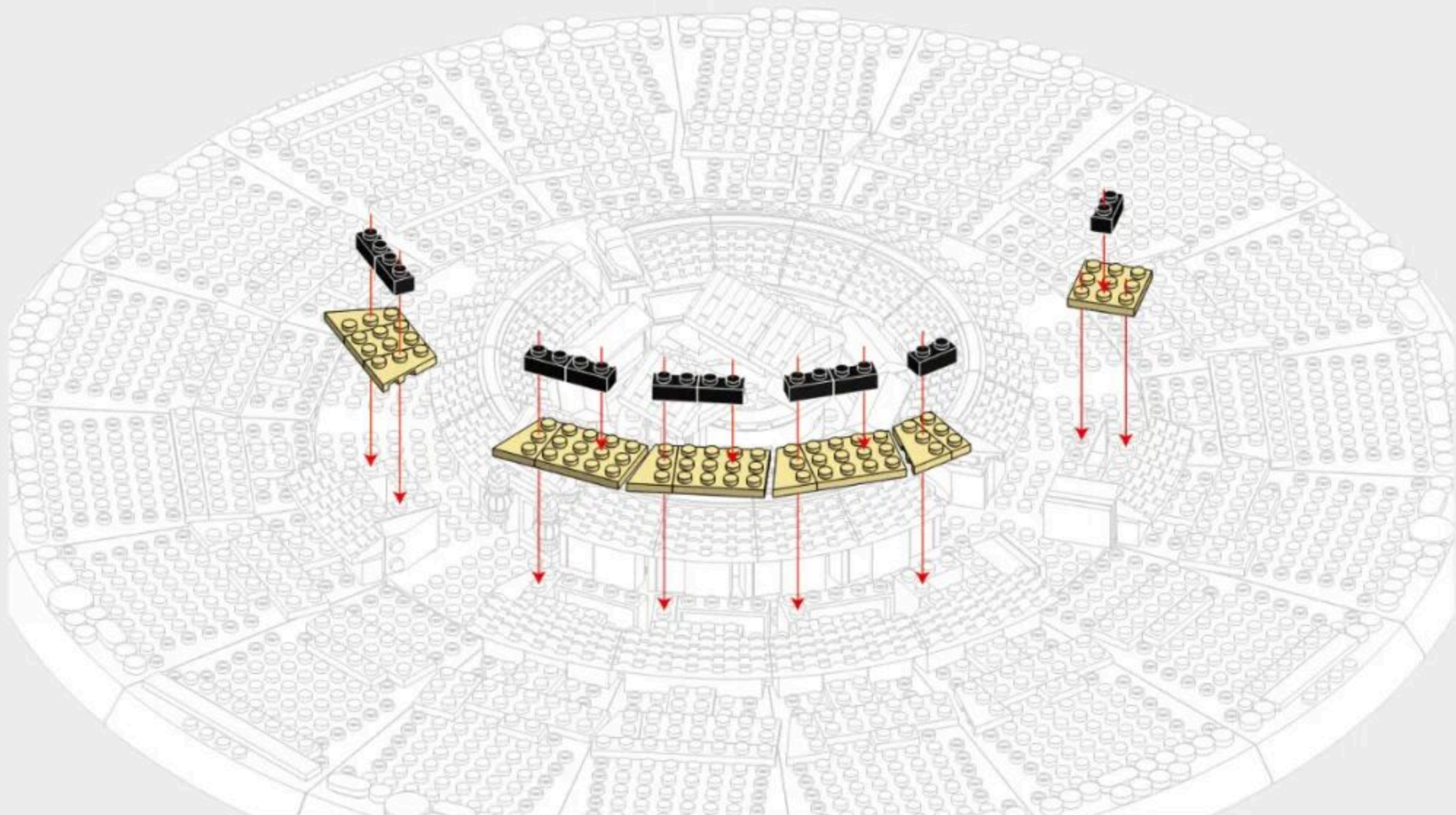

4-7

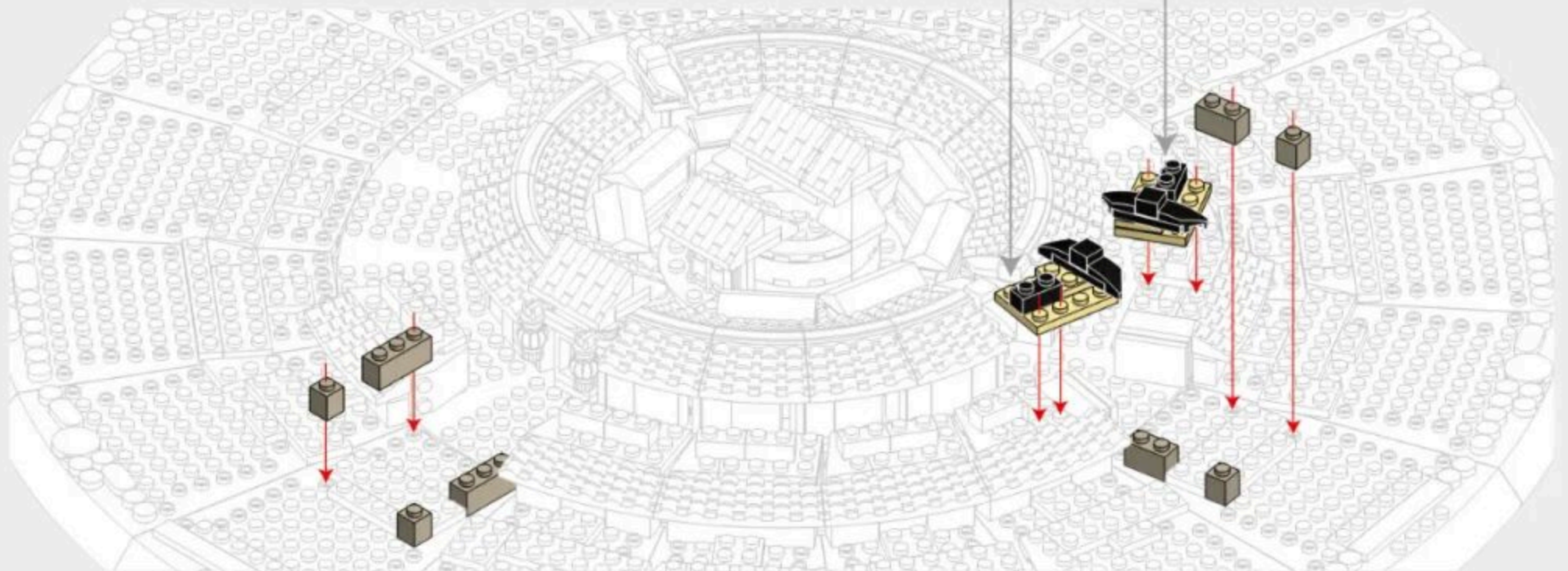
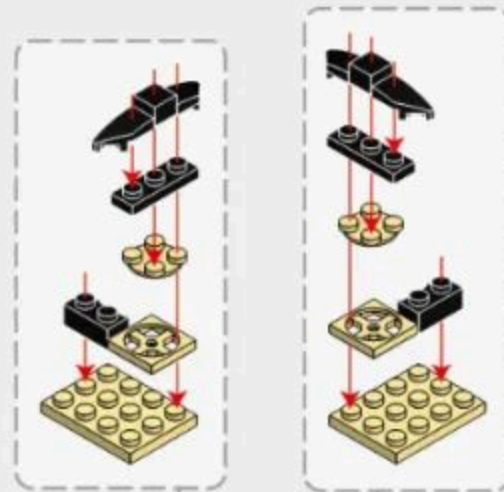
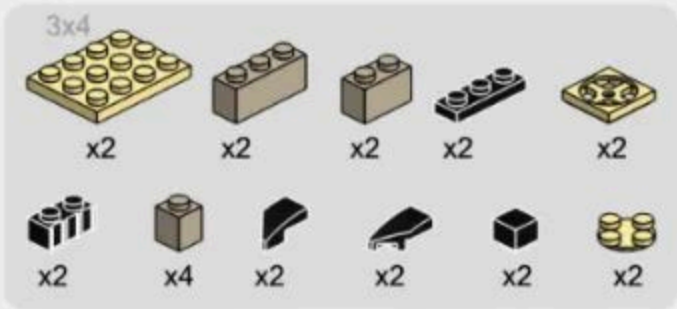

4-8

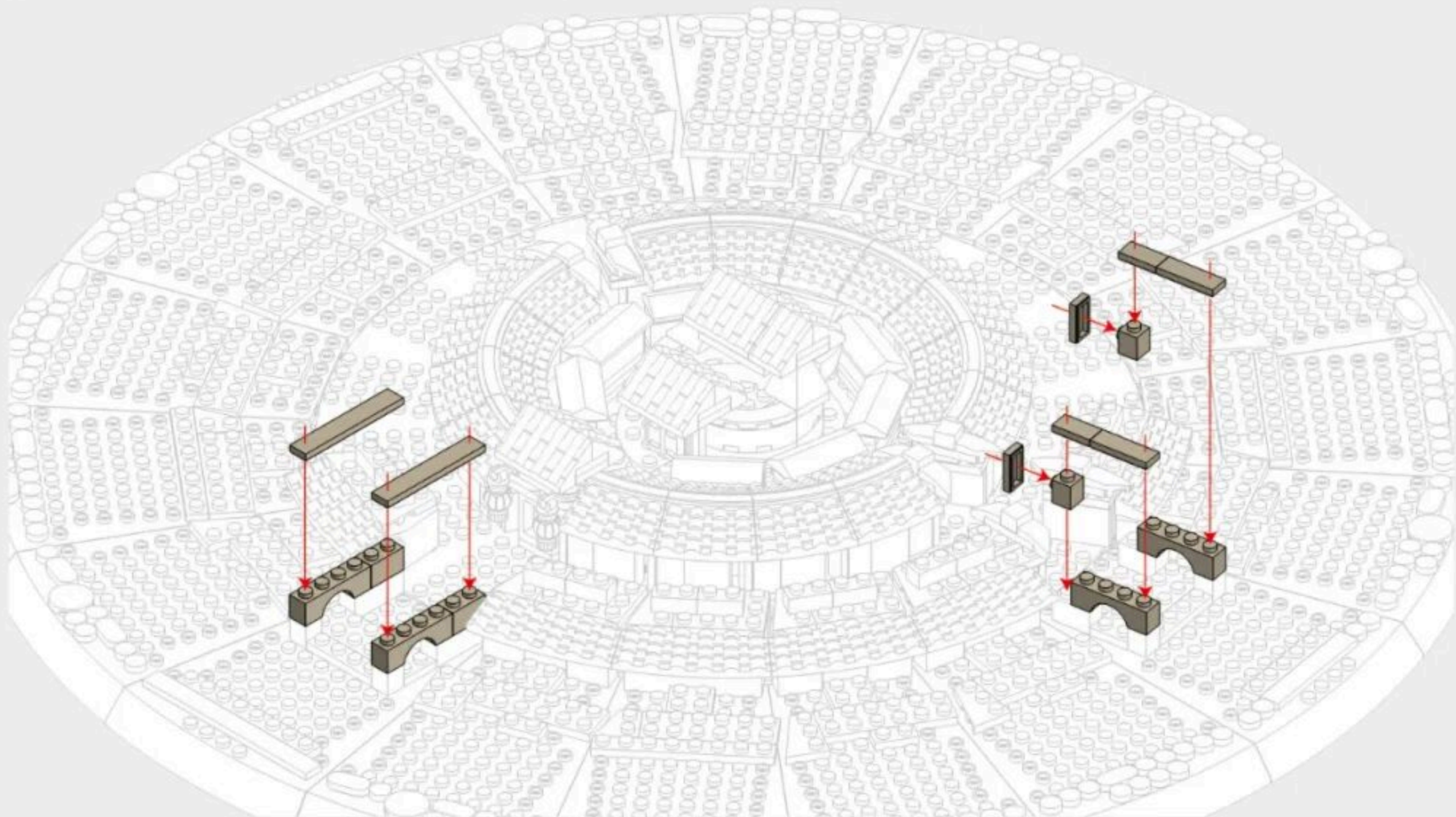

4-9

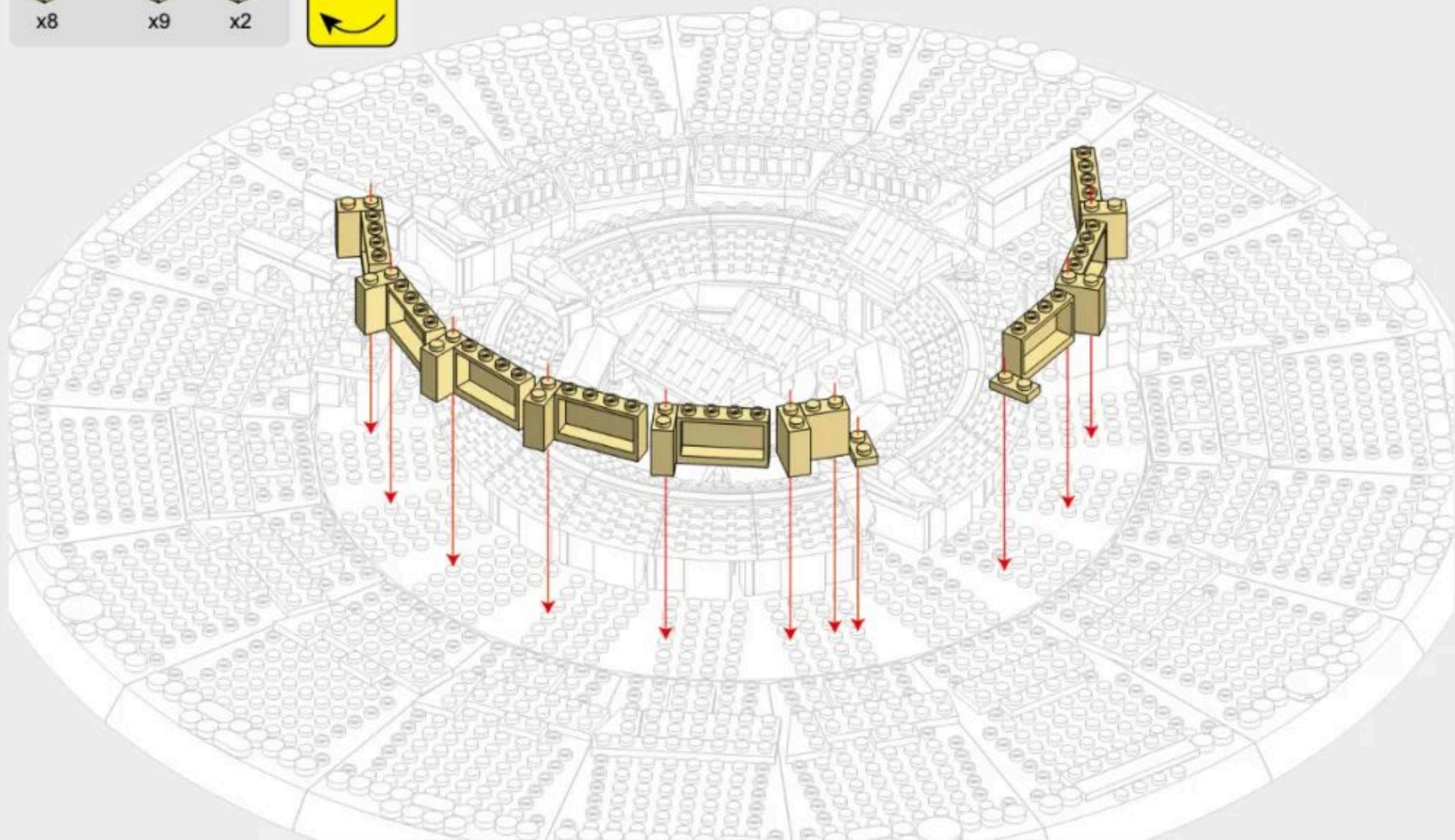

4-10

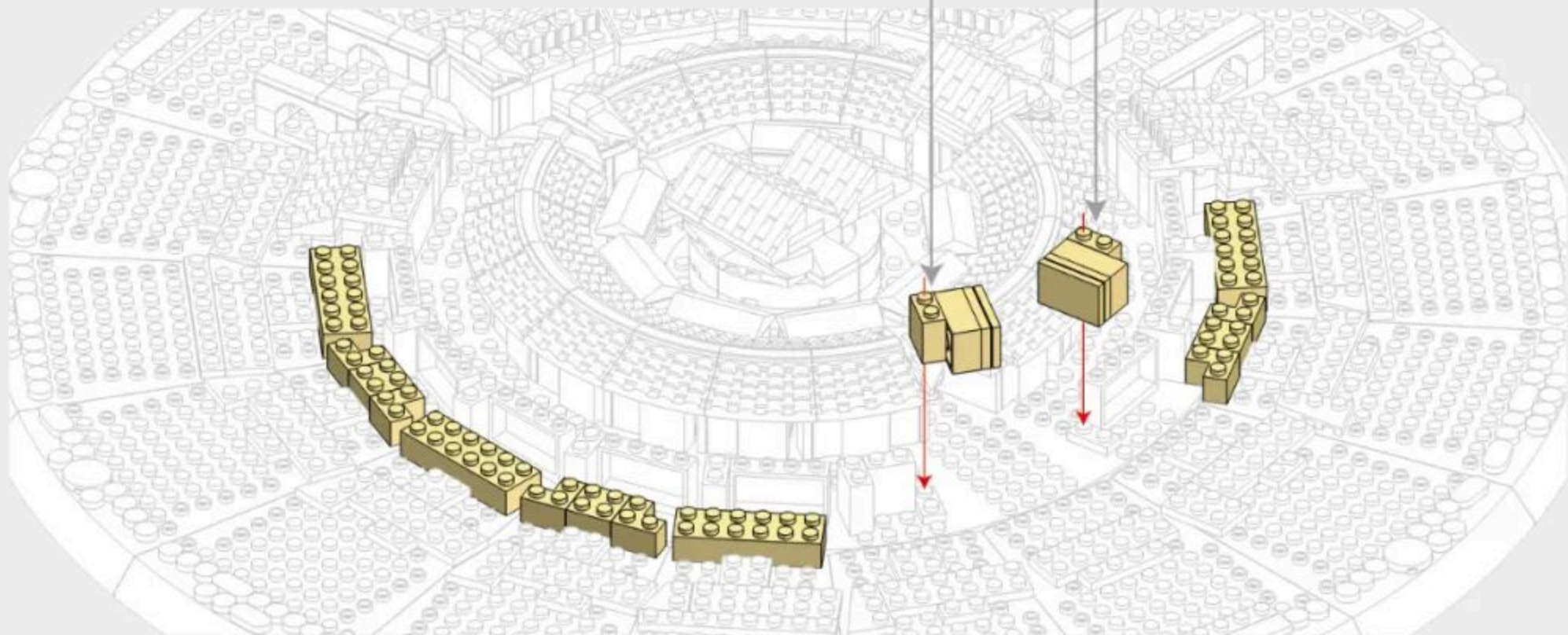
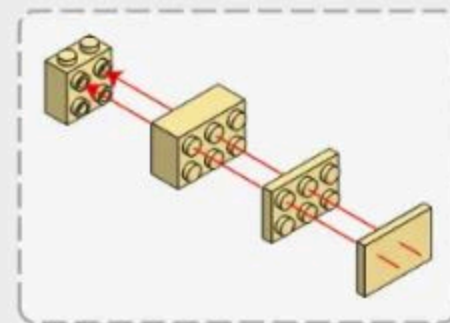
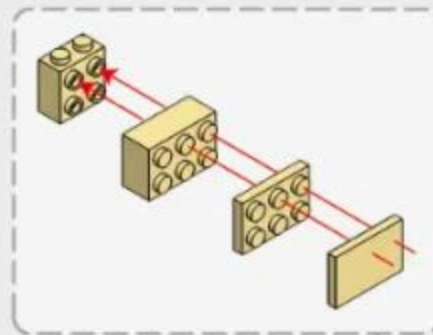
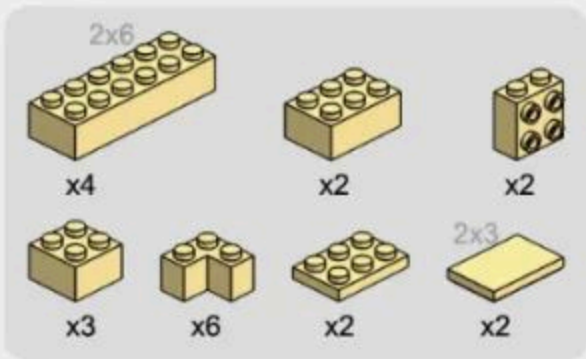

4-11

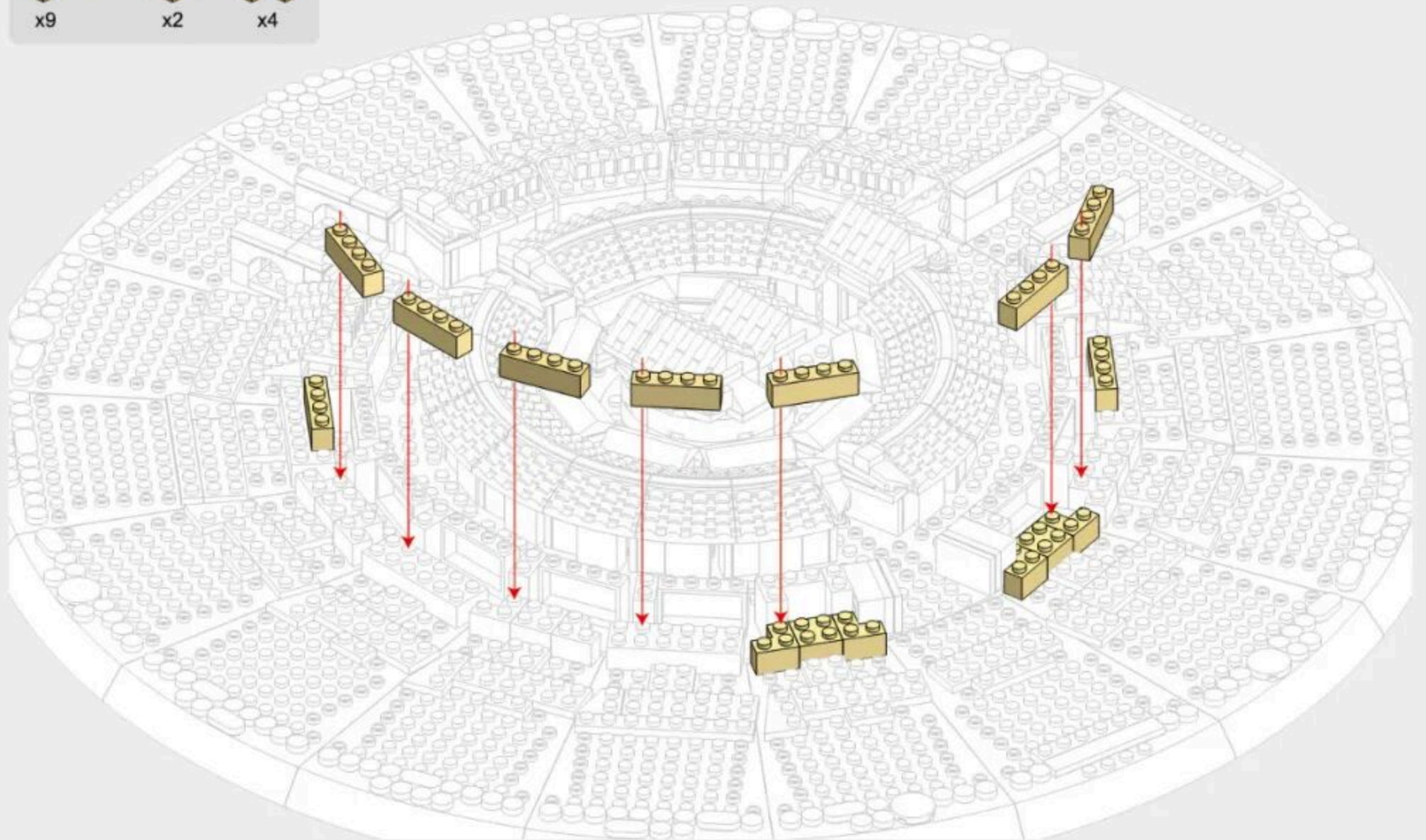
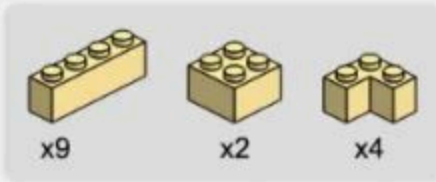

4-12

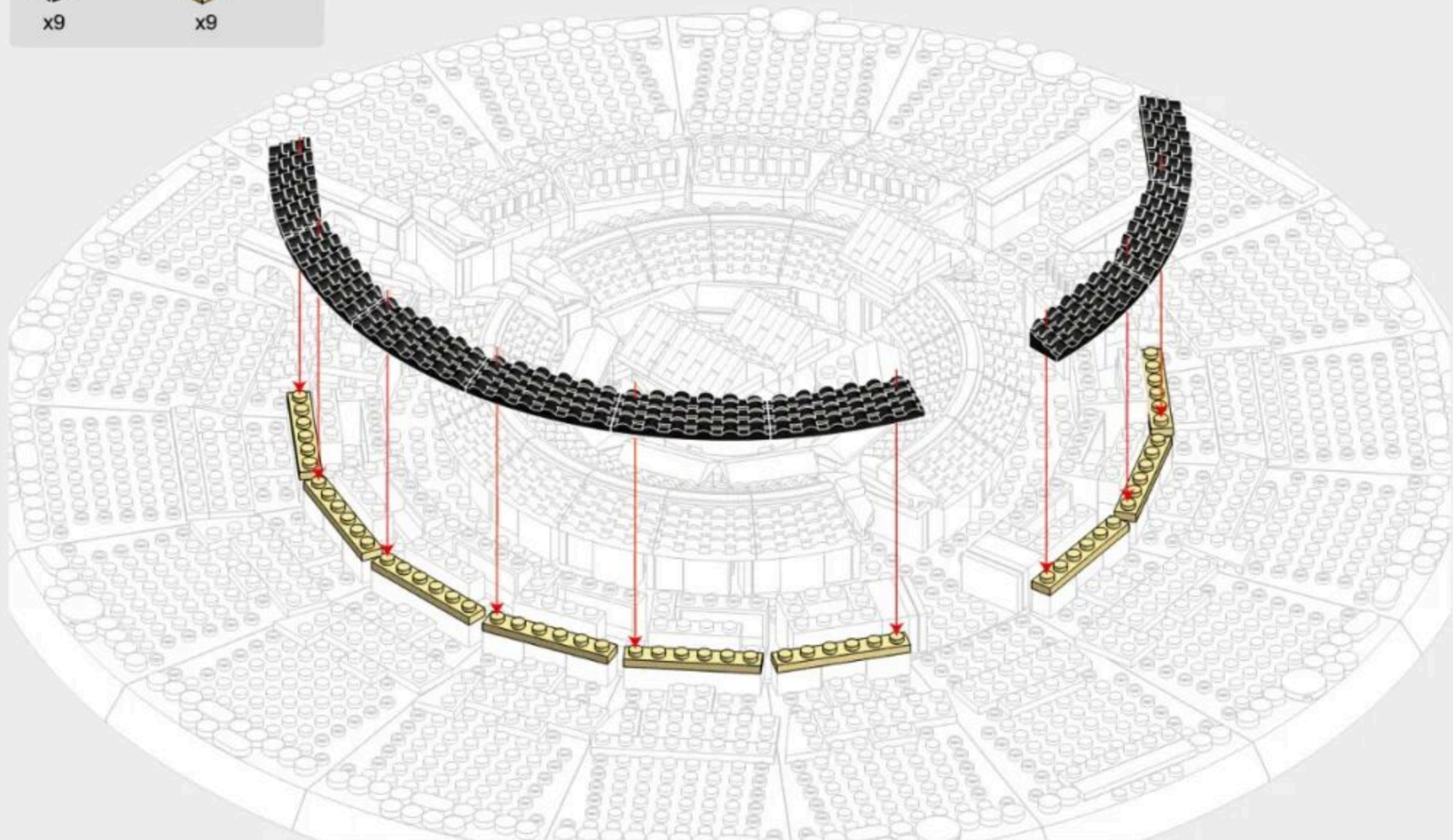
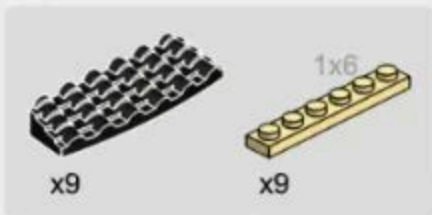

4-13

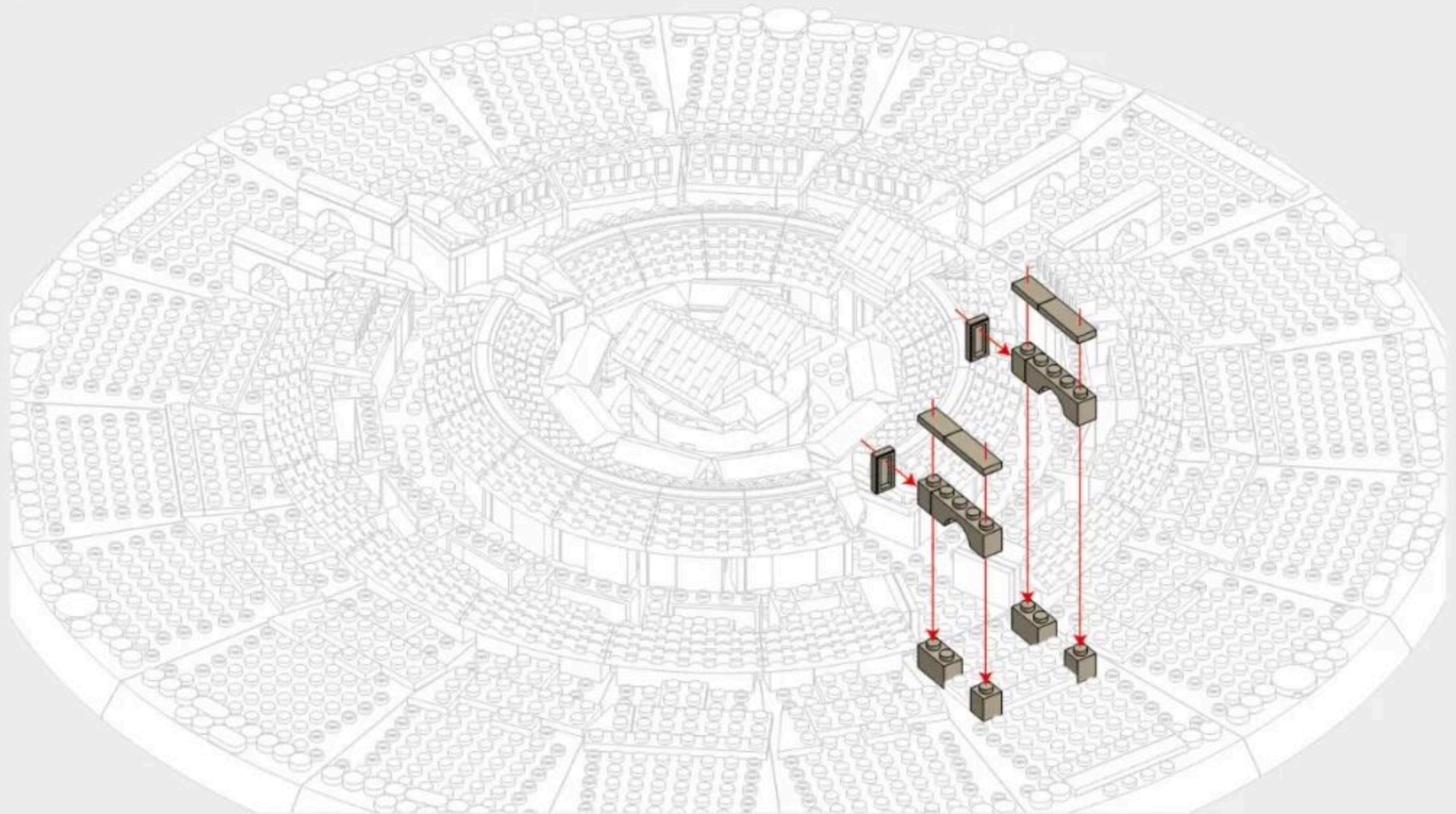

4-14

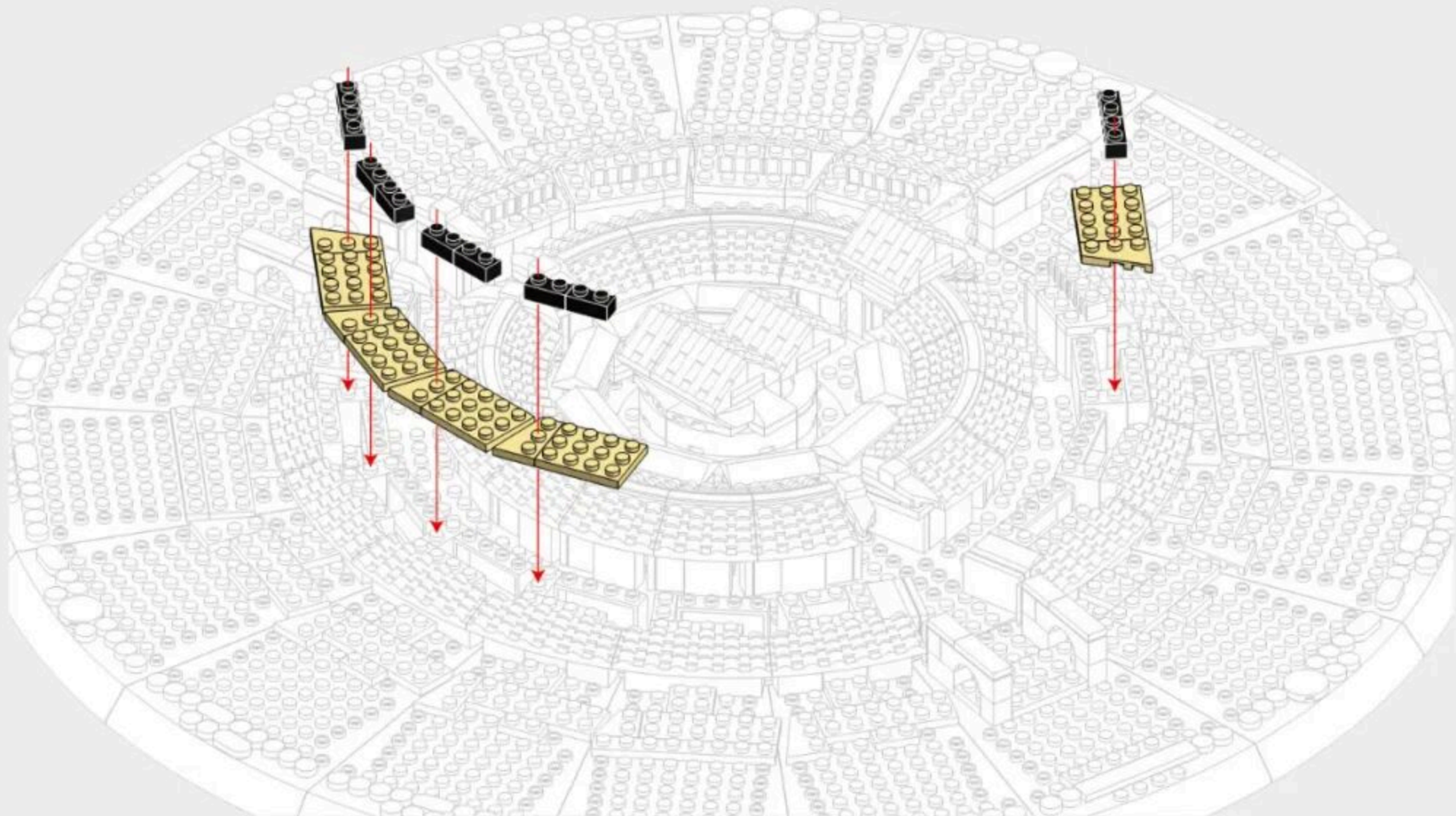
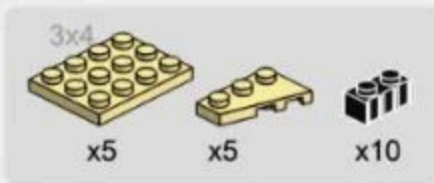

4-15

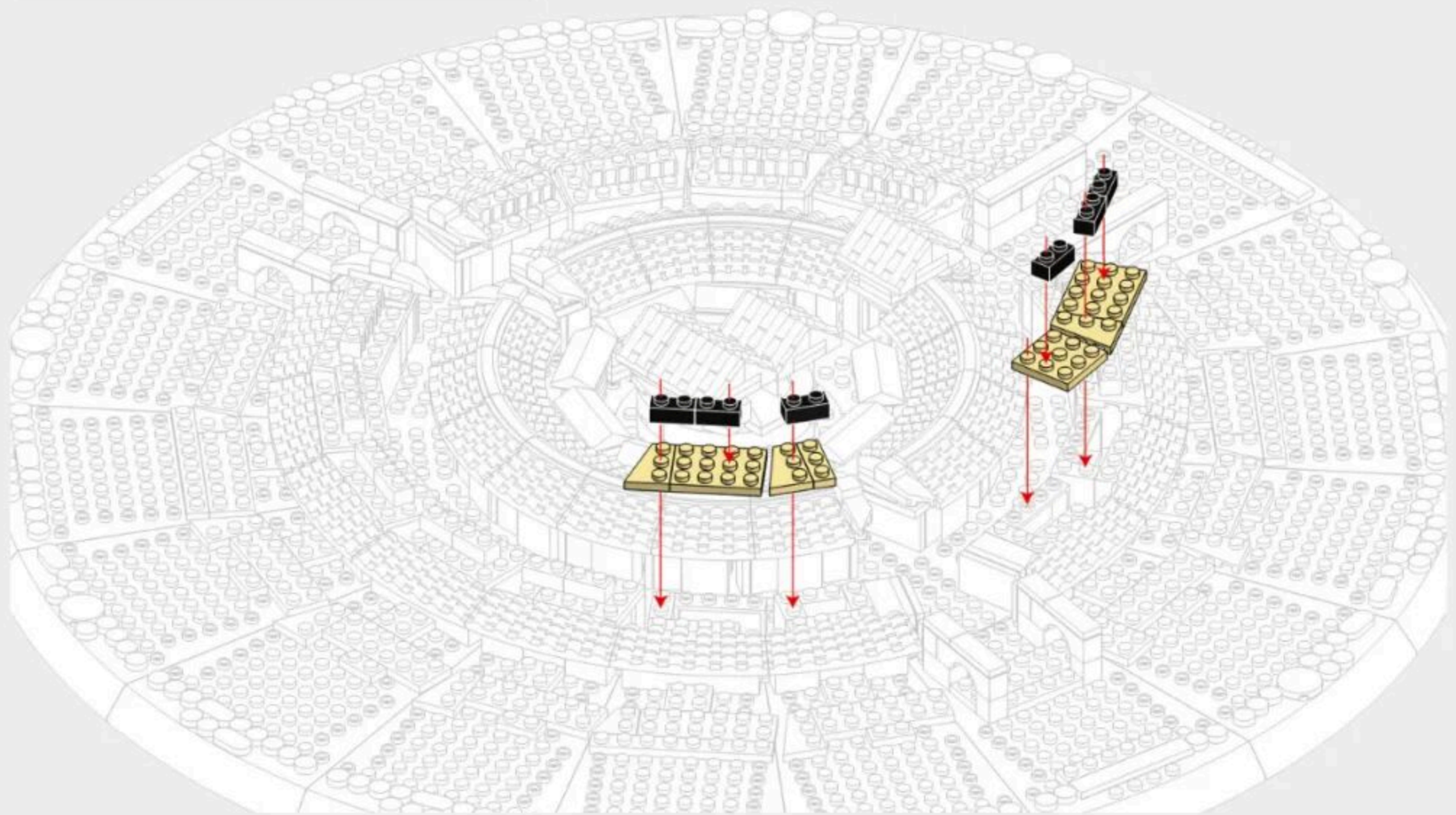
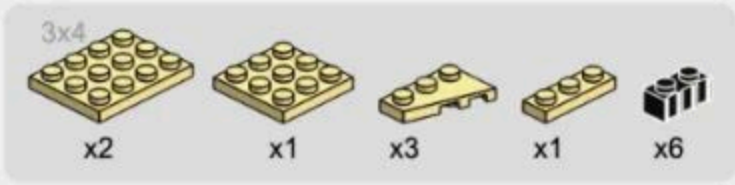

4-16

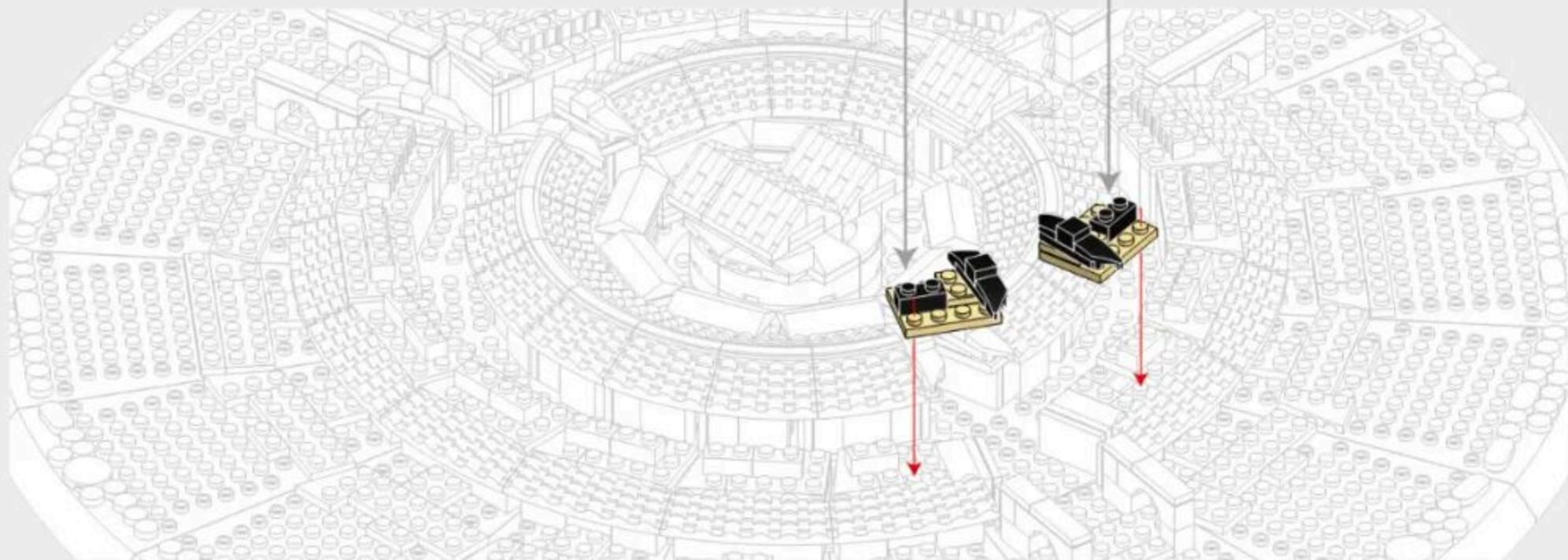
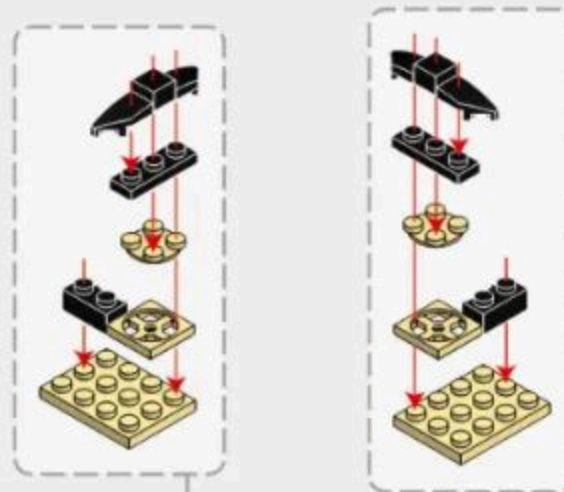

4-17

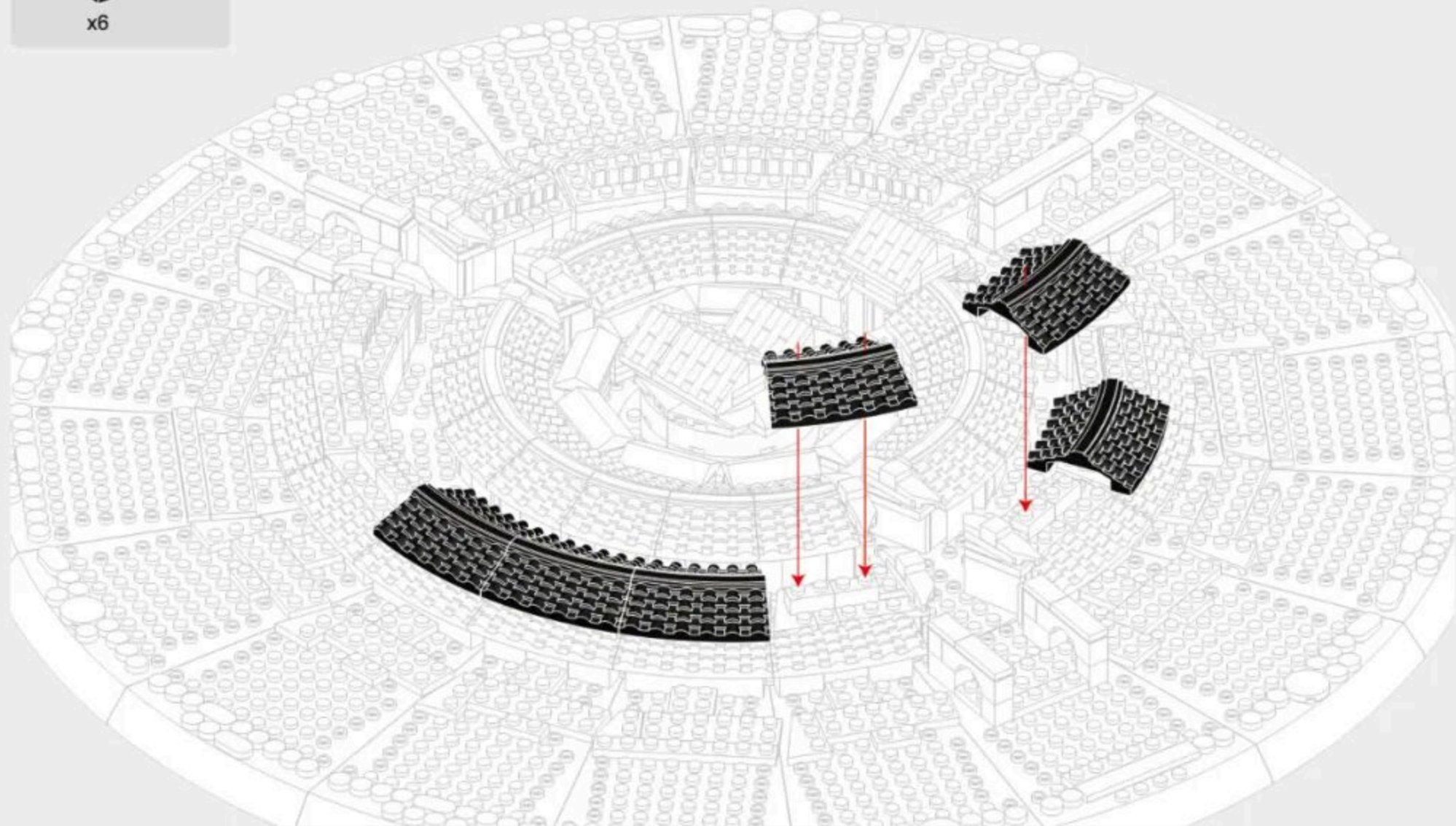
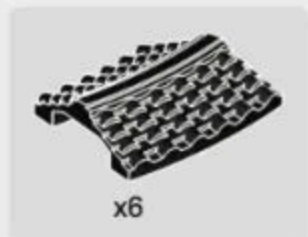

4-18

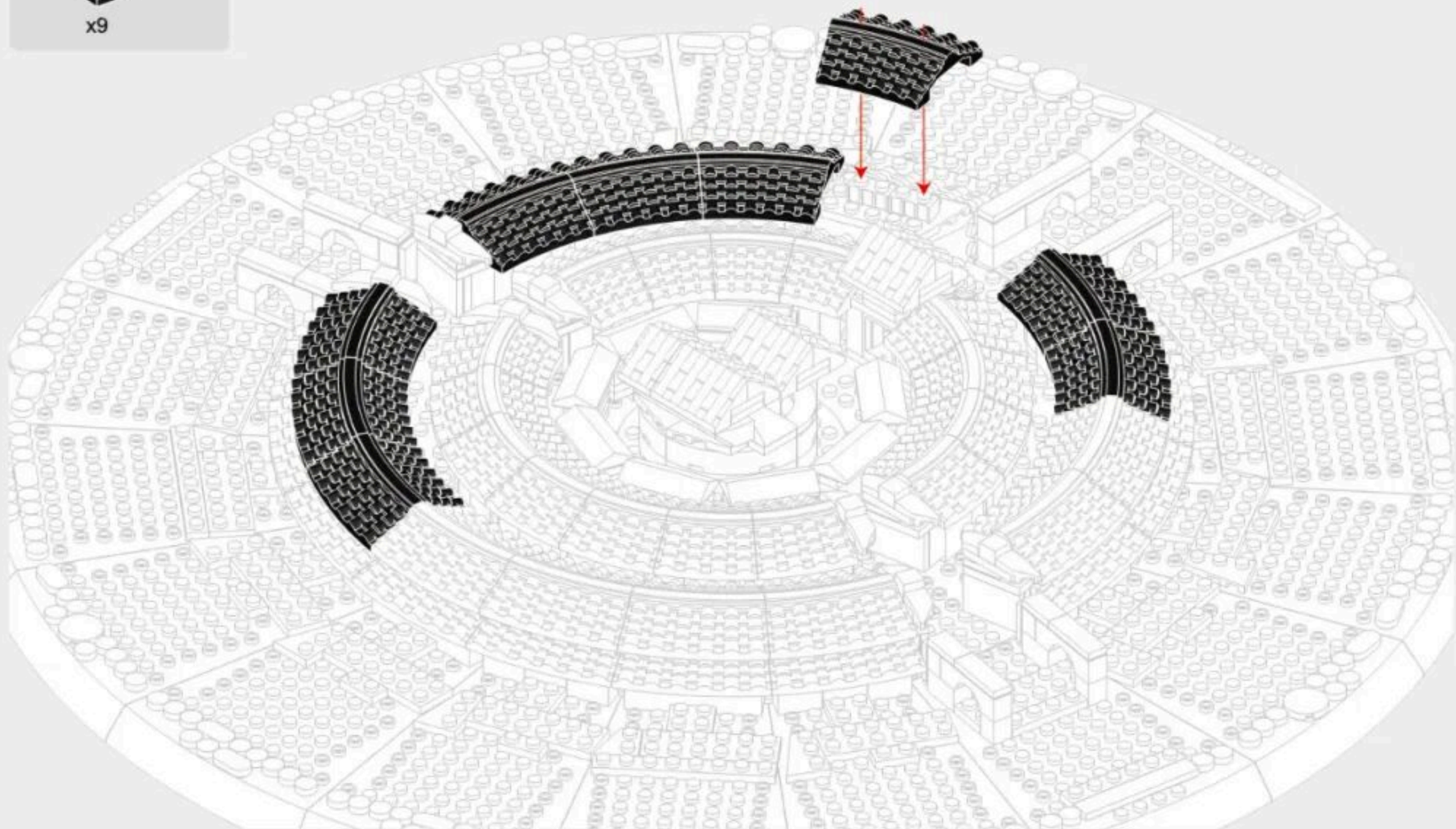
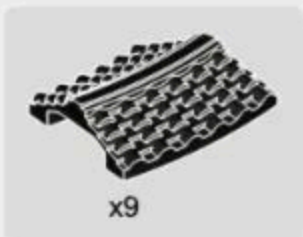



260PCS

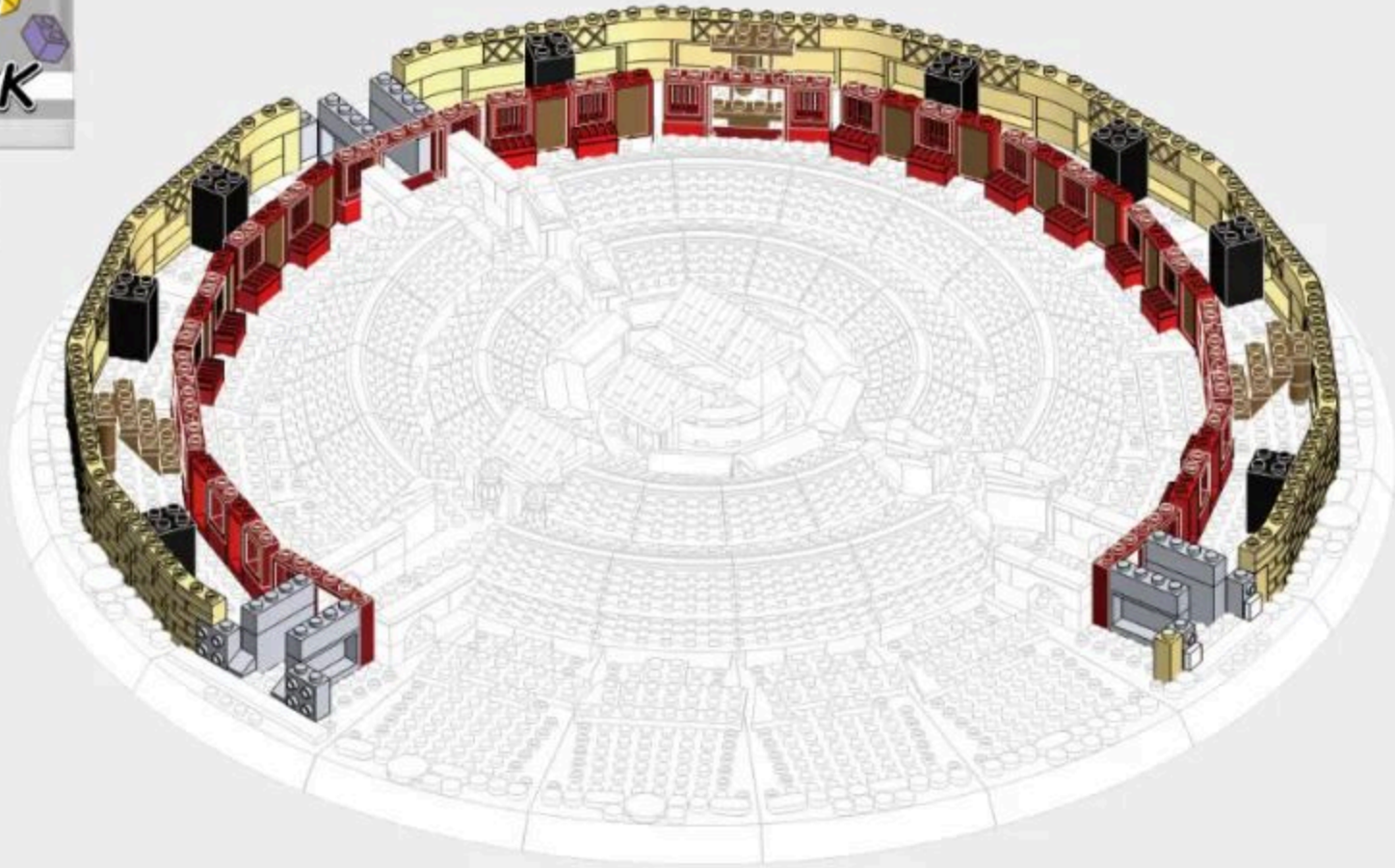

5-1



x8



x4



x8

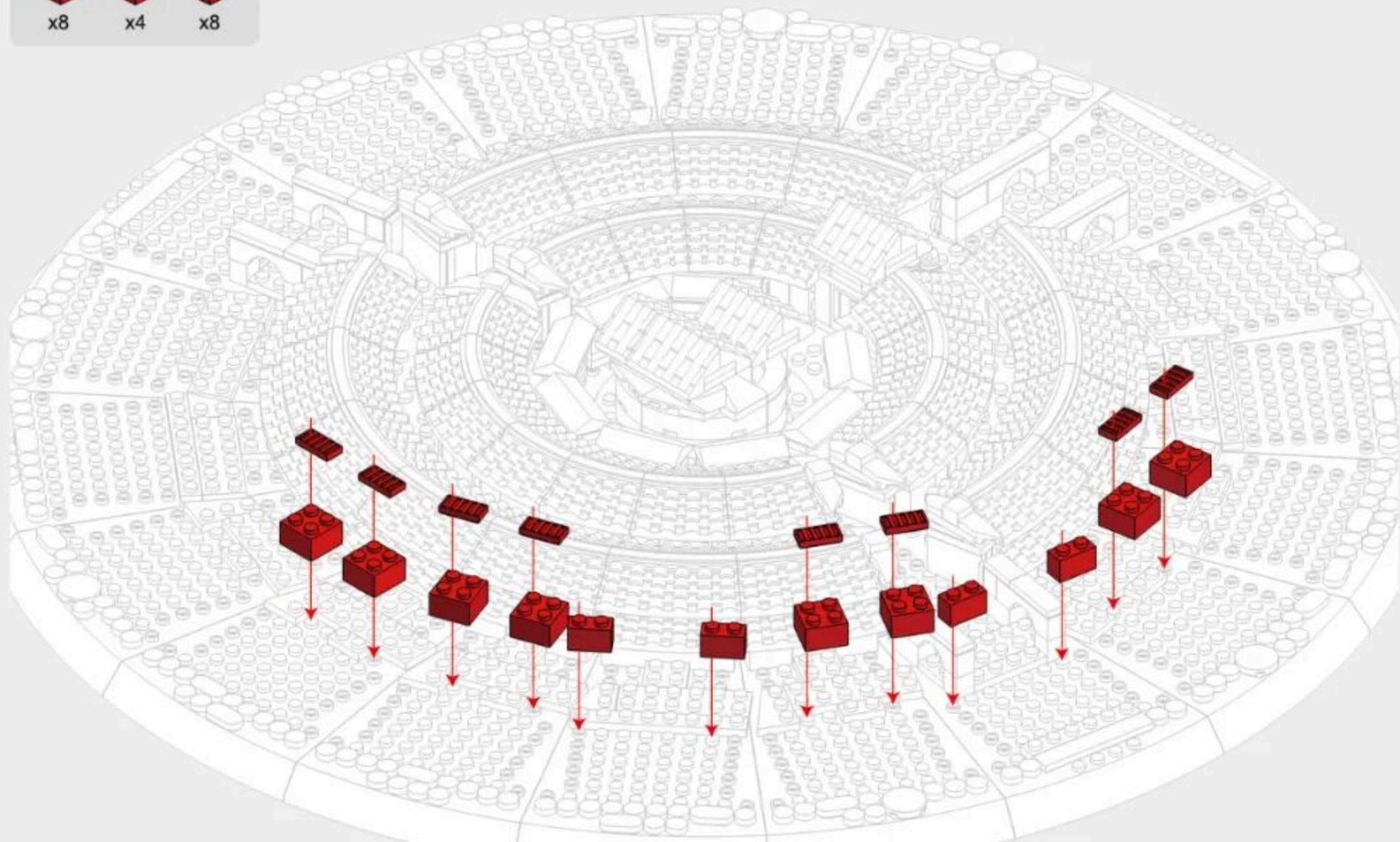

5-2

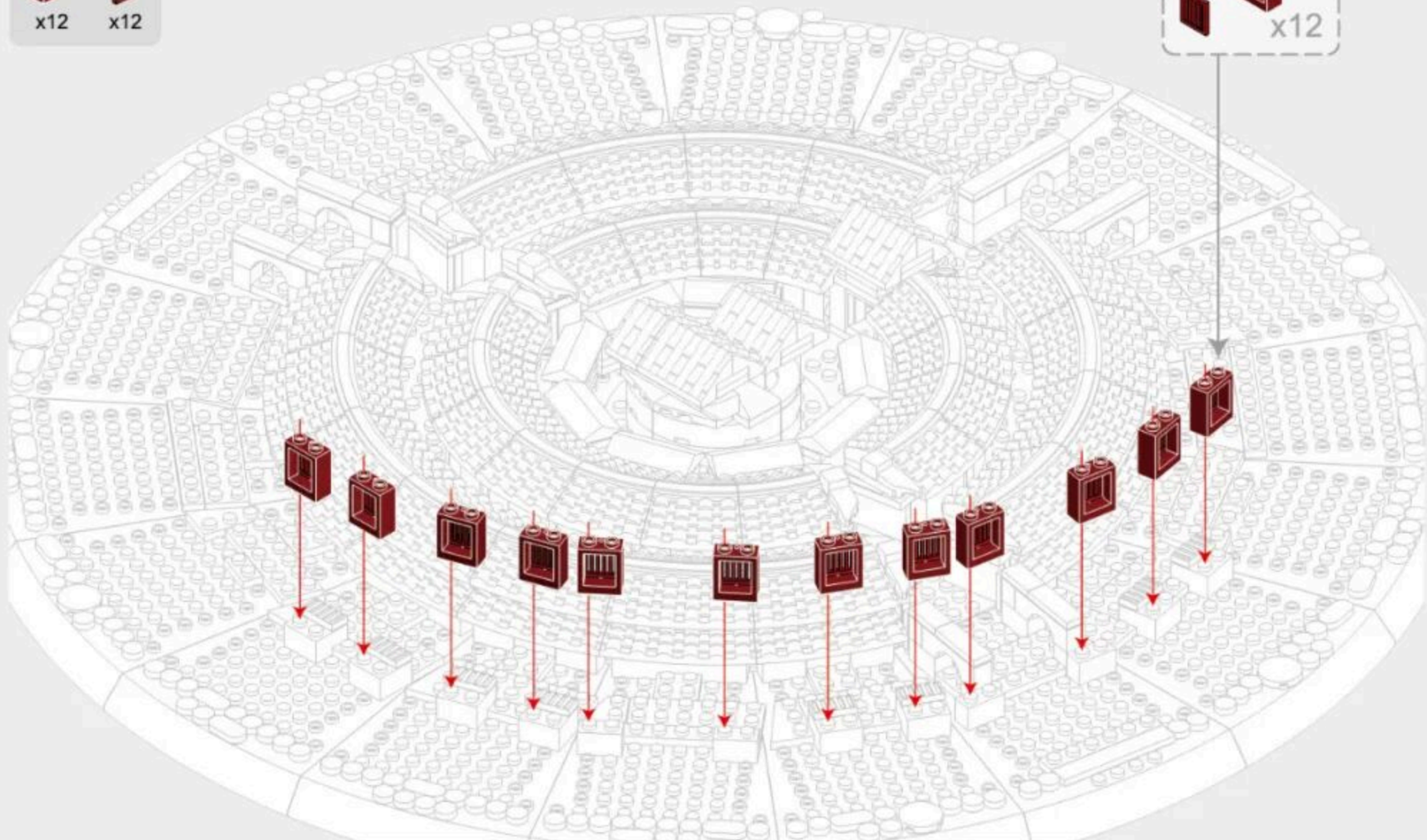

5-3

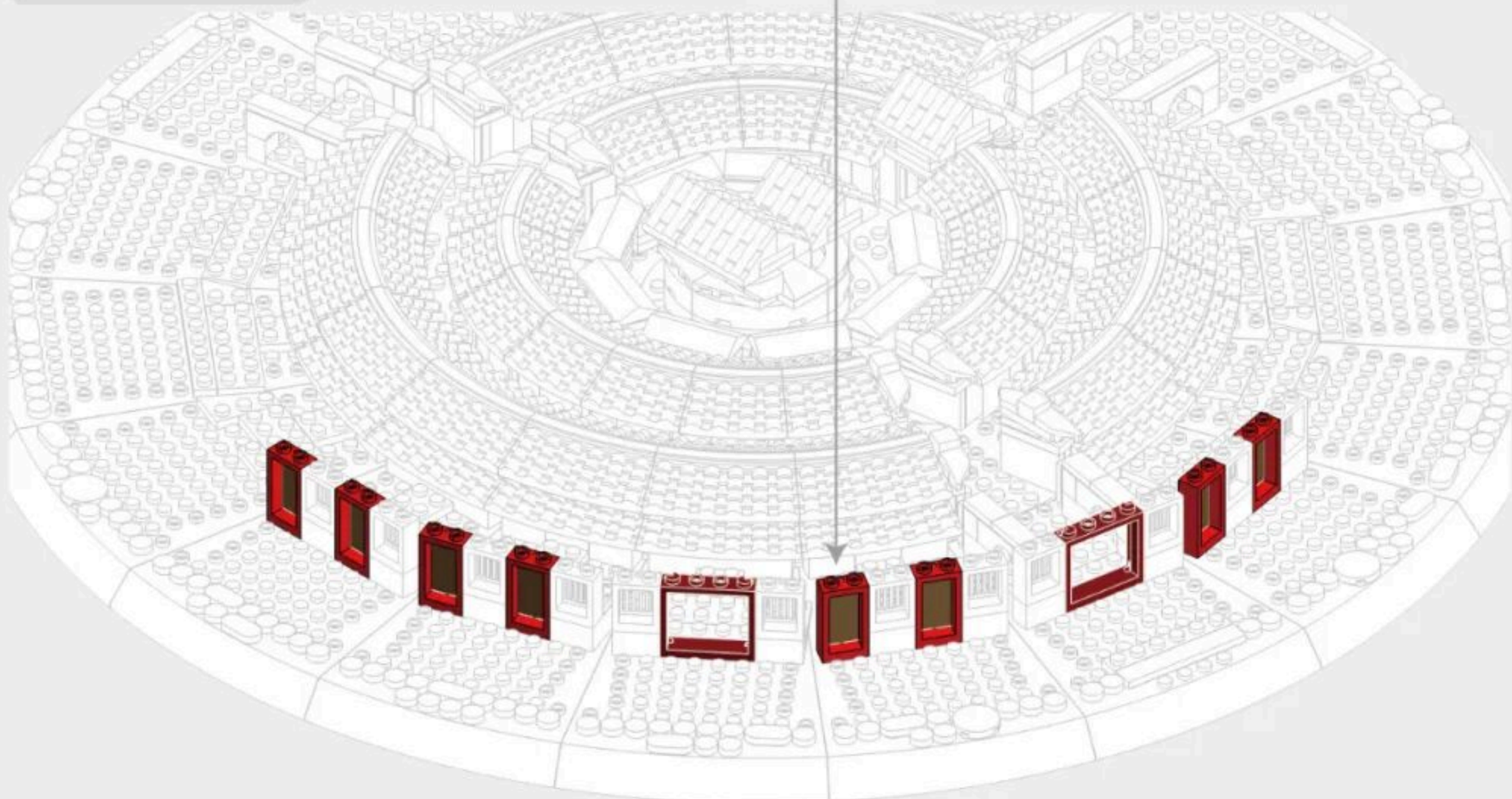

5-4

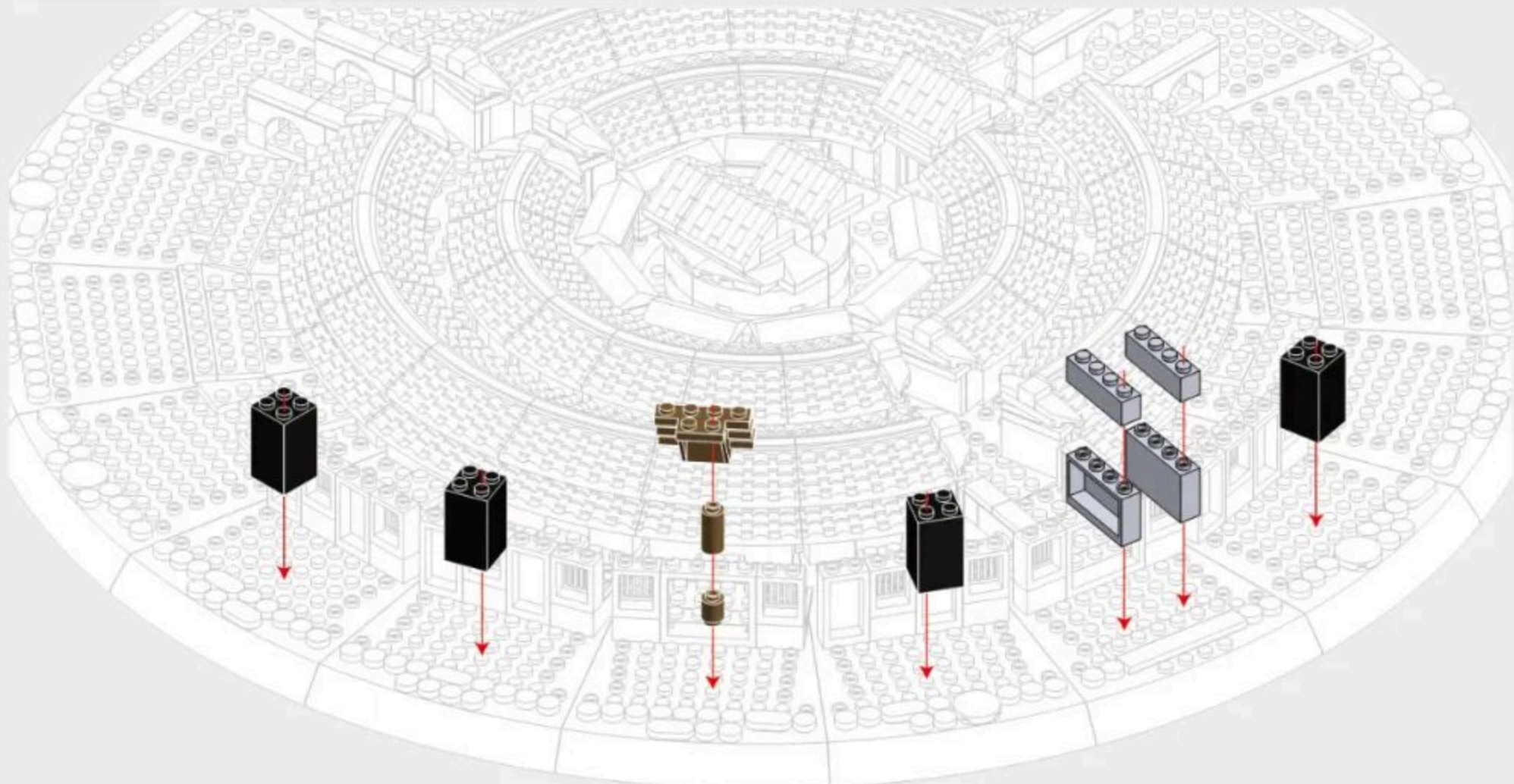
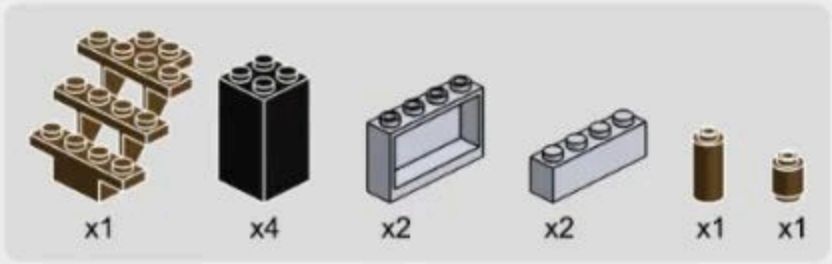

5-5



x10



x2



x2



x14



x2

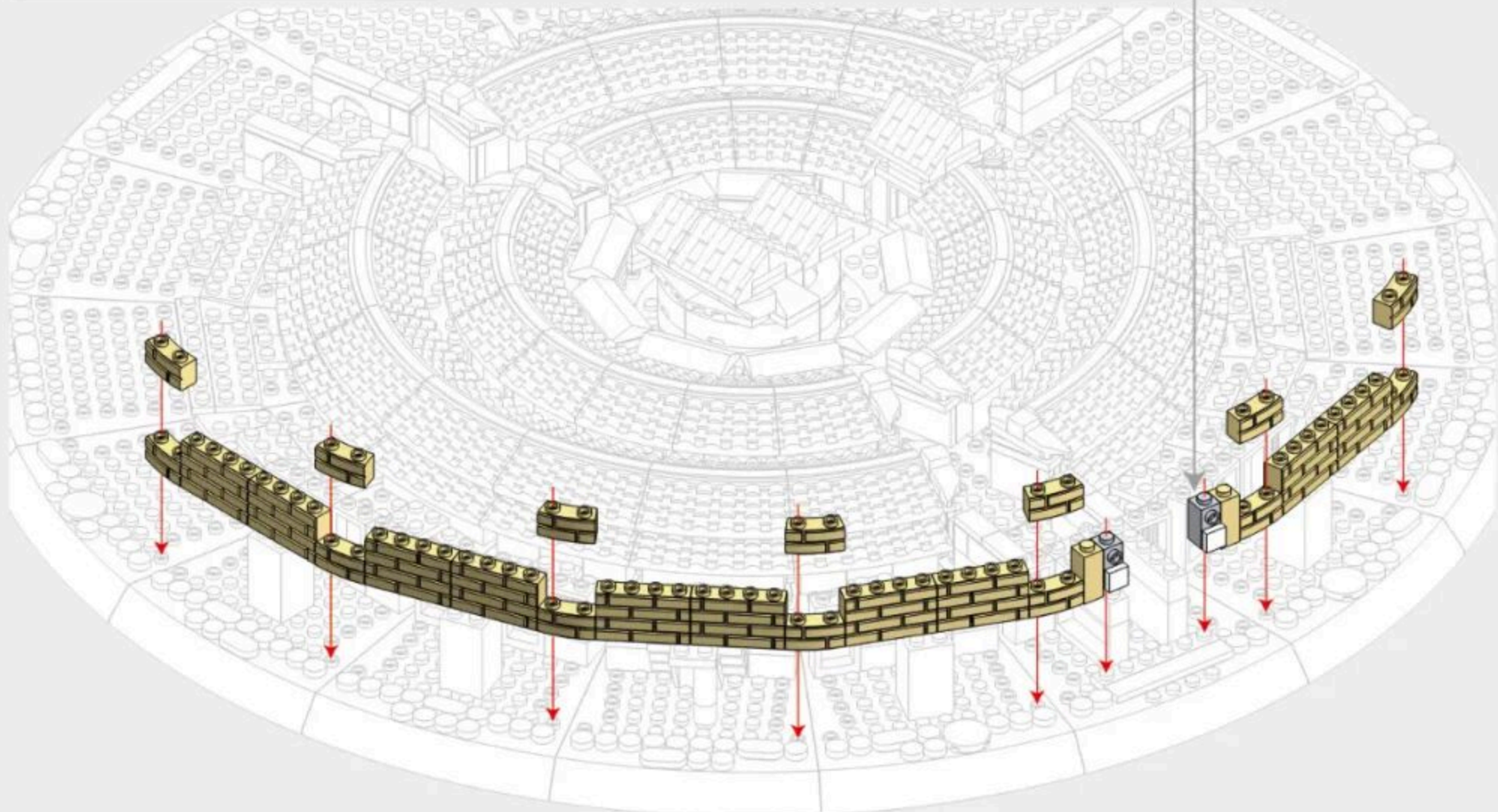
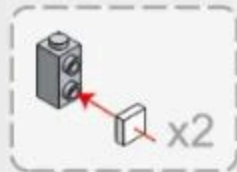

5-6



x5



x5



x5

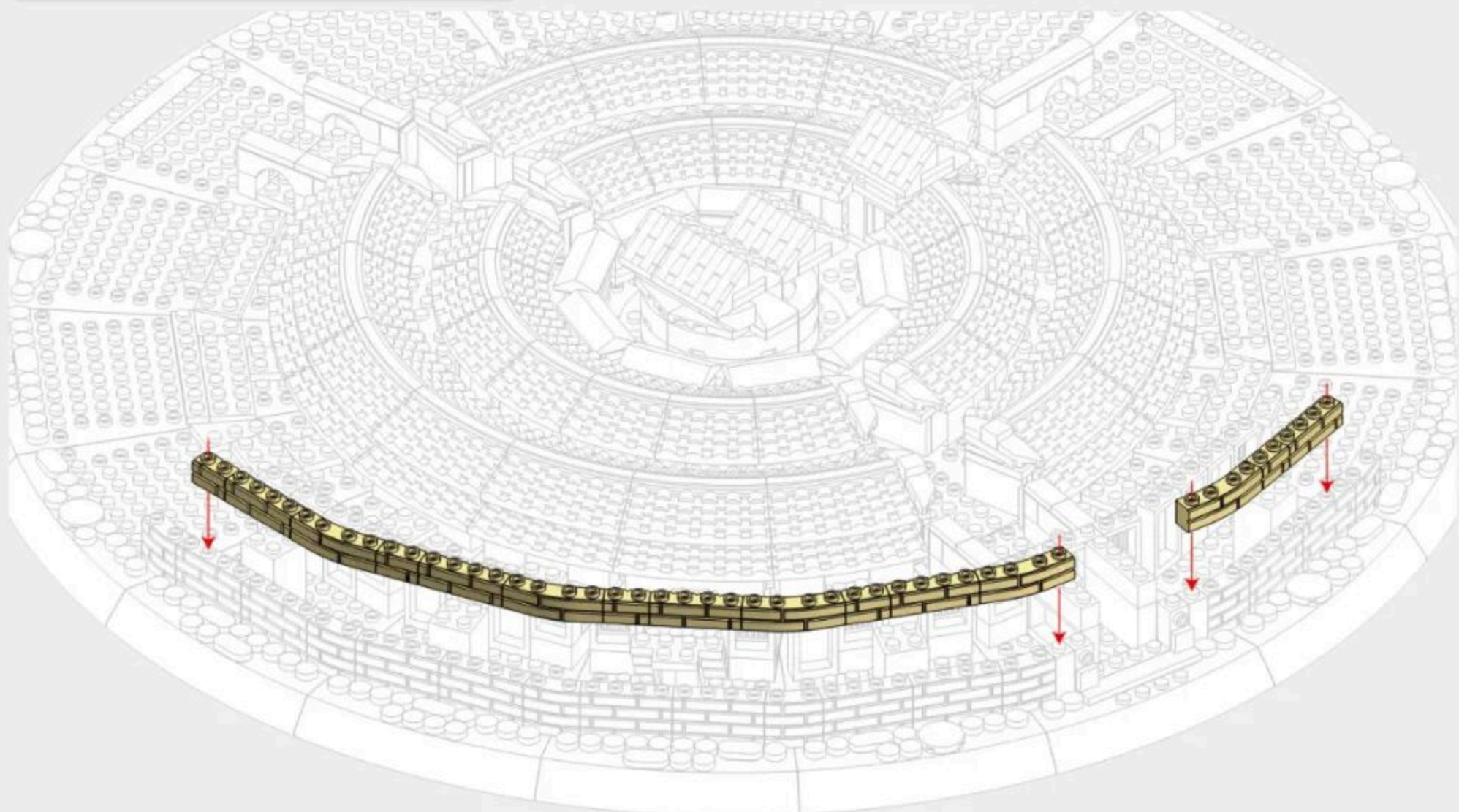

5-7

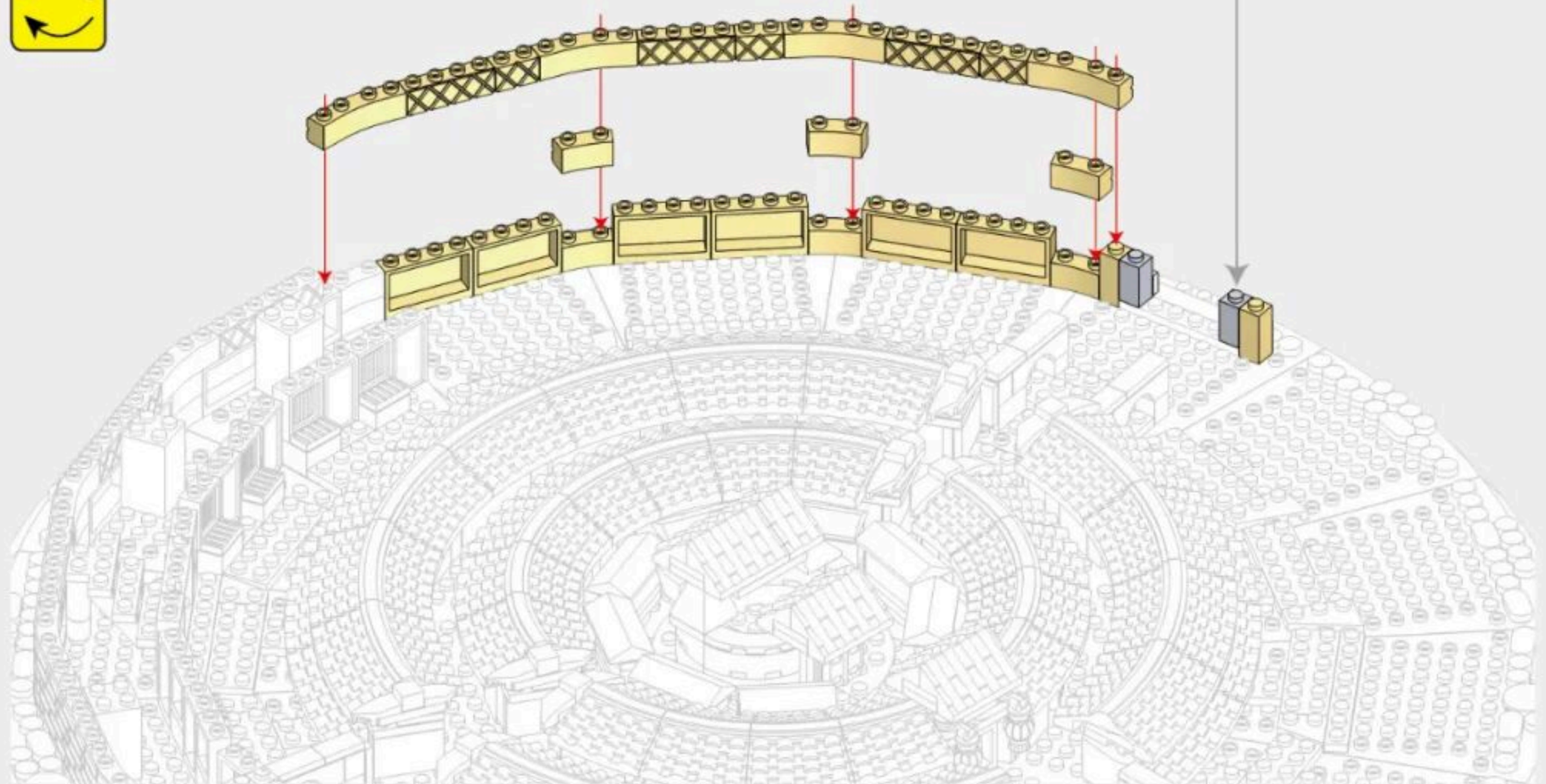
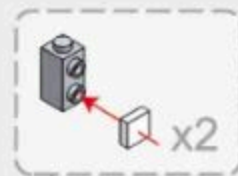

5-8

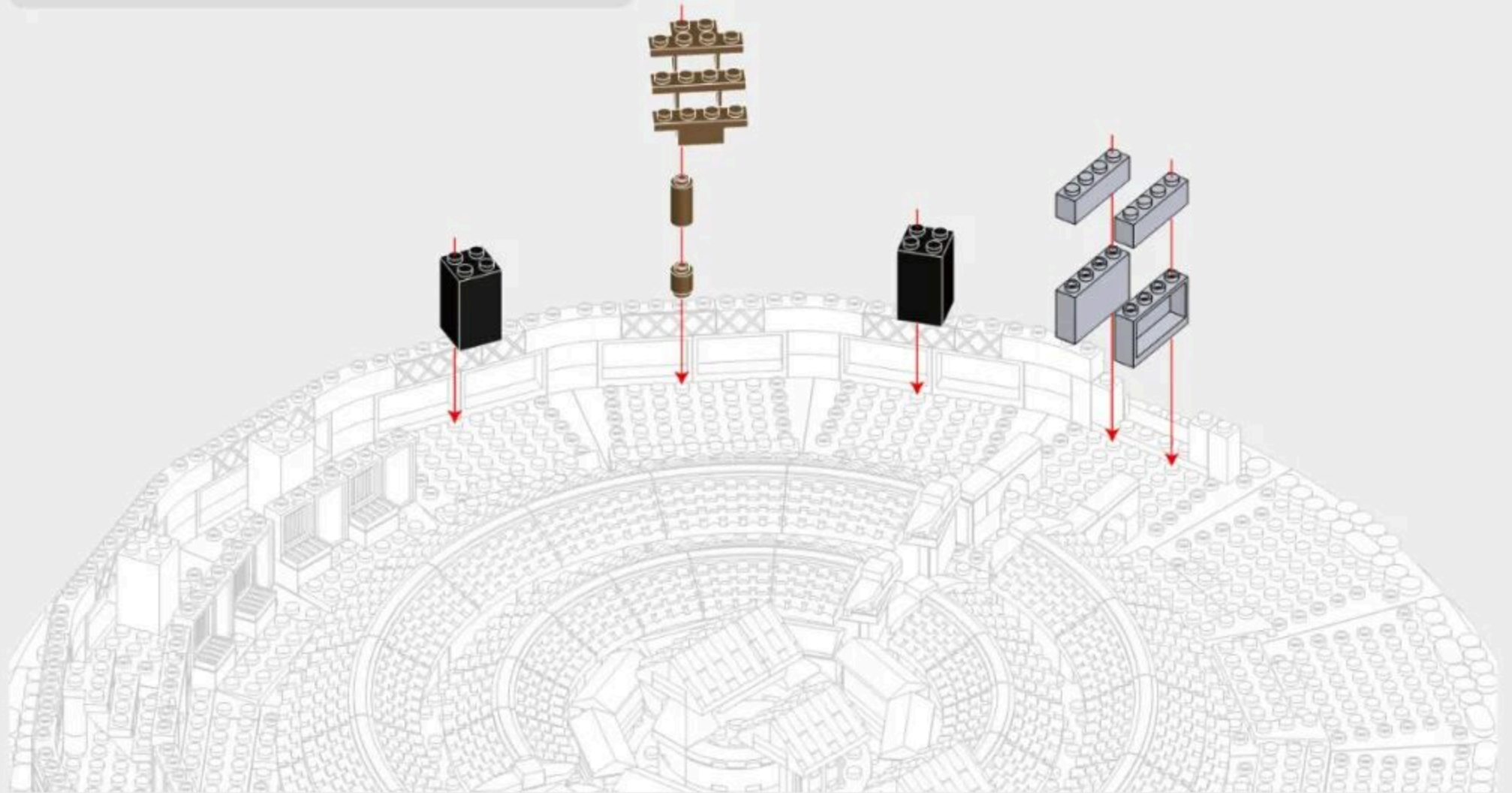
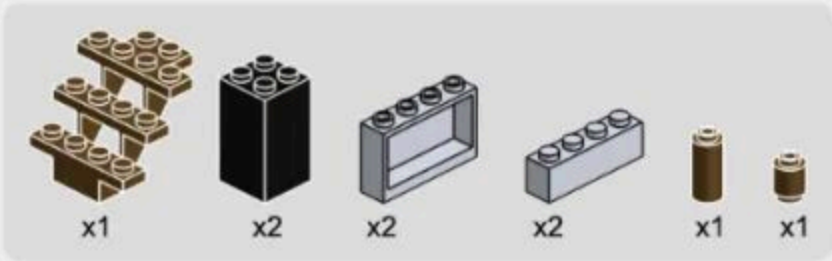

5-9

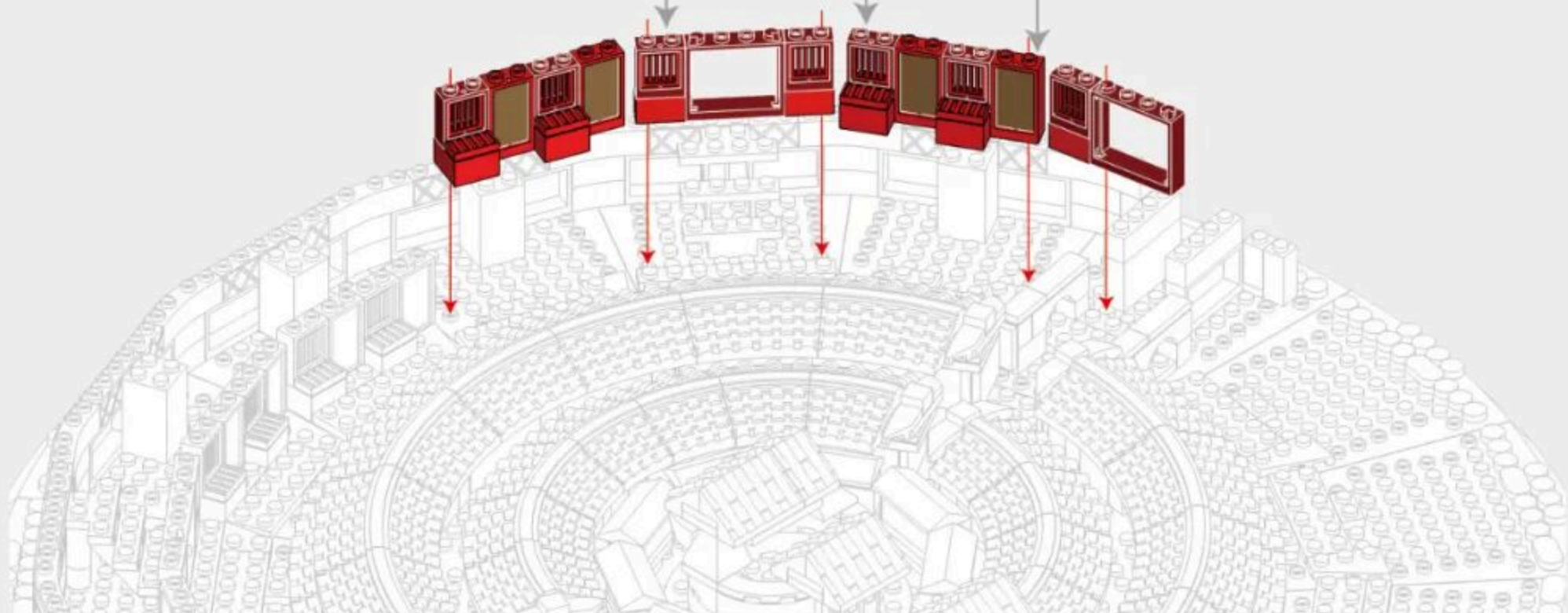
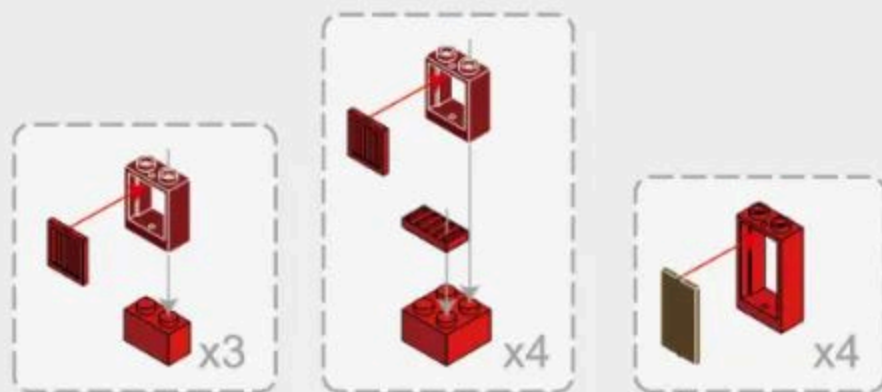
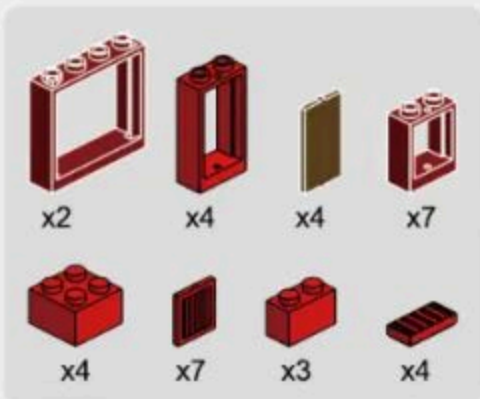

5-10

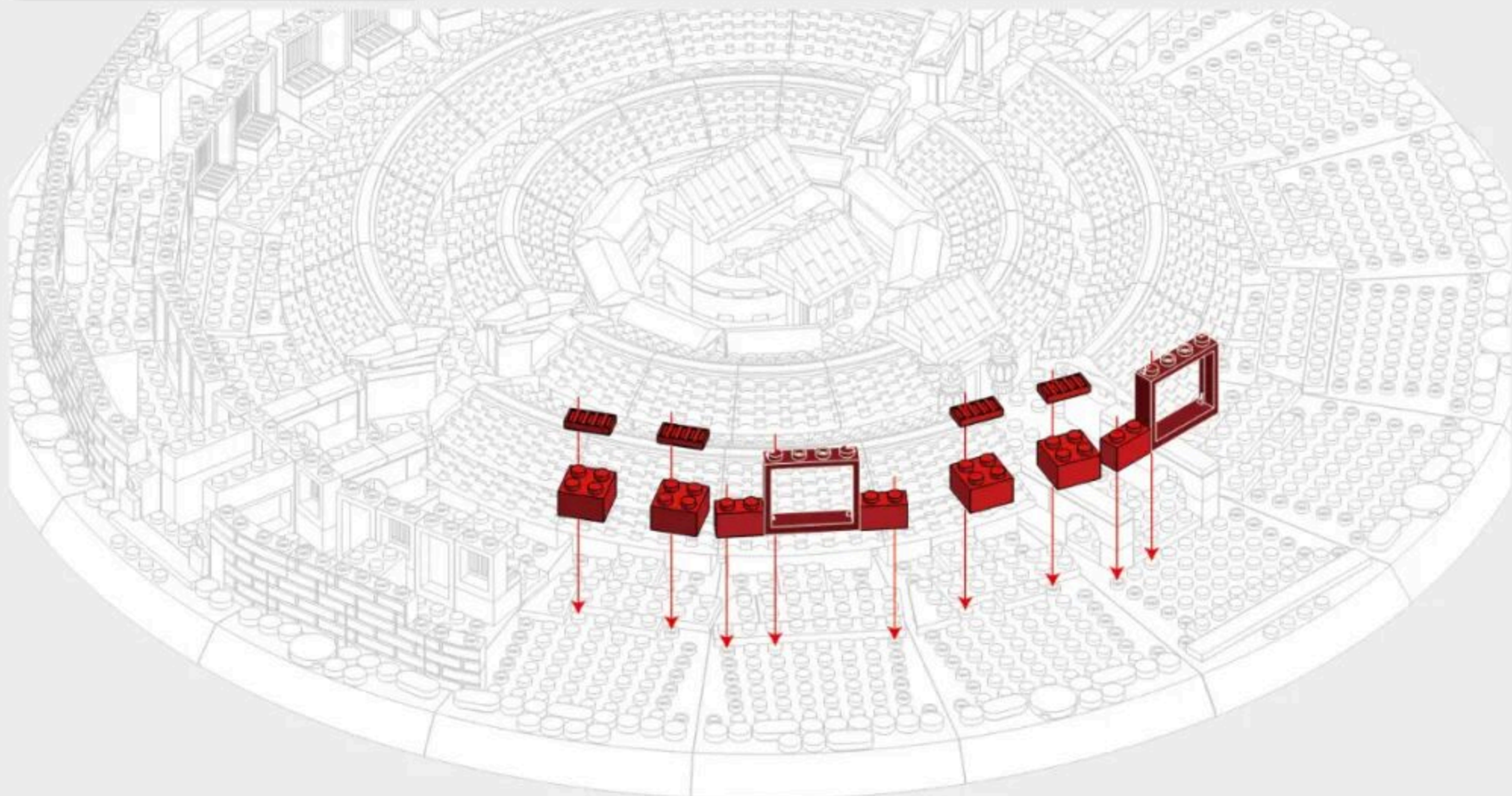
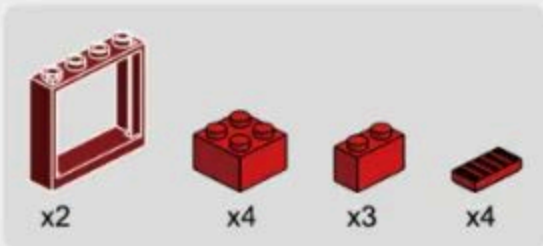

5-11

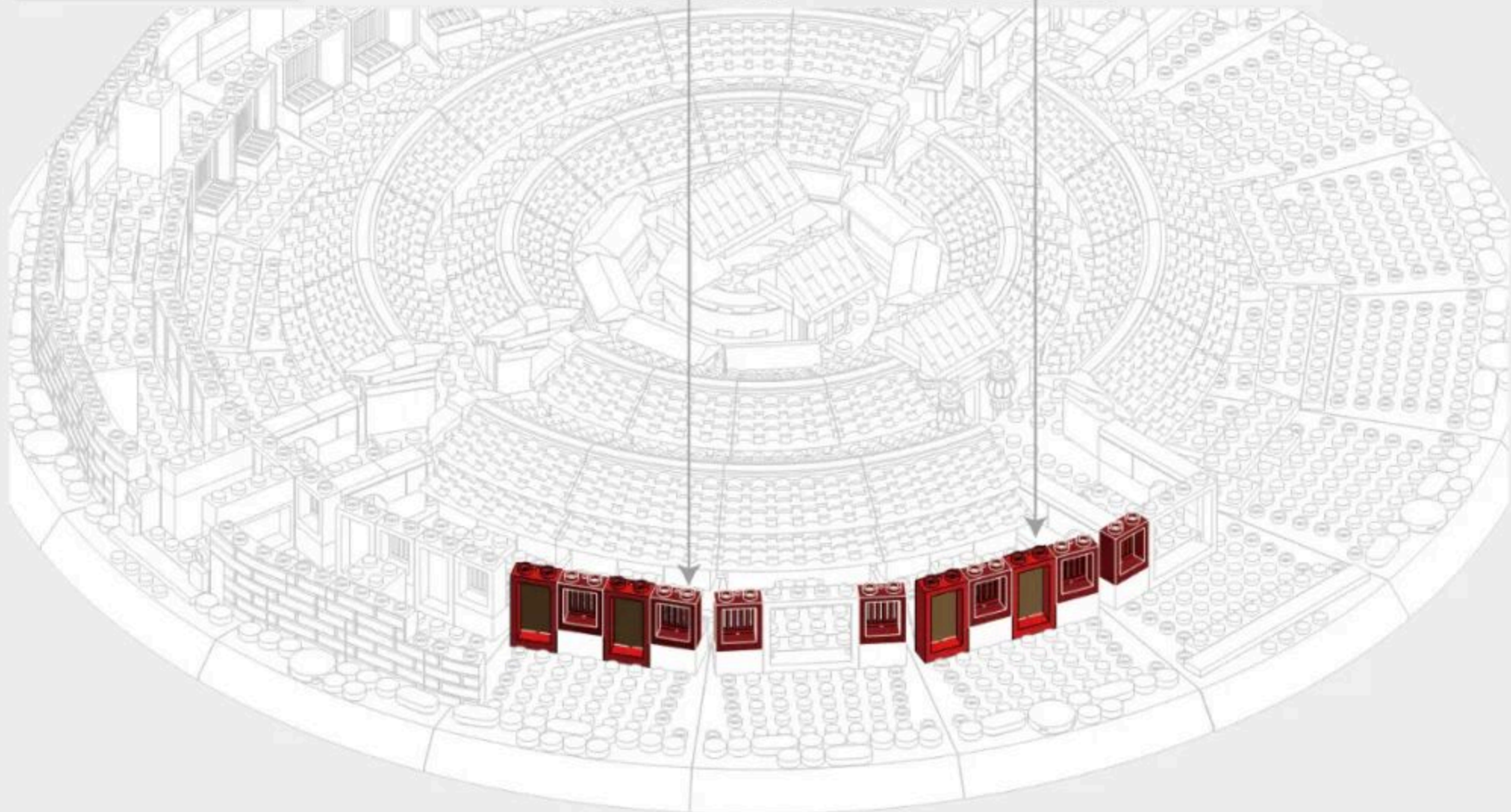

5-12

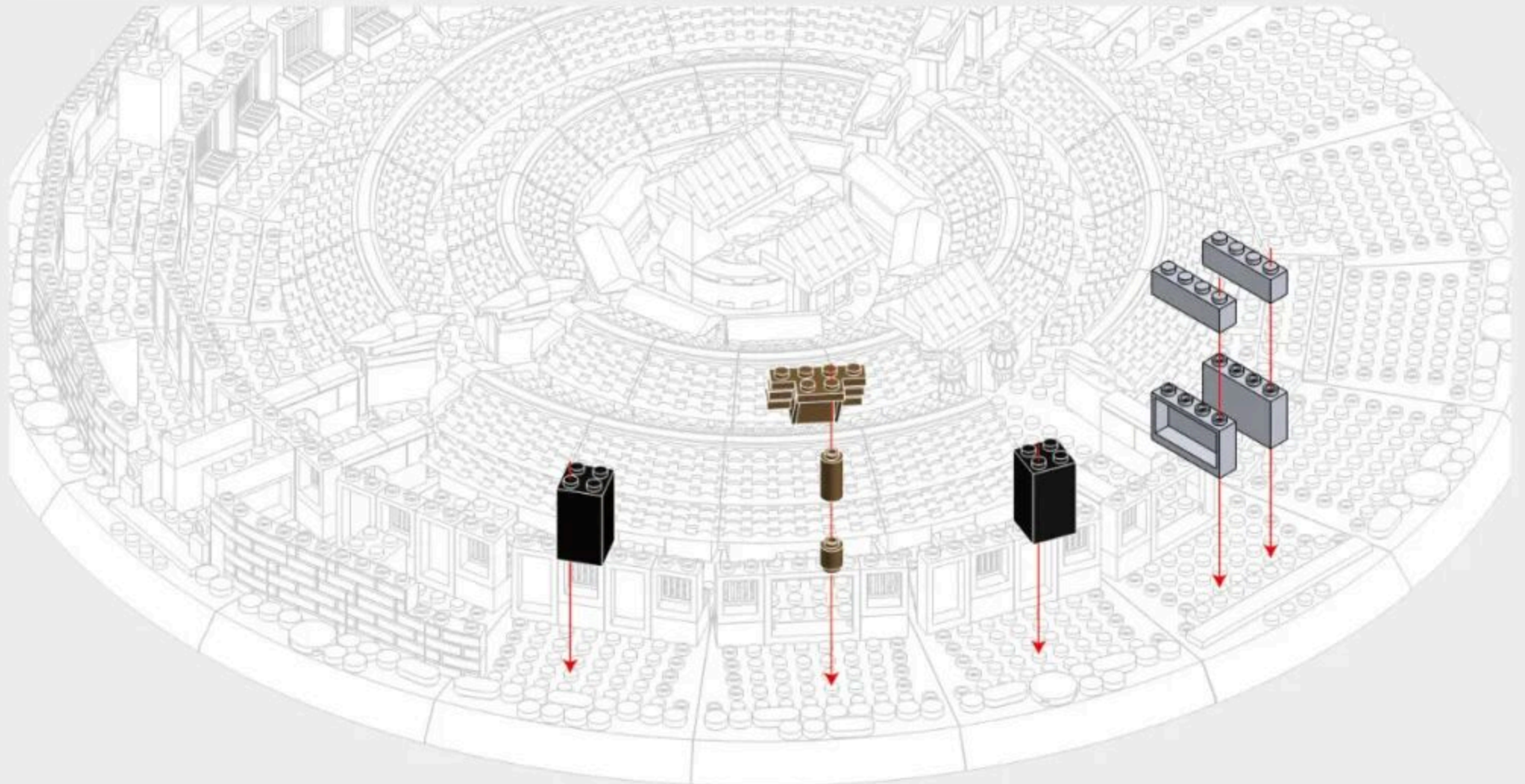
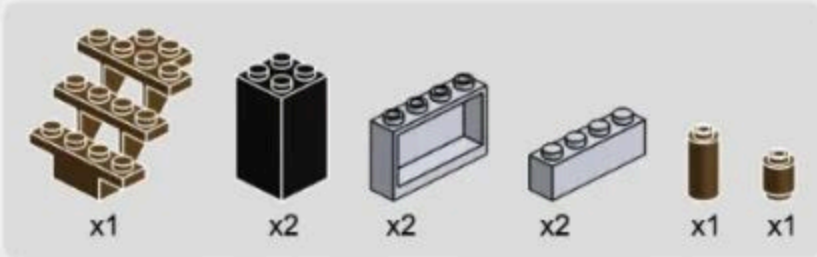

5-13



x6



x4



x2



x3



x6



x3



x2

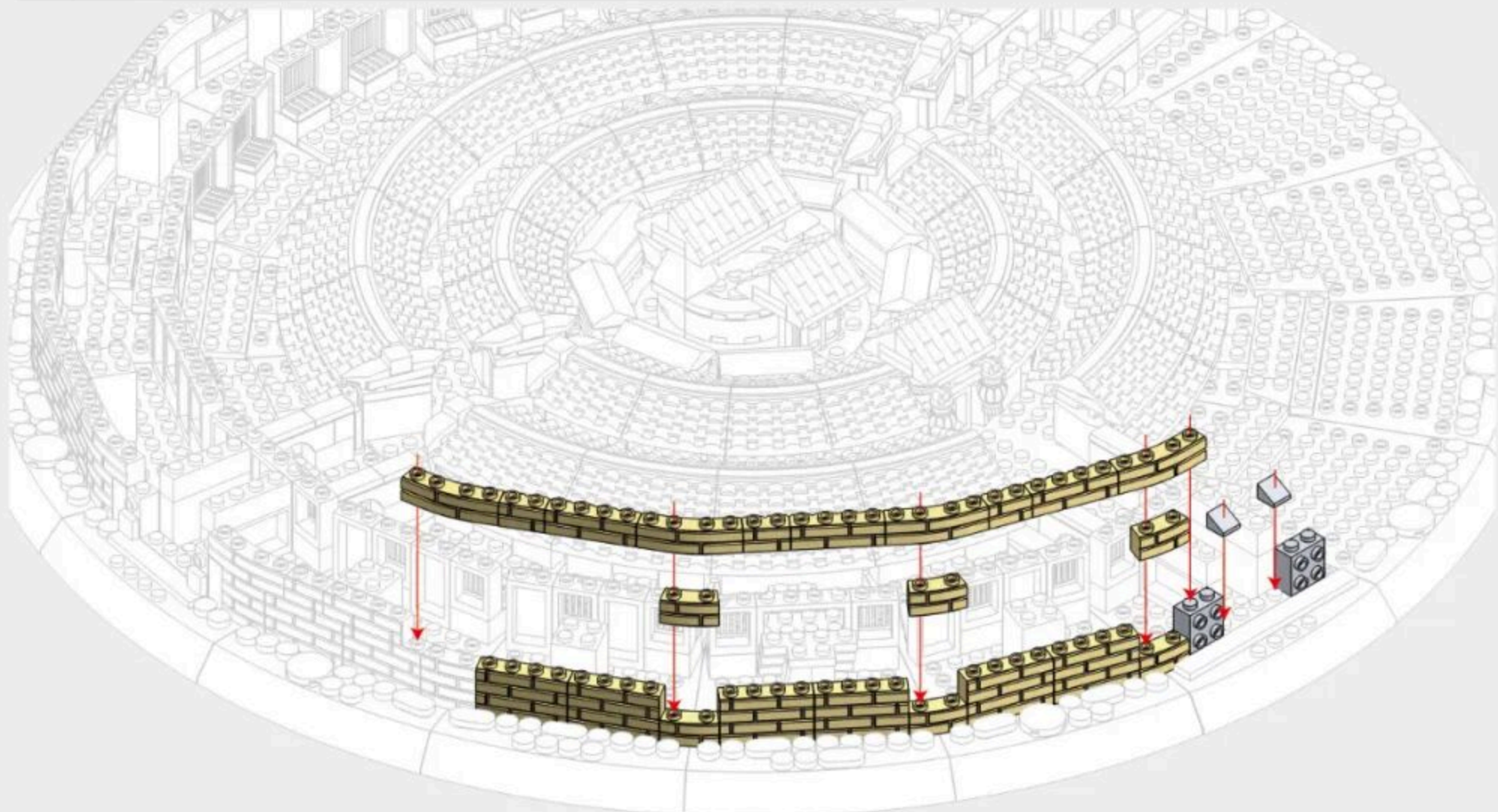



187PCS

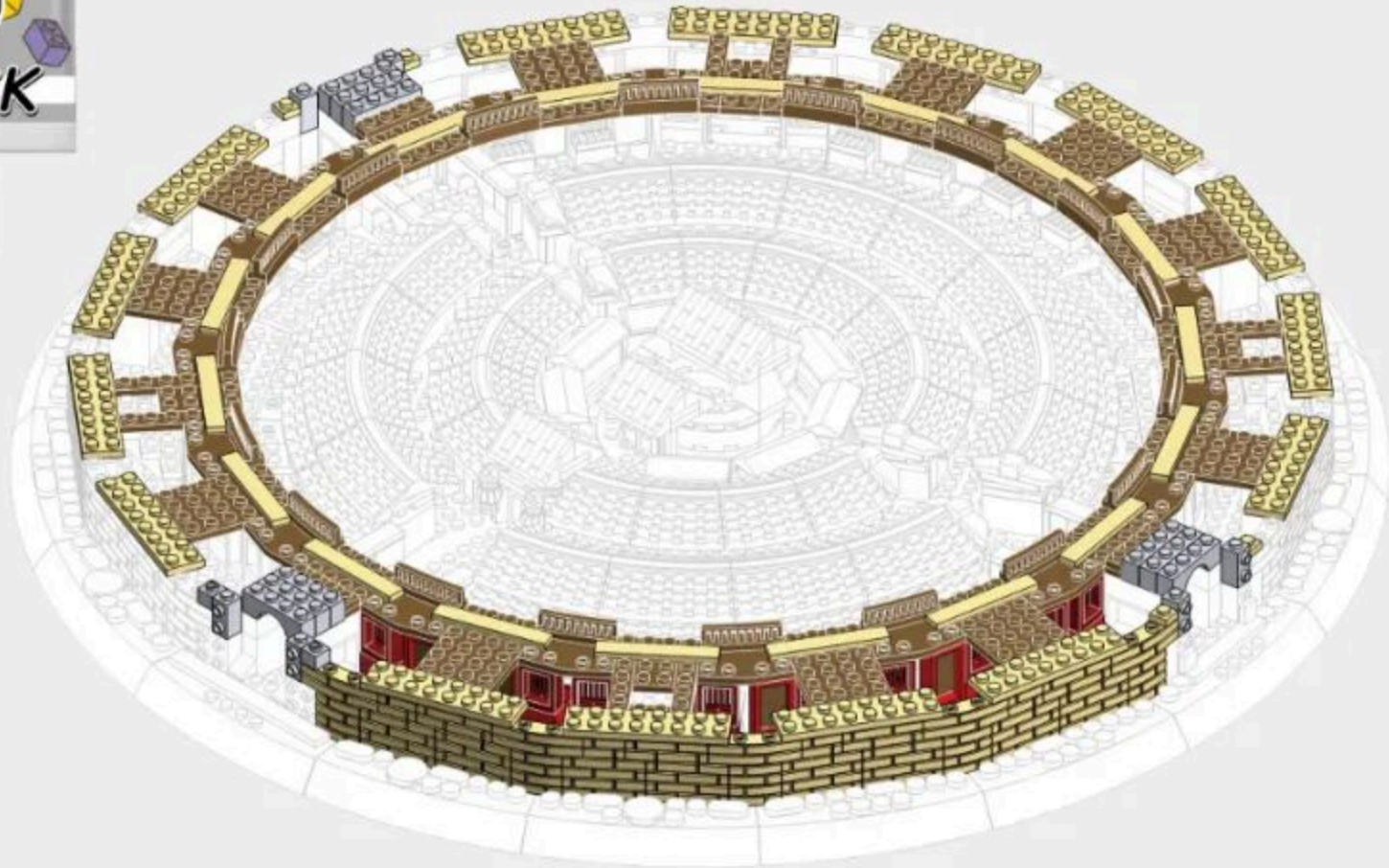

6-1

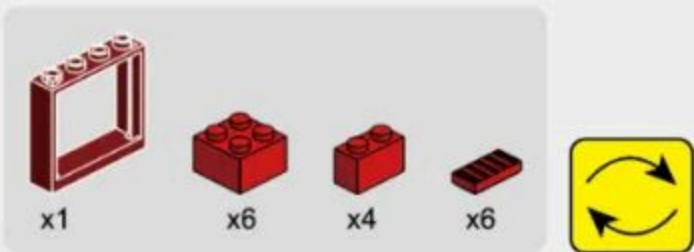

注意：此步骤仅用于搭建完整版的土楼，搭建解构版的土楼请忽略此步骤。
Tips: This step is only for constructing a complete version of the tulou. Please ignore this step if you are constructing a deconstructed version of the tulou.

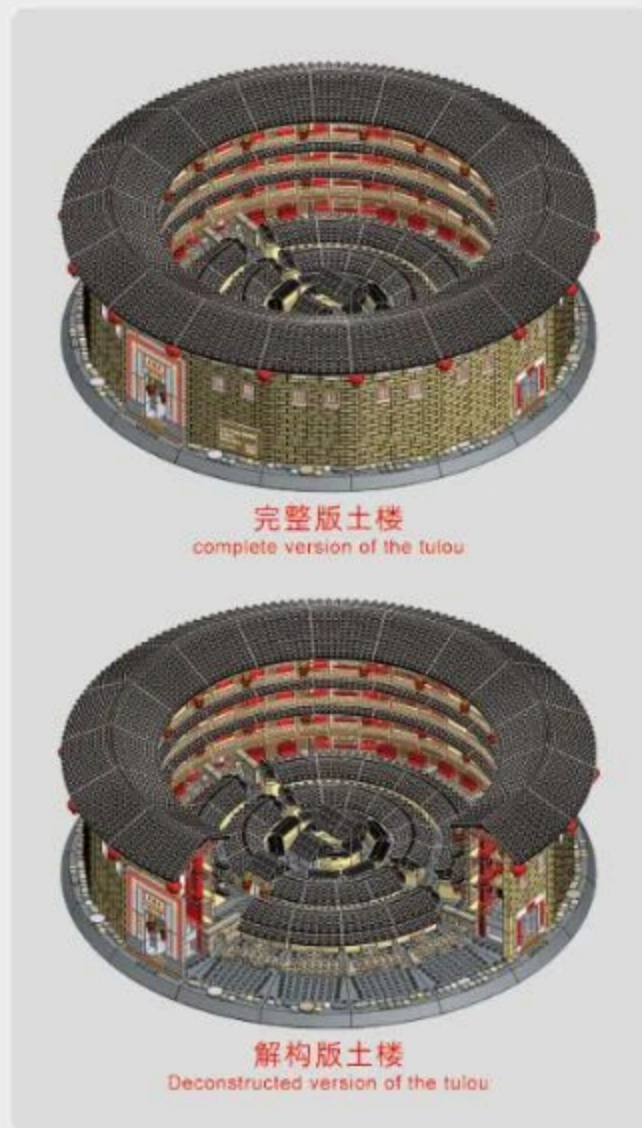
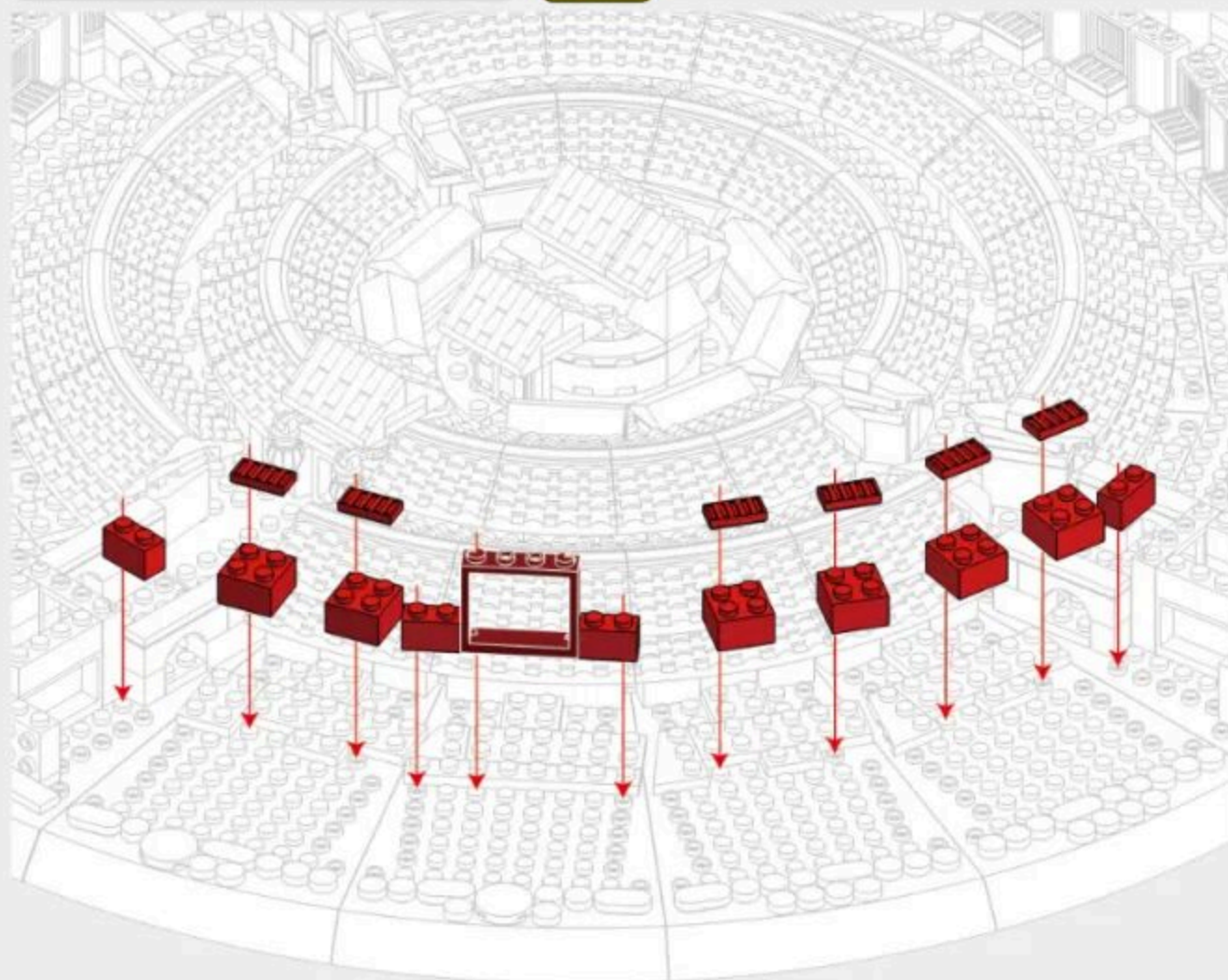

6-2



注意：此步骤仅用于搭建完整版的土楼，搭建解构版的土楼请忽略此步骤。
Tips: This step is only for constructing a complete version of the tulou.
Please ignore this step if you are constructing a deconstructed version of the tulou.

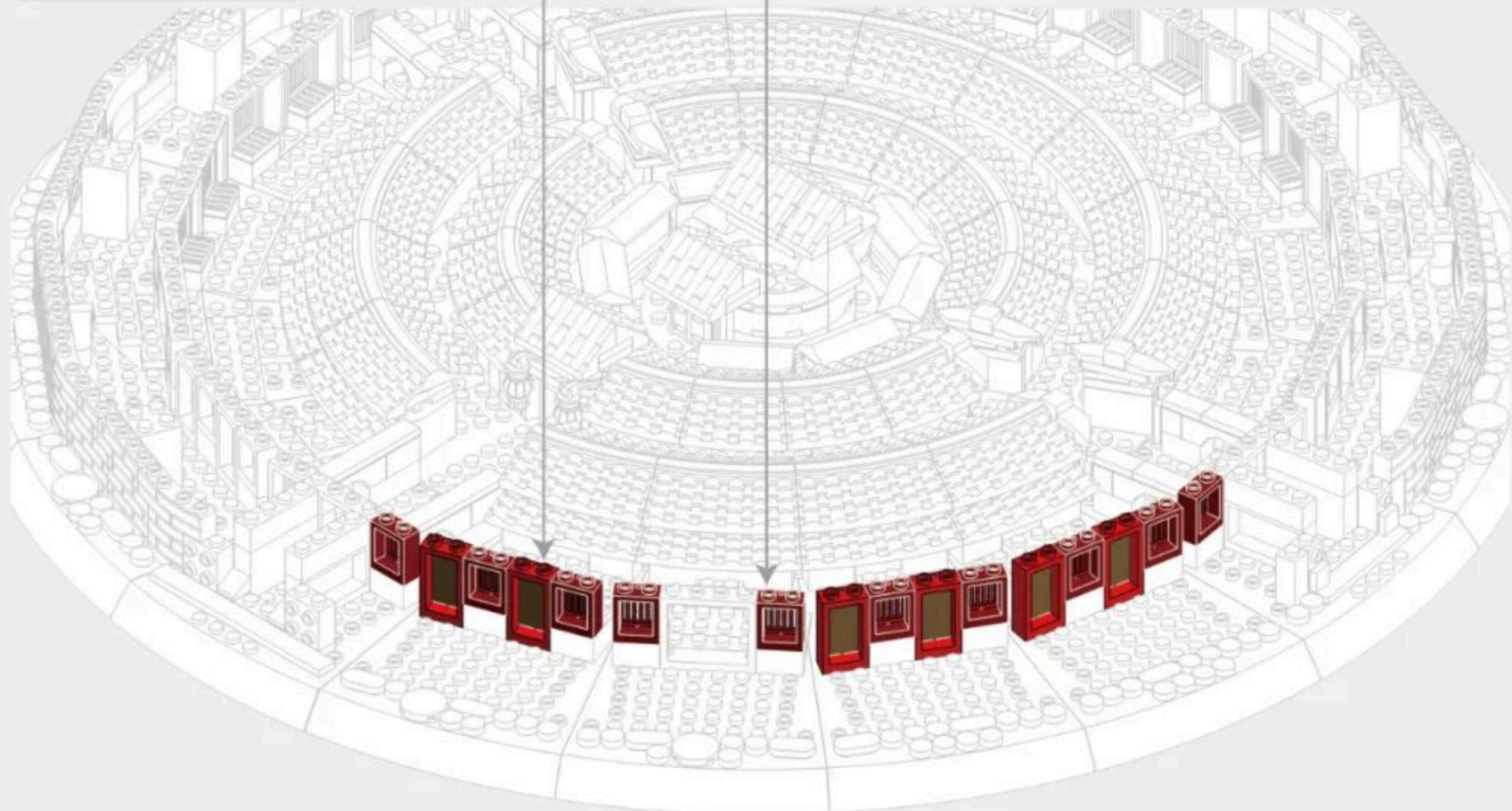

6-3



注意：此步骤仅用于搭建完整版的土楼，搭建解构版的土楼请忽略此步骤。
Tips: This step is only for constructing a complete version of the tulou.
Please ignore this step if you are constructing a deconstructed version of the tulou.

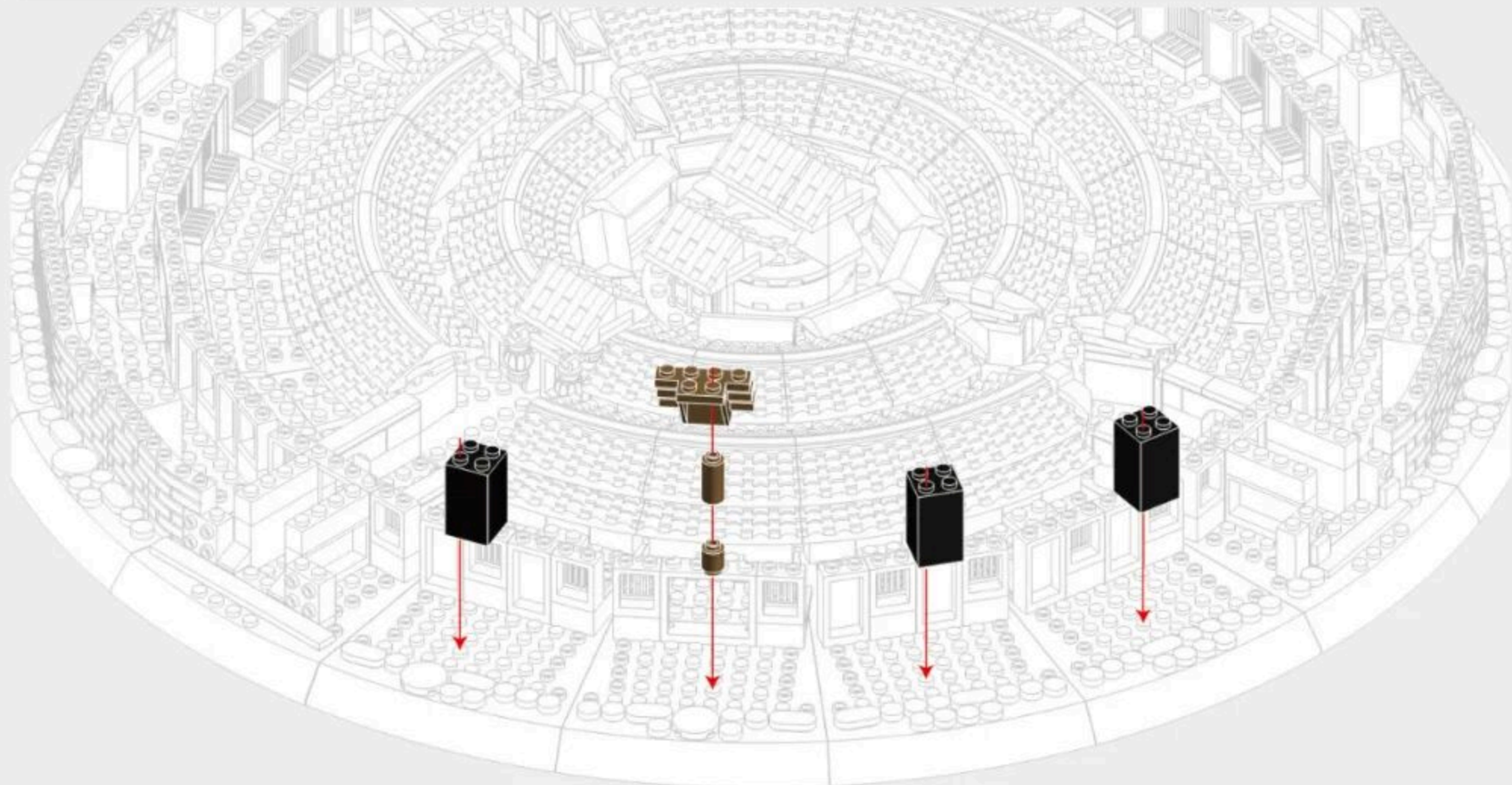

6-4



x8



x5



x4



x10



x4

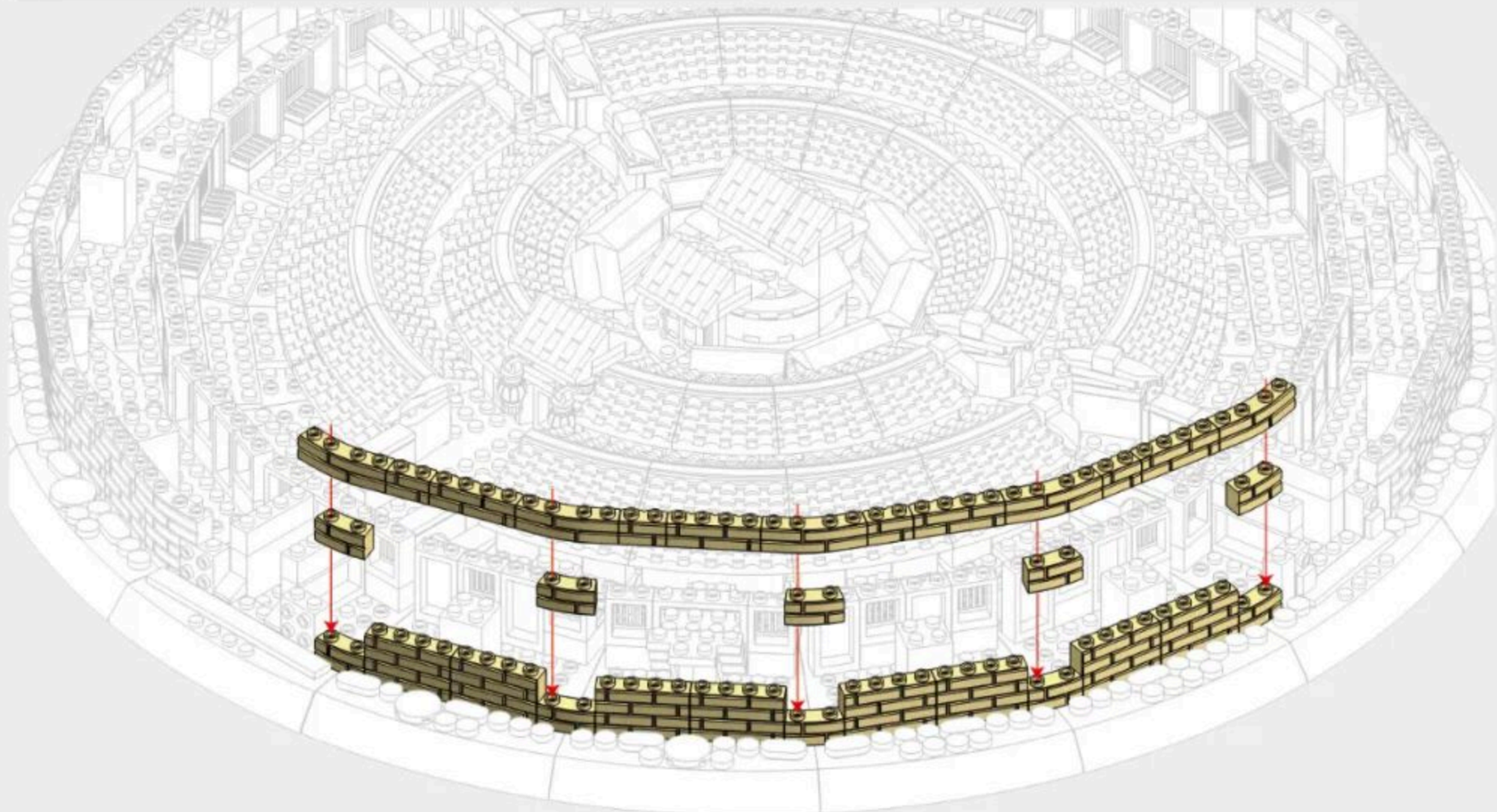

注意：此步骤仅用于搭建完整版的土楼，搭建解构版的土楼请忽略此步骤。
Tips: This step is only for constructing a complete version of the tulou.
Please ignore this step if you are constructing a deconstructed version of the tulou.

6-5

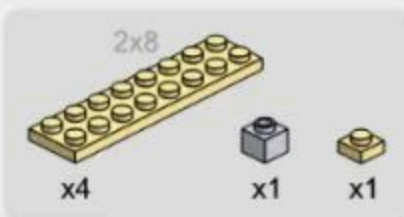

注意：此步骤仅用于搭建完整版的土楼，搭建解构版的土楼请忽略此步骤。
Tips: This step is only for constructing a complete version of the tulou.
Please ignore this step if you are constructing a deconstructed version of the tulou.

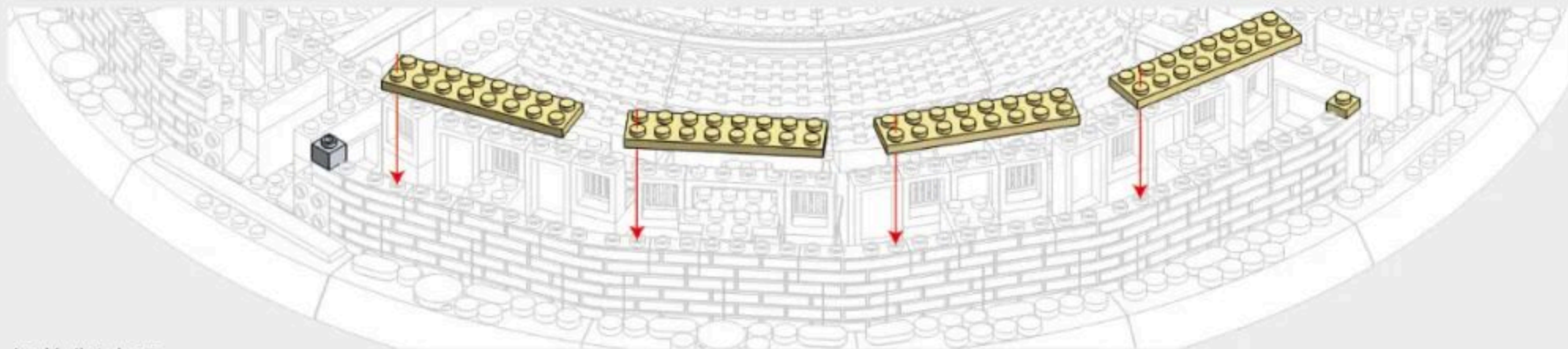

解构版步骤



注意：此步骤仅用于搭建解构版的土楼。
Tips: This step is only used to build a deconstructed version of the tulou.

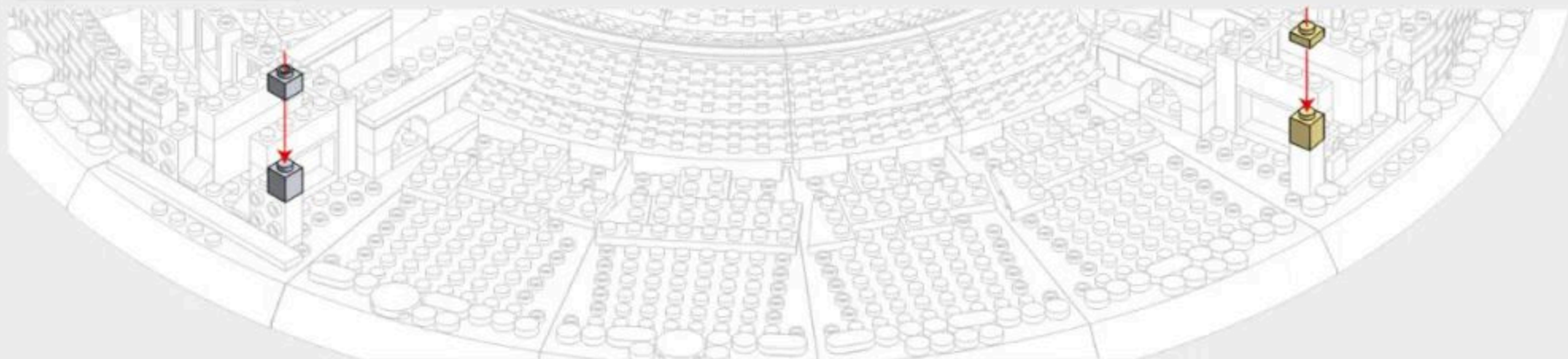

6-6

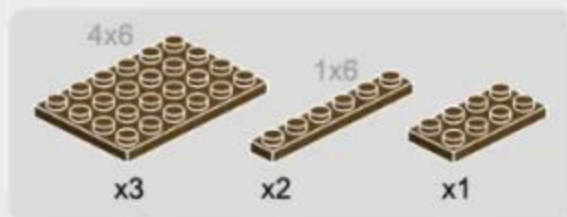

注意：此步骤仅用于搭建完整版的土楼，搭建解构版的土楼请忽略此步骤。
Tips: This step is only for constructing a complete version of the tulou.
Please ignore this step if you are constructing a deconstructed version of the tulou.

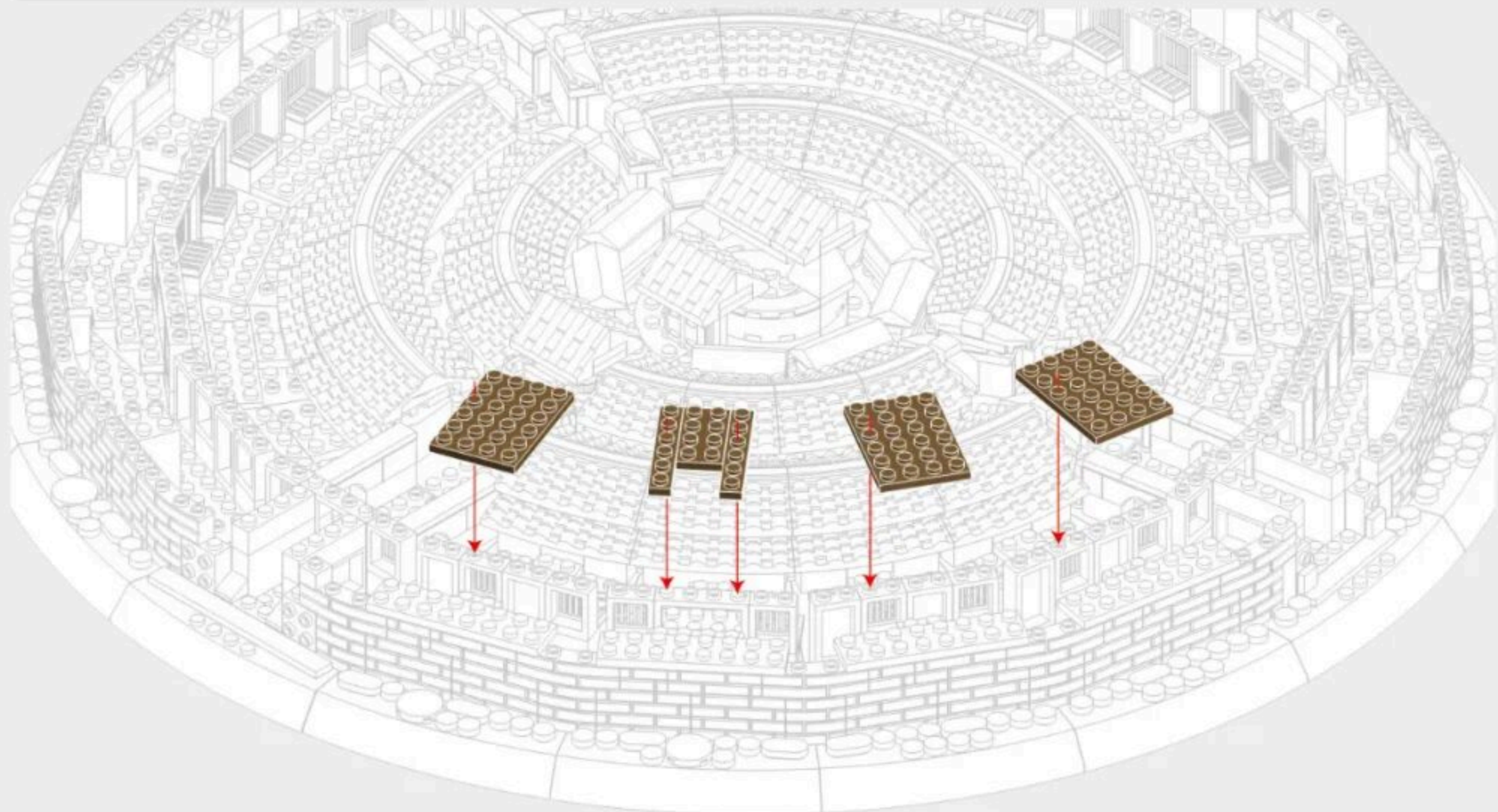

6-7



注意：此步骤仅用于搭建完整版的土楼，搭建解构版的土楼请忽略此步骤。
Tips: This step is only for constructing a complete version of the tulou.
Please ignore this step if you are constructing a deconstructed version of the tulou.

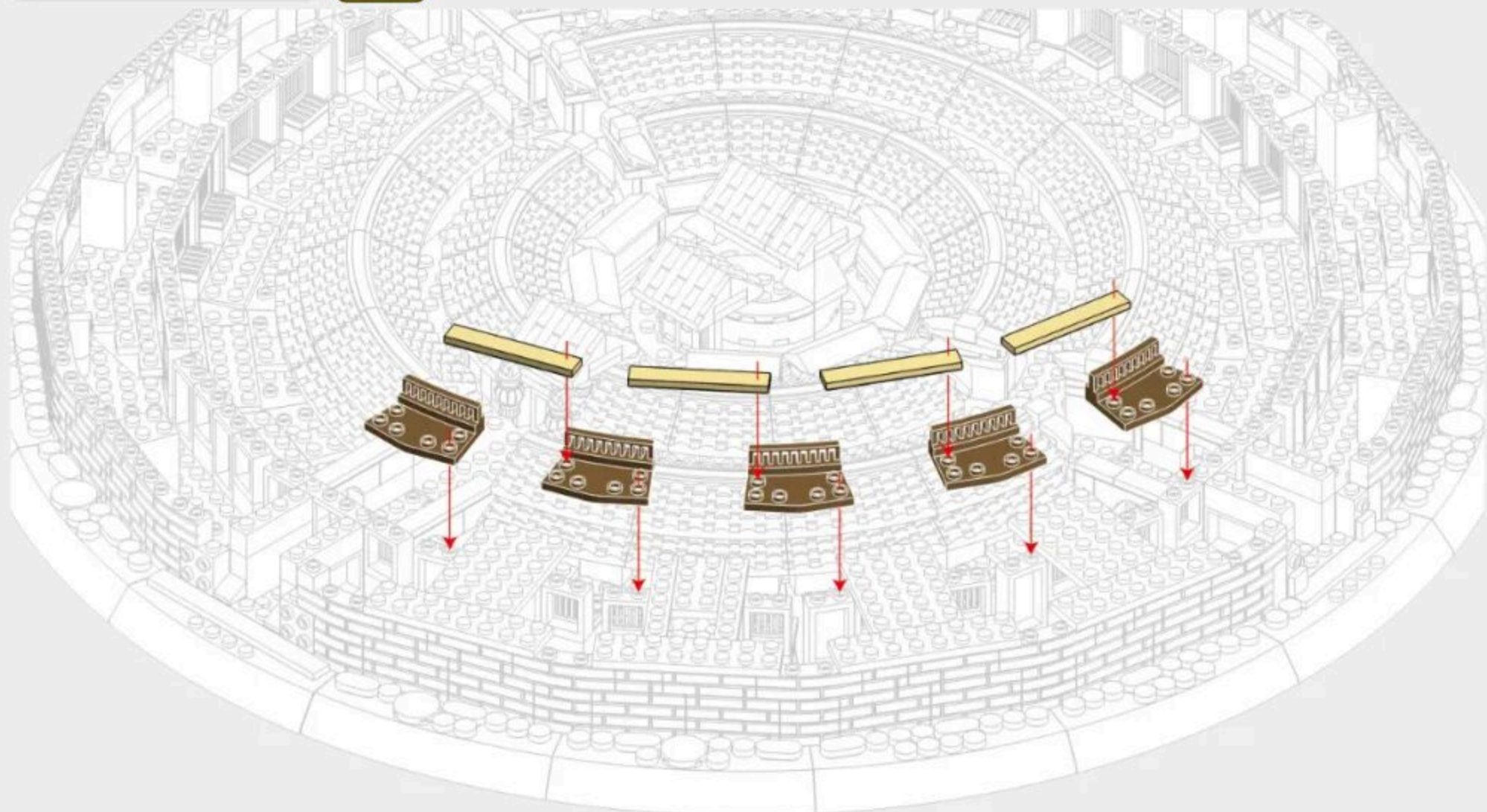

6-8

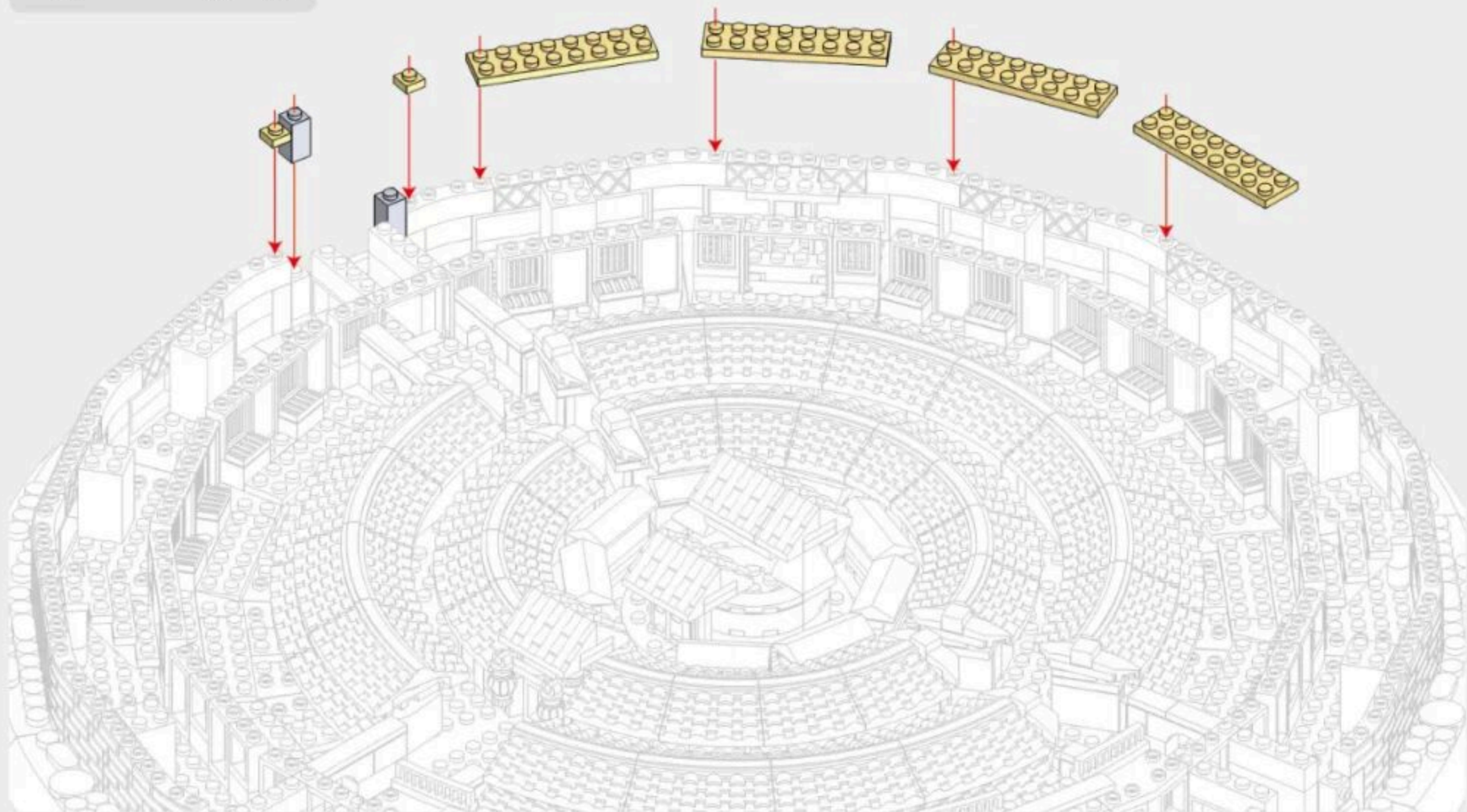
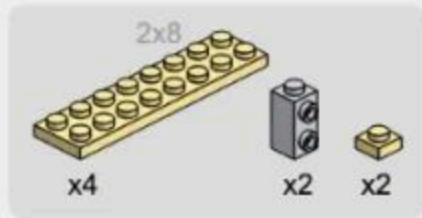

6-9

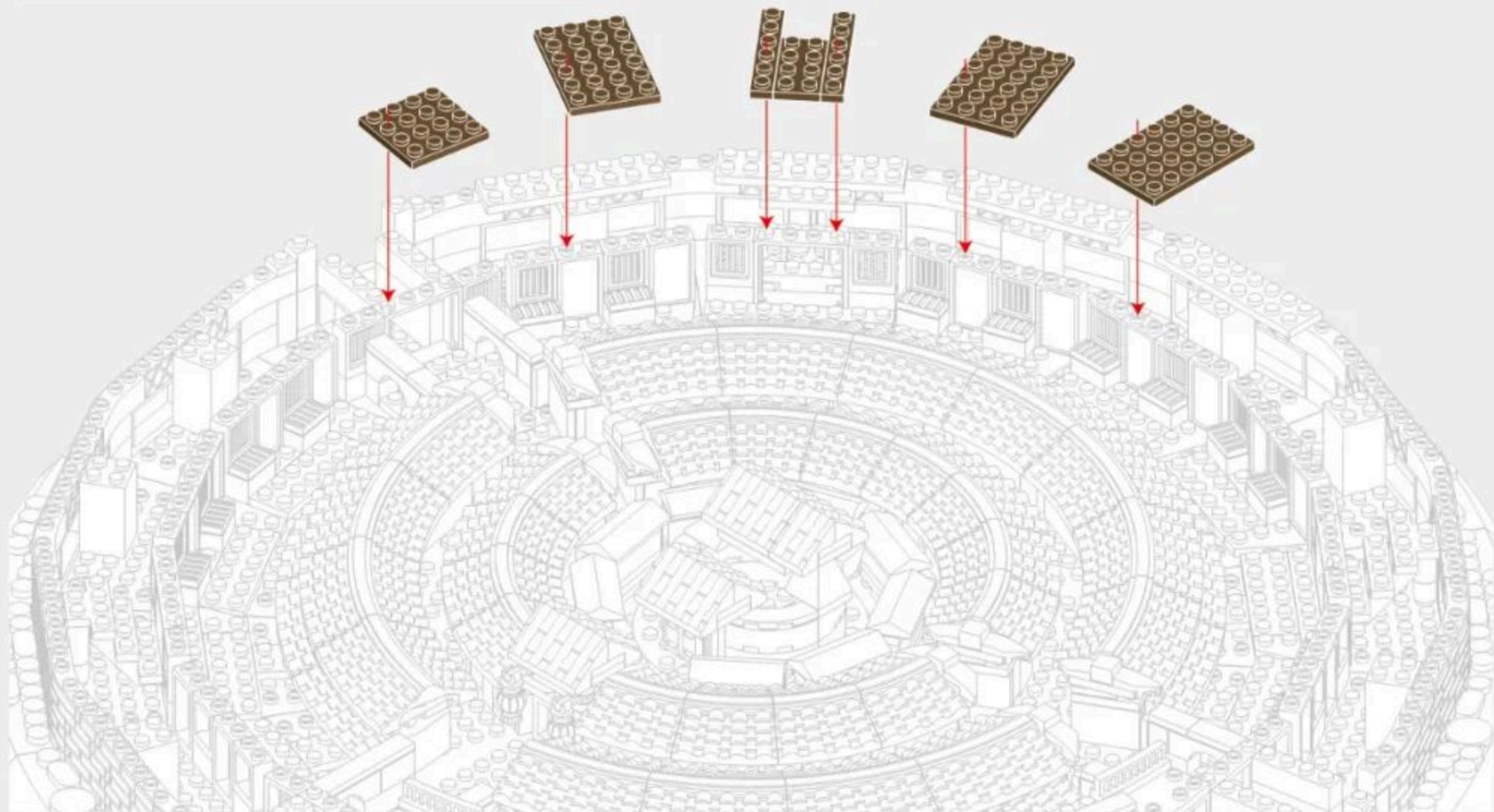
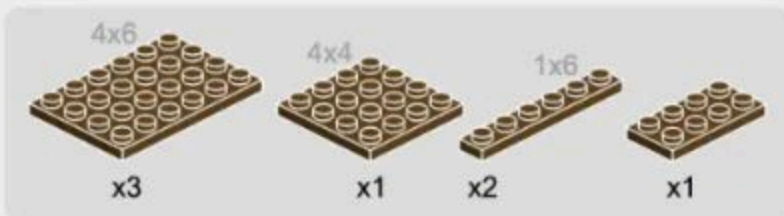

6-10

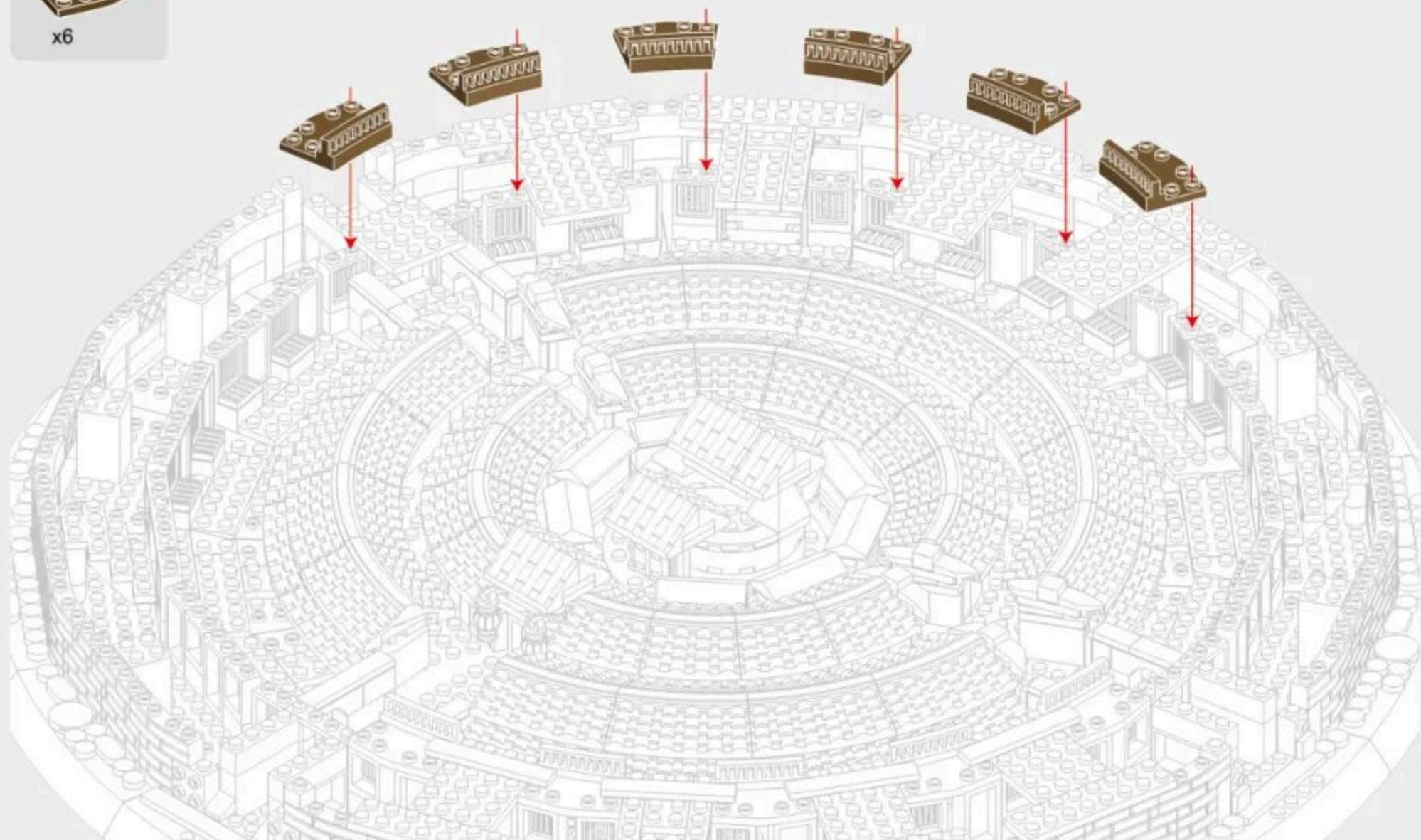

6-11

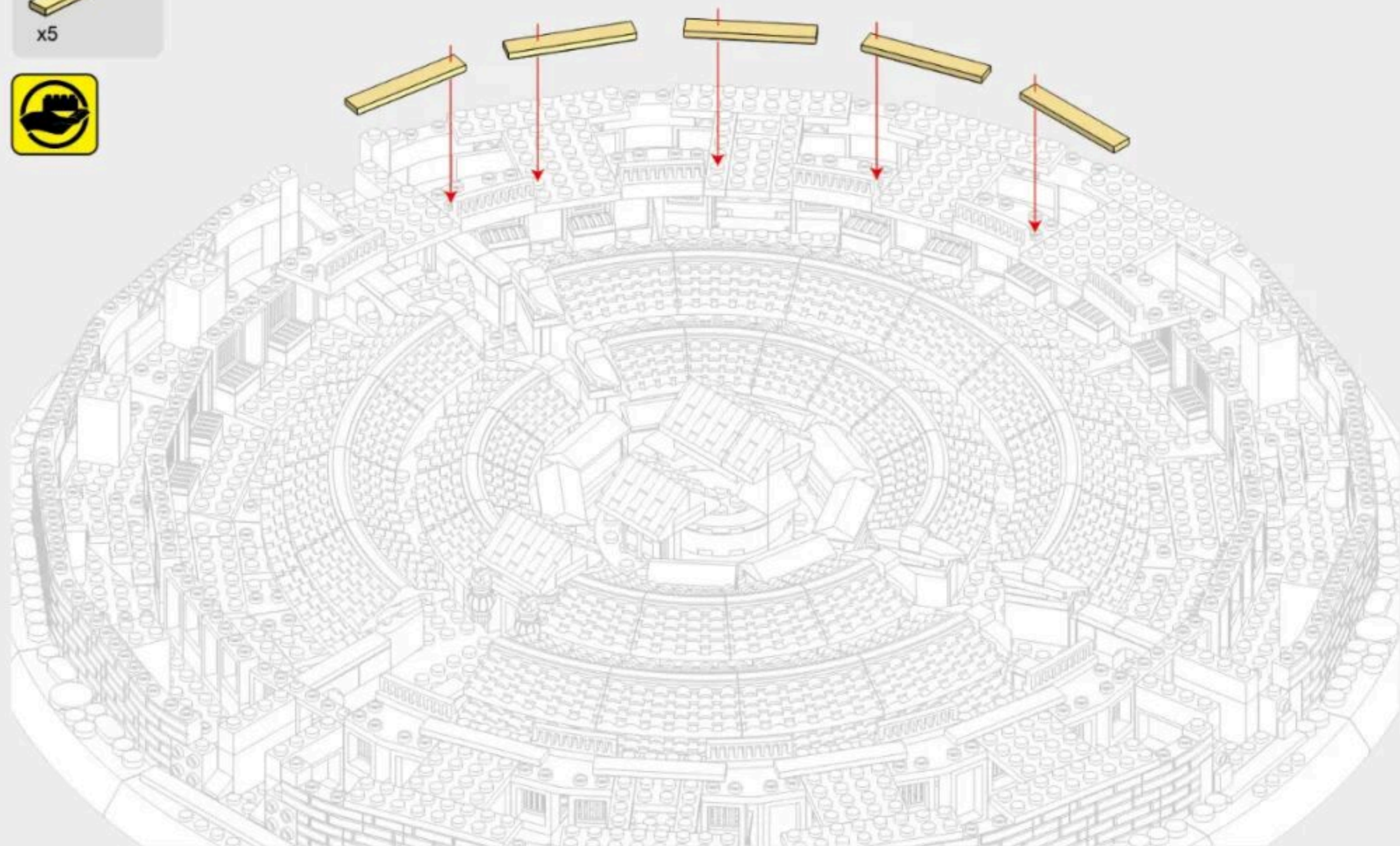

6-12



x3



x1

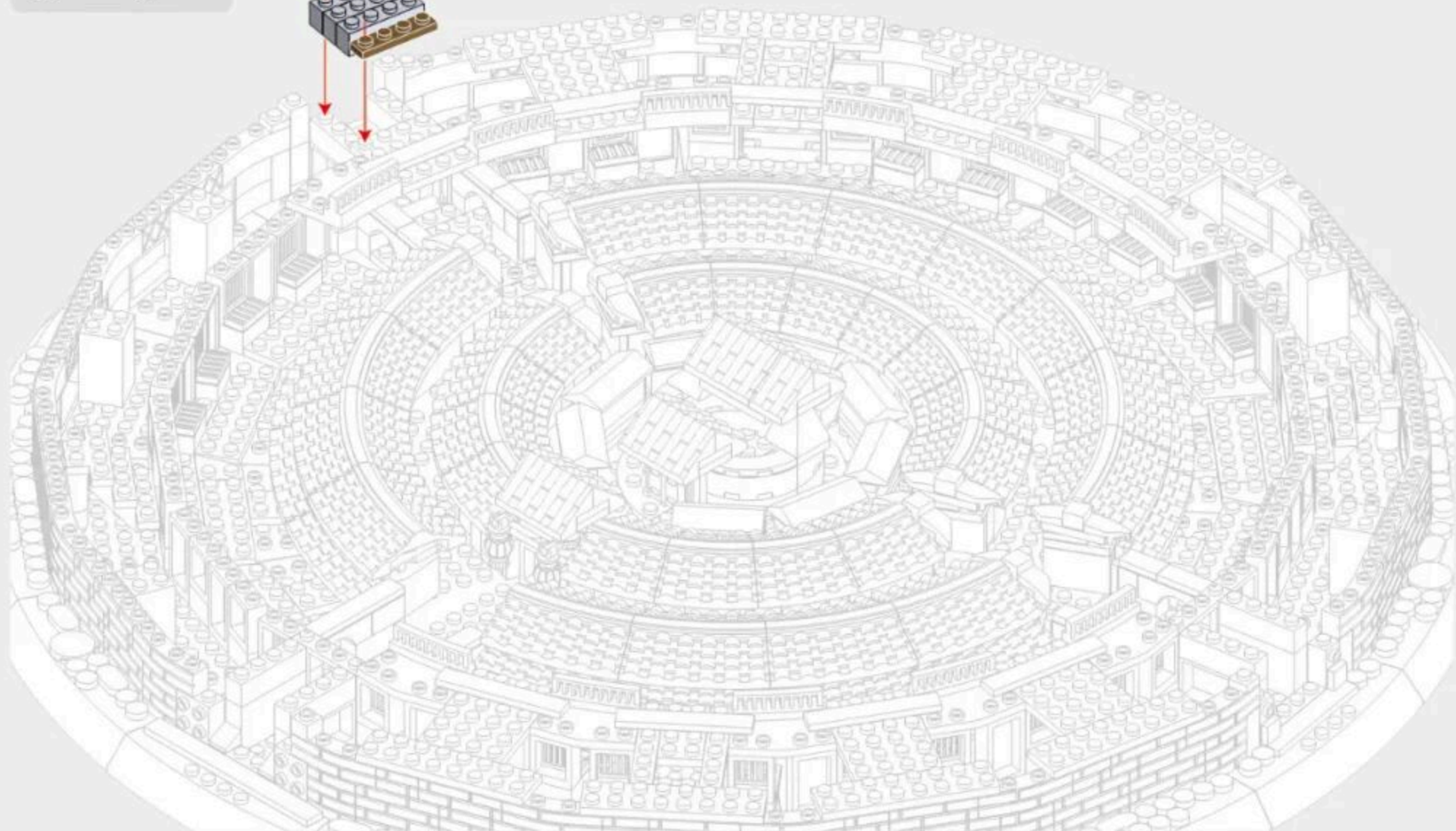
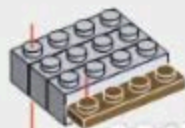

6-13

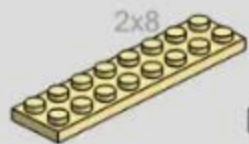

2x8

x4



x1

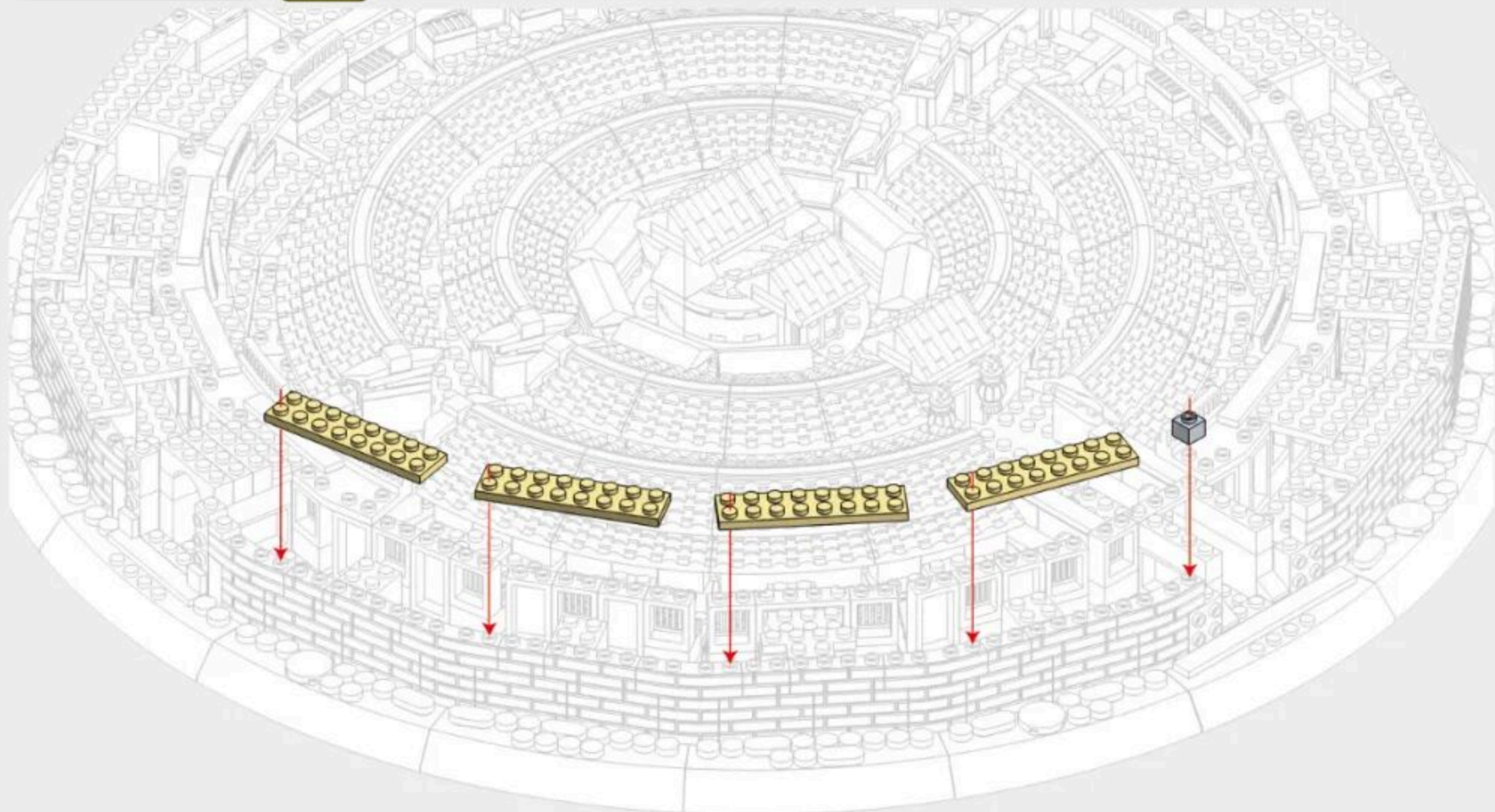

6-14

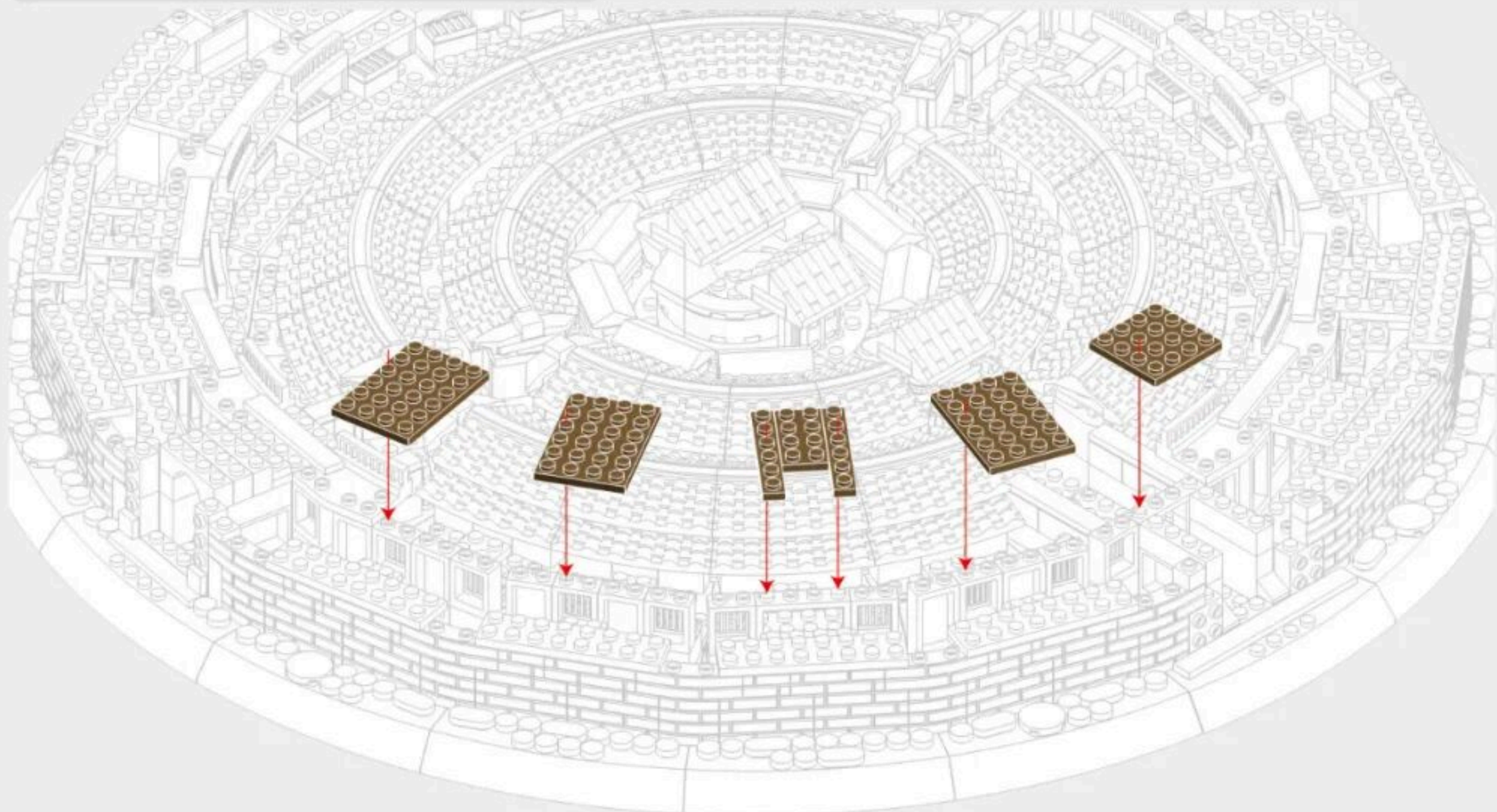
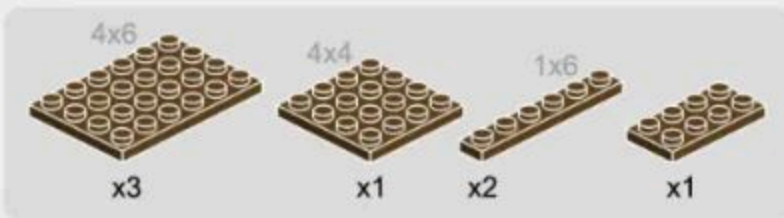

6-15

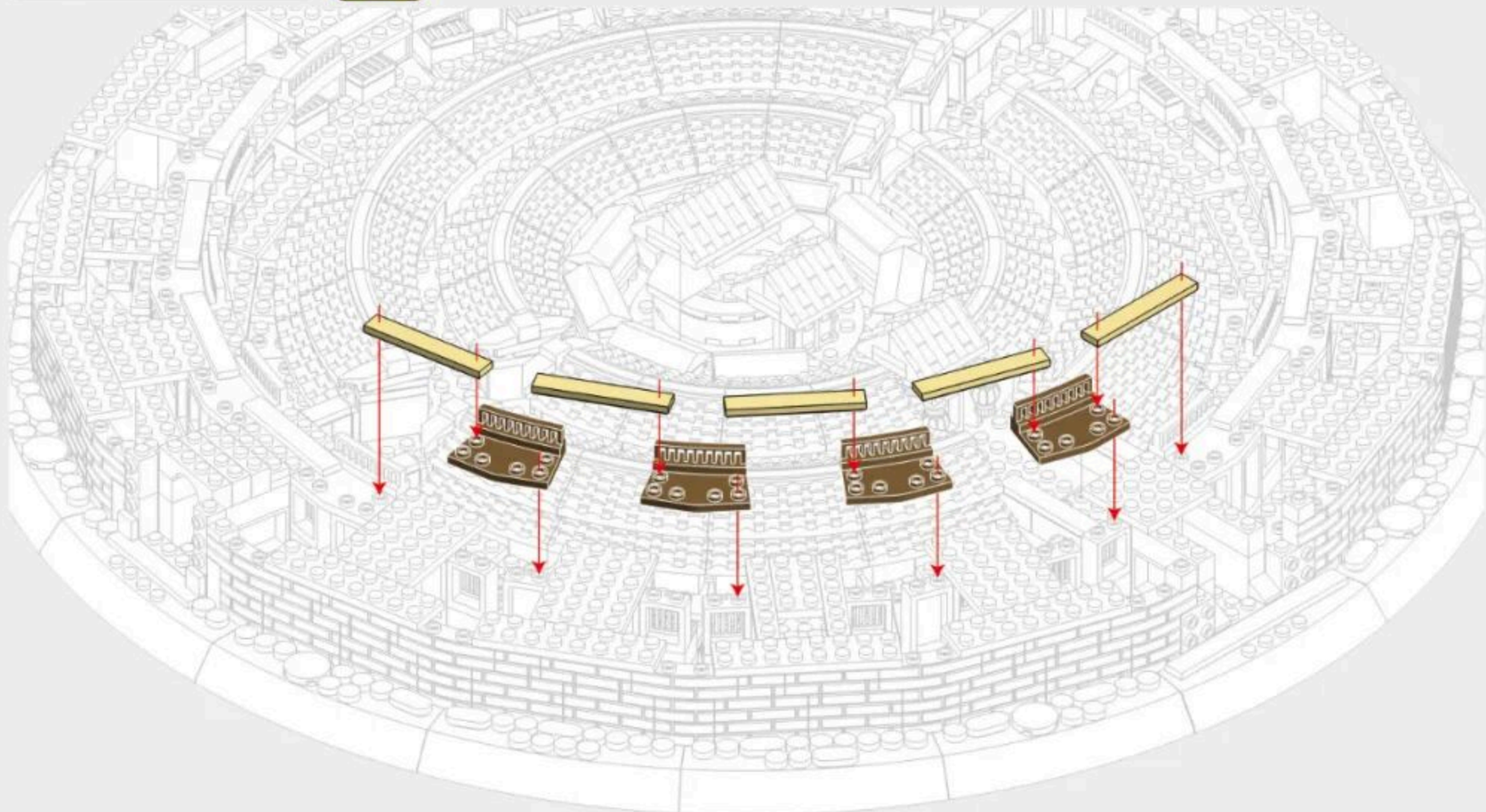

6-16



x3



x2



x1

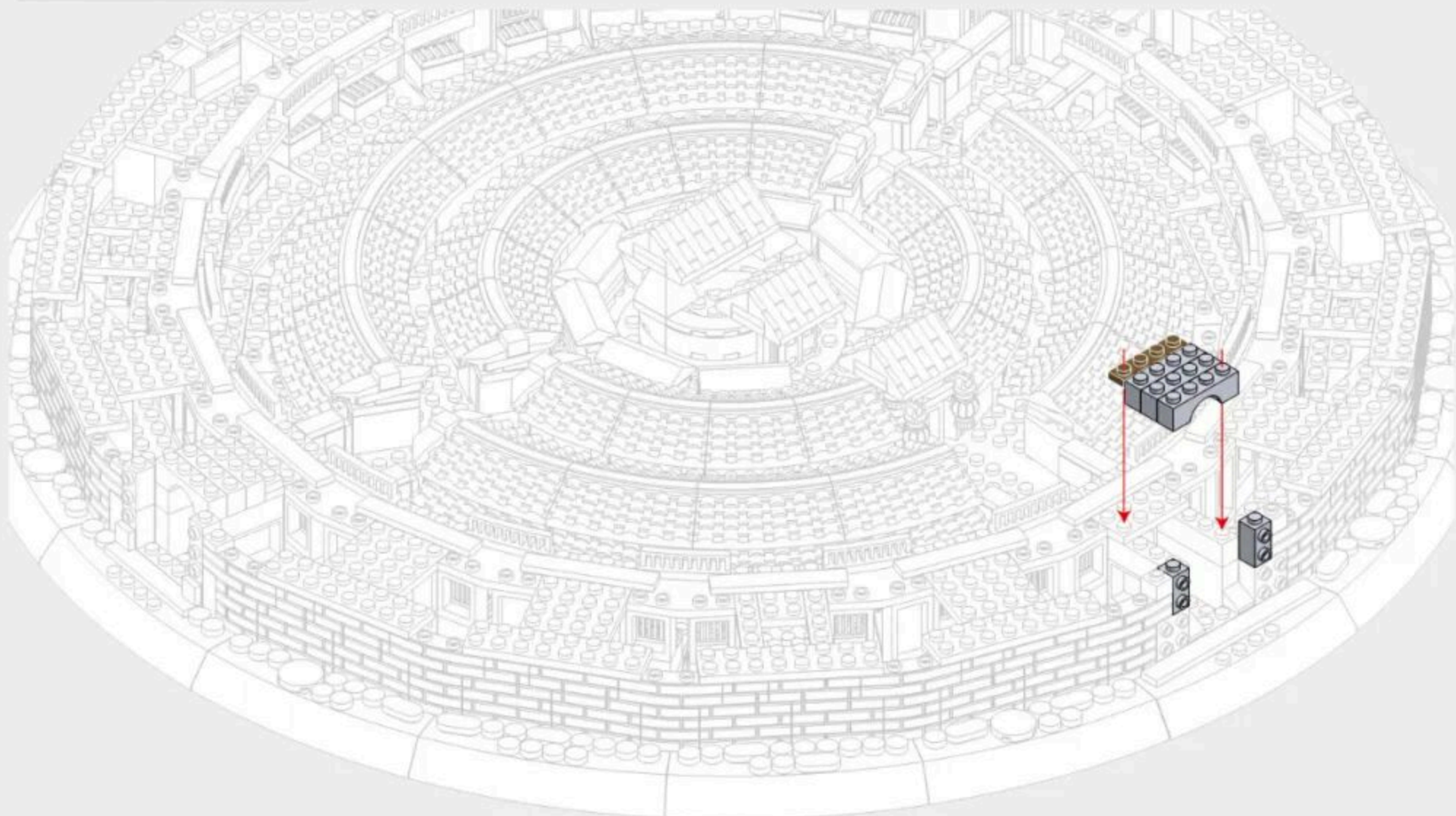

6-17

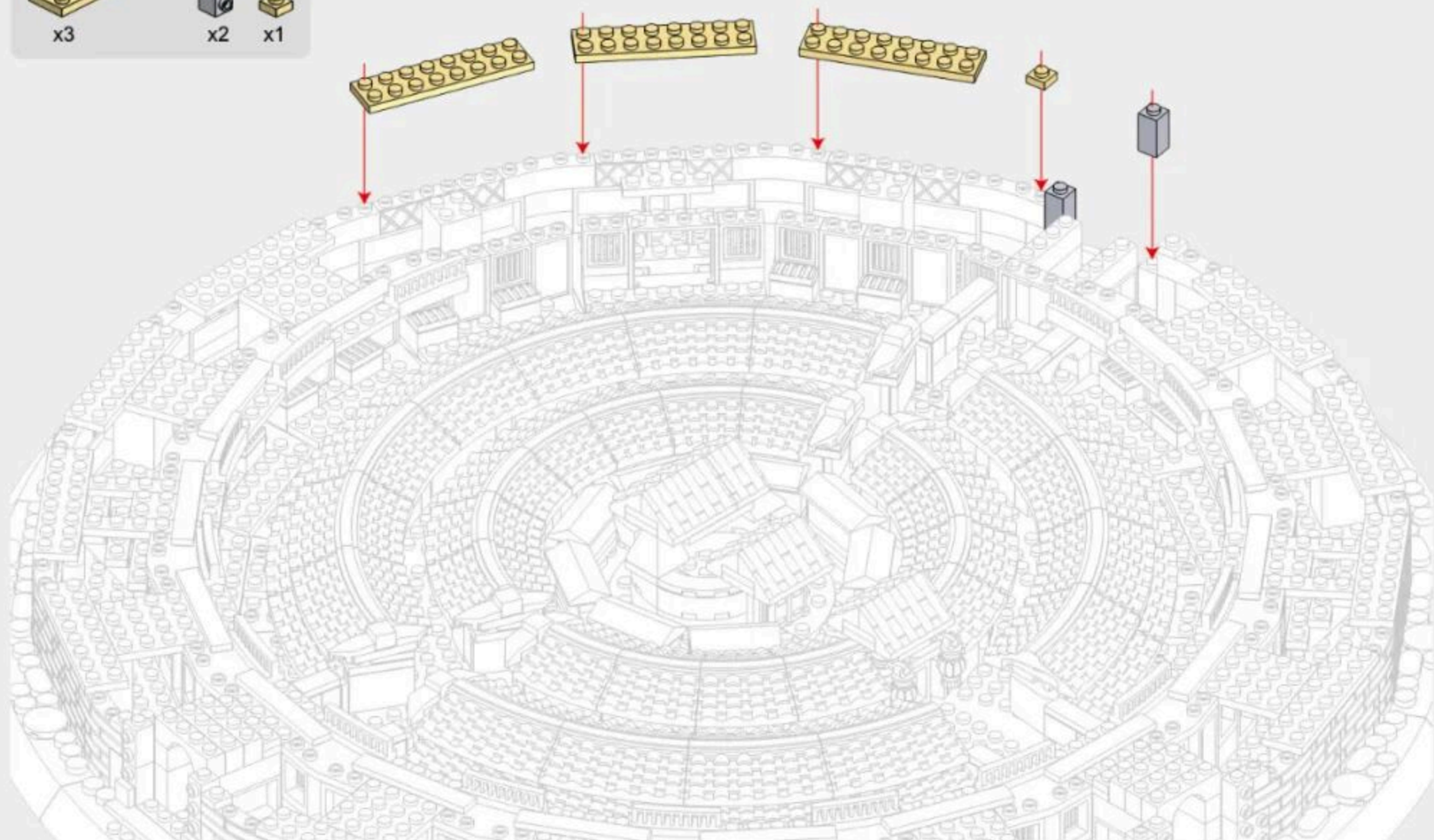
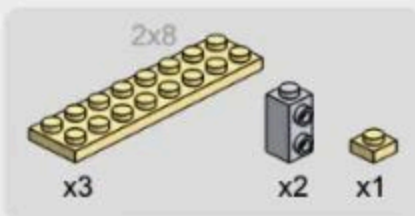

6-18

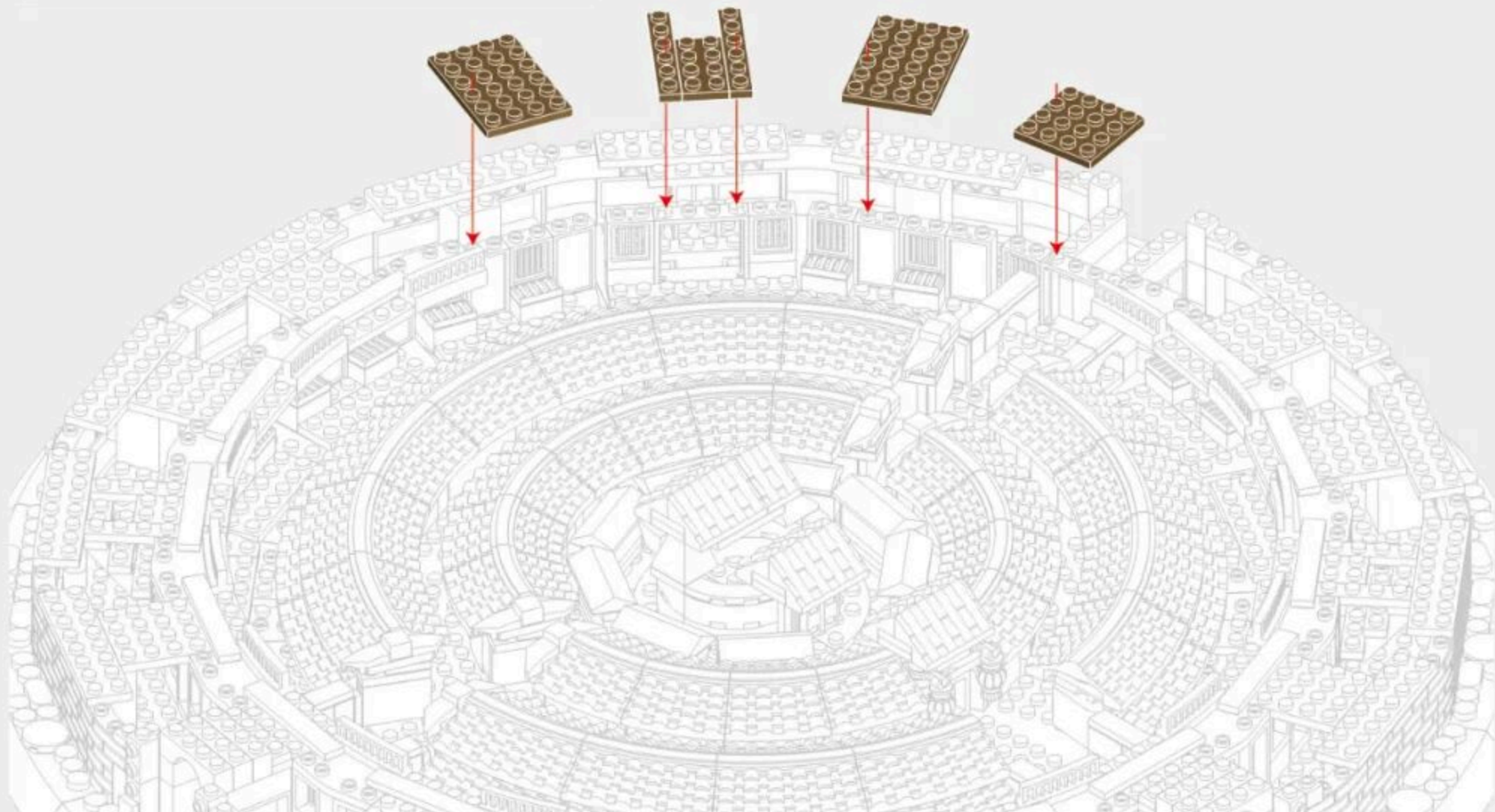
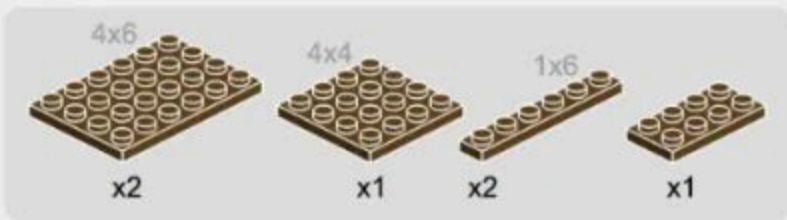

6-19

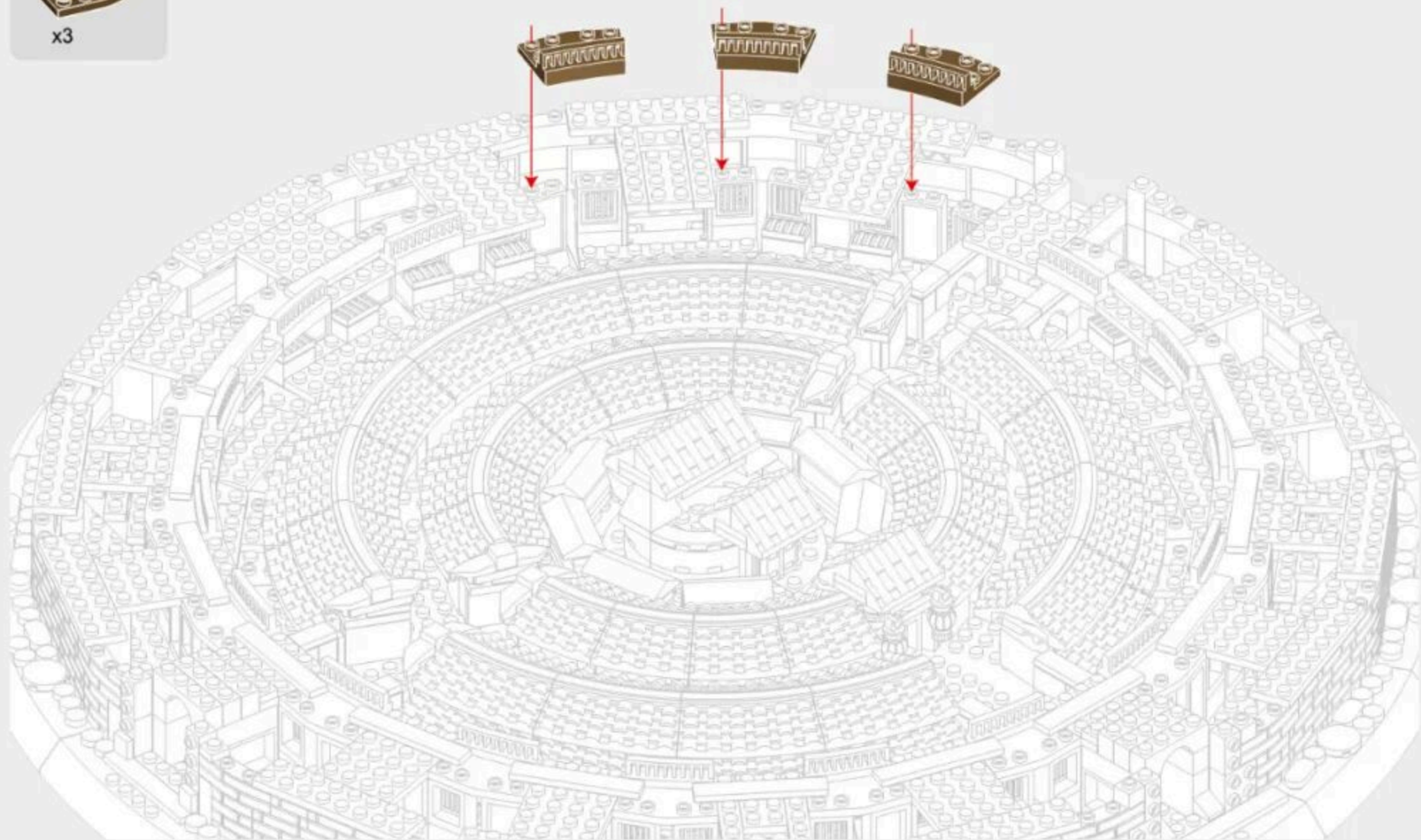

6-20

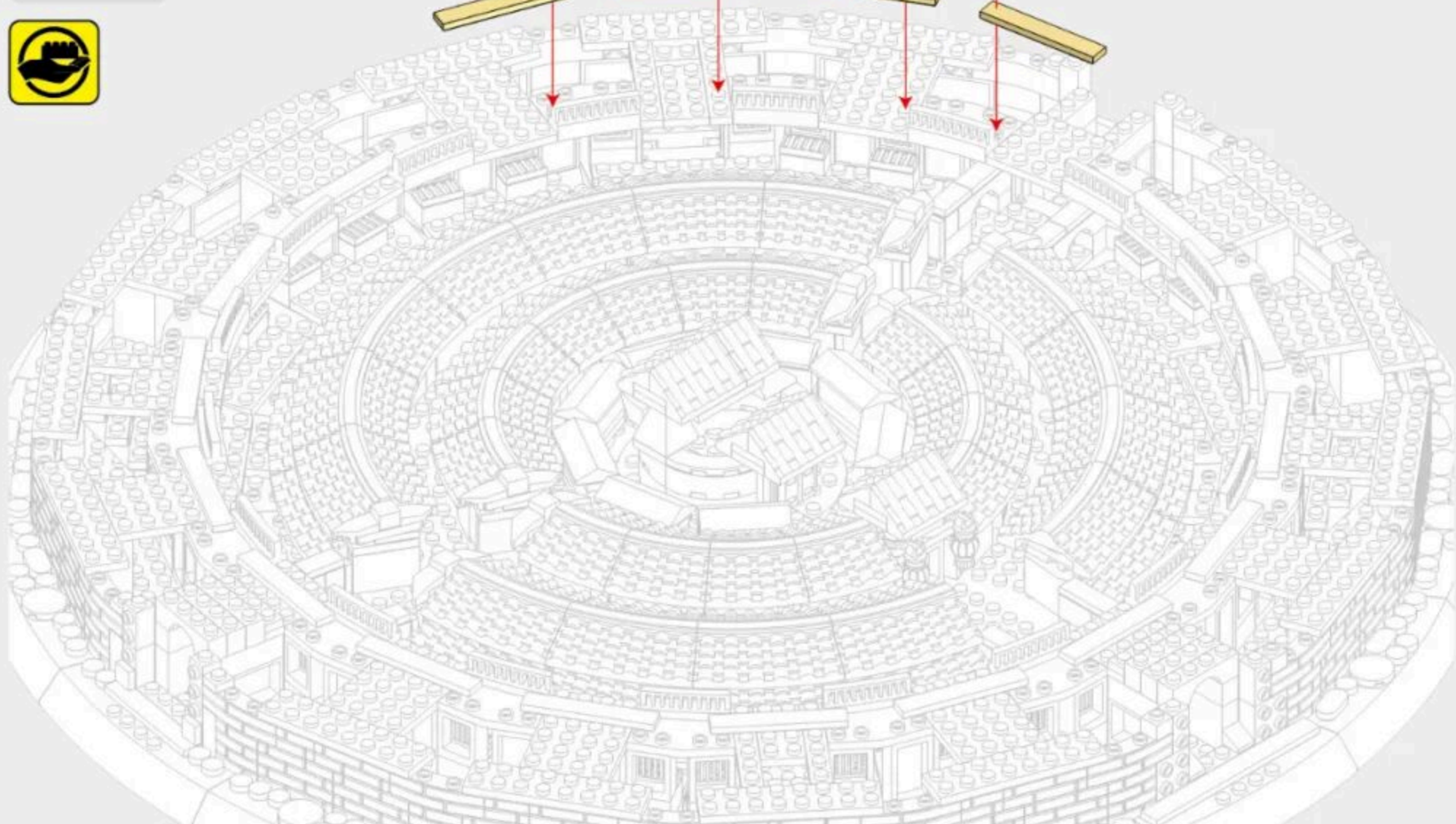
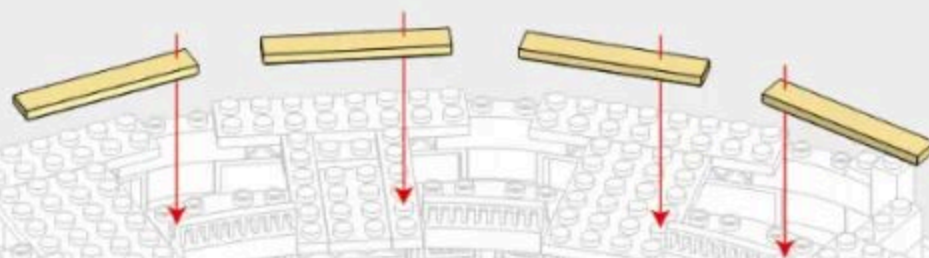

6-21

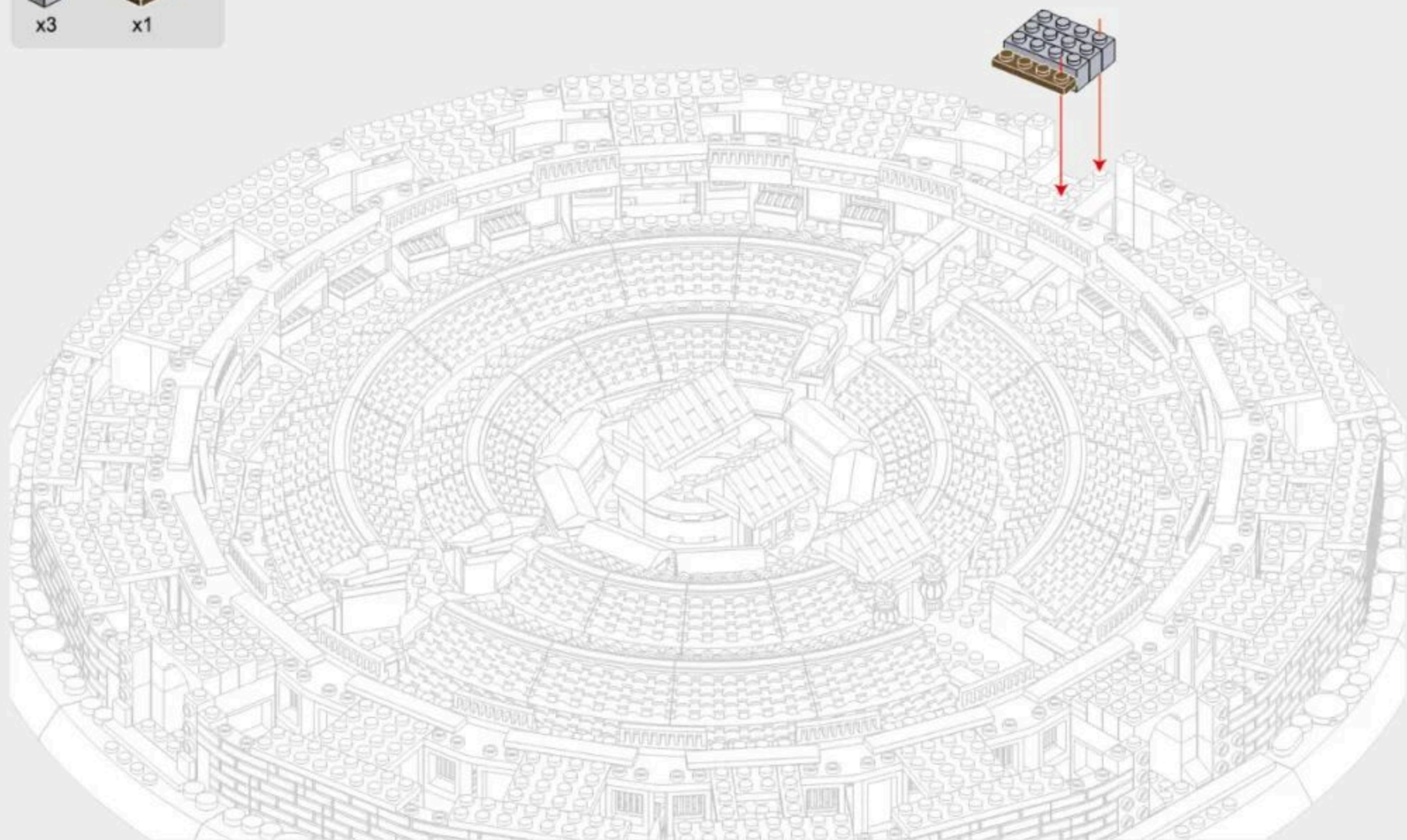
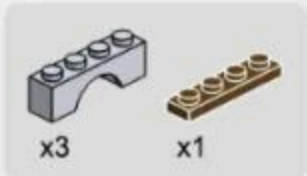



283PCS



7-1

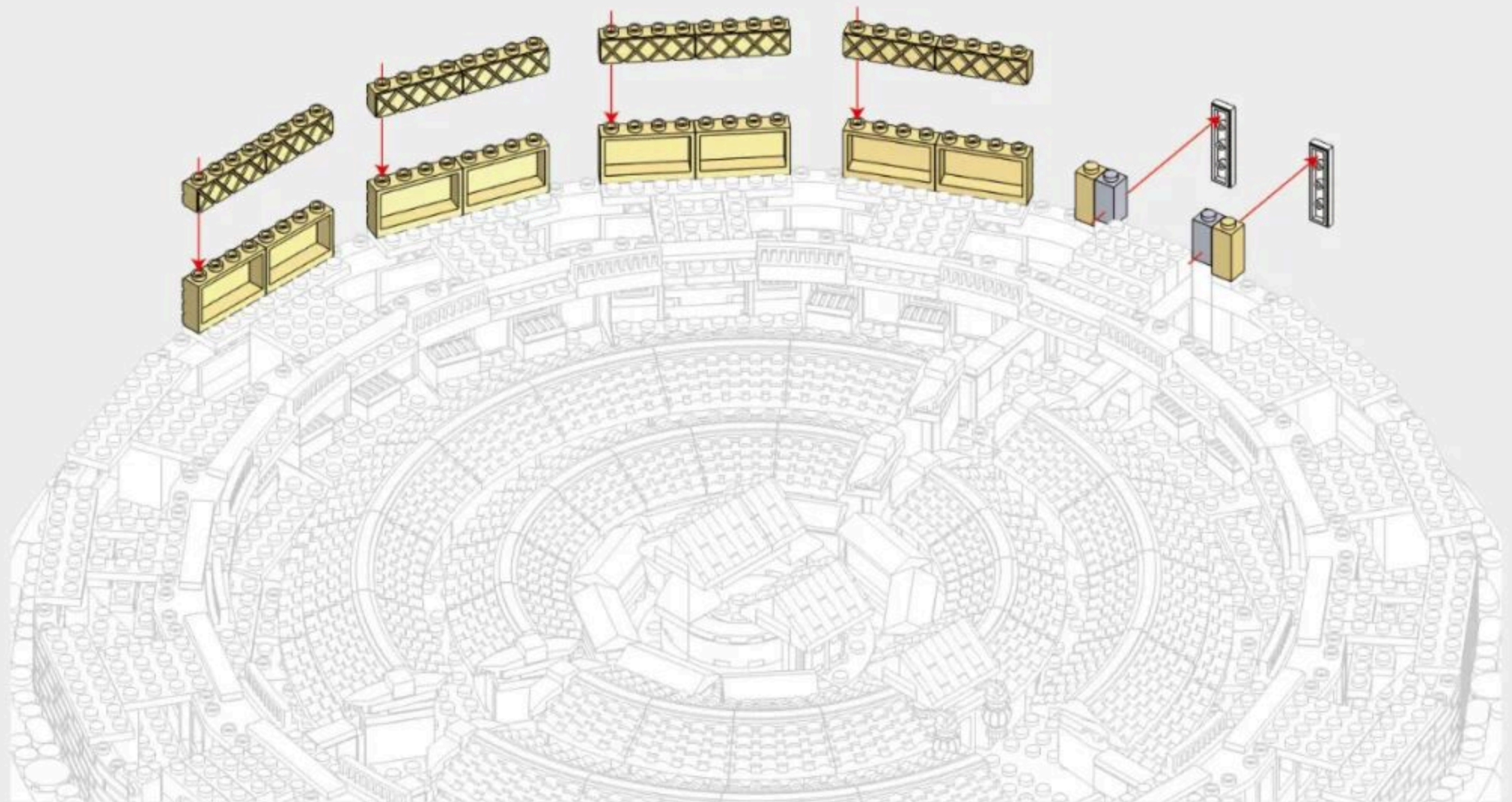

7-2



x1

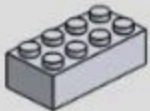

x2



x1



x2



x1



x1



x1

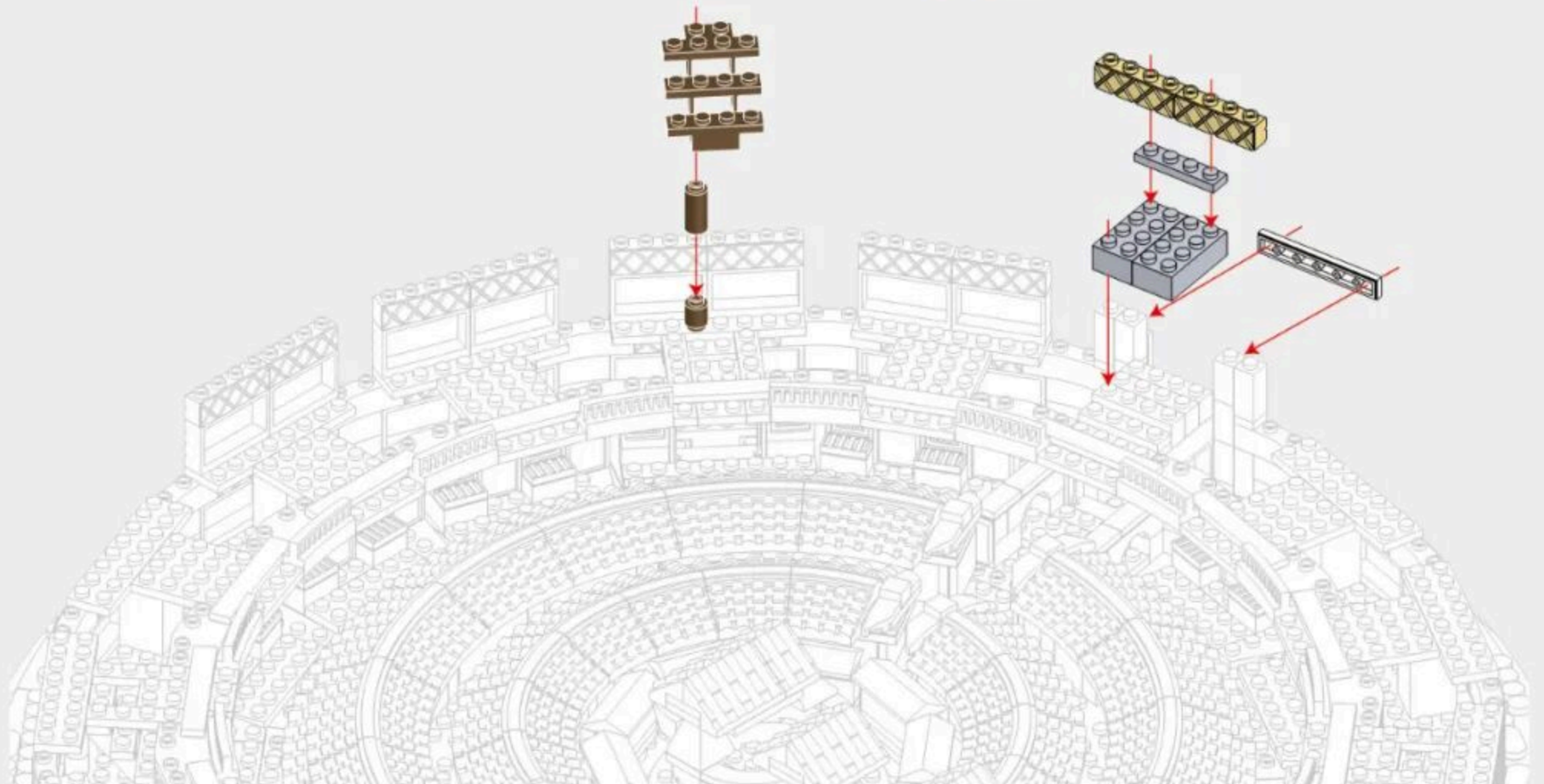

7-3

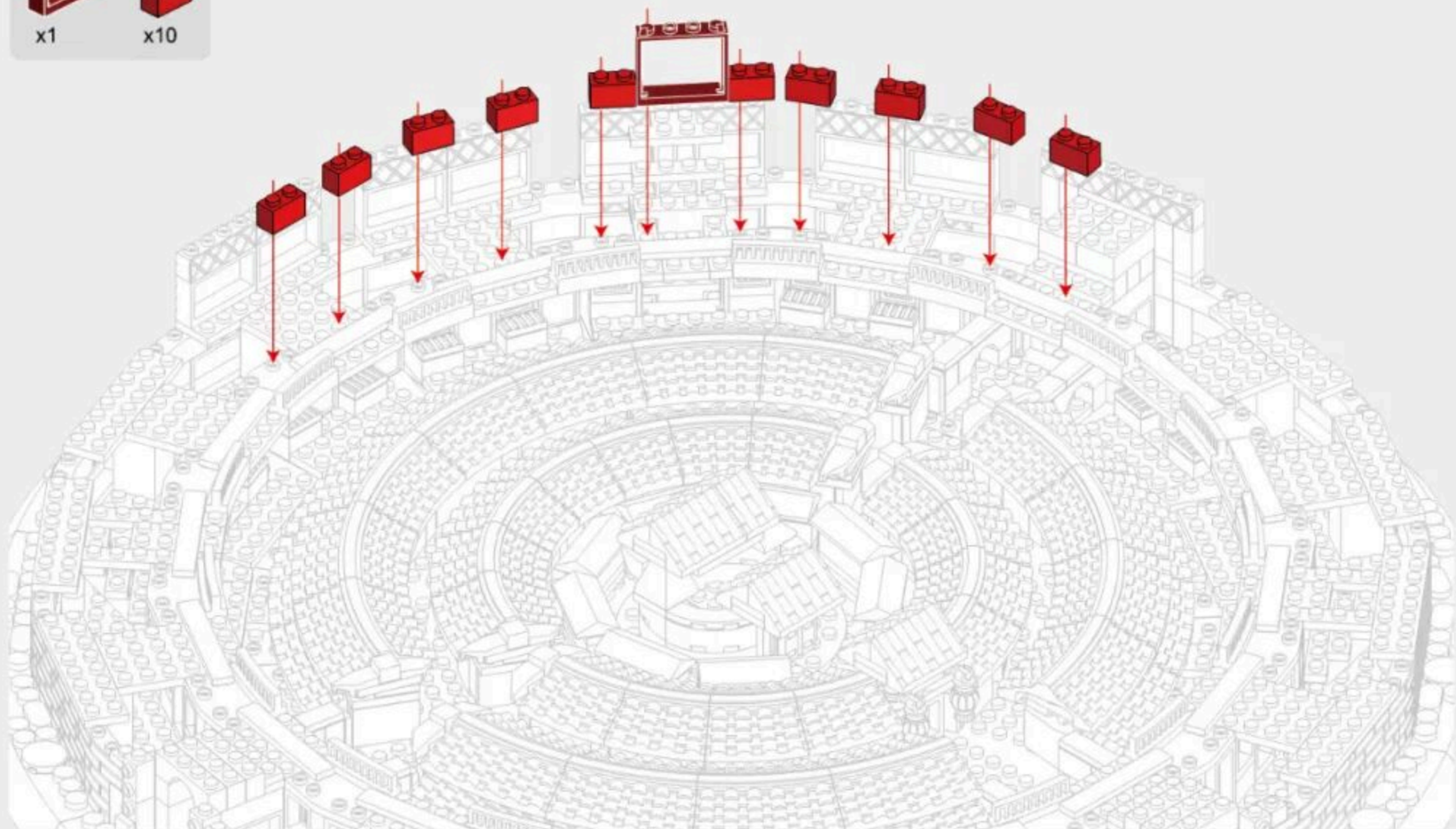

7-4

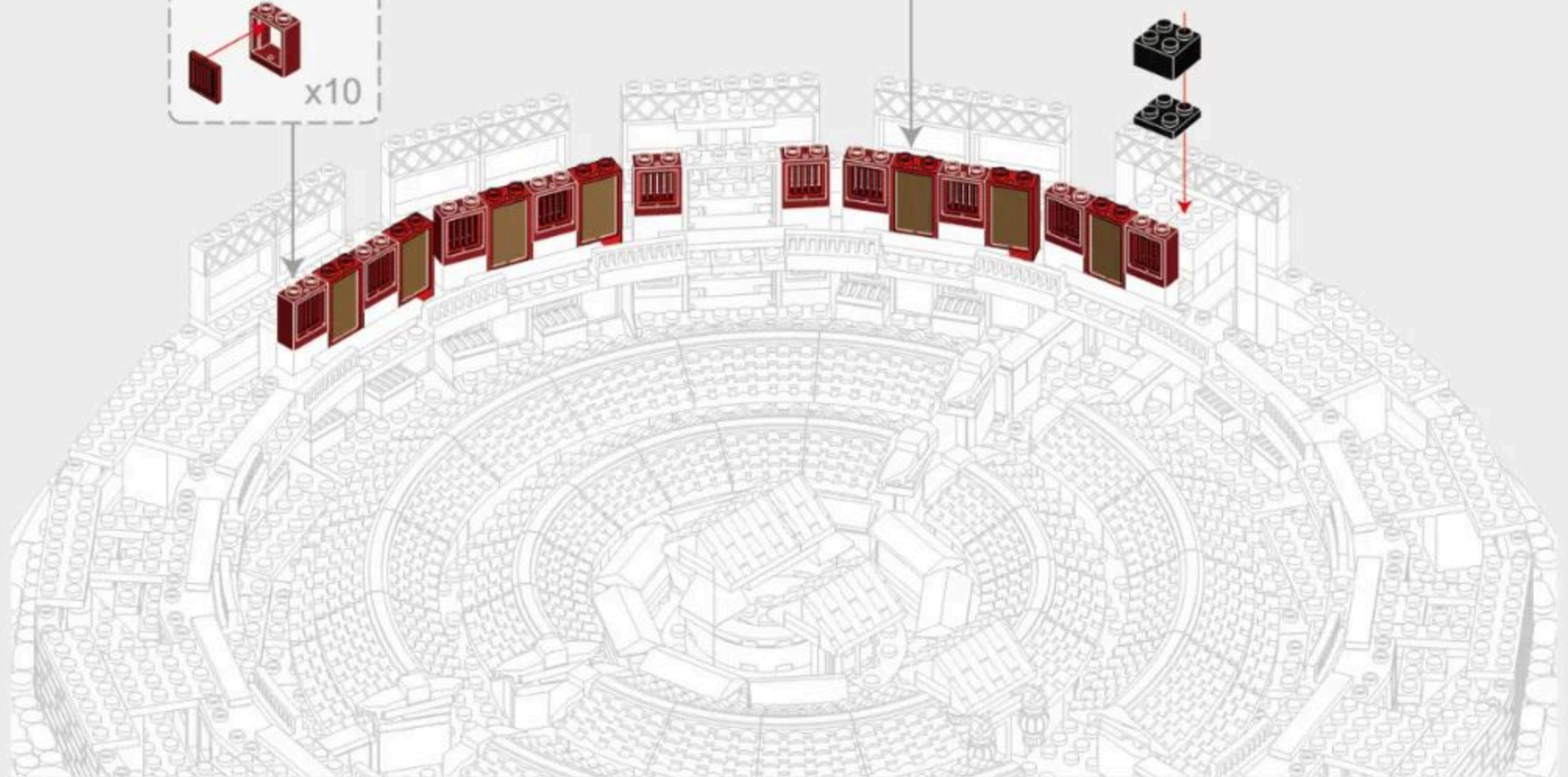
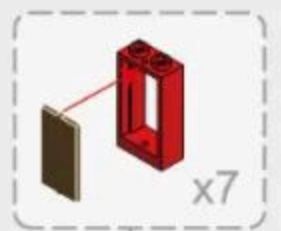

7-5

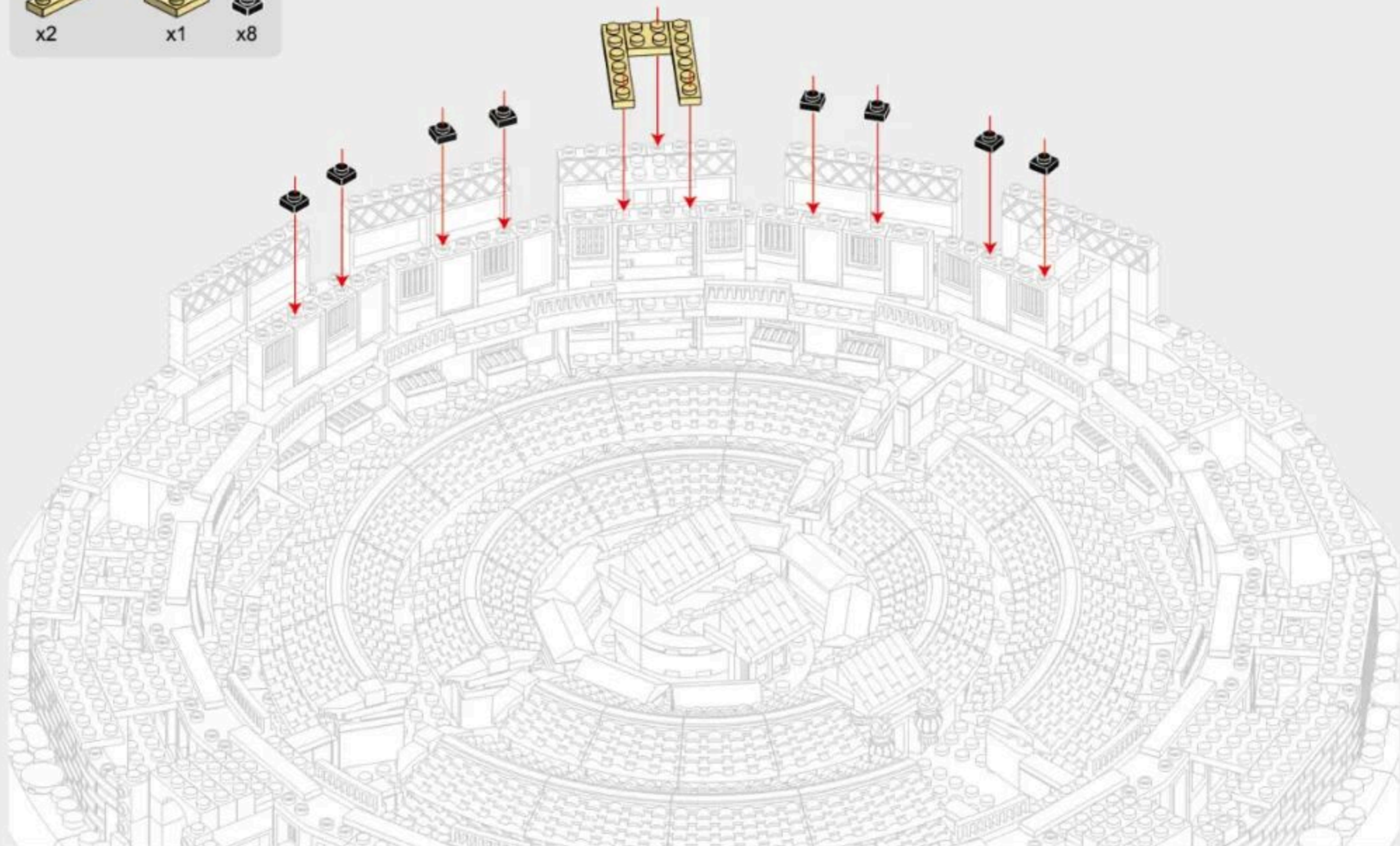
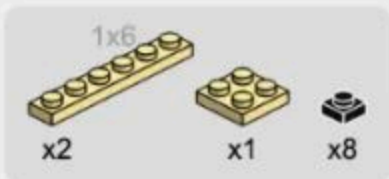

7-6

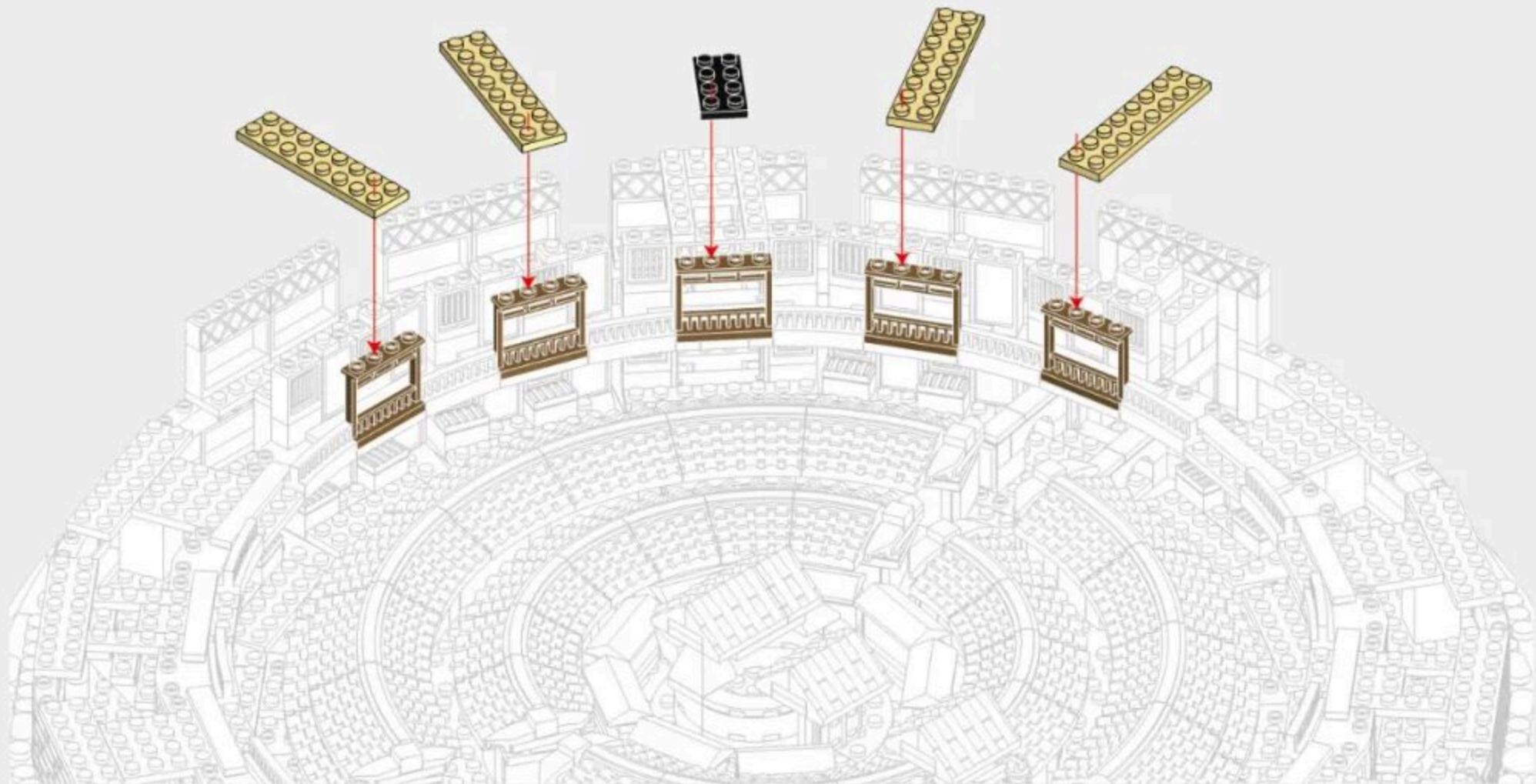
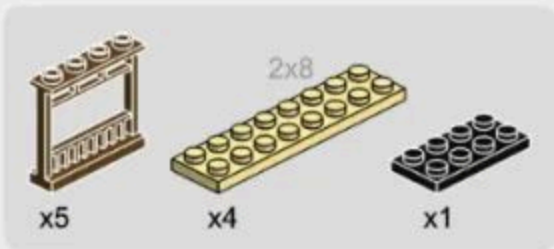

7-7

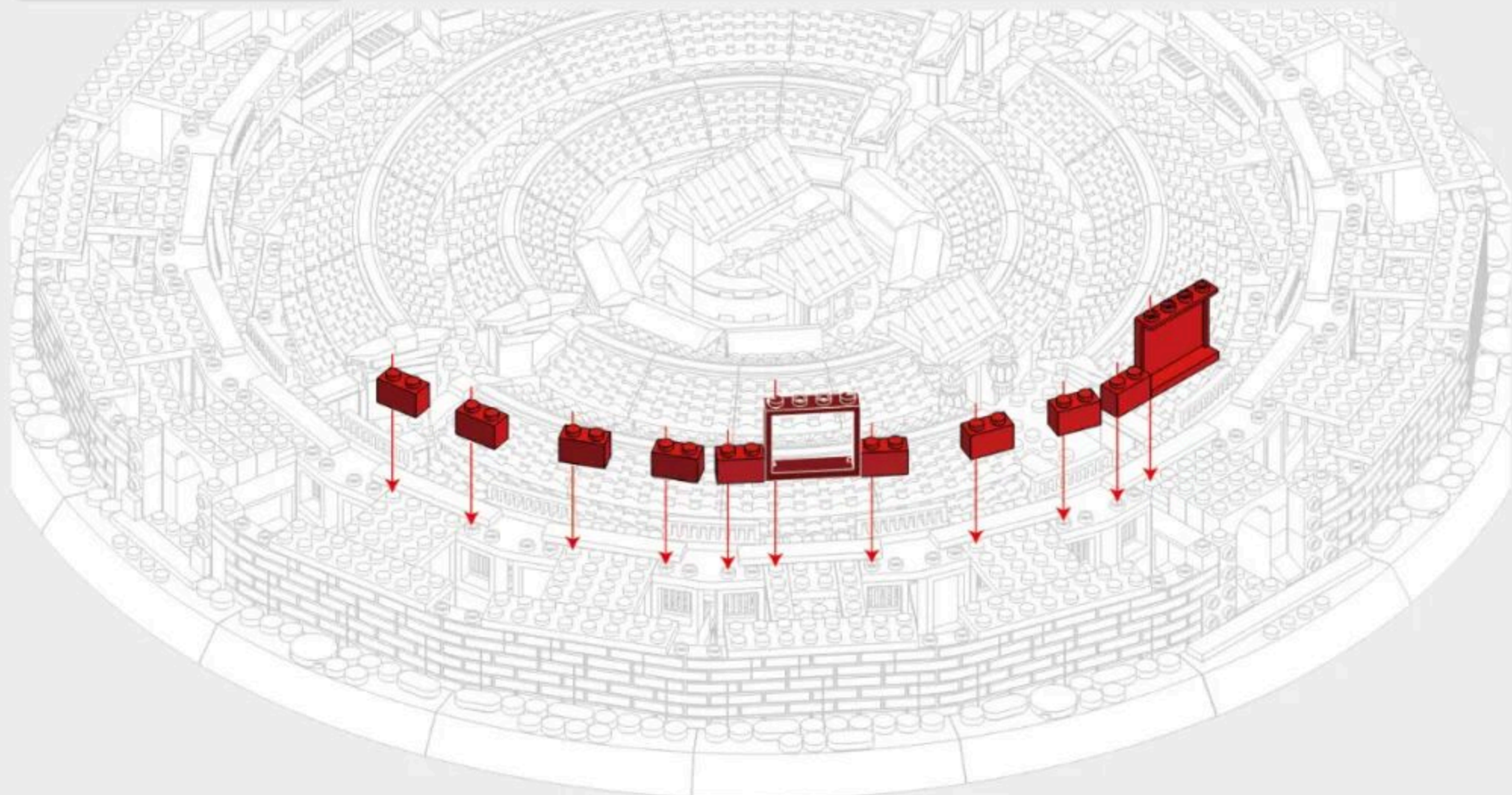
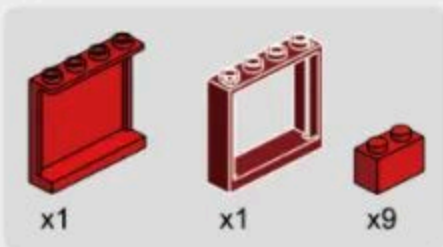

7-8



7-9

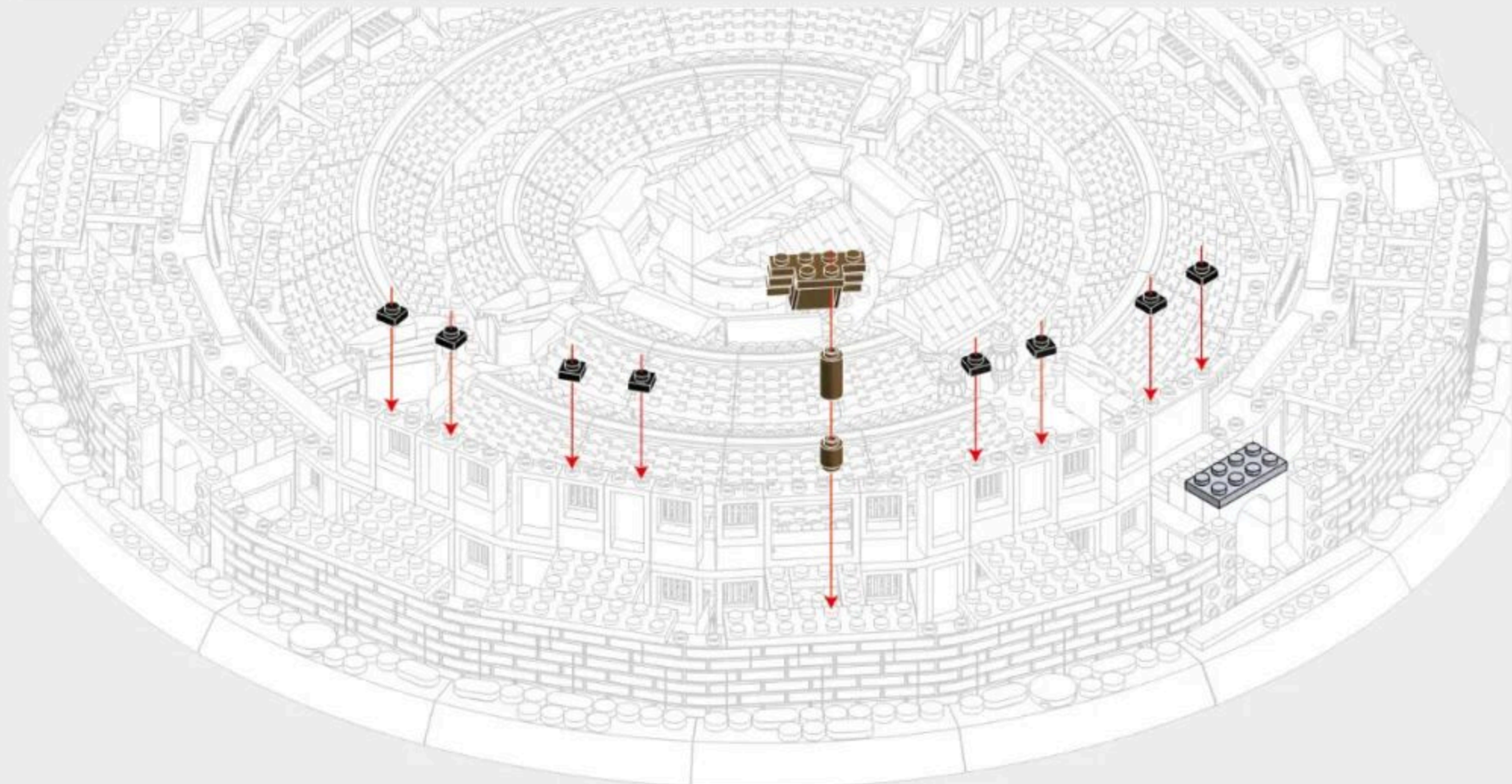

7-10

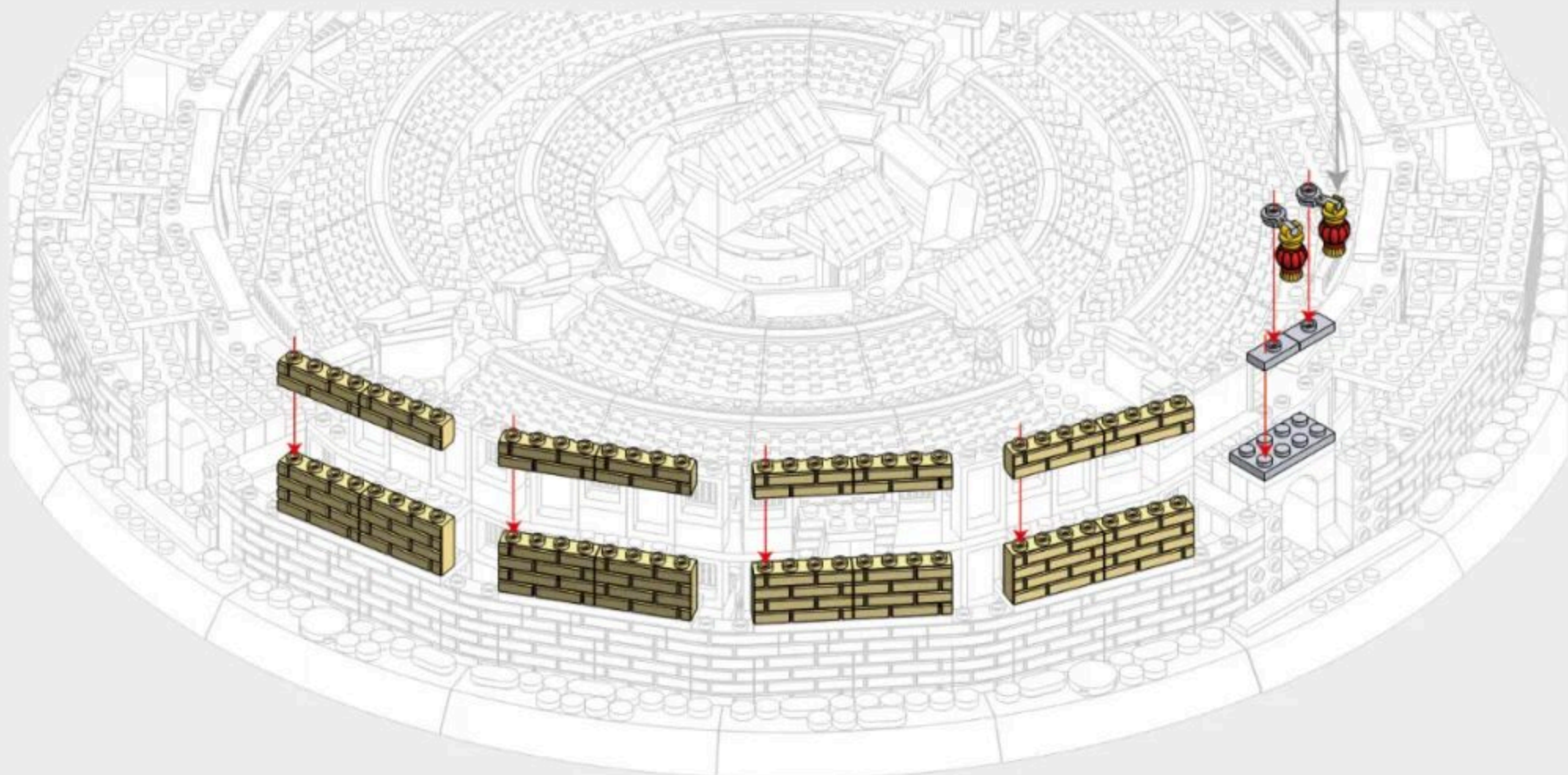
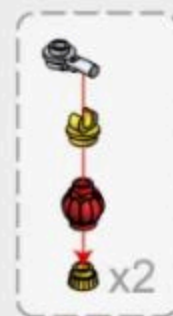

7-11

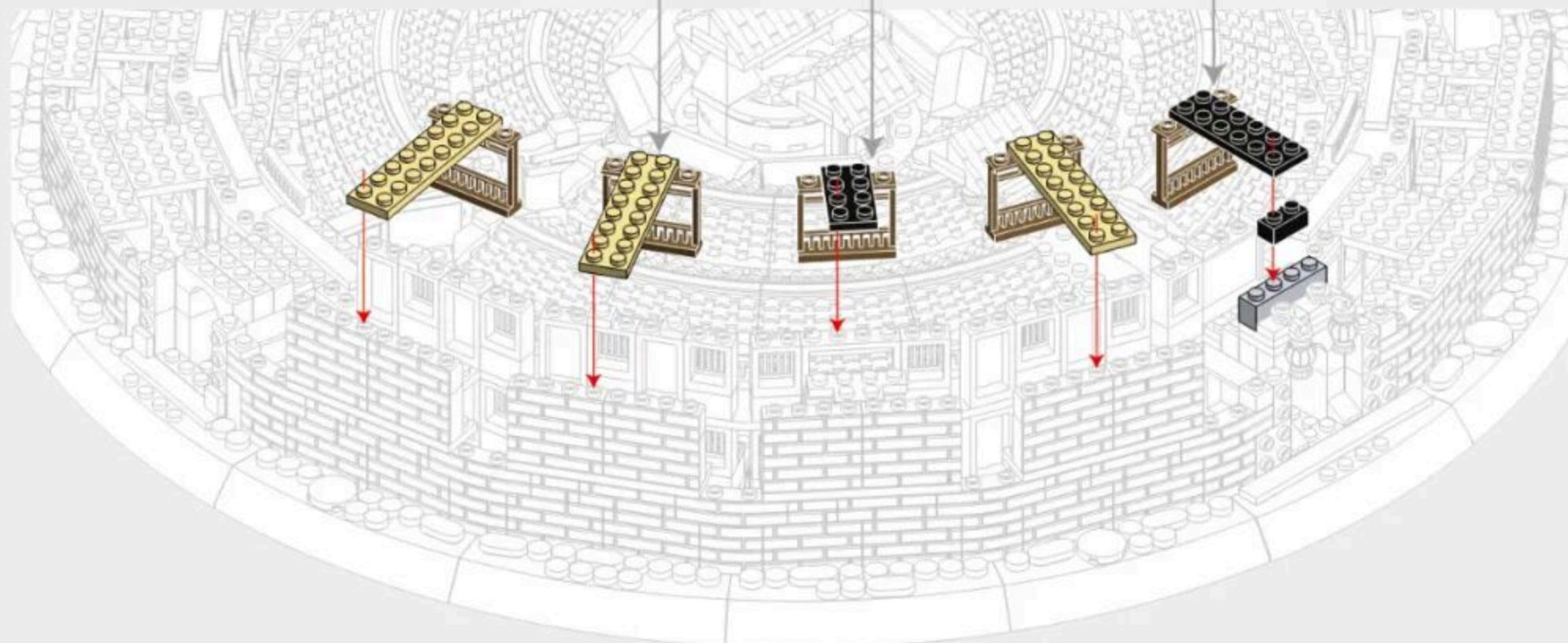
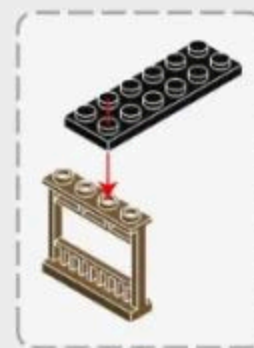
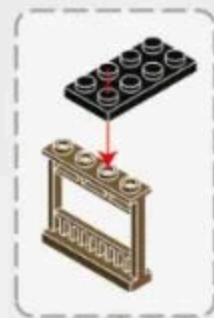
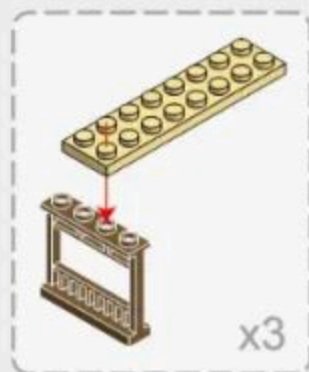
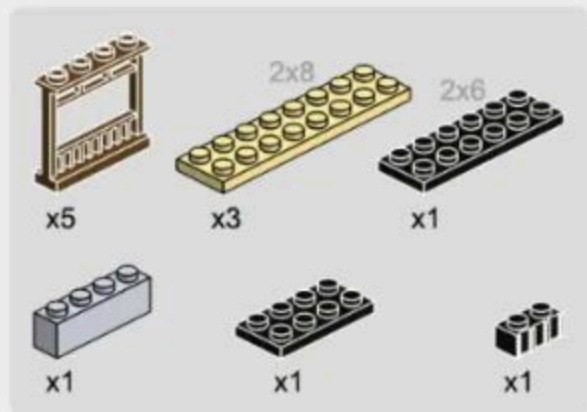

7-12

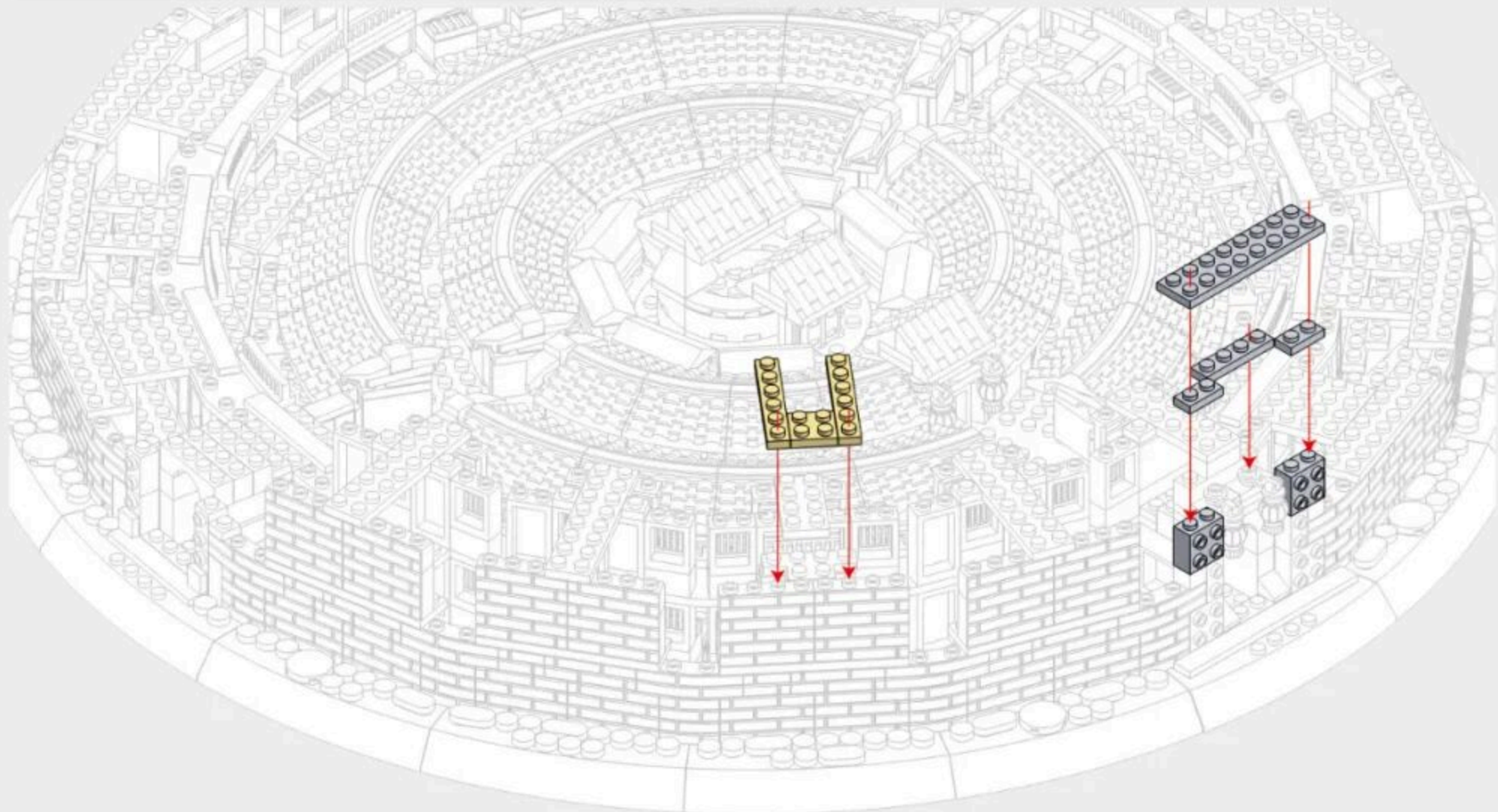

7-13



x6



x2



x6



x2



1x4

x2

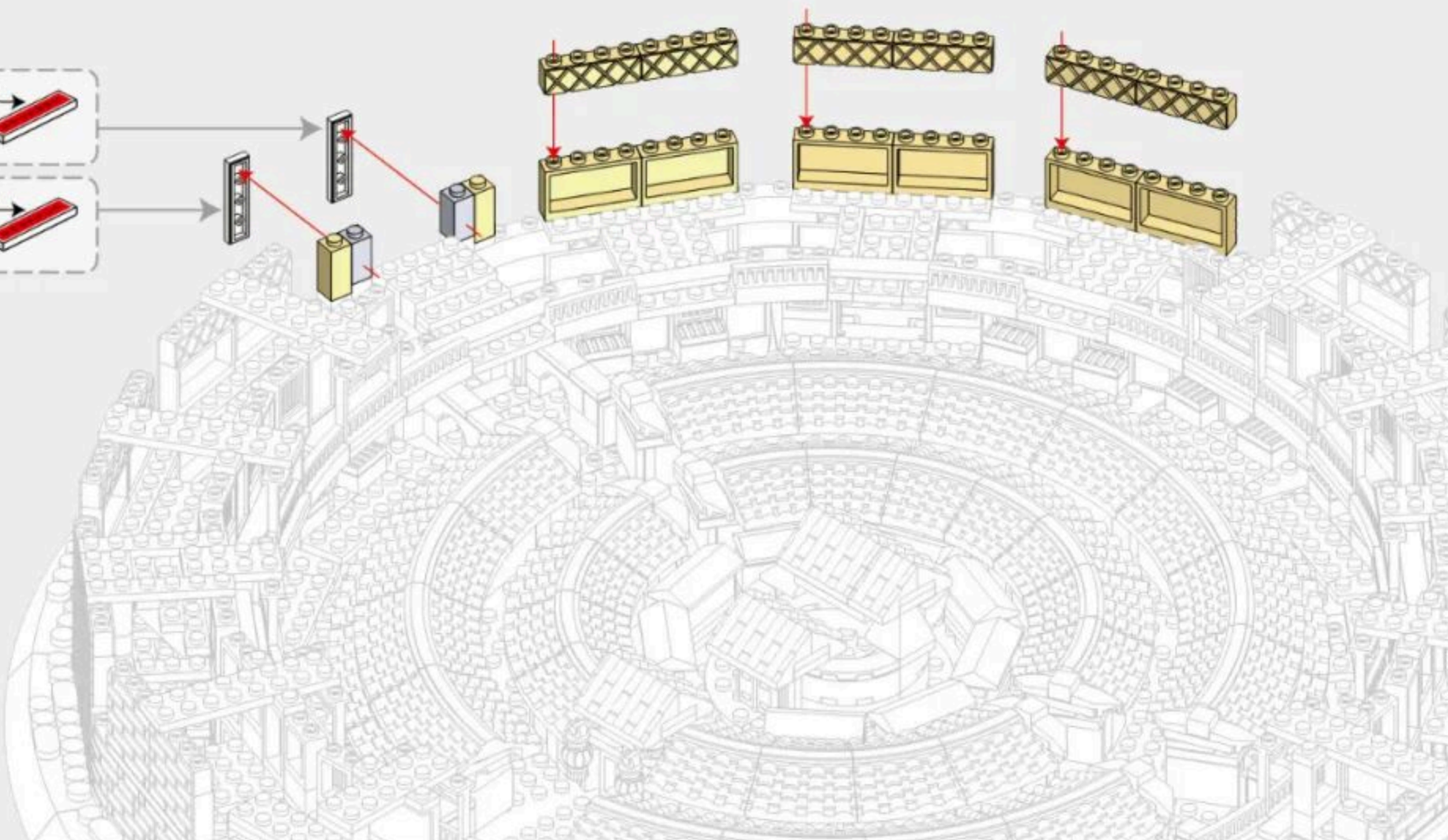
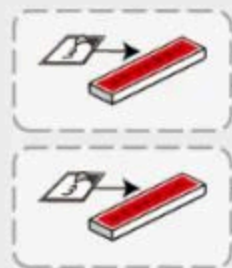

7-14

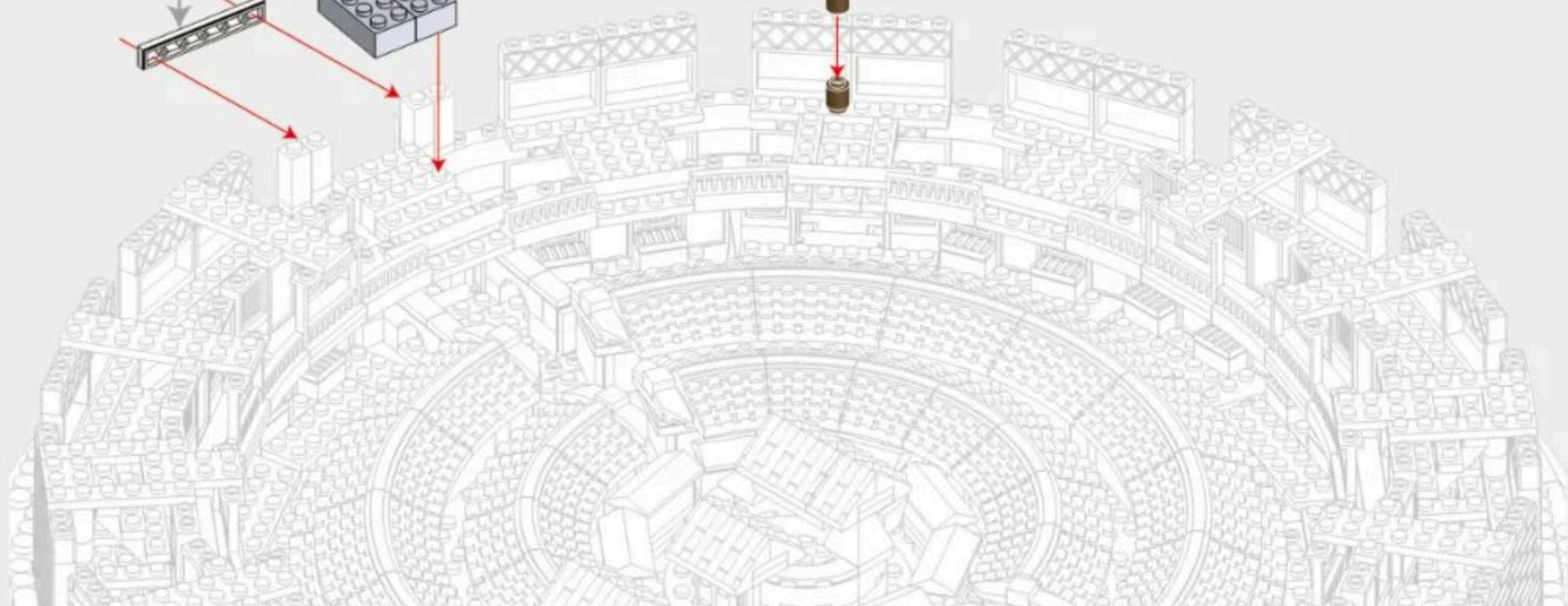
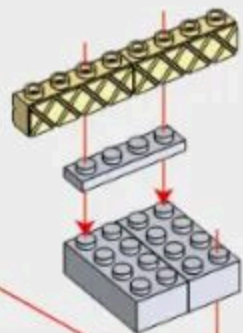
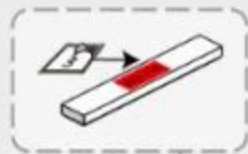
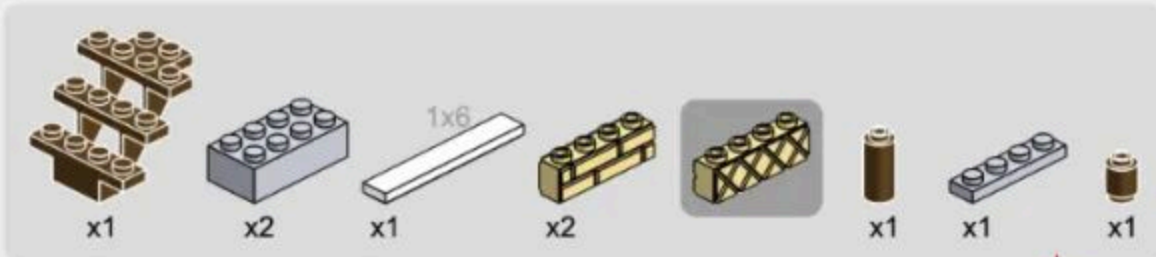

7-15

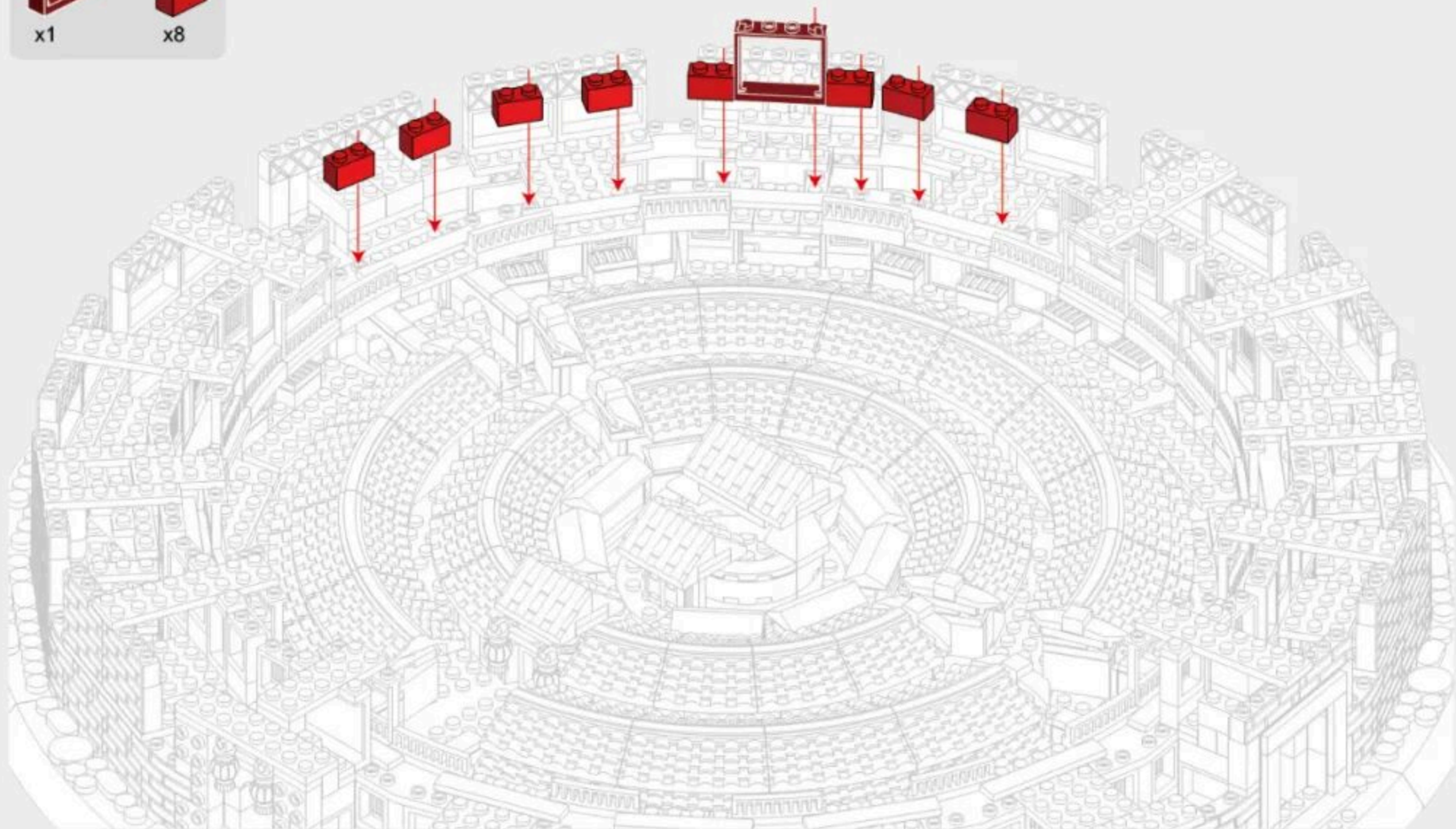
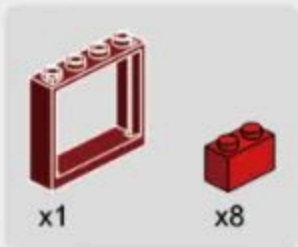

7-16

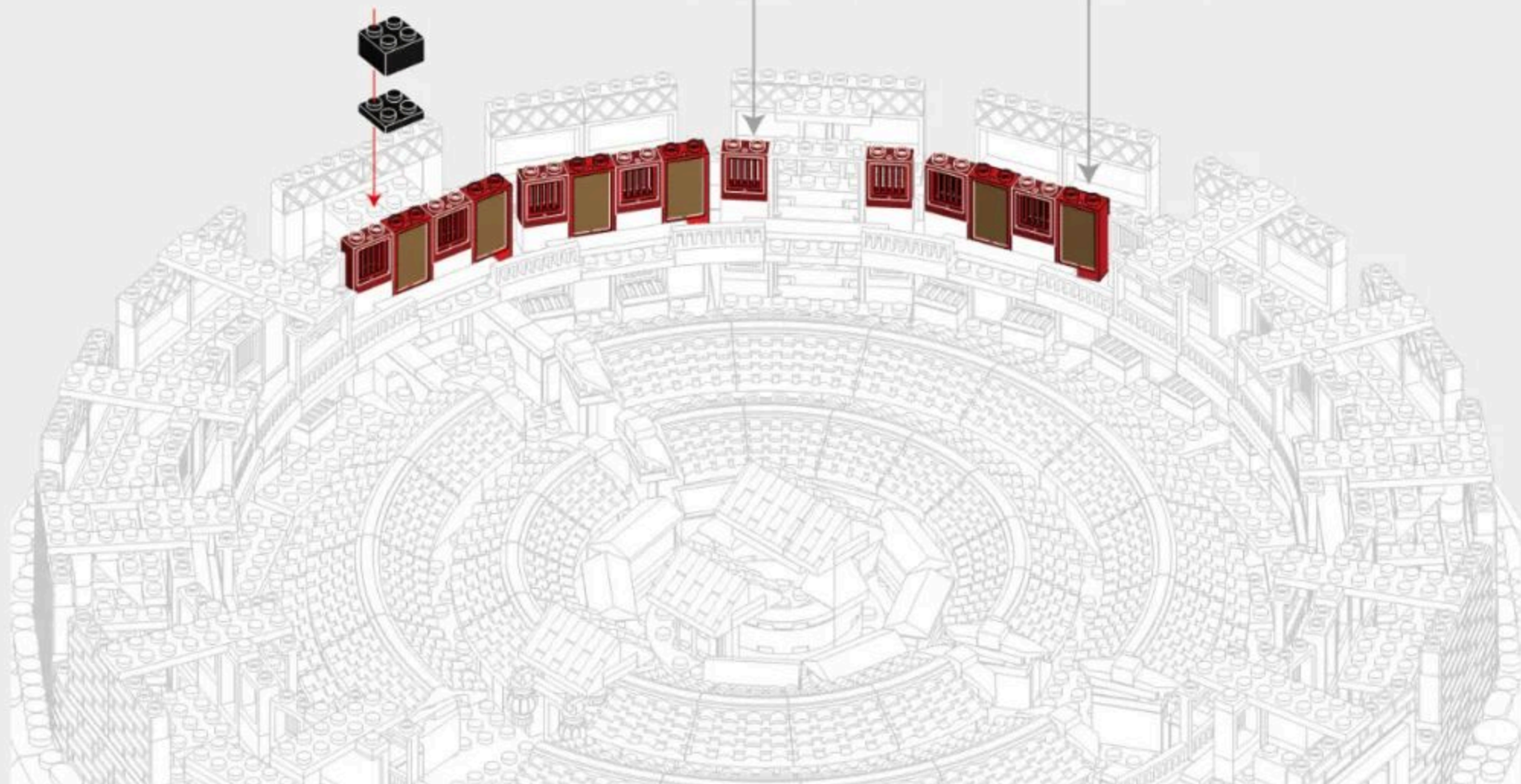
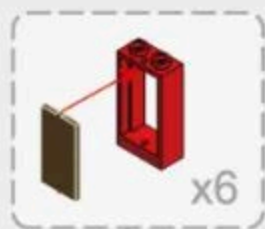

7-17

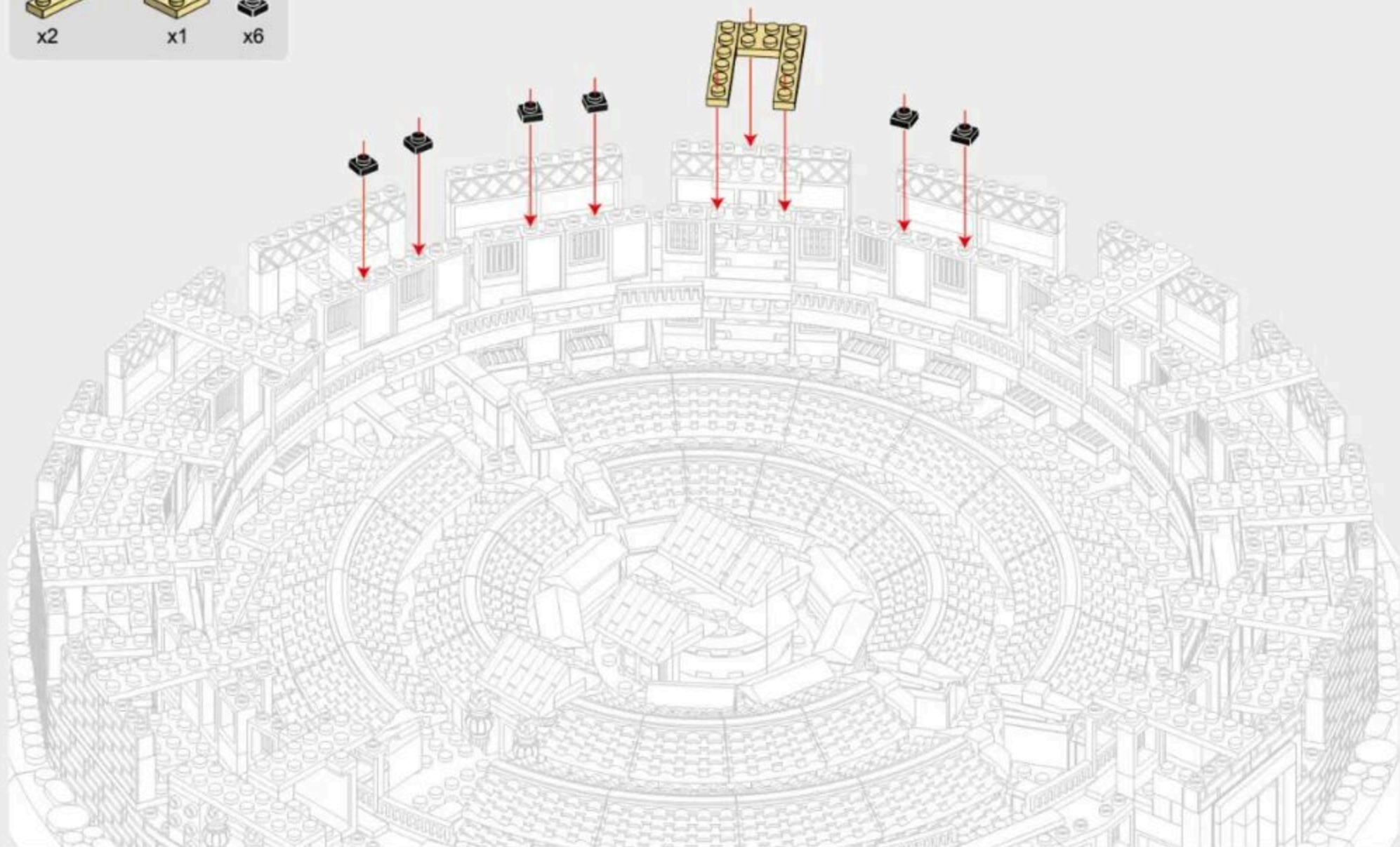

7-18

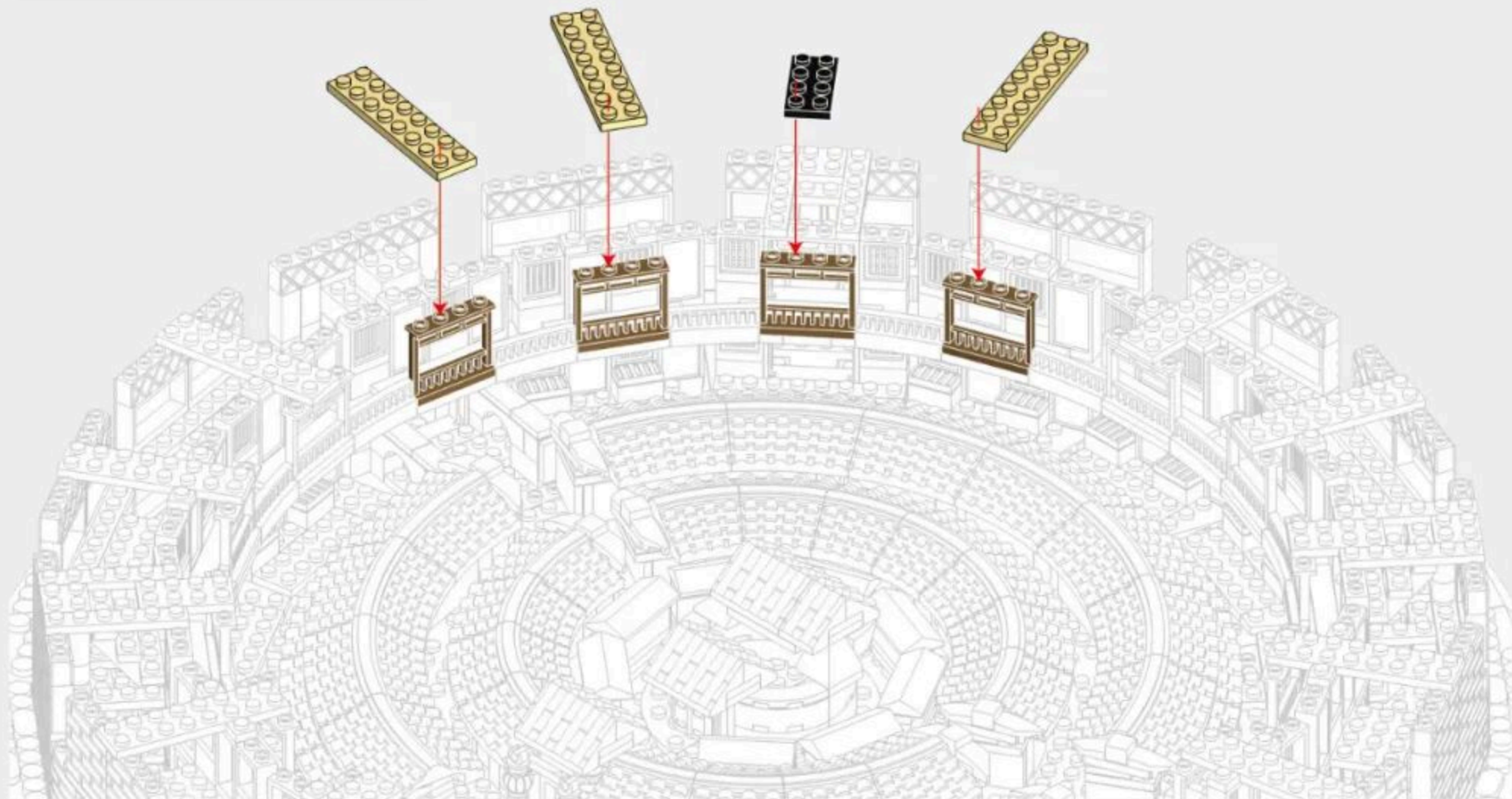
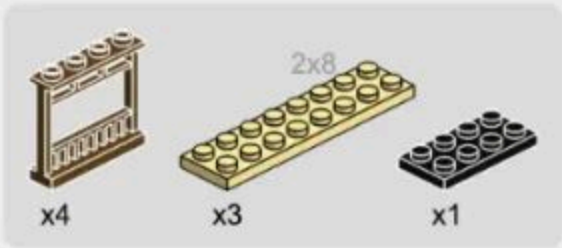



204PCS

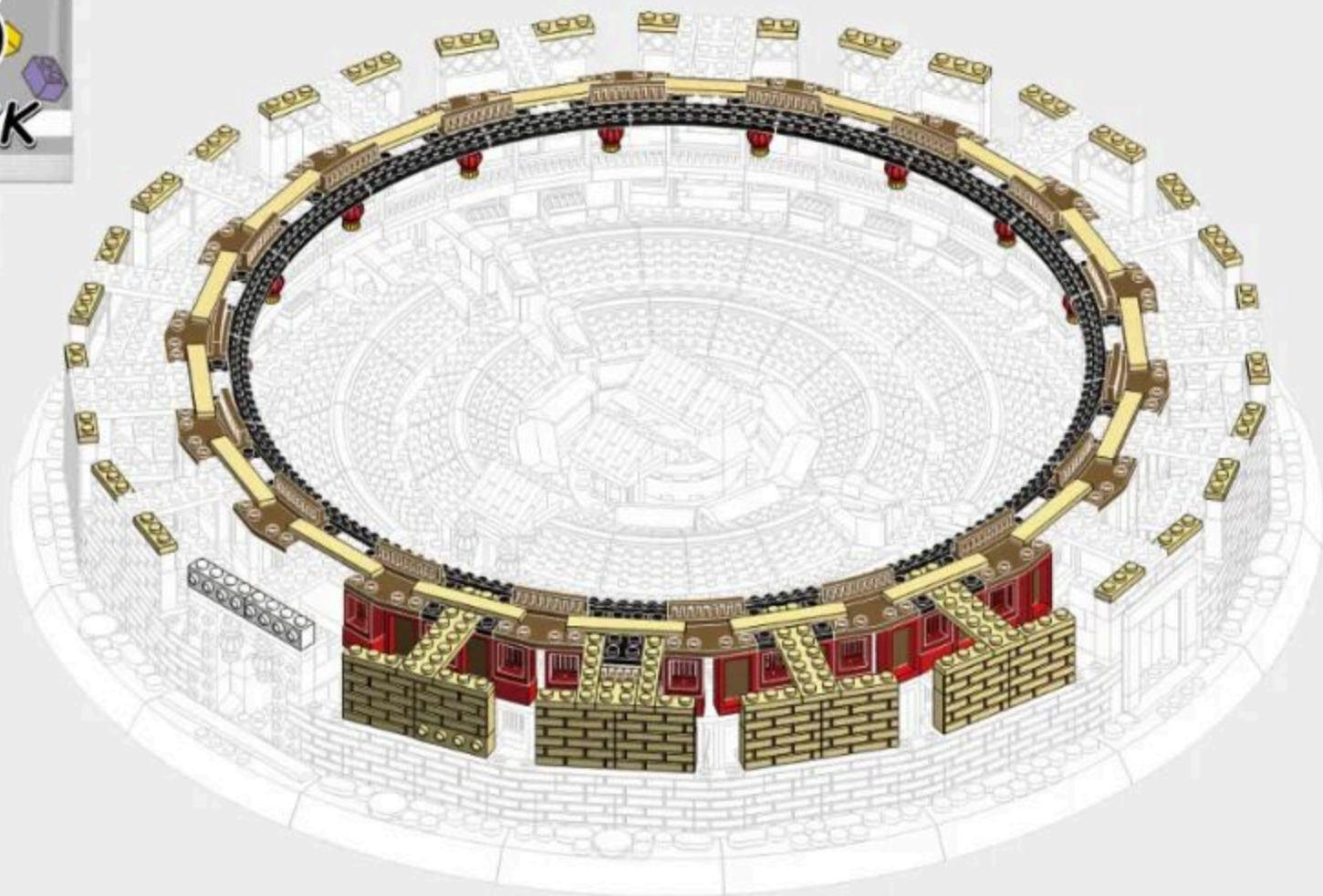

8-1

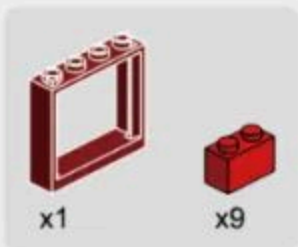

注意：此步骤仅用于搭建完整版的土楼，搭建解构版的土楼请忽略此步骤。
Tips: This step is only for constructing a complete version of the tulou.
Please ignore this step if you are constructing a deconstructed version of the tulou.

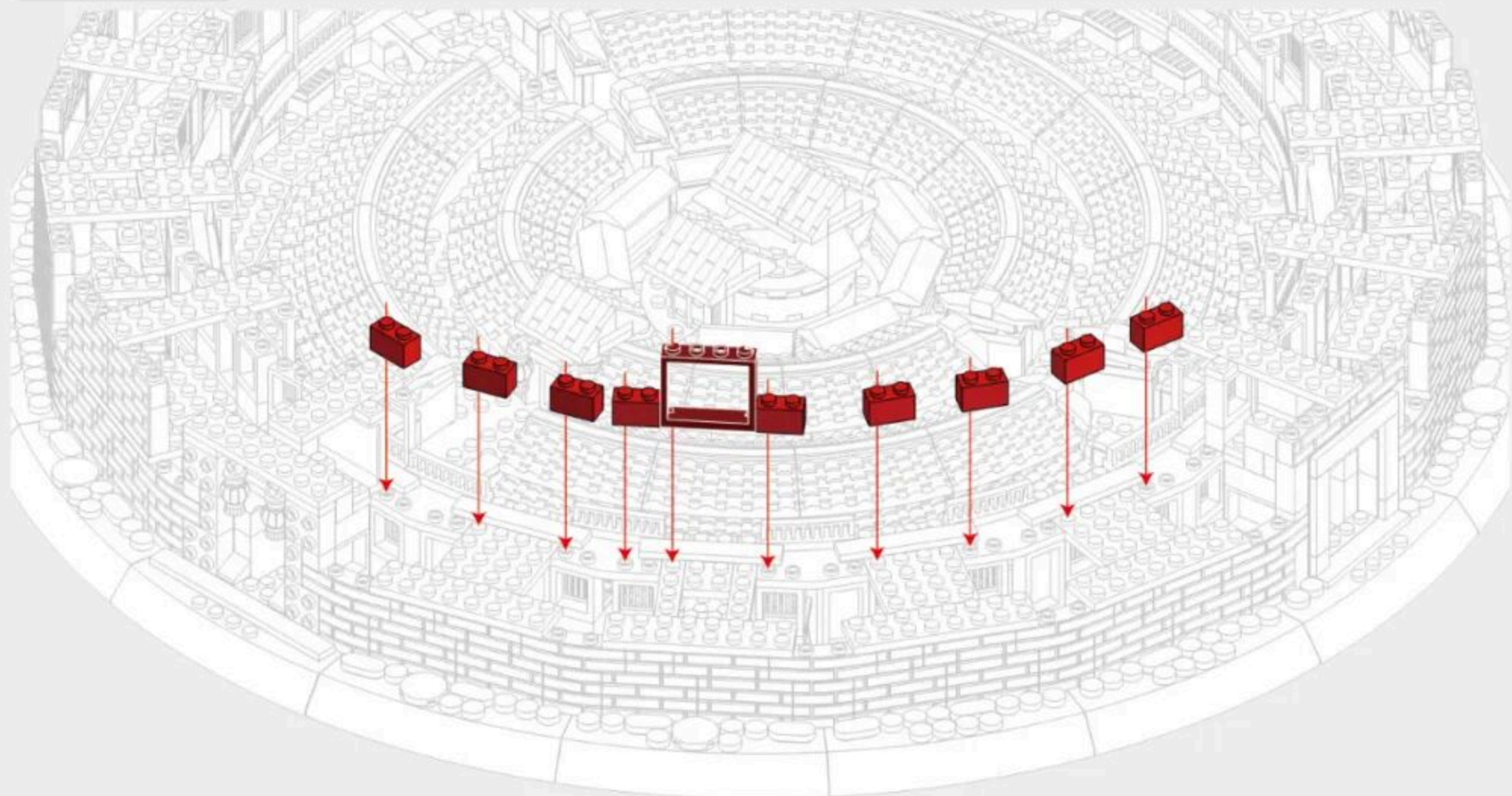

8-2

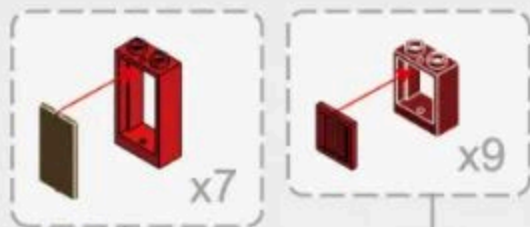

注意：此步骤仅用于搭建完整版的土楼，搭建解构版的土楼请忽略此步骤。
Tips: This step is only for constructing a complete version of the tulou.
Please ignore this step if you are constructing a deconstructed version of the tulou.



8-3

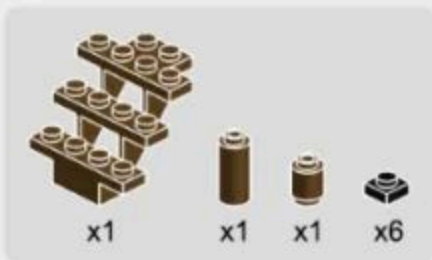

注意：此步骤仅用于搭建完整版的土楼，搭建解构版的土楼请忽略此步骤。
Tips: This step is only for constructing a complete version of the tulou.
Please ignore this step if you are constructing a deconstructed version of the tulou.

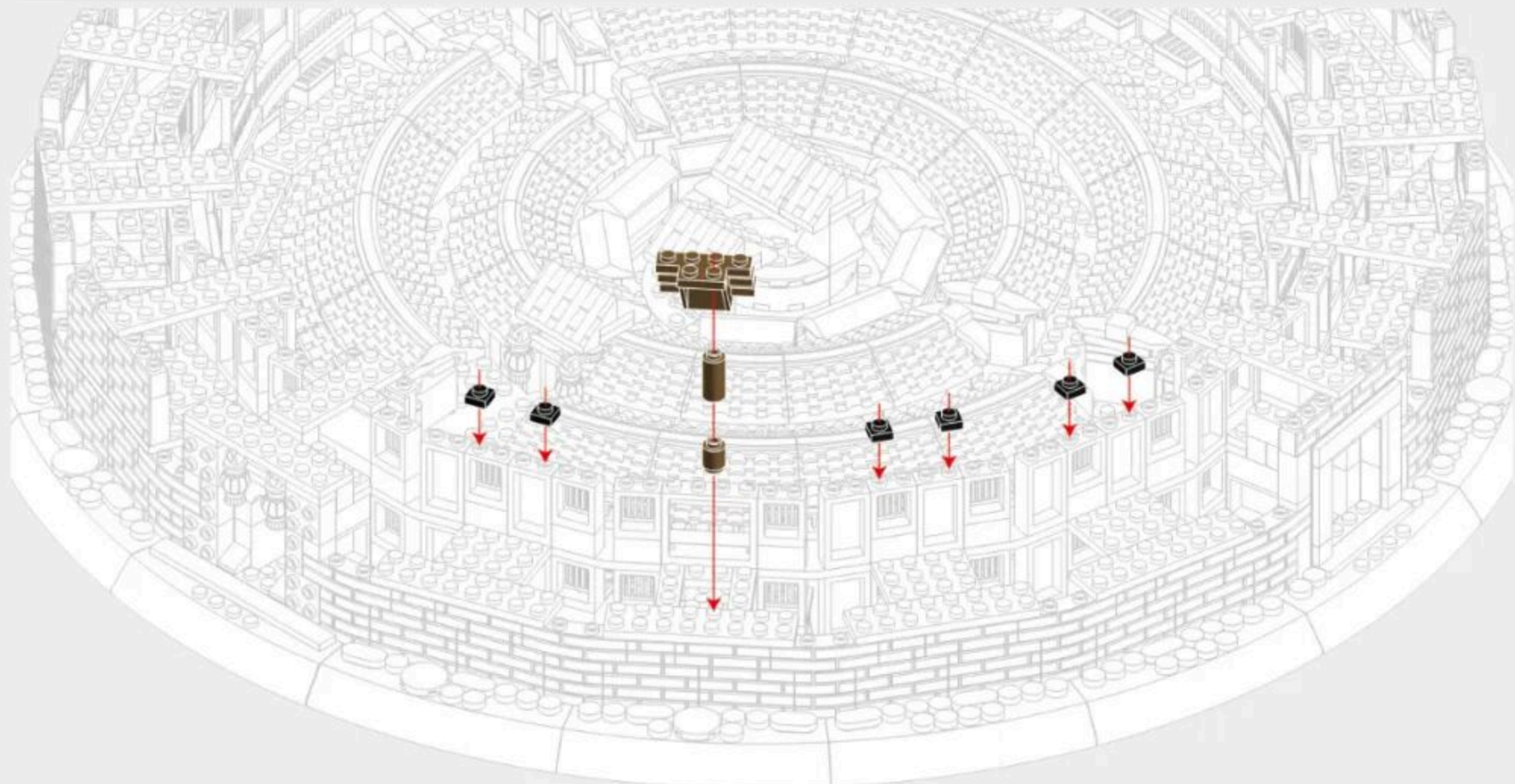

8-4



注意：此步骤仅用于搭建完整版的土楼，搭建解构版的土楼请忽略此步骤。
Tips: This step is only for constructing a complete version of the tulou.
Please ignore this step if you are constructing a deconstructed version of the tulou.

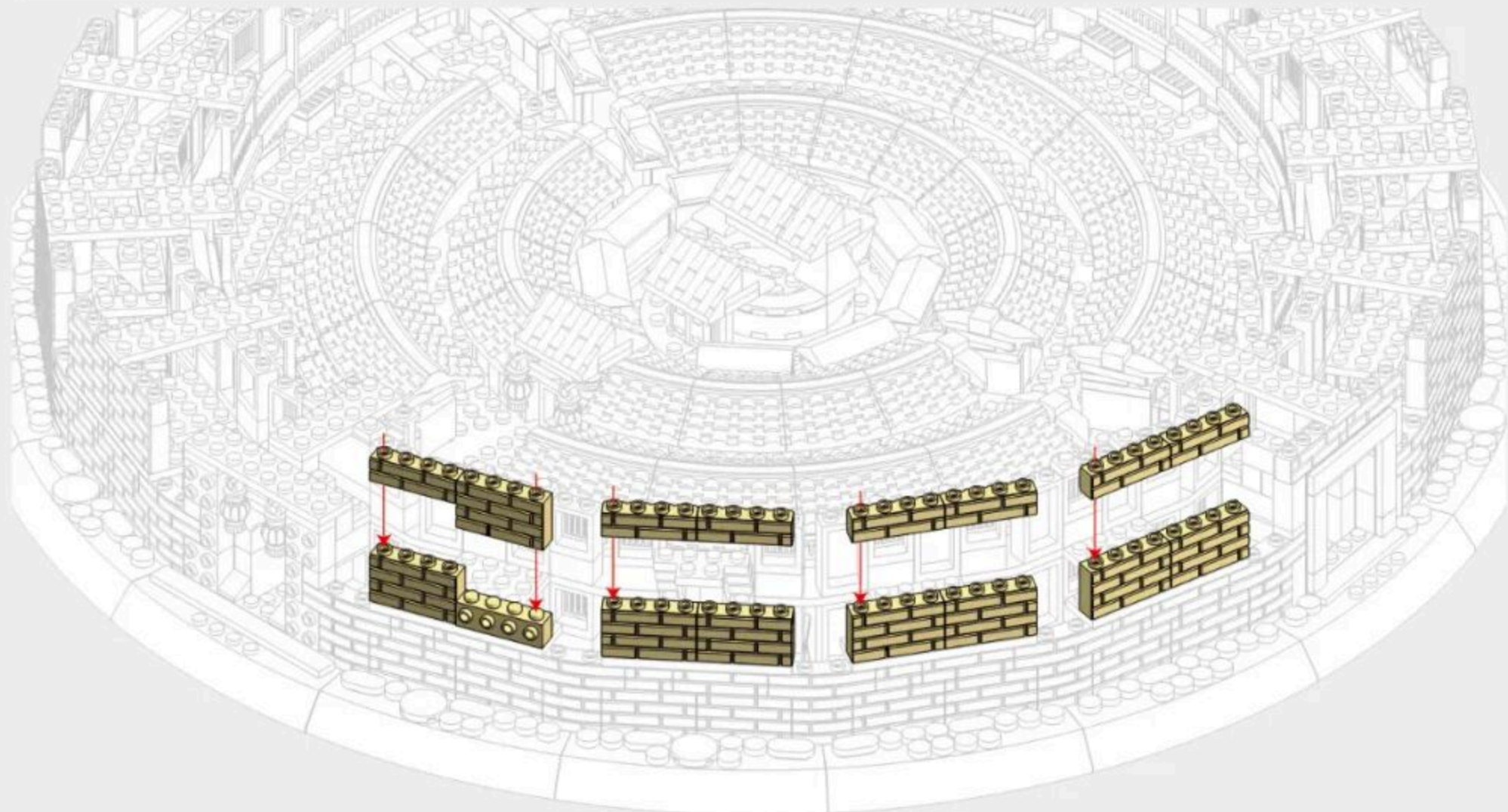

8-5



注意：此步骤仅用于搭建完整版的土楼，搭建解构版的土楼请忽略此步骤。
Tips: This step is only for constructing a complete version of the tulou.
Please ignore this step if you are constructing a deconstructed version of the tulou.

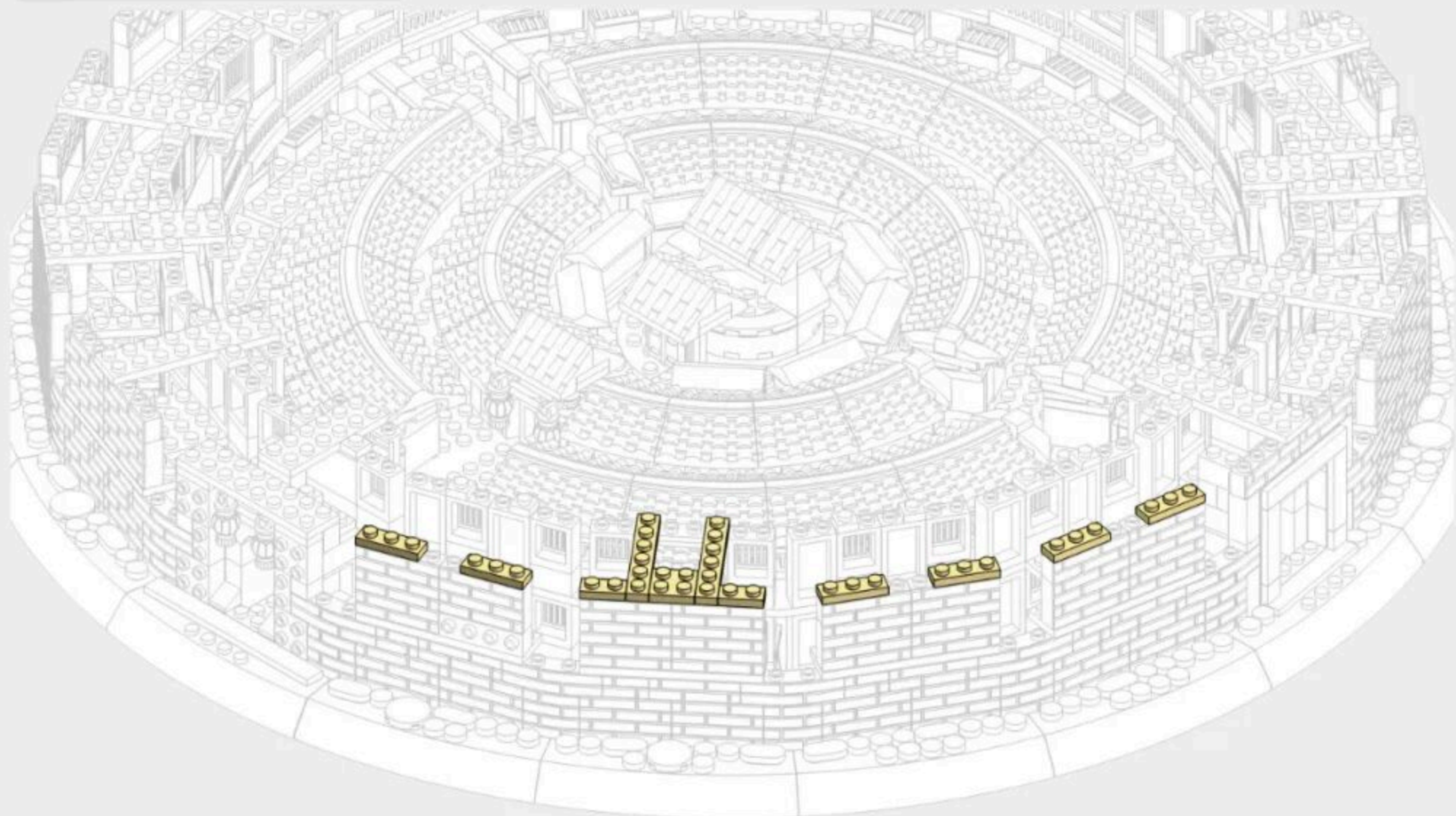

8-6

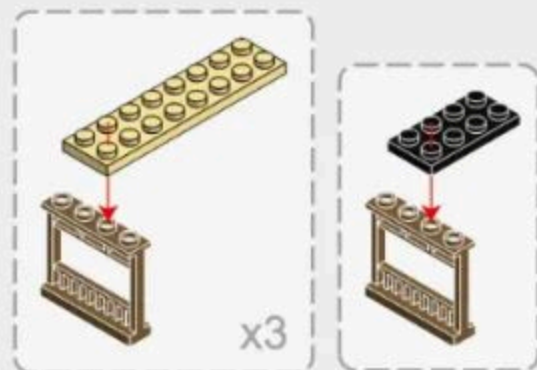
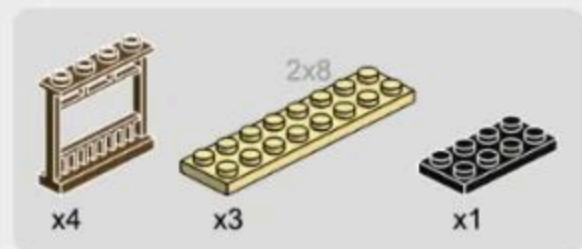

注意：此步骤仅用于搭建完整版的土楼，搭建解构版的土楼请忽略此步骤。
Tips: This step is only for constructing a complete version of the tulou.
Please ignore this step if you are constructing a deconstructed version of the tulou.

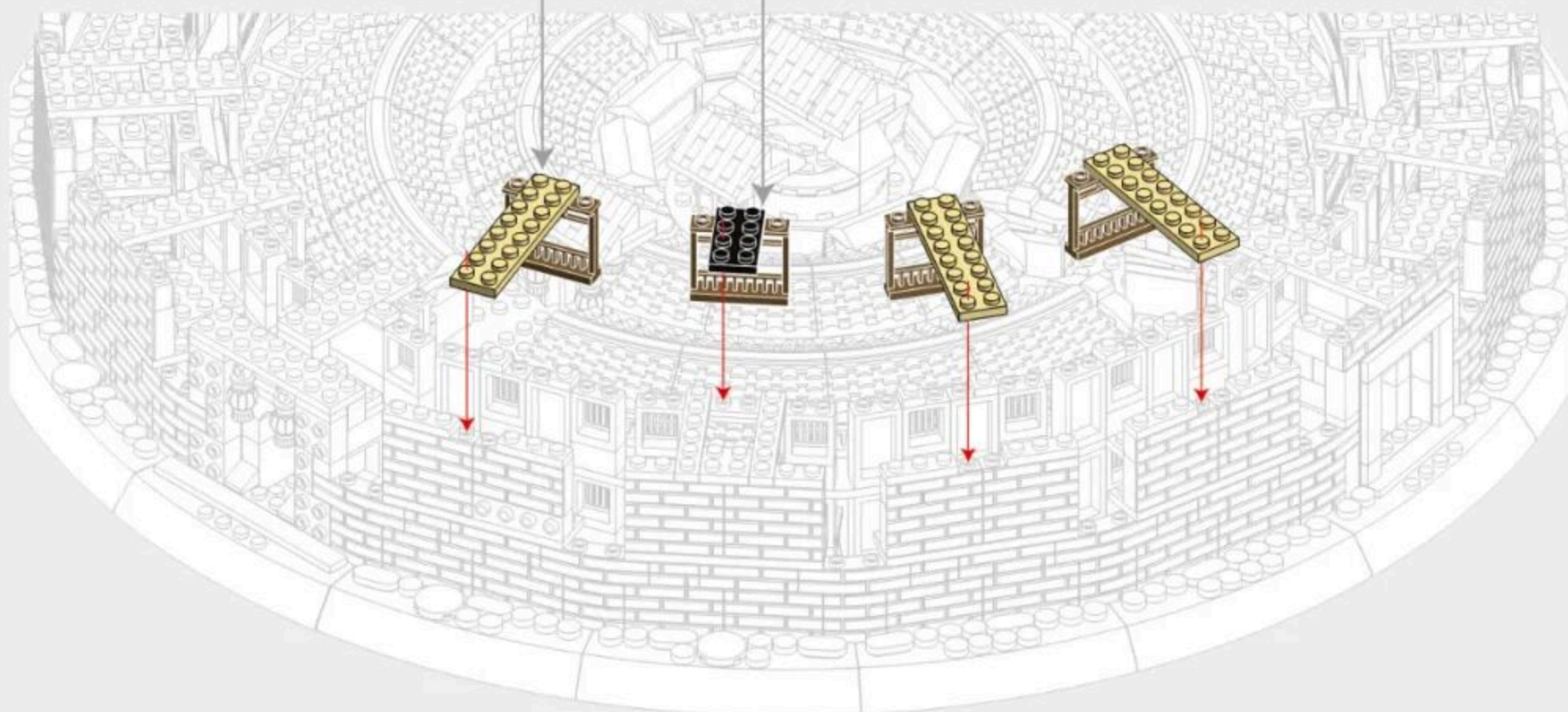

8-7



注意：此步骤仅用于搭建完整版的土楼，搭建解构版的土楼请忽略此步骤。
Tips: This step is only for constructing a complete version of the tulou.
Please ignore this step if you are constructing a deconstructed version of the tulou.



8-8

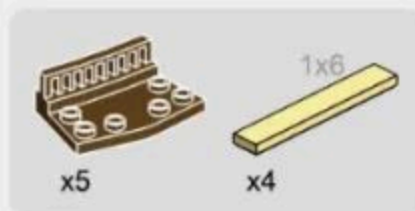

注意：此步骤仅用于搭建完整版的土楼，搭建解构版的土楼请忽略此步骤。
Tips: This step is only for constructing a complete version of the tulou.
Please ignore this step if you are constructing a deconstructed version of the tulou.

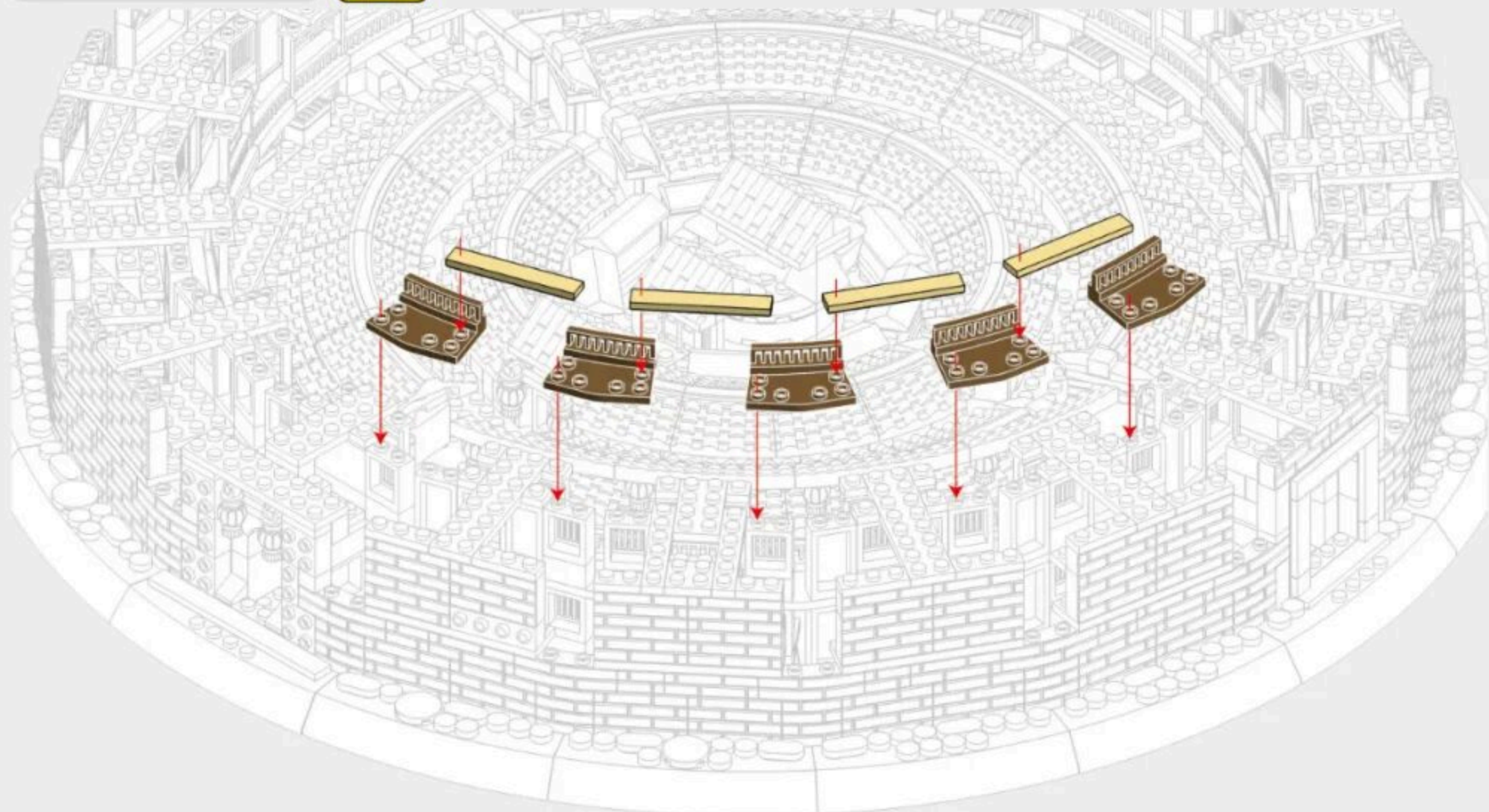

8-9

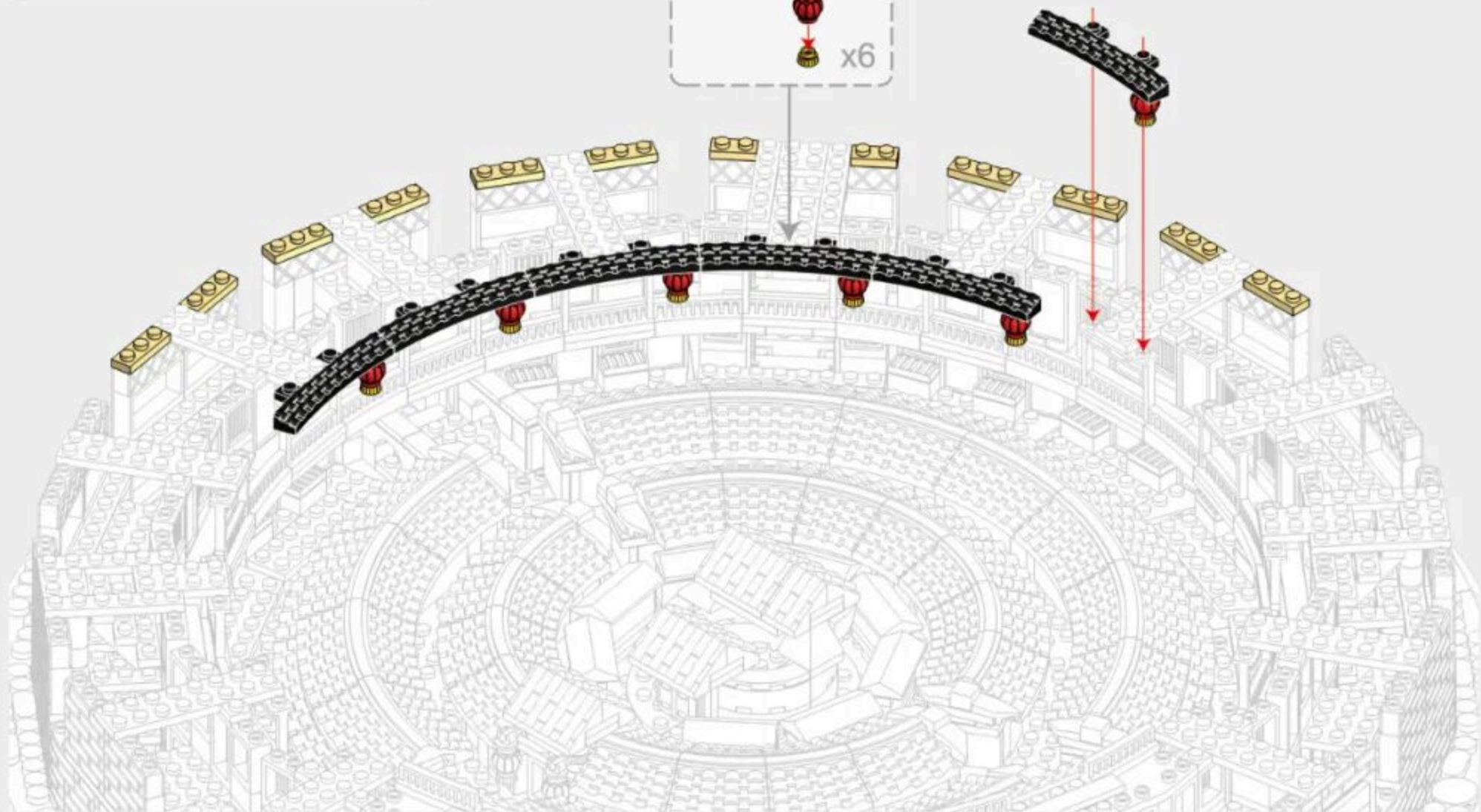

8-10

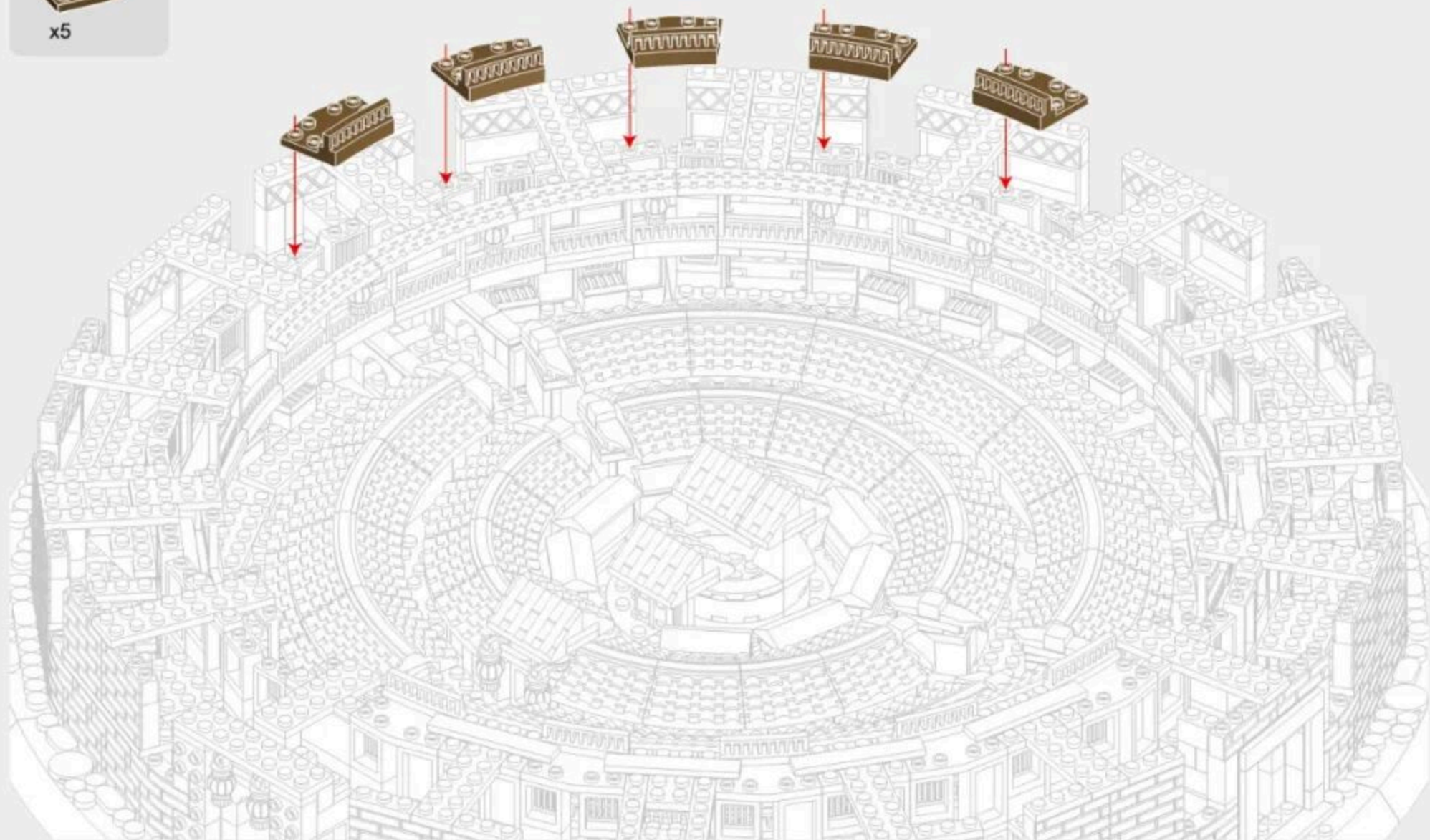

8-11

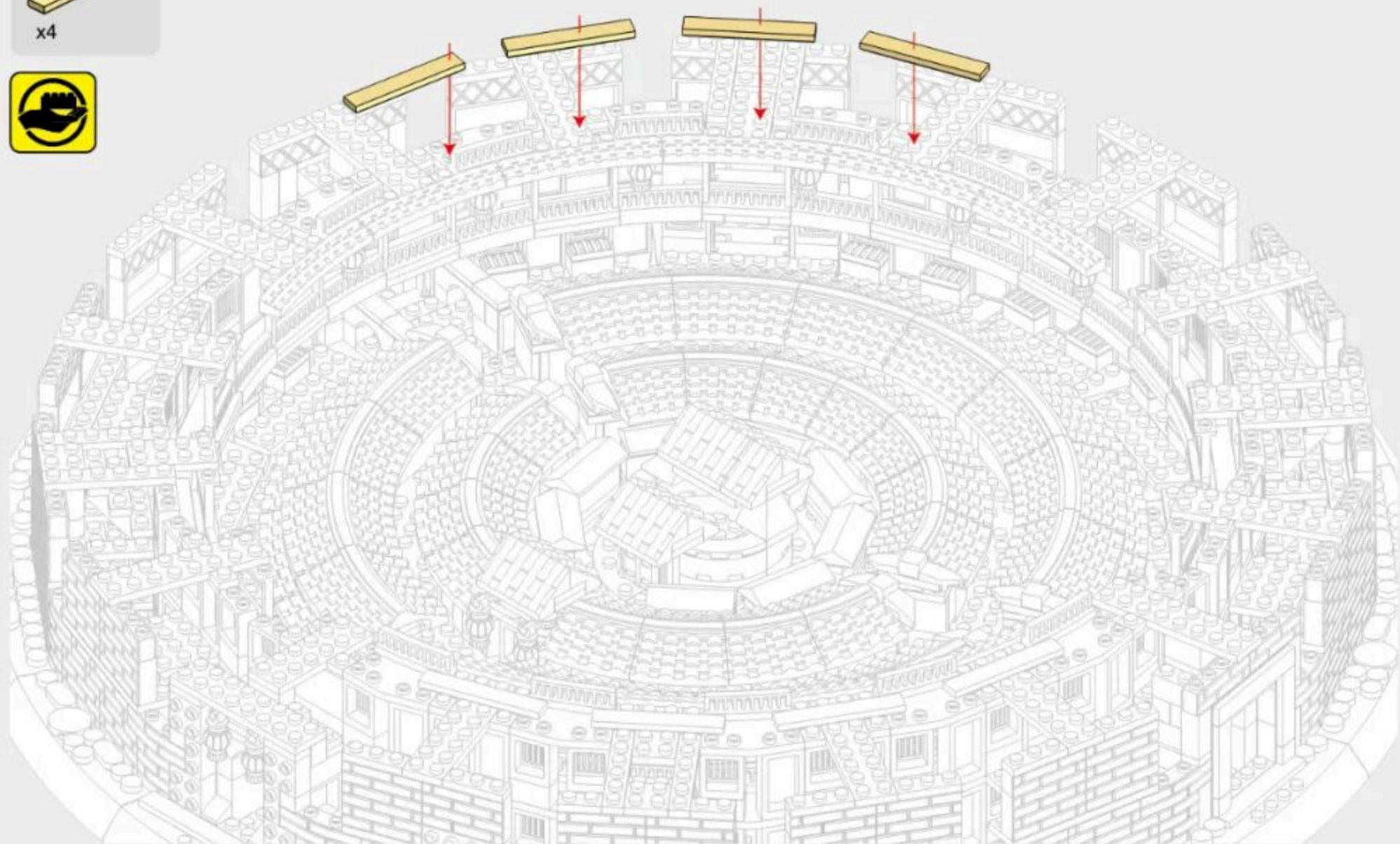

8-12

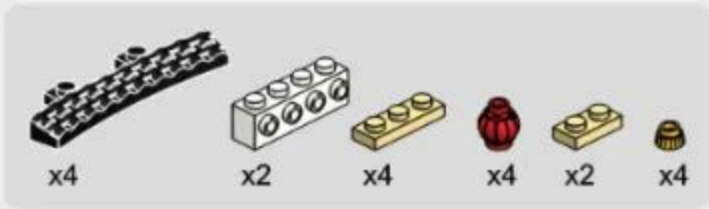

8-13

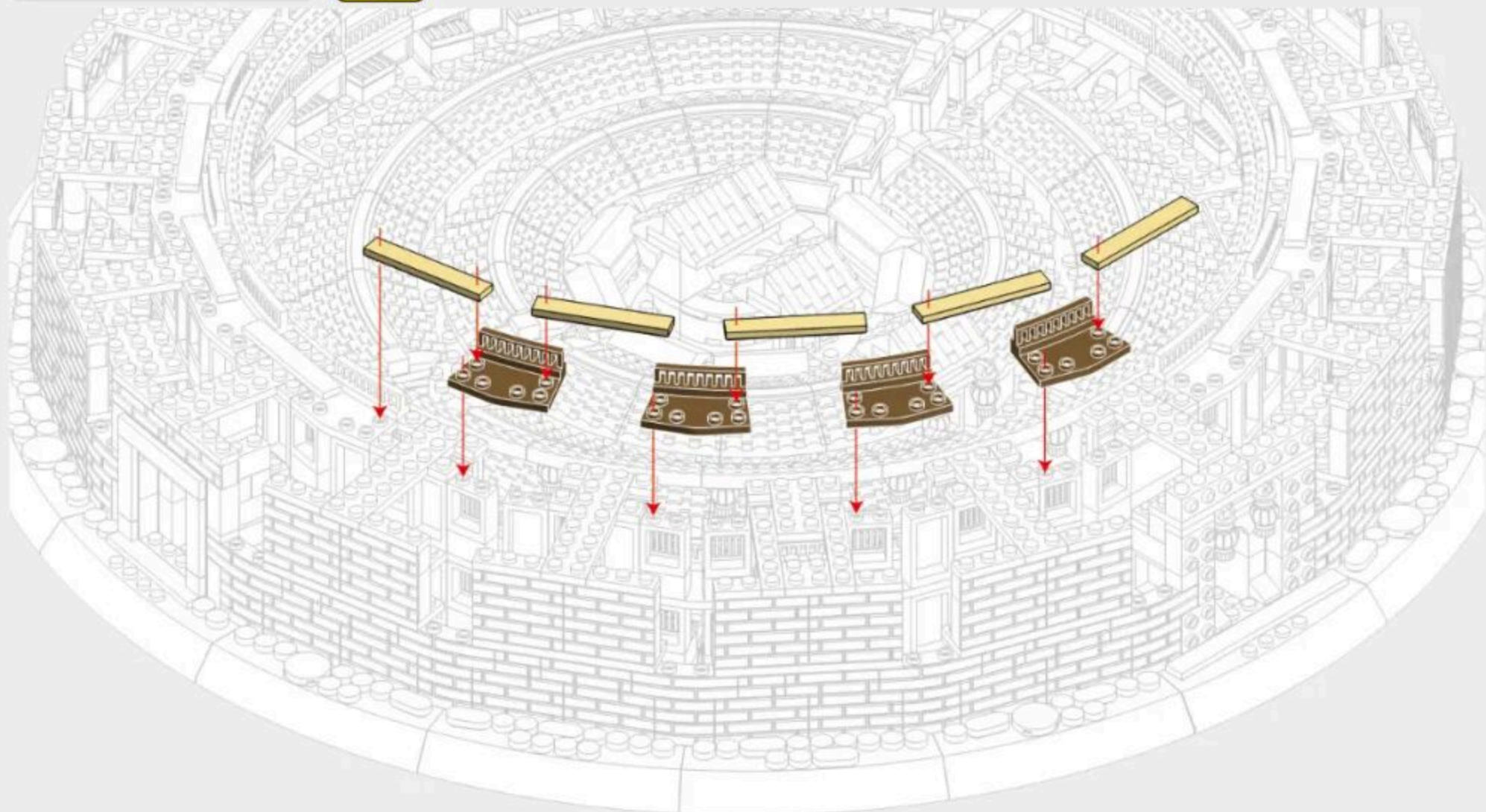
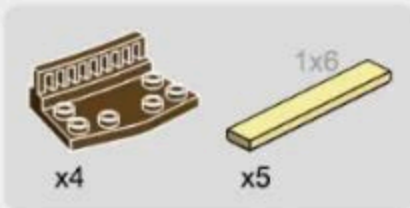

8-14

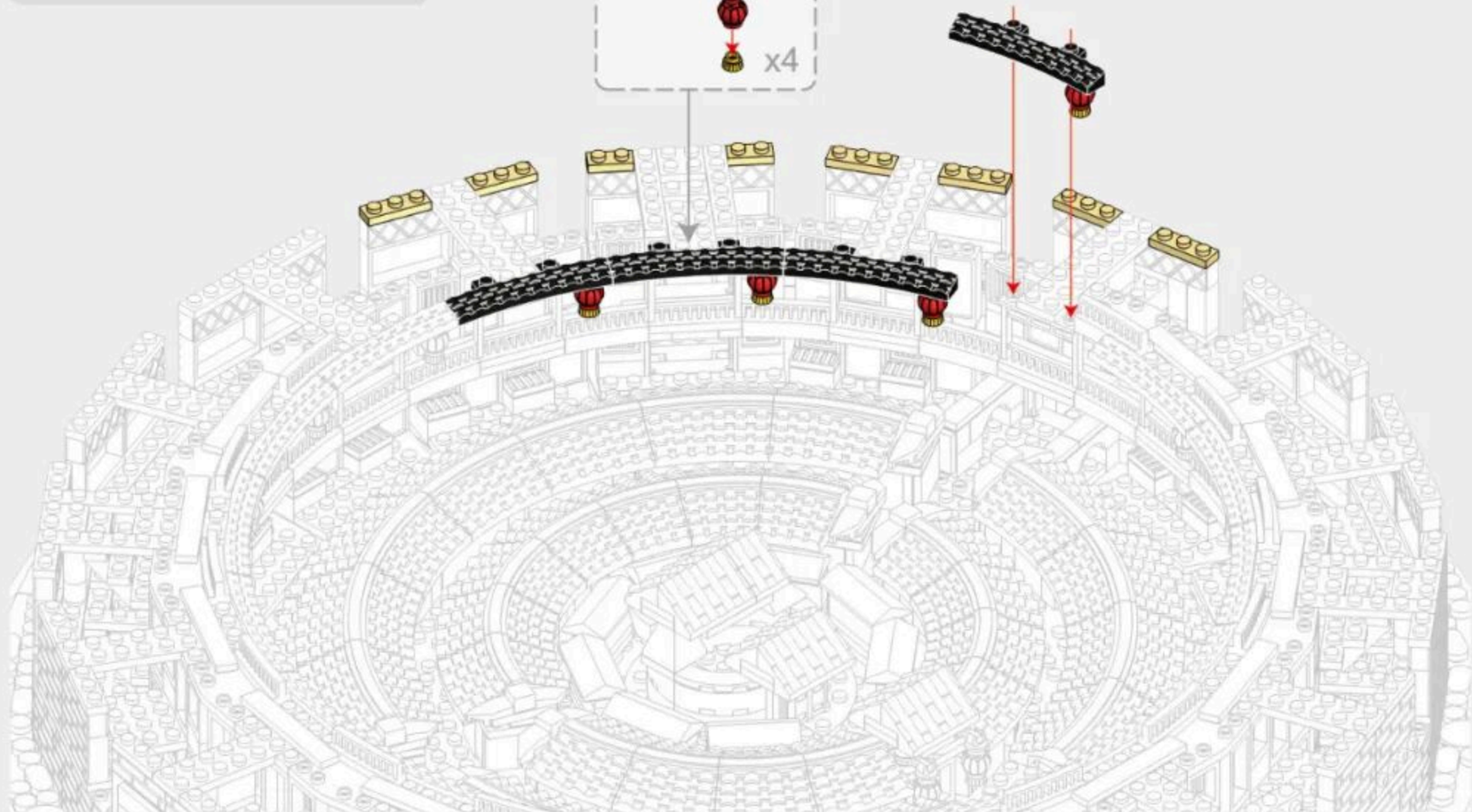

8-15

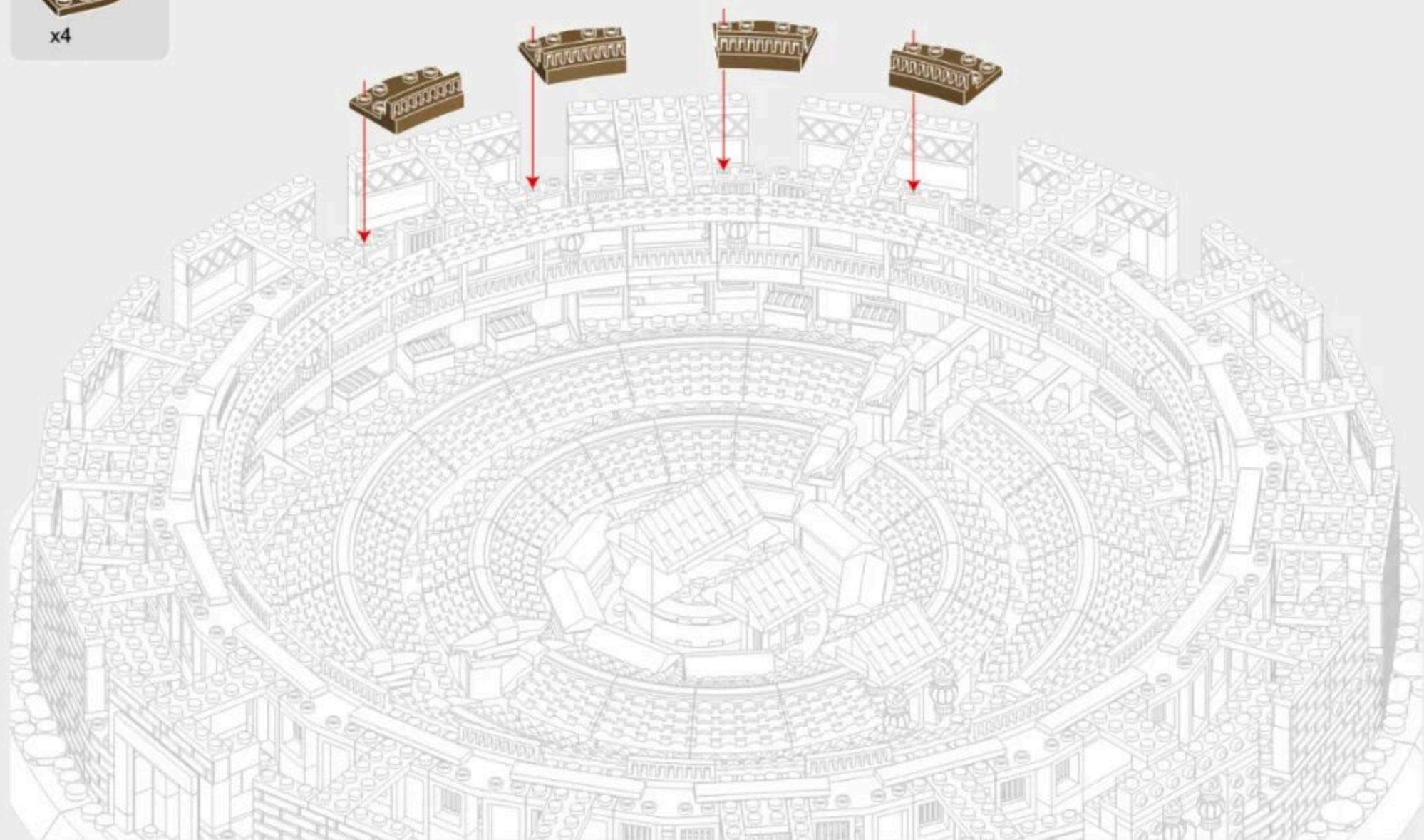

8-16

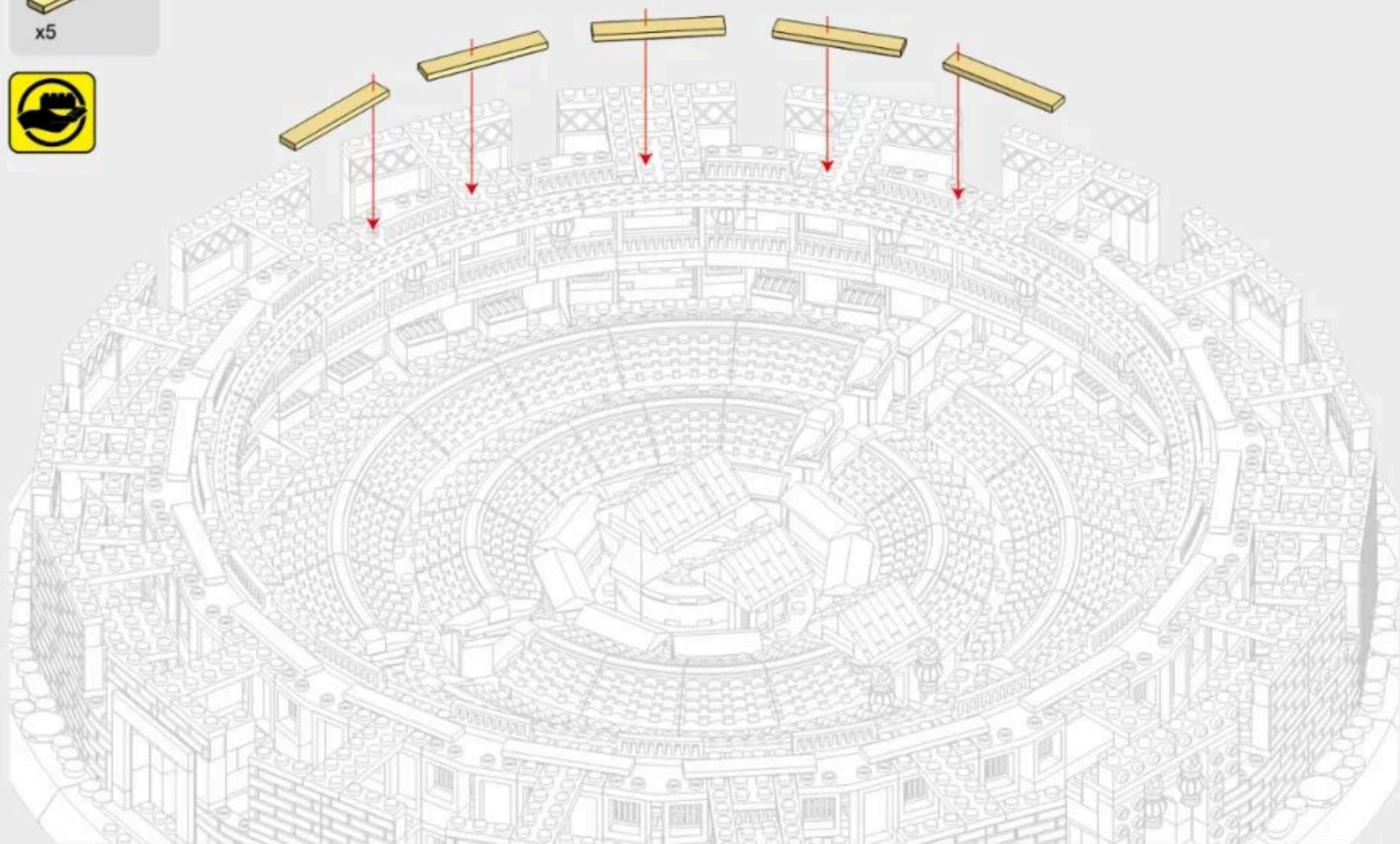
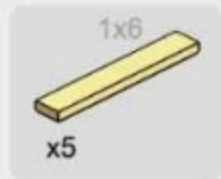



286PCS

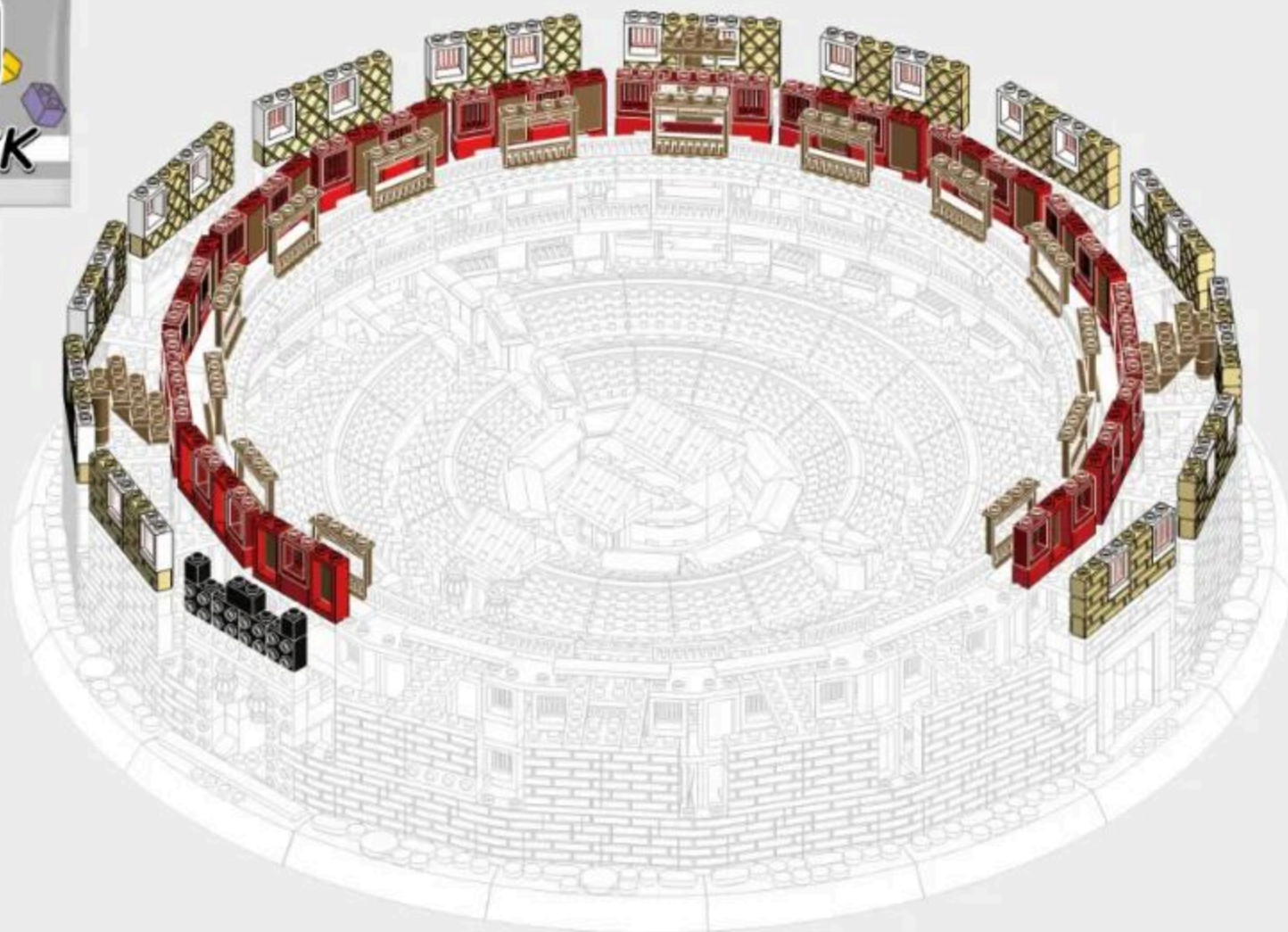

9-1

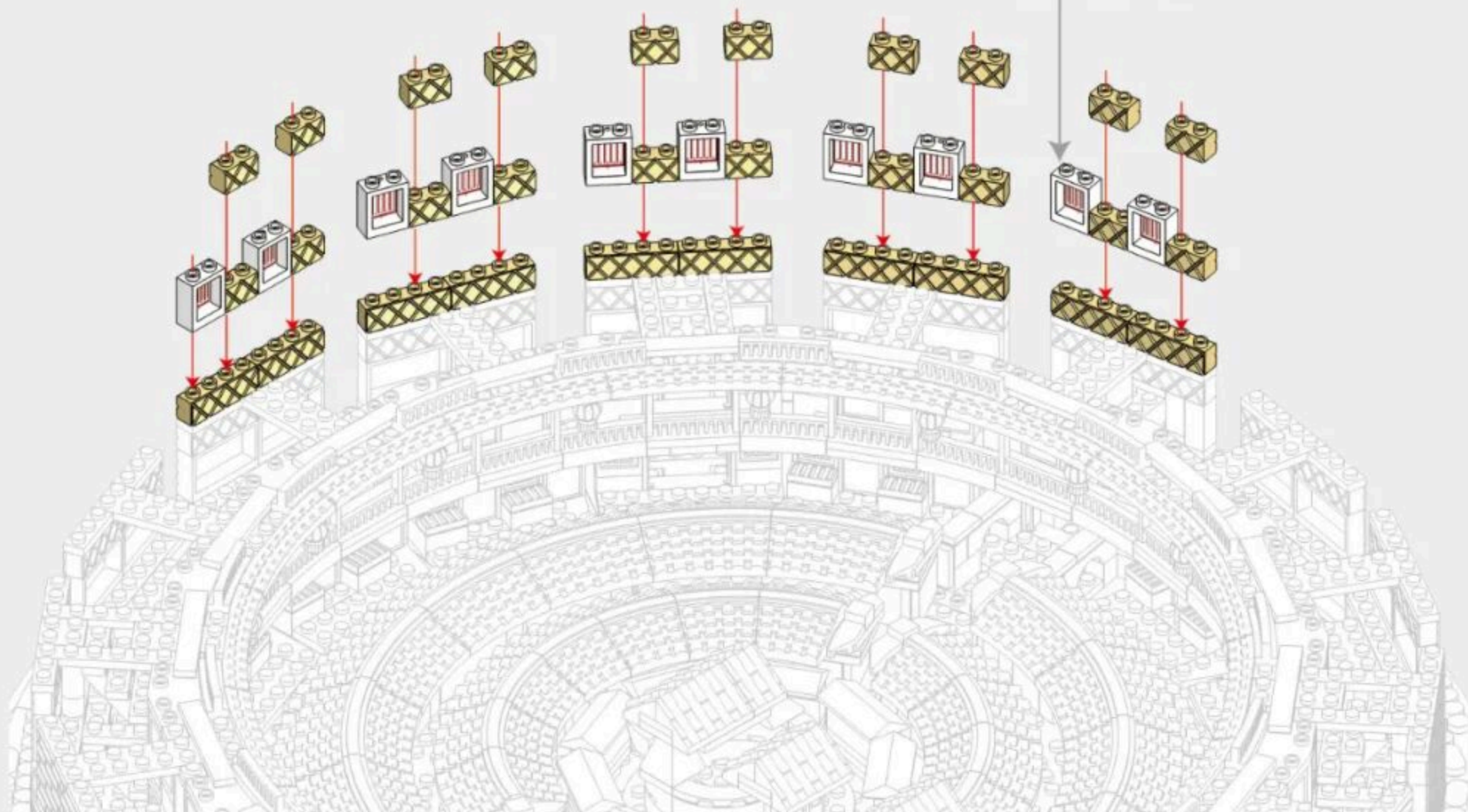
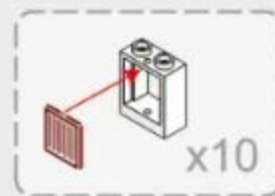

9-2

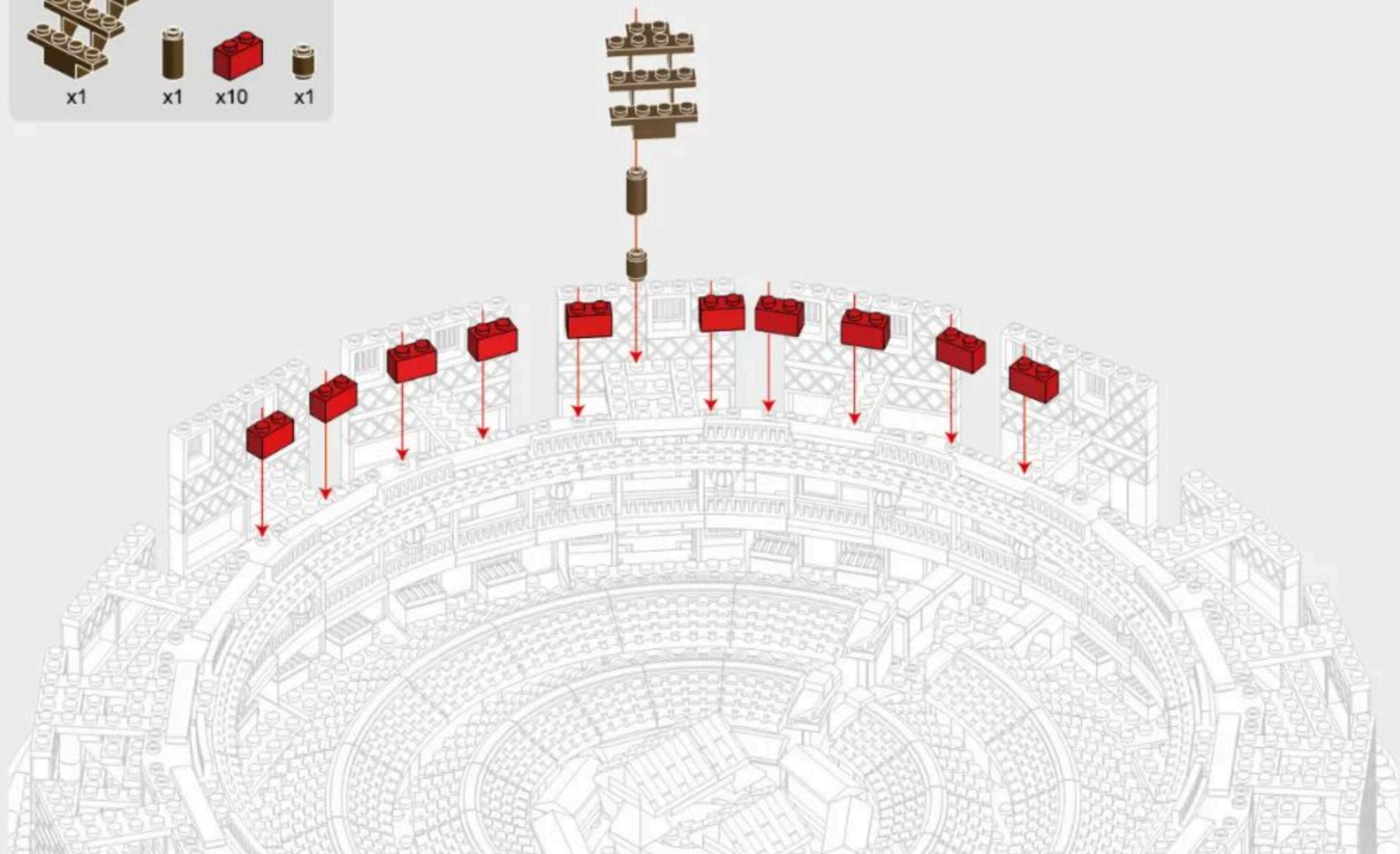
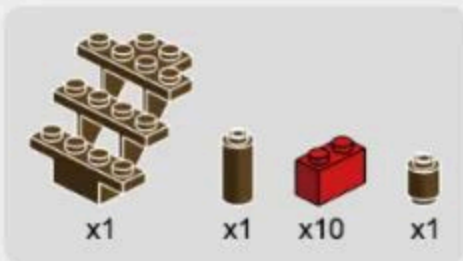

9-3

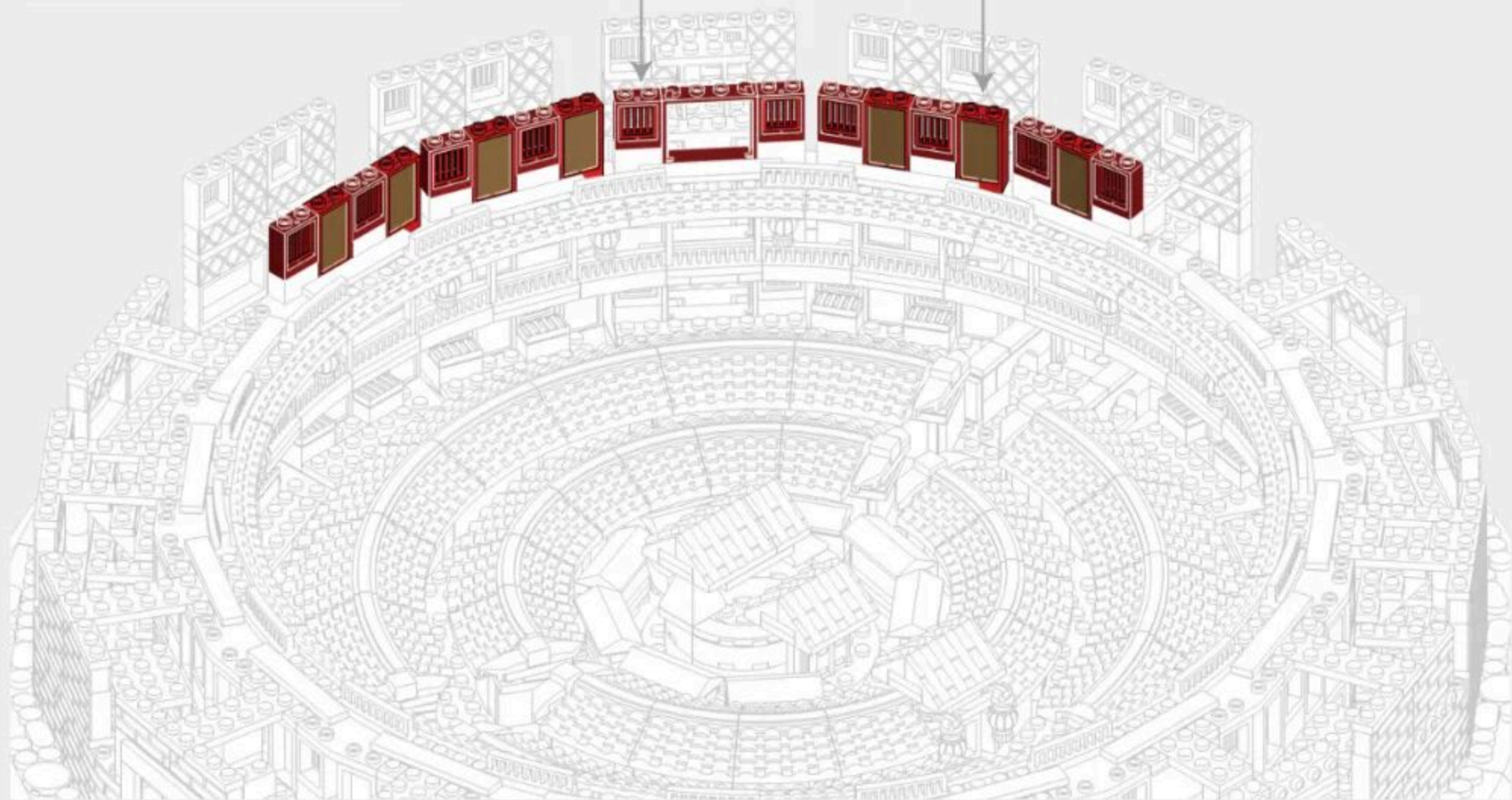
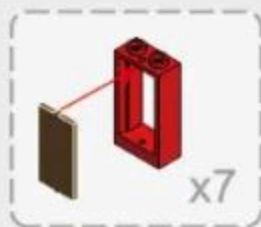
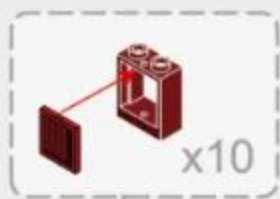

9-4

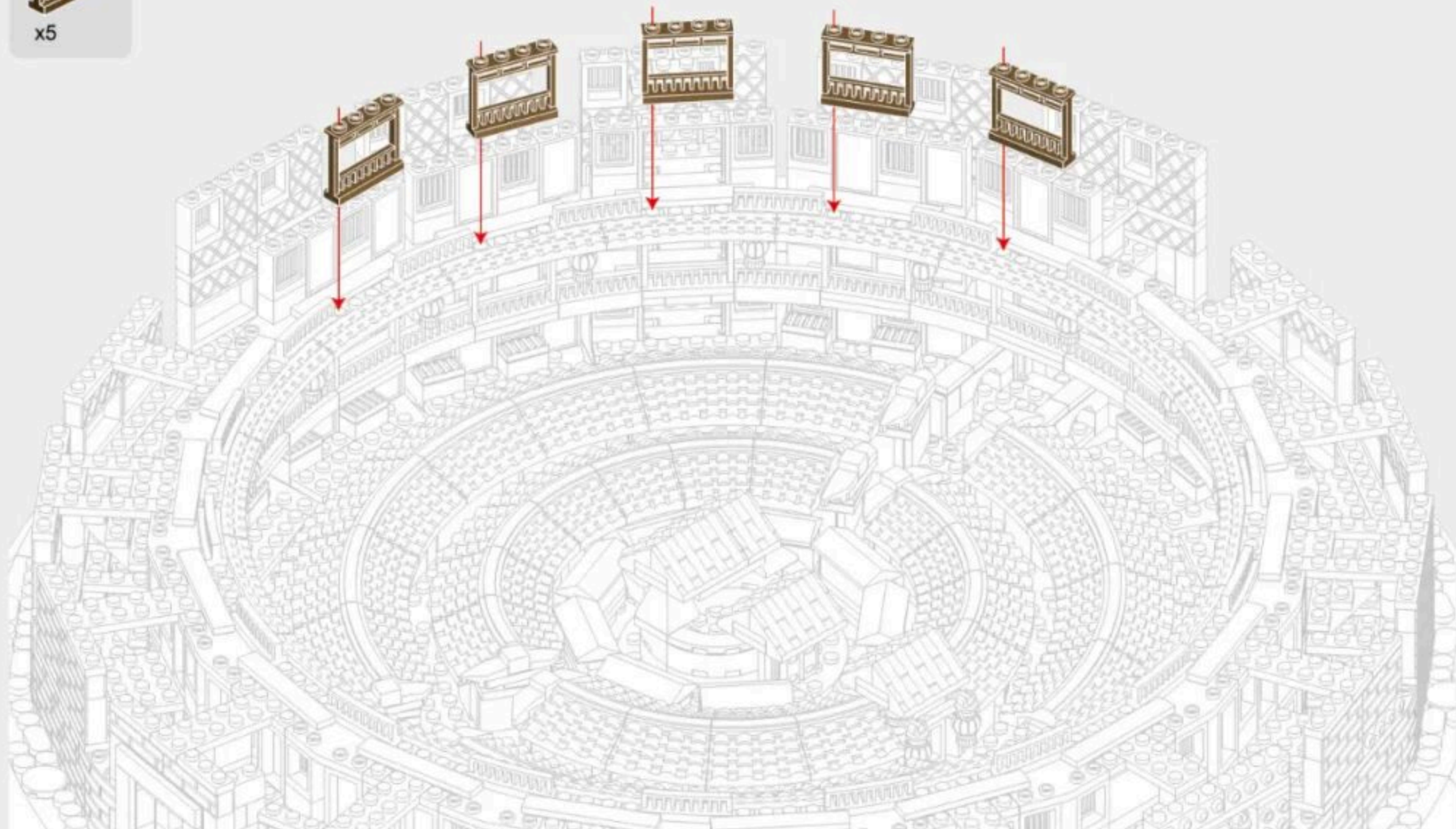

9-5



x5

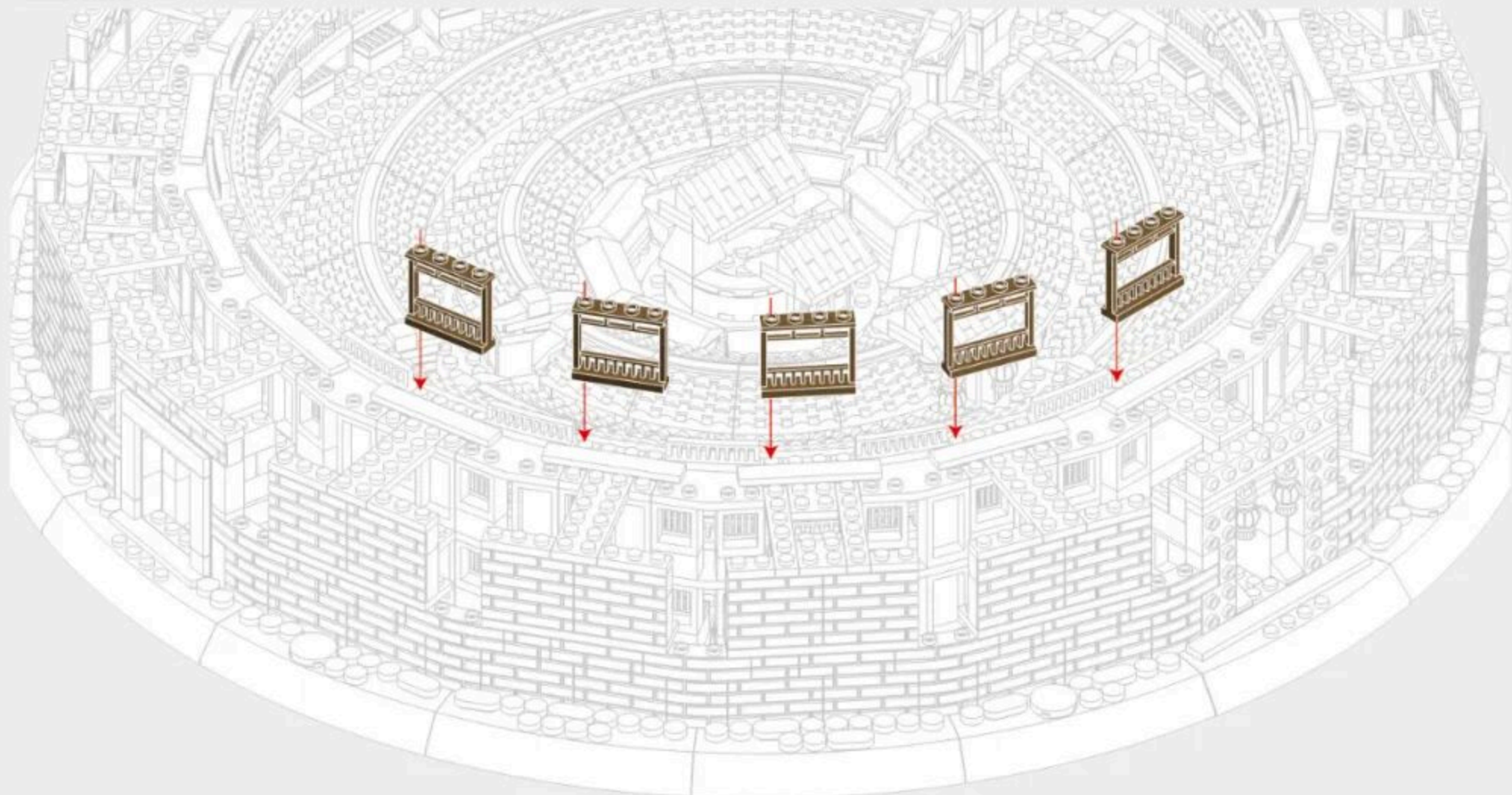

9-6

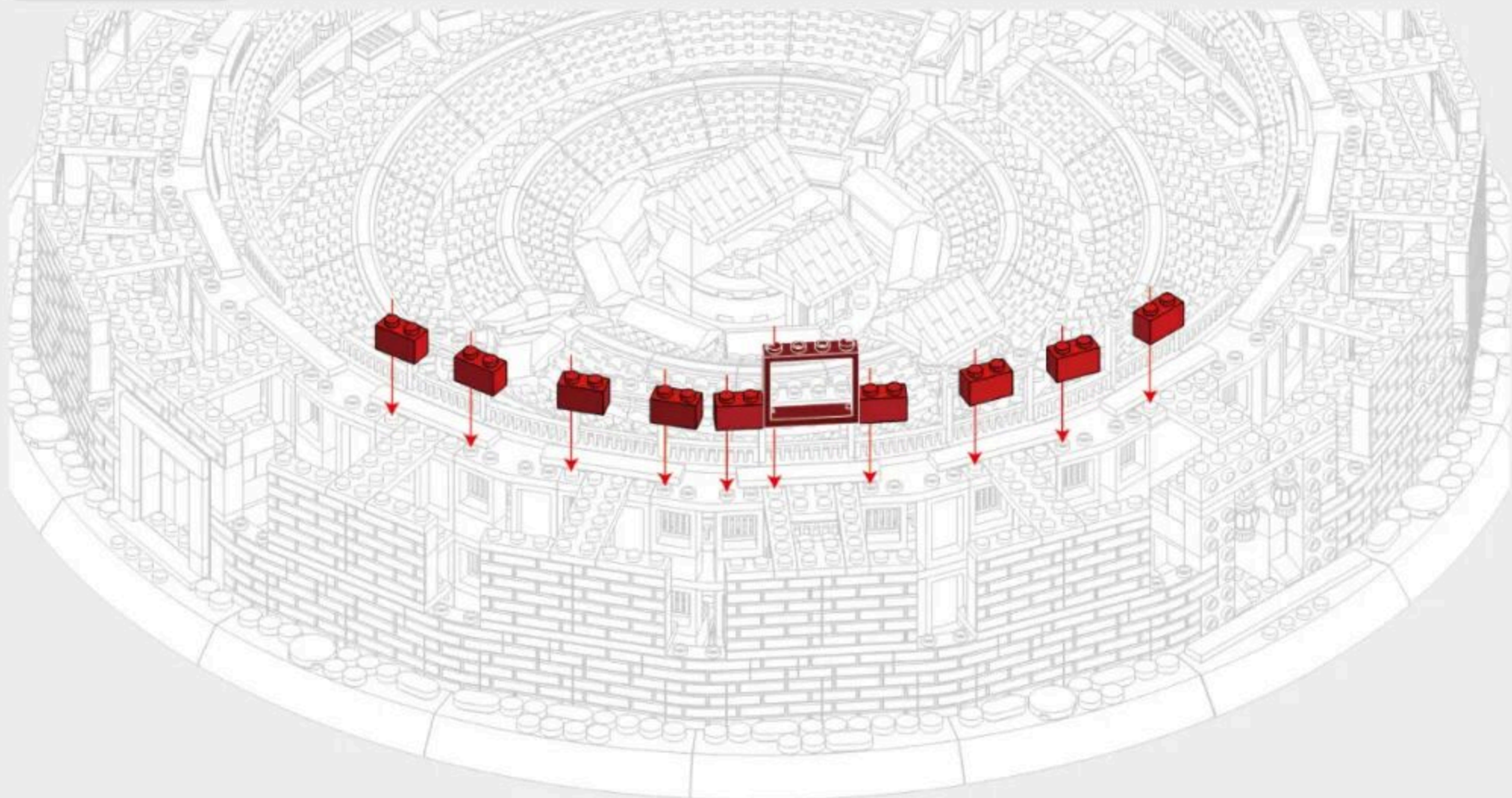

9-7

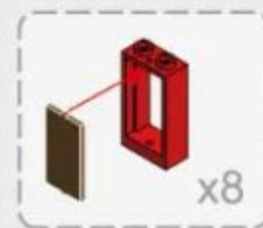

9-8

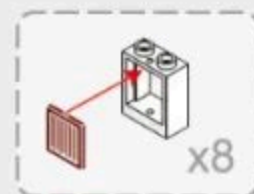

9-9

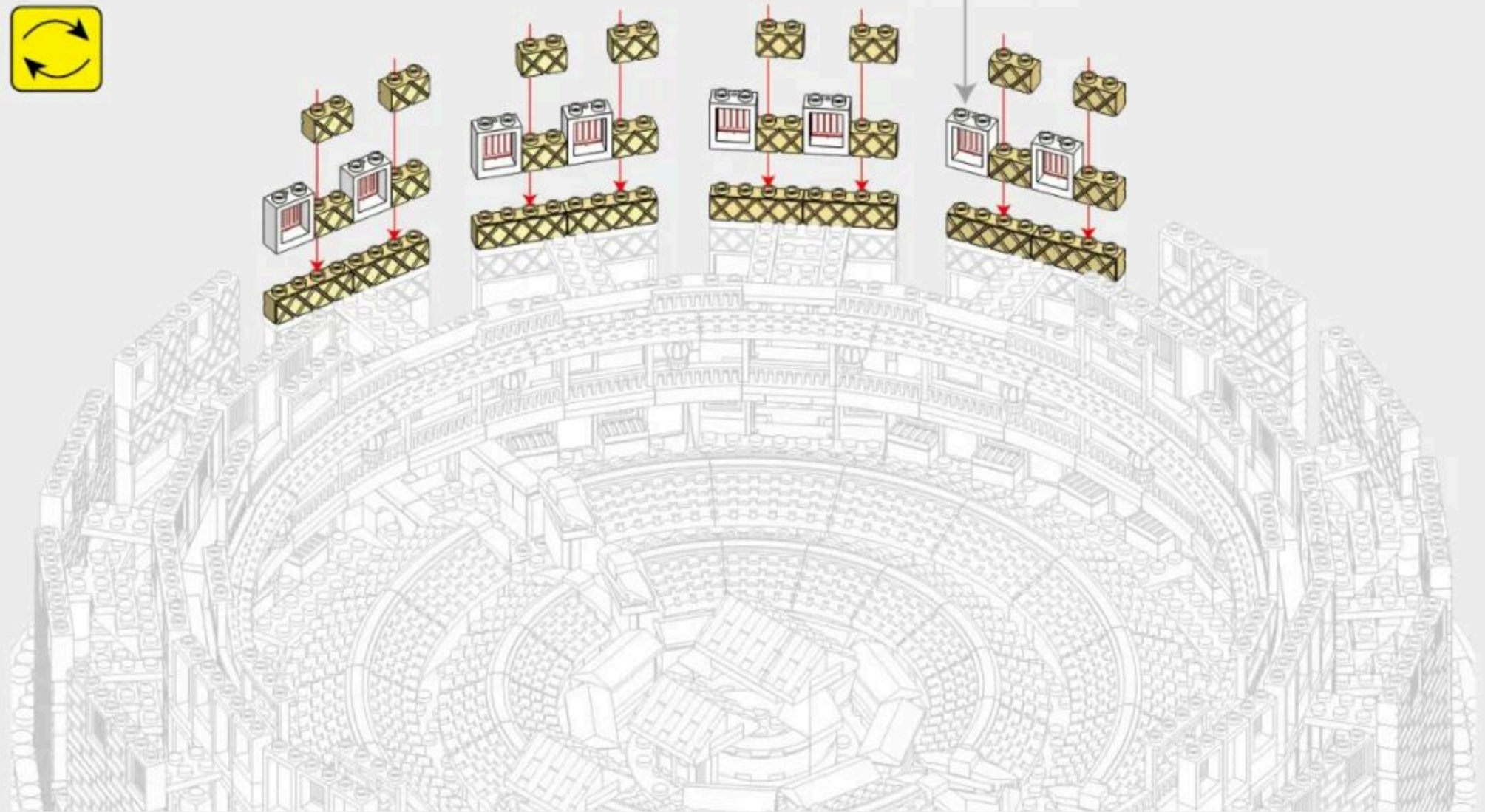
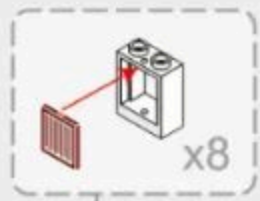

9-10

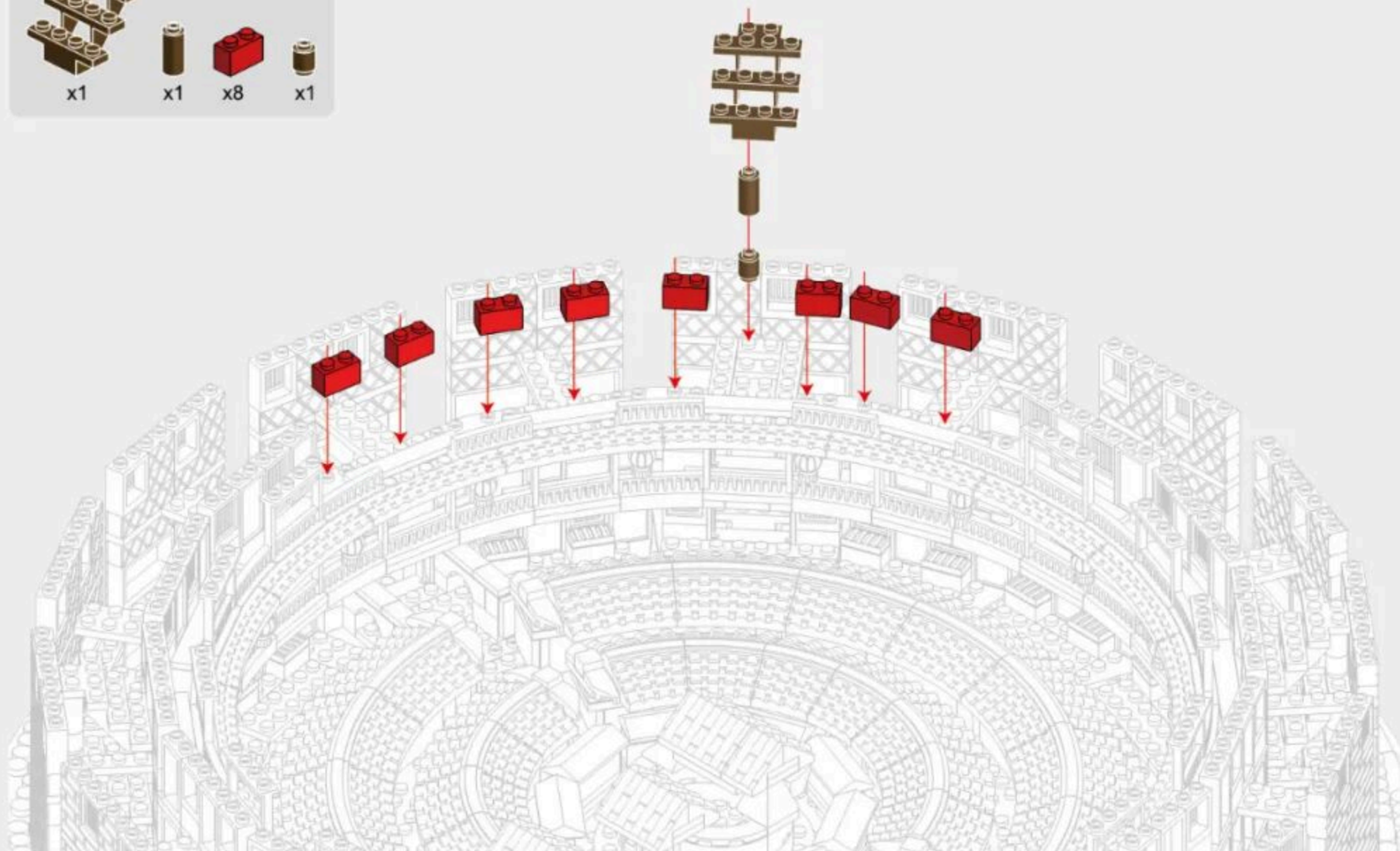
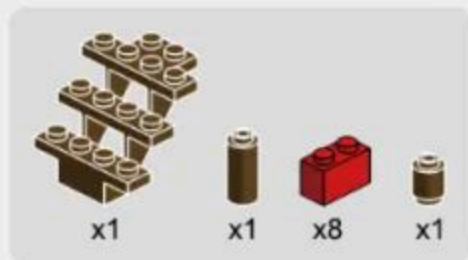

9-11

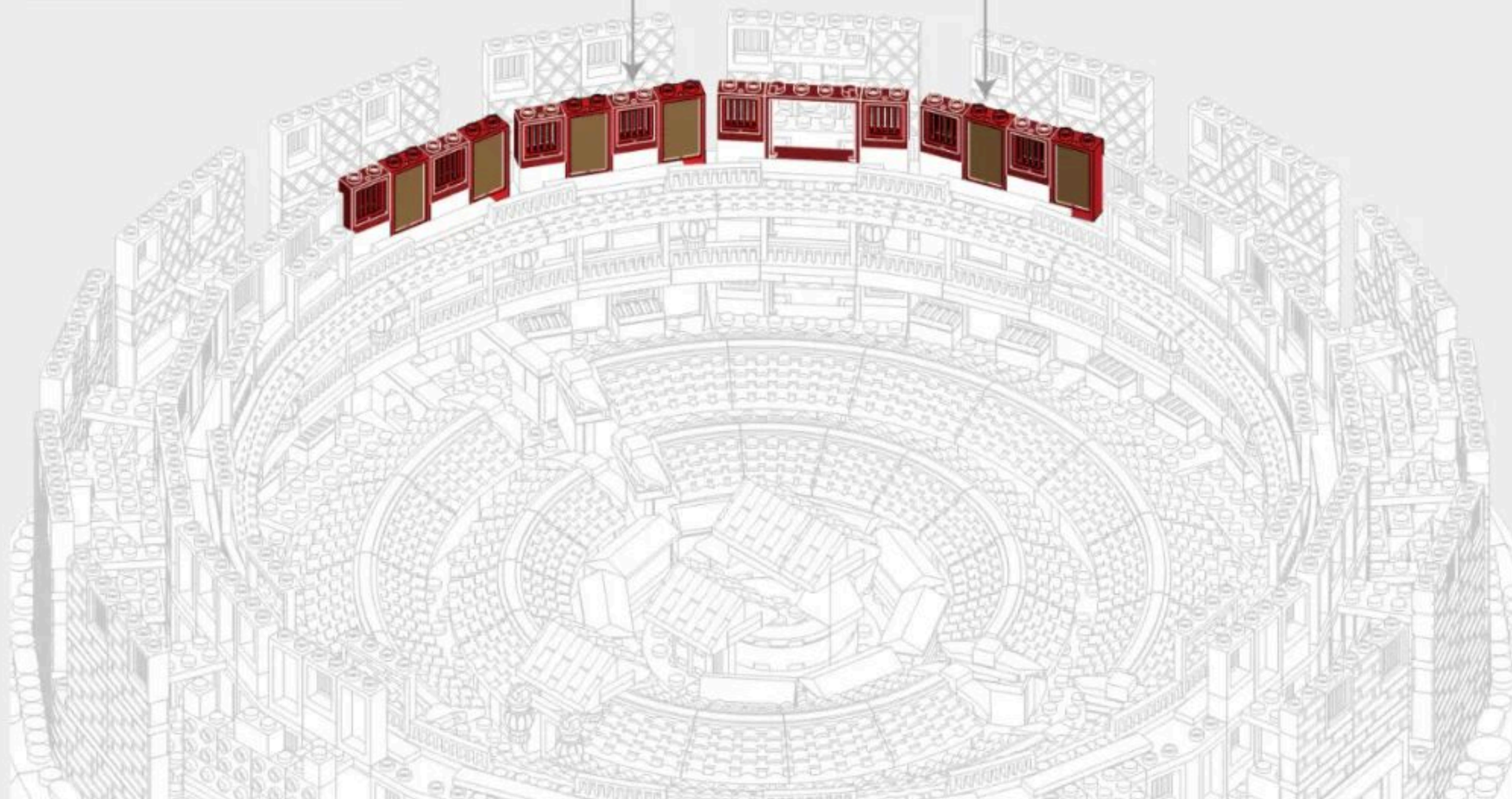

9-12



x4

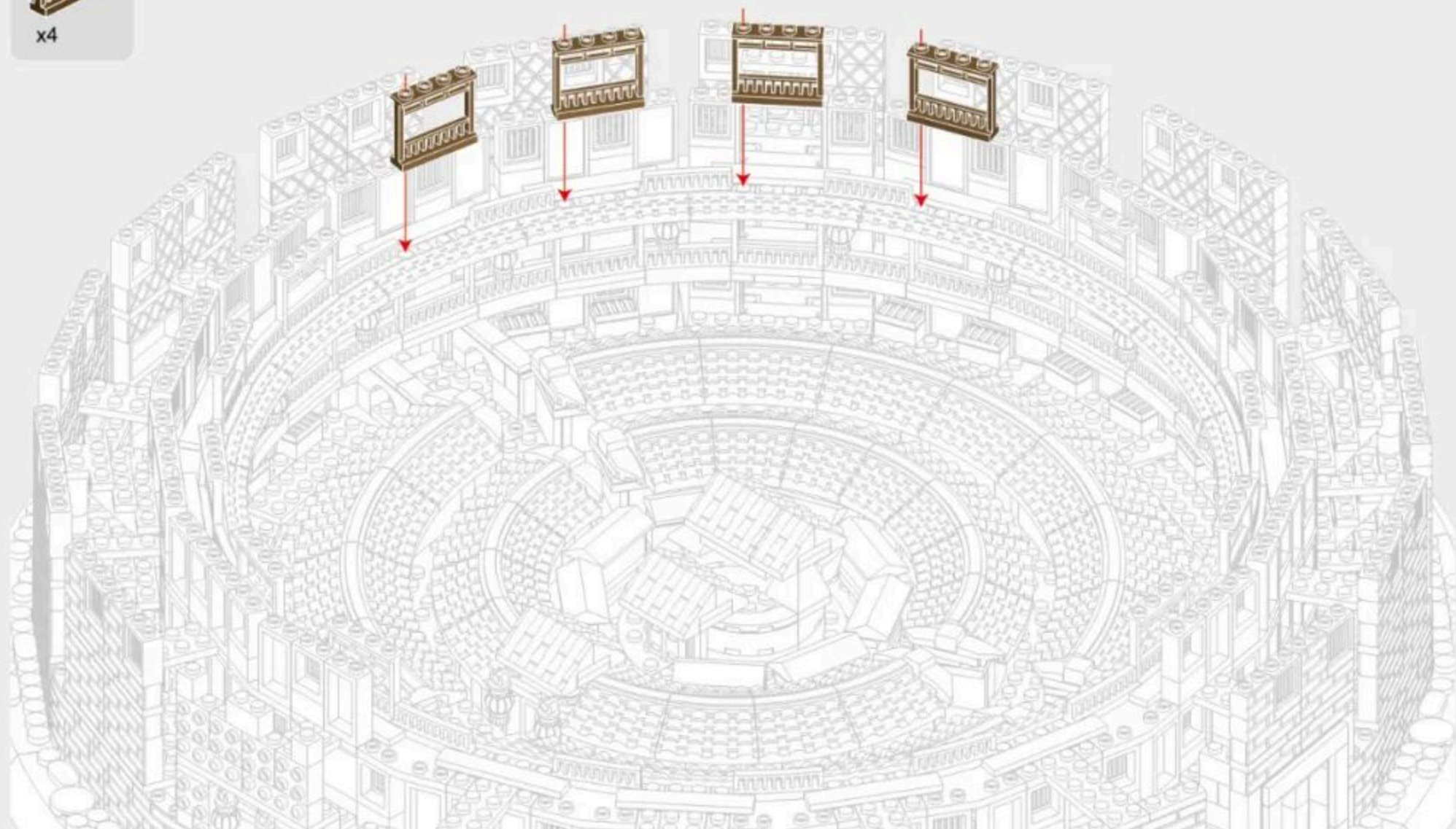

10
PACK

201 PCS

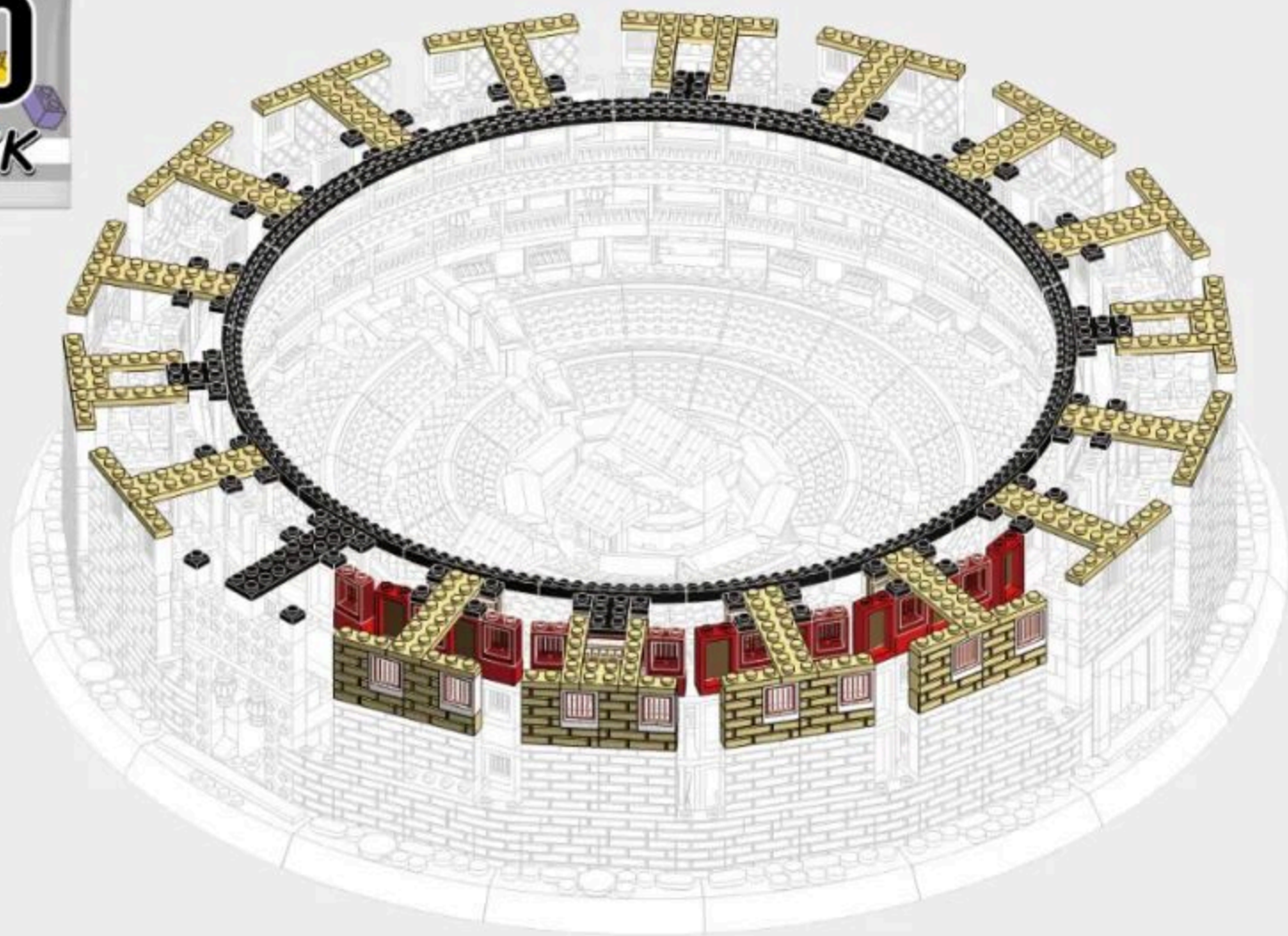

10-1



注意：此步骤仅用于搭建完整版的土楼，搭建解构版的土楼请忽略此步骤。
Tips: This step is only for constructing a complete version of the tulou.
Please ignore this step if you are constructing a deconstructed version of the tulou.

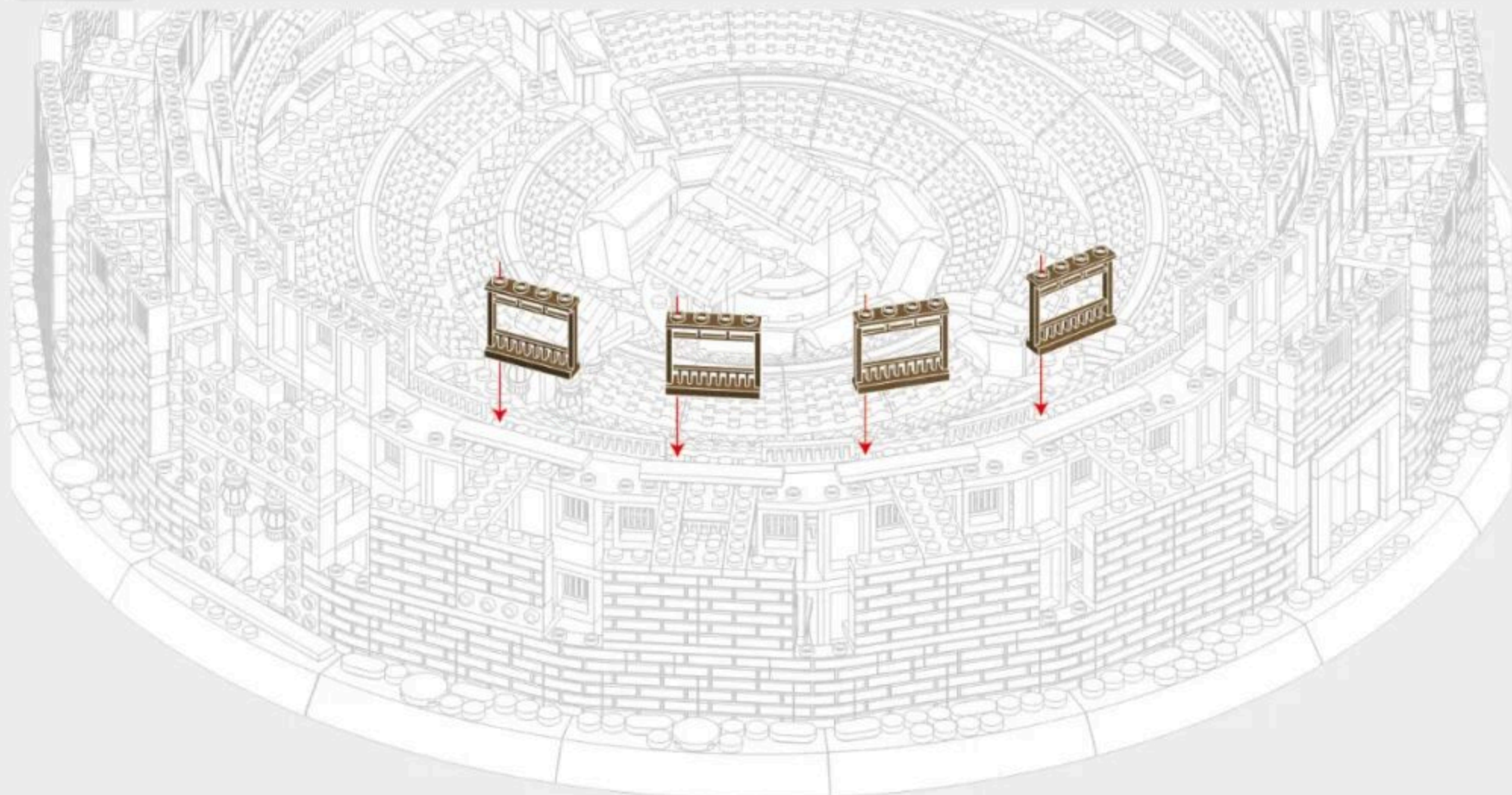

10-2



注意：此步骤仅用于搭建完整版的土楼，搭建解构版的土楼请忽略此步骤。
Tips: This step is only for constructing a complete version of the tulou.
Please ignore this step if you are constructing a deconstructed version of the tulou.

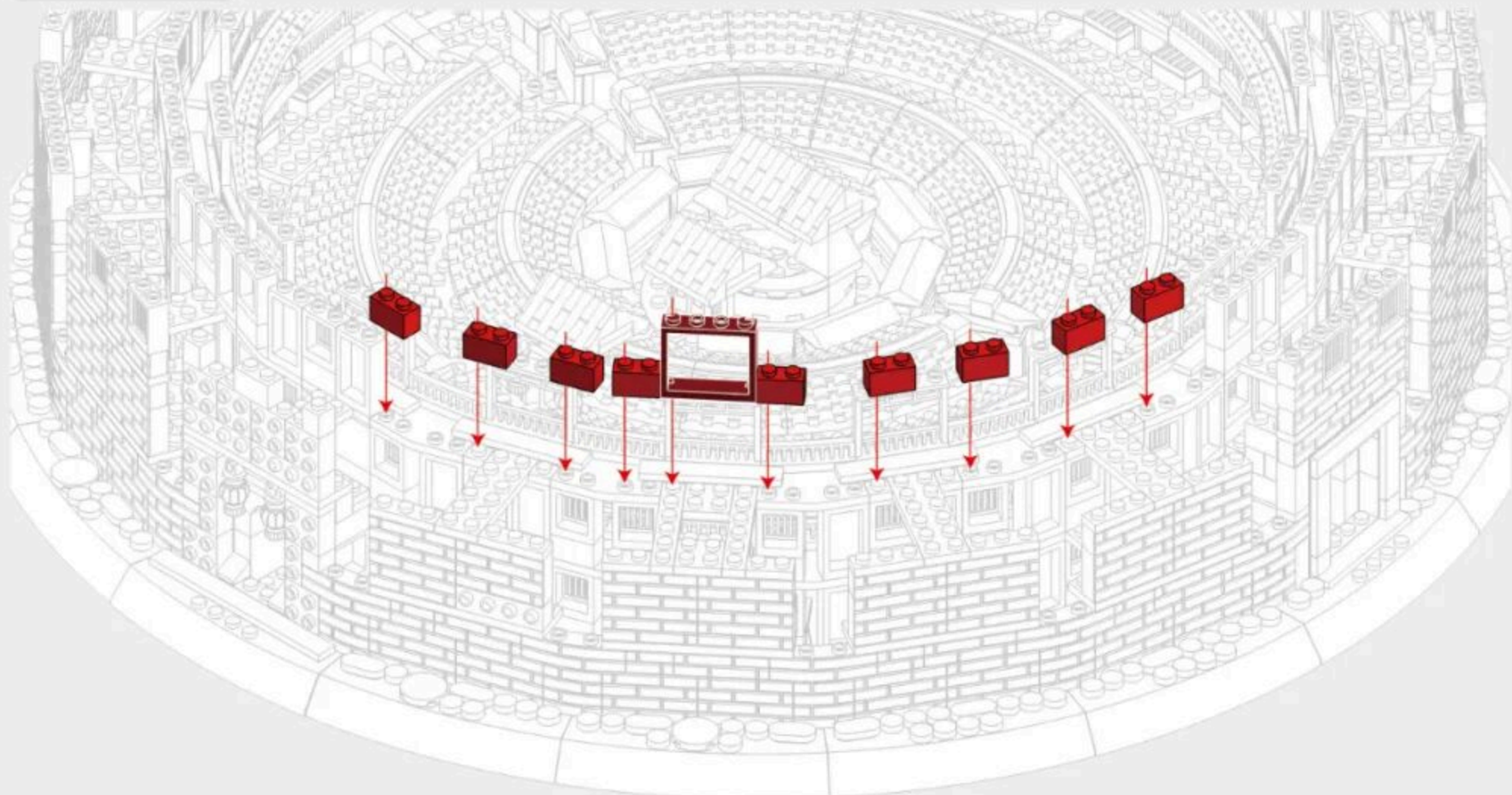

10-3



注意：此步骤仅用于搭建完整版的土楼，搭建解构版的土楼请忽略此步骤。
Tips: This step is only for constructing a complete version of the tulou.
Please ignore this step if you are constructing a deconstructed version of the tulou.



10-4

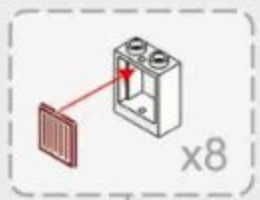

注意：此步骤仅用于搭建完整版的土楼，搭建解构版的土楼请忽略此步骤。
Tips: This step is only for constructing a complete version of the tulou.
Please ignore this step if you are constructing a deconstructed version of the tulou.



10-5

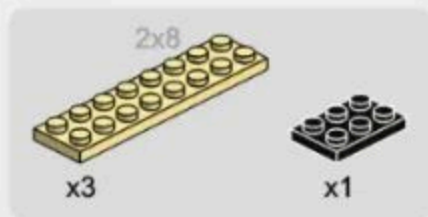

注意：此步骤仅用于搭建完整版的土楼，搭建解构版的土楼请忽略此步骤。
Tips: This step is only for constructing a complete version of the tulou.
Please ignore this step if you are constructing a deconstructed version of the tulou.

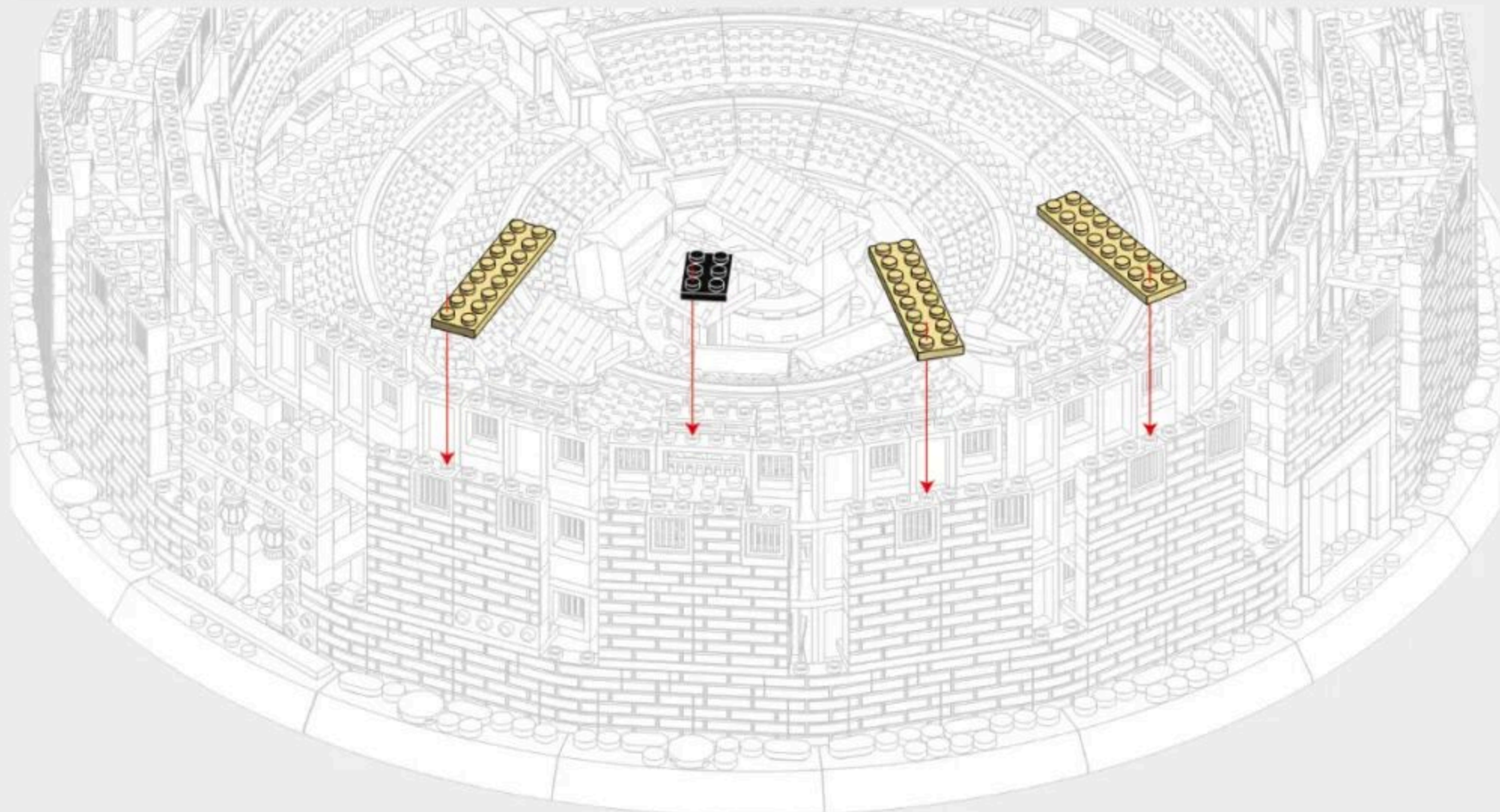

10-6



注意：此步骤仅用于搭建完整版的土楼，搭建解构版的土楼请忽略此步骤。
Tips: This step is only for constructing a complete version of the tulou.
Please ignore this step if you are constructing a deconstructed version of the tulou.

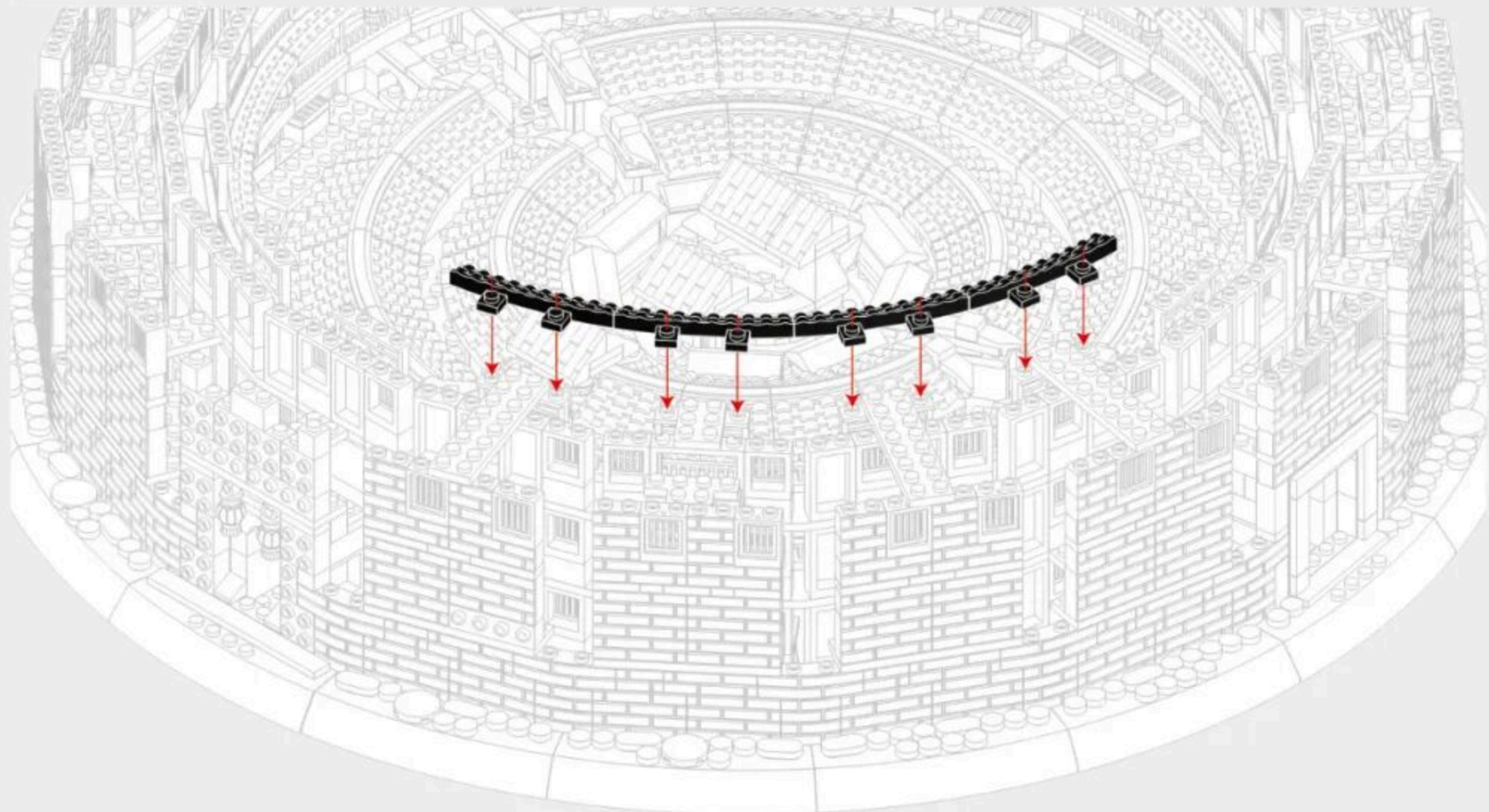

10-7



注意：此步骤仅用于搭建完整版的土楼，搭建解构版的土楼请忽略此步骤。
Tips: This step is only for constructing a complete version of the tulou.
Please ignore this step if you are constructing a deconstructed version of the tulou.

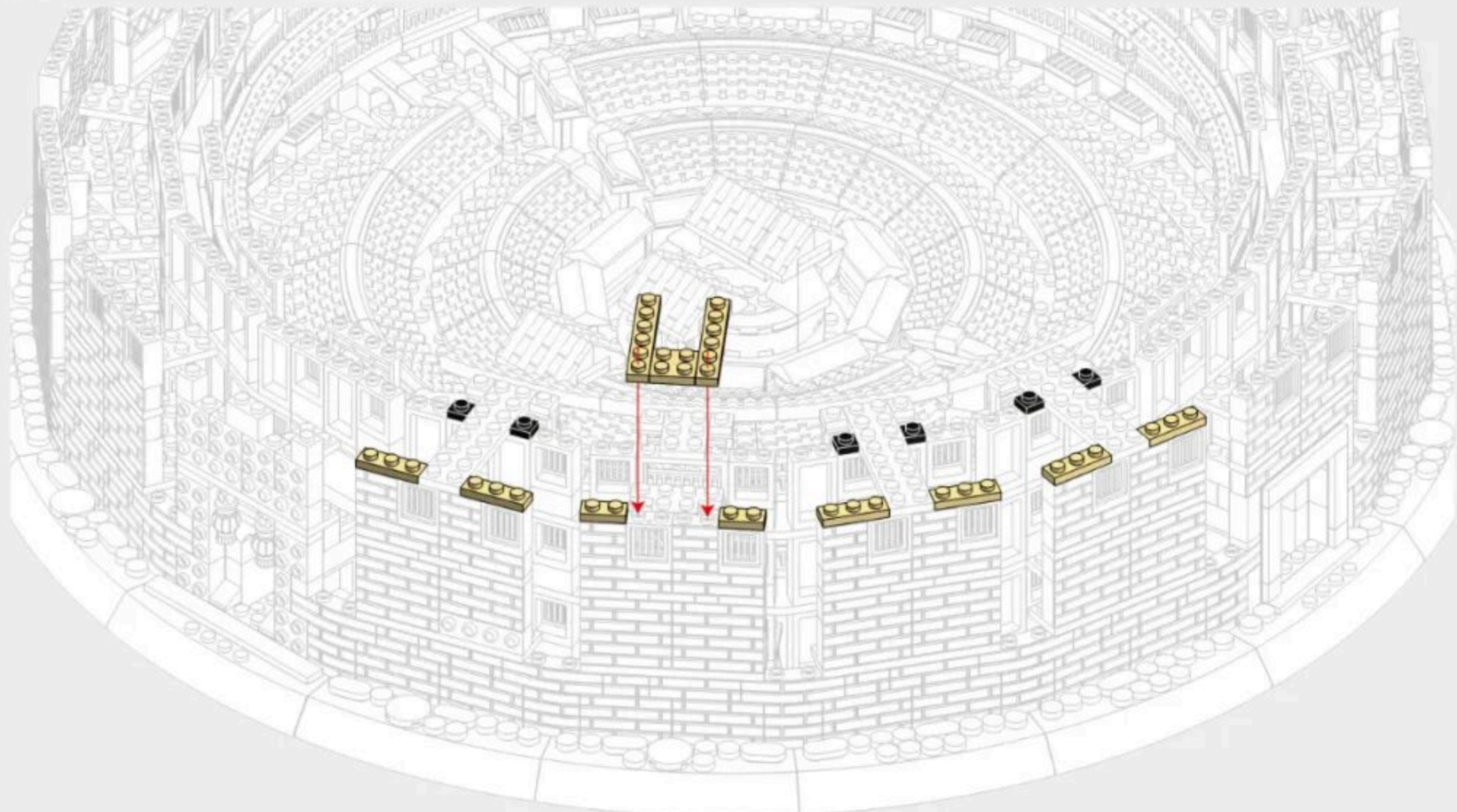

10-8

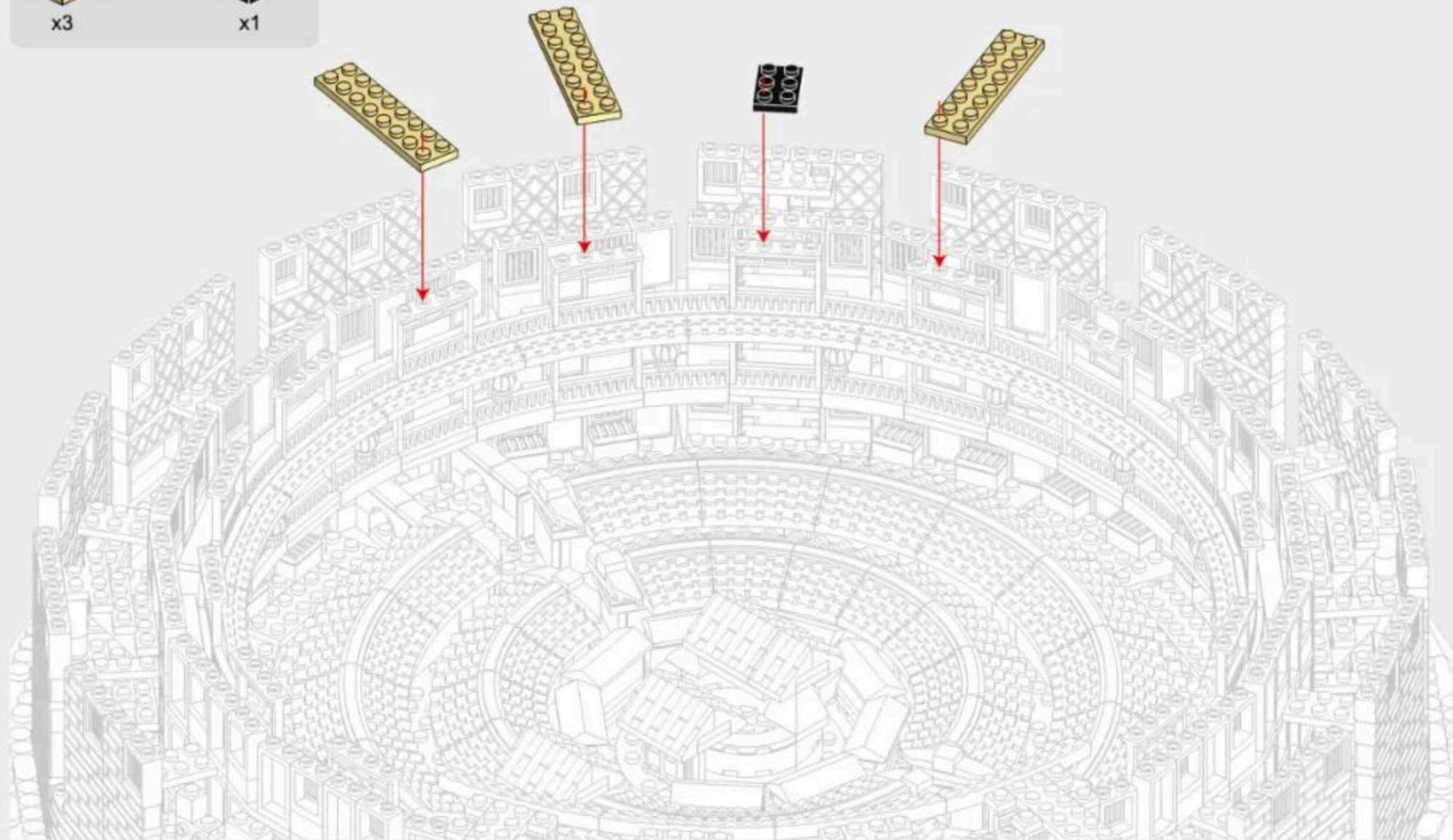
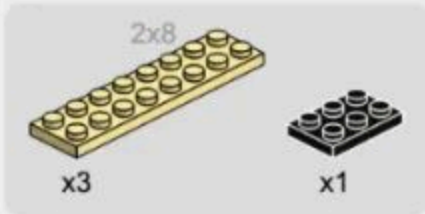

10-9

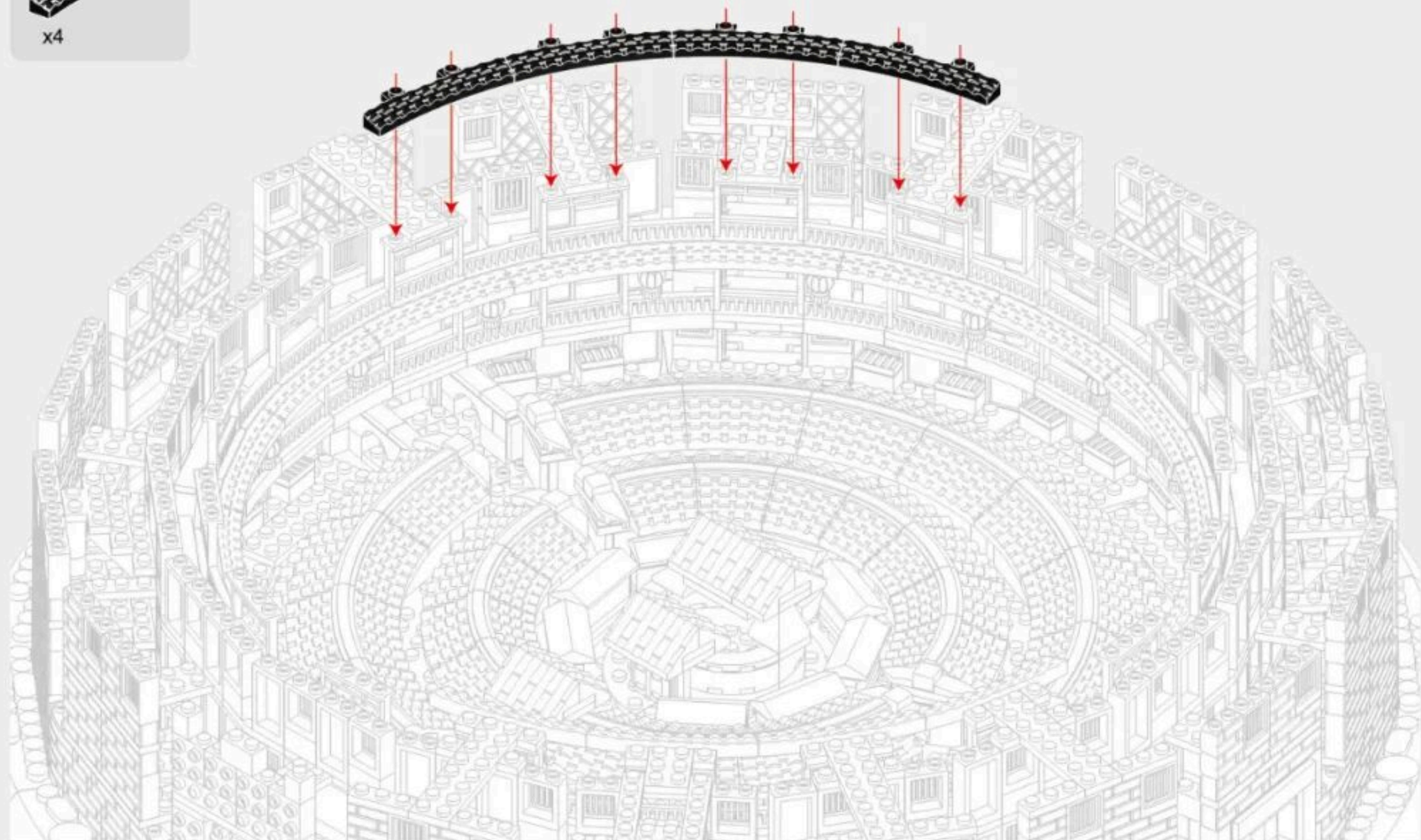

10-10

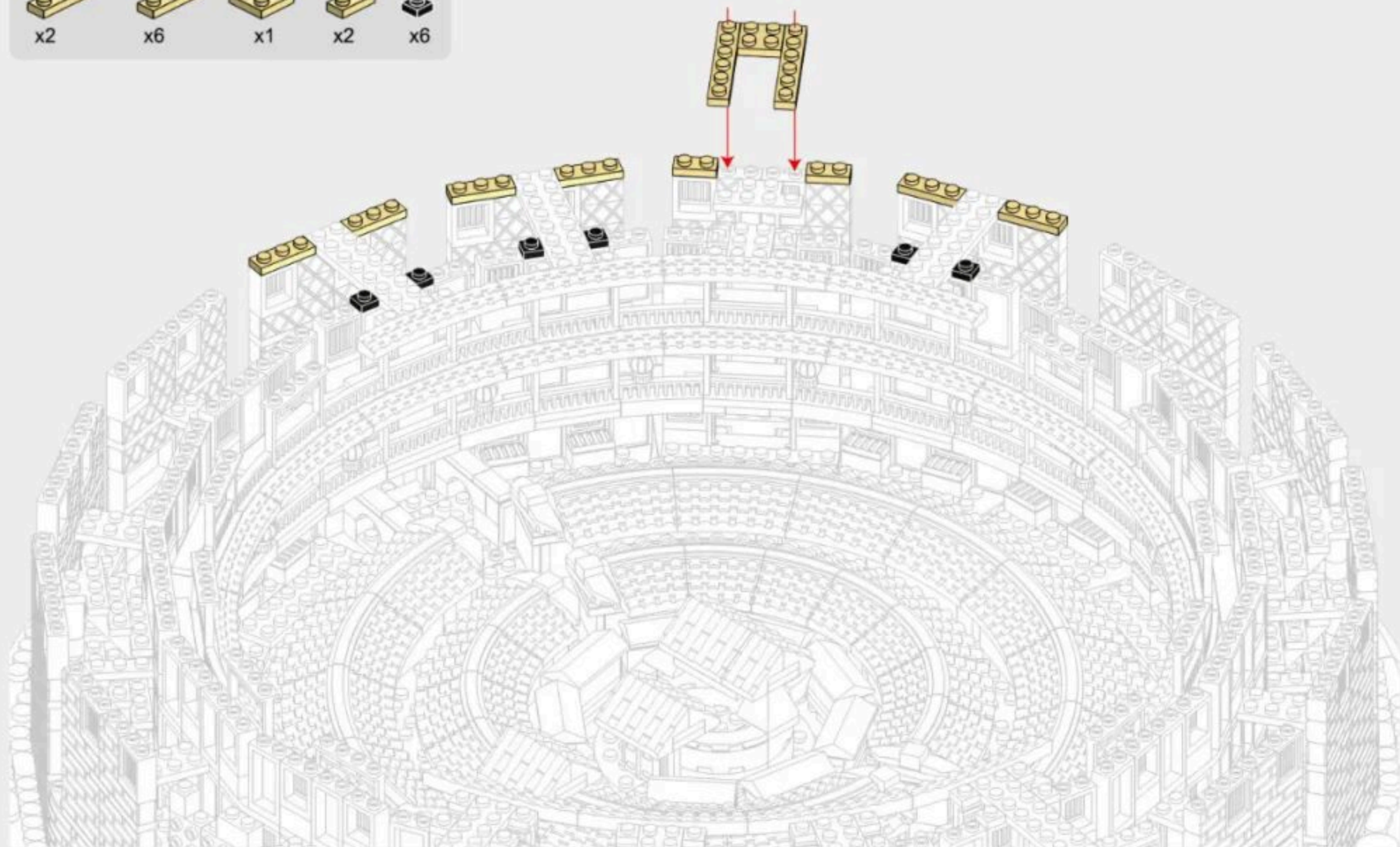

10-11

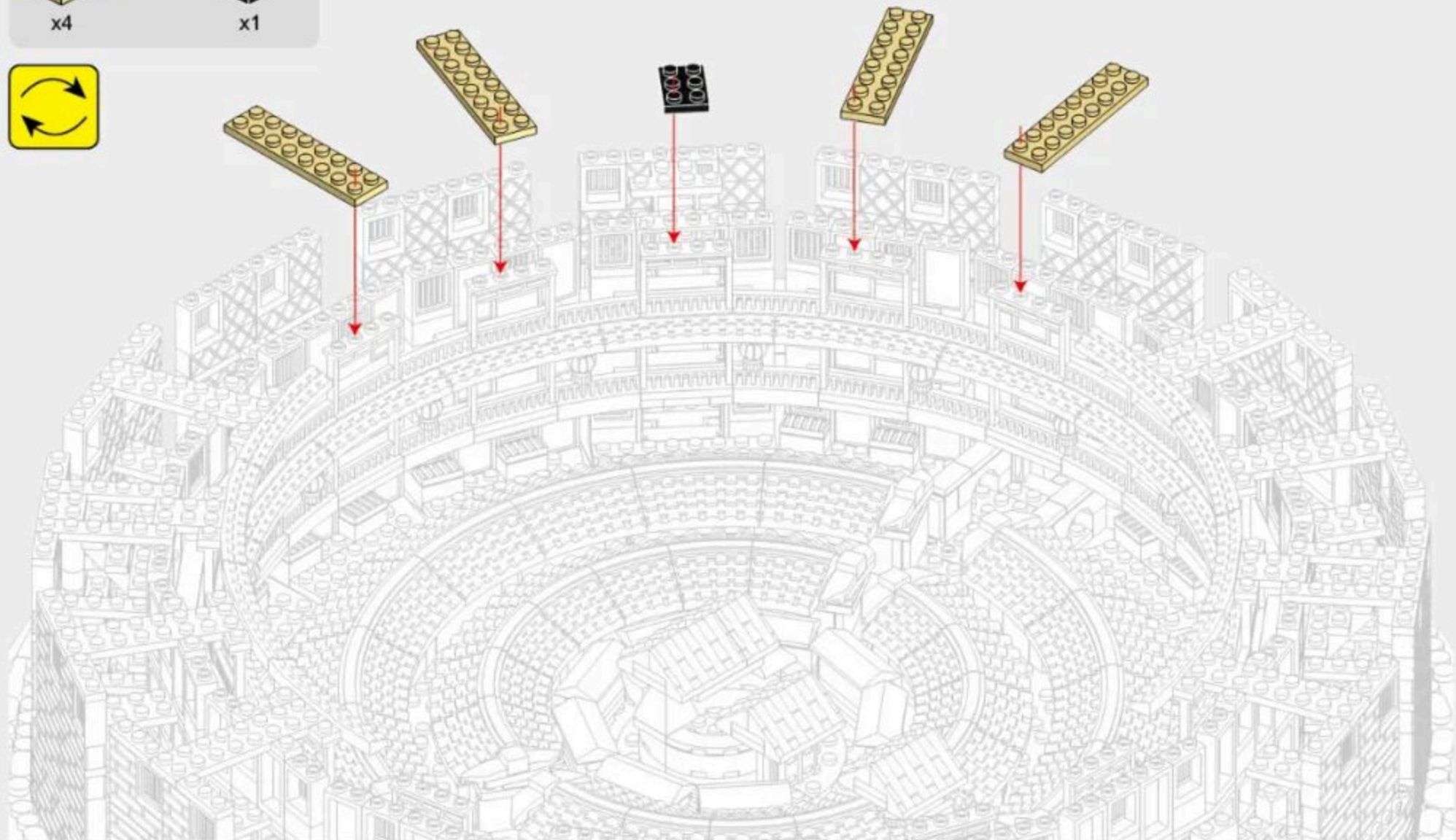
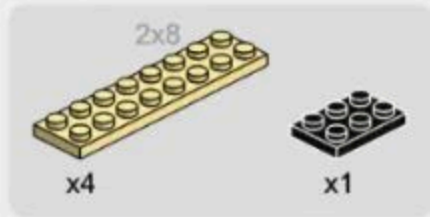

10-12

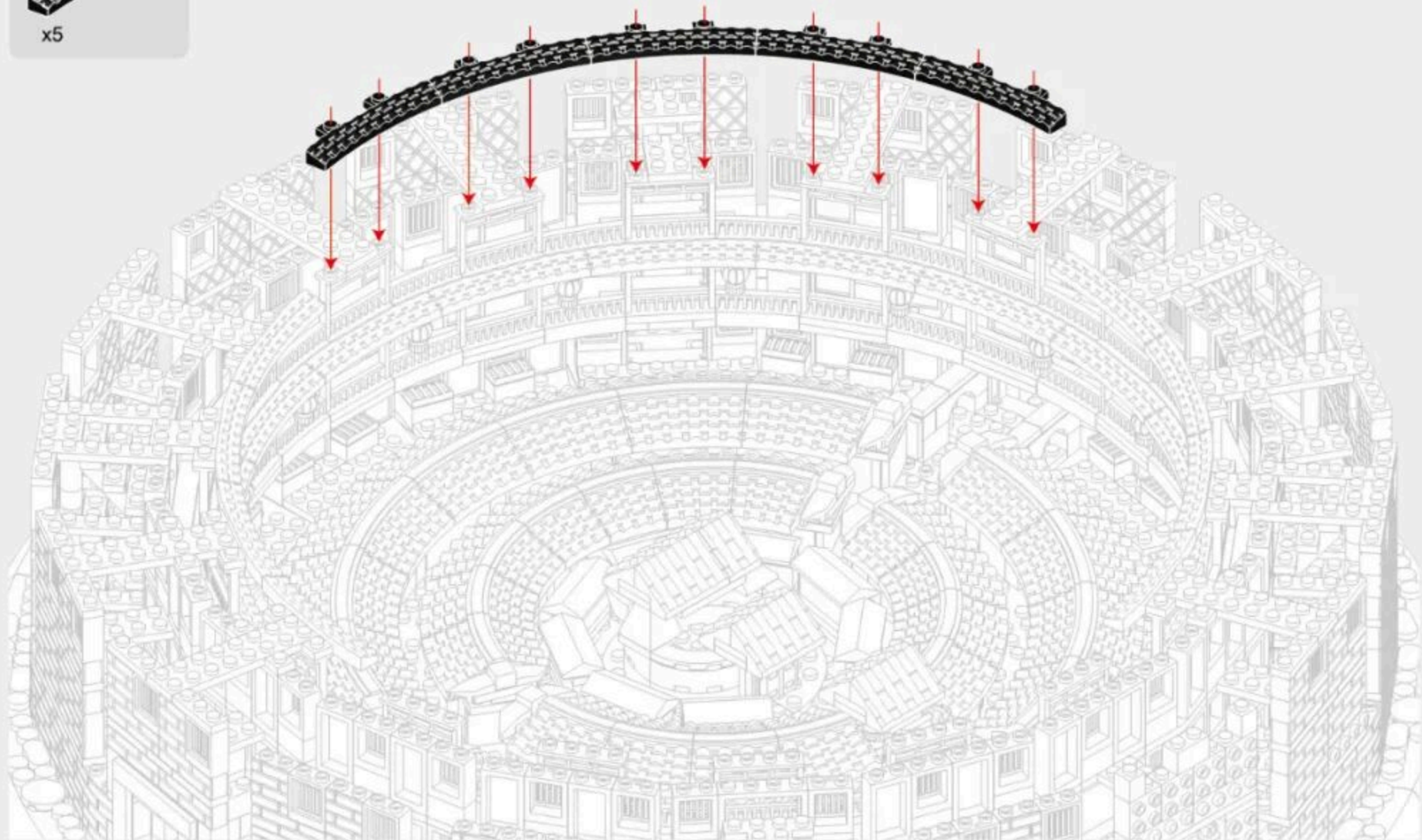

10-13

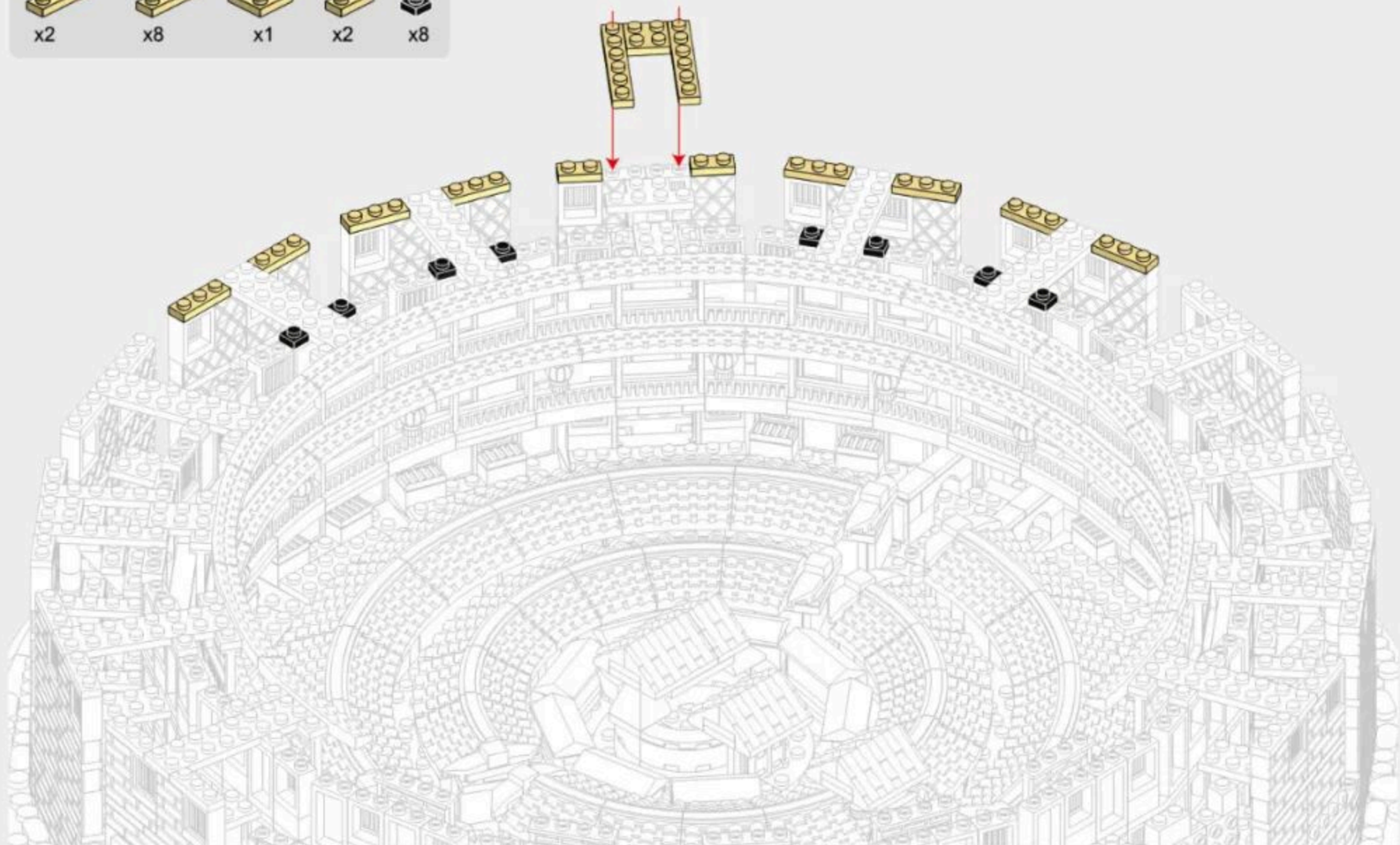
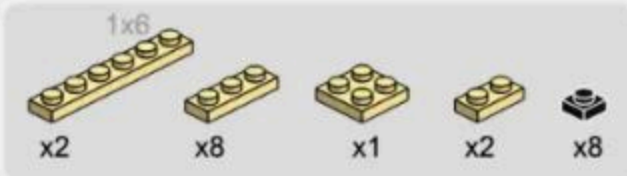

10-14

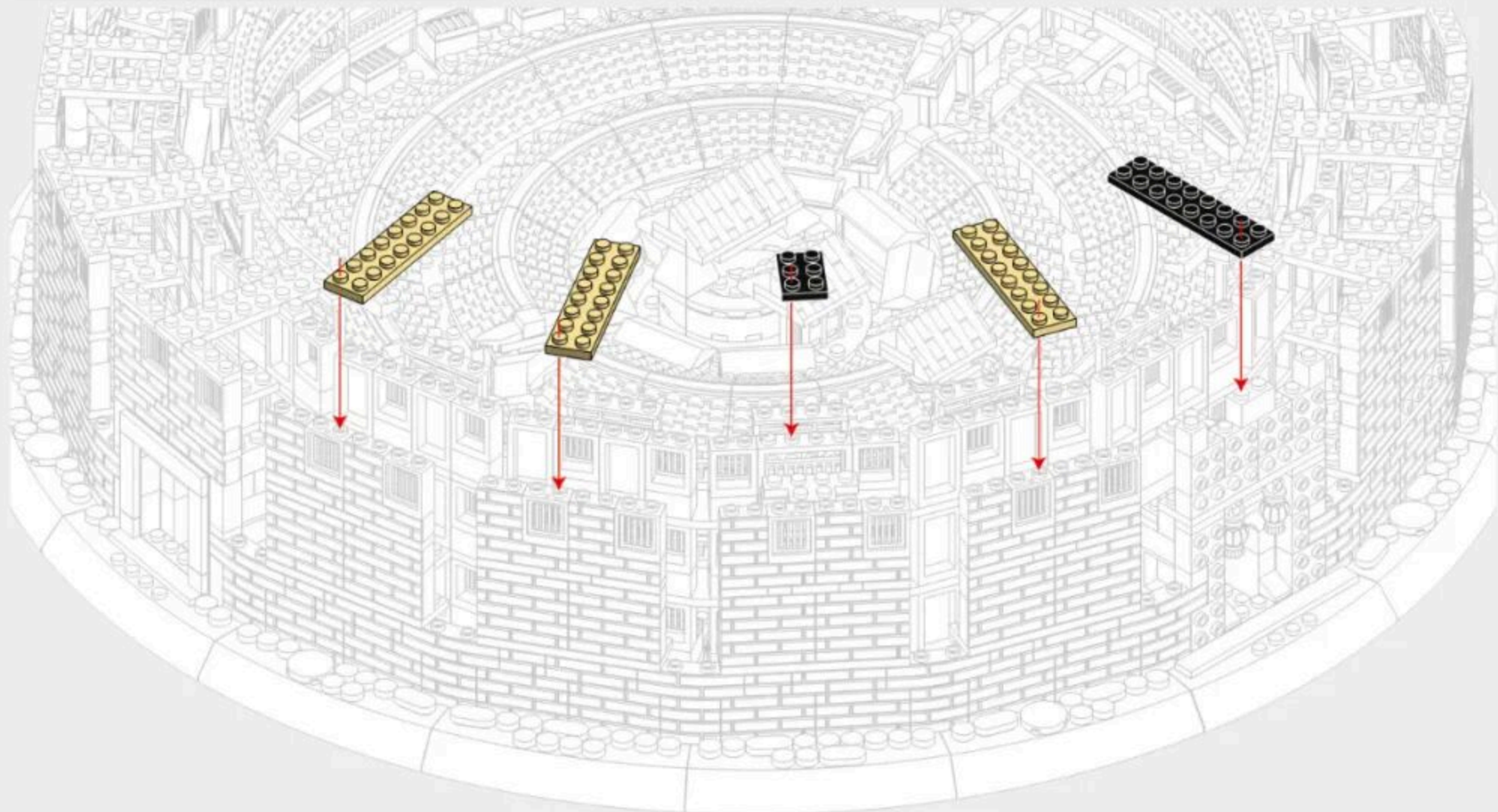

10-15

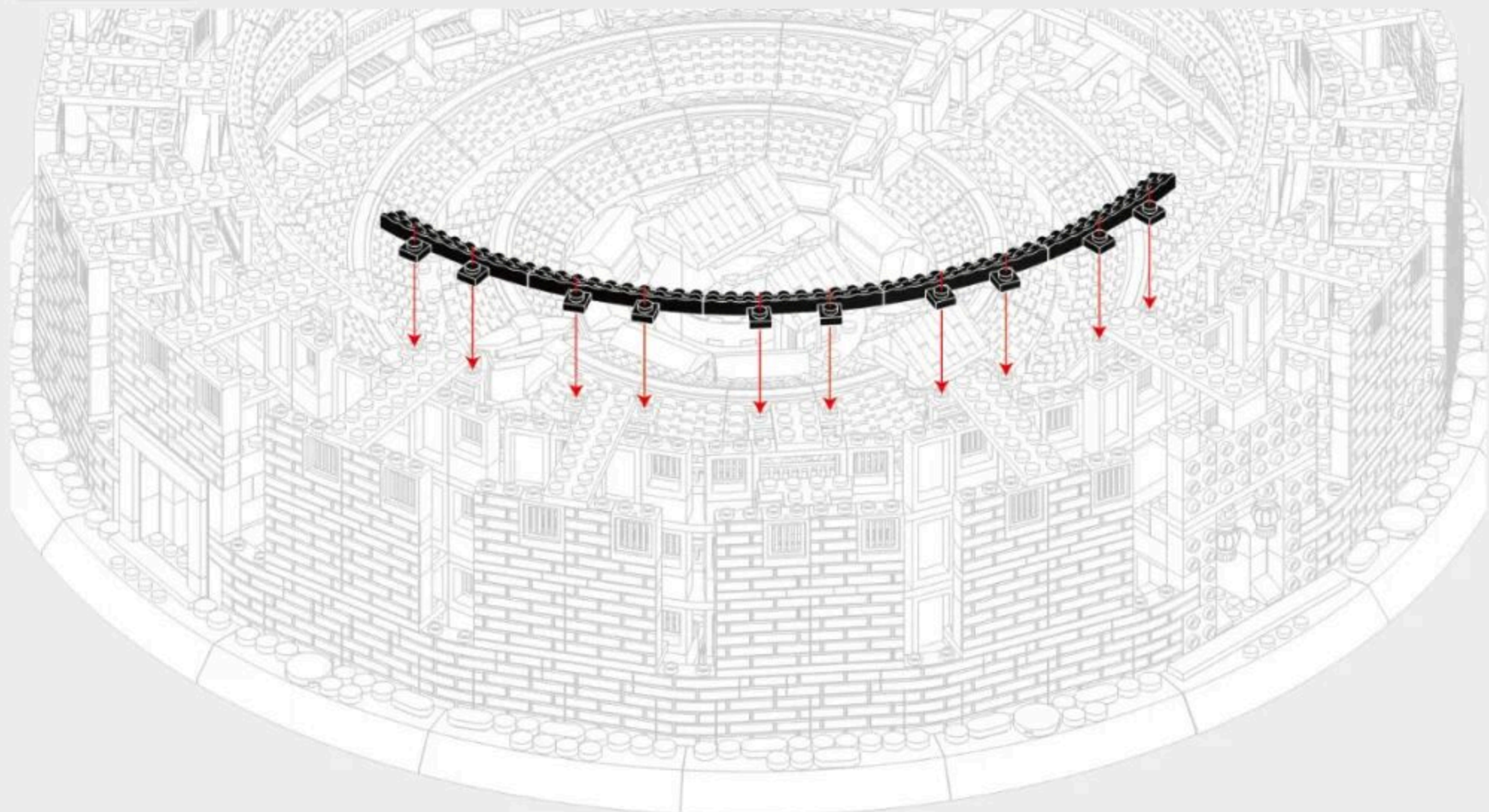

10-16

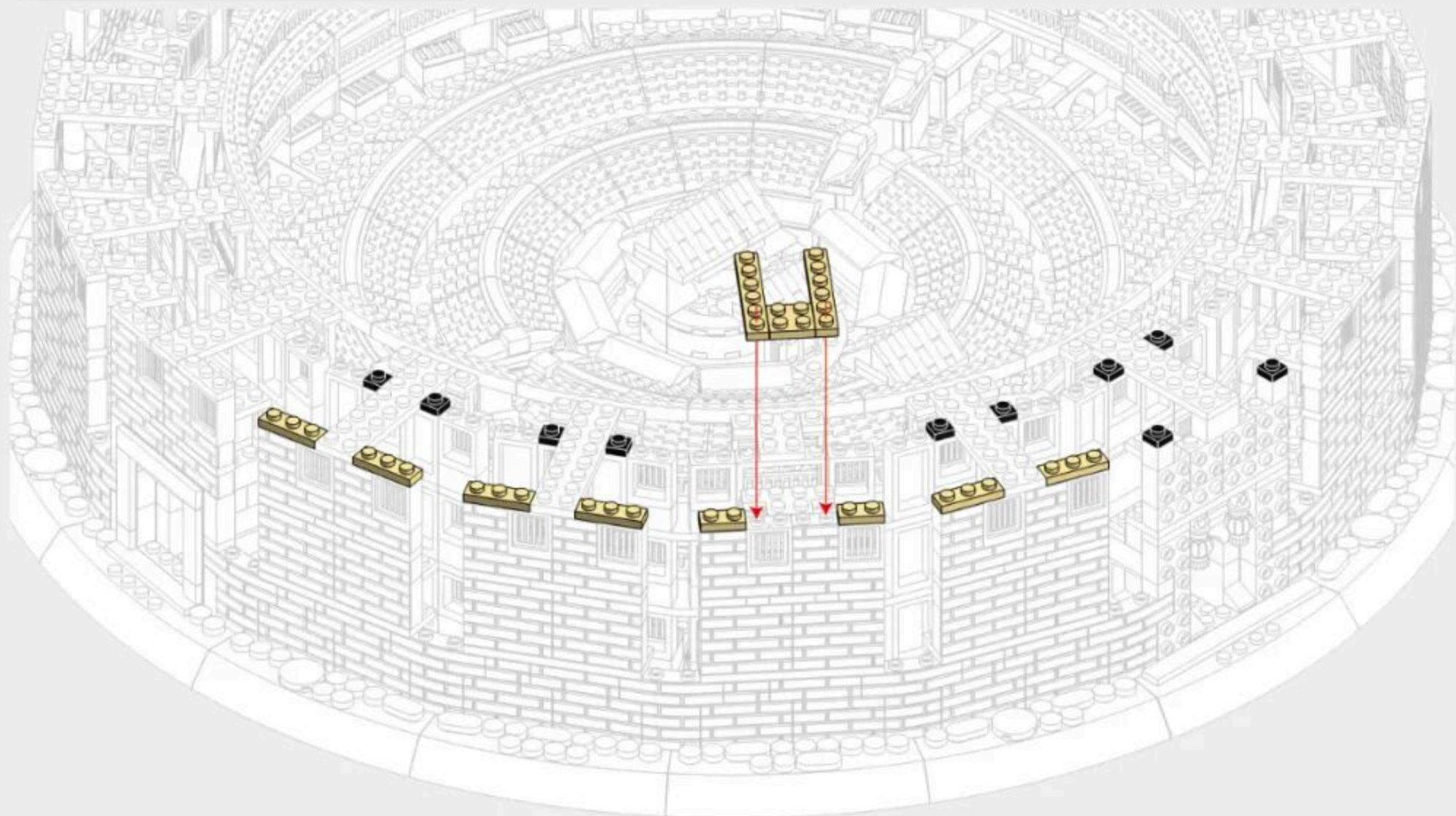
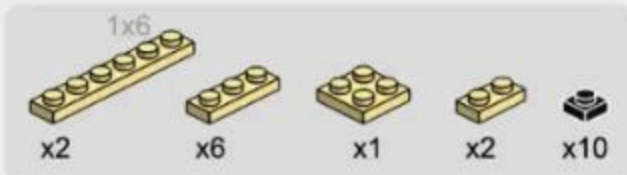

11
PACK

182PCS

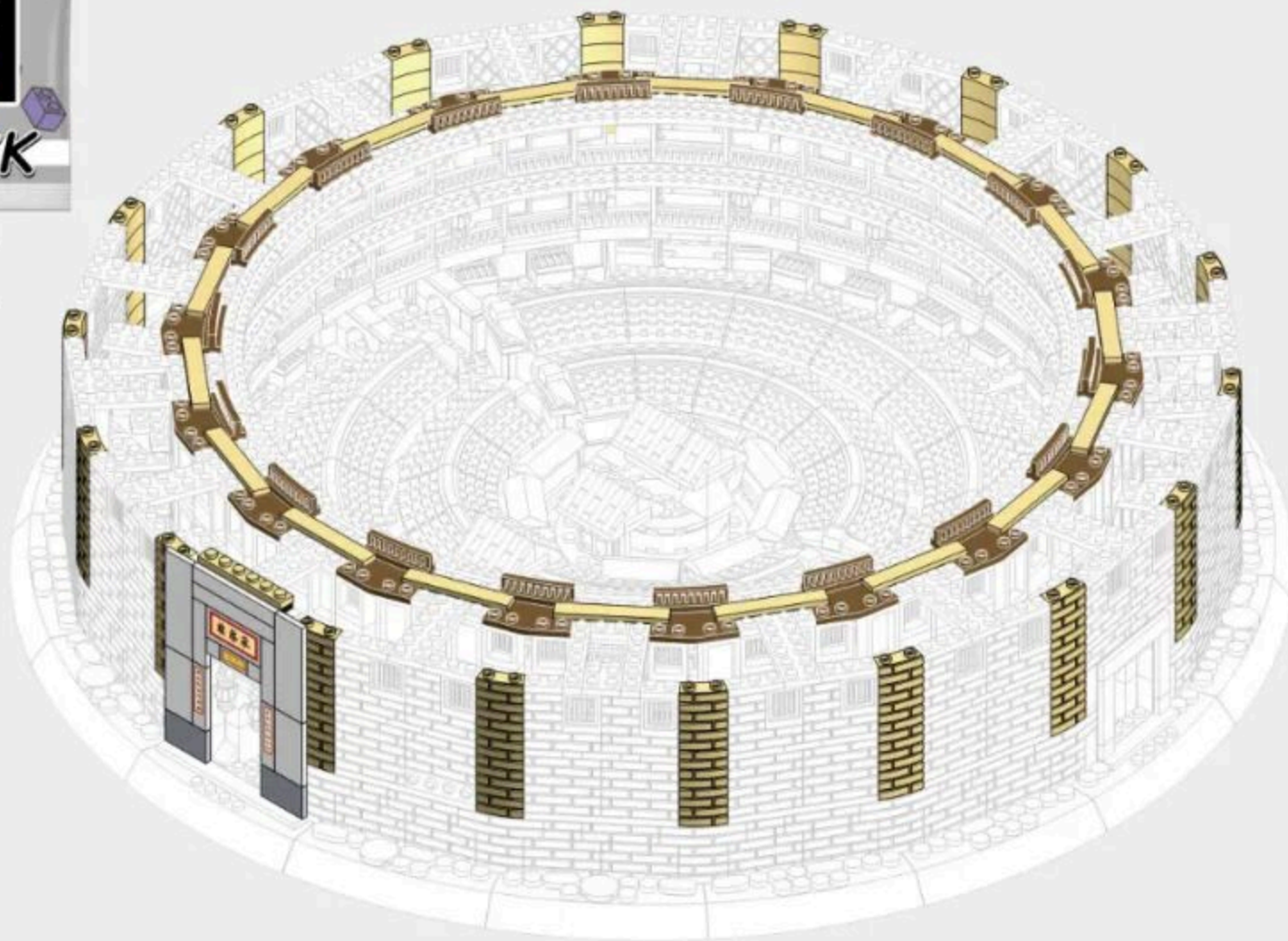

179

11-1

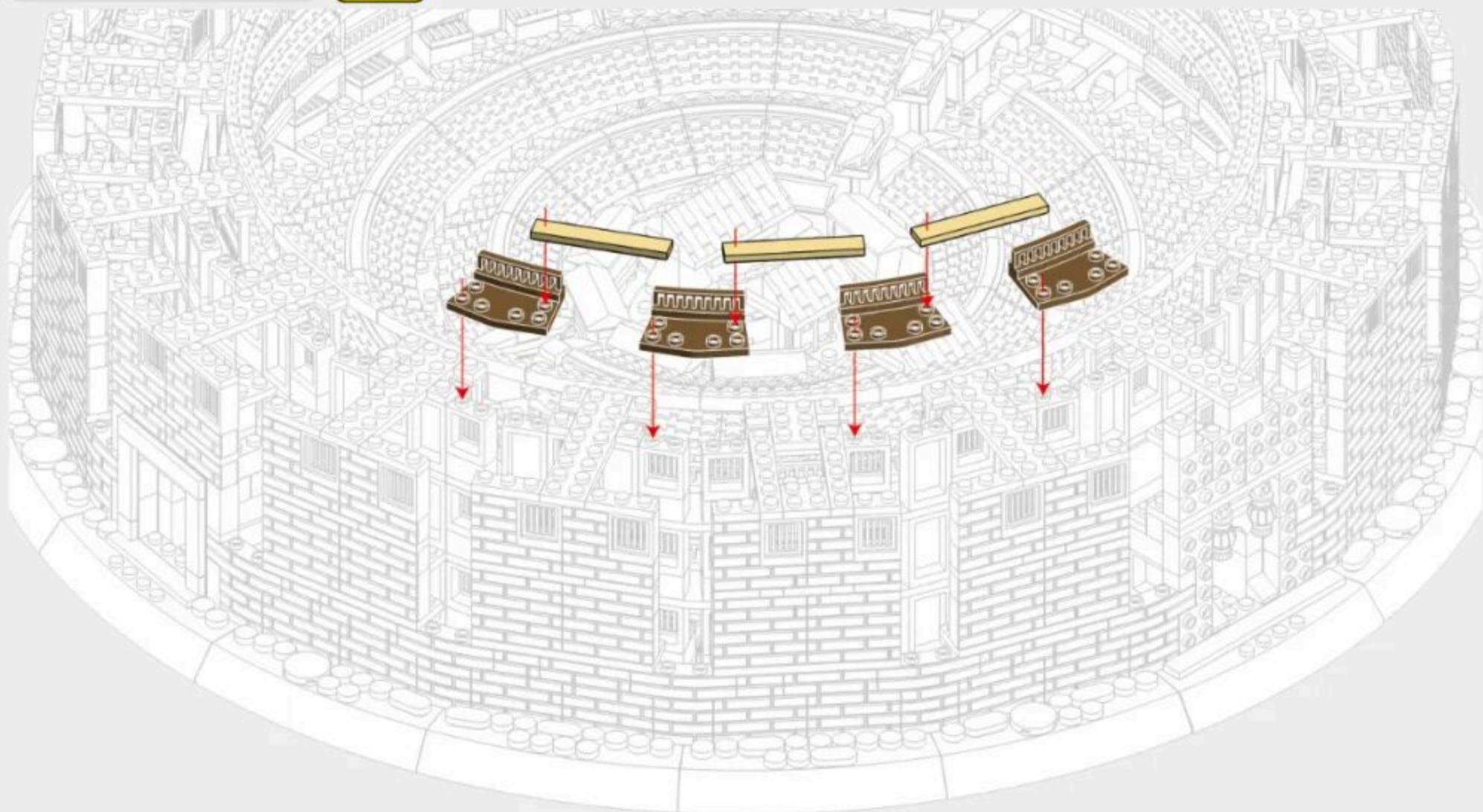
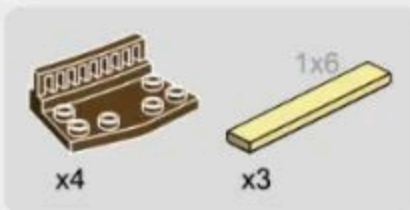

11-2



x28

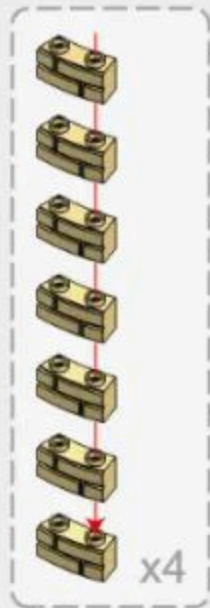

11-3

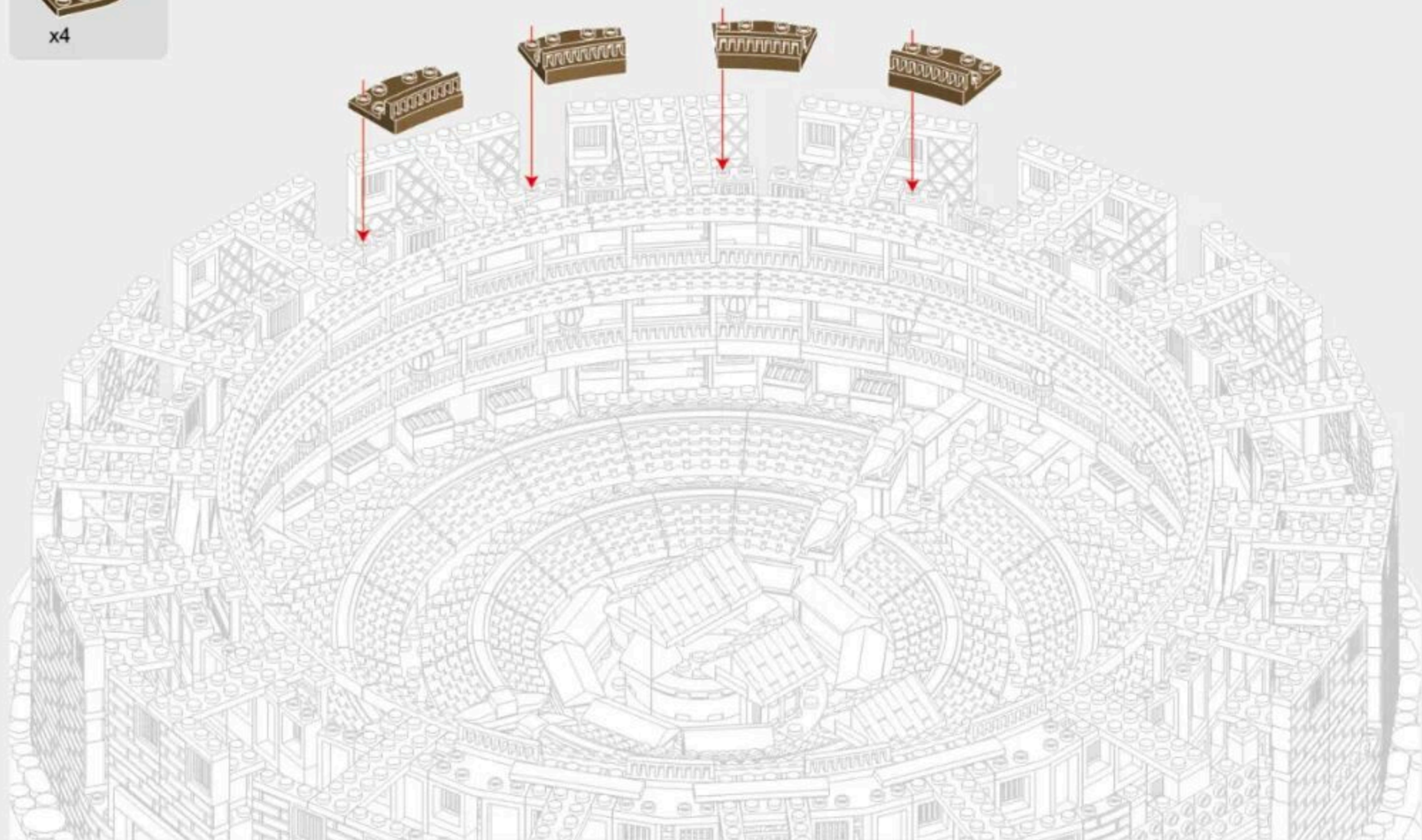

11-4

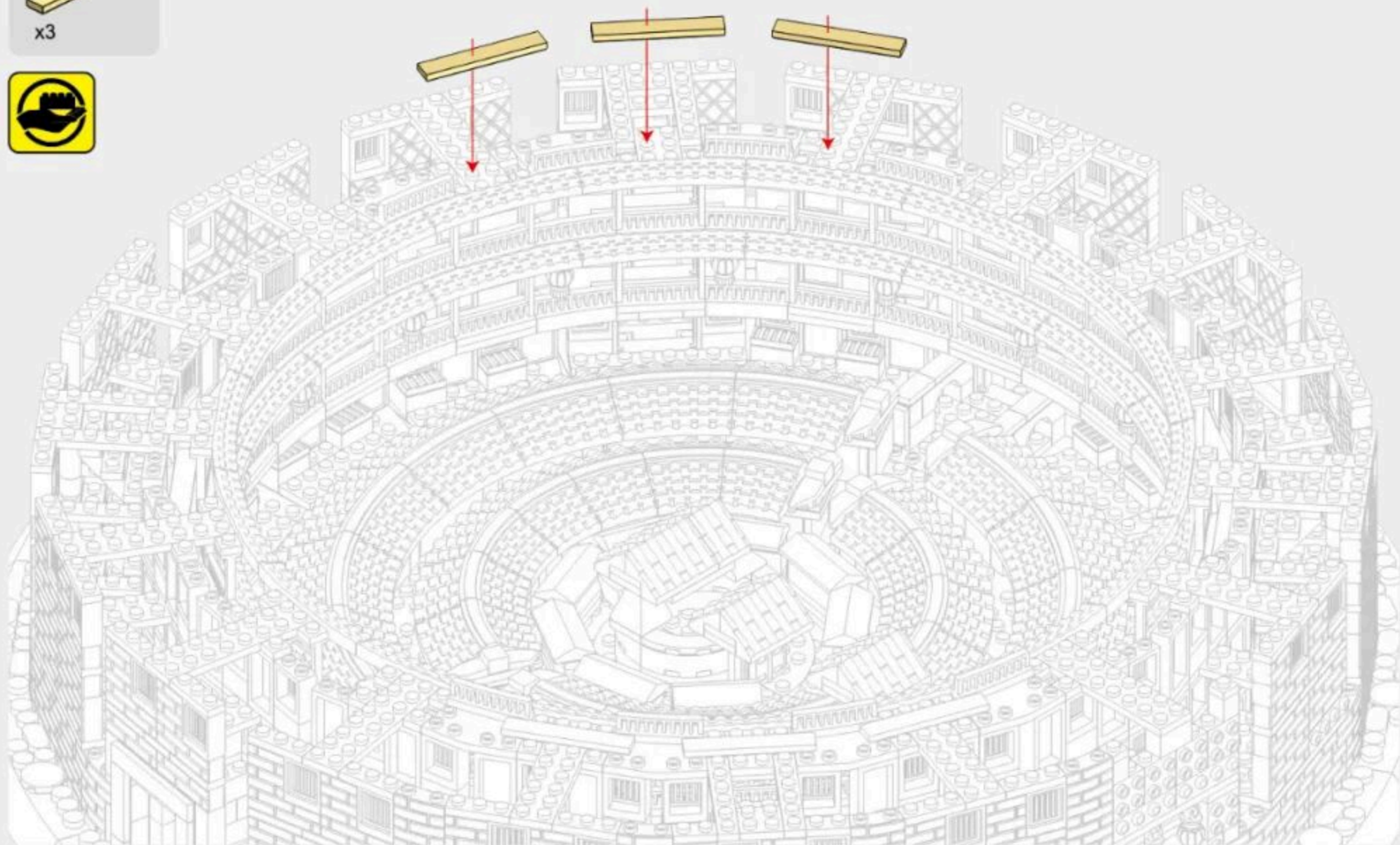

11-5



x28

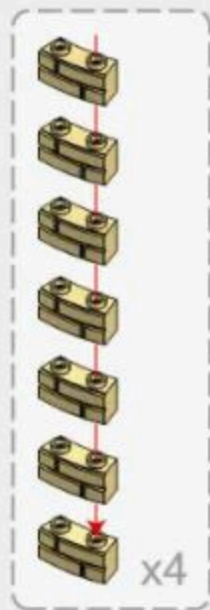
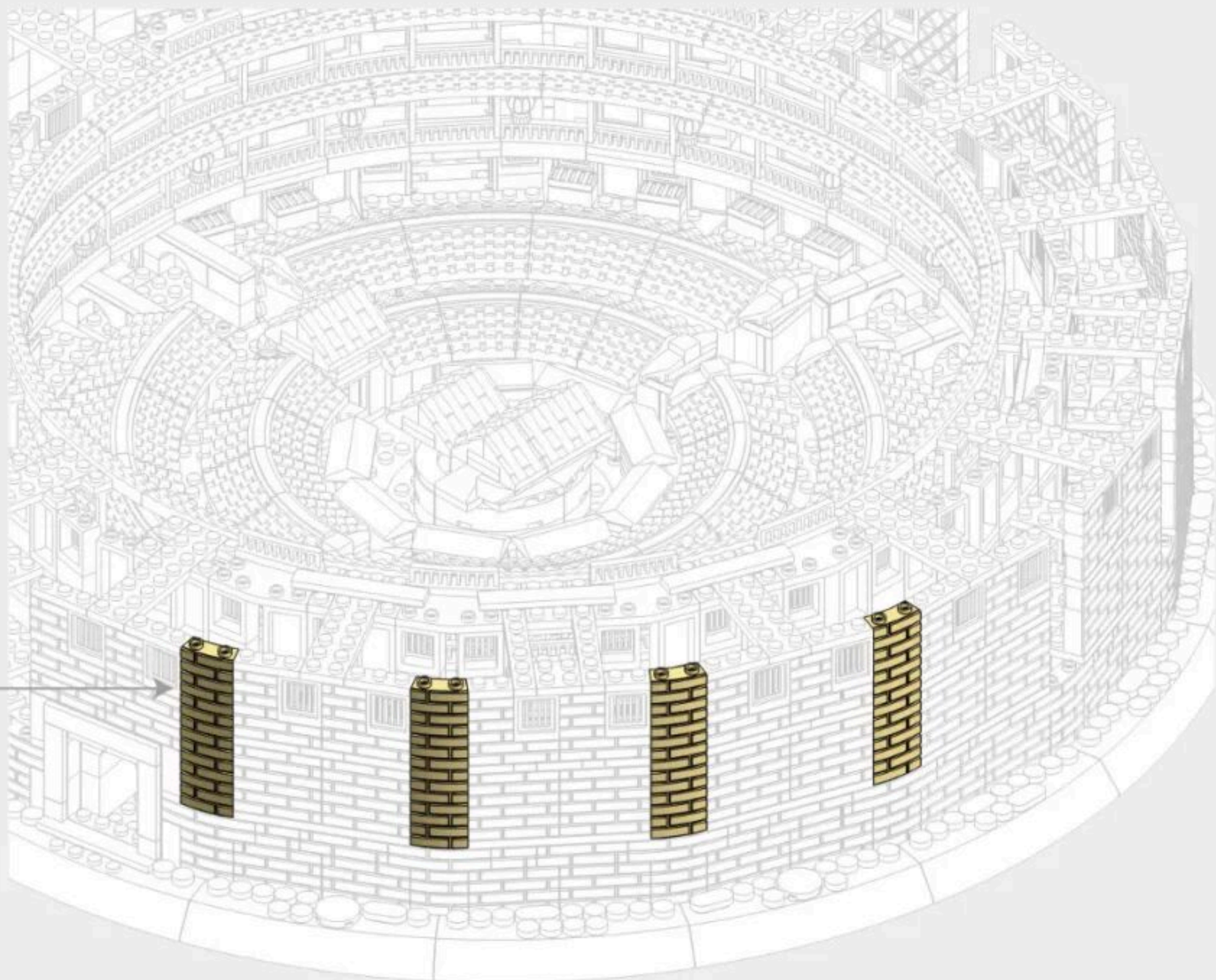

11-6

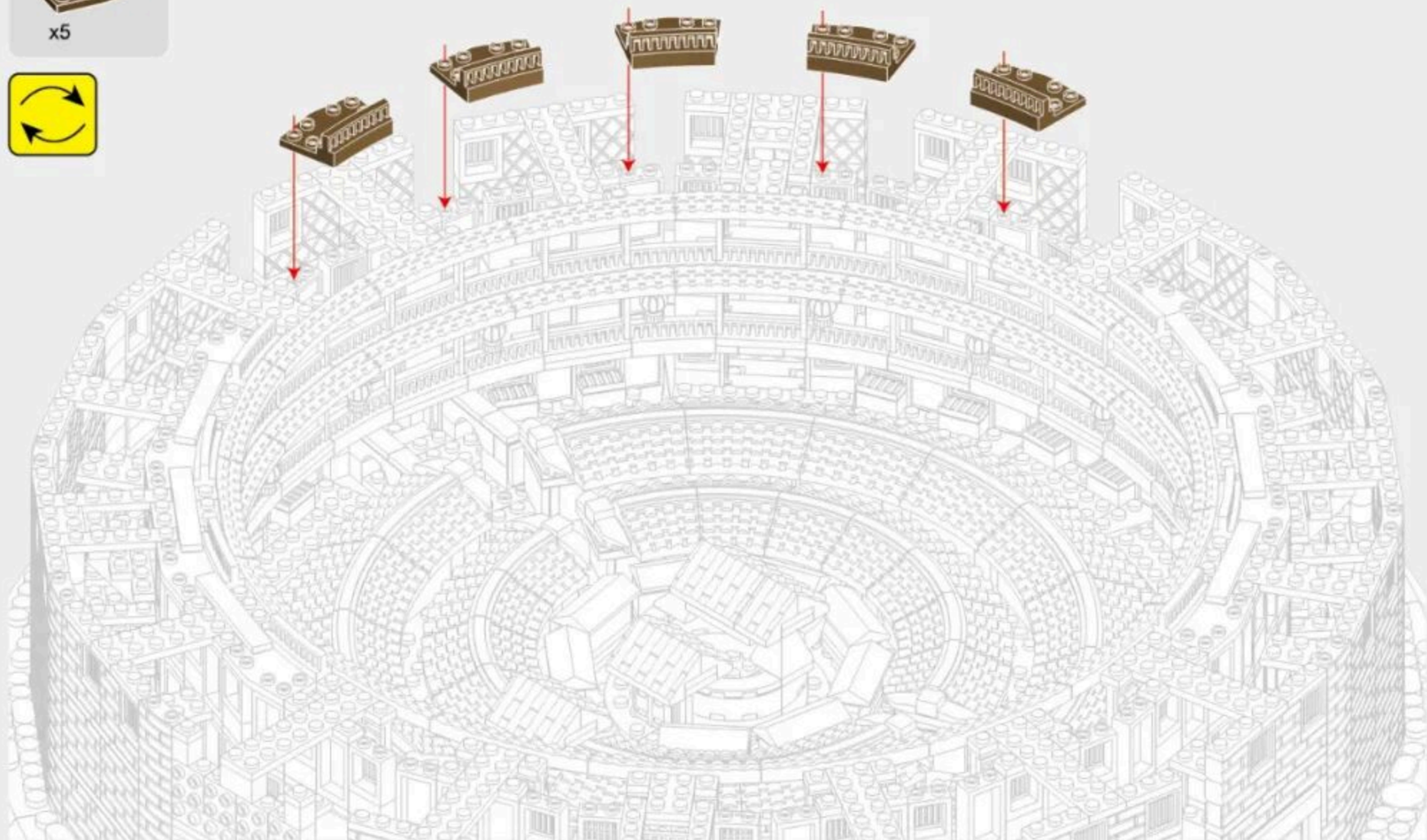

11-7

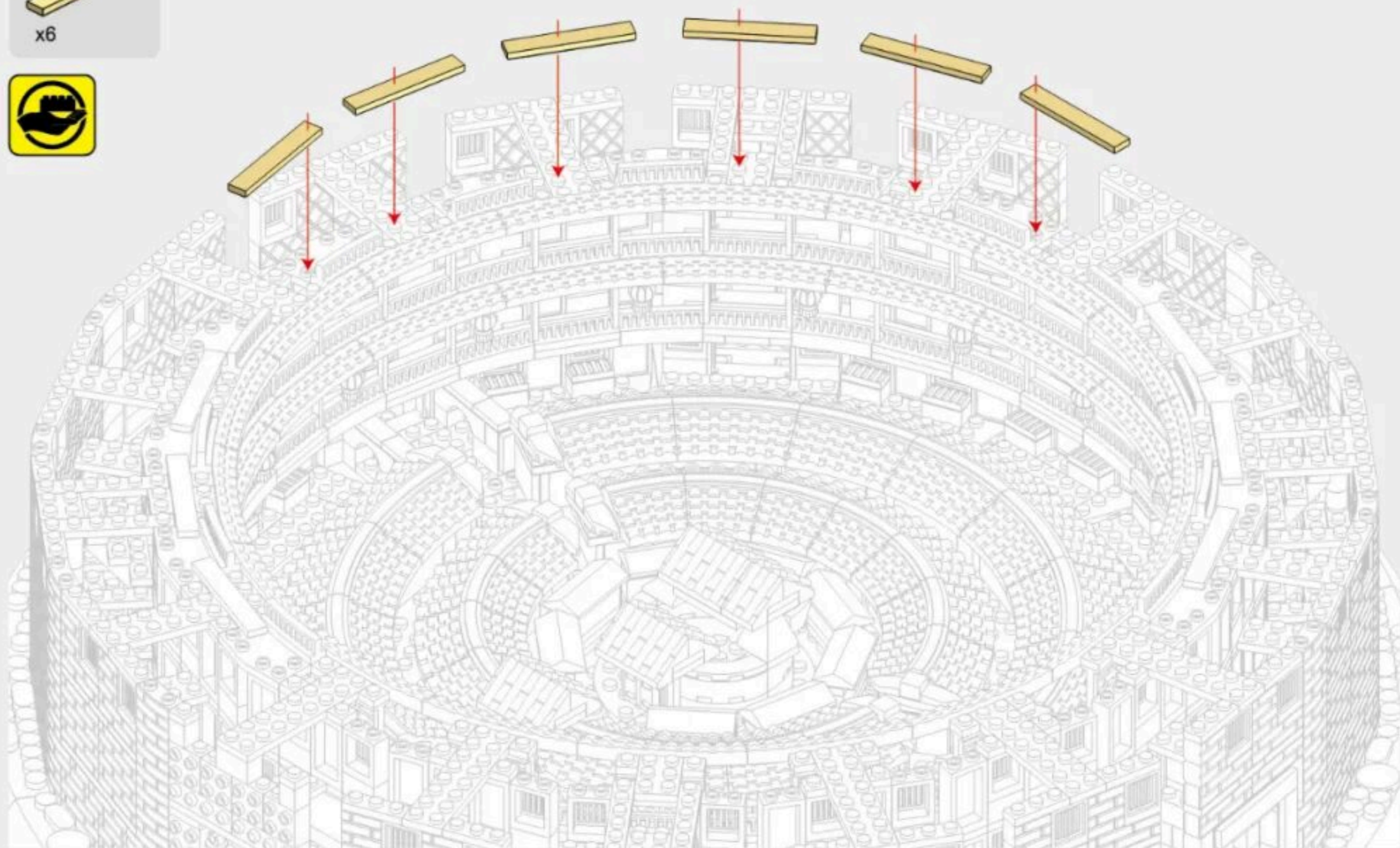
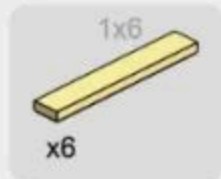

11-8



x35

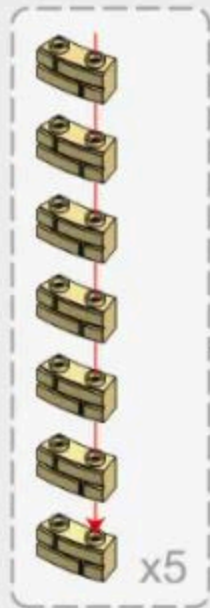
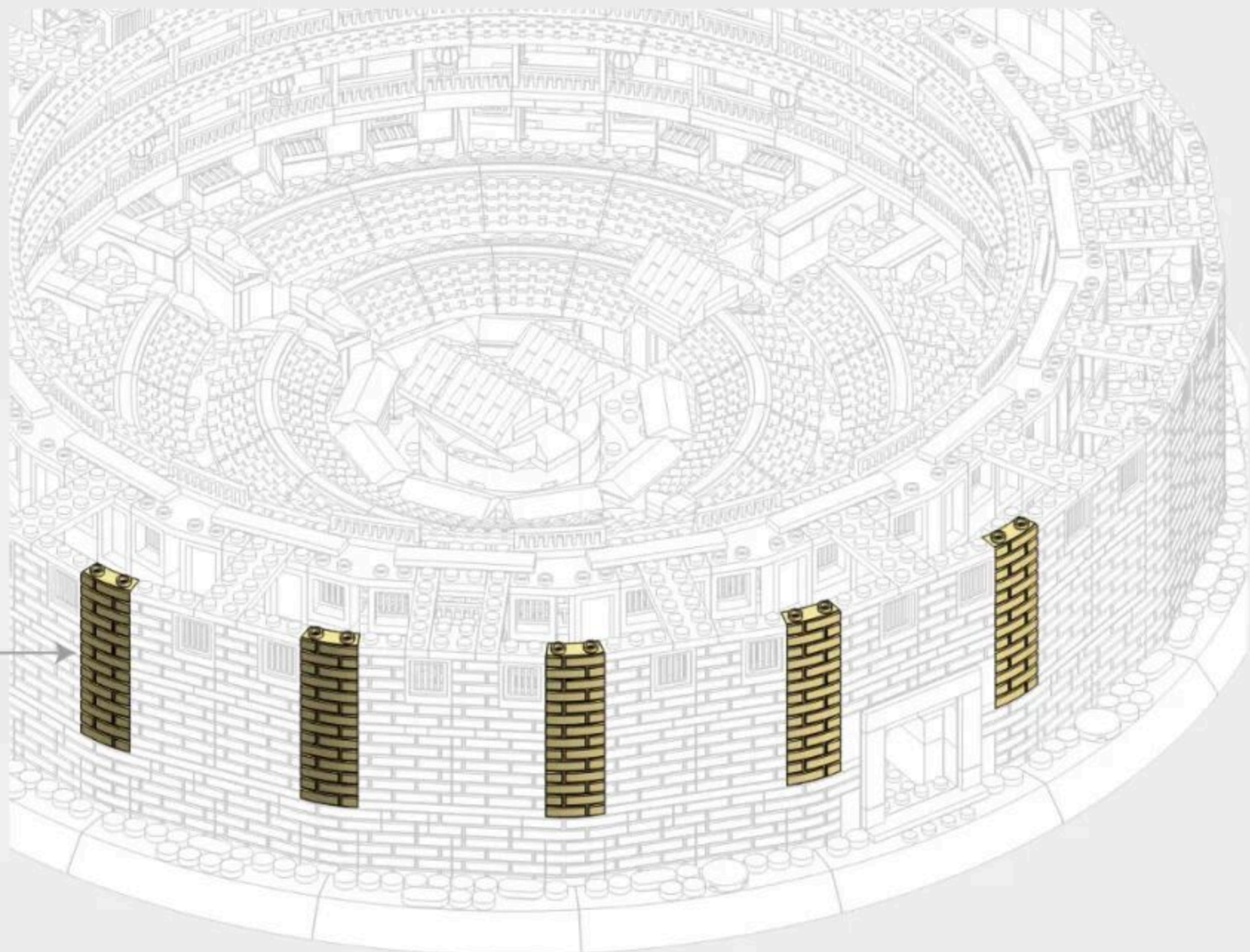

11-9

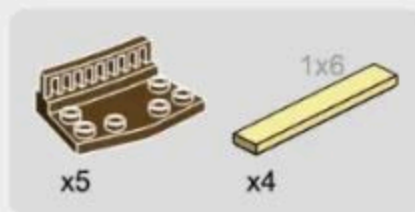

注意：此步骤仅用于搭建完整版的土楼，搭建解构版的土楼请忽略此步骤。
Tips: This step is only for constructing a complete version of the tulou.
Please ignore this step if you are constructing a deconstructed version of the tulou.

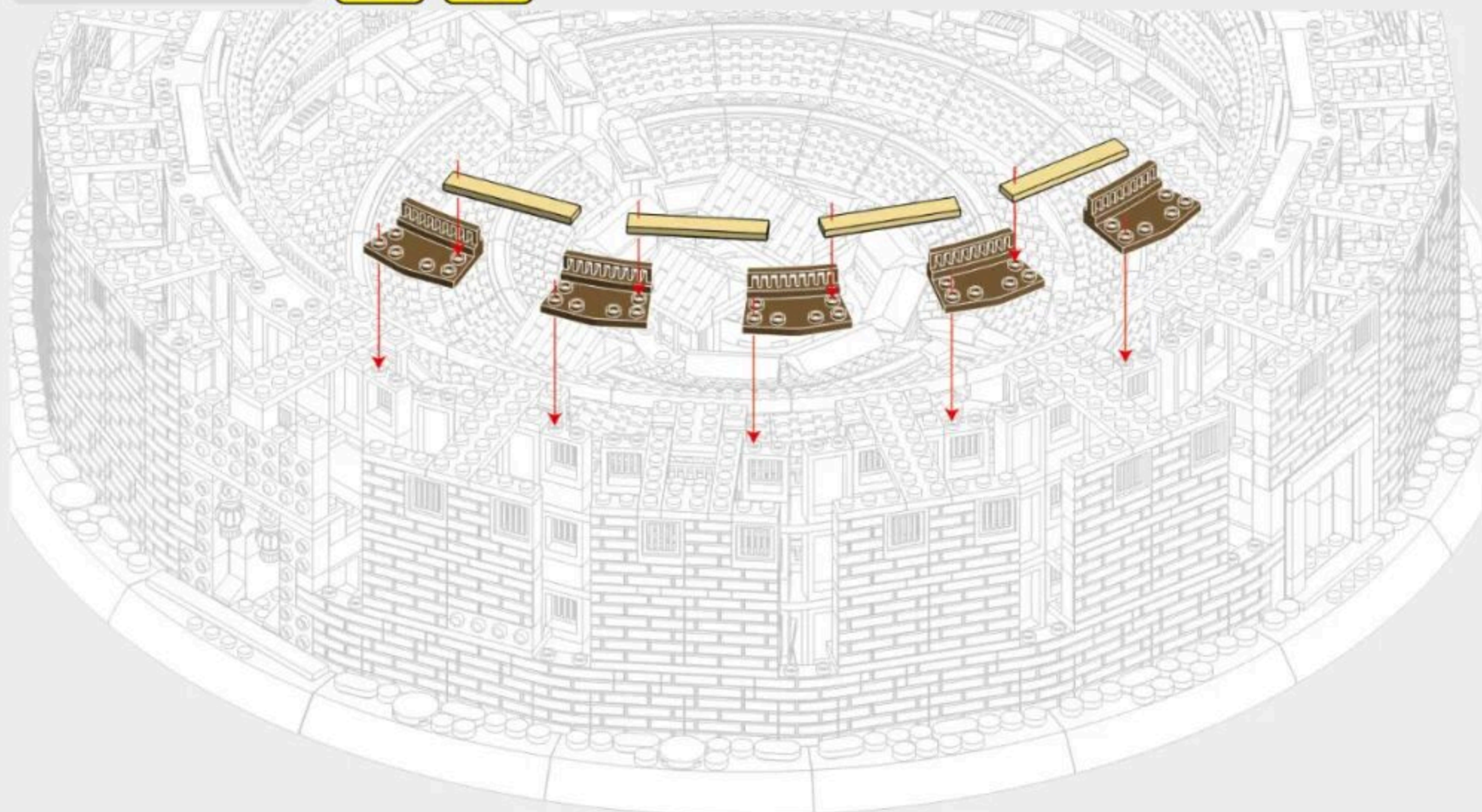

11-10



x35

注意：此步骤仅用于搭建完整版的土楼，搭建解构版的土楼请忽略此步骤。

Tips: This step is only for constructing a complete version of the tulou.

Please ignore this step if you are constructing a deconstructed version of the tulou.

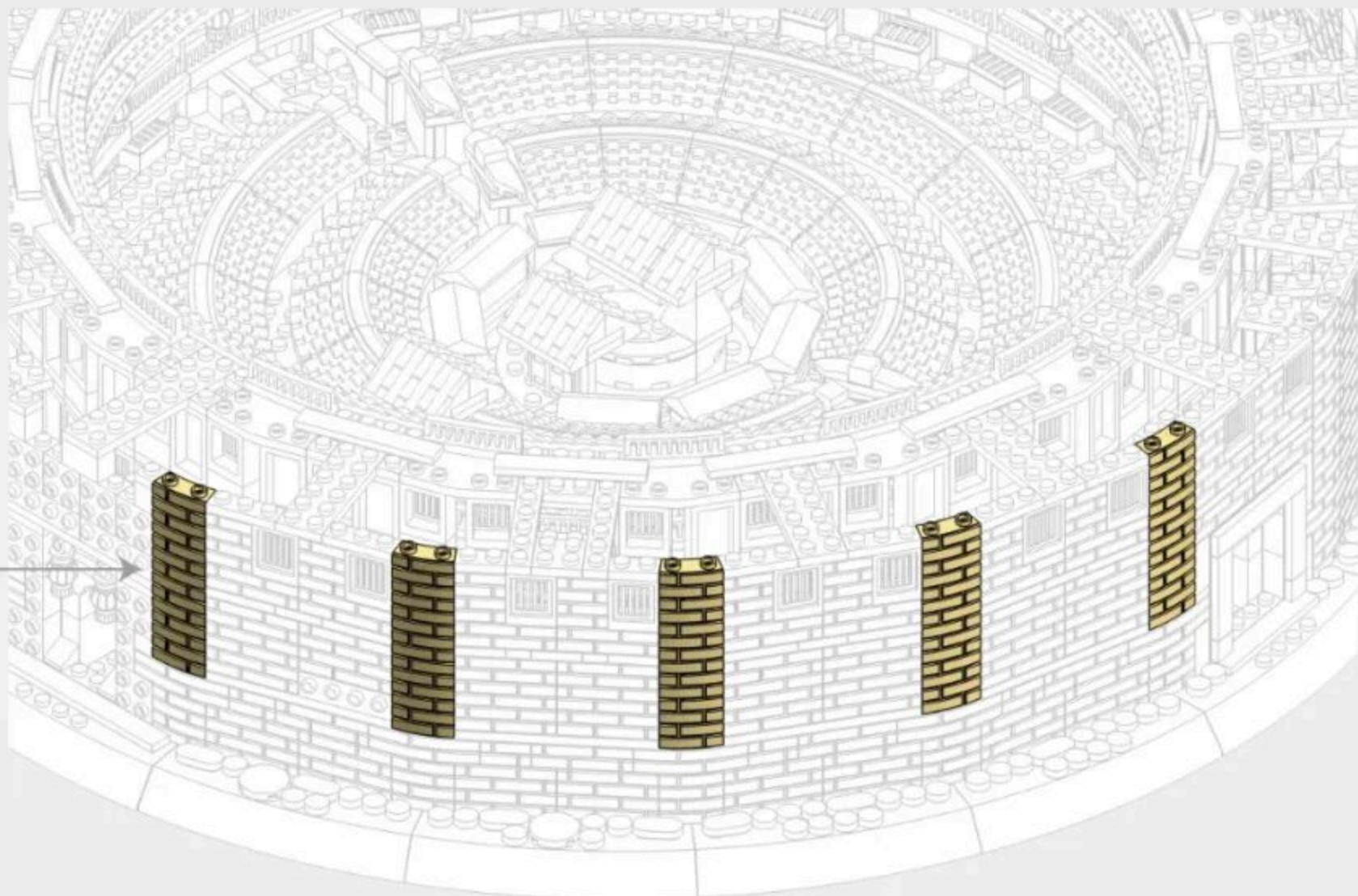
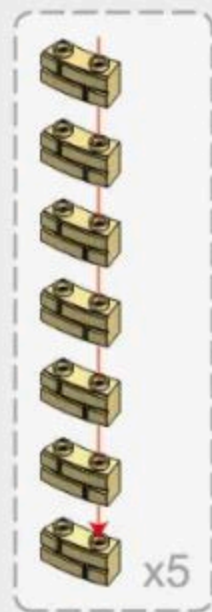

11-11

- 1x6 (yellow) x1
- 2x4 (black) x2
- 2x4 (white) x2
- 1x4 (red) x1
- 1x4 (red) x1
- 2x3 (grey) x2
- 1x1 (black) x1

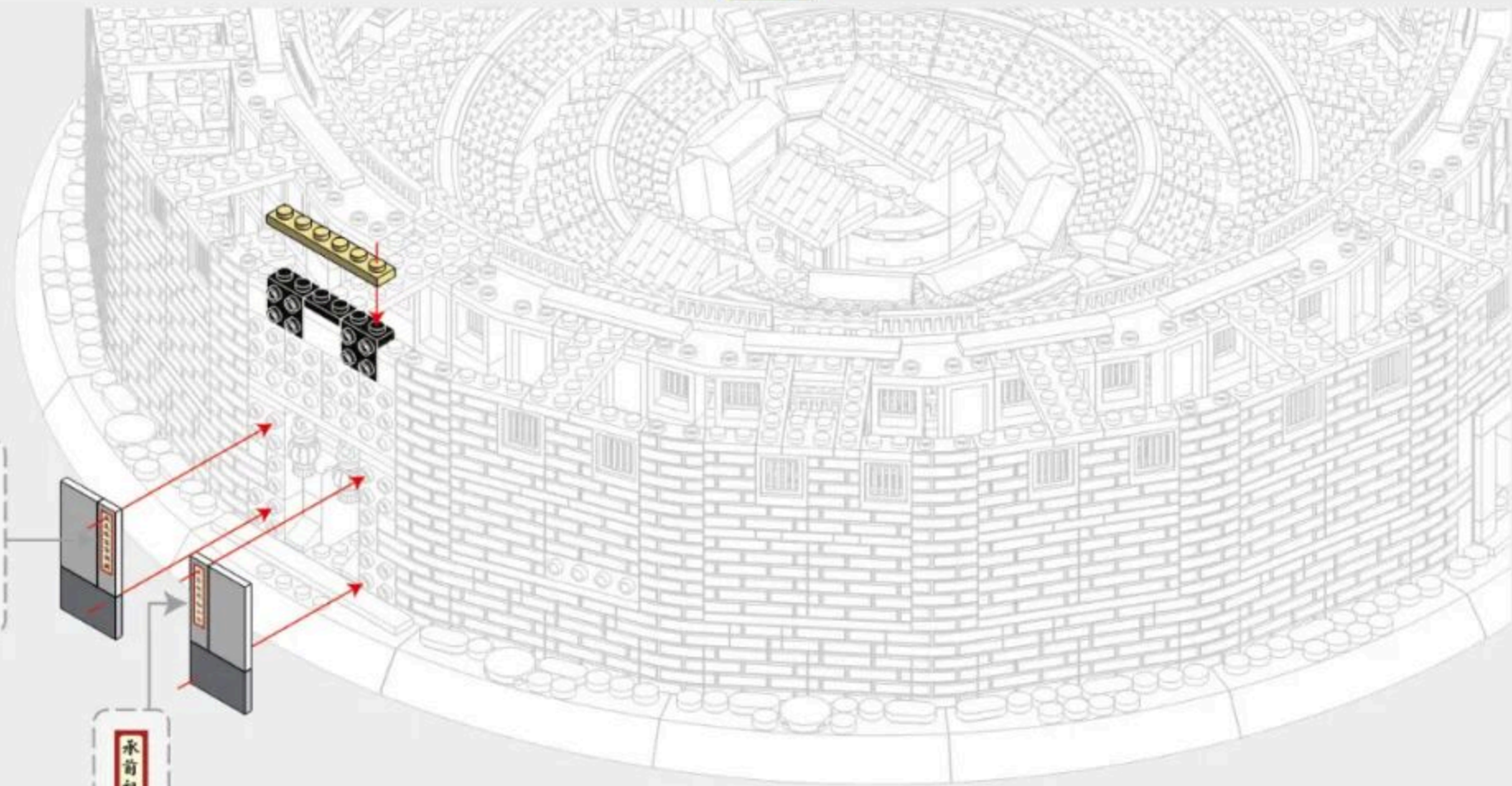

啟後孫謀濟興耕

承前祖德勤和信

11-12

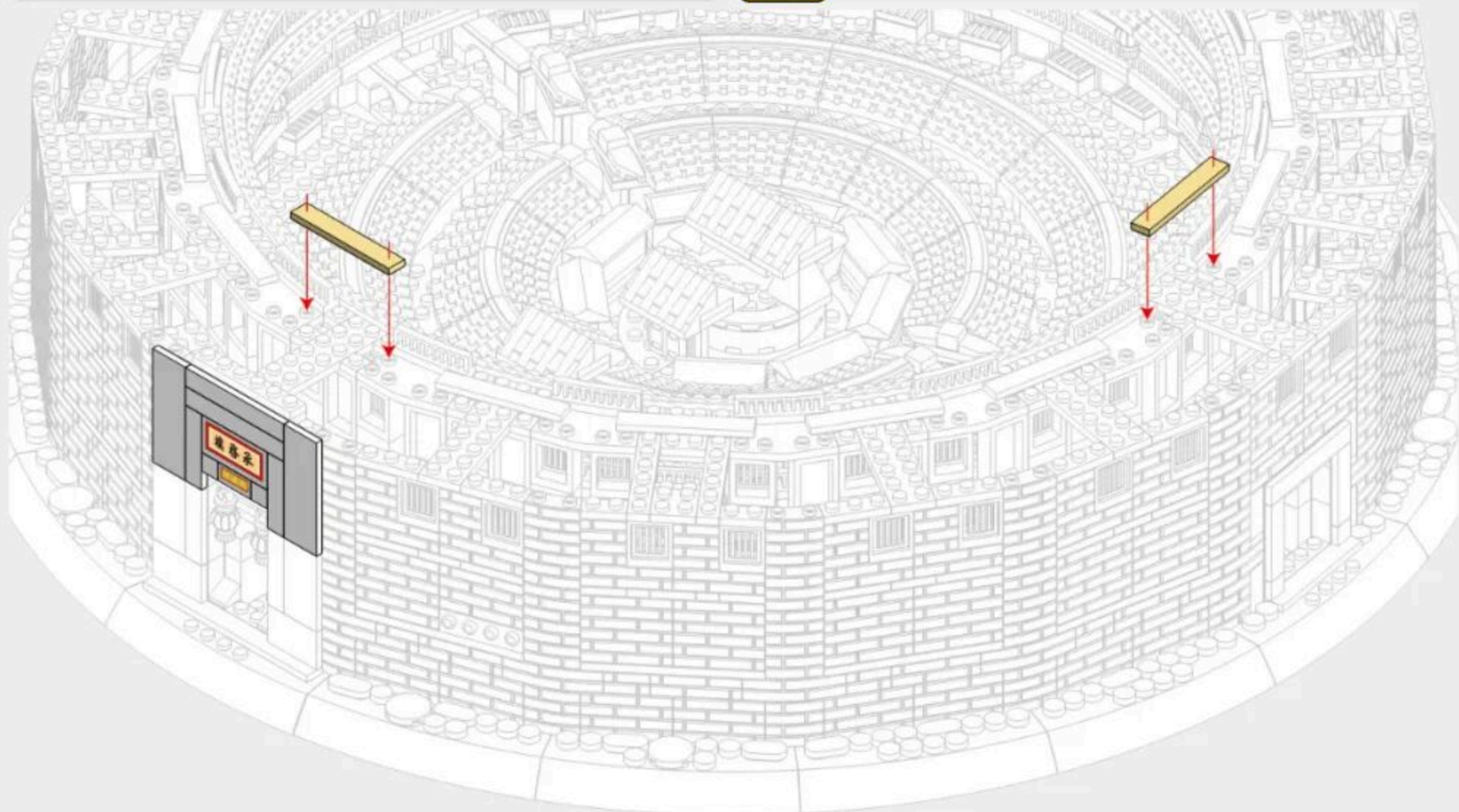
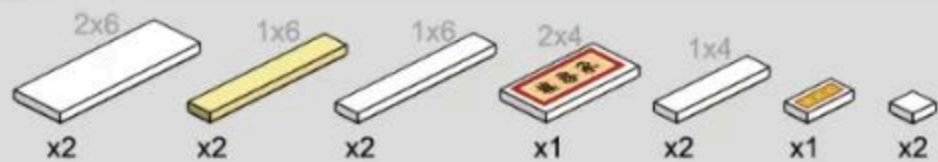

12
PACK

288PCS

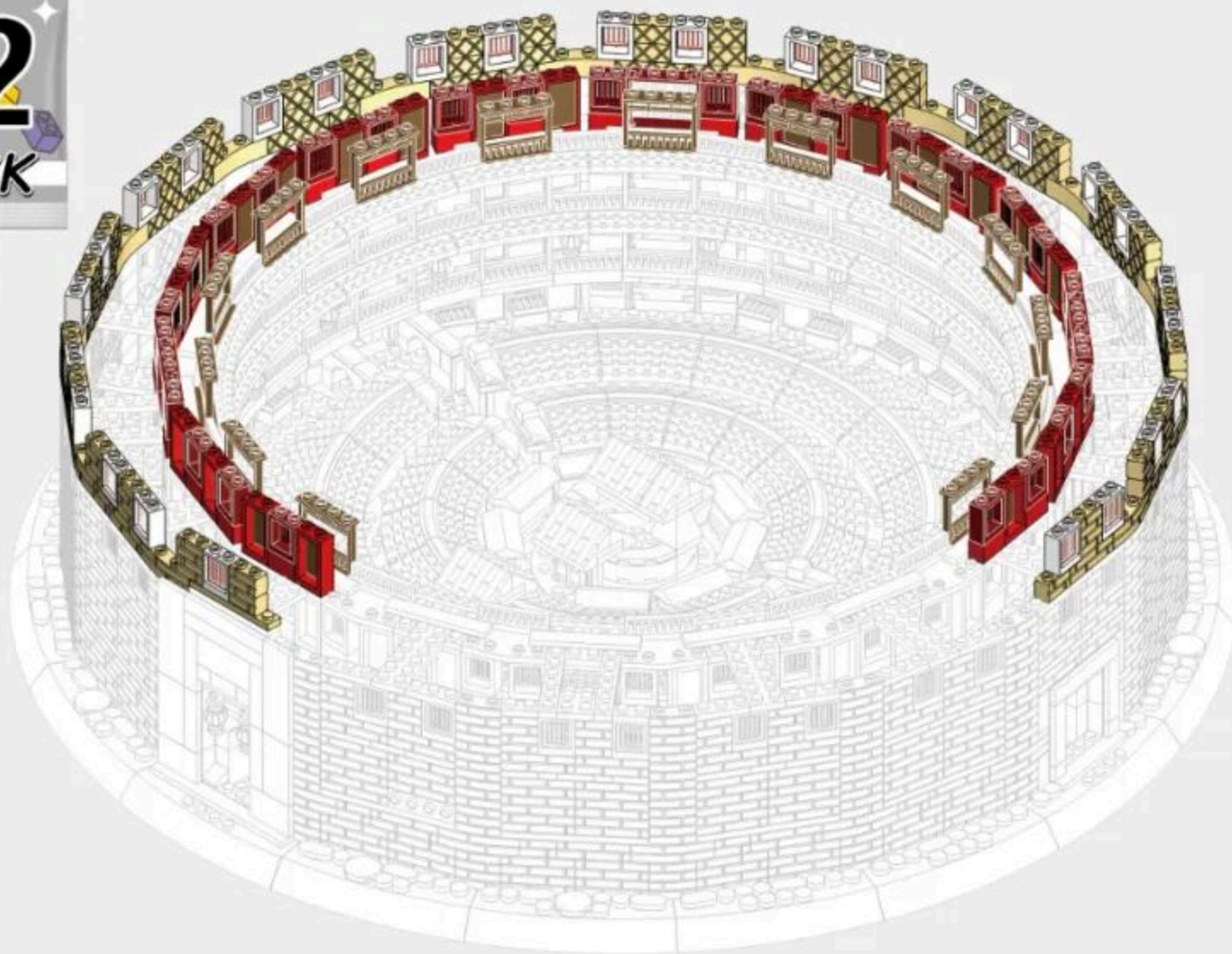

192

12-1

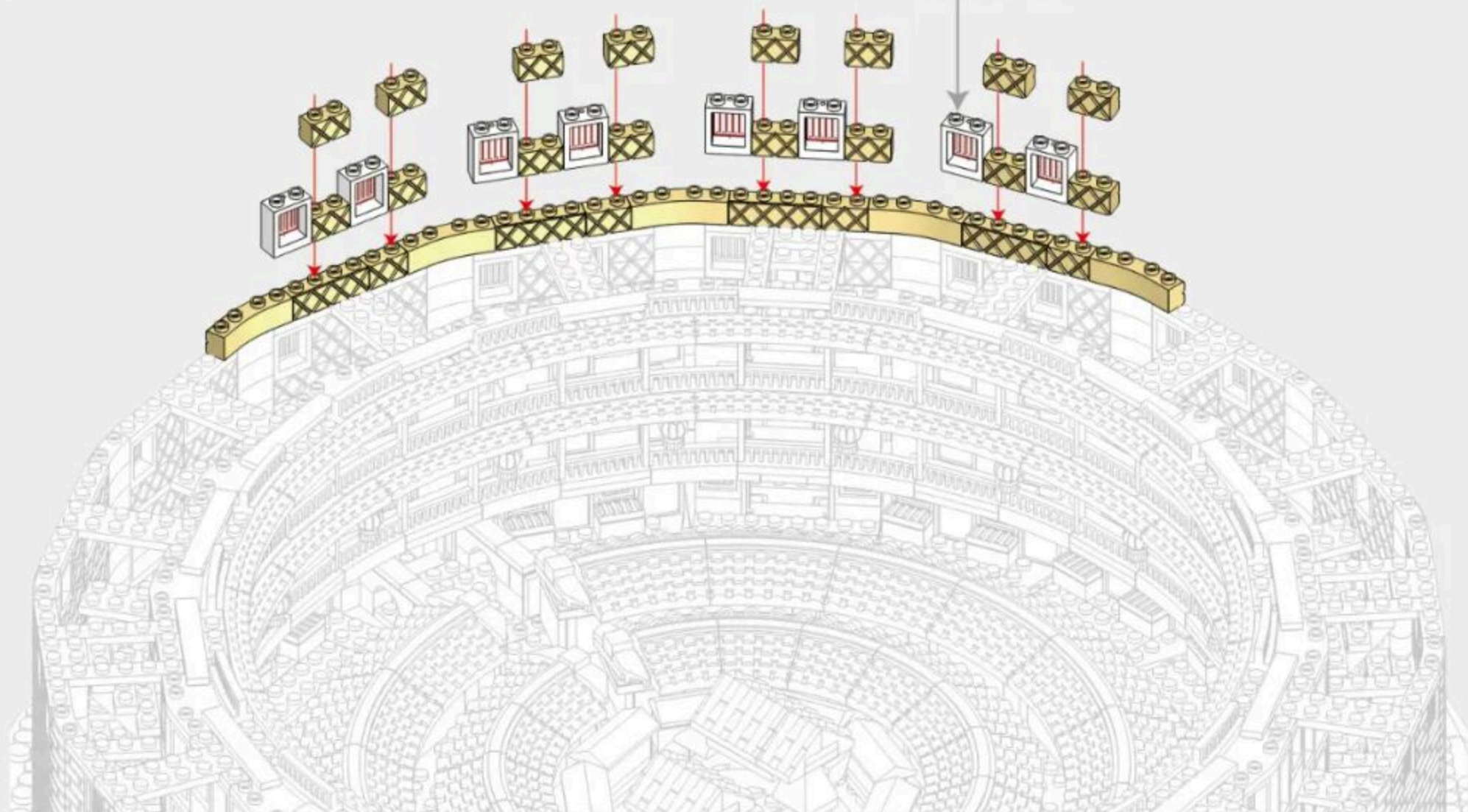
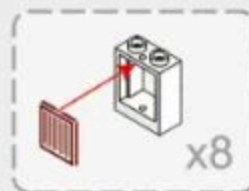

12-2

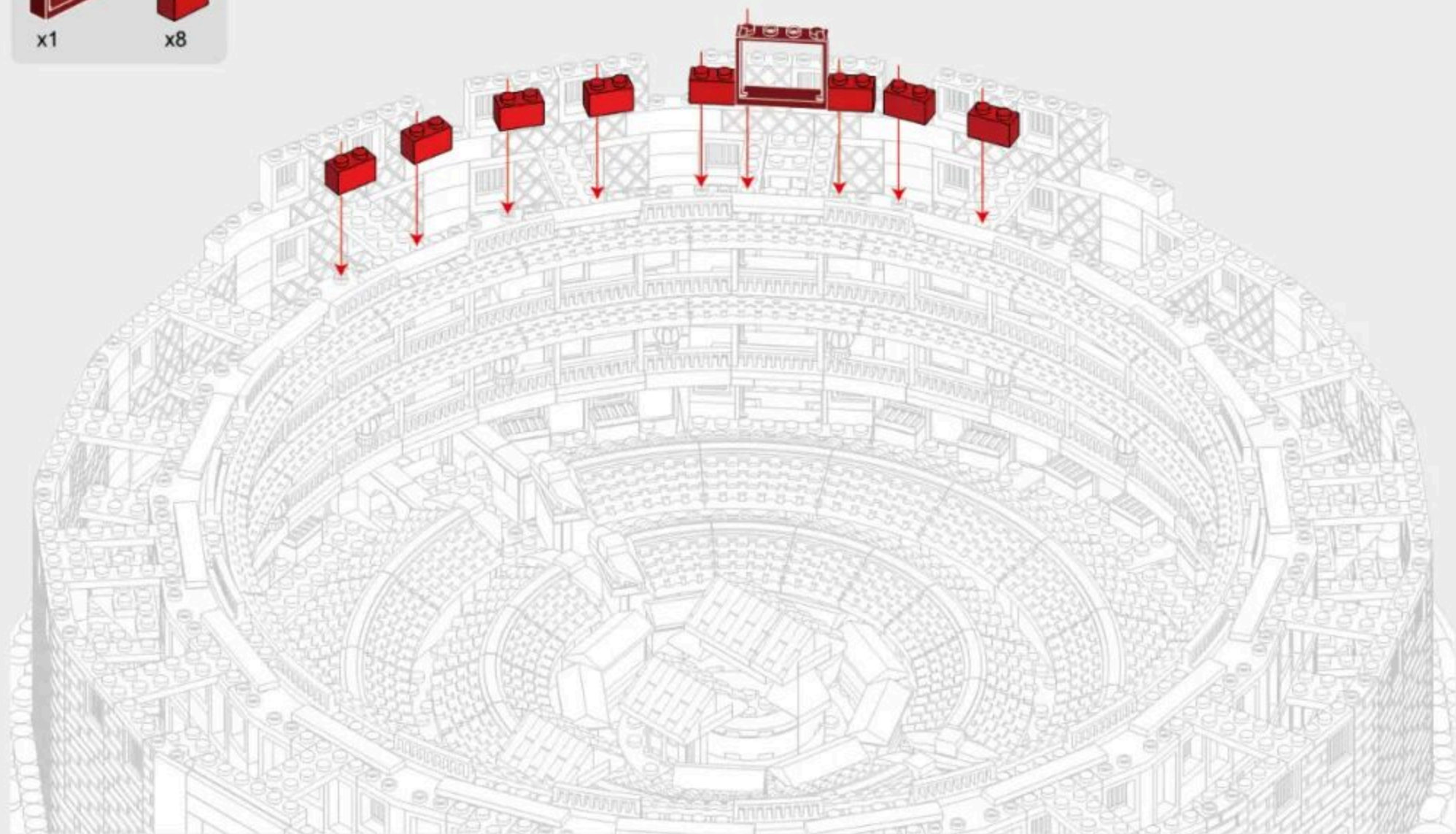
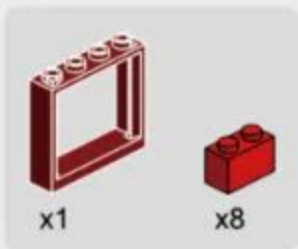

12-3

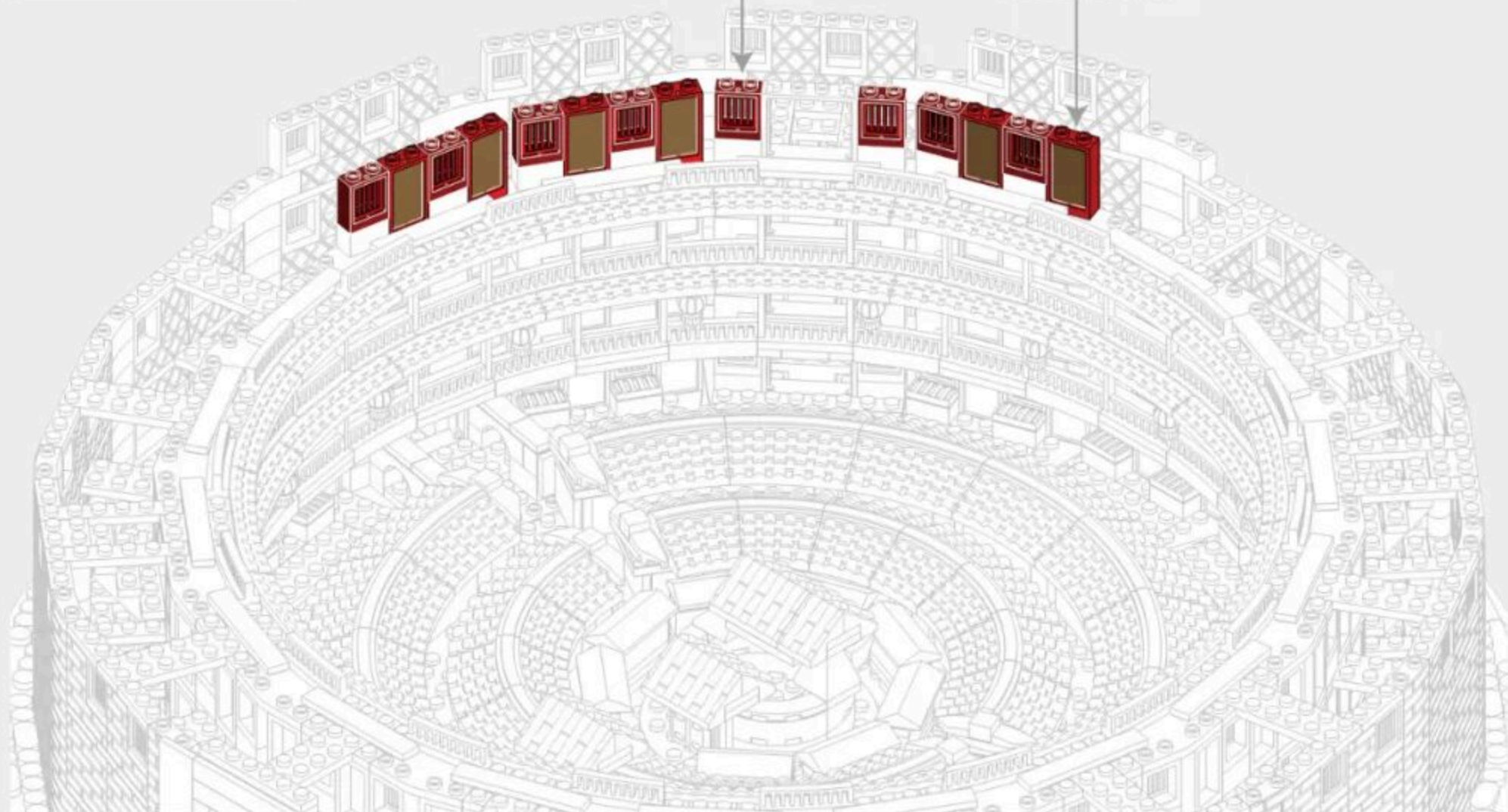
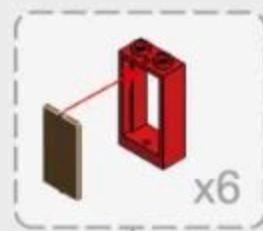

12-4



x4

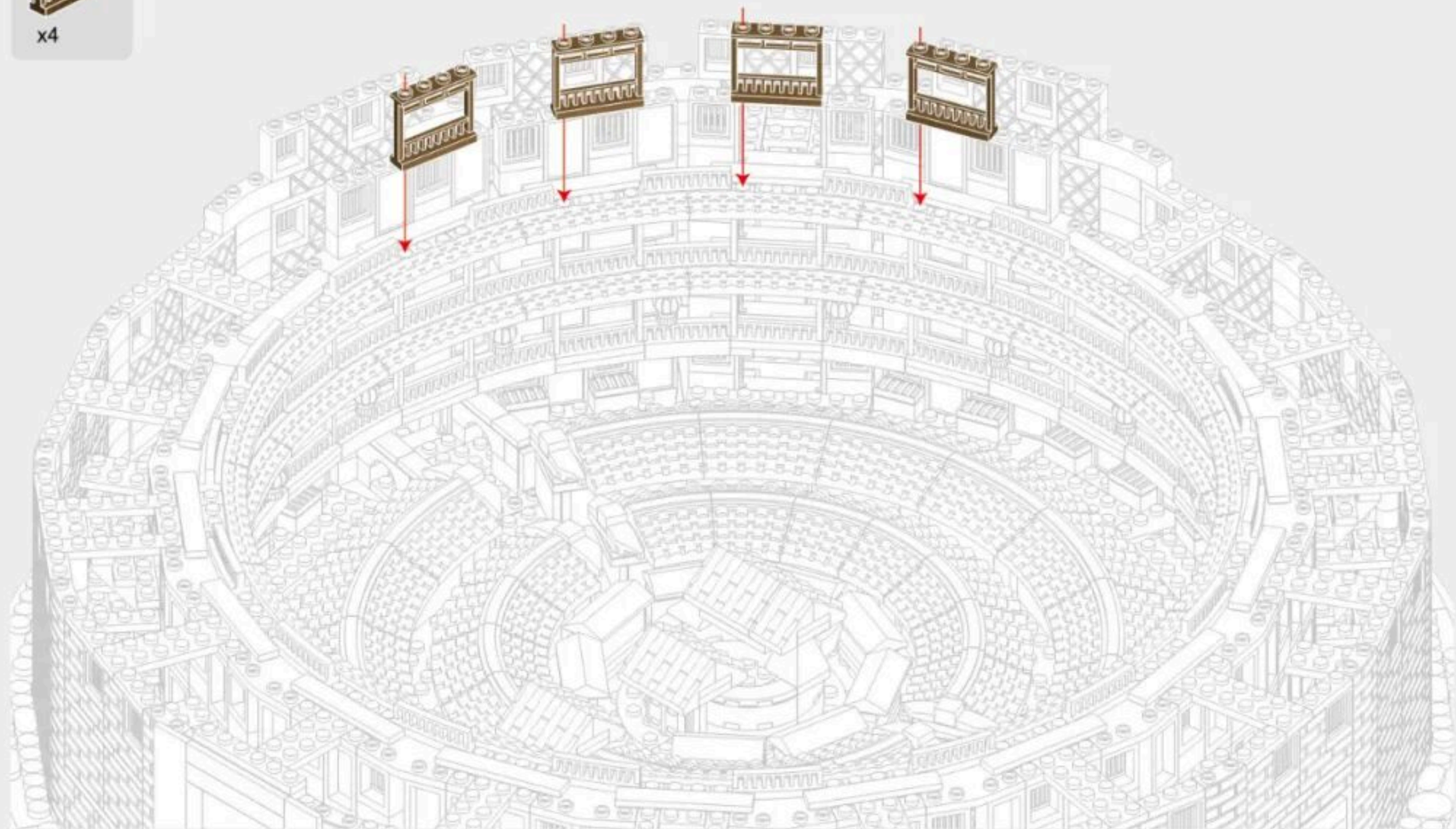

12-5

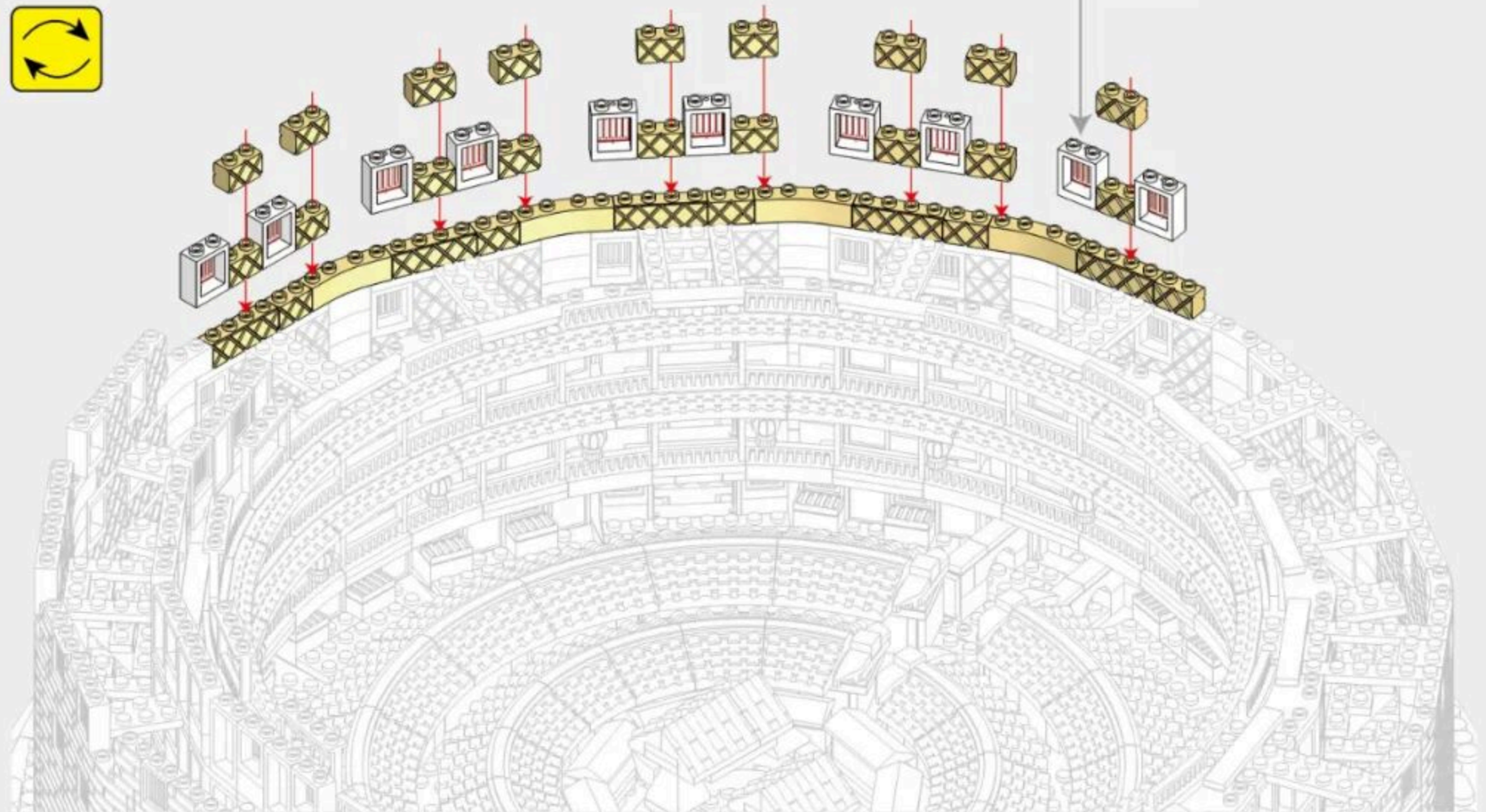
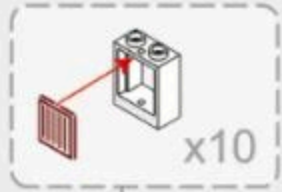

12-6



x1



x10

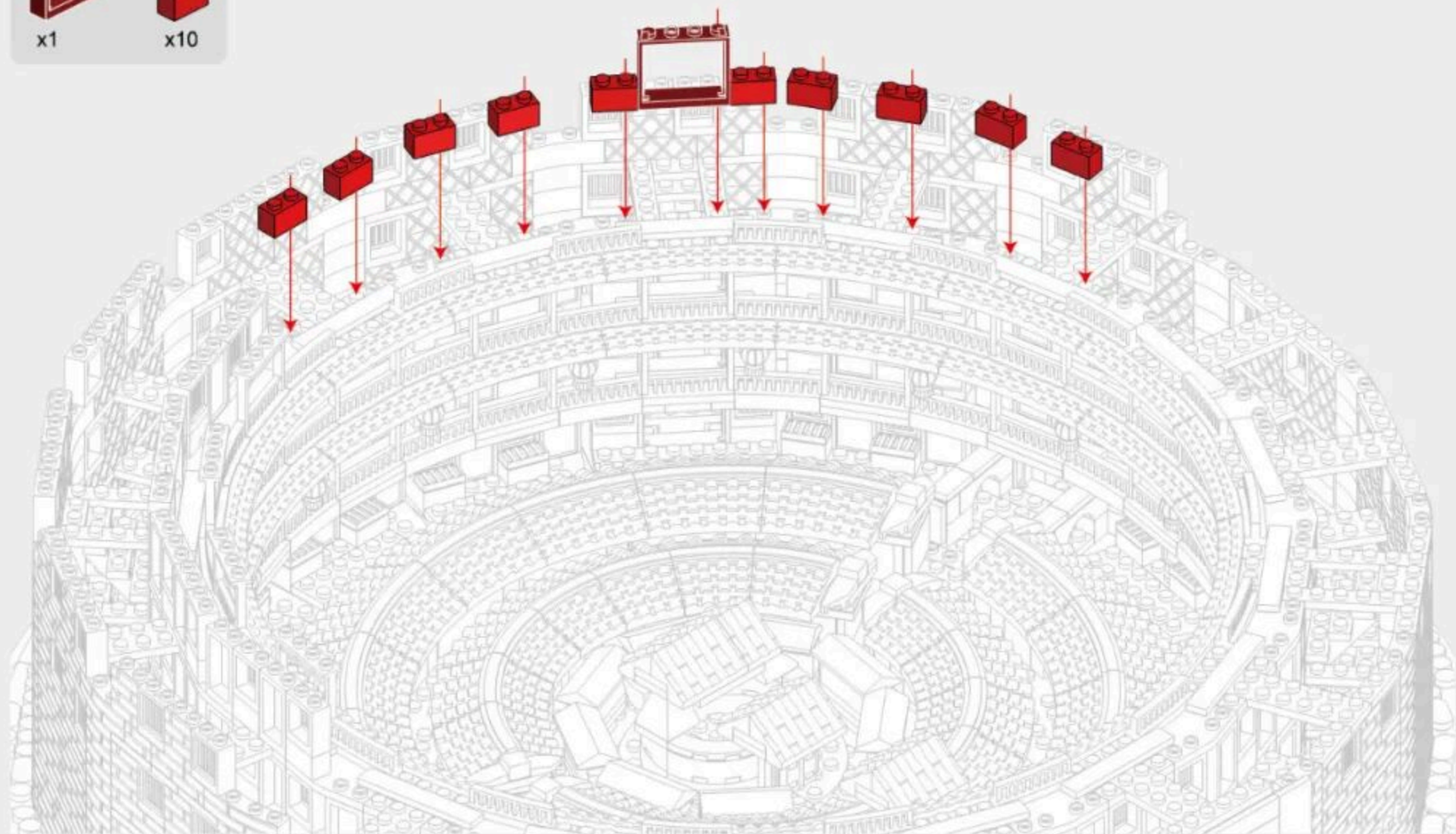

12-7

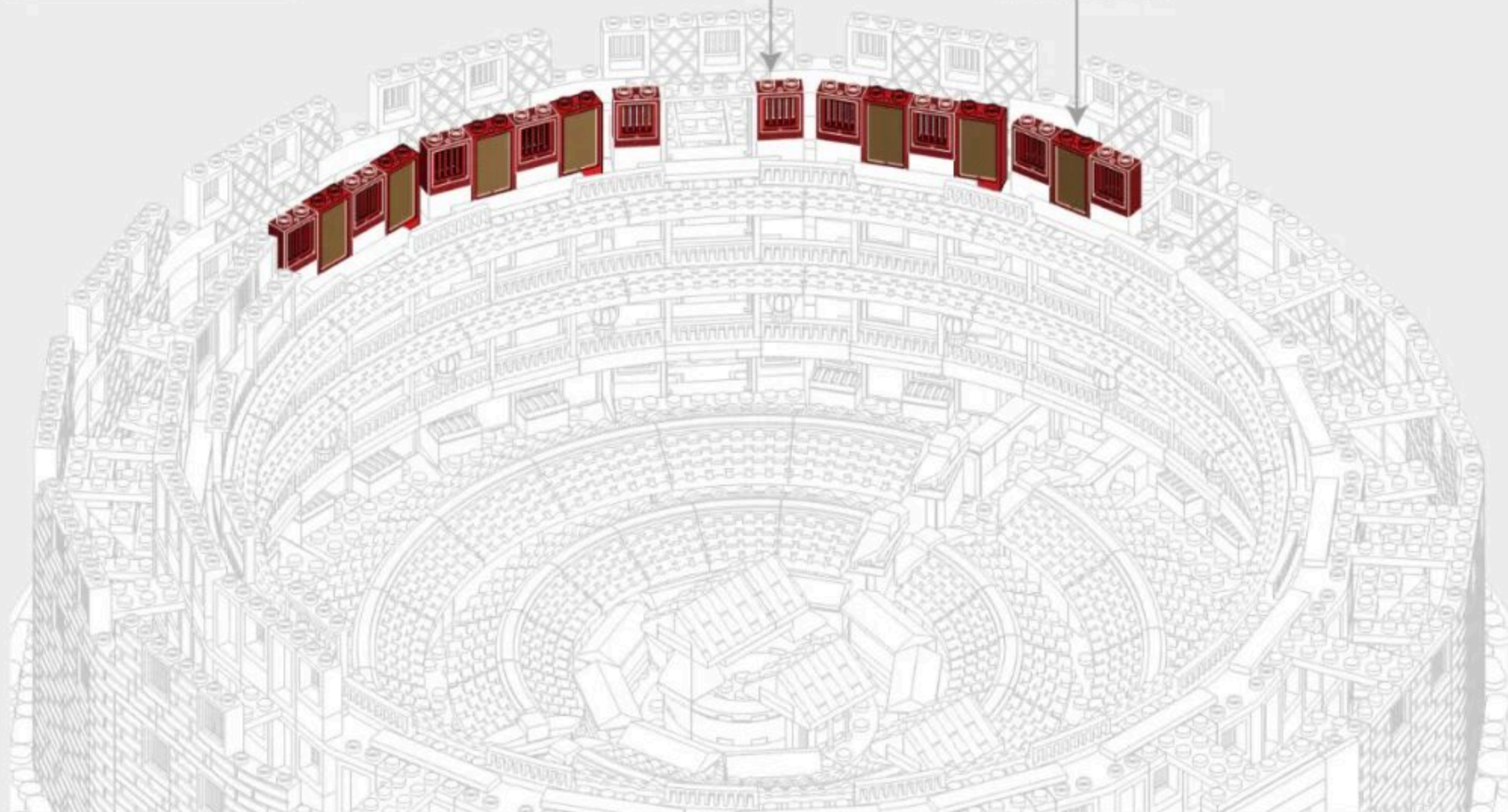
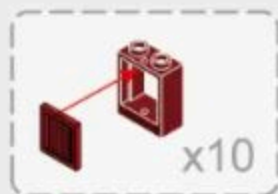

12-8

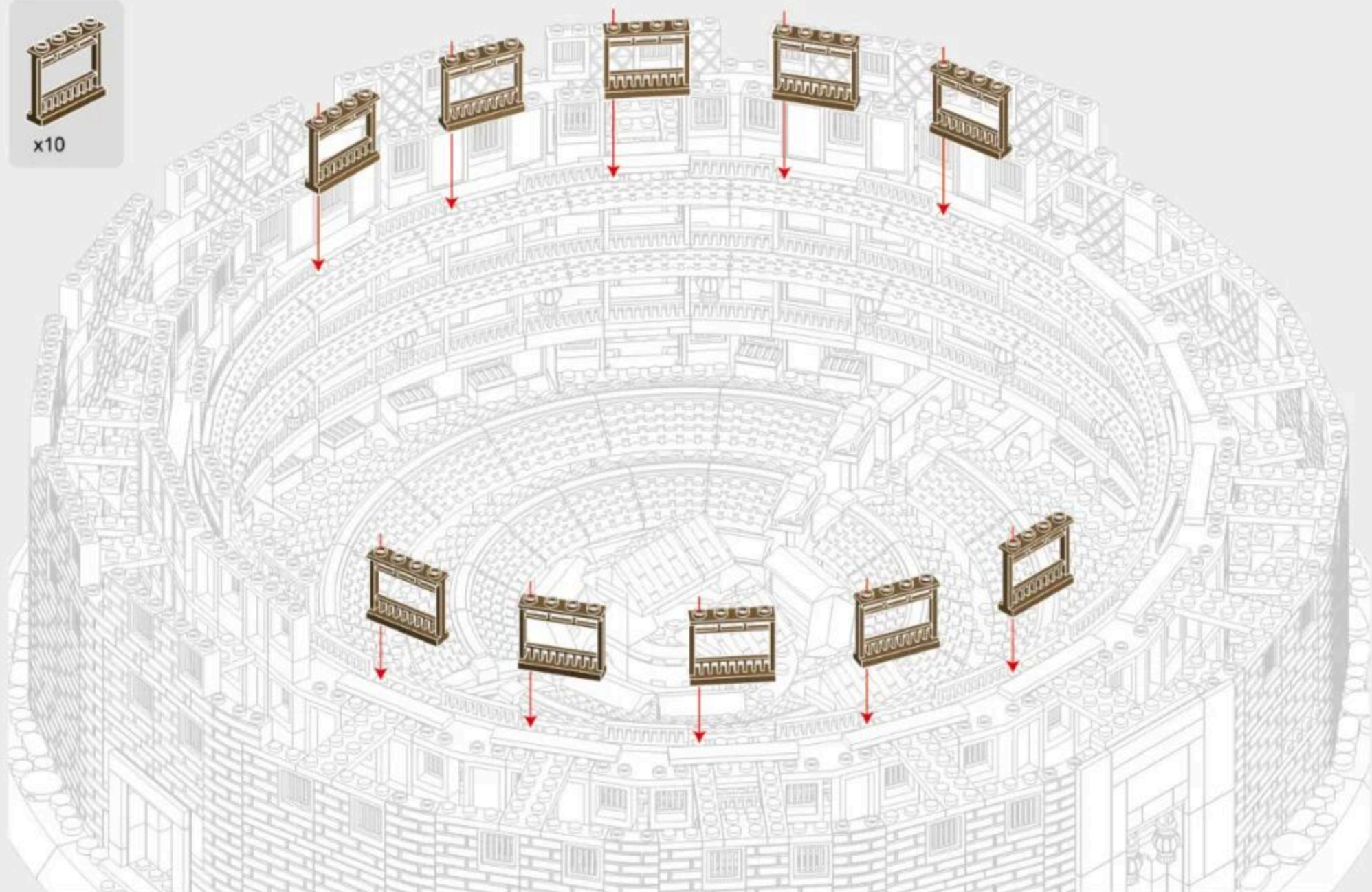

12-9

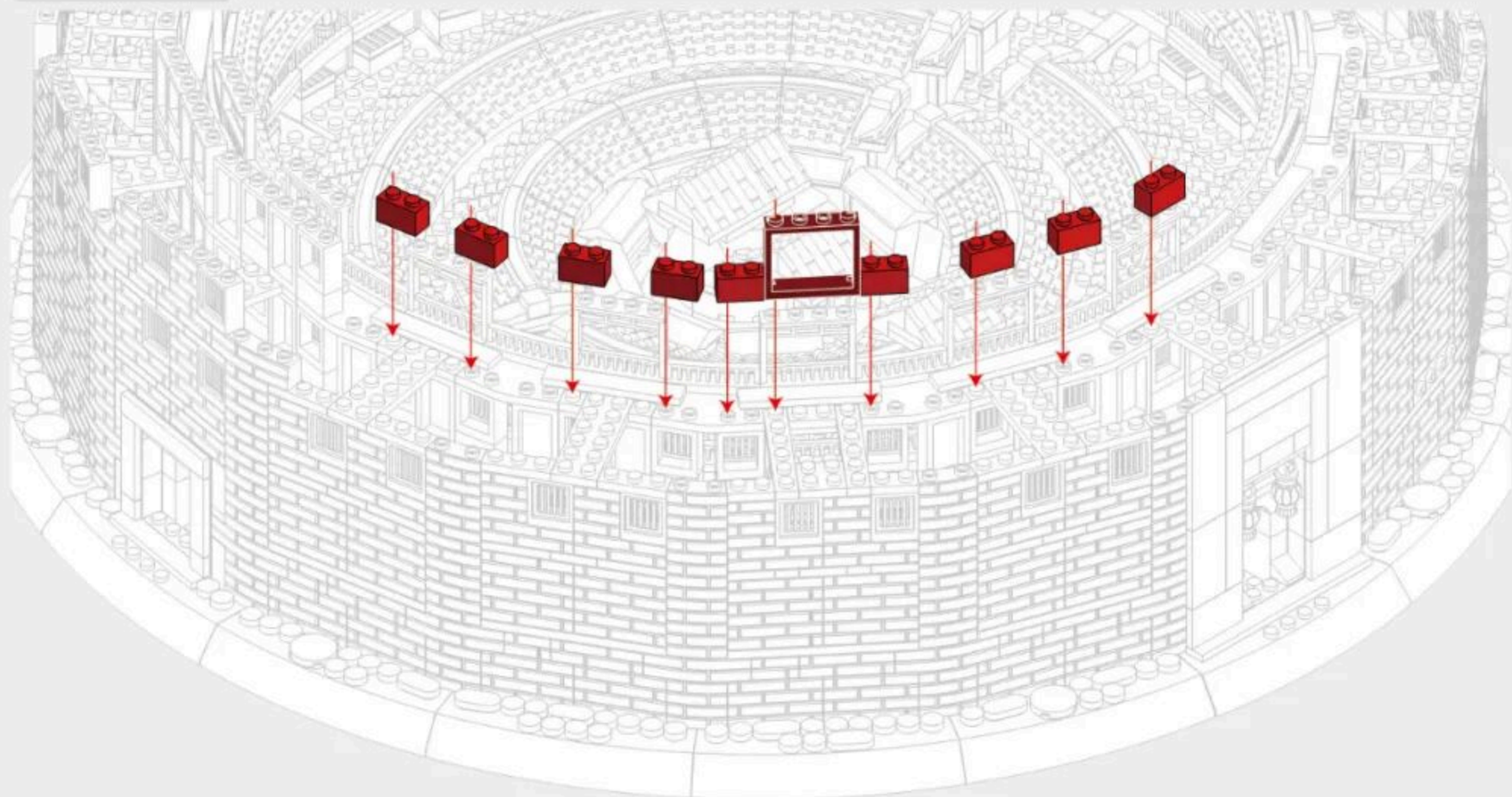
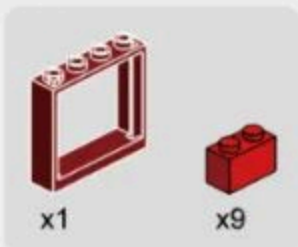

12-10

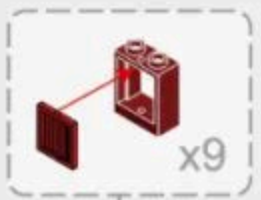

12-11

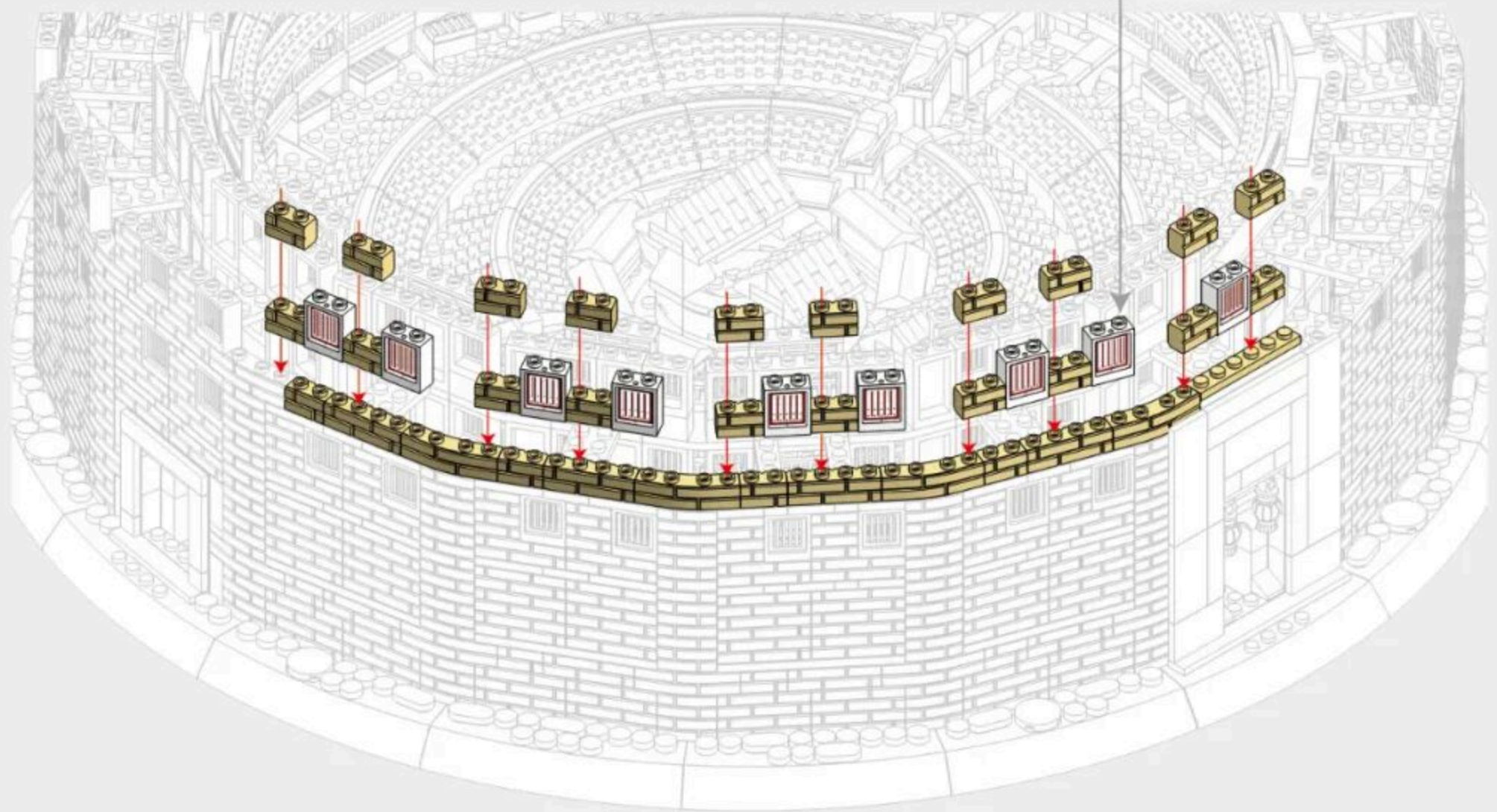
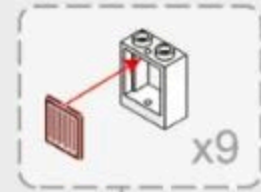

13
PACK

257 PCS



204

13-1



x10



x9

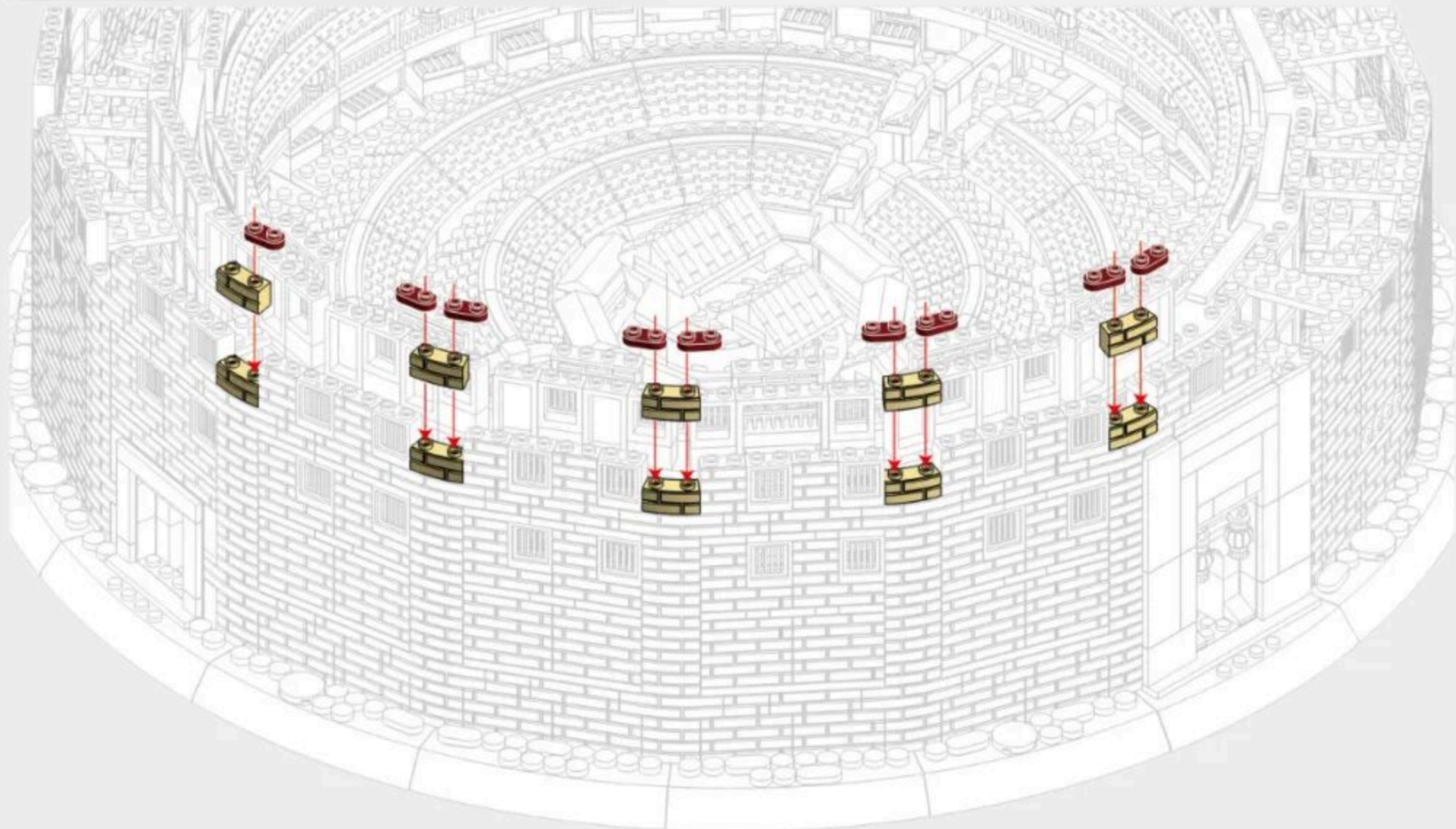

13-2

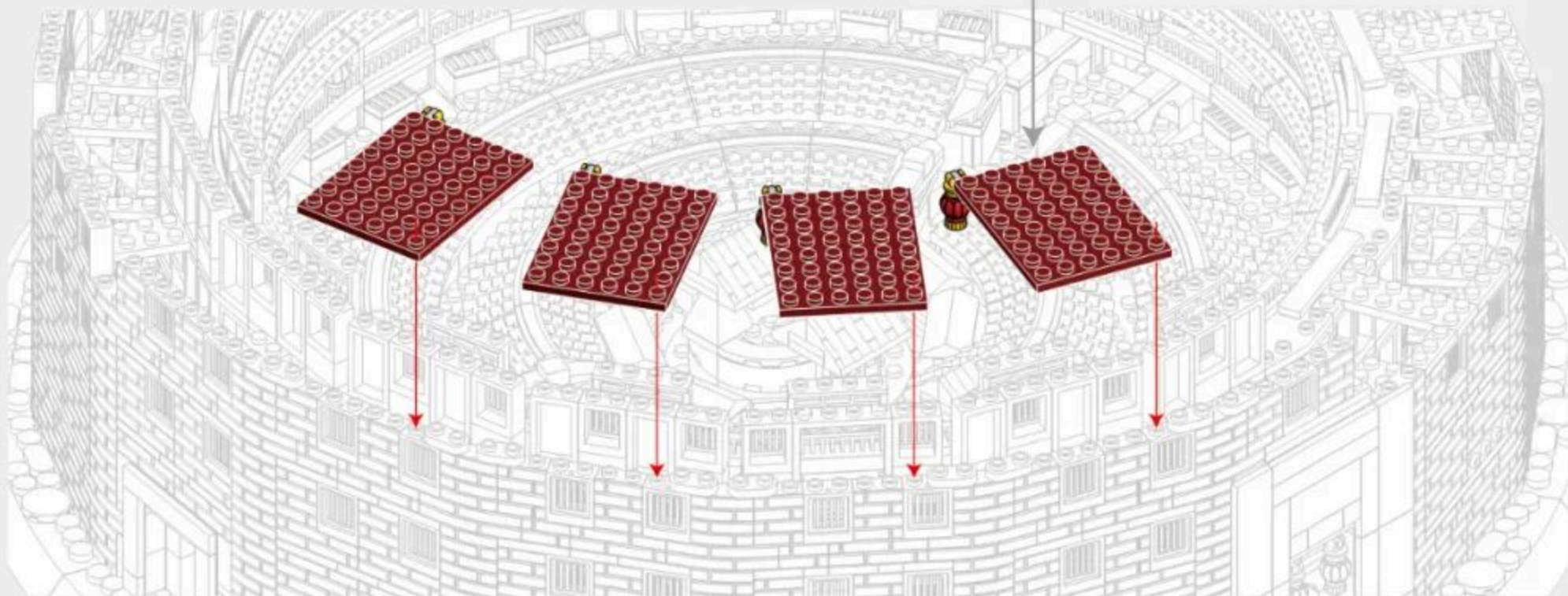
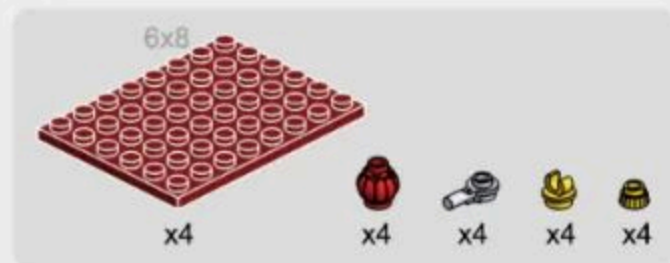

13-3

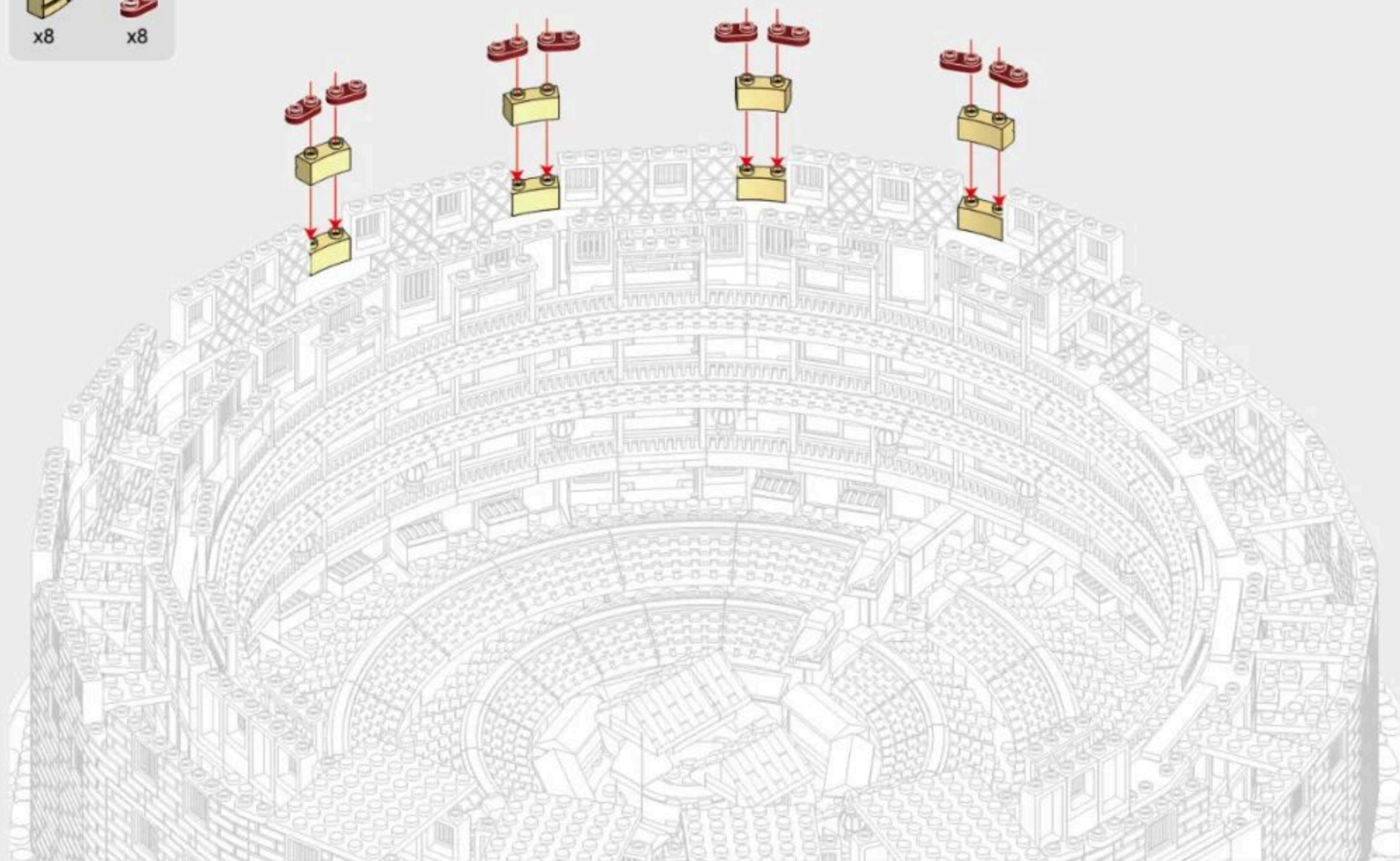

13-4

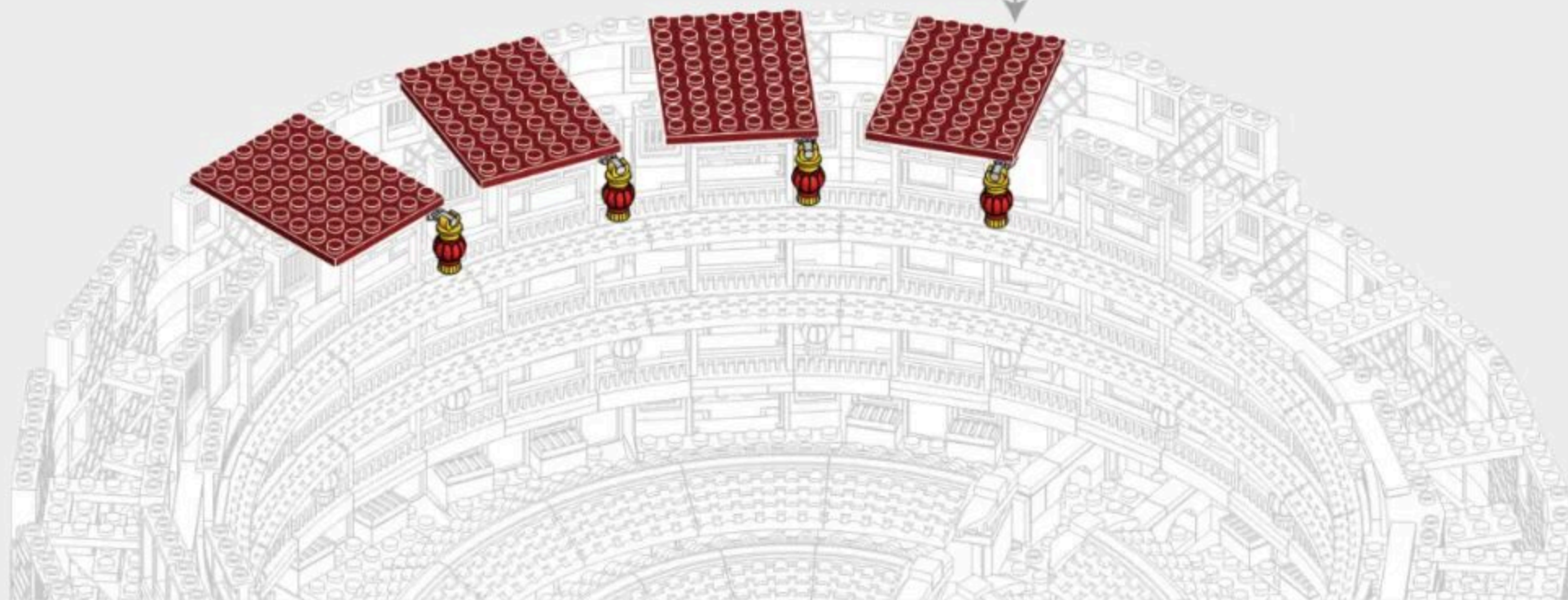
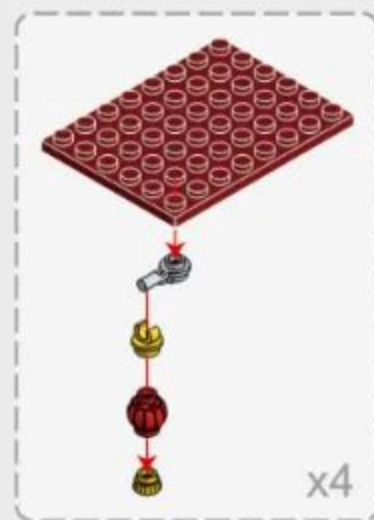
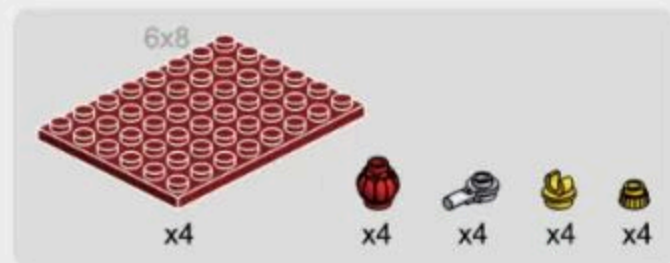

13-5

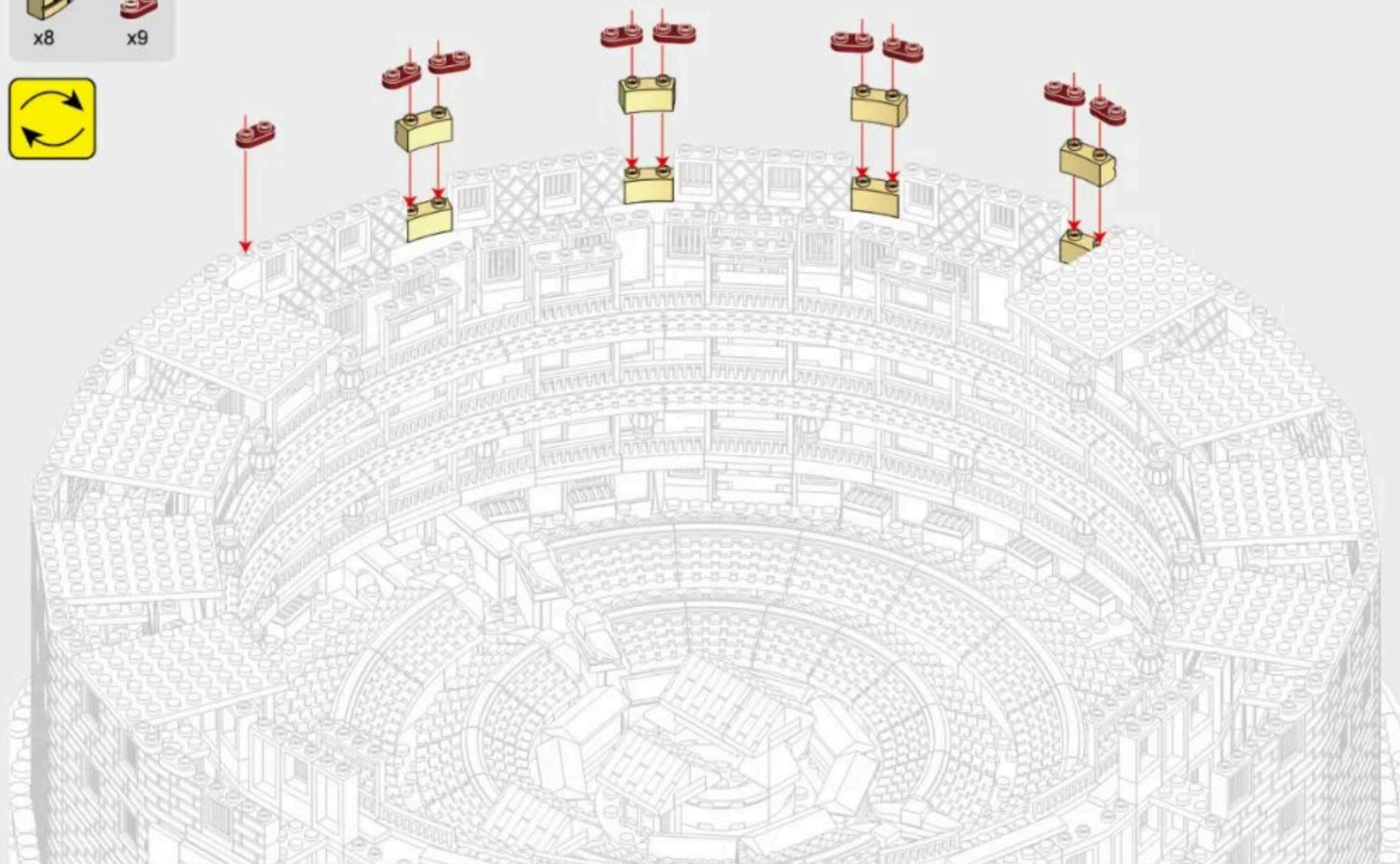

13-6

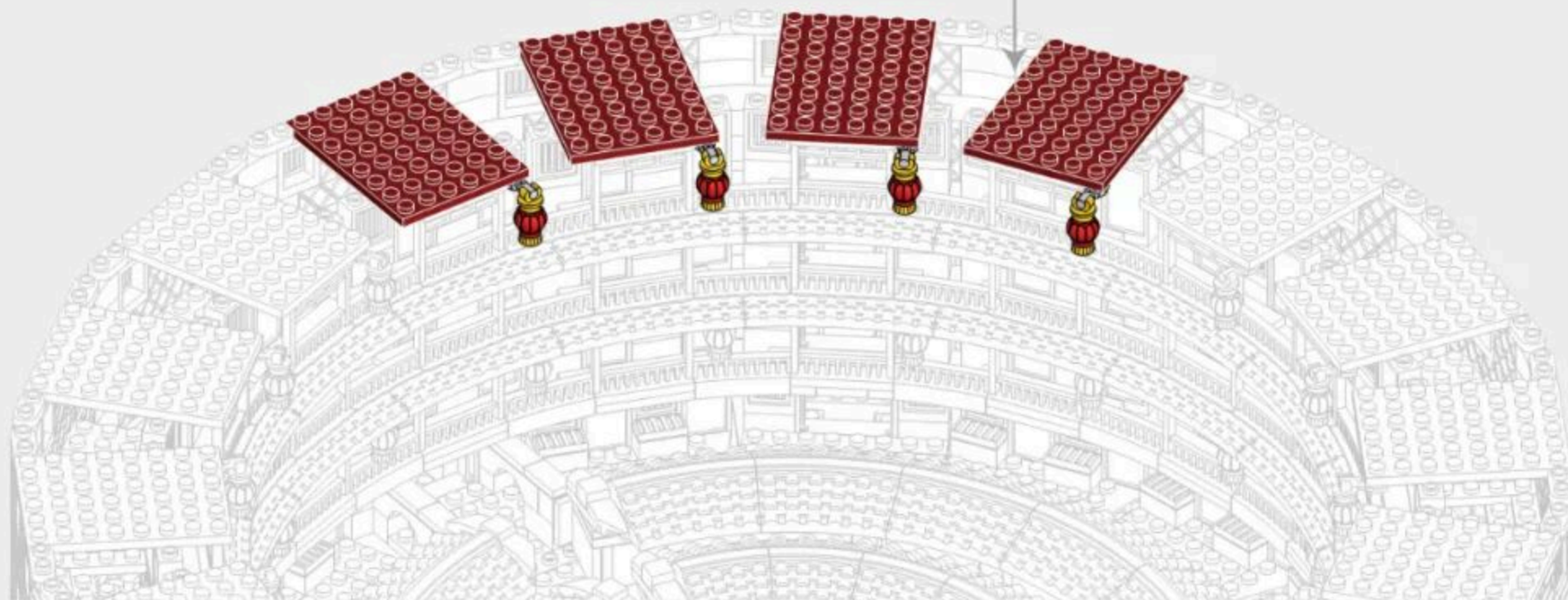
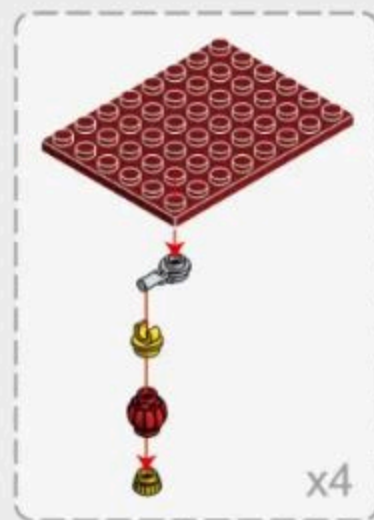
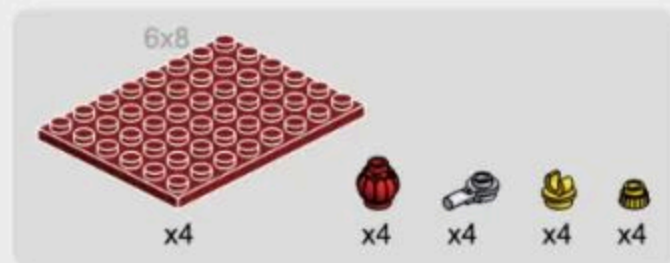

13-7



x4

注意：此步骤仅用于搭建完整版的土楼，搭建解构版的土楼请忽略此步骤。

Tips: This step is only for constructing a complete version of the tulou.

Please ignore this step if you are constructing a deconstructed version of the tulou.

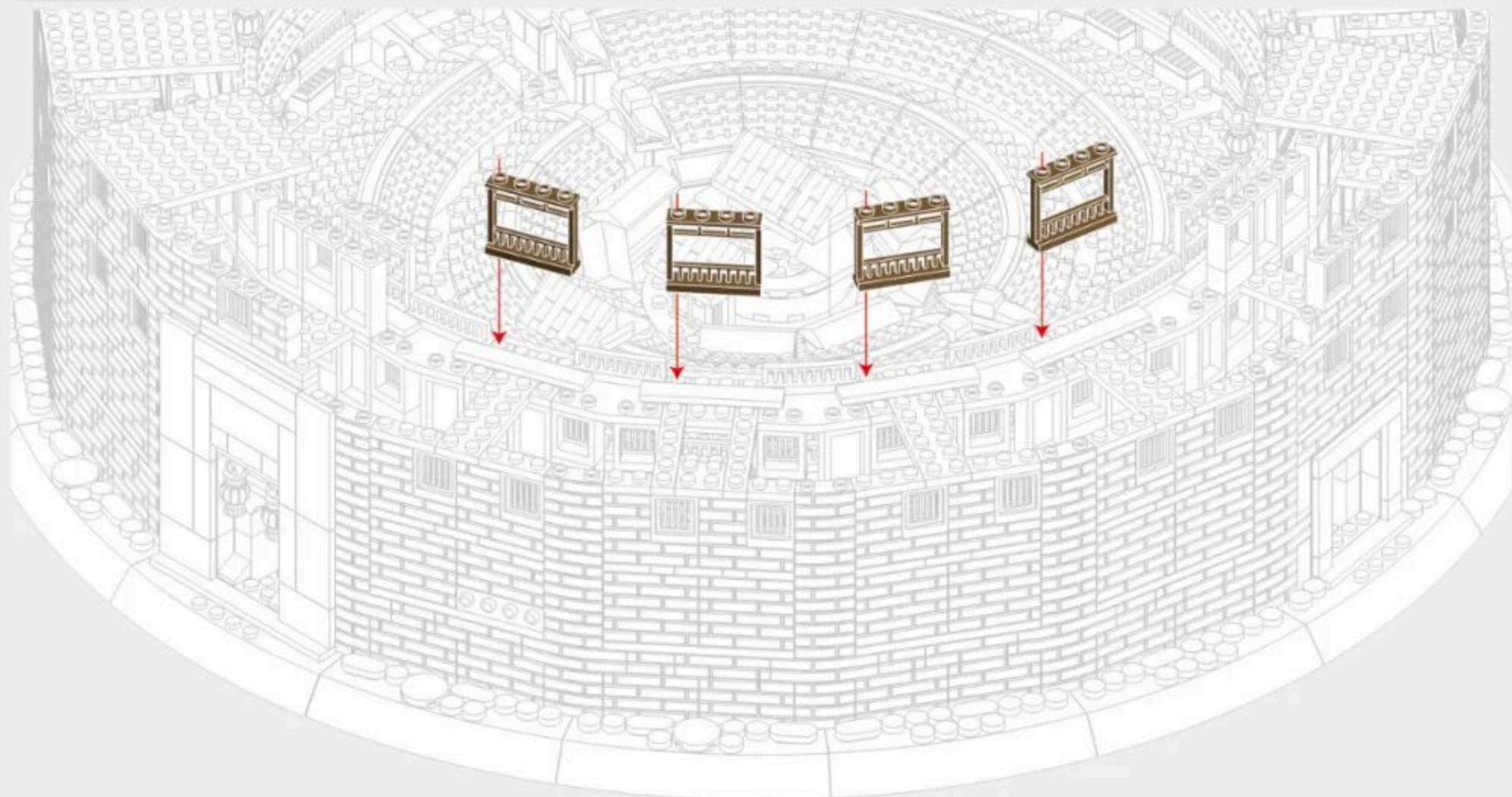

13-8



注意：此步骤仅用于搭建完整版的土楼，搭建解构版的土楼请忽略此步骤。
Tips: This step is only for constructing a complete version of the tulou.
Please ignore this step if you are constructing a deconstructed version of the tulou.

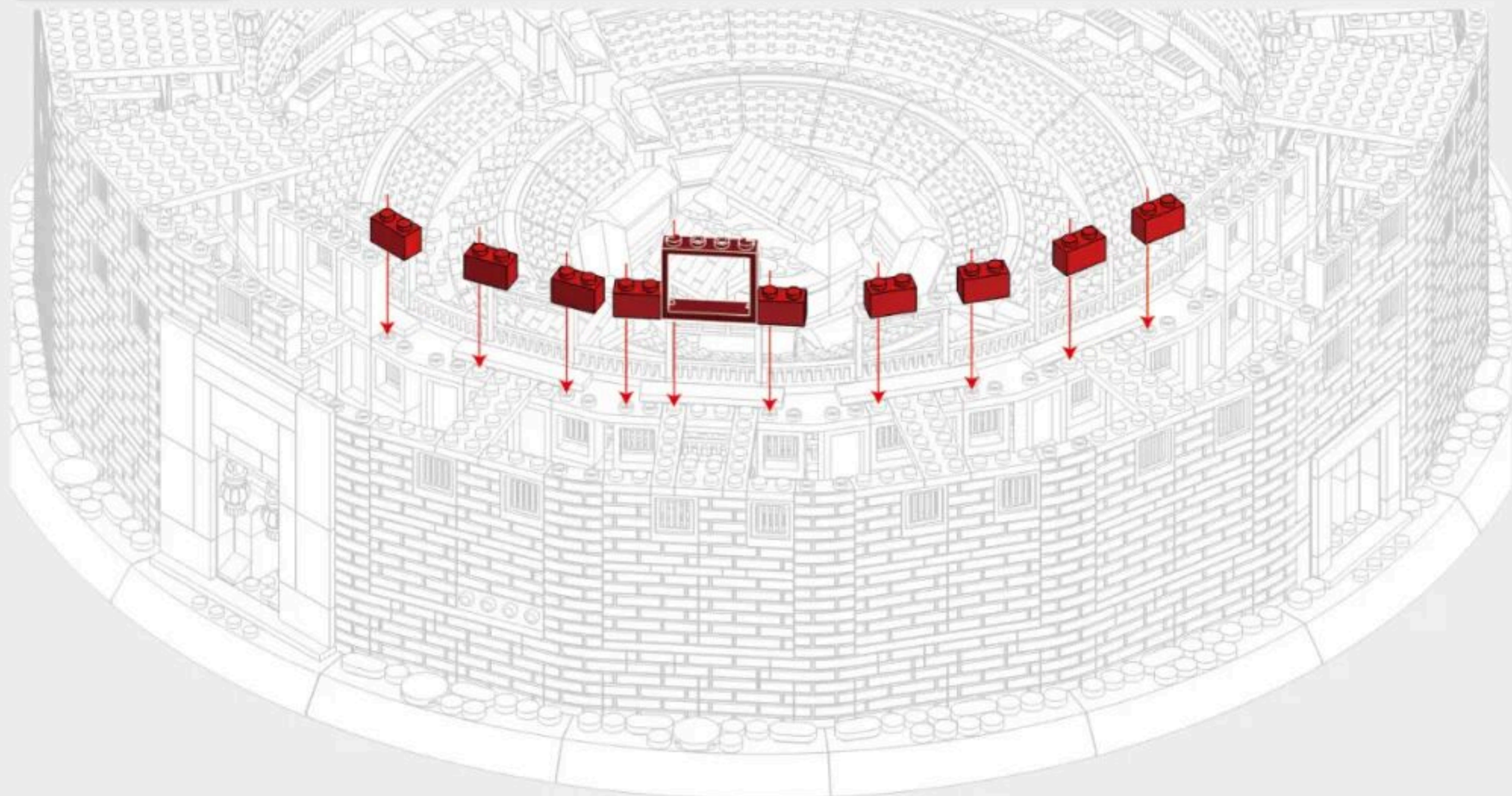

13-9

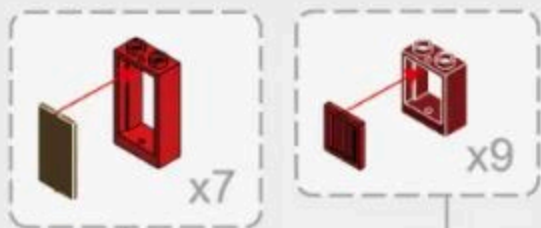

注意：此步骤仅用于搭建完整版的土楼，搭建解构版的土楼请忽略此步骤。
 Tips: This step is only for constructing a complete version of the tulou.
 Please ignore this step if you are constructing a deconstructed version of the tulou.

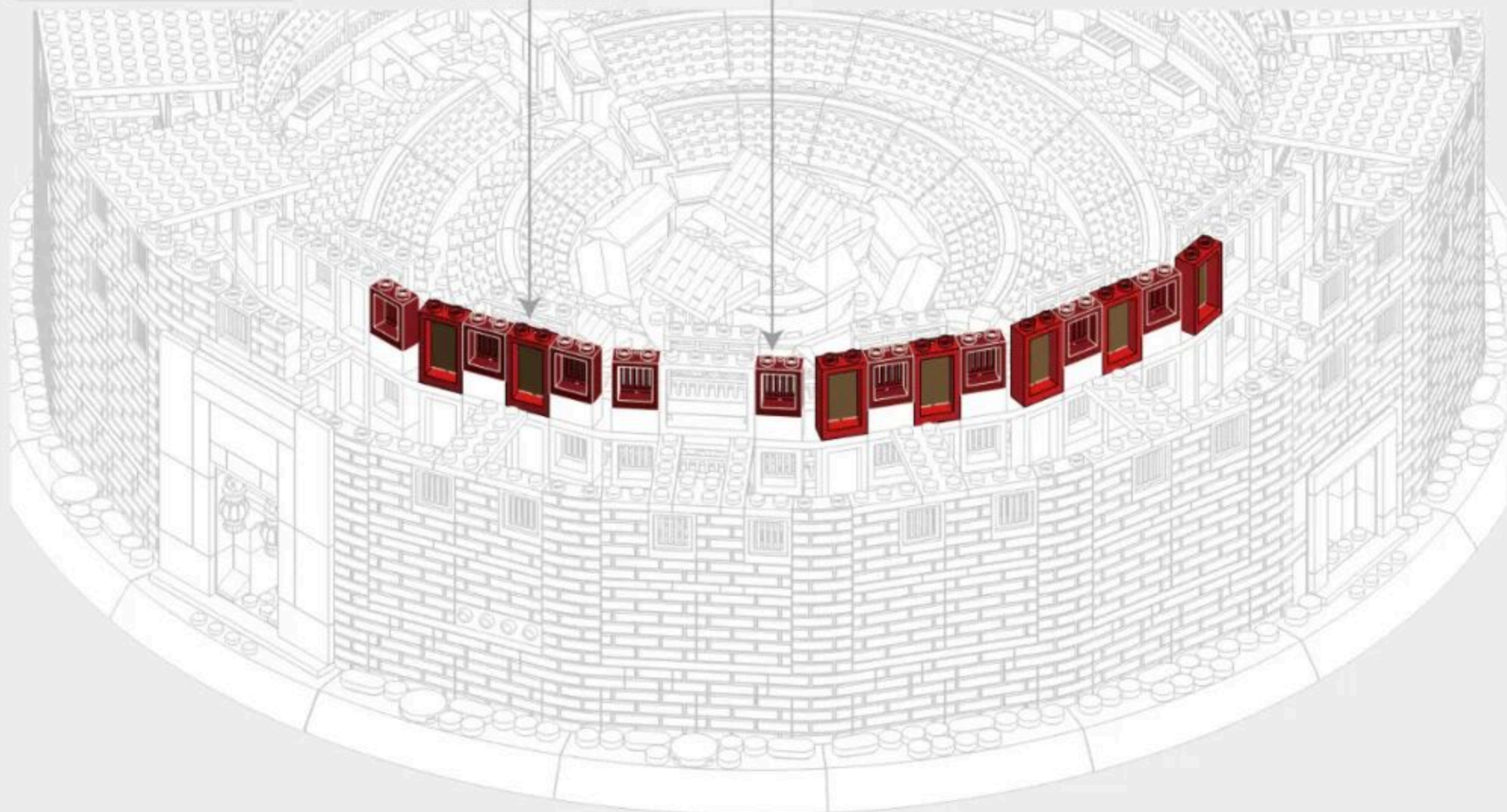

13-10

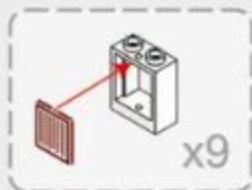

注意：此步骤仅用于搭建完整版的土楼，搭建解构版的土楼请忽略此步骤。
 Tips: This step is only for constructing a complete version of the tulou.
 Please ignore this step if you are constructing a deconstructed version of the tulou.

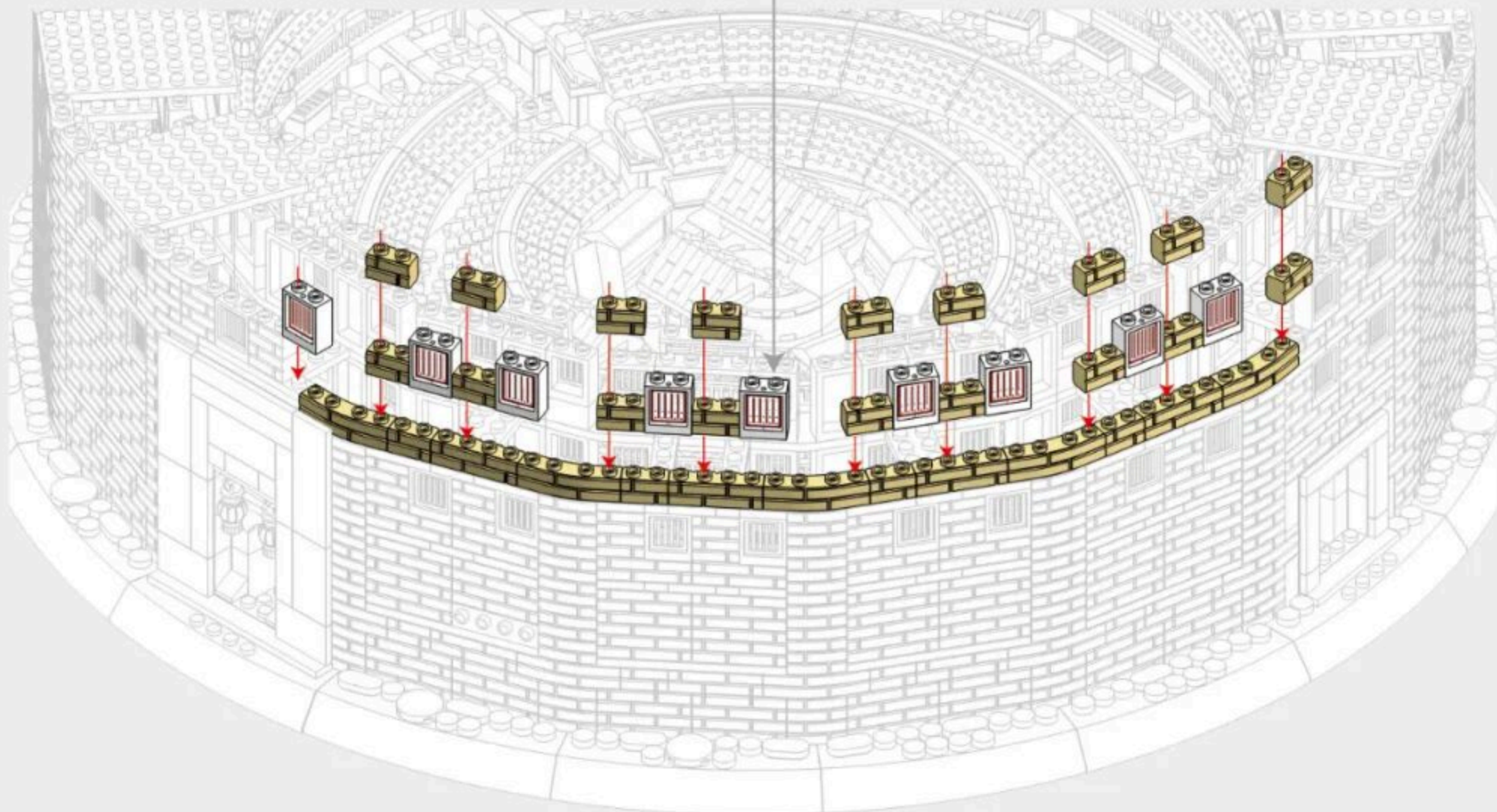

解构版步骤

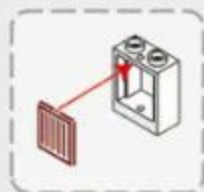

注意：此步骤仅用于搭建解构版的土楼。
Tips: This step is only used to build a deconstructed version of the tulou.

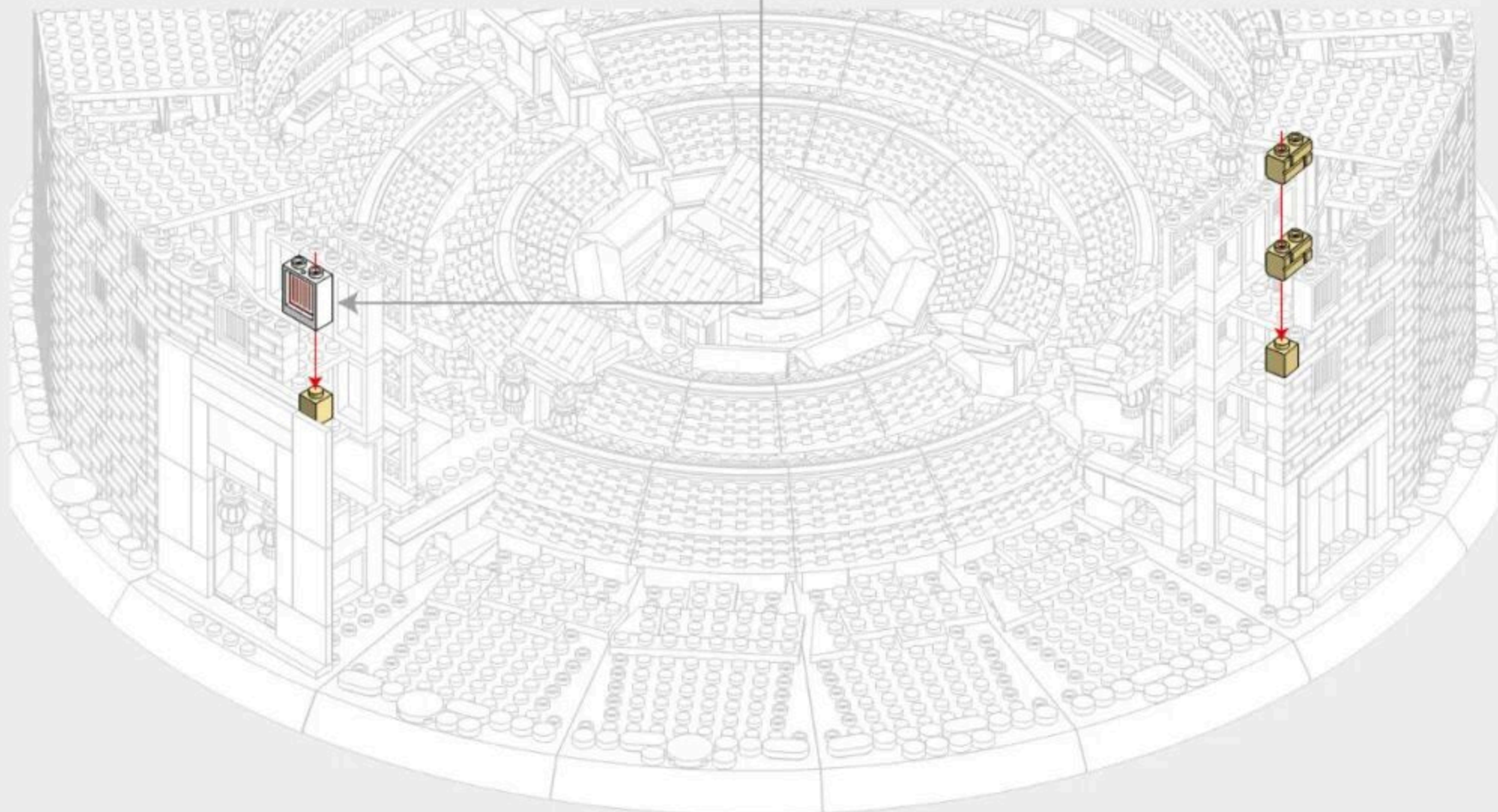

13-11



x10



x8

注意：此步骤仅用于搭建完整版的土楼，搭建解构版的土楼请忽略此步骤。
Tips: This step is only for constructing a complete version of the tulou.
Please ignore this step if you are constructing a deconstructed version of the tulou.

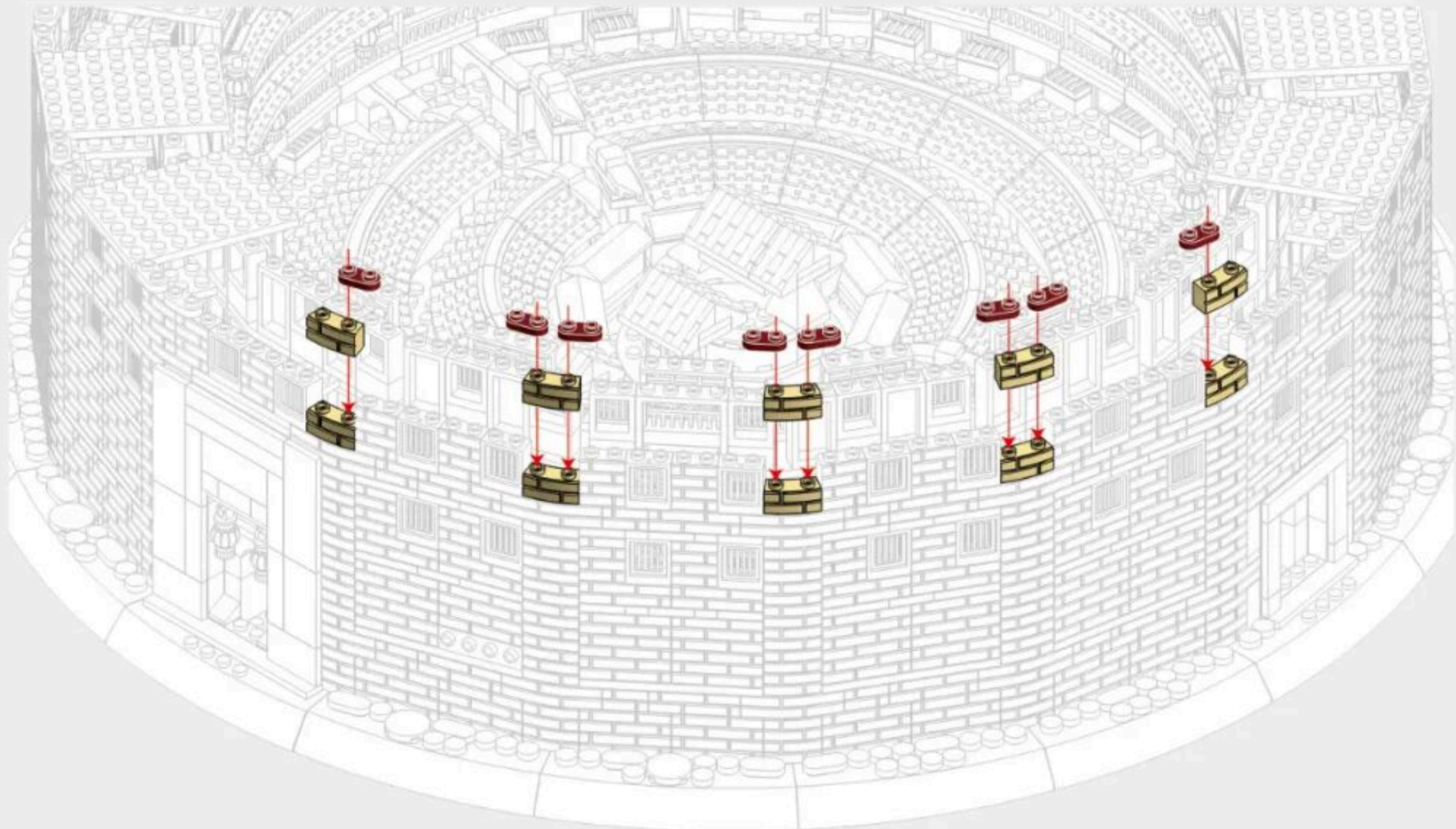

13-12

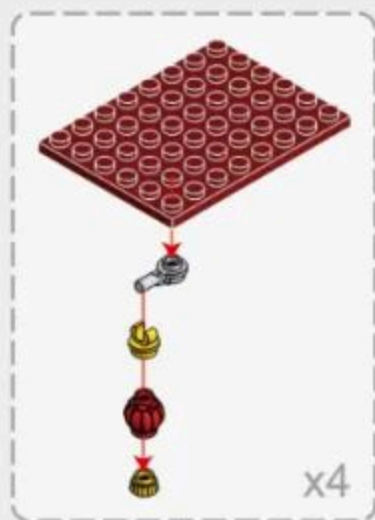
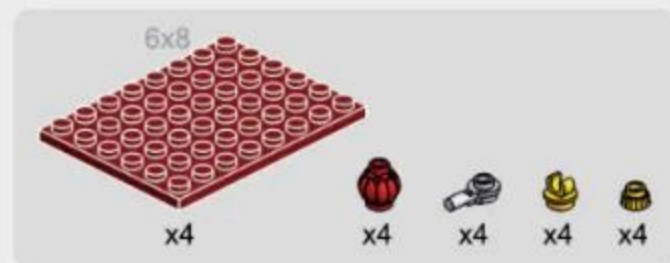

注意：此步骤仅用于搭建完整版的土楼，搭建解构版的土楼请忽略此步骤。
Tips: This step is only for constructing a complete version of the tulou.
Please ignore this step if you are constructing a deconstructed version of the tulou.



13-13

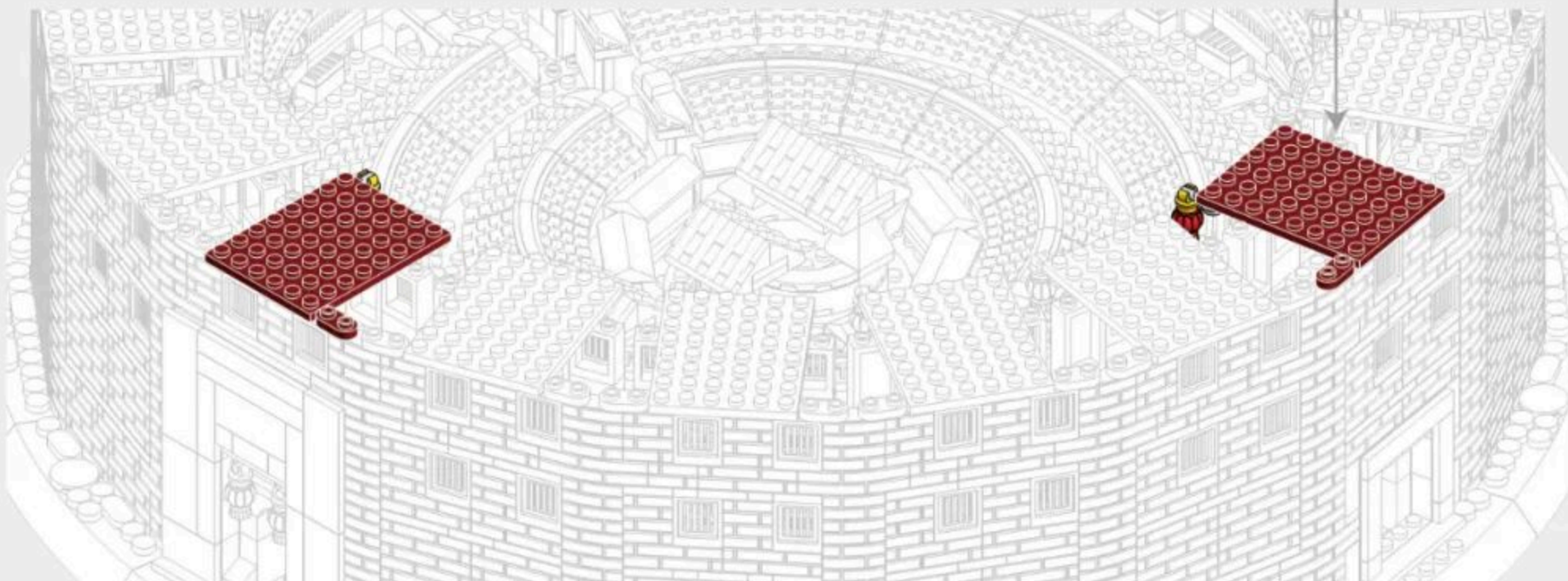
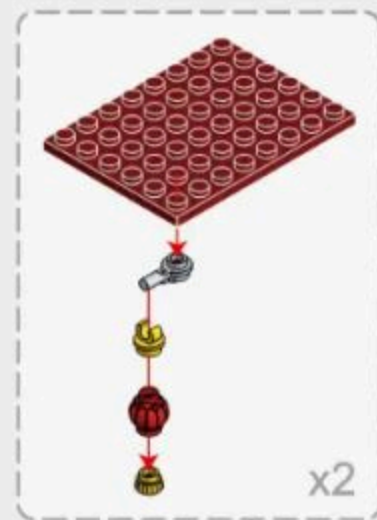

14
PACK

146PCS

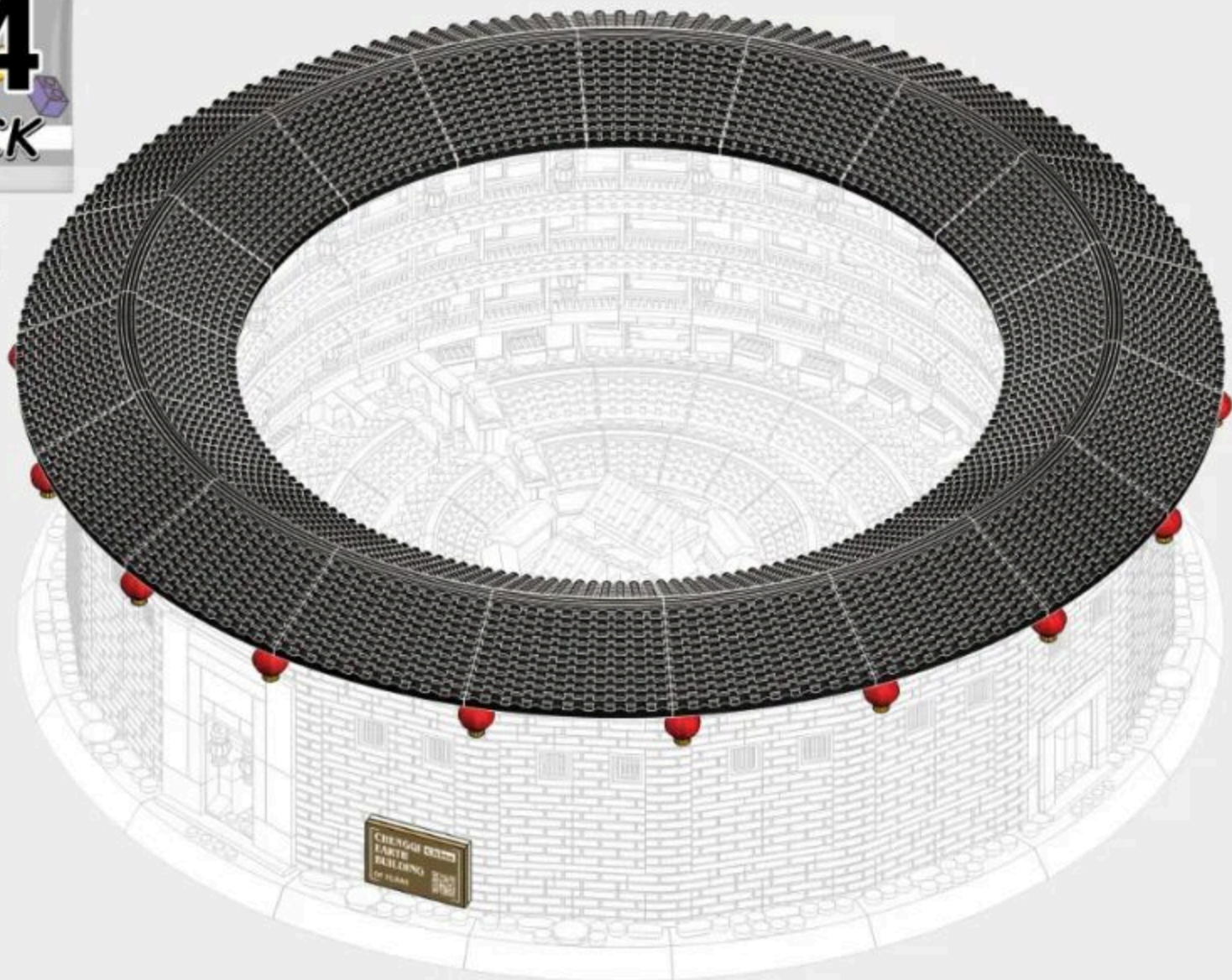

219

14-1



x4

注意：此步骤仅用于搭建完整版的土楼，搭建解构版的土楼请忽略此步骤。
Tips: This step is only for constructing a complete version of the tulou.
Please ignore this step if you are constructing a deconstructed version of the tulou.

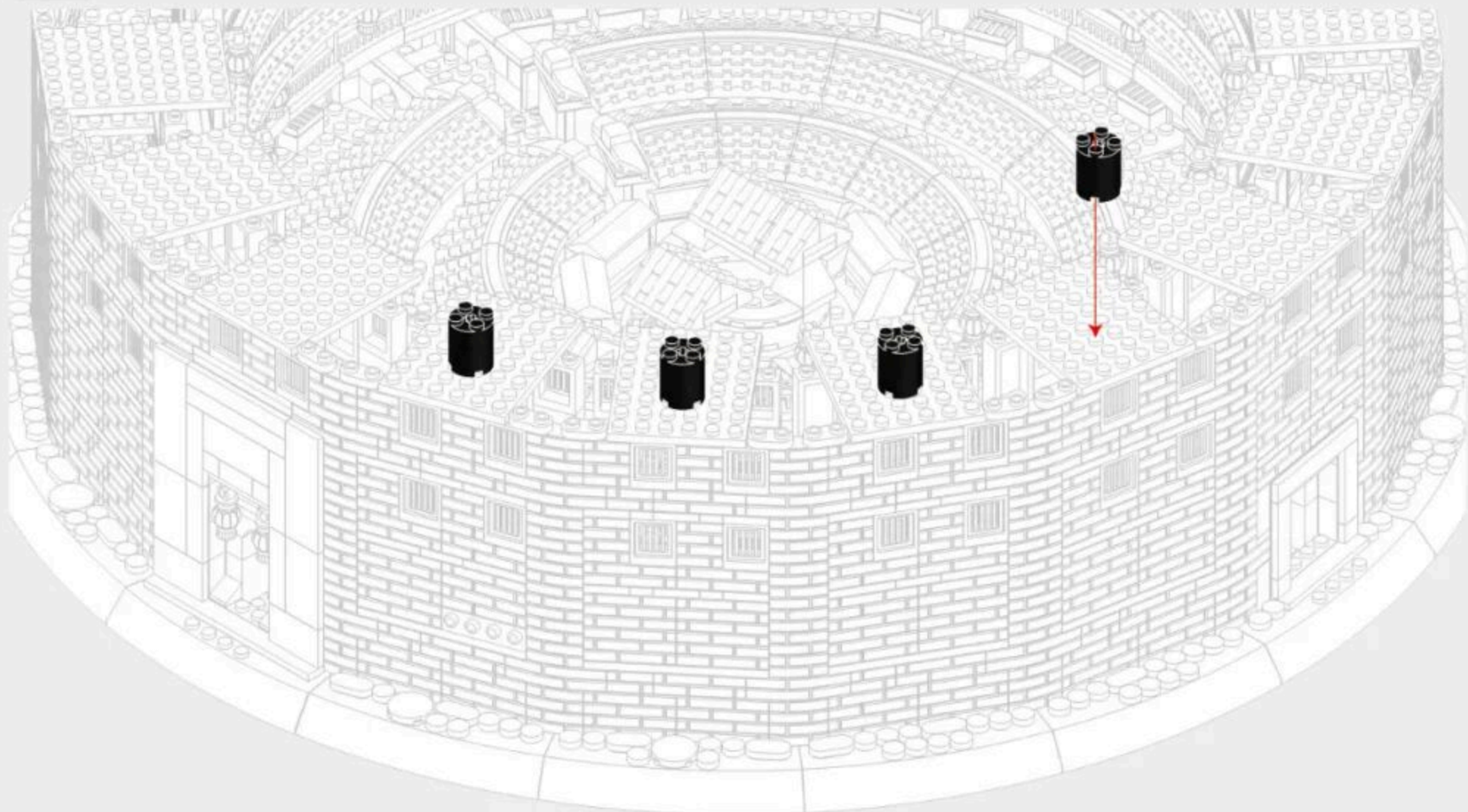

14-2

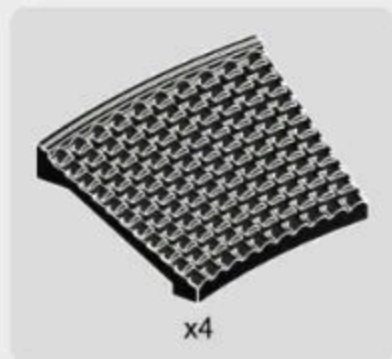

注意：此步骤仅用于搭建完整版的土楼，搭建解构版的土楼请忽略此步骤。
Tips: This step is only for constructing a complete version of the tulou.
Please ignore this step if you are constructing a deconstructed version of the tulou.

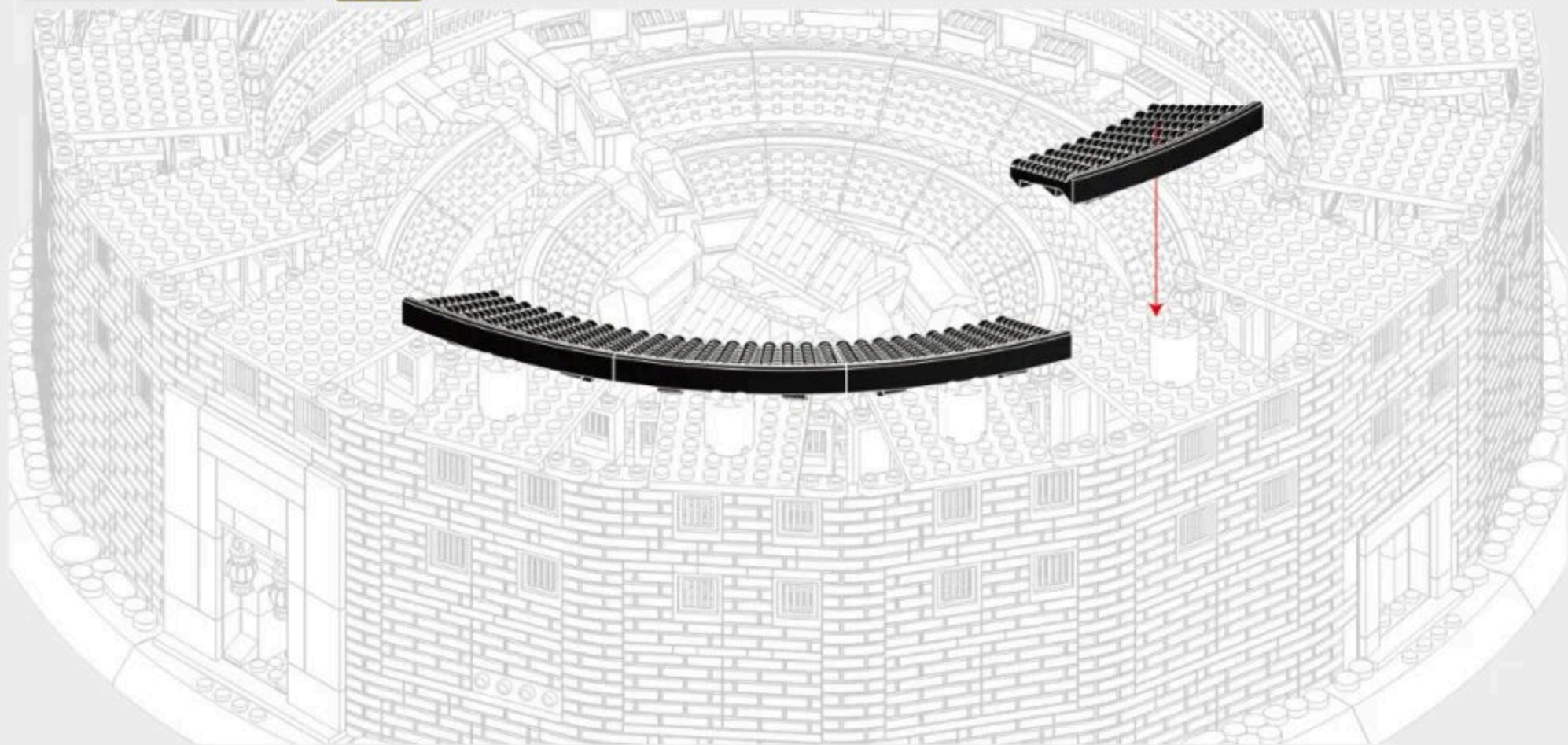

14-3

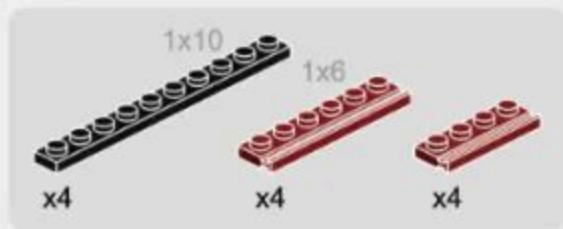

注意：此步骤仅用于搭建完整版的土楼，搭建解构版的土楼请忽略此步骤。
Tips: This step is only for constructing a complete version of the tulou.
Please ignore this step if you are constructing a deconstructed version of the tulou.

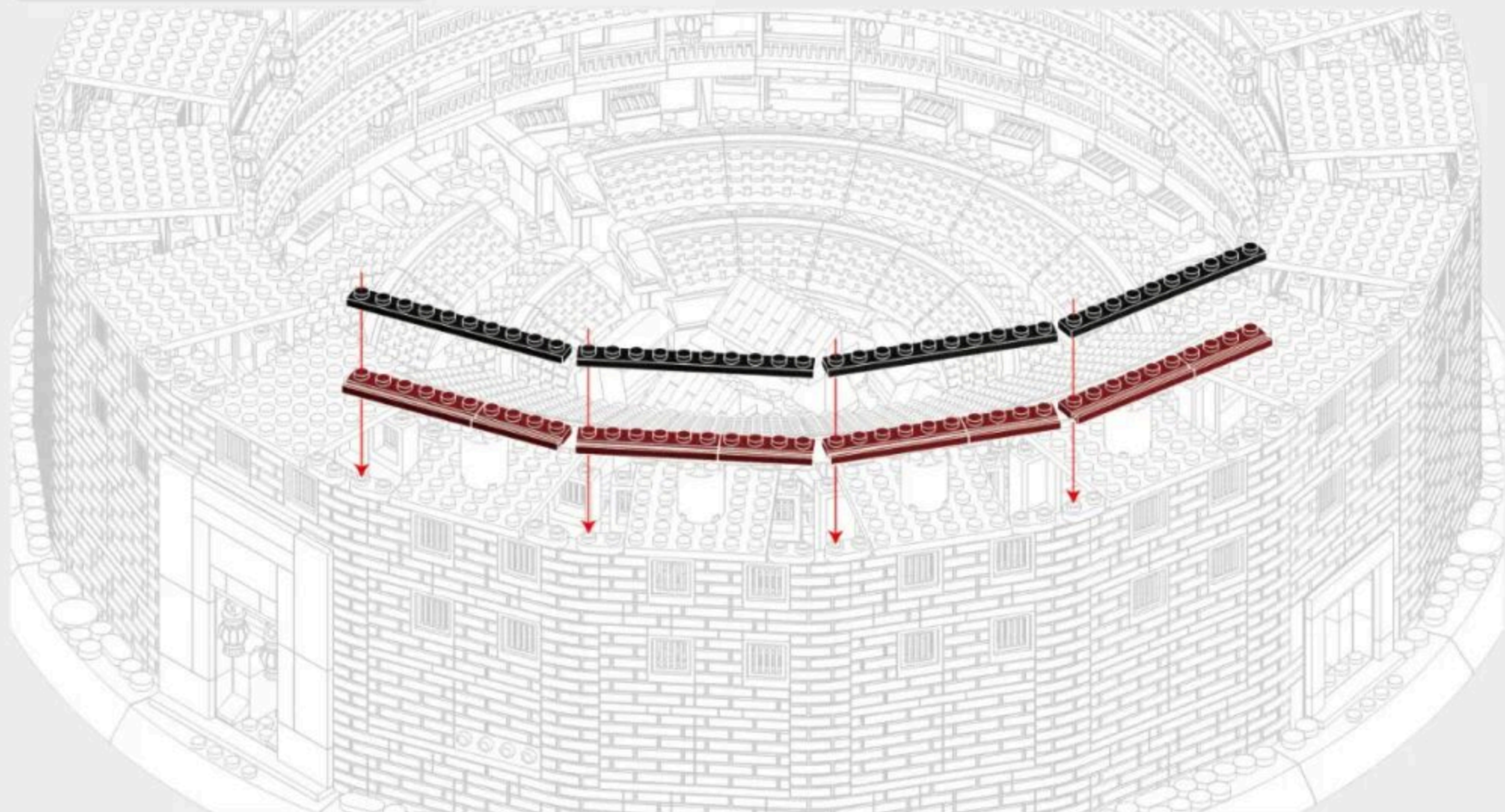

14-4

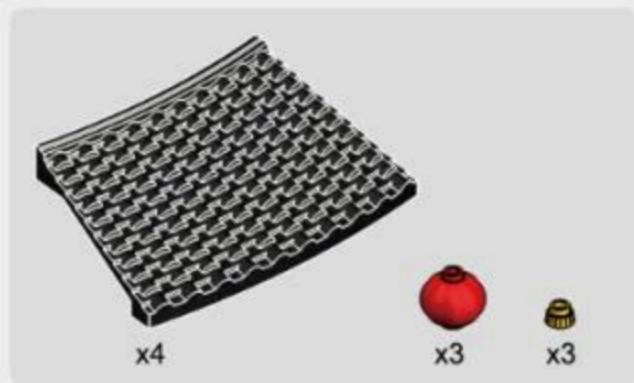

注意：此步骤仅用于搭建完整版的土楼，搭建解构版的土楼请忽略此步骤。
Tips: This step is only for constructing a complete version of the tulou.
Please ignore this step if you are constructing a deconstructed version of the tulou.

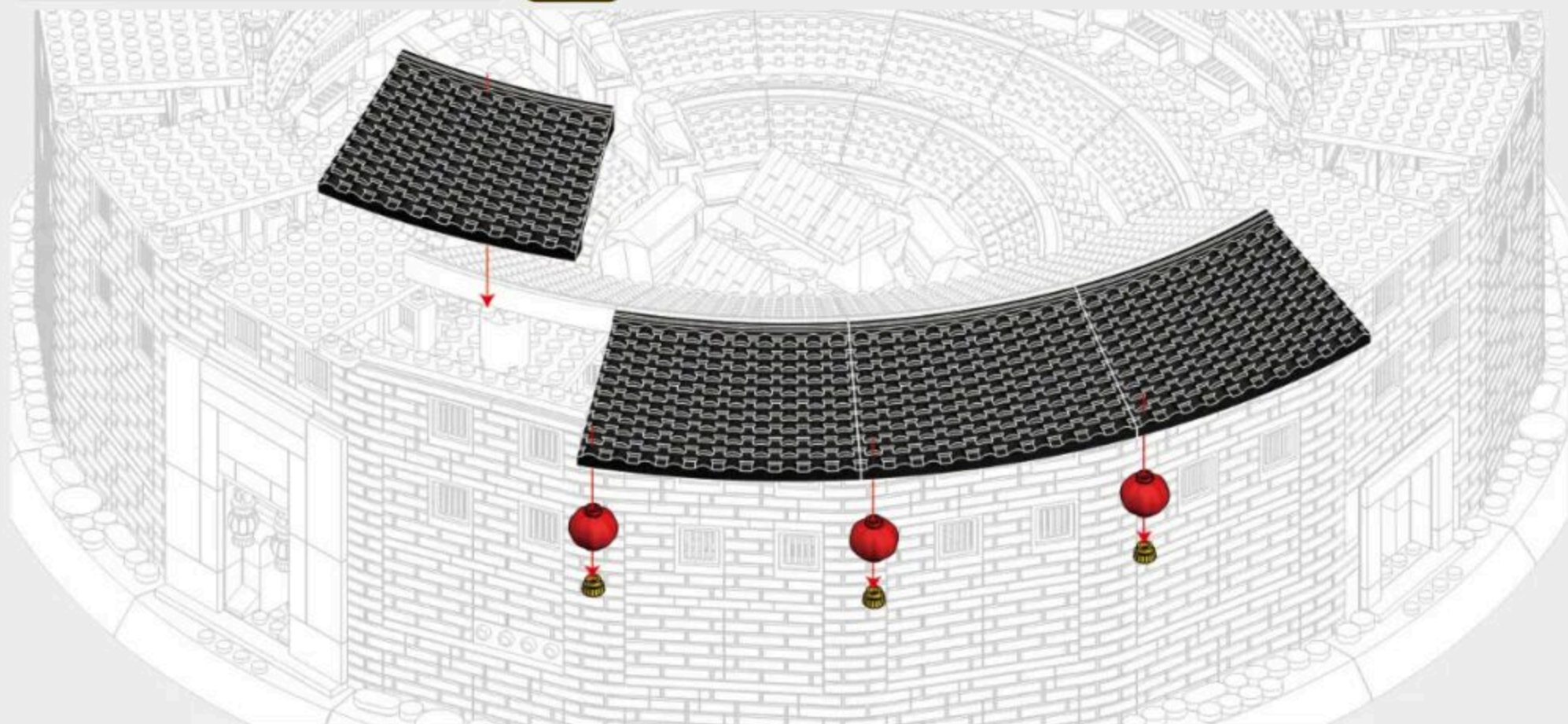

14-5

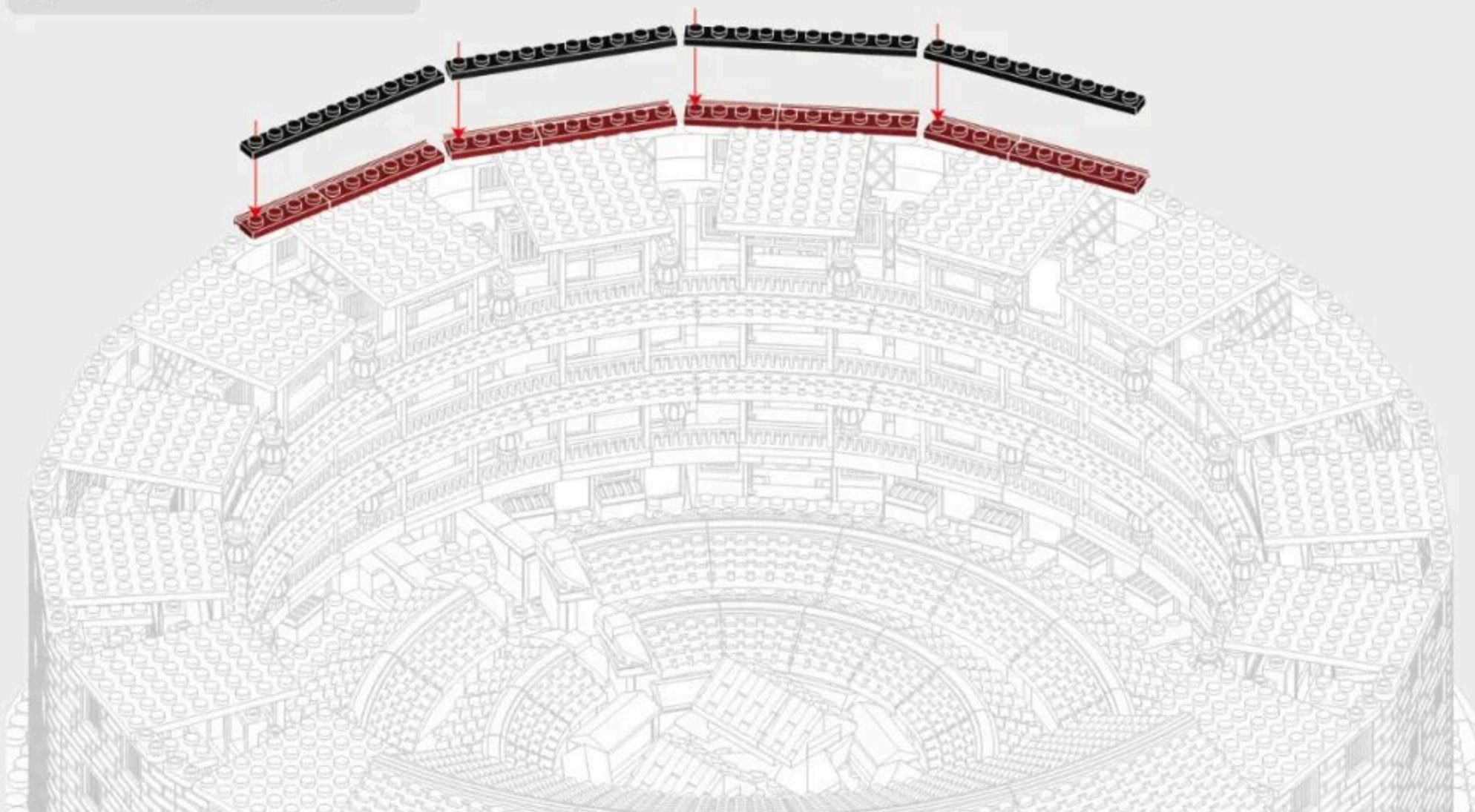
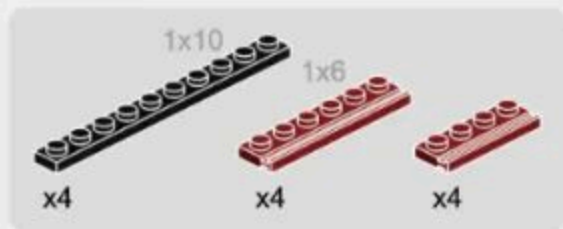

14-6

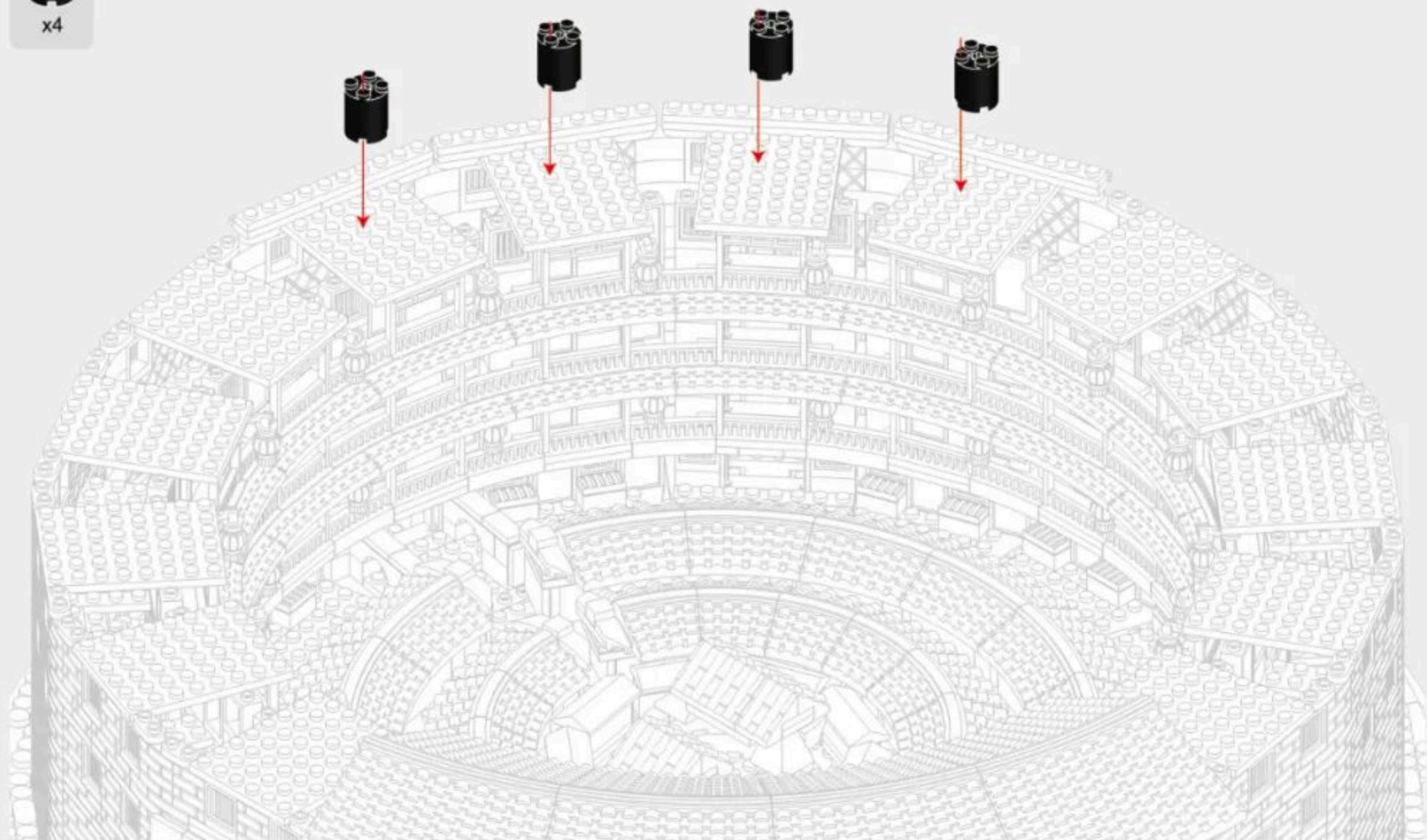

14-7

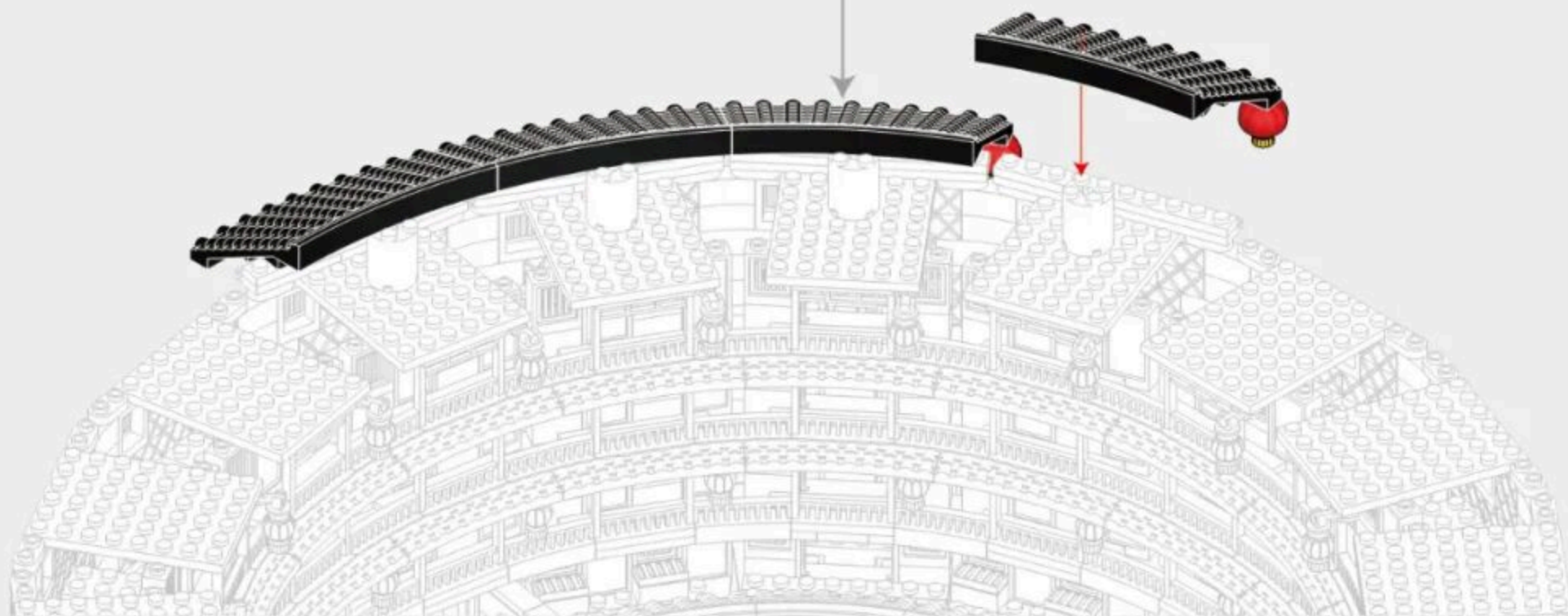
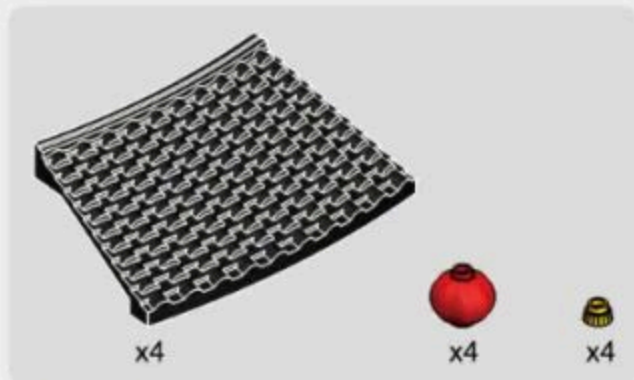

14-8

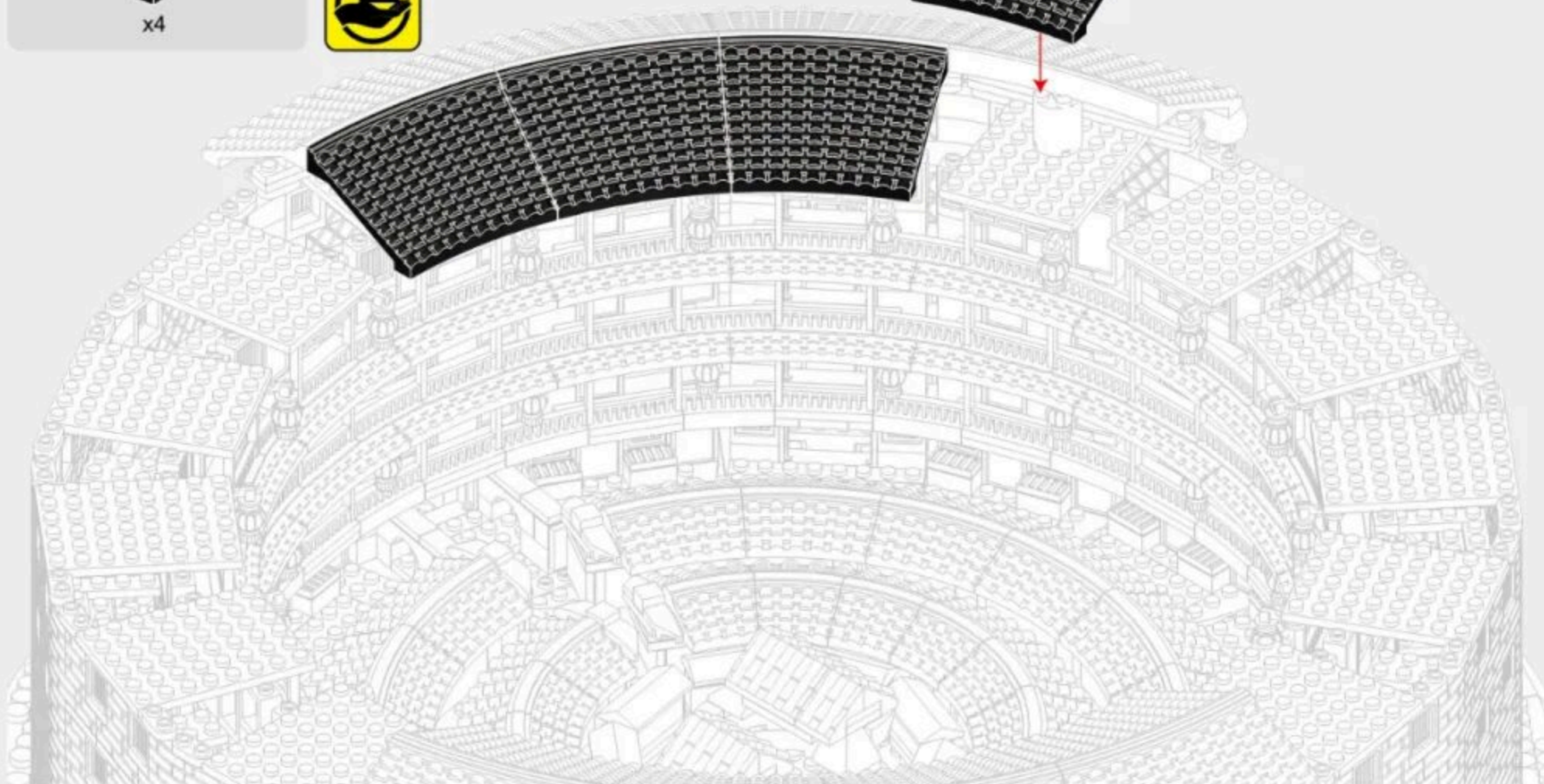
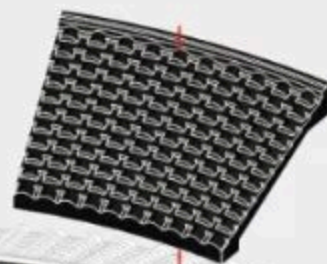
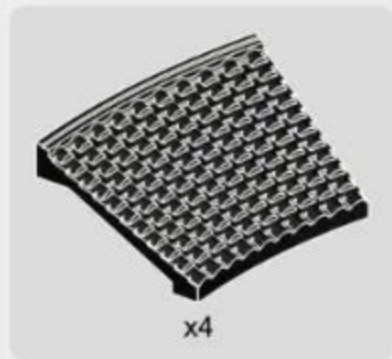

14-9

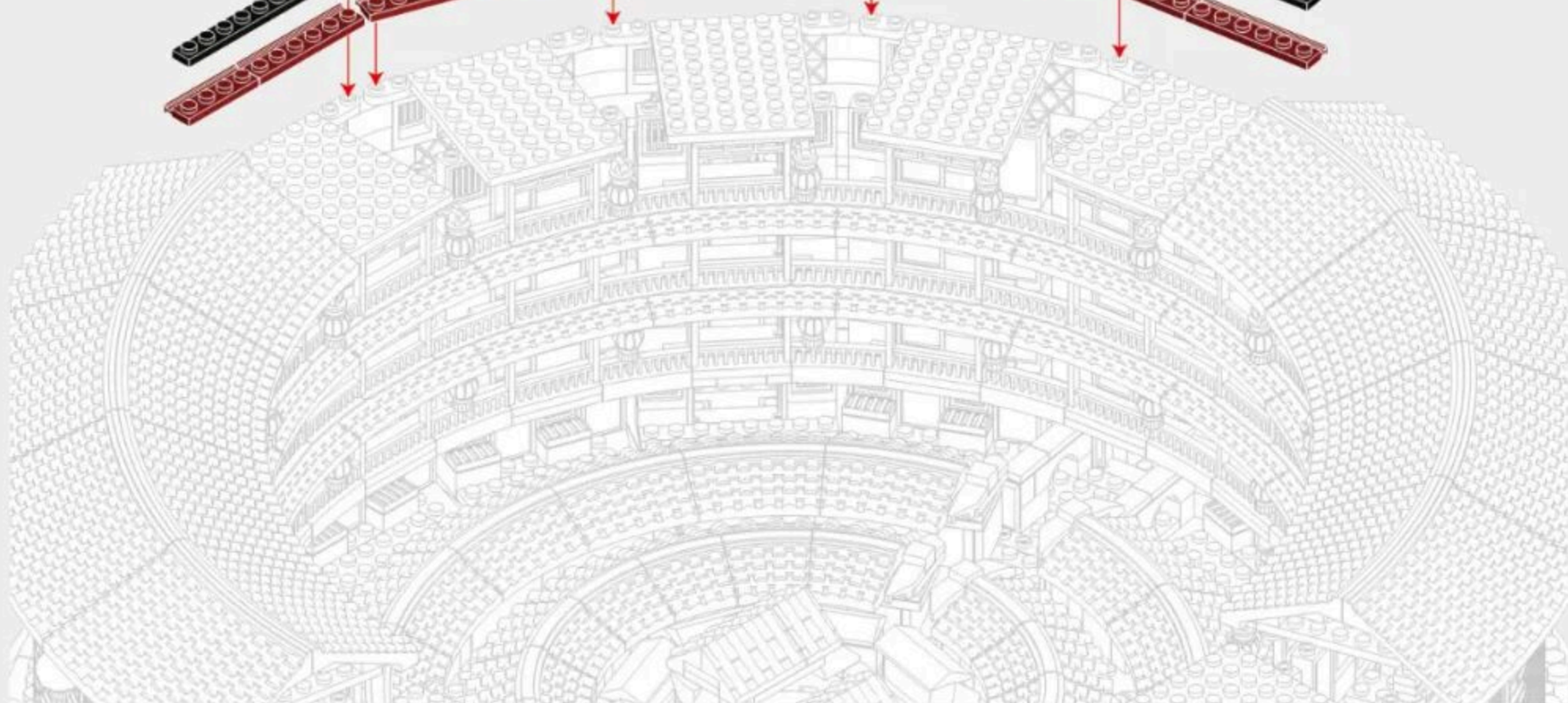
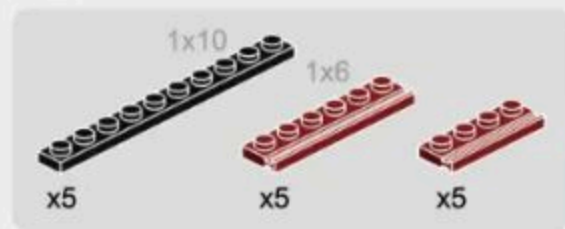

14-10

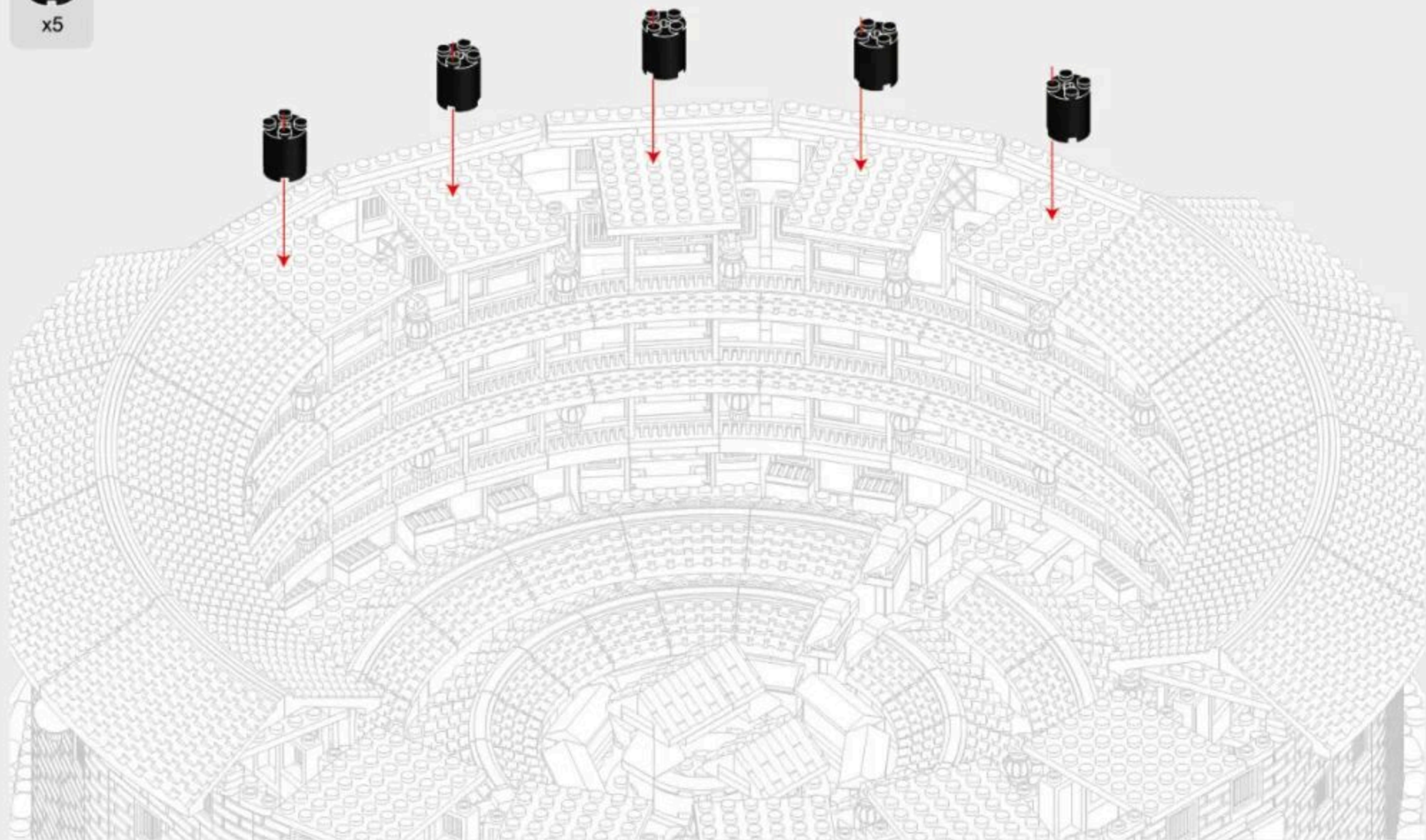

14-11

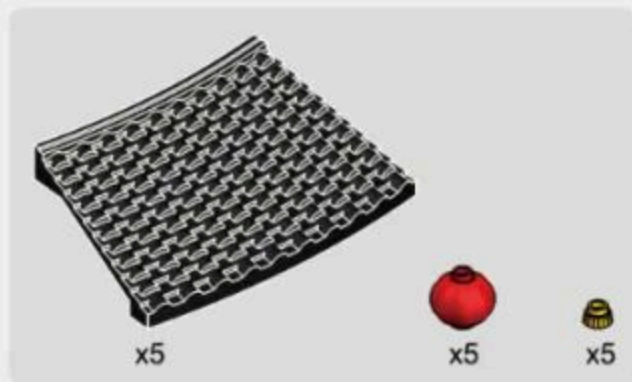

14-12

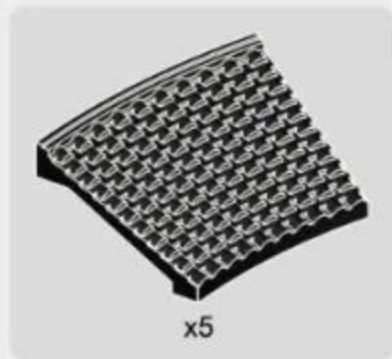

14-13



x5

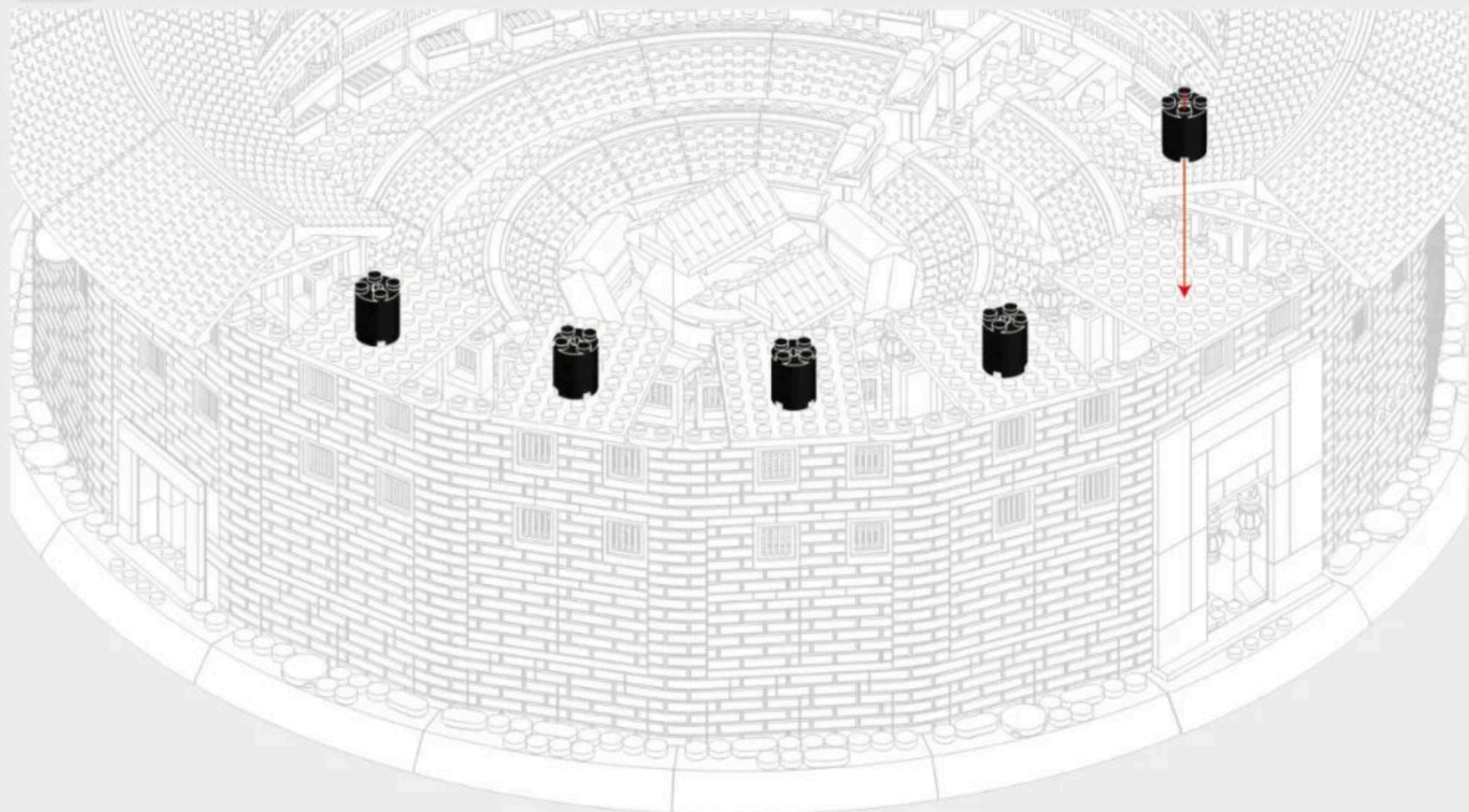

232

14-14

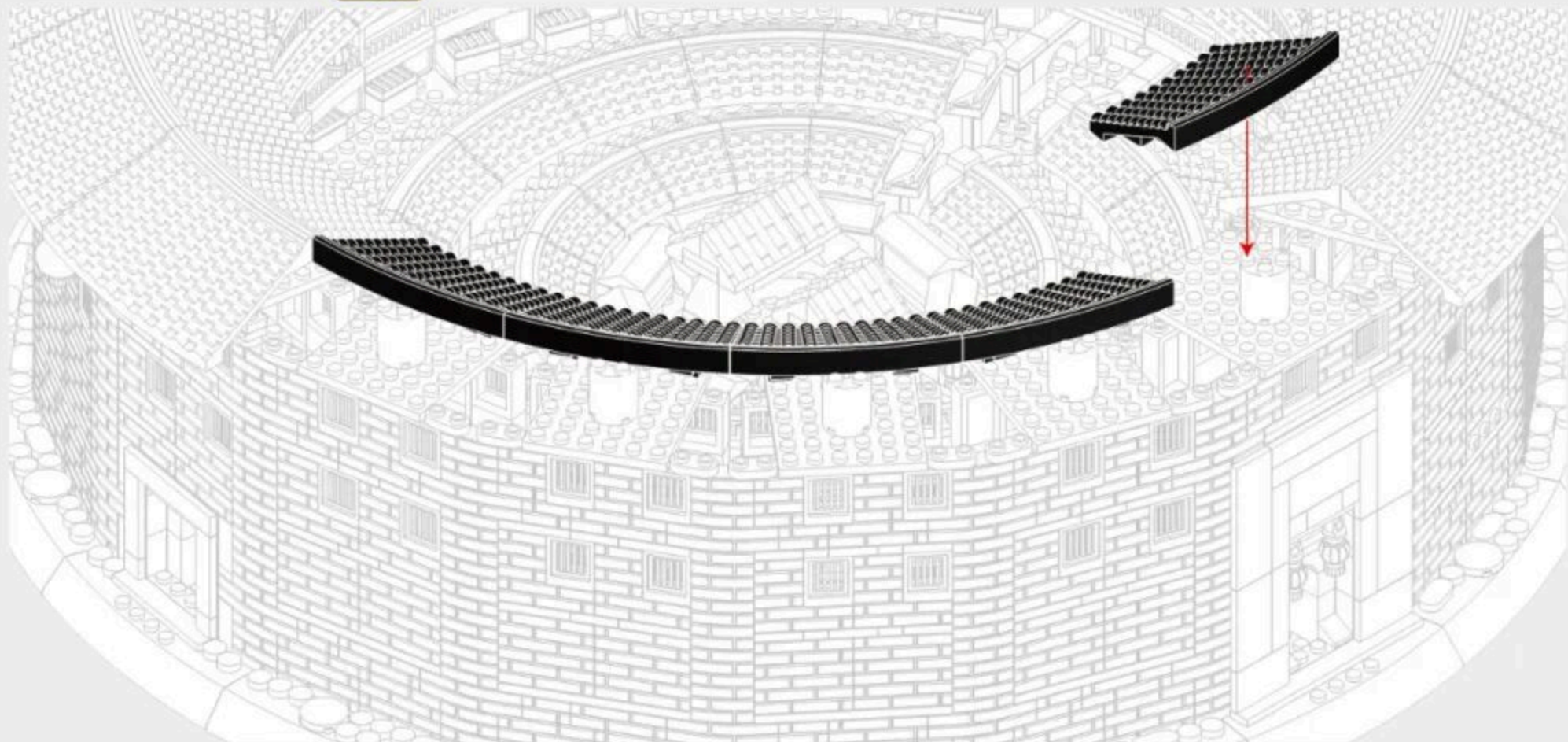
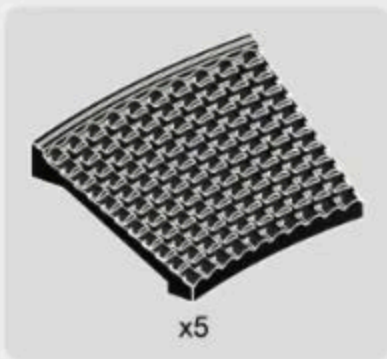

14-15

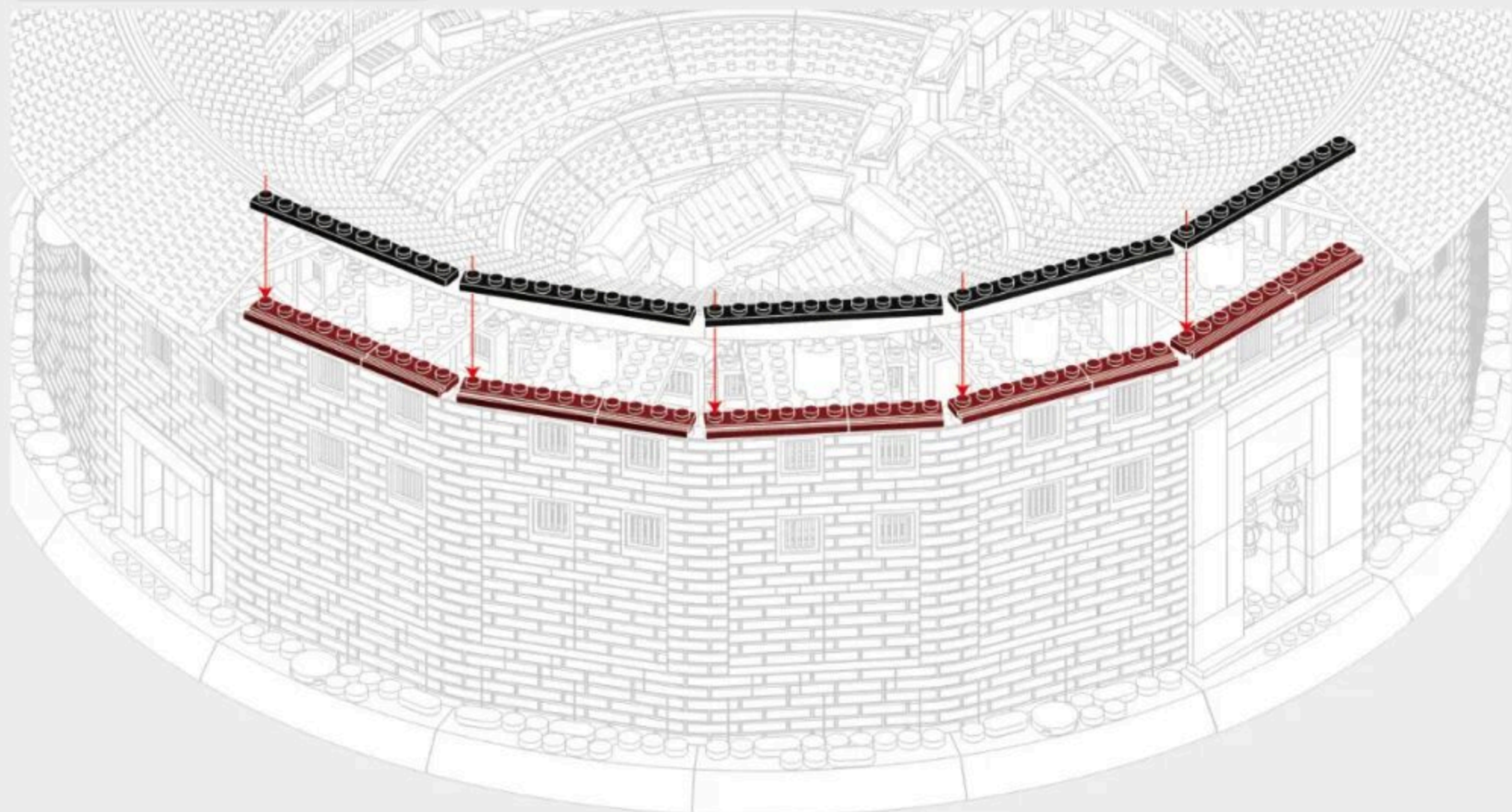
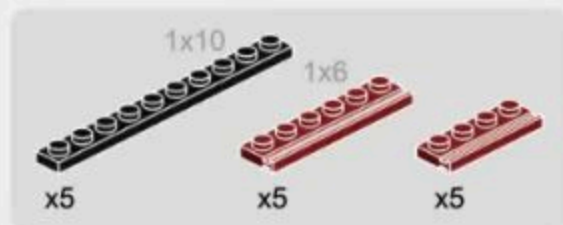

14-16

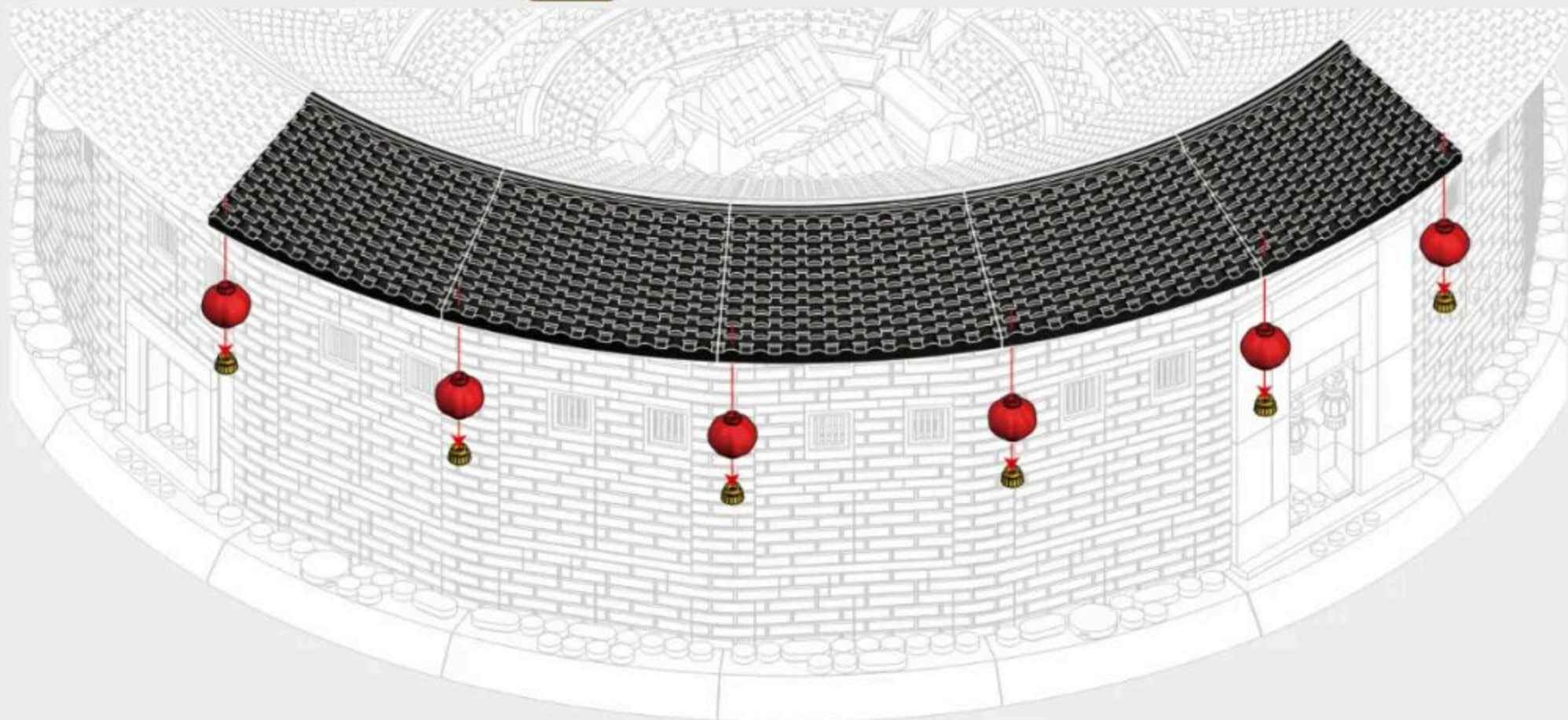
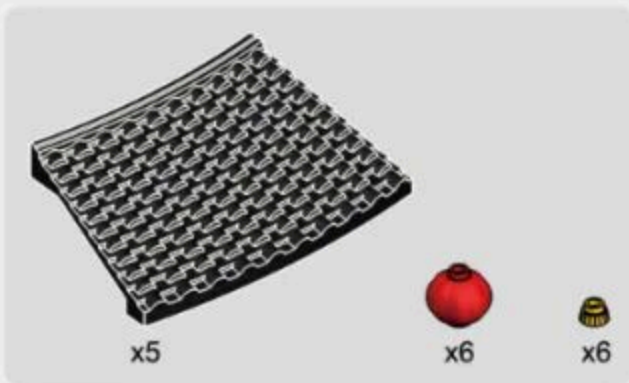

14-17

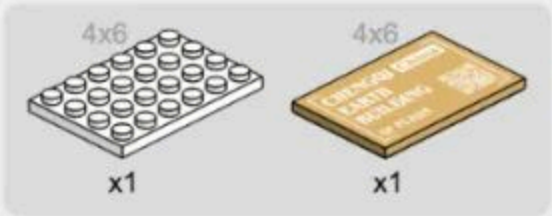

注意：此步骤仅用于搭建完整版的土楼，搭建解构版的土楼请忽略此步骤。
Tips: This step is only for constructing a complete version of the tulou.
Please ignore this step if you are constructing a deconstructed version of the tulou.

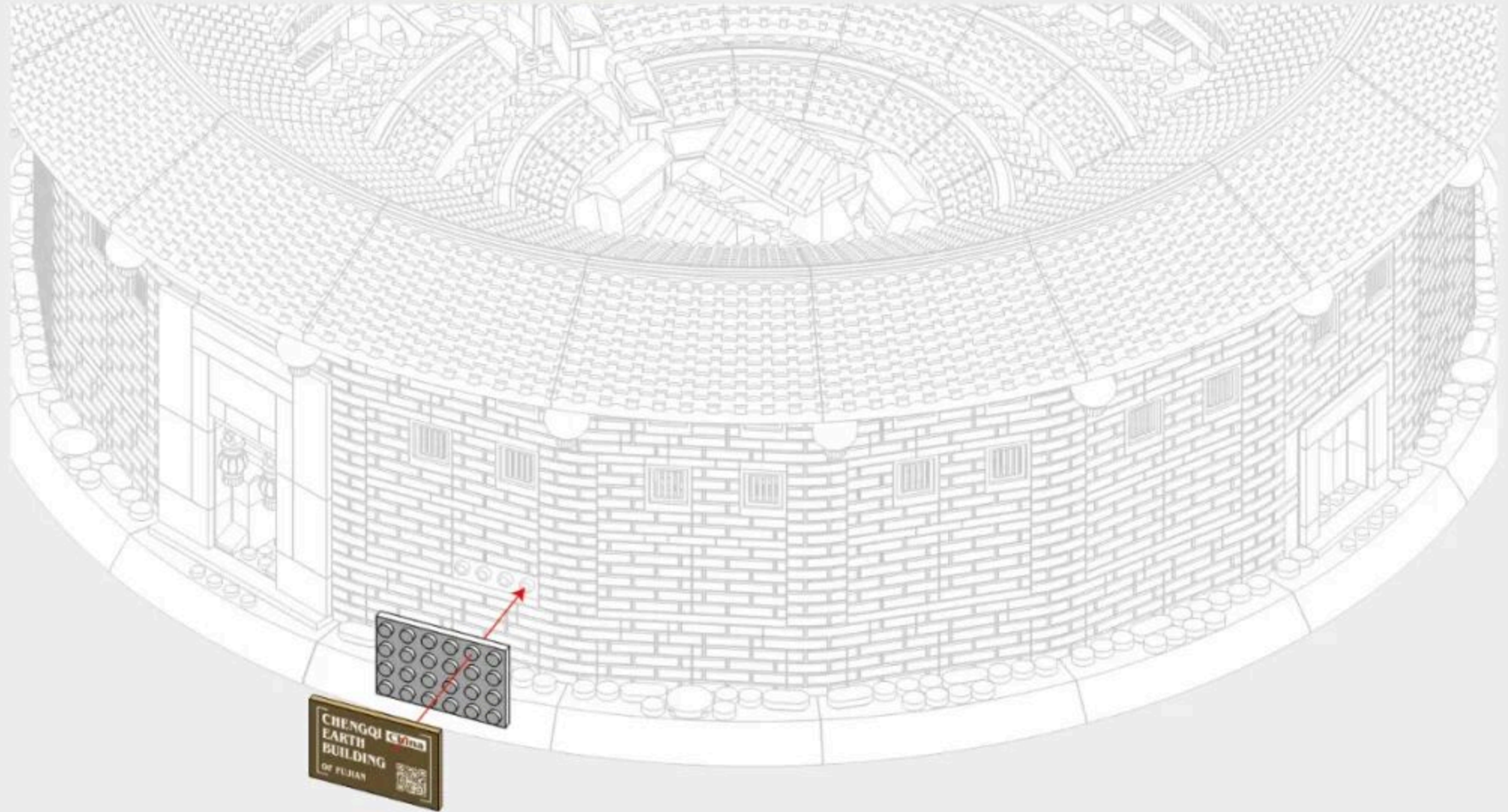

温馨提示：亲爱的万格积木玩家您好，此套产品另有灯光配件可配套装饰，如有需要请您另行到万格天猫商城或经销商处购买
Warm Reminder: Dear WanGe bricks Enthusiast, this set offers additional lighting accessories for decoration. If needed, please make a separate purchase at WanGe's Tmall store or authorized dealers.

解构版土楼
Deconstructed version of the tulou

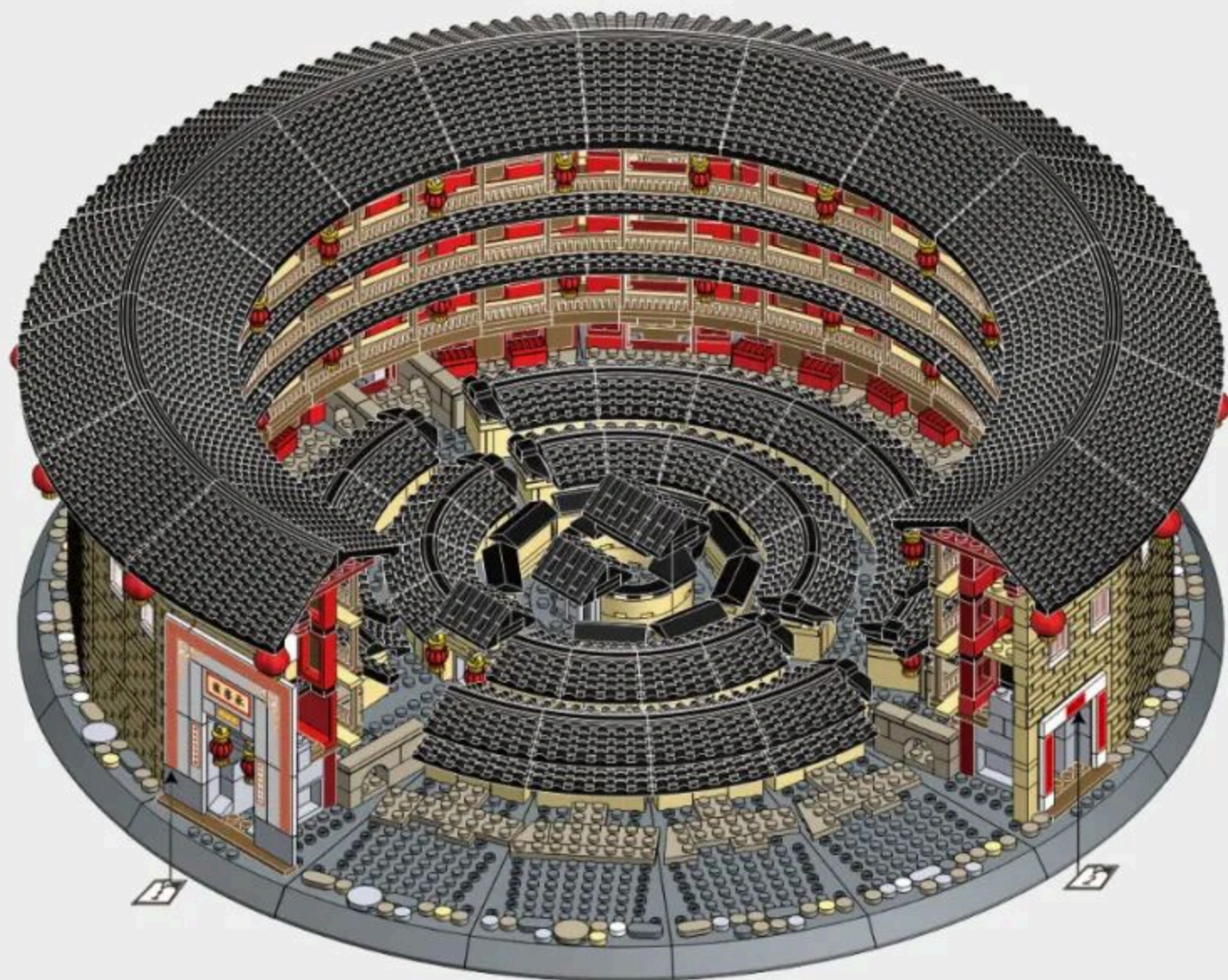

温馨提示：亲爱的万格积木玩家您好，此套产品另有灯光配件可配套装饰，如有需要请您另行到万格天猫商城或经销商处购买
Warm Reminder: Dear WanGe bricks Enthusiast, this set offers additional lighting accessories for decoration. If needed, please make a separate purchase at WanGe's Tmall store or authorized dealers.

完整版土楼
complete version of the tulou

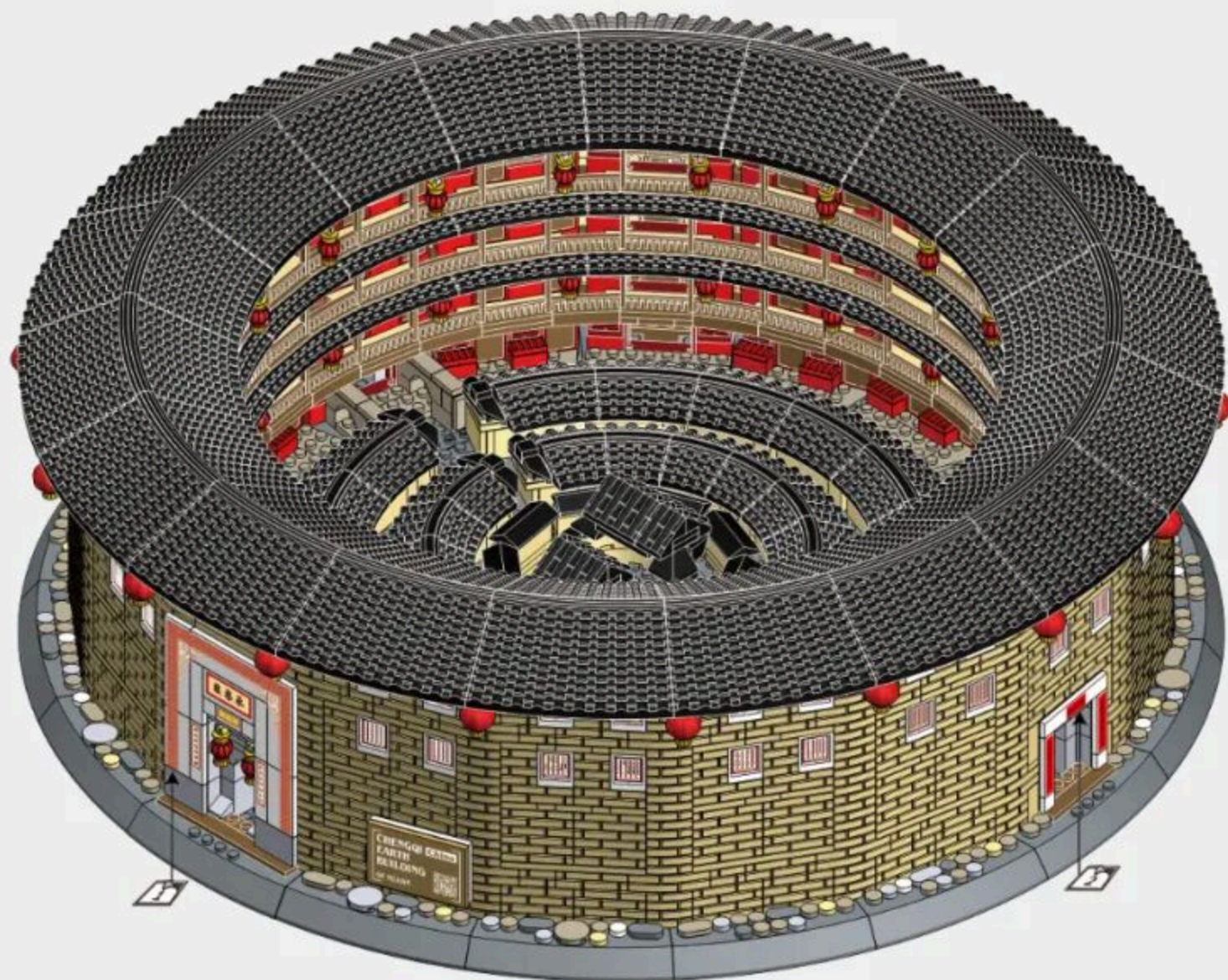

ARCHITECTURE

The World's great architecture

Shaping Skills Imagination & Curiosity Mathematical Self Discovery & Perception Parent-Child Interaction Problem Solving Creativity



6224 英国伦敦白金汉宫
BUCKINGHAM PALACE-LONDON,ENGLAND



5225 意大利罗马斗兽场
COLOSSEUM-ROME,ITALY



5226 日本东京帝国饭店
IMPERIAL HOTEL-TOKYO,JAPAN



5227 美国纽约自由女神像
STATUE OF LIBERTY-NEW YORK,AMERICA



6211 德国柏林勃兰登堡门
BRANDENBURG GATE-BERLIN, GERMANY



6222 中国甘肃长城-嘉峪关
JIAYU PASS-GANSU,CHINA



6212 日本京都清水寺仁王门
NIOMON GATE OF KIYOMIZU-DERA-KYOTO,JAPAN



6213 俄罗斯莫斯科瓦西里大教堂
SAINT BASIL'S CATHEDRAL-MOSCOW,RUSSIA



6214 中国武汉黄鹤楼
YELLOW CRANE TOWER-WUHAN,CHINA



6215 英国伦敦眼
LONDON EYE-LONDON,ENGLAND



6221 中国北京故宫-太和殿
HALL OF SUPREME HARMONY-BEIJING,CHINA



6220 沙特阿拉伯麦加大清真寺
GREAT MOSQUE OF MECCA,SAUDI ARABIA



6219 美国纽约联合国大厦
UNITED NATIONS HEADQUARTERS-NEW YORK,AMERICA



4214 美国华盛顿白宫
WHITE HOUSE-WASHINGTON D.C.,AMERICA



4212 意大利罗马许愿池
TREVI FOUNTAIN-ROME,ITALY



4213 法国巴黎卢浮宫
MUSÉE DU LOUVRE-PARIS,FRANCE



4218 新加坡-鱼尾狮
MERLION,SINGAPORE



4219 英国伦敦双子塔桥
TOWER BRIDGE-LONDON,ENGLAND



4216 美国华盛顿林肯纪念堂
LINCOLN MEMORIAL-WASHINGTON D.C.,AMERICA



4217 新加坡-金沙酒店
MARINA BAY SANDS,SINGAPORE



4210 埃及开罗吉萨金字塔
GREAT PYRAMID OF GIZA-CAIRO,EGYPT



4221 加拿大渥太华国会山庄
PARLIAMENT BUILDINGS-OTTAWA,CANADA



4211 英国伦敦伊丽莎白塔
ELIZABETH TOWER-ENGLAND



4215 加拿大多伦多电视塔
THE CN TOWER-CANADA



4220 美国纽约熨斗大厦
FLATIRON BUILDING-NEW YORK,AMERICA



4222 阿联酋迪拜哈利法塔 THE BURJ KHALIFA TOWER-DUBAI, UAE
 5224 中国上海东方明珠广播电视塔 ORIENTAL PEARL TOWER-SHANGHAI, CHINA
 5212 美国纽约帝国大厦 EMPIRE STATE BUILDING-NEW YORK, AMERICA
 5213 马来西亚吉隆坡石油双塔 PETRONAS TWIN TOWERS-KUALA LUMPUR, MALAYSIA
 5214 意大利托斯卡纳比萨斜塔 LEANING TOWER OF PISA-TUSCANY, ITALY
 5216 英国伦敦伊丽莎白塔 ELIZABETH TOWER-LONDON, ENGLAND



5219 俄罗斯莫斯科克里姆林宫钟楼 SPASSKAYA TOWER-MOSCOW, RUSSIA
 5220 阿联酋迪拜卓美亚帆船酒店 BURJ AL ARAB HOTEL-DUBAI, UAE
 5217 法国巴黎埃菲尔铁塔 EIFFEL TOWER-PARIS, FRANCE
 5221 中国台北101大楼 TAIPEI 101-TAIPEI, CHINA
 5228 美国芝加哥威利斯大厦 WILLIS TOWER-CHICAGO, AMERICA
 5231 巴西里约热内卢救世基督像 CRISTO REDENTOR-RIO DE JANEIRO, BRASIL



6223 中国武汉长江大桥 WUHAN YANGTZE RIVER BRIDGE
 5210 法国巴黎圣母院大教堂 CATHÉDRALE NOTRE DAME DE PARIS-PARIS, FRANCE
 5211 印度阿格拉泰姬陵 TAJ MAHAL-AGRA, INDIA
 5223 法国巴黎凯旋门 ARC DE TRIOMPHE-PARIS, FRANCE
 5215 英国伦敦双子塔桥 TOWER BRIDGE-LONDON, ENGLAND



5222 中国北京天坛祈年殿 HALL OF PRAYER FOR GOOD HARVESTS-BEIJING, CHINA
 6210 美国旧金山金门大桥 GOLDEN GATE BRIDGE-SAN FRANCISCO, AMERICA
 6216 中国北京万里长城（八达岭） THE GREAT WALL-BEIJING, CHINA
 5218 中国北京天安门 TIANANMEN TOWER-BEIJING, CHINA
 6217 中国西藏布达拉宫 POTALA PALACE-TIBET, CHINA



6218 芬兰罗瓦涅米圣诞老人办公室 SANTA CLAUS OFFICE-ROVANIEMI, FINLAND
 6225 墨西哥库库尔坎玛雅金字塔 EL CASTILLO-KUKULKAN, MEXICO
 6226 德国巴伐利亚新天鹅堡 SCHLOSS NEUSCHWANSTEIN-BAYERN, DEUTSCHLAND
 5229 土耳其伊斯坦布尔少女塔 MAIDEN TOWER-ISTANBUL, TURKEY
 5230 中国湖南长沙爱晚亭 AIWANTING PAVILION-HUNAN, CHINA



7210 中国上海世博会中国馆
CHINA PAVILION AT EXPO-SHANGHAI, CHINA



5232 美国宾夕法尼亚州流水别墅
FALLINGWATER-PENNSYLVANIA, AMERICA



5233 美国芝加哥范斯沃斯住宅
FARNSWORTH HOUSE-CHICAGO, AMERICA



5234 美国华盛顿唐人街
CHINA TOWN-WASHINGTON, D.C., AMERICA



3210 美国纽约自由女神像
STATUE OF LIBERTY-NEW YORK, AMERICA



4223 中国北京清华园
TSINGHUA CAMPUS-BEIJING, CHINA



7211 中国湖南岳阳楼
YUEYANG TOWER-HUNAN, CHINA



8210 澳大利亚悉尼歌剧院
SYDNEY OPERA HOUSE-BENNELONG POINT, AUSTRALIA



7212 中国江西南昌滕王阁
PAVILION OF PRINCE TENG-JIANGXI, CHINA



6227 中国河南郑州嵩山少林寺
SHAOLIN TEMPLE-HENAN, CHINA



7213 中国重庆洪崖洞
HONGYADONG-CHONGQING, CHINA



5235 美国华盛顿国会大厦
UNITED STATES CAPITOL-WASHINGTON D.C., AMERICA



5236 中国安徽滁州醉翁亭
ZUIWENG PAVILION-ANHUI, CHINA



6228 中国陕西西安钟楼
XI'AN BELL TOWER-SHAANXI, CHINA



5238 美国西雅图太空针塔
SPACE NEEDLE-SEATTLE, AMERICA



5237 法国巴黎萨伏伊别墅
VILLA SAVOYE-PARIS, FRANCE



6229 中国山西运城鹳雀楼
STORK TOWER-SHANXI, CHINA



6230 希腊爱情海圣托里尼岛
SANTORINI-FIRA, GREECE



6231 中国上海海关大楼
SHANGHAI CUSTOMS HOUSE-SHANGHAI, CHINA



5239 中国北京紫禁城角楼
TURRET OF PALACE MUSEUM-BEIJING, CHINA



5240 韩国首尔崇礼门
NAMDAEMUN-SEOUL, KOREA



5241 中国江苏南京夫子庙
CONFUCIUS TEMPLE-JIANGSU, CHINA



5242 美国纽约古根海姆博物馆
GUGGENHEIM MUSEUM-NEW YORK, AMERICA



6232 中国江苏南京秦淮河画舫
QINHUI RIVER PAINTED BOAT-JIANGSU, CHINA



6233 法国诺曼底圣米歇尔山
SAINT MICHAEL'S MOUNT-NORMANDY, FRANCE



6234 中国河南洛阳栾川老君山
THE LAOJUN MOUNTAIN-HENAN, CHINA



5243 耶路撒冷岩石圆顶
DOME OF THE ROCK-JERUSALEM



6235 中国江苏苏州寒山寺 (普明宝塔)
HANSHAN TEMPLE-JIANGSU, CHINA



4224 英国威尔特郡巨石阵
STONEHENGE-WILTSHIRE, ENGLAND



4225 中国内蒙古自治区蒙古包
MONGOLIAN YURT-INNER MONGOLIA, CHINA



8211 中国福建土楼(承启楼)
CHENGQI EARTH BUILDING, CHINA