

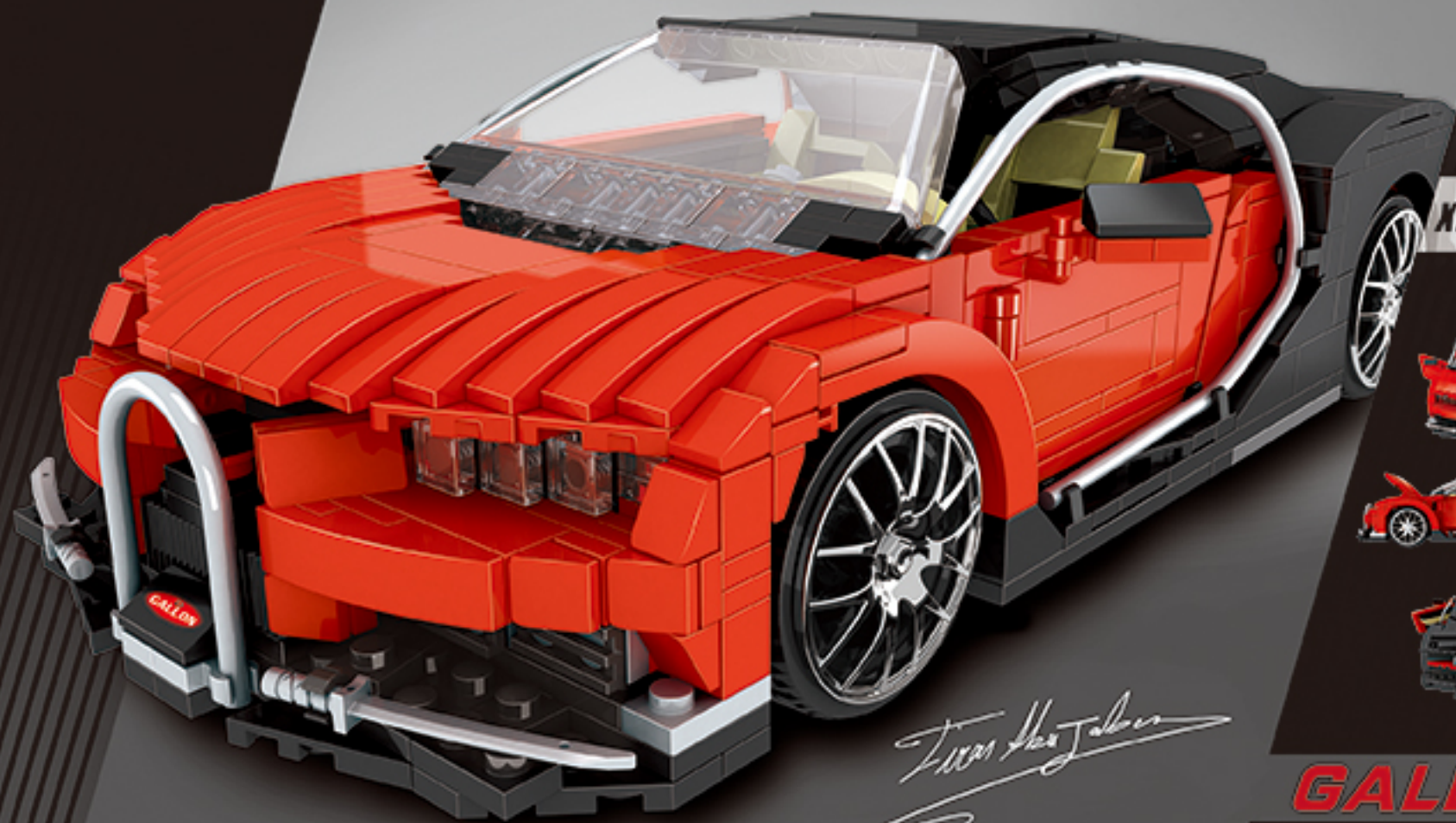

DREAM-CAR



XB-03009



Texas Hot Jobs

GALLON

About the Author's profile:

作者简介:

Name: Firas Munir Abu-Jaber **Nationality:** Jordan

姓名: Firas Munir Abu-Jaber 国籍: 约旦

He played bricks when he was children ,most of the works are to build supermodel with bricks,
孩童时期开始玩积木,大部分作品是用颗粒搭建超级车模。

the most famous model is the 2005 Ford GT,
最著名的车型是2005福特GT,

the work was uploaded to many international websites and magazines, including the Lego official website.
该作品被上传到许多国际网站和杂志,包括乐高官网。

In addition to the car model, Firas is also keen on the creation of other themed works,
除了汽车模型外,Firas也热衷于其他主题作品的创作,

such as jet fighters, helicopters, luxury yachts and so on.
比如喷气战斗机、直升机、豪华游艇等等。

Works are published on a variety of websites, magazines and books,
作品多次刊登于各种网站、杂志和书籍,

including "Topgear", "Blocks" magazine, "Bricks" magazine, "The Art of LEGO Scale Modeling"
包括"Topgear"、"Blocks"杂志、"Bricks"杂志、《The Art of LEGO Scale Modeling》等等

Rolls-Royce is the first prize at "brothers-brick".
劳斯莱斯作品更是在"brothers-brick"举行的比赛中获得一等奖。



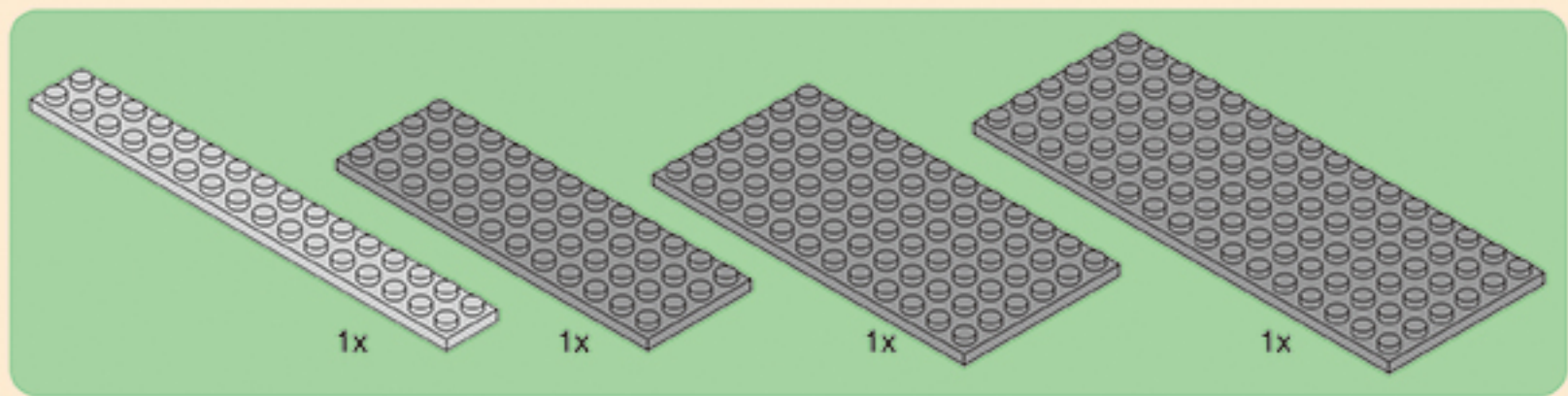

1-1

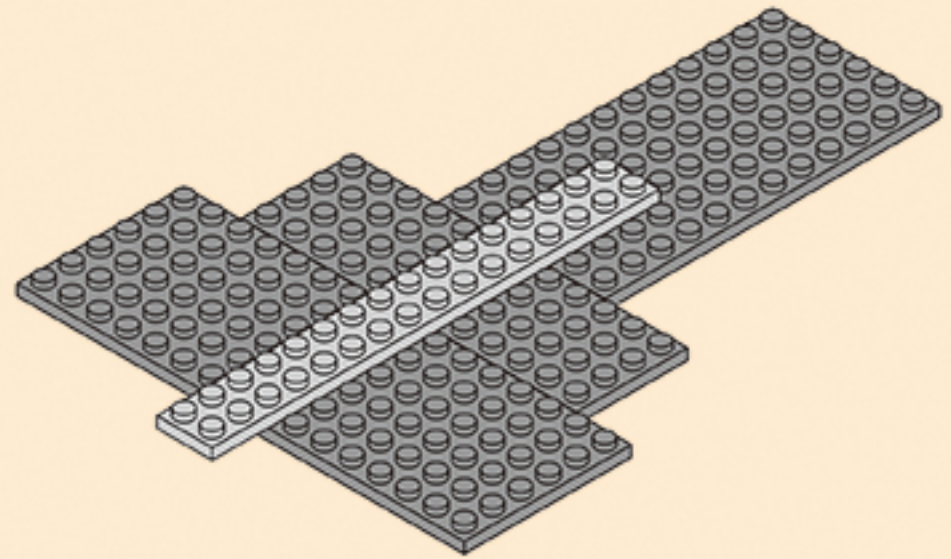

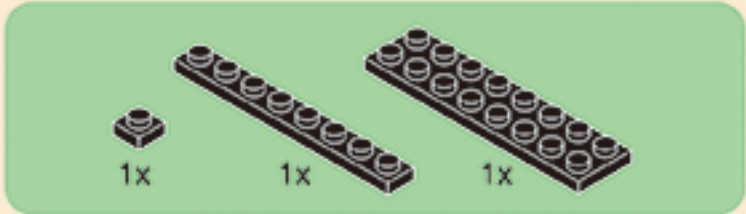

1-2.1

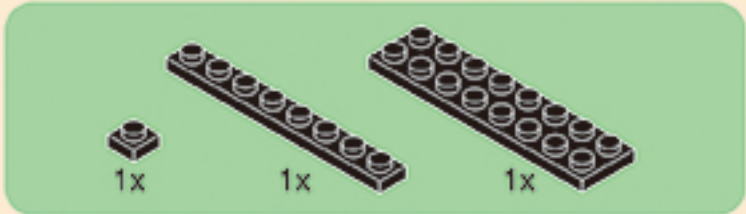
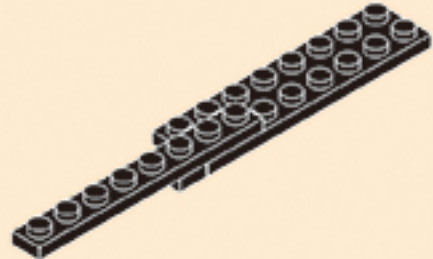
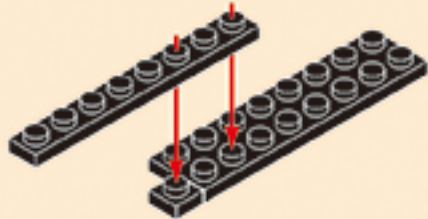

1-2.2

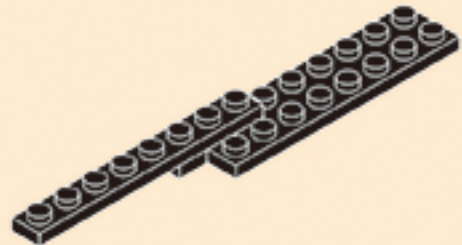
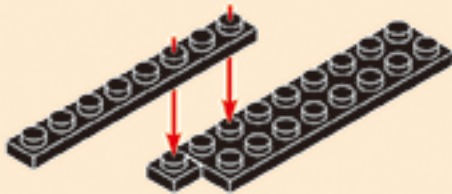

1-2

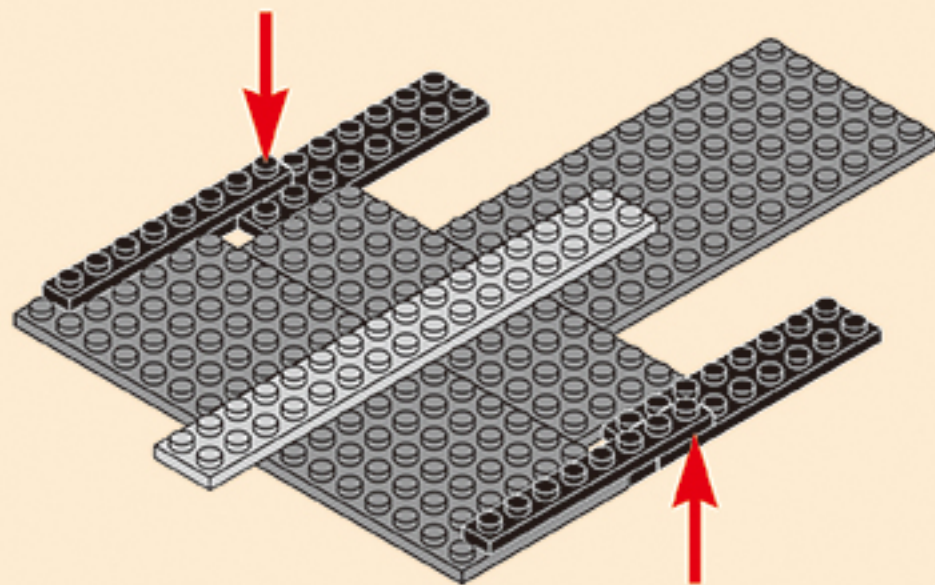

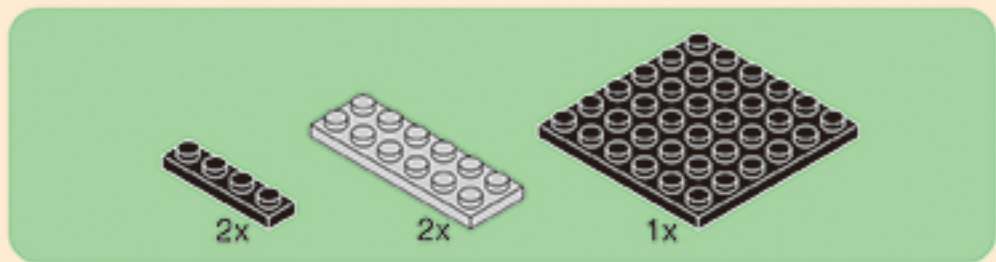

1-3

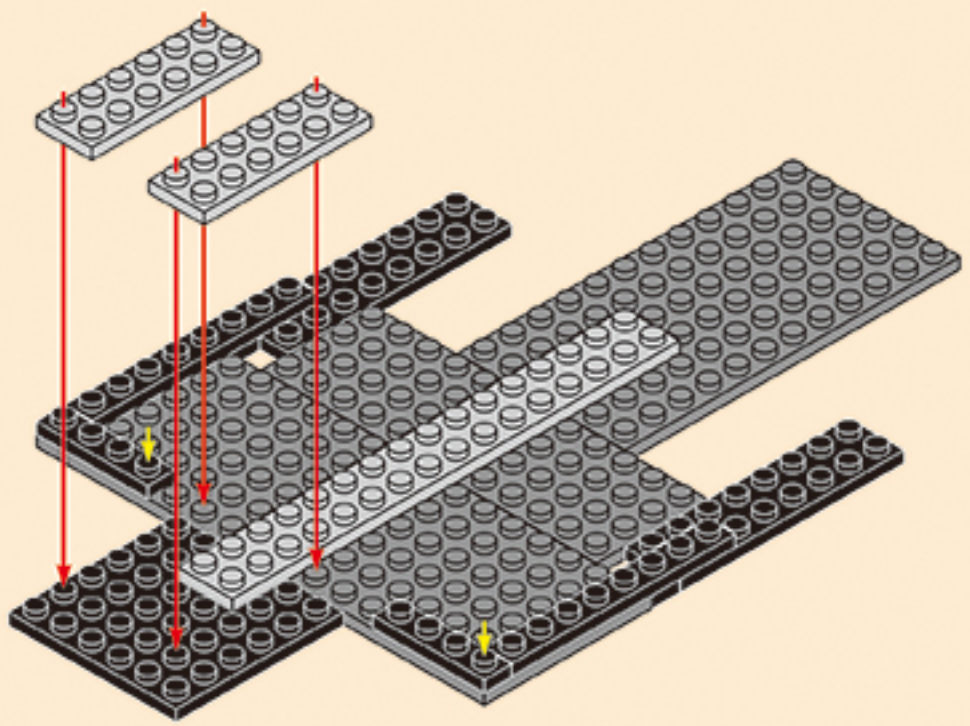

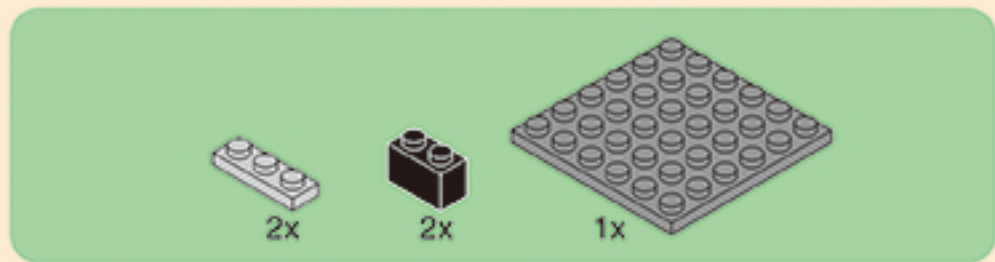

1-4

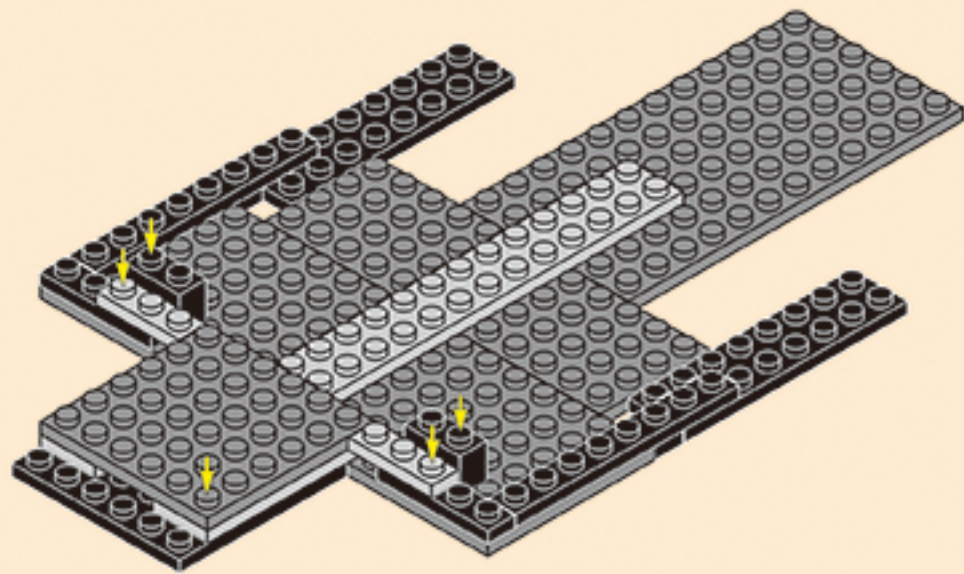

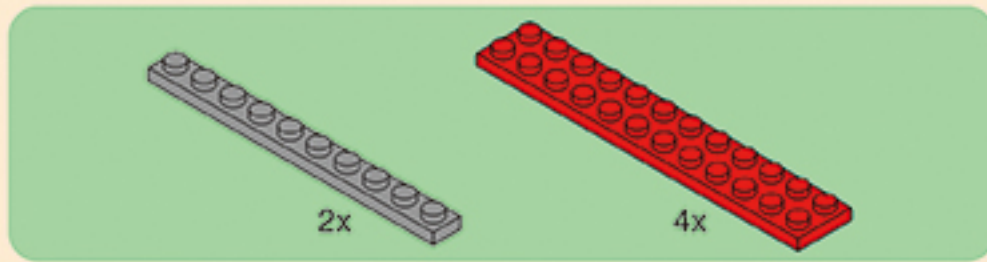

1-5

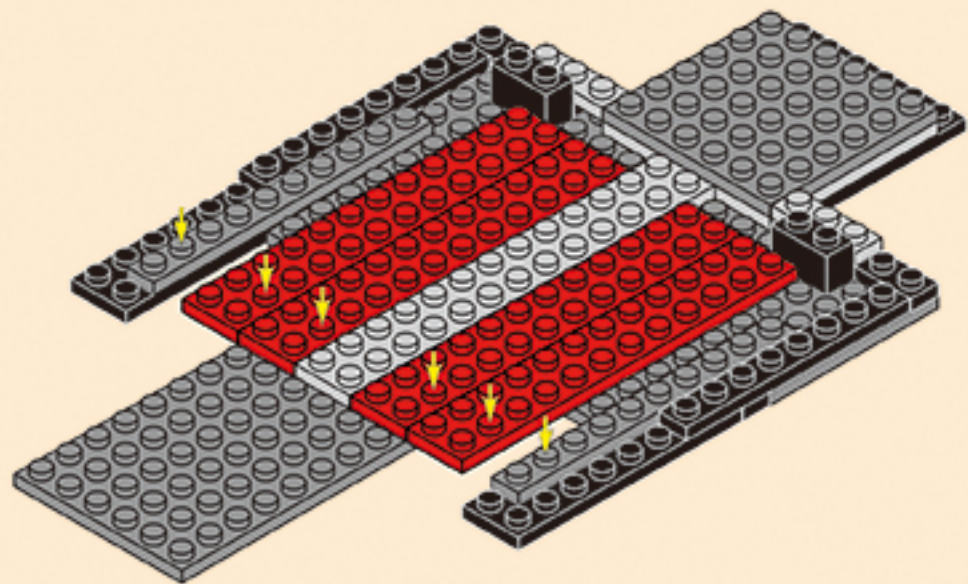

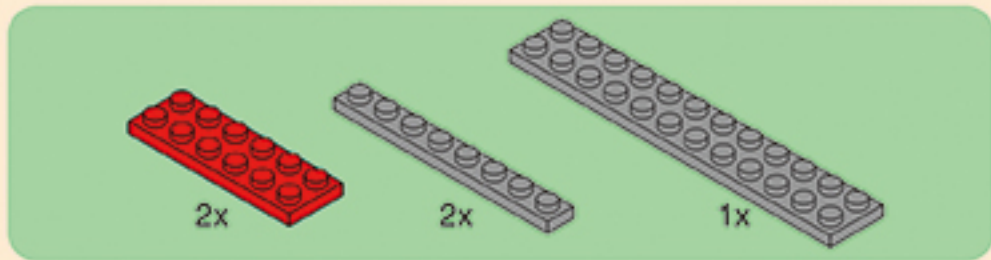

1-6

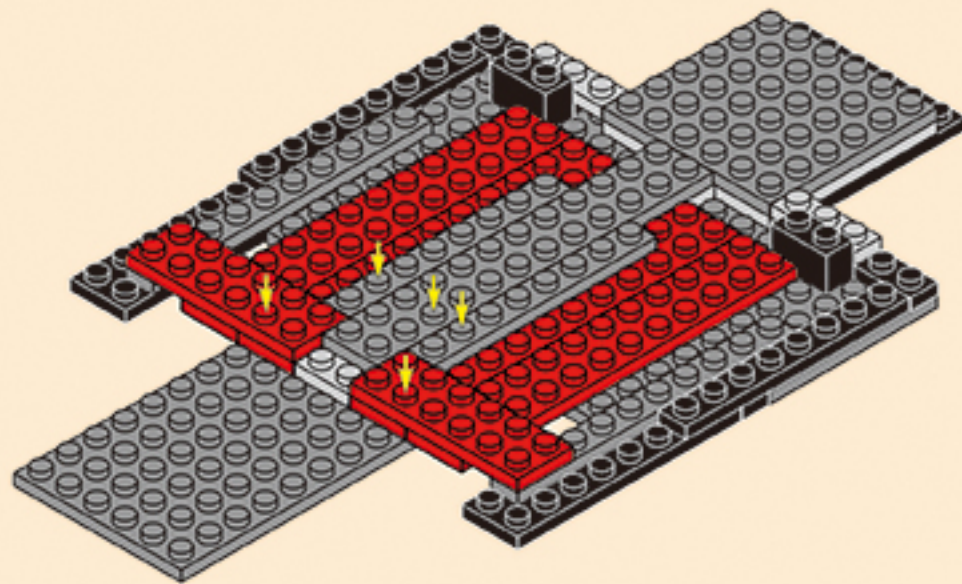

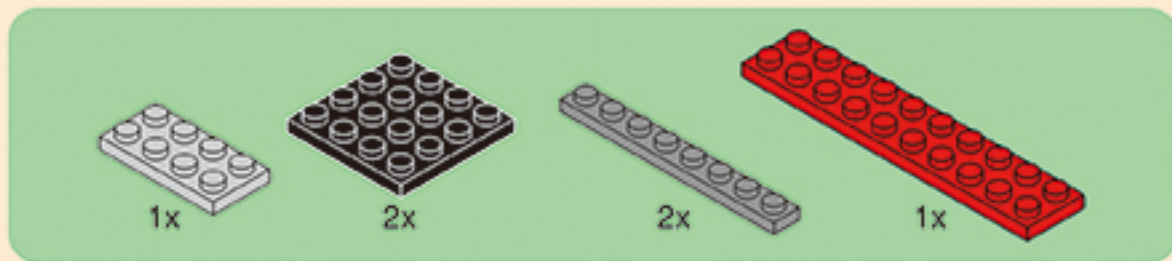

1-7

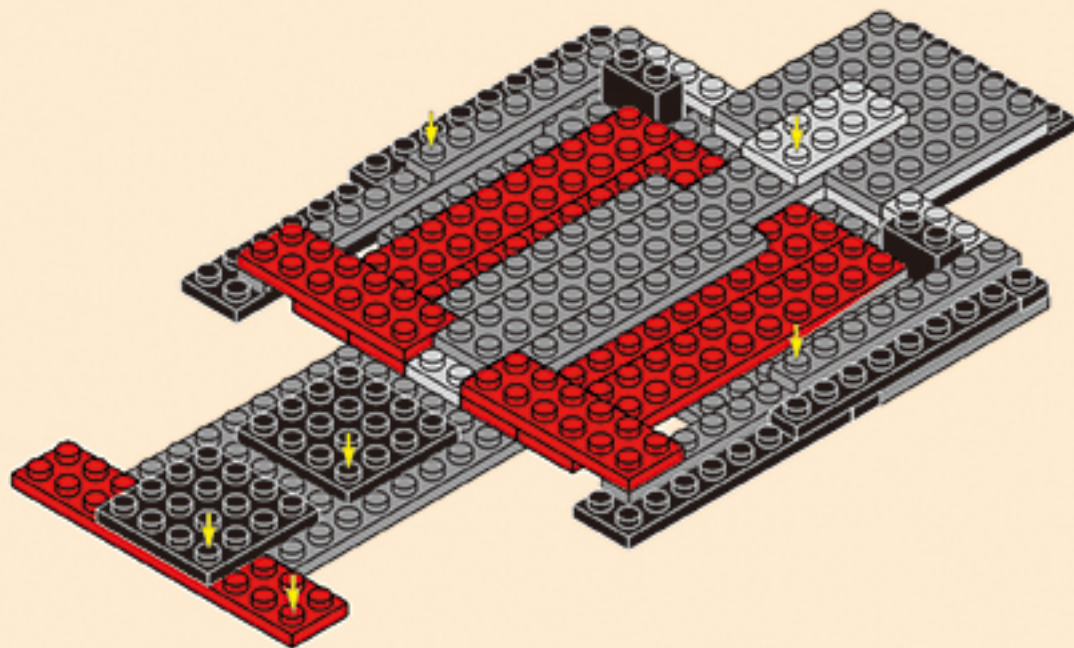

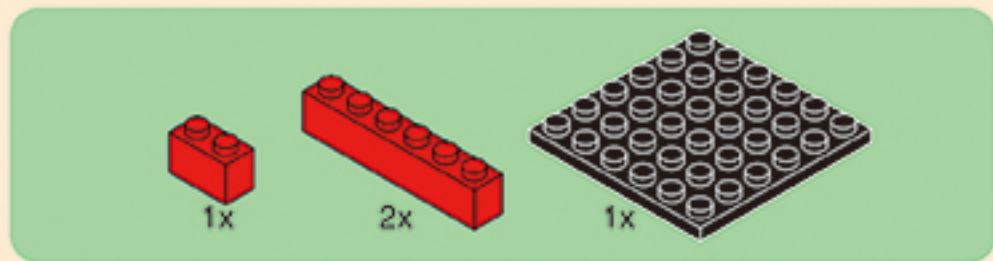

1-8

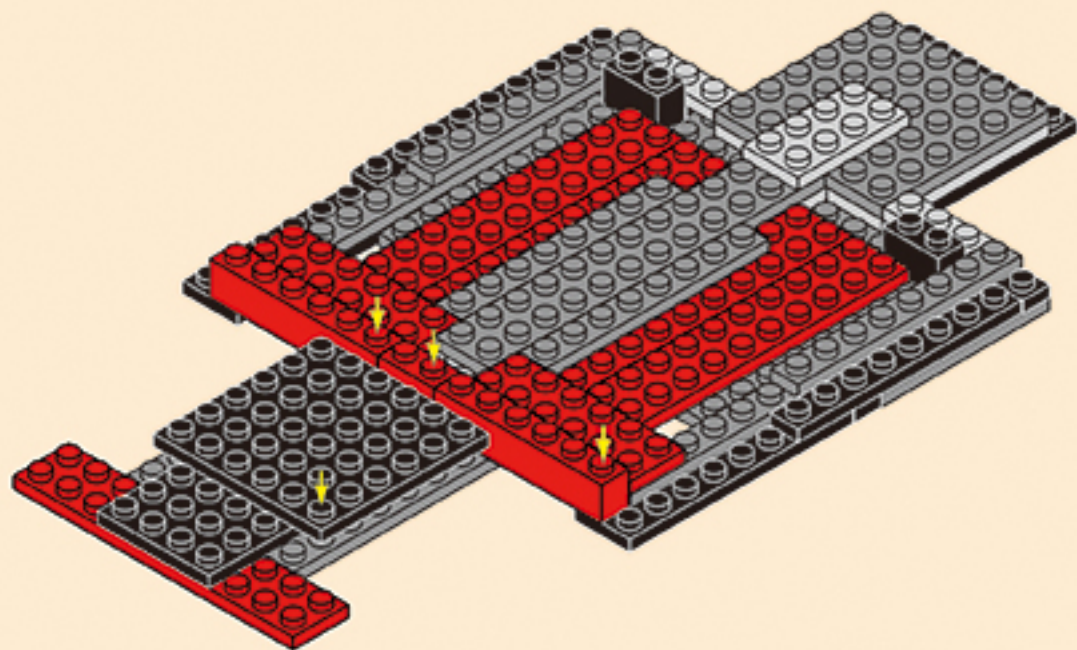

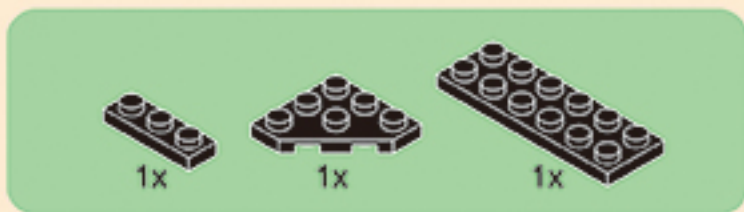

1-9.1

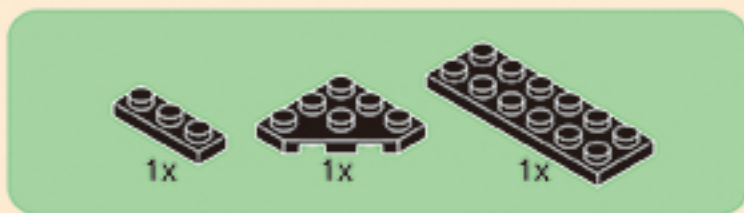
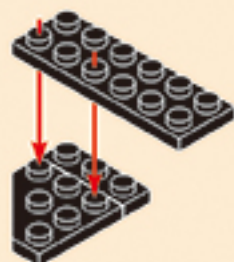

1-9.2

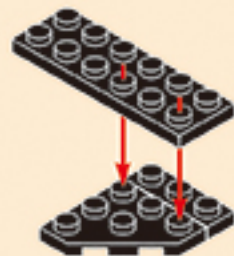

1-9

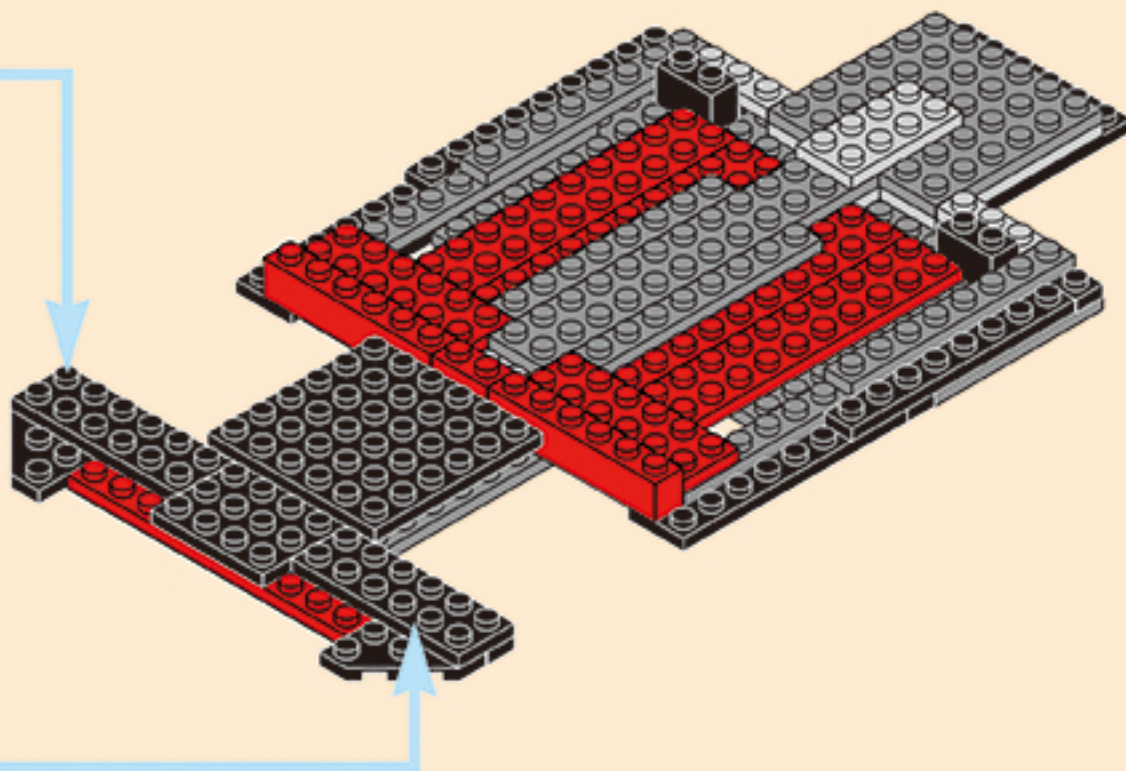

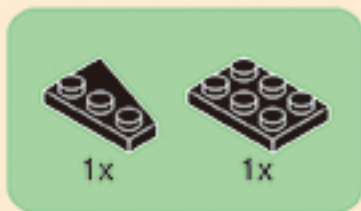

1-10.1

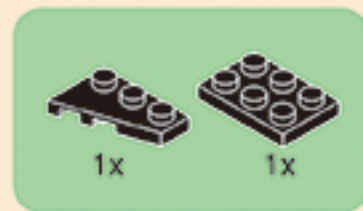

1-10.2



1-10

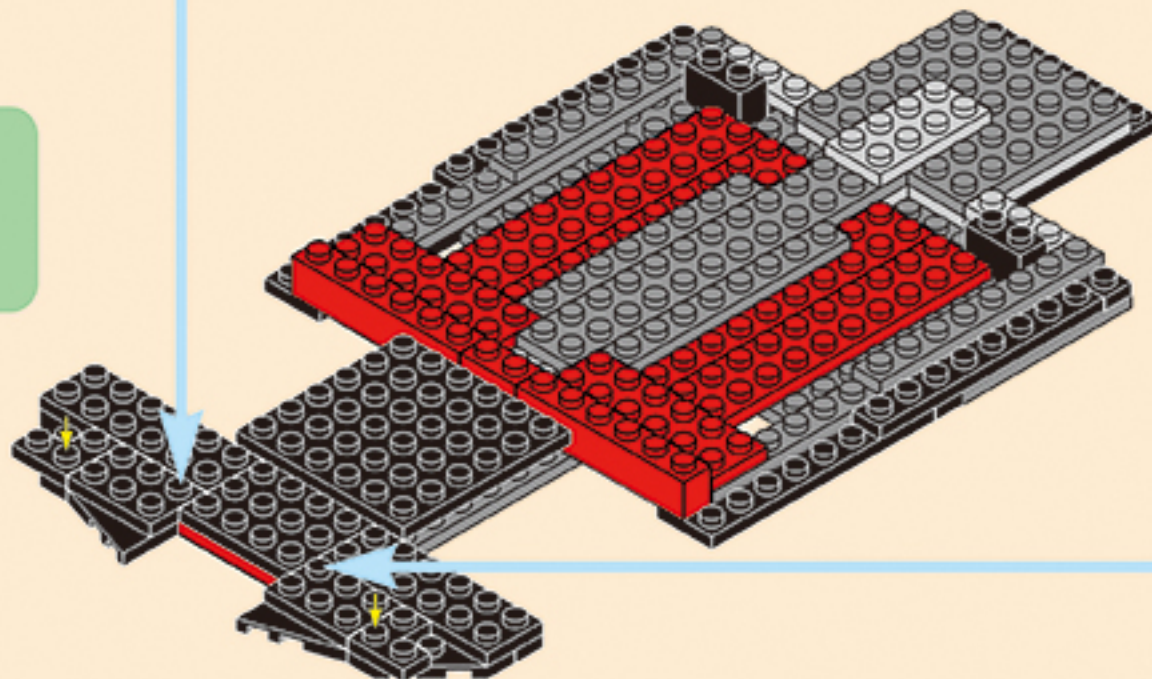

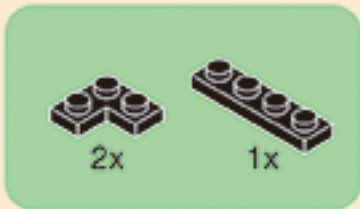

1-11.1

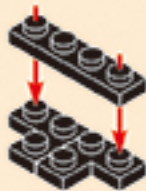

1-11.2

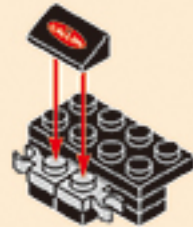

1-11

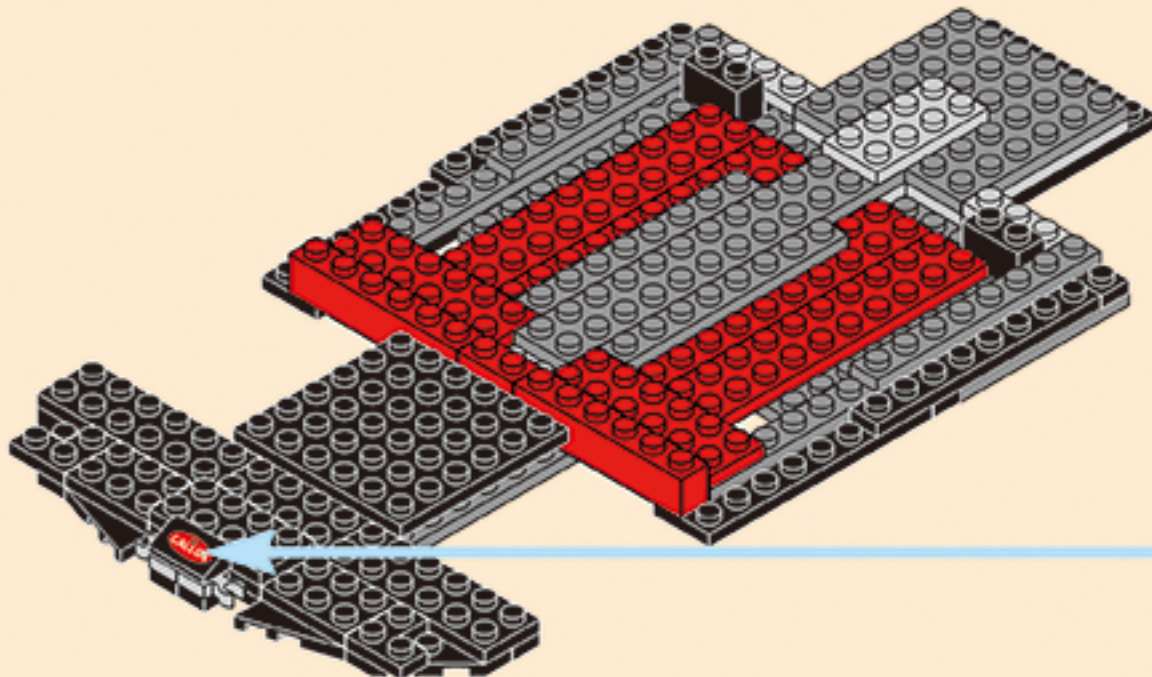

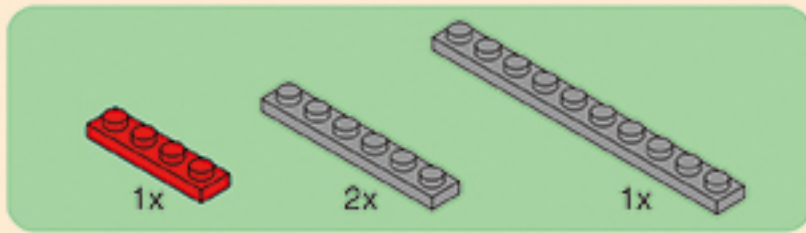

1-12

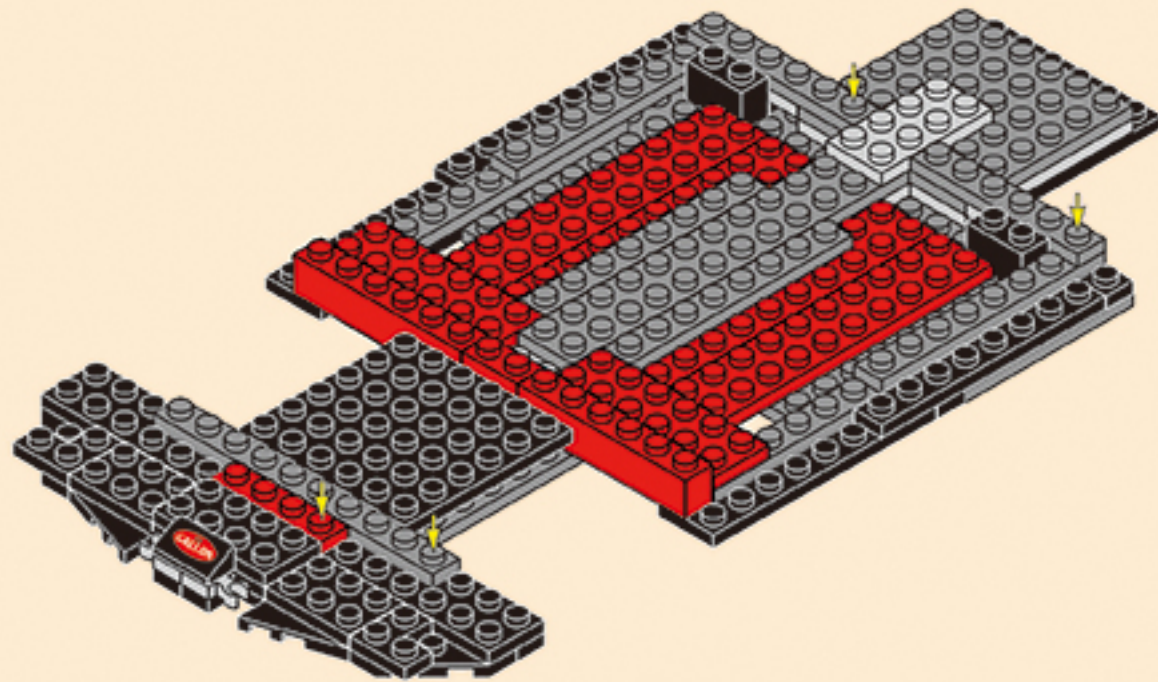

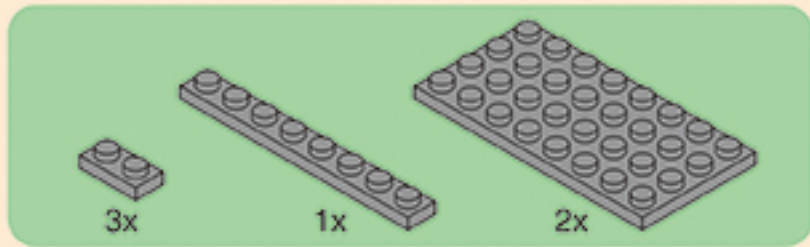

1-13

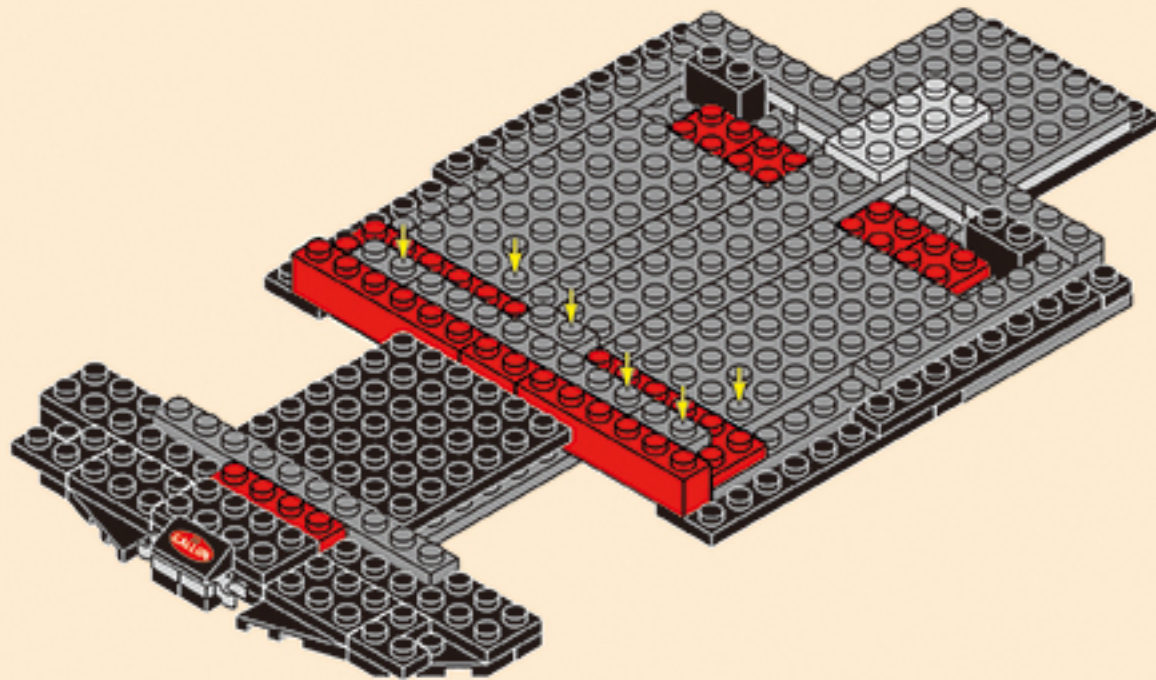

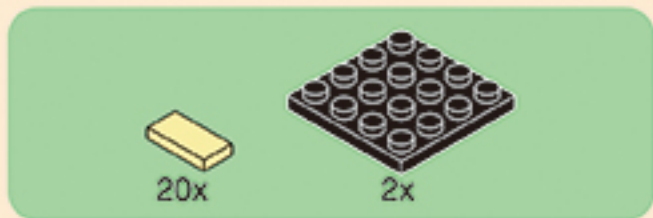

1-14

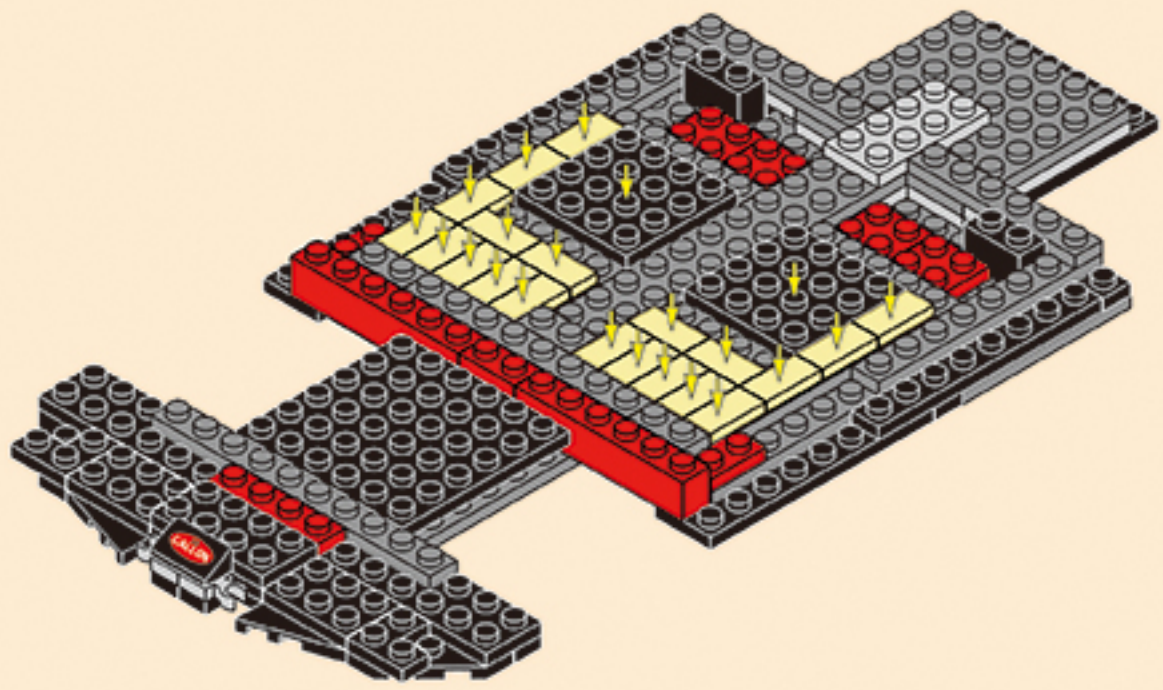

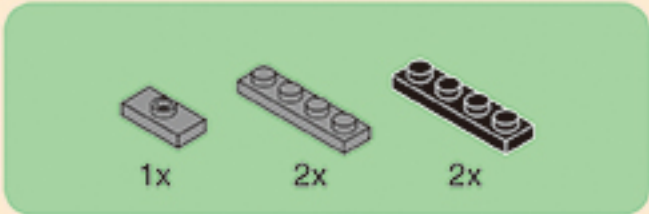

1-15

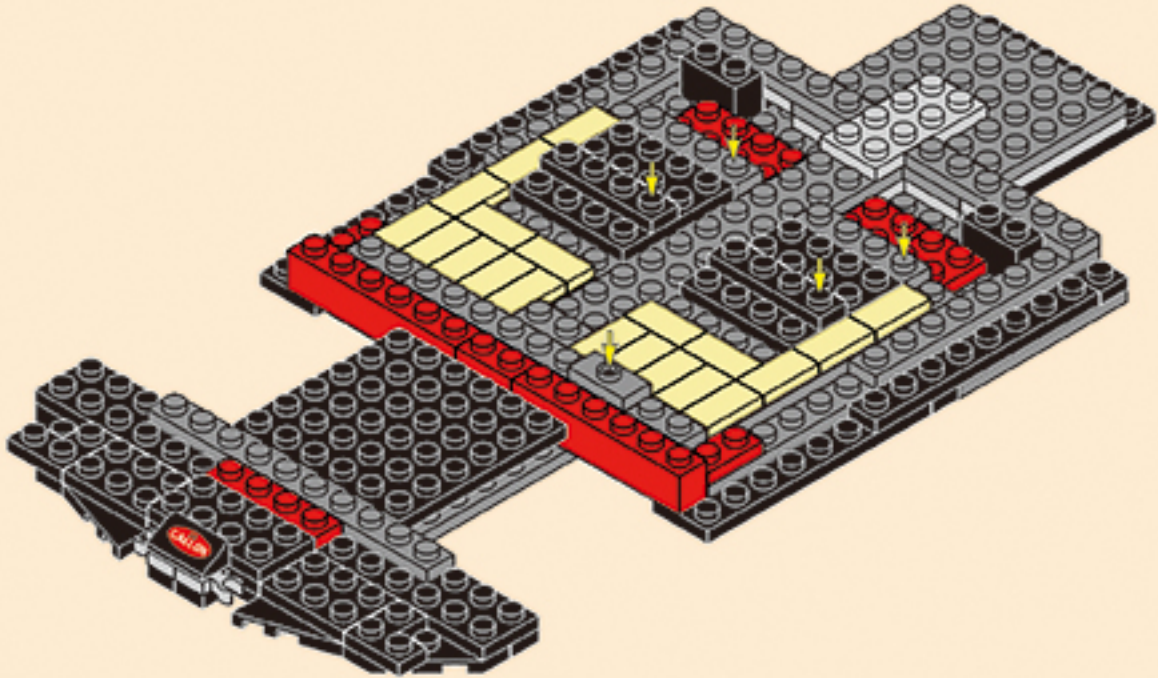

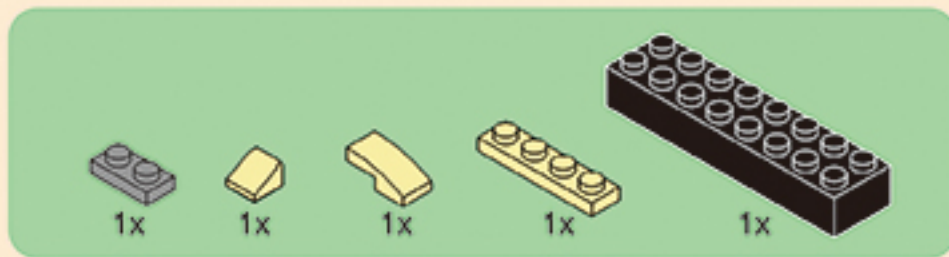

1-16

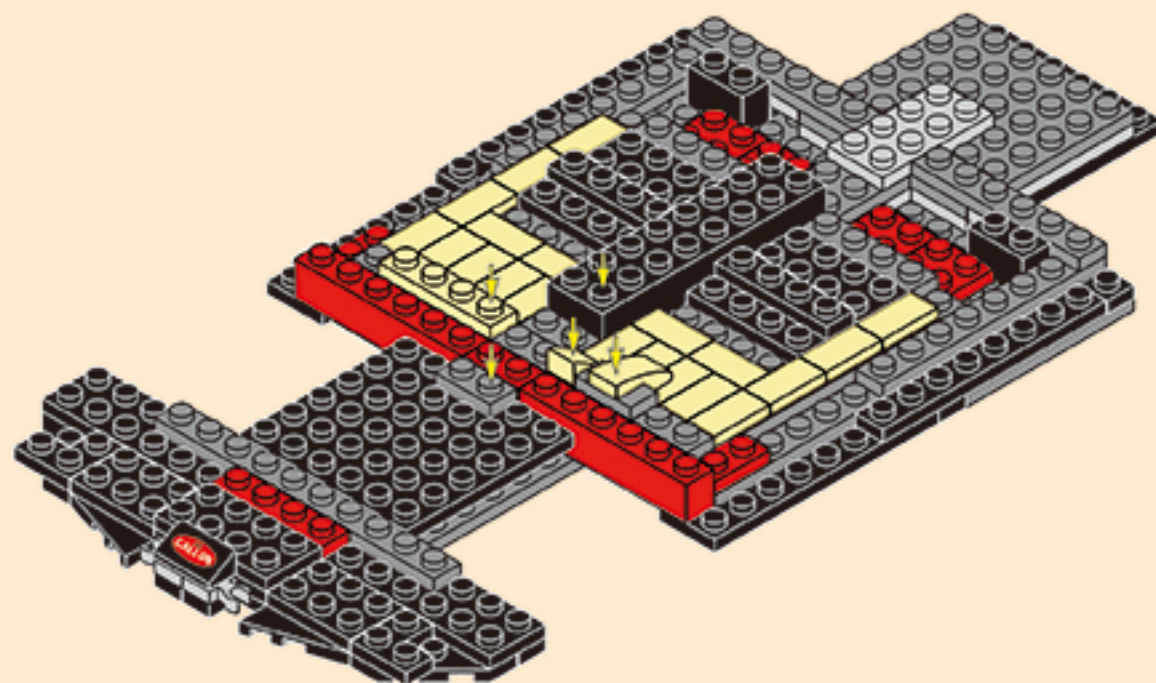

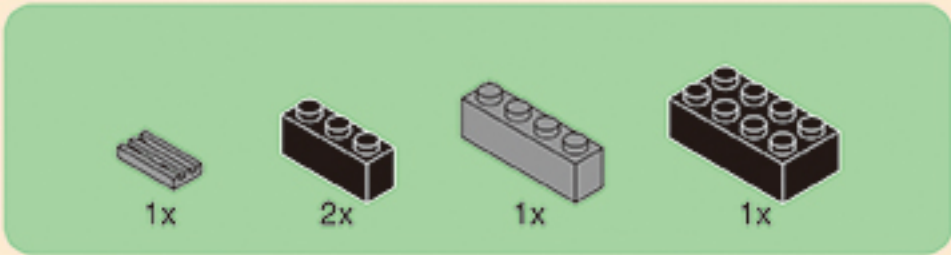

1-17

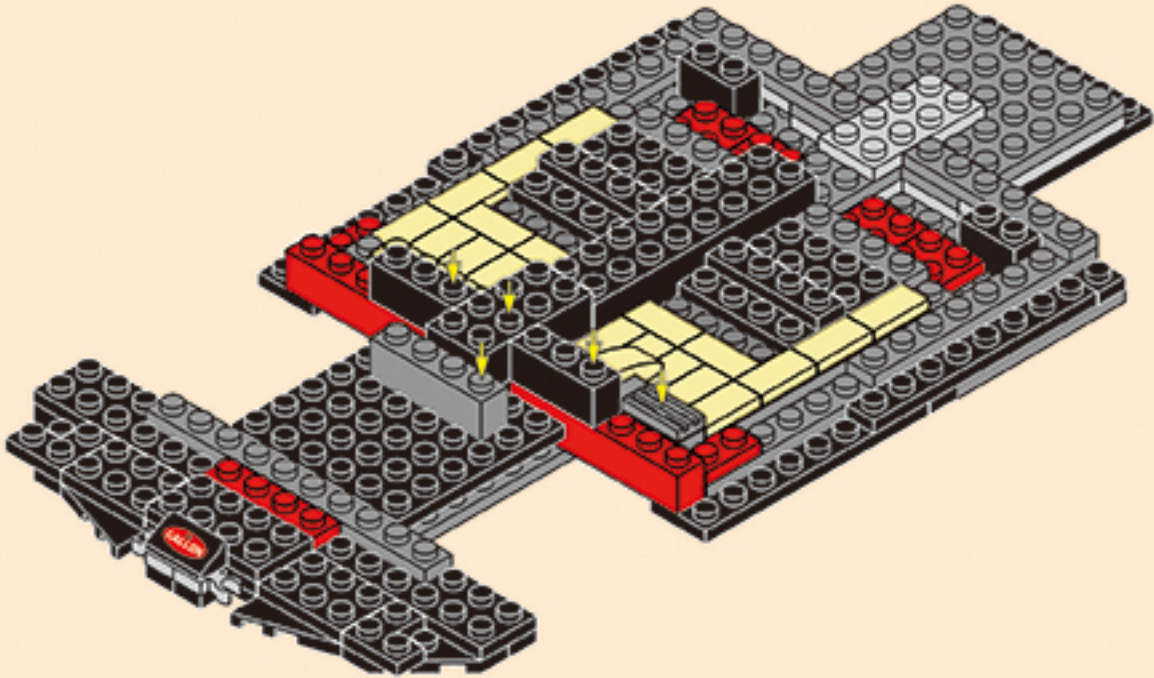

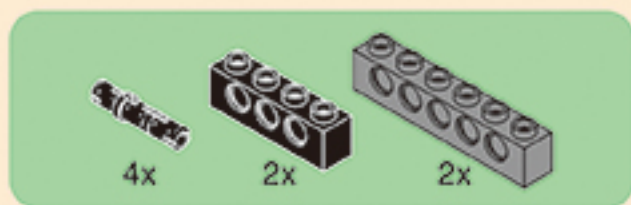

1-18.1

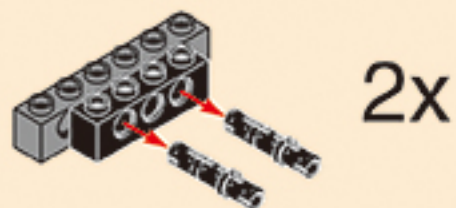

1-18.2

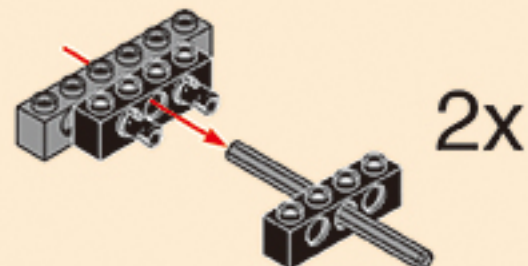

1-18.3

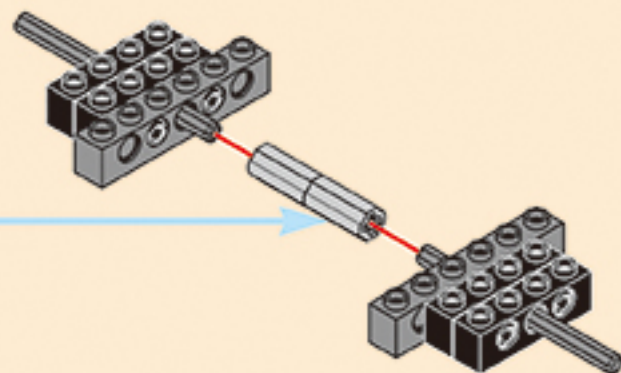
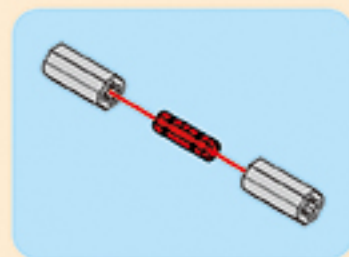

1-18

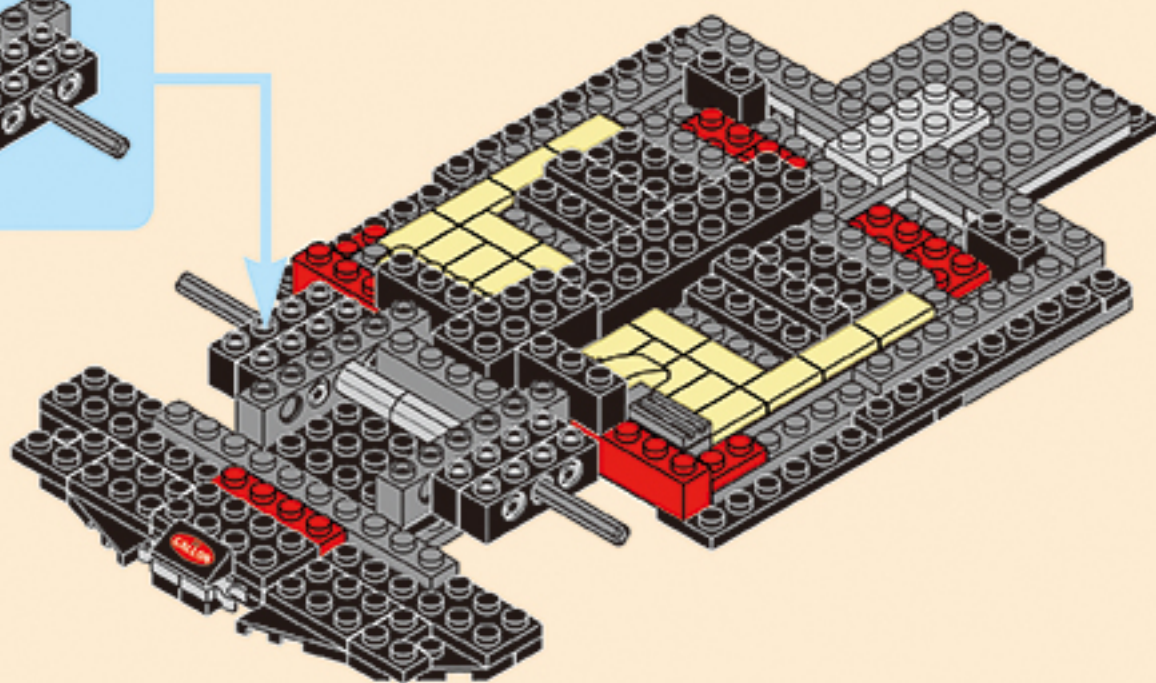
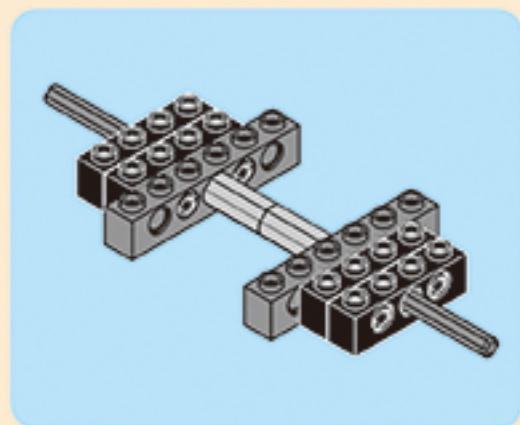

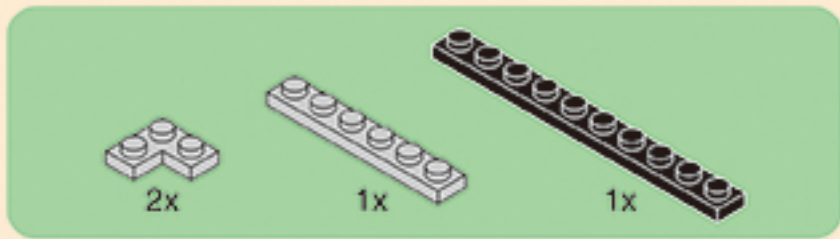

1-19

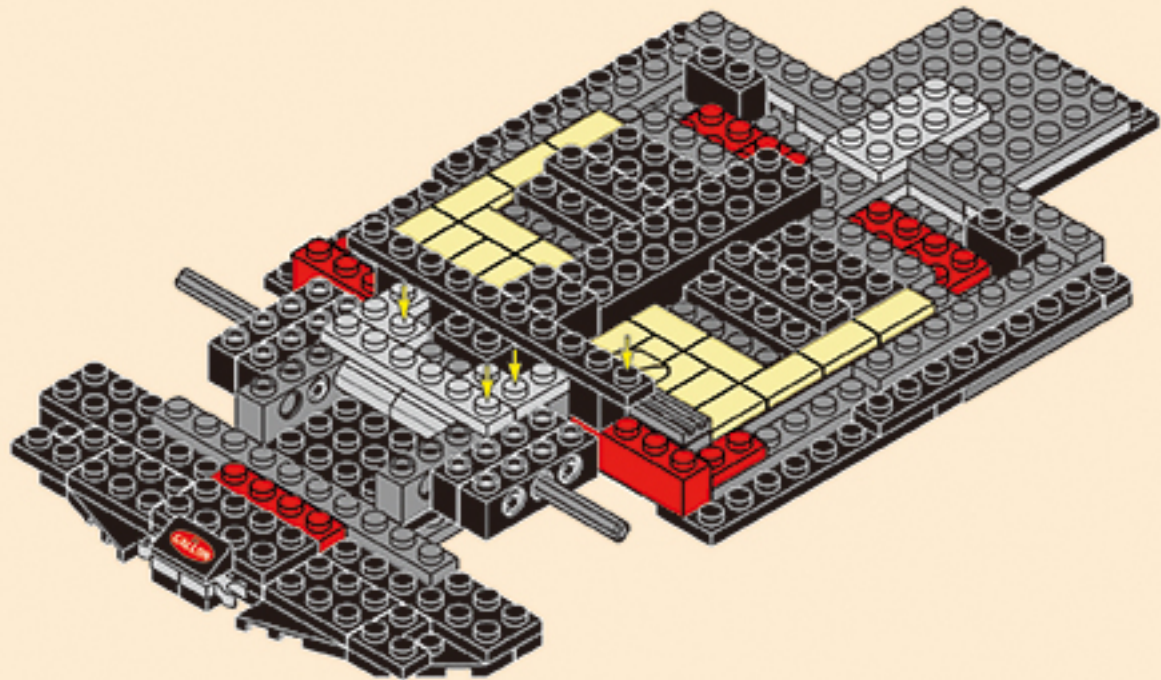



2x

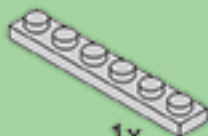

1x

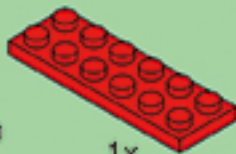

1x

1-20

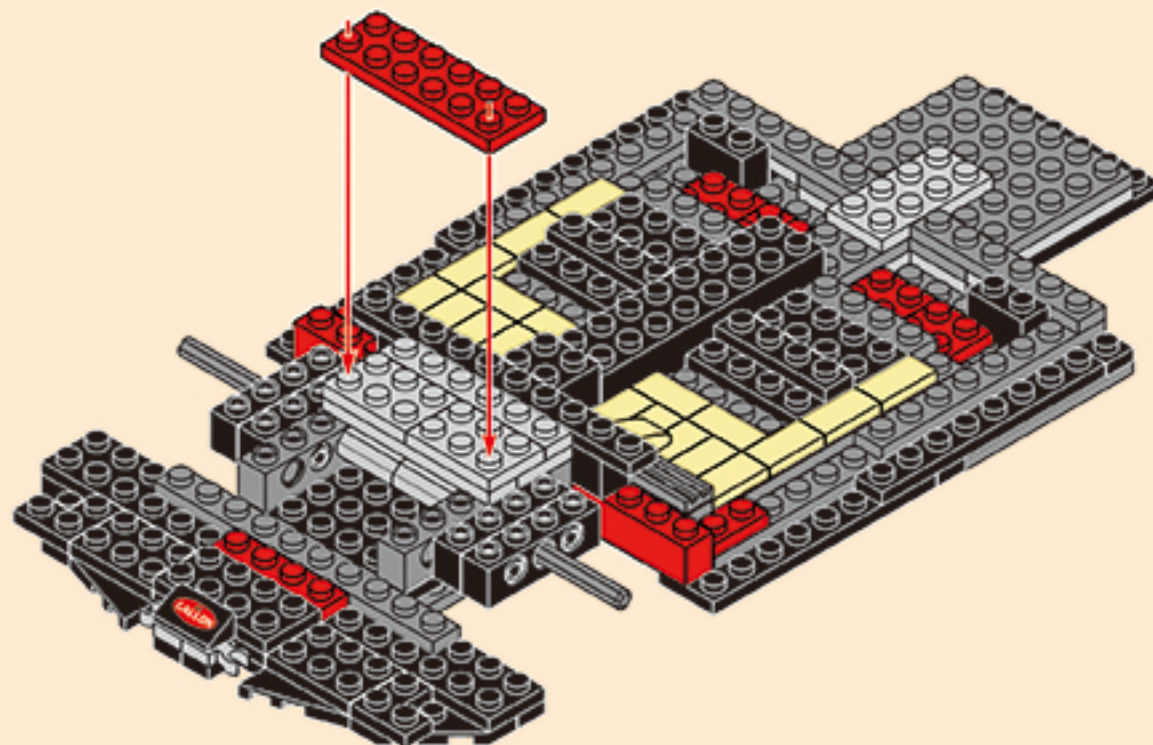

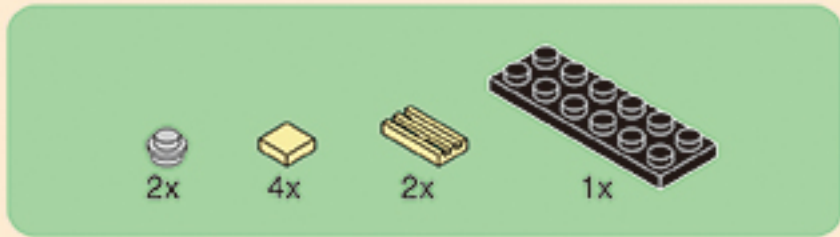

1-21

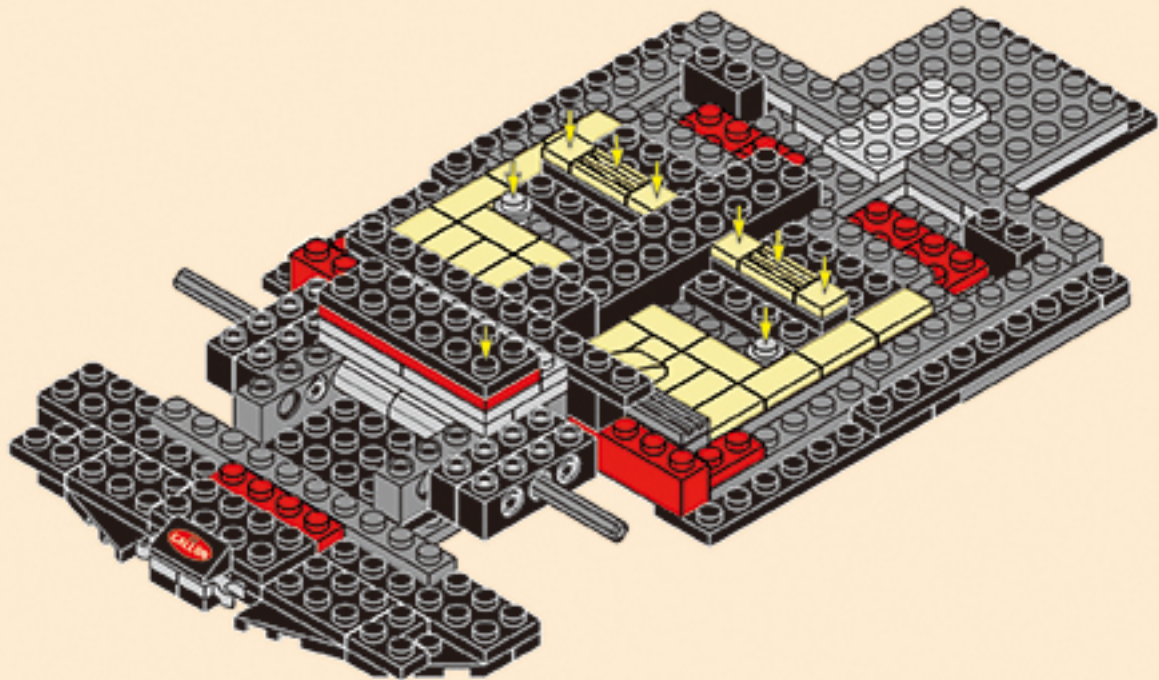



2x



2x



1x



1x

1-22

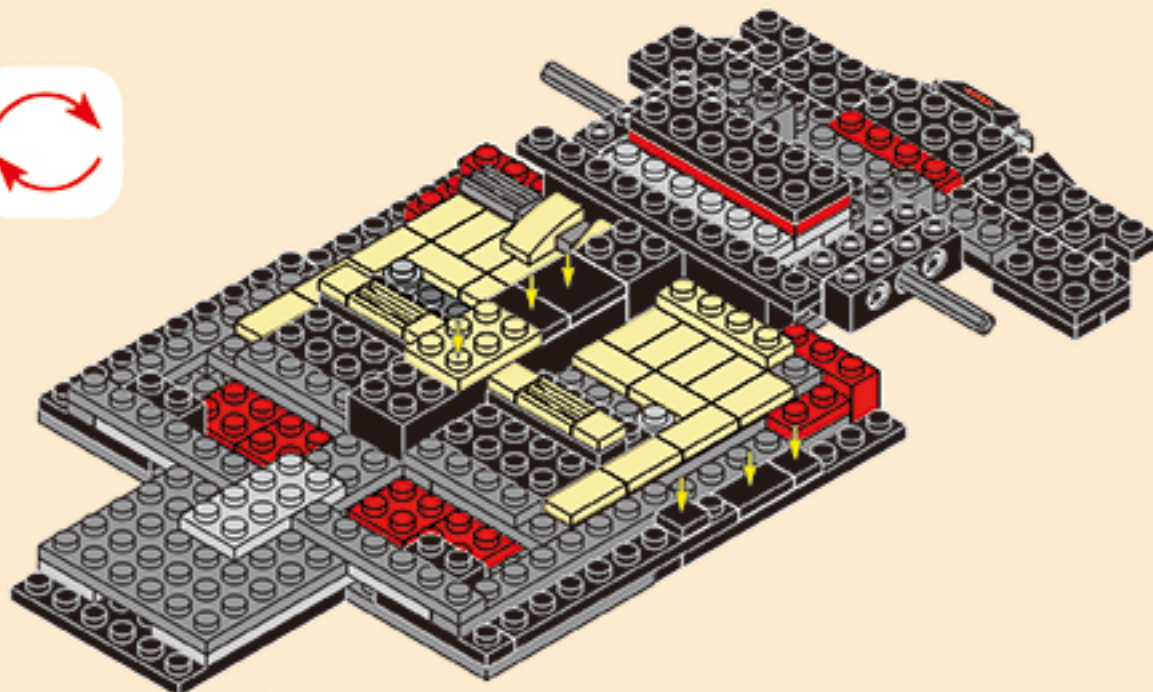

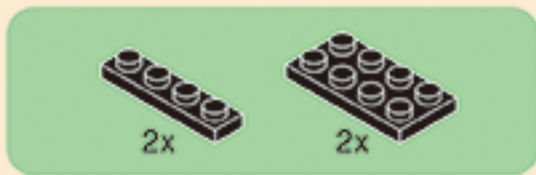

1-23.1



2x



1-23.2



2x

1-23

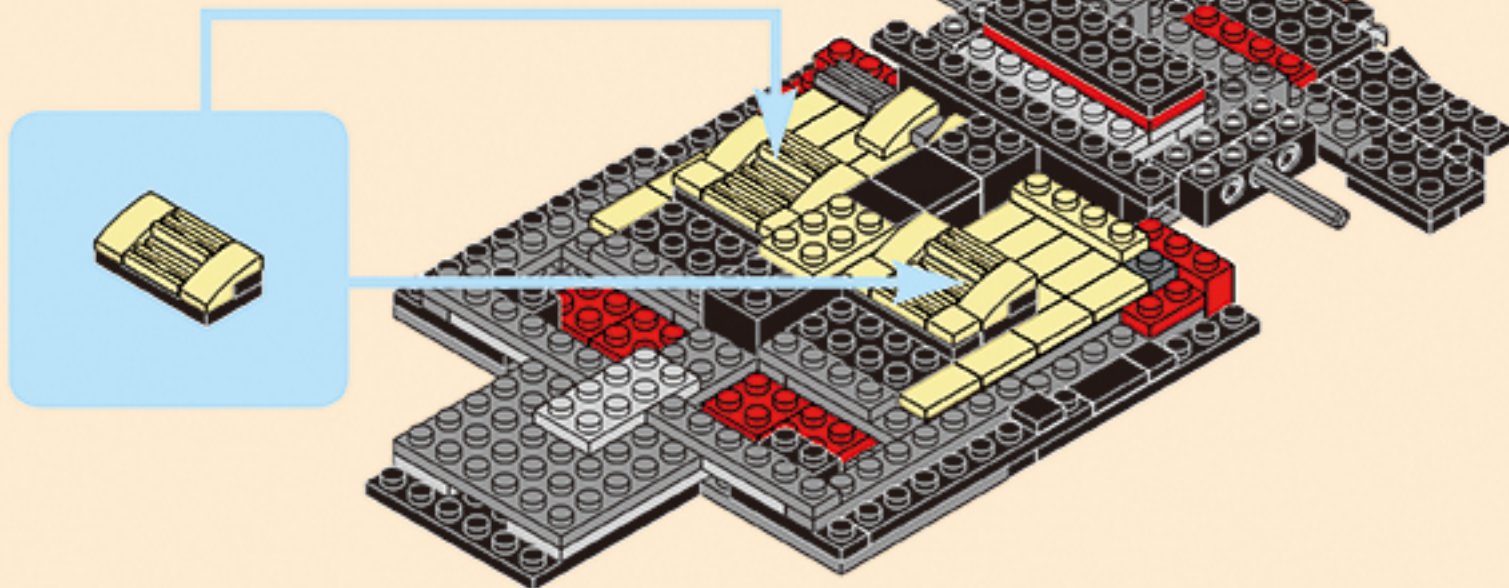



1x



1x



1x



1x

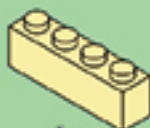

1x

1-24

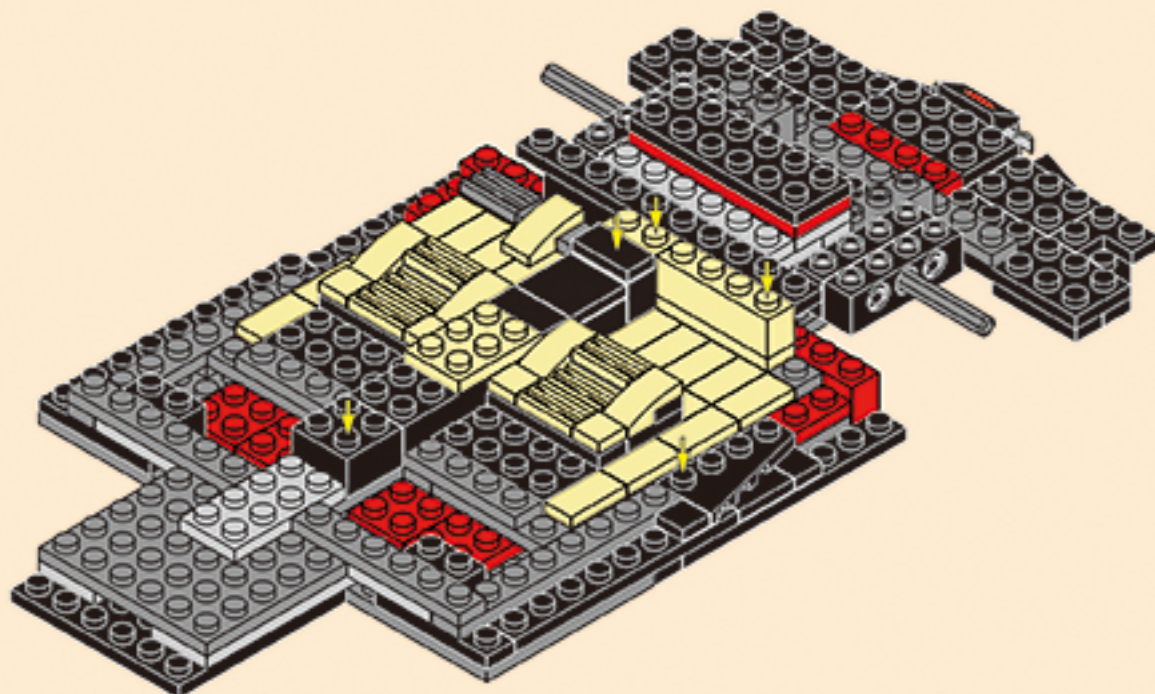

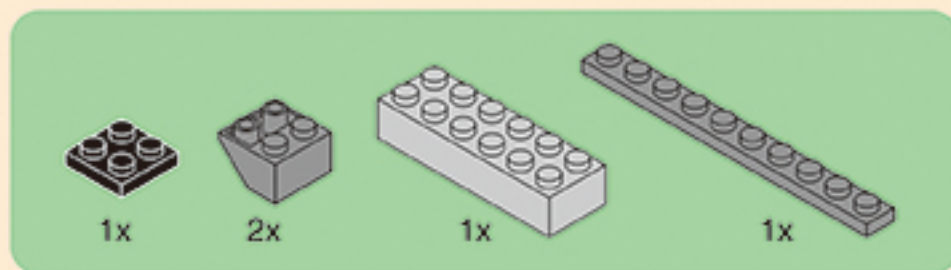

1-25

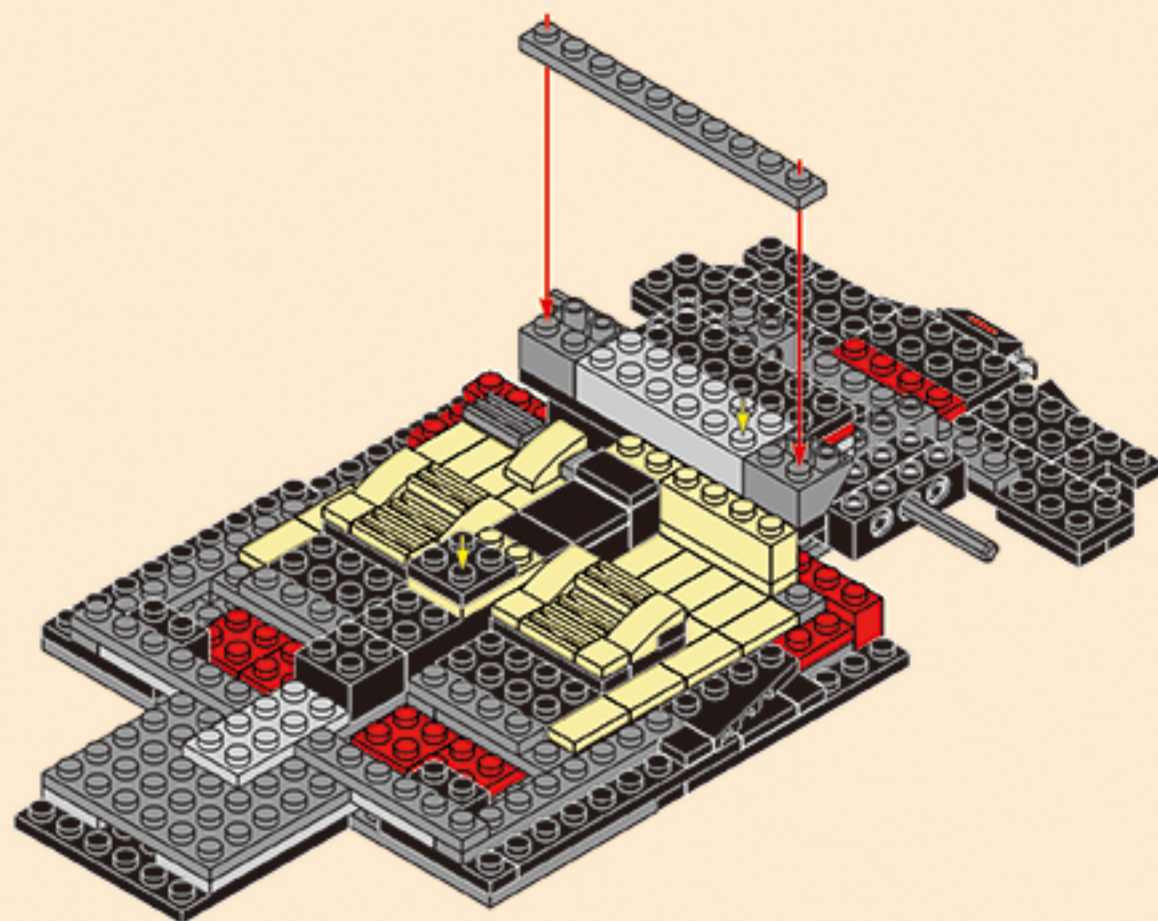



6x

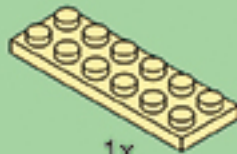

1x

1-26

1

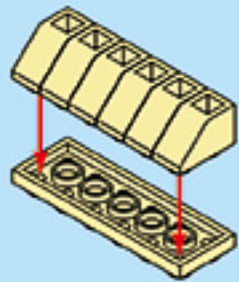

2

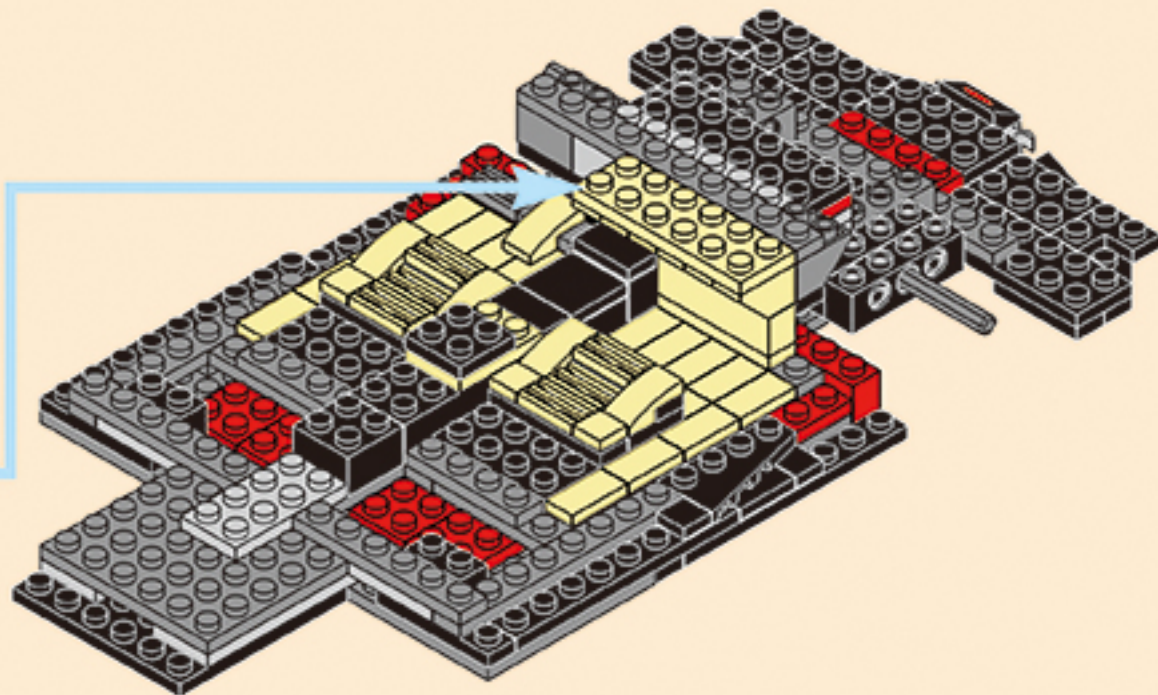
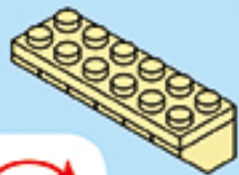

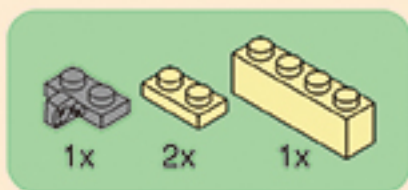

1-27.1

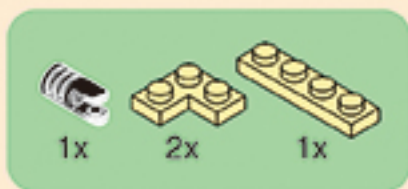
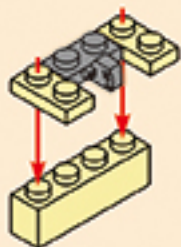

1-27.2

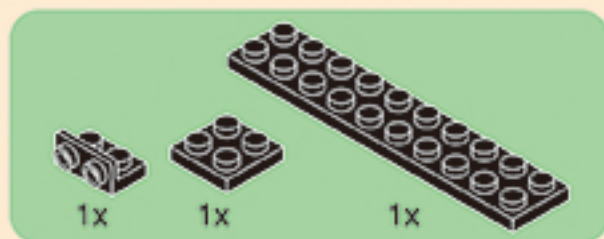
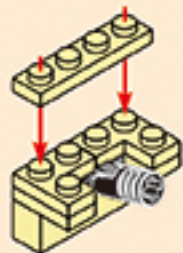

1-27.3

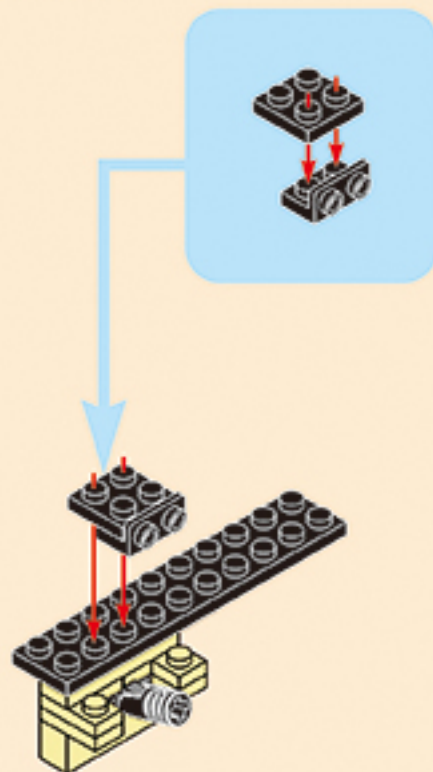

1-27.4

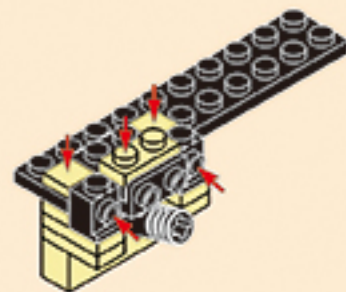

1-27.5

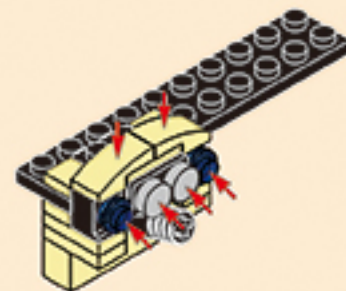



1-27.6

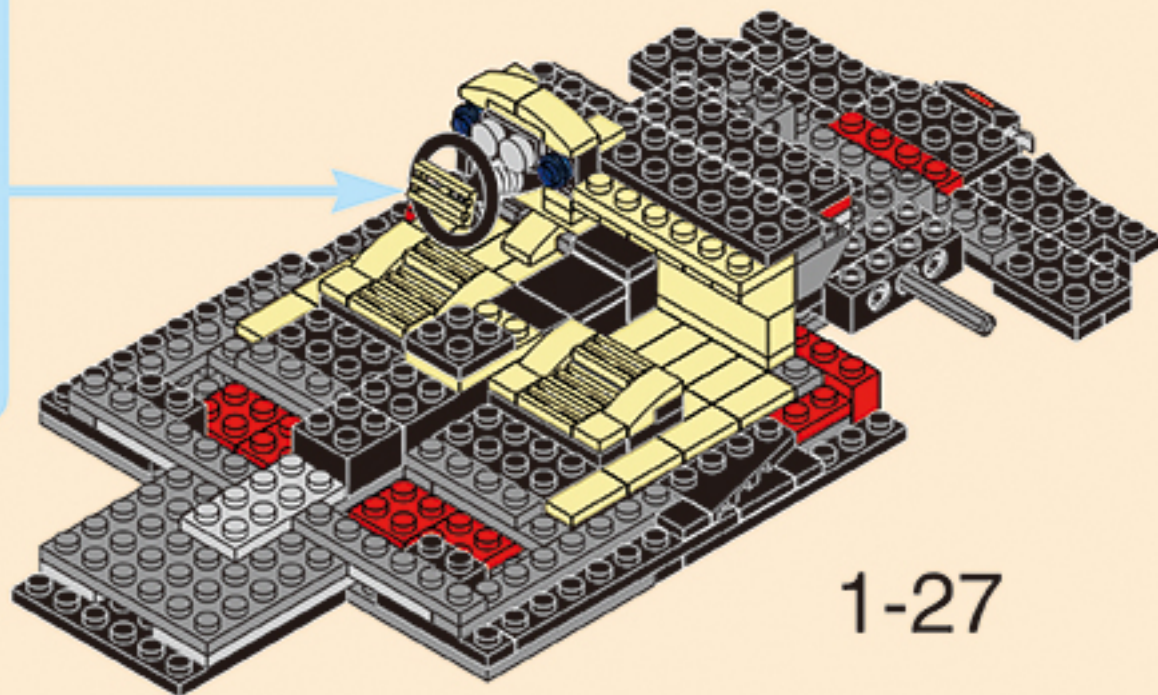
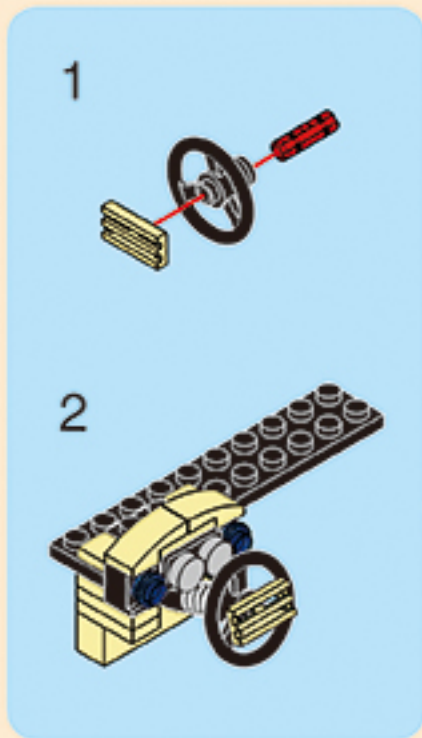

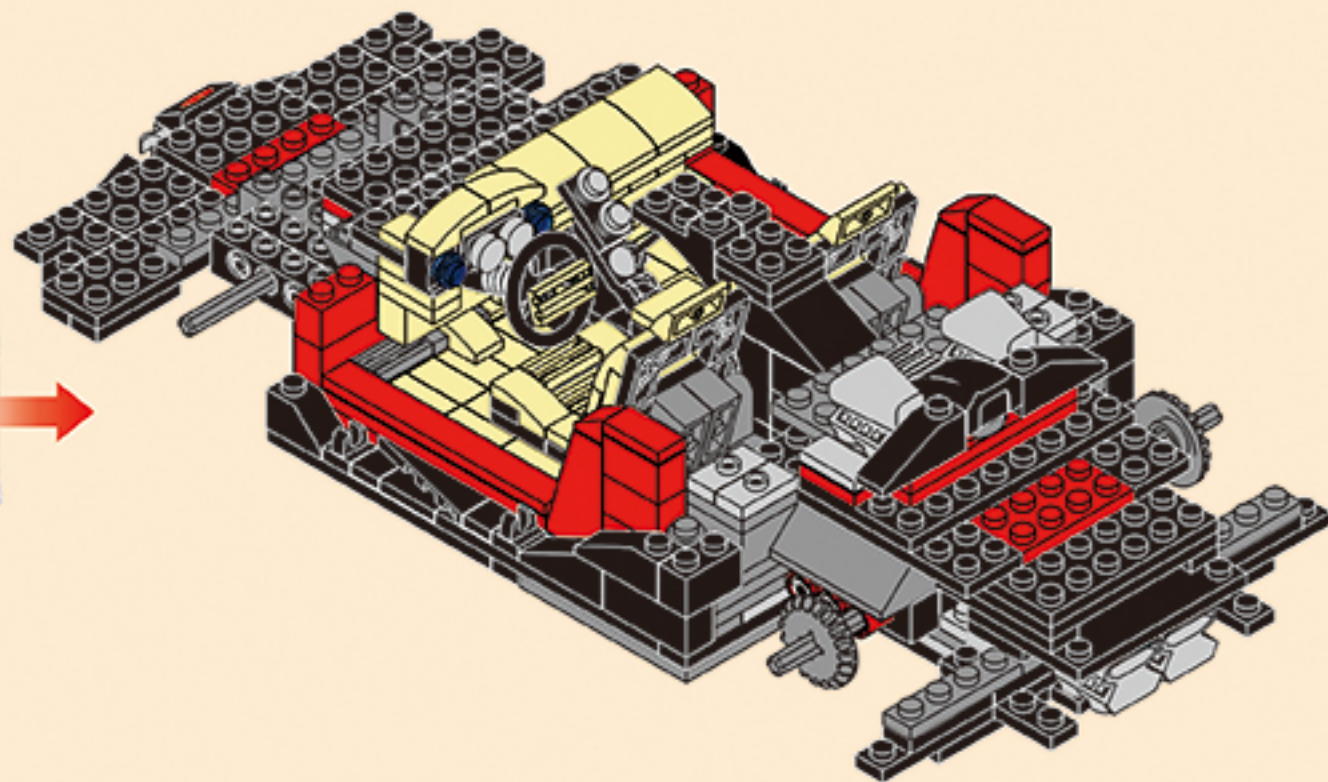



1x



2x



2x



3x

2-1

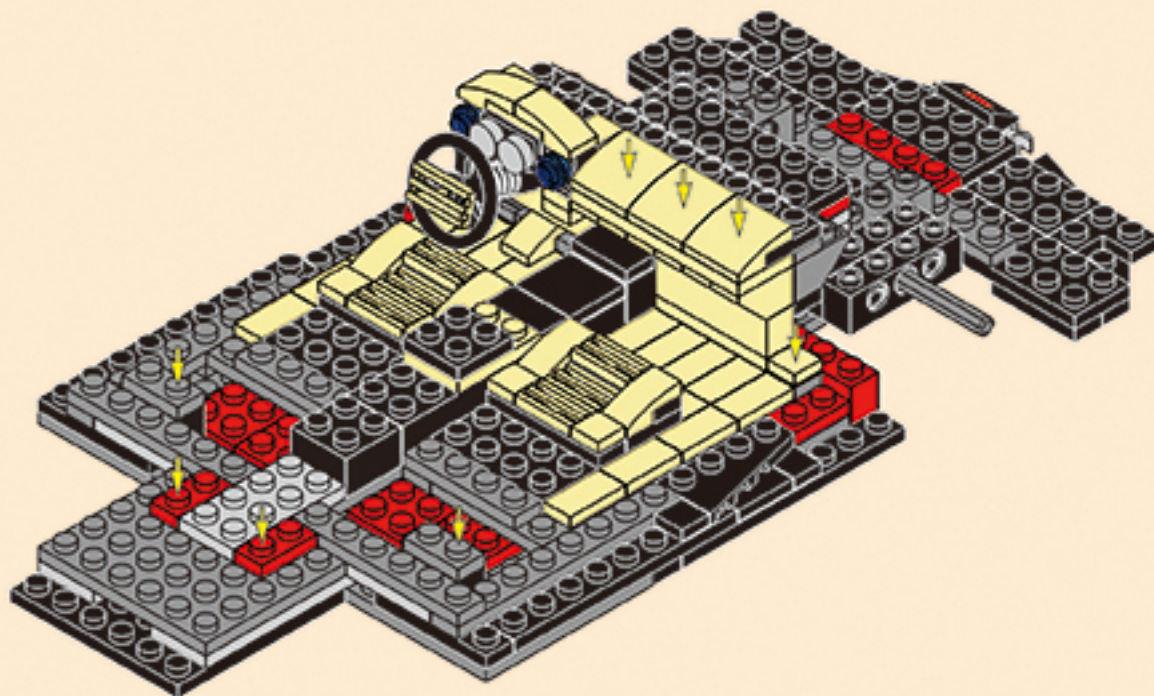



2-2.1



2-2.2



2-2.3

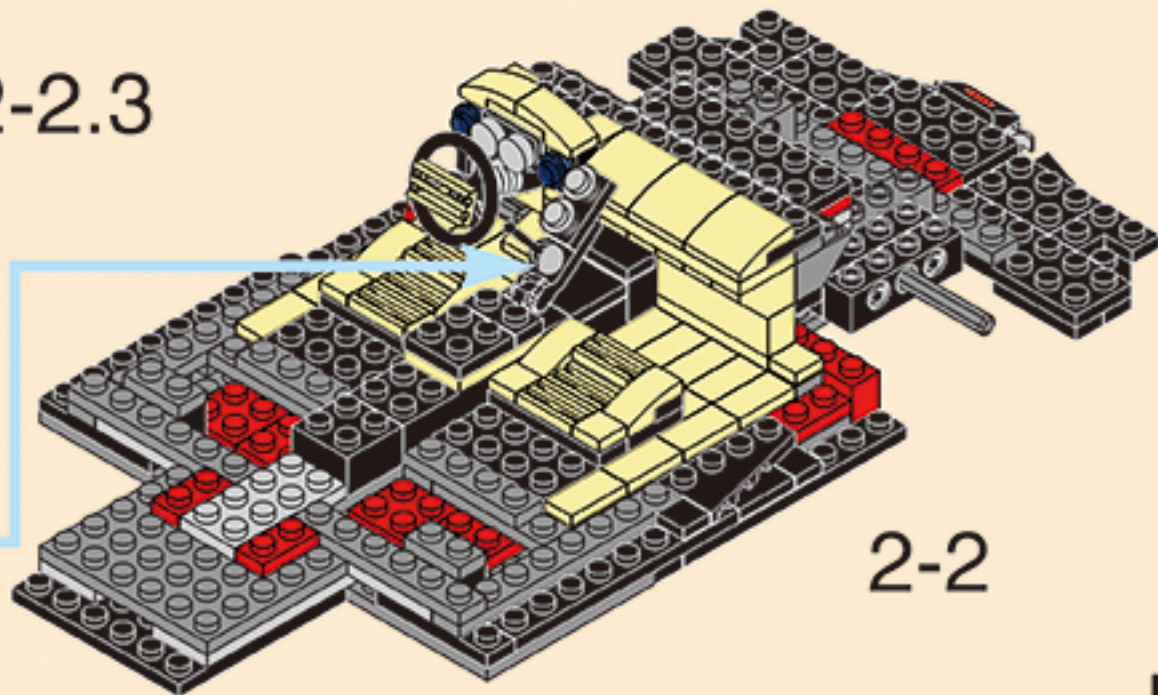
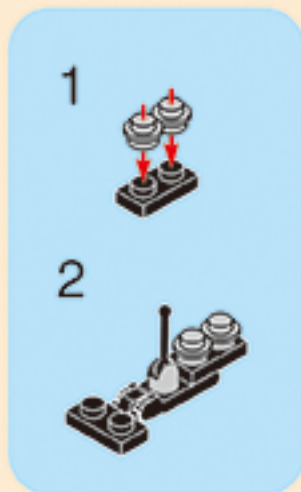

2-2

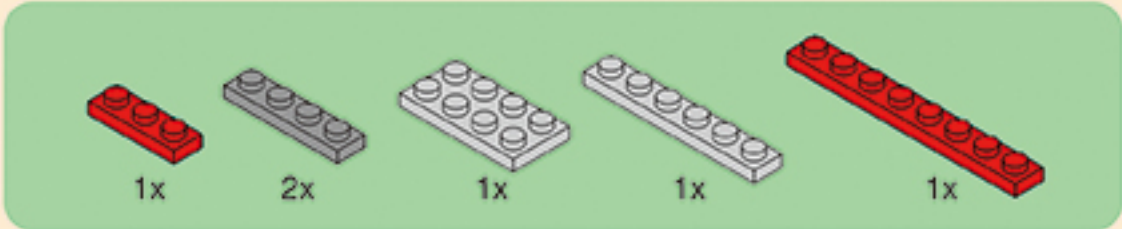

2-3

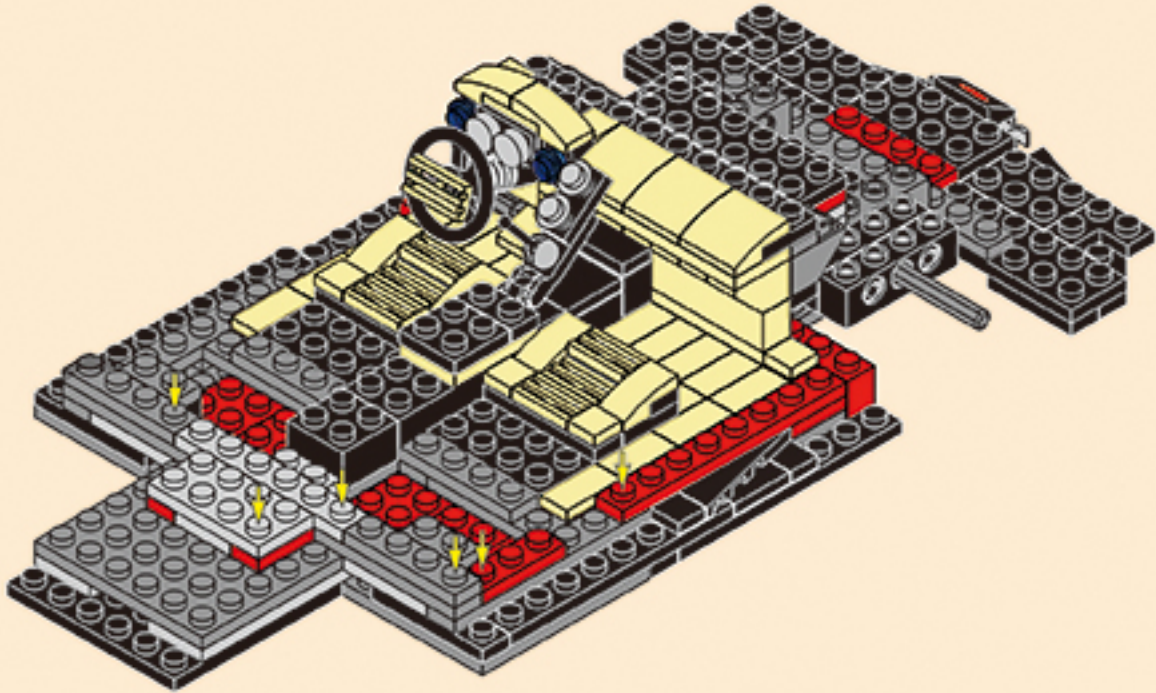

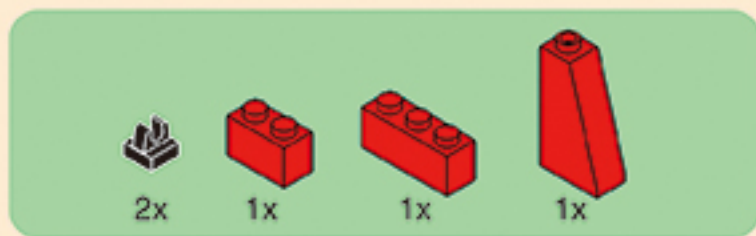

2-4

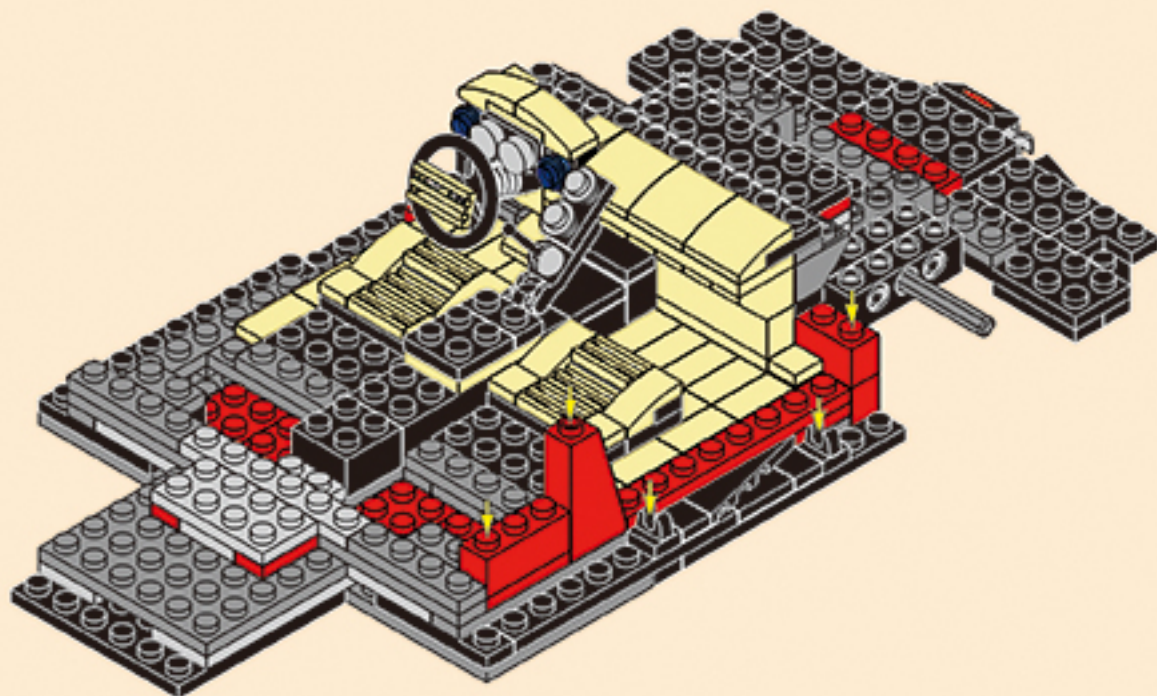



1x



1x



1x



1x



1x

2-5

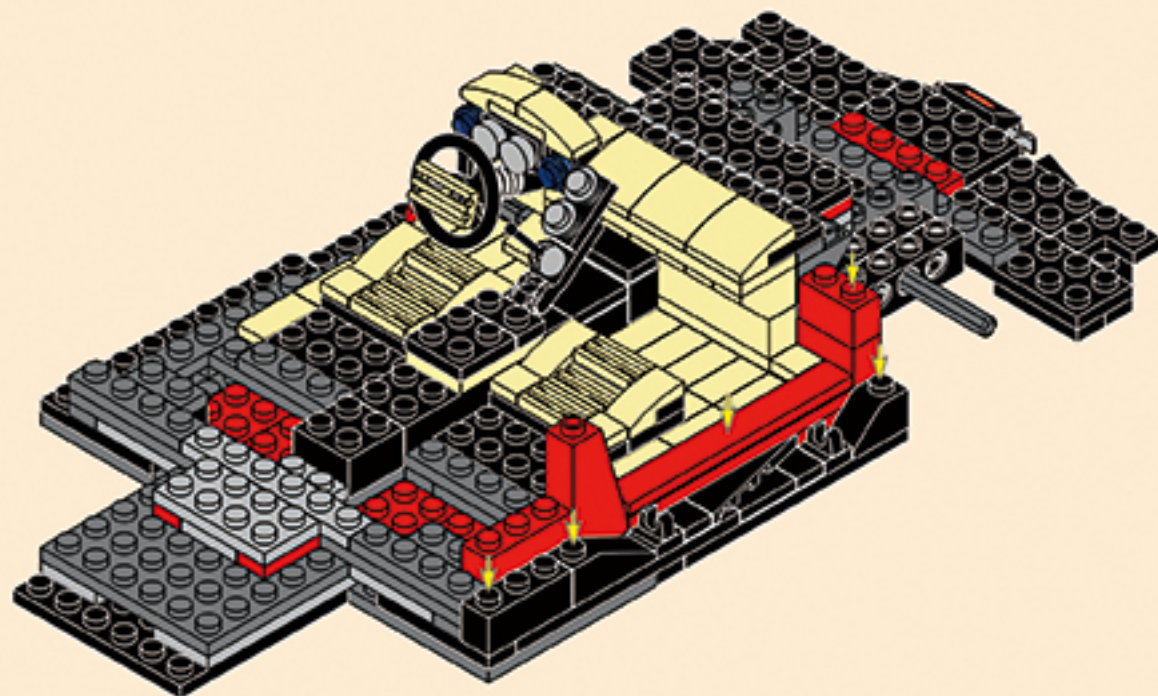

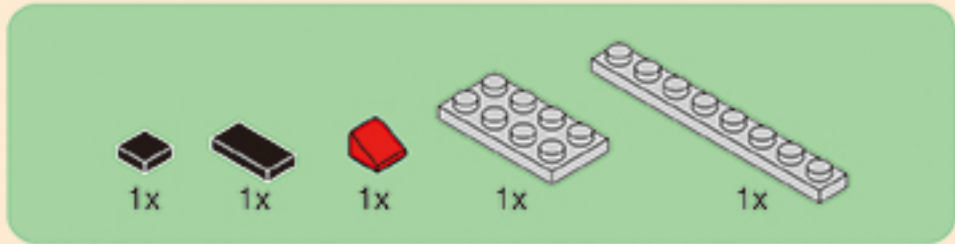

2-6

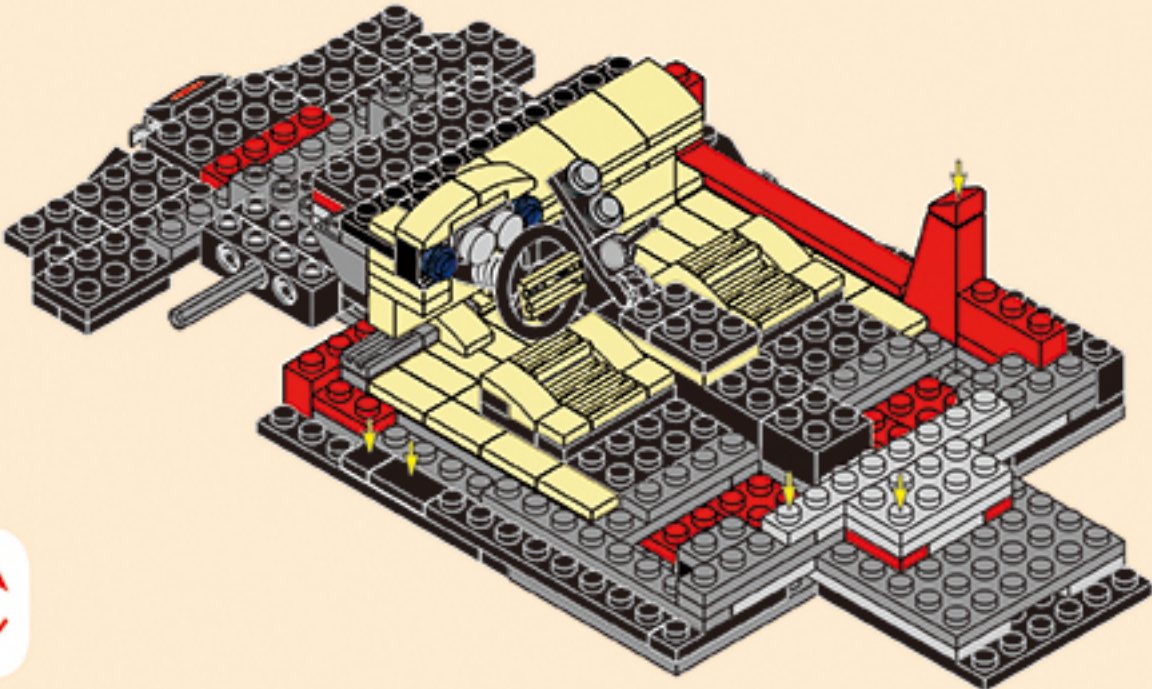

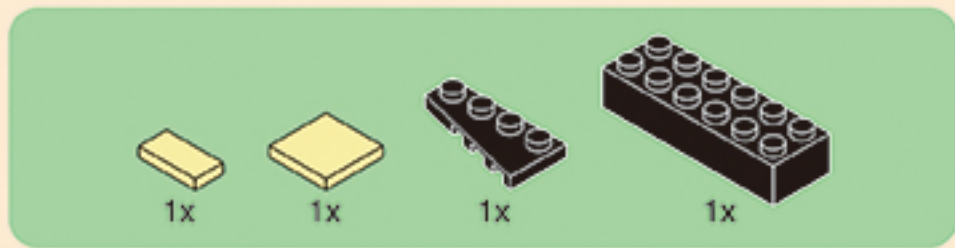

2-7

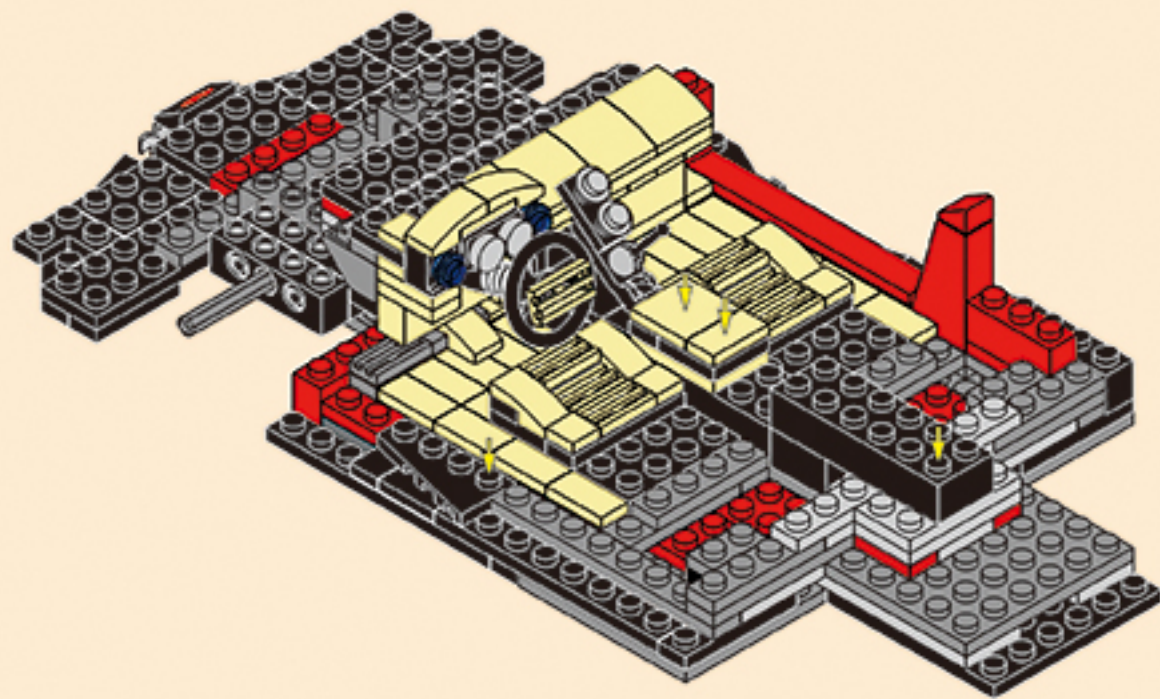



1x



2x



1x

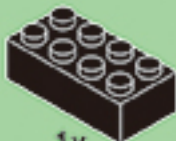

1x

2-8

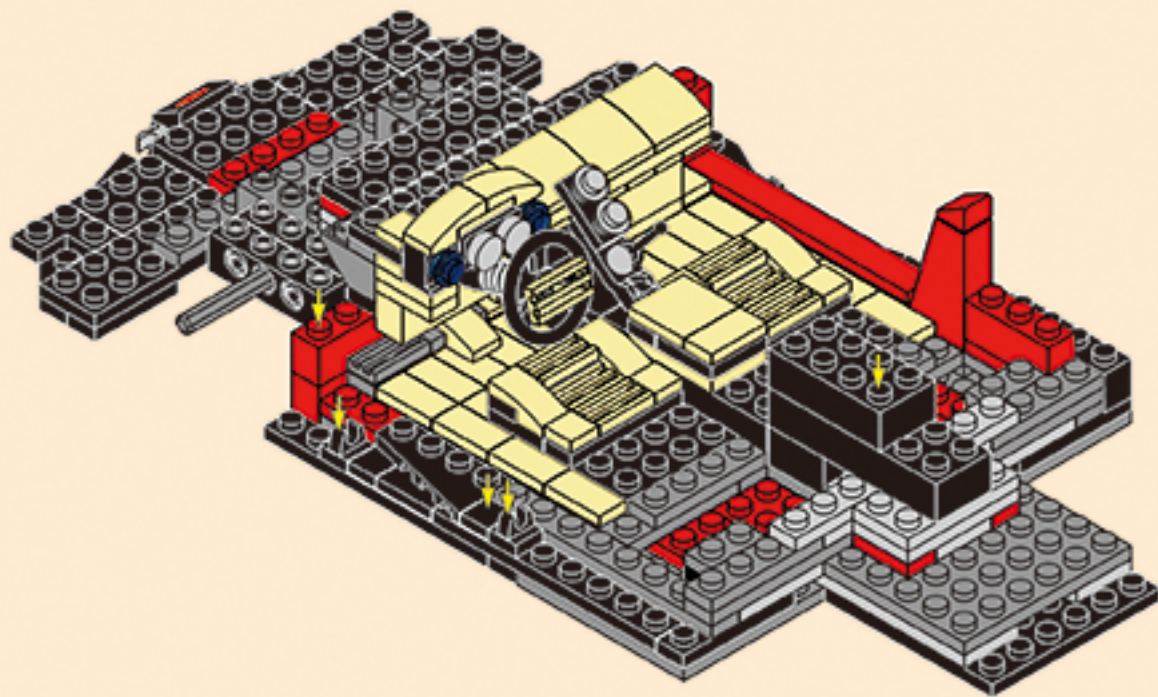



2-9.1

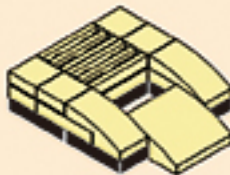
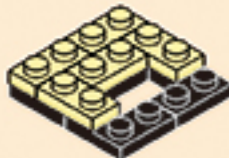
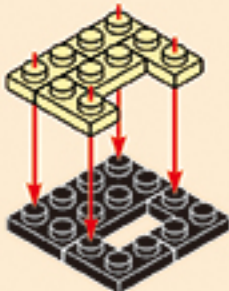

2-9.3

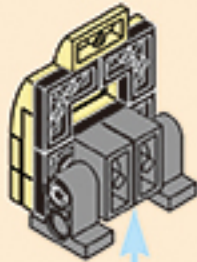
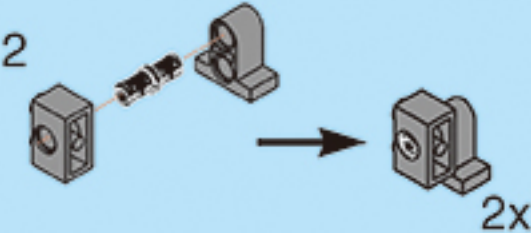
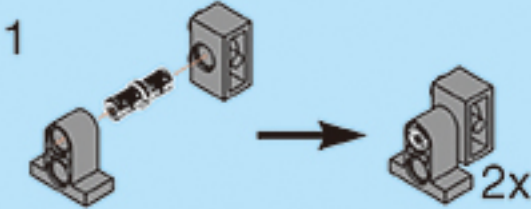

2x

2-9

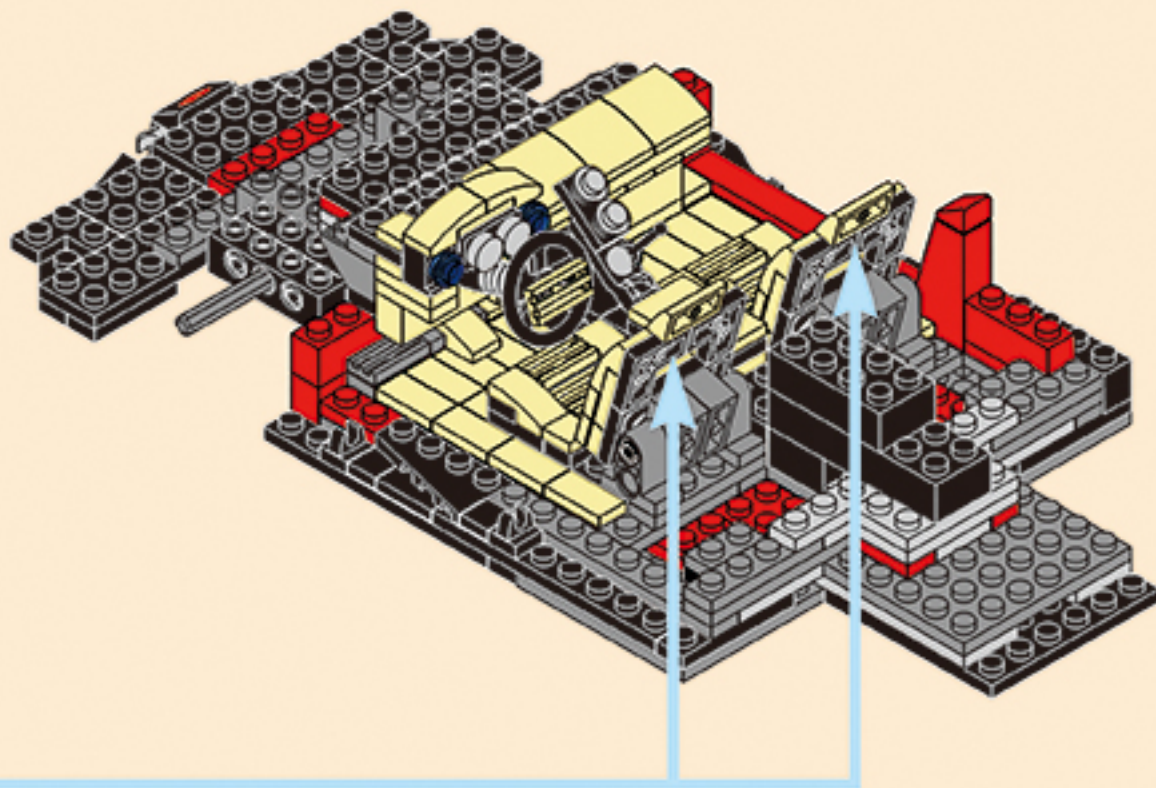

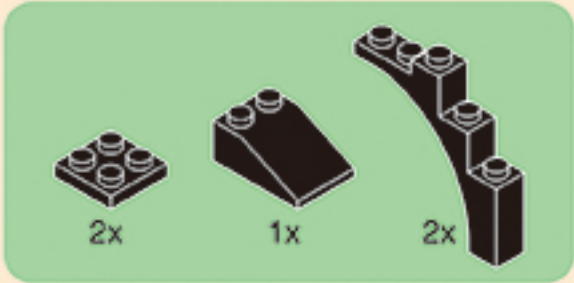

2-10

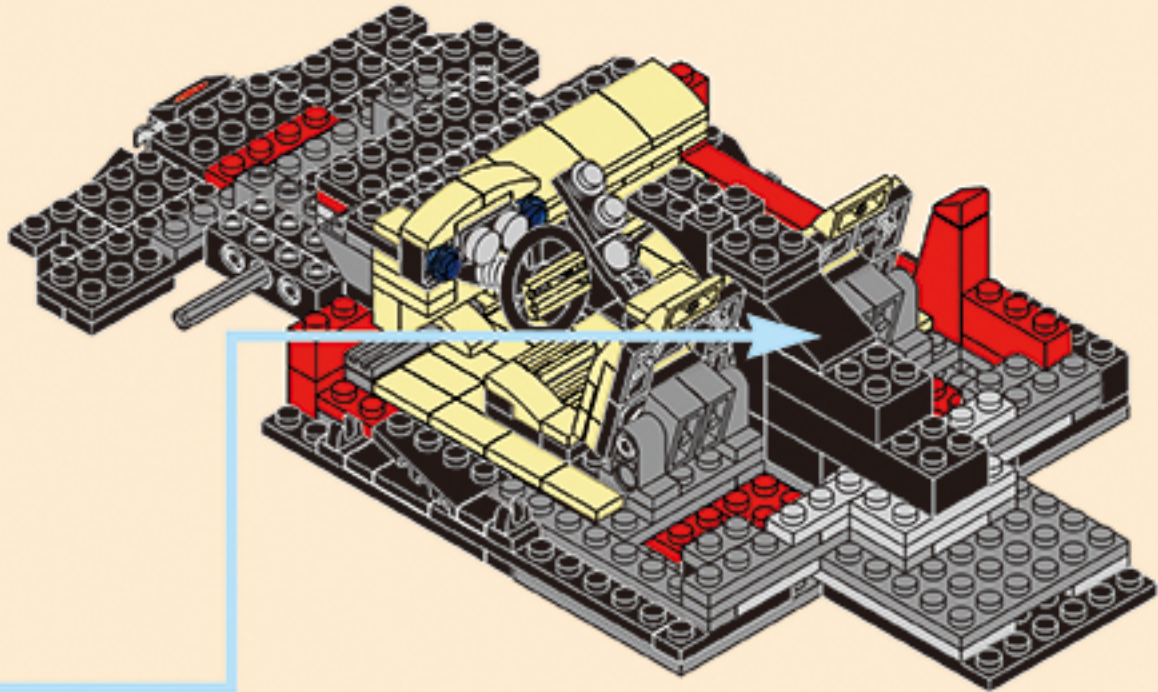
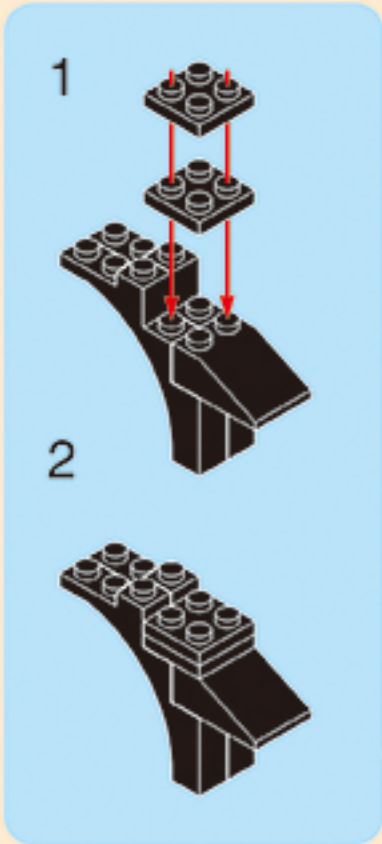

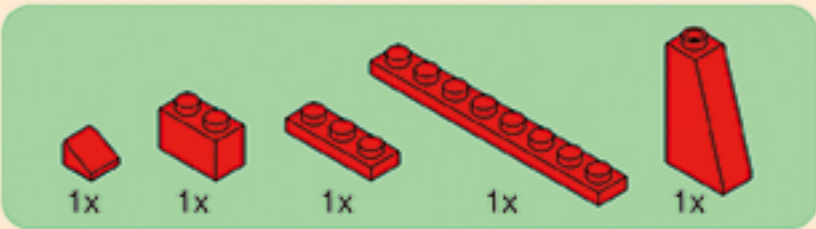

2-11

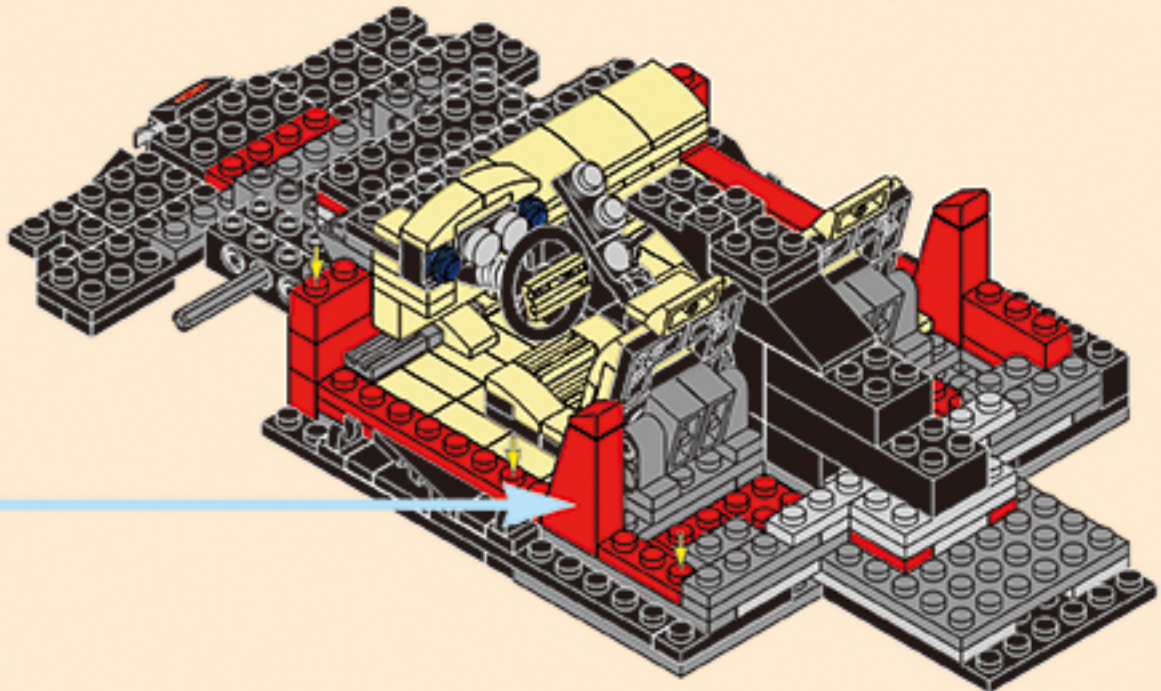
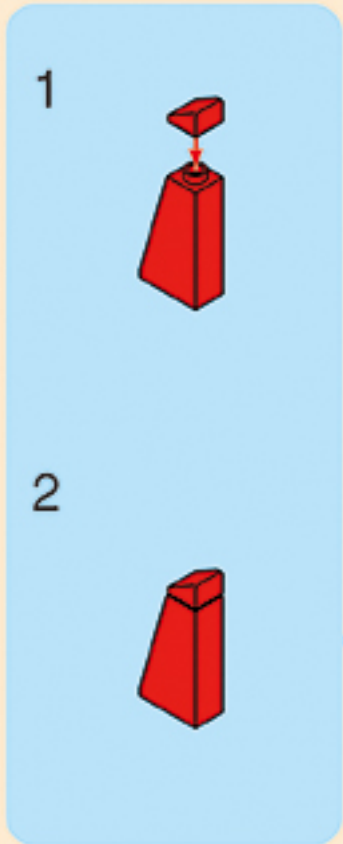



1x



1x

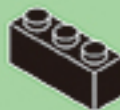

1x

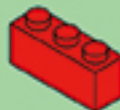

1x



1x

2-12

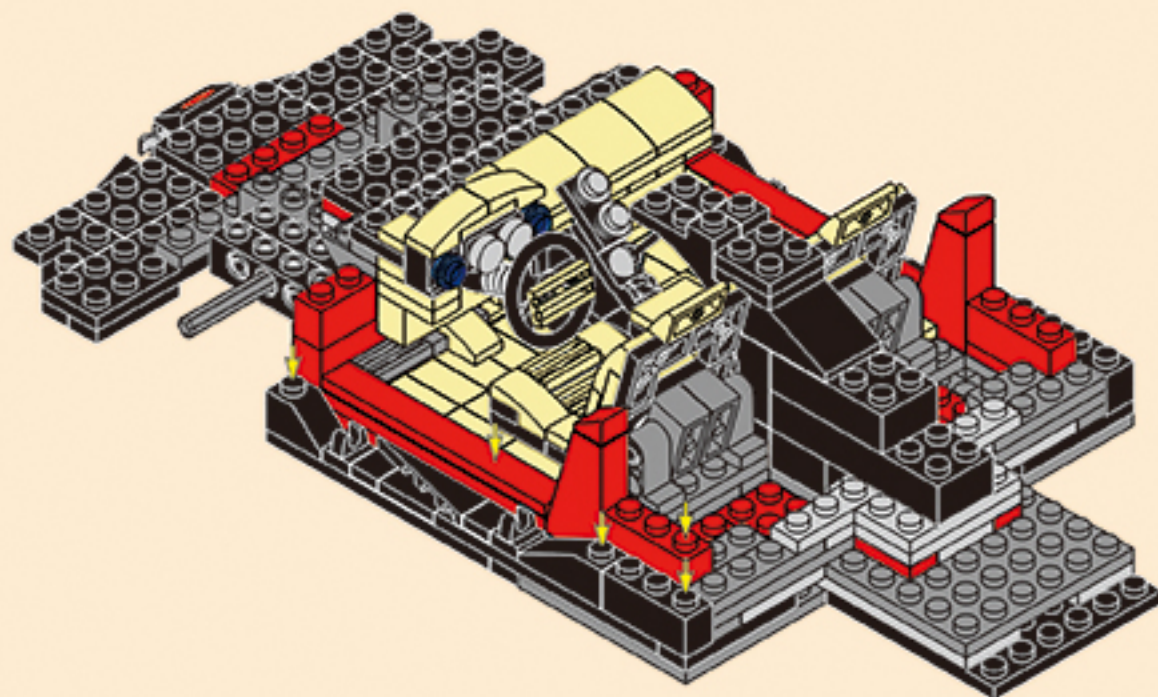

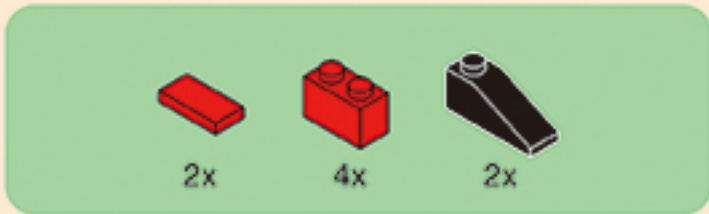

2-13

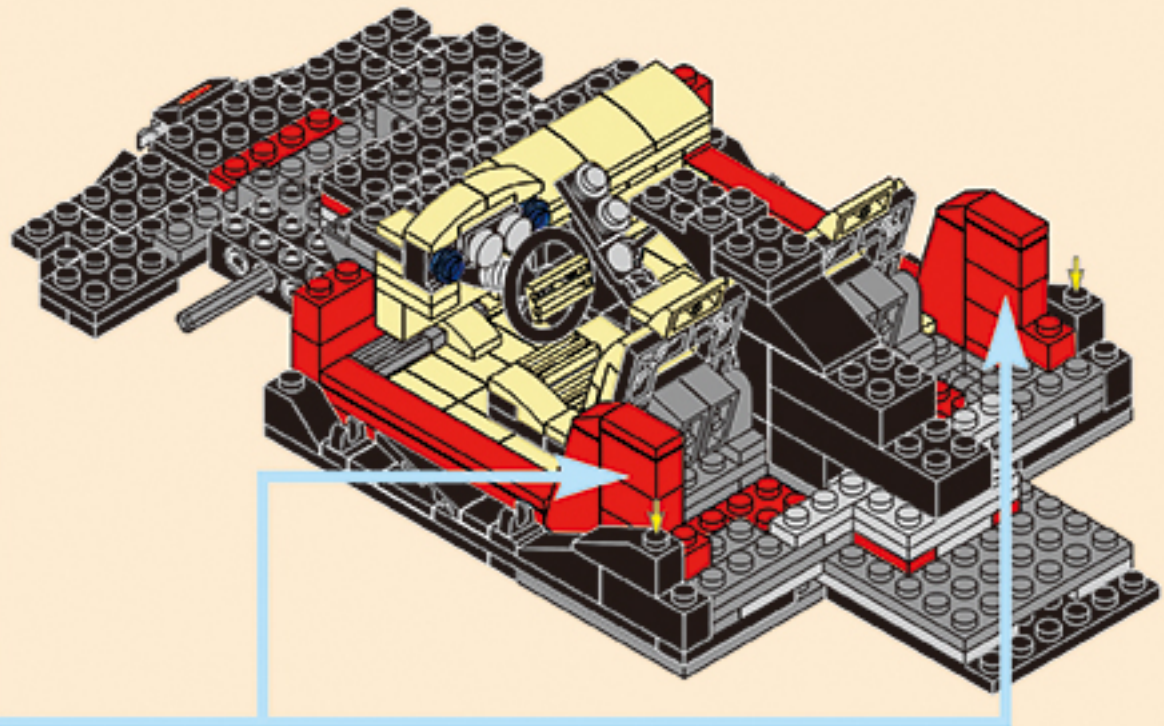
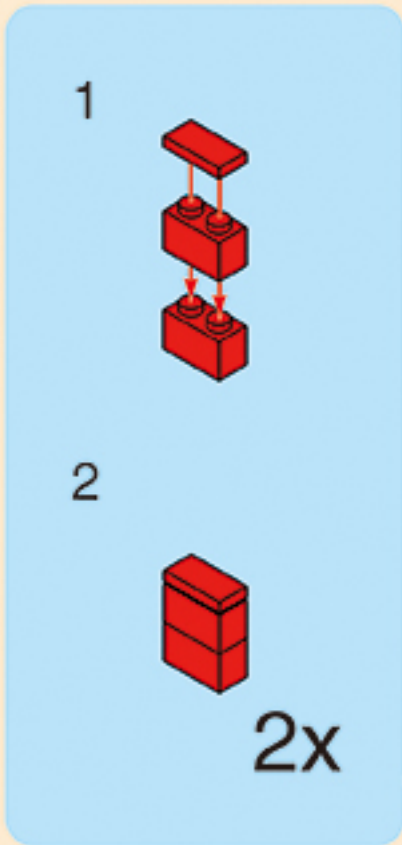

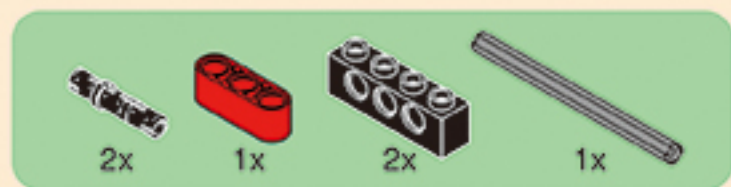

2-14.1

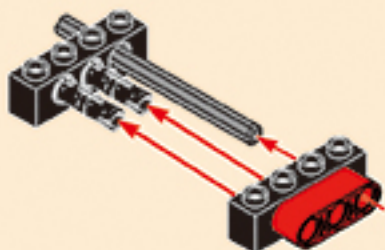

2-14.2

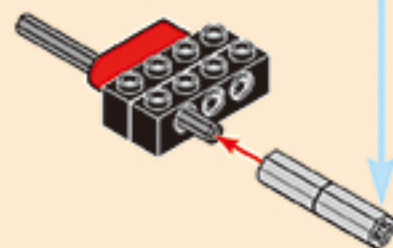
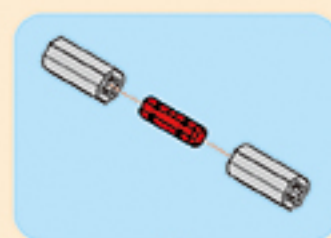

2-14.3

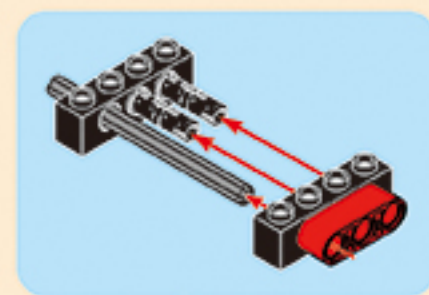
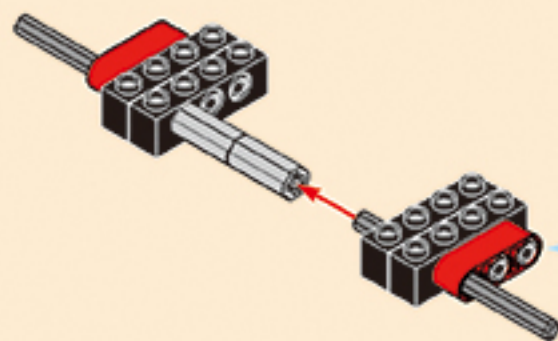

2-14

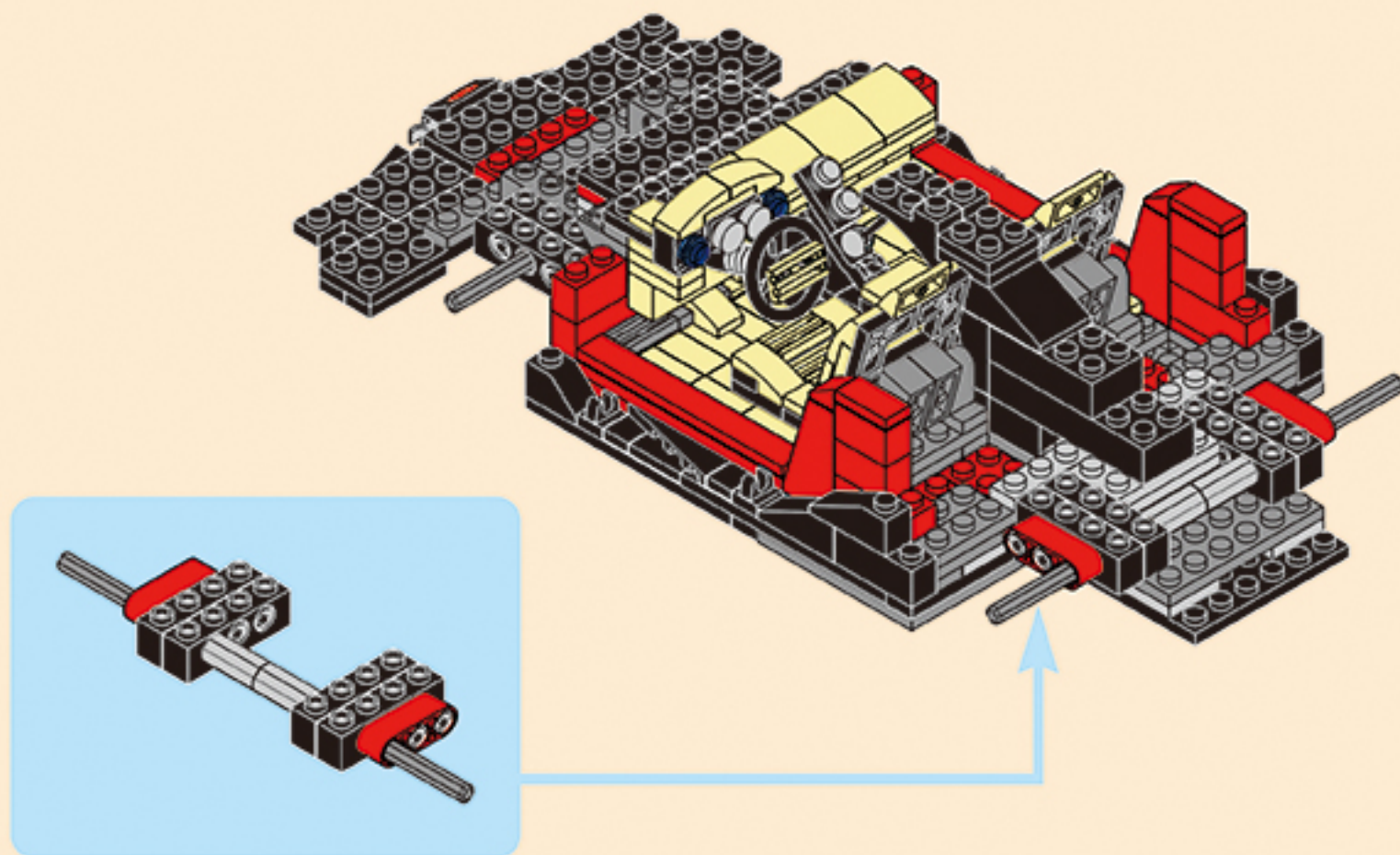

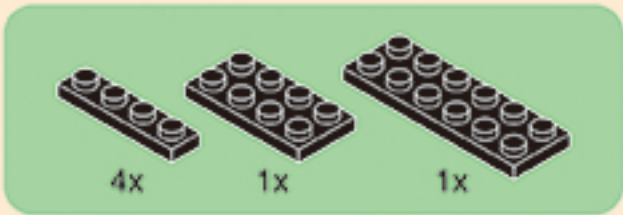

2-15

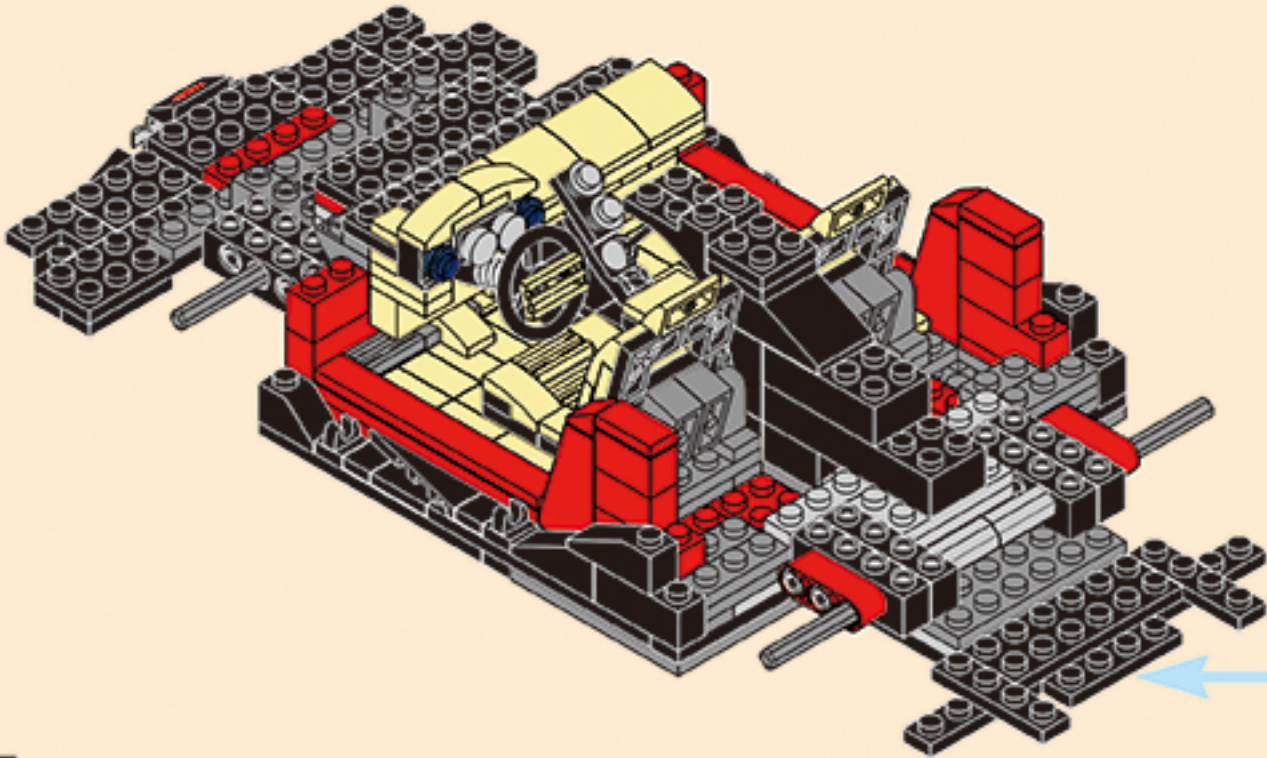
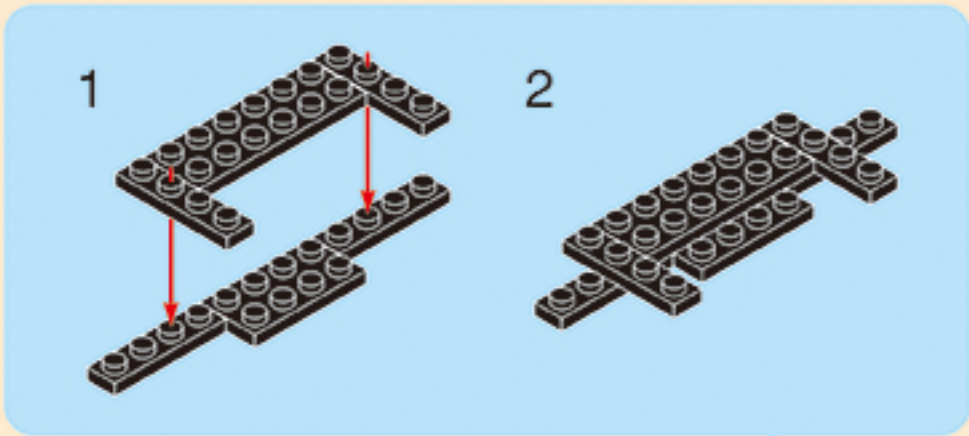

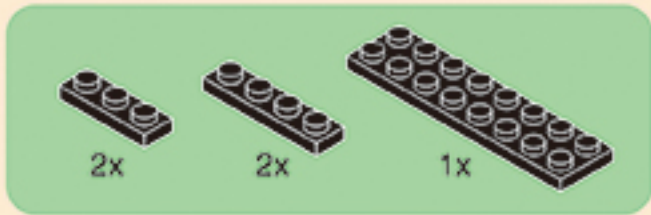

2-16

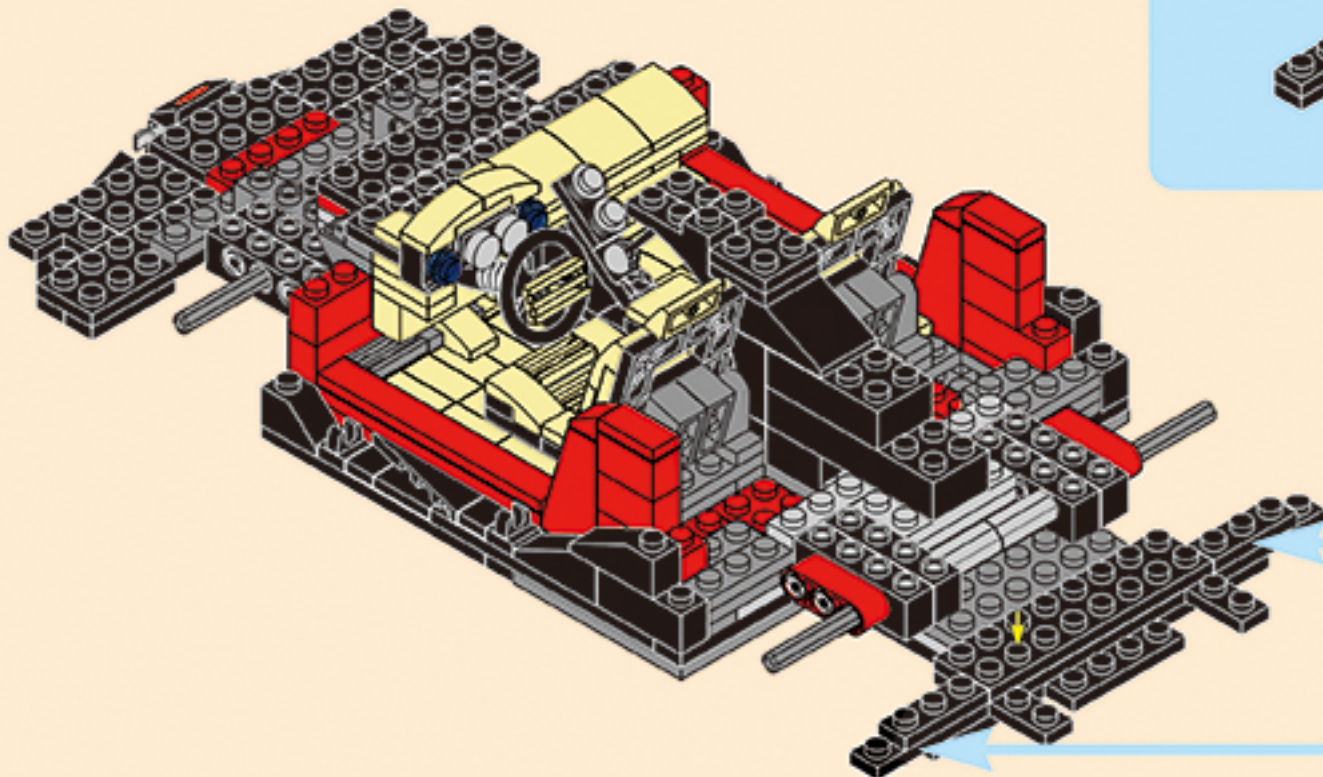
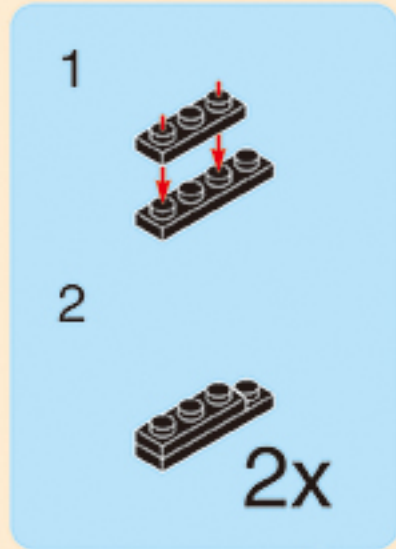

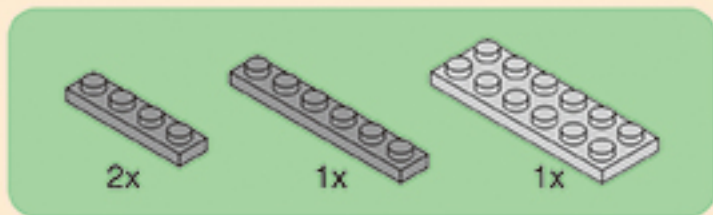

2-17

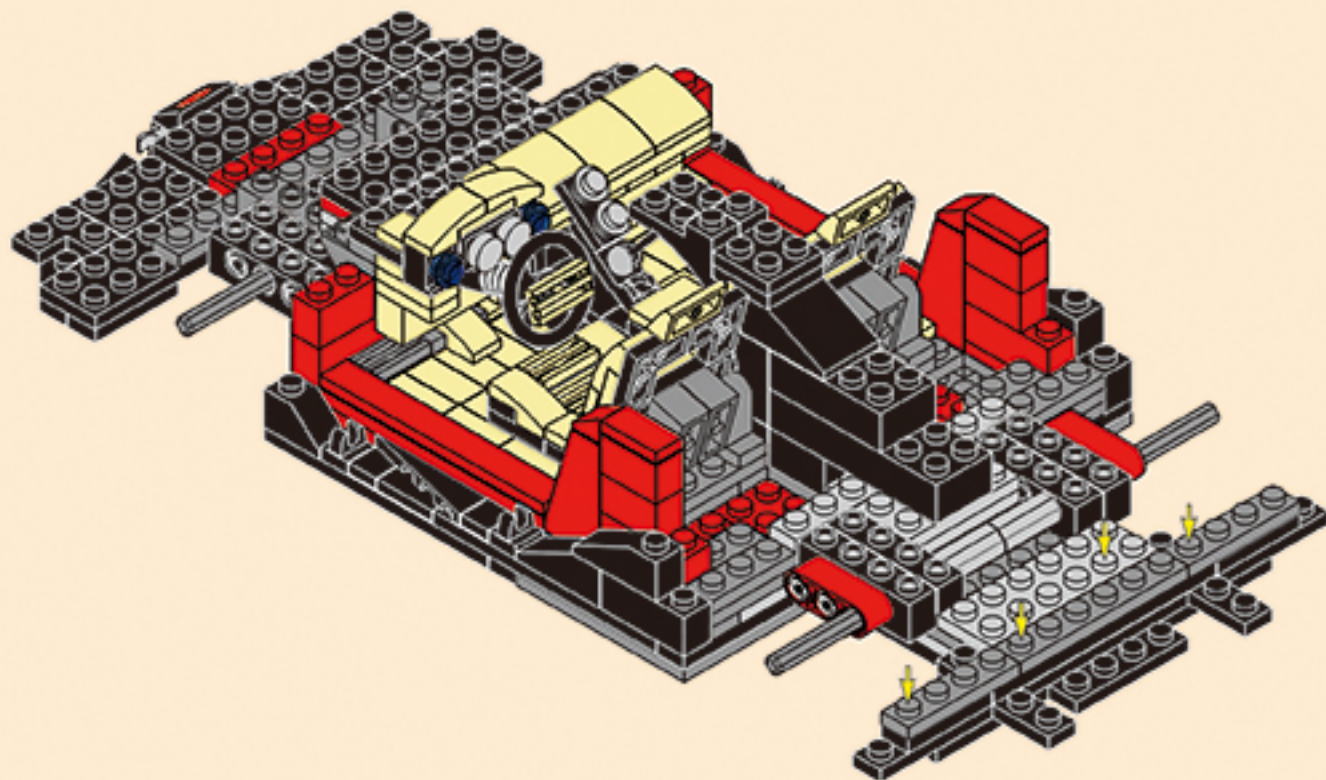



2-18

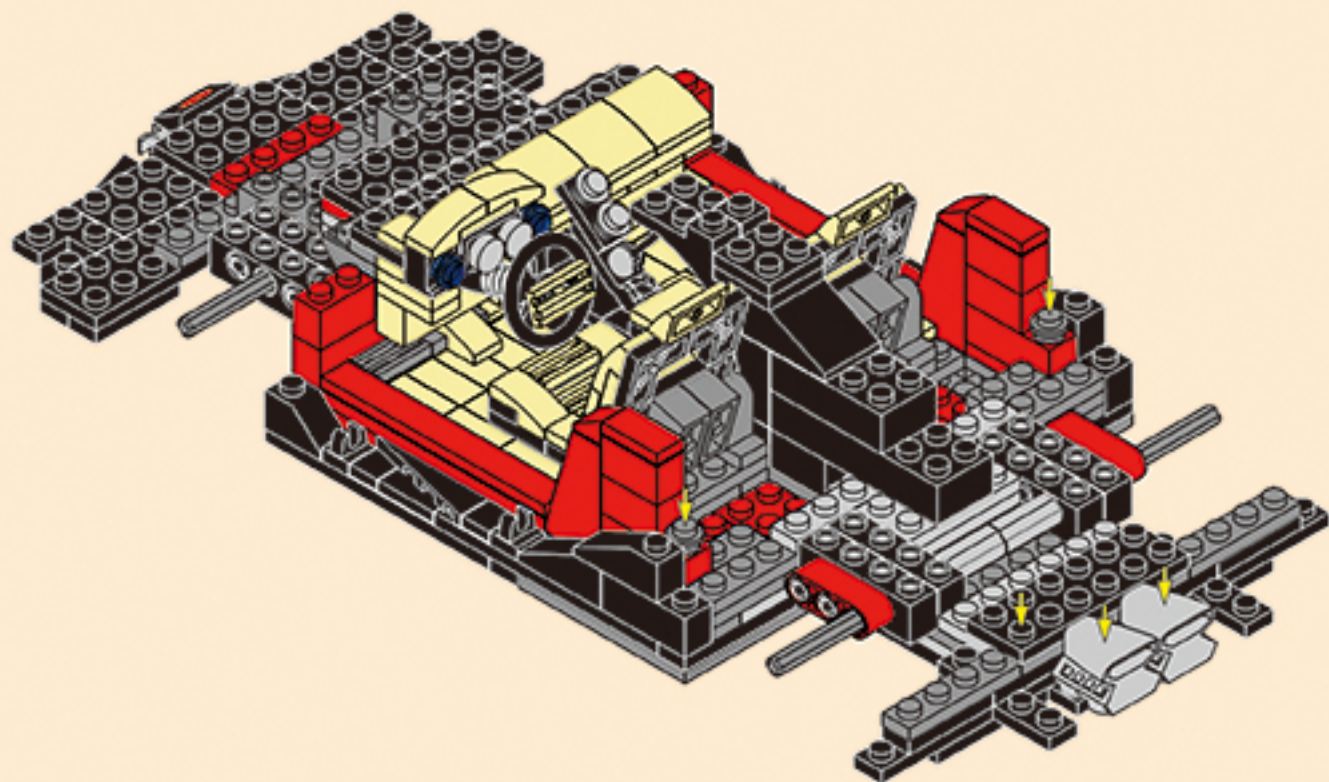

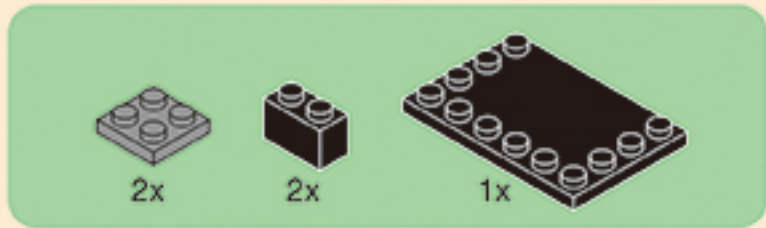

2-19

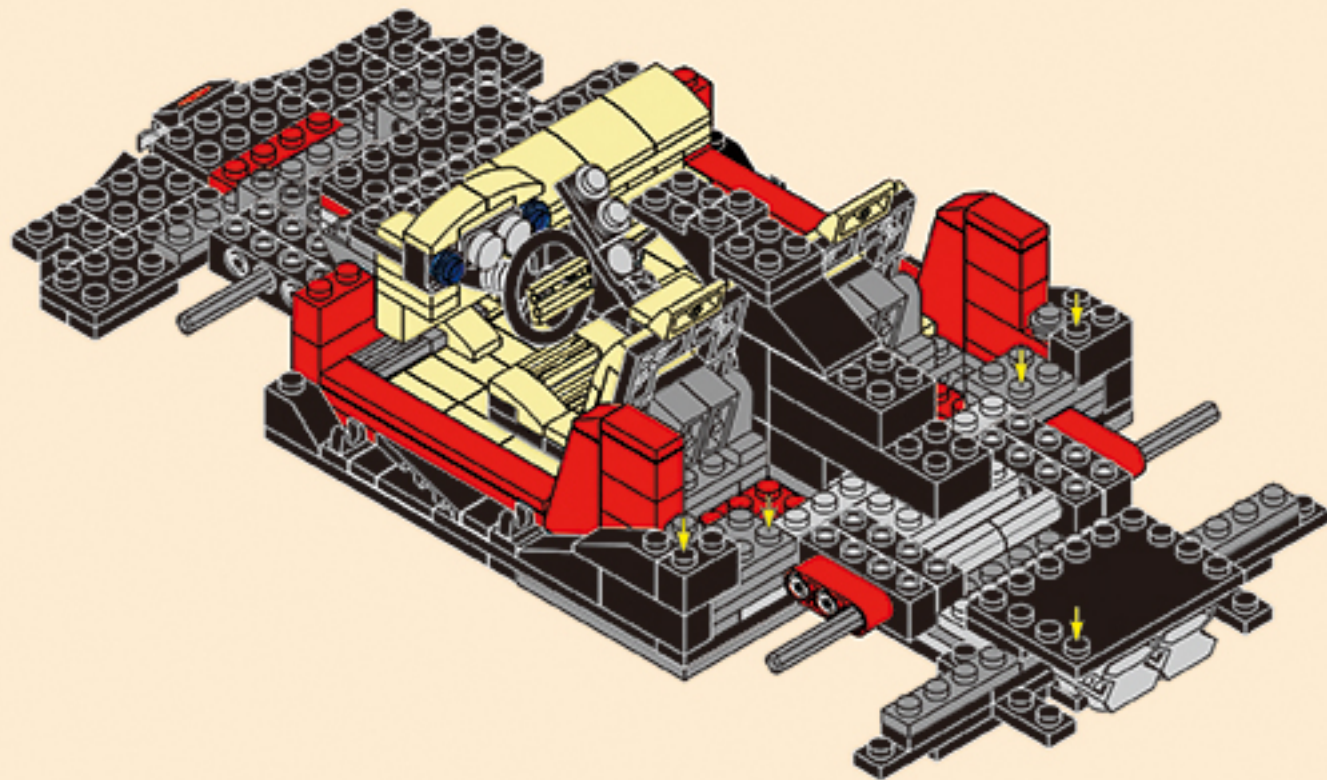



1x



2x



2x

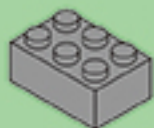

2x

2-20

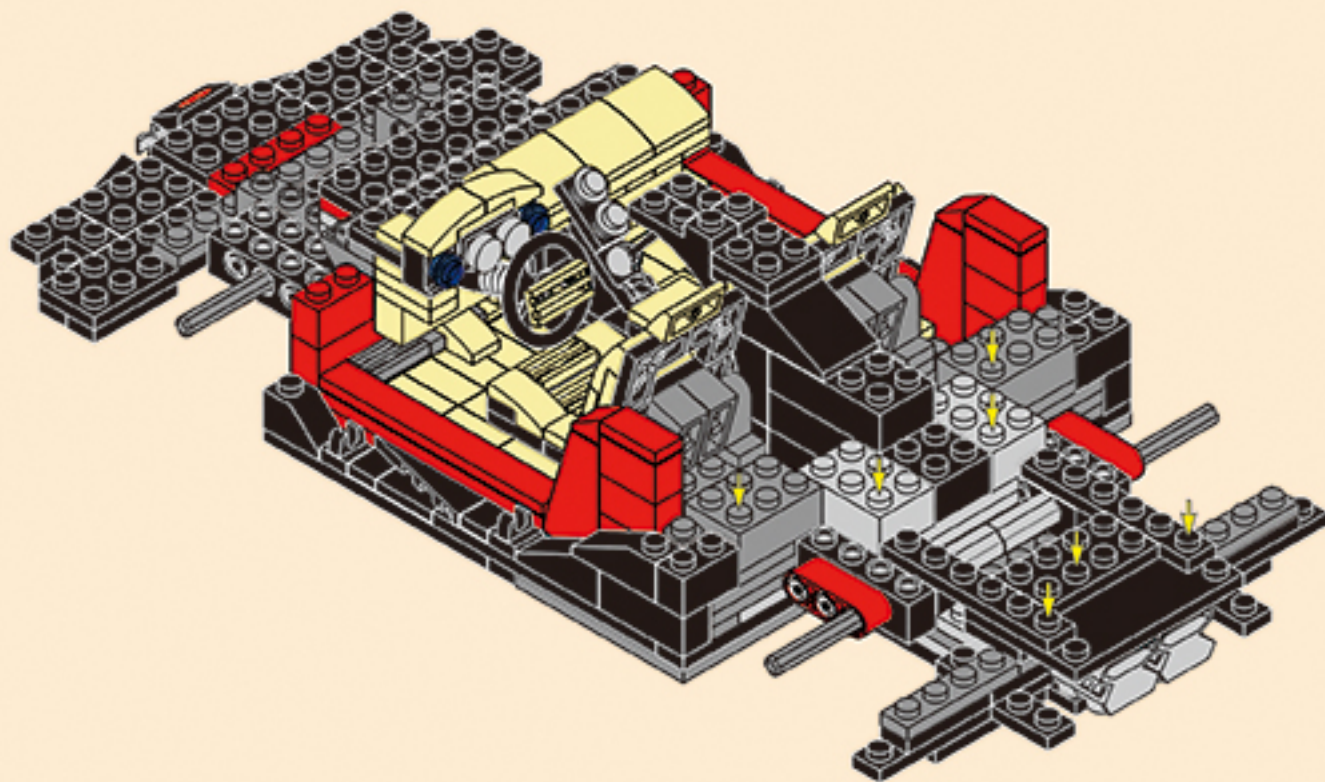

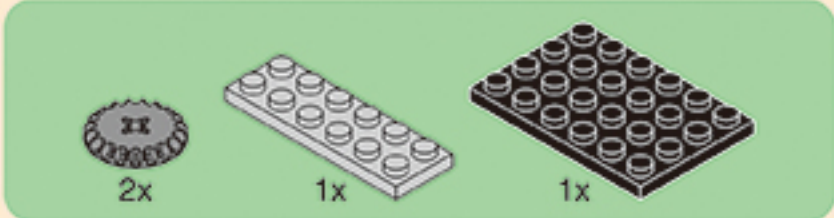

2-21

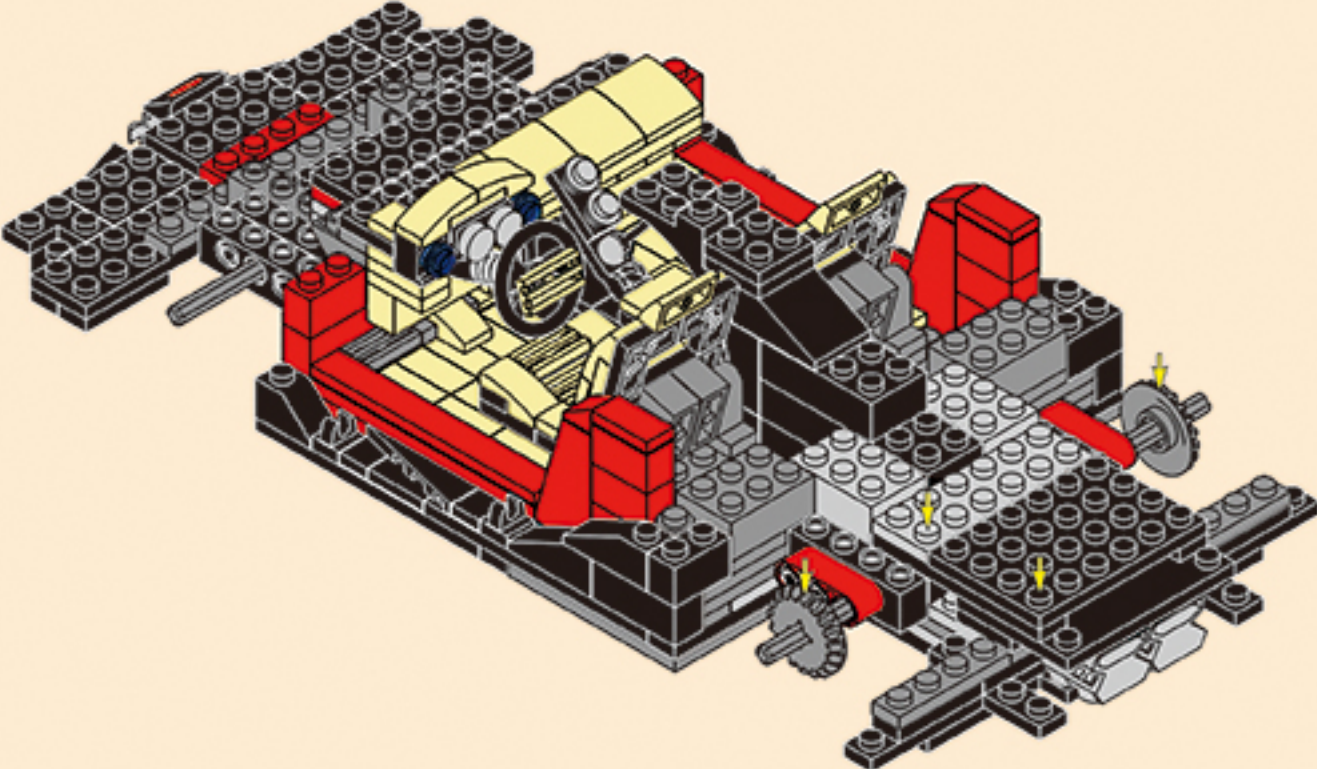

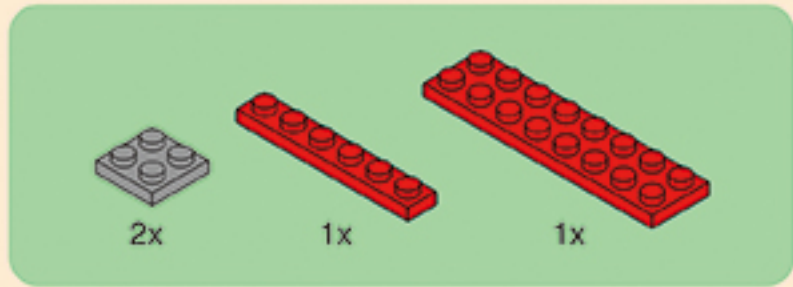

2-23

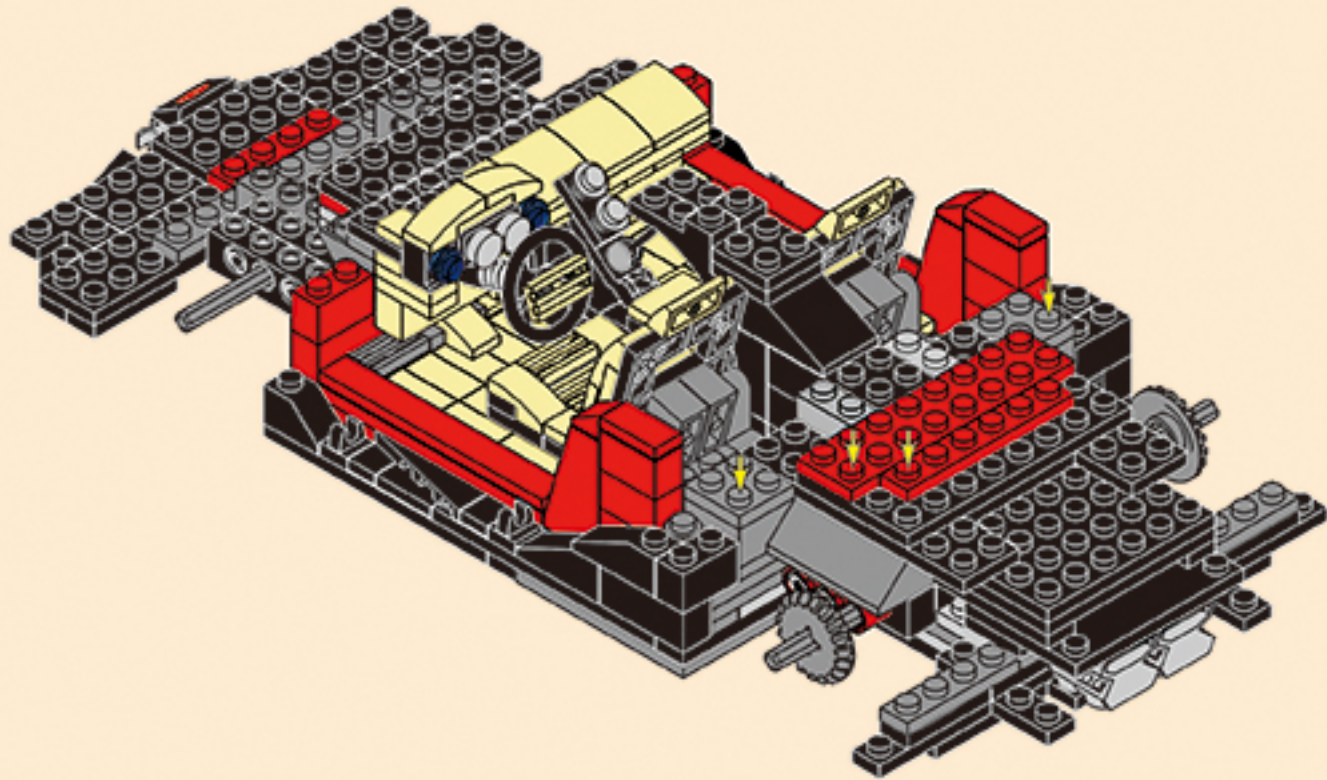

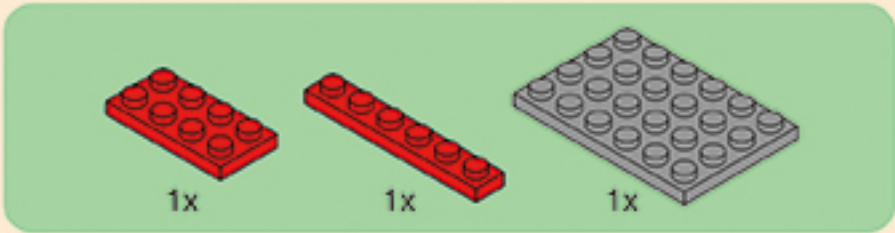

2-24

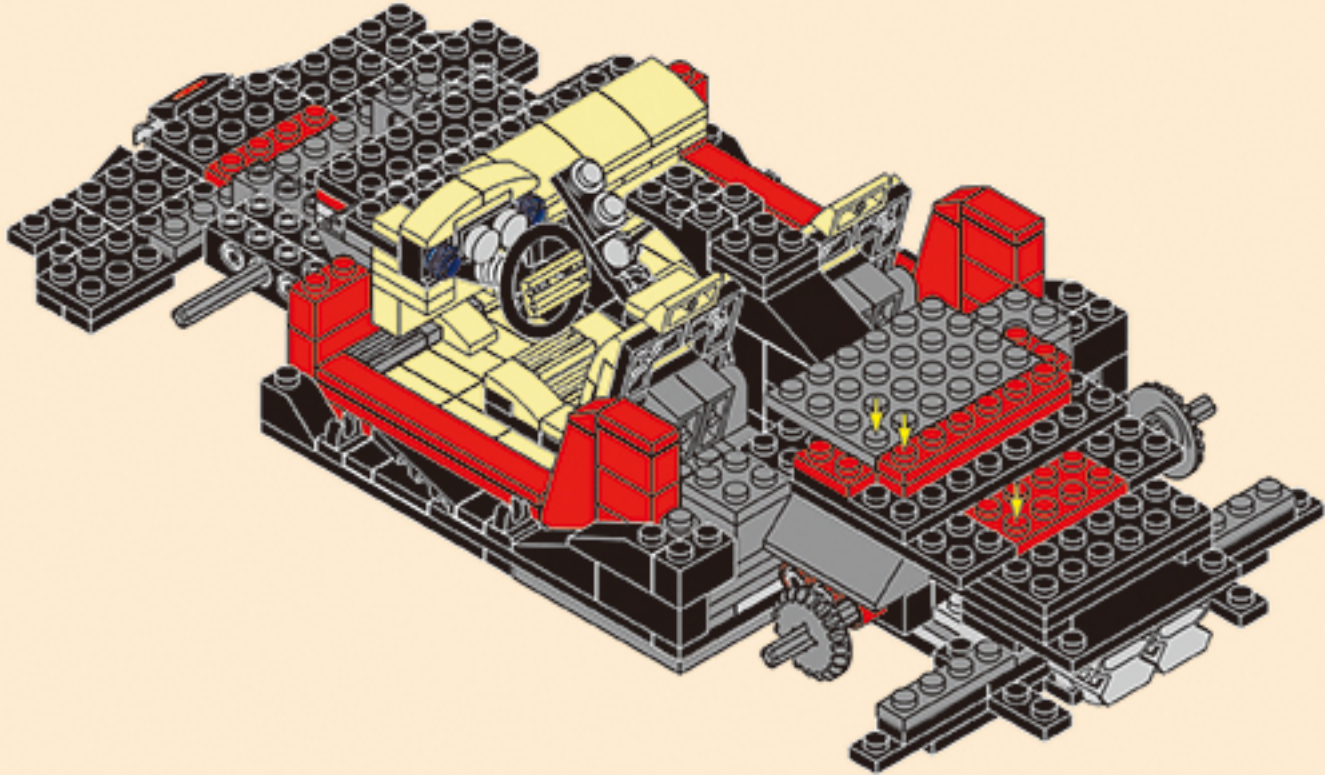



4x



2x



2x



1x

2-25

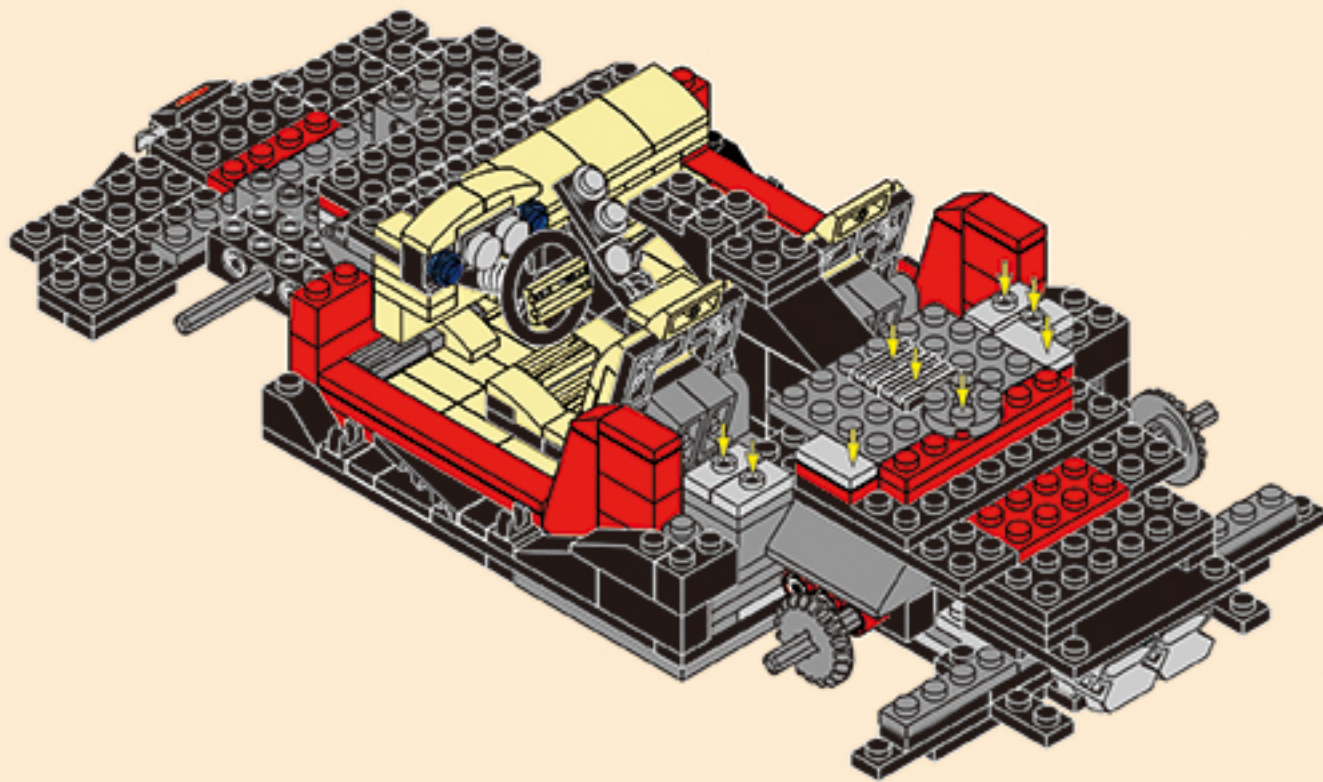



2-26

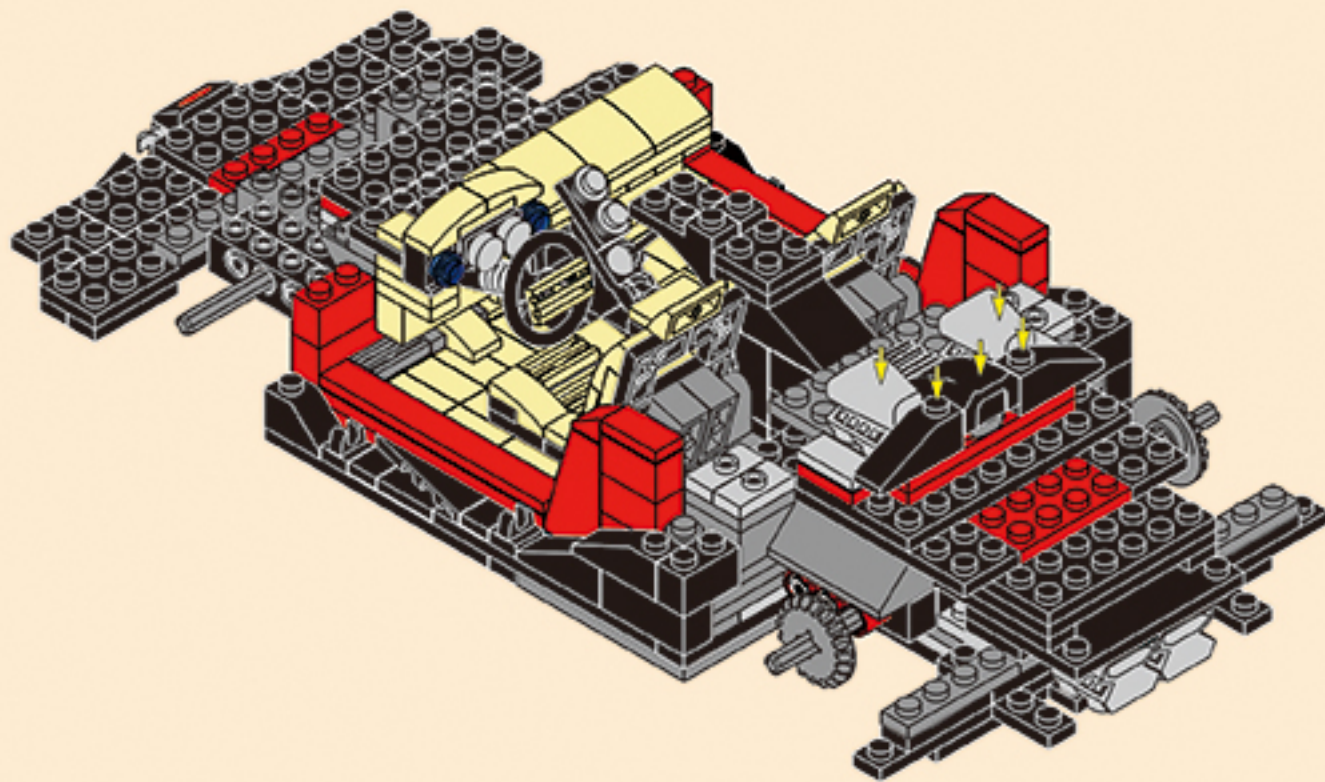

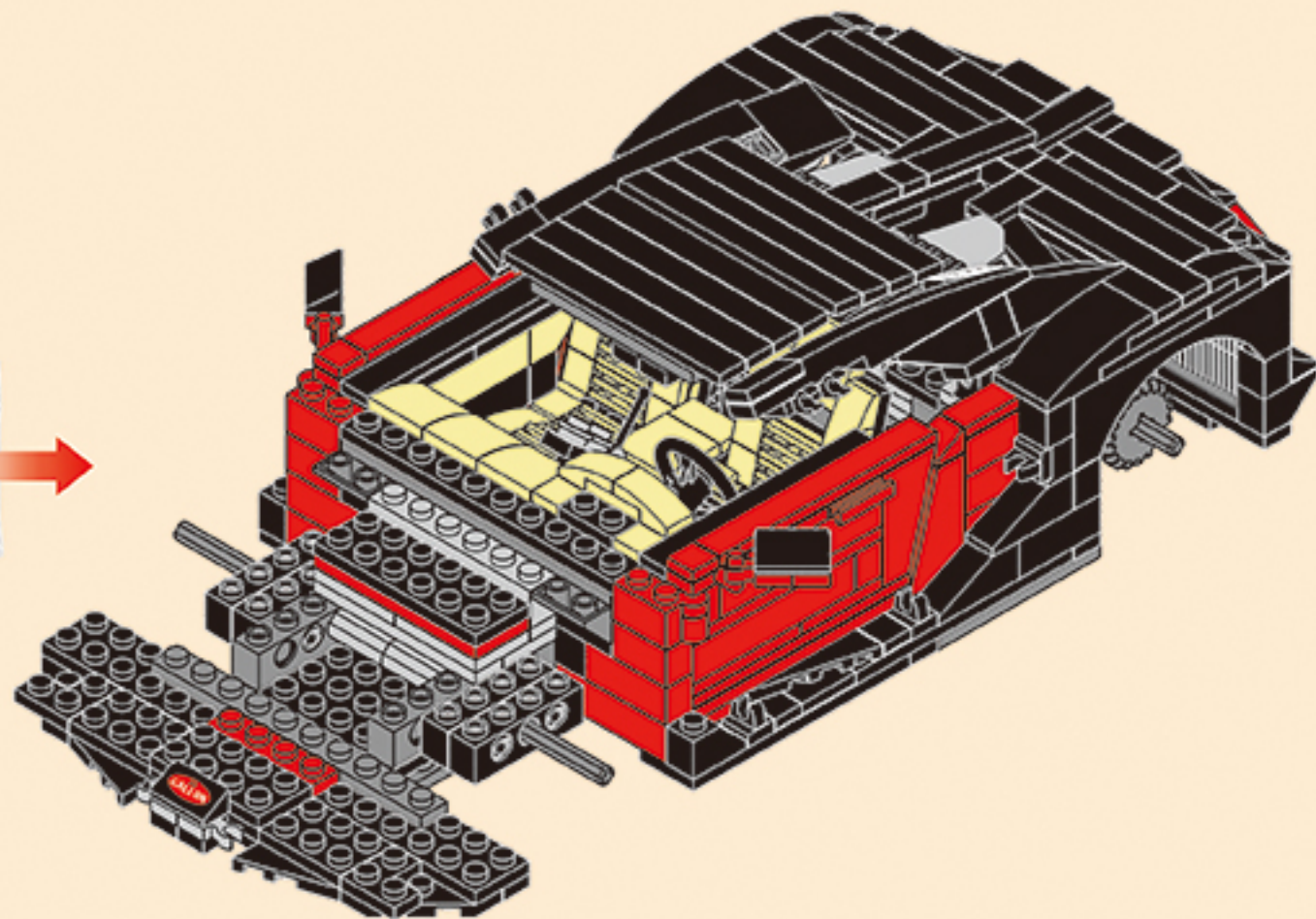



3-1

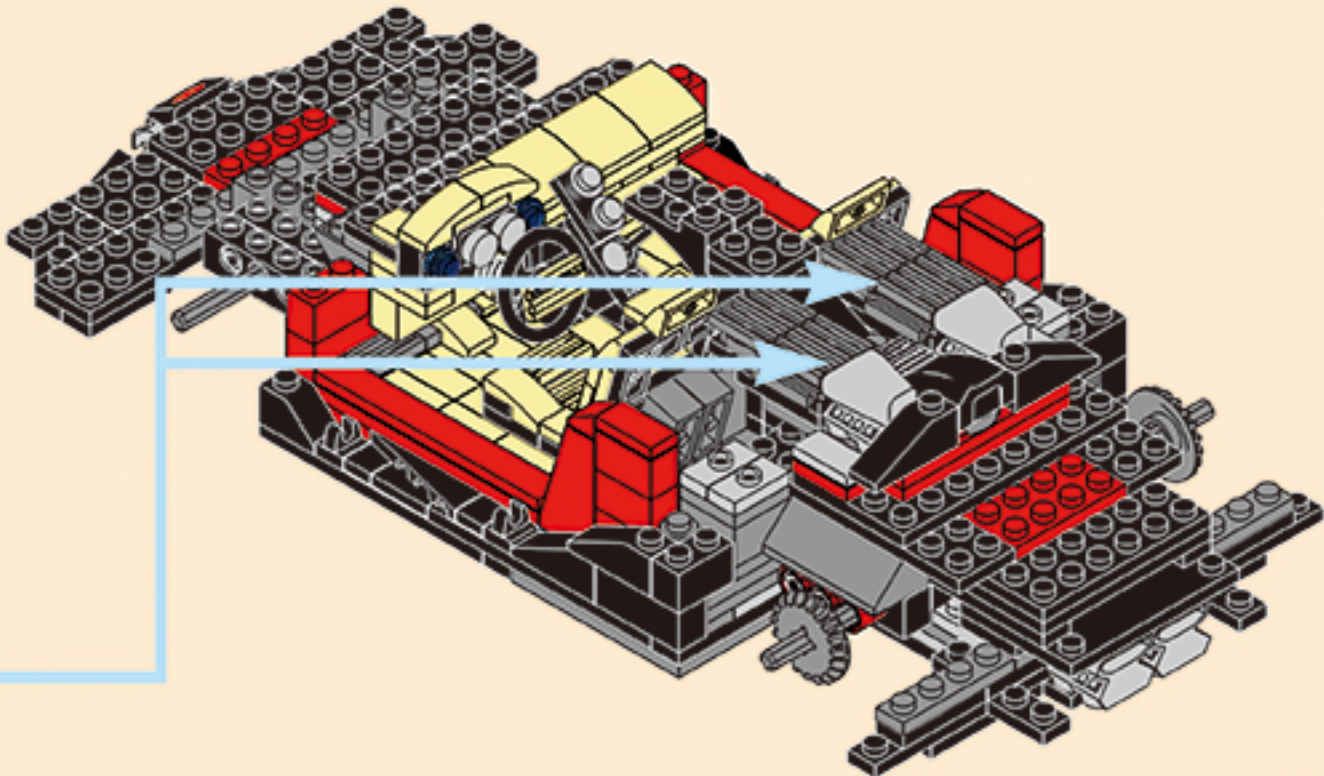
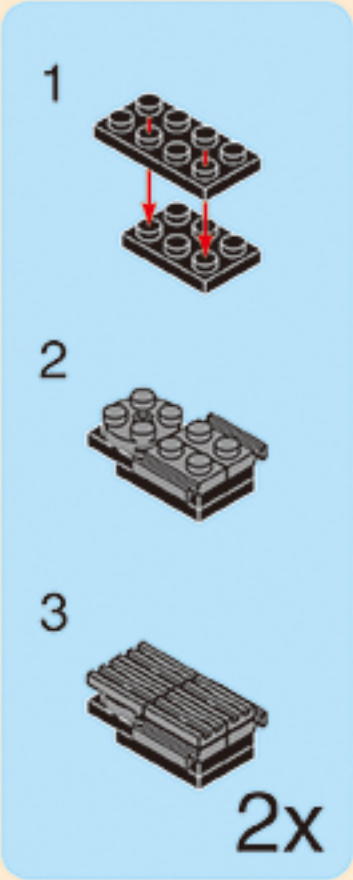

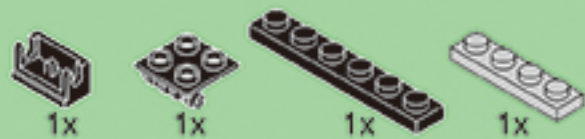

3-2.1

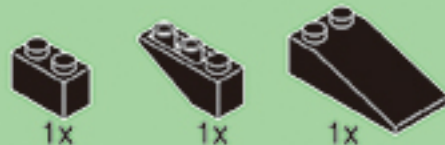

3-2.2

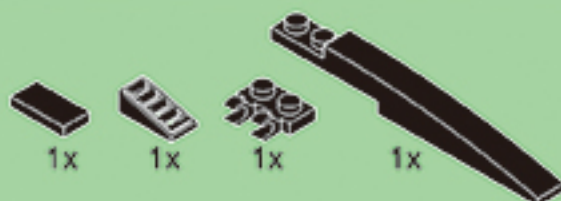
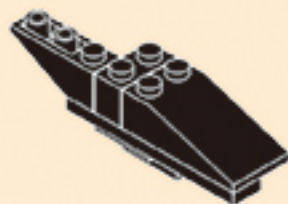

3-2.3

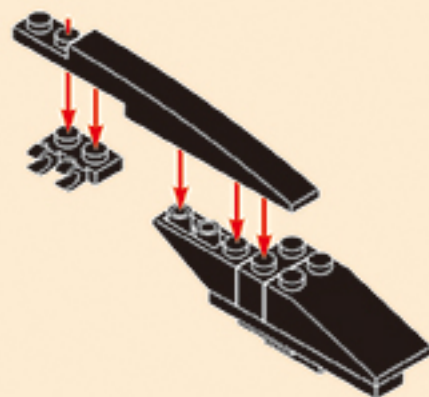

3-2.4

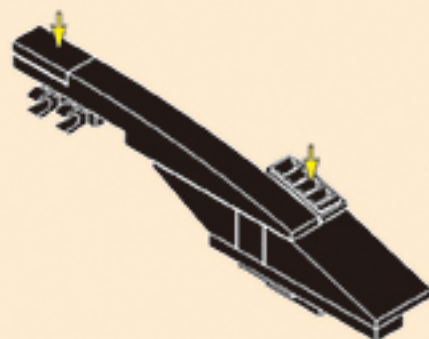

3-2

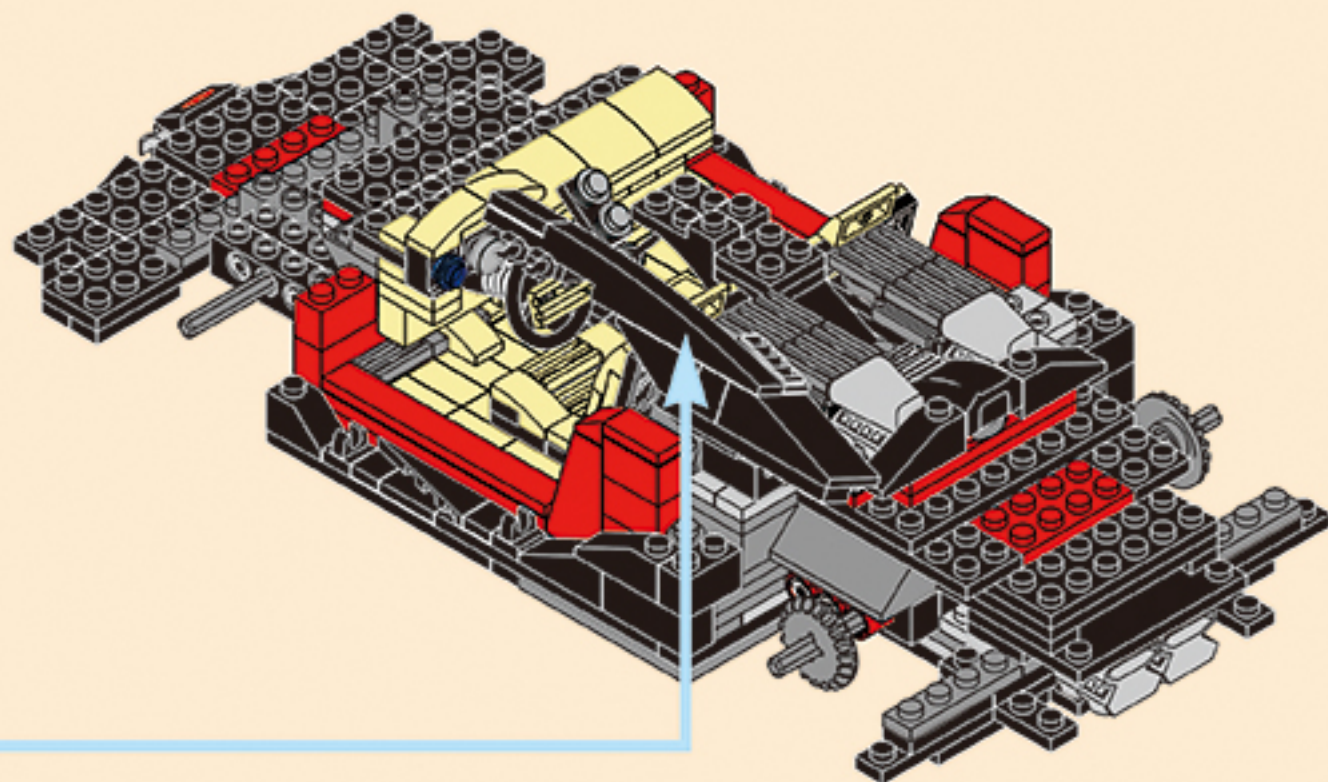

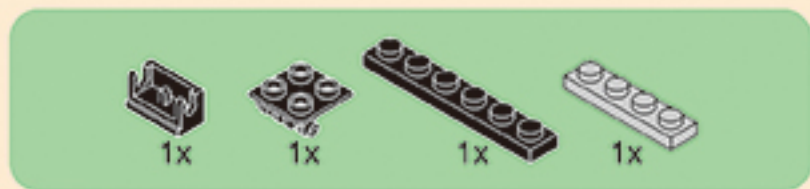

3-3.1

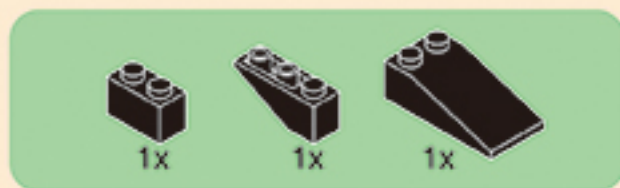

3-3.2

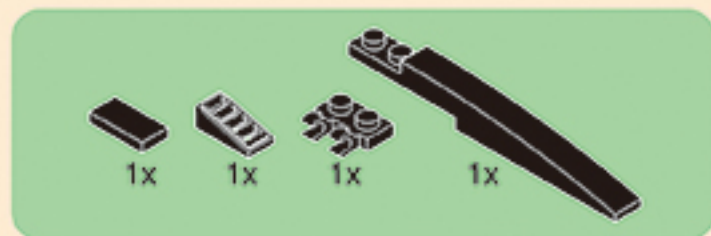
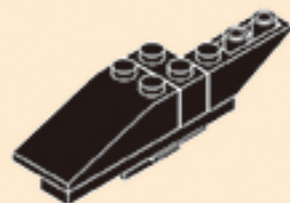

3-3.3

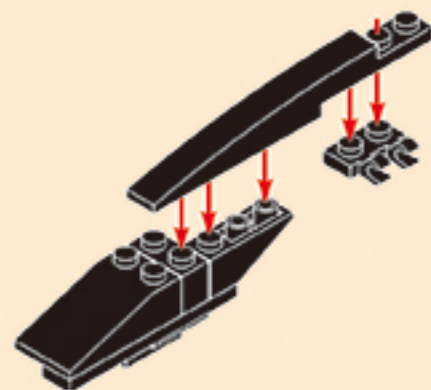

3-3.4

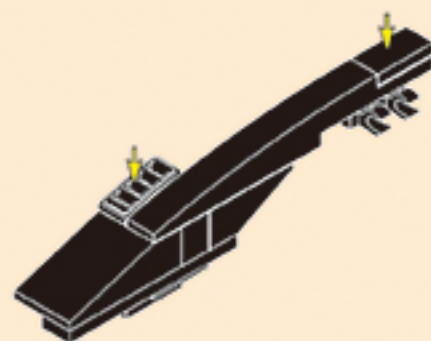

3-3

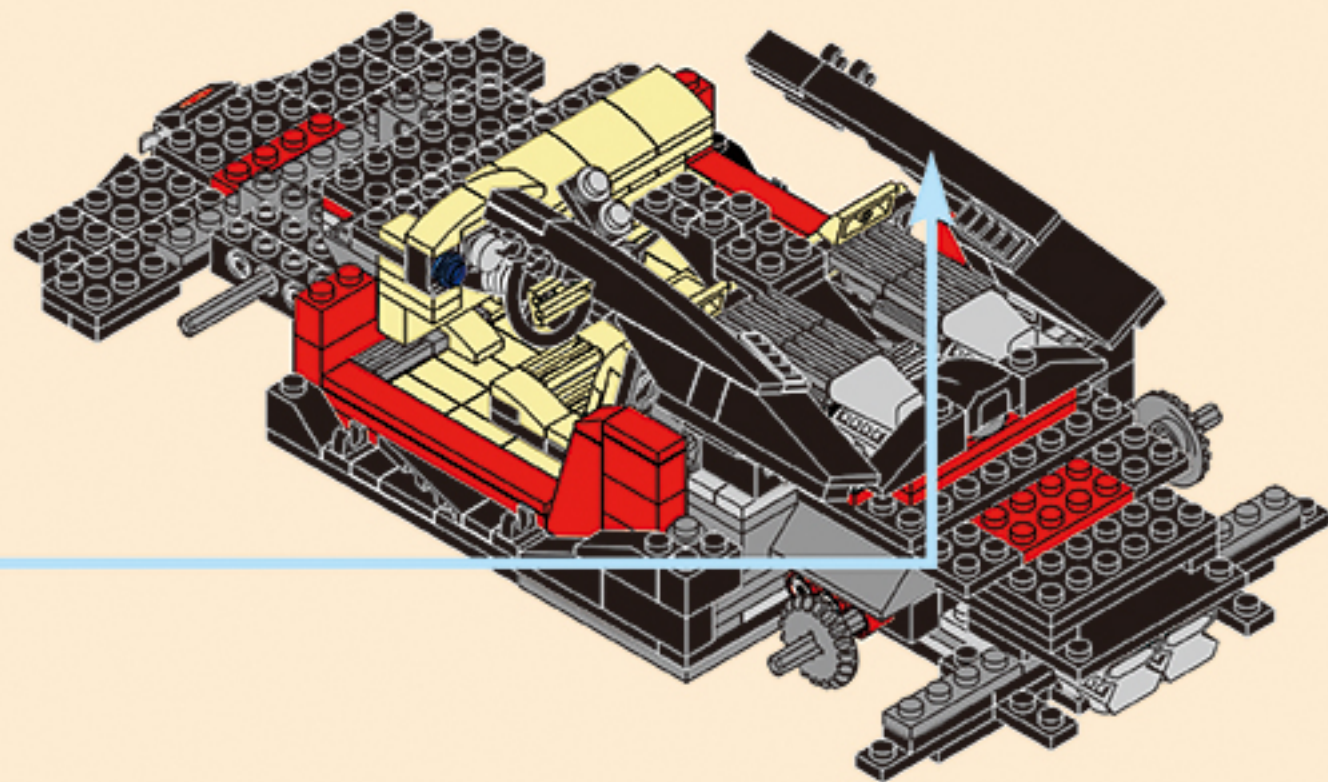



2x



4x

3-4

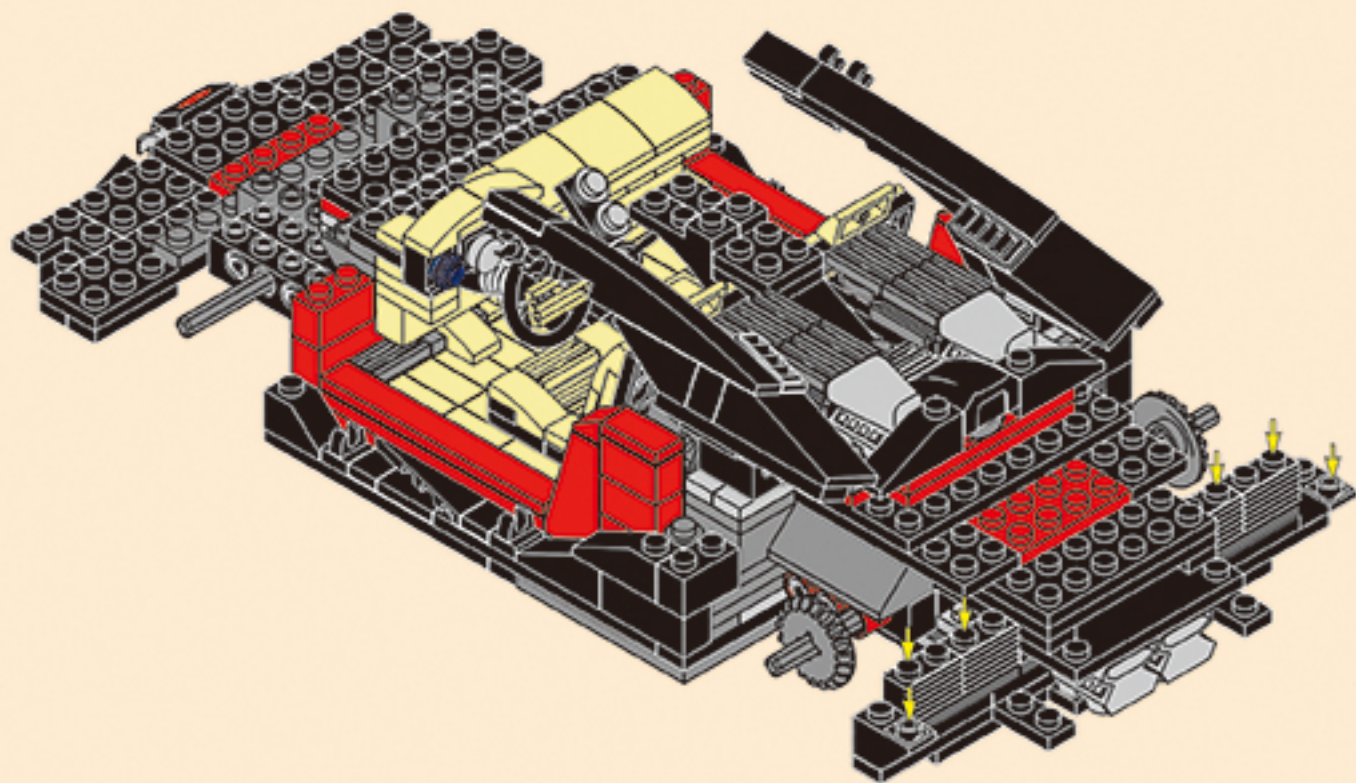

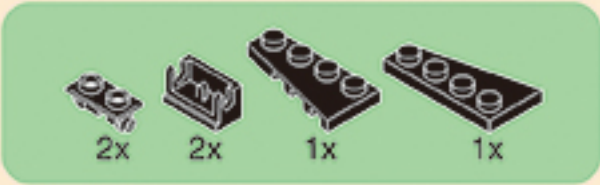

3-5

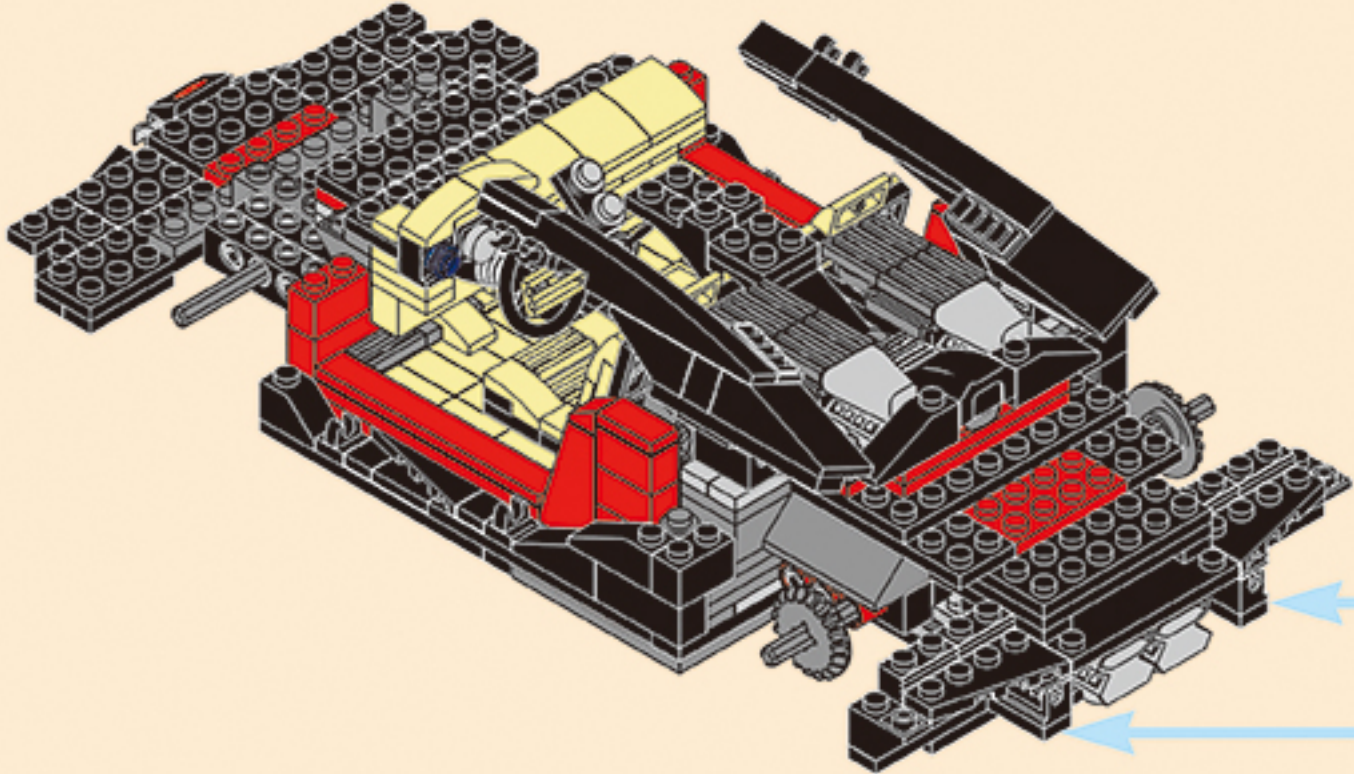
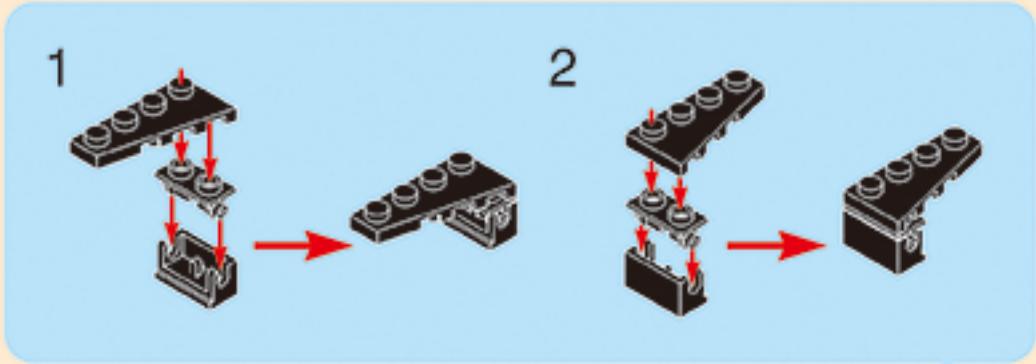



1x



1x



2x



1x

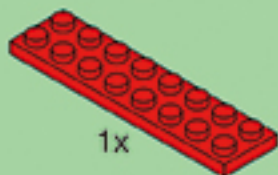

1x

3-6

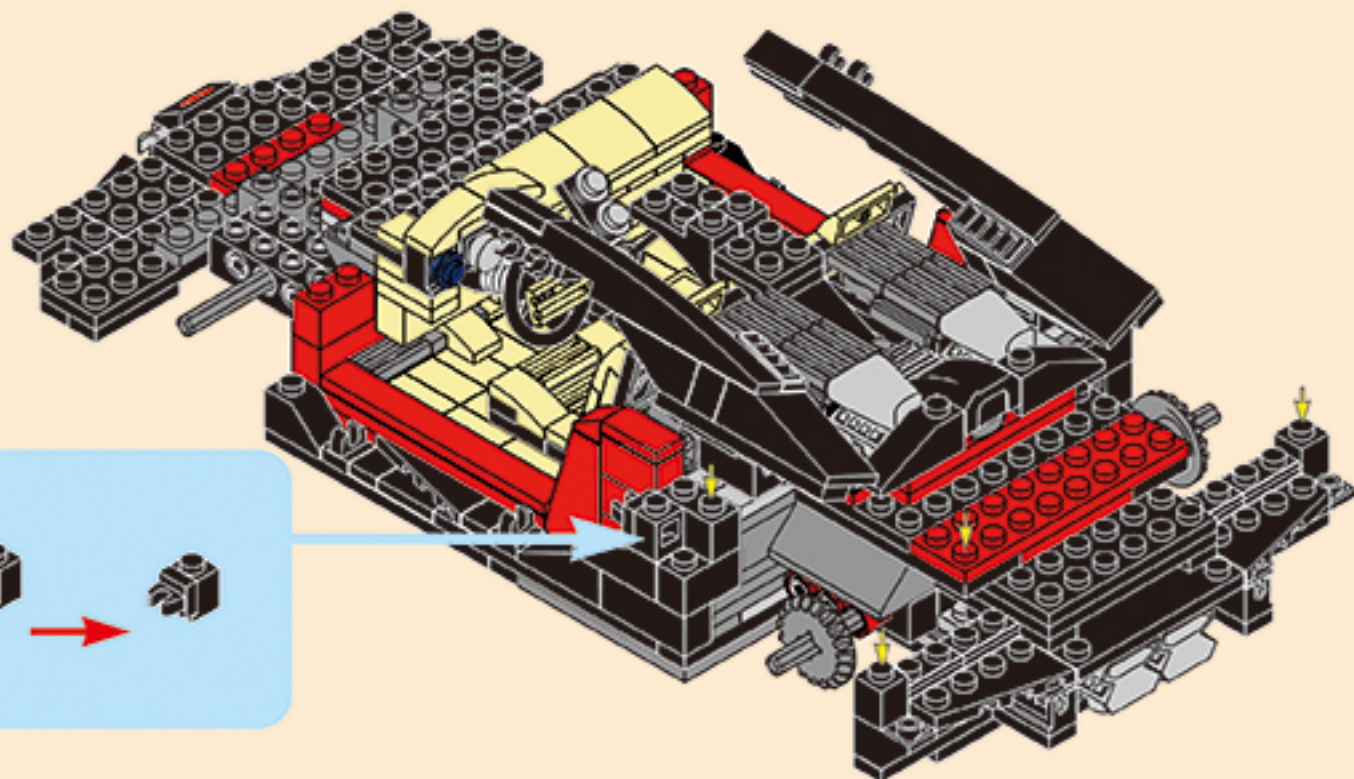

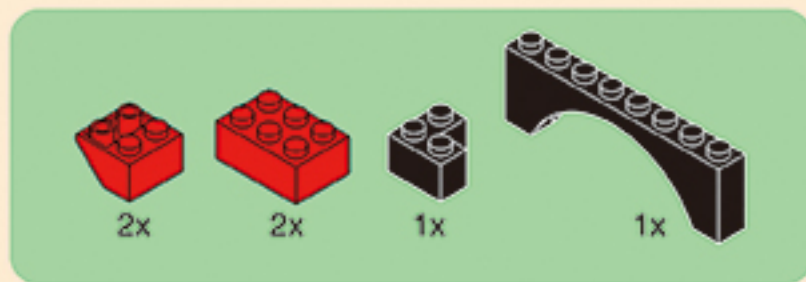

3-7

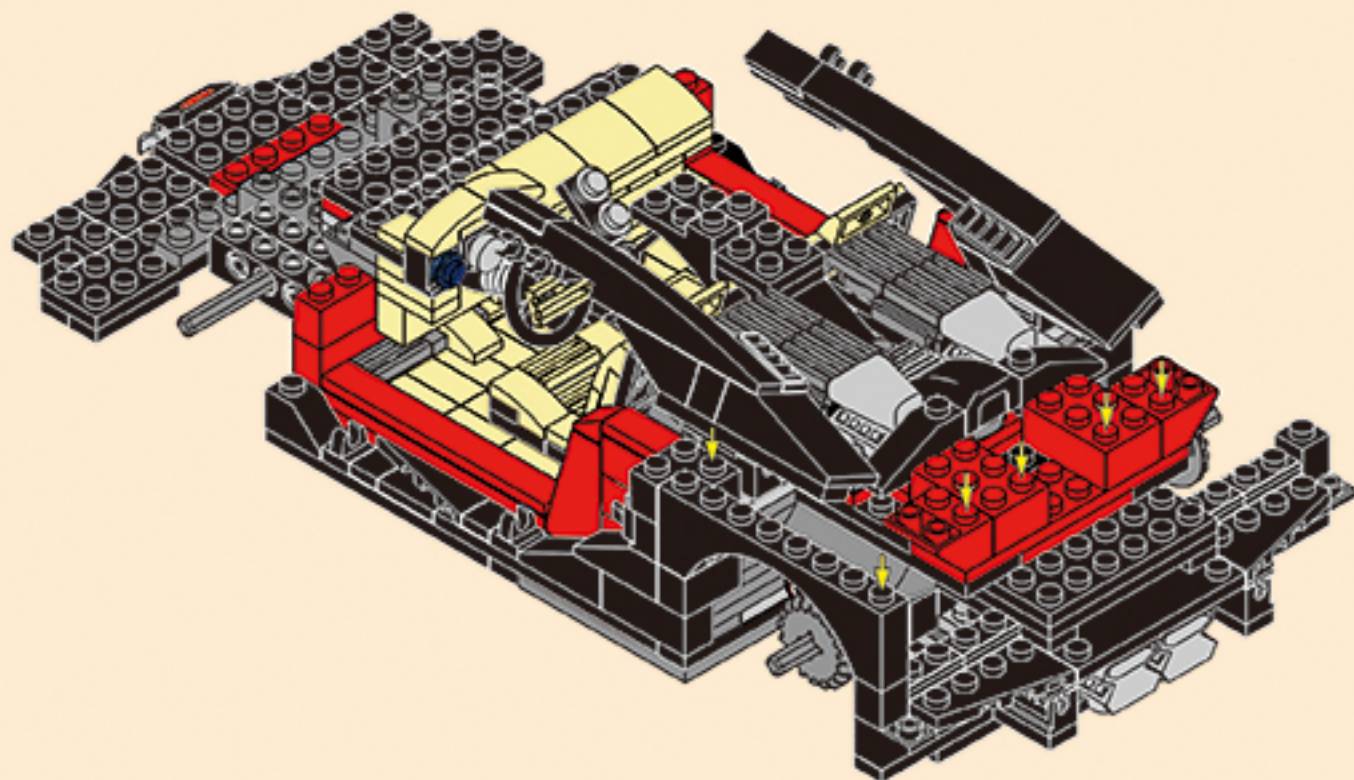

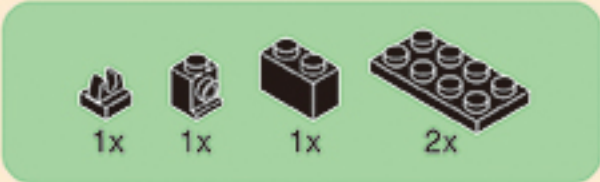

3-8

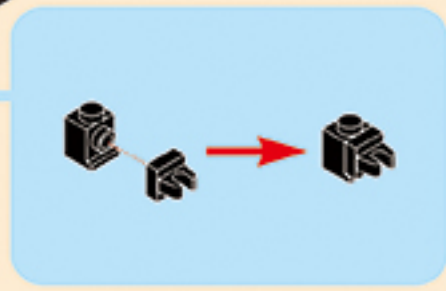
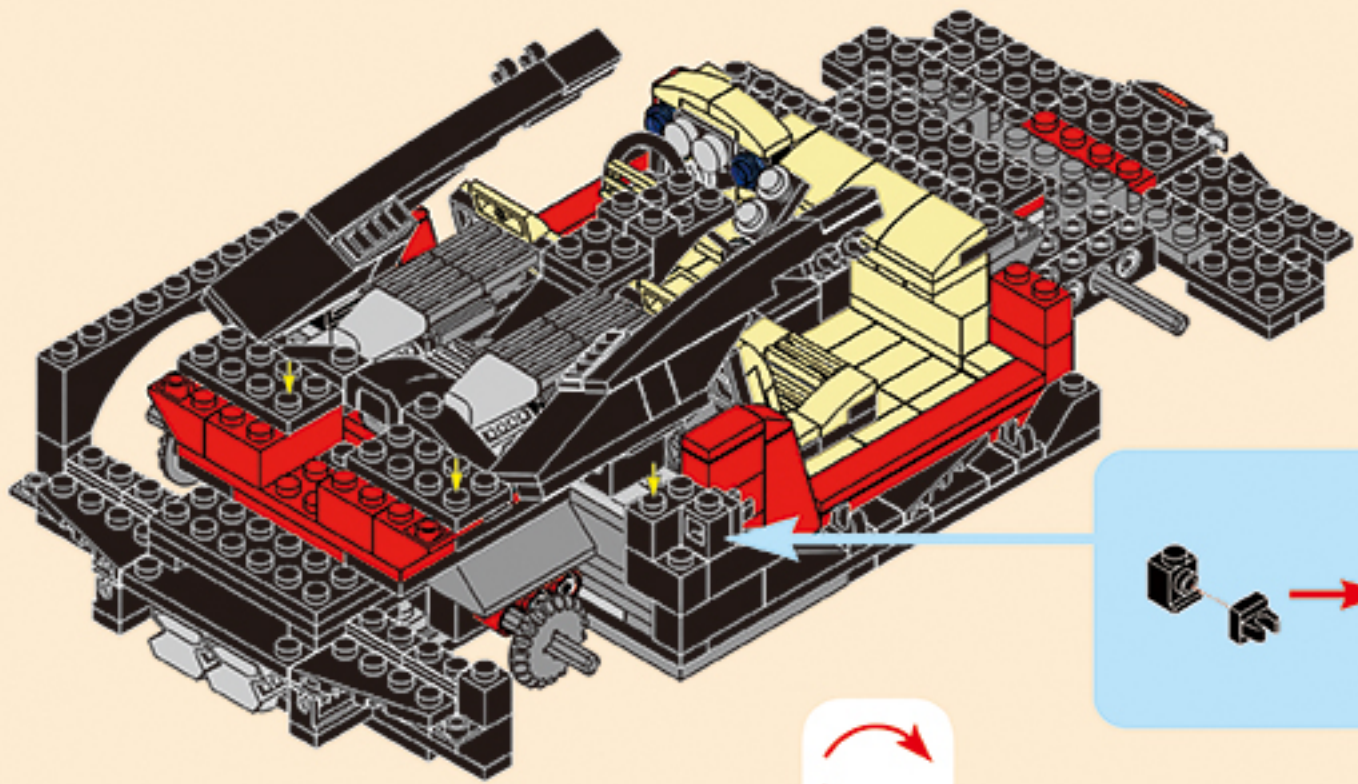

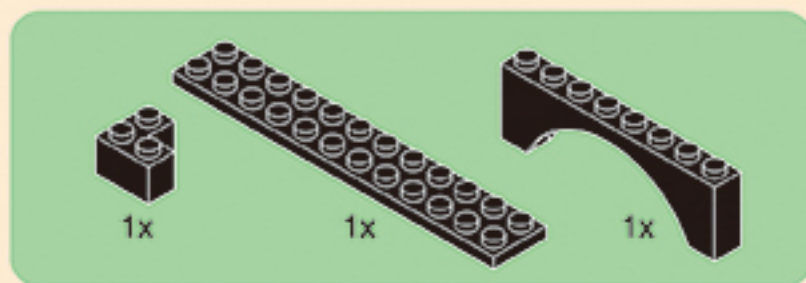

3-9

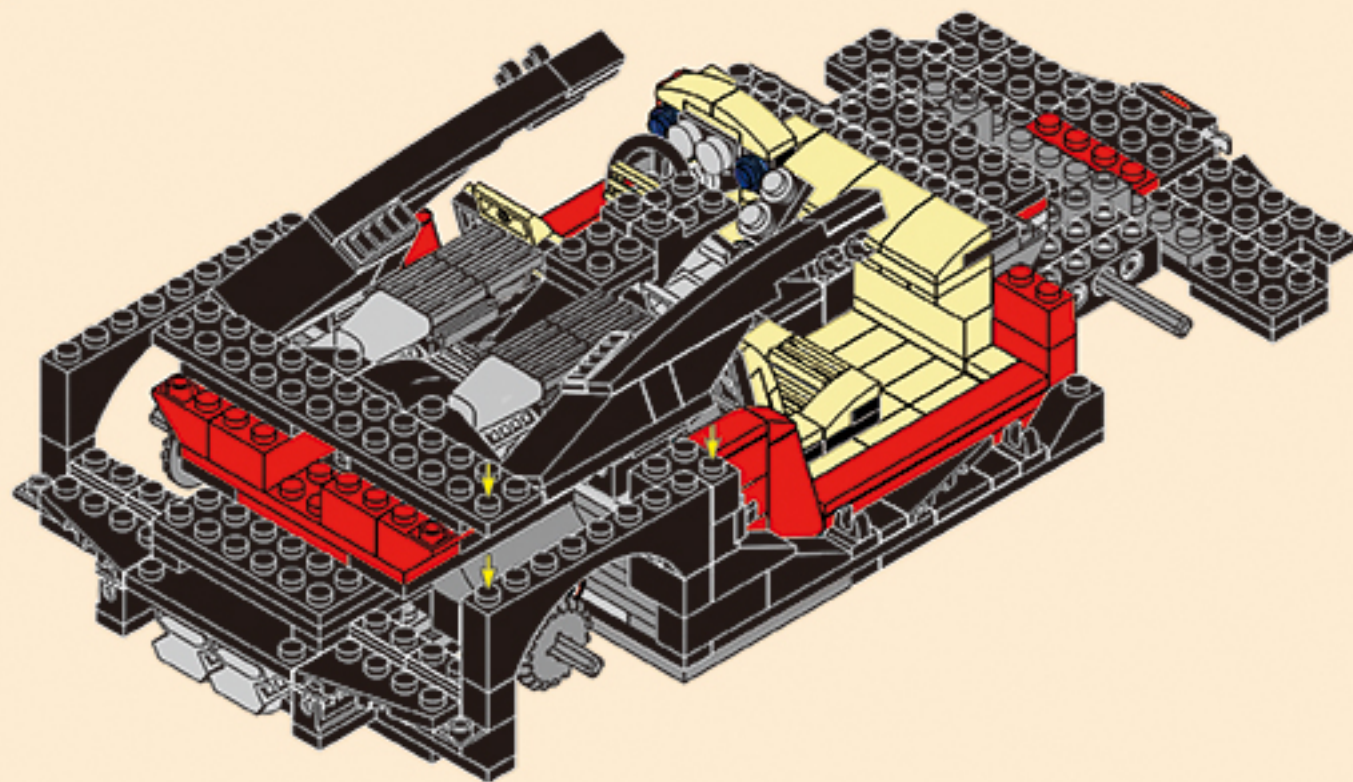

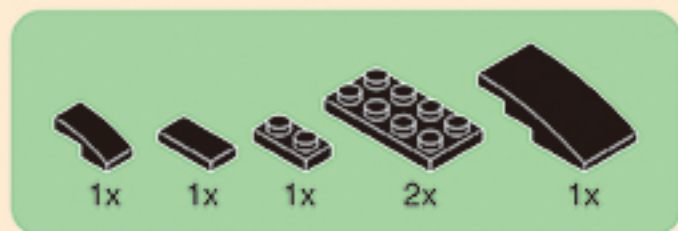

3-10.1

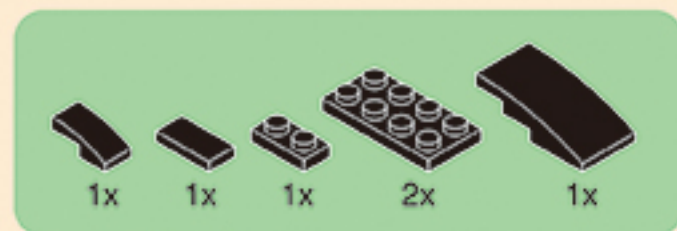
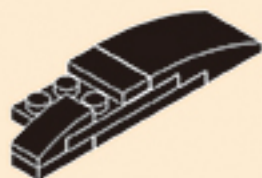
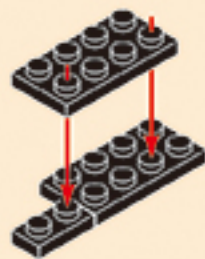

3-10.2

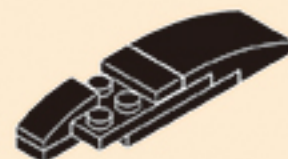
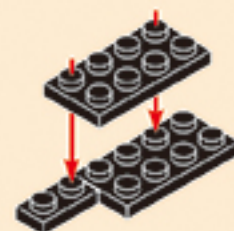

3-10

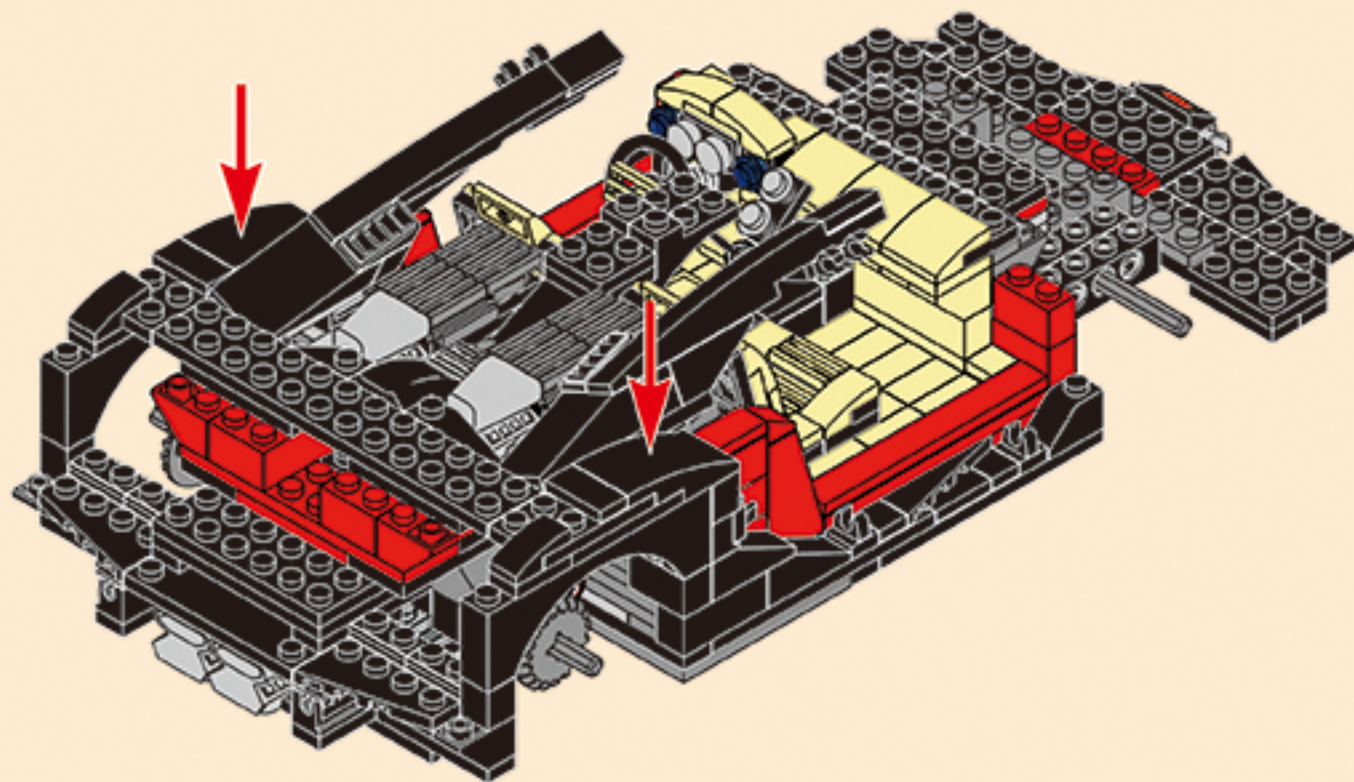



4x



4x



2x

3-11

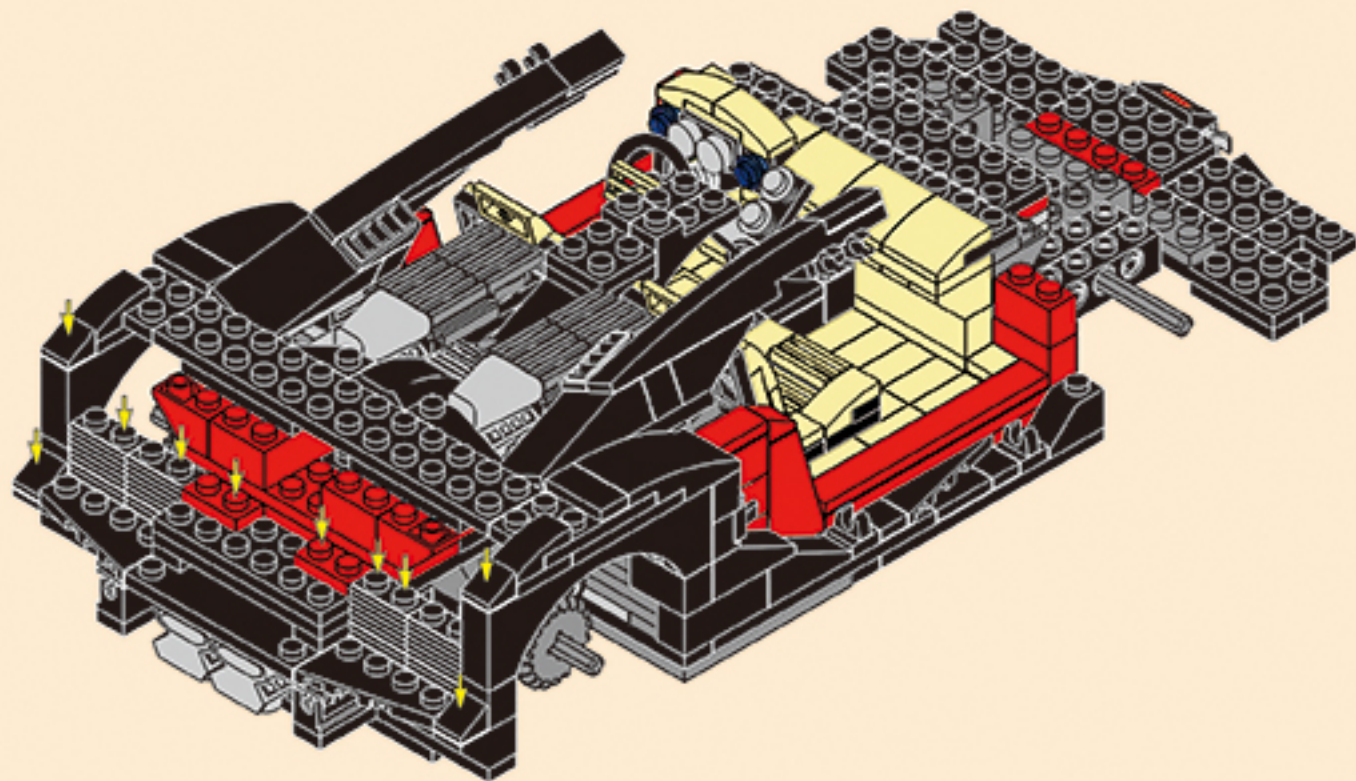

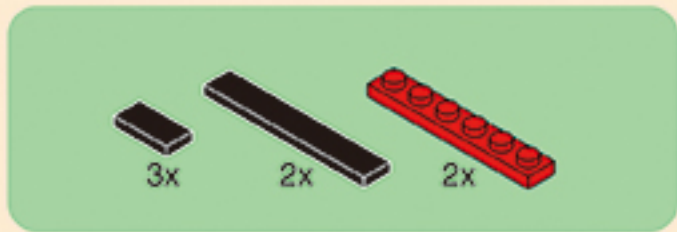

3-12

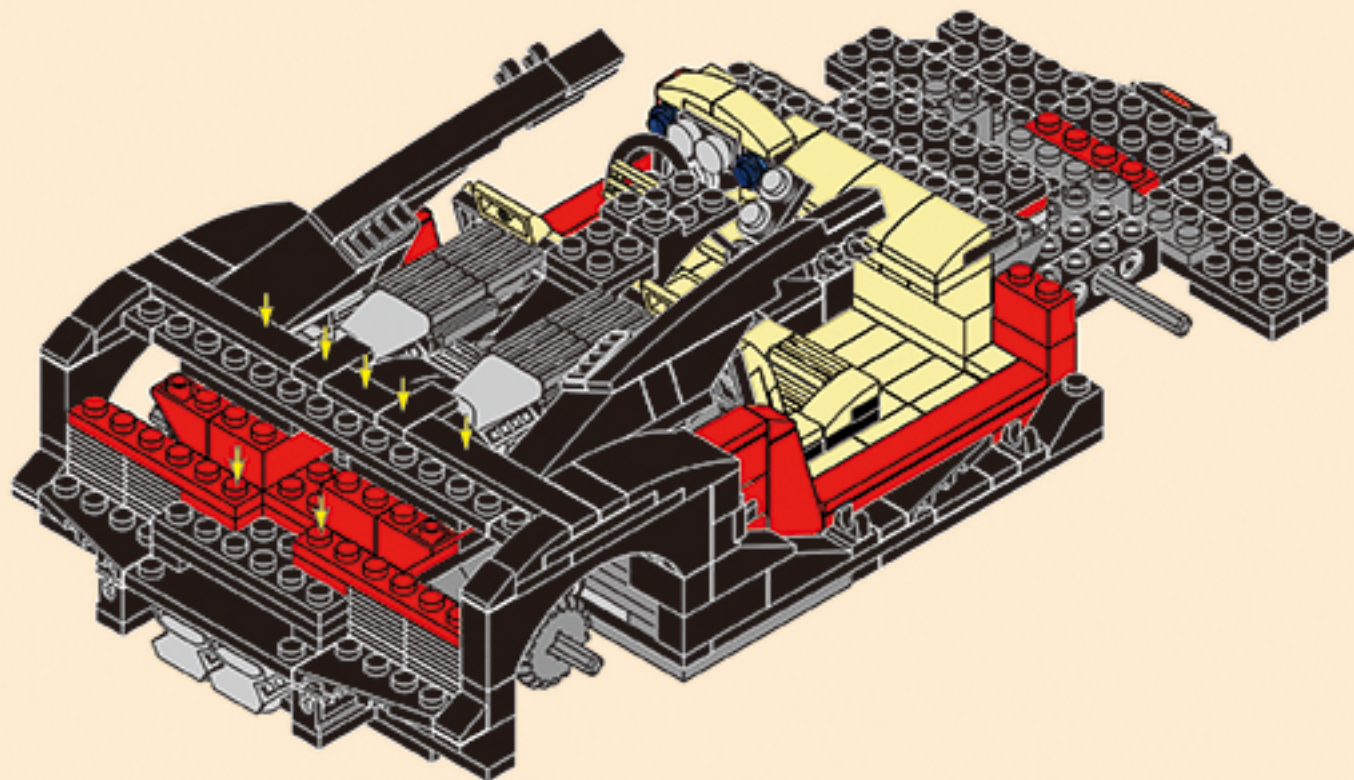



3-13

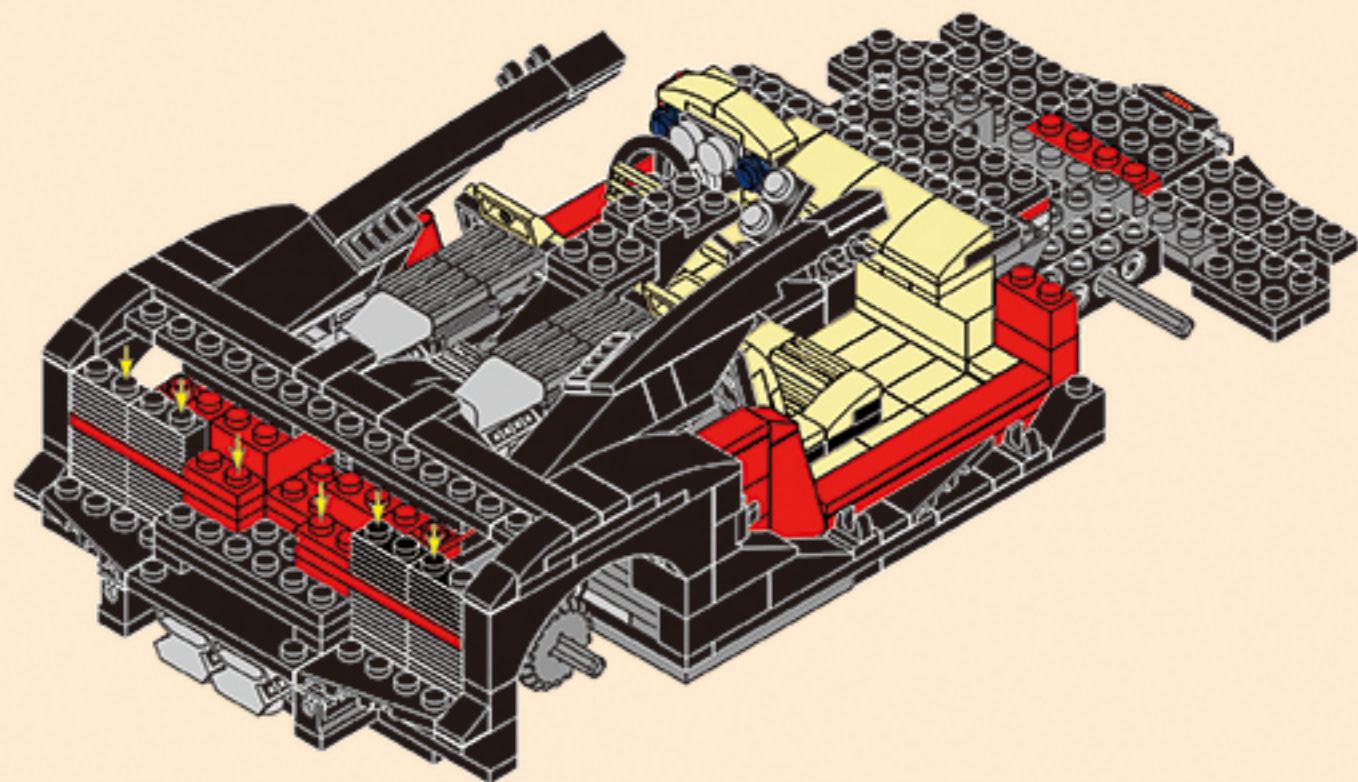

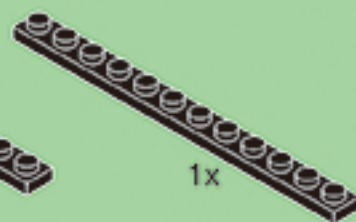
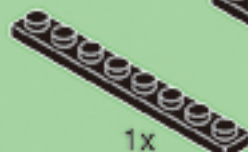
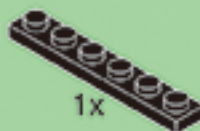

3-14

1

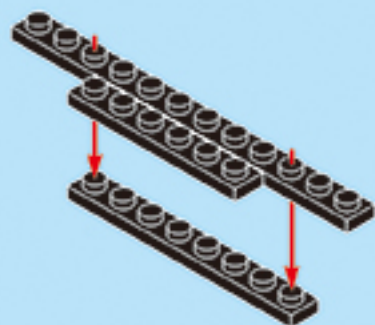

2

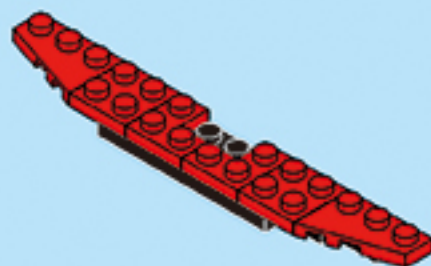

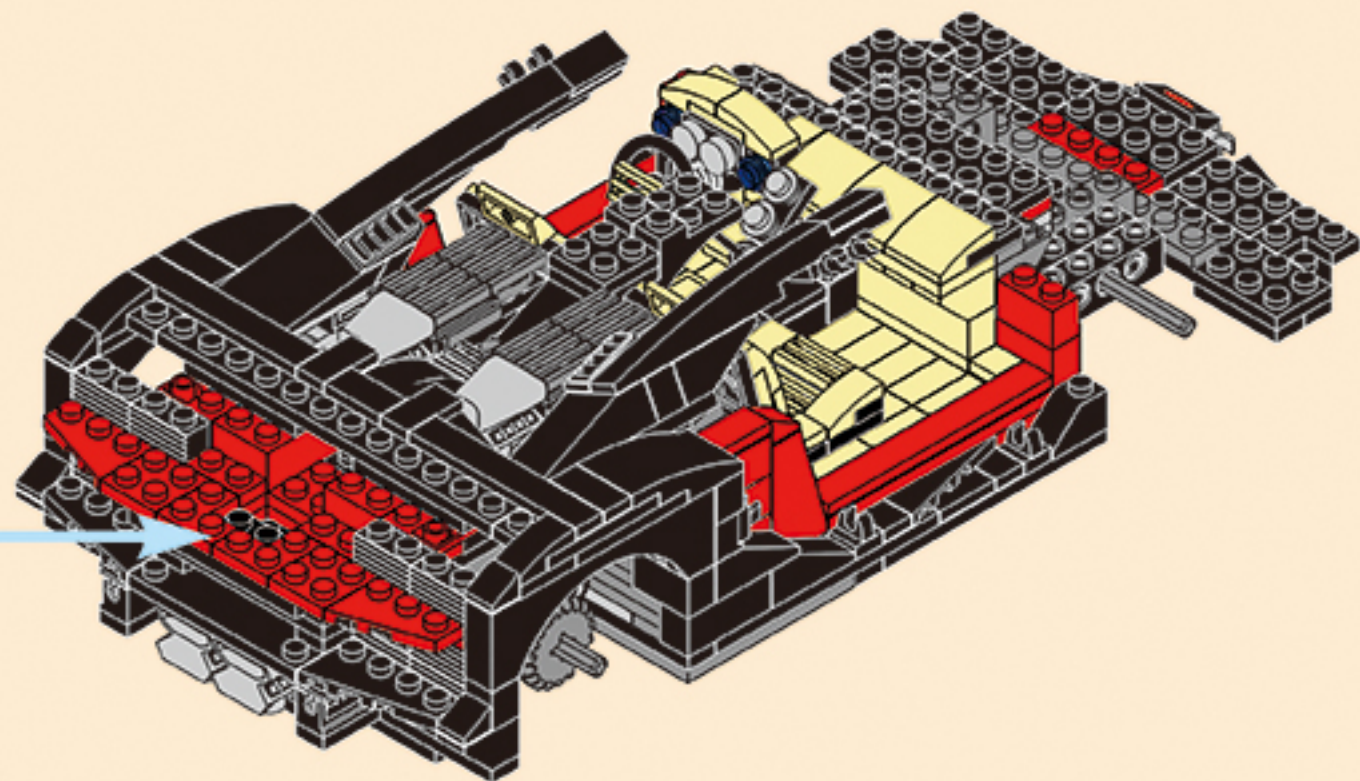

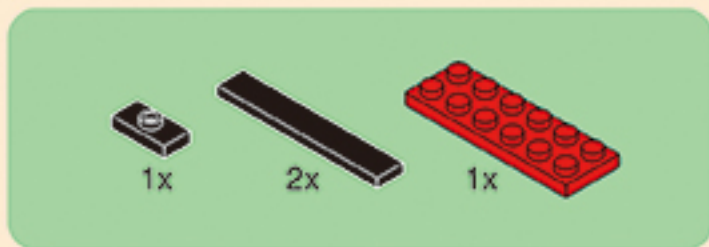

3-15

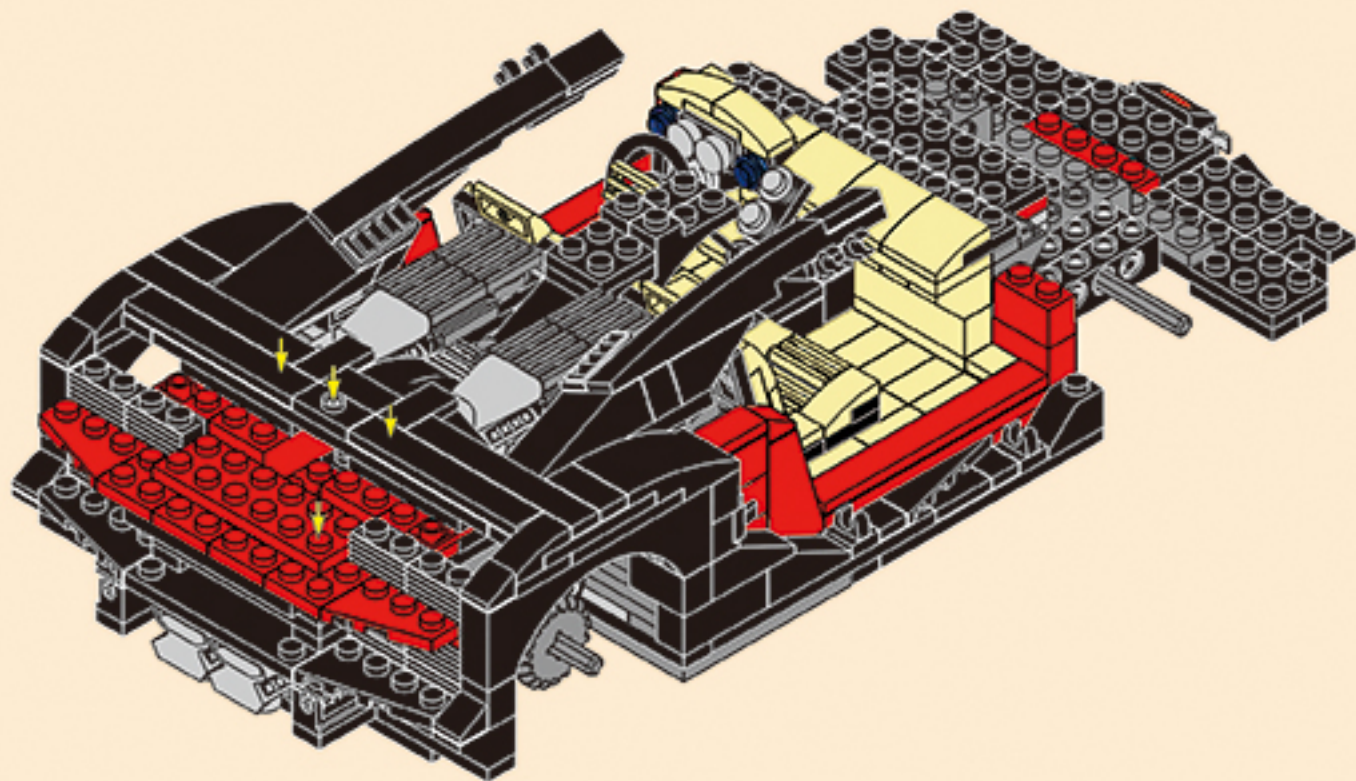

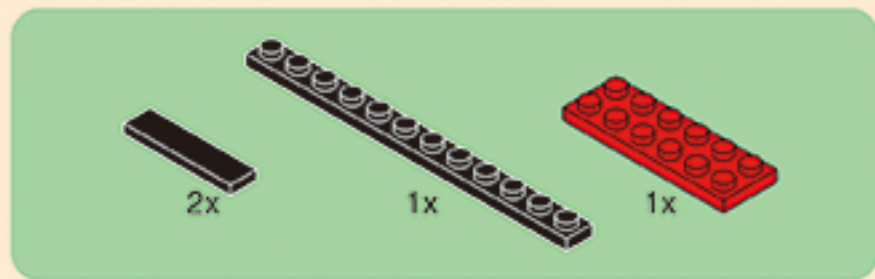

3-16

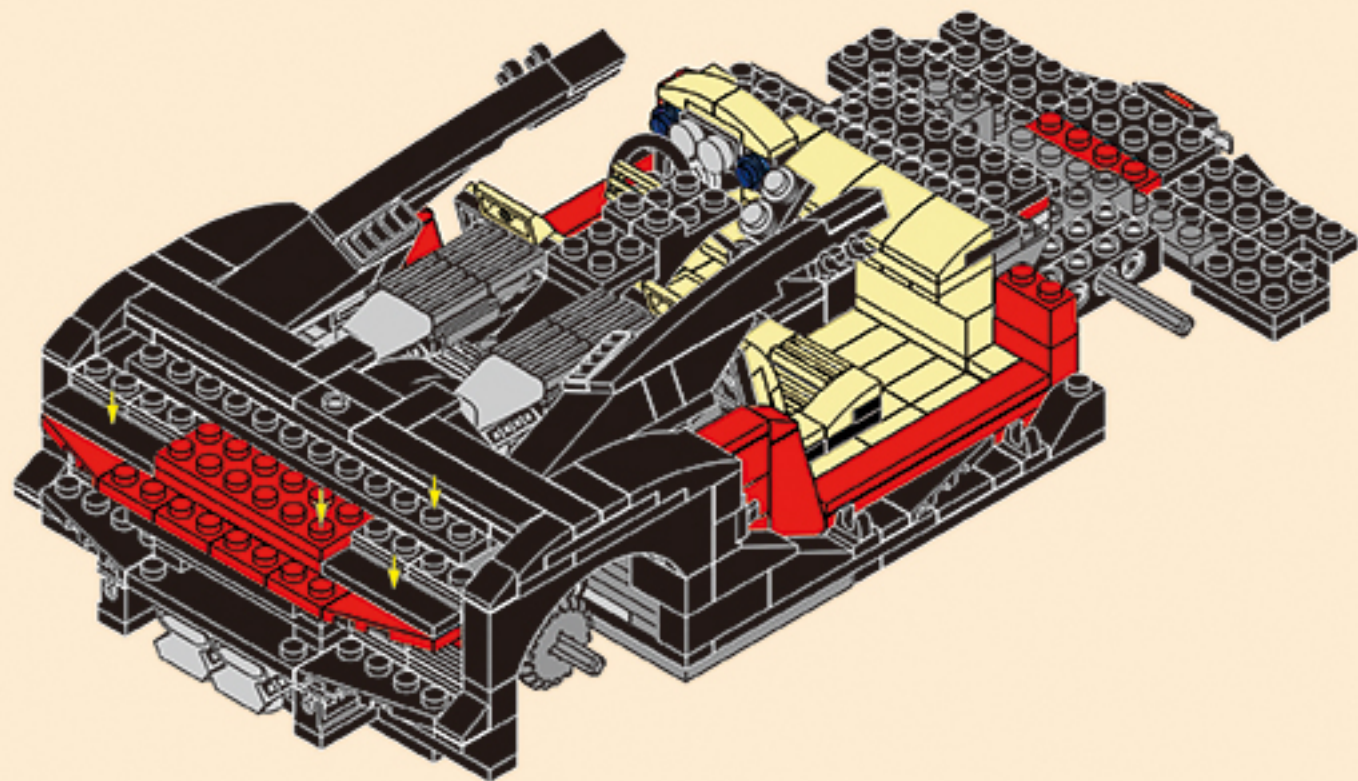

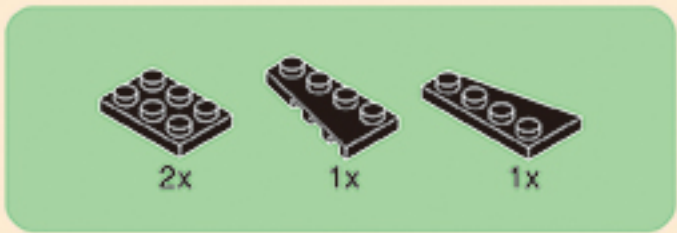

3-17

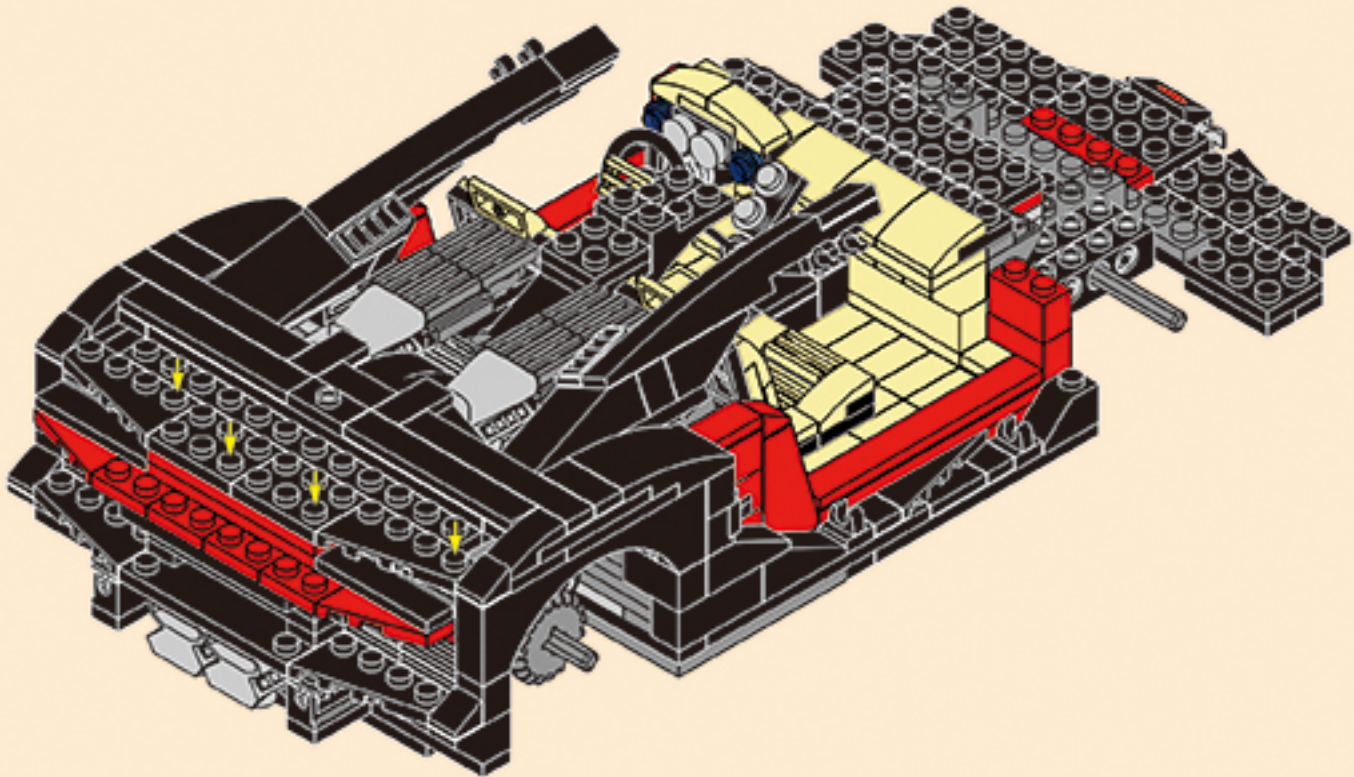

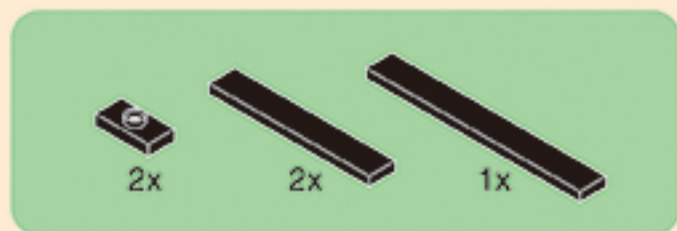

3-18

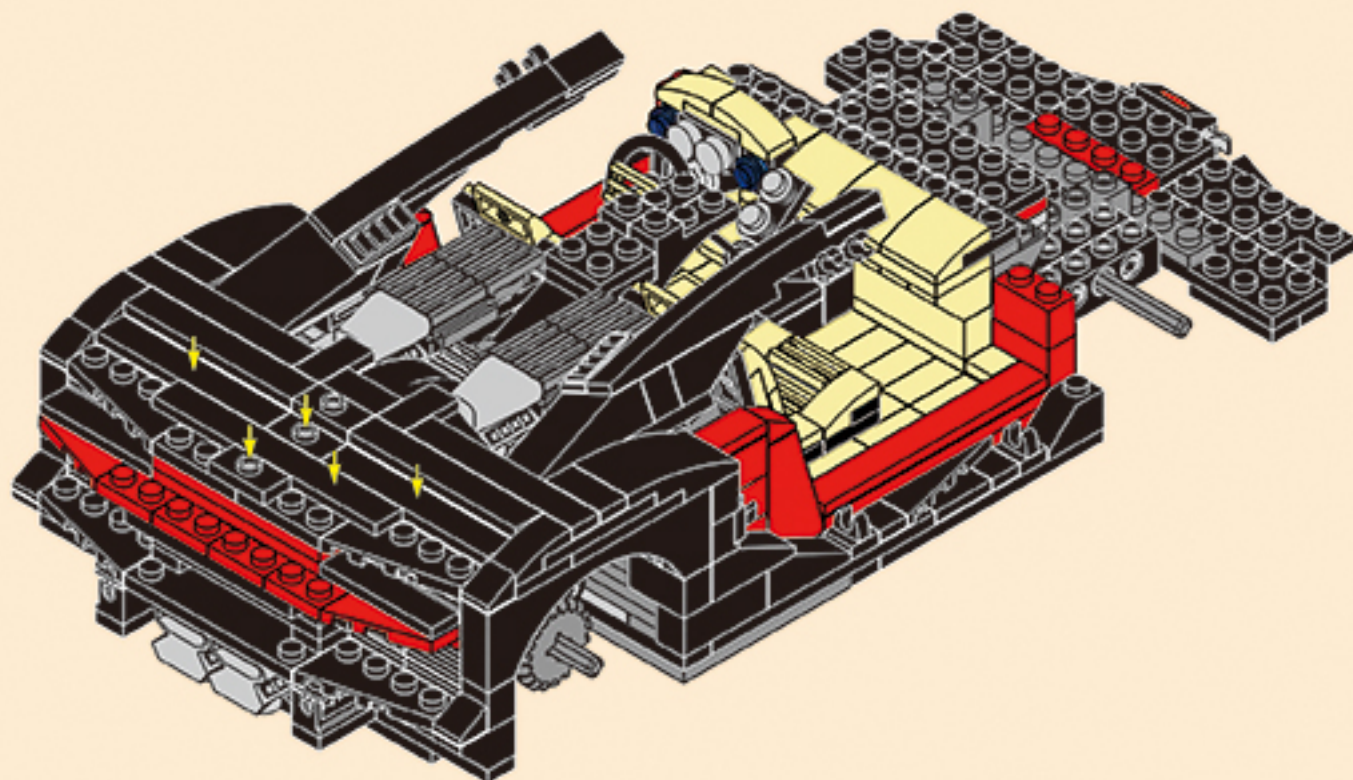

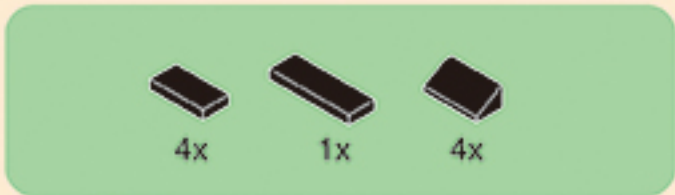

3-19

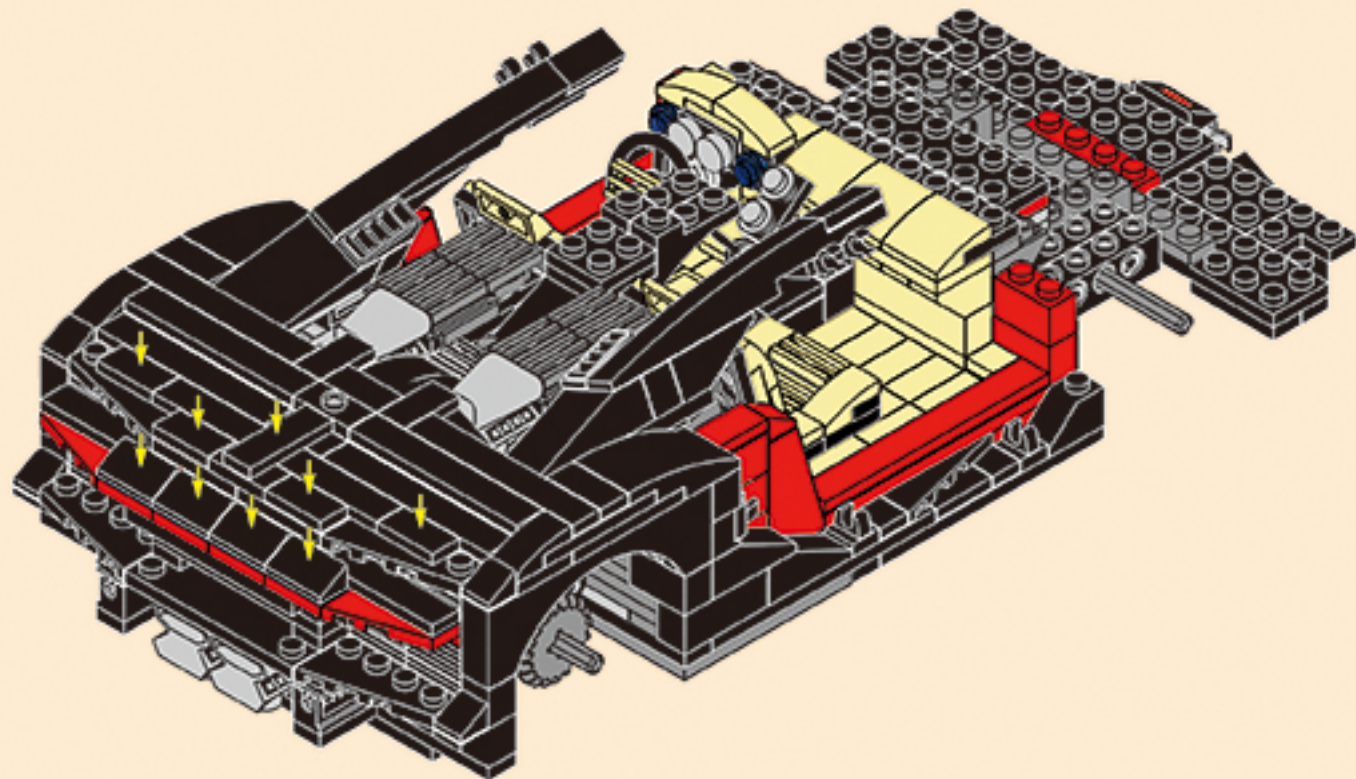



3-20

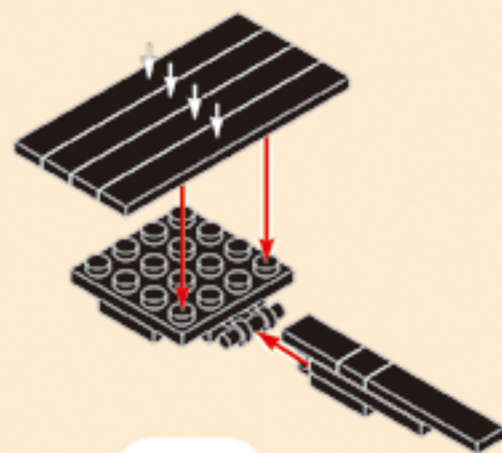
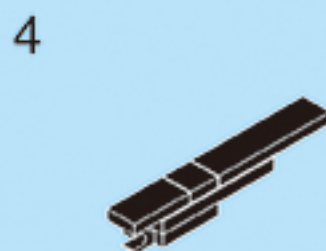
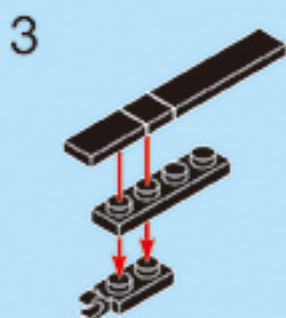
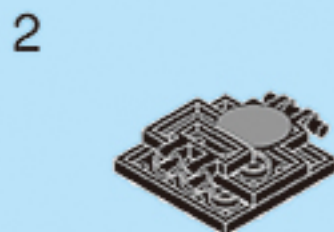
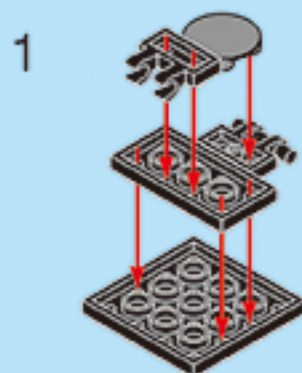

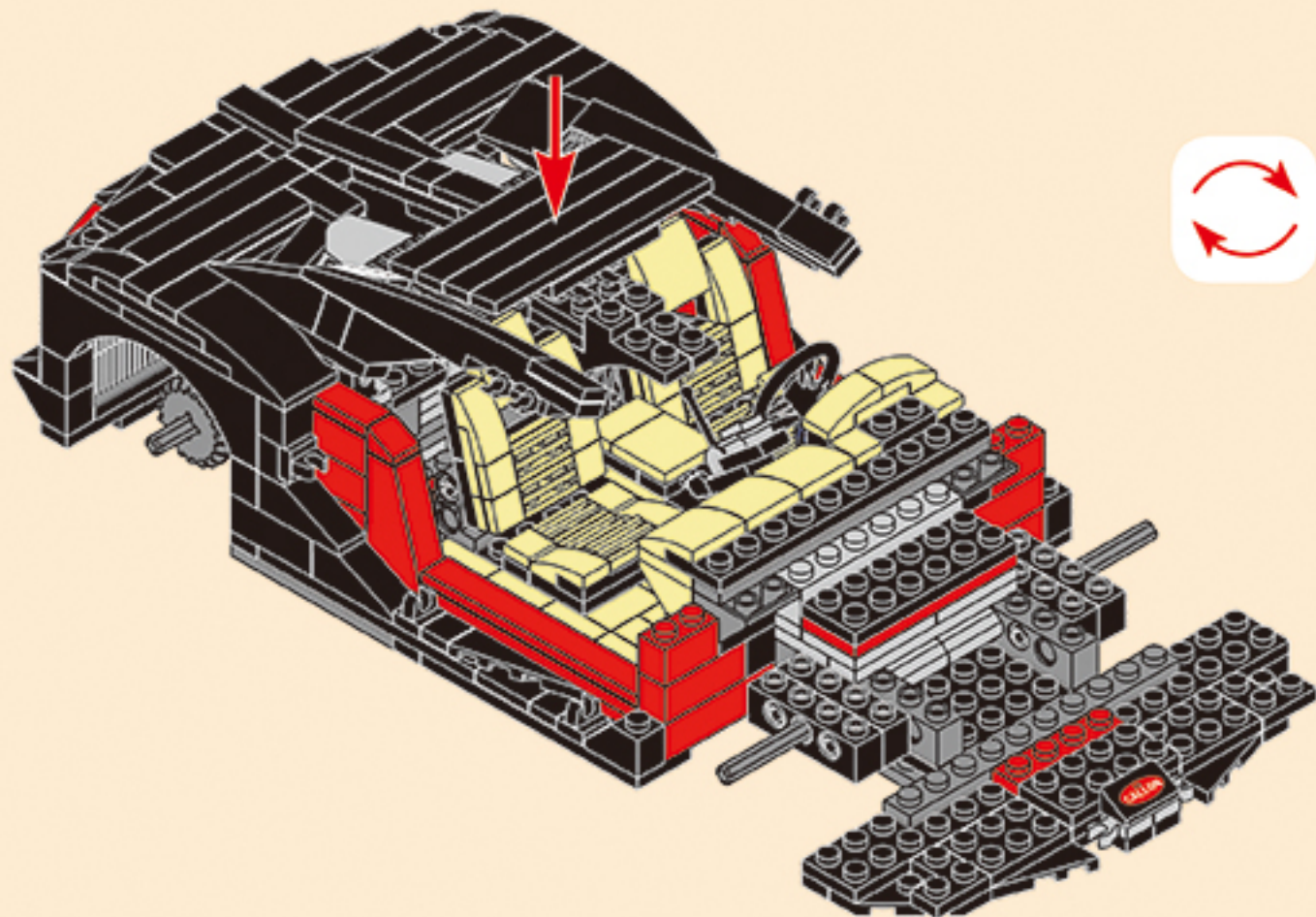



1x



1x



2x

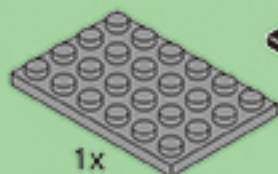

1x



4x

3-21

1

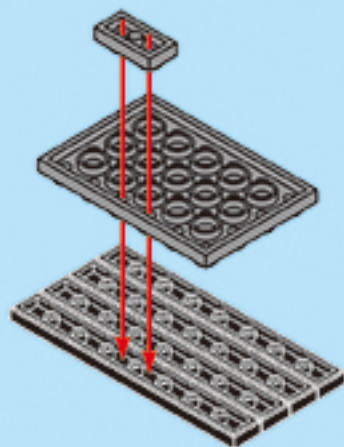

2

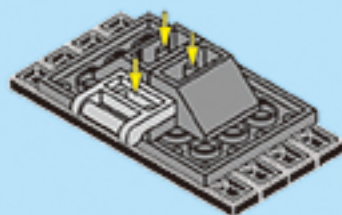

3

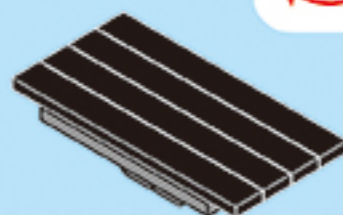

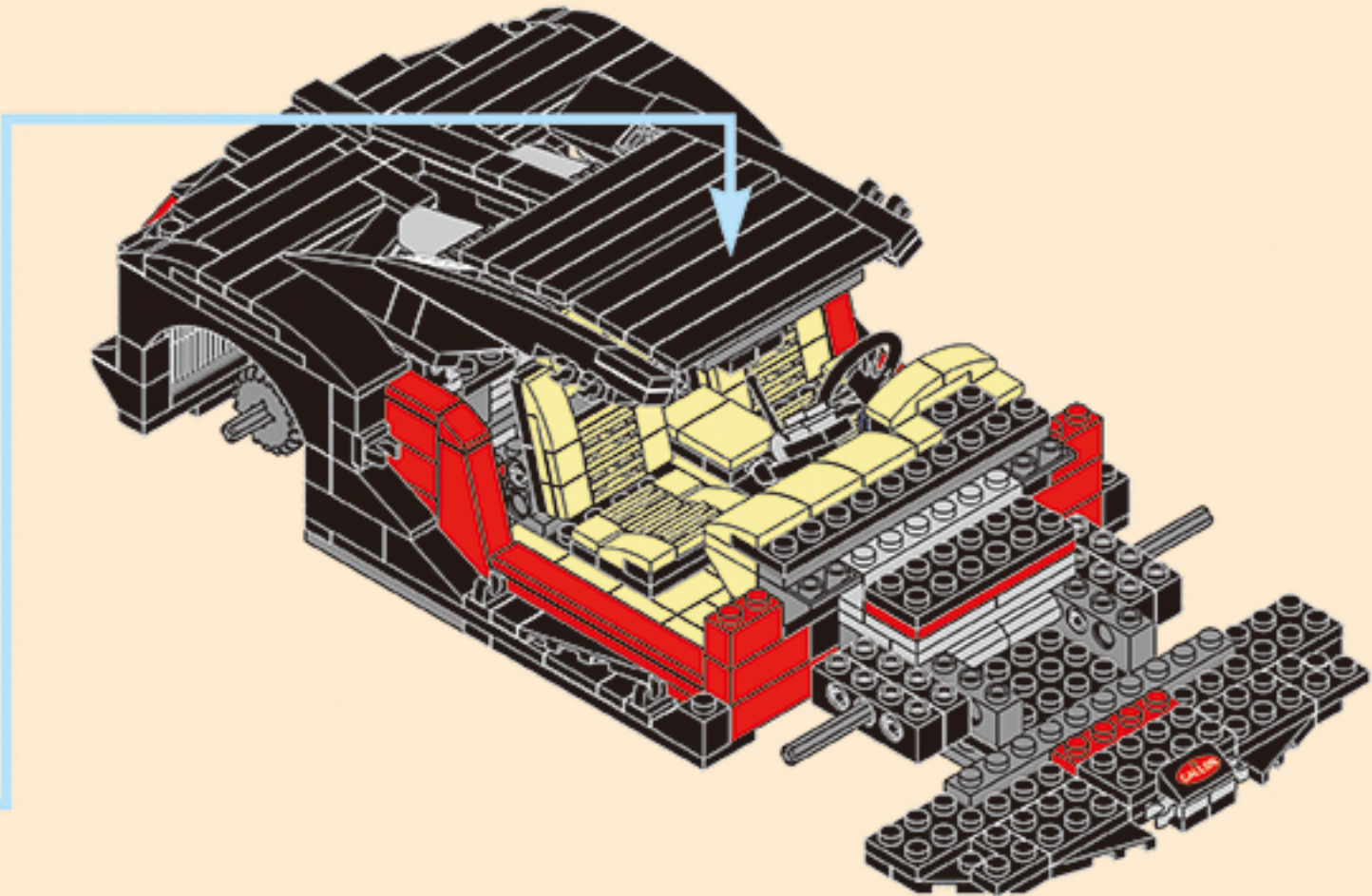

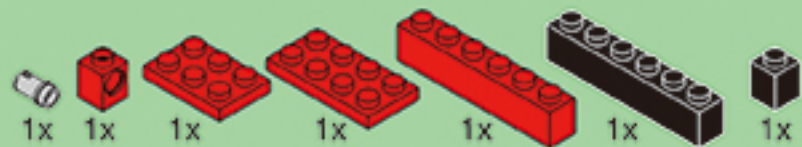

3-22.1

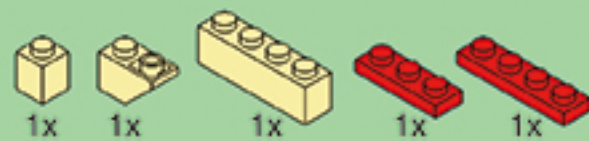
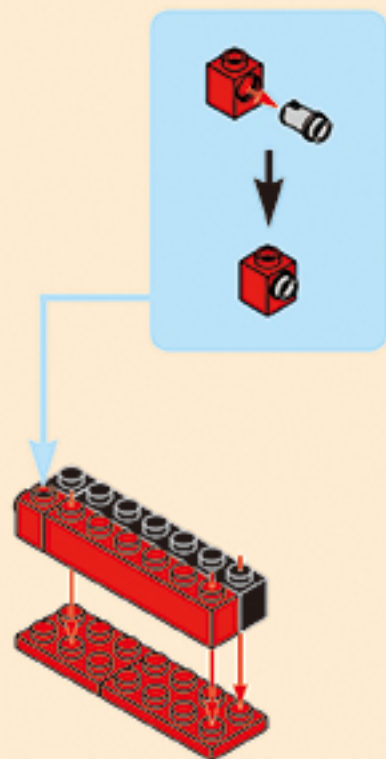

3-22.2

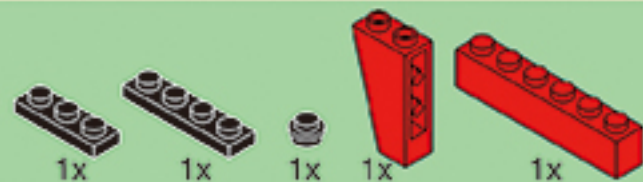
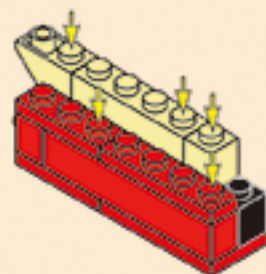

3-22.3

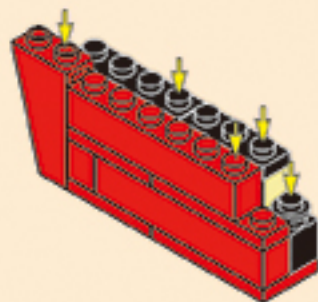



3-22.4

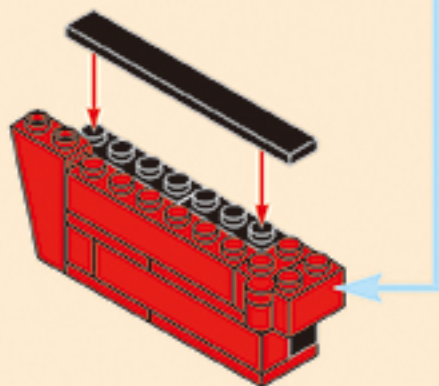
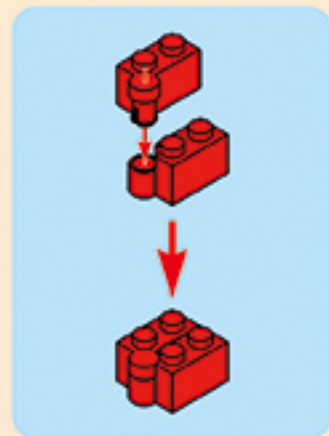

3-22.5

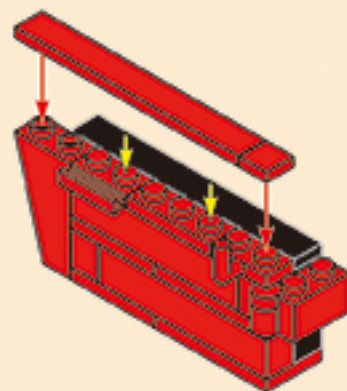

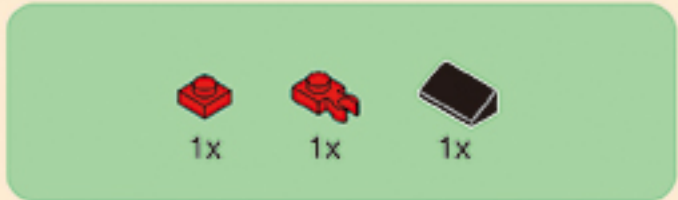

3-22.6

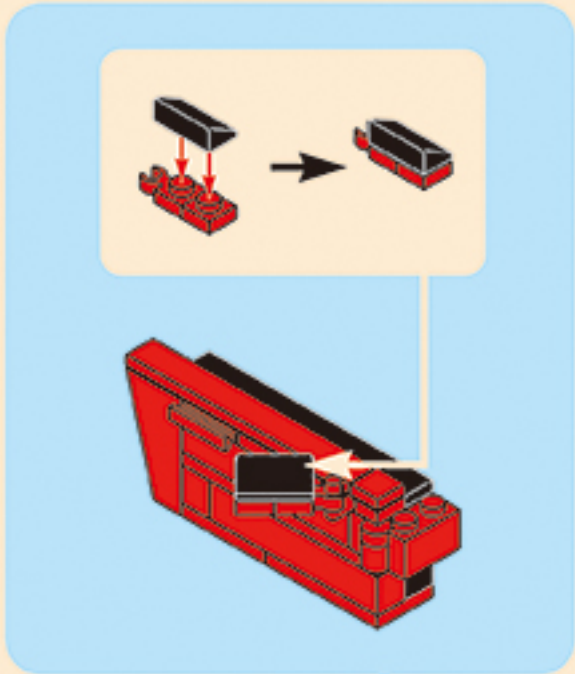
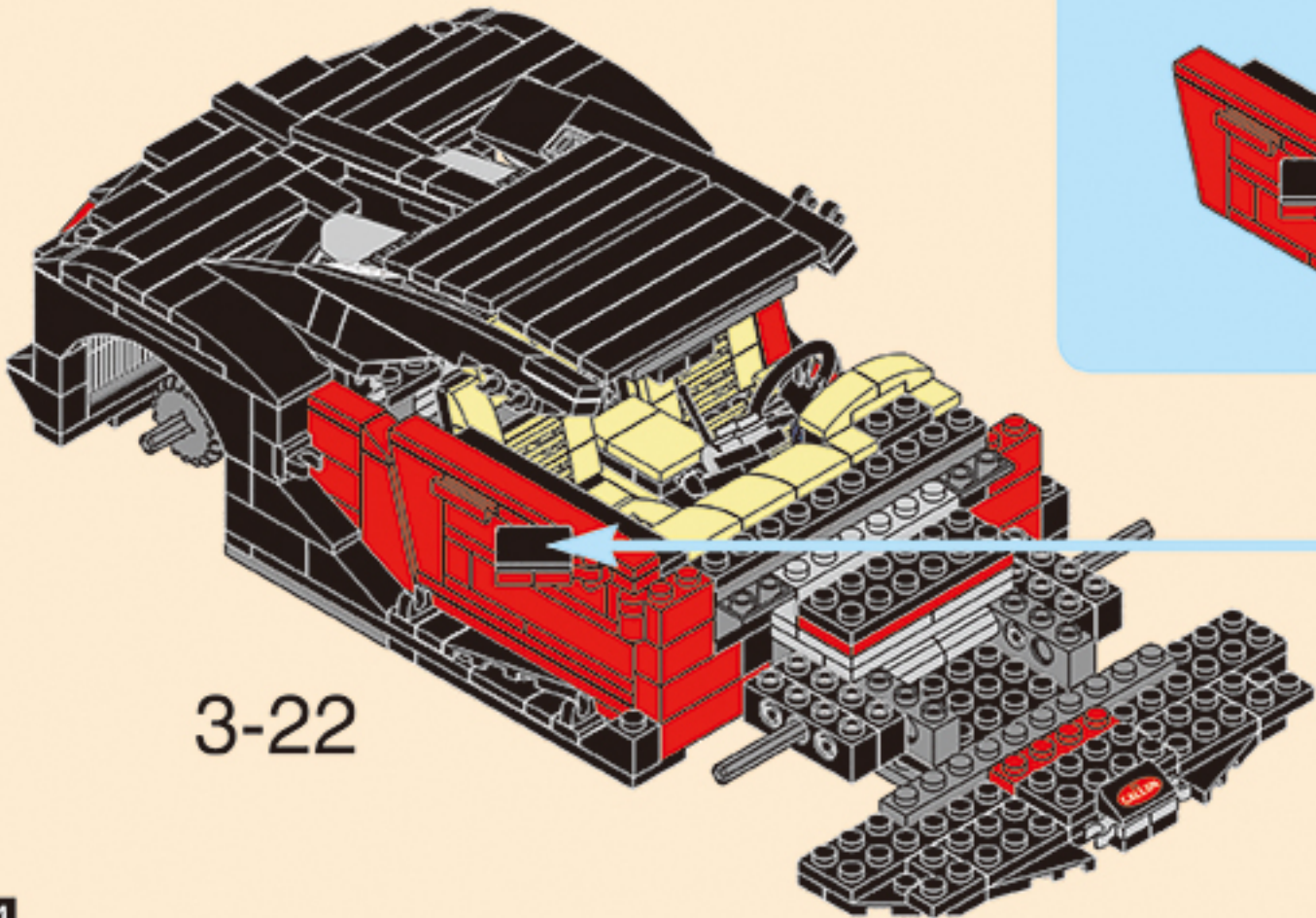

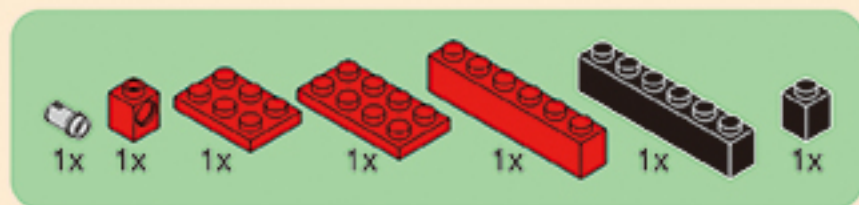

3-23.1

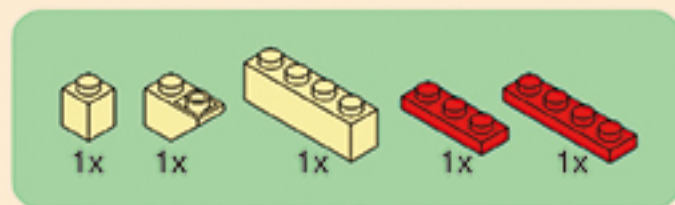
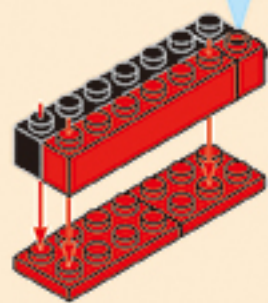
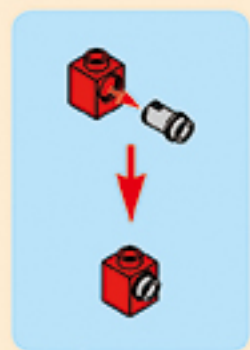

3-23.2

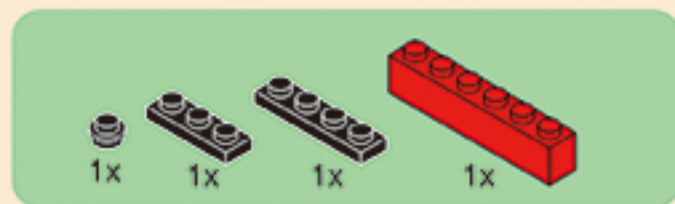
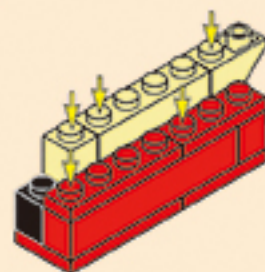

3-23.3

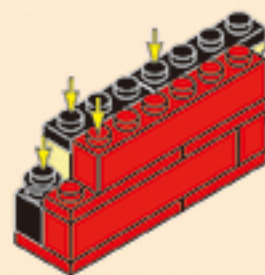

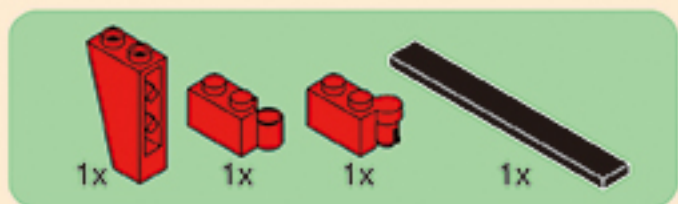

3-23.4

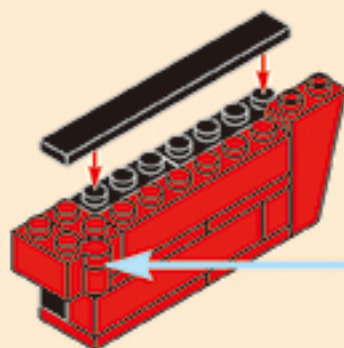
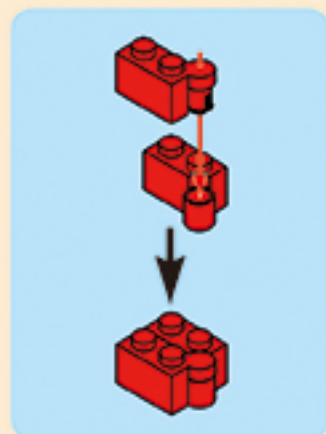

3-23.5

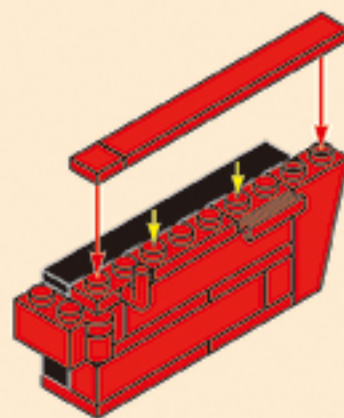

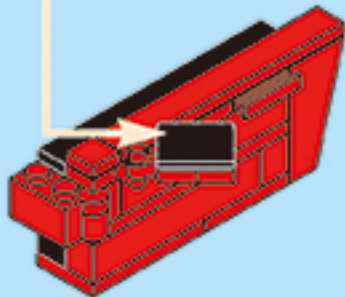
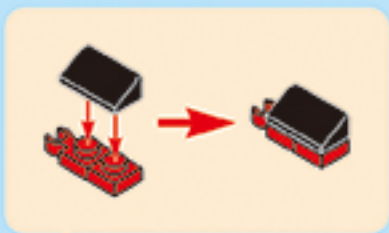

1x



1x



1x

3-23.6

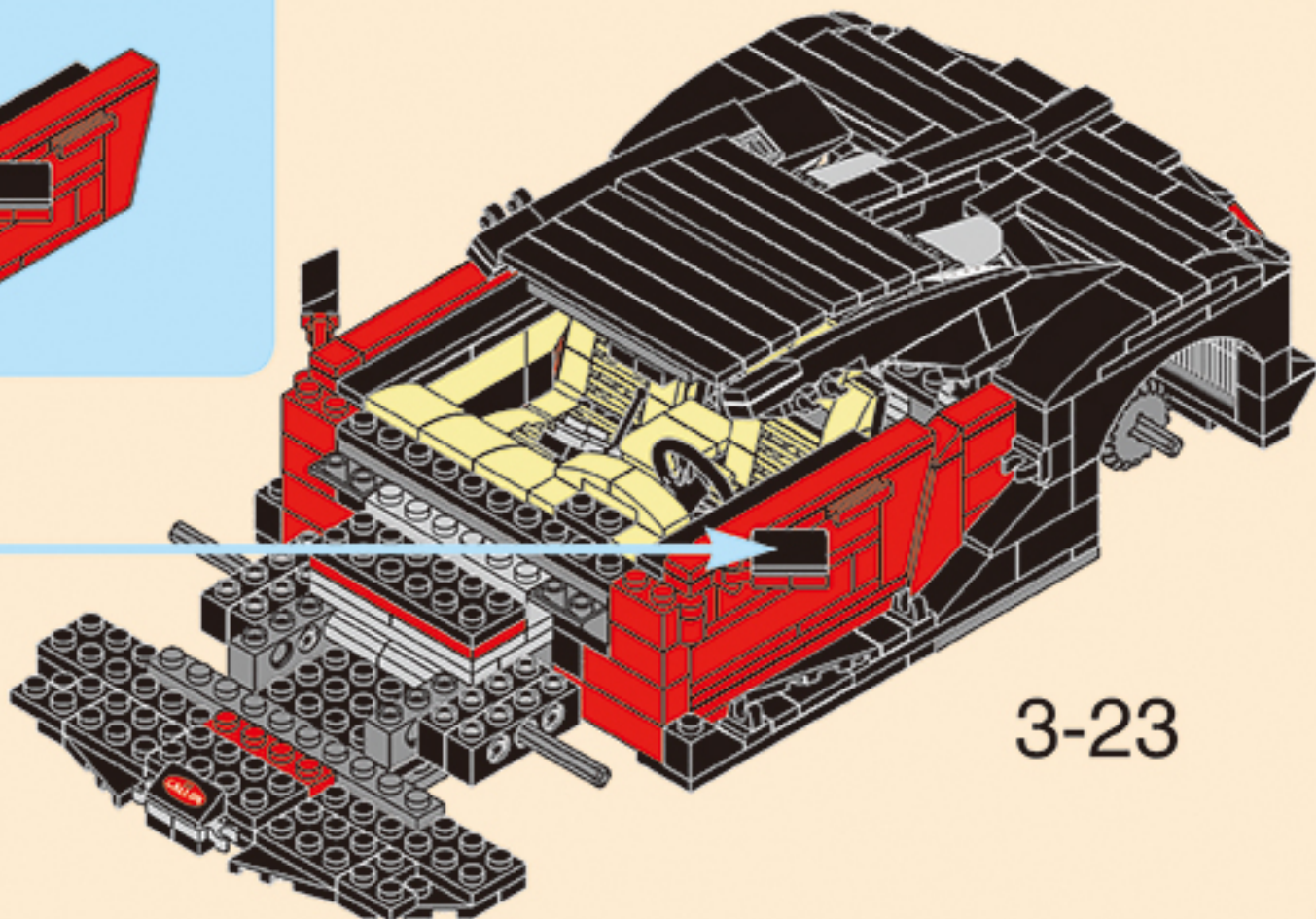

3-23

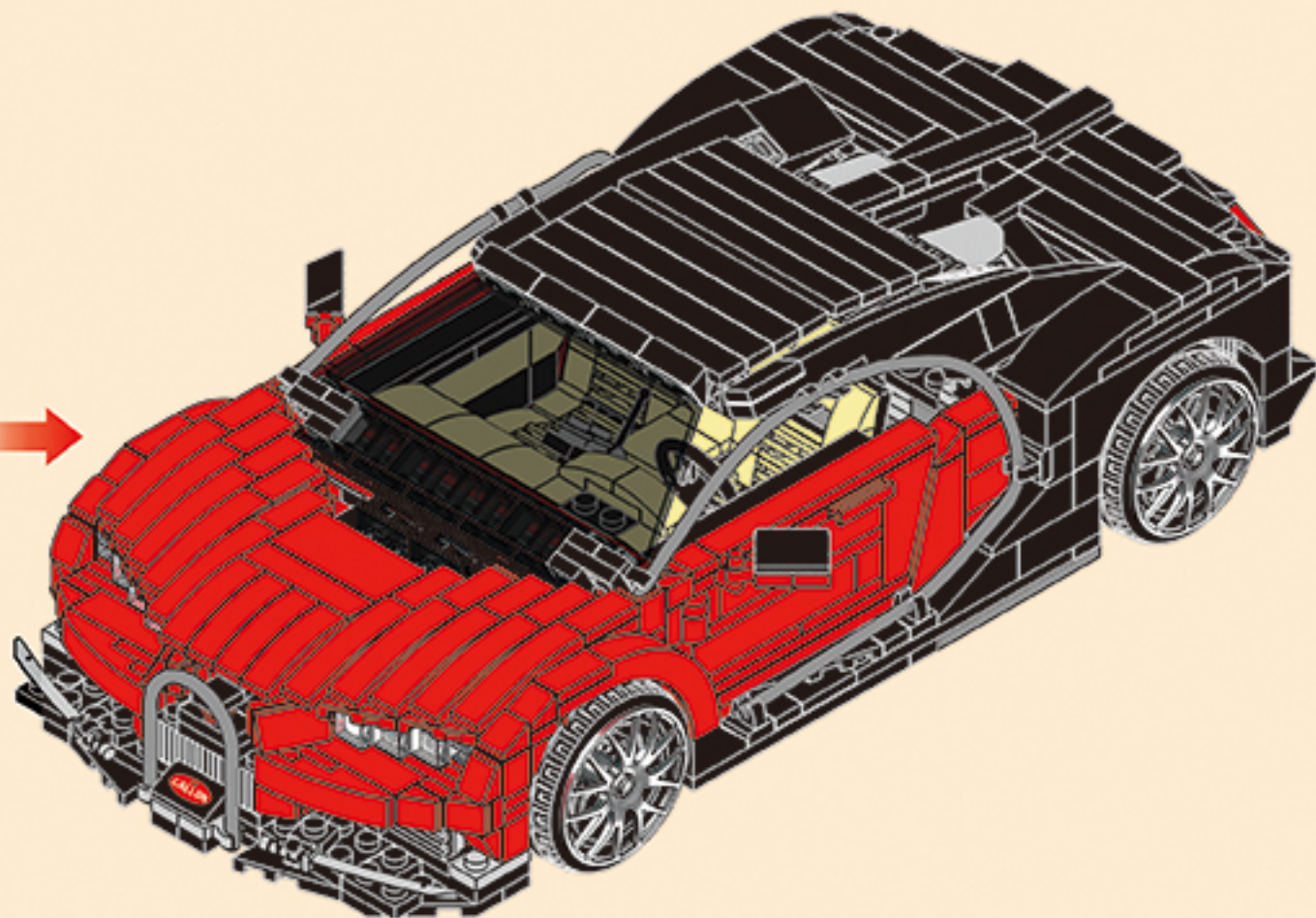

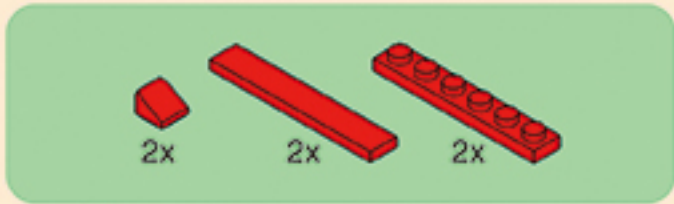

4-1

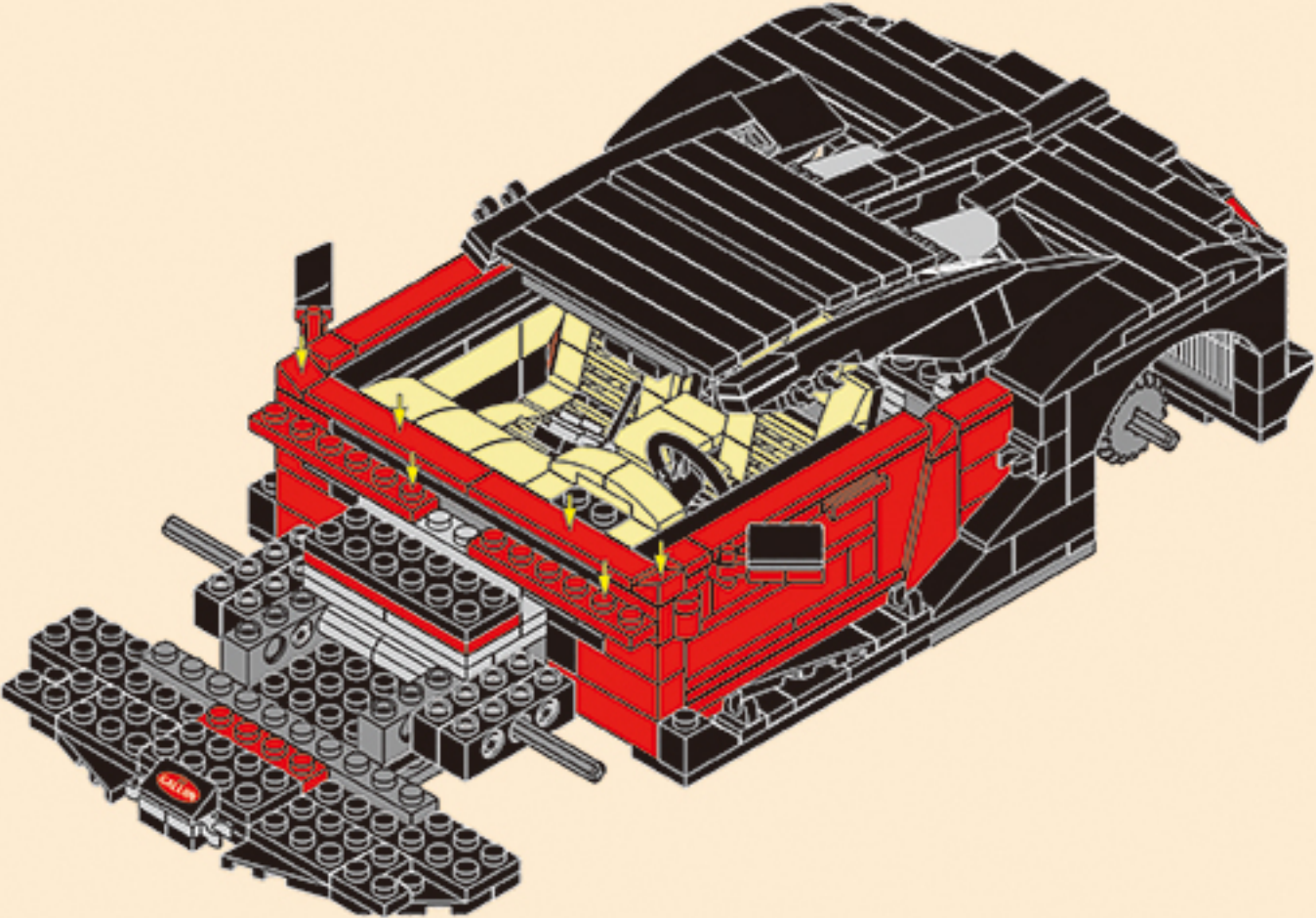



2x



2x



4x

4-2

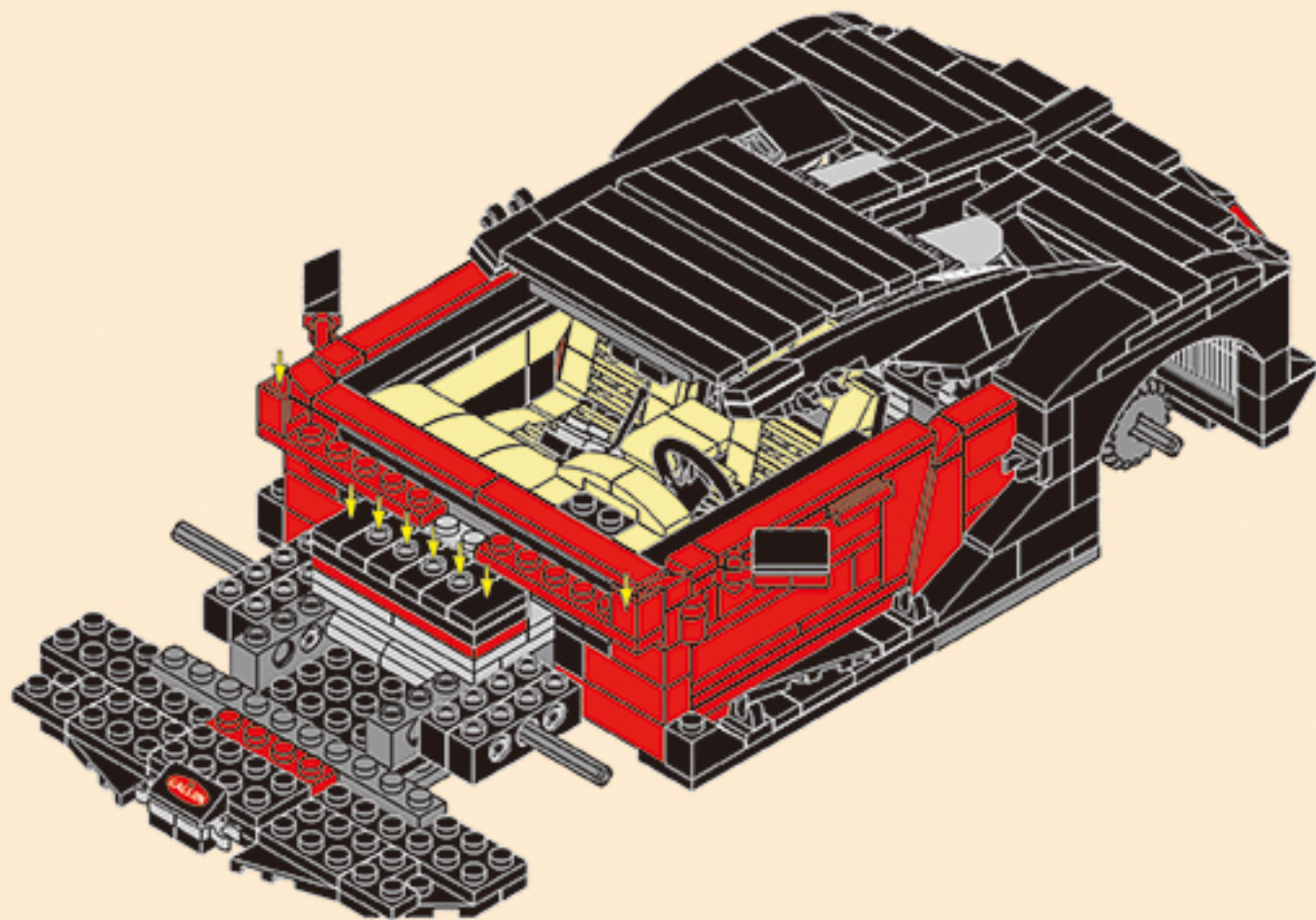

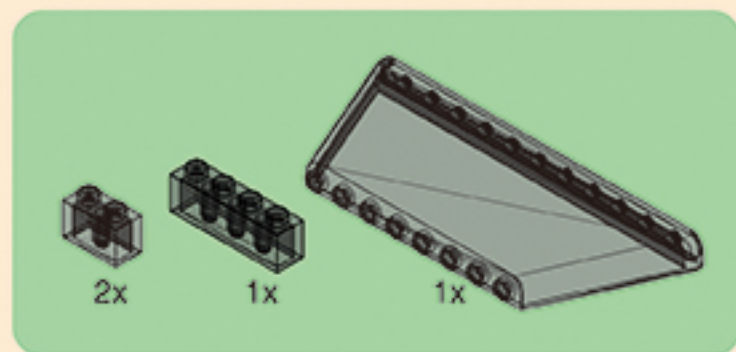

4-3.1

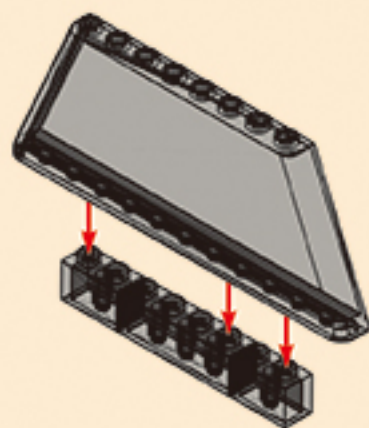

4-3.2

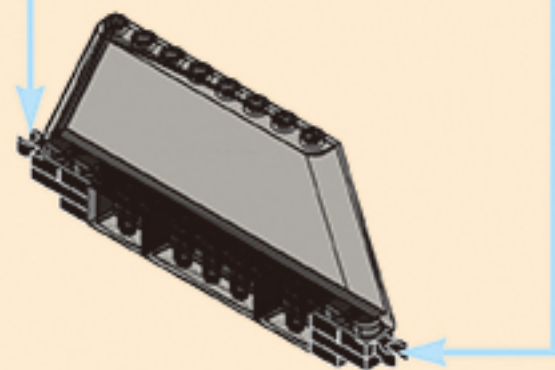
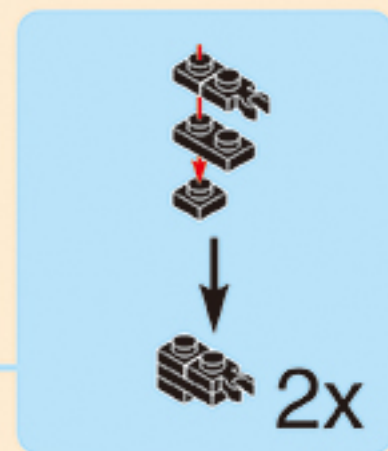



5x

4-3.3

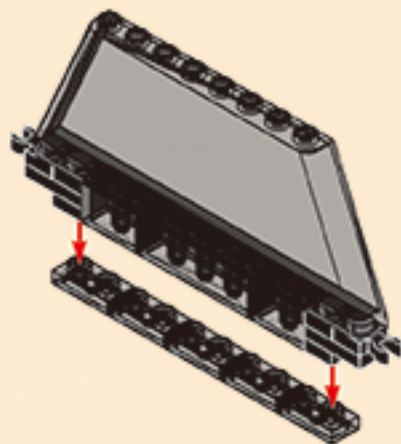

2x



2x

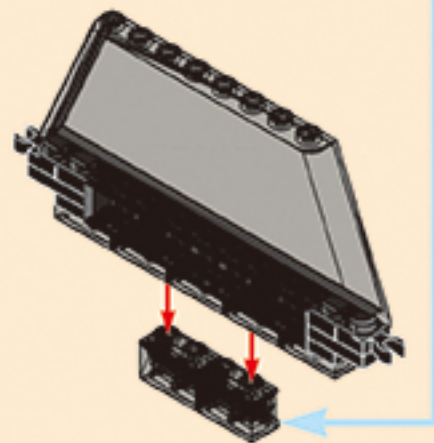
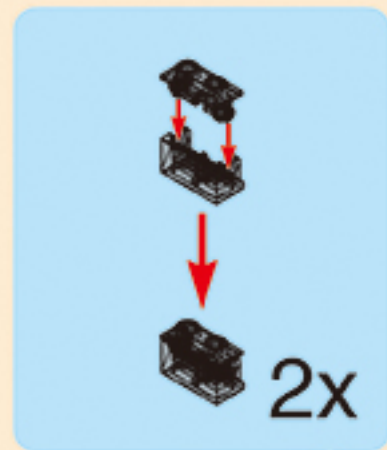



4-3

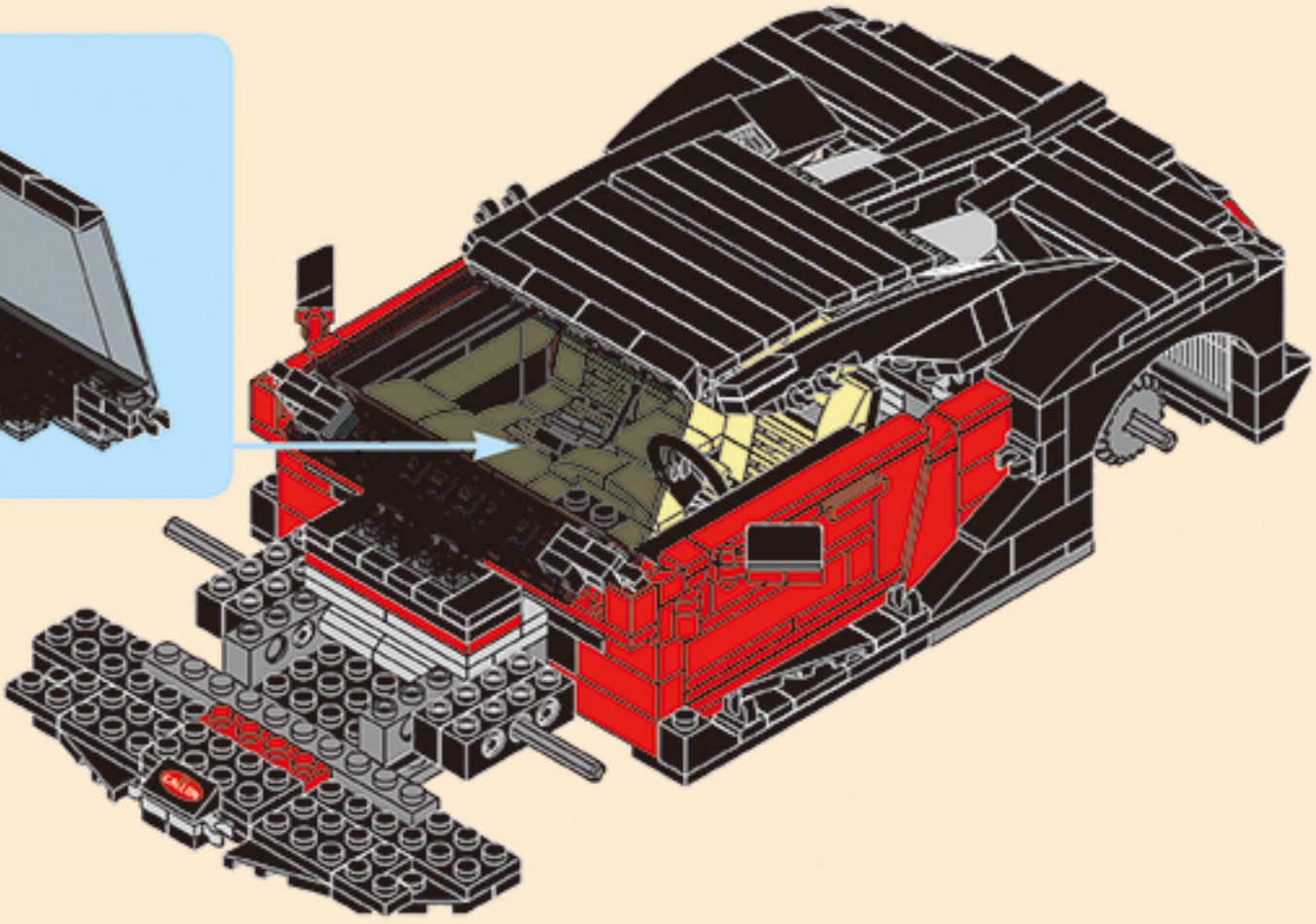
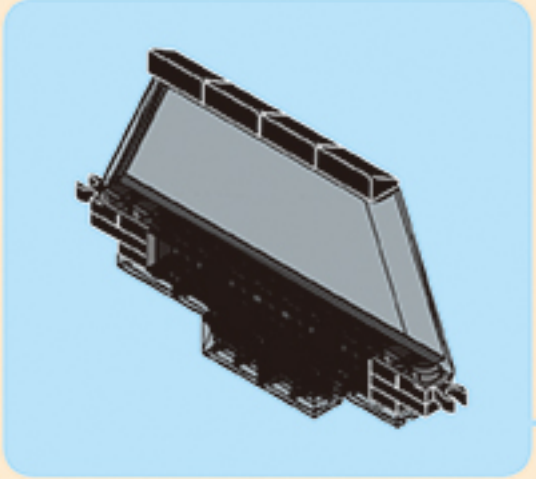



2x



2x



2x

4-4

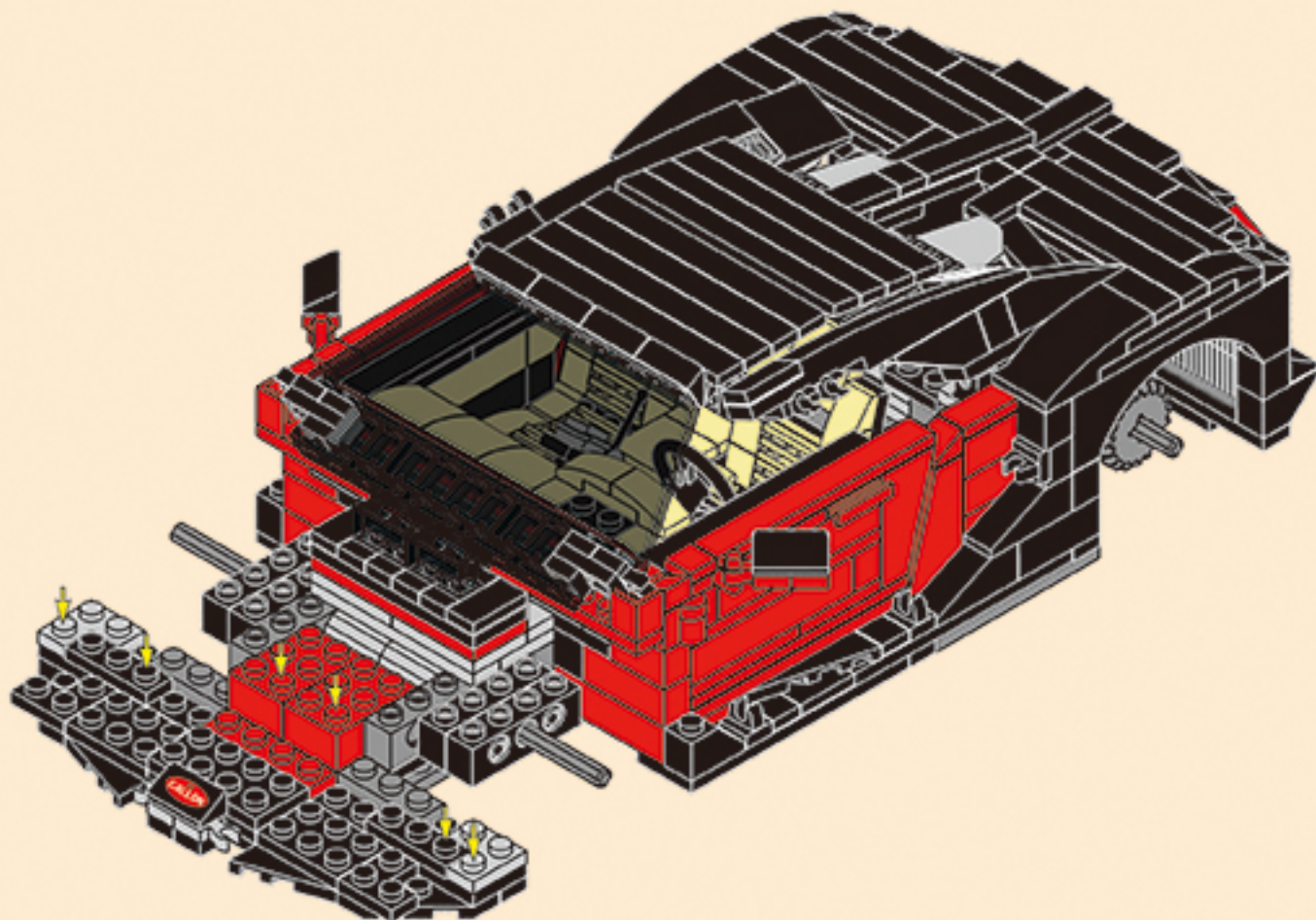

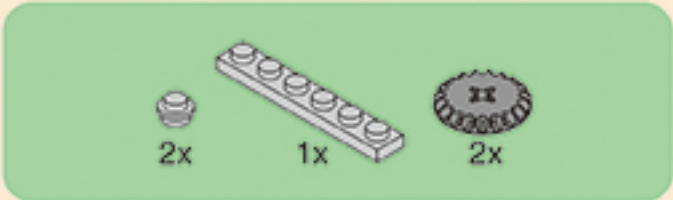

4-5

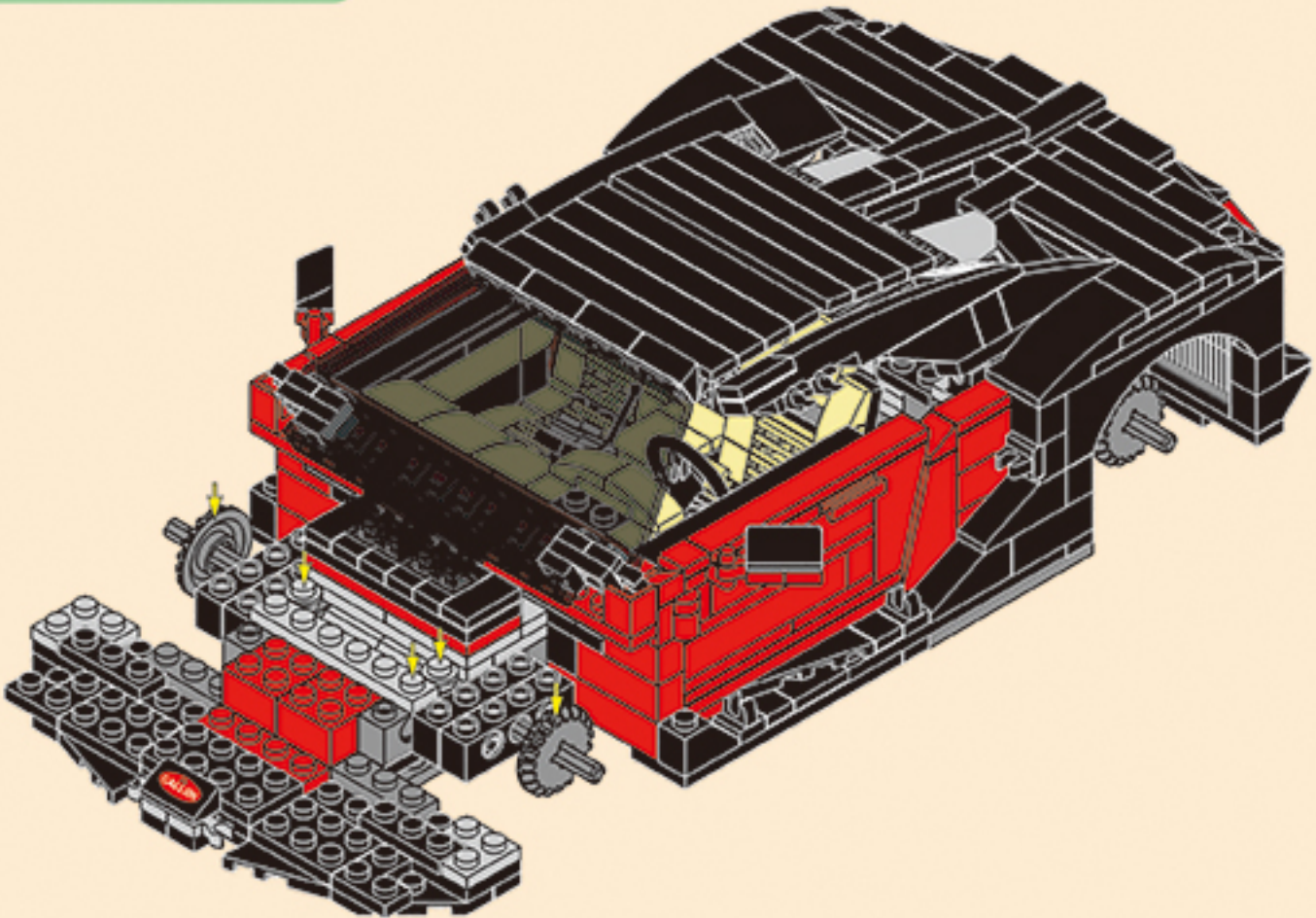



2x



2x



2x

4-6

1



2

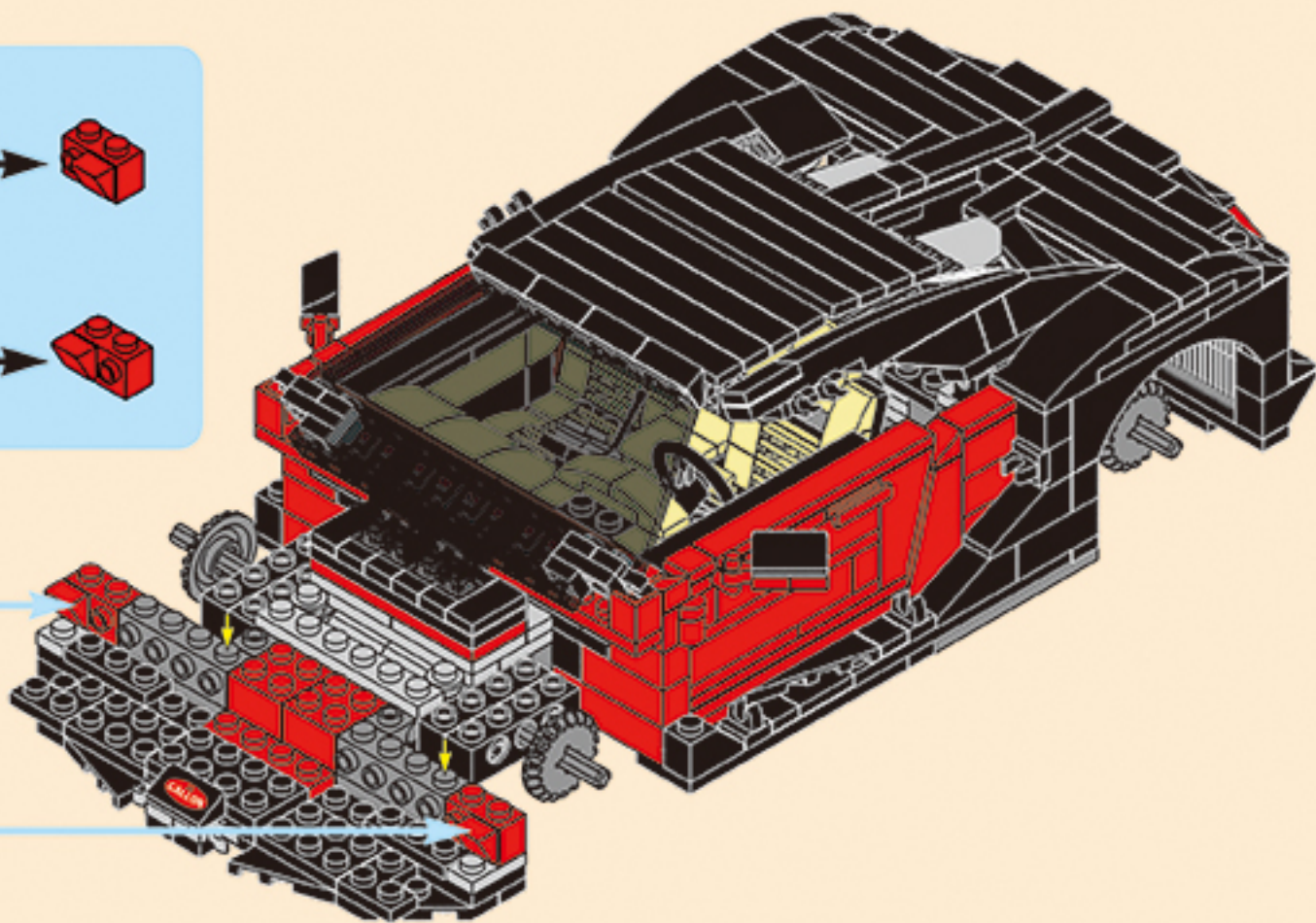
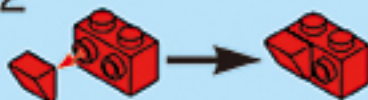

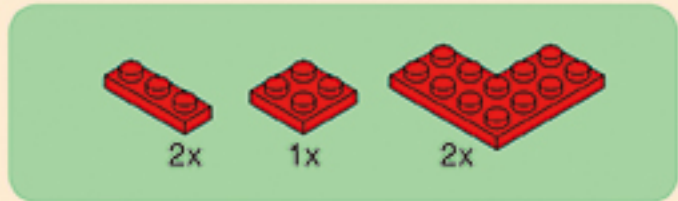

4-7

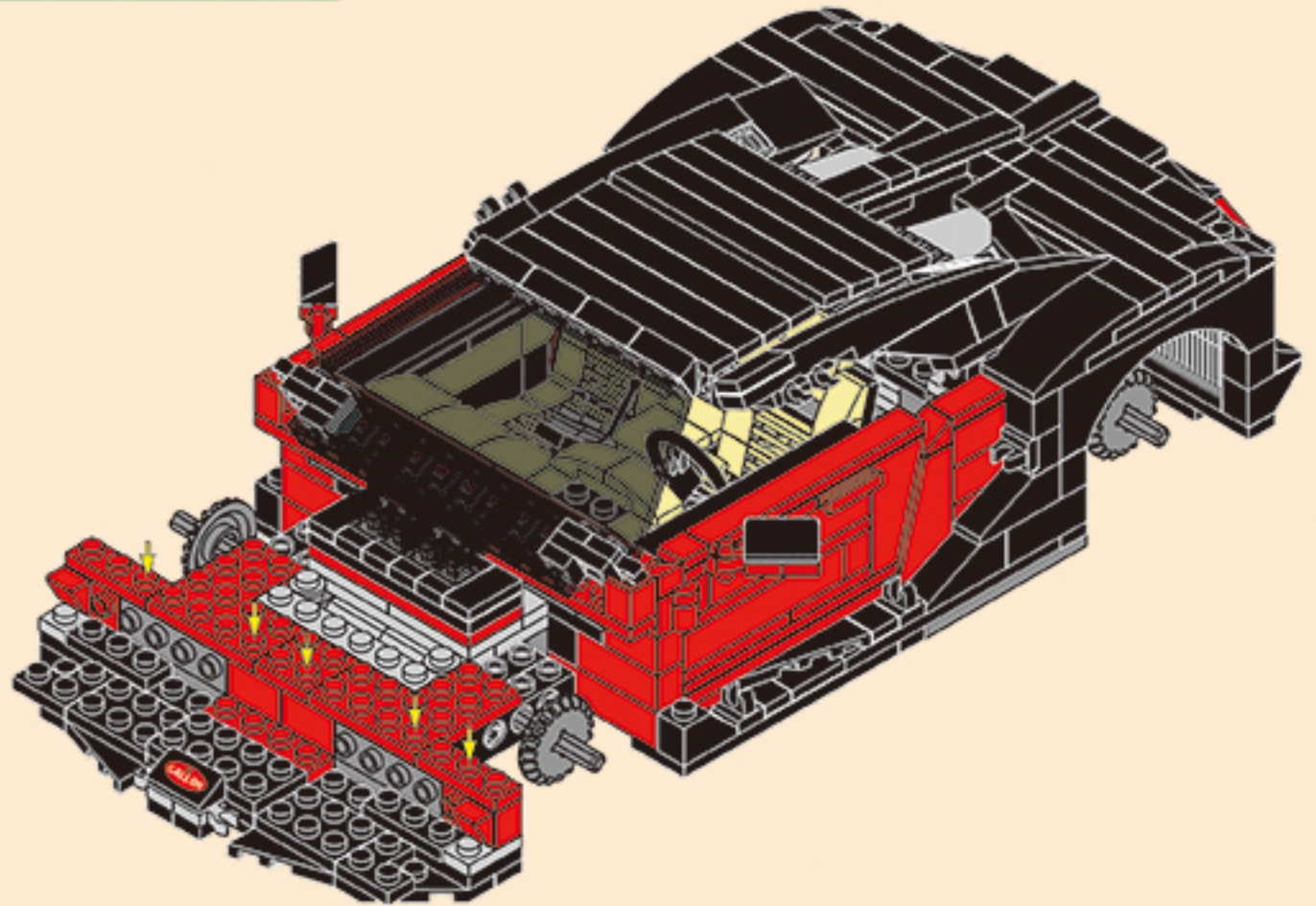

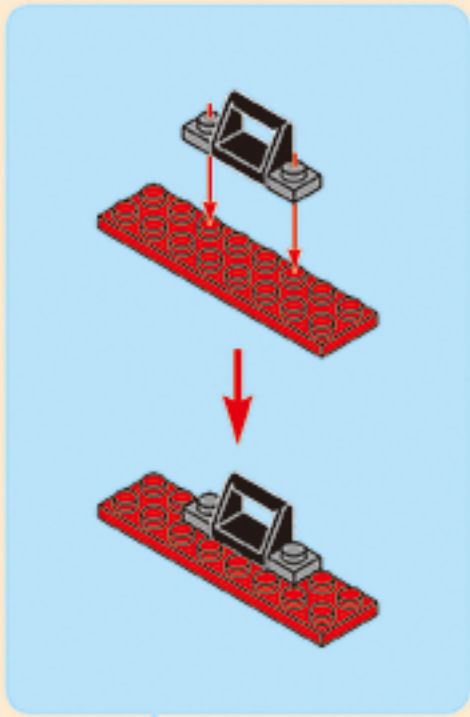

4-8

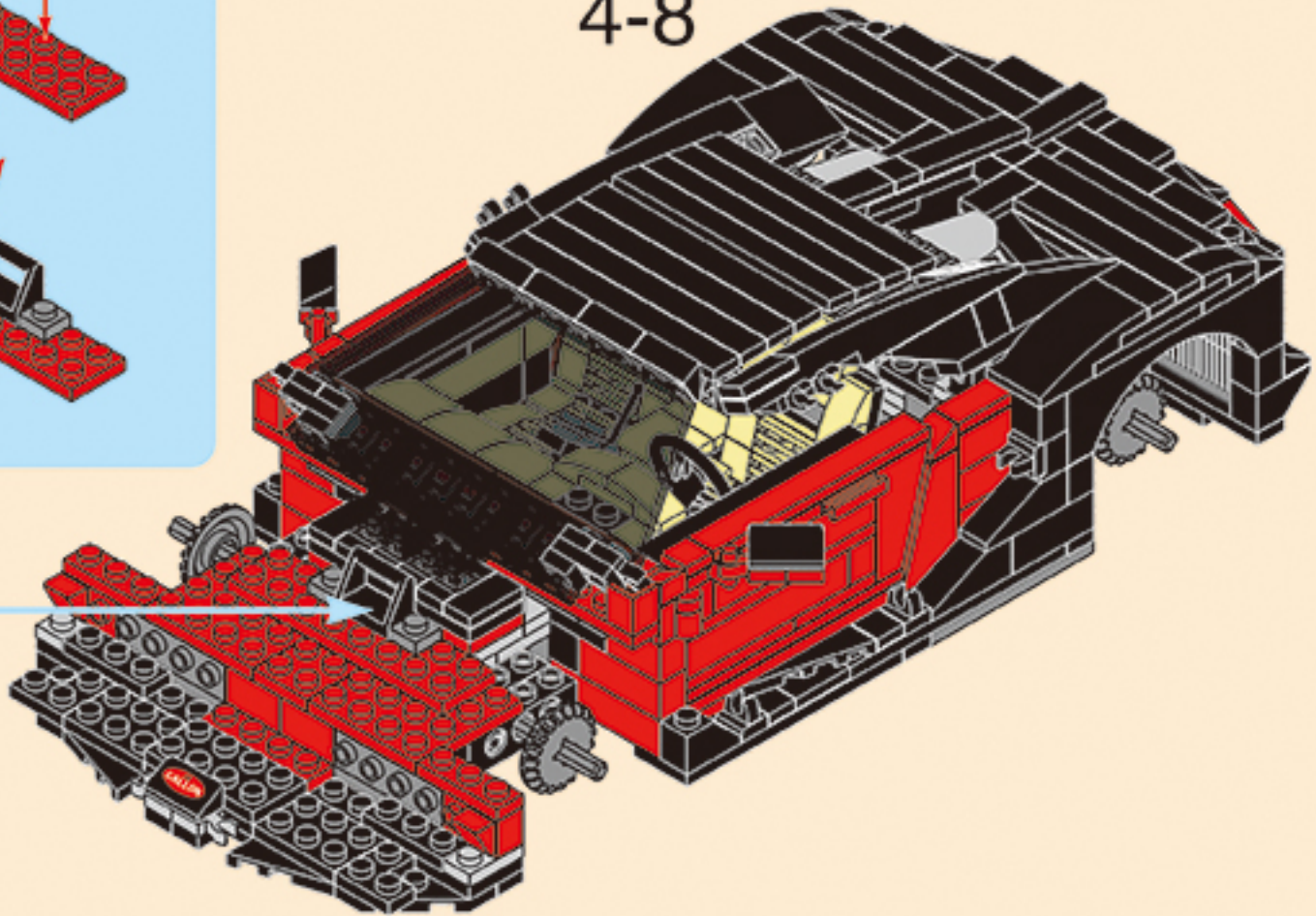

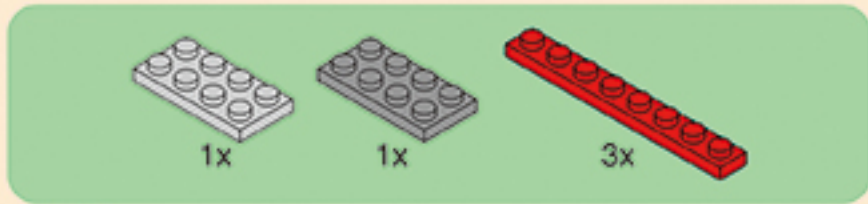

4-9

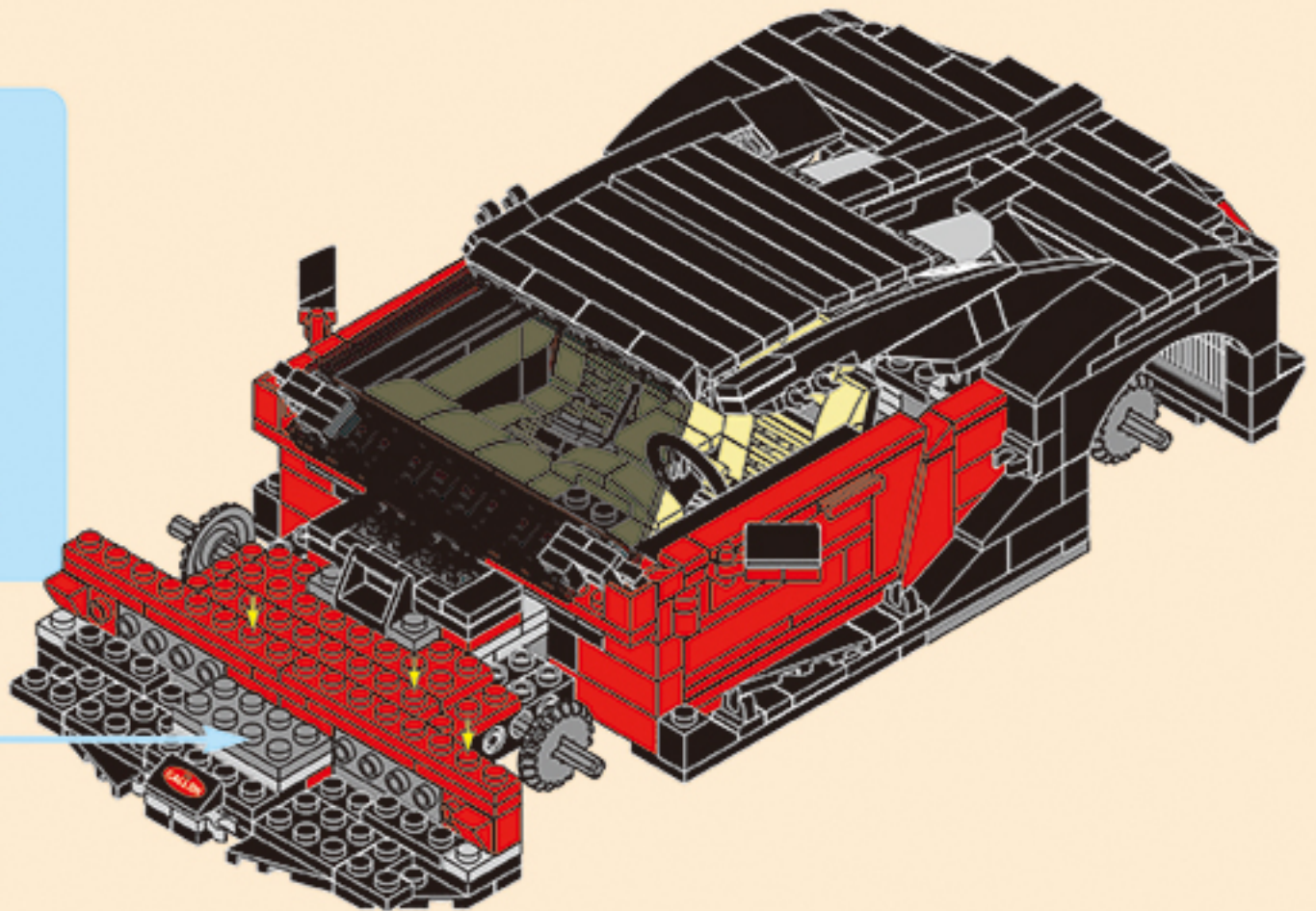
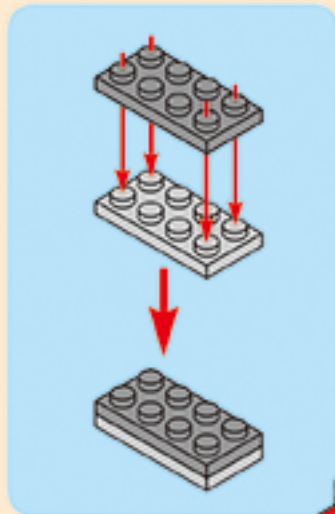



2x



1x

4-10

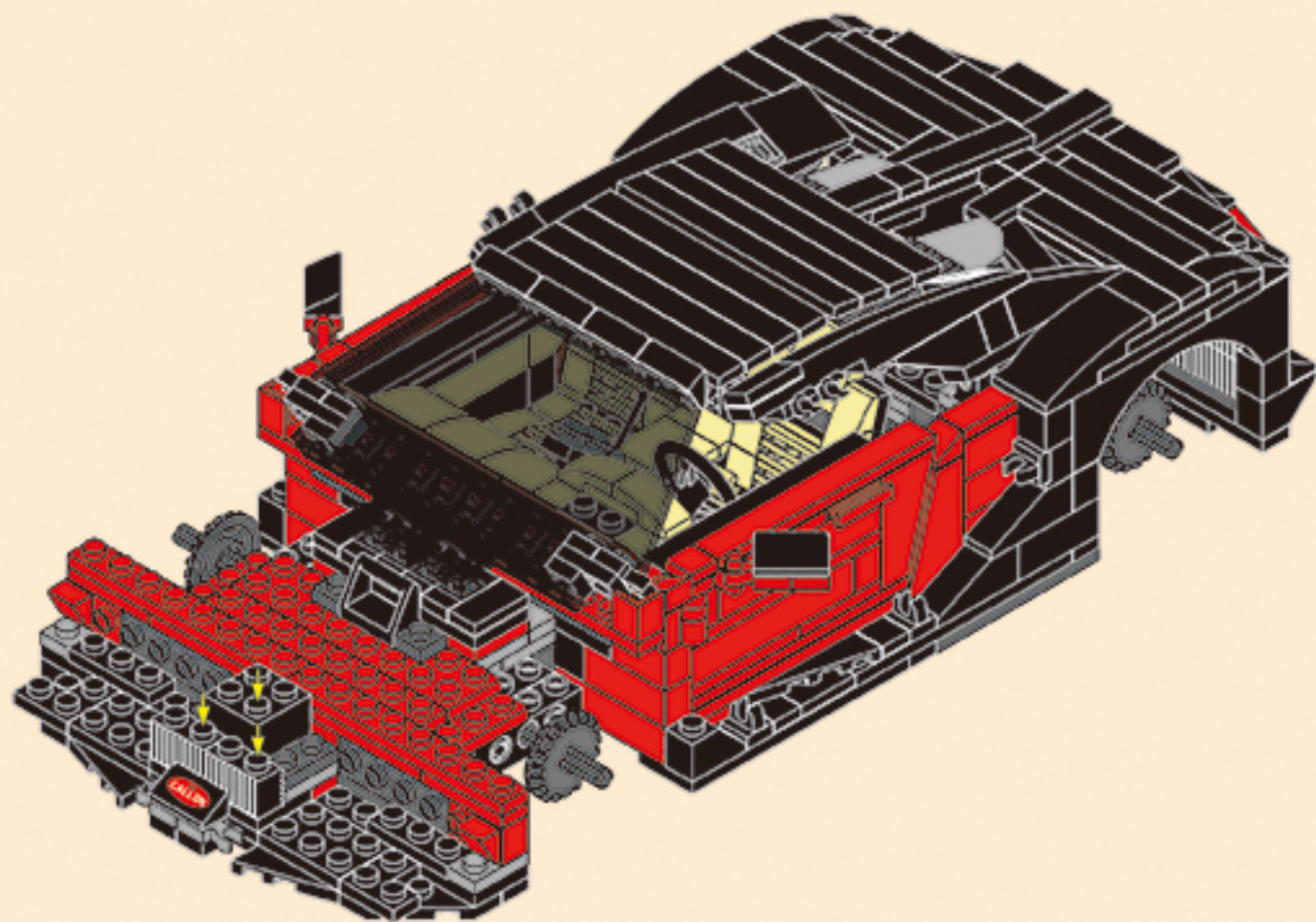



4-11

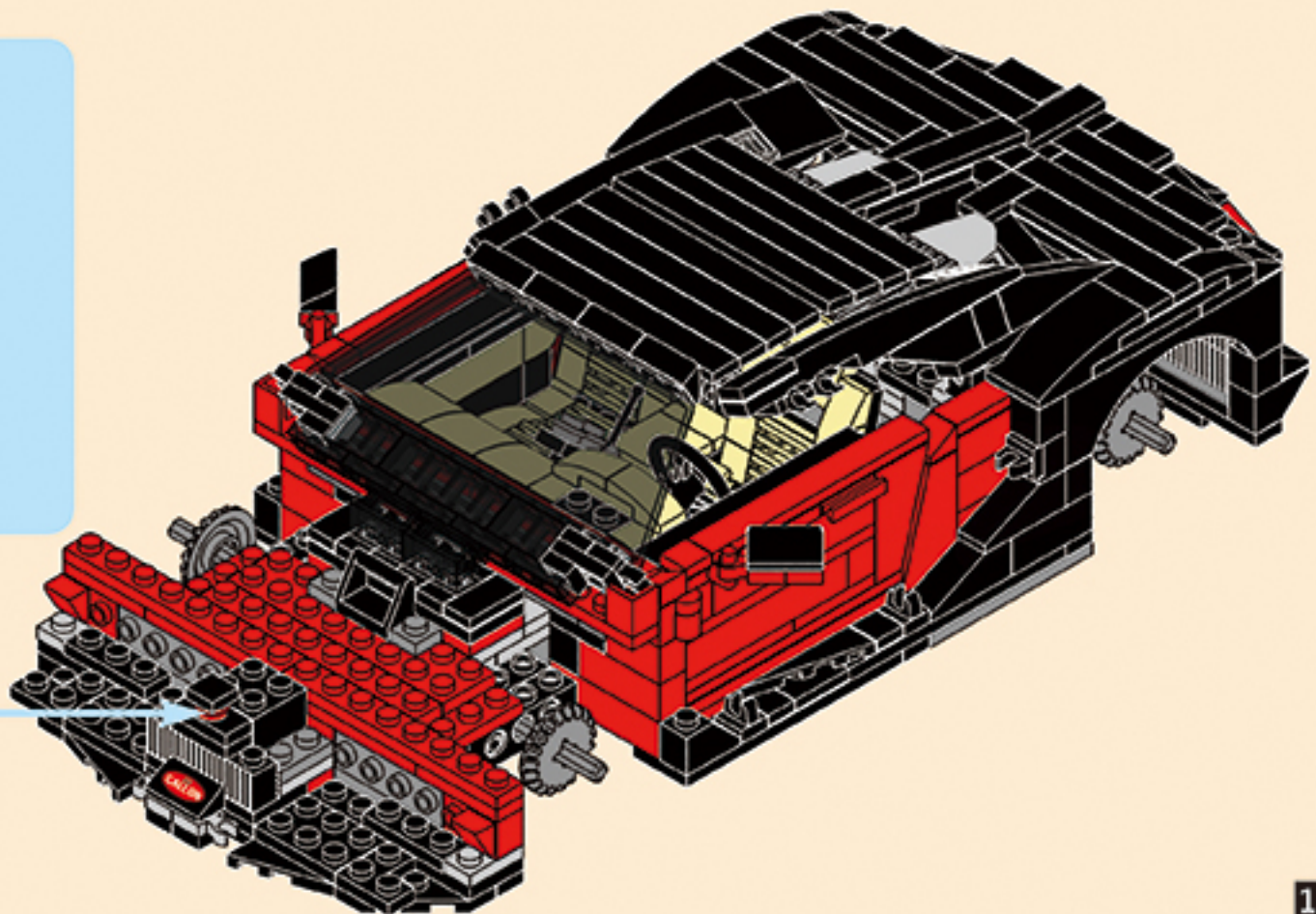
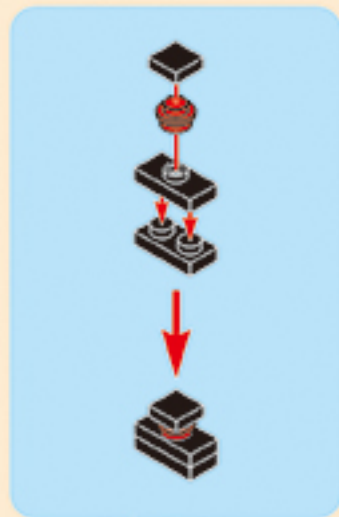



2x



2x

4-12

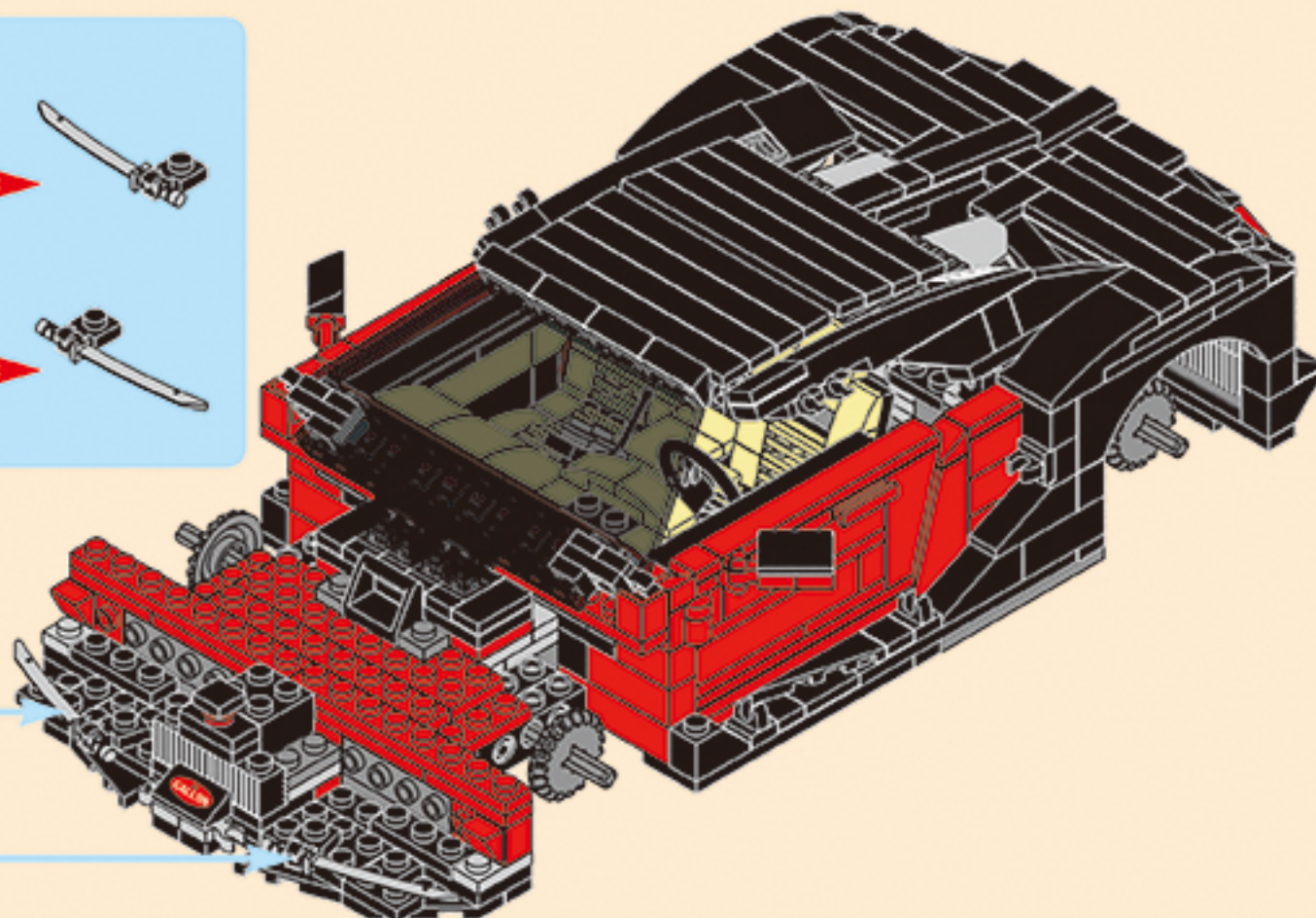
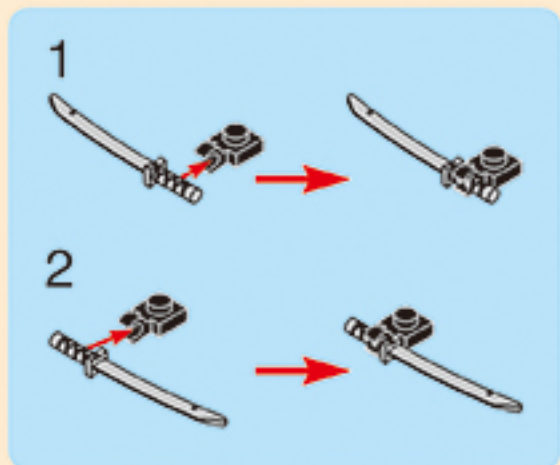

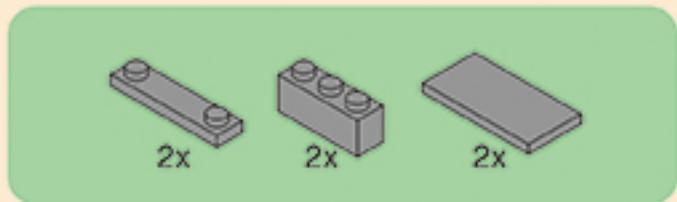

4-13

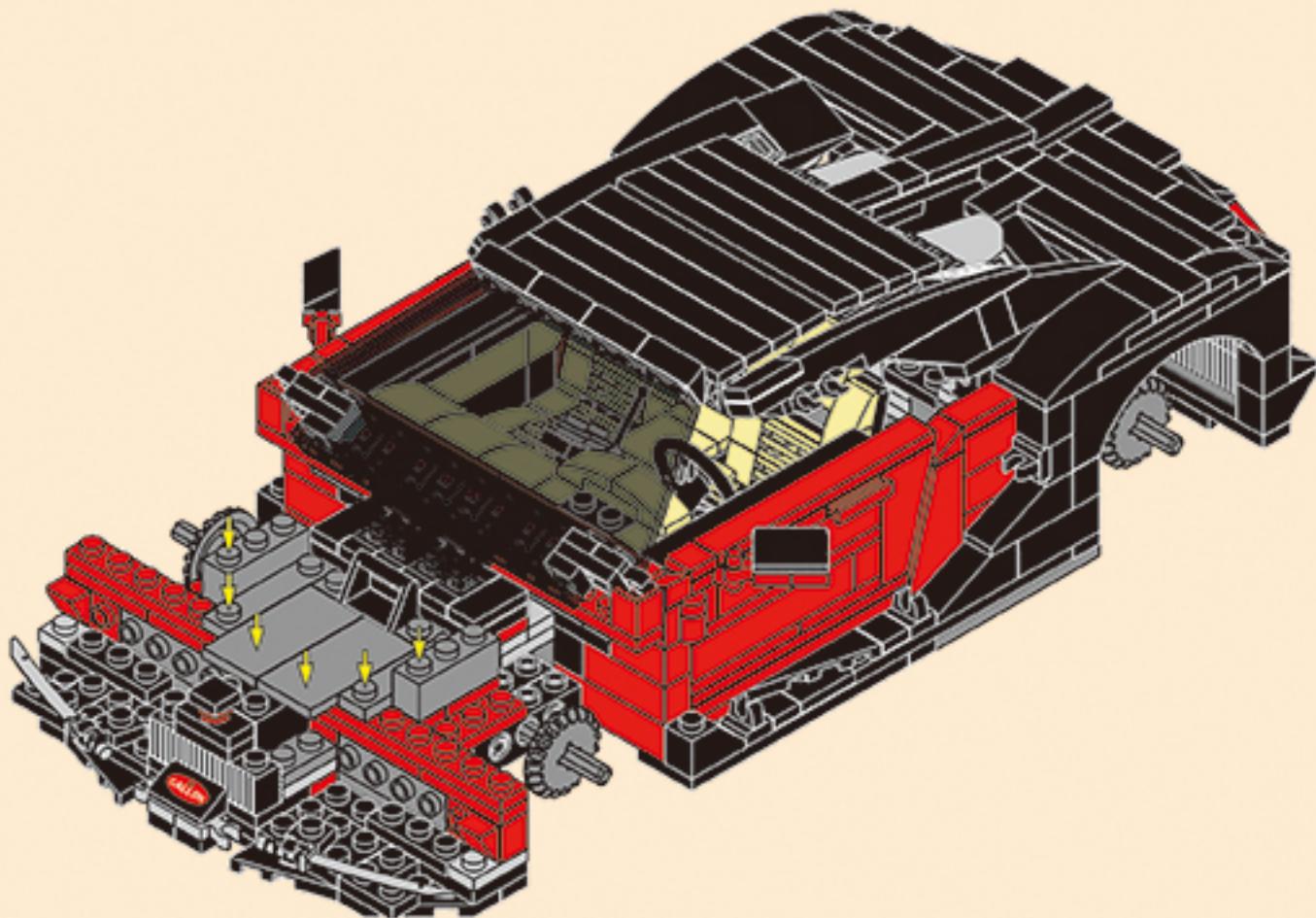

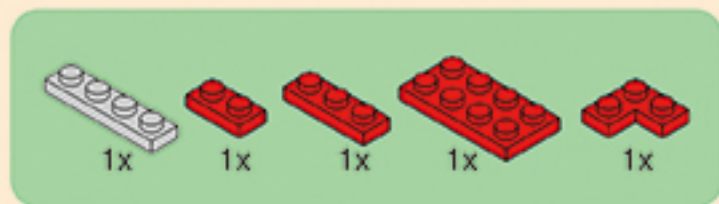

4-14.1

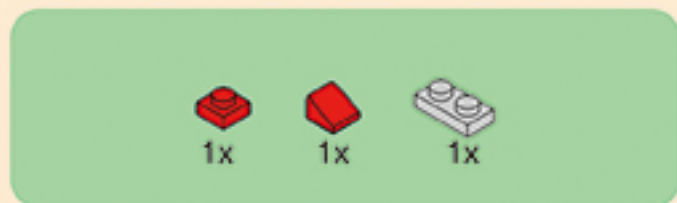
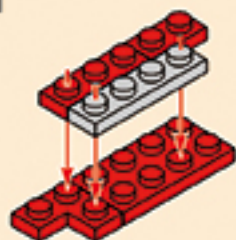

4-14.2

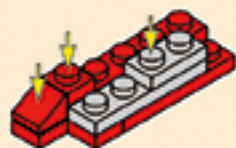

4-14.3

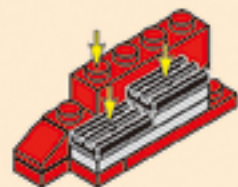

4-14.4

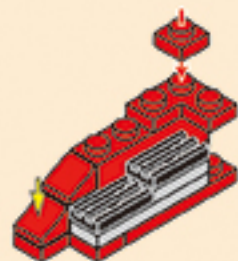

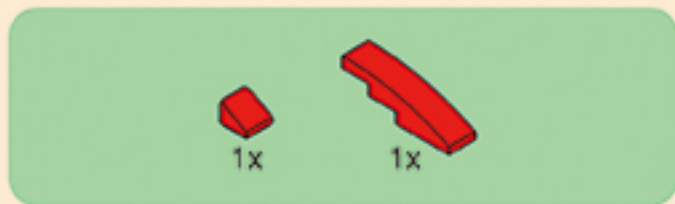

4-14.5

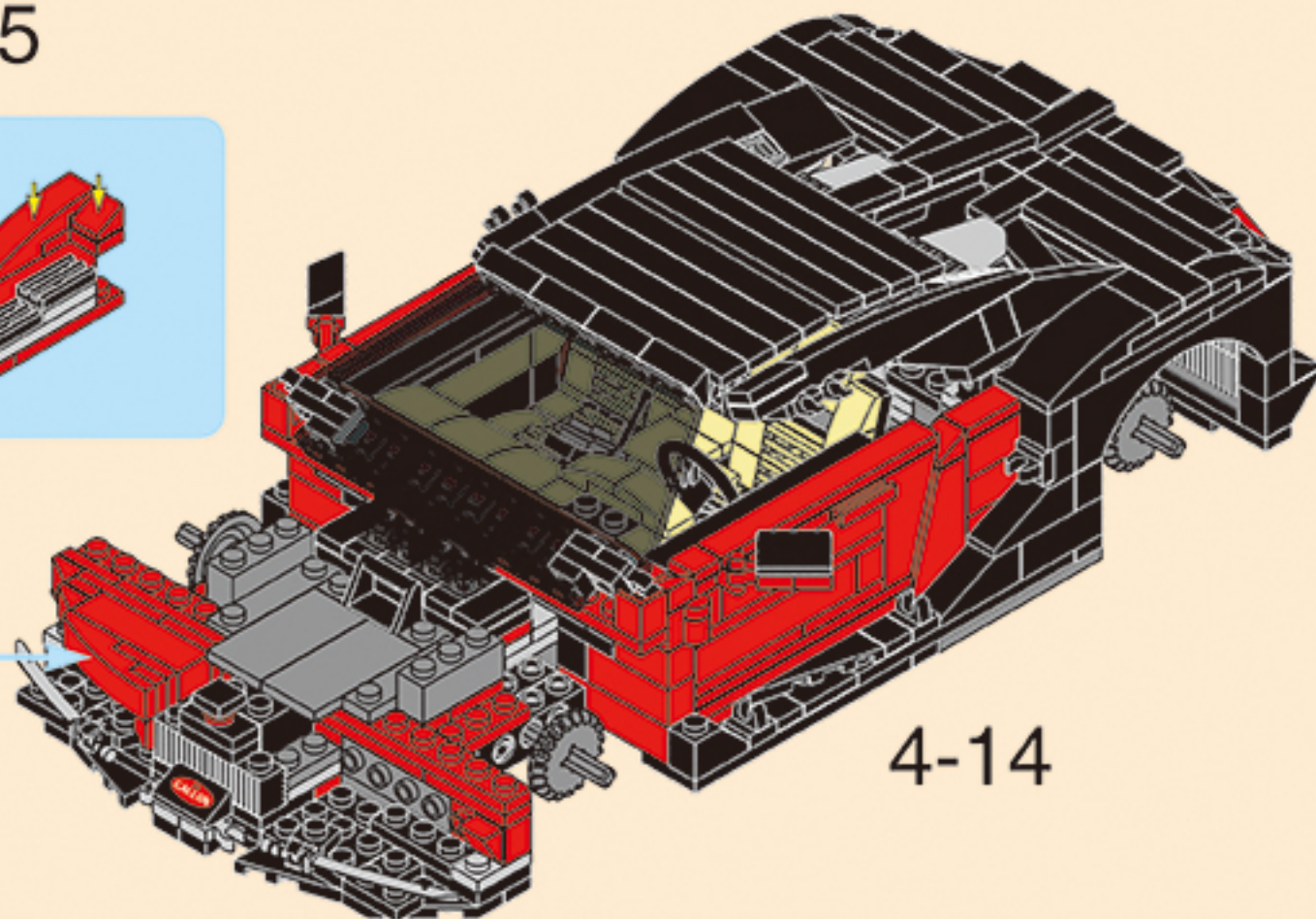
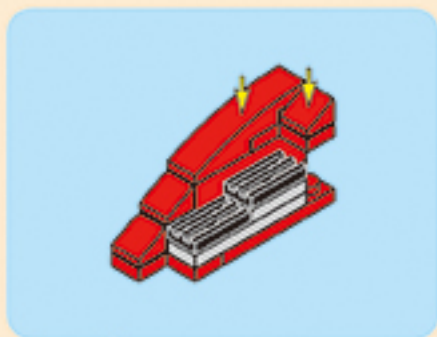

4-14

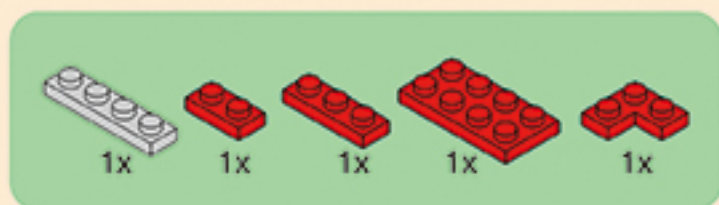

4-15.1

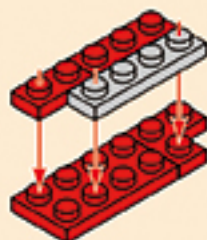

4-15.2



4-15.3

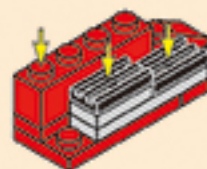

4-15.4

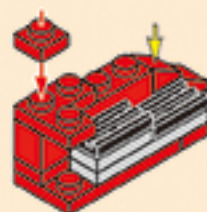

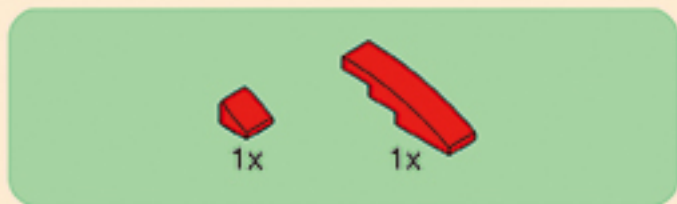

4-15.5

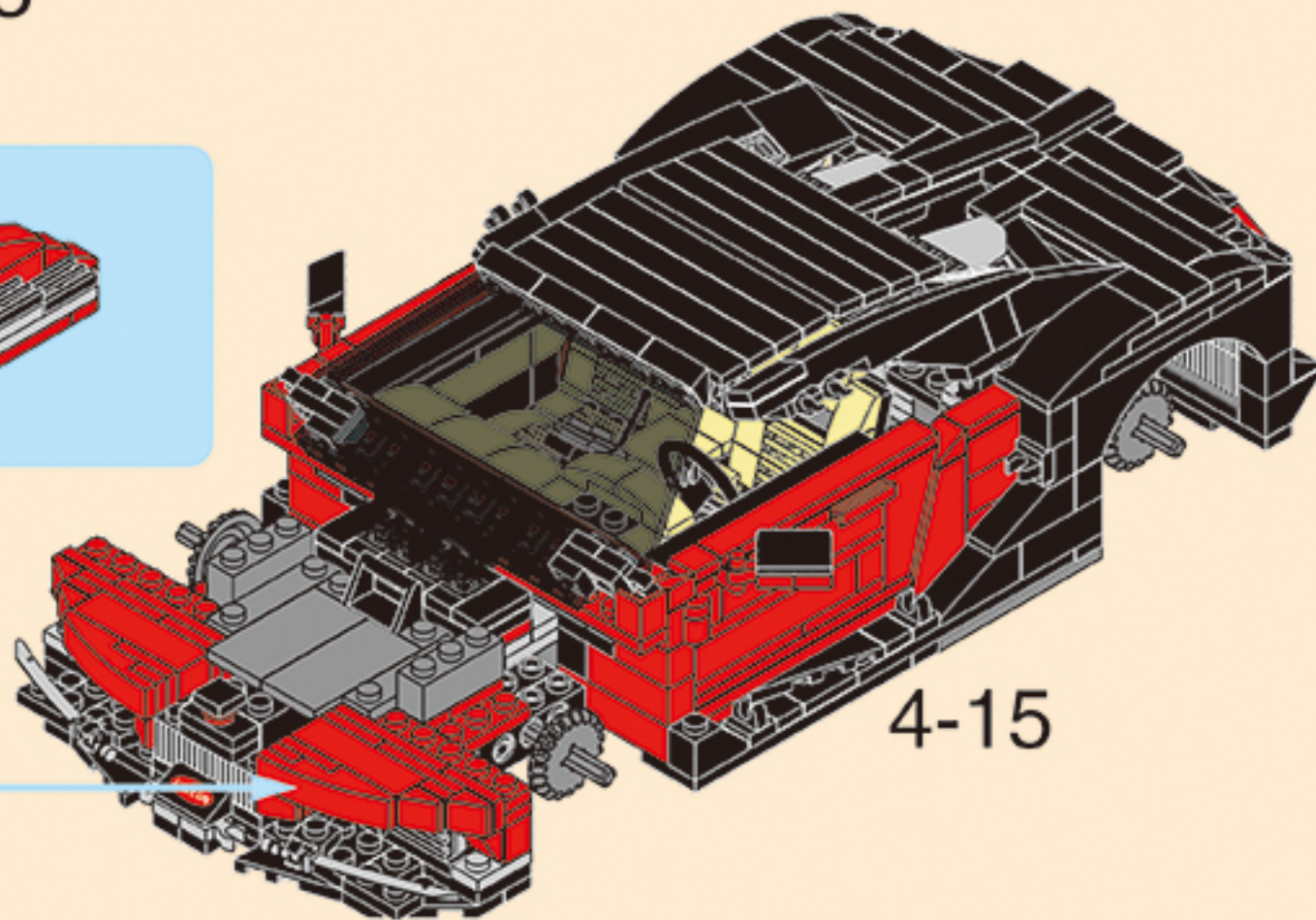
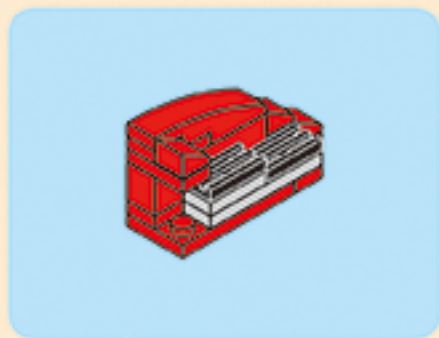



2x



2x



2x

4-16

1



2

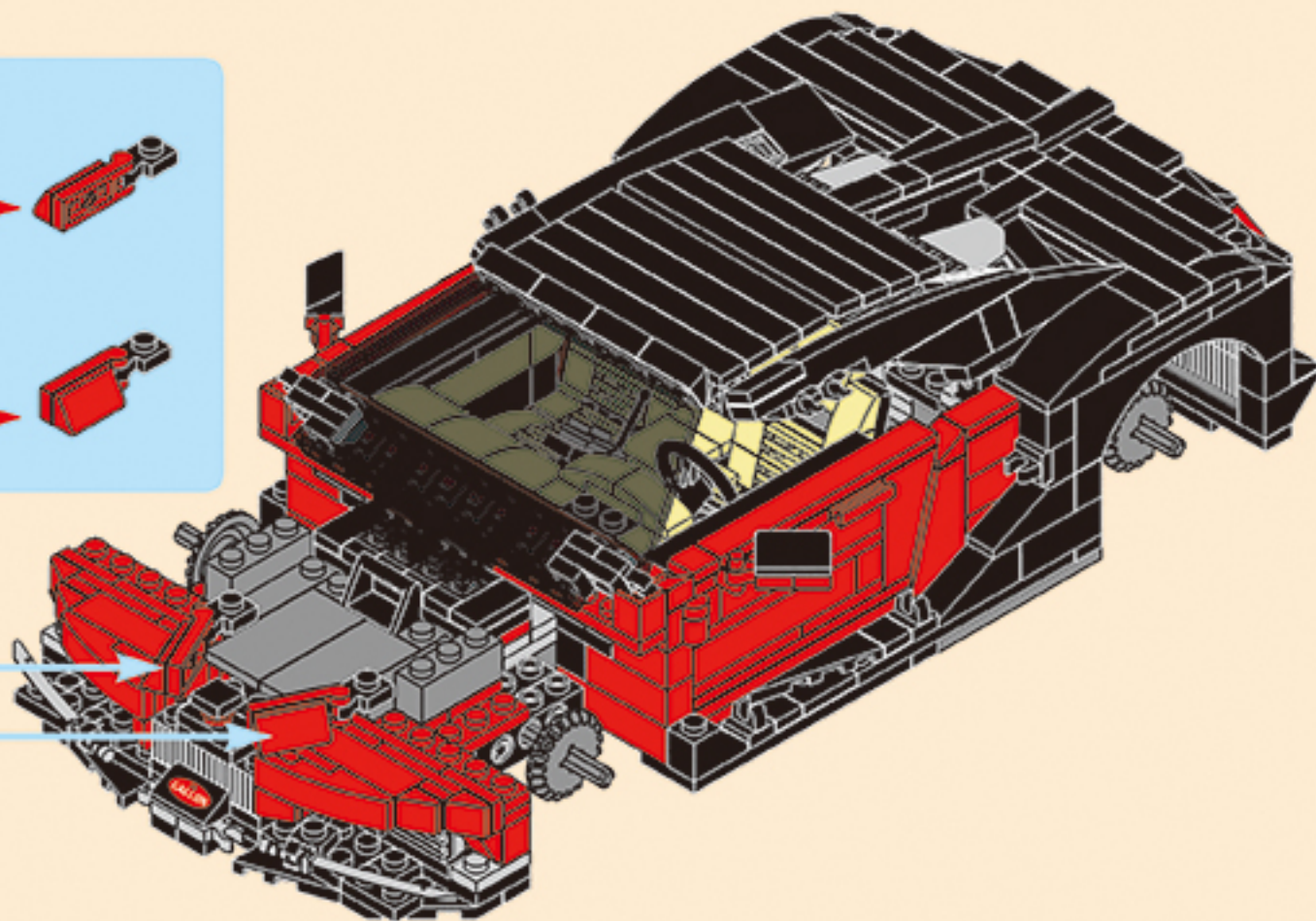

4-17

6x 2x 2x 2x 2x

1

2

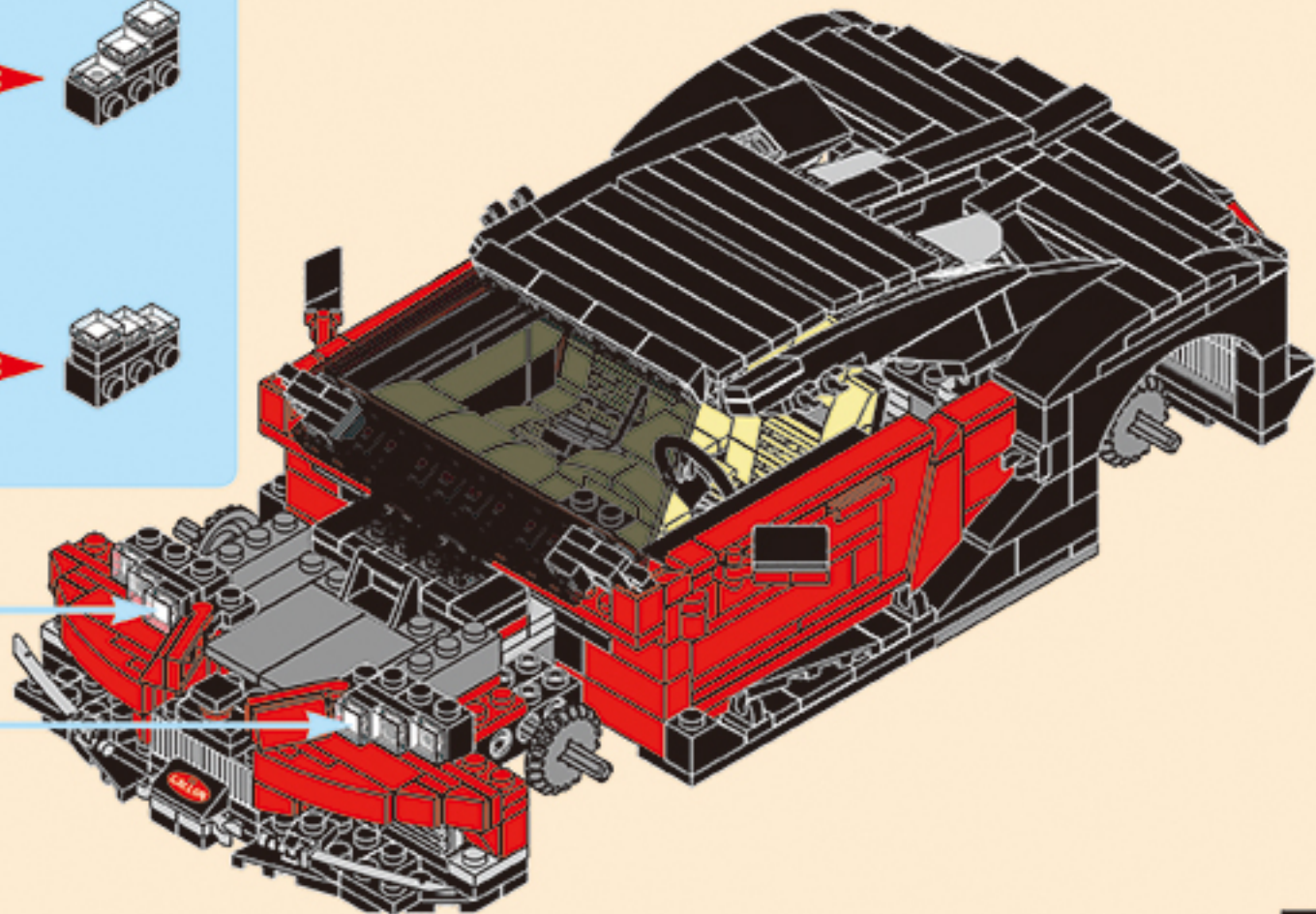



2x



2x



2x



2x

4-18



2x

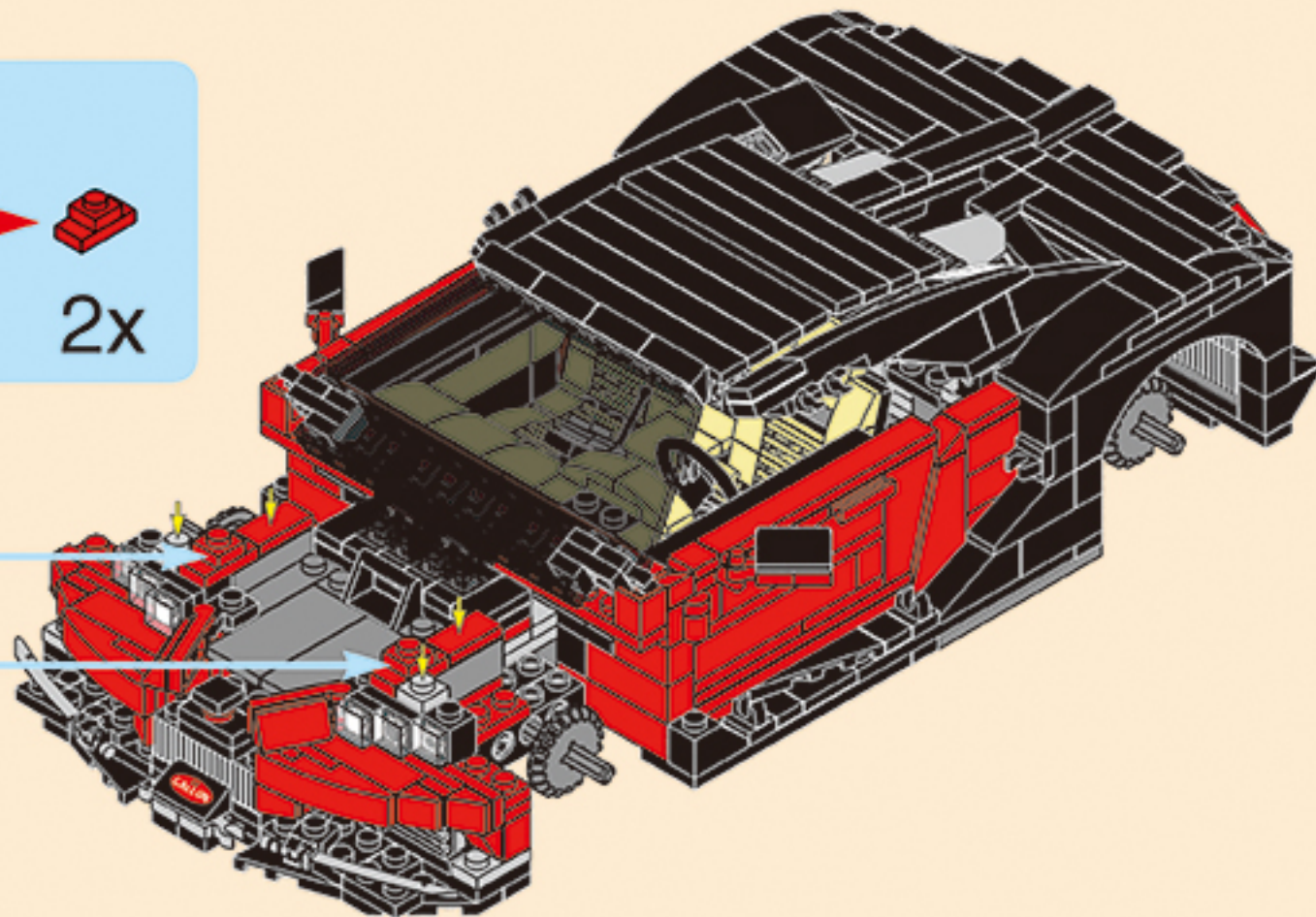



4-19

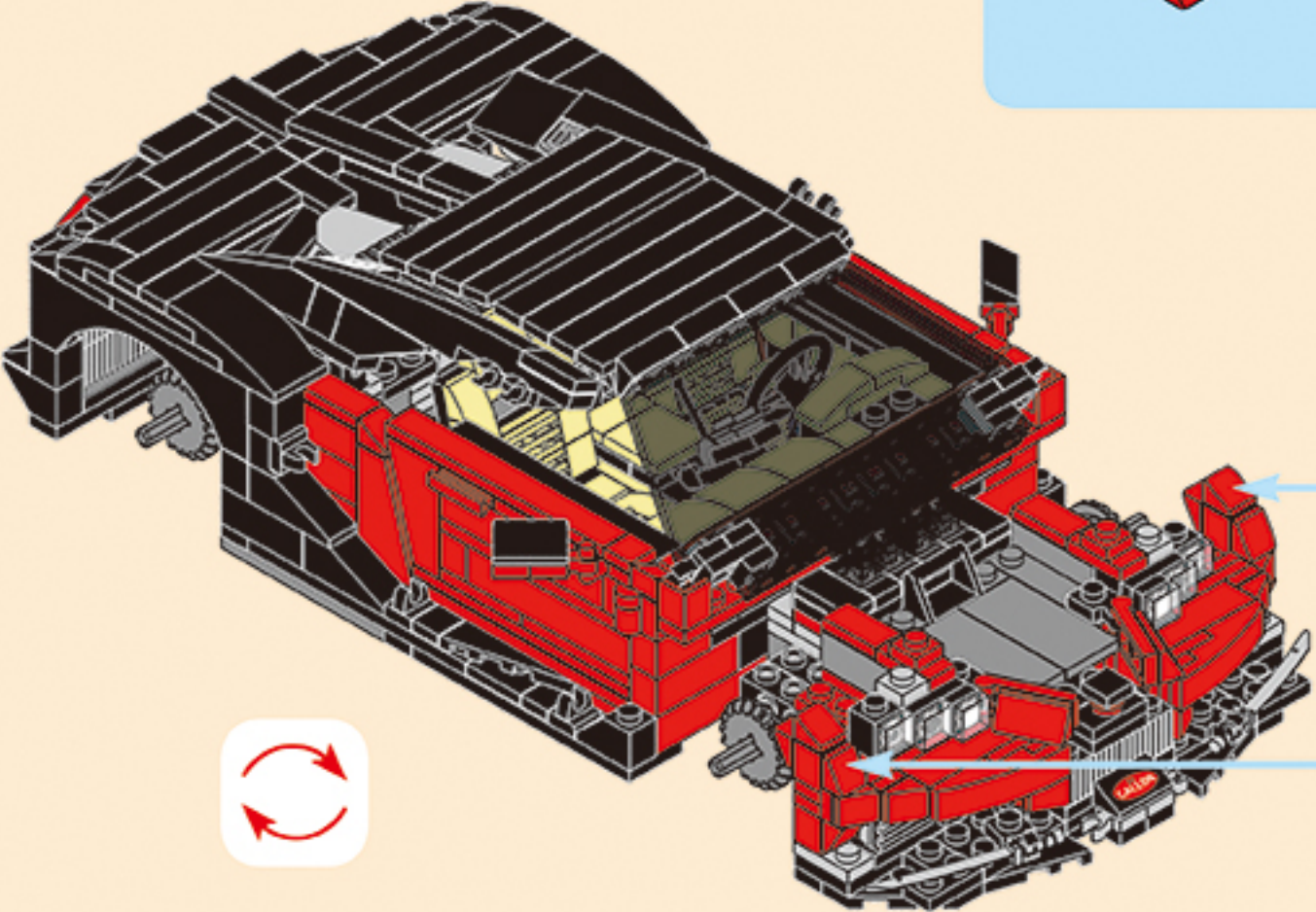
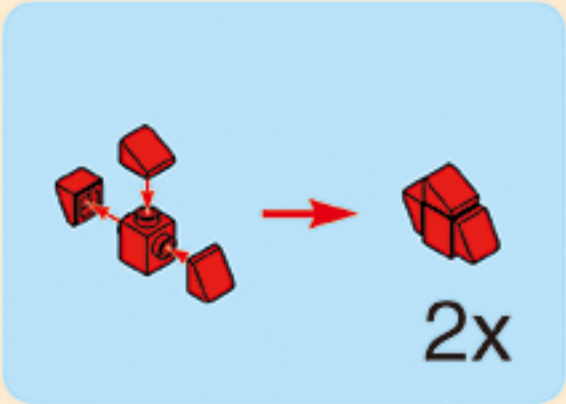



4-20

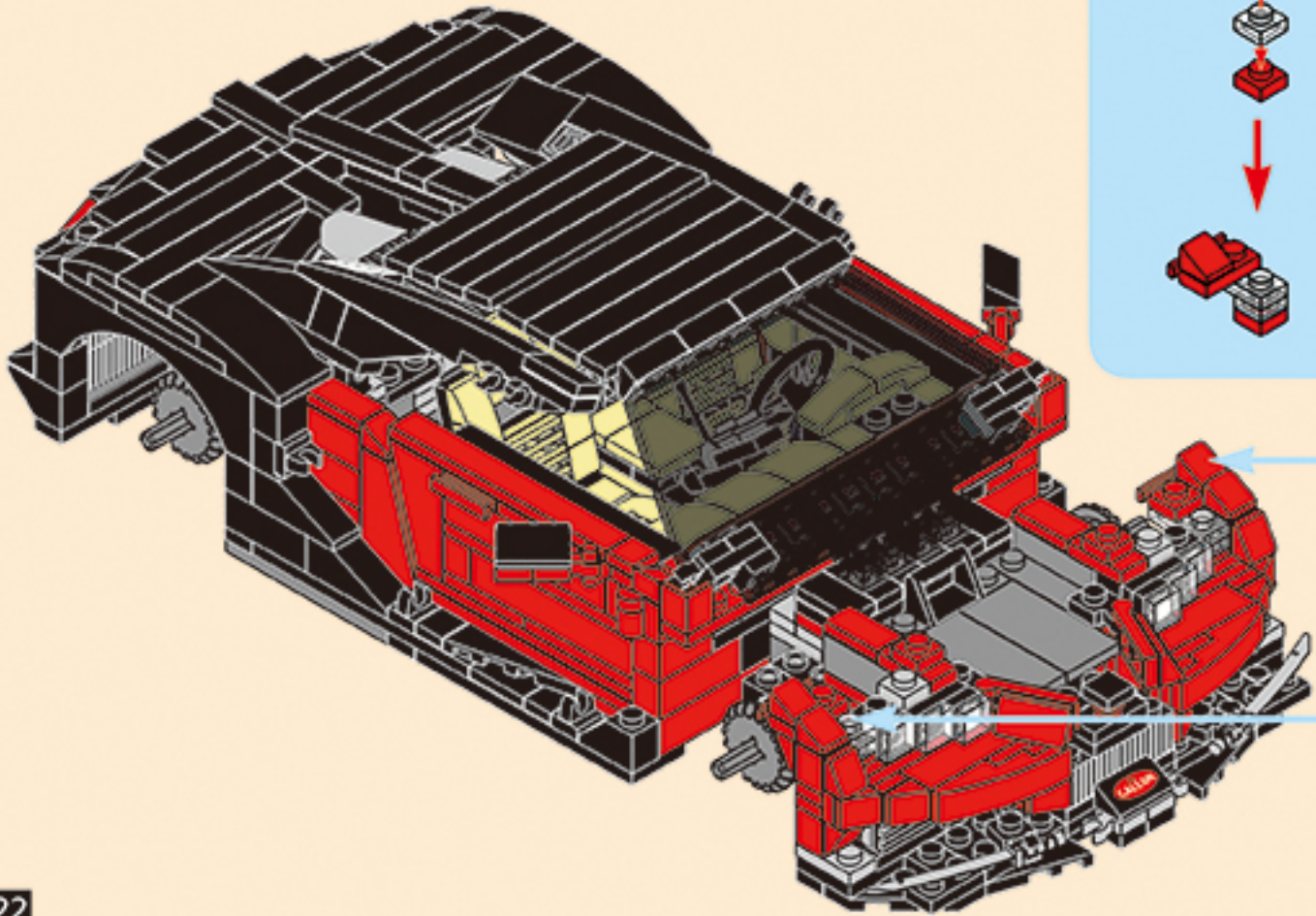
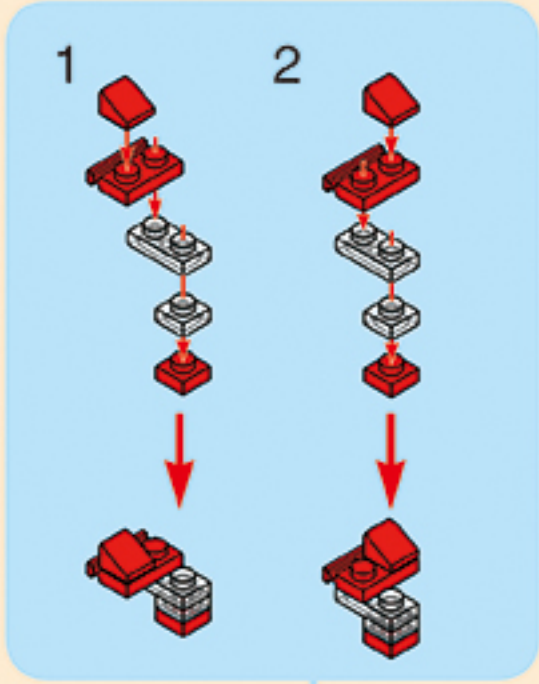

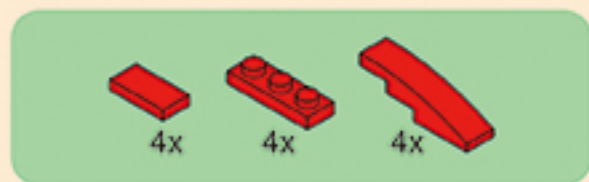

4-21.1

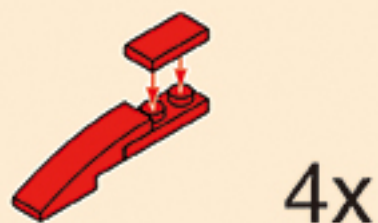

4-21.2



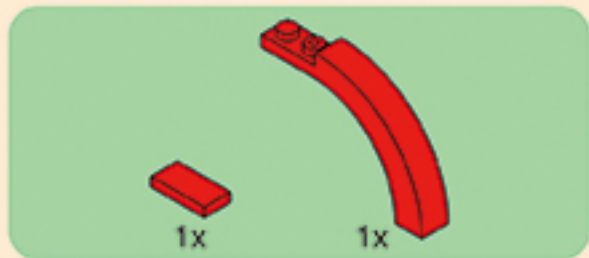

4-21.4

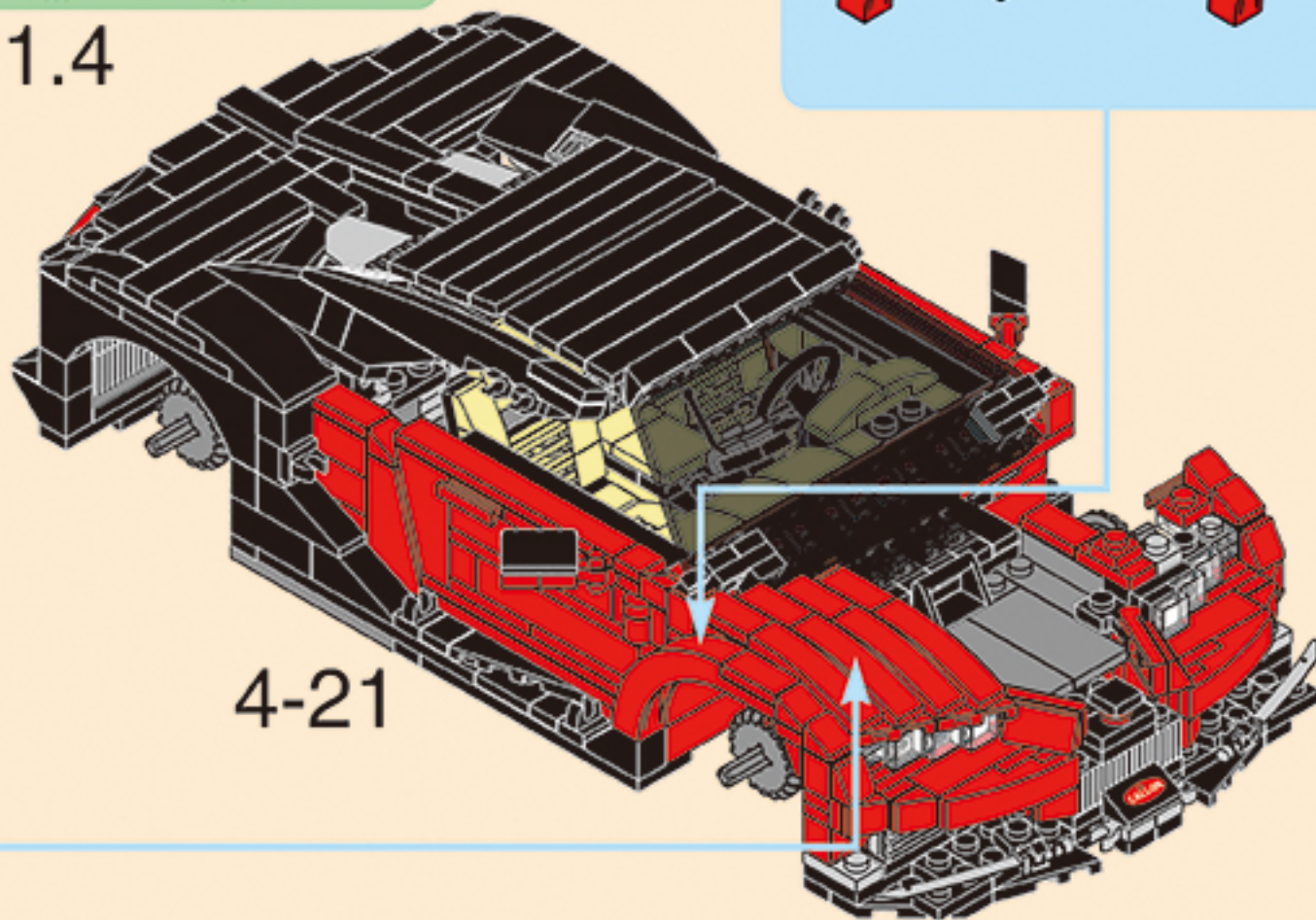
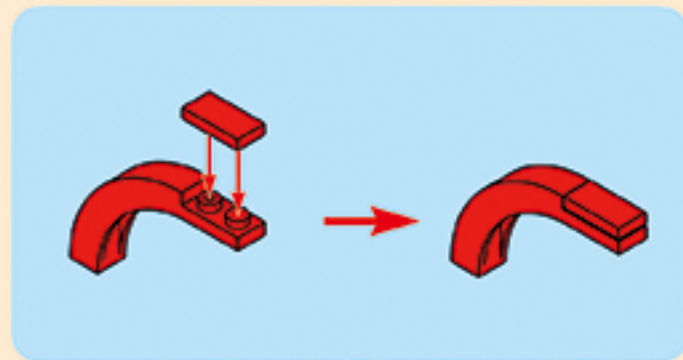

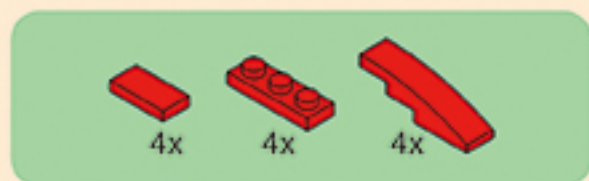

4-22.1



4x



4-22.2

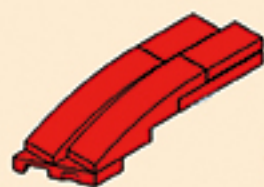

2x



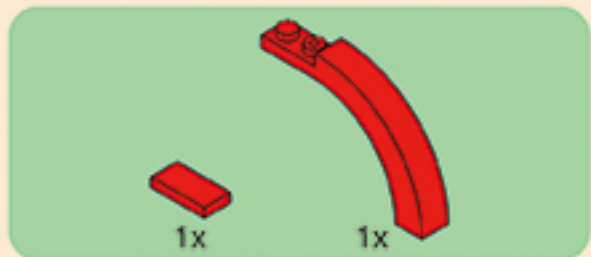

4-22.4

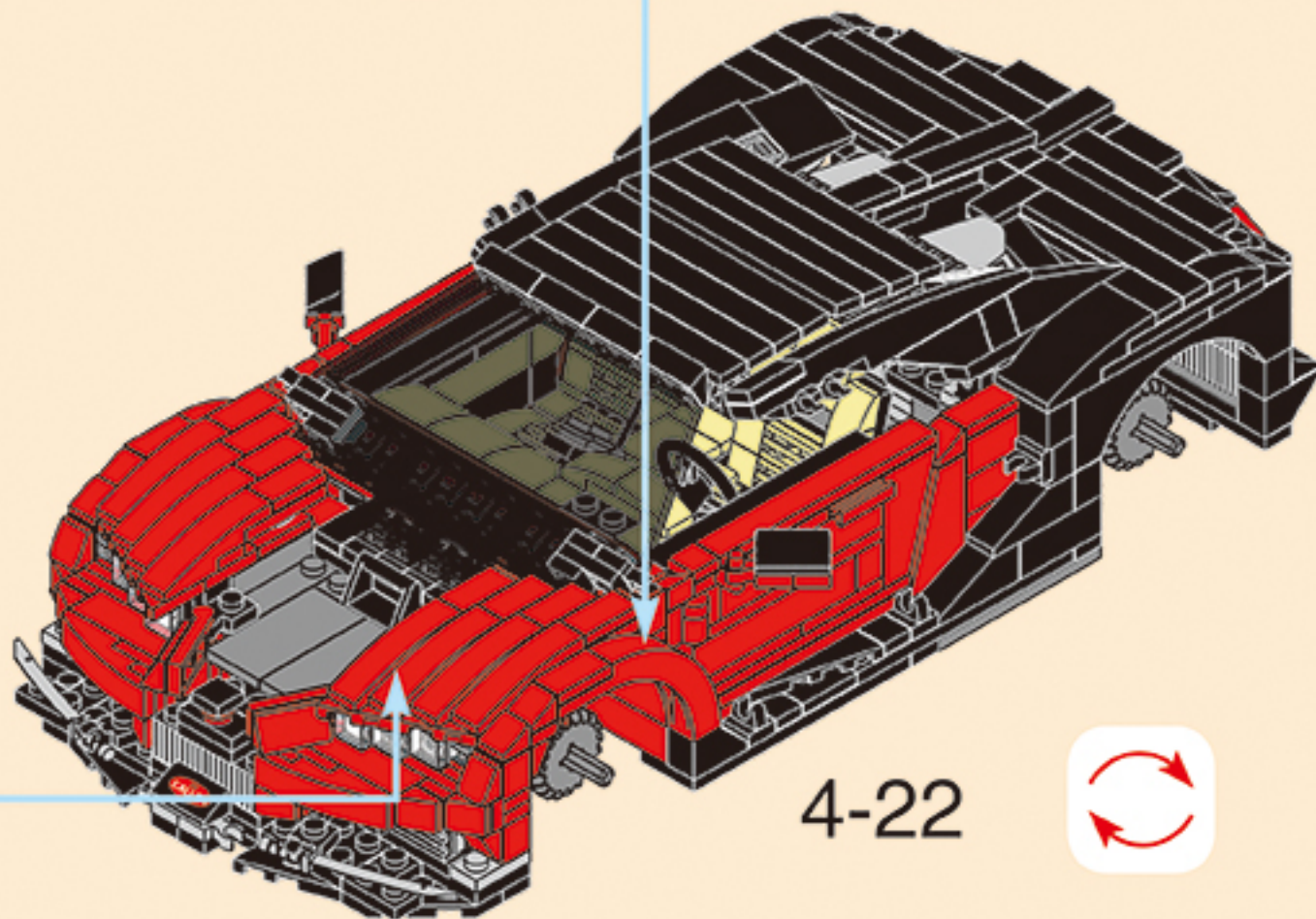
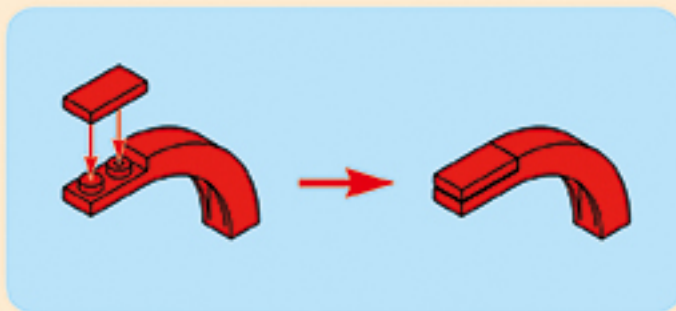

4-22





4-23.1



4-23.2

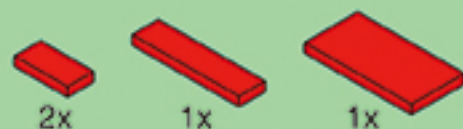
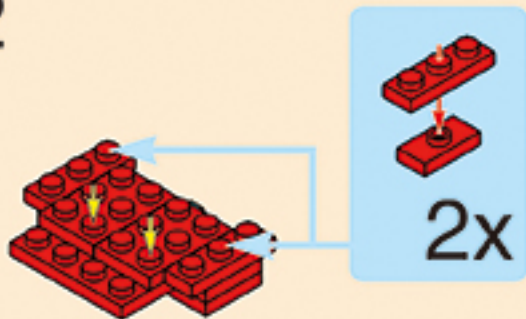

4-23.3

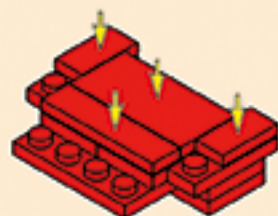

4-23.4

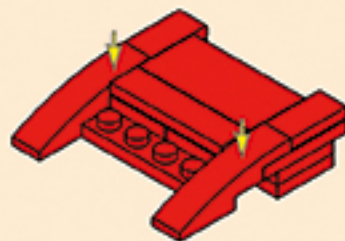



4x

4-23.4

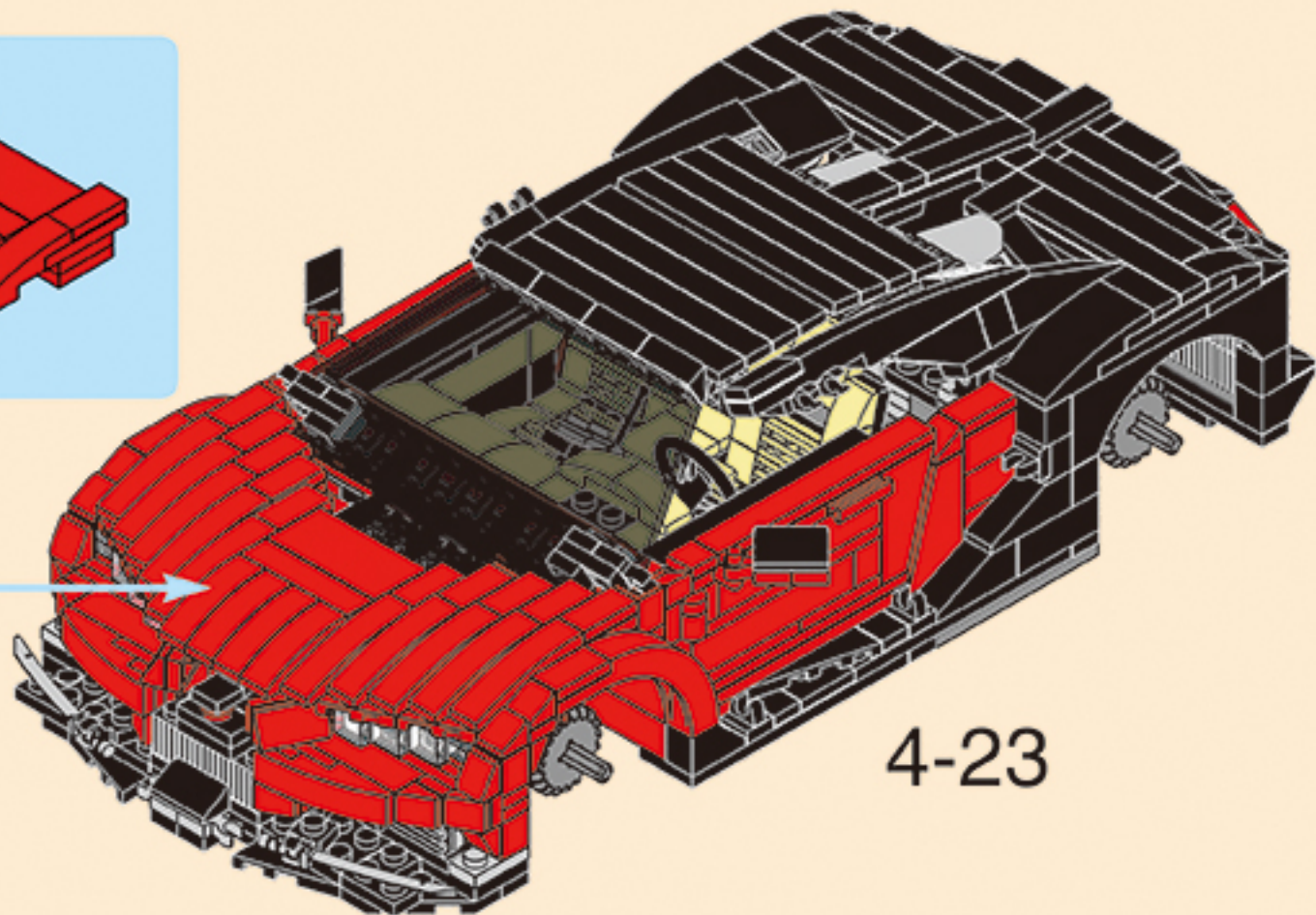
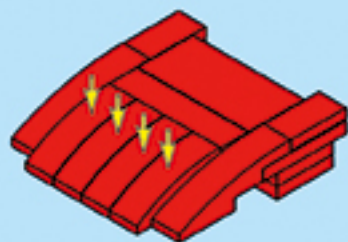

4-23

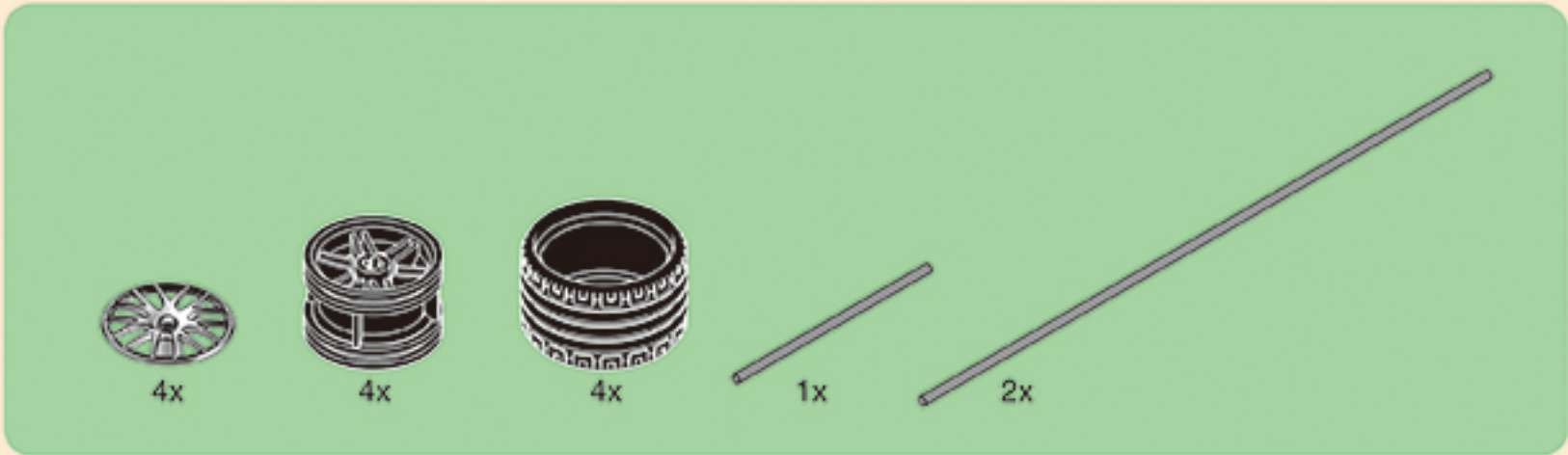

4-24.1

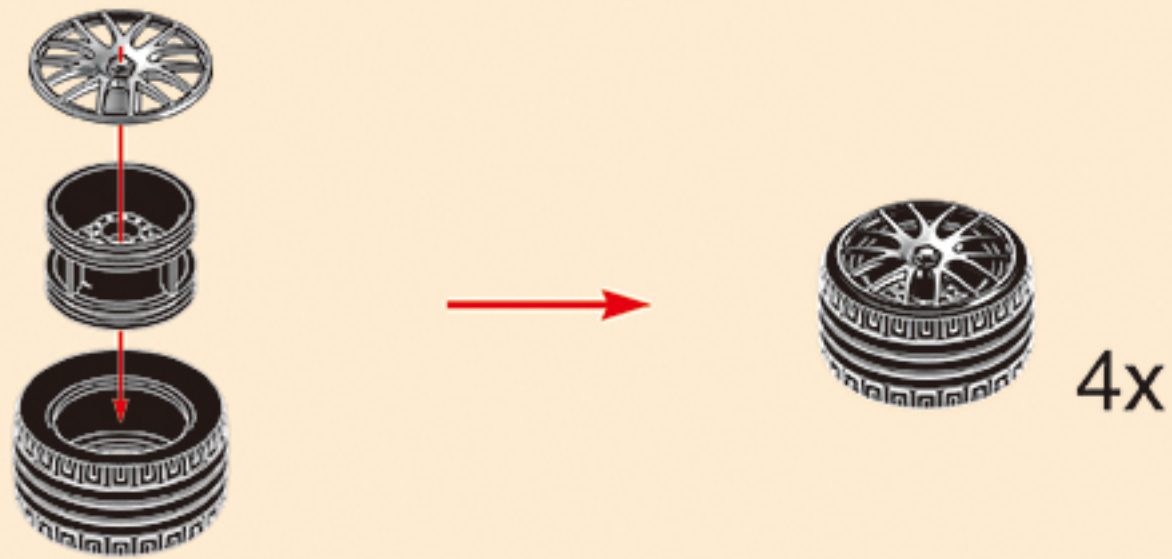

4-24

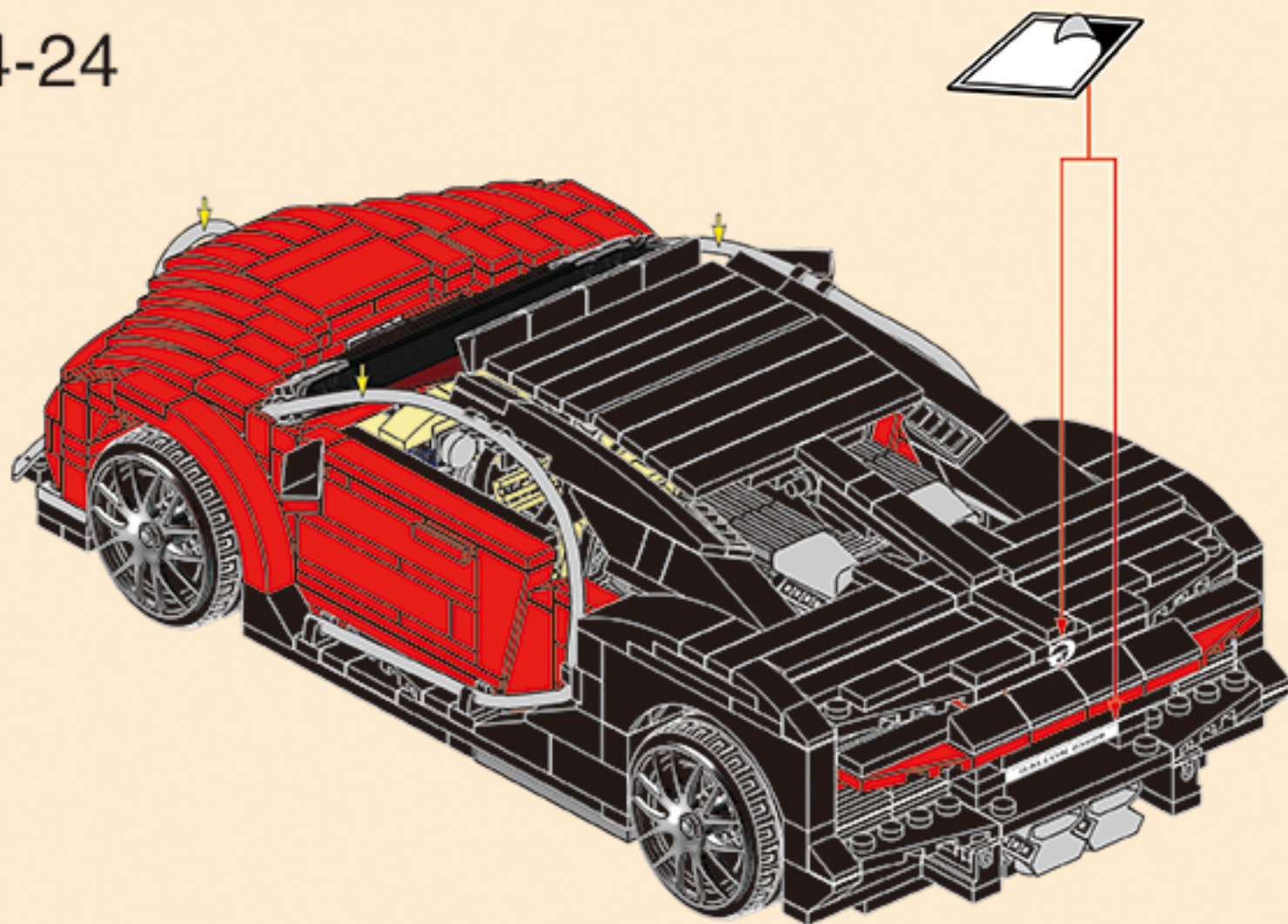

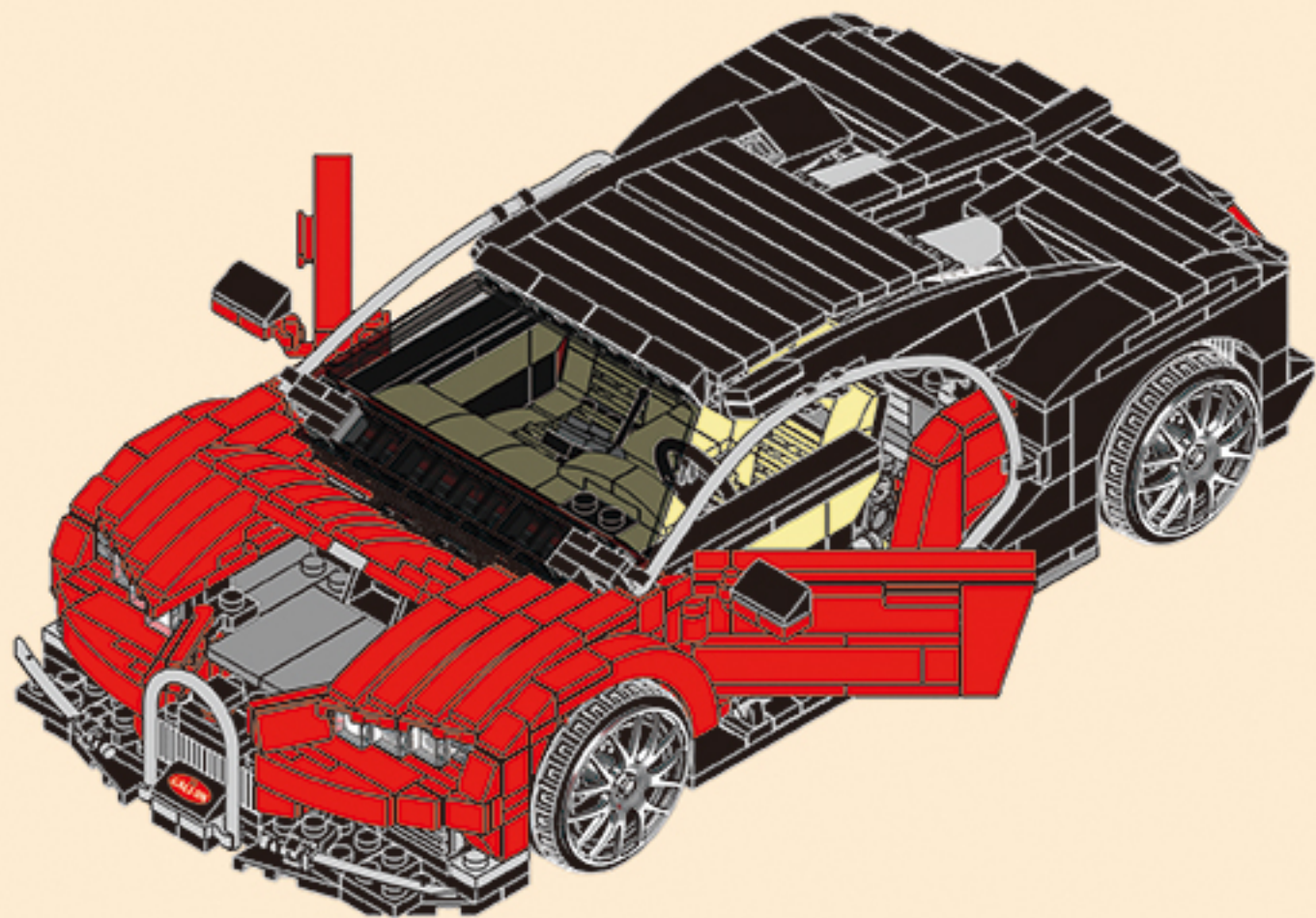

DREAM-CAR

